

XJ.075

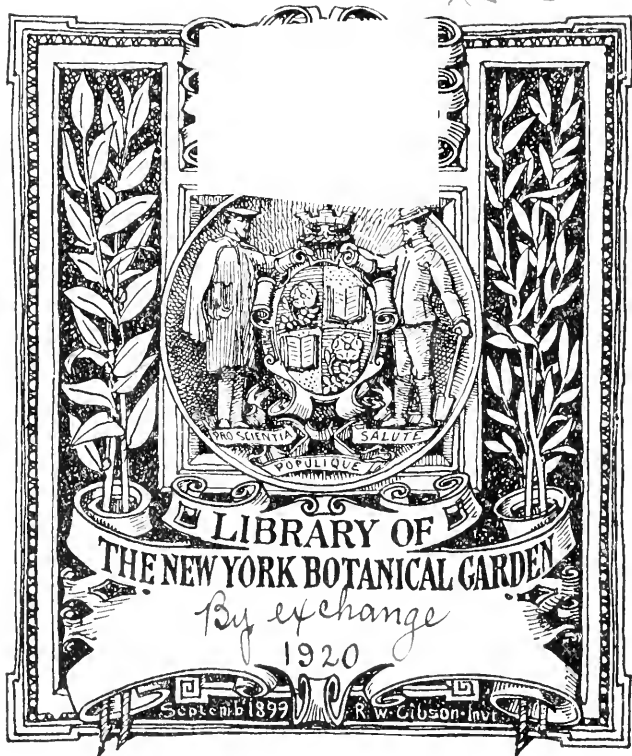

JOURNAL OF AGRICULTURAL RESEARCH

VOLUME XIX

APRIL 1—SEPTEMBER 15, 1920

PUBLISHED BY AUTHORITY OF THE SECRETARY OF AGRICULTURE
WITH THE COOPERATION OF THE ASSOCIATION
OF LAND-GRANT COLLEGES

WASHINGTON, D. C.

XJ
075
V. 19
1920

**EDITORIAL COMMITTEE OF THE
UNITED STATES DEPARTMENT OF AGRICULTURE AND
THE ASSOCIATION OF LAND-GRANT COLLEGES**

FOR THE DEPARTMENT

KARL F. KELLERMAN, CHAIRMAN

*Physiologist and Associate Chief, Bureau
of Plant Industry*

EDWIN W. ALLEN

Chief, Office of Experiment Stations

CHARLES L. MARLATT

*Entomologist and Assistant Chief, Bureau
of Entomology*

FOR THE ASSOCIATION

J. G. LIPMAN

*Dean, State College of Agriculture, and
Director, New Jersey Agricultural Experiment
Station, Rutgers College*

W. A. RILEY

*Entomologist and Chief, Division of Ento-
mology and Economic Zoology, Agricul-
tural Experiment Station of the University
of Minnesota*

R. L. WATTS

*Dean, School of Agriculture, and Director,
Agricultural Experiment Station, The
Pennsylvania State College*

All correspondence regarding articles from the Department of Agriculture should be addressed to Karl F. Kellerman, Journal of Agricultural Research, Washington, D. C.

All correspondence regarding articles from State Experiment Stations should be addressed to J. G. Lipman, New Jersey Agricultural Experiment Station, New Brunswick, N. J.

LIBRARY
NEW YORK
57
16

CONTENTS

	Page
A Teosinte-Maize Hybrid. G. N. COLLINS and J. H. KEMPTON...	1
Banana Root-Borer. G. F. MOZNETTE.....	39
Effect of Calcium Sulphate on the Solubility of Soils. M. M. McCOOL and C. E. MILLAR.....	47
Further Studies on the Influence of Humidity upon the Strength and Elasticity of Wool Fiber. J. I. HARDY.....	55
Composition and Density of the Native Vegetation in the Vicinity of the Northern Great Plains Field Station. J. T. SARVIS.....	63
Effect of Reaction of Solution on Germination of Seed and on Growth of Seedlings. ROBERT M. SALTER and T. C. McILVAINE.....	73
Philippine Downy Mildew of Maize. WILLIAM H. WESTON, JR..	97
Effect of Drugs on Milk and Fat Production. FRANK A. HAYS and MERTON G. THOMAS.....	123
Artificial and Insect Transmission of Sugar-Cane Mosaic. E. W. BRANDES.....	131
Halo-Blight of Oats. CHARLOTTE ELLIOTT.....	139
Influence of Fermentation on the Starch Content of Experimental Silage. ARTHUR W. DOX and LESTER YODER.....	173
Effect of Premature Freezing on Composition of Wheat. M. J. BGLISH.....	181
Behavior of the Citrus-Canker Organism in Soil. H. ATHERTON LEE.....	189
Decline of <i>Pseudomonas citri</i> in the Soil. H. R. FULTON.....	207
Variation of Individual Pigs in Economy of Gain. R. C. ASHBY and A. W. MALCOMSON.....	225
Production of Conidia in <i>Gibberella saubinetii</i> . JAMES G. DICKSON and HELEN JOHANN.....	235
Effect of Manure-Sulphur Composts upon the Availability of the Potassium of Greensand. A. G. McCALL and A. M. SMITH....	239
Rust in Seed Wheat and Its Relation to Seedling Infection. CHARLES W. HUNGERFORD.....	257
Practical Universality of Field Heterogeneity as a Factor Influencing Plot Yields. J. ARTHUR HARRIS.....	279
Transmission of the Mosaic Disease of Irish Potatoes. E. S. SCHULTZ and DONALD FOLSOM.....	315
Relative Susceptibility to Citrus-Canker of Different Species and Hybrids of the Genus <i>Citrus</i> , Including the Wild Relatives. GEORGE L. PELTIER and WILLIAM J. FREDERICH.....	339

	Page
Presoak Method of Seed Treatment: A Means of Preventing Seed Injury Due to Chemical Disinfectants and of Increasing Germicidal Efficiency. HARRY BRAUN	363
Daily Development of Kernels of Hannchen Barley from Flowering to Maturity at Aberdeen, Idaho. HARRY V. HARLAN	393
Development of Barley Kernels in Normal and Clipped Spikes and the Limitations of Awnless and Hooded Varieties. HARRY V. HARLAN and STEPHEN ANTHONY	431
Investigations in the Ripening and Storage of Bartlett Pears. J. R. MAGNESS	473
Further Data on the Orange Rusts of Rubus. L. O. KUNKEL	501
Germ-Free Filtrates as Antigens in the Complement-Fixation Test. WILLIAM S. GOCHENOUR	513
Mosaic Disease of Corn. E. W. BRANDES	517
Genetics of Rust Resistance in Crosses of Varieties of Triticum vulgare with Varieties of T. durum and T. dicoccum. H. K. HAYES, JOHN H. PARKER, and CARL KURTZWEIL	523
Line-Selection Work with Potatoes. O. B. WHIPPLE	543
Occurrence of the Fixed Intermediate, Hordeum intermedium haxtoni, in Crosses between H. vulgare pallidum and H. distichon palmella. HARRY V. HARLAN and H. K. HAYES	575
Index	593

ERRATA AND AUTHORS' EMENDATIONS

Page 97, line 20, "were" should read "would be."

Page 110, Table I, column 1, line 13, "24" should read "23."

Page 136, line 2, "*Pseudococcus boninensis*" should read "*Pseudococcus boninsis*."

Page 202, following line 16, add "*C. trifoliata* seedlings, however, on testing are readily susceptible to the disease."

Page 232, Table XVI, footnote, " $r = -0.452 \pm 0.068$ " should read " $r = -0.166 \pm 0.083$."

Page 236, line 1, "The spores, both conidia and ascospores, behaved alike in germination" should read "The conidia from both conidia and ascospores behaved alike in germination."

Page 242, line 22, " $Al_2(SO_4)_3 \cdot 0.18 H_2O$ " should read " $Al_2(SO_4)_3 \cdot 18 H_2O$ " and " $FeSO_4 \cdot 0.7 H_2O$ " should read " $FeSO_4 \cdot 7 H_2O$." The same correction should be made in Tables III, IV, V, and VII.

Page 278, Plate 47 and legend. "Internal hilar sorus shown at x" should be omitted. The marking x is incorrectly placed on the plate. There are two internal hilar sori shown in the lower right-hand portion of the plate.

Page 362, legend for Plate 59, line 10, "Infected leaves from twigs" should read "Infected leaves and twigs."

ILLUSTRATIONS

A TEOSINTE-MAIZE HYBRID

Text Figures

	Page
1. Height: frequency distribution of plants in F_2	13
2. Total leaves: frequency distribution of plants in F_2	13
3. Height of sucker: frequency distribution of plants in F_2	14
4. Sucker index: frequency distribution of plants in F_2	14
5. Circumference index: frequency distribution of plants in F_2	16
6. Nodes without branches: frequency distribution of plants in F_2	15
7. Nodes above: frequency distribution of plants in F_2	17
8. Nodes above on third: frequency distribution of plants in F_2	18
9. Nodes on third: frequency distribution of plants in F_2	18
10. Primary branches: frequency distribution of plants in F_2	19
11. Secondary branches: frequency distribution of plants in F_2	19
12. Secondary index: frequency distribution of plants in F_2	20
13. Tassel branches on third: frequency distribution of plants in F_2	20
14. Male branch index: frequency distribution of plants in F_2	21
15. Male secondaries: frequency distribution of plants in F_2	22
16. Double male alicoles: frequency distribution of plants in F_2	23
17. Mixed alicoles: frequency distribution of plants in F_2	23
18. Single female alicoles: frequency distribution of plants in F_2	24
19. Double female alicoles: frequency distribution of plants in F_2	24
20. Alicole index: frequency distribution of plants in F_2	25
21. Nodes silking on third: frequency distribution of plants in F_2	25
22. Nodes silking index: frequency distribution of plants in F_2	26
23. Prophyllary spikes: frequency distribution of plants in F_2	26
24. Length of prophyllary: frequency distribution of plants in F_2	27
25. Rows in central spike: frequency distribution of plants in F_2	27
26. Rows of alicoles: frequency distribution of plants in F_2	28
27. Position of best spike: frequency distribution of plants in F_2	29
28. Number of alicoles: frequency distribution of plants in F_2	29
29. Number of suckers: frequency distribution of plants in F_2	30
30. Branch silking first: frequency distribution of plants in F_2	31
31. Days to pollen: frequency distribution of plants in F_2	31
32. Pollen to silk: frequency distribution of plants in F_2	32
33. Length of internode on third: frequency distribution of plants in F_2	32

Plates

1. A.—General view of F_2 plants of teosinte-maize hybrid. B.— F_2 plants of teosinte-maize hybrid, showing diversity in size and season.....	38
2. Teosinte-maize hybrid: A.— F_2 plant No. 36. B.— F_2 plant No. 49.....	38
3. Teosinte-maize hybrid: Pistillate inflorescence of F_2 plant No. 36, shown in Plate 2, A.....	38
4. Pistillate inflorescence of plant No. 49, shown in Plate 2, B.....	38
5. Pistillate inflorescences from plant No. 94, illustrating an intermediate type of inflorescence.....	38

	Page
6. Teosinte-maize hybrid: A.—F ₂ plant No. 31, showing compact growth characteristic of many of the plants. B.—F ₂ plant No. 113, showing stiff, erect leaves. C.—F ₁ plant, grown at Lanham, Md.	38
7. Teosinte-maize hybrid: Pistillate inflorescences of the F ₁ plant shown in plant 6, C.	38

BANANA ROOT-BORER

Text Figure

1. <i>Cosmopolites sordidus</i> : Section of sheath with egg <i>in situ</i> in compartment.	44
--	----

Plates

8. Banana root-borer (<i>Cosmopolites sordidus</i>): Adult.	46
9. Egg and larva of banana root-borer: A.—Egg. B.—Larva, side view. C.—Head of larva, dorsal view. D.—Head of larva, face view. E.—Head of larva, side view. F.—Dorsal view of seventh, eighth, and ninth abdominal segments. G.—Posterior view of segments 7 to 10.	46
10. Pupa and adult of banana root-borer: A.—Ventral view of pupa. B.—Lateral view of head and thorax of pupa. C.—Dorsal view of pupa.	46
11. A.—Young, healthy banana plant bulb with lateral roots. B.—Young banana plant cut into, showing work of the larvæ of the banana root-borer.	46

FURTHER STUDIES ON THE INFLUENCE OF HUMIDITY UPON THE STRENGTH AND ELASTICITY OF WOOL FIBER

Text Figures

1. Graphs showing the effect of humidity upon the breaking strength of wool fiber.	56
2. Graphs showing the effect of humidity upon the elasticity of wool fiber.	57
3. Graphs showing the relation between the diameter and the tensile strength of wool fiber.	60
4. Graphs showing the effect of humidity upon the breaking strength and elasticity of wool fiber.	62

COMPOSITION AND DENSITY OF THE NATIVE VEGETATION IN THE VICINITY OF THE NORTHERN GREAT PLAINS FIELD STATION

Text Figures

1. Diagram of grass mat: A, from side; B, from above. <i>a</i> , Basal cover; <i>b</i> , foliage cover.	68
2. Meter quadrat in 30-acre pasture mapped in detail in 1915.	69

Plates

12. General view of native vegetation near Mandan, N. Dak., showing composition and density.	72
13. A.—View across area of <i>Andropogon furcatus</i> . B.—Close view of <i>Aristida longiseta</i> bunches.	72
14. A.—Close view, from above, of meter quadrat in 30-acre pasture. B.—Meter quadrat in 30-acre pasture.	72

EFFECT OF REACTION OF SOLUTION ON GERMINATION OF SEEDS AND ON GROWTH OF SEEDLINGS

Text Figures

	Page
1. A, graph showing the relation of reaction to the contents of $H_3C_6H_5O_7$ and NaOH employed in the cultures of series A; B, graph showing the change of reaction found after 4 days' growth of wheat seedlings in series A...	76
2. A, graph showing the change in reaction obtained by electrometric titration in series B; B, graph showing the change of reaction found after 4 days' growth of wheat seedlings in cultures of series B.....	77
3. Graph showing the relation of growth of wheat seedlings to reaction in series A.....	79
4. Graphs showing the relation of growth of wheat, soybean, corn, and alfalfa seedlings to reaction in series B.....	81
5. Graphs showing the relative weights of sprouts produced by seeds of wheat, corn, soybeans, alfalfa, and red clover in 7-day germination period at various reactions.....	89

Plate

15. A.—Method of growing wheat seedlings. B.—Appearance of wheat seedlings in series A at time of harvesting. C.—Appearance of wheat seedlings in series B at time of harvesting.....	96
---	----

PHILIPPINE DOWNY MILDEW OF MAIZE

Text Figures

1. Graph showing variation in length of conidia of <i>Sclerospora philippinensis</i> ..	111
2. Graph showing variation in diameter of conidia of <i>Sclerospora philippinensis</i> ..	111
3. Diagram showing ratios of length to width of conidia of <i>Sclerospora philippinensis</i> , arranged in classes and indicating limits of variation and mode..	111

Plates

A. Young maize plant, showing the effects of a very early attack of the downy mildew on a small, early maturing variety, Manobo Yellow.....	122
B. Young maize plants, showing the effects of later attack of the downy mildew on a large, late-maturing variety, Guam White Dent.....	122
16. A.—Portion of a field of Moro White maize, showing heavy loss from the downy mildew. B.—View near the edge of a field of Guam White Dent maize, showing the ravages of the downy mildew.....	122
17. A.—A frequently encountered type of downy mildew effect. B.—A serious case of downy mildew injury, one of hundreds in a badly attacked maize field.....	122
18. A.—A common result of downy mildew attack. B.—A maize plant seriously injured by the downy mildew stands in front. C.—One hill in a maize plot which lost heavily from attacks by the downy mildew.....	122
19. A.—A case of abnormal growth of a maize plant as the result of an attack by downy mildew. B.—A maize plant which, when nearly mature, became infected by the downy mildew through a small sucker previously developed.....	122
20. A.—A deformed and partly sterile ear complex produced by a maize plant as a result of downy mildew infection. B.—A maize ear developed abnormally as a result of the downy mildew. C.—Ear of a maize plant infected by the downy mildew.....	122

	Page
21. A.—A near view of the thick down of conidiophores which has been produced on the upper surface of a badly diseased maize leaf. B.—Upper surface of a badly infected maize leaf from a maturing plant. C.—Upper surface of the middle portion of a maize leaf from a very young plant which has only recently developed the markings of the disease.	122
22. A.—View of a row of Egyptian sorghum showing tall, green, healthy plants at the left and at the right a dwarfed, yellowish white plant which is infected by the downy mildew. B.—Near view of this diseased sorghum plant. C.—A comparative view of healthy teosinte (right), and teosinte seriously infected with the downy mildew (left).	122
23. A.—Portion of the typical crooked, irregular mycelium with numerous haustoria which is found in the mesophyll of badly infected leaves, here freed from the host tissue by maceration. B.—Longitudinal section cut from the center of a maize stem 8 inches from the ground. C.—Portion of the mycelium freed by maceration from tissue of the midrib at the base of a badly infected leaf. D.—Hypha cut in cross section as it lies between three adjacent mesophyll cells of the host. E.—Transverse section from a badly infected portion of a maize leaf, showing the abundant mycelium running between the cells of the bundle sheath and forming in the substomatal air chamber the branches (a) that grow out through the stoma to form the conidiophores. F.—Portion of a hypha lying between adjacent mesophyll cells, one of which has formed a many-layered wall around the haustorium invading it. G.—Portion of a hypha similar to that shown in F but with the haustorium unhindered in its invasion of the host cell. H.—Bit of mycelium such as is shown in A but more highly magnified to show the haustoria.	122
24. A.—Slender, sparingly branched conidiophore bearing comparatively few conidia. B.—Tip of branch with two conidia <i>in situ</i> . C.—Stout, much-branched, mature conidiophore bearing 38 spores. D.—Upper portion of a nearly mature conidiophore with one secondary branch which has failed to branch further and has terminated in a single conidium only. E.—Small, stunted, sparingly branched conidiophore produced on maize during the light dew of the hot, dry season. F.—Basal cell with two thick crosswalls; from maize. G.—An unusual basal cell with two septa and an abnormally large footlike base. H, J, L.—Typical basal cells of conidiophores. I.—Upper portion of an underdeveloped conidiophore bearing three spores on sterigmata arising directly from the top of the main axis. K.—Tip of an ultimate branch with two sterigmata-bearing conidia. M.—Basal cell of a conidiophore from teosinte with septum formation progressing by the centripetal extension of a cellulose-pectose ring.	122
25. A.—Conidiophore from sorghum, partly matured and bearing few conidia. B.—Conidiophore from teosinte, nearly mature, with extensive system of branches bearing many conidia. C.—Typical conidia from sorghum. D.—Typical conidia from teosinte. E.—Typical conidia from teosinte which have germinated in dew on the leaf surface. F.—Conidium from teosinte germinating by an extensive branched hypha when maintained in dew at 7° C. G.—Conidium from teosinte germinating while still attached to its sterigma. H.—Typical conidia from maize, showing common variations in shape and size. I.—Two conidia from maize just beginning to germinate in rain water. J.—Two conidia from maize germinating in sterilized brook water maintained at 8° C. K.—Coni-	

	Page
dium from maize germinating in dew on the leaf surface. L.—Conidium from maize giving rise to extensive branching hyphae in a dilute decoction of young maize kernels.	122

EFFECT OF DRUGS ON MILK AND FAT PRODUCTION

Text Figures

1. Graph showing effect of tonic mixture No. 1 on butter-fat and milk yield.	127
2. Graph showing effect of air-slaked lime on butter-fat and milk yield.	127
3. Graph showing effect of Fowler's solution of arsenic on butter-fat and milk yield.	128
4. Graph showing effect of powdered gentian on butter-fat and milk yield.	128
5. Graph showing effect of the German tonic mixture on butter-fat and milk yield.	129
6. Graph showing effect of physostigmine sulphate on butter-fat and milk yield.	129
7. Graph showing effect of sodium bicarbonate on butter-fat and milk yield.	130
8. Graph showing effect of ginger on butter-fat and milk yield.	130

HALO-BLIGHT OF OATS

Plates

C. Halo lesions on flag leaves of Wisconsin No. 14 oats.	172
26. Typical isolated halo lesions.	172
27. Halo lesions on Wisconsin No. 14 oats produced by spraying with a water suspension of the stock organism May 26, 1917.	172
28. Infection from untreated 1916 seed of Wisconsin No. 124 oats.	172
29. Spikelets of Wisconsin No. 14 oats: A.—Left and center spikelets show natural infection with halo-blight. B.—Upper spikelet shows typical isolated halo lesion near base.	172
30. A.—Two per cent +5 glucose Difco peptone-beef bouillon agar slant of No. 36. B.—Two per cent potato-dextrose agar slants.	172
31. A.—Three-day colony of stock on 2 per cent dextrose-potato agar. B.—Two-day colonies of stock on +10 beef-peptone agar. C.—Five-day colony of stock on potato-dextrose agar. D.—Five-day colony of No. 36 on +10 beef-peptone agar. E.—Three-day colony on 2 per cent glucose Difco peptone beef bouillon agar. F.—Seven-day colony of stock on +15 beef-peptone agar. G.—Margin of 3-day colony of stock on +15 gelatin.	172
32. A.—Five-day colonies of stock on potato-dextrose agar. B.—Three-day colony of stock on potato-dextrose agar.	172
33. Isolations from sections of halo lesion.	172
34. A.—No. 36 from 24-hour potato-dextrose agar slant; carbol fuchsin stain. B. Stock from 24-hour potato-dextrose agar; Ribbert's capsule stain. C.—Stock from 4-day potato-dextrose agar; carbol fuchsin stain, showing long chains. D.—Stock from 3-day potato-dextrose agar; Ribbert's capsule stain. E.—Stock from 1-day +15 beef-peptone agar; Van Ermengem stain. F.—No. 36 from 1-day +5 beef-peptone agar; Caesar-Gil stain.	172
35. Sections of oat leaves through halo lesions, showing bacteria in the tissues.	172

BEHAVIOR OF THE CITRUS-CANKER ORGANISM IN THE SOIL

Plates

36. A.—Citrus-cankers on mature wood of trunk of <i>Citrus aurantifolia</i> . B.—Citrus-cankers on mature wood of branches of <i>Citrus aurantifolia</i>	206
--	-----

	Page
37. A.—Results of inoculations with <i>Pseudomonas citri</i> upon roots of sweet orange (<i>Citrus sinensis</i>). B.—Skeletonized leaves of Ellen grapefruit recovered from buried soil.....	206

PRODUCTION OF CONIDIA IN *GIBBERELLA SAUBINETII*

Text Figure

- | | |
|--|-----|
| 1. Conidial production in <i>Gibberella saubinetii</i> (Mont.) Sacc.: A, Ascospores from cornstalk, germinated in distilled water, producing conidia in three days; B, D, typical conidia and conidiophore from a 28-hour-old hanging drop culture from a conidium from A; C, germinating conidia from a 52-hour-old plate culture; E, conidiophore and germinating conidia from a 47-hour-old colony in a Van Tiegham cell..... | 236 |
|--|-----|

EFFECT OF MANURE-SULPHUR COMPOSTS UPON THE AVAILABILITY OF THE POTASSIUM OF GREENSAND

Text Figure

- | | |
|---|-----|
| 1. Diagrams showing relation of the water-soluble acidity to the water-soluble potassium at different time periods for different greensand composts.... | 250 |
|---|-----|

RUST IN SEED WHEAT AND ITS RELATION TO SEEDLING INFECTION

Text Figure

- | | |
|--|-----|
| 1. Diagram of air-washing apparatus for isolated room used for growing rust-infected seed..... | 268 |
|--|-----|

Plates

38. Heads of Kubanka durum wheat heavily infected with stemrust.....	277
39. A.—Portion of one of the heads shown in Plate 38. B.—Wheat kernels showing typical stemrust infection.....	278
40. Exterior view of isolated room in the pathological greenhouse at the University of Wisconsin, showing (a) the exterior portion of air-washing apparatus used to wash all air drawn into the room, (b) the canvas curtain used for shading on warm days, and (c) the sprinkling attachment used to throw spray of water over the roof to aid in keeping the room cool.....	278
41. A.—Photograph of wheat grown in flats in isolated room in greenhouse at the University of Wisconsin. B.—Same plants as A, when well headed....	278
42. Longitudinal section through hilar portion of an immature wheat kernel, showing sorus of stemrust.....	278
43. Longitudinal section through the hilum of a wheat kernel infected with stemrust, showing unusually large internal sori extending nearly across the kernel.....	278
44. Cross section of a mature wheat kernel infected with stemrust, showing telia in the ventral groove.....	278
45. Enlarged portion of section shown in Plate 44, showing telia on surface of ventral groove.....	278
46. Longitudinal section of embryo of germinated wheat kernel showing large internal rust at x in hilar tissue at base of embryonic tissue.....	278
47. Longitudinal section of the embryo further advanced in development than that shown in Plate 50.....	278
48. Longitudinal section through young secondary root of wheat embryo, showing presence of intracellular mycelium.....	278

PRACTICAL UNIVERSALITY OF FIELD HETEROGENEITY AS A FACTOR INFLUENCING PLOT YIELDS

Text Figures

	Page
1. Montgomery's diagram of 5.5 by 5.5 foot plots of Turkey wheat, showing variations in the percentage of nitrogen in the grain	283
2. Diagram showing yield of alfalfa in first cutting, 1913, on the Huntley experimental tract.	286
3. Diagram showing yield of alfalfa in second cutting, 1913, on the Huntley experimental tract.	287
4. Diagram showing yield of alfalfa in first cutting, 1914, on the Huntley experimental tract.	288
5. Diagram showing yield of alfalfa in second cutting, 1914, on the Huntley experimental tract.	289
6. Diagram showing yield of alfalfa in third cutting, 1914, on the Huntley experimental tract.	290
7. Diagram showing yield of unhusked rice in Coombs and Grantham's 54 plots $\frac{1}{2}$ by $\frac{1}{2}$ chain square	296
8. Diagram showing yield of ear corn, 1915, on the Huntley experimental tract.	297
9. Diagram showing yield of ear corn, 1916, on the Huntley experimental tract.	298
10. Diagram showing location of sample areas examined for soil moisture in a field at San Antonio Experimental Farm.	302

TRANSMISSION OF THE MOSAIC DISEASE OF IRISH POTATOES

Plates

49. Vines of Green Mountain variety inoculated with juice from healthy foliage of the same variety.	338
50. Vines of Bliss Triumph variety inoculated with juice from healthy foliage of Irish Cobbler variety.	338
51. Vines of Irish Cobbler variety inoculated with juice from healthy foliage of the same variety.	338
52. Vines of Green Mountain variety inoculated with juice from mosaic foliage of the same variety.	338
53. Vines of Green Mountain variety inoculated with juice from mosaic foliage of Bliss Triumph variety.	338
54. Vines of Green Mountain variety inoculated with juice from mosaic foliage of Irish Cobbler variety.	338
55. Vines of Bliss Triumph variety inoculated with juice from mosaic foliage of Irish Cobbler variety.	338
56. Vines of Irish Cobbler variety inoculated with juice from mosaic foliage of the same variety showing bad stage of mosaic.	338

RELATIVE SUSCEPTIBILITY TO CITRUS-CANKER OF DIFFERENT SPECIES AND HYBRIDS OF THE GENUS CITRUS, INCLUDING THE WILD RELATIVES

Plates

57. Leaf of <i>Casimiroa edulis</i> with naturally occurring spots from the greenhouse inoculations.	362
58. Infected leaves from plants of <i>Chaetospermum glutinosum</i> in the greenhouse experiments, showing the types of canker spots produced.	362

	Page
59. A.—Leaves of <i>Atalantia citrioides</i> and <i>A. ceylonica</i> (center) from plants in the greenhouse experiments, showing the canker spots typically produced on these plants. B.—Compound leaf of <i>Hesperthusa crenulata</i> from isolation field, with naturally occurring canker spots on two of the leaves. C.—Leaves of <i>Microcitrus Garrowayi</i> from plants in the greenhouse experiments, with different types of canker spots. D, E.—Infected leaves and twigs of <i>Eremocitrus glauca</i> from greenhouse plants, showing the large flat spots on the leaves and the rather corky spots on the twig and thorn.	362
60. A.—Typically infected leaf of <i>Fortunella margarita</i> . B.—Old leaf of <i>Citrus grandis</i> , with raised, compact, oily, unruptured spots. C.— <i>Fortunella Hindsii</i> , with ruptured corky spots. D.— <i>Citrus</i> sp., Kansu of Yuzu Orange. E.— <i>Citrus aurantifolia</i> , showing typical infection.	362
61. Upper and lower leaf surfaces of a <i>Citrus hystrix</i> leaf with a heavy natural canker infection.	362
62. Typically infected leaves of <i>Citrus grandis</i> from field plants showing extreme susceptibility.	362
63. A.—Leaves and twigs of faustrime from greenhouse experiment with typical spots. B.—Types of spots found on <i>Citrus nobilis</i> (King of Siam, Naranja, and tangerine). C.—Leaf of the citrangequat from greenhouse experiment. D.—Citrumelo leaf with typical canker spots. E.—Upper and lower surface of a naturally infected leaf of <i>Citrus mitis</i> in the field. .	362
64. Naturally infected leaves of <i>Citrus nobilis</i> var. <i>unshiu</i> from the field, showing various types of spots produced.	362
65. Some of the hybrids of <i>Porcirus trifoliata</i> , showing vigor, type of growth, leaf characters, and relative susceptibility to citrus-canker, arranged in order of their susceptibility.	362
66. A.—Limelos in the greenhouse inoculation experiments, showing type of growth, leaf characters, and susceptibility to citrus-canker. B.—Limequats in the greenhouse inoculation experiments, showing type of growth, character of leaves, and susceptibility to citrus-canker.	362
67. A.—Siamelos in the greenhouse inoculation experiments, showing type of growth, leaf characters, and susceptibility to citrus-canker. B.—Comparison of type of growth, leaf characters, and susceptibility to citrus-canker in clemelo, satsumelo, and tangelo in the greenhouse inoculation experiments.	362
68. A.—Results of the greenhouse inoculations with some of the false hybrids. B.—Tangelos in the greenhouse inoculation experiments, showing type of growth, leaf character, and susceptibility to citrus-canker.	362

PRESOAK METHOD OF SEED TREATMENT: A MEANS OF PREVENTING SEED INJURY DUE TO CHEMICAL DISINFECTANTS AND OF INCREASING GERMICIDAL EFFICIENCY

Text Figures

1. Graph showing effect of formalin 1 to 400 treatments with and without presoaking.	370
2. Graph showing effect of formalin 1 to 200 treatments with and without presoaking.	372
3. Graph showing effect of formalin 1 to 320, with and without presoaking. . . .	374
4. Graph showing effect of copper sulphate 1 to 80, with and without presoaking, on wheat and barley seed germination.	375
5. Graph showing effect of formalin 1 to 320, with and without presoaking, on wheat seed germination under field conditions.	377

	Page
6. Graph showing effect of formalin and copper-sulphate presoak treatments of $\frac{1}{2}$ -bushel wheat seed lots.	378
7. Graph showing effect of formalin 1 to 320 treatments for various periods, with and without presoaking.	385
8. Graph showing effect of formalin 1 to 320 and 1 to 200 on germination of corn, barley, and oats with and without presoaking.	386
9. Curve showing rate of absorption of water by dry wheat seeds.	387

Plates

69. Relative injury to wheat-seed germination caused by short and long formalin treatments.	392
70. Effect of formalin 1 to 400 treatment for 6 hours, with and without 6-hour presoak. 1. Fultz wheat. 2. Poole wheat.	392
71. Effect of formalin 1 to 400 treatment for 6 hours, with and without 6-hour presoak. 1. Fulcaster wheat. 2. Turkey wheat.	392
72. Stimulating effect of the presoak method of treatment with formalin 1 to 400.	392
73. Effect of formalin 1 to 200 treatment for 6 hours, with and without 6-hour presoak.	392
74. Effect of formalin 1 to 320 treatment for 6 hours, with and without 6-hour presoak.	392
75. 1. Fife wheat: A, B, control, 83 per cent germination; C, D, seeds treated with formalin 1 to 320 for 3 hours, 62 per cent germination; E, F, seeds presoaked 6 hours, then formalin 1 to 320 for 6 hours, 90 per cent germination. 2. Poole wheat: A, B, control, 85 per cent germination; C, D, seeds treated with formalin 1 to 320 for 6 hours, 55 per cent germination; E, F, seeds presoaked 6 hours, then formalin 1 to 320 for 6 hours, 88 per cent germination. 3. Effect of soaking in water throughout presoak period, compared with procedure of keeping moist 6 hours: A, B, Fife wheat; C, D, Poole wheat; A, C, seeds soaked in water 5 hours, then treated with formalin 1 to 320 for 7 hours; B, D, seeds soaked in water 10 minutes, drained, and kept moist 6 hours, then treated with formalin 1 to 320 for 6 hours.	392
76. Effect of formalin and copper sulphate on wheat and of copper sulphate on barley, with and without presoaking.	392
77. Effect of presoak method used with copper-sulphate treatment of wheat. .	392
78. Effect of presoak method used with formalin 1 to 320 on wheat under field conditions.	392
79. Effect of presoak method used with formalin 1 to 400 on blackchaff bacteria	392
80. Effect of presoak method used with formalin 1 to 400 on blackchaff bacteria	392
81. Effect of presoak method on barley and oats.	392
82. Effect of presoak method used on barley, oats, and corn.	392

DAILY DEVELOPMENT OF KERNELS OF HANNCHEN BARLEY FROM FLOWERING
TO MATURITY AT ABERDEEN, IDAHO

Text Figures

1. Graph showing length, lateral diameter, and dorsoventral diameter of barley kernels for the 25 days following flowering.	395
2. Graph showing percentage of moisture per kernel from date of flowering. .	397
3. Graph showing maximum and mean daily temperatures recorded at Aberdeen, Idaho, from July 8 to August 4, 1916 (broken line), and from July 15 to August 10, 1918 (solid line).	398

	Page
4. Graph showing lateral and dorsoventral diameters of the ovary tip as compared with length, lateral diameter, and dorsoventral diameter of the kernel for the 26 days following flowering in 1916.	408
5. Graph showing average length of kernels 6, 7, and 8 (solid line), average lateral diameter (dotted line), and average dorsoventral diameter (broken line) from plot 1 in 1917.	410
6. Graph showing average length of barley kernels, including ovary tip, from flowering to near maximum development in plot 1 in 1917.	411
7. Graph showing average lateral diameter of barley kernels from flowering until near maximum development, plot 1, 1917.	412
8. Graph showing dorsoventral diameters of barley kernels from flowering until near maximum development.	413
9. Graph showing wet weight of individual kernels 5, 8, and 10, by days, from date of flowering to near maturity in 1917.	418
10. Graph showing average wet weights of kernels from flowering to maturity in plot 1 in 1917.	419
11. Graph showing dry matter per kernel from date of flowering to near maturity in 1916 (dotted line) and in 1917 (solid line).	420
12. Graph showing dry matter per kernel at 12-hour intervals from flowering to maturity.	421
13. Graph showing dry-weight gain of kernels 6, 7, and 8 in 12-hour periods. .	422
14. Graph showing percentage of moisture in morning and evening samples of Hannchen barley in 1917.	422
15. Graph showing nitrogen per kernel from date of flowering in 1916 (broken line) and in 1917 (solid line).	424
16. Graph showing ash per kernel from date of flowering in 1916 (broken line) and in 1917 (solid line) and the percentage of ash in 1917 (dotted line). .	426
17. Periods of development of the barley kernel as indicated by records during three years at Aberdeen, Idaho.	427

Plates

83. A.—Fertilized ovary. B.—Kernel 1 day old. C.—Kernel 2 days old. D.—Kernel 3 days old.	430
84. A.—Kernel 4 days old. B.—Kernel 5 days old. C.—Kernel 6 days old. D.—Kernel at later stage of development.	430
85. Kernel 5 days after fertilization.	430
86. Kernel 6 days after fertilization.	430
87. Kernel 9 days after fertilization.	430
88. Kernel 14 days after flowering.	430
89. Kernel 20 days after fertilization, at which time growth was nearly completed.	430
90. Kernel 25 days after fertilization, growth completed.	430
91. Section of a nearly mature kernel, showing cells next the furrow.	430

DEVELOPMENT OF BARLEY KERNELS IN NORMAL AND CLIPPED SPIKES AND
THE LIMITATIONS OF AWNLESS AND HOODED VARIETIES

Text Figures

1. Graph showing growth in length, lateral diameter, and dorsoventral diameter of kernels of Manchuria barley in normal and clipped spikes.	448
2. Graph showing wet weight of kernels of Manchuria barley from normal and clipped spikes.	449

	Page
3. Graph showing dry matter in kernels of Manchuria barley from normal and clipped spikes.	449
4. Graph showing total ash in kernels of Manchuria barley from normal and clipped spikes.	450
5. Graph showing total nitrogen in kernels of Manchuria barley from normal and clipped spikes.	451
6. Graph showing water in kernels of Manchuria barley from normal and clipped spikes.	451
7. Graph showing growth in length, lateral diameter, and dorsoventral diameter of kernels of Hannchen barley in normal and clipped spikes.	463
8. Graph showing wet weight of kernels of Hannchen barley from normal and clipped spikes.	464
9. Graph showing dry matter in kernels of Hannchen barley from normal and clipped spikes.	465
10. Graph showing percentage of ash in the kernels, rachises, paleae, and awns of normal spikes of Hannchen barley and in the kernels, rachises, and paleae of clipped spikes.	467
11. Graph showing total nitrogen in kernels of Hannchen barley from normal and clipped spikes.	468
12. Graph showing water in kernels of Hannchen barley from normal and clipped spikes.	469
13. Graph showing relation of length of awn to weight of clipped kernels and unclipped spikelets on a 2-rowed barley grown at Arlington Farm, Va.	470

INVESTIGATIONS IN THE RIPENING AND STORAGE OF BARTLETT PEARS

Text Figures

1. Sugars in Bartlett pears from Sacramento, Calif.	484
2. Sugars in Bartlett pears from Suisun, Calif.	485
3. Sugars in Bartlett pears from Medford, Oreg.	486
4. Sugars in Bartlett pears from Yakima, Wash.	487
5. Acids in Bartlett pears from Sacramento, Calif.	490
6. Acids in Bartlett pears from Suisun, Calif.	491
7. Acids in Bartlett pears from Medford, Oreg.	491
8. Acids in Bartlett pears from Yakima, Wash.	492

FURTHER DATA ON THE ORANGE-RUSTS OF RUBUS

Plates

D. 1.—Infected black raspberry leaf covered with the caeomas of <i>Gymnoconia interstitialis</i> . 2.—Blackberry leaf infected with the short-cycled orange-rust.	512
92. Manner of germination of the spores of the two orange-rusts.	512
93. Short-cycled orange-rust.	512
94. <i>Gymnoconia interstitialis</i>	512

MOSAIC DISEASE OF CORN

Plates

95. Mosaic disease of corn.	522
96. Mosaic disease of corn: Effect of early infection on the ear.	522

GENETICS OF RUST RESISTANCE IN CROSSES OF VARIETIES OF TRITICUM VULGARE WITH VARIETIES OF T. DURUM AND T. DICOCCUM

Plates

	Page
97. A.—Pollen grains of Marquis wheat B. —F ₁ Marquis×Kubanka (C I 2094), showing sterile grains C.—Pollen grains of Kubanka (C I 2094). D.—Stems of Kubanka (C I 2094) grown under rust-epidemic conditions. E.—F ₁ Kubanka (C I 2094)×Marquis, showing normal uredinia. F.—Marquis, the susceptible parent. H.—F ₁ emmer (Minnesota 1165)×Marquis, showing no normal uredinia. I.—Minnesota 1165, the resistant emmer parent.	542
98. A, B, C.—Face and side views, respectively, of heads of Iumillo (C I 1736), F ₁ Iumillo×Marquis, and Marquis. D, E, F.—Face and side views, respectively, of heads of emmer, Minnesota 1165, F ₁ emmer×Marquis, and Marquis. G, H, I.—Kernels of Marquis, F ₁ emmer×Marquis, and emmer.	542
99. Representative heads of F ₃ families of the cross between durum and Marquis.	542
100. A.—F ₃ family of a cross between emmer (Minnesota 1165), and Marquis, showing face and side view. B.—Heads of an F ₃ family which resembled common wheat. C.—Heads of different plants of an F ₃ family of a cross between emmer (C I 1524) and Marquis. D.—Represents a very frequent sort of segregation obtained in the F ₃ generation.	542
101. Heads of resistant and susceptible wheat obtained in the F ₃ generation from the cross between Marquis and durum.	542
102. Greenhouse experiment.	542

OCCURRENCE OF THE FIXED INTERMEDIATE, HORDEUM INTERMEDIUM HAXTONI, IN CROSSES BETWEEN H. VULGARE PALLIDUM AND H. DISTICHON PALMELLA

Plates

103. Individual heads, representing the three phenotypic progeny classes in which the lateral florets bear awns.	591
104. Individual heads, representing the phenotypic progeny classes in which the lemmas of the lateral florets are rounded and awnless.	591
105. A.—Awn-pointed individual, heterozygous for regressive 6-rowed and 2-rowed characters. B.—Short-awned individual, heterozygous for regressive 6-rowed and 2-rowed characters. C.—Long-awned individual, heterozygous for regressive 6-rowed and 2-rowed characters. D.—Three spikes of Mansfield barley from the same plant, showing the variations of fertility in the lateral florets.	591
106. A.—Infertile spike of potentially fertile <i>Hordeum intermedium</i> . B.—Fertile spike of <i>H. intermedium</i> . C.—Var. <i>atterbergii</i> , probably a sterile <i>intermedium</i>	591

JOURNAL OF AGRICULTURAL RESEARCH

CONTENTS

	Page
A Teosinte-Maize Hybrid - - - - -	1
G. N. COLLINS and J. H. KEMPTON (Contribution from Bureau of Plant Industry)	
Banana Root-Borer - - - - -	39
G. F. MOZNETTE (Contribution from Bureau of Entomology)	

PUBLISHED BY AUTHORITY OF THE SECRETARY OF AGRICULTURE,
WITH THE COOPERATION OF THE ASSOCIATION OF
LAND-GRANT COLLEGES

WASHINGTON, D. C.

**EDITORIAL COMMITTEE OF THE
UNITED STATES DEPARTMENT OF AGRICULTURE AND
THE ASSOCIATION OF LAND-GRANT COLLEGES**

FOR THE DEPARTMENT

KARL F. KELLERMAN, CHAIRMAN

*Physiologist and Associate Chief, Bureau
of Plant Industry*

EDWIN W. ALLEN

Chief, Office of Experiment Stations

CHARLES L. MARLATT

*Entomologist and Assistant Chief, Bureau
of Entomology*

FOR THE ASSOCIATION

J. G. LIPMAN

*Dean, State College of Agriculture, and
Director, New Jersey Agricultural Experiment
Station, Rutgers College*

W. A. RILEY

*Entomologist and Chief, Division of Entomology
and Economic Zoology, Agricultural
Experiment Station of the University
of Minnesota*

R. L. WATTS,

*Dean, School of Agriculture, and Director,
Agricultural Experiment Station, The
Pennsylvania State College*

All correspondence regarding articles from the Department of Agriculture should be addressed to Karl F. Kellerman, Journal of Agricultural Research, Washington, D. C.

All correspondence regarding articles from State Experiment Stations should be addressed to J. G. Lipman, New Jersey Agricultural Experiment Station, New Brunswick, N. J.

LIBRARY
NEW YORK
BOTANICAL
GARDENS

JOURNAL OF AGRICULTURAL RESEARCH

VOL. XIX

WASHINGTON, D. C., APRIL 1, 1920

NO. 1

A TEOSINTE-MAIZE HYBRID

By G. N. COLLINS, *Botanist*, and J. H. KEMPTON, *Assistant, Acclimitization and Adaptation of Crop Plants and Cotton Breeding Investigations, Bureau of Plant Industry, United States Department of Agriculture*

INTRODUCTION

The only plant which has been considered as an ancestor of our cultivated varieties of maize is teosinte (*Euchlaena mexicana* Schrad.). Although placed in a different genus and separated by pronounced morphological differences, teosinte hybridizes freely with maize. In Mexico, where teosinte is native, both teosinte and maize frequently show contamination. Dilute maize hybrids are of such general occurrence in teosinte that it is difficult to decide whether the various forms of teosinte have all descended from one or more wild species.

In attempting to determine more definitely the relation of teosinte to the origin of maize, it is important to know something of the mode of inheritance of the characters which separate the two genera. The following paper is a study of the behavior of a number of the more sharply contrasted characters in the second generation of a hybrid between Florida teosinte and a diminutive variety of maize known as Tom Thumb pop corn. This variety of maize was chosen on account of its very short season and the large number of characters in which it contrasts sharply with teosinte.

The name Florida teosinte is applied to the variety cultivated for forage in the southern part of the United States. This variety shows less evidence of contamination with maize than any other form that has come under our observation, and for this reason it was chosen for these experiments. It is not known how this plant reached Florida. What appears to be the same variety has been obtained from Tampico and Monterey, Mexico, but whether it is native in Mexico has not yet been determined. Seed of the Florida variety has found its way to many tropical countries, and it may have been introduced into eastern Mexico, either directly or indirectly, from Florida. Teosinte is wild in western Mexico; but none of the forms known from that side of the country can with any assurance be referred to the same variety, or even to the same species as the Florida plant.

JUN 11 1920

The restriction of seed production to southern Florida is probably the chief reason why the use of teosinte is not more general, since it is an excellent forage plant. Where comparative tests have been made, it usually produces a larger tonnage of forage than any other plant.

It has been pointed out by Gernert¹ that teosinte is resistant to the attacks of plant lice, an immunity that it would be desirable to transfer to maize. Teosinte also appears to be more resistant to corn smut than any of the varieties of maize with which we are familiar. Stok² reports that in Java teosinte is immune to the chlorosis disease of corn.

Hybrids of maize and teosinte have been grown before, but nothing of commercial importance has thus far been produced. It would seem, however, that if certain combinations of characters could be effected and maintained, the resulting forms would find a place in agriculture.

One of the objects of the experiment was to determine to what extent the characteristics of the parents would be disassociated in the hybrids. Would the much-branched habit of teosinte continue to be associated with a teosinte-like inflorescence, or would profusely branched plants appear bearing maize-like ears? Would the early maturing plants all be maize-like or would there be early plants having the desirable forage characteristics of teosinte?

To proceed with any assurance in securing the desired combinations, it would be of advantage to know to what extent the characters can be separated and with what degree of freedom desirable characters from the different parents can be combined. If, as has been stated,³ hybrids of maize and teosinte eventually revert to either one or the other parent, it would be futile to attempt to secure desirable combinations.

From the standpoint of genetics, the cross is of especial interest, since perhaps nowhere else, with either plants or animals, has it been possible to secure fertile hybrids between two forms separated by such profound structural differences.

FIRST GENERATION OF TEOSINTE-MAIZE HYBRID

Several unsuccessful attempts were made to hybridize the Tom Thumb pop corn and the Florida teosinte in the field, the great disparity in their seasons making it difficult to bring them into flower at the same time. These efforts were continued in the greenhouse, and the hybrids were finally secured in the early spring of 1914.

Because of the peculiar effect of greenhouse conditions, the parental teosinte plants were greatly reduced in size and presented an unusual

¹ GERNERT, W. B. APHIS IMMUNITY OF TEOSINTE-CORN HYBRIDS. *In Science*, n. s. v. 46, no. 1190, p. 390-392. 1917.

² STOK, J. E. VAN DER. BESPREKING DER RESULTATEN VERKREGEN MET DE KRUISSING TUSSEHEN ZEA MAIS L. (MAIS, DJAGOENG) (=REANA LUXURIANS DUR.=TEOSINTE). EN EUCHLAENA MEXICANA SCHRAD. *In Teysmannia*, jaarg. 21, afl. 1, p. 47-59, 1 pl. 1910. Abstract in English in *Amer. Nat.*, v. 47, no. 560, p. 511-512. 1913.

³ HARSHBERGER, J. W. FERTILE CROSSES OF TEOSINTE AND MAIZE. *In Gard. and Forest*, v. 9, no. 462, p. 522-523. 1896. Quotes a letter from Dr. Dugés.

appearance. The plants consisted of single culms not in excess of 50 cm. in height with no suckers and with only from 8 to 11 total nodes. The flowering habits also were affected, the simple culms each terminating in a single spike which produced very little pollen, while the pistillate spikes were borne directly in the axils of the upper two or three sheaths. Accompanying the reduction in size and the alteration in appearance was a corresponding reduction in the time elapsing between germination and flowering. Normal plants grown in Florida flower in about 200 days after germination, while the plants raised in the greenhouse flowered in about 70 days.

The Tom Thumb plants, from seed sown a week or two later, were more nearly normal. Although somewhat reduced in height, the plants produced from 8 to 11 nodes, which is the usual range under field conditions. The terminal inflorescences were entirely staminate, pistillate flowers being produced only in the normal position.

Because of lack of teosinte pollen, all the hybrids were made by using teosinte plants as the female parents. Since the greatest number of seeds in a spike never exceeded 6, the quantity of hybrid seed was small. Three teosinte plants were used as female parents, and a total of 11 hybrid seeds was secured. All these seeds plainly showed the effect of hybridization, being increased in size until they protruded from the hardened glumes.

Nine of the 11 seeds were planted at Lanham in the spring of 1914 and 5 plants reached maturity, though the production of viable seed was prevented by early frosts. Four of the 5 plants were strikingly similar in appearance, and the structure of the inflorescence was alike in all. The fifth plant, though like the preceding 4 in floral characteristics, was greatly reduced in size; in fact, it was little if any taller than normal Tom Thumb but had numerous suckers.

The four normal F_1 plants were about 18 dcm. high with 6 or 7 suckers arising from nodes below the ground. These suckers usually equaled the main stalks in height. In appearance they were replicas of the main culms, though in time of flowering they behaved like those of maize, being several days later. The branching of the main stalk was not continuous, 1 or 2 nodes usually failing to develop branches. These branchless nodes were about the eighth or ninth produced. The total number of nodes on the main culm ranged from 17 to 21. The uppermost branch on three of the plants was in the third node from the top, while the fourth plant was similar to pure teosinte in bearing the uppermost branch at the second node.

The terminal panicles resembled those of maize in that they all had 8-rowed central spikes instead of terminating in a 4-rowed branch as in teosinte; but in three of the four plants this 8-rowed spike drooped as in teosinte, while in maize the central spikes are erect. The pistillate spikes of the hybrid were all 4-rowed, with the spikelets paired and the spikes

decidedly flattened. The plants were much more proterandrous than even normal maize, and the first silks appeared from the basal or prophyllary node of the uppermost branch. About 95 days elapsed from the date of germination before the first pollen was shed, and the first silks appeared from 10 to 21 days later. The season proved to be too short to mature the fruit properly, and no viable seeds were obtained. A photograph of one of the F_1 plants is shown in Plate 6, C, and the pistillate inflorescence of the same plant in Plate 7.

The two seeds remaining from the original cross were planted at Chula Vista, Calif., in 1915, but only one plant was brought to maturity. This plant produced viable seed and became the parent of the second generation discussed in the present paper. Although grown in a climate decidedly different from that at Lanham, Md., the F_1 plant at Chula Vista was strikingly similar in every respect to its sister plants grown the preceding year. It also was proterandrous, though requiring 102 days from germination to the shedding of pollen. The uppermost branch was in the second node from the top, and the plant produced many suckers arising from nodes below the ground. The terminal panicle had an 8-rowed central spike, and the female spikes were all 4-rowed, as in the Lanham plants.

Since the F_1 plants were comparatively uniform, it was not until the great diversity of the second generation became apparent that the characters were formulated. Consequently many of the characters subsequently used were not recorded for the F_1 plants, and no direct comparisons could be made. In any case, the very small number of F_1 plants precluded statistical analysis.

SECOND GENERATION OF TEOSINTE-MAIZE HYBRID

The second generation, consisting of 127 plants, was grown at Chula Vista in the season of 1916. The hills were spaced 4 feet by 3 feet, and only one seed was planted in a hill. This generous spacing, together with the fact that the germination was low, removed all effects of crowding and allowed the plants to develop naturally, an important feature with plants exhibiting such a wide range of size, habits of growth, and season of maturity.

The impression gained from the general appearance of the F_2 plants was that the great majority were of one type, with the remaining plants falling into other fairly well-defined classes. This impression was dispelled as the plants were carefully examined and the measurements of individual characters recorded. The general impression of uniformity was doubtless due to the fact that the branching habit of a plant is its most conspicuous feature. (See Pl. 1.) The measurements showed, in fact, that the number of suckers was among the least variable of the characters measured, 65 per cent of the plants having between 7 and 15 suckers.

METHODS OF MEASUREMENT

The field measurements¹ of the characters, including dates of flowering and size and number of the several organs, were transferred to punched cards, each card representing an individual plant. Practically all the calculations were made by the use of electric sorting and tabulating machines. The distribution and means were obtained by sorting with respect to each character, using the tabulator to count the cards in each class.

In calculating the standard deviation the departures were taken from zero, as recommended by Harris.²

The formula used was $\sigma = \sqrt{\frac{\sum D^2 f}{N} - M^2}$, where σ = standard deviation; D = departure—in this instance, the class; f = frequency; N = total number; and M = mean. $\sum D^2 f$ was found by multiplying on a calculating machine the summed values for each class (as found by the tabulating machine) by the class and summing the products.

The formula for calculating correlation coefficients proposed by Jennings³ was found to be admirably adapted to the use of tabulating machines.

The formula is

$$r = \frac{\sum XY \cdot N - \sum X \cdot \sum Y}{\sqrt{(\sum X^2 \cdot N - (\sum X)^2) \cdot (\sum Y^2 \cdot N - (\sum Y)^2)}}$$

in which X and Y = the values of the measurements and N = the number of individuals.

In applying this formula the following procedure is recommended by Jennings. Find the values: $\sum X$, $\sum X^2$, $\sum Y$, $\sum Y^2$, and $\sum XY$; next find the values of a , b , and c as follows:

$$\begin{aligned} a &= \sum XY \cdot N - \sum X \cdot \sum Y \\ b &= \sum X^2 \cdot N - (\sum X)^2 \\ c &= \sum Y^2 \cdot N - (\sum Y)^2 \end{aligned}$$

Then

$$R_x = \frac{a}{c}$$

$$R_y = \frac{a}{b}$$

and finally $r = \sqrt{R_x \cdot R_y}$.

Since the use of mechanical tabulating machines in the calculation of correlations seems not to have been described, it may not be out of place to explain the procedure followed.

¹ It was necessary to go over the field at intervals of two or three days throughout the growing season to record flowering dates and the position of first silk and to insure an accurate count of the total number of leaves. This work, together with the planting and care of the experiment, was done by Mr. C. G. Marshall.

² HARRIS, J. Arthur. THE ARITHMETIC OF THE PRODUCT MOMENT METHOD OF CALCULATING THE COEFFICIENT OF CORRELATION. *In Amer. Nat.*, v. 44, no. 527, p. 693-699. 1910.

³ JENNINGS, H. S. HEREDITY, VARIATION, AND THE RESULTS OF SELECTION IN THE UNIPARENTAL REPRODUCTION OF *DIFFLUGIA CORONA*. *In Genetics*, v. 1, no. 5, p. 467-534, 19 fig. 1916.

The first step in calculating product moment correlations was to reject all cards which did not have values recorded for all the characters. This left a population of 88. The cards were then sorted into the classes of the first character (X of the formula), and the classes were separated by stop cards. While the cards were in this order the tabulator gave the summed values for each of the characters for each class of the first character ($\Sigma_x X$ and $\Sigma_x Y$), the number of individuals in each class, and the total value for each of the characters. Each of the entries in the table thus formed ($\Sigma_x X$ and $\Sigma_x Y$) was then multiplied by the class value, and the products were summed on a calculator, giving ΣX^2 and ΣXY .

These summations when multiplied by the number gave $\Sigma X^2 \cdot N$ for the first character and $\Sigma XY \cdot N$ for the remaining characters in the formula for all correlations with the first character. The totals for each character multiplied by the total of the first character gave $(\Sigma X)^2$ for the first character and $\Sigma X \cdot \Sigma Y$ for the remaining characters.

The cards were then sorted for the second character, and the same procedure was followed. In each operation the totals should check, and since each character entered as both X and Y , no additional checking is necessary, each correlation being in effect calculated twice with each operation independently checked. The actual regression lines were readily plotted by dividing the values ΣYX by the number of individuals in the respective classes.

The number of characters for which all correlations can be calculated is limited, of course, by the number that can be recorded on a card. The largest card at our disposal had 45 columns, which would accommodate but 26 characters; and since we wished to consider 33 characters, a second card was used on which the more important characters were repeated, with the addition of the characters not recorded on the first card.

The distributions in the alicole group were bimodal to an extent that seemed to preclude the use of the product-moment method. Correlations within this group were, therefore, calculated by Yule's method for the coefficient of association. Biserial correlations were used to determine the relation between alicole characters and characters outside this group.

Probable errors are not given in the table, since all correlations were calculated from the same population of 88 individuals. In the discussion, correlations of less than 0.25, which is 3.5 times the error, are considered insignificant.

In discussions of genetic correlations it is necessary to distinguish between the instances where two characters derived from the same parent tend to be inherited together and those where one of the characters has entered the hybrid from one parent and the correlated character has been derived from the other parent.

The terms "coherence" and "disherence" will here be used to designate the direction of the correlations with respect to the parental combinations.

The terms "linkage" or "coupling," which are in more general use, might be used in place of coherence; but both these terms imply that the relation is between Mendelian or alternative characters, while most of the characters under discussion show quantitative instead of alternative differences. Furthermore, there appears to be no term in general use that can be applied to the cases where the correlation is the opposite of a linkage or coupling. The use of the word "repulsion" would seriously confuse the issue, since that term implies the disassociation of dominant characters without regard to whether they have entered the hybrid from the same or different parents. In using "coherence" instead of "linkage" there is no intention to imply that the ultimate determinants of the characters are not inherited in Mendelian fashion; but since no attempt toward factorial analysis is made, it seems better to use a more general term.

DESCRIPTION OF CHARACTERS

Thirty-three characters were recorded and their correlations considered. Many of these characters fall into groups the members of which would seem to be mutually related, either physically or physiologically. Eight such groups are recognized, comprising in all 26 characters. Among the 7 remaining characters considered as independent, physiological relations, if they exist, are more obscure. The grouping of the characters is shown below, with the abbreviated designations of the characters which will be used throughout the paper.

HEIGHT GROUP (P. 11-16)

HEIGHT.—Height of the main culm in decimeters.

TOTAL LEAVES.—Total number of leaves or nodes produced on the main culm.

HEIGHT OF SUCKER.—Height of the tallest sucker or tiller in decimeters.

SUCKER INDEX.—Height of the tallest sucker, expressed as a percentage of the height of the main culm.

CIRCUMFERENCE INDEX.—Circumference of the thickest internode in millimeters, expressed as a percentage of the height of the main culm measured in centimeters.

NODES WITHOUT BRANCHES.—Number of nodes between the uppermost sucker, or the surface of the ground, and the lowest developed branch.

NODES ABOVE GROUP (P. 16-19)

NODES ABOVE.—Number of nodes on the main culm above the ear or uppermost branch.

NODES ABOVE ON THIRD.—Number of nodes above the uppermost secondary branch of the third branch from the top.

NODES ON THIRD.—Number of nodes on the third primary branch from the top.

TASSEL GROUP (P. 19-21)

PRIMARY BRANCHES.—Number of primary branches in the terminal inflorescence of the main culm.

SECONDARY BRANCHES.—Number of secondary branches in the terminal inflorescence of the main culm.

SECONDARY INDEX.—Number of secondary branches, expressed as a percentage of the primary and secondary branches combined.

TASSEL BRANCHES ON THIRD.—Number of branches in the terminal inflorescence of the third branch from the top.

MALE BRANCH GROUP (P. 21-22)

MALE BRANCH INDEX.—Number of primary branches terminating in a staminate inflorescence, expressed as a percentage of the total leaves.

MALE SECONDARIES.—Number of secondary branches terminating in a staminate inflorescence on the third branch from the top.

ALICOLE GROUP (P. 22-25)

DOUBLE MALE ALICOLES.—Number of alicoles or alveoli with two staminate spikelets in the best-developed spike of the pistillate inflorescence, expressed as a percentage of the total number of alicoles in the spike.

MIXED ALICOLES.—Number of alicoles with one staminate and one pistillate spikelet in the best-developed spike, expressed as a percentage of the total number of alicoles in the spike.

SINGLE FEMALE ALICOLES.—Number of alicoles with a single pistillate spikelet in the best-developed spike, expressed as a percentage of the total number of alicoles in the spike.

DOUBLE FEMALE ALICOLES.—Number of alicoles with two pistillate spikelets in the best-developed spike, expressed as a percentage of the total number of alicoles in the spike.

ALICOLE INDEX.—Number of alicoles with a single pistillate spikelet, expressed as a percentage of the sum of single and double female alicoles in the spike.

NODES SILKING GROUP (P. 25-26)

NODES SILKING ON THIRD.—Number of nodes producing silks on third branch from top.

NODES SILKING INDEX.—Number of nodes producing silks on third branch, expressed as a percentage of the number of nodes on the third branch.

PROPHYLLARY GROUP (P. 26-27)

PROPHYLLARY SPIKES.—Number of pistillate spikes in the axil of the prophyllum of the third branch.

LENGTH OF PROPHYLLARY.—Length in centimeters of the prophyllary branch of the third branch from the top.

NUMBER OF ROWS GROUP (P. 27-28)

ROWS IN CENTRAL SPIKE.—Number of rows of spikelets in the central spike of the terminal inflorescence of the main culm.

ROWS OF ALICOLES.—Number of rows of alicoles in the best-developed pistillate spike of the third branch from the top.

INDEPENDENT CHARACTERS (P. 23-33)

POSITION OF BEST SPIKE.—Position on the third branch of the node bearing the best-developed spike. The nodes were numbered from the base of the branch, the branch in the axil of the prophyllum being recorded as zero.

NUMBER OF ALICOLES.—Number of alicoles in the best-developed spike of the third branch from the top.

NUMBER OF SUCKERS.—Number of branches on the main culm or on primary branches that originated below or near the surface of the ground.

BRANCH SILKING FIRST.—Number of branches on the main culm above the branch on which silk appeared earliest.

DAYS TO POLLEN.—Number of days from planting to the first production of pollen.

POLLEN TO SILK.—Number of days from the first production of pollen to the first emergence of silks.

LENGTH OF INTERNODE ON THIRD.—Length of the third branch from the top divided by the number of internodes on the same branch.

A knowledge of the behavior of the individual characters in the second generation can best be obtained by a study of the distribution diagrams, figures 1 to 33.

To facilitate the study of the relation of the characters to one another in inheritance, the table of correlations, Table III, is provided. Anything approaching a complete analysis of the data is, of course, out of the question; but the correlation coefficients and the statistical constants given in Tables IV and V afford a means for testing the validity of any assumed relationship. In the discussion of the characters an attempt will be made to indicate the more striking correlations.

TABLE IV.—Distribution of individuals in F_2 of teosinte-maize hybrid with respect to various characters

Units of measurement.	Height (fig. 1). ^a	Total leaves (fig. 2). ^a	Height of sucker (fig. 3). ^a	Nodes without branches (fig. 6). ^a	Nodes above (fig. 7). ^a	Nodes above on third (fig. 8). ^a	Nodes on third (fig. 9). ^a	Primary branches (fig. 10). ^a	Secondary branches (fig. 11). ^a	Tassel branches on third (fig. 13). ^a	Male secondaries (fig. 15). ^a	Nodes silking on third (fig. 21). ^a
0.....				79	1				2	7	56	1
1.....				4	85				1	10	10	
2.....	1			9	34	61			3	9	10	
3.....	1			12	5	10			6	11	13	8
4.....	1			5	2	3	5		11	11	6	27
5.....				5			22	1	4	4	12	26
6.....			1	2		1	29		8	9	9	25
7.....			1	2			24		9	8	4	21
8.....	5			2			20		10	10	1	9
9.....	3	1	1	1			7	4	8	8		3
10.....	6		2	1			12	4	7	13		1
11.....	5		4				2	3	9	2		
12.....	25		12				1	5	1	5		
13.....	4	1	7					11	7	1		
14.....	21	1	11				1	9		2		
15.....	9	1	8					10	2	3		
16.....	11	4	21					11	4	2		
17.....	9	11	12					12	2			
18.....	8	6	14					14	3	1		
19.....	5	10	7					9	2			
20.....	3	7	10					5	4			
21.....	1	19	5					11				
22.....	4	3	4					5	4			
23.....	1	11						5	1			
24.....		6	1					3	2			
25.....		8	1					1	2			
26.....		5							1			
27.....		2	1									
28.....		7						1	2			
29.....		3						1	1			
30.....		6										
31.....		3										
32.....		1										
33.....		5							3			
34.....									1			
35.....									1			
36.....												
37.....									1			
38.....												
39.....		1							1			
40.....												
41.....									1			
42.....												
44.....									1			
46.....												
52.....									1			
53.....												
Number.....	123	122	123	120	125	122	123	125	125	112	122	121
Mean.....	14.1	22.7	16.2	1.28	1.36	1.78	7.0	16.8	10.9	6.13	2.04	5.52
Standard deviation.....	4.0	5.1	3.47	2.21	.62	.81	1.92	4.1	11.8	4.07	2.39	1.67

^a Figures indicate number of plants exhibiting each character to the extent shown in the first column. For discussion of units of measurement see p. 7-8.

des ing ex.	Prophyllary spikes.	Length of prophyllary.	Rows in central spike.	Position of best spike.	Number of alleoles.	Number of suckers.	Branch silking first.	Days to pollen.	Pollen to silk.	Length of inter- node on third.
0.40	0.07	0.16	D 0.05	-0.20	D 0.07	0.05	0.02	0.47	D 0.11	D-0.33
.12	.01	D- .04	- .14	- .18	- .18	D- .10	.33	.79	D .02	D- .66
.02	D- .01	.20	D .06	D .03	D .17	.21	.03	.1402
.23	D- .12	.01	D- .01	D .31	D .09	.17	D- .36	D- .42	D .18	.48
.....	.00	D .02	D- .03	.21	.12	- .19	- .17	.31
.07	- .17	- .17	.02	D- .15	D- .12	- .31	D .04	D .36	- .29
.17	- .13	- .09	.20	.10	.20	- .15	- .30	- .23	D- .06	D .04
.38	- .10	- .06	.26	.03	.16	- .02	- .26	- .26	D- .04	- .02
.22	- .29	- .19	.05	.73	.15	D .05	- .37	.11	- .05
.12	.03	.04	D .12	- .02	D .10	.01	.01	.32	D .04	D- .25
.14	.05	- .00	- .07	- .20	- .08	D- .01	.32	.59	D- .36
.....	.00	.02	- .30	- .17	- .25	.0457	- .03
.20	D- .09	D- .16	- .18	D .24	- .19	D- .05	.05	.17	D- .15
.02	.23	.12	- .04	.12	D .06	.14	.33	.03	D- .04
.13	.19	.38	D .08	D .18	D .16	.02	D- .29	D- .40	D .04	.51
.....	D- .13	.10	D .22	D .03	D .13	.0000	.00
.....	D- .09	.12	- .29	- .08	- .15	.0000
.....	D- .04	D- .10	- .35	.00	- .38	.3015	D .01
.....	D .07	D .13	.23	.04	.31	- .29	- .15	.05
.10	D- .09	D- .10	- .12	- .05	- .37	.11	.09	.17	D- .21
.35	.00	.09	- .03	D .47	D .05	.01	D- .12	.07	D .18	D- .04
.....	.39	.40	- .04	- .25	D .09	.03	.07	.0609
.3959	D .08	- .56	D .05	.08	.14	.08	- .18	.10
.40	.59	- .01	D .31	D .15	.10	.05	D- .19	D .06	.29
.04	D- .08	- .01	D- .05	.37	D .02	- .01	- .09	D- .18	D .06
.25	- .56	D .31	D- .0501	D .09	- .34	- .09	.40	D .02
.09	D .05	D .13	.37	.01	- .11	D .05	- .29	.01	D .23
.03	.08	.10	D .02	D .09	- .1102	D- .09	- .23	.16
.07	.14	.05	- .01	- .34	D .05	.0231	D- .21
.06	.08	D- .19	- .09	- .09	- .29	D- .09	.31	- .14	D- .56
.....	- .18	D .06	D- .18	.40	.01	- .23	- .14
.09	.10	.29	D .06	D .02	D .23	.16	D- .21	D- .56

TABLE III—Correlation of characters in F_2 of *Zoosma-maize* hybrid^a

Characters considered ^b	Height	Total leaves	Length of sucker	Sucker index	Circumference index	Nodes without branches	Nodes above	Nodes above on third	Nodes on third	Primary branches	Secondary branches	Secondary index	Tassel branches on third	Male branch index	Male secondaries	Double male alcohols	Mixed alcohols	Single female alcohols	Double female alcohols	Alcohol index	Nodes silking on third	Nodes silking index	Prophyllary spokes	Length of prophyllary	Row in central spike	Position of best spike	Number of shocks	Number of sucker	Branch strike first	Days to pollen	Pollen to silk	Length of internode on third		
Height		0.69	0.21	D=0.41	-0.62	D 0.42	-0.20	-0.17	-0.18	0.45	0.63	0.47	0.19	D=0.11	D=0.28	0.00	0.00	0.07	D=0.07	D=0.04	0.01	D=0.20	0.07	0.16	D=0.05	-0.20	D=0.07	0.05	0.02	0.17	D=0.11	1.00		
Total leaves	0.69		0.32	D=0.48	-0.11	D 0.44	-0.20	-0.21	-0.16	0.45	0.66	0.52	0.18	D=0.07	D=0.41	0.00	0.00	0.14	D=0.14	D=0.04	0.05	D=0.20	0.16	D=0.04	-0.14	D=0.07	0.11	0.13	0.11	0.17	D=0.11	1.00		
Height of sucker	0.21	0.32			-0.10	D 0.44	-0.14	-0.06	D=0.14	0.45	0.45	0.47	0.10	D=0.10	0.03	0.00	0.00	0.07	D=0.03	D=0.01	0.05	D=0.12	0.16	D=0.06	D=0.05	D=0.15	0.15	0.02	0.05	0.14	D=0.11	1.00		
Sucker index	D=0.41	D=0.48	0.30				D=0.11	D=0.17	D=0.11	D=0.32	D=0.46	D=0.47	D=0.10	D=0.05	0.42	-0.12	0.29	0.00	D=0.01	D=0.01	0.05	D=0.12	0.16	D=0.06	D=0.05	D=0.15	0.15	0.02	0.05	0.14	D=0.11	1.00		
Circumference index	-0.62	-0.11		D=0.41			-0.08	-0.14	D=0.11	0.45	0.63	0.47	0.19	D=0.11	D=0.28	0.00	0.00	0.07	D=0.07	D=0.04	0.01	D=0.20	0.07	0.16	D=0.05	-0.20	D=0.07	0.05	0.02	0.17	D=0.11	1.00		
Nodes without branches	D=0.28	D=0.44	D=0.04				-0.11	D=0.05	D=0.22	D=0.15	D=0.29	D=0.47	D=0.10	D=0.10	-0.10	0.00	0.00	0.00	D=0.01	D=0.01	0.00	D=0.12	0.16	D=0.06	D=0.05	D=0.15	0.15	0.02	0.05	0.14	D=0.11	1.00		
Nodes above	-0.20	-0.20	-0.11	D=0.11	0.08	0.11																												
Nodes above on third	0.17	0.17	0.06	D=0.17	0.14	D=0.05	0.17																											
Nodes on third	-0.18	-0.18	D=0.11	D=0.17																														
Primary branches	0.45	0.45	-0.13	D=0.12	0.00	D=0.18	-0.05	-0.04	-0.12																									
Secondary branches	0.63	0.66	0.15	D=0.16																														
Secondary index	0.47	0.52			-0.11																													
Tassel branches on third	0.19	0.18	0.10	D=0.15	D=0.10	-0.04	D=0.02	D=0.05	D=0.05	0.19	0.24	0.21	0.19	D=0.09	D=0.06	D=0.20	D=0.06	D=0.06	D=0.06	D=0.06	0.14	D=0.12	D=0.16	D=0.15	D=0.24	D=0.24	D=0.12	D=0.21	0.05	0.17	0.11	1.00		
Male branch index	D=0.11	D=0.07	D=0.10	D=0.05	D=0.10	-0.11	-0.11	-0.19	D=0.05	0.19	0.24	0.21	0.19	D=0.09	D=0.06	D=0.20	D=0.06	D=0.06	D=0.06	D=0.06	0.14	D=0.12	D=0.16	D=0.15	D=0.24	D=0.24	D=0.12	D=0.21	0.05	0.17	0.11	1.00		
Male secondaries	D=0.28	D=0.44	0.13	D=0.12	D=0.10	-0.10	D=0.09	D=0.08	D=0.11	D=0.04	D=0.18	D=0.12	D=0.06	D=0.06	D=0.20	D=0.06	D=0.06	D=0.06	D=0.06	D=0.06	0.14	D=0.12	D=0.16	D=0.15	D=0.24	D=0.24	D=0.12	D=0.21	0.05	0.17	0.11	1.00		
Double male alcohols	0.00	0.00	0.12	D=0.06	0.00	0.00	0.00	0.00	0.00	0.00	D=0.21																							
Mixed alcohols	0.00	0.00	0.29	D=0.16	0.00	0.00	0.00	0.00	0.00	0.00	D=0.21																							
Single female alcohols	-0.07	0.14	0.06	D=0.10	0.00	0.00	0.00	0.00	0.00	0.00	D=0.21																							
Double female alcohols	D=0.07	0.14	-0.07	D=0.04	0.00	0.00	0.00	0.00	0.00	0.00	D=0.21																							
Alcohol index	D=0.04	0.14	D=0.05	D=0.02	-0.02	-0.02	-0.22	0.08	-0.14	D=0.10	0.09																							
Nodes silking on third	0.01	0.01	0.06	D=0.06	0.00	-0.05	-0.04	-0.24	D=0.01	0.13	0.06	D=0.01	0.14	D=0.19	0.10	0.09	0.12	D=0.16	D=0.09	D=0.05	0.15	D=0.12	D=0.09	D=0.01	D=0.01	D=0.01	D=0.01	0.13	0.13	0.13	0.13	0.13	1.00	
Nodes silking index	D=0.46	D=0.12	D=0.06	D=0.11																														
Prophyllary spokes	0.07	0.01	D=0.01	D=0.12																														
Length of prophyllary	0.10	D=0.04	0.10	D=0.01	D=0.02	-0.17	-0.11	-0.10	-0.29	0.02	-0.04	0.00	D=0.09	0.21	0.19	D=0.11	D=0.09	D=0.04	D=0.07	D=0.00	0.00	0.10	0.10	0.05	D=0.05	D=0.05	D=0.05	0.14	0.14	0.14	0.14	0.14	1.00	
Row in central spike	D=0.05	-0.14	D=0.06	D=0.01	D=0.01	0.00	0.00	0.00	0.00	0.00	D=0.12	-0.07	-0.30	-0.04	D=0.08	D=0.22	-0.29	-0.15	-0.25	-0.12	-0.01	-0.04	D=0.08	-0.01	D=0.01	D=0.01	D=0.01	0.17	0.17	0.17	0.17	0.17	1.00	
Position of best spike	-0.20	-0.18	D=0.05	D=0.11	0.11	0.12	0.15	0.10	0.03	0.11	-0.02	-0.20	-0.17	D=0.24	-0.12	D=0.18	D=0.01	-0.05	0.00	-0.04	-0.05	D=0.42	-0.25	D=0.12	D=0.05	D=0.05	D=0.05	0.14	0.14	0.14	0.14	0.14	1.00	
Number of shocks	D=0.07	-0.18	D=0.17	D=0.09	0.12	D=0.12	0.20	0.10	0.15	0.10	-0.08	-0.25	-0.19	D=0.10	D=0.16	D=0.11	-0.15	-0.08	0.00	0.00	0.00	D=0.01	D=0.01	D=0.11	D=0.11	D=0.11	D=0.11	0.17	0.17	0.17	0.17	0.17	1.00	
Number of suckers	-0.05	D=0.10	0.21	-0.17	-0.19	-0.15	-0.02	D=0.01	0.01	D=0.04	-0.04	D=0.05	0.14	0.02	0.00	0.00	0.00	0.00	0.00	0.00	0.10	0.10	0.10	0.10	D=0.09	D=0.09	D=0.09	0.14	0.14	0.14	0.14	0.14	1.00	
Branch strike first	0.02	0.11	0.21	D=0.16	D=0.04	0.04	-0.10	-0.26	-0.17	0.01	-0.12	-0.05	-0.33	D=0.29	D=0.09	D=0.01	0.00	0.00	0.00	0.00	0.10	0.10	0.10	0.10	D=0.09	D=0.09	D=0.09	0.14	0.14	0.14	0.14	0.14	1.00	
Days of pollen	-0.17	-0.19	0.14	D=0.42	-0.17	D=0.16	-0.21	-0.30	-0.21	0.37	0.59	0.57	0.17	-0.03	D=0.10	0.00	0.00	0.15	-0.15	0.17	0.07	0.00	0.08	D=0.10	-0.09	-0.09	-0.29	D=0.09	0.17	0.17	0.17	0.17	1.00	
Pollen to silk	D=0.11	D=0.02	D=0.18	D=0.11	D=0.11	D=0.06	D=0.04	D=0.04	D=0.04	D=0.04	D=0.04	D=0.04	D=0.04	D=0.04	D=0.04	D=0.04	D=0.04	D=0.04	D=0.04	D=0.04	D=0.04	D=0.04	D=0.04	D=0.04	D=0.04	D=0.04	D=0.04	0.11	0.11	0.11	0.11	0.11	1.00	
Length of internode on third	D=0.11	D=0.66	0.02	D=0.48	-0.29	D=0.04	-0.02	-0.01	D=0.25	D=0.16	D=0.16	D=0.16	D=0.16	D=0.04	D=0.04	D=0.04	D=0.04	D=0.04	D=0.04	D=0.04	D=0.04	D=0.04	D=0.04	D=0.04	D=0.04	D=0.04	D=0.04	0.11	0.11	0.11	0.11	0.11	1.00	

TABLE IV.—*Distribution of individuals in F₂ of teosinte-maize hybrid with respect to various characters—Continued*

Units of measurement.	Prophyllary spikes (fig. 23). ^a	Length of prophyllary (fig. 24). ^a	Rows in central spike (fig. 25). ^a	Rows of all-coles (fig. 26). ^a	Position of best spike (fig. 27). ^a	Number of all-coles (fig. 28). ^a	Number of suckers (fig. 29). ^a	Branch silking first (fig. 30). ^a	Days to pollen (fig. 31). ^{a, b}	Pollen to silk (fig. 32). ^a	Length of internode on third (fig. 33). ^a
0	23	13			22		3		3	1	
1	23				23			43	15	2	
2	12			III	13		1	43	27	1	2
3	12			IO	29		2	11	25		1
4	15		23		11		8	6	15	1	6
5	11	3	14		6		2	3	13	1	4
6	30		19	I	5		3		11	5	5
7	5		5		3	I	11		10	4	5
8	1	3	62		1	I	8		3	4	14
9	2	7			2		3	10	3	3	5
10	3	9	2			8	8			3	15
11	3	5				1	10			5	8
12		15				5	9			3	17
13		15				9	11			5	9
14	I	8				9	9			1	6
15		9				7	7			3	3
16		7				16	2			3	3
17		4				6	1			7	5
18		4				16	5			6	3
19		2				14	3			6	
20		2				8	3			8	4
21		1				4	2			2	
22		2				2	3			1	I
23		3				5	1			6	
24		2								3	
25		1				2				4	
26						4	I			2	
27		I					I			4	
28						I				3	
29						I				1	
30						3				I	
31											
32		2					I			I	
33										I	
34						2				I	
35										3	
36										1	
37		I								2	
38											
39										I	
40		I									
41											
42		I				2					
44											
46										I	
52											
53										I	
Number	114	121	125	123	120	133	127	106	125	122	119
Mean	19	13.4	6.62	2.13	2.47	17.9	11.7	1.89	111.9	18.3	10.9
Standard deviation	3.04	7.09	1.87	.38	2.14	6.17	3.36	.44	21.5	9.7	4.19

^a Figures indicate number of plants exhibiting each character to the extent shown in the first column. For discussion of units of measurement see p. 7-8.
^b First date recorded 71 days after planting and subsequently at 10-day periods.

DISCUSSION OF CHARACTERS AND THEIR CORRELATIONS

HEIGHT GROUP

HEIGHT

Confining the measurement of height to the main stalk does not always give a fair idea of the size of the plant, since there were many individuals in which the suckers greatly exceeded the main stalk. (See distribution of sucker index, Table V.)

TABLE V.—Distribution of individuals in F_2 of teosinte-maize hybrid with respect to characters recorded as indices

Units of measurement.	Double male alicoles (fig. 16). ^a	Mixed alicoles (fig. 17). ^a	Single female alicoles (fig. 18). ^a	Double female alicoles (fig. 19). ^a	Alicole index (fig. 20). ^a	Units of measurement.	Sucker index (fig. 4). ^a	Units of measurement.	Circumference index (fig. 5). ^a	Units of measurement.	Secondary index (fig. 12). ^a	Units of measurement.	Male branch index (fig. 14). ^a	Nodes silking index (fig. 22). ^a
Per ct.						Per cent.		Per ct.		Per cent.		Per ct.		
0-4	105	110	34	18	36	41-50	1	24	1	0	2	6-9	1	1
5-14	2	6	27	4	25	51-60	2	25	1	10	1	10-19	2
15-24	3	1	13	6	12	61-70	1	26	1	11	13	20-29	26
25-34	6	3	5	4	5	71-80	1	27	21	12	30-39	23	1
35-44	5	3	5	8	5	81-90	11	28	1	31	17	40-49	48	2
45-54	4	7	3	91-100	20	29	1	41	12	50-59	15	8
55-64	7	9	7	101-110	30	30	51	12	60-69	5	11
65-74	6	6	4	111-120	21	31	2	61	12	70-79	4	15
75-84	6	14	121-130	19	32	1	71	9	80-89	27
85-94	5	23	3	131-140	7	33	4	81	8	90-99	21
95-100	12	24	19	141-150	2	34	1	91	1	100	35
						151-160	1	35	3	101-110	7			
						161-170	1	36	3	111-121	4			
						171-180	1	37	2	121-130	3			
								38	5	131-140	1			
						221-230	1	39	4	141-150	2			
								40	8	151-160	2			
						451-460	1	41	7	161-170			
								42	5	171-180	1			
								43	5	181-190	3			
								44	6	191-200	1			
								45	5					
								46	4	321-330	1			
								47	4					
								48	5					
								49	3					
								50	4					
								51					
								52	1					
								53	2					
								54	4					
								55	3					
								56	1					
								57	4					
								58	2					
								61	1					
								62	1					
								63	2					
								69	1					
								78	1					
								83	1					
								91	1					
No.	123	123	123	123	123		110	110	124	118	121
M.	4.55	2.36	32.4	61.0	34.0		121.5	45.2	70.0	41.5	80.6
σ.	11.9	7.96	46.5	68.0	47.3		37.7	12.4	49.0	8.8	18.8

^a Figures give number of plants exhibiting each character to the extent shown in first column in this section of the table.

The average height of Tom Thumb maize plants at Chula Vista was 6 dcm. and that of Florida teosinte 23 dcm. The F_1 plants averaged 17 dcm. The mean of the F_2 plants was 14. The range was from 2 to 23 dcm. The distribution (fig. 1) was as nearly normal as could be expected from the number of individuals involved. There is, furthermore, no indication of skewness, the mode and the mean practically coinciding.

Although the parental varieties differ greatly in height, the parental species overlap. Indeed the taller varieties of maize probably exceed the tallest teosinte in height.

Height is positively correlated with all of the four tassel measurements, and the correlations are significantly higher than was found in a progeny

of Tom Thumb where two of these characters were recorded. Thus there is evidence of coherence between height and the character of the tassel.

Disherence with male secondaries is indicated by a correlation of -0.28 ± 0.07 . The negative correlation of -0.46 ± 0.06 with nodes silking index would also seem a clear example of disherence.

The correlation of 0.47 with days to pollen indicates coherence of this character with height. In both parent populations this correlation was negative, but under most circumstances the late plants of a maize variety are taller than the early plants.

The negative correlation of -0.33 with length of internode on third is in the direction of a disherence, though this is probably associated with the negative correlation between height and sucker index, which is to some extent physical. Anything which tended to interfere with the growth of the main culm would doubtless stimulate the development of all the branches.

TOTAL LEAVES

The total number of leaves on the main culm in Tom Thumb is usually 11, in Florida teosinte about 37. The mean in the F_2 hybrid plants was 23, with a range from 9 to 38. The distribution (fig. 2) is normal, and the variability as measured by the coefficient of variation is the lowest recorded for any character.

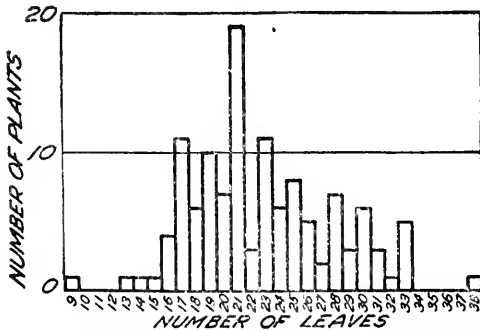

FIG. 2.—Total leaves: frequency distribution of plants in F_2 . Class value, one leaf.

usually an intra-variatal correlation of about 0.3 between total leaves and height. Corresponding data for teosinte are not available, but the coefficient of 0.69 in the hybrid material affords some evidence of coherence between these characters.

The correlations of total leaves with other characters are similar to those of height, with the exception that there is no evidence of disherence with nodes silking index. There is also coherence with branch silking first.

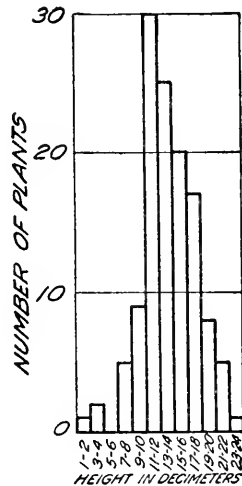

FIG. 1.—Height: frequency distribution of plants in F_2 . Class value, 2 dem.

HEIGHT OF SUCKER

Measurements were taken from the ground to the tip of the tassel of the tallest sucker or tiller and recorded in decimeters. Tom Thumb almost never produces a sucker. In Florida teosinte there are usually numerous suckers of practically the same height as the main culm. The parent varieties are thus widely separated, but there are varieties of maize with suckers taller than any recorded in teosinte. The mean of the F_2 hybrid plants was 16.2, ranging from 6 to 27, with a practically normal distribution (fig. 3).

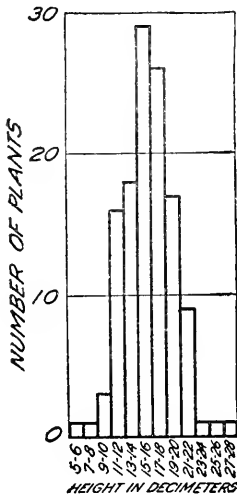

FIG. 3.—Height of sucker: frequency distribution of plants in F_2 . Class value, 2 decm.

This measurement was taken as the best single expression of the tendency to produce tall suckers. Since Tom Thumb almost never produces suckers, the index is practically zero for the male parent of the hybrid. In Florida teosinte the index is usually about 100. In one population of 87, the mean was 99.4, with a range from 90 to 110. In the F_2 hybrid plants the mean was 117, with a range from 50 to 460. The distribution (fig. 4) was unimodal and symmetrical with the exception of a few stragglers probably representing plants with abnormal main culms.

The coherences outside the group are with male secondaries, mixed alicoles, and length of internode on third. The disherences are with three members of the height group, nodes on third branch, two of the tassel measurements, position of best spike, branch silking first, and days to pollen.

There is thus more direct evidence of disherence than of coherence with this character. It should be remembered, however, that the negative correlation of sucker index with height is in a sense physical, since the

The only character outside the group showing a significant correlation with height of sucker is secondary branches. The correlation is in the direction of a coherence.

SUCKER INDEX

This character was determined by dividing the height of the tallest sucker by the height of the plant and multiplying by 100. It is thus the height of the tallest sucker expressed as a percentage of the height of the main

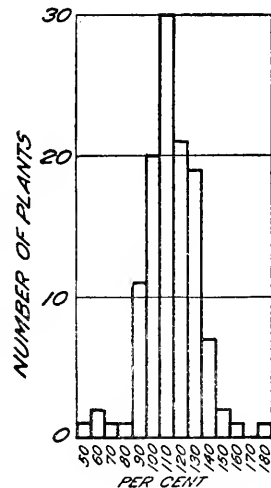

FIG. 4.—Sucker index: frequency distribution of plants in F_2 . Class value, 10 per cent. One plant at 230 and one at 460.

one is a function of the other. The other differences may follow as secondary relations due to this correlation with height.

CIRCUMFERENCE INDEX

In a population of 87, the circumference of the culm of Florida teosinte averaged 61 mm. Under similar conditions the circumference of Tom Thumb was approximately 35 mm. The mean of the F₂ hybrid plants was 56 mm.

Since circumference is so closely associated with the general size of the plant, the circumference measurement was recorded as a percentage of the height of the plant, and the measurement is termed a circumference index.

While in direct measurement the culms of teosinte are thicker than those of Tom Thumb, teosinte is much more slender. In circumference index a high value is therefore a variation toward the maize parent. The mean index of Florida teosinte was 2.7, that of Tom Thumb about 6.0. The mean of the hybrid plants was 4.5, with a normal distribution (fig. 5).

Circumference shows one significant and independent coherence, that with pollen to silk, and a difference with male secondaries.

NODES WITHOUT BRANCHES

This character is the number of nodes between the lowest branch and the uppermost sucker or the surface of the ground. In teosinte, branches are normally developed in the axils of all leaves on the main culm, except the uppermost. The tendency to suppress branches at the nodes just above the ground appears, however, when the plants are grown under unfavorable conditions. In a planting of Florida teosinte at Chula Vista in 1918 the average number of nodes without branches was 7.6.

In maize there are always a number of nodes without branches between the uppermost sucker and the lowest ear. In Tom Thumb where no suckers are developed, the number can not be definitely determined, since the surface of the ground can not be located with accuracy. But since the average total number of leaves in Tom Thumb is 11 and there is an average of 3 nodes above the single ear and about 5 nodes below the surface of the ground, the mean number of nodes without branches is about 3.

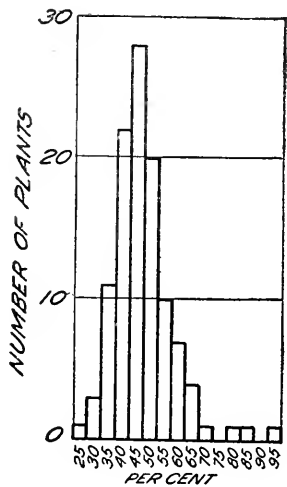

FIG. 5.—Circumference index: frequency distribution of plants in F₂. Class value, 5 per cent.

The mean number of nodes without branches in the F_2 hybrid plants was 1.05. The distribution (fig. 6) was far from normal, and there is some indication of two modes. Seventy-nine of the individuals were at zero. Of the remaining 41 plants the largest number, 12, had 3 nodes without branches, with a fairly uniform distribution ranging from 1 to 9.

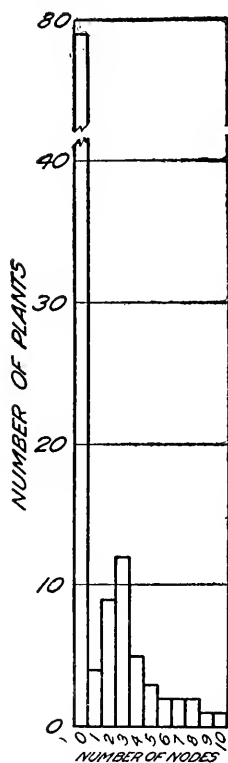

FIG. 6.—Nodes without branches: frequency distribution of plants in F_2 . Class value, one node.

The significant correlations outside the group were coherences with both of the characters in the male branch group, number of suckers and length of internode on third. The disherences are with secondary branches and days to pollen.

NODES ABOVE GROUP

NODES ABOVE

In teosinte of all varieties there is almost without exception one node above the uppermost branch. In maize the number varies from 8 or 9 to 2 or 3; only in rare and abnormal specimens is it reduced to one. The limits as observed in the Tom Thumb variety are 3 and 5, with the mean at 3.4. This character, while not so constant as total leaves, is less subject to environmental influences than most of the characters recorded.

There is some question of the propriety of considering the number of nodes above the ear in maize as strictly homologous with the number of nodes above the uppermost branch of teosinte. In maize the uppermost branch, or ear, is normally the best developed, while in teosinte the most fruitful branch is usually the third or fourth from the top. See Tables I and II.

If the uppermost branch in teosinte is not homologous with the uppermost branch or ear in maize, the complete absence of any trace of a bud in the axils of the leaves above the upper ear in maize calls for some explanation. It is difficult to believe that branches in the axils of the upper leaves of maize could have been so completely suppressed as to leave neither a trace nor a tendency to reappear as an abnormality. It appears more reasonable to assume that in maize additional nodes have been intercalated or that these sterile nodes in maize, instead of representing a change from the condition found in teosinte, have been derived from a distinct ancestor.

In the first generation there were two plants with one node above and three with two. The range in the second generation was from one to four, with one possibly abnormal plant with none. The distribution

(fig. 7) is decidedly skew, more than half the plants having one, but there is no indication of bimodality.

In maize there is always an intravarietal correlation between nodes above and total number of leaves and other characters that are expressions of size. Since Tom Thumb maize is smaller and has a much smaller number of leaves than teosinte, coherence with these size characters would not be masked by physiological correlations.

It is therefore interesting to note that the tassel characters, which in pure strains of maize are positively correlated with nodes above, are here negatively correlated, affording clear evidence of coherence. There are also significant correlations in the direction of coherence with the male branch characters and node silking first. There are no significant disherences.

NODES ABOVE ON THIRD

In all varieties of teosinte the number of nodes above the uppermost secondary on the third branch is one, as on the main culm. In maize the value will depend on what is considered the homologue of the third branch from the top in teosinte. Taken strictly, the upper branch in maize is the ear, and the third branch from the top, when such exists, would be an earlike branch that in some types would partake somewhat of the nature of a sucker. If sufficiently suckerlike, the number of nodes above the uppermost secondary of such a branch would correspond to those of the main stalk, that is, the range would be from 3 to 8. If, however, the ear of maize be assumed to correspond to some branch below the uppermost in teosinte, those above the ear having been suppressed, the number of nodes above the uppermost secondary would be much greater, for in this case the branch would be an ear and the secondary branches would be the secondary ears which almost invariably are borne in the axil of the lowest husk. In any case the number would be larger in maize than in teosinte.

This character was recorded for three of the F_1 plants. In two of these the number was 1; in the other it was 2. The average number in the F_2 hybrid plants was 1.78, with no indication of bimodality. The distribution (fig. 8) is much less skew than for the nodes above on the main culm, the mode being at 2. In its correlations, this character is similar to nodes above on the main stalk.

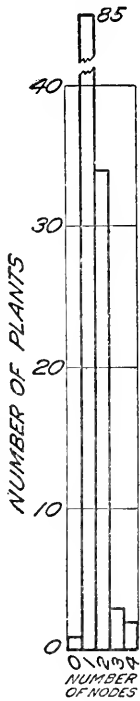

FIG. 7.—Nodes above: frequency distribution of plants in F_2 . Class value, one node.

NODES ON THIRD

This character is instructive chiefly as a means of throwing light on the homologies between the branches of teosinte and maize and as a means of calculating the average length of internodes on the third branch described below.

If each husk on an ear of maize represents a node, the third branch from the top, which would still be earlike, would have even in Tom Thumb from 6 to 8 nodes. In other varieties this number would be even larger. On the other hand, if the leaves from which the husks are derived have been subdivided, thus increasing the apparent number of nodes, the number of nodes on this branch of the hybrids might be expected to agree pretty closely with the number in teosinte, which varies from 2 to 5. The modal number in the F_2 hybrid plants was 6, the mean was 7.15, with a range from 4 to 14. There was no indication of bimodality (fig. 9). There was no indication in the hybrid plants that leaves were subdivided, each leaf being borne on a well-defined internode. The increased number of nodes over that of teosinte goes to support the idea that each of the husks on an ear of maize represents an internode of the branch.

In common with the other characters of this group, the correlations with secondary branches and prophyllary spikes would seem significant coherences. In these correlations a high value of one character is correlated with a low value of the other, and any general tendency

to vigor would reduce the correlation.

The correlations with position of best spike and node silking first are of doubtful significance, there being an obvious physiological connection between these characters and the number of nodes in the third branch.

All the significant disherent correlations are of a nature that suggests a physiological explanation.

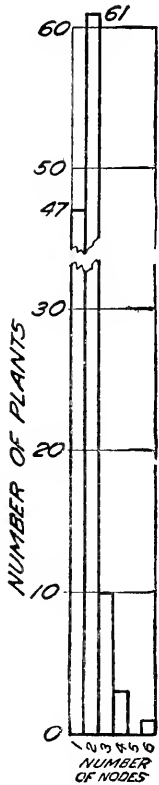

FIG. 8.—Nodes above on third: frequency distribution of plants in F_2 . Class value, one node.

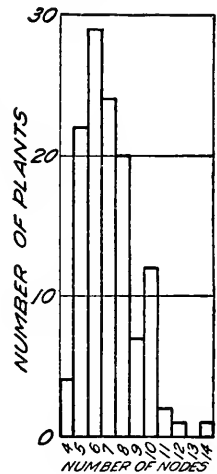

FIG. 9.—Nodes on third: frequency distribution of plants in F_2 . Class value, one node.

TASSEL GROUP

PRIMARY BRANCHES

Primary tassel branches are much more numerous in teosinte than in any but the very largest varieties of maize. In the Tom Thumb variety the maximum number observed was 9, and this falls far below the number in any normal teosinte plant. The mean number for Tom Thumb and Florida teosinte grown under similar conditions was 4.6 and 12.5, respectively. In the F_1 plants the number ranged from 16 to 20. In the second generation the mean was 16.7 with a range from 5 to 29. The distribution (fig. 10) was symmetrical and unimodal.

There are two significant independent coherences, one with characters of the height group and the other with days to pollen. There are also two disherences, one with number of single female alicoles, the other with length of internode on third. The apparent disherence with sucker index is probably associated with the negative correlation of sucker index with the other height characters.

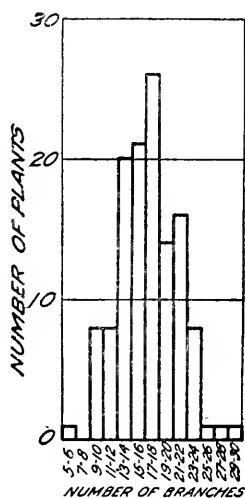

FIG. 10.—Primary branches: frequency distribution of plants in F_2 . Class value, two branches.

SECONDARY BRANCHES

Teosinte has a much larger number of secondary tassel branches than maize. The specific ranges of the parents may overlap, but the Tom Thumb variety seldom develops secondary branches, while in Florida teosinte the mean number was 10.3.

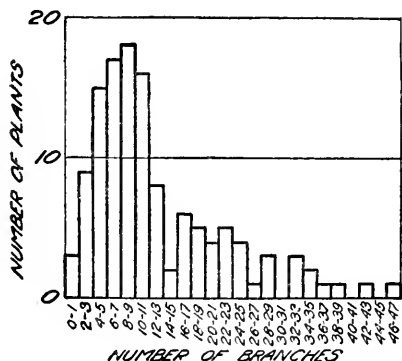

FIG. 11.—Secondary branches: frequency distribution of plants in F_2 . Class value, two branches.

In the F_2 hybrid plants the mean was 12.6, with a range from 0 to 46. The distribution (fig. 11) is very skew, the mode being near 8, but there is little evidence of more than one mode.

This character shows more evidence of coherence than does the character primary branches. It is closely correlated with three of the measurements of height.

There is the same negative correlation with sucker index; and in addition the positive correlation with nodes without branches, which is in the direction of a disherence, is here above 0.25.

A most striking example of coherence is the negative correlation of secondary branches with all three of the nodes above group. The other coherences are with male branches, branch silking first, and days to pollen. The only clear evidence of disherence is with male secondaries and length of internode on third.

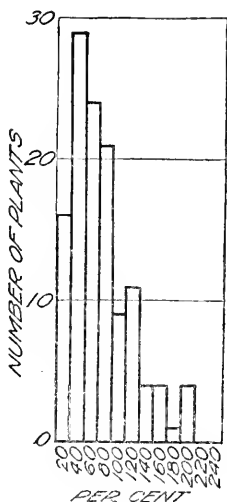

FIG. 12.—Secondary index: frequency distribution of plants in F_2 . Class value, 20 per cent. One plant at 34%.

SECONDARY INDEX

This character, which is the number of secondary branches expressed as a percentage of the total branches, distinguishes more sharply between maize and teosinte than does the direct measurement of either primary or secondary branches. Secondary tassel branches are relatively as well as absolutely much more numerous in teosinte than in maize. In teosinte they equal or exceed the number of primary branches, while in maize the number of secondaries equals the number of the primaries only in some of the large tropical varieties.

In the F_2 hybrid plants the mean was 70, with a very skew distribution (fig. 12) but with no evidence of more than one mode.

The correlations are similar to those with the direct measurements of tassel branches, except the additional coherences with number of alicoles and rows in central spike.

TASSEL BRANCHES ON THIRD

In teosinte the modal number of tassel branches on the third branch from the top is two. When teosinte is grown under rather unfavorable conditions where the number of branches is reduced, there is evidence of a bimodal distribution, in that plants with two branches or none are more numerous than plants with a single branch. In maize the number is zero, since all branches from the upper nodes of maize are normally unbranched.

In the F_2 hybrid plants the mean was 6.1. The distribution (fig. 13) was skew, with slight indication of two modes.

Although closely correlated with the tassel characters of the main stalk, this character shows no significant correlations outside the group except with number of nodes on third.

This is in the direction of a disherence; but the relation is doubtless physiological, since both characters would be similarly affected by changes in general vigor.



FIG. 13.—Tassel branches on third: frequency distribution of plants in F_2 . Class value, two branches.

The five tassel characters form a closely correlated group. With few exceptions all the members of the group show similar relations with other characters. With the exception of secondary index, all are direct measurements that might be expected to increase with increased vigor; and were it not for this character the correlations with the direct measurements in the height group might be considered physiological. The same may be said of the nodes above group. The disherent correlation of tassel branches on third with nodes on third branch is also physiological, since a highly developed third branch would naturally have a larger number of tassel branches.

The clearest evidences of coherence are the correlations of secondary index with rows in central spike and that between secondary branches and branch silking first. Disherence is indicated by the negative correlations between all the tassel characters and the two characters male secondaries and length of internode on third.

MALE BRANCH GROUP

MALE BRANCH INDEX

This character was calculated by dividing the number of branches terminating in staminate inflorescences, excluding suckers, by the total number of leaves and multiplying by 100. It is thus the number of male branches expressed as a percentage of total leaves or internodes of the main culm.

In normal maize none of the branches above the suckers bear staminate flowers, although staminate tips and perfect flowered spikelets are common abnormalities. In teosinte all primary branches normally end in a staminate inflorescence. There is, then, no overlapping of either of the varieties or species with respect to this character.

The F₂ hybrid plants ranged from 0 to 71 with the mean at 37. The distribution (fig. 14) is practically symmetrical and clearly unimodal.

There are four significant correlations, all in the direction of coherences. They are with nodes without branches, nodes above, alicole index, and branch silking first. Except in the correlation with alicole index, a physiological explanation is suggested.

MALE SECONDARIES

As a measure of this character, all secondary branches on the third branch from the top of the plant that bore staminate spikelets were counted.

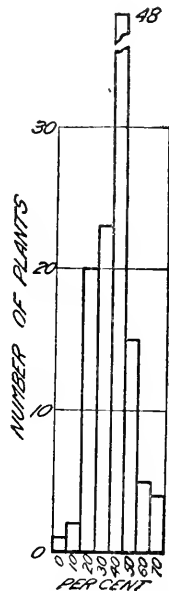

FIG. 14.—Male branch index: frequency distribution of plants in F₂. Class value, 10 per cent.

In normal maize there would be no secondary branches bearing staminate spikelets. In Florida teosinte the number is usually 2 or 3. In the F_2 hybrid plants the mean number was 2. The range was from 0 to 8. Nearly half the plants had no staminate secondaries and there is almost no indication of a second mode (fig. 15).

Nearly all the significant correlations not readily assignable to physiological relations are disherent. Thus height, total leaves, and circumference index in the height group, secondary branches and secondary index in the tassel group, branch silking first, and days to pollen all show disherent correlations. Many of these are related, since they would be similarly affected by changes in vigor, but it is difficult to understand why increased vigor should result in a smaller number of male secondaries; and the negative correlation with secondary index is difficult to understand as other than genetic.

The absence of correlation between male secondaries and male branch index, which are placed in the same group because both are measures of the tendency to produce staminate spikelets, is in itself an indication of disherence.

CHARACTERS OF THE PISTILLATE INFLORESCENCE ALICOLE GROUP

To discuss the characters of the pistillate inflorescence of the hybrids between maize and teosinte, a short preliminary description is necessary.

In maize both staminate and pistillate spikelets are borne in pairs. In the pistillate inflorescence each pair of spikelets occupies a pit or alveolus

In the staminate inflorescences there is only a faint suggestion of an alveolus. In teosinte the arrangement of the staminate spikelets is like that in maize; but in the pistillate inflorescence the spikelets are borne singly, each occupying a highly specialized alveolus. In hybrids of maize and teosinte, all permutations of the above arrangements occur, and to facilitate description the term alicole is used for the spikelet or spikelets arising from a single alveolus or having a common origin. Thus an alicole may consist of one or more staminate spikelets, one or more pistillate spikelets, or both pistillate and staminate spikelets.¹

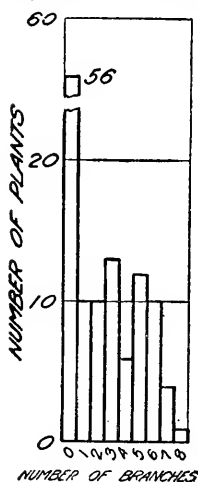

FIG. 15.—Male secondaries: frequency distribution of plants in F_2 . Class value, one branch.

¹ For a more complete discussion of the pistillate inflorescence of teosinte and maize hybrids see COLLINS, G. N. STRUCTURE OF THE MAIZE EAR AS INDICATED IN ZEA-EUCHLAENA HYBRIDS. *In Jour. Agr. Research*, v. 17, no. 3, p. 127-135, 1 fig., pl. 16-18. 1919.

In normal maize the number of rows of alicoles is always half the number of rows of grains. In the hybrid plants, however, 4-rowed spikes may consist of either two rows of alicoles, each with two seeds, or four rows of alicoles, each with a single seed. Plants exhibiting the range of variation with respect to the pistillate inflorescence are shown in Plates 2 to 5.

As a basis of comparing the pistillate inflorescences of the hybrid plants, the best-developed spike on the third branch from the top of the plant was chosen and the number and nature of the alicoles were recorded. To eliminate as far as possible differences associated with the size of the spike, the number of alicoles of the classes single male, double male, single female, double female, and mixed (one male and one female) was expressed as a percentage of the total number of alicoles in the spike.

DOUBLE MALE ALICOLES

Neither maize nor teosinte normally produces male spikelets in the pistillate inflorescences. In the F_2 hybrids, however, out of 123 plants in which the nature of the pistillate inflorescences was determined, 18 had some alicoles with two staminate spikelets, in 2 plants the number being as high as 50 per cent (fig. 16).

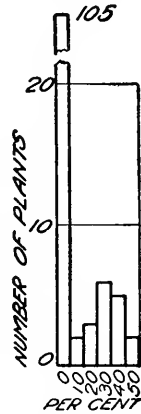

FIG. 16.—Double male alicoles: frequency distribution of plants in F_2 Class value, 10 per cent.

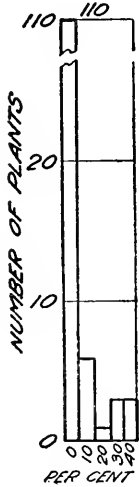

FIG. 17.—Mixed alicoles: frequency distribution of plants in F_2 Class value, 10 per cent.

MIXED ALICOLES

Mixed alicoles are not a character of either maize or teosinte. There were, however, 13 F_2 hybrid plants with mixed alicoles, the highest percentage being 40 (fig. 17).

SINGLE FEMALE ALICOLES

Single female alicoles are a universal character of teosinte, while in maize no variety is known in which the seeds are not paired. Single female alicoles may occur in rare instances on a part of an ear of maize where the number of rows is reduced toward the tip.

In the F_2 hybrid plants, although there was practically a continuous series from 0 to 100 per cent, there were distinct indications of a tendency to segregate into the two parental forms, there being two modes, one at 0, the other at 100 (fig. 18). The numbers at these two modes were 34 and 12, indicating that the maize character is dominant.

In this connection it should be recalled that in the F_1 plants the alicoles of the pistillate inflorescence all bore two spikelets.

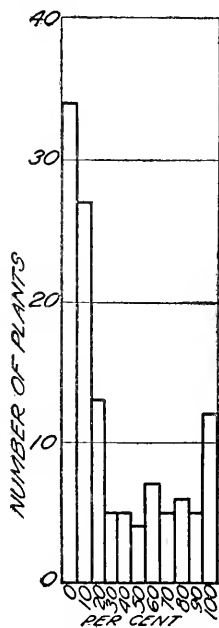

FIG. 18.—Single female alicoles; frequency distribution of plants in F_2 . Class value, 10 per cent.

or the double alicoles of maize to predominate is the nearest approach to Mendelian behavior among the characters recorded.

The measurements of the alicole group form such a closely related series that their correlations may be discussed together. Significant coherences are shown with both characters of the male branch group and with number of alicoles, rows in the central spike, and number of suckers. The only significant disherence is between single female alicoles and primary branches.

Some of the coherences may be of a physiological nature, but the almost complete absence of any evidence of disherence with this group of characters which most nearly approaches an alternative method of inheritance should perhaps be noted.

DOUBLE FEMALE ALICOLES

Double female alicoles may be considered allelomorphic to single alicoles, but owing to the occurrence of plants with small percentages of double male and mixed alicoles the percentages are not exact reciprocals. There is, however, the same bimodality (fig. 19), the numbers indicating the dominant nature of this character.

ALICOLE INDEX

With the idea that mixed and male alicoles were in the nature of abnormalities, the number of single female alicoles was expressed as a percentage of the combined single and double female alicoles. There were 36 plants with no single female alicoles and 19 with no double female alicoles.

If the individuals are separated into two groups at the low point in the bimodal curve, which is 50 per cent, the numbers are 83 below this point and 37 above (fig. 20).

The tendency for either the single alicoles of teosinte

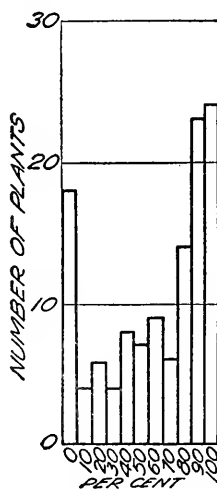

FIG. 19.—Double female alicoles; frequency distribution of plants in F_2 . Class value, 10 per cent.

NODES SILKING GROUP

NODES SILKING ON THIRD

This character, which is the number of nodes producing silk on the third branch from the top, was chosen with the idea of indicating the distinction between teosinte and maize with respect to the production of secondary fruiting branches on the upper part of the main culm. In all varieties of maize, branches from the upper part of the plant are normally simple, though secondary ears are a common abnormality. The branches of the ears of *Zea ramosa* are not subtended by bracts, and they arise from separate internodes only in the sense that branches from the tassel represent separate internodes.

Teosinte normally produces silks at two or three nodes of the third branch from the top. The average for 87 Florida teosinte plants was 2.3, with a range from 0 to 4. Since there are seldom more than 4 nodes on the third branch, the difference is more significant than the numbers would make it appear.

In the F₂ hybrid plants the range was from 0 to 10, with the mean at 5.5. The distribution (fig. 21) is practically symmetrical and unimodal.

There are three significant correlations with this character, but all appear to be physiological. The positive correlation with nodes on third branch is obviously almost physical; that with male secondaries is only slightly less so. The correlation with position of best spike of 0.47 might be considered a disherence, but it seems not unreasonable that with more nodes silking the best spike would, on the average, be located farther from the base. This is supported by the negative correlation of node silking index with position of best spike.

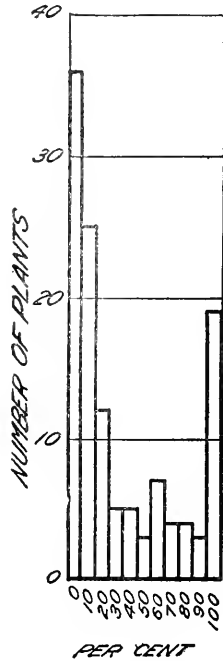

FIG. 20.—Ailicole Index: frequency distribution of plants in F₂. Class value, 10 per cent.

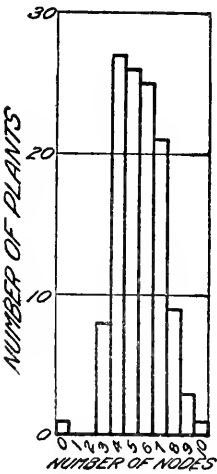

FIG. 21.—Nodes silking on third: frequency distribution of plants in F₂. Class value, one node.

NODES SILKING INDEX

The number of secondary branches silking as expressed in the preceding character is very definitely associated with the length of the third branch, the branches with more nodes having the greatest number

silking. With a view to obtaining an expression of the tendency to produce secondary branches independent of the length of the primary branch, the number of nodes silking on the third branch was expressed as a percentage of the total number of nodes on the branch.

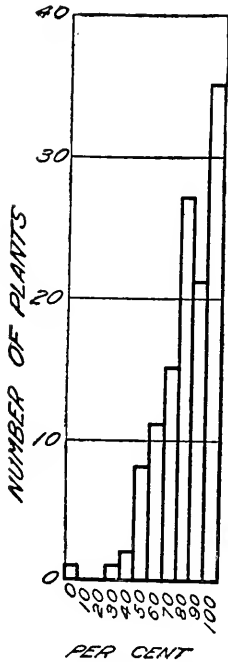

FIG. 22.—Nodes silking index: frequency distribution of plants in F₂. Class value, 10 per cent.

character is therefore one that is sharply contrasted in the parents. Two of the F₁ plants in which this character was recorded each produced a single prophyllary spike.

In the second generation, 23 of the plants either had no prophyllary branch or it was not sufficiently developed to bear a spike. In 23 plants the branch consisted of an unbranched spike. The remaining 68 plants had from 2 to 14 spikes. The mean number for all plants was 3.1, the distribution (fig. 23) being skew but with no evidence of more than one mode. The three significant correlations are all coherent, but all may be physiological.

In teosinte the percentage is normally 100,¹ in maize 0. In F₂ hybrid plants the range was from 0 to 100. The modal number was 100, with the numbers diminishing with fair regularity to 0 (fig. 22). The mean was 78.

With the exception of the negative correlation with position of best spike, all the coherences are obviously physiological. On the other hand, the disherent correlation with height would appear to be genetic.

PROPHYLLARY GROUP
PROPHYLLARY SPIKES

Prophyllary branches are rare in maize and have never been observed in Tom Thumb. In varieties where prophyllary branches do occur they are simple. In teosinte, prophyllary branches are always well-developed; and in Florida teosinte, the average number of spikes is 6.3, with a range from 3 to 11. The disposition of the spikes in teosinte is shown in Table I. This

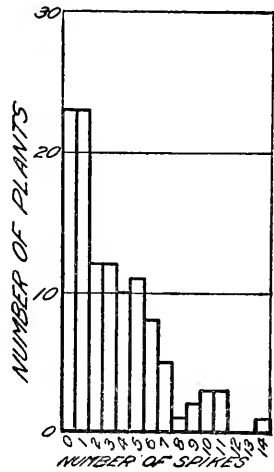

FIG. 23.—Prophyllary spikes: frequency distribution of plants in F₂. Class value, one spike.

¹ This follows from the fact that although there is no branch produced in the axil of the uppermost leaf there is a fruiting branch borne in the axil of the prophyllum.

LENGTH OF PROPHYLLARY

This character is closely associated with the number of spikes in the prophyllary, and like that character it distinguishes sharply between the parental varieties and species.

The mean length of the prophyllary branch in 87 plants of Florida teosinte was 10.8 cm. The mean length in the F₂ hybrid plants was 13.4 cm. There was some evidence of two modes (fig. 24), one at 0, the other at 13.

There are three significant coherent correlations—namely, with male secondaries, nodes silking index, and length of internode on third.

The correlation with position of best spike is also significant but disherent.

Although prophyllary spikes and length of prophyllary have a positive correlation of 0.59, the first is negatively correlated with position of best spike while the correlation with the second is negative. Thus, as the prophyllary branch becomes longer there are more spikes, but they are smaller.

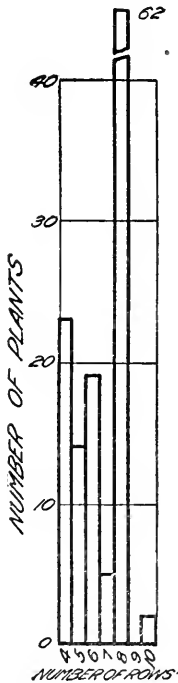

FIG. 25.—Rows in central spike: frequency distribution of plants in F₂. Class value, one row.

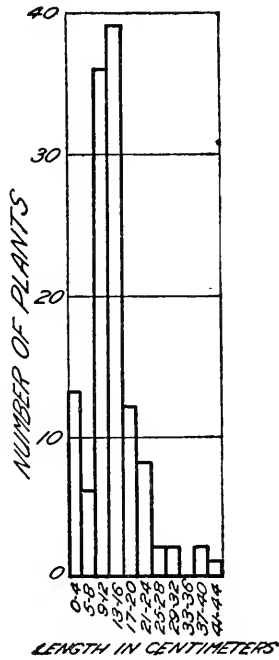

FIG. 24.—Length of prophyllary: frequency distribution of plants in F₂. Class value, 4 cm.

NUMBER OF ROWS GROUP
ROWS IN CENTRAL SPIKE

The number of rows of spikelets in the central spike of the tassel is a close homologue of the number of rows of seeds in the pistillate inflorescence. At first thought this might seem not to be the case in teosinte where all the spikes of the staminate inflorescence are 4-rowed and those of the pistillate inflorescence are 2-rowed. This apparent disagreement is occasioned by the suppression of one of each pair of spikelets in the pistillate inflorescence, there being in each instance 2 rows of alicoles.

In maize, so far as observed, plants with 8-rowed ears always have 8-rowed central spikes. With the higher number of rows the arrangement in the central spike becomes indistinct.

In pure teosinte there is, properly speaking, no central spike, since the last division of the inflorescence gives two equal branches, each bearing 4 rows of spikelets. In the F_2 hybrid plants there were all stages from the condition found in teosinte, which was recorded as 4-rowed, to a well-formed central spike; and the number of rows is one of the best measures of the differentiation into a central spike. In many plants the number of rows was greater by 2 at the base of the spike than at the top. In such instances the intermediate odd number was assigned,

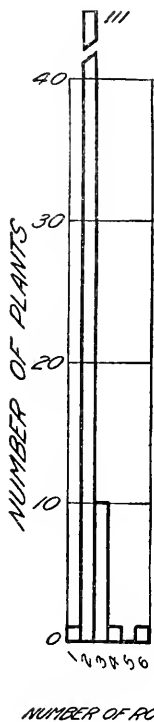

FIG. 26.—Rows of alicoles: frequency distribution of plants in F_2 . Class value, one row.

The distribution (fig. 25) was slightly bimodal, the modes being at 4 and 8, with the mean at 6.6.

All the significant correlations with this character are coherences, though none are very close.

It is of interest that the only other tassel character showing coherence with rows in central spike is secondary index. All other tassel measurements might be expected to increase with increased vigor; and since coherences would appear as negative correlations, any tendency for rows of central spike to increase with size would reduce the coherences. Two of the five alicole characters show significant coherences. There is also a significant coherence with number of alicoles.

ROWS OF ALICOLES

The number of rows of alicoles in the pistillate inflorescence is one of the most striking differences between teosinte and maize. In all varieties of teosinte the number is 2. The lowest number in maize is 4, as is characteristic of all 8-rowed varieties. In the large-eared varieties the number reaches 18. All the F_1 plants had uniformly 2 rows of alicoles, indicating the dominance of the teosinte character.

In the second generation 111 out of 123 plants also had 2 rows (fig. 26). This number is 19 in excess of the number expected if the character were behaving as a simple Mendelian unit. The uniformity of the F_2 plants with respect to this character made it impossible to determine correlations, but of the 12 plants with more than 2 rows of alicoles all but 1 had more than 4 rows in the central spike.

INDEPENDENT CHARACTERS

POSITION OF BEST SPIKE

In maize the pistillate spike is terminal on the branch. In teosinte there are usually a number of spikes of nearly equal size, the prophyllary branch usually producing spikes as large as any on the branch.

In the F_2 hybrid plants this character was determined on the third branch. The nodes were numbered from the base of the branch, the prophyllary branch being recorded as 0. The range was from 0 to 9, with the mode at 3. The mean was 2.22. The distribution (fig. 27) was decidedly skew, but there was little evidence of more than one mode.

In its relation to other characters, this character is very irregular. The large number of disherent correlations may indicate that the terminal position of the pistillate inflorescence in maize is not inherited as a tendency for the lateral pistillate inflorescences to be located near the top of the branch. When secondary ears are developed in maize they are always near the base of the branch, and the expression of this tendency in inheritance may be the explanation of the apparently disherent correlations.

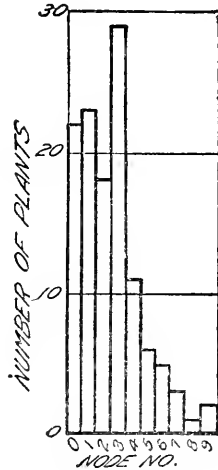

FIG. 27.—Position of best spike: frequency distribution of plants in F_2 . Class value, one node.

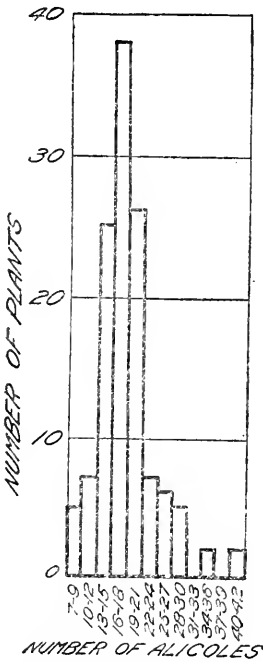

FIG. 28.—Number of alicoles: frequency distribution of plants in F_2 . Class value, three alicoles.

NUMBER OF ALICOLES

The number of alicoles in a well-developed spike of Florida teosinte is 7. In Tom Thumb maize the number is seldom less than 100. The lowest number recorded in a normal ear of maize is 50, in a Peruvian variety from the region of Lake Titicaca. This is, therefore,

one of the characters in which there is no approach to overlapping in the parental species.

The F_1 plants had spikes with from 11 to 18 alicoles. In the second generation the range was from 7 to 40. The mean was 17.85 with nearly symmetrical distribution (fig. 28), the mode being at 16.

The significant coherences with characters in the alicole group afford perhaps the most direct evidence that has appeared that the characters of the pistillate inflorescence tend to be inherited as a unit.

The correlation with rows in the central spike is perhaps physiological. There are no significant disherences.

NUMBER OF SUCKERS

Florida teosinte is characterized by a large number of suckers or branches that arise from below or near the ground. In a population of Florida teosinte at Chula Vista, grown in 1917, the average number of suckers was 14. Tom Thumb never produces suckers on normal plants, and no variety of maize has been studied that produces as many suckers as teosinte. The expression of this character is so dependent on environmental conditions, however, that statements regarding the range in maize would have little value. The most vigorous F_1 plant produced 11 suckers.

In the second generation the range was from 0 to 32, with the mode at 13 and the mean at 11.7. There is no evidence of more than one mode (fig. 29).

There are, in all, three significant correlations with this character, nodes without branches, single female alicoles, and double female alicoles—all of them coherences. The first of these is obviously physiological, since a large number of suckers and a small number of vacant nodes are both expressions of a tendency to produce branches. The other two are practically different expressions of the same character and indicate a coherence.

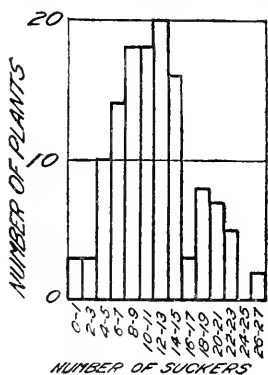

FIG. 29.—Number of suckers: frequency distribution of plants in F_2 . Class value, two suckers. One plant at 32.

BRANCH SILKING FIRST

In recording this character the primary branches were counted from the top. In maize the uppermost branch is the first to silk, except in rare instances where the second ear may silk a day or two in advance of the first. In teosinte the fourth or fifth branch is usually the first to silk. This character therefore distinguishes sharply between the parents with respect to both the variety and the species.

The F_2 hybrid plants ranged from 1 to 5, with equal numbers at 1 and 2. The mean was 1.9, the distribution (fig. 30) was skew and unimodal.

With the height group there are two significant correlations, one a coherence with total leaves, the other a disherence with sucker index. This disherence doubtless results from the negative correlation between total leaves and sucker index. The partial correlation of node silking first

with either total leaves or sucker index, with the other character constant, is less than three times the probable error. There are also significant correlations with all the characters of the nodes above group. These correlations are in a sense physical, since the value representing the node silking first must always be greater than the nodes above. In the male branch group there is a significant coherence with male branch index and a disherence with male branches on third. In addition there are significant coherences with secondary branches, position of best spike, and days to pollen.

DAYS TO POLLEN

Although profoundly influenced by the environment, the length of time before pollen is shed is the best measure of the length of season required for development. Under similar conditions there are few varieties of maize that require so long a time to mature as Florida teosinte, and Tom Thumb is one of the earliest varieties of maize. The period for Florida teosinte under conditions similar to those where the hybrid plants were grown was 162 days, and for Tom Thumb 43 days.

The average time for the F_1 was 98 days. The F_2 plants averaged 112 days, with a single mode at 96 days (fig. 31). The earliest plant flowered in 71 days, and the latest required 165 days from the date of planting.

With characters of the height group there are two significant coherences, height and total leaves, and two significant disherences, sucker index and nodes without branches.

The correlation with height is an especially striking coherence, since the positive correlation is 0.47 while the same correlations in both teosinte and Tom Thumb are negative, being 0.46 and 0.11, respectively. Days to pollen and total leaves in teosinte have a correlation of 0.14, a correlation significantly lower than the 0.79 of the hybrids.

The negative correlation with sucker index appears to result from the negative correlation of

sucker index with total leaves.

The coherence with nodes above on third is barely significant and may be physiological. There are significant coherences with three of the four tassel measurements, and in Tom Thumb the three tassel measurements recorded are all negatively correlated with days to pollen.

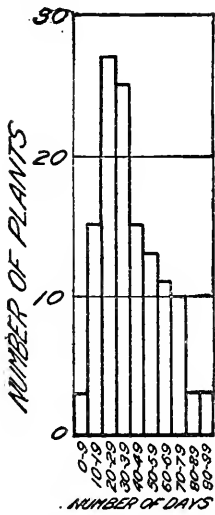

FIG. 31.—Days to pollen: frequency distribution of plants in F_2 . Class value, 10 days.

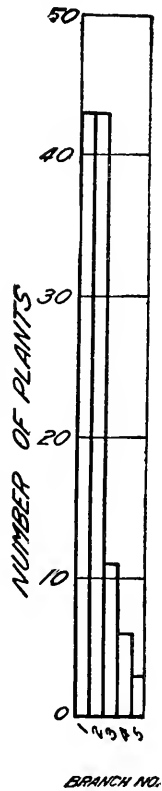

FIG. 30.—Branch silking first: frequency distribution of plants in F_2 . Class value, one branch.

There are also significant coherences with number of alicoles and node silking first. The disherent correlations with male secondaries and length of internode on third appear to be genetic. That with length of internode on third is the highest coefficient with days to pollen.

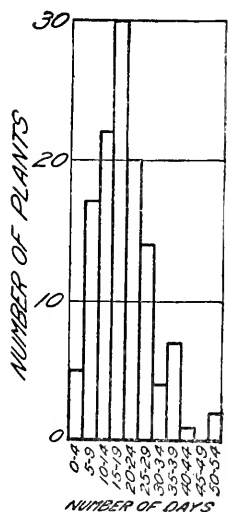

FIG. 32.—Pollen to silk; frequency distribution of plants in F₂. Class value, five days.

ing from 0 to 53 days, with the mean at 18.3. The distribution (fig. 32) was symmetrical and unimodal.

There are but two significant correlations with this character, both coherences. These are with circumference index and position of best spike. The latter is in one sense physiological.

LENGTH OF INTERNODE ON THIRD

This character was determined by dividing the length of the third branch by the number of internodes. The branches from the upper nodes of a maize plant are much shortened. An accurate measure is impossible on account of the difficulty of accurately determining the number of nodes. In Tom Thumb it would, however, be somewhat less than 1 cm., and in normal maize plants of any variety it would scarcely exceed 3 cm. In a normally developed teosinte plant the internodes of the third branch will average about 10 cm. This character was not recorded in the first generation. In the F₂ plants the mean was 10.9 cm. The range was from 2 to 22, with practically a normal distribution (fig. 33).

POLLEN TO SILK

Maize is normally proterandrous. There are, however, proterogynous strains of maize, and proterogynous individuals in almost any strain are not uncommon. Tom Thumb is normally proterandrous by about 10 days. Florida teosinte appears to be normally proterogynous. It has always been so in our experiments; and an examination of the fields at Clarcona, Fla., in 1914, showed the plants to be silking from 7 to 10 days before pollen. Durango teosinte, on the other hand, under most conditions is proterandrous.

In both maize and teosinte this character is especially susceptible to environmental influence. The F₁ plants were decidedly proterandrous at both Lanham and Chula Vista. None of the F₂ plants were proterogynous, the proterandry rang-

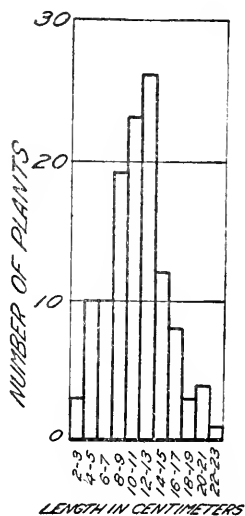

FIG. 33.—Length of internode on third; frequency distribution of plants in F₂. Class value, 2 cm.

This character might be expected to be closely related to number of nodes on third, since in a mathematical sense it is a function of that character. However, the correlation between length of internode on the third branch and nodes on third is -0.05 .

Length of internode on third shows a larger number of significant correlations than does any other character.

A high expression of the character might be expected to be associated with increased general vigor, but many of the correlations are in the opposite direction. There is distinctly more evidence of disherence than of coherence. In fact, three of the four significant coherences may be physiological, while most of the disherences are not to be explained in this way.

Especially significant are the pronounced negative correlations with height and total leaves. Only slightly less striking are the negative correlations with two of the tassel characters.

DISCUSSION OF CORRELATIONS

It would be very difficult, if not impossible, to determine with accuracy the number of independent correlations. The interrelation of the characters is of a most intricate nature; and even if the data warranted the calculation of the partial correlations of each pair with all other characters constant, the facts would still be very inadequately represented. Correlations take no account of causation or the sequence in which characters are determined.

It is clear that the values of some characters are directly influenced by others, the relation being causal in nature. Thus the number of total leaves acts as a limiting factor to the number of branches ending in male flowers, and the correlation of any character with number of branches ending in male flowers may to some extent follow as a secondary relation to the correlation between the character in question and total leaves. On the other hand, it is obviously absurd to reason that branches ending in male flowers may influence the total leaves; and to correct the correlation with total leaves by making branches ending in male flowers constant might represent a mathematical relation, but the determination would have no biological significance.

An attempt was made to determine whether the more striking disherent correlations might result from the correlations of other interrelated characters. Thus height and the index of nodes silking on the third branch, which showed a disherent correlation of -0.46 , were found to be mutually correlated with four other characters to an extent that would materially influence the correlation in question. The partial correlation of height and index of nodes silking on the third branch with all of the

four correlated characters constant was found to be -0.69 . Such relations must stand, therefore, as disherences so far as the recorded data are concerned.

A study of the correlations shows that within wide physiological limits there are no incompatible combinations. On the other hand, all the characters are in a sense interrelated. Having in mind the theory that ascribes the determinants of characters to definite locations on the chromosomes, the authors examined the correlations to determine whether there were groups of characters between which there were no significant correlations. No such grouping was apparent, and it was possible to arrange the entire series so that they formed a single group with no correlation lower than ± 0.31 .

If the results of this experiment are interpreted in terms of the theory mentioned above, it follows from the blended character of the inheritance that practically all the characters result from the combined action of numerous factors. The failure of the characters to fall into groups the members of which are genetically correlated further indicates that the factors for the individual characters must be distributed in different chromosomes.

CORRELATION AMONG DESIRABLE CHARACTERS

Among the characters measured, a certain few are indicative of desirable characteristics from the standpoint of a forage plant. The more important of those are (1) total leaves, indicative of the luxuriant foliage of the teosinte, (2) circumference index, a small circumference in proportion to the height indicating the slender, edible stalks of the teosinte, (3) nodes silking on third branch, indicating the profuse production of seed of the teosinte, (4) number of suckers, indicating the abundant production of forage of the teosinte, (5) male branch index, indicative of the numerous branches of teosinte, (6) number of alicoles in the best spike, indicating the large pistillate inflorescences of maize, (7) rows in the central spike, indicating the many-rowed inflorescences of maize, and (8) days to pollen, a low value indicating the short season of maize.

The interrelation of these selected characters is shown in Table VI. Of the 27 combinations of these characters there are 9 in which both of the desired characters are possessed by teosinte, 3 in which both are possessed by maize, and 15 where it is desired to combine teosinte and maize characters.

TABLE VI.—*Correlation of characters desirable in a forage plant^a*

Characters considered.	Circumference index.	Nodes silking on third.	Number of suckers.	Male branch index.	Number of alicoles.	Rows in central spike.	Days to pollen.
Total leaves.....	-0.31	0.05	-0.10	-0.07	-0.18	-0.14	0.79
Circumference index.....		.00	-.19		.12	-.03	-.17
Nodes silking on third.....			.01	-.19	.05	-.03	.07
Number of suckers.....				.14	-.11	-.02	-.09
Male branch index.....					.06	-.04	.03
Number of alicoles.....						.37	-.29
Rows in central spike.....							-.09

^a Figures in bold-face type indicate coefficients of correlation between the characters where a combination of teosinte and maize characteristics is desired.

Of the 15 character pairs where new combinations are desired, there is only one significant correlation. This is days to pollen and total leaves. In this one instance the relation is in a sense physical, since there is obviously a physical limit to the number of leaves that can be developed in a very short season. The indications from this comparison are, therefore, that coherence presents few obstacles to the securing of desired combinations. (Pl. 2; 6, A, B.)

Another view of the comparative independence of the characters may be gained by an examination of the plants that were most like maize or teosinte with respect to some of the more important characters. Table VII is provided to make this possible. Each pair of columns gives the measurements for two plants, one of which was the most like maize and the other the most like teosinte with respect to the character named at the head of the column.

TABLE VII.—*Comparison of individual plants, showing the extreme variations toward maize and teosinte, respectively^a*

Characters considered.	Average.	Height.		Total leaves.		Height of sucker.		Sucker index.		Circumference index.		Male branches. ^b		Number of suckers.		Number of alicoles.		Days to pollen.		Rows of alicoles.		
		Maize-like (plant 19).	Teosinte-like (plant 38).	Maize-like (plant 17).	Teosinte-like (plant 62).	Maize-like (plant 78).	Teosinte-like (plant 20).	Maize-like (plant 78).	Teosinte-like (plant 19).	Maize-like (plant 115).	Teosinte-like (plant 64).	Maize-like (plant 46).	Teosinte-like (plant 62).	Maize-like (plant 81).	Teosinte-like (plant 35).	Maize-like (plant 136).	Teosinte-like (plant 24).	Maize-like (plant 27).	Teosinte-like (plant 38).	Maize-like (plant 36).	Teosinte-like (plant 49).	
Height.....	14	4	23	14	20	14	4	8	17	...	22	9	14	15	17	9	23	14	11	14	24	
Total leaves.....	23	22	33	13	38	23	26	23	22	...	23	29	38	19	20	23	28	21	33	19	24	
Height of sucker.....	16	20	21	17	23	6	27	6	20	18	17	7	23	0	16	16	19	13	21	15	12	
Sucker index.....	112	460	90	130	100	50	140	50	460	230	100	...	100	0	110	110	110	140	90	110	110	
Circumference index.....	4.5	...	3.5	...	4.4	4.0	...	4.0	...	9.1	2.4	...	4.4	3.5	4.3	5.5	...	5.0	3.5	5.0	5.0	
Male branches ^b	8	9	5	12	21	5	5	5	9	18	9	...	0	21	5	6	10	9	6	5	5	7
Number of suckers.....	12	14	8	21	7	4	15	4	14	11	14	2	7	0	23	13	20	15	8	3	15	
Number of alicoles.....	18	19	17	34	21	15	21	10	23	21	29	34	17	9	40	7	12	17	30	9	9	
Days to pollen.....	112	103	105	103	121	100	108	100	103	142	106	...	121	129	138	100	131	69	165	110	110	
Rows of alicoles.....	2.1	2	2	2	3	2	2	2	2	3	2	2	3	2	3	2	2	2	2	3	2	

^a Each pair of columns gives the measurements of two plants, one of which was most like maize and the other most like teosinte with respect to the character given at the head of the columns. The value of the character for which the plant was selected is given in bold-face type. For description of units of measurement, see p. 7-8.

^b The number of primary branches that terminate in a staminate panicle, exclusive of suckers.

It may seem that, except for the character chosen, the values for the most part depart little from the mean values. For example, under total leaves the most maize-like plant which had 13 leaves was particularly maize-like in no other character. It was even below the average in number of alicoles in the best spike and had almost the maximum number of suckers. On the other hand, the plant with the greatest number of leaves had also the greatest number of male branches but was decidedly maize-like with respect to number of suckers and number of alicoles.

CONCLUSIONS

The genetic relations of the principal characters of maize and teosinte were investigated in a cross between a small variety of pop corn and Florida teosinte, a large forage grass generically distinct from maize. The F_1 plants showed characters which, for the most part, were intermediate between those of the parents.

The F_2 plants were also intermediate, with a greatly extended range of variation. Thirty-three of the characters that differentiate the parents were chosen and recorded for each of the 127 F_2 plants. The distribution of these characters with one or two exceptions showed little or no evidence of alternative or Mendelian inheritance.

With respect to the individual characters, the extreme variants approached, and in some instance exceeded, those of the parents; but none of the plants possessed any large number of the characters of either maize or teosinte.

The results showed the greatest freedom of recombination. All combinations of characters appeared that might reasonably be expected with so limited a number of individuals. There were many instances of coherence or partial coupling, but there was an almost equal number of instances where characters derived from different parents showed a tendency to combine more frequently than would be expected as the result of chance. In such a complicated series it was found impossible, however, to distinguish primary from secondary correlations.

While there appeared to be no incompatible combinations, there were, on the other hand, no completely independent characters. Every character recorded showed significant correlation with one or more other characters; and these in turn were correlated with still others, with the result that all the characters were interrelated and formed a single group. It is possible, in fact, to arrange all the characters in such a way that they form a single group in which there is no coefficient of correlation lower than ± 0.31 .

The nearest approach to Mendelian inheritance was shown by the arrangement of the spikelets in the pistillate inflorescence (fig. 18, 19, 20). In maize the female spikelets are borne in pairs (double female alicoles); in teosinte the female spikelets are borne singly (single female

alicoles). Dominance of the maize character was complete in the first generation. In the second generation the segregation was not complete, there being many plants with both single and double female alicoles; but the number of individuals in which double female alicoles predominated was approximately three times the number in which there were more single female alicoles.

It was found that the characters of the pistillate inflorescence were subdivided in transmission to a remarkable degree. Thus the maize ear, instead of behaving as a unit, was subdivided into a large number of separately inherited units, such as number of rows, closely crowded seeds, and shortened peduncles, all of which were inherited more or less independently. Number of rows was still further resolved into paired or single spikelets and the number of rows of alicoles in which they were borne.

A surprisingly large number of the plants combined the abundant production of suckers characteristic of the teosinte parent with the sturdy, upright character of maize and resulted in very leafy, compact plants of a type that should prove valuable for forage purposes. (See Pl. 6, A.)

It remains to be seen whether the new combinations can be maintained and made to breed true. The results of previous experiments with maize hybrids would indicate that selection for a few generations will fix any desired combination.

PLATE I

A.—General view of F_2 plants of teosinte-maize hybrid.

B.— F_2 plants of teosinte-maize hybrid, showing diversity in size and season.

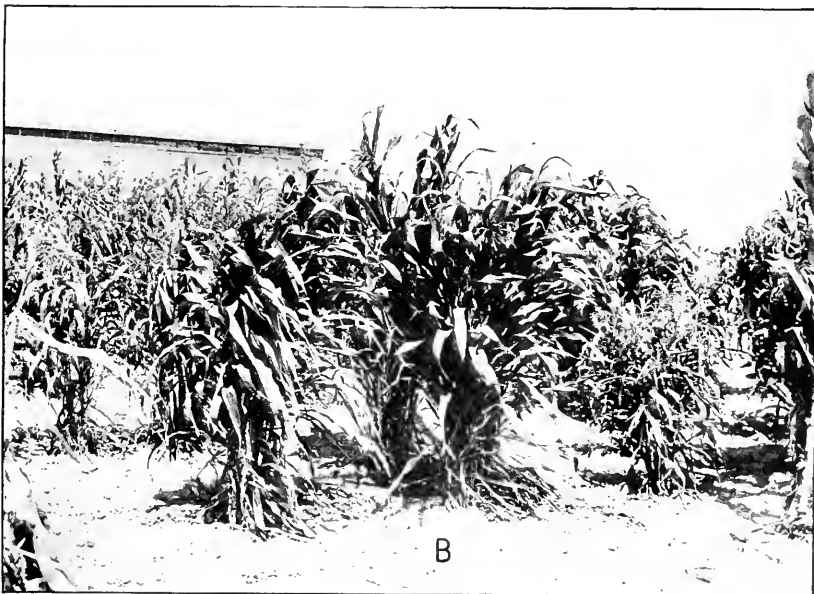
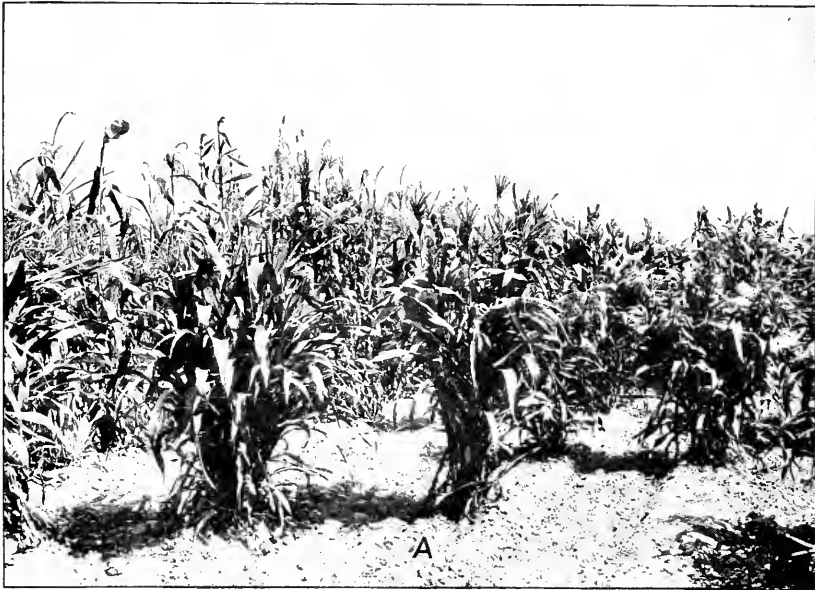



PLATE 2

Teosinte-maize hybrid:

A.—F₂ plant No. 36. This plant bore the most maize-like pistillate inflorescence that appeared in the second generation.

B.—F₂ plant No. 49. The pistillate inflorescences of this plant were among those most nearly resembling teosinte.

PLATE 3

Teosinte-maize hybrid:

Pistillate inflorescence of F_2 plant No. 36, shown in Plate 2, A. Natural size.

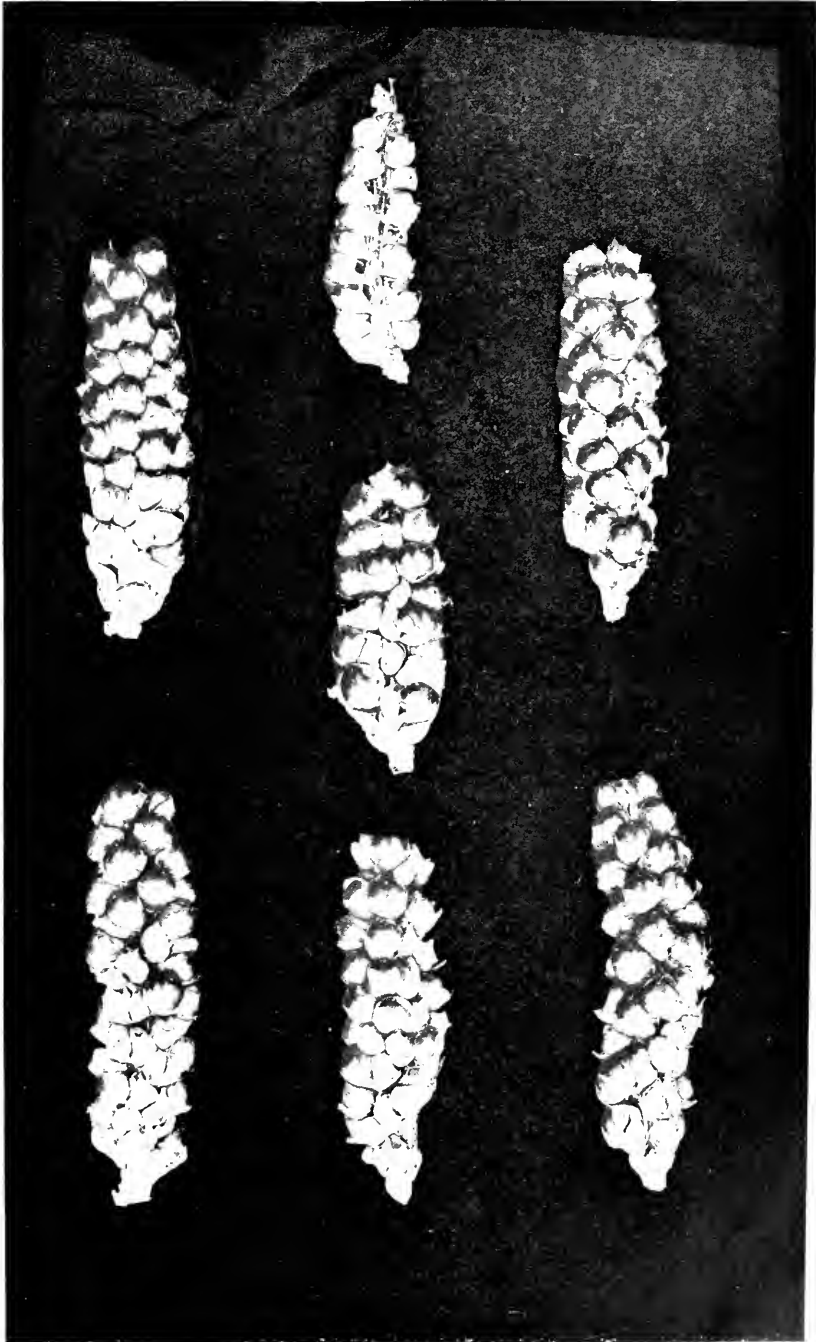

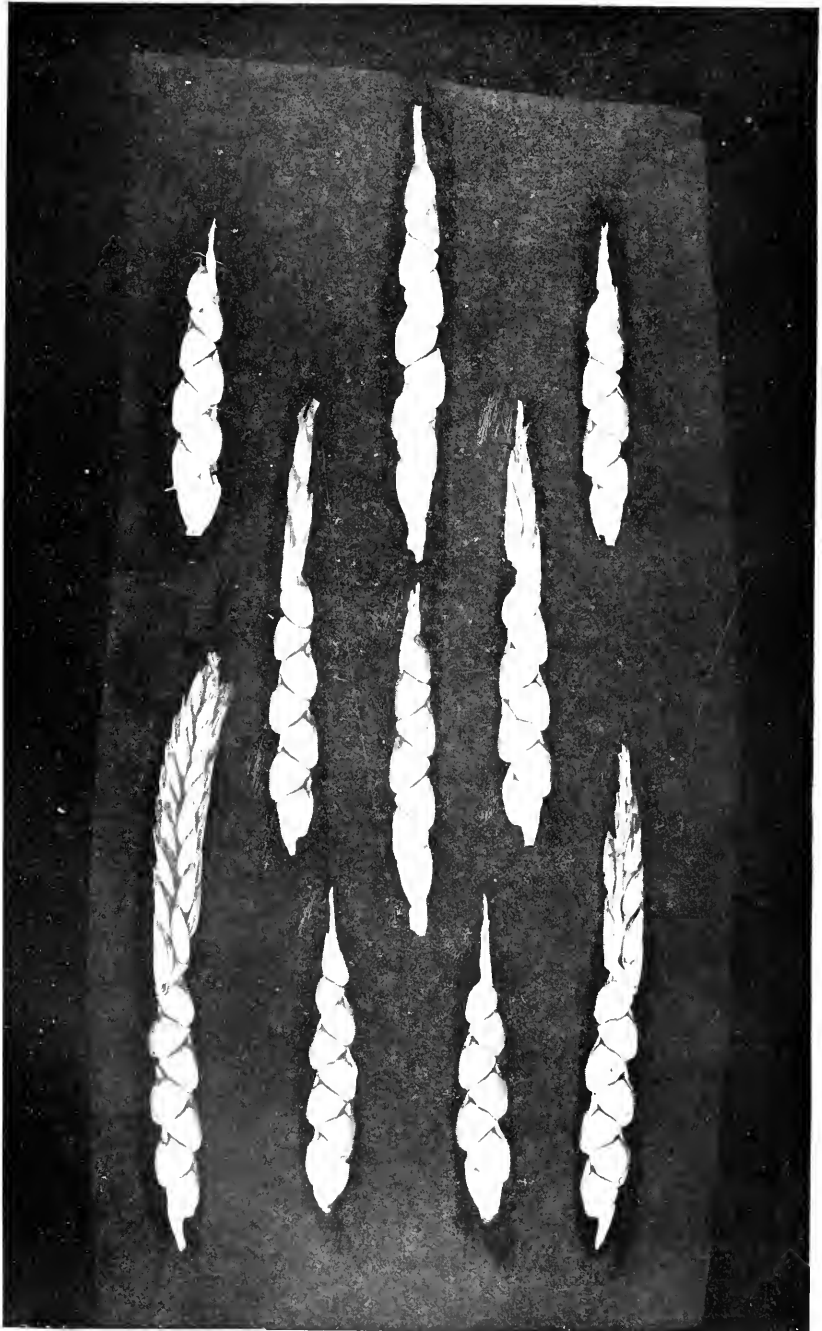
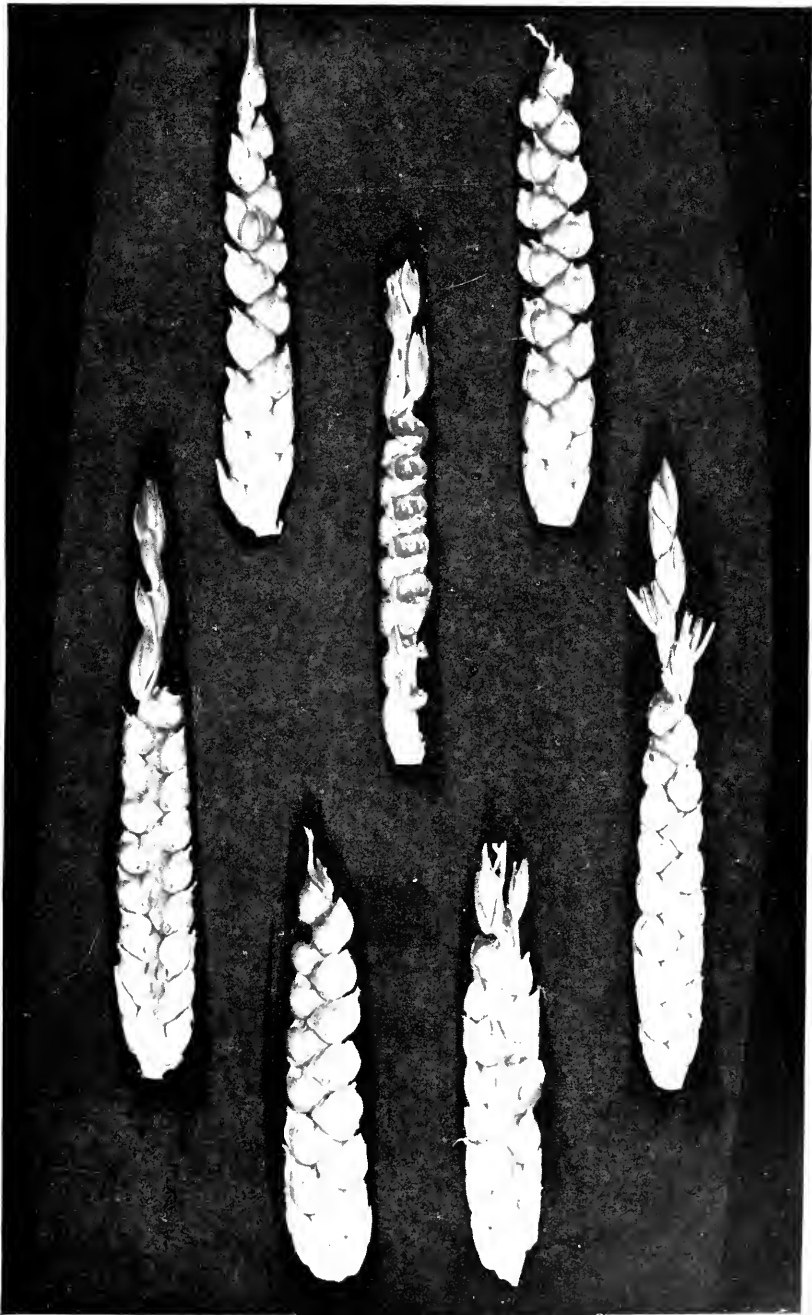

PLATE 4

Pistillate inflorescence of plant No. 49, shown in Plate 2, B.

PLATE 5

Pistillate inflorescences from plant No. 94, illustrating an intermediate type of inflorescence. The arrangement of the alicoles is much like that of teosinte, but 90 per cent of the alicoles are double female.



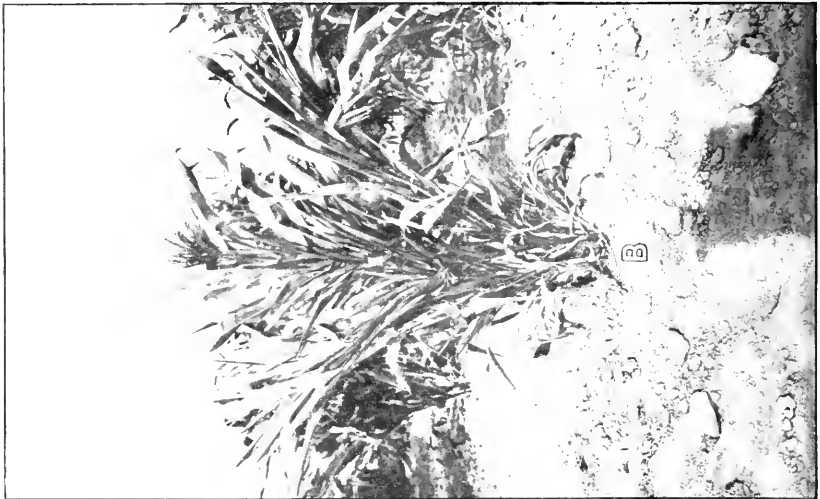

PLATE 6

Teosinte-maize hybrid:

A.—F₂ plant No. 31, showing compact growth characteristic of many of the plants. Although only 14 dcm. high, this plant had 30 leaves on the main culm, nearly equaling teosinte in this respect. The plant resembled maize in having no spikes developed in the axil of the prophyllum.

B.—F₂ plant No. 113, showing stiff, erect leaves. This plant resembled teosinte in being very late in maturing, yet it was among the most maize-like with respect to circumference index.

C.—F₁ plant, grown at Lanham, Md.

PLATE 7

Teosinte-maize hybrid:

Pistillate inflorescences of the F_1 plant shown in Plant 6, C.

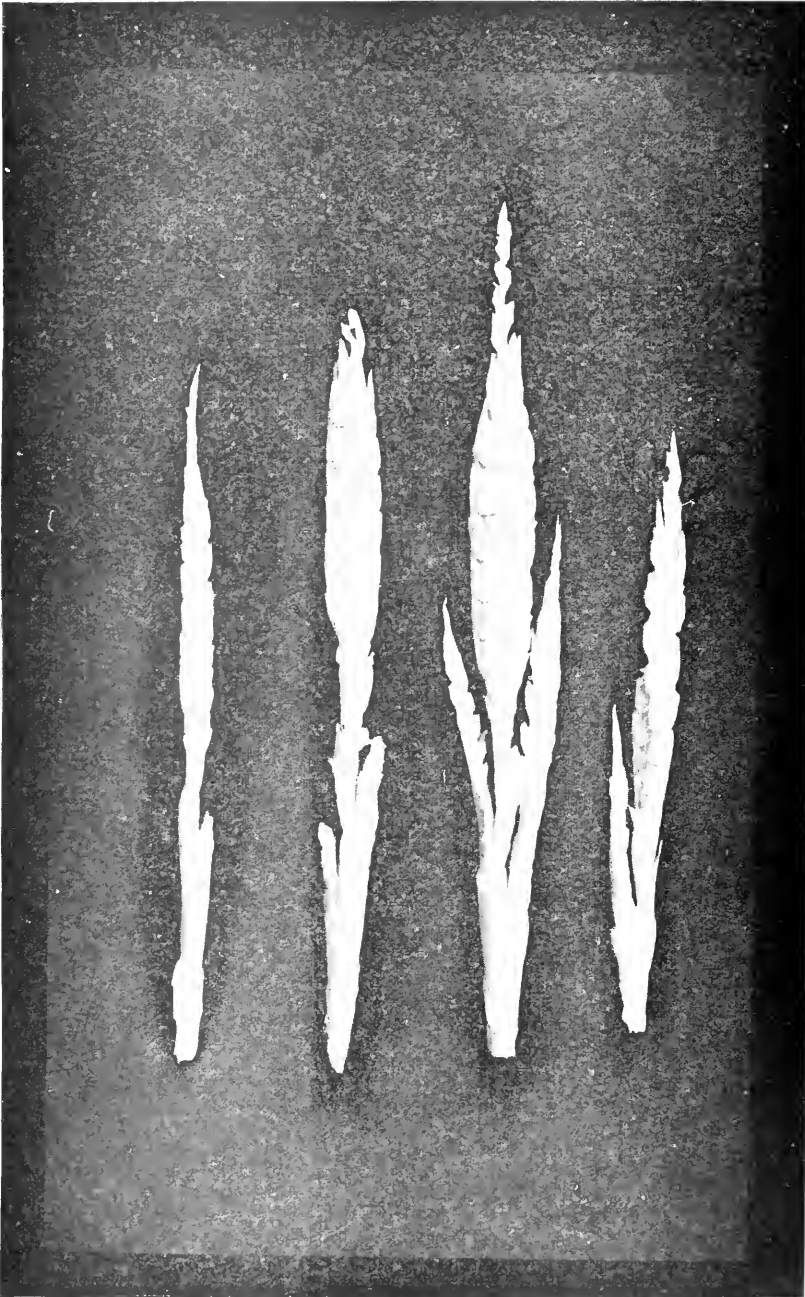

BANANA ROOT-BORER

By G. F. MOZNETTE¹

Entomological Inspector, Tropical and Subtropical Fruit Insect Investigations, Bureau of Entomology, United States Department of Agriculture

INTRODUCTION

The existence in Florida of a root-weevil peculiar to the banana was brought to the writer's attention in December, 1917, by the receipt of some specimens from a grower near Larkins, in Dade County, Fla., who advised the writer of serious damage to his banana plants. The insect was determined by Dr. W. Dwight Pierce at Washington, D. C., as the banana root-borer, *Cosmopolites sordidus* Germar, a dangerous banana pest prevalent in almost every section where bananas are grown for commercial purposes. Since this species and all plants infested with it had been declared to be public nuisances in Florida, the State Plant Board at Gainesville, Fla., was immediately notified, and eradication and inspection work was begun. It was during the eradication and inspection work that the writer, cooperating with members of the State Plant Board, was enabled to make a number of observations on the habits of this species; and it was thought well to publish the following data to aid others who may find this pest of the banana in the State of Florida or wherever bananas are grown.

A national quarantine was placed on this species April 1, 1918. This quarantine forbids the importation into the United States from foreign countries where the banana root-borer exists of all species and varieties of banana plants (*Musa* spp.) or portions thereof, except for experimental and scientific purposes.

The spread of the insect from one country to another is probably accomplished by the transportation of infested suckers for planting (11, p. 33-34);² and its spread within any locality most likely follows the killing out of infested stools, after which the adults travel in search of fresh supplies of food plants. Within a locality they could also be spread by the transportation of infested suckers or young plants for propagation.

HISTORY AND DISTRIBUTION

The adult (Pl. 8) was described as *Calandra sordida* by Germar (6) in 1824. The genus *Cosmopolites* was established for this species by Chevrolat (3) in 1885.

E. Fleutiaux (5) recorded it from Madagascar in 1903, stating that it was a serious enemy of the banana on that island. In 1908 C. H. Knowles (9) mentioned carbon disulphid as a means of control in the

¹ Technical descriptions of the stages of the weevil by W. Dwight Pierce.

² Reference is made by number (italic) to "Literature cited," p. 46.

Fiji Islands. In 1912 H. A. Ballou (1, p. 112) reported the species as doing serious damage to bananas in the Lesser Antilles.

During 1914 T. Fletcher (4, p. 342-343, fig. 201) published records of this species from southern India as existing in the regions of Malabar, Caimbatore, Godavari, and Ganjam. In the same year Frank P. Jepson (8), then working with the species in the Fiji Islands, where it is serious, made a mission to Java in quest of the natural enemies of the species and brought into the Fiji Islands some predatory beetles. He was successful in introducing some histerid beetles which were keeping the borers down in Java.

Later in 1916 Ballou (2) reported this insect as widely distributed in the Tropics, it being found in Jamaica, Guadeloupe, Dominica, Martinique, and Trinidad in the West Indies; Brazil in South America; and the Philippines, Fiji, Borneo, Sumatra, India, Queensland, and the Straits Settlements in the East.

Besides the localities cited, Frank P. Jepson (8) in 1914 recorded additional places where it is found: Java, Ceylon, New Guinea, Malacca, Saigon, China, Raratonga, Reunion, Sikhim, North Bengal, Pequ, Tenasserim, Andaman Islands, Sambak, and the Seychelles.

In Florida investigations showed that the infested plantings at Larkins had all been made four years previous to the discovery of the weevils, with plants procured from a nursery in the northern part of Florida which had, in turn, secured the plants from a nursery in southern Florida. In March, 1918, the weevils were found at the nursery in southern Florida, and every effort was made to exterminate them. It may be that many shipments of infested plants were made from this source, and it is very important that every occurrence of this pest be located and eradicated. Since the insect attacks sugar cane also it is not improbable that its presence would seriously interfere in the future with the development of large sugar and sirup industries. It is not known how this insect found its way into Florida, but no doubt it came in with sprouts or young plants introduced for propagation.

HOST PLANTS

According to published records there does not seem to be a great variety of host plants, *Cosmopolites sordidus* apparently having confined itself thus far almost entirely to the banana, attacking all varieties. The borer has been reported, however, as attacking sugar cane. In Fiji, Jepson (7) states that the borer does not appear to display more partiality for one variety of banana than another.

CHARACTER OF THE INJURY

The young suckers attacked by the borers wither and die in a very short space of time. This is due to the feeding and tunneling of the grubs or larvæ between the lateral roots and the bulb (Pl. 11, B), thus cutting off the flow of sap to the plant. The banana plant has no central

tap root, but is supported by numerous lateral roots (Pl. 11, A). An indication that a young plant is infested is the withering and drying of the curled roll of unopened leaves or growing part of the plant. The root, upon examination, is found to be riddled with the larvæ of this insect and when cut open discloses the borer *in situ*. The adult weevils are abundant in the soil about the root and also are found under loose fiber surrounding the base of the stem, at the crown. They also congregate in the cavities caused by the larvæ at the base of the bulb of the banana plant. In the planting at Larkins, Fla., where the infestation was first found, the writer collected 55 adults at the base of one plant and as many as 60 larvæ and pupæ in the bulb. The older plants infested appeared tall and spindling and no doubt succeeded in growing as much as they did by the presence of numerous lateral roots surrounding the bulbs of the plants and because the attacks of the insects had been gradual. Most of the bananas in the planting were old and so riddled by the larvæ as to be readily felled. After feeding thoroughly on a plant the weevils abandon it for another.

TECHNICAL DESCRIPTIONS OF THE SPECIES

The following descriptions by Dr. W. Dwight Pierce are based upon specimens collected at Larkins, Fla., January 19, 1918. The fine drawings accompanying the descriptions were made under Dr. Pierce's supervision by Mr. Harry Bradford and by Dr. Adam Böving.

EGG

The egg is elongate oval, about 2 mm. in length, rounded at one end and more or less pointed at the other, and pure white in color.

LARVA (PL. 9, B-G)

The larva is characteristically calandrid in form (Pl. 9, B), having the eighth and ninth segments transformed into a sort of pygidial plate bearing very large elongated spiracles on the eighth segment (Pl. 9, F, G). The other abdominal spiracles are all very minute and indistinct. The mesothoracic spiracles are very large. The length of a full-grown larva is at least 13 mm. (The writer has not had a live specimen to measure.) The body is white and the head shield dark reddish brown. The head is quite prominent. The head shield is broadly, elongately emarginate behind (Pl. 9, C). From the center of the emargination on the median line the epicranial suture passes forward, separating the epicranium into two parts (Pl. 9, C). This suture is strongly marked with black on its posterior half and is white from thence forward to the frons, behind which it divides and forms two frontal sutures (Pl. 9, D).

The frons (Pl. 9, D) is subtriangular, emarginate at anterior angles for the antennæ, and emarginate along the epistoma for attachment of the clypeus. The median line is faintly indicated by a dark line in the basal half. The frons has two pairs of large setæ and two pairs of tiny setæ; the three posterior pairs, the last of which is the smallest though the first is also small, form a triangle, the first and last pairs being almost equidistant. The anterior or epistomal pair of setæ are large and are attached opposite the basal angles of the clypeus and some little distance from the antennal fossæ.

The epicranial areas are located on each side of the epicranial suture (Pl. 9, C-E). A pair of light lines depart from the frontal sutures and pass backward almost as far as the light median line of the epicranium, corresponding to adfrontal sutures which sometimes occur in the Rhynchophora. Each lobe of the epicranium bears setæ as follows: One at each terminus of the rudimentary adfrontal suture; a small one opposite the middle of the frontal suture, and a longer one behind this almost equidistant from the epicranial suture; a long hair opposite the basal third of the frontal suture; one opposite the middle of the pleurostoma; one near the hypostomal angle of the mandible; one opposite the basal third of the hypostoma; one on disk behind this; and four tiny ones on the disk near the median basal angle of the lobe.

The antenna is a fleshy 2-jointed appendage located at the lateral angle of the frons (Pl. 9, D); the first joint is broad and short and bears one or more tiny hairs; the second joint is slender, finger-like, but short. The mandibles (Pl. 9, D, E) are very dark brown, bidentate, with median and basal hairs. The clypeus (Pl. 9, D) is attached in front of the frons and is basally margined with dark brown, but otherwise light in color. It bears four tiny hairs on the epistomal margin. The labrum (Pl. 9, D) is not so broad, is rounded in front, has a row of four setæ in front of the middle, and is margined with setæ. The maxillæ (Pl. 9, D, E) are elongate, terminated by a 2-jointed palpus and a setose lacinia. They are provided with four setæ, two near palpus and one near base. The stipes labii (Pl. 9, D, E) is triangular cordate, rather acutely angulate at base, bearing 2-jointed palpi at basal angles with a discal pair of setæ and with several pairs of basal setæ.

The body is glabrous except for the usual hairs found on each segment (Pl. 9, B). The prothorax is not divided dorsally on the anterior margin, which corresponds to the praescutum. There are six pairs of setæ, the last of which occurs in the region of the alar lobe. Behind these on the scutal area are four pairs of hairs, the last of which occurs on the alar lobe. The mesothoracic spiracle occurs on a large lobe which causes an emargination of the prothorax and lies very close to the head. It is very elongate with a longitudinal slit. The mesothorax and metathorax dorsally consist of a spindle-shaped praescutum with a single pair of setæ and the scutellum, extending from alar lobe to alar lobe and bearing only two pairs of hairs in the region of the alar lobe. The epipleurum of the mesothorax and metathorax bears a single hair. Each hypopleural lobe bears two setæ. The sternum of the thorax consists of a median area or eusternum and two lateral lobes more or less connected medianly behind the sternum. The median portion is the sternellum and the lateral portions are the parasternal plates. Each thoracic sternum bears one pair of hairs, and each parasternum bears three pairs of hairs.

The first seven abdominal segments are normal, and each bears a very minute spiracle. In a fully matured specimen these segments grow larger to the fourth or fifth segment and then decrease in size. The seventh segment is the smallest of the normal segments. Dorsally each segment is transversely divided into four parts, praescutum, scutum, scutellum, and postscutellum. Each praescutum bears one pair of setæ and each scutellum bears a small lateral pair. Each epipleural lobe bears two pairs of setæ; and each hypopleural lobe is apparently longitudinally divided into two parts, the lower of which bears a single seta. Ventrally, each segment has two transverse lobes, the front one being the eusternum with the presternum depressed in front of it and the parasternum and lobe at each side. The second transverse area is transversely depressed and frontally consists of sternellum and poststernellum. There are no setæ on the sternum of the abdomen. The eighth segment is dorsally greatly modified with a single pair of hairs on the praescutum and a single pair on the scutellar area, and with very elongated spiracles quite prominent (Pl. 9, F, G). Just outside of the spiracles on the epipleural lobe are two strong setæ.

The dorsal face of the eighth segment is declivous (Pl. 9, B); the dorsum of the ninth segment is flattened and bears four pairs of setæ, as shown in the figure (Pl. 9, F). The

dorsum of the ninth segment extends underneath, so that it is apical to the entire tenth segment. The tenth segment is completely ventral and very small. The tip of the abdomen showing the position of the tenth segment is illustrated in Plate 9, G.

PUPA (PL. 10)

Elongate, about 12 mm. long, white. This pupa is characteristically calandrid in the possession of very large thoracic spiracles located on a prominent lobe at the base of the prothorax (Pl. 10, B). The beak is very irregularly margined with numerous transverse depressions (Pl. 10, A). There are four pairs of large setæ and two pairs of tiny setæ on the head and beak. The four larger pairs of setæ are borne on tubercles, one on the head and three on the beak. The two pairs of tiny setæ are located medianly to the two basal pairs on the beak, as shown in the drawing. The prothorax (Pl. 10, C) is rather elongate subquadrate, rounded in front, with basal angles rounded, and bears six pairs of setigerous tubercles, of which the apical pair are the largest. There are two antero-lateral, two postero-lateral, and one antero-median pairs of setæ. The mesothorax has one pair of scutellar setæ. The first six abdominal segments are normal, and each bears three pairs of scutellar setæ. The first six abdominal spiracles are larger and more prominent than the larval spiracles. The seventh and eighth spiracles are minute. The first two ventral segments are very much crowded. The seventh, eighth, ninth, and tenth segments are greatly modified both above and below. Dorsally the seventh segment is elongate, apically it is tuberculate, and it has two pairs of setigerous tubercles, one pair being on the larger apical tubercles. From a lateral view, it is seen that the seventh segment is dorsally the terminal segment, but ventrally it is surpassed by the other segments. In other words, it is laterally emarginate for the reception of the other segments, each of which includes the succeeding segment. The ninth segment is provided with a pair of very long, chitinous processes, corresponding to the cerci, at the side of which are two setigerous tubercles.

Ventrally (Pl. 10, A) the mesothorax is smallest, prothorax next, and metathorax next. The mesosternum is protuberant, the metasternum elongate and flattened. The coxæ are spherical; the femora are setigerous at the apex. The wing pads extend only to about the apex of the fourth abdominal segment.

ADULT (PL. 8)

Length 11 mm.; breadth at base of elytra 4 mm. Head small, spherical; beak separated from head by constriction, swollen in basal third, finely punctate in basal half; moderately curved, slender and cylindrical and smooth in apical half. Scrobes located in basal third beneath the swelling, oval, more approximate behind than in front. Gular suture extending almost entire length of venter of beak and head. Antennæ geniculate, scape almost as long as funicle. Funicle 6-jointed, first joint moniliform, succeeding joints more closely appressed, last joint very closely appressed to club. Club 2-jointed, basal joint occupying two-thirds of the length, shining, with a few minute hairs; apical joint spongy, short, and rounded at apex. Other funicular joints bearing a few tiny hairs. Eyes finely granulate, elongate oval, transversely contiguous beneath, anteriorly margined. Prothorax very long; moderately evenly punctate, with an irregular smooth median line indicated on disk; constricted near apex, apex tubular; narrowest at apex, roundly broadening to about the middle; sides almost parallel from middle. Scutellum small, subquadrate, moderately short, with slight humeral angles. Striæ moderately impressed, punctate. Intervals of irregular width, the first, third, and fifth being slightly wider than the alternate intervals, minutely punctate. Pygidium almost vertical, spongy, pubescent, with setigerous punctures. Undersides more sparsely punctate. Sternum flattened. Procoxæ and mesocoxæ cylindrical, metacoxæ oval, trochanters small, femora laterally

compressed and curved, ventrally inflated at middle, emarginate beyond this and bilobed at apex, thus forming a groove for the tibiae. Tibiae moderately straight, grooved beneath and provided with a row of setae on each side of the groove, apically curved downwards, terminating in a strong hook. Tarsi 4-jointed, first longer than broad, widest at apex, second about as long as broad, third about as long as first but broader at apex, emarginate for reception of fourth. Fourth elongate, curved, sub-cylindrical, armed with two curved, divergent claws. Intercoxal piece broad, angulate. First two abdominal segments connate at middle. Third and fourth segments about as long as second. Fifth segment longer, turned downward.

LIFE HISTORY

The female beetle having been fertilized enters between a leaf sheath and the stem and selects a spot for the deposition of an egg. The beetle then prepares a small cavity by means of the powerful mandibles located at the tip of the rostrum or beak. After having completed the cavity the beetle reverses its position and with the aid of the ovipositor deposits a single egg in the prepared place (fig. 1). On February 9, 1918, many

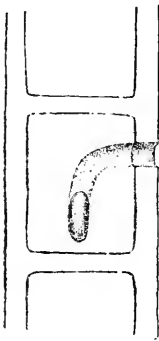

FIG. 1.—*Cosmopolites sordidus*: Section of sheath with egg *in situ* in compartment.

eggs were observed which were laid apparently a short time previously in the tissues, usually in the small compartments in the sheaths or stem. A few eggs were even found laid loosely in the slightly decayed leaf sheaths close to the healthy fleshy banana bulb, from which place they entered the bulb. The eggs, for the most part, are deposited singly in the sheaths near the crown at the surface of the soil. On hatching, the egg does not completely collapse. The larvæ eat their way in all directions in the bulb, and one can easily trace a channel as it gradually grows wider, terminating in a pouch near the outer surface in which the larva pupates on reaching maturity. The records for oviposition, hatching, and pupation are given in Table I.

TABLE I.—Egg and larval records of *Cosmopolites sordidus*, 1918

Egg No.	Egg deposited.	Egg hatched.	Larva pupated.
1.....	Feb. 10	Feb. 15	Mar. 2
2.....	do.....	do.....	Mar. 3
3.....	do.....	do.....	Do.
4.....	do.....	Feb. 16	Mar. 2
5.....	do.....	do.....	Mar. 3
6.....	do.....	Feb. 17	Mar. 4
7.....	do.....	do.....	Mar. 3
8.....	do.....	do.....	Mar. 6
9.....	do.....	do.....	Mar. 5
10.....	do.....	do.....	Mar. 6

From a few experiments the egg period was found to last from 5 to 7 days. From the character of the channels of the grubs it is the opinion of the writer that the eggs are deposited in the outer sheaths or between the outer sheath and the stem, the grubs working their way into the body of the bulb or trunk. The work of the larvæ is particularly destructive, since they girdle the plant in the immediate vicinity of the lateral roots put out from the bulb of the plant (Pl. 11, A), thus cutting off the passage of the sap. The larvæ not only work frequently in this region just described but may be found tunneling into the main trunk as far as the heartwood. The larvæ usually work below ground, but in a number of instances the writer has found them in the trunk as high as 2 feet above ground. The larval stage was found to last over a period of from 15 to 20 days. Due to the scarcity of material and to the fact that all infestations were gradually destroyed and cleaned up, the writer was unable to make further records on the seasonal habits of the species.

The larvæ upon attaining maturity construct an oval space at the end of the burrows, usually well toward the outer layers, where the larval head is cast, and where the larva pupates. The pupæ are naked. Jepson found in Fiji that a period of from 5 to 8 days from the time of pupation elapses before the emergence of the adult. The adults bear wings and are very sluggish. When disturbed they will "play 'possum" for a considerable length of time. The adults are gregarious and were found in clusters in cavities and depressions in the outer sheaths of the banana close to the surface of the ground and also below the surface. The length of life of the adult is not known. The writer has kept them in captivity without food for two months. Jepson in Fiji has kept the beetles in captivity about 14 weeks without food, and in the state of nature they undoubtedly will live longer. In all probability the banana root-borer continues to breed all the year round, provided that the food supply is plentiful. The beetles are nocturnal, only coming up from the soil at night for their activities above ground.

CONTROL

Since bananas are grown year after year on the same land and are produced from suckers springing from the parent plant, a plantation usually forms a breeding ground and nursery for these insects. The borer's mode of life renders it a difficult pest to control, as Knowles and Jepson (10) noted in Fiji. The egg, larval, and pupal periods are passed in or on the bulb of the banana or plantain. The adults apparently do not move far from the place where they have lived and developed so long as suitable food is available to attract the egg-laying females. In Java *Cosmopolites sordidus* is preyed upon and kept down by the larvæ of a histerial beetle and by those of some beetle of the family of Hydrophilidae. Jepson introduced these species into Fiji, where the banana root-borer is a serious

pest. Where banana plants are found infested in Florida and elsewhere in the States they should be destroyed immediately, and traps should be laid by using strips of healthy banana trunks. In Florida strips of banana plants proved more successful as a trap than did young plants on an infested piece of ground. As the beetles congregate under and about these strips they should be burned and the process repeated until the beetles are eradicated. It is very important that the traps be renewed, since the beetles are capable of living a considerable time without food.

LITERATURE CITED

- (1) BALLOU, H. A.
1912. INSECT PESTS OF THE LESSER ANTILLES. Imp. Dept. Agr. West Indies, Pamphlet Ser. 71, 210 p., 185 fig.
- (2) ———
1916. THE BANANA WEEVIL. *In Agr. News [Barbados]*, v. 15, no. 364, p. 123.
- (3) CHEVROLAT, A.
1885. CALANDRIDES. *In Ann. Soc. Ent. France*, s. 6, v. 5, p. 275-292.
- (4) FLETCHER, T. Bainbridge.
1914. SOME SOUTH INDIAN INSECTS ... 565 p., 440 fig., 50 col. pl. Madras.
- (5) FLEUTIAUX, E.
1903. LES INSECTES. *In Agr. Prat. Pays Chauds*, ann. 2, no. 10, p. 495-502; no. 12, p. 745-760.
- (6) GERMAR, E. F.
1824. INSECTORUM SPECIES NOVAE AUT MINUS COGNITAE DESCRIPTIONIBUS ILLUSTRATAE. v. 1 (Coleoptera), 624 p., 2 pl. Halae.
- (7) JEPSON, Frank P.
1911. REPORT ON ECONOMIC ENTOMOLOGY. Fiji Dept. Agr. Council Paper 25, 89 p., 7 pl.
- (8) ———
1914. A MISSION TO JAVA IN QUEST OF NATURAL ENEMIES FOR A COLEOPTEROUS PEST OF BANANAS (COSMOPOLITES SORDIDA, CHEVR.). Dept. Agr. Fiji, Bul. 7, 18 p., 3 pl.
- (9) KNOWLES, C. H.
1900. INSECT PESTS. [THE BANANA WEEVIL. (SPHENOPHORUS SORDIDUS)]. *In* Legisl. Council, Fiji, Agriculture (Report on, for the year 1908), p. 20. Council Paper 27.
- (10) ——— and JEPSON, Frank P.
1912. THE BANANA IN FIJI. Dept. Agr. Fiji, Bul. 4, 17 p., 3 pl.
- (11) PIERCE, W. Dwight.
1917. A MANUAL OF DANGEROUS INSECTS LIKELY TO BE INTRODUCED IN THE UNITED STATES THROUGH IMPORTATIONS. 256 p., 49 pl. Washington, D. C. Published by U. S. Dept. Agr. Off. Sec.

PLATE 8

Banana root-borer (*Cosmopolites sordidus*): Adult.

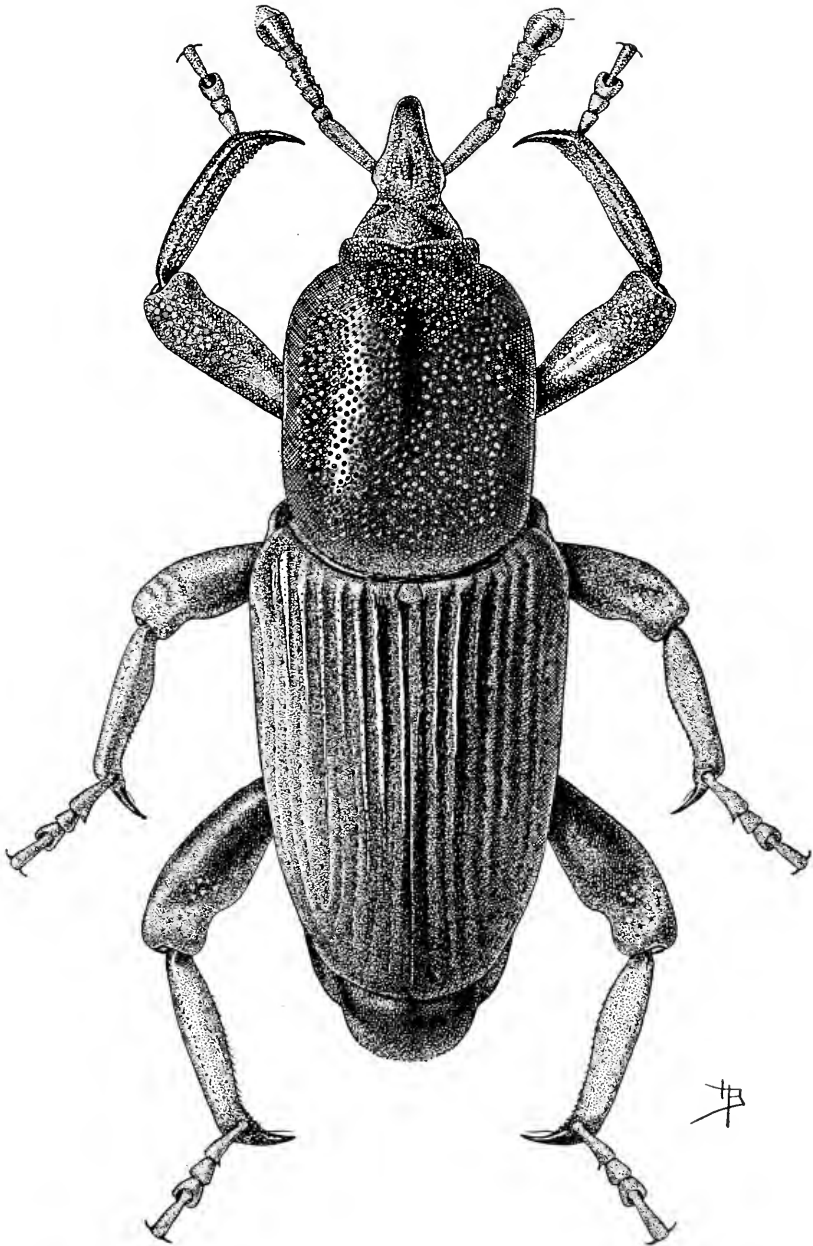

77

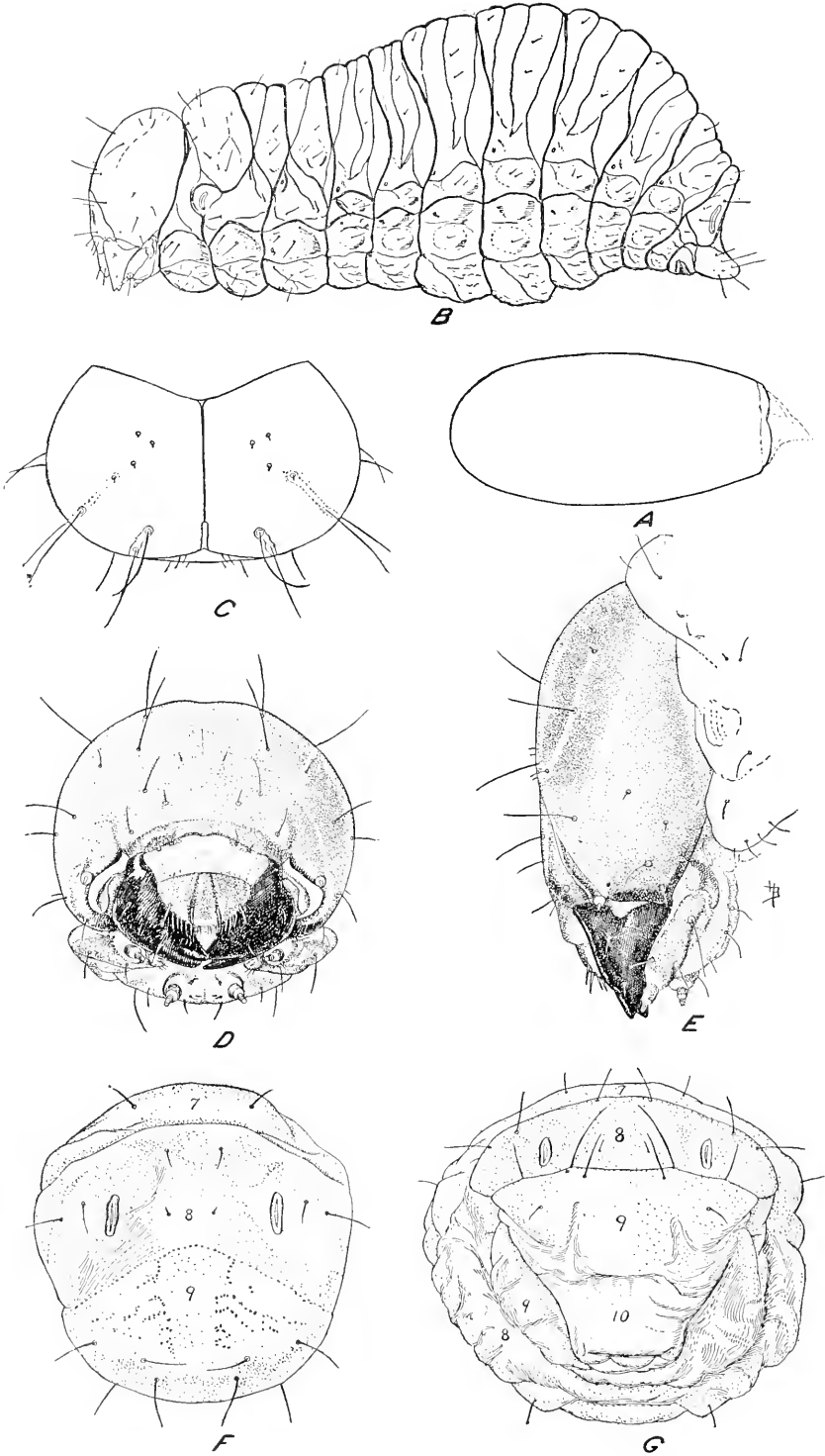

PLATE 9

Egg and larva of banana root-borer:

- A.—Egg.
- B.—Larva, side view.
- C.—Head of larva, dorsal view.
- D.—Head of larva, face view.
- E.—Head of larva, side view.
- F.—Dorsal view of seventh, eighth, and ninth abdominal segments.
- G.—Posterior view of segments 7 to 10.

PLATE 10

Pupa and adult of banana root-borer:

A.—Ventral view of pupa.

B.—Lateral view of head and thorax of pupa.

C.—Dorsal view of pupa.

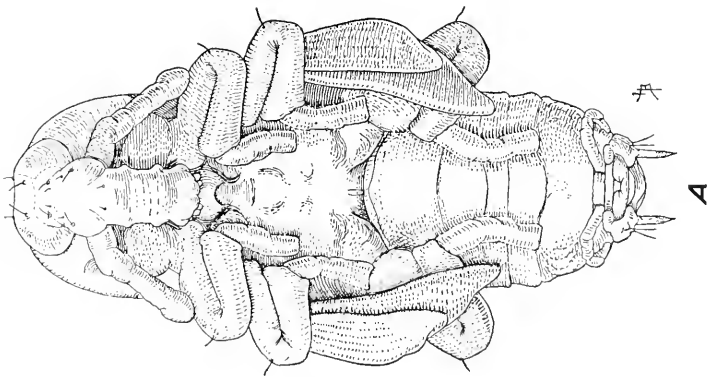
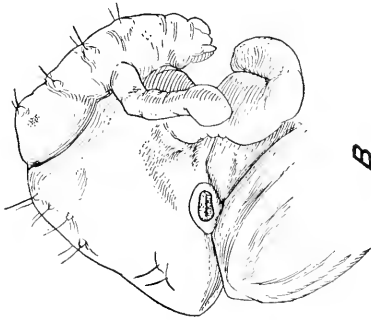
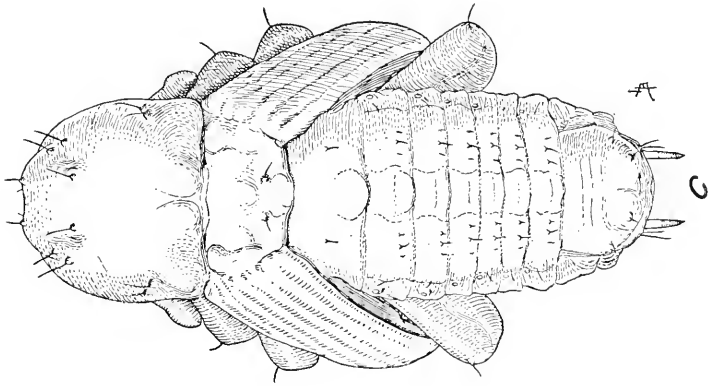

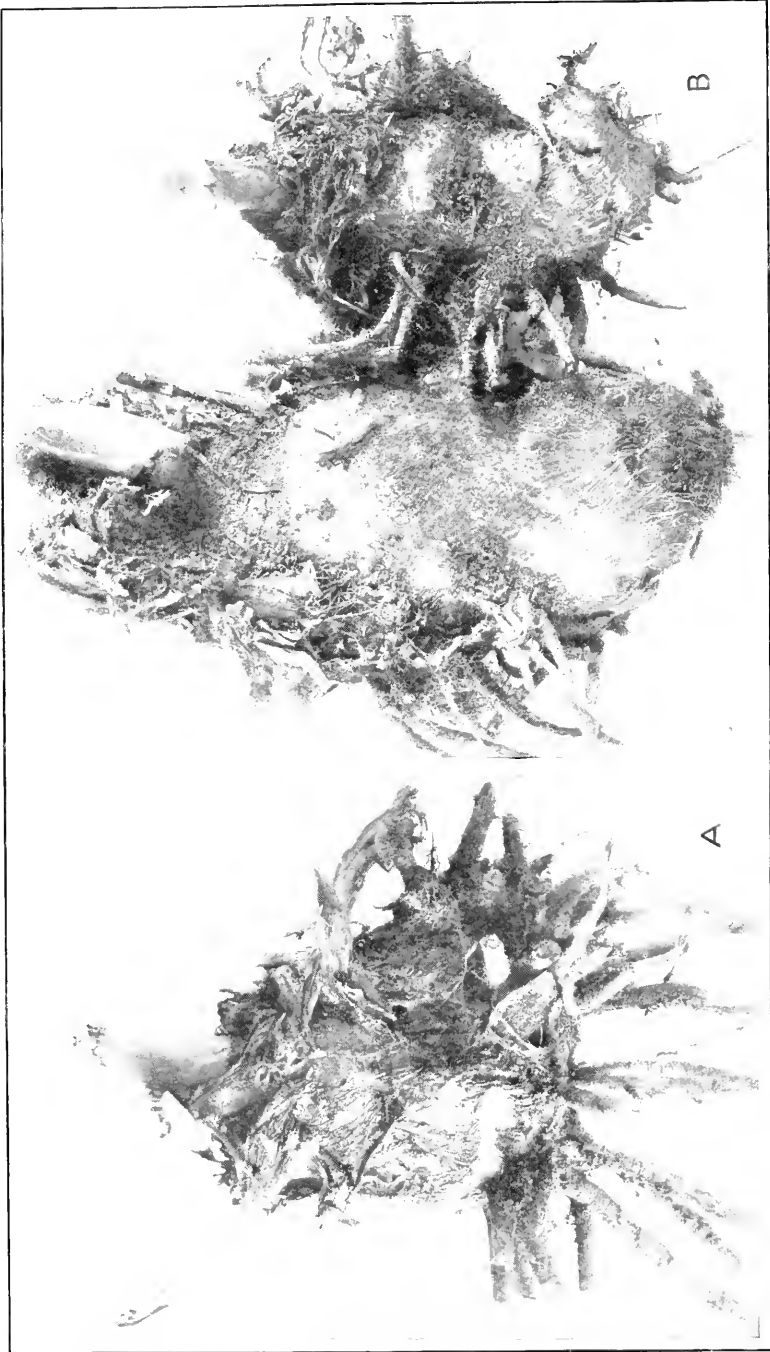

PLATE II

A.—Young healthy banana plant bulb with lateral roots.

B.—Young banana plant cut into, showing work of the larvæ of the banana root-borer. Illustration shows how lateral roots become severed by grubs working near roots.

164175°—20—5

JOURNAL OF AGRICULTURAL RESEARCH

CONTENTS

	Page
Effect of Calcium Sulphate on the Solubility of Soils -	47
M. M. McCOOL and C. E. MILLAR	
(Contribution from Michigan Agricultural Experiment Station)	
Further Studies on the Influence of Humidity Upon the Strength and Elasticity of Wool Fiber - - - -	55
J. I. HARDY	
(Contribution from Wyoming Agricultural Experiment Station)	
Composition and Density of the Native Vegetation in the Vicinity of the Northern Great Plains Field Station -	63
J. T. SARVIS	
(Contribution from Bureau of Plant Industry)	
Effect of Reaction of Solution on Germination of Seed and on Growth of Seedlings - - - - -	73
ROBERT M. SALTER and T. C. McILVAINE	
(Contribution from West Virginia Agricultural Experiment Station)	

PUBLISHED BY AUTHORITY OF THE SECRETARY OF AGRICULTURE,
WITH THE COOPERATION OF THE ASSOCIATION OF
LAND-GRANT COLLEGES

WASHINGTON, D. C.

**EDITORIAL COMMITTEE OF THE
UNITED STATES DEPARTMENT OF AGRICULTURE AND
THE ASSOCIATION OF LAND-GRANT COLLEGES**

FOR THE DEPARTMENT

KARL F. KELLERMAN, CHAIRMAN

*Physiologist and Associate Chief, Bureau
of Plant Industry*

EDWIN W. ALLEN

Chief, Office of Experiment Stations

CHARLES L. MARLATT

*Entomologist and Assistant Chief, Bureau
of Entomology*

FOR THE ASSOCIATION

J. G. LIPMAN

*Dean, State College of Agriculture, and
Director, New Jersey Agricultural Experi-
ment Station, Rutgers College*

W. A. RILEY

*Entomologist and Chief, Division of Ento-
mology and Economic Zoology, Agricul-
tural Experiment Station of the University
of Minnesota*

R. L. WATTS

*Dean, School of Agriculture, and Director,
Agricultural Experiment Station, The
Pennsylvania State College*

All correspondence regarding articles from the Department of Agriculture should be addressed to Karl F. Kellerman, Journal of Agricultural Research, Washington, D. C.

All correspondence regarding articles from State Experiment Stations should be addressed to J. G. Lipman, New Jersey Agricultural Experiment Station, New Brunswick, N. J.

JOURNAL OF AGRICULTURAL RESEARCH

VOL. XIX

WASHINGTON, D. C., APRIL 15, 1920

No. 2

EFFECT OF CALCIUM SULPHATE ON THE SOLUBILITY OF SOILS

By M. M. McCool, *Professor of Soils*, and C. E. MILLAR, *Associate Professor of Soils*,
Michigan Agricultural Experiment Station

Additional information on the rate of formation of soluble salts in soils as affected by different factors is desirable. One phase of the subject of special interest is the immediate and residuary effects of fertilizing materials on soils. It seems that aside from its theoretical interest, such information should be of assistance in accounting for results that are obtained from the use of certain substances under field conditions. We have interviewed several of the earlier settlers in southern Michigan and have been informed by them that calcium sulphate was used rather freely by some farmers during the earlier stages of the State's agricultural development. The general impression of those whom we interviewed is that the application of calcium sulphate resulted favorably for a time, increasing the yields of small grains and clover, but later on failed to bring the desired results; hence this substance came to be looked upon as a soil stimulant. Some farmers are using it on wheat and clover, although the amount so consumed is relatively small. According to early reports, which are to be considered in a later publication, similar conditions existed in the agricultural regions of some of the eastern States.

Because of the experiences of the early agriculturists, the increasing interest in the fertilizing value of calcium sulphate, and the widespread use of acid phosphate, which contains appreciable amounts of the sulphate, it was considered advisable to investigate the effect of the sulphate both alone and in junction with calcium phosphate on the formation of soluble salts in soils, as well as the effect on the carbon-dioxid production. The freezing-point method was used to determine the former, and the titration method the latter.

METHOD OF PROCEDURE

In determining the effect of the chemicals on the rate of formation of soluble salts, 200 gm. of the soils in question were brought into contact

with 500 cc. each of distilled water and the substance in solution, and allowed to stand 24 hours with several thorough agitations. At the close of this period the mass was transferred to filter paper in large funnels. In some cases the soluble salts were reduced to a very low concentration by washing with distilled water, while in others the soils were removed, after drainage had ceased, but otherwise treated in the same way as in the former instances. The rate of formation of soluble substances in treated and untreated soils was determined under two sets of moisture conditions. The one which is here called low water content approximated the so-called optimum condition for plant growth; and the other, which is here called high water content, was secured by allowing 1 part of soil to 0.7 part of water and provided sufficient moisture to saturate the soil and leave a small column of about $\frac{1}{8}$ inch above it.

Soils of the following description were used in all the experiments:

Soil 1, a silt loam, light phase, containing a large amount of organic matter.

Soil 2, a heavy sand, rather low in organic content.

Soil 3, a fine sandy loam with a medium supply of organic matter.

Soil 4, a very fine sand containing a small amount of organic material.

Soil 5, a very heavy silt loam with a very high content of organic matter.

Soil 6, a silt loam well supplied with organic material.

EXPERIMENTAL RESULTS

The first series of experiments to be reported is the one in which the soils were treated with calcium sulphate, drained, and made up to the high water content, or 1 part of soil to 0.7 part distilled water. Treated and untreated portions of each of the soils studied were placed in jelly glasses, which were tightly covered and let stand in the laboratory. At about 4-day intervals they were thoroughly aerated by stirring, the covers being removed for one-half hour or more. The soils employed were air-dry and had been stored in the laboratory about 160 days. The results are set forth in Table I.

TABLE I.—Effect of calcium sulphate on the solubility of unwashed soils held at high water content for various periods

Soil No.	Condition of soil.	Freezing-point depressions.					
		After 2 days.	After 4 days.	After 6 days.	After 8 days.	After 10 days.	After 30 days.
1	Treated	°C. 0.042	°C. 0.040	°C. 0.055	°C. 0.058	°C. 0.063	°C. 0.091
	Untreated003	.005	.008	.011	.013	.024
2	Treated044	.045	.050	.055	.059	.080
	Untreated000	.004	.005	.007	.009	.011
3	Treated043	.051	.054	.057	.058	.057
	Untreated002	.004	.006	.007	.008	.014
4	Treated045	.050	.050	.053	.055	.138
	Untreated000	.002	.004	.006	.010	.017
5	Treated046	.048	.051	.055	.058	.075
	Untreated003	.002	.004	.006	.012	.018
6	Treated045	.042	.050	.051	.052	.089
	Untreated008	.012	.012	.018	.024	.032

The effect of the calcium sulphate on the rate of formation of soluble salts in the soils investigated is appreciable. According to the data set forth in Table I, as well as other data not recorded, the reaction is rather gradual and prolonged. Of course the initial concentration of the solutions of the treated soils was high, and it is possible that this influenced the rate of changes which afterwards took place in the mass.

It was considered advisable to wash the soils until the concentration of the solution in the soils was at a very low point. This was done, and the series of tests with washed soils was carried on at the same time and under the same conditions as the previous one. The results obtained are presented in Table II. An examination of this table shows that the residuary effect of the calcium sulphate on the rate of formation of soluble substances in the soils is remarkable. The changes in the concentration of the soil solution did not all take place at once but continued for a number of days.

TABLE II.—*Effect of calcium sulphate on the solubility of washed soils held at high water content for various periods*

Soil No.	Condition of soil.	Freezing-point depressions.					
		After 2 days.	After 4 days.	After 6 days.	After 8 days.	After 10 days.	After 30 days.
		°C.	°C.	°C.	°C.	°C.	°C.
1	Treated.....	0.011	0.015	0.030	0.044	0.071	0.101
	Untreated.....	.003	.005	.008	.011	.013	.026
2	Treated.....	.002	.005	.012	.024	.057	.073
	Untreated.....	.000	.004	.005	.007	.009	.011
3	Treated.....	.000	.004	.010	.016	.028	.066
	Untreated.....	.002	.004	.006	.007	.009	.014
4	Treated.....	.000	.005	.018	.022	.058	.184
	Untreated.....	.000	.002	.004	.006	.010	.017
5	Treated.....	.001	.015	.028	.042	.052	.070
	Untreated.....	.003	.002	.004	.006	.012	.018
6	Treated.....	.000	.008	.013	.014	.024	.098
	Untreated.....	.008	.012	.012	.018	.024	.032

A clay loam soil was treated with the calcium-sulphate solution, washed, and let stand 30 days at the high water content, again washed until the freezing-point lowering of the solution in the soil was 0.005° C., and again let stand 30 days. At the end of this period the freezing-point lowering of the control or untreated soil was 0.040°, and that of the treated soil was 0.102°. The residuary effect of the treatment is quite persistent.

Another series was run in which the water content of the washed soils was lower, or approximately the so-called optimum point. The concentration of the solution in the soil was not determined until the end of a 30-day period. At that time the freezing-point lowerings of the soils were great and not strikingly different from those of the high water series. The results of this experiment are given in Table III.

TABLE III.—Effect of calcium sulphate on the solubility of washed soils held at low water content for 30 days

Soil No.	Condition of soil.	Freezing-point depressions.
		°C.
1	Treated.....	0.103
	Untreated.....	.015
2	Treated.....	.085
	Untreated.....	.010
3	Treated.....	.111
	Untreated.....	.013
4	Treated.....	.163
	Untreated.....	.007
5	Treated.....	.099
	Untreated.....	.023
6	Treated.....	.096
	Untreated.....	.023

Inasmuch as acid phosphate contains both calcium sulphate and calcium phosphate, a series was run in which the soils were treated with a saturated solution of calcium sulphate, a *N/10* calcium phosphate, and also a combination of the two. After treatment the soils were washed as in the series described above and let stand at the high water content 30 days. At the close of the period the concentration of the soil solution was determined by the freezing-point method. The results are given in Table IV.

TABLE IV.—Effect of calcium sulphate and calcium phosphate alone and in combination on the solubility of soils after 30 days

Kind of soil and treatment.	Freezing-point depressions.
	°C.
Sandy loam:	
Treated with calcium sulphate.....	0.134
Treated with calcium sulphate and calcium phosphate.....	.094
Treated with calcium phosphate.....	.028
Untreated.....	.035
Silt loam:	
Treated with calcium sulphate.....	.096
Treated with calcium sulphate and calcium phosphate.....	.084
Treated with calcium phosphate.....	.032
Untreated.....	.042

A glance at the data composing Table IV reveals that the calcium sulphate in the presence of the calcium phosphate is somewhat less active in changing the rate of solubility of these soils than it is when used alone. Moreover, where the calcium phosphate alone is added to the soils the solubility is somewhat lessened. This is in accord with the results reported by Bouyoucos.¹

¹ BOUYOUCOS, George J. RATE AND EXTENT OF SOLUBILITY OF SOILS UNDER DIFFERENT TREATMENTS AND CONDITIONS. Mich. Agr. Exp. Sta. Tech. Bul. 44, 49 p. 1919.

The results cited above immediately raise the question as to whether the great increase in concentration of the soil solution resulting from treatment with calcium sulphate is due to a stimulation of biological activities or to chemical reactions. To throw some light on this question experiments were undertaken in which the rate of production of carbon dioxide was measured. The method of procedure was as follows: The soils were allowed to stand over night in a saturated solution of calcium sulphate. They were then filtered and washed with distilled water until the concentration of the soil solution, when the soils were just saturated, was only a few parts per million. The soils were then allowed to dry. After thorough mixing, 60 gm. were weighed into 4-ounce bottles. The desired amount of water was then added and the bottles stoppered with rubber stoppers fitted with tubing so arranged that a current of air could be readily drawn through the soil. The bottles were stored in the dark at room temperature, and every 10 days the carbon dioxide was swept out by means of a current of air free from this substance, and the amount of carbon dioxide was determined. Samples of untreated soil were prepared in a similar manner and the carbon dioxide determined as outlined. Tables V and VI show the milligrams of carbon dioxide produced during the 10-day periods and also the total production for the 30-day period at the water contents used.

TABLE V.—*Effect of calcium sulphate on the production of carbon dioxide at high water content*

Soil No.	Treatment.	Carbon dioxide produced in—			Total carbon dioxide produced.
		10 days.	20 days.	30 days.	
		<i>Mgm.</i>	<i>Mgm.</i>	<i>Mgm.</i>	<i>Mgm.</i>
1	Calcium sulphate.....	3.74	9.24	7.26	20.24
	No treatment.....	8.14	9.02	5.72	22.88
2	Calcium sulphate.....	5.06	7.48	7.26	19.80
	No treatment.....	7.26	8.80	7.04	23.10
3	Calcium sulphate.....	5.94	9.00	8.14	23.08
	No treatment.....	7.92	11.88	9.68	29.48
4	Calcium sulphate.....	5.28	7.04	5.94	18.26
	No treatment.....	3.74	7.04	7.04	17.82
5	Calcium sulphate.....	9.02	12.76	13.20	34.98
	No treatment.....	5.94	10.34	8.80	25.08
6	Calcium sulphate.....	9.24	12.76	11.88	33.88
	No treatment.....	11.00	13.42	10.56	34.98

TABLE VI.—Effect of calcium sulphate on the production of carbon dioxide at low water content

Soil No.	Treatment.	Carbon dioxide produced in—			Total carbon dioxide produced.
		10 days.	20 days.	30 days.	
		<i>Mgm.</i>	<i>Mgm.</i>	<i>Mgm.</i>	<i>Mgm.</i>
1	Calcium sulphate.....	3.96	3.52	2.86	10.34
	No treatment.....	8.14	6.16	4.84	19.14
2	Calcium sulphate.....	4.40	3.30	3.30	11.00
	No treatment.....	7.81	5.06	4.40	17.27
3	Calcium sulphate.....	2.64	2.20	1.70	6.54
	No treatment.....	8.58	6.16	5.28	20.02
4	Calcium sulphate.....	3.30	2.64	2.42	8.36
	No treatment.....	5.50	3.52	2.86	11.88
5	Calcium sulphate.....	7.26	6.16	5.28	18.70
	No treatment.....	9.90	7.48	6.00	23.08
6	Calcium sulphate.....	6.38	5.72	4.62	16.72
	No treatment.....	10.78	7.26	5.28	23.32

At the high water content the production of carbon dioxide for the first 10-day period was depressed slightly in four soils by the treatment with sulphate, but in two soils it was stimulated. During the second period three of the untreated samples of soil still showed a slightly greater rate of production of carbon dioxide than the corresponding treated samples, and one of the treated samples of soil produced somewhat more of this material than the untreated. The remaining soils showed very slight differences in the production of carbon dioxide. During the third period there were more variations, two untreated samples producing more gas than the corresponding treated samples and three treated samples showing more activity than the untreated. The total production of carbon dioxide for the 30 days was greater for the untreated samples in four cases and less in one, and one soil showed practically no difference.

Without exception the untreated samples maintained at low water content showed a greater production of carbon dioxide for each period than the corresponding treated samples. In some instances the difference was so small as to be negligible, while in others it was very great. In every case the total production for 30 days was decidedly greater for the untreated samples.

It would appear from the data presented that the biological activities do not account for the changes in the solubility of the soils when treated with calcium sulphate, if the carbon-dioxide production may be taken as a measure. On the whole, there was a slight depression of such activities, especially when the samples were maintained at the low water content. This is somewhat at variance with the results reported by Fred and Hart,¹ who found an increased production of carbon dioxide from soil

¹ FRED, E. B., and HART, E. B. THE COMPARATIVE EFFECT OF PHOSPHATES AND SULPHATES ON SOIL BACTERIA. Wis. Agr. Exp. Sta. Research Bul. 35, p. 35-66, 6 fig. 1915.

containing 0.25 and 0.5 per cent calcium sulphate. It should be borne in mind, however, that the method of treating the samples was quite different from that in the experiment here reported. Several investigators have also reported a slight stimulation in ammonia production as a result of treatment with small amounts of calcium sulphate. In none of these experiments, however, were the soils thoroughly washed after treatment with the sulphate, and consequently it does not seem to be justifiable to make direct comparisons with our results.

At the expiration of 30 days the concentration of the soil solution of the samples maintained at the high water content was determined by thoroughly stirring the sample, withdrawing a portion to a freezing-point tube, and making the determination in the usual manner. Sufficient water was added to the samples maintained at the low moisture content to bring them up to that of the corresponding samples maintained at the high water content. The results of these determinations, together with the parts per million of soluble material, are presented in Tables VII and VIII.

TABLE VII.—*Effect of calcium sulphate on the solubility of soils held at high water content for 30 days*

Soil No.	Treatment.	Freezing-point depressions.	Soluble material.
		° C.	<i>P. p. m.</i>
1	Calcium sulphate.....	0.101	2,525
	No treatment.....	.026	650
2	Calcium sulphate.....	.073	1,825
	No treatment.....	.011	275
3	Calcium sulphate.....	.066	1,650
	No treatment.....	.014	350
4	Calcium sulphate.....	.184	4,600
	No treatment.....	.017	425
5	Calcium sulphate.....	.070	1,750
	No treatment.....	.063	1,575
6	Calcium sulphate.....	.098	2,450
	No treatment.....	.042	1,050

TABLE VIII.—*Effect of calcium sulphate on the solubility of soils held at low water content for 30 days*

Soil No.	Treatment.	Freezing-point depressions.	Soluble material.
		° C.	<i>P. p. m.</i>
1	Calcium sulphate.....	0.103	2,575
	No treatment.....	.015	375
2	Calcium sulphate.....	.085	2,125
	No treatment.....	.010	250
3	Calcium sulphate.....	.111	2,775
	No treatment.....	.013	325
4	Calcium sulphate.....	.163	4,075
	No treatment.....	.007	175
5	Calcium sulphate.....	.099	2,475
	No treatment.....	.023	575
6	Calcium sulphate.....	.096	2,400
	No treatment.....	.023	575

The total quantity of soluble material formed during the 30 days does not coincide with the amount of the carbon dioxide produced. The data show the treated samples to contain many times the amount of soluble material found in the corresponding untreated samples. There is one exception to this in the case of soil 5 at the high water content, where the treated sample contained only 175 parts per million more of soluble material than the untreated. It must be concluded, therefore, that the increase in soluble material takes place without the evolution of increased amounts of carbon dioxide and therefore is presumably due to other than biological agencies.

SUMMARY AND CONCLUSIONS

Six different soils were treated with a saturated solution of calcium sulphate. In one series of experiments the mass was transferred to filter paper, permitted to drain, and then transferred to containers and the rate of formation of soluble substances determined by means of the freezing-point method. The treatment was found to have increased the solubility of the soil to an appreciable extent.

In another series the amount of soluble material was reduced to a minimum by washing with distilled water, and the residuary effects of the treatment on the solubility were likewise determined. The calcium-sulphate treatment was found to have resulted in a very large increase in the rate of formation of soluble substances. The effects were great even when the soils were washed the second time. Obviously the treatment results in changes in the composition of the soil mass—in other words, a soil of different properties is formed. It seems that it is possible to alter the composition of the soil solution and that whether such change will have any effect on plant growth or not or whether the effect will be favorable or unfavorable will depend upon the nature of the soil and of the substances added. Moreover, it is probable that this phase of the subject has not received sufficient attention in connection with our field experiments.

Two soils of somewhat different texture and organic content were treated with a saturated solution of calcium sulphate, a *N/10* solution of calcium phosphate, and a combination of the two. The soils were washed, and the rate of formation of soluble salts was determined. The calcium sulphate markedly increased the solubility in each soil, while the calcium phosphate decreased the rate of formation of soluble substances. When calcium phosphate was used in conjunction with calcium sulphate, it counteracted the effects of the latter to some extent.

If the carbon dioxide produced, as determined by the methods used, is taken as a measurement of the biological activities, the increase in the rate of formation of soluble substances brought about by the calcium-sulphate treatment is due mainly to other causes.

FURTHER STUDIES ON THE INFLUENCE OF HUMIDITY UPON THE STRENGTH AND ELASTICITY OF WOOL FIBER¹

By J. I. HARDY

Associate Wool Specialist, Wyoming Agricultural Experiment Station

INTRODUCTION

In a previous issue of the Journal the author published a preliminary report² of his work on the influence of humidity upon the strength and elasticity of wool fiber. An attempt was made to obtain a better method of testing wool in order that wool from sheep under various conditions of breeding, feeding, and range management might be satisfactorily tested. A study was also made upon the strength and elasticity of wool in an unscoured state under various conditions of humidity. A review of the literature was given in the earlier report and will not be repeated at this time.

EXPERIMENTAL WORK

After the work referred to above had been completed, further studies were begun upon scoured wool. As in the previous work, all samples were tested with a McKenzie fiber-testing machine. Wherever diameters are reported they are the results of measurements with a micrometer caliper unless otherwise stated. This micrometer had a ratchet stop and was graduated to read in hundredths of a millimeter. The micrometer was used in the lower jaw of the testing machine and had a small hand lens held stationary before it. With this arrangement it was possible to interpolate the readings to 0.001 mm. The diameters of the fibers were read at four different points. The smallest of these figures was in each case used in computing the tensile strength of the wool fiber.

Samples 991, 994, 996, and 997 had been extracted with ether and washed with hot water and tested at each of five relative humidities, 40, 50, 60, 70, and 80 per cent, when the operator was suddenly called into military service. The results of this work are given in Tables I and II.

TABLE I.—*Tensile strength of wool fiber at five different humidities*

Sample No.	Number of fibers.	At relative humidity of—				
		40 per cent.	50 per cent.	60 per cent.	70 per cent.	80 per cent.
		<i>Mgm.</i>	<i>Mgm.</i>	<i>Mgm.</i>	<i>Mgm.</i>	<i>Mgm.</i>
991.....	100	279.22	299.47	289.85	264.29	258.02
994.....	100	274.77	280.50	279.73	255.22	269.59
996.....	100	295.64	302.00	281.47	281.40	271.83
997.....	100	215.34	210.48	201.87	200.67	196.56
Average.....		266.24	273.11	263.24	250.39	249.00

¹ Approved for publication in the Journal of Agricultural Research by the Director of the Agricultural Experiment Station of the University of Wyoming.

² HARDY, J. I. INFLUENCE OF HUMIDITY UPON THE STRENGTH AND THE ELASTICITY OF WOOL FIBER. *In* Jour. Agr. Research, v. 14, no. 8, p. 285-296, 2 fig., pl. 48, 1918. Literature cited, p. 294-295.

TABLE II.—Elasticity of wool fiber at five different humidities

Sample No.	Number of fibers.	At relative humidity of—				
		40 per cent.	50 per cent.	60 per cent.	70 per cent.	80 per cent.
		<i>Per cent.</i>	<i>Per cent.</i>	<i>Per cent.</i>	<i>Per cent.</i>	<i>Per cent.</i>
991.....	100	27.80	29.08	28.48	29.24	30.04
994.....	100	28.64	30.92	31.08	31.32	34.20
996.....	100	34.32	38.32	38.28	40.36	37.40
997.....	100	24.20	25.28	27.28	27.00	26.48
Average.....		28.74	30.90	31.28	31.98	32.03

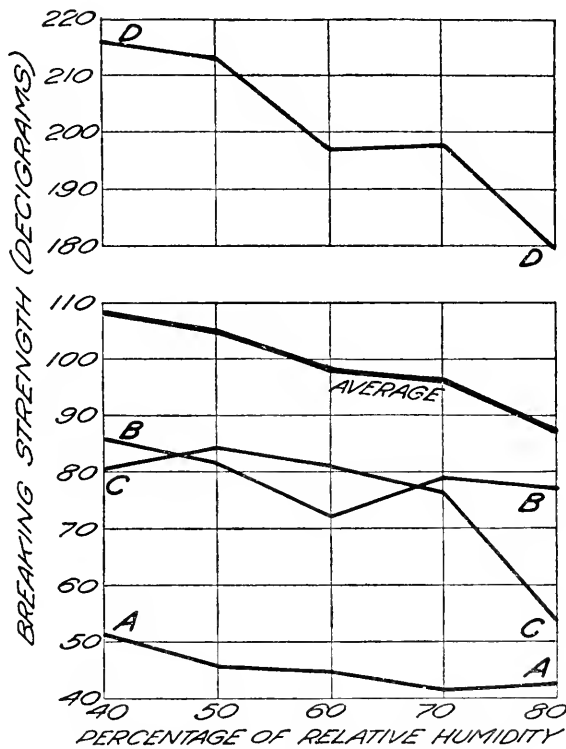

FIG. 1.—Graphs showing the effect of humidity upon the breaking strength of wool fiber.

Table I shows an average increase in the tensile strength of scoured wool as the humidity is raised from 40 to 50 per cent, and a decrease as the humidity is raised from 50 to 80 per cent. In Table II the average percentage of elasticity is shown to increase as the humidity is raised from 40 to 80 per cent.

A new operator was put upon the work in order to obtain more data under the same conditions and additional data on fibers of a smaller diameter. The diameter of the fibers of sample 991 averaged 0.016 mm.,

while samples 994, 996, and 997 had an average diameter of 0.026, 0.029, and 0.025 mm., respectively. There was one sample of wool with an average diameter of fibers less than 0.02 mm., and there were three samples with the average diameter above that figure.

The new set of samples chosen, A, B, C, and D, consisted of four samples with average diameters of 0.012, 0.018, 0.017, and 0.031 mm., respectively. Three of these samples were under 0.02 mm. in diameter, and one was larger. The range in average diameter of the fibers tested is from 0.012 to 0.031 mm. Fibers were tested from small locks of scoured wool from samples A, B, C, and D until 200 fibers were tested at each of

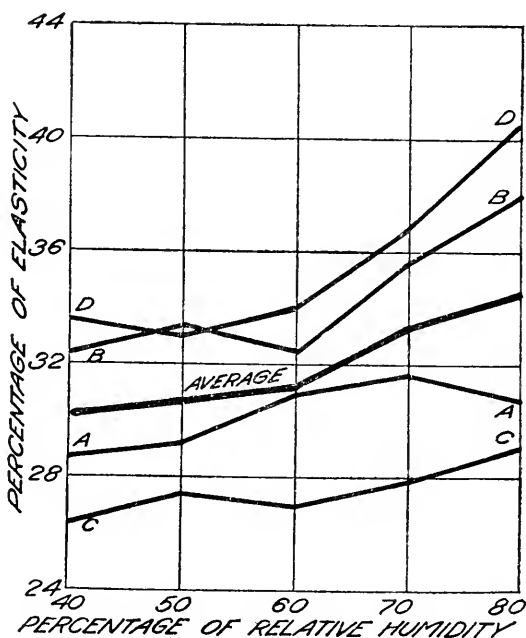

FIG. 2.—Graphs showing the effect of humidity upon the elasticity of wool fiber.

five humidities, as shown in Table III. It will be noted that the breaking strength of the fibers decreases quite uniformly as the humidity increases. Sample D shows a decrease in its tensile strength as the humidity increases up to 80 per cent, when there is a very slight increase. In A, B, and C the tensile strength seems to fluctuate up and down with no particular uniformity. These values for tensile strength were much more variable than those for the breaking strength. Several hundred additional fibers were tested on A, B, C, and D at humidities of 40 and 50 per cent, since the greatest variability seemed to occur at these two points. Graphs showing the values obtained on these samples of scoured wool for breaking strength and elasticity are shown in figures 1 and 2.

TABLE III.—Diameter, breaking strength, and tensile strength of scoured wool fibers at five different humidities

Sample No.	At relative humidity of 40 per cent.					At relative humidity of 50 per cent.				
	Diameter in thousandths of a mm. (average of 100).	Breaking strength (average of 100).	Average.	Tensile strength per thousandth of a sq. mm.		Diameter in thousandths of a mm. (average of 100).	Breaking strength (average of 100).	Average.	Tensile strength per thousandth of a sq. mm.	
				Average of 100.	Average of 200.				Average of 100.	Average of 200.
		<i>Dgm.</i>	<i>Dgm.</i>	<i>Mgm.</i>	<i>Mgm.</i>		<i>Dgm.</i>	<i>Dgm.</i>	<i>Mgm.</i>	<i>Mgm.</i>
A.....	11.9 13.2	48.59 48.52	48.56	433.97 359.33	396.65	10.79 11.54	47.67 43.10	45.39	521.67 412.08	466.88
B.....	20.04 20.34	86.62 92.04	89.33	274.37 284.60	279.49	17.86 18.83	82.81 89.52	86.17	330.37 319.36	324.87
C.....	19.89 17.44	88.03 82.52	85.28	283.29 320.63	301.96	17.40 17.40	82.89 79.53	81.21	349.05 334.54	341.80
D.....	30.78 30.48	208.02 211.32	209.68	281.50 280.38	280.94	32.57 31.36	221.86 207.22	214.54	266.54 268.74	267.64

Sample No.	At relative humidity of 60 per cent.					At relative humidity of 70 per cent.				
	Diameter in thousandths of a mm. (average of 100).	Breaking strength (average of 100).	Average.	Tensile strength per thousandth of a sq. mm.		Diameter in thousandths of a mm. (average of 100).	Breaking strength (average of 100).	Average.	Tensile strength per thousandth of a sq. mm.	
				Average of 100.	Average of 200.				Average of 100.	Average of 200.
		<i>Dgm.</i>	<i>Dgm.</i>	<i>Mgm.</i>	<i>Mgm.</i>		<i>Dgm.</i>	<i>Dgm.</i>	<i>Mgm.</i>	<i>Mgm.</i>
A.....	11.84 12.75	44.89 44.91	44.90	407.40 352.07	379.74	10.80 11.09	41.09 39.53	40.31	455.25 409.27	432.26
B.....	16.44 16.55	72.85 71.74	72.30	343.30 329.51	336.41	18.55 16.85	85.86 74.08	79.97	324.14 334.41	329.28
C.....	18.37	81.02	81.02	305.68	305.68	16.57 17.08	74.62 79.23	76.93	347.76 345.78	346.77
D.....	30.65	197.02	197.02	266.27	266.27	31.26 30.35	199.67 193.31	196.49	260.07 267.20	263.64

Sample No.	At relative humidity of 80 per cent.				
	Diameter in thousandths of a mm. (average of 100).	Breaking strength (average of 100).	Average.	Tensile strength per thousandth of a sq. mm.	
				Average of 100.	Average of 200.
		<i>Dgm.</i>	<i>Dgm.</i>	<i>Mgm.</i>	<i>Mgm.</i>
A.....	11.97 10.45	45.41 40.48	42.95	403.85 471.98	437.92
B.....	17.26 18.64	73.79 86.08	79.94	315.37 314.72	315.05
C.....	13.62 14.65	51.46 56.10	53.78	353.21 333.42	343.32
D.....	30.02 28.69	183.75 175.83	179.79	259.60 272.24	265.92

The heavy line shows the average values obtained for all the results secured at each humidity. The average breaking strengths of these samples of scoured wool decrease as the humidity increases, while the elasticity shows an increase with an increase in humidity.

The wide variations in the values for tensile strength as compared with similar values for breaking strength led the writer to compare the tensile strengths of fibers of different diameters in locks of wool A, B, and D.

Graphs showing the variation in the tensile strengths of three different samples of wool are shown in figure 3 in the curves A-A, B-B, and D-D.

The fibers tested in these curves range from 0.008 to 0.038 mm. in diameter. The number of fibers tested at each humidity varies considerably. In some cases only 30 or 40 were tested, while in other cases as many as 250 of a given diameter were tested. Sample A of curve A-A ranges in fineness from 0.008 to 0.018 mm. The tensile strength decreases from 667 to 260 mgm. per thousandth of a square millimeter at the lowest point. Sample B shows a decrease from 466 mgm. at 0.01 mm. to 315 mgm. at 0.022 mm. The curve of sample B follows that of sample A very closely from a diameter of 0.01 mm. to one of 0.018 mm. and rises slightly from a diameter of 0.018 mm. to one of 0.022 mm. Sample D decreases from 320 mgm. at 0.023 mm. to 232 mgm. at 0.038 mm.

These curves show that the tensile strength of wool decreases with an increase in diameter. The drop is most abrupt with the sample of fine wool. The coarsest sample has the most gradual drop in its diameter and tensile strength curves. If the breaking strength of wool varied directly as the area of cross section, the curve would follow the line E-E. If the breaking strength varied as the diameter or circumference, the tensile strength curve would follow the line F-F. The curve for the tensile strength of sample D follows the line D-D and lies between these two lines E-E and F-F. This fact seems to indicate that the breaking strength of medium and coarse wool varies with some power of the diameter which lies somewhere between the first and second.

For fine wool like sample A, a curve showing the strength of the wool very closely follows a curve plotted with $\frac{1}{D}$, or any constant, and the first power of the diameter. This fact indicates that the breaking strength of fine wool does not vary directly with the area of the cross section but with a value which is very close to the first power of the diameter. Curve C-C shows the relation between the tensile strengths and diameters of wool fibers obtained from data published by Hill.¹ In the present experiment, 1,000 fibers were broken to obtain the points in this curve, and each diameter was measured after breaking as nearly as possible at the point of breakage. This curve also follows very closely the curve F-F. By inspecting the graphs it is easy to see that the widest variations in the curve F-F plotted from $\frac{1}{D}$ are found at the smallest diameters. As this curve approaches the larger diameters it tends to become rather flat.

In the first three samples of Table III there is a large variation between the largest and smallest tensile strengths of the wool fibers of those samples. When fibers are tested with such a wide variation in their tensile strength as is found in locks of fine wool, it is necessary that these fibers be carefully mixed in order to get satisfactory results. There is a tendency for an operator to pull the largest fibers in fine wool, while with

¹ HILL, J. A. STUDIES ON THE STRENGTH AND ELASTICITY OF THE WOOL FIBER. I. THE PROBABLE ERROR OF THE MEAN. *In* Wyo. Agr. Exp. Sta. 21st Ann. Rpt., 1910-11, suppl., 139 p. 1911.

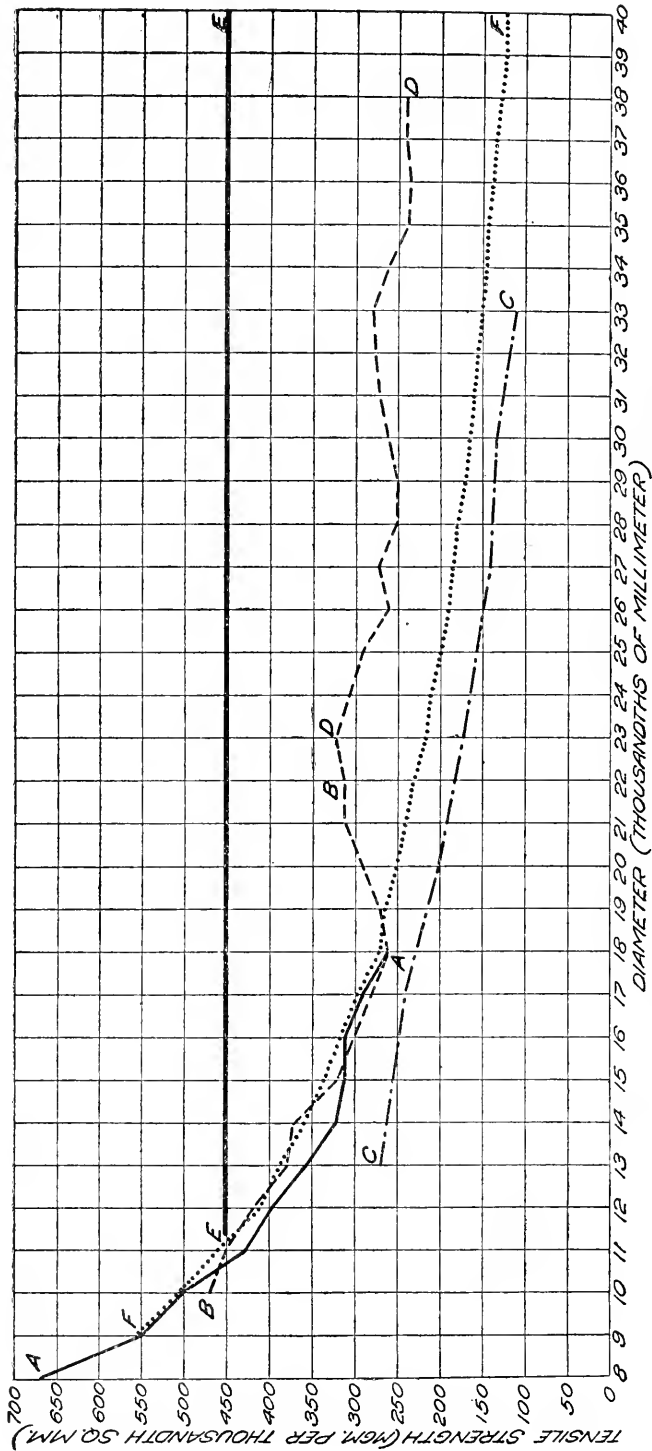

Fig. 3.—Graphs showing the relation between the diameter and the tensile strength of wool fiber.

coarser samples there is not such a tendency. This fact and the fact that larger fibers can be more accurately measured with a micrometer caliper make it possible to get satisfactory results for tensile strengths with samples of coarser wools. Then again the coarser wools have breaking strengths which vary more closely with the areas of the cross section of the wool than do the breaking strengths of fine wool samples, as is shown in F-F of figure 3. The coarse wools may be measured from the original lock, and their breaking and tensile strengths may be determined quite satisfactorily.

Sometimes it is necessary to make the closest possible comparison of the effects of various conditions or chemical reagents on a given grade of wool, as in the case at hand. The writer desired to determine the effects of various humidities upon a uniformly mixed sample of wool. Single fibers were drawn from sample B and placed consecutively in six different groups, numbered 1 to 6, with their ends extending from one piece of adhesive tape to another which was laid parallel to it and about 2¾ inches from it. Always beginning with No. 1, these fibers were placed one at a time in each of these six groups until 100 fibers, or the desired number, were in each of the six small locks. By making five series of these groups and subjecting the same numbers of each group to the same test, it is possible to get some very satisfactory comparisons. Although it is very tedious work, these fibers may be picked out by hand at the rate of 200 an hour. Five small locks, each containing 120 fibers, were tested in the scoured condition at humidities of 40, 50, 60, 70, and 80 per cent and saturated. Similar locks were scoured with ether and hot water and tested under the same conditions. The saturated fibers were kept between moist filter papers until tested.

Table IV and figure 4 show the results of this experiment.

TABLE IV.—*Elasticity and breaking strength of scoured and unscoured wool from sample B*

[Average of 600 fibers]

Percentage of humidity.	Scoured wool.		Unscoured wool.	
	Elasticity.	Breaking strength.	Elasticity.	Breaking strength.
	<i>Per cent.</i>	<i>Dgm.</i>	<i>Per cent.</i>	<i>Dgm.</i>
40.....	25. 80	65. 14	26. 40	60. 06
50.....	30. 76	64. 11	31. 48	68. 97
60.....	33. 96	64. 64	34. 72	67. 01
70.....	37. 08	59. 53	38. 00	63. 80
80.....	40. 08	60. 10	43. 64	60. 44
Saturated.....	33. 76	59. 16	34. 60	63. 42

The curve for unscoured wool shows that the breaking strength decreases as the relative humidity changes from 40 to 80 per cent and increases when the wool becomes saturated. In scoured wool the curve is more irregular. There is a definite drop as the humidity changes from

40 to 80 per cent, although the curve makes almost a straight line from 70 per cent up to the point of saturation. The elasticity curves for scoured and unscoured wool are nearly parallel, rising as the humidity changes from 40 to 80 per cent and falling from this point to that of saturation.

SUMMARY

(1) The tensile strength of wool increases with the decrease in the diameter of the wool fiber.

(2) Fine wool has a breaking strength varying more closely with the first than with the second power of the diameter.

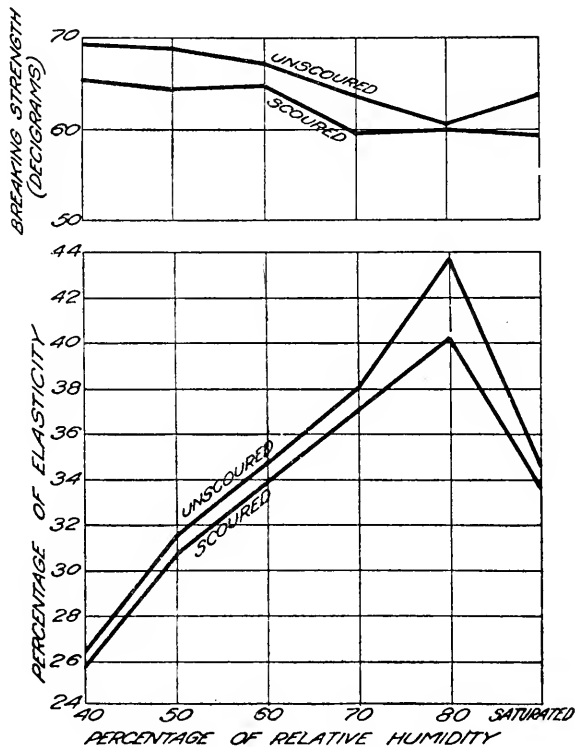

FIG. 4.—Graphs showing the effect of humidity upon the breaking strength and elasticity of wool fiber.

(3) Coarse wool has a breaking strength varying with a figure which lies somewhere between the first and second powers of the diameter.

(4) It is necessary to mix samples of fine wool carefully before testing in a testing machine if the best results are to be obtained.

(5) The breaking strength and tensile strength of both scoured and unscoured wool decrease with an increase in relative humidity from 40 to 80 per cent and show a tendency to increase from this point to that of saturation.

(6) The elasticity of scoured and unscoured wool increases with an increase in relative humidity from 40 to 80 per cent and decreases from this point to that of saturation.

COMPOSITION AND DENSITY OF THE NATIVE VEGETATION IN THE VICINITY OF THE NORTHERN GREAT PLAINS FIELD STATION

By J. T. SARVIS

Assistant in Dry-Land Agriculture, Bureau of Plant Industry, United States Department of Agriculture

INTRODUCTION

The grazing industry in the Northern Great Plains area is intimately concerned with the composition and density of the native vegetation. This paper deals with the native vegetation as it exists at present in the section under consideration. While parts of the discussion will apply in general to the Great Plains area, it pertains to western North Dakota and in particular to the territory adjacent to the Missouri River on the west near Mandan. This point lies practically on the one hundred and first meridian and just south of the forty-seventh parallel, north latitude. The Bureau of Plant Industry has one of a number of field stations located here under the direction of the Office of Dry-Land Agriculture. One of the lines of investigation in connection with this station is a grazing experiment in cooperation with the North Dakota State Experiment Station. This investigation is primarily concerned with determining the carrying capacity of the range in that section and working out a grazing system adapted to conditions in the Great Plains. In connection with this work it is necessary to make detailed studies of the native vegetation in order to observe any changes that may occur in the structure of the plant cover. These studies have furnished the material of this paper.¹

TOPOGRAPHY AND SOIL

The topography of the area around Mandan varies from rolling to nearly level. The land is cut by numerous ravines and coulees, which drain into the Heart and Missouri Rivers. The altitude of the field station is approximately 1,700 feet above sea level.

The following description of the soil of this area is quoted from "The Story of the Prairies" by Willard (9),² formerly geologist at the North Dakota Agricultural College:

A belt having an indefinite edge to the westward lies along the west side of the Missouri River, which belt represents the western limits of the glaciated area of North Dakota, and of the Continent of North America. This "belt" of land along the west

¹ The annual reports by the author of the cooperative grazing experiment at Mandan have been frequently referred to and used in the preparation of this paper. These reports are on file in the Office of Dry-Land Agriculture, the North Dakota Agricultural College, and the Mandan Field Station.

² Reference is made by number (italic) to "Literature cited," p. 71-72.

side of the river shows by the character of the soils and the rocks that lie upon or near the surface that the great continental glacier was once here. Toward the west the belt fades out and becomes indistinguishable from the land farther west over which the ice did not pass, but the eastern part of the belt is sufficiently modified as to the soils and the landscape features to be readily recognized.

The soils, therefore, in the belt bordering the Missouri River on the west constitute a transition type from the glacial soils of the eastern portion of the State to the non-glaciated or residual soils of the southwestern portion of the State.

CLIMATE

The United States Weather Bureau Station at Bismarck has made continuous meteorological observations since 1875. Bismarck is located on the east side of the Missouri River, only about 5 miles distant from Mandan. Observations were begun at the Mandan Field Station during 1913. From 1875 to 1914, inclusive, or 40 years, the mean annual precipitation was 17.41 inches. The greatest annual amount during this period was 30.92 inches in 1876, while the lowest was 11.03 inches in 1899. During 1917 the record at the Mandan Field Station was 10.31 inches. The mean seasonal precipitation from April 1 to July 31, inclusive, was 9.91 inches during the 40-year period. The month of maximum precipitation is June, with a mean of over 3.5 inches, and the month of minimum precipitation is February, with less than 0.5 inch.

The temperature is extreme in both winter and summer. The lowest recorded to date was 45° F. below zero in January, 1916, while the highest was 107° above zero in July, 1910 and 1917. The average dates of killing frosts in spring and autumn are about May 15 and September 15, respectively, but frosts have occurred as late as June 7 and as early as August 23. The average frost-free period is 128 days. The prevailing wind direction is from the northwest. The average wind movement near the ground is about 6 miles per hour.

PLANT FORMATION

According to a map of "Plant Formations of the United States," by Shantz and Zon,¹ this region would come within the "short-grass formation." However, Dr. F. E. Clements, who visited the field station during the summer of 1917, is of the opinion that it would be more properly placed in the "long-grass" or "prairie formation," because of the long grasses and other plants which are typical of a prairie formation. From actual determinations in the field the percentages of short-grass and long-grass cover have been found to be nearly equal, so that the formation could be put in either class, according to the viewpoint of the observer. If the secondary plant layer is considered as the determining factor, the region falls in the long-grass formation. The vegetation in this particular area might be considered as in a transition zone, since the dominating species are typical of both formations.

¹ SHANTZ, H. L., and ZON, R. PLANT FORMATIONS OF THE UNITED STATES. Paper presented before the Ecological Society of America at its annual meeting in New York in 1916. The map will appear in the Agricultural Atlas.

The dominating species are *Bouteloua gracilis* (*B. oligostachya*) and *Stipa comata*, which form a distinct association. This is an association composed of *Bouteloua gracilis*, which is typical of the short-grass formation, and *Stipa comata*, which is a typical long-grass species. This association is dominated by the *Bouteloua*. Sarvis¹ has described in a paper other sections of western North Dakota which show the same dominating species.

COMPOSITION OF THE VEGETATION

In Plate 12 is illustrated the general character of the vegetation on the prairie in the Mandan region. In 1915, when this photograph was taken, the season was very favorable, and all plants reached a maximum development. The composition of the vegetation is thus very clearly illustrated.

In the following list of plants the arrangement of species is in the order of abundance. The order of the primary and secondary species is subject to slight modifications as the studies are extended. The order of the dominant species was determined by measurements from quadrat maps and in the field. The order of the primary species, other than grasses, was determined by count. The secondary species are listed in the estimated order of their abundance.

DOMINANT SPECIES

- | | | |
|---------------------------|--|-------------------------|
| <i>Bouteloua gracilis</i> | | <i>Carex filifolia</i> |
| <i>Stipa comata</i> | | <i>Carex heliophila</i> |

PRIMARY SPECIES

- | | | |
|---------------------------------|--|--------------------------------|
| <i>Artemisia gnaphalodes</i> | | <i>Artemisia frigida</i> |
| <i>Koeleria cristata</i> | | <i>Stipa viridula</i> |
| <i>Solidago pulcherrima</i> | | <i>Eschinacea angustifolia</i> |
| <i>Agropyron smithii</i> | | <i>Aristida longiseta</i> |
| <i>Artemisia dracunculoides</i> | | <i>Polygala alba</i> |
| <i>Psoralea argophylla</i> | | <i>Stipa spartea</i> |
| <i>Andropogon scoparius</i> | | <i>Ratibida columnaris</i> |

SECONDARY SPECIES

- | | | |
|-------------------------------|--|-------------------------------|
| <i>Muhlenbergia cuspidata</i> | | <i>Aster multiflorus</i> |
| <i>Lacinaria punctata</i> | | <i>Petalostemon purpureum</i> |
| <i>Calamovilfa longifolia</i> | | <i>Petalostemon candidum</i> |
| <i>Agropyron caninum</i> | | <i>Lactuca pulchella</i> |
| <i>Bouteloua curtipendula</i> | | <i>Vicia sparsifolia</i> |
| <i>Comandra pallida</i> | | <i>Agropyron tenerum</i> |

The grasses, other than the dominant species, are in the estimated order of abundance. It is difficult to make individual counts of them, since they usually occur in bunches. If bunches or mats were considered as single plants and enumerated as such the number would have no significance when compared with that of other plants which usually occur as individuals.

¹ SARVIS, J. T. NATIVE GRASSES OF WESTERN NORTH DAKOTA. Paper presented before the Ecological Society of America at its annual meeting in New York in 1916.

When the vegetation is considered from the standpoint of grazing, only a very few species are important factors in the total amount of forage annually produced. Sampson (6) has discussed this point more fully. In this region, *Bouteloua gracilis* and *Stipa comata* are the most important species, both on account of their total forage production and their value as grazing grasses.

The value of a given species for grazing purposes depends upon (1) its abundance, (2) whether it is relished by stock, (3) its length of growing season, (4) its ability to withstand trampling and to recover readily from grazing, and (5) its adaptation to drought conditions. According to these requirements, *Bouteloua gracilis* would take first rank and *Stipa comata* would be second in importance.

A plant may be of importance in relation to grazing because of its abundance, whether it is or is not of grazing value. If it is a valuable grazing species it is of primary importance, and if it is of minor grazing value it is of importance because it occupies ground surface that might otherwise support a more valuable species. On the other hand, a species may be greatly relished by stock, as *Andropogon furcatus* at Mandan, but occur in such limited areas that it is unimportant in the total amount of forage annually produced. In pastures where this grass occurs it is cropped close to the ground throughout the season, as illustrated in Plate 13, A.

Bouteloua gracilis is grazed with avidity at all times of the year. It cures well on the ground without great loss of its nutritive value, and late in the fall cattle eat it in preference to any other grass. Although *Stipa comata* has the disadvantage, for a short period, of its sharp needles, it is so much more abundant than other species, except *B. gracilis*, that it enters largely into the feed of grazing animals. It is the first grass to produce green shoots in the spring, and it usually produces more growth late in the fall than do other species.

A grass that is similar in appearance and often confused with *Bouteloua gracilis* is *Bulbilis dactyloides*, or buffalo grass. It has a better reputation for grazing and is more widely known by a popular name than any other single species of grass in the Great Plains. However, out of several thousand acres of native vegetation surrounding the field station, there are less than 5 acres of the true buffalo grass. On a trip over western North Dakota in the summer of 1916, the author found this grass in only a few small areas. Blue grama (*Bouteloua gracilis*) is and always has been called buffalo grass by the people in the Great Plains area. This misnomer has been and is so universal that it is difficult to obtain reliable information concerning the abundance and importance of buffalo and blue grama grasses for grazing in the early history of the range. However, at present the true buffalo grass occurs only in small amounts in this region and in western North Dakota, where it is evident it never

was as abundant as in western South Dakota. Pound and Clements (4) said in regard to buffalo grass:

The buffalo-grass was, until recently, supposed to have once covered the greater portion of Nebraska; its disappearance has, as a matter of sentiment, been connected with that of the buffalo. The patches of buffalo-grass, which are found scattered here and there over the State, are to be regarded as intrusions rather than stragglers left by a retreating species.

Griffiths (2) says in regard to *Bulbilis dactyloides*:

Bouteloua gracilis, especially when not in head, is very similar and frequently mistaken for it. On this account the true buffalo grass is very much overestimated in importance, because there are so many things included with it in the popular mind. Much of the credit given this species is due to the grammas, which in age especially look much like it. On the other hand, the species is an important one throughout its range.

In southwestern South Dakota, at the Ardmore Field Station, where a grazing experiment is now being conducted, the important grazing grasses are *Bulbilis dactyloides*, *Bouteloua gracilis*, and *Agropyron smithii*. This association is dominated by the *Bulbilis*.

It often happens that a species that is of little grazing value in one section is of value in another area. For example, *Aristida longiseta* is of little grazing value at Mandan, since it is the last plant that cattle will take even when the pasturage is short, as illustrated in Plate 13, B. However, in other sections, Griffiths, Bidwell, and Goodrich (2) report this species as being of considerable value.

Some species are indicators of overgrazing, as *Artemisia frigida* at Mandan. In pastures where this plant occurs in abundance it usually will be found that the area has been overstocked for several seasons.

In the vegetation of this area no poisonous plants are abundant enough to be harmful. However, in areas farther west in North Dakota, the common "loco weed" (*Oxytropis lamberti*) is abundant and causes serious losses of stock in certain seasons.

All the plants mentioned in the list on page 65 enter more or less into the feed of grazing animals, but, as noted, only a few species produce a considerable percentage of the total forage. One of the reasons for this fact is the inability of many plants to produce more than a limited second growth after they have once been removed by grazing.

DENSITY OF VEGETATION

In a consideration of plant density in relation to grazing problems it is desirable and necessary to make clear and concise distinctions between frequently recurring terms. Plant density should refer to the "stand" or thickness of plants upon the ground surface. The ground surface is the total area of land under consideration, whether vegetated or unvegetated. Bare ground should be understood to refer to the un-vegetated portion of the ground surface or the spaces in the cover between

individual plants or between mats and bunches of species which grow in that manner. The term cover (8), or ground cover (5), is frequently and conveniently used in connection with discussions of vegetation. However, when the term cover is applied in connection with grazing investigations it should be defined, for it may mean one of two things: (1) basal cover, or the ground surface limits of living vegetation, or (2) the foliage cover, which is the plant layers above the basal cover. When the foliage cover is removed, as by close grazing or clipping, the basal cover remains. Plant layers as described by Clements (1) are vertical zones based on the height of plants. On the prairie around Mandan two layers are important—the ground layer, as *Bouteloua* and *Carex*, and the secondary layer, as *Stipa* and *Psoralea*.

Species that grow in mats or in bunches are most accurately expressed in terms of basal cover. For example, *Bouteloua* basal cover would refer to the amount of ground surface actually covered by *Bouteloua* if the foliage were removed by grazing or clipping. In such species it is possible to make the determinations with almost mathematical precision. Species that occur as individuals are best expressed in terms of their abundance per unit area. Shantz (7) says in regard to this point:

Those species which form mats can not be well represented in numbers per square meter, and on this account the percentage of surface covered is given instead.

The foregoing statements in regard to basal and foliage cover are very clearly illustrated in Plate 14. In 1915 the foliage cover was very



FIG. 1.—Diagram of grass mat; A, from side; B, from above. a, Basal cover; b, foliage cover.

heavy because growth conditions were favorable and the area had not been grazed. An estimate of the total cover based upon the amount of foliage cover could easily have been made at that time. But in 1916 on the same area, with the foliage cover removed, there would have been no basis for comparison with the 1915 condition. This illustrates the undesirability of utilizing the foliage cover, under all conditions, as a basis for estimating the possibilities of forage production and the consequent carrying capacity. A clear distinction between basal cover and foliage cover is, therefore, necessary and important.

The two illustrations of Plate 14 picture the same area, but one illustrates a heavy foliage cover and the other only the basal cover. However, the potential ability of the area to produce under similar conditions as heavy a foliage cover as in 1915 is unchanged.

Figure 1 illustrates the difference between the basal cover and the foliage cover. The limit of basal growth is *a*, while the limit of foliage growth is *b*. In a given case the surface area of the foliage cover is greater than that of the basal cover, yet the amount of forage is the same. The basal cover is more permanent than the foliage cover, since the latter may be readily removed by grazing. The quadrat map (fig. 2) in the 30-acre pasture, which was mapped in 1915 and remapped in 1916, shows,

with the exception of a few annual species, the basal cover to be practically the same in both years. If the maps had been drawn on the basis of the foliage cover, there would have been a great difference between the 1915 and 1916 maps. The photographs illustrate this difference more clearly than would be possible by quadrat maps. But if the maps are drawn on a basis of the basal cover, various maps of a given quadrat would show actual changes as they occur from grazing. This is really

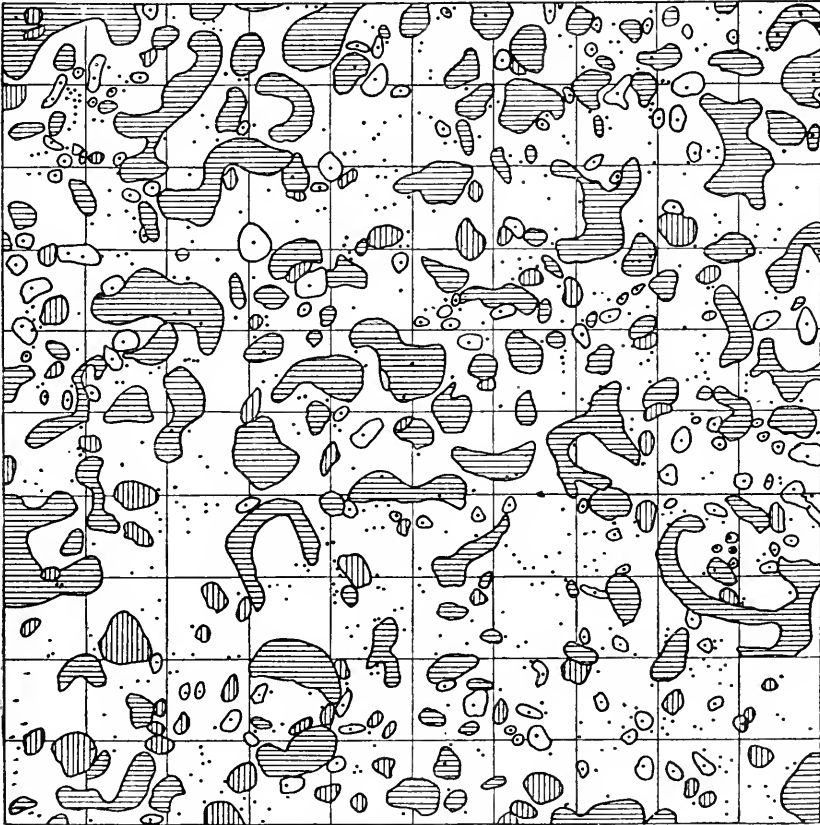

FIG. 2.—Meter quadrat in 30-acre pasture mapped in detail in 1915. Cross hatching represents *Bouteloua gracilis*; vertical hatching, *Stipa comata*. The presence of other species is indicated by dots and outlined areas.

the important point in relation to grazing systems. If grazing has been severe, the basal cover is likely to be changed rapidly, but under normal conditions it should change gradually. This is especially true in such regions as Mandan, where most of the vegetation is made up of perennial species. Sampson (5) says in regard to increase of ground cover:

The increase in actual stand or ground covered was due almost entirely to the enlargement of the tufts, and text figures 5 and 6 show that even under season-long protection the bunch-grasses and other valuable plants do not increase rapidly by this means.

Since the carrying capacity of the range is largely dependent upon the density of the vegetation, it is obvious that this factor should be carefully determined. If density is determined on the basis of the foliage cover, even when this is possible, the carrying capacity is likely to be placed too high, because of favorable growth conditions or an accumulation of previous growth, and overgrazing will result. In normal seasons the amount of forage a given area of ground surface can produce is largely determined by its basal cover. Therefore, the basis for an estimate of the amount of ground surface covered by vegetation should be founded upon the basal cover. The foliage cover is the important consideration for immediate grazing, but the basal cover more nearly determines the future possibilities of a given area of land for grazing purposes.

AMOUNT OF BASAL COVER AT MANDAN

From quadrat maps drawn to show bare and covered ground surface the total basal cover has been determined. The maps show about 60 per cent vegetated and 40 per cent bare ground. From quadrat maps, such as that in figure 2, made in the various pastures, the percentages of basal cover of *Bouteloua* and *Stipa* were determined. These are approximately 20 and 10 per cent, respectively. These determinations were all made from the maps by means of a planimeter.

Shantz (7) has made a number of estimates on the amount of cover in a series of quadrats in the mesa region near Pikes Peak. He has expressed the amounts in percentages in each case. The same method is followed in the present studies. This is a most convenient system, especially when it is desired to express a given species in terms of amount of total cover. Sampson (5) expresses the "density of vegetation" in terms of tenths, using 10 as complete ground cover. In order to avoid confusion, the amounts of cover as used in connection with the Mandan grazing experiment are expressed in percentages.

From the amounts of basal cover of *Bouteloua gracilis* and *Stipa comata* it is readily seen how important they are from the standpoint of grazing in this section. Griffiths, Bidwell, and Goodrich (2) have discussed the value of these grasses for forage. From clipping experiments at Mandan in 1917, in connection with the grazing studies, the *Bouteloua* was found to have produced from 40 to 50 per cent and *Stipa* from 15 to 20 per cent of the total forage for the season. When the quadrats were clipped, the vegetation was separated into six parts, as follows: *Bouteloua gracilis*, *Stipa comata*, *Aristida longiseta*, other grasses, *Carex filifolia* and *C. heliophila*, and other plants. Columns are also reserved for the sum of *B. gracilis* and *S. comata* and for the total weight of all grasses and of all species. From these data it is possible to determine the relation of one species or group to another or to the total weight of all species. The various amounts were recorded in grams, weighed both green and air-dried. From these data it appears evident that the ground layer is the important one from the standpoint of grazing in this section.

The abundance of a given species often appears greater than is determined by actual counts per unit area. Pound and Clements (4) have fully discussed this point. From Plate 12 it would appear that *Psoralea argophylla* is the most abundant species. However, by a number of actual counts per unit area it was found to be fourth in abundance of plants other than grasses and sedges.

SUMMARY

(1) The data and conclusions presented in this paper have been obtained in connection with a grazing experiment at the Bureau of Plant Industry Field Station near Mandan, N. Dak. This experiment is designed to determine the carrying capacity of the native vegetation and the effects upon it of different intensities and methods of grazing.

(2) The vegetation is composed of a large number of species, only a few of which produce a considerable amount of the total forage. The dominating species are *Bouteloua gracilis* and *Stipa comata*.

(3) The density of the vegetation is determined by the thickness of plants upon the ground surface and not by the foliage growth. The term cover used in connection with density may mean basal cover or foliage cover. The former remains after the latter has been removed by close grazing or clipping.

(4) The total basal cover of all species in the Mandan region is approximately 60 per cent of the ground surface. *Bouteloua gracilis* has a basal cover of about 20 per cent and *Stipa comata* nearly 10 per cent of the ground surface.

(5) Clipping data of different day periods showed that *Bouteloua gracilis* had produced from 40 to 50 per cent and *Stipa comata* from 15 to 20 per cent of the total forage. The remainder was made up of a number of other species.

LITERATURE CITED

- (1) CLEMENTS, Frederic E.
1916. PLANT SUCCESSION; AN ANALYSIS OF THE DEVELOPMENT OF VEGETATION. xiii, 512 p., illus., pl. Washington, D. C. (Carnegie Inst. Washington, Pub. 242.)
- (2) GRIFFITHS, David, BIDWELL, George L., and GOODRICH, Charles E.
1915. NATIVE PASTURE GRASSES OF THE UNITED STATES. U. S. Dept. Agr. Bul. 201, 52 p., 9 pl.
- (3) POUND, Roscoe, and CLEMENTS, Frederic E.
1898. A METHOD OF DETERMINING THE ABUNDANCE OF SECONDARY SPECIES. *In* Minn. Bot. Studies, s. 2, pt. 1, p. 19-24.
- (4) ————
1900. THE PHYTOGEOGRAPHY OF NEBRASKA. ed. 2, 442 p., 4 maps. Lincoln, Nebr. (Univ. Nebr. Bot. Survey, no. 8.) Bibliography, p. 22-30.
- (5) SAMPSON, Arthur W.
1914. NATURAL REVEGETATION OF RANGE LANDS BASED UPON GROWTH REQUIREMENTS AND LIFE HISTORY OF THE VEGETATION. *In* Jour. Agr. Research, v. 3, no. 2, p. 93-148, 6 fig., pl. 12-23.

-
- (6) SAMPSON, ARTHUR W.
1917. IMPORTANT RANGE PLANTS: THEIR LIFE HISTORY AND FORAGE VALUE.
U. S. Dept. Agr. Bul. 545, 63 p., 56 pl.
- (7) SHANTZ, H. L.
1906. A STUDY OF THE VEGETATION OF THE MESA REGION EAST OF PIKES PEAK.
In Bot. Gaz., v. 42, no. 1, p. 16-47, fig. 1-7; no. 3, p. 179-207, fig. 10-13.
- (8) ———
1911. NATURAL VEGETATION AS AN INDICATOR OF THE CAPABILITIES OF LAND
FOR CROP PRODUCTION IN THE GREAT PLAINS AREA. U. S. Dept. Agr.
Bur. Plant Indus. Bul. 201, 100 p., 23 fig., 6 pl.
- (9) WILLARD, Daniel E.
1908. THE STORY OF THE PRAIRIES; OR, THE LANDSCAPE GEOLOGY OF NORTH
DAKOTA. ed. 5, 377 p., illus., pl., maps. Chicago.

PLATE 12

General view of native vegetation near Mandan, N. Dak., showing composition and density. The following species are evident in the photograph: *Psoralea argophylla*, *Echinacea angustifolia*, *Artemisia frigida*, *Bouteloua gracilis*, *Stipa comata*, *S. viridula*, and *Ratibida columnaris*.

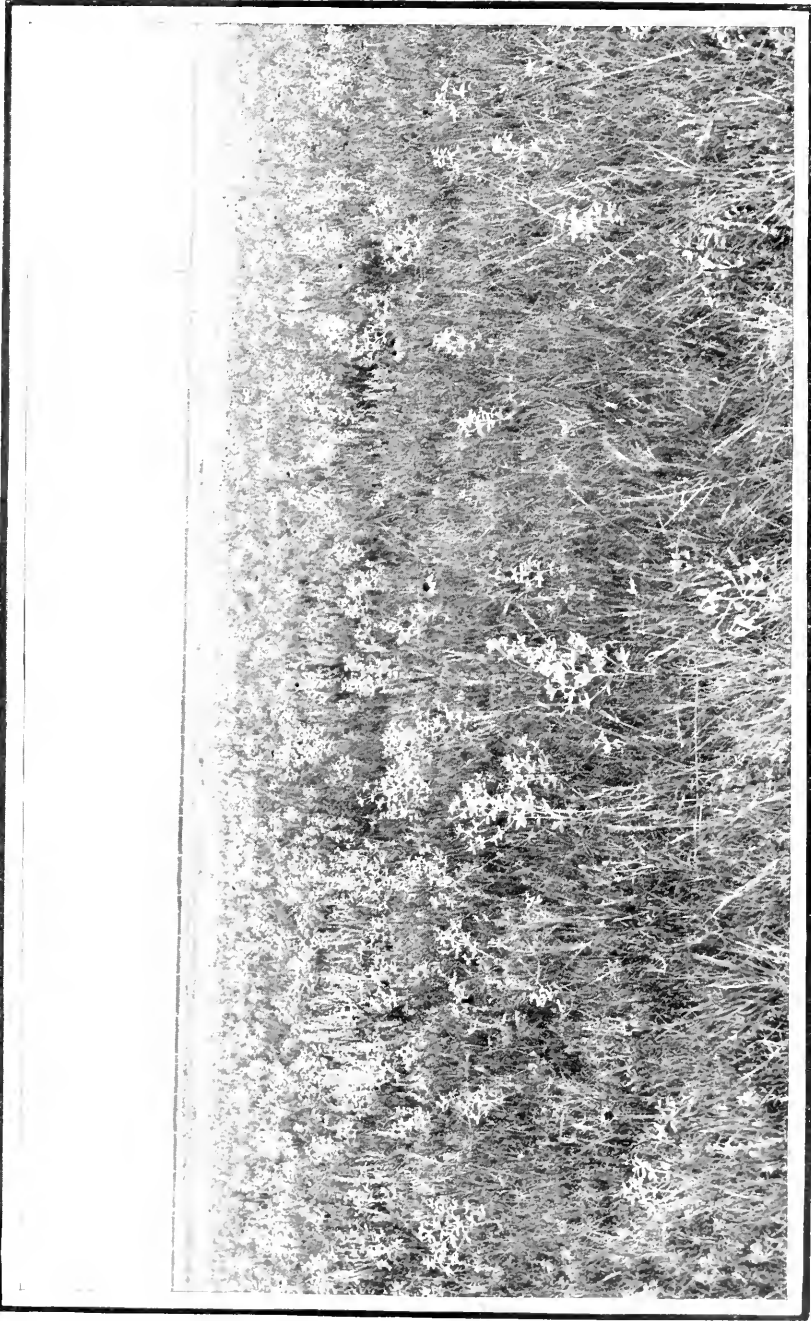



PLATE 13

A.—View across area of *Andropogon furcatus*. This grass is closely grazed, as it is greatly relished by cattle. Mandan, N. Dak., Nov. 2, 1917.

B.—Close view of *Aristida longiseta* bunches. All other vegetation has been removed by cattle close to the bunches. Mandan, N. Dak., Nov. 2, 1917.

PLATE 14

A.—Close view, from above, of meter quadrat in 30-acre pasture. This is the same area shown in B but was taken in 1916 after the foliage cover had been removed by grazing. Only basal cover remains. Mandan, N. Dak., Oct. 10, 1916.

B.—Meter quadrat in 30-acre pasture. This shows the cover as it appeared before grazing. Mandan, N. Dak., July 28, 1915.

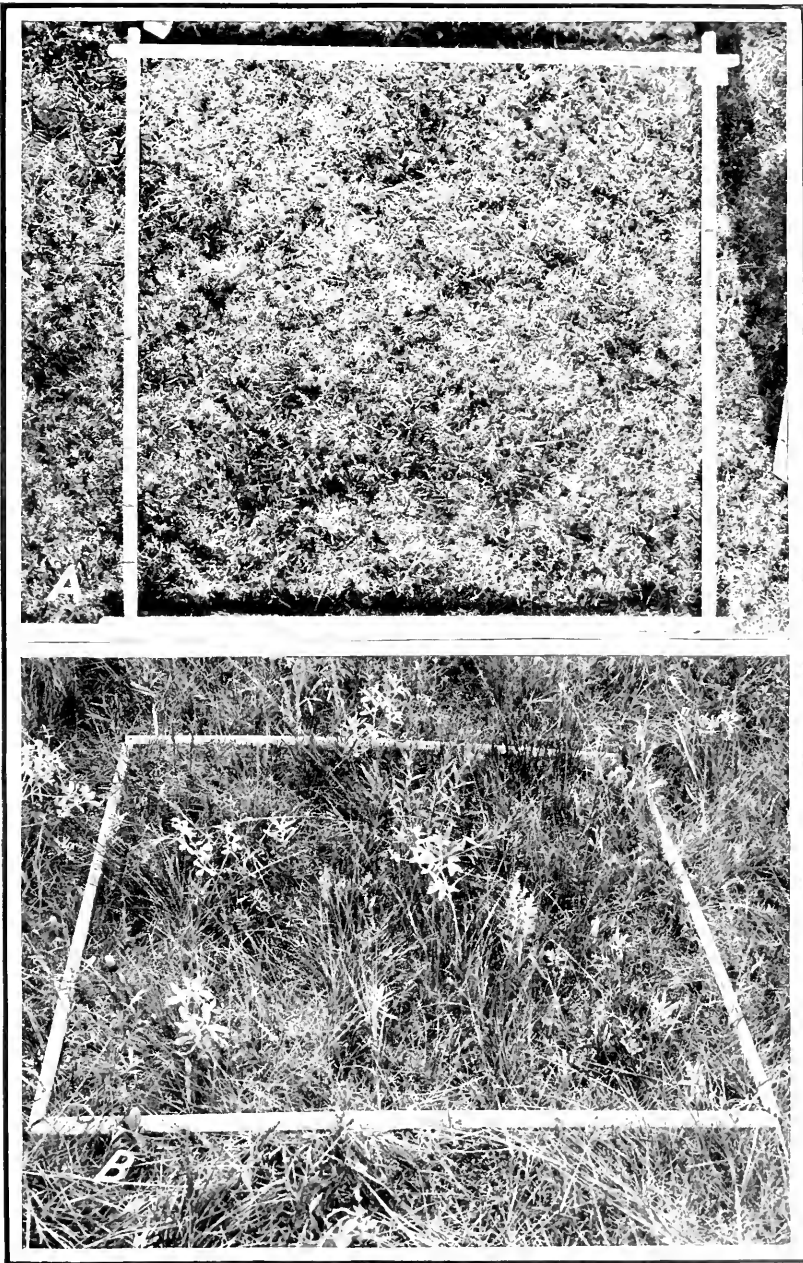

EFFECT OF REACTION OF SOLUTION ON GERMINATION OF SEEDS AND ON GROWTH OF SEEDLINGS

By ROBERT M. SALTER, *Soil Chemist*, and T. C. MCLVAINE, *Assistant Agronomist*,
West Virginia Agricultural Experiment Station

INTRODUCTION

Recent investigations have emphasized the importance of the intensity factor of soil acidity. The growth of plants is more logically associated with hydrogen-ion concentration than with total acidity as measured by a soil's capacity to neutralize or absorb bases. However, other factors than the direct physiological influence of the hydrogen or hydroxyl ion upon the plant itself are undoubtedly operative in producing the effects attributed to soil reaction, these factors being either conditioned by the reaction or associated with it. Thus, indirect effects upon plant growth would be produced by: (1) The extent to which the soil's reaction is favorable for the development of soil organisms, more particularly those responsible for nitrogen transformation and nitrogen accumulation; (2) changes in the solubilities of soil constituents as affected by reaction, this applying not only to essential elements such as calcium, magnesium, potassium, and phosphorus but also to those having toxic properties, such as aluminium, manganese, and ferrous iron where increases in concentration would be expected with increase in acidity; and (3) changes produced in physical properties of soils attendant upon changes in reaction.

Although the mass of data on the relation of soil acidity to plant growth is already large, few well-defined attempts have been made to separate the individual factors concerned and study them under conditions permitting the control or elimination of other factors. The present investigation was undertaken with the aim of studying the direct physiological influence of reaction as measured by hydrogen-ion concentration upon plant growth. Solution culture was resorted to in order to control or eliminate other factors as far as possible.

EXPERIMENTAL METHODS

In the work herein reported, wheat, corn, soybean, and alfalfa seedlings were grown in a series of solution cultures having as far as possible a constant nutrient composition and osmotic concentration and varying in reaction from a hydrogen-ion concentration of approximately 1×10^{-2} to 1×10^{-8} or 2 P_H to 8 P_H .¹

¹ In this report the P_H values of Sorensen will be used to state the reaction of the solutions, the value P_H being the negative common logarithm of the actual numerical concentration of hydrogen ions. Thus a concentration of hydrogen ions of 1×10^{-5} would correspond to a P_H value of 5.

NUTRIENT COMPOSITION OF SOLUTIONS

The need for a basic nutrient culture of favorable physiological balance was recognized. The attempt was at first made to adjust Shive's solutions No. R₅C₂ and R₃C₃ (24),¹ which he found best suited to the growth of wheat seedlings, to the various reactions desired for the work by additions of the requisite amounts of an acid or base. However, because of the extensive precipitation of phosphates of calcium and magnesium in the more alkaline members of such series, these solutions were found unsuited to the work at hand.

Two series of solutions were eventually employed which varied somewhat in composition from Shive's best solutions. The maximum partial ionic concentrations in volume equivalents for the two solutions used are given in Table I, the composition of Shive's solutions being included for purposes of comparison.

TABLE I.—Maximum ionic concentrations of solutions

[Expressed as gram-equivalents per liter]

Kind of solution.	Na ⁺ .	K ⁺ .	$\frac{1}{2}$ Ca ⁺⁺ .	$\frac{1}{2}$ Mg ⁺⁺ .	NO ₃ ⁻ .	$\frac{1}{2}$ SO ₄ ⁻ .	H ₃ PO ₄ ⁻ .	H ₃ C ₆ H ₅ O ₇ ⁻ .	Cl ⁻ .
Series A..	$\left\{ \begin{array}{l} 0.0100 \\ \text{to} \\ .0200 \end{array} \right.$	0.0360	0.0050	0.0050	0.0100	0.0050	0.0180	$\left\{ \begin{array}{l} 0.0100 \\ \text{to} \\ .0000 \end{array} \right.$	0.0050
Series B..									
Shive's'									
R ₅ C ₃ ...		0.0180	0.0104	0.0300	0.0104	0.0300	0.0180
R ₃ C ₃ ...		0.0108	0.0156	0.0400	0.0156	0.0400	0.0108

The salts, acids, and base used and their volume-molecular concentrations were as follows:

Series A.—Dipotassium phosphate (K₂HPO₄), 0.0180 m.; sodium nitrate (NaNO₃), 0.0100 m.; calcium chlorid (CaCl₂), 0.0025 m.; magnesium sulphate (MgSO₄), 0.0025 m.; sodium hydroxid (NaOH), 0.0000 to 0.0100 m.; and citric acid (H₃C₆H₅O₇), 0.0100 to 0.0000 m.

Series B.—Potassium sulphate (K₂SO₄), 0.0040 m.; potassium nitrate (KNO₃), 0.0100 m.; CaCl₂, 0.0025 m.; MgSO₄, 0.0025 m., phosphoric acid (H₃PO₄), 0.0180 m., sodium hydroxid (NaOH), 0.0000 to 0.0360 m.

To each 500 cc. of culture solution there were added 5 drops of a ferric phosphate solution containing 0.25 gm. of FePO₄ per 100 cc.

VARIATION OF REACTION

The ideal method of adjusting the reaction in such a series of cultures

¹ Reference is made by number (*italic*) to "Literature cited," p. 93-95.

would be one which would permit a variation in unit steps over the desired range and at the same time produce solutions of sufficient stability to prevent small changes in the total amount of acid or base from seriously affecting the reaction. In other words, the solution should have a "buffer" nature. In the titration of strong acids with strong bases, a point is reached, as neutrality is approached, at which further additions of small increments of base produce very rapid decreases in the hydrogen-ion concentration. This corresponds to a rapid rise in the voltage curve obtained in the electrometric titration of such solutions. Any solution selected within this region of rapid change is unsuited to work requiring constancy of reaction, particularly when subject to possible small changes in total acidity. With acids and bases of low dissociation this difficulty is not so marked, changes of reaction being much less abrupt under similar conditions.¹ Such solutions are commonly said to possess a buffer nature and are well adapted to work similar to that herein reported.

In series A the reaction was varied by adding H_3C_6 and NaOH to the successive cultures in amounts equivalent to the following volume-molecular concentrations:

Culture No.	$H_3C_6H_3O_7$.	NaOH.
	<i>M.</i>	<i>M.</i>
1.....	0.0100	0.0000
2.....	.0080	.0020
3.....	.0060	.0040
4.....	.0040	.0060
5.....	.0030	.0070
6.....	.0020	.0080
7.....	.0000	.0100

The reaction curve as determined by the hydrogen electrode for this series is shown in figure 1, A.² It will be noted that this solution possesses sufficient buffer action to prevent any rapid changes in reaction with change in total content of acid and base.

¹ For a more complete discussion of this subject see Hillebrand (10).

² The measurements of hydrogen-ion concentration were made by means of the gas chain and hydrogen electrode, using the potentiometer system and measuring electromotive force to 0.0001 volt. For electrometric titrations a special cell equipped with mechanical stirring device was designed.

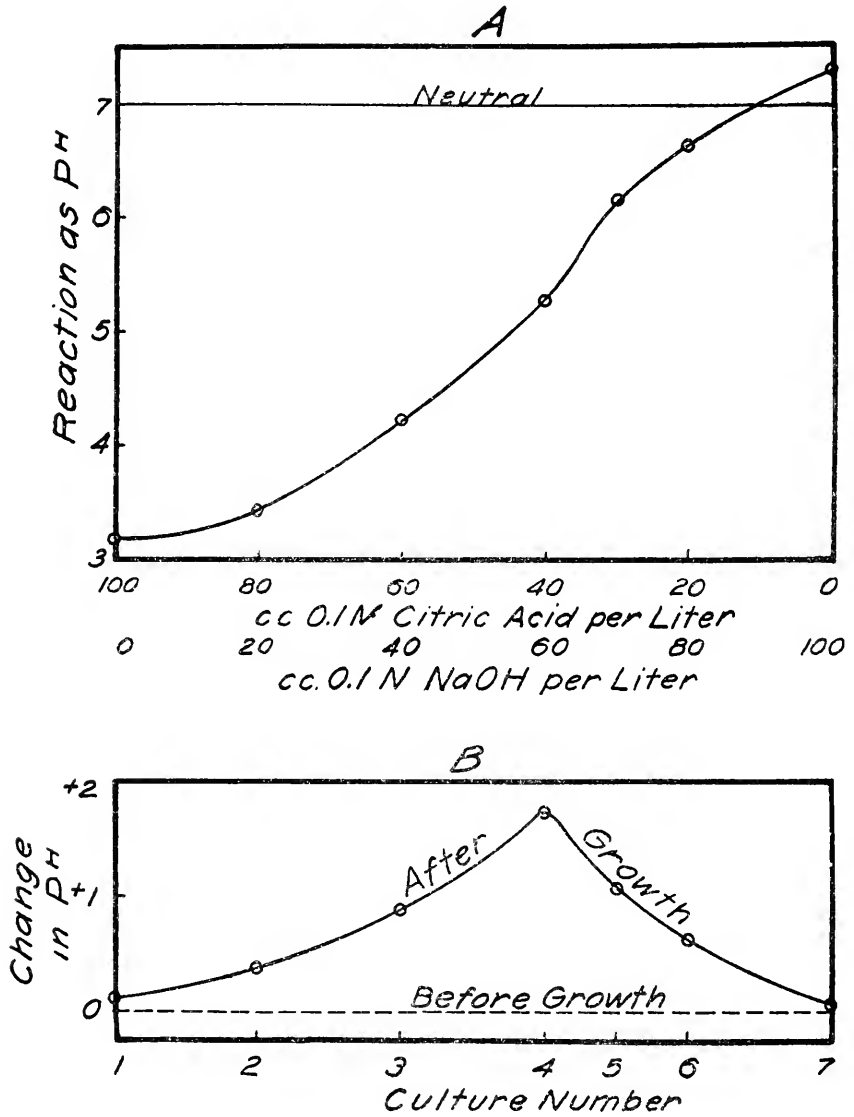

FIG. 1.—A, graph showing the relation of reaction to the contents of $\text{H}_3\text{C}_6\text{H}_5\text{O}_7$ and NaOH employed in the cultures of series A; B, graph showing the change of reaction found after 4 days' growth of wheat seedlings in series A.

In series B the reaction was varied by adding to all cultures sufficient H_3PO_4 to make the solution 0.0180 molecular and then NaOH in the following volume-molecular concentrations:

Culture No.	NaOH.
	M.
1.....	0.0000
2.....	.0144
3.....	.0174
4.....	.0181
5.....	.0198
6.....	.0288
7.....	.0360

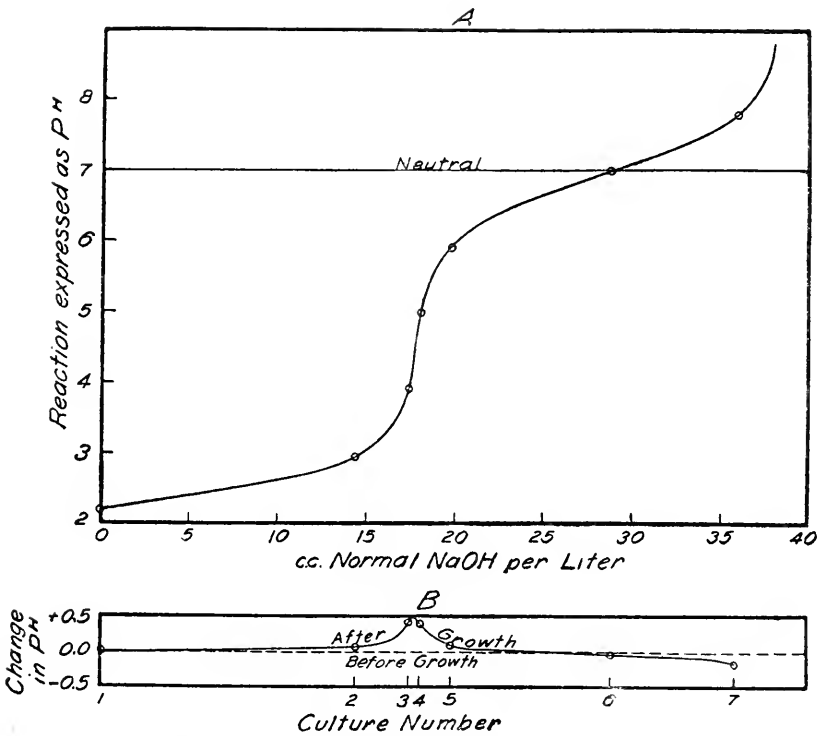

FIG. 2.—A, graph showing the change in reaction obtained by electrometric titration in series B; B, graph showing the change of reaction found after 4 days' growth of wheat seedlings in cultures of series B.

The electrometric titration curve for this solution (fig. 2, A) was used as a basis for determining the amounts of NaOH necessary to produce a series of seven cultures ranging from about 2 P_H to about 8 P_H and increasing in approximately equal steps of 1 P_H. The curve shows a rather abrupt rise at a point representing the complete neutralization of one hydrogen ion of the H_3PO_4 molecule. As will be shown later, the solutions chosen upon the steep part of the curve were less stable in reaction than those chosen upon the more nearly horizontal parts of the curve.

OSMOTIC CONCENTRATION

The osmotic concentrations of the solutions were not determined, because the data on the electrolytic dissociation of the component acids and salts under the variety of reactions used is not available and the authors did not have access to the necessary apparatus for making cryoscopic determinations. However, the relatively small change in total volume-molecular concentration within either series would indicate that little, if any, difference in growth within a given series should probably be attributed to the osmotic factor.

WATER EMPLOYED

All cultures were made from distilled water which had been rendered nontoxic by treating with carbon black as first recommended by Livingston (14).

TECHNIC OF GERMINATION AND GROWTH OF SEEDLINGS

The seeds of wheat, soybeans, and corn were germinated by supporting them upon a paraffined wire gauze which was floated by means of corks so that it was just even with the surface of nontoxic distilled water contained in a porcelain enameled pan. The seedlings were transferred to the various cultures when the plumules had attained a length of from 4 to 5 cm. The alfalfa seeds were germinated upon pads of filter paper in Petri dishes and transferred to the cultures after the seedling had attained a length of about 4 cm.

The wheat and alfalfa seedlings were grown in Non-Sol and Pyrex beakers holding 250 cc. of culture solution and were supported upon perforated caps of paraffined cheesecloth according to the method of Haas (7). The corn and soybean seedlings were grown in 8-ounce jars of flint glass and supported with corks according to the method of Totttingham (26). All beakers and jars were covered with black paper to exclude light. The solutions were renewed on all cultures every fourth day, and the glassware was thoroughly cleansed and sterilized before being used again. The reactions of the solutions used for growing wheat seedlings in both series were determined both before and after the 4-day periods. It was found that the successive solutions made up for a given reaction varied from each other by negligible amounts, so the solutions used for the growth of soybean, corn, and alfalfa seedlings were tested only at irregular intervals.

EXPERIMENTAL DATA AND DISCUSSION OF RESULTS

SERIES A

Wheat seedlings were grown for a period of 16 days in solutions having the composition given for series A. Growth was determined by taking the green weight of roots and tops, exclusive of seeds. Twelve seedlings were grown in each culture, and all seven cultures of the series were duplicated. The duplicate cultures agreed closely in all cases and are there-

fore not reported separately. The green weights obtained for tops, roots, and entire plants, exclusive of seeds, are given in Table II. The average reaction of each culture at the beginning and at the end of the 4-day periods and for the entire 16 days is also included in the table. The relative total green weights, based upon the highest, taken as 100, are shown in figure 3 plotted against the average P_H of the solutions, and the appearance of the seedlings at time of harvesting is shown in Plate 15, A, B.

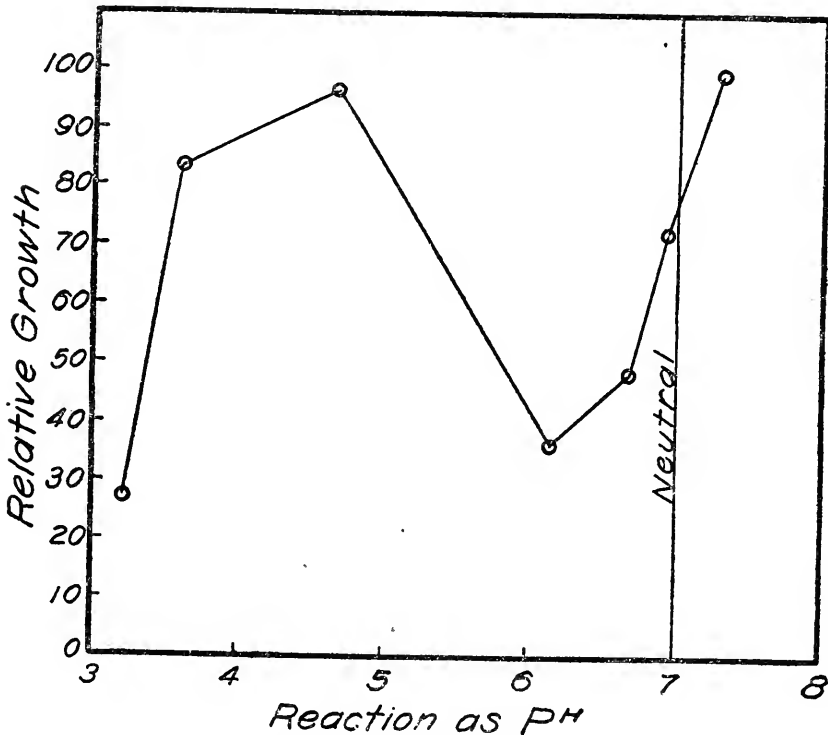

FIG. 3.—Graph showing the relation of growth of wheat seedlings to reaction in series A.

TABLE II.—Average reaction of cultures in series A and green weights of plants grown for period of 16 days

Culture No.	Average reaction of culture.			Green weight of 10 plants.		
	Before growth.	After growth.	Entire period.	Tops.	Roots.	Entire seedling.
	P_H .	P_H .	P_H .	Gm.	Gm.	Gm.
1.....	3.18	3.29	3.23	0.410	0.049	0.459
2.....	3.44	3.80	3.62	1.345	.079	1.425
3.....	4.22	5.10	4.67	1.440	.204	1.644
4.....	5.26	7.02	6.14	.570	.049	.619
5.....	6.15	7.21	6.68	.737	.091	.828
6.....	6.61	7.24	6.92	1.087	.171	1.258
7.....	7.28	7.34	7.31	1.375	.331	1.706

A brief consideration of the results obtained in this series shows them to be abnormal, since one would scarcely expect the decided drop in growth in cultures 4, 5, and 6 if reaction were the only factor concerned. The fact that there developed a decided opalescent or colloidal appearance in these cultures in about 24 hours after their renewal, together with the fact that there was a large decrease in acidity during the 4 days' growth of seedlings indicated that they were infected with some bacterial organism which evidently used the citric acid present as a source of energy. Microscopic examination of these solutions showed this to be the case, and it was at once surmised that the depressant effect of these solutions upon the growth of wheat seedlings was probably due to the assimilation of the nitrates by these bacteria. This hypothesis was substantiated by a determination of nitrates in all seven cultures at the end of a 4-day period. The relative total green weights of seedlings, based upon the highest taken as 100, the relative nitrate content, based upon the highest taken as 100, and the relative decrease in acidity of the solutions, based upon the greatest decrease taken as 100, are shown in Table III. The relation of the change in reaction taking place in the 4-day period to the original reaction of the solution is shown graphically in figure 1, B.

TABLE III.—Comparative total green weights, nitrate content, and acidity of cultures of series A at end of 4-day period

Solution No.	Relative yield (green weights of whole plants).	Relative amount of nitrates at end of 4-day period.	Relative decrease in acidity (increase in P _H).
	<i>Gm.</i>	<i>Gm.</i>	
1.....	26.9	84.0	6.2
2.....	83.5	92.8	22.2
3.....	96.4	78.0	50.0
4.....	36.3	6.0	100.00
5.....	48.5	7.8	60.3
6.....	73.7	24.0	35.8
7.....	100.0	100.0	3.4

The data show that depression in growth in cultures 4, 5, and 6 is associated with low amounts of nitrates left in solution and with large decrease in acidity. It seems safe, therefore, to conclude that the bacteria present were responsible for the abnormal effects obtained in this series. It should be noted that although there was more citric acid available to the bacteria in culture No. 3 than in No. 4, there was actually much smaller assimilation of nitrates in the former culture, while the wheat growth in No. 3 was almost equal to that in the best member of the series. Apparently the acidity of this culture has suppressed the growth of the nitrate-assimilating bacteria but has not had a correspondingly unfavorable effect on the growth of wheat seedlings. Since there was little difference in the amounts of nitrates present in cultures 1, 2, and 3 it seems

probable that the depression in growth found in cultures 1 and 2 was due to the physiological effect of their reaction upon the wheat seedlings.

The results obtained from this series do not give accurate data concerning the effect of reaction upon the growth of wheat seedlings over the entire range investigated. It seemed well, however, to include them in this report on account of their bearing upon a large amount of investigative work showing the ability of bacteria and fungi to compete with higher plants for inorganic nitrogen if supplied with a proper source of energy and carbon in the form of organic matter. This power of microorganisms has been demonstrated by numerous investigators under both solution and soil-culture methods. For a more complete discussion and an extensive bibliography on this subject the reader is referred to the publication of Doryland (4).

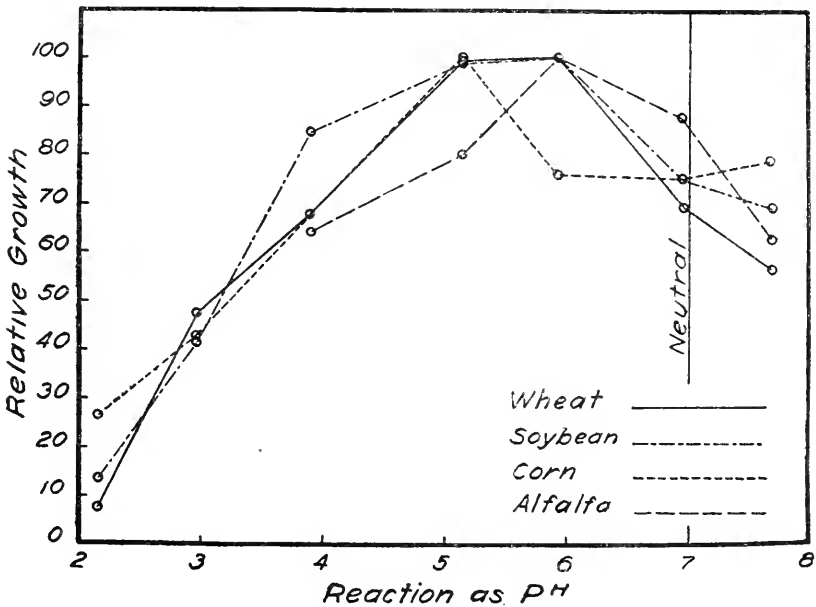

FIG. 4.—Graphs showing the relation of growth of wheat, soybean, corn, and alfalfa seedlings to reaction in series B.

SERIES B

On account of the difficulties arising from bacterial infection when citric acid was employed in the cultures, further work was confined to solutions having the composition given for series B. Wheat, soybeans, corn, and alfalfa seedlings were grown, all cultures being duplicated in the wheat, corn, and alfalfa series and quadruplicated in the soybean series. The numbers of seedlings grown in each culture were as follows: wheat, 12; soybean, 6; corn, 4; alfalfa, 20. The following periods of

growth were maintained: wheat, 18 days; soybeans, 16 days; corn, 8 days; alfalfa, 20 days. In Table IV are given the green weights of seedlings at time of harvesting and the average reaction of each culture as shown by the determinations of hydrogen-ion concentration made at the beginning and end of the 4-day periods on the cultures of the wheat series only. In figure 4 the relative total green weights, based upon the highest weight taken as 100 in each instance, are shown plotted against the average P_{H^+} of the cultures. Plate 15, C, shows the appearance of the wheat plants at the time of harvesting.

TABLE IV.—Average reactions of cultures of series B and green weights of seedlings at time of harvesting

WHEAT				
Culture No.	Reaction.	Green weight of 10 plants.		
		Tops.	Roots.	Entire plants exclusive of seeds.
	P_{H^+} .	Gm.	Gm.	Gm.
1.....	2.17	^a 0.230	^a 0.067	^a 0.297
2.....	2.96	1.730	.143	1.873
3.....	4.11	2.548	.149	2.697
4.....	5.16	3.581	.372	3.953
5.....	5.94	3.620	.356	3.976
6.....	6.97	2.421	.324	2.745
7.....	7.71	2.103	.141	2.244

SOYBEANS		
Culture No.	Reaction. ^b	Green weight of 10 plants (entire).
	P_{H^+} .	Gm.
1.....	2.17	^a 4.93
2.....	2.96	7.62
3.....	4.11	15.76
4.....	5.16	18.54
5.....	5.94	18.74
6.....	6.97	14.13
7.....	7.71	12.87

^a Seedlings dead at time of harvesting.

^b Because of the uniformity of reaction of successive cultures made up to represent a given reaction and the relatively small changes in reaction produced by growth of seedlings it is assumed that the average reactions found in the wheat series apply to the cultures of the soybean, corn, and alfalfa series. Occasional determinations on cultures of the latter series showed this to be true.

TABLE IV.—Average reactions of cultures of series B and green weights of seedlings at time of harvesting—Continued

CORN

Culture No.	Reaction. ^a	Green weight of 10 plants, exclusive of seeds.
	<i>P_H</i> .	<i>Gm.</i>
1.....	2.17	^b 3.53
2.....	2.96	5.60
3.....	4.11	8.98
4.....	5.16	13.30
5.....	5.94	10.14
6.....	6.97	10.03
7.....	7.71	10.47

ALFALFA

Culture No.	Reaction. ^a	Green weight of 10 plants (entire).
	<i>P_H</i> .	<i>Gm.</i>
1.....	2.17	(<i>b</i>)
2.....	2.96	(<i>b</i>)
3.....	4.11	0.317
4.....	5.16	.397
5.....	5.94	.496
6.....	6.97	.435
7.....	7.71	.310

^a Because of the uniformity of reaction of successive cultures made up to represent a given reaction and the relatively small changes in reaction produced by growth of seedlings, it is assumed that the average reactions found in the wheat series apply to the cultures of the soybean, corn, and alfalfa series. Occasional determinations on cultures of the latter series showed this to be true.

^b Seedlings dead at time of harvesting.

Before discussing the foregoing data mention should be made of the fact that while in practically all cases duplicate cultures agreed closely, there was occasionally considerable variation between the individual plants in a single culture of soybeans and corn, while in alfalfa there was considerable mortality among the plants in all cultures of the series. For this reason in drawing conclusions from the foregoing data the authors prefer to consider the work with soybeans, corn, and alfalfa as somewhat preliminary in nature. This does not apply to the wheat series, where no significant variations were found between the plants in the cultures representing a given reaction.

The effects of acids and alkalies upon seedlings grown in solution culture have been quite extensively investigated by Kahlenberg and True (13), Heald (9), Cameron and Breazeale (2), Hartwell and Pember (8), Breazeale and LeClerc (1), Dachnowski (3), Miyake (18), Gedroitz (6), Loew (15), and Hoagland (11). A complete review of the reports

covering the work of these investigators is not deemed necessary in this paper, however, since with the exception of that of Hoagland, none of the foregoing researches are comparable with that herein reported, for the reason that actual measurements of hydrogen-ion or hydroxyl-ion concentrations were not made, total titratable acidity or basicity being taken as a measure of the reaction. This leads to erroneous conclusions where substances possessing a buffer nature, such as phosphates, are present in solution. On the other hand, results obtained from the use of solutions of single acids or bases are probably abnormal, since they lack the antagonistic effects noted in more complete nutrient cultures and probably operative under soil conditions. Furthermore, solutions of single strong acids or bases of the concentrations ordinarily employed in such work are extremely unstable and liable to large changes in reaction. This is particularly true in alkaline solutions where absorption of atmospheric carbon dioxide is not prevented. With organic acids there is also the possibility of change in reaction due to bacterial infection similar to that noted under series A of the present study.

Hoagland (11) investigated the effect of reaction on the growth of barley seedlings grown in partial nutrient solutions of like osmotic concentration, in which the reaction was varied by the use of the various potassium phosphates. Reaction was determined by use of the hydrogen electrode. He found a hydrogen-ion concentration of 0.7×10^{-5} ($5.15 P_H$) to be favorable to growth, while a concentration of 0.3×10^{-3} ($3.50 P_H$) was very toxic. A concentration of hydroxyl ions greater than 1.8×10^{-6} ($8.25 P_H$) was found to be distinctly injurious, and when exceeding 2.5×10^{-5} ($9.40 P_H$) extremely toxic. It is unfortunate that no solution of reaction between $3.50 P_H$ and $5.15 P_H$ was employed in this work, since the former reaction was extremely toxic and the latter favorable to growth. This is particularly true, since it has been shown in the author's laboratory that this range of reaction represents a variation from a small to an unusually high total acidity (lime requirement) in soils.

In series B of the present study, a reaction of $5.94 P_H$ gave maximum growth of wheat and soybeans, and in both cases a reaction of $5.16 P_H$ was but slightly less favorable. With corn seedlings maximum growth occurred at a reaction of $5.16 P_H$, while a reaction of $5.94 P_H$ was considerably less favorable. Maximum growth of alfalfa occurred in the culture having a reaction of $5.94 P_H$, while a reaction of $5.16 P_H$ considerably depressed the growth. A reaction of $4.11 P_H$ was somewhat less favorable to soybeans and distinctly less so to corn, wheat, and alfalfa than a reaction of $5.16 P_H$. A reaction of $2.96 P_H$ resulted in the death of all alfalfa plants in the culture, and while there was some growth of wheat, soybeans, and corn, at the time of harvesting the leaves of all plants had begun to die at the tips. The roots of these plants produced no lateral growth at this reaction and at time of harvesting had turned

brown in color and supported vigorous growths of mold. It seems probable, therefore, that all plants would have died in these cultures and that 2.96 P_H is really below the critical reaction for all crops studied. A reaction of 2.17 P_H killed all seedlings a few days after transplanting, and while in Table IV weights are included for the seedlings from cultures having this reaction, these represent the weights of the dead seedlings at time of harvesting. Abundant growth of molds occurred upon the roots of all plants in cultures of this reaction. A reaction of approximate neutrality, 6.97 P_H , was found less favorable to the growth of seedlings of all four crops than a slightly acid reaction, while a reaction of 7.71 P_H still further depressed the growth of all crops excepting corn, where a slight increase was observed, the latter probably falling within experimental error. A study of the growth curves (fig. 4), shows that the optimum reaction for alfalfa was apparently higher than for the other crops studied. While maximum growth occurred at 5.94 P_H , a reaction of 6.97 P_H had a less injurious effect and a reaction of 5.16 P_H a more injurious effect than was found with wheat, soybeans, and corn. This agrees with the relative adaptation to soil reaction of the several crops commonly observed in field practice. In this connection it is interesting to note that Fred and Davenport (5) have recently shown that the critical reaction for the bacterium *Rhizobium leguminosarum*, symbiotically associated with alfalfa, is 4.9 P_H , while that for the corresponding organism associated with the soybean is 3.3 P_H .

CHANGE OF REACTION INCIDENT TO GROWTH

As previously noted, determinations of reaction by means of the hydrogen electrode were made upon the cultures of the wheat series at the beginning and end of each 4-day period—that is, before and after renewing the solution on each culture. The average reaction at the beginning and at the end of the 4-day periods for wheat in series B and the changes observed in reaction are given in Table V. The relation between the change of reaction and the position of a given culture with respect to the electrometric titration curve is brought out by a comparison of the curves shown in figure 2, A, and figure 2, B.

TABLE V.—Change in reaction during 4-day periods

Culture No.	Reaction before growth.	Reaction after growth.	Change in reaction.
1.....	P_H 2.17	P_H 2.17	0.00
2.....	2.94	2.98	+ .04
3.....	3.90	4.31	+ .41
4.....	4.95	5.36	+ .41
5.....	5.90	5.98	+ .08
6.....	6.99	6.95	- .04
7.....	7.79	7.62	- .17

It will be noted that the actual numerical value of the change in reaction is closely related to the stability of a given culture as indicated by the slope of the electrometric titration curve at the point representing the composition of the solution. There appears, however, to be a general tendency for the more acid cultures of the series to become slightly less acid while the more alkaline members tend to become slightly less alkaline. The conditions were not such as to permit accurate determination of the change in total titrable acidity or basicity produced by growth. However, if the points on the electrometric titration curve (fig. 2, A), corresponding to the reaction of each culture before and after growth of seedlings, are projected upon the horizontal axis representing quantity of total alkali added, it is found that in cultures 2 to 7, inclusive, there were no large differences in the quantitative value of the change in reaction—that is, a change in reaction of 0.41 P_H in culture 3 or 4 does not necessarily correspond to a greater change in total acidity than a change of 0.08 P_H in culture 5. The exact cause of the change in reaction, whether due to root excretions, to selective ionic absorption, or to other factors, was not determined. The results obtained agree with those of Pantanelli (20), who found a general tendency for plants grown in solution culture to regulate the reaction towards that most favorable to growth. The results agree also with the more recent work of Hoagland (11, 12), who found that barley grown in partial and complete nutrient cultures caused the reaction to approach that of approximate neutrality. On account of the difference in conditions the foregoing data are not necessarily contradictory to the results of Breazeale and LeClerc (1), who grew wheat seedlings in solutions of the single salts K_2SO_4 , potassium chlorid (KCl), and $NaNO_3$ and found a development of acidity in the potassium salts and of basicity in $NaNO_3$ apparently due to selective ionic absorption. However, in the more recent work of Hoagland (12), who grew barley plants in single salt solutions of KCl, K_2SO_4 , $MgSO_4$, potassium phosphate (K_3PO_4), ammonium chlorid (NH_4Cl), and $NaNO_3$, he found that—

in no case was a condition either of excessive OH ion or H ion concentration produced, although absorption had been active. The acid reaction when present was due to slightly dissociated acids, usually carbonic, or to acid salts in the case of NH_4Cl solution. Possibly in some cases organic acids were formed.

In this connection it should be mentioned that Haas (7) grew wheat seedlings in distilled water and found no change of reaction, measurements being made after carbon dioxide had been removed.

POSSIBLE INFLUENCE OF FACTORS OTHER THAN REACTION

While it seems probable that the variations observed in the growth of the seedlings under the range of reactions employed were the direct

result of the variation in reaction, yet it should be noted that certain other factors might have been operative to an undetermined extent.

Attention has already been called to the probable small variations in osmotic concentrations of the cultures within a given series. It seems doubtful whether such variations could have exerted any appreciable effect.

There was a variation in sodium content from an equivalent concentration of zero in culture 1 to 0.0360 in culture 7 of series B. It has recently been shown in the researches of Shive (25) that the substitution of an equivalent amount of sodium phosphate (NaH_2PO_4) for part of the potassium phosphate (KH_2PO_4) of a 3-salt nutrient culture produced considerable increases in the growth of soybean seedlings. In the present work, however, the greatest variations in growth were associated with the smallest changes in sodium content. Thus culture 2, to which had been added sodium as NaOH equivalent to 0.0144 m. was apparently below the critical reaction for all plants studied, while maximum growth of all plants was obtained in either culture No. 4 or No. 5 to which had been added NaOH equivalent to 0.0181 m. and 0.0198 m., respectively. It seems highly improbable that the variations in growth could have been to any appreciable extent induced by such small variations in the total sodium content.

The contents of calcium and magnesium employed in the cultural solutions were purposely kept low. (See Table I.) There was nevertheless a trace of precipitate of the phosphates of these metals formed in culture 6, which had a reaction of 6.97 P_{H} , and a somewhat more abundant precipitate in culture 7, which had a reaction of 7.71 P_{H} . To what extent the change in concentration thus produced might have influenced the results was not determined. Attention has previously been called to the possibility of similar changes in solubility of these elements at corresponding reactions under soil conditions.

In the work of Shive (25), previously mentioned, a toxicity of monobasic phosphates was shown toward soybeans grown in soil and in solution culture. While a general relation between the degree of injury sustained by the plants and the total acidity of the cultures was noted in this work, the fact that determinations of hydrogen-ion concentration were not made prevented accurate conclusions as to the actual part played by the acidity factor in the production of the injurious effects associated with the monophosphate group. The data obtained in the present study indicate that there was probably little effect of the H_2PO_4 group aside from that produced by the hydrogen ion formed in its dissociation. This is brought out by the fact that in culture 4 there was maximum growth of corn seedlings and very nearly maximum growth of wheat and soybean seedlings; whereas in the composition of this solution, H_3PO_4 equivalent to a concentration of 0.0180 m. and NaOH equivalent to a concentration of 0.0181 m. were employed—that is,

approximately enough alkali was used just to neutralize the first hydrogen ion of the H_3PO_4 molecule. The concentration of the monophosphate group was undoubtedly higher in this culture, therefore, than in any others of the series, since all the phosphorus present existed as the equivalent of monosodium phosphate. In the cultures below No. 4 an increasing part of the phosphorus exists as H_3PO_4 , while in the cultures above No. 4 an increasing amount exists as sodium phosphate (Na_2HPO_4).

THE EFFECT OF REACTION ON GERMINATION

The effects of acids and alkalies upon the germination of seeds have been studied by Promsy (22, 23), Micheels (16, 17), and Plate (21). The general conclusions can be drawn from these investigations that a slightly acid reaction is favorable to the germination of most seeds, while bases exert an injurious effect. The relation of germination to acidity varies considerably with seeds of different plants and with the acid used, organic acids being apparently more favorable than inorganic when used in equivalent amounts. This is probably due to their lower dissociation. Promsy found that the optimum concentration of acids ranged from 0.5 to 5 parts per thousand, depending upon the nature of the seed and the acid employed. Higher concentrations of acid inhibit or prevent germination. It is asserted that the effects of acids and bases on germination are a result of their favorable or unfavorable influence on the enzymic processes concerned.

The authors are not familiar with any work showing the effect of reaction on germination in which hydrogen-ion or hydroxyl-ion concentration is taken as a measure of the reaction, or with any work showing the relative sensitivity of germination and of the subsequent growth of the plant to reaction so determined. Breazeale and LeClerc (1), in explaining some of their results obtained in the growth of wheat seedlings in acid cultures, draw the conclusion that the depressant effect of acidity is greater during germination than in the subsequent growth of the plant. They explain this by assuming a high sensitivity of the enzymes concerned in germination, particularly the oxidases and peroxidases, to the acid condition. From a practical standpoint it would seem desirable to know to what extent the effects of soil acidity are due to its injurious influence on germination and to its effects on the subsequent growth of the crop. Numerous instances have come under the authors' observation in which seed planted in soils of high acidity apparently germinated normally but either ceased to grow or died after the plants had attained a small growth. This would indicate a condition opposite to the conclusion of Breazeale and LeClerc (1).

To investigate this point seeds of wheat, corn, soybeans, alfalfa, and red clover were germinated in solutions having the same nutrient composition and reaction as those used in the growth of seedlings in series B. The seeds were germinated upon pads of three ashless filters placed in Petri

dishes in which had been placed porcelain plates of such size as to prevent submersion of the filter paper in the solution except at the periphery of the dish. At the beginning of the experiment 20 cc. of the proper solution were added to each dish, allowed to stand 10 minutes, poured off, and replaced with 20 cc. of fresh solution. This was done in order to guard against change in concentration due to adsorption of solutes by the filter paper. The number of seeds germinated in each dish was as follows: alfalfa, 40; red clover, 50; corn, 10; soybeans, 10; wheat, 25. To avoid the effect of individual variation the dishes were triplicated in the test with corn and duplicated in the test with soybeans. The solution was renewed on all dishes every other day. The dishes were kept at room temperature for seven days, at which time a germination count

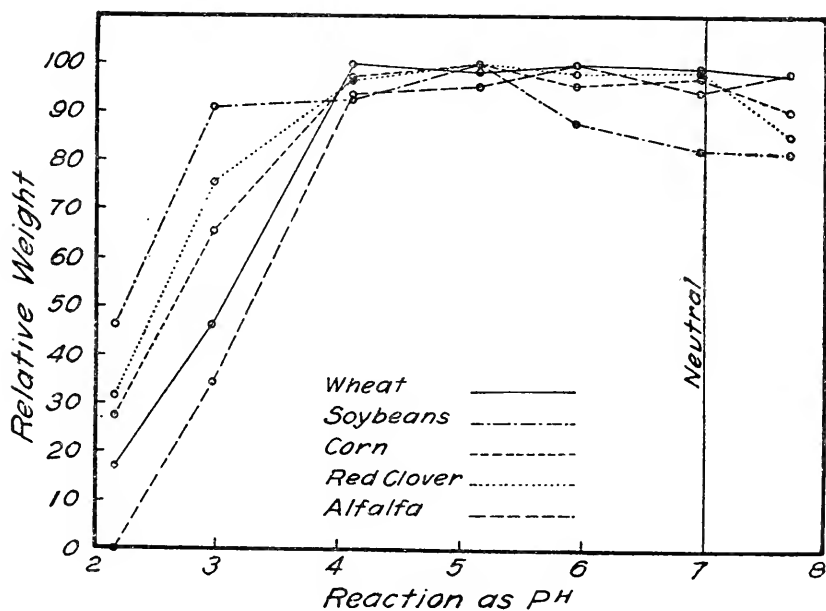

FIG. 5.—Graphs showing the relative weights of sprouts produced by seeds of wheat, corn, soybeans, alfalfa, and red clover in 7-day germination period at various reactions.

was taken and the green weight of the sprouts determined. The weight was taken for the entire seedling of the legumes, but the seeds were excluded in weighing the wheat and corn.

The number of seeds germinating in each culture and the average weights of the sprouts from 10 seeds are given in Table VI. The relative green weights of sprouts, based upon the largest weight taken as 100 in each instance, are shown plotted against the reaction of the cultures in figure 5.

TABLE VI.—Number of seeds germinating and average green weight of sprouts from 10 seeds

ALFALFA, 40 SEEDS TESTED

Dish No.	Reaction.	Number of seeds germinating.	Average weight of sprouts.	Notes.
	<i>P_H</i> .		<i>Gm.</i>	
1.....	2.17	0	Much mold, seeds swelled but no sprouts.
2.....	2.96	30	0.066	Some mold.
3.....	4.11	35	.181	No mold.
4.....	5.16	33	.184	Do.
5.....	5.94	33	.193	Do.
6.....	6.97	35	.182	Do.
7.....	7.71	27	.190	Do.

RED CLOVER, 50 SEEDS TESTED

1.....	2.17	5	0.048	Much mold, sprouts dead.
2.....	2.96	43	.115	Root tips brown and dead, some mold.
3.....	4.11	50	.148	No mold.
4.....	5.16	47	.153	Do.
5.....	5.94	45	.150	Do.
6.....	6.97	45	.151	Do.
7.....	7.71	47	.131	Do.

SOYBEANS, 20 SEEDS TESTED

1.....	2.17	4	1.665	Much mold, sprouts dead.
2.....	2.96	20	3.284	Root tips brown and dead, some mold.
3.....	4.11	18	3.350	No mold.
4.....	5.16	20	3.607	Do.
5.....	5.94	20	3.173	Do.
6.....	6.97	19	2.975	Do.
7.....	7.71	20	2.960	Do.

TABLE VI.—Number of seeds germinating and average green weight of sprouts from 10 seeds—Continued

CORN, 30 SEEDS TESTED

Dish No.	Reaction.	Number seeds germinating.	Average green weight of sprouts.	Notes.
	P_H .		<i>Gm.</i>	
1.....	2. 17	26	0. 941	Small growth of mold, sprouts dead.
2.....	2. 96	29	2. 247	No mold.
3.....	4. 11	29	3. 357	Do.
4V.....	5. 16	30	3. 447	Do.
5.....	5. 94	30	3. 293	Do.
6.....	6. 97	29	3. 353	Do.
7.....	7. 71	29	3. 130	Do.

WHEAT, 25 SEEDS TESTED

1.....	2. 17	16	0. 198	Much mold, sprouts dead.
2.....	2. 96	22	. 541	Some mold.
3.....	4. 11	25	1. 163	No mold.
4.....	5. 16	22	1. 143	Do.
5.....	5. 94	23	1. 164	Do.
6.....	6. 97	25	1. 156	Do.
7.....	7. 71	23	1. 141	Do.

While there is evidence of some abnormalities in the foregoing data, the authors believe the following conclusions are justified:

A reaction of 4.11 P_H did not exert a depressing effect on the germination of any of the seeds studied as measured by the germination count and the green weight of the sprouts at the end of the 7-day period. It will be recalled that the same reaction was found to depress the growth of seedlings of alfalfa, soybeans, corn, and wheat. Apparently the process of germination is not so susceptible to injury by acidity as is the subsequent process of growth with these plants.

A reaction of 2.96 P_H did not have any considerable effect upon the number of seeds germinating but considerably reduced the weight of the sprouts produced except with soybeans. In the latter case the roots had begun to turn brown in color and die at the tips at the end of the 7-day period. Some mold grew on the seeds in all dishes of this reaction.

Swelling of all seeds took place in dishes having a reaction of 2.17 P_H , and some small sprouts were produced from all seeds except those of alfalfa. All sprouts were apparently dead at the end of the 7-day period, and a severe growth of mold was present in all dishes of this reaction.

A reaction of 7.71 P_H decreased to a slight extent the weight of sprouts of all plants except alfalfa and wheat but did not appreciably lower the number of seeds germinating.

The optimum reaction for the germination of the seeds of the five plants studied is probably below 7.71 P_H and above 2.96 P_H .

GENERAL APPLICATION OF RESULTS TO FIELD PRACTICE

Most experiment stations recommend the use of such amounts of lime as will neutralize the total acidity present and maintain a soil at a neutral or slightly alkaline reaction. The results herein reported would indicate that if the direct physiological effect of excessive acidity upon plant growth were the only factor concerned, it would be more desirable to recommend such amounts of lime as would maintain the soil at a slightly acid reaction such as would be represented by a P_H value of 5 or 6. On the other hand, attention has been called to the necessity of further investigation of the other factors associated with acidity before this conclusion is warranted. Thus, a high optimum reaction (in P_H) for the development of the nitrogen-transforming organisms of a soil might counterbalance completely the advantages of a slightly acid reaction for the growth of the plant itself. The authors have investigations in progress, including solution, pot, and field plot studies, which it is hoped will give further evidence upon the part played by the other factors concerned.

SUMMARY

(1) A study has been made of the effects of reaction, as measured by hydrogen-ion concentration, upon the growth of the seedling of wheat, soybeans, corn, and alfalfa in solution culture and upon the germination of the seeds of wheat, soybeans, corn, alfalfa, and red clover, under conditions permitting the elimination or control of factors other than reaction.

(2) Citric acid was found unsuitable for adjusting the reaction of culture solutions for such work on account of bacterial infection which produced rapid changes in reaction and nitrate content. The nitrate-assimilating bacteria in this case were found more sensitive to acidity than were wheat seedlings.

(3) A satisfactory method of adjusting the reaction of the culture solutions was found to be the addition of a uniform amount of H_3PO_4 to all cultures and increasing amounts of NaOH to successive cultures.

(4) Maximum growth of seedlings of wheat, soybeans, and alfalfa occurred in cultures having a reaction of 5.94 P_H , while corn produced greatest growth in the cultures having a reaction of 5.16 P_H .

(5) A reaction of 5.16 P_H was approximately equal to 5.94 P_H for the growth of soybeans and wheat but decidedly less favorable for the growth of alfalfa.

(6) A reaction of 4.11 P_H was somewhat less favorable to soybeans and distinctly less favorable to corn, wheat, and alfalfa than a reaction of 5.16 P_H .

(7) A reaction of 2.96 P_H is probably below the critical reaction for all plants studied.

(8) A reaction of 2.16 P_H caused the death of the seedlings of all plants within a comparatively short time and was found to favor the growth of molds in the cultures.

(9) A reaction of approximate neutrality (6.97 P_H) was slightly less favorable to alfalfa and decidedly less so to wheat, corn, and soybeans than a slightly acid reaction.

(10) A reaction of 7.71 P_H produced further depression of growth beyond that observed at 6.97 P_H except in the case of corn seedlings.

(11) The hydroxyl ion was apparently more harmful than the hydrogen ion in equivalent concentrations.

(12) Measurements of reaction of solutions before and after the growth of wheat seedlings showed a general tendency for the plant to adjust the reaction toward a point slightly below neutrality.

(13) The actual value of the change of reaction produced by the growth of seedlings in a given culture was found to be a function of the stability of the solution as indicated by the slope of the electrometric titration curve at the point representing the composition of the solution.

(14) No indication was obtained of any harmful effect of the monophosphate group, H_2PO_4 , other than that produced by the hydrogen ion formed through its dissociation.

(15) Germination of the seed was found less sensitive to an acid reaction in wheat, corn, soybeans, and alfalfa than was the subsequent growth of the seedling.

(16) A reaction of 4.11 P_H did not exert a depressing effect on the germination of any of the seeds studied.

(17) A reaction of 2.96 P_H did not appreciably affect the number of seeds germinating but considerably reduced the weight and apparent vigor of the sprouts produced.

(18) A reaction of 2.16 P_H did not prevent the formation of sprouts except in alfalfa, but all sprouts produced were dead at the end of the 7-day germination period. This reaction induced the extensive growth of molds upon the seeds.

(19) The optimum reaction for the germination of the seeds of the five plants studied is probably below 7.71 P_H and above 2.96 P_H , a slightly acid reaction being found most favorable in all cases.

LITERATURE CITED

- (1) BREAZEALE, J. F., and LECLERC, J. A.
1912. THE GROWTH OF WHEAT SEEDLINGS AS AFFECTED BY ACID OR ALKALINE CONDITIONS. U. S. Dept. Agr. Bur. Chem. Bul. 149, 18 p., 8 pl.
- (2) CAMERON, F. K., and BREAZEALE, J. F.
1904. THE TOXIC ACTION OF ACIDS AND SALTS ON SEEDLINGS. *In* Jour. Phys. Chem., v. 8, no. 1, p. 1-13.

- (3) DACHNOWSKI, Alfred.
1914. THE EFFECTS OF ACID AND ALKALINE SOLUTIONS UPON THE WATER RELATIONS AND THE METABOLISM OF PLANTS. *In Amer. Jour. Bot.*, v 1, no 8, p. 412-440, 4 fig. Literature, p. 435.
- (4) DORYLAND, C. J. T.
1916. THE INFLUENCE OF ENERGY MATERIAL UPON THE RELATION OF SOIL MICROORGANISMS TO SOLUBLE PLANT FOOD. *N. Dak. Agr. Exp. Sta. Bul.* 116, p. 319-401, 2 fig. Literature cited, p. 398-401.
- (5) FRED, E. B., and DAVENPORT, Audrey.
1918. INFLUENCE OF REACTION ON NITROGEN-ASSIMILATING BACTERIA. *In Jour. Agr. Research*, v. 14, no. 8, p. 317-336. Literature cited, p. 335-336.
- (6) GEDROITZ, K.
1910. THE EFFECT OF ACIDS, ALKALIS, AND SOME INORGANIC SALTS ON PLANTS. (Abstract.) *In Exp. Sta. Rec.*, v. 24, no. 7, p. 630. 1911. Original article in *Russ. Zhur. Opuitn. Agron.* (*Russ. Jour. Exp. Landw.*) god 11, kniga 4, p. 544-578; kniga 5, p. 641-669; abstract in German, p. 669-678. 1910. Not seen.
- (7) HAAS, A. R.
1916. THE EXCRETION OF ACIDS BY ROOTS. *In Proc. Nat. Acad. Sci.*, v. 2, no. 10, p. 561-566.
- (8) HARTWELL, Burt L., and PEMBER, F. R.
1907. THE RELATION BETWEEN THE EFFECTS OF LIMING, AND OF NUTRIENT SOLUTIONS CONTAINING DIFFERENT AMOUNTS OF ACID, UPON THE GROWTH OF CERTAIN CEREALS. *R. I. Agr. Exp. Sta. 20th Ann. Rpt.*, 1906/07, p. 358-380, 2 fig.
- (9) HEALD, F. D.
1896. ON THE TOXIC EFFECT OF DILUTE SOLUTIONS OF ACIDS AND SALTS UPON PLANTS. *In Bot. Gaz.*, v. 22, no. 2, p. 125-153, pl. 7.
- (10) HILDEBRAND, J. H.
1913. SOME APPLICATIONS OF THE HYDROGEN ELECTRODE IN ANALYSIS, RESEARCH, AND TEACHING. *In Jour. Amer. Chem. Soc.*, v. 35, no. 7, p. 847-871, 15 fig.
- (11) HOAGLAND, D. R.
1917. THE EFFECT OF HYDROGEN AND HYDROXYL ION CONCENTRATING ON THE GROWTH OF BARLEY SEEDLINGS. *In Soil Sci.*, v. 3, no. 6, p. 547-560. Literature cited, p. 559-560.
- (12) ———
1918. THE RELATION OF THE PLANT TO THE REACTION OF THE NUTRIENT SOLUTION. *In Science*, n. s. v. 48, no. 1243, p. 422-425.
- (13) KAHLBERG, Louis, and TRUE, Rodney H.
1896. ON THE TOXIC ACTION OF DISSOLVED SALTS AND THEIR ELECTROLYTIC DISSOCIATION. *In Bot. Gaz.*, v. 32, no. 2, p. 81-124.
- (14) LIVINGSTON, Burton Edward.
1907. FURTHER STUDIES ON THE PROPERTIES OF UNPRODUCTIVE SOILS. *U. S. Dept. Agr. Bur. Soils Bul.* 36, 71 p., 7 pl.
- (15) LOEW, Fred A.
1903. THE TOXIC EFFECT OF H AND OH IONS ON SEEDLINGS OF INDIAN CORN. *In Science*, n. s., v. 18, no. 453, p. 304-308.
- (16) MICHEELS, Henri.
1909. ACTION OF AQUEOUS SOLUTIONS OF ELECTROLYTES ON GERMINATION. (Abstract.) *In Chem. Abs.*, v. 4, no. 15, p. 1984-1985. 1910. Original article in *Acad. Roy. Belg. Bul. Cl. Sci.*, 1909, no. 11, p. 1076-1118. 1909. Not seen.

- (17) ———
 1912. ACTION OF DILUTE SOLUTIONS OF ELECTROLYTES ON GERMINATION. (Abstract.) *In Chem. Abs.*, v. 7, no. 21, p. 3607-3608. 1913. Original article in *Acad. Roy. Belg. Bul. Cl. Sci.*, 1912, no. 11, p. 753-765. 1912.
- (18) MIYAKE, K.
 1914. UEBER DIE WIRKUNG VON SAÜREN, ALKALIEN UND EINIGER ALKALI AUF DEM WACHSTUM DER REISPFLANZEN. *In Trans. Sapporo Nat. Hist. Soc.*, v. 5, pt. 2, p. 91-95.
- (19) ———
 1916. THE TOXIC ACTION OF SOLUBLE ALUMINIUM SALTS UPON THE GROWTH OF THE RICE PLANT. *In Jour. Biol. Chem.*, v. 25, no. 1, p. 23-28.
- (20) PANTANELLI, E.
 1915. UBER IONENAUFNAHME. *In Jahrb. Wiss. Bot. [Pringsheim]*, Bd. 56, p. 689-733. *Literatur*, p. 730-733.
- (21) PLATE, F.
 1913. IMBIBITION IN THE SEEDS OF "AVENA SATIVA." (Abstract). *In Chem. Abs.*, v. 8, no. 2, p. 360. 1914. Original article in *Atti R. Accad. Lincei, Ser. 5, Rend.*, v. 22, sem. 2, fasc. 3, p. 133-140. 1913. Not seen.
- (22) PROMSY, G.
 1911. DE L'INFLUENCE DE L'ACIDITÉ SUR LA GERMINATION. *In Compt. Rend. Acad. Sci. [Paris]*, t. 152, no. 8, p. 450-452.
- (23) ———
 1912. THE ROLE OF ACIDS IN GERMINATION. (Abstract.) *In Exp. Sta. Rec.*, v. 29, no. 1, p. 26. 1913. Original article in *Bul. Soc. Nat. Agr. France*, t. 72, p. 916-922. 1912. Not seen.
- (24) SHIVE, John W.
 1915. A STUDY OF PHYSIOLOGICAL BALANCE IN NUTRIENT MEDIA. *In Physiol. Researches*, v. 1, no. 7, p. 327-397, 15 fig. *Literature cited*, p. 396-397.
- (25) ———
 1918. TOXICITY OF MONOBASIC PHOSPHATES TOWARDS SOYBEANS GROWN IN SOIL AND SOLUTION-CULTURES. *In Soil Sci.*, v. 5, no. 2, p. 87-122, 5 fig. *References*, p. 121-122.
- (26) TOTTINGHAM, William E.
 1914. A QUANTITATIVE CHEMICAL AND PHYSIOLOGICAL STUDY OF NUTRIENT SOLUTIONS FOR PLANT CULTURES. *In Physiol. Researches*, v. 1, no. 4, p. 133-245, 15 fig. *Literature cited*, p. 242-245.

PLATE 15

A.—Method of growing wheat seedlings. (Paper covers removed from beakers.)

B.—Appearance of wheat seedlings in series A at time of harvesting.

C.—Appearance of wheat seedlings in series B at time of harvesting.

(96)

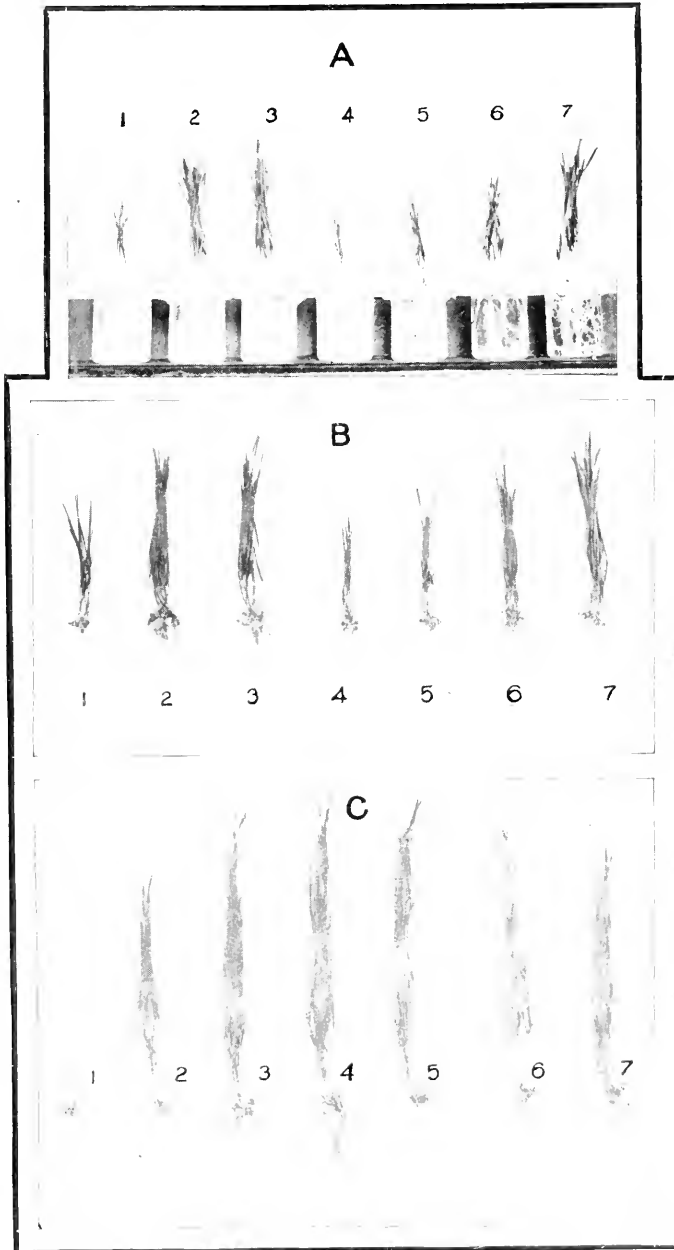

JOURNAL OF AGRICULTURAL RESEARCH

CONTENTS

	Page
Philippine Downy Mildew of Maize - - - -	97
WILLIAM H. WESTON, JR. (Contribution from Bureau of Plant Industry)	
Effect of Drugs on Milk and Fat Production - - -	123
FRANK A. HAYS and MERTON G. THOMAS (Contribution from Delaware Agricultural Experiment Station)	
Artificial and Insect Transmission of Sugar-Cane Mosaic -	131
E. W. ERANDES (Contribution from Bureau of Plant Industry)	

PUBLISHED BY AUTHORITY OF THE SECRETARY OF AGRICULTURE,
WITH THE COOPERATION OF THE ASSOCIATION OF
LAND-GRANT COLLEGES

WASHINGTON, D. C.

**EDITORIAL COMMITTEE OF THE
UNITED STATES DEPARTMENT OF AGRICULTURE AND
THE ASSOCIATION OF LAND-GRANT COLLEGES**

FOR THE DEPARTMENT

KARL F. KELLERMAN, CHAIRMAN

*Physiologist and Associate Chief, Bureau
of Plant Industry*

EDWIN W. ALLEN

Chief, Office of Experiment Stations

CHARLES L. MARLATT

*Entomologist and Assistant Chief, Bureau
of Entomology*

FOR THE ASSOCIATION

J. G. LIPMAN

*Dean, State College of Agriculture, and
Director, New Jersey Agricultural Experiment
Station, Rutgers College.*

W. A. RILEY

*Entomologist and Chief, Division of Ento-
mology and Economic Zoology, Agricul-
tural Experiment Station of the University
of Minnesota*

R. L. WATTS,

*Dean, School of Agriculture, and Director,
Agricultural Experiment Station, The
Pennsylvania State College.*

All correspondence regarding articles from the Department of Agriculture should be addressed to Karl F. Kellerman, Journal of Agricultural Research, Washington, D. C.

All correspondence regarding articles from State Experiment Stations should be addressed to J. G. Lipman, New Jersey Agricultural Experiment Station, New Brunswick, N. J.

LIBRARY
OF THE
BUREAU OF
PLANT INDUSTRY
WASHINGTON
D. C.

JOURNAL OF AGRICULTURAL RESEARCH

VOL. XIX

WASHINGTON, D. C., MAY 1, 1920

No. 3

PHILIPPINE DOWNY MILDEW OF MAIZE

By WILLIAM H. WESTON, JR.¹

Pathologist in Charge of Downy Mildew Investigations, Office of Cereal Investigations, Bureau of Plant Industry, United States Department of Agriculture

During the past 20 years there have been reported from the Orient several downy mildew diseases of maize, sugar cane, and other economic grasses, caused by members of the genus *Sclerospora* of the Peronosporaceae. The most recently noted of these has been found in the Philippine Islands, where it causes very serious damage to maize, a crop which in area under cultivation is second only to rice. In 1916, a brief note by Prof. Baker (*1*)², of the College of Agriculture, first mentioned the occurrence and destructive power of the disease. In 1918, a short description of it with drawings of the causal fungus was published by Reinking (*17*). No further information concerning this dangerous disease has been published, but it is known that it occasions heavy and constant losses in the maize crop of this the richest of our oriental possessions and represents a grave potential menace to this extremely valuable crop of our own country.

The danger of the introduction of this disease to the cornfields of America was felt to be sufficiently grave to warrant a full investigation in the Philippines and elsewhere in the Orient. By such research it was expected to determine the distribution and life history of this organism and to devise methods of control. With these data in hand, the chances of promptly checking the disease were greatly increased should it gain a foothold in the United States at any time in the future. In the meantime, a quarantine was established against the importation of corn from the Orient.

It was the privilege of the writer to be detailed to this investigation, and since April, 1918, he has been at work on it in the Philippines.

The following paper deals with the general features of the disease and with the characteristics of the causal *Sclerospora* and its systematic position

¹ The writer wishes to express his thanks to Dean Baker, Prof. Reinking, Prof. Elayda, and others at the College of Agriculture of the University of the Philippines for so generously furnishing laboratory facilities, land, and other assistance; to Mr. S. Apostol, of the Philippine Bureau of Agriculture, for information on the distribution of the disease; and to Dr. E. D. Merrill, of the Bureau of Science, for many courtesies which have aided the progress of this investigation.

² Reference is made by number (*italic*) to "Literature cited," p. 121-122.

JUN 2 1920

or relationship to other downy mildews destructive to cereal, forage, and sugar-cane crops in the Orient.

DISTRIBUTION

Broadly speaking, the disease is distributed throughout the Philippine Islands. Through the personal observation of the writer and through information given by Dr. Reinking, of the College of Agriculture, by his students, and by members of the Bureau of Agriculture, the disease is known to exist in the Cotobato Valley of the Island of Mindanao at the south, in the Islands of Cebu and Occidental Negros, and in the provinces of Batangas, Laguna, Rizal, Cavite, Bulacan, Tarlac, Pampanga, Nueva Ecija, Pangasinan, Ilocos Norte, la Union, and Isabela in Luzon at the north. In some of these localities the disease appears to have been present for more than 10 years, but as yet not enough is known to warrant a discussion of its probable origin.

DESTRUCTIVENESS

The disease is unusually destructive. It is impossible for one accustomed only to the comparatively light losses occasioned by the maize diseases of the United States corn belt to form any conception of the epidemic intensity of the attacks of this downy mildew under favorable conditions, or of the terrible destruction which it occasions (Pl. 16). Of the aggregate loss to the \$8,820,000 maize crop of the Philippines no estimate can be made, because farmers do not recognize the trouble as a disease but regard it as the result of excessive rain or other unfavorable conditions and accept it with fatalistic resignation. In Laguna and Batangas, however, where maize is a major crop and where the writer has studied the disease in the native fields, losses of 40 to 60 per cent are frequent, and in some cases as high as 82 per cent of infection has been counted. In the experimental and acclimatization plots at the College of Agriculture, where the growing of unacclimatized varieties and the constant presence of actively infecting plants combine to make the conditions especially favorable for infection, the losses ordinarily are high. In several beds of United States sweetcorn, planted during the rainy season, every plant was killed before producing any seed.

The severity of the disease in the individual corn plant varies with conditions from the extreme stunting and weakening of the plant resulting in death about one month after planting to the less virulent attacks in spite of which the plant shows a fair growth and ultimately produces a small, more or less poorly formed ear. Even in the few lightly affected cases the grain production is not nearly normal, and in most cases complete barrenness or premature destruction occurs, so the aggregate loss in the average field attacked by the mildew is large. In some localities corn growing has been abandoned for the culture of upland rice because of the ravages of the disease. Moreover, this loss can not be offset in part

by using diseased plants for fodder, for cattle appear to dislike the taste and will not eat the infected plants unless they are mixed with a liberal proportion of the healthy.

One of the most serious features of the attack by the downy mildew is that the infected plants are rendered susceptible to the attacks of a number of secondary parasitic organisms which contribute to the destruction of the weakened plants. In the rainy season there frequently occur destructive rots of the stem, ear, and shank, with which at least two species of *Pythium* and bacteria appear to be associated, while a species of *Helminthosporium*, which is only occasionally severe on healthy plants, is usually very destructive to plants weakened by downy mildew.

SYMPTOMS

The effect of the disease on the corn plant varies greatly with such conditions as the age of the plant when infected, the means by which infection takes place, the varietal nature and individual condition of the host, and the environmental conditions which accompany and follow infection. As a result, no small, clearly defined group of symptoms can be described which will entirely cover the effects of the disease on the host.

In general, however, the disease may be said to manifest itself by the loss of chlorophyll in more or less sharply defined areas of the leaf, by the production of a whitish down of conidiophores principally on the chlorotic area, and by a more or less extensive alteration in the form or the normal growth of the plant. The change in color is the most striking and obvious symptom. Since, however, somewhat similar changes in color and form may result from other causes, the characteristic downiness is the surest indication of the disease.

The effects of the disease may appear at any time from the putting out of the third or fourth leaf to the formation and maturing of the tassel and ear, but in any case the tissue of the host is thoroughly invaded by the mycelium before any external signs appear.

When appearing early in the development of the plant the symptoms are as follows: The second, third, or perhaps the fourth leaf, when nearly developed, shows at the base two or three rather narrow, longitudinal stripes of a pale yellow to whitish color (Pl. A) with the exception of which the leaf is quite the normal green. However, the two or three leaves already partly developed above this, and all the leaves which subsequently appear, are almost completely whitish or pale yellow. Moreover, these leaves never attain the normal shape and size but remain much narrower and become rigid, so that they ascend stiffly instead of bending in the normal flexible manner (Pl. A). The growth of the stem is also checked, so that the plant becomes more or less dwarfed. As the growth of the leaf sheaths is not decreased proportionately, they often deeply overlap to form a cover which may inclose and even project beyond the stunted tassel (Pl. 18, A). The root system also is usually affected so that

it does not develop properly but becomes stunted and functionally inadequate.

The subsequent fate of an infected plant varies with conditions. In the rainy season it almost invariably succumbs rapidly to secondary infections by species of *Pythium*, *Helminthosporium*, or *Fusarium*. In the dry season, however, although it usually turns brown, withers, and soon dies, such a plant may struggle along to the tasseling state and may even produce a stunted ear with occasionally a few grains.

When the disease appears later in the development of the corn plant the symptoms are as follows: The first leaf to show any signs of the disease, which may be the fourth or fifth or even up to the eighth, will have at the base pale stripes similar to, but more extensive and broader than, those described for plants which show the disease early (Pl. B). All subsequent leaves show a somewhat similar striping but in a progressively more marked degree, the markings on each successive leaf being more extensive than those on its predecessor and running nearer the tip, while the last leaves are striped throughout their entire length.

The shape of the stripes varies greatly. On the lower leaves they are usually merged at the base into a solid yellowish white area from which irregular elongations run up into the normal green towards the tip of the leaf (Pl. B). On the middle leaves the solid yellowish white area at the base is somewhat smaller in extent, but the prolongations from it run more nearly to the tip, while on the upper leaves these discolored stripes extend from the base to the tip of the leaf but are more broken and irregular and even merge laterally and anastomose so that a marbled or mottled appearance is given to the otherwise green leaf.

The shape and size of these leaves, however, is very little altered, and they usually have the breadth and flexibility which characterize leaves of the normal plant. At times, however, the midribs become brittle from the invasion of the fungus mycelium, break where they join the sheath, and hang straight down along the stem (Pl. 17). The growth and structure of the stem are often normal, and the root system is strong and well developed. It is in the reproductive structures of these later-infested plants that the injurious effect of the disease is shown especially. The tassel, although usually appearing at the normal time and often seemingly unharmed structurally, may show decreased production of pollen and frequently is extremely malformed (Pl. 17, A). The ear also is even more seriously affected. Even a mediocre ear is a very rare occurrence (in 1 out of 150 diseased plants), while customarily the ear is more or less completely sterile and malformed (Pl. 20).

This malformation of the reproductive structures is of frequent and regular occurrence in maize infected by the Philippine downy mildew. In plants attacked at all ages by the disease there is induced a great variety of the most remarkable malformations and monstrosities of the ear and tassel. These show a wide range of the fasciations, phyllodies,

reduplications, virescences, and other abnormalities of the various categories of monstrous growths that are recognized in teratology. Less frequently also the vegetative parts of the infected plants show abnormalities induced by the disease, fasciations and torsions of the stem (Pl. 17, B) and shank (Pl. 19, A) being most common. These abnormalities, of course, are frequently induced by other diseases and by unfavorable conditions of the environment, but their occurrence in connection with the downy mildew is so common as to form an accessory symptom of diagnostic value.

One other marked effect of the disease is the delaying of ear production. Normal plants in a plot invariably will bear well-developed ears in the "milk" or "glazing" stage before the diseased plants have developed ears to the "silking" stage.

It should be noted that the loss of chlorophyll and the consequent yellowish or whitish color of the marked areas, which is so characteristic a symptom of the disease, is by no means permanent but serves particularly to point out the earlier stages of the attack. As the diseased plant matures, however, and the fungus begins to terminate its period of spore production, the marked areas become more and more green, the contrast between the normal green and the paler portions of the leaf becoming less and less distinct until, finally, in plants less heavily attacked, the marked areas may so far regain their green color as to be almost indistinguishable from the normal.

All these plants which show the disease at a late date do not necessarily undergo rapid destruction as in the cases of early attack. On the contrary, although the plants are more susceptible to the secondary infections than are their healthy companions, they may mature along with them, drying and withering at a date only slightly earlier than normal. In some cases the infected plants seem stimulated by the downy mildew to prolonged activity and show persistent and excessive growth of husks, or of bracts in the deformed tassels, after adjacent plants are withered and dry (Pl. 19, A).

The susceptibility to infection is greatest in the young seedling and decreases markedly as the plant develops, so that by the time it has tasselled and is forming ears its tissue is, as a rule, too mature and resistant to permit infection. If, however, as is frequently the case in some varieties, the main plant sends out secondary shoots or suckers, these may rapidly become infected (Pl. 19, B), and through them the infection may spread to the main plant even though it is so far matured as to have its kernels hardening.

When attacked in this way, the mature plant shows symptoms different from any of those described above. The lower leaves are inconspicuously marked throughout their length with narrow, pale, yellow-green to rusty green stripes, which are not continuous but are irregularly broken and interrupted. On the middle leaves, as a rule, the markings

are similar in character but occupy principally the more distal part of the leaves, while the upper leaves are either entirely unmarked or have the striping confined to a small part of the leaf tip. Since most of the parts of the plant are matured, they show no change in form as a result of the infection, but the ear, if not mature, may elongate slightly and project from the husks at the tip (Pl. 19, B). It is to be noted that a plant thus attacked, in contrast to those previously described which are infected early, is marked least extensively and conspicuously on the upper leaves and most extensively on the lower leaves, has ears little if at all altered, and bears no conidiophores on the marked areas.

The production of conidiophores on the diseased plant is, of course, a symptom valuable in recognizing the disease (Pl. 21). Unfortunately, however, the process of conidiophore formation takes place almost exclusively at night and is controlled largely by conditions of the environment. The details of this relationship will be given later. It need only be said here that a plant may be attacked heavily by the fungus, the mycelium of which invades its tissues throughout, and may show the changes of color and growth which are characteristic of the disease and yet never form conidiophores and conidia unless external conditions are favorable.

A comparison of the symptoms of the Philippine downy mildew with those which characterize the downy mildew of maize in other countries shows many similarities.

In the closely related Javan mildew of maize, Palm (15) has recognized three distinct sets of symptoms. Of these, the symptoms of type A correspond in general to the description given above for plants attacked early in life, while the symptoms of type B correspond to those of plants attacked later. Type C, however, is characterized by narrow, inconspicuous stripes of a dark brown color running the full length of the lowest leaves and decreasing in extent on successively younger leaves until the last marked leaves show these stripes at the tip only, while the still later leaves are of the normal green throughout.

No specimens corresponding exactly to the description and illustrations of Palm's type C have been seen in the study of the Philippine maize mildew. Occasional stripings of this sort have been observed on the lower leaves of plants whose upper leaves showed the general or restricted discoloration already described. Maturing plants infected through suckers have shown inconspicuous, dark orange-colored stripings, extensive on the upper leaves and decreasing in area on the lower. In no case, however, has an immature plant been seen with these dark markings of the leaves decreasing on successively younger leaves until the latest are untouched.

For the Philippine maize mildew it does not seem justifiable to attempt to make such hard and fast categories as the types A, B, and C of Palm, although the symptoms shown by many plants can be more or less

roughly grouped under the types described above. The discolorations, growth changes, and other effects of the disease all differ markedly in accordance with time of infection, the varietal and individual character of the plant attacked, and the conditions of the environment. Hence there are encountered not only such diseased specimens as can be included conveniently in the three types recognized by Palm but also some plants which show symptoms intermediate between the types and others which show various combinations of these symptoms.

The occurrence of such sharply marked categories of symptoms as those described by Palm might with some justice be suspected to be the manifestation of different biologic strains of the causal fungus. In the Philippine maize-mildew, however, cross inoculations with spores from infected plants corresponding to Palm's symptom types, as well as biometric studies of the spores and conidiophores from these plants, disprove this assumption. Moreover, a series of experiments in which several varieties of maize were inoculated in various ways at different ages and subjected to different environmental conditions, although not entirely completed, has shown that the changes of color and growth produced in the plant by the disease differ with variations in these factors. All the evidence of field observations also supports this conclusion. In general, then, while the symptoms of the Philippine maize-mildew resemble those of the Javan, they appear to be much more varied and less easily grouped into sharply defined categories.

In the related Formosan downy mildew, Miyake (14) has described in detail only the symptoms shown by attacked sugar cane, which is the host most severely affected. He states that in maize the stripes are not particularly pronounced and the plant is not noticeably hindered in growth, for it ripens and shows only a slight decrease in yield. While this description would fit occasional plants attacked by the Philippine maize-mildew, it by no means depicts adequately the injurious effects in even the average case and would seem to indicate that the Formosan mildew is far less destructive to maize than is the Philippine.

Upon comparing the maize downy mildew of the Philippines with that of British India described by Butler (4), it is to be noted that the symptoms of the latter resemble in general those seen in the Philippines, although in the Indian disease more emphasis is laid on the checking of the internode growth and the consequent stunted appearance of the attacked plants than seems to be warranted from observation in the Philippines. Moreover, although the maize-mildew of British India has been present in that country since 1911, it has, in marked contrast to the Philippine disease, caused only slight sporadic injury.

HOSTS

Under field conditions throughout the Philippine Islands maize is the only crop on which the downy mildew occurs with sufficient severity to attract attention or to occasion appreciable loss. In the trial plots at

the College of Agriculture, however, where many kinds of cereal, forage, and cane crops were grown under conditions favoring infection, the downy mildew was found also to attack teosinte (*Euchlaena luxurians* Schrad.) and sorghum (*Andropogon sorghum* (Linn.) Brot.).

With teosinte, the percentage of infection and resulting loss is not quite so great as with maize, and the symptoms are less pronounced (Pl. 22, C), since the attacked individuals, especially those showing the disease late in their development, are much less conspicuously marked and are very seldom appreciably deformed, while the conidiophores are more scattered and more scantily produced.

As might be expected, hybrids resulting from the crossing of maize and teosinte are also susceptible to the disease, the degree of susceptibility and the effect on the plants attacked being intermediate between those shown by the two ancestors.

In sorghum the percentage of infection is very low, and the few plants infected are easily overlooked, because they turn pale when still very young (Pl. 22, B), bear but few conidiophores, and wither and die after a brief period of weak, stunted growth. No cases of individuals more conspicuously marked or deformed, in which the disease appeared later, were ever seen; and the loss was limited to the destruction of the few attacked plants.

Cross-inoculation experiments and the biometric study of spores and conidiophores show that the same causal fungus is involved in all these cases.

In view of this condition, it would naturally be suspected that other members of the Maydeae and Andropogoneae might also prove susceptible to the disease. So far, however, in spite of extensive search, no such Sclerospora, characterized by a conspicuous and rapidly spreading conidial stage, has been found in this region under natural conditions on the many wild grasses related to maize. However, the writer has found on *Saccharum spontaneum* L., a very common wild grass here, a Sclerospora which although of very frequent and widespread occurrence produces only the characteristic thick-walled resting spores. Further description of this Sclerospora will be given in a later paper, but it should be said at this point that this oogonial form on wild grass does not appear to be connected with the conidial form growing on cultivated maize, sorghum, and teosinte.

Moreover, inoculations such as were successful in the case of maize, sorghum, and teosinte have so far failed to accomplish the transfer of the disease to other related Gramineae—namely, *Coix lachryma-jobi* L., Philippine, United States, and Hawaiian strains; *Coix ma yuen*, Philippine and United States strains; several varieties of sugar cane (*Saccharum officinarum* L.), uba or Japanese cane (*Saccharum* sp.), and the native grasses, cogon (*Imperata cylindracea* L.), anias (*Andropogon sorghum* var. *halepense* L.), and aguingay (*Rottboellia exaltata* L.). In view of the

difficulties in securing artificial infection, these negative results are by no means conclusive, although the successful infection of maize, sorghum, and teosinte under the same conditions would seem to indicate that these other relatives are far less susceptible.

These inoculations will be detailed more fully in a later paper, but it should be said here that they were made from about 2 a. m. until dawn because the spore production was found to take place at this time. It seems highly probable that spore production is nocturnal in the other related downy mildews of the Orient as well and that the uncertain results of inoculations with them has been due to the failure to use fresh spores.

It is of interest to compare these results with those obtained for the other related downy mildews of the Orient. In Formosa, Miyake (14) successfully transferred *Sclerospora sacchari* T. Miy. from sugar cane to maize and teosinte and vice versa, but was unable to infect rice, sorghum, wheat, or millet. In India, although their infection experiments were unsuccessful, Butler (3) and Kulkarni (10) note the occurrence on teosinte of the conidial stage of a *Sclerospora* which they suspect may be identical with that of maize (*Sclerospora maydis* (Rac.) Butler.)

In Java, no extensive attempts were made by either Rutgers (19) or Palm (15) to obtain artificial inoculation of other hosts with the Javan downy mildew of maize (*Sclerospora javanica* Palm). They state, however, that under conditions favoring infection in the field, neither sugar cane nor the common wild alang-alang grass (*Imperata* sp.) was found infected and that, although teosinte itself is immune, the hybrid between teosinte and maize is, if anything, more susceptible than the variety of maize from which it is derived.

CAUSAL ORGANISM

The fungus which causes this extremely destructive disease of maize in the Philippines belongs to the Peronosporaceous genus *Sclerospora*, as Baker (1) and Reinking (17) already have reported. It should be noted, however, that it shows especially close relationship, not to the type species *Sclerospora graminicola* (Sacc.) Schroet., which is distinguished by the germination of the conidia by zoospores and the abundant production of oospores, but to those other oriental members of the genus which are characterized by the germination of the conidia by tubes and the partial or complete lack of oospores. However, setting aside the question of the affinities of the fungus for a later discussion, its characteristics will now be considered.

MYCELIUM

As a rule, as soon as the maize plant shows any external indication of the disease, the mycelium is found to be quite generally distributed throughout the host tissue, the root being the only main organ which is not extensively invaded. This invasion is most marked in the vegetative

parts of the plant but to a lesser degree affects the male and female inflorescences also.

Since the mycelium is relatively inconspicuous, its course throughout the host tissue is followed with difficulty. However, by means of transverse and longitudinal sections cut in various thicknesses and stained with iron-alum-haematoxylin and eosin or with gentian violet or methyl blue it was possible to trace the relation of the hyphae to the host tissue. Moreover, by subjecting such sections to the processes of maceration, clearing, and subsequent staining used by Mangin (13) and Berlese (2) the host tissue was readily dissociated and cleared sufficiently to permit the examination of large sections of the mycelium. By these methods material was studied from all parts of plants in various stages of infection, and the nature of the hyphae, their relation to the host tissue, and their location and abundance in different parts of the host were ascertained.

The hyphae are most abundant in the discolored areas of the infected leaves but may be found throughout the plant in unmarked parts of the leaves, in the branch tips of the apparently unaffected tassel, and at the base of the seemingly healthy stem some feet below the first discolored leaf.

In the leaf sheaths, leaves, and such modified foliar structures as the husks and glumes, the mycelium is most abundant among the cells of the bundle sheaths and in the mesophyll tissue (Pl. 23, E), but occasional hyphae are found in the fundamental tissue and even among the elements of the bundles themselves.

In the stem, ear shanks, cob, and tassel rachis, the mycelium follows the bundles, running for the most part parallel to them among the cells of the bundle sheath (Pl. 23, B) and less frequently sending out hyphae more extensively into the surrounding fundamental tissue.

In badly infected ears the mycelium usually runs out from the cob along the funiculus of attachment into the undeveloped parts of the abortive kernels, and occasional hyphae are encountered even in the chaff, seed coats, and endosperm of the apparently healthy kernels, though not in the embryo itself.

Wherever found, the hyphae are almost invariably intercellular in position, occupying even the smallest spaces between the cells, and even forcing adjacent cells apart as they grow between them. Occasionally hyphae were seen which apparently passed within the cells, but the interference of the host tissue was such that their position could not be ascertained with entire certainty. Since the size and shape of the hyphae are determined to a large extent by the nature of the intercellular spaces which they occupy, there is very little regularity in these characteristics in most cases. When separated by maceration, the hyphae are seen to be of two general types—namely, the long, slender, occasionally branching hyphae which lie alongside the vascular bundles in the stem and leaves'

and the lobed, contorted, irregularly branched, gnarled, and crooked hyphae which run in and out among the mesophyll cells of the leaves (Pl. 23, A).

The first kind seem to serve for communication from one part of the host to the other and can be followed for considerable distances even in longitudinal section (Pl. 23, B). The second kind appear to act as a means of establishing connection with the mesophyll cells, especially with the bundle sheath, in order to derive nutriment therefrom, since they are found in every possible crevice in the most intimate contact with the host cells (Pl. 23, A, E).

Haustoria are produced by both types of hyphae but are best developed or most pronounced on the crooked assimilatory hyphae among the mesophyll cells in the leaf. In shape the haustoria are simple, papillate to tubular (Pl. 23, F, G), as a rule, but they may be somewhat lobed (Pl. 23, H). In no case, however, were such markedly digitate haustoria seen as those figured by Rutgers (19, Pl. 6) for the Javan *Sclerospora*. The haustoria penetrate portions of the host cell wall, against which the hyphae are closely appressed, and project into the lumen. Not only the cells of the mesophyll, bundle sheath, and pith are penetrated, but also occasional cells of the epidermis (Pl. 23, E, c) and even the xylem (Pl. 23, E, b).

In any case, the haustoria accomplish the penetration of the host cell without occasioning its collapse, although the wall often is wrinkled and the turgidity of the cell decreased, apparently through the extraction of its contents by the parasite. The chloroplasts of the parasitized cells are gradually destroyed through the action of the fungus, with the result that the badly infected areas lose their green hue and assume the pale yellow or whitish color symptomatic of the disease. Occasionally the host cell surrounds the haustoria of the parasite with a thick wall (Pl. 23, F), as if in protective response to the injurious stimulus of the fungus, a condition observed also by Butler (3) in *Sclerospora graminicola* (Sacc.) Schroet. on Pennisetum.

The hyphae are hyaline, rarely if ever septate, thin-walled, with granular content, and vary greatly in size, $8\ \mu$ being perhaps the most common diameter. The haustoria are similar in structure and usually about $8\ \mu$ long by $2\ \mu$ in diameter.

In the larger air chambers which underlie the stomata, the mycelium develops somewhat irregular clusters of stout branches (Pl. 23, E, a), from which, under favorable conditions, the conidiophore initials arise and grow out through the stomata to produce the conidiophores.

CONIDIOPHORES

Conidiophores may be said, in general, to be produced on any part of the plant save the roots. They occur on the main stem, on the leaves, leaf sheaths, and ear husks, and on the main axis, branches, and glumes

of the tassel. Most commonly, however, the conidia appear on the leaves and leaf sheaths, where they occupy principally the conspicuous mottled and discolored areas which have been described.

On whatever part of the plant they may be found, the conidiophores emerge at night, provided there is present a thin layer of dew, rain, or mist. Damp air alone does not seem to permit their formation. Under favorable conditions the process of conidiophore emergence and conidia production begins about midnight and may continue a few hours after dawn, provided the weather is favorably rainy. When seen at night in the luxuriance of their growth, the innumerable conidiophores projecting slightly from the thin film of moisture on the leaves form a very distinct grayish white down, which is by no means even suggested by the dry, matted fragments which remain when the hot morning sun has dried the surface of the leaves (Pl. 21, A).

This process of conidiophore development and conidia production has never been described, and, since it shows several points of interest, it will be presented in detail in a subsequent paper. In general, however, it occurs as follows:

From the stomata of the infected portion one or more club-shaped hyphae grow out. These elongate, and under favorable conditions the paired protrusions finally bud out from their tips and become the stout primary branches. From the tips of these in turn bud out the beginnings of the secondary, and from these, at length, the tertiary branches, each of which usually terminates in one or two tapering sterigmata. Since the initial protrusions which develop into the branches arise almost invariably in pairs, the structure of the mature conidiophore is characteristically dichotomous, instances of the suppression or delayed formation of a branch being, on the whole, rather rare (Pl. 24, D). Finally, from the tip of each sterigma there buds one conidium as a spherical protrusion which enlarges and lengthens until it attains the elongate oval or rounded oblong shape of the mature spore and is separated from the sterigma tip by a cross wall.

When fully formed the conidiophore appears as in Plate 24, C, and consists essentially of a main axis which begins with an elongate basal cell and broadens gradually until it divides into the two to four stout main branches. From each of these extend two to four smaller secondary branches, each of which in turn bears two to four tertiary branches that terminate severally in one or two tapering sterigmata, each bearing at its tip a conidium. Although under favorable conditions the conidiophores are of the large, well-developed type just described, they frequently show such variations in structure as the omission of the second and third series of branches and a general reduction in branches, sterigmata, and consequently number of conidia (Pl. 24, E). On vigorous conidiophores 32 to 96 conidia may be borne, while on poorly developed ones there may be as few as 8 or even 3. In size also there is great varia-

tion, the total length of the conidiophore even in abundant dew varying from 260 to 400 μ , although most commonly it is about 340 μ , while in scanty dew, such as occurs in the hot season, lengths of 160 to 200 μ are generally encountered. In either case, however, the greatest width, just below the branches, is from 15 to 26 μ . The sterigmata are consistently about 10 μ in length, with a diameter at the base of about 6 μ .

The basal cell is invariably present in the mature conidiophore, forming a structural feature which should be emphasized as distinctive (Pl. 24, H, J, L). This cell reaches its greatest width at the septum which separates it from the rest of the main axis and tapers gradually downward throughout its length, terminating in a rounded, slightly swollen foot which is connected by a slender hypha with the internal mycelium through the stomatal pore. The greatest width of the basal cell is usually about 12 μ , but the length varies from the customary extremes in heavy dew (60 to 120 μ) to 30 or even 20 μ in a scanty film of moisture (Pl. 24, E).

When fully mature the conidia are most commonly elongate, ellipsoid, elongate ovoid, or rounded cylindrical in shape, are thin-walled and hyaline, and have a more or less finely granular content. The tip is broadly rounded and lacks any papilla or other modification, while the base shows an apiculus, a slight thickening and protrusion of the wall at the point of attachment to the sterigma. Wide variations in the shape of the conidia are common, examples being found of all of the types from subspherical, pyriform, or even lemon-shaped to the extremely elongate types which are shown in Plate 25, C-L.

A method has been devised by Rosenbaum (18) for expressing quantitatively the shapes encountered in a study of large numbers of conidia of *Phytophthora*. This method, which consists in classifying and plotting the ratios of length to width, is of value in that it gives a quantitative idea of the relative predominance of certain shapes of conidia in a species and furnishes a reliable basis for comparison with others. Unfortunately, however, this method can make no distinction between conidia which are ovate or obovate, pyriform, or obpyriform, ellipsoid, allantoid, or cylindrical, provided their length and greatest diameter be the same. Therefore, while the ratios of length to width of 400 conidia of the Philippine *Sclerospora* of maize are presented here in tabular and diagrammatic form for comparison with other species, a clearer idea of the variations in shape is probably to be obtained from the figures in Plate 25.

The size of the conidia also varies greatly. When large numbers are examined, examples are found with such widely different dimensions as to include those given for several other species. It is difficult, therefore, to give a correct impression of the size of the conidia by means of the extreme dimensions within which they vary, or even by means of the average dimensions. However, the method of grouping together large numbers of representative conidia into a series of measurement classes and plotting curves to show their frequency of occurrence has been used

successfully in describing the size of similarly variable bodies, first by Rosenbaum (18) for *Phytophthora* and more recently by Gaumann (6) for *Peronospora*. This method seems especially valuable in the case of such variable structures as the conidia of the *Peronosporaceae*, since by means of it data gathered from large numbers of individuals may be so presented that the range of variation in size which is encountered, as well as the size class which predominates in the species, is at once apparent. Also it furnishes a most accurate method for comparing the sizes of such bodies in different species.

TABLE I.—Measurements and ratios of length to width of 400 conidia of *Sclerospora philippinensis* arranged in classes.

Number of conidia in 400.	Length classes. μ.	Number of conidia in 400.	Width classes. μ.	Number of conidia in 400.	Ratio of length to width classes.
1	17 to 18.9	1	11 to 12.9	1	1.05 to 1.14
1	19 to 20.9	0		0	1.15 to 1.24
2	21 to 22.9	8	13 to 14.9	3	1.25 to 1.34
1	23 to 24.9	6		6	1.35 to 1.44
4	25 to 26.9	41	15 to 16.9	9	1.45 to 1.54
10	27 to 28.9	30		30	1.55 to 1.64
35	29 to 30.9	160	17 to 18.9	53	1.65 to 1.74
68	31 to 32.9	59		59	1.75 to 1.84
75	33 to 34.9	148	19 to 20.9	70	1.85 to 1.94
64	35 to 36.9	59		59	1.95 to 2.04
55	37 to 38.9	41	21 to 22.9	40	2.05 to 2.14
30	39 to 40.9	32		32	2.15 to 2.24
24	41 to 42.9	1	23 to 24.9	21	2.25 to 2.34
21	43 to 44.9	9		9	2.35 to 2.44
7	45 to 46.9	2		2	2.45 to 2.54
2	47 to 48.9	3		3	2.55 to 2.64
0	49 to 50.9	0		0	2.65 to 2.74
1	51 to 52.9	3		3	2.75 to 2.84

For these reasons this method seems well adapted to depict the size of the conidia of the *Sclerospora* of Philippine maize. Accordingly the measurements of 400 conidia are given in tabular form and are also plotted as curves (fig. 1, 2). The ratio of length to diameter in classes is given in figure 3. These show clearly that while spores are encountered with such widely differing dimensions as 18 μ long by 12 μ in diameter, and 51 by 23 μ, the size which predominates is 34 μ by 18 μ, and by far the greater number of spores encountered are from 27 to 39 μ in length by 17 to 21 μ in diameter. Although these measurements are of conidia produced on maize, they have been compared and found to agree with similar measurements of conidia from teosinte and sorghum. On comparing like tabulations of dimensions of fresh conidia with those from material mounted in glycerin or dried, the writer finds constant slight differences, particularly in width. Therefore, these 400 measurements were made on four occasions at the beginning of the period of maximum conidia production (2 to 3 a. m.) from fresh material mounted in dew

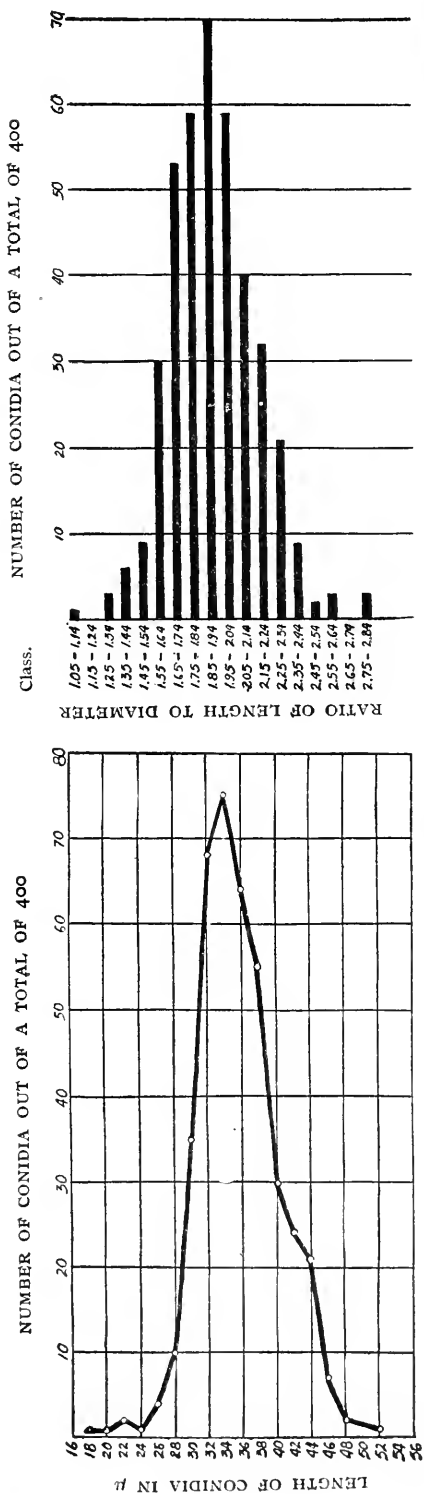

Fig. 1.—Graph showing variation in length of conidia of *Sclerospora philippinensis*.

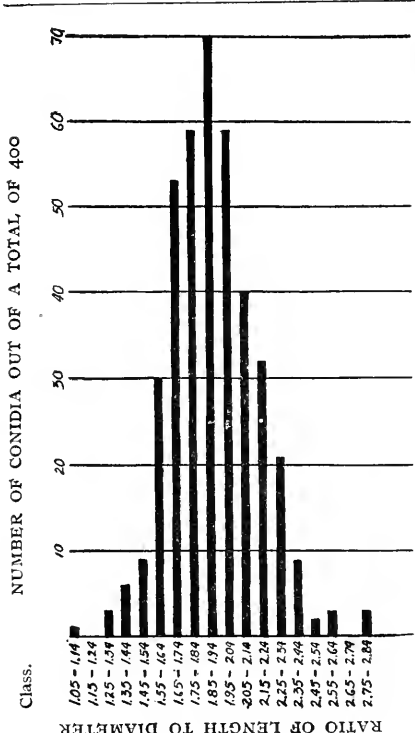

Fig. 3.—Diagram showing ratios of length to width of conidia of *Sclerospora philippinensis*, arranged in classes, and indicating limits of variation and mode.

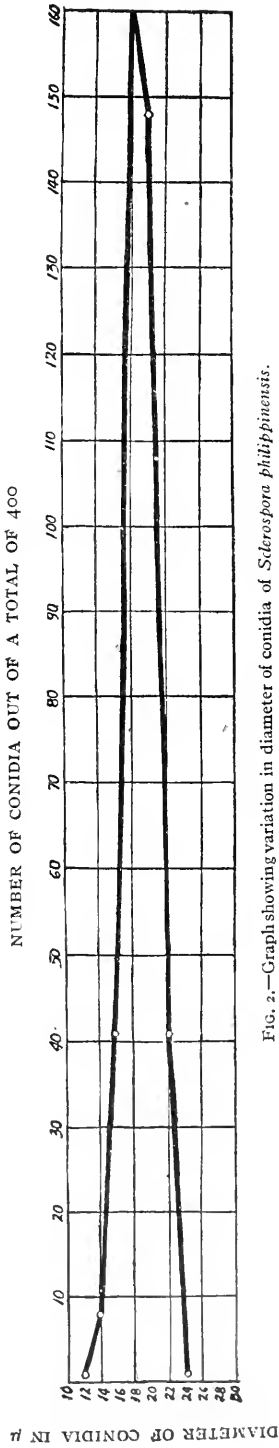

Fig. 2.—Graph showing variation in diameter of conidia of *Sclerospora philippinensis*.

or rain water, and they probably furnish an expression of the conidia dimensions and a means of comparison with other species which is as accurate as it is possible to obtain.

It is interesting to note that occasional monstrous conidia were seen, resembling somewhat those described by Miyake (14) for *Sclerospora sacchari*. Since these have the same structure and history as those of more usual size and appear to represent merely the upper extreme of the widely varying conidia dimensions, they are regarded by the writer as of no special significance.

Germination of the fresh conidia takes place readily in dew, in rain water, in water from clear brooks, in dilute nutrient solutions of various kinds, and on similar solutions solidified with 1 per cent agar. When once the conidia are dried, however, they will no longer germinate under any conditions. On the moist surfaces of newly infected plants in the field, large numbers of conidia may be found germinating vigorously at any time from about 3 a. m. until dawn, but after the rapidly drying effect of the early sun has been felt for one or two hours there can be found on the same plants only shrivelled spores incapable of further development. Germination is preceded by a swelling and consequent alteration in size and shape of the conidium and invariably proceeds by the protrusion of one or more germ tubes (Pl. 25, C-L). This may take place from any part of the spore, and the hyphae thus produced may simply elongate (Pl. 25, C, J) or develop variously into extensively branching systems (Pl. 25, E, F, L). Occasionally the hyphae of germination grow up into the air for a short distance and produce at their tips an ovoid swelling that might perhaps be interpreted as an abortive attempt at a secondary conidium formation such as has been found in other Peronosporaceae. In no case was the production of zoospores by the conidia observed, although repeated attempts were made to induce this method of germination.

In spite of the ease with which the conidia produce germ tubes, all attempts to induce continued independent development of the mycelium in artificial media have been unsuccessful, the growth seemingly ceasing when the nutriment of the spore is exhausted. In view of the tropical habitat of this *Sclerospora* it is of interest to note that the conidia germinate readily when maintained at a temperature as low as 6.5° C., even though the temperature at which they most commonly germinate is from 20 to 24°.

In spite of extensive search, none of the resting or resistant bodies customarily encountered in this or other genera of the Peronosporaceae, such as chlamydo-spores and parthenogenetic or normal oogonia, have ever been found to be associated with the conidial stage of this fungus. Every effort has been made to find such structures. The progress of the disease has been observed in individual plants from the time of their infection by the fungus to their ultimate disintegration in many varie-

ties representing the several types of maize and teosinte and in sorghums, under all the various conditions of the wet, dry, and transitional periods of the year. Furthermore, infected plants have been subjected to various changes in temperature, moisture, light, aeration, and soil, in the attempt to induce the formation of such structures. So far, all efforts have been in vain, and, although facilities were not available for any such experiment as subjecting the infected plants to long-continued cold or total freezing such as might occur in our own corn belt, still the experiments which were made seem to indicate that the formation of resting bodies by the fungus in maize occurs very rarely if at all under the conditions naturally encountered in the Philippine Islands.

The possibility that the conidial stage may be restricted to maize while the production of oogonia takes place on some other host invites consideration. As has been mentioned above, the writer has found a *Sclerospora* attacking a common field grass, *Saccharum spontaneum*, in this region; but whether this fungus, of which only the oogonial stage has been seen, is in any way connected with the conidia-bearing *Sclerospora* on maize remains to be determined.

IDENTITY OF THE CAUSAL FUNGUS

The important question of the identity of this Philippine *Sclerospora* necessitates a comparison with the other members of the genus. Since our knowledge of the Philippine form is at present confined to its conidial phase solely, no comparison is possible between it and those species of which only the oogonial stage has been recorded, such as the remarkable *Sclerospora magnusiana* Sor. (20) of *Equisetum* from Russia, the rare *Sclerospora farlowii* Griff. (7) of *Chloris* from western North America, the recently described *Sclerospora miscanthi* T. Miy. (14) of *Miscanthus* from Japan, or even the more common *Sclerospora macrospora* Sacc. (8), which is widely distributed on a large number of grasses and even has been found on the tassels of maize in Italy. Likewise, the type species *Sclerospora graminicola* (Sacc.) Schroet., although known from all over the world on a wide range of wild and cultivated grasses and even recorded on maize in Argentina (21), can not be directly compared, because the conidial stage, even though known, is rare and is characterized by the germination of the conidia by zoospores and by the invariable predominance of the typical oospores.

A far closer relationship is shown between the Philippine form and those Oriental species which occur on maize or related gramineous hosts and are characterized by the partial or complete lack of an oogonial stage, with the concomitant predominance of the conidial phase, which is distinguished further by the germination of the conidia by tubes.

Of these there have been enumerated the following: *Sclerospora javanica* (Rac.) Palm, of Java (originally described by Raciborski as *Peronospora maydis*); *Sclerospora maydis* (Rac.) But., of India; and

Sclerospora sacchari T. Miy., described by Miyake from Formosa but reported by Lyon (11, 12) also in the Fiji Islands and Queensland.

It has been assumed by Baker (1) and Reinking (17) that the Philippine *Sclerospora* of maize is identical with *Sclerospora maydis* (Rac.) But. of India, and this has been generally accepted by other investigators. Since no detailed description of the species with critical measurements has been published, and the single conidiophore and few spores figured by Reinking are hardly enough on which to base a decision, it seems necessary to corroborate the identification of the fungus.

A comparison with *Sclerospora maydis* (Rac.) But. of India and also with the other related species mentioned above is accordingly in order. Such a comparison must necessarily consider the field characters of the disease, such as its effect on the plants attacked, its severity, and its fatality to the various hosts, as well as the specific peculiarities of the causal organism itself. Of these the characteristic structure and dimensions of the organism itself are most valuable, since the field characters show, on the one hand, a general similarity in all these fungi and, on the other hand, vary so widely under different conditions as to be confusing even in one species.

The *Sclerospora* causing the Philippine disease is known in its conidial phases only, and a comparison of this form with other species must be based on this stage. Such a comparison is confronted by many difficulties. In the first place, the characters most valuable from the systematic point of view have been found by the writer to vary greatly under different conditions and at different stages in the development of the Philippine form, and they probably do so in the other forms also. For instance, the very important characters of the size and shape of the conidia and the structure and dimensions of the conidiophores vary greatly at different stages of development and under different conditions.

The conidia begin as small spherical outgrowths from the sterigmata tips, and in their development become larger and more elongate, passing through ellipsoid (Pl. 24, A), oval (Pl. 25, A), and even pyriform stages before they eventually assume the elongate ovoid ellipsoid or rounded cylindrical shape of complete maturity (Pl. 24, C). They are then separated from the sterigma tip by the septum.

This characteristic shape is transient, however, for, after they are free from the conidiophores, the spores show an almost immediate imbibition of moisture, which results in a marked increase in size and in a more rotund shape, due to the greater bulging of the side walls. Moreover, the apiculus which marks the point at which the spore was attached to the sterigma is modified, by the swelling of the spore, to a low, rounded curve.

Since the partially developed spores of various shapes and sizes may be detached from the sterigmata and still retain their contents and germinability, and since marked changes from the shape and size of the

mature spores normally follow when it is free, it is obvious that a mount of spores usually comprises a motley collection of shapes and sizes, only a comparatively small number of which represent the characteristics of the normal and mature spore.

Moreover, aside from these variations which mark the normal development of the spore, there are also changes in size and shape resulting from abnormal conditions such as the sudden checking of development by unusual drying of the necessary layer of moisture on the leaf.

The size and structural characteristics of the conidiophores also vary markedly with attendant environmental conditions. The normal order is for primary, secondary, and tertiary branches to form before the sterigmata develop and begin to bud out the spores. If the gradual drying of the film of moisture on the leaf surface begins to check this process before its completion, however, sterigmata formation and spore production ensue prematurely, and conidia may be borne on the secondary or primary branches of the conidiophore (Pl. 24, I), or even on the apex of the main axis itself. Similarly, the growth of the basal cell and main axis may be curtailed (Pl. 24, E). Obviously, as a result of these changes, the height of the conidiophore shows a corresponding alteration.

Finally, after it has lost its conidia, the conidiophore shrivels and is dried to an almost unrecognizable mummy by the morning sun.

Since it appears highly probable that similar variations in size and structure occur also in the other oriental mildews, it is difficult to make any adequate comparison from the data available. To permit accurate comparison one should have descriptions and illustrations of material, or the material itself, collected under the optimum conditions, which in the case of the Philippine downy mildew occur on cool nights with heavy dew or persistent rain from 2 to 4 a. m.

In the light of this fact, Miyake's (14) data are valuable, as he recognized that conidiophores and conidia were produced at night, and his drawings show that he illustrated excellent material. Most investigators, however, failed to realize this, and their material, as their descriptions and drawings show, was inadequate and scanty.

When one compares the available data, inadequate though they be, the following points are apparent. The Philippine and Javan *Sclerosporas* are alike in that the conidial phase is the only one yet known.

The conidiophores of the former closely resemble those of *Sclerospora javanica* Palm both in size and structural characteristics, such as the basal cell, the main axis, the branch system, and the ultimate sterigmata. On the contrary, the conidia of the two forms are noticeably different. In the Javan fungus they are oblong rotund in shape and measure 19 to 26 μ in length by 15 to 20 μ in diameter, while in the Philippine mildew they are elongate ellipsoid, elongate oval, or rounded cylindric and markedly longer, most of the conidia encountered measuring about 34 μ in length

by $17\ \mu$ in diameter, and comparatively few showing the shortness which marks the Javan form. Moreover, although the field characters of the two diseases are very similar, the Javan *Sclerospora* presents an additional point of difference in that it does not attack teosinte, although teosinte-maize hybrids are, if anything, even more susceptible to it than maize itself (19).

To *Sclerospora sacchari* T. Miy., of Formosa, the Philippine maize mildew shows a very close resemblance in the size, the form, and even the minor structural characteristics of the conidiophores. Also, the conidia of the two forms are evidently quite similar, since the illustrations and the description (ellipsoid or oblong with rounded apex, 25 to $41\ \mu$ long by 15 to $23\ \mu$ in diameter) of the Formosan conidia are applicable to those of the Philippine species also. A marked difference between the two, however, is shown in their virulence on various hosts, for, while *Sclerospora sacchari* grows on both maize and teosinte as does the Philippine *Sclerospora*, still the former attacks sugar cane of many varieties, including those grown most commonly in the Philippine Islands, with violent intensity, while the latter, so far as is known, does not infect that crop at all. In the Philippines, in regions heavily infected with the maize-mildew, sugar-cane fields comprising many varieties grown under widely varying conditions and situated adjacent to the badly infected maize, and even containing some maize plants growing among and in contact with the young cane, have been under frequent observation during all stages of their development for over a year, and yet no case of infection with the downy mildew of maize has ever been seen.

Moreover, inoculation experiments such as were successful with maize, teosinte, and sorghum have so far failed to cause infection of the Philippine *Sclerospora* of maize on sugar-cane varieties found susceptible to the Formosan disease. Furthermore, the oogonial stage which has been reported for *Sclerospora sacchari* T. Miy. forms an additional point wherein it differs from the Philippine fungus, although it should be noted that the oogonia, which have been found only once and are not figured, have not been proved to be connected with the conidial stage of *Sclerospora sacchari*.

On comparing the Philippine downy mildew of maize with the British Indian species (*Sclerospora maydis* (Rac.) But.), with which it has been regarded as identical, a close resemblance indeed is apparent. The conidia especially are similar in both shape and size in so far as one can judge from the data available; the lack of any other type of spore is another point of agreement. In considering the conidiophores of the former, however, it should be noted that the description, dimensions, and illustrations indicate that the material was imperfect, for if one may judge from the Philippine fungus, the size and the abruptly ending base of the conidiophore signify that the main axis had been broken off just above the basal cell. Any accurate comparison, therefore, is difficult. The

sterigmata, however, are comparable, and it is clear that those of the British Indian fungus are markedly larger (15 to 20 μ long) than those of the Philippine species.

Moreover, the field characteristics are noticeably different. Although Butler reported the first attack of the disease at Pusa in 1912 and emphasized the probability of its spreading to other fields of the region, his latest report (5) indicates that it has continued to be only slightly and restrictedly destructive, an effect markedly in contrast to the rapid spread and serious damage of the Philippine fungus. Also, Butler's description emphasizes the stunting of the growth and resultant bunched appearance of the plant as a characteristic feature of the disease in India, while in the Philippines this is but one and certainly not the most striking effect of the disease.

While the matter is necessarily unsettled because of lack of adequate description of the British Indian form, certain points would seem to indicate that the maize-mildew of India is a different physiological variety and probably a different species from that of the Philippines. These points are the differences in the causal fungi and the symptoms, and especially the lack of virulence shown by the Indian disease and its failure to spread through Bengal where "maize is a crop of considerable importance" and where the conditions of climate and culture are little if at all different from those of some infested regions of the Philippines.

In any case, however, it should be noted that the name *Sclerospora maydis* (Rac.) But. is not strictly a tenable one, for it was applied to the British Indian maize-mildew by Butler (3, p. 15) on the assumption that it was identical with the Javan. Butler (4, p. 275-276) concluded from his comparison with the diagrammatic drawings and incomplete descriptions of Raciborski (16) that the downy mildew of maize in British India—

was found to be identical with the one which causes great damage to this crop in Java,

and that—

its cause is a fungus named *Peronospora maydis* by Raciborski.

The more recent and extensive work of Palm (15), however, has shown clearly that the Javan fungus, although indeed a *Sclerospora*, is a distinct species, one which Palm names *Sclerospora javanica*. This leaves *Sclerospora maydis* (Rac.) But. as the name of the British Indian maize-mildew.

Therefore, because the points of difference already considered seem to indicate that the downy mildew of maize in the Philippines is not identical with the one in British India, and because the name *Sclerospora maydis* (Rac.) But., given to the latter, is technically untenable, it seems necessary to distinguish the Philippine downy mildew of maize. Hence it is

given the name of *Sclerospora philippinensis*, n. sp., with the diagnosis as follows:

***Sclerospora philippinensis*, n. sp.¹**

Sclerospora Maydis, Reinking, 1918, in Philippine Jour. Sci., s. A, v. 13, no. 5, fig. 39, pl. 20, fig. 1-2, not Butler.

Forming linear or irregular whitish yellow to pale spots, often entirely discoloring the leaves and more or less deforming the host.

Mycelial hyphae growing intercellularly in all parts except the root, branched, slender, usually about 8 μ in diameter, but irregularly constricted and inflated, haustoria simple, vesiculiform to subdigitate, small, about 8 μ long and 2 μ in diameter.

Conidiophores always produced in night dew and growing out of the stomata, erect, 150 to 400 μ long, 15 to 26 μ thick, bearing a basal cell in the lower part, dichotomously branched two to four times above, branches robust, sterigmata conoid to subulate, 10 μ long, slightly curved.

Conidia elongate ellipsoid, elongate ovoid, or rounded cylindrical, varying in size, usually 27 to 39 μ long by 17 to 21 μ broad, hyaline, with thin episporium, minutely granular within, slightly rounded at the apex, provided with a minute apiculus at the base, always germinating by a tube.

Oospores not yet seen.

Material of the type has been deposited in the pathologic collections of the Bureau of Plant Industry, Washington, D. C., in the Cryptogamic Herbarium at Harvard University, Cambridge, Mass., and in the herbarium of the Bureau of Science, Manila, P. I.

So far as at present known there exist in the Orient the following *Sclerosporas* which are of primary importance, since they cause serious diseases of maize.

Sclerospora javanica Palm, known on maize and maize-teosinte hybrids in Java, Madoerah, and Sumatra.

Sclerospora maydis (Rac.) But., known on maize and teosinte in Bengal, British India.

Sclerospora sacchari T. Miy., known on maize, sugar cane, and teosinte in Formosa, and on sugar cane in Queensland and the Fiji Islands.

Sclerospora philippinensis, n. sp., known on maize, teosinte, and sorghum in the Philippine Islands.

All these species are very similar in their effects and show close relationship in structure and development. All are characterized by the

¹ *Sclerospora philippinensis*, sp. nov.

Maculas lineares vel irregulares, albido-flavas vel pallidas efficiens, saepe totum folium discolorans, et matricem plus minusve deformans.

Hyphis mycelicis inter cellulas in totas partes praeter radicem crescentibus, ramosis, tenuibus, plerumque circa 8 μ in diametrum, sed irregulariter constrictis inflatisque, cum haustoriis simplicibus, vesiculiformibus subdigitatisve, minutis, circa 8 μ longis et 2 μ in diametrum ornatis.

Conidiophoriis semper in rore nocturno productis, e stomatibus egredientibus, erectis, 150-400 μ longis, 15-26 μ crassis, in parte inferiore cellulas basiales gerentibus, superne 2-4 dichotomo-ramosis, ramis robustie cum sterigmatibus conoideo-subulatis, 10 μ longis, leviter curvatis.

Conidiis elongato-ellipsoideis, elongato-ovoideis vel rotundato-cylindraceis, variis dimensione, plerumque 27-39 μ longis et 17-21 μ latis, hyalinis, episporio tenue, intus minute granulosis, apice leviter rotundatis; basi cum apiculo minute munitis, semper per tubum germinantibus.

Oosporis nondum visis.

Hab. in foliis, vaginis, glumis, bracteis, culmis, et inflorescentiis praecipue *Zea maydis*, rarius *Euchlaenae luxuriantis* et *Andropogonis sorghi* per omnes partes in insulis Philippinis.

predominance of the conidial stage, no oospores having been found connected with any save *Sclerospora sacchari*, with which, indeed, the relationship is not very well established.

Furthermore in all these species the conidiophores are large and prominent with a differentiated basal cell, stout main axis, and extensive dichotomous system of branches comprising large primary, secondary, tertiary, and even quaternary branches. The germination of the conidia also is invariably by means of hyphae.

In contrast to these species the cosmopolitan *Sclerospora graminicola* (Sacc.) Schroet., the type on which the genus was established, is characterized by the predominance of the oogonial stage, the conidial phase being comparatively rare; by its smaller inconspicuous conidiophores, which lack a differentiated basal cell and give rise to few short primary or at times secondary branches only; and by the regular germination of the "conidia" by zoospores.

Such marked and essential differences certainly appear to indicate that these oriental species should be separated from the type as a different genus; but, in the opinion of the writer, such a step can not be made with justice until more is known of the conidial stage of *Sclerospora graminicola* and of the oogonial stage of the oriental forms.

Moreover, whether *Sclerospora graminicola* var. *andropogonis-sorghii* Kulk. should be included with the oriental group by virtue of its well-developed conidiophores and the germination of the conidia by hyphae, as Ito (9) suggests, also depends on further knowledge of the points just mentioned.

When one considers the great variations in effect on the host and even in such essential features as the characteristics of the conidiophores and conidia, which have been found by the writer to occur in *Sclerospora philippinensis* under different conditions of the environment at different stages of its development and on various hosts, one can not avoid a suspicion that these oriental forms may in reality be a single species. It is not inconceivable that such may be the case and that the variation in effect on the host, the susceptibility of different plants in different places, and the variations in structure of the causal organism may all be due to environmental conditions of the regions in which they are found. Obviously to settle these important points conclusively there is need of extensive cross-inoculation experiments and of comparative studies, using optimum material and methods which emphasize important characters quantitatively as well as qualitatively.

The problems of the origin of these destructive *Sclerosporas* of maize and of their geographic distribution, their appearance in the Orient where maize has only been introduced since about 1496, and their absence as yet from the Western Hemisphere where maize originated, are all too involved for consideration at present.

In any case, however, the increasing attention which these dangerous downy mildews of maize have demanded by their destructive activity throughout the Orient in recent years must necessarily arouse the apprehension of all who are concerned with the valuable corn and sugar-cane interests of the United States.

SUMMARY

(1) For several years there has been known to occur in the Philippine Islands a destructive downy mildew of maize, which not only causes serious losses in that region but also threatens our own valuable corn crop, should it reach the United States. Prior to investigations by the writer no extensive study of this disease has been made. This paper presents certain results in regard to the distribution, severity, and characteristics of the disease and the nature and relationships of the causal fungus.

(2) The disease occurs throughout the Philippine Islands, where it evidently has been established for some years.

(3) It is extremely destructive. Under favorable conditions whole fields are destroyed, and in some districts it has even forced the natives to abandon corn culture entirely.

(4) Representative varieties of all types of maize are highly susceptible, and teosinte, maize-teosinte hybrids, and sorghum are attacked, but with less virulence. Inoculation experiments on a number of related plants, both wild and cultivated, gave negative results.

(5) Symptoms of the disease may appear from the time the plants are seedlings with three or four leaves to the time the tassels and silk are developed. In general, infected plants show a yellowing of the leaves in more or less restricted striped areas, a whitish down of conidiophores, principally on the leaves, abnormalities in growth of the vegetative parts, and abortive development of the ear, resulting in partial or complete sterility. These effects of the disease are described and illustrated.

(6) The causal fungus belongs to the genus *Sclerospora* of the Peronosporaceae and is characterized by the predominance of its conidial stage, the lack of oospores, so far as known, and the invariable germination of its conidia by hyphae. In these respects it differs from the type species *Sclerospora graminicola* (Sacc.) Schroet., which is distinguished by its evanescent conidial stage, its predominating oospores, and the germination of its "conidia" by zoospores. The Philippine species shows close relationship to the following recently described oriental species, all of which attack maize: *Sclerospora javanica* Palm, of Java, *Sclerospora maydis* (Rac.) But., of British India, and *Sclerospora sacchari* T. Miy., of Formosa, Queensland, and the Fiji Islands.

The Philippine *Sclerospora* appears to be a new species and is described as *Sclerospora philippinensis*, n. sp.

(7) Maize plants usually are infected as very young seedlings, and less often as they mature. In any case, however, when the symptoms appear, the mycelium of the fungus already has invaded the host tissue extensively. The mycelium may be found in practically every part of the maize plant with the exception of the root, but is most abundant among the bundle sheath cells of the leaf.

(8) The conidiophores are produced in vast numbers but only at night when a thin layer of dew or rain is on the leaf surface. They vary greatly in size and development according to the depth and persistence of this layer. These variations are described and figured.

(9) Since the conidia also show wide variation in size and shape, an attempt is made to give a quantitative idea of this by tables and graphs of the measurements of 400 specimens. When fresh, the conidia germinate readily in water and various culture media at temperatures ranging from 6.5° to 25° C., and invariably by hyphae. Once they have become dried the conidia no longer germinate; hence their distribution and the infection of new plants occurs almost always before dawn.

(10) In spite of extensive search, no oospores or other resting bodies have yet been found to be produced by this *Sclerospora*. It apparently maintains itself by transmission from plant to plant. The writer has found the oospore stage of a new *Sclerospora* on *Saccharum spontaneum* L., a common wild grass of the Philippines. Whether this is in any way connected with the conidial stage on maize remains to be determined.

LITERATURE CITED

- (1) BAKER, C. F.
1916. ADDITIONAL NOTES ON PHILIPPINE PLANT DISEASES. *In* Philippine Agr. and Forester, v. 5, no. 3, p. 73-78.
- (2) BERLESE, E. J.
1898-1904. SAGGIO DI UNA MONOGRAFIA DELLE PERONOSPORACEE (1898-1903).
In Riv. Patol. Veg., s. 2, v. 6, p. 79-110, pl. 7-10; v. 7, p. 19-37, 1898; v. 9, p. 1-126, illus., 1901; v. 10, p. 185-298, illus., 1904. Reprinted.
- (3) BUTLER, E. J.
1907. SOME DISEASES OF CEREALS CAUSED BY SCLEROSPORA GRAMINICOLA. *In* Mem. Dept. Agr. India Bot. Ser., v. 2, no. 1, 24 p., 5 pl.
- (4) ———
1913. THE DOWNY MILDEW OF MAIZE (*SCLEROSPORA MAYDIS* (RAC.) BUTL.). *In* Mem. Dept. Agr. India Bot. Ser., v. 5, no. 5, p. 275-280, pl. 8-9 (1 col.).
- (5) ———
1918. FUNGI AND DISEASES IN PLANTS . . . 547 p., illus., pl. Calcutta. Bibliography, p. 518-531.
- (6) GÄUMANN, Ernst.
1918. ÜBER DIS SPEZIALISATION DER PERONOSPORA AUF EINIGEN SCROPHULARIACEEN. *In* Ann. Mycol., v. 16, no. ½, p. 189-199, 6 fig. Zitierte Literatur, p. 199.
- (7) GRIFFITHS, D.
1907. CONCERNING SOME WEST AMERICAN FUNGI. *In* Bul. Torrey Bot. Club, v. 34, no. 4, p. 207-211. (Continued article.)

- (8) IPPOLITO, G. D', and TRAVERSO, G. B.
1903. LA SCLEROSPORA MACROSPORA SACC. PARASSITA DELLE INFIORESCENZE DI ZEA MAYS LIN. *In Staz. Sper. Agrar. Ital.*, v. 36, p. 975-996, pl. 9-11.
- (9) ITO, Seiya.
1913. KLEINE NOTIZEN UEBER PARASITISCHE PILZE JAPANS. *In Bot. Mag.* Tokyo, v. 27, no. 323, p. 217-223.
- (10) KULKARNI, G. S.
1913. OBSERVATIONS ON THE DOWNY MILDEW (SCLEROSPORA GRAMINICOLA (SACC.) SCHROET.) OF BAJRI AND JOWAR. *In Mem. Dept. Agr. India Bot. Ser.*, v. 5, no. 5, p. 268-273, pl. 6-7 (1 col.).
- (11) LYON, H. L.
1911. NOTES ON THE SUGAR INDUSTRY OF FIJI. *In Hawaiian Planters' Rec.*, v. 4, no. 6, p. 318-339, 6 fig.
- (12) ———
1915. THE AUSTRALIAN LEAF STRIPE DISEASE OF SUGAR CANE. *In Hawaiian Planters' Rec.*, v. 12, no. 4, p. 257-265, 2 fig.
- (13) MANGIN, L.
1890. SUR LA STRUCTURE DES PÉRONOSPORÉES. *In Compt. Rend. Acad. Sci.* [Paris], t. III, no. 24, p. 923-926.
- (14) MIYAKE, Tsutome.
1911. ON A FUNGUS DISEASE OF SUGAR CANE CAUSED BY A NEW PARASITIC FUNGUS, SCLEROSPORA SACCHARI T. MIY. *In Rpt. Sugar Exp. Sta. Govt. Formosa, Div. Path. Bul.* 1, 61 p., 9 pl. *In Japanese.*
- (15) PALM, B.
1918. ONDERZOEKINGEN OVER DE OMO LIJER VAN DE MAIS. (With an English summary.) *In Meded. Lab. Plantenziekten [Batavia]*, no. 32, 78 p., 7 pl.
- (16) RACIBORSKI, M.
1897. LIJER, EINE GEFÄHRLICHE MAISKRANKHEIT. *In Ber. Deut. Bot. Gesell.*, Jahrg. 15, Heft 8, p. 475-478, 4 fig.
- (17) REINKING, O. A.
1918. PHILIPPINE ECONOMIC-PLANT DISEASES. *In Philippine Jour. Sci.*, s. A.; v. 13, no. 4, p. 165-216, fig. 1-20; no. 5, p. 217-274, fig. 21-42, 22 pl.
- (18) ROSENBAUM, J.
1917. STUDIES OF THE GENUS PHYTOPHTHORA. *In Jour. Agr. Research*, v. 8, no. 7, p. 233-276, 13 fig., pl. 71-77. Literature cited, p. 273-276.
- (19) RUTGERS, A. A. L.
1916. DE LIJER-ZIEKTE DER MAIS. *In Meded. Lab. Plantenziekten*, no. 22, 30 p., 7 pl. (3 col.).
Cover-title: De Peronospora-Ziekte der Mais.
- (20) SOROKINE, N.
1889. MATERIAUX POUR LA FLORE CRYPTOGAMIQUE DE L'ASIE CENTRALE. *In Rev. Mycol.*, ann. 11, no. 43, p. 136-152, pl. 90.
- (21) SPEGAZZINI, C.
1909. MYCÈTES ARGENTINENSIS. SER. IV. *In An. Mus. Nac. Buenos Aires*, s. 3, t. 12, p. 257-458. (Continued article.)



PLATE A¹

Young maize plant, showing the effects of a very early attack of the downy mildew on a small, early maturing variety, Manobo Yellow. Notice the dwarfing and the pale appearance of the plant as a whole, the narrowness and stiffness of the leaves, and the narrow striping of the later leaves throughout their length. The plant was 32 days old when photographed and had first shown the disease two weeks after emerging from the soil. One-fourth natural size.

¹ In the preparation of Plates A and B the diseased plants were photographed and enlargements were colored to correspond as closely as possible to the living specimens. Prepared by L. S. Weston.

PLATE B

Young maize plants, showing the effects of later attack of the downy mildew on a large, late-maturing variety, Guam White Dent.

The two plants at the right are diseased; the one at the left is healthy. Notice the characteristic markings on the larger diseased plant—the whitish yellow sheath of the lowest affected leaf, the short narrow stripes at the base of the next leaf, and on the later leaves the whitening of the entire breadth at the base and the extension of broad stripes increasingly far into the normal green of each successive leaf tip. The leaves are nearly as broad and flexible as in normal plants, and their growth is little checked, if at all. The plants are 31 days old and developed the symptoms of the disease 25 days after emerging from the soil. One-seventh natural size.



PLATE 16¹

A.—Portion of a field of Moro White maize, showing heavy loss from the downy mildew. At the left, near the scale, is seen the only healthy plant that remains in this part of the field. Near it are several pale, stunted plants which are already withering, while in the background may be seen other plants less seriously attacked.

B.—View near the edge of a field of Guam White Dent maize, showing the ravages of the downy mildew. The tall, dark-leaved plant near the scale and two others a little farther back are the only healthy plants seen. Notice the stunted, withering specimens in the foreground, and at the right the seriously affected individual with stiffly ascending, striped leaves.

¹ On the scale which appears in this and the following photographs each black division equals 5 cm. Photographs by W. H. Weston.



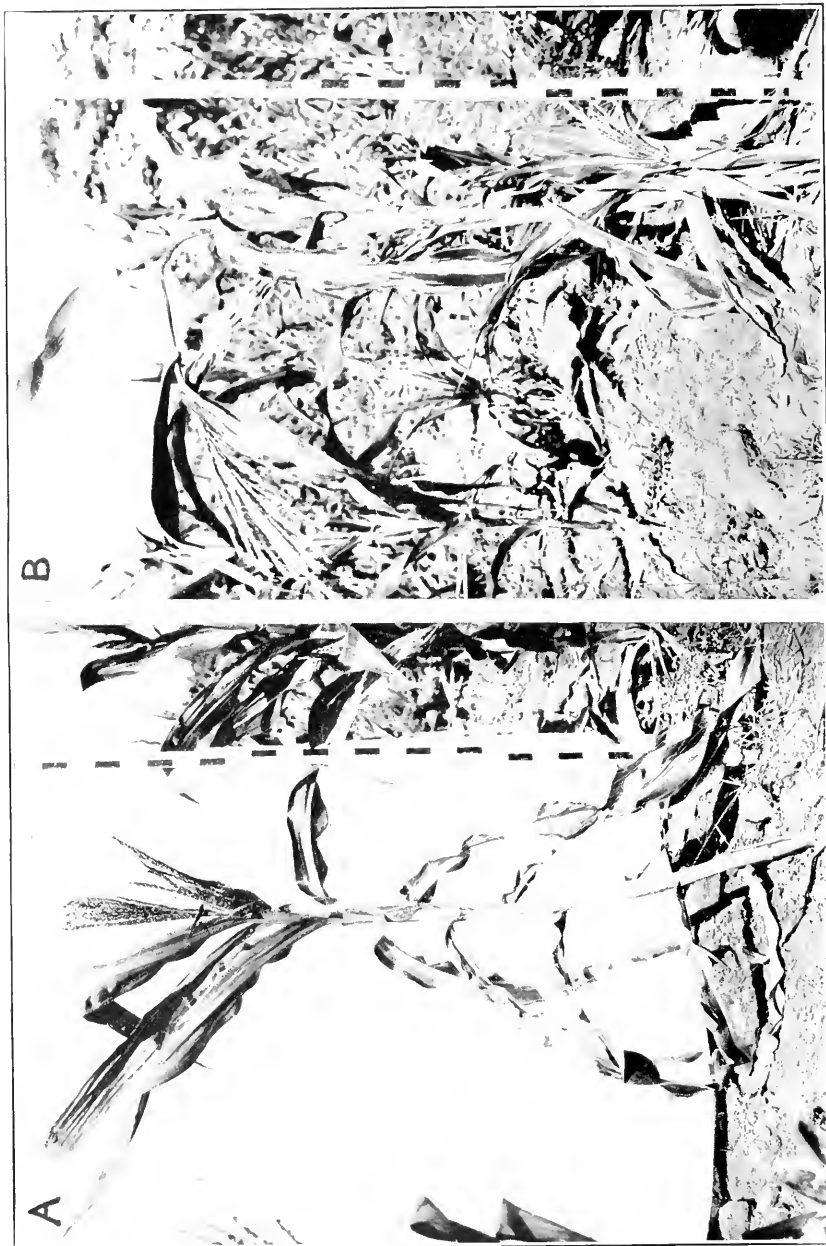

PLATE 17

A.—A frequently encountered type of downy mildew effect. The maize plant is sterile, with no ear borne in the normal place but with a couple of small, abortive ears growing at the base of the tassel. The leaf sheaths are whitish yellow, and conspicuous stripes of the same color occupy a large proportion of the leaves. These are stiff and brittle, the young ones at the top of the plant ascending at an unnatural angle and the older ones breaking and hanging down stiffly.

B.—A serious case of downy mildew injury, one of hundreds in a badly attacked maize field. The conspicuous striping of the leaves and the crooked stalk at once attract attention. The small ear is sterile. At the base of the plant can be seen another one badly dwarfed by the disease.

PLATE 18

A.—A common result of downy mildew attack. In both maize plants shown the growth of the internodes has been checked so that the leaf sheaths overlap and the unexpanded tassel is still partly surrounded by them. The striping of the leaves and their stiff, brittle character are easily seen. Both plants were entirely barren.

B.—A maize plant seriously injured by the downy mildew stands in front. Its stunted habit and striped leaves are striking evidences of the disease. Of the two abnormal ears, the one at the right was entirely sterile while the one from which the husks have been removed bore a few viable seeds. In the same hill, behind, is a healthy plant, only the lower part of which is shown.

C.—One hill in a maize plot which lost heavily from attacks by the downy mildew. The diseased plant at the left, although nearly as tall as the healthy companion at the right, is less strong and has a poorly developed ear which is only partly inclosed in husks and bears very few kernels.

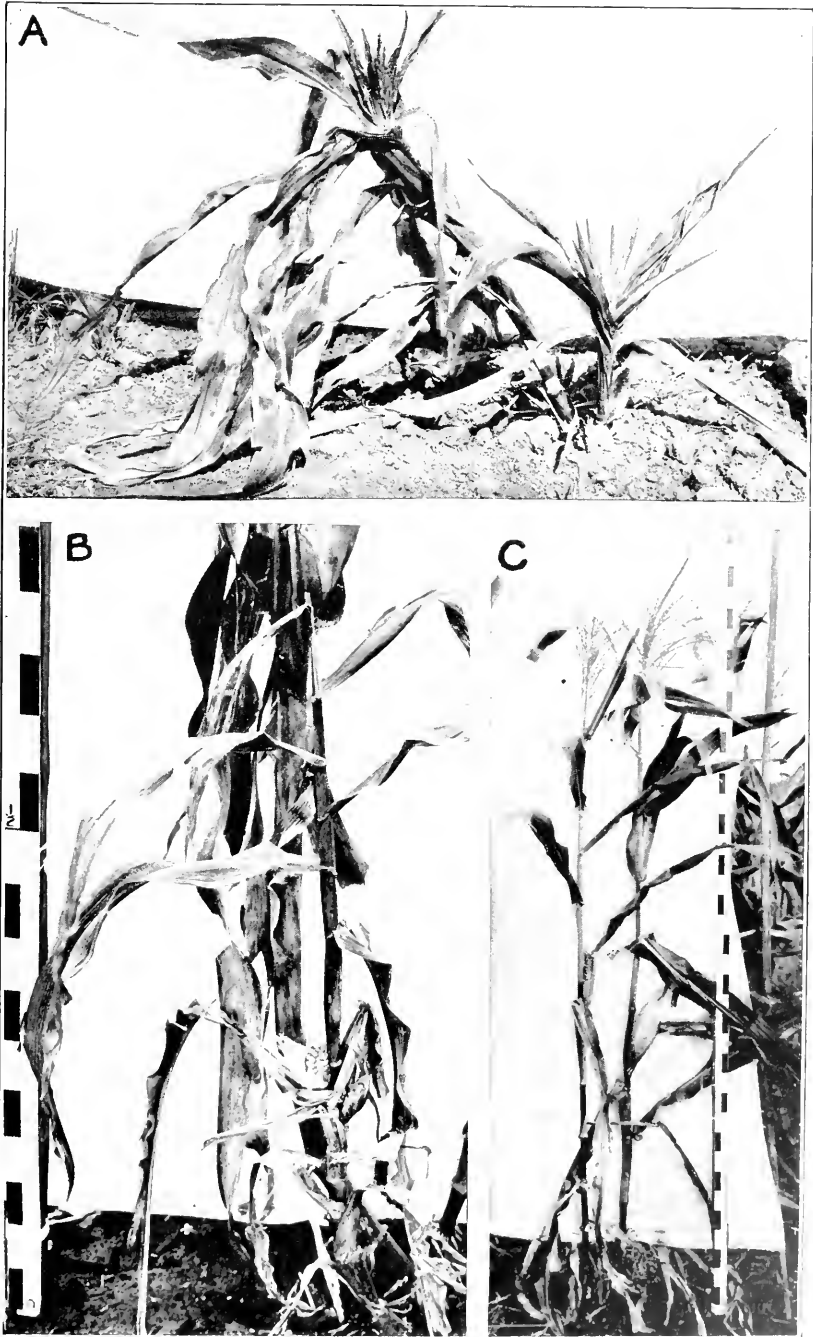

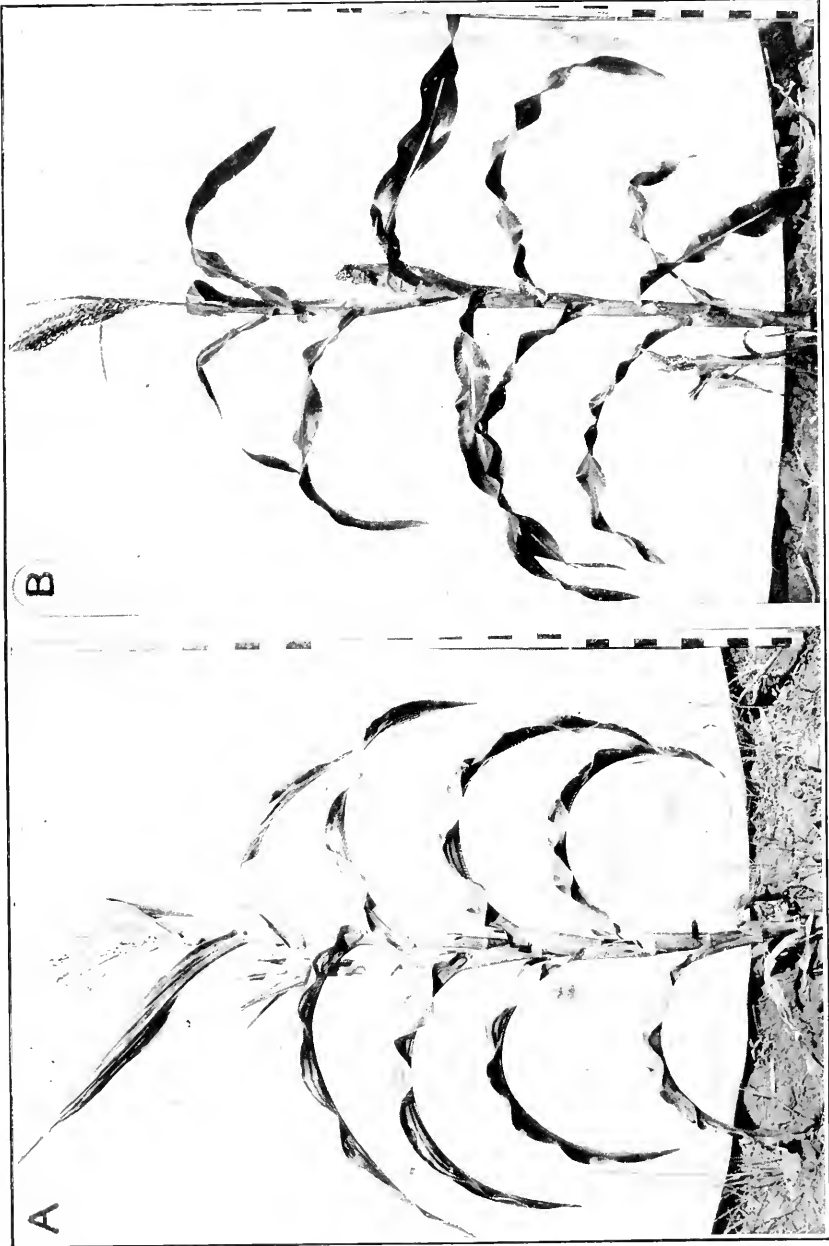

PLATE 19

A.—A case of abnormal growth of a maize plant as the result of an attack by downy mildew. The shank has elongated enormously, and an excessive development of the husks has taken place. Only a small, completely sterile ear has formed.

B.—A maize plant which, when nearly mature, became infected by the downy mildew through a small sucker previously developed. The sucker is obviously infected, but the large plant, aside from faint leaf stripings which escape the camera, shows the effect of the disease only in its unexpanded tassel and protruding ear tip.

PLATE 20

A.—A deformed and partly sterile ear complex produced by a maize plant as a result of downy mildew infection. Notice the branching and elongation of the shank, the abnormal development and arrangement of many of the kernels, and the inclosing of a few kernels in tunicate bracts. The husks have been removed. This specimen is from a Yellow Dent variety that normally has one large and well-developed ear.

B.—A maize ear developed abnormally as a result of the downy mildew. The husks, beyond which the upper third of the ear protruded, have been partly removed. Save for two or three at the base with partly developed kernels, all the florets were sterile, green in color, and bract-like in texture. Healthy plants of this Yellow Dent variety bear large ears well covered over by husks.

C.—Ear of a maize plant infected by the downy mildew. Only a few viable seeds have been formed, the remainder of the florets being poorly developed and sterile. Notice the conspicuous stripes on the leaves. Before the husks were removed the tip of the ear protruded beyond them. Normally this White Flint variety bears long, well-filled ears.

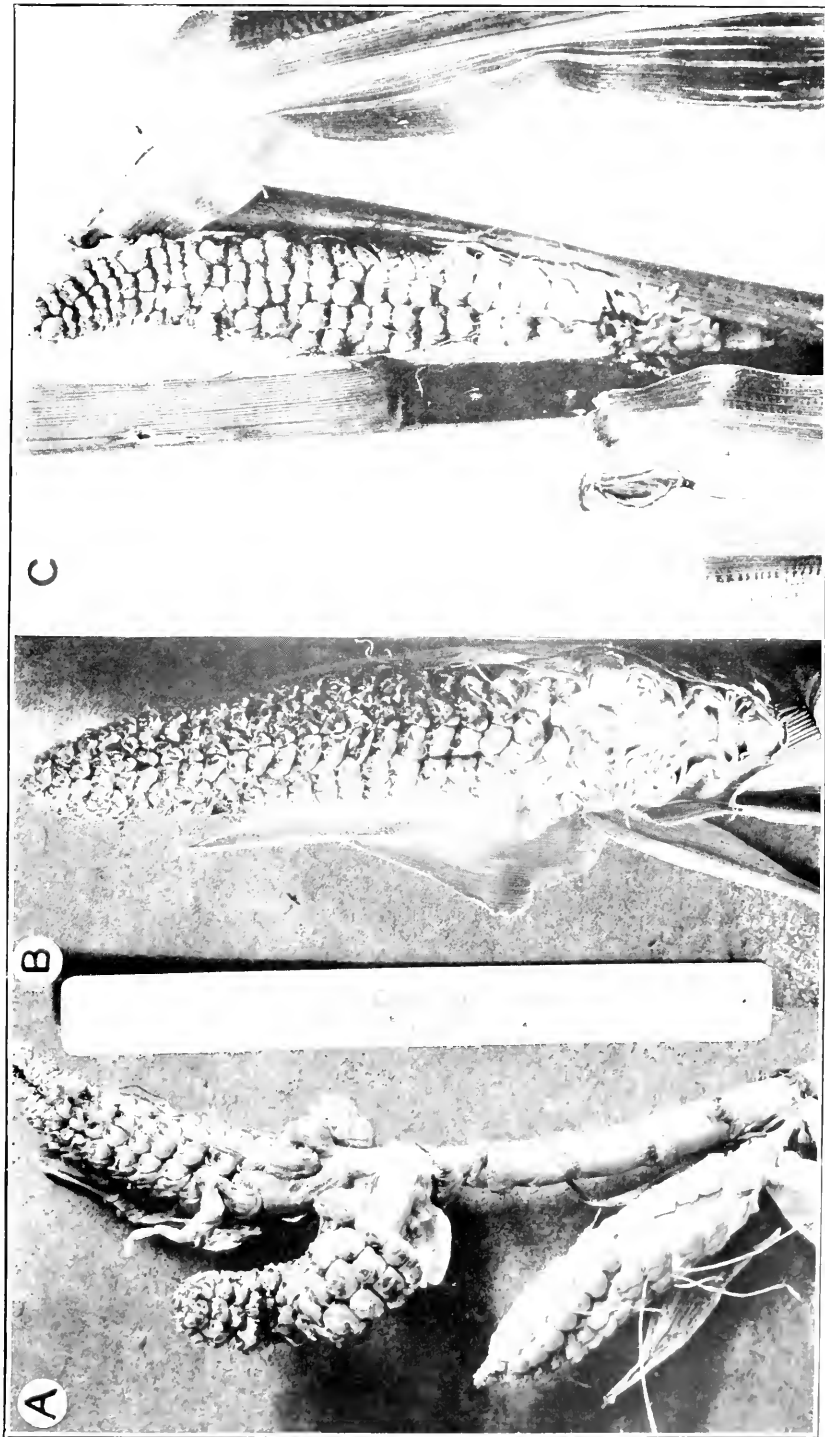

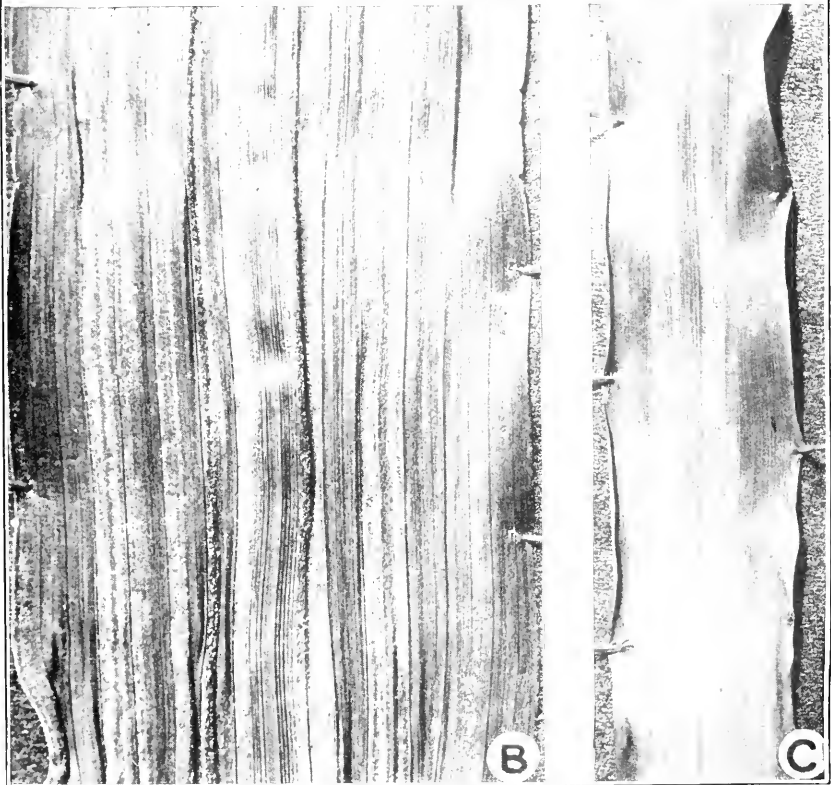
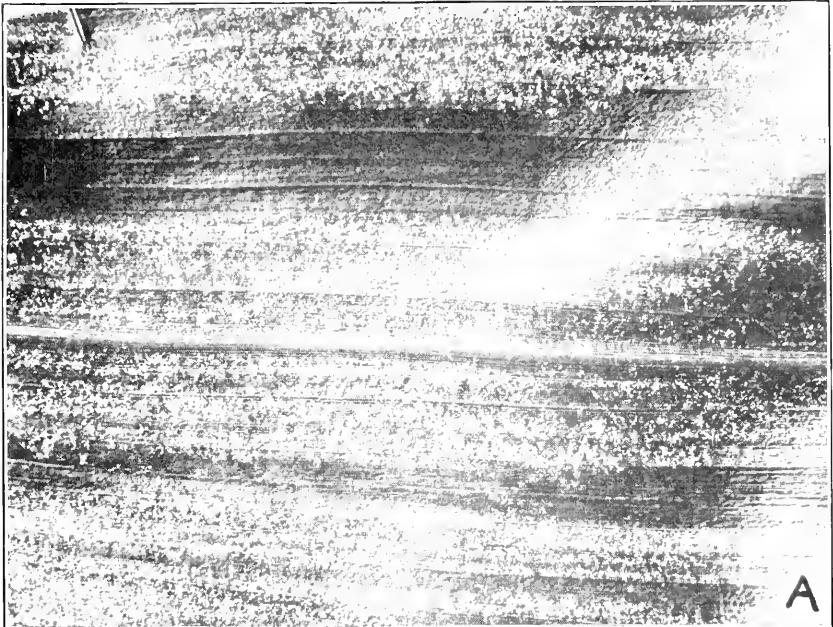

PLATE 21

A.—A near view of the thick down of conidiophores which has been produced on the upper surface of a badly diseased maize leaf. This gives an idea of the vast numbers of conidiophores which are borne on even a small area. The regions where they are formed most abundantly correspond in general to the stripings of the leaf. The layer of dew in which the conidiophores were produced has just dried. $\times 2$.

B.—Upper surface of a badly infected maize leaf from a maturing plant. Conidiophore production is in this case restricted to the yellowish white stripes like those shown in the colored plate. $\times 1\frac{1}{2}$.

C.—Upper surface of the middle portion of a maize leaf from a very young plant which has only recently developed the markings of the disease. The stripes are seen to be covered with conidiophores even up to the ends. $\times 1\frac{1}{2}$.

PLATE 22

A.—View of a row of Egyptian sorghum showing tall, green, healthy plants at the left and at the right a dwarfed, yellowish white plant which is infected by the downy mildew.

B.—Near view of this diseased sorghum plant. Notice the slender, stunted habit, the pallor and faint stripings of the leaves.

C.—A comparative view of healthy teosinte (right), and teosinte seriously infected with the downy mildew (left). The healthy plant has many suckers and is large and vigorous with broad, flexible, dark green leaves and well-developed inflorescences. The diseased plant has no suckers, is stunted and weak, and bears slender, stiff, brittle leaves, which are pale in color and inconspicuously striped, and poorly developed tassels containing a few abortive seeds at the base.

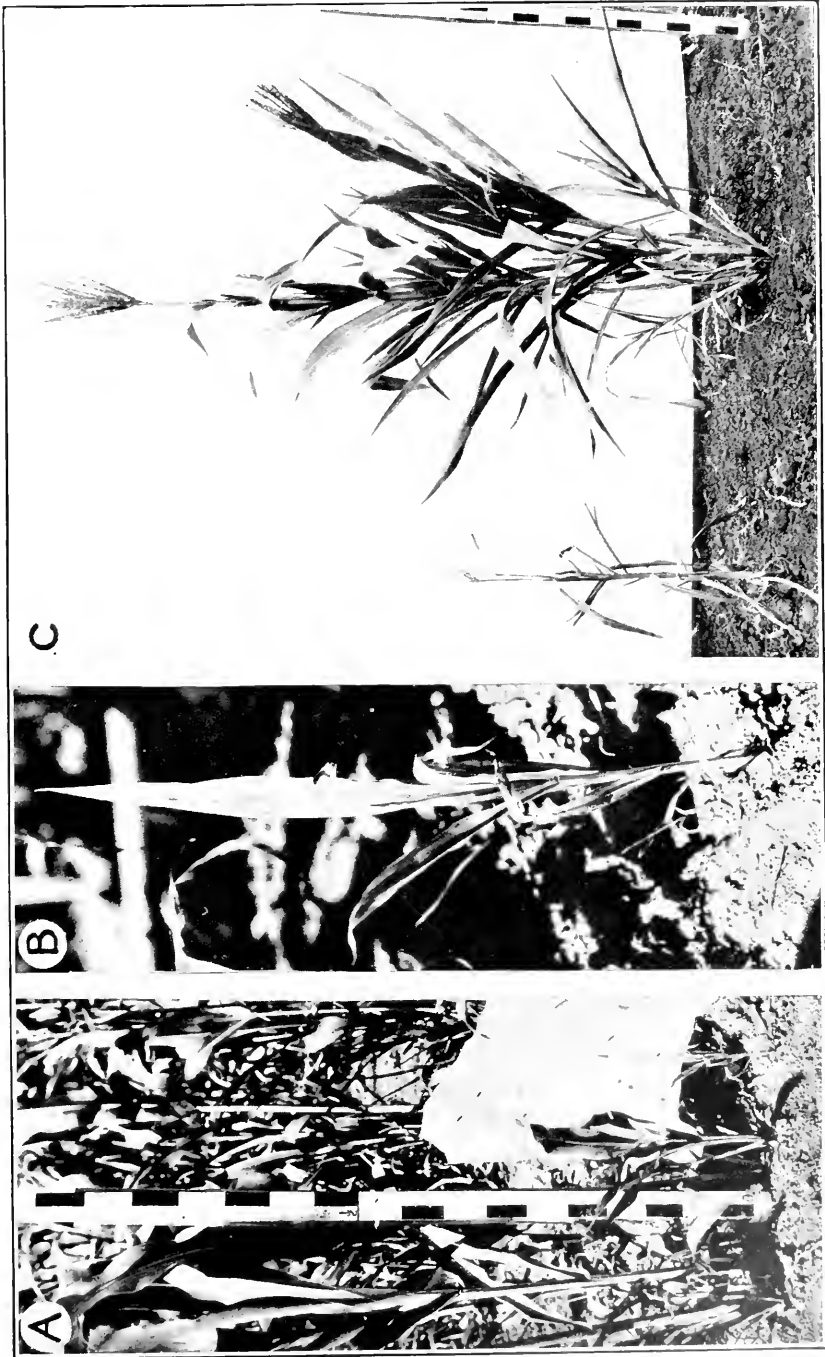

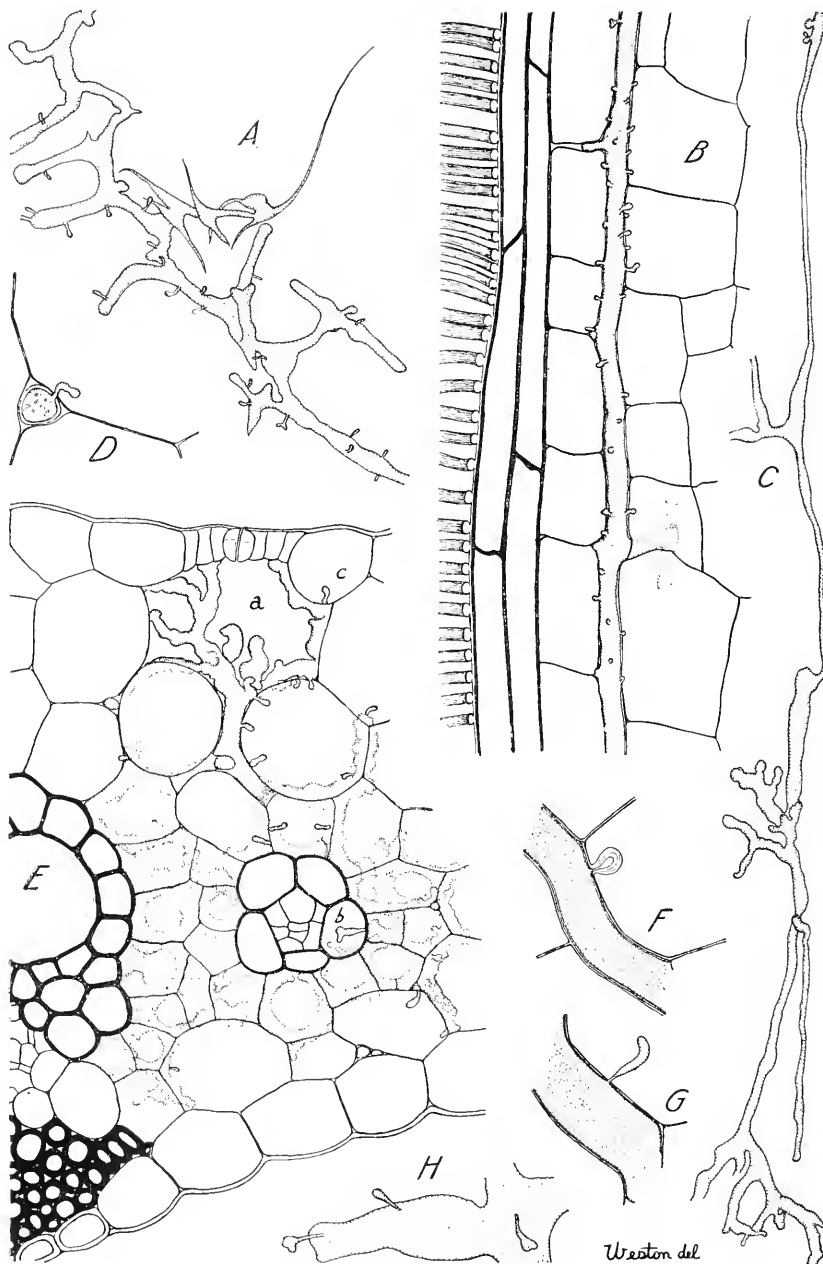

PLATE 23¹

A.—Portion of the typical crooked, irregular mycelium with numerous haustoria which is found in the mesophyll of badly infected leaves, here freed from the host tissue by maceration. × 375.

B.—Longitudinal section cut from the center of a maize stem 8 inches from the ground. The plant, over 5 feet in height, was just putting out its tassel and had recently shown markings of the disease on its four uppermost leaves. A strand of the mycelium can be seen running alongside the bundle between cells of the bundle sheath which are penetrated by numerous haustoria. × 375.

C.—Portion of the mycelium freed by maceration from tissue of the midrib at the base of a badly infected leaf. × 375.

D.—Hypha cut in cross section as it lies between three adjacent mesophyll cells of the host. The penetration of a characteristic haustorium into one of the host cells is shown. × 850.

E.—Transverse section from a badly infected portion of a maize leaf, showing the abundant mycelium running between the cells of the bundle sheath and forming in the substomatal air chamber the branches (*a*) that grow out through the stoma to form the conidiophores. The haustoria are seen penetrating not only the mesophyll cells but also a cell of the xylem (*b*) and the epidermis (*c*). × 375.

F.—Portion of a hypha lying between adjacent mesophyll cells, one of which has formed a many-layered wall around the haustorium invading it. × 850.

G.—Portion of a hypha similar to that shown in F but with the haustorium unhindered in its invasion of the host cell. × 850.

H.—Bit of mycelium such as is shown in A but more highly magnified to show the haustoria. × 850.

¹ The drawings were made with the aid of a camera lucida and are all from preserved material of maize.

PLATE 24¹

A.—Slender, sparingly branched conidiophore bearing comparatively few conidia. It is only partially matured, as can be seen from the small size and rotund shape of the conidia and from the incomplete development of the septum. From maize during heavy dew. $\times 375$.

B.—Tip of branch with two conidia *in situ*. Treated with osmic acid and stained, thus differentiating the two sterigmata as more hyaline than the branch tip. $\times 750$.

C.—Stout, much-branched, mature conidiophore bearing 38 spores. From maize during heavy dew. $\times 375$.

D.—Upper portion of a nearly mature conidiophore with one secondary branch which has failed to branch further and has terminated in a single conidium only. $\times 375$.

E.—Small, stunted, sparingly branched conidiophore produced on maize during the light dew of the hot, dry season. Note the poorly formed cell and the small size and restricted development of the conidiophore as a whole in comparison with those formed in heavy dew, as shown in A and C. $\times 375$.

F.—Basal cell with two thick crosswalls; From maize. $\times 375$.

G.—An unusual basal cell with two septa and an abnormally large footlike base. $\times 375$.

H, J, L.—Typical basal cells of conidiophores. $\times 375$.

I.—Upper portion of an underdeveloped conidiophore bearing three spores on sterigmata arising directly from the top of the main axis. $\times 375$.

K.—Tip of an ultimate branch with two sterigmata bearing conidia. The right conidium is shown as if in optical section, the left in surface view. $\times 850$.

M.—Basal cell of a conidiophore from teosinte with septum formation progressing by the centripetal extension of a cellulose-pectose ring. The footlike projection at the base is abnormally large. $\times 375$.

¹ The drawings were made with the aid of a camera lucida and are from fresh material, with the exception of B, G, K, and M. G, I, and M are from material on teosinte; all other figures are from material on maize.

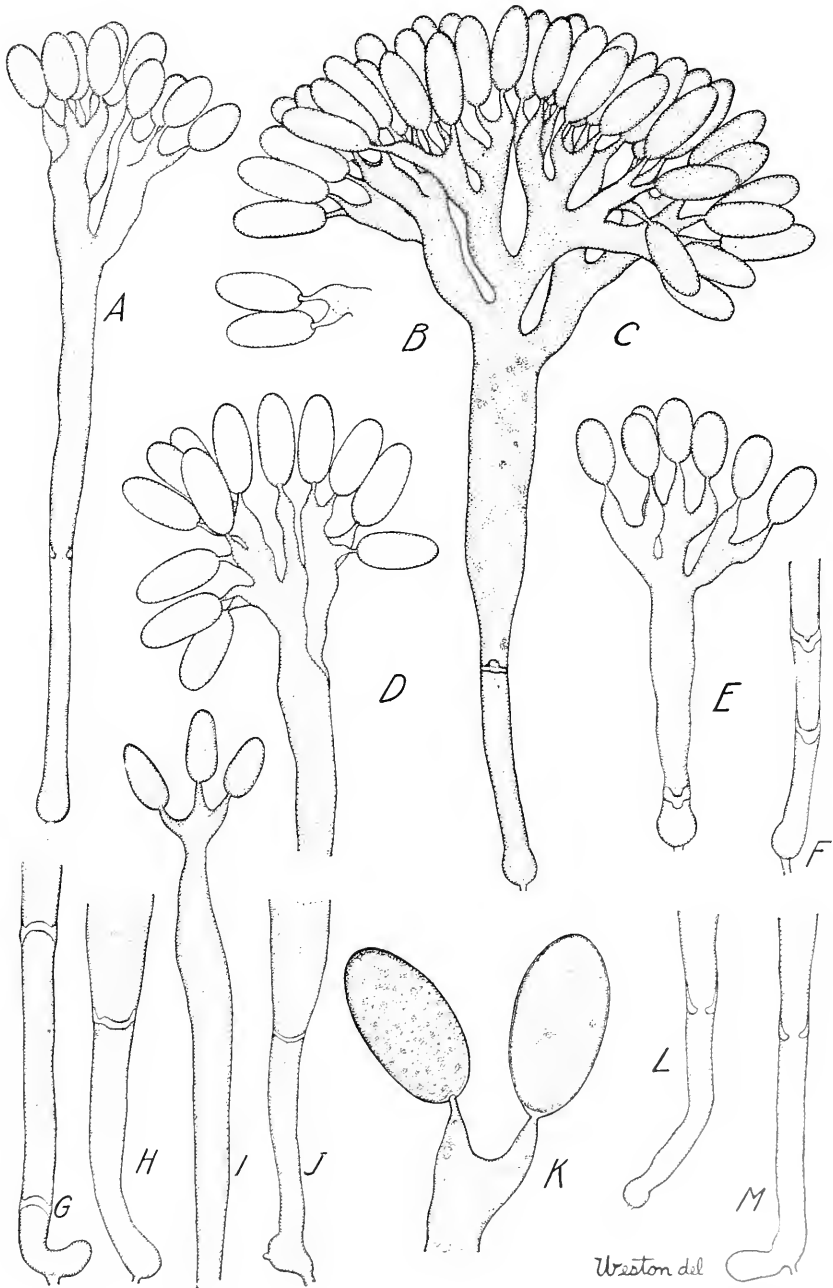

Weston del

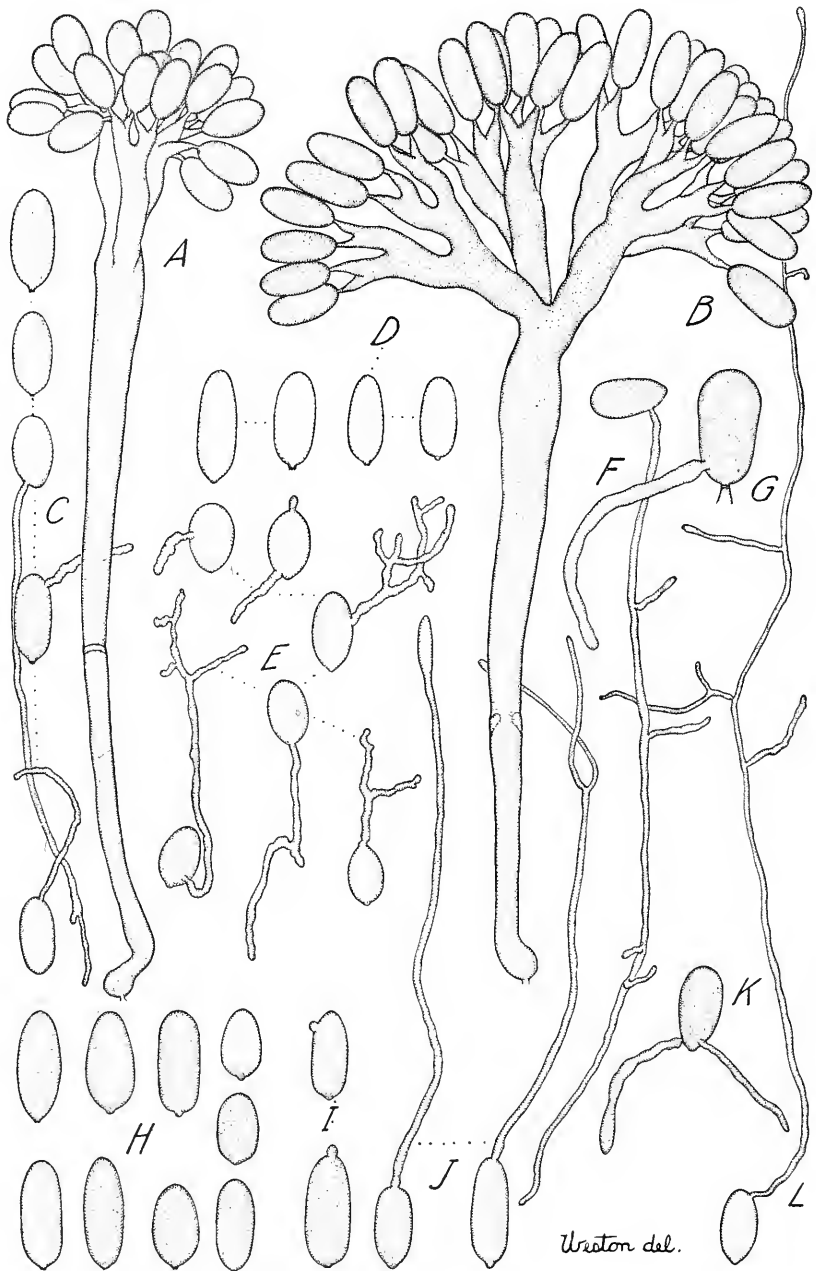

PLATE 25¹

A.—Conidiophore from sorghum, partly matured and bearing few conidia. Compare with Plate 24, A. × 375.

B.—Conidiophore from teosinte, nearly mature, with extensive system of branches bearing many conidia. Compare with Plate 24, C. × 375.

C.—Typical conidia from sorghum. Three are germinating in dew by means of relatively simple hyphae. × 375.

D.—Typical conidia from teosinte. × 375.

E.—Typical conidia from teosinte which have germinated in dew on the leaf surface. × 375.

F.—Conidium from teosinte germinating by an extensive branched hypha when maintained in dew at 7° C. × 375.

G.—Conidium from teosinte germinating while still attached to its sterigma. × 500.

H.—Typical conidia from maize, showing common variations in shape and size. × 375.

I.—Two conidia from maize just beginning to germinate in rain water. × 375.

J.—Two conidia from maize germinating in sterilized brook water maintained at 8° C. × 375.

K.—Conidium from maize germinating in dew on the leaf surface. × 375.

L.—Conidium from maize giving rise to extensive branching hyphae in a dilute decoction of young maize kernels. × 375.

¹The drawings were made with the aid of a camera lucida and are all from fresh material with the exception of A and G.

EFFECT OF DRUGS ON MILK AND FAT PRODUCTION

By FRANK A. HAYS, *Associate*, and MERTON G. THOMAS,

Assistant in Animal Husbandry, Delaware Agricultural Experiment Station

The opinion that milk production and butter-fat yield can be influenced by the use of drugs is widespread among dairymen. Many have their own opinions on this question, and some prominent feeders have been accused of "drugging" test cows. Three of our advanced registry associations now prohibit the use of all drugs during the official test period.

Marshall¹ states that some drugs and feeds are said to increase the milk and butter-fat yield. Friedberger and Fröhner² inform us that a number of galactogogues have always been recommended together with a liberal supply of feed largely fluid in character. They mention preparations of antimony, sulphur, chlorate of potash, fennel, juniper berries, caraway seed, aniseed, dill, and common salt. These writers recommend the "milk powder" used as drug No. 5 in the experiment reported below.

The value of an experimental test of different drugs lies not in the fact that it might make possible some abnormal test records in the hands of the unscrupulous but in the fact that it will furnish some information on the relation of feed components to the complex physiological processes of milk secretion.

PREVIOUS WORK

Henderson³ reports the effects of using six different drugs as galactogogues. Each drug was used on 10 cows, and the period of treatment was either two days or one week, with a control period of equal length either before or after treatment.

Henderson summarizes his results as follows:

1. With sodium bi-carbonate the cows increased the milk yield but neither the fat production nor the per cent. of fat in the milk.
2. With ginger the cows increased the per cent. of fat in the milk but decreased the milk yield and total fat production.
3. With pilocarpine hydrochlor injected into the cows hypodermically in most cases the cows increased both the per cent. of fat in the milk and total milk production.
4. With malt extract the cows in most cases appeared to increase the milk and butter fat production, but it had no effect upon the per cent. of fat in the milk.
5. Neither gentian nor powdered nux vomica had any effect either on the milk production or on the quality of the milk.
6. When grain alcohol was applied to the udder just previous to milking, no effect on the milk production or per cent. of fat in the milk was noted.

¹ MARSHALL, Francis H. A. THE PHYSIOLOGY OF REPRODUCTION . . . p. 566. London, 1910.

² FRIEDBERGER, Franz, and FRÖHNER, Eugen. VETERINARY PATHOLOGY. Translated by M. H. Hayes. ed. 6, v. 1, p. 396-397. London, Chicago, 1908.

³ HENDERSON, Harry Oran. A STUDY OF FORCED FEEDING AND METHODS USED IN ADVANCED REGISTRY FEEDING. In Penn. Agr. Exp. Sta. Ann. Rpt. 1915/16, p. 393-410. 1918.

McCandlish¹ reports two series of trials with galactogoges. In the first series one cow was used and in the second there were three. The experimental period covered two days in each series, with a control period of two to four days following.

Results as given by McCandlish may be summarized as follows:

1. On the whole, alcohol depressed rather than stimulated milk and butter fat production.
2. Castor oil decreased the percentage of fat in milk, but the changes in milk yield were not appreciable.
3. Pituitarin treatment resulted in decreased milk and butter-fat yield.
4. Administration of pilocarpine and physostigmine resulted in an increased fat yield in the first series. One of the cows in the second series showed an increased fat yield, while the other two showed a decrease in milk yield.
5. The effect of aloes was greatly reduced milk yield and a fat yield somewhat reduced, but the averages show little change.
6. A mixture of epsom salts, common salt, and nux vomica showed only slight effect on milk and fat yield.

THE EXPERIMENT²

The experiment was begun April 14, 1919, and closed July 11, 1919. The objects of the experiments were:

1. To determine the effect of various drugs on the butter-fat test of milking cows.
2. To study the effect on the total fat yield of producing cows.
3. To determine whether drugs have an effect on the health or on total milk production.

METHOD

Four cows of mature age were chosen as experimental animals. No. 1 was a grade Holstein, No. 2 was a pure-bred Holstein, and No. 3 and 4 were pure-bred Guernseys. The interval of experimentation with each drug was five days. A control period of five days preceded all experimental periods, except the first five days of the experiment. Each of the four cows received a different drug for a 5-day period. This was followed by a 5-day control period during which no drugs were given. At the end of this period the drugs were shifted so that each cow received a different drug from the one previously given. Thus the control and experimental periods alternated, and the order in which the drugs were given was so arranged that each cow received each of the eight drugs for a 5-day period.

The cows experimented upon were milked twice daily, the weight of milk was recorded, and composite samples of the milk from each cow were tested for butter fat daily.

Drug mixture No. 1 was recommended to us by a prominent dairyman. The mixture No. 5 is one recommended by Friedberger and

¹ McCANDLISH, Andrew C. THE POSSIBILITY OF INCREASING MILK AND BUTTERFAT PRODUCTION BY THE ADMINISTRATION OF DRUGS. *In Jour. Dairy Sci.*, v. 1, no. 6, p. 475-486. 1918.

² Credit is due Dr. C. C. Palmer for administering drug No. 6 hypodermically.

Fröhner.¹ All the drugs except No. 6 were given mixed with the grain feed twice daily.

DRUGS USED

1. Food tonic consisting of 100 pounds oil meal, 5 pounds saltpeter, 5 pounds epsom salts, 5 pounds gentian, 5 pounds fenugreek, 8 pounds powdered charcoal, and 5 pounds sulphur, fed at the rate of 2 ounces daily per cow in two feeds.

2. Air-slaked lime, fed at the rate of 2 ounces daily per cow in two feeds.

3. Fowler's solution of arsenic, fed at the rate of 2 fluid ounces daily per cow in two feeds.

4. Gentian fed at the rate of 2 ounces daily per cow in two feeds.

5. Tonic mixture consisting of the following: 3 ounces black sulphid of antimony; 1½ ounces sulphur; 5 ounces each of fennel, caraway, and juniper berries, 1 pound common salt, fed at the rate of 2 ounces daily per cow in two feeds.

6. One gr. physostigmine sulphate injected hypodermically daily per cow, ½ grain in two doses.

7. Sodium bicarbonate, fed at the rate of 2 ounces daily per cow in two feeds.

8. Ginger, fed at the rate of 2 ounces daily per cow in two feeds.

EXPERIMENTAL RESULTS

Figures 1 to 8 present graphically the individual milk and butter-fat yield of each cow. A solid line is used for the control period and a dotted line for the experimental period.

Figure 1 shows the results of the tonic mixture. There was a slight increase in fat for the pure-bred Holstein and for one of the Guernseys, but the other cows showed no perceptible change. The milk yield was slightly increased for one Guernsey and slightly decreased for the other three cows.

Figure 2 shows that air-slaked lime increased the fat yield in two cases and the milk yield in two cases.

Figure 3 shows that when Fowler's solution of arsenic was used, two cows increased in fat production and three in milk production.

Figure 4 indicates that powdered gentian has a tendency to increase fat yield slightly but has little effect on milk production.

Figure 5 shows that the German tonic mixture did not increase either fat or milk production.

Figure 6 seems to indicate that physostigmine sulphate has a depressing effect on both milk and fat yield.

Figure 7 unfortunately shows the fat record for only three cows. There is no indication of any appreciable effect of sodium bicarbonate on production

¹ FRIEDBERGER, FRAUJ, and FRÖHNER, Eugen. *OP. CIT.*

Figure 8 indicates that cows fed ginger begin to decline in production about the second or third day.

Table I gives a summary of results, showing the average of the four cows in total milk and total butter fat and the average test as obtained by dividing the fat yield by the milk yield given in the table.

TABLE I.—Effect of drugs on milk yield, fat test, and fat yield during 5-day period

Drugs used.	Average total milk.			Fat test.			Average total butter fat.		
	Control.	Treated.	Gain or loss.	Control.	Treated.	Gain or loss.	Control.	Treated.	Gain or loss.
Food tonic No. 1.....	Pounds.	Pounds.	Pounds.	Per ct.	Per ct.	Per ct.	Pounds.	Pounds.	Pounds.
Air-slaked lime.....	92.2	93.7	+ 1.5	4.37	4.57	+0.20	3.998	4.285	+0.287
Fowler's solution of arsenic.....	67.3	81.9	+14.6	5.21	5.00	- .21	3.599	4.095	+ .596
Gentian.....	107.3	109.0	+ 1.7	3.72	3.86	+ .14	3.995	4.210	+ .215
German tonic mixture.....	113.5	108.2	- 5.3	3.93	3.98	+ .05	4.459	4.302	- .157
Physostigmine sulphate.....	108.3	108.0	- .3	3.97	3.75	- .22	4.295	4.049	- .246
Sodium bicarbonate.....	108.7	99.9	- 8.8	3.89	3.60	- .29	4.226	3.706	- .520
Ginger.....	93.1	90.8	+ 2.3	4.43	4.43	+ .00	4.132	4.020	- .112
	92.5	93.8	+ 1.3	4.28	4.32	+ .04	3.968	4.055	+ .087

Drugs 1, 2, 3, and 8 slightly increased the milk yield, but this increase is insignificant except when air-slaked lime was fed. The increase of 21.7 per cent for the air-slaked lime group we think is significant. Gentian and physostigmine sulphate seem to depress the milk yield, and the German tonic mixture No. 5, and sodium bicarbonate have but little effect.

The fat test was appreciably increased by tonic No. 1, by lime, and by Fowler's solution. There was significant decline in fat test shown by the groups fed the German tonic mixture and physostigmine sulphate.

Average total butter-fat production was probably significantly increased by air-slaked lime. Food tonic No. 1 and Fowler's solution show increase of 0.28 and 0.21 pound, respectively, in fat for the 5-day period. A decline of 0.52 pound is shown by the physostigmine sulphate group. The decline in other groups is not considered significant.

No difficulty was encountered in getting the cows to take any of the drugs, and no effect on their physical condition was observed.

SUMMARY

(1) A study of individual records and average records does not indicate that drugs have a very pronounced effect on the production of the dairy cow.

(2) Air-slaked lime fed in 2-ounce doses daily may possibly increase milk production and total fat yield.

(3) No other drug or mixture tested proved to be of value to increase production.

(4) Results do not indicate that the difference in character of milk of Holstein and Guernsey cows has any relation to their manner of reaction to drugs.

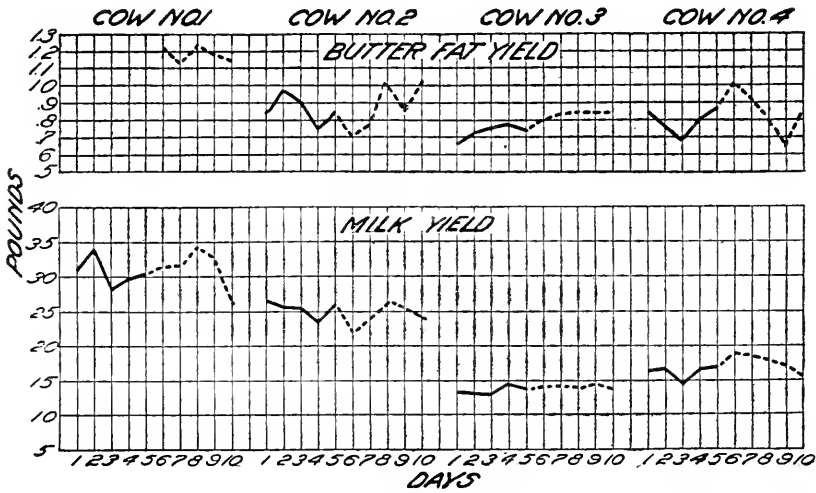

FIG. 1.—Graph showing effect of tonic mixture No. 1 on butter-fat and milk yield.

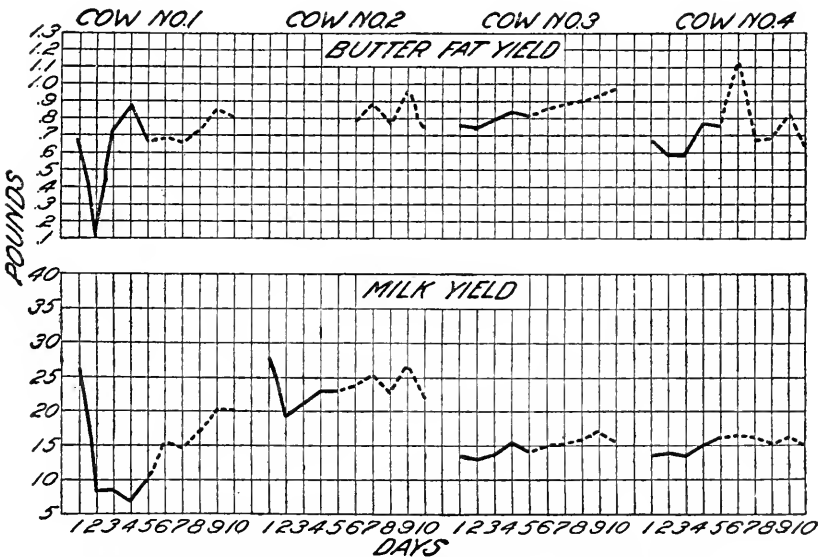

FIG. 2.—Graph showing effect of air-slaked lime on butter-fat and milk yield.

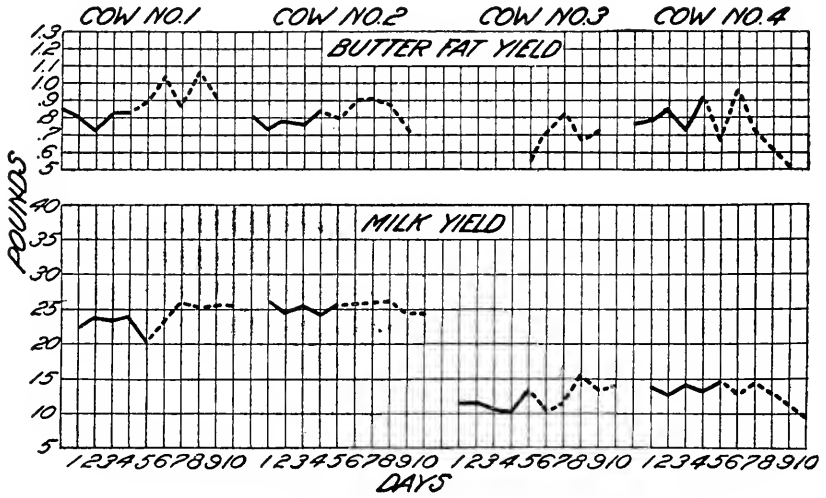

FIG. 3.—Graph showing effect of Fowler's solution of arsenic on butter-fat and milk yield.

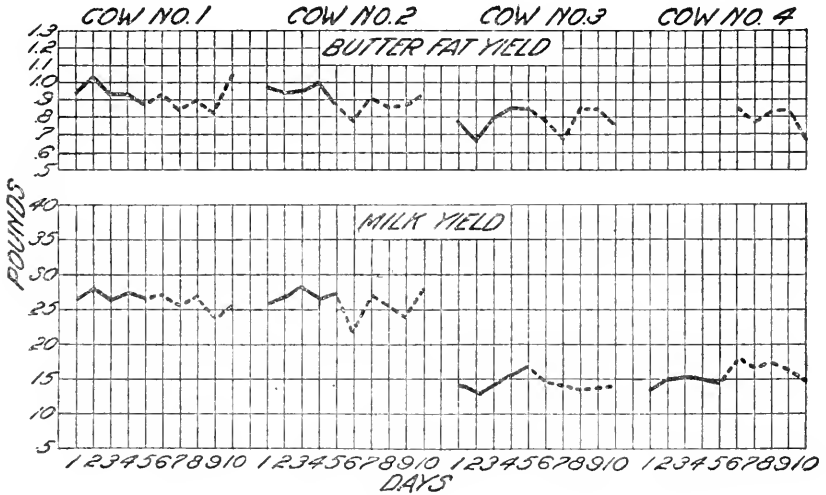

FIG. 4.—Graph showing effect of powdered gentian on butter-fat and milk yield.

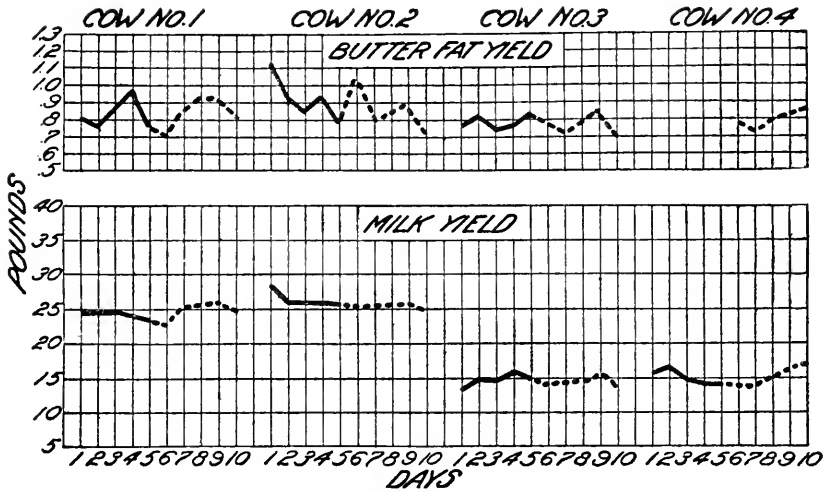

FIG. 5.—Graph showing effect of the German tonic mixture on butter-fat and milk yield.

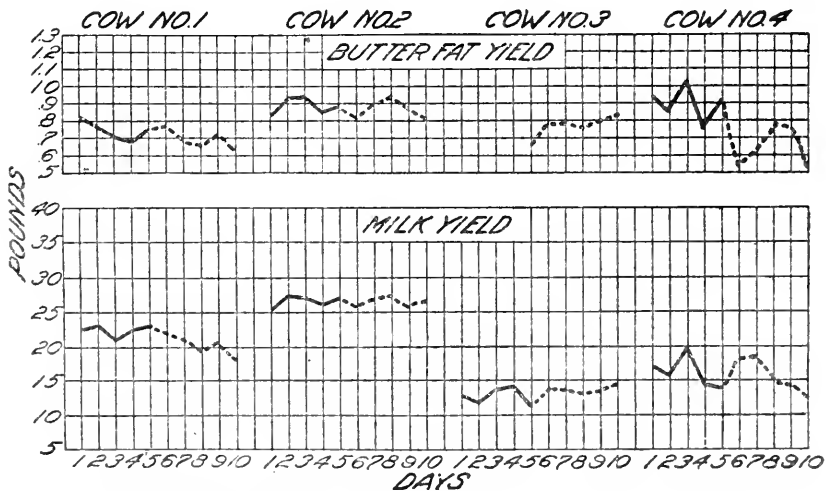

FIG. 6.—Graph showing effect of physostigmine sulphate on butter-fat and milk yield.

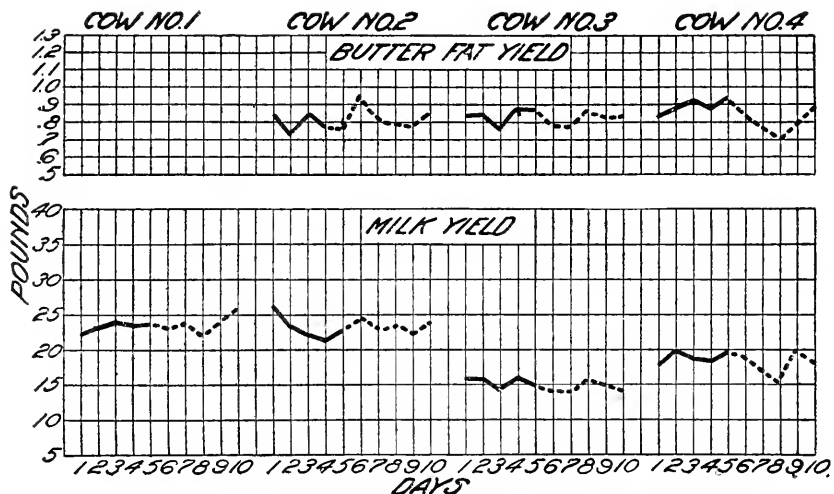

FIG. 7.—Graph showing effect of sodium bicarbonate on butter-fat and milk yield.

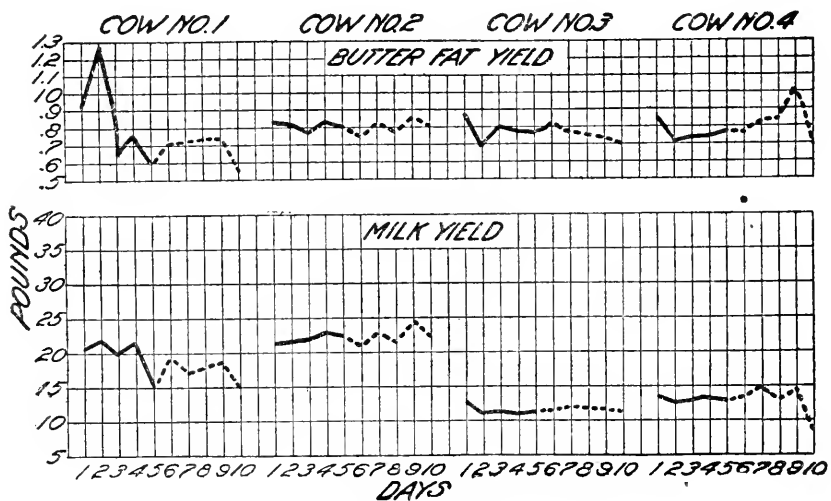

FIG. 8.—Graph showing effect of ginger on butter-fat and milk yield.

ARTIFICIAL AND INSECT TRANSMISSION OF SUGAR-CANE MOSAIC

By E. W. BRANDES

Pathologist, Office of Sugar-Plant Investigations, Bureau of Plant Industry, United States Department of Agriculture

The infectious nature of sugar-cane mosaic can hardly be questioned in the light of field observations bearing out this point made in Georgia and Florida last year and in Porto Rico during the preceding two years (1)¹. Records of well-controlled inoculation experiments, however, have been wholly lacking. A number of investigators, beginning with the Dutch workers in Java, have attempted to produce the disease by artificial inoculation and by the use of suspected insect carriers; but in all cases results have been negative or inconclusive. Where success has been reported the experiments were carried on under unsatisfactory conditions, and the results were repudiated by contemporaneous workers who attempted to repeat the experiments. Kamerling (3) in 1902 reports that he secured infection by inoculating healthy plants with sap from diseased plants. He says (in translation):

So far as the kind of disease is concerned, we are dealing with a disease analogous to the notorious mosaic of tobacco, that is, with an infectious disease, which, however, in all probability is not caused by a parasitic organism.

As is the case with tobacco mosaic, the disease has been successfully transmitted by inoculating healthy plants with juice pressed out of diseased plants. (Footnote: My inoculations with juice of diseased cane were performed in the same way as the inoculation tests of Beijerinck with juice of tobacco plants affected with mosaic.)

These inoculation tests, however, throw little light on the manner of origin and of dissemination in nature.

One very great difficulty in carrying out tests on the way in which the disease originates and is disseminated in nature is in securing cuttings that do not have a predisposition toward the disease. From the best possible selected Moga cuttings a certain number of check plants in my pot cultures showed stripe disease; and I have had a similar experience with specially selected cuttings from Van Delden in Soekaboemi, which in Koenigen produced a crop practically free from disease.

This vague reference to his experiments and his admission of disease in the control plants was not very convincing and was discredited by later Dutch investigators. Kobus (4), van der Stok (6), and Wilbrink and Ledebøer (7) were unable to produce the disease by using the method of Kamerling. Wilbrink and Ledebøer say (in translation):

So sudden a severe outbreak as Kobus already observed gives rise to the suspicion that we are perhaps dealing with an infectious disease, as is the case, for example, with the mosaic disease of tobacco, analogous to the stripe disease in very many respects. Dr. Kamerling states in the Annual Report of the Experiment Station of Kagok for

¹ Reference is made by number (italic) to "Literature cited," p. 138.

1902 that he succeeded in inoculating healthy plants with the disease by injecting sap from diseased plants. We have repeated these inoculation experiments as far as we have been able to obtain data about them, but without success. Neither have we been able to find any other indication that the disease is contagious.

They conclude with Kobus and van der Stok that the mosaic is an expression of bud variation. No reference is made to successful inoculation experiments in the numerous papers on mosaic in the Hawaiian Sugar Planters' Record for 1911-1919. Stevenson (5) reports hundreds of inoculations of many cane varieties by various methods during 1917 and 1918, all with negative results. Prof. F. S. Earle, in an unpublished paper, calls attention to a method of inoculating with juice expressed under oil to prevent oxidation. Some of the plants he inoculated became diseased, but the experiment was inconclusive and open to the criticism that it was carried on without control plants in a field where cases of the disease were appearing naturally.

Various writers have called attention to the possibility of insect carriers of the mosaic disease, but no published proof has appeared, and the statements have been based on analogy with other apparently similar diseases and on field observations. The failure of all efforts to obtain uniform or dependable results with either artificial methods of inoculation or with insects has been one of the conspicuous peculiarities in the behavior of sugar-cane mosaic. In all inoculation work in plant pathology it is necessary to secure a very high percentage of infection in inoculated plants where control plants are not absolutely protected from extraneous infection. In diseases like cane mosaic, where, for reasons which we are not in a position to discuss at present, the percentage of infection resulting from experimental inoculation is not high, it is not only necessary that all experimental plants be apparently healthy but also that they be of known healthy parentage for at least one generation back and preferably more. Further than this, the experiments should be performed under absolutely controlled conditions. The prevention of contamination of experimental plants with diseased material by direct or indirect contact must be absolute. Special precautions must be taken to prevent the admittance to treated plants of insects or any other animals other than the ones being experimented with.

The writer became convinced, after observations and experiments with the mosaic disease dating from the summer of 1916, that more reliance can be placed on the results of experiments performed in some region far removed from any chance of accidental infection. It was owing to these considerations that the experiments recorded here were performed at a distance from the seat of any natural infection, because the required conditions would be practically impossible to obtain where the disease is prevalent.

The first experiments were conducted in a quarantine greenhouse near Garrett Park, Md. Later experiments were made in several green-

houses at Washington. The insects used were those at hand which were known to feed on sugar cane. Provision has been made by cooperation with the Bureau of Entomology to collect information leading to the identification of the particular insect or insects responsible for secondary infections in the infested cane regions. Mr. George N. Wolcott, of the Bureau of Entomology, is at present working on that phase of the problem in Porto Rico.

EXPERIMENTS AT GARRETT PARK, MD.¹

Seed pieces from diseased parent stock were received from time to time during 1918 and 1919 and planted in the greenhouse, which was screened with physician's cloth so that insects could not escape. On August 10, 1918, a shipment of diseased *Crystalina* cane from Ensenada, P. R., was planted. Yellow Bantam sweetcorn and Sugar Drip, Early Amber, and Japanese Ribbon sorghum were planted August 13, 1918, in the same greenhouse. On September 24, 1918, a shipment of diseased Rayada cane from Rio Piedras, P. R., was planted. Diseased seed pieces of Morado, Yellow Caledonia, *Crystalina*, and Rayada varieties from Arecibo, P. R., were planted on April 24, 1919. Similar pieces of Selangore, D.-117, and Rayada from Mayaguez, P. R., were planted on April 25, 1919. Lastly a shipment from Yauco, P. R., containing diseased seed pieces of G. C.-701, G. C.-1486, B.-3922, B.-6450, and P. R.-260 were planted May 1, 1919.

Through the kindness of Dr. Erwin F. Smith, cuttings of Lahaina cane were secured from plants which had been growing in one of his greenhouses at Washington for more than six years and showed absolutely no signs of mosaic. These cuttings were planted in pots in a third greenhouse at Washington on December 10, 1918. All the cane, diseased and healthy, sprouted and grew well. All cuttings from diseased parents produced mottled sprouts, without exception, and all cuttings from Dr. Smith's healthy cane produced in great contrast healthy plants with leaves of uniform dark green color.

EXPERIMENT 1.—This was a preliminary experiment to determine whether infection could take place by natural means, merely by exposing healthy plants in the same greenhouse with diseased plants. On May 10, 1919, 5 healthy cane plants, 5 months old, in pots were taken from the greenhouse in Washington and placed in the quarantine greenhouse at Garrett Park, Md., in such a way that the leaves did not come in contact with the leaves of diseased plants. At that time the corn aphid (*Aphis maidis*)² was abundant on the sorghum. The wild grasses, a few clumps of which came up as weeds in the greenhouse, were infested with red spiders (*Tetranychus binaculatus*). Both these insects were seen occasionally in the cane. A small leafhopper was also seen but was not captured

¹ Thanks are due Dr. Caroline Rumbold, who was in charge of this work during the writer's absence on trips to the Tropics.

² Identified by Dr. A. C. Baker, of the Bureau of Entomology, United States Department of Agriculture.

and consequently was not determined. On June 3, 1919, all five of the Lahaina cane plants from Dr. Smith's greenhouse showed unmistakable incipient signs of mosaic. Two weeks later all were well-developed cases.

EXPERIMENT 2.—On July 3, 1919, 15 healthy cane plants of the Lahaina variety, 7 months old, were removed from the greenhouse in Washington to the "pesthouse" at Garrett Park. Five were placed within the house unprotected as before, and 5 were placed in each of two insect-proof cages. On July 22, 4 of the exposed plants showed incipient signs of mosaic. On August 2 the remaining plant showed evidence of being infected, and a week later all the exposed plants exhibited well-advanced leaf symptoms. At this time the 10 control plants in cages were perfectly normal and continued so until they were used in another experiment two months later.

EXPERIMENT 3.—Seeds of sweetcorn (Yellow Bantam variety) and sorghum (Sugar Drip, Early Amber, and Japanese Ribbon) were planted on August 13, 1918, in the Garrett Park quarantine greenhouse. They germinated and grew slowly during the winter, then more rapidly in the spring. A number of volunteer grasses that came up as weeds in the greenhouse were allowed to mature. All these plants soon became heavily infested with corn aphid. Sorghum seed from the same lot was planted in a greenhouse at Washington. On May 7, 1919, a few mottled leaves appeared on the sorghum plants at Garrett Park. Examination of the wild grasses revealed the typical streaking and mottling in practically every stool of crabgrass (*Syntherisma sanguinalis*), foxtail (*Chaetochloa lutescens*) and *Panicum dichotomiflorum*. Other wild grasses in the greenhouse were normal. At this time the sorghum control plants in the Washington greenhouse and the wild grasses of the same species outside the greenhouse at Garrett Park showed no signs of mosaic, nor did they show any evidence of mosaic during the remainder of the summer.

EXPERIMENT 4.—On August 7, 1919, about 50 adult individuals of the sharp-headed grain leafhopper (*Draeculacephala molipes*)¹ collected two days previously on mosaic-diseased sugar cane at Audubon Park, New Orleans, La., were placed in a cage with 5 healthy cane plants at the Garrett Park greenhouse. The leafhoppers immediately began feeding on the healthy cane. No infection was evident after two months.

EXPERIMENTS AT WASHINGTON

During September, 1919, nearly all experiments were transferred to greenhouses especially prepared to receive them at Washington. Ventilators of the 2-story greenhouse, formerly used by Dr. Smith for bananas, were screened with physician's cloth; and the diseased cane plants of all varieties were removed to it from Garrett Park. A greenhouse in another range, separated by a roadway from the first, was screened; and

¹ Identified by Mr. T. E. Holloway, Bureau of Entomology, United States Department of Agriculture.

300 healthy Lahaina cane plants, from cuttings supplied by Dr. Smith, were placed therein. These plants were from the same source as the ones previously mentioned. The second greenhouse was divided into halves by a tight glass partition. One compartment was used for propagating healthy stock, and the other compartment was used for artificial inoculation experiments. Both compartments were kept free from insects by frequent fumigation. In the banana house, or "pesthouse" fumigation was not practiced on account of cage experiments with insects. The greatest precautions were taken to prevent accidental infection of plants in the house where healthy stock was growing. This house was invariably the first one visited by the gardener for routine work such as watering, and both houses were kept padlocked at all times. Probably because of this care no single case of mosaic has appeared there or on control plants in either house in any of the experiments.

INOCULATIONS WITH INSECTS

EXPERIMENT 1.—On October 8, 1919, 10 individuals of *Aphis maidis* were transferred with a camel's-hair brush from mosaic sorghum to each of four young healthy cane plants in separate cages. A fifth cage was reserved for two healthy plants as controls. On October 28 all four plants showed incipient signs of mosaic. On November 18 they were all unmistakable, well-advanced cases. The two control plants remained healthy.

EXPERIMENT 2.—On February 2, 1920, 12 to 15 individuals of *Aphis maidis* were lifted from mosaic sorghum and placed on each of three healthy cane plants in separate cages. Two healthy cane plants were placed in a fourth cage for controls. On February 28 two of the treated plants showed signs of mosaic and on March 5 were typical cases. The two control plants remained healthy.

EXPERIMENT 3.—On February 2, 1920, one mosaic sorghum plant infested with *Aphis maidis* was placed in a cage with a healthy cane plant in such a way that the leaves of the two plants intermingled. On March 21 the cane plant showed unmistakable signs of infection.

EXPERIMENT 4.—February 2, 1920, 10 individuals of *Aphis maidis* were lifted from a diseased cane plant of variety G. C.-701 and placed on a healthy cane plant in a cage. No infection was apparent on March 15.

EXPERIMENT 5.—On October 8, 1919, 15 specimens of *Draeculacephala molipes* were placed in each of five cages containing one healthy and one mosaic cane plants. On January 5, 1920, approximately three months later, there was no evidence of infection.

EXPERIMENT 6.—On January 5, 1920, 15 specimens of *Draeculacephala molipes* were placed in each of two cages containing two mosaic sorghum plants and two healthy cane plants. On March 11 there was no sign of infection on any of the cane plants.

EXPERIMENT 7.—On November 20, 1919, two mosaic cane plants of the Rayada variety, infested with the sugar-cane mealy bug (*Pseudococcus boninensis* (Kuw.),¹ were placed in each of two cages, together with two healthy cane plants of the Lahaina variety. A few of the mealy bugs were transferred from diseased plants to all healthy plants. Ants were assiduously tending the mealy bugs. On March 11, 1920, all healthy plants were badly infested with mealy bugs but there was no mosaic infection.

ARTIFICIAL INOCULATIONS

Virus was obtained for artificial inoculation by two methods. Cell sap from young leaves, designated as virus No. 1, was obtained by grinding the young, tightly rolled leaves of diseased Rayada cane in a food chopper and straining through several thicknesses of cheesecloth. It was used undiluted for inoculating immediately after being prepared. Virus No. 2 consisted of cane juice from the youngest joints, including the growing point. To prevent oxidation this was pressed out under a mineral oil (Nujol) in a specially designed press (2). This also was used undiluted as soon as it was prepared. Inoculations were made in the compartment of the fumigated greenhouse separated from all diseased material and protected by every means from accidental infection. The results of these inoculations are given in Tables I and II.

In addition to the control plants injured with a sterile needle, there were about 100 other healthy plants of the Lahaina variety in the compartment. No case of mosaic developed among these plants.

TABLE I.—Effect of artificial inoculation of Lahaina cane with triturated young leaves (virus No. 1)

[Plants inoculated Jan. 8, 1920]

Number of plants.	Treatment.	Results.
10.	Virus rubbed on unbroken surface of young leaves with fingers.	All healthy Mar. 21.
10.	Youngest leaves inoculated by numerous needle pricks.	One mosaic Mar. 21.
5.	Control plants pricked with sterile needle.	All healthy Mar. 21.
10.	Epidermal layer of young leaf cells scarified with sharp needle dipped in virus.	Do.
5.	Control plants scarified with sterile needle.	Do.
10.	Young leaves scarified as above and virus rubbed in vigorously with the fingers.	Do.
10.	Inoculated by injecting $\frac{1}{2}$ cc. of virus into growing point with hypodermic syringe.	Two mosaic Feb. 14; eight healthy Mar. 21.
5.	Control plants punctured at growing point with sterile needle.	All healthy Mar. 21.

¹ Identified by Mr. Harold Morrison, of the Bureau of Entomology, United States Department of Agriculture.

TABLE II.—Effect of artificial inoculation of Lahaina cane with juice from cane unoxidized (virus No. 2)

[Plants inoculated Jan. 7, 1920]

Number of plants.	Treatment.	Results.
10.....	Virus rubbed on unbroken surface of young leaves with fingers.	All healthy Mar. 21.
10.....	Youngest leaves inoculated by numerous needle pricks.	Do.
5.....	Control plants pricked with sterile needle.....	Do.
10.....	Epidermal layer of young leaf cells scarified with sharp needle dipped in virus.	Do.
5.....	Control plants scarified with sterile needle.....	Do.
10.....	Young leaves scarified as above and virus rubbed in vigorously with fingers.	Do.
10.....	Inoculated by injecting 1/2 cc. of virus into growing point with hypodermic syringe.	Eight mosaic Feb. 6 to 14.
5.....	Control plants punctured at growing point with sterile needle.	All healthy Mar. 21.

DISCUSSION

From the foregoing results it may be inferred that the sugar-cane mosaic virus is highly infectious only when exacting demands in the matter of favorable conditions are satisfied. Erratic spreading under natural conditions in the field also indicates the necessity for special conditions, which are not as yet known. It is considered as proved, however, that the cell sap of diseased plants is infectious when introduced in the proper manner and that the disease can be transmitted by insects. Just what insects are responsible for dissemination in the cane regions remains to be proved. The failure of the sharp-headed grain leafhopper to transmit the disease under the conditions of these experiments is surprising. This insect is very common on cane in Louisiana, and as a result of field observations suspicion was directed toward it from the first. Other leafhoppers are now being tested. The successful experiments with the corn aphid is of great interest scientifically, but it is not believed that transmission of mosaic is restricted to this insect or to other aphids more abundant on cane. *Aphis maidis*, however, has been reported on sugar cane from practically every sugar-cane region in the world.

That cane mosaic is analogous with other mosaic diseases is brought out by a number of facts, aside from the visible signs of the disease. As in many other mosaics, the infectious material does not seem to be highly specialized, but may attack other plants of the same family. The cell sap of infected plants contains some organism, not visible by ordinary means, which is capable of inducing the disease when injected into healthy plants. Leaves which are mature at the time of inoculation never show any signs of mosaic. This fact, typical of all mosaics, has been brought

out in all inoculation experiments with sugar cane. The disease can be transmitted by certain sucking insects. There is no known period of saprogenesis in the existence of the virus. Seed transmission of the virus is one of the phenomena concerning which divergent results have been recorded for the various mosaic diseases. This point has not been definitely settled for sugar-cane mosaic, but mosaic sorghum plants failed to produce mosaic progeny in two experiments.

LITERATURE CITED

- (1) BRANDES, E. W.
1919. THE MOSAIC DISEASE OF SUGAR CANE AND OTHER GRASSES. *In* U. S. Dept. Agr. Bul. 829, 26 p., 5 fig., 1 col. pl.
- (2) CLARK, W. Blair.
1917. A SAMPLING PRESS. *In* Jour. Indus. and Engin. Chem., v. 9, no. 8, p. 788.
- (3) KAMERLING, Z.
1903. DE GELE STREPENZIEKTE DER BLADEREN. *In* Verslag 1902 Proefsta. Suikerriet West Java "Kakok" to Pekalongan, p. 76-81.
- (4) KOBUS, J. D.
1908. VERGELIJKENDE PROEVEN OMTRENT GELE-STREPENZIEKTE. *In* Arch. Java-Suikerindus., jaarg. 16, p. 350-374. Reprinted as Meded. Proefsta. Javasuikerindus., no. 12, p. 319-342.
- (5) STEVENSON, John A.
1919. THE MOTTLING OR YELLOW STRIPE DISEASE OF SUGAR-CANE. *In* Jour. Dept. Agr. and Labor Porto Rico, v. 4 (i. e. 3), no. 3, p. 3-76, illus., 3 col. pl. Literature cited, p. 73-76.
- (6) STOK, J. E. VAN DER.
1907. VERSCHIJNSELEN VAN TUSSCHENRASVARIABILITEIT BIJ HET SUIKERRIET. (PROEVE EENER VERKLARING DER GELE-STREPENZIEKTE EN DER SEREHZIEKTE.) *In* Arch. Java Suikerindus., jaarg. 15, p. 581-601. Reprinted as Meded. Proefsta. Oost-Java, s. 4, no. 36, p. 457-477.
- (7) WILBRINK, G., and LEDEBOER, F.
1910. BIJDRAGE TOT DE KENNIS DER GELE STREPENZIEKTE. *In* Arch. Suikerindus. Nederl. Indië, jaarg. 18, p. 465-518. Reprinted as Meded. Proefsta. Java-Suikerindus., deel 2, no. 39, p. 443-495, 5 pl. (4 col.).

JOURNAL OF AGRICULTURAL RESEARCH

CONTENTS

Halo-Blight of Oats - - - - - Page 139

CHARLOTTE ELLIOTT

(Contribution from Bureau of Plant Industry)

Influence of Fermentation on the Starch Content of Experimental Silage - - - - - 173

ARTHUR W. DOX and LESTER YODER

(Contribution from Iowa Agricultural Experiment Station)

Effect of Premature Freezing on Composition of Wheat - 181

M. J. BLISH

(Contribution from Montana Agricultural Experiment Station)

PUBLISHED BY AUTHORITY OF THE SECRETARY OF AGRICULTURE,
WITH THE COOPERATION OF THE ASSOCIATION OF
LAND-GRANT COLLEGES

WASHINGTON, D. C.

**EDITORIAL COMMITTEE OF THE
UNITED STATES DEPARTMENT OF AGRICULTURE AND
THE ASSOCIATION OF LAND-GRANT COLLEGES**

FOR THE DEPARTMENT

KARL F. KELLERMAN, CHAIRMAN

*Physiologist and Associate Chief, Bureau
of Plant Industry*

EDWIN W. ALLEN

Chief, Office of Experiment Stations

CHARLES L. MARLATT

*Entomologist and Assistant Chief, Bureau
of Entomology*

FOR THE ASSOCIATION

J. G. LIPMAN

*Dean, State College of Agriculture, and
Director, New Jersey Agricultural Experi-
ment Station, Rutgers College*

W. A. RILEY

*Entomologist and Chief, Division of Ento-
mology and Economic Zoology, Agricul-
tural Experiment Station of the University
of Minnesota*

R. L. WATTS

*Dean, School of Agriculture, and Director,
Agricultural Experiment Station, The
Pennsylvania State College*

All correspondence regarding articles from the Department of Agriculture should be addressed to Karl F. Kellerman, Journal of Agricultural Research, Washington, D. C.

All correspondence regarding articles from State Experiment Stations should be addressed to J. G. Lipman, New Jersey Agricultural Experiment Station, New Brunswick, N. J.

U. S. DEPARTMENT OF AGRICULTURE
BUREAU OF PLANT INDUSTRY
WASHINGTON, D. C.

JOURNAL OF AGRICULTURAL RESEARCH

VOL. XIX

WASHINGTON, D. C., MAY 15, 1920

No. 4

HALO-BLIGHT OF OATS¹

By CHARLOTTE ELLIOTT

*Scientific Assistant, Laboratory of Plant Pathology, Bureau of Plant Industry,
United States Department of Agriculture*

INTRODUCTION

The present paper is a description and discussion of a bacterial disease of oats which has been the subject of investigation by the writer for the past three years. This "halo-blight" is a disease which occurs to at least some extent each year throughout the oat-growing sections of the central and eastern States and becomes of economic importance during certain seasons when weather conditions are particularly favorable to its development.

During the season of 1918 field observations and specimens of diseased plants from widely separated sections of Wisconsin showed that this disease occurred in practically all the oat fields of the State and was responsible for the abnormal condition prevalent in the early part of that season.

DESCRIPTION OF HALO-BLIGHT LESIONS

The halo-blight is most conspicuous on the leaves (Pl. C; 26), although it may occur on leaf sheaths and glumes (Pl. 29). Typical well-developed lesions of the disease are oval chlorotic spots $\frac{1}{2}$ to 2 cm. or more in diameter about points of infection which consist of gray-brown collapsed tissue measuring from 1 to several millimeters in length. The halolike border is at first only slightly lighter green than the surrounding tissue, but as it becomes older it loses more of its green color and forms oval yellow halos about the central infection areas.

Lesions are first visible as light green oval spots 4 to 5 mm. in diameter with central sunken points of infection at first evident only on one side of the leaf. This center of infection increases slowly in size, penetrates

¹ The greater part of this work was carried on at the University of Wisconsin during 1917 and 1918 under the direction of Prof. L. R. Jones and was continued in the Pathological Laboratory of the United States Department of Agriculture during 1918 and 1919 under the direction of Dr. Erwin F. Smith. The writer also wishes to acknowledge the courtesy of the Boston Branch of the Association of Collegiate Alumnae whose research fellowship she held during the college year of 1917-18.

JUN 16 1920

the leaf tissue, and in a day or two forms a gray or brown dry tissue from 1 to several millimeters in diameter, evident on both sides of the leaf blade. The halolike margin spreads rapidly, becoming uniformly lighter green to yellow or showing concentric markings (Pl. 26) of different shades of green and yellow. Occasionally these halolike margins are prolonged at one end into points (Pl. C) from 1 to several centimeters long. They may extend as yellow streaks through the center or along the margin to the tip of the leaf, but ordinarily they appear as oval spots, measuring 1 cm. or more in diameter. Marginal infections are common, forming crescent-shaped lesions. These halolike lesions are conspicuous and characteristic. Except in the central infection area the tissues remain turgid and have a normal appearance except for the paler yellowish color. There is no water-soaked margin about the halo as described by Wolf and Foster (10)¹ for similar lesions of the wildfire disease of tobacco, and the spots do not fall out of the leaves. Exudate does not occur in connection with the lesions. When several lesions occur on the same leaf they often coalesce and produce a general yellowing followed by a breaking across of leaf blades (Pl. C) or a shriveling and drying of tips and margins. During periods of warm, dry weather yellow haloed leaf tissue loses its turgidity and color and forms oval, gray-brown dead spots which on some leaves have narrow, brown margins and on others narrow, yellow halolike margins. Very rarely the dead tissue may assume a pinkish or reddish brown color. In separate lesions the oval outline of the dead halo persists, and even when the whole leaf becomes dry and brown, the original halo outlines may still be distinguished.

PREVALENCE AND GEOGRAPHICAL DISTRIBUTION

Personal observations in Wisconsin and specimens of diseased plants from Ohio, Illinois, Indiana, Minnesota, Tennessee, California, and Virginia have led to the conclusion that halo-blight is present in oat fields every season, scattered lesions occurring on the lower leaves more or less throughout the season and occasionally attacking the panicles. These lesions on the lower leaves are more or less hidden by the fresher upper leaves and so escape observation. Only under particularly favorable weather conditions does the blight develop sufficiently to attract attention or to do serious damage.

FIELD WORK IN 1918

During the season of 1918 weather conditions favorable to halo-blight prevailed in Wisconsin and parts of adjoining States, causing an unusually severe bacterial blighting. In the experimental plots, halo lesions began to appear on from 1 to 25 per cent of the young plants about the middle of May. By May 25 practically every plant showed

¹ Reference is made by number (italic) to "Literature cited," p. 172.

some spotting. During the last week in May and the first week in June all untreated plots looked yellowed or slightly browned when viewed from a distance. Practically every first leaf and half of the second leaves were yellowed and dead. Many leaves had yellowed, shriveled tips and margins, and single lesions were abundant on the upper leaves of many varieties.

Every field about Madison showed some blighting. Usually the brown, dead leaves were easily seen from the road, and 100 per cent of infection was not at all uncommon. Some fields south of Madison showed distinct yellow spots from a yard to a rod or more in diameter.

One field of oats near Monroe, Wis., visited May 29, was so badly blighted as to show from a distance a general yellowing with scattered patches of more marked yellow. Closer examination showed abundant halo lesions, every plant being infected. About 3 per cent of the plants were yellowed throughout, the outer leaves were water-soaked and dead, and some whole plants were stunted to such an extent that their recovery seemed doubtful. On the remaining 97 per cent of the plants the outer two to three leaves were collapsed and dead, and the others showed scattered halo lesions in varying stages of development. Where the blight was farther advanced the leaves were broken over and the tips shriveled and brown. Other leaves showed typical, conspicuous, isolated halo lesions which were central or marginal, covering one-half to the entire width of the leaf blade. The plants in this field showed no marked reddening. They had been badly beaten by recent driving storms. Two other oat fields in the vicinity showed a normal stand, but the halo-blight was abundant. No plants remained uninfected, but nevertheless none were stunted or entirely yellowed, and chances for recovery were much better than for the field described above. The blight was general throughout the section about Monroe, and the two fields last mentioned probably represented the average. This yellowed condition of oat fields in this section was first evident May 26 and was reported by a number of farmers.

From May 31 to June 2 oat fields were visited by the writer in five counties of southern Wisconsin. More than 130 fields were inspected, and every one showed halo-blight varying in amount from a fraction of 1 per cent to 100 per cent, the latter being much the more common. The amount varied not only in individual fields but also conspicuously in different counties.

In Jefferson County 26 fields were visited. The oats were about half grown. One-fourth of the fields showed only scattered lesions on the lower leaves—an infection of 1 per cent or less. About one-half of the fields showed a general spotting of the lower leaves on from 60 to 100 per cent of the plants. In some cases the infection was in patches from 2 to 6 feet in diameter, where every plant had all but the last one or two leaves badly spotted. A few fields showed general and heavy infection of 100 per cent of the plants. Even the upper leaves were spotted.

The lower leaves were mostly gone, but a general yellowing of the fields was not marked. Only one field was so seriously affected as to show heavy general blighting and large yellow spots 1 to 3 rods across. About 60 per cent infection of the lower leaves was typical for the fields throughout this section.

In Dodge County the halo-blight was much more abundant. Of the 37 fields visited all showed at least 20 per cent infection; 5 showed light infection—spotting of the lower leaves of 20 to 50 per cent of the plants. This infection, however, was evident from the road. Over half of these fields showed heavy infection—60 to 100 per cent—on at least the lower leaves, and yellowed spots in the fields. The plants in these yellowed spots had little normal green leaf area, and as many as 10 per cent of the plants were entirely yellow and stunted. About one-third of the fields showed 100 per cent infection of the lower leaves, the browned tips and margins showing plainly and often giving a brownish tinge to the fields. In two fields the lower two to three leaves were practically dead and the upper leaves so badly spotted as to give a general yellow color to the fields. In all fields visited in Dodge County blight was evident without a close examination and was sufficiently severe to threaten the crop if unfavorable weather conditions continued. New green leaves were just beginning to appear.

In Fond du Lac County, farther north, the plants were smaller—6 to 8 inches high—and the blight was not heavy in most fields. Seven fields showed only traces of blight on lower leaves—1 to 30 per cent. One showed 100 per cent infection on the lower leaves and another heavy infection—100 per cent—and a general yellowing of the field.

In Columbia and Sauk Counties 10 fields showed a normal blue-green color but had 20 to 100 per cent infection on the lower leaves. Ten other fields showed yellow spots or a general yellowing of the fields. This section was second to Dodge County in the amount of bacterial blight.

Reports and specimens of plants from 35 counties in Wisconsin showed that leaf lesions were general throughout the oat-growing sections of the State and that a single disease, the halo-blight, was responsible for the trouble. A similar condition was reported for the oat fields of southern Minnesota, Iowa, northern Illinois, and Indiana.

For several years previous to 1918 this bacterial blight was observed in Wisconsin oat fields, but there was never enough of it to attract particular attention. The cool, cloudy days and frequent rains of the 1918 oat season proved to be just the conditions necessary to favor the development and spread of the disease. The average rainfall for May, 1918, was 6.66 inches, or considerably more than the normal for that month and greater than for any year since 1892. At Madison there were only four clear days during the month, and at least four heavy rainstorms were accompanied by strong, driving winds especially favorable to the spread of the disease. During June the weather conditions were much

less favorable for the spread of the bacterial blight. The total precipitation in Wisconsin for June was 2.31 inches, or below normal, while the average temperature increased from 58.1° F. in May to 63.9° in June.

With this rise in temperature and decrease in rainfall reports came in of improved conditions in the oat fields. The new leaves which came out were unspotted, and by the last of the month all the fields had resumed a normal color and appeared to have almost completely recovered. The badly yellowed field near Monroe was visited again July 2. It had resumed a normal green color throughout with no halo lesions on the upper leaves and only scattered old lesions lower down. The stand was thin and the plants smaller than in adjoining fields. Neighboring fields were just heading out, but this field would be 10 days to 2 weeks late. Other fields showing yellow spots were reported to have resumed a normal color, but plants in spots previously yellowed were at least a week behind the others in development. This change of weather conditions in June came at an opportune time. Continued cloudy, rainy weather would undoubtedly have destroyed many plants and reduced the yield. As it was, reports for the two seasons of 1917 and 1918 show an increase per acre for the whole State of 2.2 bushels in 1918, but this increase would undoubtedly have been more than doubled but for the presence of halo-blight. Following the unusually severe bacterial blight of the early part of the season, blasting of panicles was also unusually abundant and general throughout Wisconsin oat fields during 1918. In extreme cases as many as 25 to 50 per cent of the spikelets in a head were undeveloped. Counts of 30 panicles in a severely blighted spot gave an average of 29 spikelets per panicle and 31 per cent blasting. Counts of 30 panicles from a part of this same plot not severely halo-blighted gave an average of 34 spikelets per panicle and 20 per cent blasting.

On six panicles sent in from Lincoln County the numbers of normal and blasted spikelets were as follows:

Panicle No.	Number of normal spikelets.	Number of blasted spikelets.
1	36	28
2	24	^a 34
3	38	28
4	10	8
5	34	20
6	16	19

^a Top blasted.

The blasted spikelets are mostly in the lower half of the panicle, but occasionally the upper half is blasted as in No. 2.

All the experimental plots showed considerable blasting and numerous empty spikelets. Counts of 36 panicles of Wisconsin No. 14 oats from treated seed showed an average of 11 per cent of the spikelets blasted,

varying from 0 to 30 per cent. Counts of 40 similar panicles showed 21 per cent of the spikelets blasted. Experiments carried on during the summer of 1918 indicate that this blasting is probably not due to the bacterial disease but to the unusual meteorological conditions which favored the development and spread of the bacterial blight.

BACTERIAL ISOLATION EXPERIMENTS

Oat plants showing typical lesions of halo-blight were collected from fields around Madison, Wis., and from other points in the State, from Tennessee, Urbana, Ill., Lafayette, Ind., Wooster, Ohio, Davis, Calif., and Arlington Farm, Va. Twenty-eight isolations were made from these lesions, and 36 isolations from halo lesions produced by inoculations in the field and greenhouse. Most of these isolations were from leaf lesions, but a few were made from lesions on glumes (Pl. 29).

The first isolations were made by washing the leaf tissue through 10 sterile water blanks, crushing on a sterile slide, transferring to broth, and plating from this broth suspension. Later isolations were made by dipping the tissue for a second in 95 per cent alcohol, then into 1 to 1,000 mercuric chlorid ($HgCl_2$) for one minute, washing through three sterile water blanks, and proceeding as in the earlier method. This later method proved to be more satisfactory, but a comparison of the results from both methods proved interesting.

From all these isolations, with the exception of two from glumes, typical white colonies of the halo organism were obtained. These appeared on potato agar in from 1 to 3 days. When the first method of isolation was used, without sterilizing the surfaces of the tissues, yellow colonies appeared on the plates with the white colonies in 25 per cent of the isolations from natural infections and in 22 per cent of the isolations from inoculation experiments. When the surfaces of the lesions were sterilized in mercuric chlorid for one minute no yellow colonies were obtained. Twelve isolations were made from natural infections, using mercuric chlorid; and a still larger number were made from lesions due to inoculation experiments. One set of isolations was made by placing the leaf tissue in the mercuric chlorid for only 30 seconds. This leaf tissue had been sprayed with a mixed culture of yellow and white organisms. Yellow colonies appeared on the plates with the white colonies, but the yellow colonies were not nearly so numerous as on plates poured from tissue which had not been sterilized. If the tissue had remained in the mercuric chlorid for 60 seconds instead of 30 seconds no yellow colonies would have appeared. These yellow organisms appear to be surface saprophytes and do not occur within the tissues.

The yellow colonies were mostly of one kind, judged by their appearance on agar plates—round, smooth, shining, lemon-yellow with entire margins—and they appeared on the potato agar in from one to two days. This type of colony was chosen for inoculation experiments.

The white colonies of halo-producing organisms from natural infections were all alike on beef-peptone agar, but on potato agar two only of the many isolations gave colonies of a slightly different character, like that designated in this paper as "stock."

On potato agar most of the isolations gave raised, umbonate colonies of a butyrous consistency with thin margins, entire or slightly undulate. This was the usual type of colony isolated. The two varying isolations were from a leaf lesion from Lafayette, Ind., and a glume lesion on Wisconsin No. 14 oats in an experimental plot. (See Pl. 31, C; 32, A.) The colonies were thicker and of an equal thickness out to the margin; the margin was slightly undulate, and the consistency of the colony was like that of boiled starch or gelatin. They gave a more rapid and abundant growth on potato agar than the common type. This second type of colony is the same as an isolation made in 1916 by Mr. Reddy from a halo lesion on oats and kept as a stock culture at Madison, Wis.

The pathogenicity of each of these 28 isolations from natural infections was tested and proved by one or more inoculation experiments. Mr. Reddy's oat stock culture and isolation No. 36 (the common form) from a leaf lesion from Wooster, Ohio, were used as representatives of the two types of white colonies in the inoculation and cultural work and are designated respectively as "stock" and "36."

INOCULATION EXPERIMENTS

1. Inoculation experiments were carried on at Madison, Wis., in experimental plots out of doors and in the greenhouses. The plants in the field were in various stages of development, from half grown to fully headed; and those in the greenhouse were from 4 to 8 inches high. The uninjured plants were sprayed with water suspensions of organisms from agar slants 2 days to 1 week old. The greenhouse plants were then placed in damp chambers for 48 hours. Plants sprayed in the field were covered with water-proofed translucent (glassine) bags for the same length of time. Control plants were sprayed with sterile water and treated in the same manner. Oat plants of Wisconsin No. 1, Wisconsin No. 5, and Wisconsin No. 14 were used for greenhouse inoculations. Wisconsin No. 14 was used more often than the others because it proved to be more susceptible than any other variety. Occasionally halo lesions appeared at the end of the first 48 hours, when the plants were removed from the damp chamber; but usually none appeared until 3 to 4 days after inoculation. On young plants the lesions were often so numerous that centers of infection appeared in rows where the organisms had entered the stomata. The halolike discolorations around these points of sunken tissue were at first only slightly lighter green than the normal tissue but quickly became more marked until about a week after inoculation, when the tissue was a distinct yellowish green

to yellow. Numerous confluent lesions quickly killed the leaf tips and margins, which shriveled, turned brown, and died. Isolated lesions developed in the same way into distinct oval spots of yellow tissue 1 cm. or more in diameter with small dead centers. Infection was always abundant on inoculated oat plants. (See Pl. 27.)

Cultures proved by inoculation experiments to be pathogenic were kept as stock cultures. In this way 21 such cultures were obtained.

2. Since both yellow and white colonies were isolated from leaf sections showing halo lesions, inoculations were made with pure cultures of each and also with mixed cultures of yellow and white colonies for comparison with inoculation work done by Thomas F. Manns (3, p. 107, Pl. I). In 25 inoculation experiments pure cultures of the white halo organisms produced abundant and typical infections. In 13 tests, pure cultures of the yellow organisms produced no lesions whatsoever. Twelve sets of inoculations were made with mixed cultures by combining the 2 white halo organisms, No. 36 and stock, with 4 different isolations of yellow organisms. Isolation 39a from a leaf lesion from Urbana, Ill., was the yellow organism most often used. Separate pure cultures of yellow and white organisms were used for control inoculations. The cultures were mixed just before the inoculations were made for the reason that long-continued attempts to grow mixed cultures in broth or on various agars were not successful.¹ In the 12 inoculation tests with the yellow and white mixed cultures typical halo infections were produced, but the lesions were only one-half to three-fourths as abundant as on plants inoculated with pure cultures of the white organisms. The development of lesions from mixed cultures was also somewhat retarded, the infections being evident from one to two days later than those obtained from the pure white cultures. These inoculation experiments showed plainly that the white organism alone is responsible for the production of the halo lesions while the yellow organisms used are neither parasites nor favorable to parasitism.

3. In June, 1918, field inoculations were made on the following 13 Wisconsin varieties: Wisconsin No. 1, 3, 4, 5, 7, 13, 14, 15, 22, 25, 49, 52, and 62. The plants were just beginning to head out, and the experiment was carried on to test the pathogenicity of the white organisms on mature leaves and on panicles, and the effects of possible lesions upon the development of the panicles, spikelets, and kernels. Water suspensions of the halo organisms were sprayed into unopened sheaths upon uninjured bundles of plants, the tops of which were drawn together and tied close so as to be covered with bags, and upon bundles of plants

¹ For two months mixed cultures of white and yellow organisms were grown on potato agar and in 4-10 beef-peptone broth. Plates poured from these cultures when they were 5 days old showed a few white and many yellow organisms in the broth cultures and about equal numbers of yellow and white on agar. Plates poured from these cultures 7½ weeks later showed no growth of either white or yellow colonies from the agar and showed pure cultures of the yellow organisms from the broth. On the contrary, separate pure cultures of the same organisms held for the same time in these media and under the same conditions gave abundant and characteristic colonies on the plates poured.

injured with a scalpel or drawn between the fingers to rub off the bloom. Bundles of control plants were treated in the same manner and sprayed with sterile water. All inoculated and control plants were covered with glassine bags for 48 hours, as stated above. Characteristic halo lesions appeared on all the varieties inoculated except Wisconsin No. 4. Only uninjured plants of this variety were inoculated. Five other varieties (No. 22, 25, 49, 52, and 62) showed no lesions on uninjured plants, but all varieties showed fairly abundant spotting of leaves and sheaths of plants which had had the bloom removed or had been cut with a scalpel. Some of these leaves were almost entirely yellowed with lesions. On 6 varieties lesions appeared on uninjured plants, but the lesions were not nearly so abundant as on injured leaves and panicles. Wisconsin No. 7 was the only variety in which the panicles were entirely out of the sheaths. In this variety every spikelet of the injured panicles showed halo lesions which stood out as oval yellow spots on the glumes. About half of the spikelets in these panicles were not filled out. Spikelets of untreated panicles of the same variety were also poorly filled out. Under favorable conditions the panicles appear to be just as susceptible to halo-blight as the leaves. Wisconsin No. 14 also showed heavy spotting of injured panicles. Uninjured spikelets of two varieties were halo-spotted when the suspension was sprayed into the unopened sheath.

Though none of the controls showed any halo lesions, both water-sprayed controls and inoculated plants showed considerable sterility, amounting to from one-fifth to one-half of the spikelets in a panicle. Untreated heads of the same varieties and in the same plots showed either no sterility at all or only traces at the base of the panicle. This sterility was particularly abundant when either the water suspension or sterile water was sprayed into unopened sheaths or sheaths just opening at the top. The fact that both controls and inoculated plants showed the same amounts of sterility would indicate that the sterility was not due to the effects of the organism. Excessive moisture around the developing spikelets while these were still inclosed within the sheath offers the most plausible explanation for this sterility. In the same way heavy rains at the time oat fields are heading out probably account for the sterility commonly observed in oat fields. This set of field inoculations has led to the following conclusions:

1. Leaves and panicles of oat plants approaching maturity are susceptible to halo infection under favorable conditions.
2. Infection takes place more readily on injured than on uninjured parts of the plants.
3. Some varieties are more susceptible to infection than others. Greenhouse inoculations on young plants also led to this conclusion.
4. Although both natural and artificial halo infection may occur on heads, these infections are not responsible for the blasting of oat heads. Sterility is due probably to physiological rather than pathological conditions.

CULTURAL CHARACTERS

I.—STOCK HALO ORGANISM

MORPHOLOGY.—The organism is a motile rod with rounded ends (Pl. 34, B, E), sometimes occurring singly or paired, but usually in short to long chains (Pl. 34, C). Organisms grown on beef-peptone agar and potato agar and stained with Ribbert's capsule stain, gentian violet, and carbol fuchsin measure from 1 to 4 μ in length and from 0.4 to 0.8 μ in width, with an average of 0.65 by 2.3 μ . Stained by the Van Ermengen method from 24-hour cultures on beef-peptone agar, the organism shows from one to several polar flagella about the same length as the organism or only a little longer (Pl. 34, E). No spores have been observed, although special staining methods with hot carbol fuchsin and methylene blue were used. Capsules are formed on both potato and beef-peptone agar and were stained with Ribbert's capsule stain (Pl. 34, D). Compact pseudozoogloae are not formed—that is, there is little or no viscosity. No branched forms have been observed.

NUTRIENT BROTH.—Beef-peptone bouillon (+10) shows light clouding in 24 hours at 25° C. In 5 days there is moderate uniform clouding, and a flocculent white film or pellicle forms on the surface and falls to the bottom of the tube in small white flakes. On further shaking the flakes disappear. In older cultures there may be no pellicle but merely a slight ring around the surface. The clouding is never very heavy, and the thin surface film soon disappears. The medium is gradually changed in color until at the end of 60 days it is a deep amber brown.¹ The odor of decay is distinct with more or less of the penetrating smell of ammonia. The sediment in cultures from recent isolations is loosely flocculent. There was a somewhat viscid swirl in some of the old broths containing sodium chlorid. Rectangular crystals form at the surface.

BROTH PLUS ABSOLUTE ALCOHOL.—To 10 cc. of +15 beef-peptone bouillon absolute alcohol was added to make 4, 5, 6, and 7 per cent. There was heavy clouding in 4 and 5 per cent, moderate clouding in 6 per cent, and slight clouding in two out of three tubes of 7 per cent.

AGAR STROKE.—On +10 beef-peptone agar slants growth in 2 days is moderate, flat, undulate, white, shining, translucent, slightly contoured, butyrous. The medium is slightly browned. There is a slight odor of decay.

On potato-dextrose agar slants the growth in 2 days is abundant, slightly undulate, raised, glistening, smooth, opaque, white, of gelatinous consistency (Pl. 30, B, b). The medium is unchanged and there is no odor.

AGAR COLONIES.—(1) On poured plates of +10² beef-peptone agar from +10 broth cultures, colonies appear after 30 hours at 25° C. as tiny translucent dots. When 2 days old the colonies are 1 to 2 mm. in diame-

¹ RIDGWAY, ROBERT. COLOR STANDARDS AND COLOR NOMENCLATURE. 43 p., 53 col. pl. Washington, D. C. 1912.

² Fuller's scale.

ter, white, smooth, shining, round, with a denser center. When 11 days old they are more or less irregularly circular, 5 to 10 mm. in diameter in thin-sown plates, and flat with slightly raised margins. Microscopically, with low powers, the internal structure is filamentous, the margin consisting of folded parallel strands or chains. The margin is undulate. Deep colonies are lens-shaped and opaque. The medium may be slightly browned. The markings in Plate 31, A, B, E, F, are characteristic of these colonies under a hand lens, and they do not disappear as the colonies grow older. Very similar markings appear in young colonies of some of the softrot organisms. A half dozen of these softrot organisms tried on oats have not produced any halo lesions.

(2) On plates of potato-dextrose agar the colonies grow more rapidly. They are raised, white, shining, opaque, with only slightly undulate or entire margins, and of the same gelatinous consistency described above (Pl. 31, C; 32, A.)

GELATIN COLONIES.—Growth slow, circular, crateriform, margins entire to undulate with folded strands (Pl. 31, G), liquefaction saucer-shaped, rather slow.

GELATIN STAB.—Growth on +10 peptone gelatin at 22° C. is slow, best at the top, with only a slight filiform growth along line of stab, liquefaction crateriform. At the end of 2 days a small pit is formed at the surface 3 mm. deep. At the end of 6 days liquefaction extends two-thirds of the way across a 20-mm. tube, and the pit is 10 mm. deep. At the end of 18 days liquefaction covers the surface to a depth of 14 mm. At the end of 60 days (at 20°) the tube is only half liquefied.

POTATO CYLINDERS.—At 25° C. there is moderate growth in 24 hours and slight darkening of the medium. At the end of 4 days growth is abundant, flat, smooth, glistening, butyrous to slimy, of a cream color, and the medium is a uniform dark gray color. At the end of 20 days there is a decided odor of decay. There is feeble diastasic action on starch.

SMITH'S POTATO STARCH JELLY (5).—Growth moderate, diastasic action feeble, medium stained a light bluish green. Traces of dextrin.

STARCH AGAR.—To melted tubes of +10 beef-peptone agar sterile potato starch was added and plates poured. Tests with iodine showed no diastasic action.

LITMUS SUGAR AGARS.—One per cent lactose, maltose, dextrose, saccharose, and galactose were used in beef-peptone litmus agar. Change of medium to a bright red showed considerable acid production with dextrose and galactose; with saccharose there was less acid produced; and with lactose and maltose there was no evidence of acid production. Reduction of litmus took place to a slight extent under the streaks with dextrose and maltose.

MILK.—In fresh isolations a soft curd forms in from 5 to 7 days, followed by slow peptonization of the curd, which is completed in from 5

to 6 weeks. In old isolations curd usually is absent. The medium does not become viscid or slimy. The liquid at the top of the tube is sometimes a yellowish green but more often brown. This brown color may be confined to a surface layer a few millimeters deep or may extend throughout the liquid medium. In old tubes the fluid is coffee-colored. It is unlike any color in Ridgway, but is somewhat like his moss brown.

LITMUS MILK.—At room temperature the medium begins to turn slightly blue in 2 days, beginning at the top; and in 5 or 6 days it is frequently stratiform, being deepest blue at the top. Reduction begins at the end of a week, the tubes becoming cream-colored throughout, and clearing at the top or showing reduction only at the bottom of the tube for a depth of 1 cm. or more. There is no curdling, and clearing is complete in 2 weeks. At the end of 2 months the tubes are a deep blue-black and sometimes of a gelatinous consistency. At no time is there any reddening.

METHYLENE BLUE IN MILK.—In fresh isolations reduction begins in 3 days and is completed in 7 days, except for a rim of blue at the top 1 mm. deep. Curdling takes place in 1 week; peptonization begins soon after and is completed in 5 weeks, the clear liquid being yellowish to neuvider green, especially toward the top.

COHN'S SOLUTION.—Growth is very slight, appearing in 24 hours and increasing slightly the second day. In a week clearing begins, and at the end of 3 or 4 weeks there is no clouding and only a little precipitate. Nonfluorescent. No crystals.

USCHINSKY'S SOLUTION.—The medium shows light clouding in 24 hours. In 48 hours a thin flocculent white film has formed over the surface and shakes down in fine particles. In 4 days there is moderate clouding, a slight surface film, and the medium is a pale turtle green. In 2 weeks a heavy white rim has formed around the surface of the liquid. When the cultures are 6 weeks old there is considerable white precipitate—fluid, not viscid—and slides stained in carbol fuchsin show a network of long chains (Pl. 34, C). Fluorescence persists in old cultures.

FERMI'S SOLUTION.—Light clouding occurs in 24 hours. In 4 days there is moderate clouding and a delicate surface film which shakes down in fine flocculent particles. In 4 days as much growth as in Uschinsky. In 2 weeks the clouding is heavy, the medium has a greenish tinge, and there is a heavy white surface pellicle 2 to 3 mm. deep, which shakes down in strings of fine white particles. There is considerable white precipitate—a heavy growth. In 3 weeks the white surface pellicle and the precipitate become cream-colored. No chains are formed. Greening first visible after about 2 weeks. At end of a month surface pellicle and precipitate tan color. Clouding and pellicle twice as abundant as in Uschinsky.

LOEFFLER'S BLOOD SERUM.—Growth moderate, filiform to slightly undulate, flat, glistening, smooth, medium slightly browned beneath the streak. No liquefaction, not even after 2 months.

SOYKA'S RICE MEDIUM.—The growth and medium in all cases except one were cream colored. A culture marked "stock b" turned the medium a buff-pink.

NUTRIENT BROTH PLUS CARBON COMPOUNDS.—To tubes of +10 beef-peptone bouillon 1 per cent asparagin was added and to other tubes 1 per cent asparagin plus 1 per cent dextrose were added. The growth was equally good in both kinds of media. The organisms seem to obtain their carbon as readily from asparagin as from dextrose.

INDOL PRODUCTION.—Feeble or absent in beef-peptone bouillon or 1 per cent peptone water containing 0.5 disodium phosphate and 0.1 magnesium sulphate.

HYDROGEN SULPHID.—Hydrogen sulphid is not produced. Lead acetate paper suspended over broth cultures is not blackened, and the medium is unchanged when streaks are made on lead carbonate agar plates.

AMMONIA PRODUCTION.—Moderate. Made tests with Nessler's reagent.

NITRATE IN NITRATE BROTH.—No gas is produced in fermentation tubes. Nitrates are not reduced. Tests were made at the end of 9 days and at the end of 2 months.

TEMPERATURE RELATIONS.—The maximum temperature for growth, tested on beef broth and on agar and potato, is 31° C. The minimum temperature for growth is below 0°. Tubes surrounded with ice showed clouding. The optimum temperature for growth is 24° to 25°. The thermal death point is between 47° and 48°.

MOISTURE RELATIONS.—The organisms are very readily killed by drying. Smears were made from 5-day-old broth cultures to sterile cover glasses and placed in sterile Petri dishes. Pieces of these cover glasses transferred to sterile bouillon after 3 hours showed growth in all. All were dead at end of 24 hours. In a repetition, transfers after 6 hours gave no growth.

FERMENTATION TESTS: (1) POTATO JUICE.—Undiluted potato juice was expressed after passing the pared tubers through a meat grinder. Moderate clouding in open arm of fermentation tubes. No growth in closed arm and no gas.

(2) MILK.—At the end of a week the milk at the open end had cleared without evident curdling. Two days later the milk in the closed end had curdled. This curd was gradually peptonized, about a third of it remaining at the end of 2 months. The cleared liquid in the open arm was browned—a chestnut to auburn brown at the surface and gradually changing to a lighter shade through the open arm and a third of the way up the closed arm. No gas was formed.

(3) CARBON COMPOUNDS.—Tests were made in the fermentation tubes with 2 per cent solutions of dextrose, saccharose, maltose, lactose, mannit, glycerin, and levulose in 2 per cent water solutions of Difco's and Witte's peptones. *Bacillus coli* Escherich was used as a control and produced gas in the closed arm. The oat organism produced no gas and

did not grow in the closed arms of tubes containing maltose or lactose. In tubes containing saccharose, glycerin, and mannit there was growth at first only in the open arm, with a sharp line of demarcation between open and closed arms. At the end of a week clouding began to appear in the closed arms of tubes containing these three substances. In 3 weeks there was light clouding throughout the closed arms in saccharose, moderate clouding throughout the closed arms in mannit, and in glycerin heavy clouding to within an inch of the top of the closed arm with light clouding on up to the top. In a later test there was again light clouding throughout the closed arms of tubes containing saccharose. In two later tests a moderate clouding appeared in the closed arms of tubes of saccharose and dextrose in from 4 to 7 days. In a later test of mannit and glycerin there was no clouding in the closed arm. Tests for ammonia with Nessler's reagent gave a positive reaction in solutions of maltose, saccharose, mannit, glycerin, and lactose, but only traces of ammonia or negative reactions in cultures containing dextrose. Titrations with phenolphthalein as an indicator show a higher total titrable acidity in the cultures than in the controls in saccharose and dextrose. These solutions were also acid to litmus as compared with controls in two later experiments. The hydrogen-ion concentrations, determined after about 6 weeks by the colorimetric method, were as follows: Control, $P_H=4.8$; dextrose, $P_H=4.8$; maltose, $P_H=7$; saccharose, $P_H=6.4$; and lactose, $P_H=4.8$.

The organisms grew best in saccharose, levulose, and dextrose, showing heavy growth in the open arm and slight to moderate growth in the closed arm. This organism is evidently a facultative anaerobe when certain sugars are available.

TOLERATION OF ACIDS.—Transfers were made to tubes of +10 beef-peptone broth containing 0.1 per cent and 0.2 per cent of citric, tartaric, and malic acids. There was good growth in 0.1 per cent of each acid but only slight growth or none at all in 0.2 per cent.

TOLERATION OF SODIUM CHLORID.—Neutral beef-peptone bouillon containing, respectively, 2, 3, 4, 5, 6, and 7 per cent of sodium chlorid was inoculated from potato agar slants. There was slight clouding of 2 per cent after 3 days. None of the stronger solutions clouded, but slides made from a stringy white precipitate and stained with carbol fuchsin showed that long chains of cells had been formed in all strengths of sodium chlorid. A second test was made, using neutral broth with 0.5, 1, 1.5, 2, 3, and 4 per cent solutions of sodium chlorid and inoculating from broth cultures. There was slight clouding in 1 per cent at the end of 2 days, slight clouding in 1.5 per cent at the end of 3 days, moderate clouding in 1.5 per cent at the end of 5 days. At the end of 7 days there was slight clouding in 2 per cent and moderate clouding and a stringy swirl of precipitate in 2 per cent at the end of 19 days. Stained slides of precipitate from 1.5 and 2 per cent solutions showed a network of long chains. In the second test there was no growth in solutions of more than 2 per cent.

OPTIMUM REACTION AND TOLERATION LIMITS.—Beef-peptone bouillon was adjusted to each of the following reactions with sodium hydroxid and hydrochloric acid +20, +15, +10, +5, 0, -5, -6, -13, -16, and -22. These were uniformly inoculated from broth cultures and kept at 24° C. At the end of 24 hours there was light clouding in -5, 0, +5, and +10. Subsequent clouding occurred in -6 and +15. A stringy precipitate formed in -13, and on -15 a thin surface film developed and the medium was slightly darkened. At the end of 48 hours the clouding in +5 was slightly heavier than in +10, and the flocculent surface film slightly heavier. Clearing began in 3 weeks. At that time +10 was browned, +15 slightly deeper brown, and +5 and -5 showed a greenish tinge. The optimum reaction for growth is, therefore, +5 Fuller's scale, although +10 and +15 are also favorable reactions.

In later tests the limits of growth on agar were +27 and -17, and in bouillon +27 and -18, when the agar was reinoculated from an alkaline culture.

VOLATILE ACIDS.—Tests for volatile acids were negative. Cultures were grown in tap water containing 1 per cent Witte's peptone and 1 per cent dextrose. The steam from these cultures gave an alkaline reaction to litmus although the liquid was acid to litmus.

FREEZING.—Six plates were poured in +15 agar from 24-hour +15 broth cultures. This 24-hour culture was exposed for 1 hour in salt and crushed ice and then six more plates were poured. Eighty-seven per cent of the organisms were killed by this treatment.

EFFECT OF SUNLIGHT.—The organism is sensitive to sunlight; 80 per cent were killed by 15 minutes' exposure on ice in thinly sown beef-peptone agar plates.

VITALITY ON CULTURE MEDIA.—Typical colonies of this organism have been obtained from +10 beef-peptone agar slants which have stood for 11 months and from broth cultures 10 months old. These were tested by inoculation on young oat plants and gave abundant and typical halo lesions.

LOSS OF VIRULENCE.—Loss of virulence on culture media has not been observed in cultures carried for more than 3 years.

GROUP NUMBER.¹—221.2323023.

The name *Bacterium coronafaciens*, n. sp., is suggested for this organism.

TECHNICAL DESCRIPTION

Bacterium coronafaciens, n. sp.

A motile rod with rounded ends and polar flagella; single, in pairs or long chains, average measurement 2.3 by 0.65 μ ; no spores, zoogloea, or involution forms; capsules are formed; slightly facultative anaerobic. On nutrient agar colonies are white, round becoming irregularly circular, flat with slightly raised margins, surface smooth or slightly contoured; deep colonies are lens-shaped and opaque. Its proteolytic

¹ SOCIETY OF AMERICAN BACTERIOLOGISTS. DESCRIPTIVE CHART. Indorsed by the society for general use at the annual meeting Dec. 31, 1914. Prepared by the committee on revision of chart identification of bacterial species.

power is moderate; gelatin is liquefied slowly, beginning in 2 days and not complete in 60 days; reduction of litmus occurs in milk, and the casein is digested without curdling; milk curdles in 5 days, and peptonization is completed in 5 weeks. No acid is produced in milk. Oxidations of proteins are incomplete; ammonia is produced; hydrogen sulphid, gas, and indol are not produced. Nitrates are not reduced. There is slight diastasic action on potato cylinders. Good growth in Uschinsky's solution and in Fermi's solution. Growth in Cohn's solution is scanty. Maximum temperature for growth is 31° C., minimum below 0°, optimum 24° to 25°, thermal death point between 47° and 48°. Tolerates sodium hydroxid to -18 Fuller's scale and hydrochloric acid to +27. The optimum reaction for growth is +5 Fuller's scale. Gram-negative, not acid-fast, stains readily and uniformly with gentian violet and methylene blue. Stains more or less irregularly with carbol fuchsin (often polar staining). Sensitive to drying; 87 per cent killed by freezing, 80 per cent killed by sunlight. Vitality on culture media long. Pathogenic on varieties of cultivated oats and to a slight degree on wheat, rye, and barley, producing oval halo-like lesions of chlorotic tissue surrounding dead brown centers of infection.

Beef-peptone agar and beef bouillon are favorable media for prolonged growth. Growth on potato agar brings out more distinguishing characteristics.

II.—ISOLATION NO. 36

This isolation was made from a halo lesion on oats obtained from Wooster, Ohio, in June, 1917. It has the same group number as the stock halo organism just described but differs from it in the characters mentioned below. The differences, though not very marked, seem to be fairly constant, while the lesions from which the cultures were isolated and which they produce in inoculation work can not be distinguished. The stock organism seems to be slightly more virulent.

MORPHOLOGY.—The organism occurs singly or in twos but seldom in long chains (Pl. 34, A). Stained by Ribbert's capsule stain it measures from 1.1 to 3 μ in length and from 0.5 to 0.8 μ , in width, not including the capsule, with an average measurement of 0.66 by 2.1 μ .

BEEF AGAR PLATES.—On +10 beef-peptone agar, the surface colonies remain round, and the margin tends to remain entire (Pl. 31, D).

POTATO-DEXTROSE AGAR STROKE.—Two-day-old slants from broth show moderate flatter growth, which is filiform and dull, with more or less wrinkling on the surface. The growth is somewhat translucent and of a butyrous to slightly membranous consistency (Pl. 30, B, a).

GELATIN STAB.—Liquefaction is more rapid, being complete in 40 days.

TOLERATION OF SODIUM CHLORID.—Same as stock, but slides from a 2 per cent solution stained with carbol fuchsin show only a few scattered short chains.

LITMUS MILK.—Litmus is not reduced.

METHYLENE BLUE.—Digestion of casein a little slower than with stock.

USCHINSKY'S SOLUTION.—No chains on slide stained with carbol fuchsin.

COHN'S SOLUTION.—Clouding heavier than with stock. Crystals are formed on the sides of the tubes.

STARCH AGAR.—The organism showed a feeble diastasic action on starch.

TEMPERATURE RELATIONS.—Thermal death point is between 47° and 48° C.

Strain 36 usually gives a greenish tinge to bouillon cultures, which in old cultures contrasts strongly with the brown of old "stock" cultures. On ordinary beef-peptone agar the two strains can not be distinguished but on potato-dextrose agar there is considerable difference in amount of growth, and they are noticeably different in consistency. The most important differences perhaps are in size and in nonformation of chains. The rods of No. 36 are shorter and plumper. They seem to be two strains of the same organism.

III.—YELLOW ORGANISM

MORPHOLOGY.—The organism is a motile rod with rounded ends and one to several polar flagella. It occurs singly or in short chains. When grown for 24 hours on beef-peptone agar and stained by the Duckwall modification of Pitfield method, it has an average measurement of 3.5 by 1.4 μ , varying in length from 2.3 to 3.7 μ , and in width from 0.98 to 2.1 μ . No spores have been found.

BEEF-PEPTONE AGAR PLATES.—Colonies appear after 24 hours on +10 beef-peptone agar; in 2 days they measure 2 mm. in diameter and are a translucent light yellow. When a week old, surface colonies are circular, 4 to 5 mm. in diameter, raised, smooth, lemon-yellow, with entire translucent margins. Microscopically the internal structure is finely granular. Deep colonies are lens-shaped and opaque.

BEEF-PEPTONE AGAR STROKE.—Growth in two days is moderate, filiform, flat, glistening, slightly contoured, translucent, light orange-yellow, with a faint odor. Consistency is butyrous, and medium is unchanged (Pl. 30, B, c). The organism lives at least three or four months on beef-peptone agar.

POTATO AGAR STROKE.—In two days the growth is abundant, filiform, flat, spreading, glistening, smooth, opaque, light orange-yellow. The medium is unchanged, and the consistency butyrous.

GELATIN STABS.—At 22° C. growth in +10 nutrient peptone gelatin is moderate. The liquefaction at first is saccate along the stab and later stratiform. Liquefaction is completed in 40 days. The surface growth has a pinkish tinge, but the precipitate is yellow.

BEEF-PEPTONE BROTH.—There is moderate clouding in +10 beef-peptone broth in 24 hours at 25° C., very heavy clouding in 48 hours, and a slight flocculent surface growth. In 3 days there is a heavy membranous pellicle which breaks up when shaken and sinks to the bottom of the tube. The precipitate is abundant and finely granular. Clearing begins in about 2 weeks.

TOLERATION OF SODIUM CHLORID.—Tables of neutral beef-peptone bouillon containing respectively 2, 3, 4, 5, 6, and 7 per cent of sodium chlorid were inoculated from potato agar slants. In 24 hours there was

clouding in 2, 3, 4, and 5 per cent solutions. In 3 days there was a very slight clouding in 6 and 7 per cent solutions. A stringy yellow precipitate formed in the 4, 5, 6, and 7 per cent. Slides made from 2 and 3 per cent solutions and stained with carbol fuchsin showed long chains of cells. There were no long chains in the 4, 5, 6, and 7 per cent. In a second test a delicate pink surface film, not previously observed, formed in 0.5, 1, 1.5, 2, 3, and 4 per cent solutions; and a pink stringy precipitate formed in 2 and 3 per cent, becoming a brick red in 4 per cent.

POTATO CYLINDERS.—At 25° C. there was slight growth in 24 hours and a slight graying of the medium. In 4 days there was abundant yellow growth, and the medium had become slightly browned. Growth was filiform, flat, raised, glistening, somewhat contoured, orange-yellow to red on top. There was no odor, and the consistency was butyrous. There was no action on the starch.

MILK.—Milk titrating +18 on Fuller's scale was inoculated from 9-day-old potato agar slants. A slight yellow surface film was formed in 2 days. At the end of 1 week yellow precipitate was evident. Curdling began in 3 weeks. There was a slight separation of curd and whey at the end of 2 months. The solid curd gradually dried down without any evidence of peptonization.

LITMUS MILK.—Complete reduction occurs in 24 hours, leaving the medium cream-colored. Shaking tended to restore the color. After about a week some of the reduced tubes were steamed, whereupon the original lavender color returned. Curdling occurred in 3 weeks. There was no evidence of digestion at the end of 2 months.

METHYLENE BLUE IN MILK.—Reduction takes place in 24 hours. In 3 weeks there is curdling and the blue color begins to return at the tops of the tubes. No peptonization.

USCHINSKY'S SOLUTION.—There is moderate clouding in 24 hours at 25° C. and a membranous surface film. At the end of 2 days there is a fairly heavy light yellow surface film. In 4 days there is heavy clouding and a heavy surface film and yellow precipitate. Slides stained with carbol fuchsin show many short chains.

FERMI'S SOLUTION.—There is moderate clouding in 24 hours at 25° C. In 2 days there is a fairly heavy light yellow surface film. In 4 days the clouding is heavy and there is a heavy orange-colored surface film 2 mm. thick. At the end of a week this pellicle is 4 mm. thick. Clearing begins in 2 weeks, and yellow strands extend from the heavy pellicle to the bottom of the tube. At the end of 3 weeks the pellicle is 1 cm. thick. In 4 weeks the medium has a greenish tinge. No chains were observed on slides stained with carbol fuchsin.

COHN'S SOLUTION.—There is a slight clouding at the end of 2 days at 25° C. At the end of 4 days the clouding is still very light, and there is just a trace of surface growth. Rhomboid crystals are formed on the tube above the liquid. Growth is very slight in comparison with that in Fermi's solution.

BLOOD SERUM.—Growth was moderate, filiform, slightly raised, orange-yellow, smooth, shining. In 2 weeks the center of the growth became red, but the author was unable to verify this change in 1919. The medium was unchanged.

LITMUS SUGAR AGARS.—In 24 hours there is a slight reddening of litmus dextrose agar and in 3 days reduction has begun in the lower end of the tubes, the upper two-thirds being rose red. Litmus-lactose and litmus-maltose agar show reduction in the lower ends of the tubes in 3 days. These tubes are red through the center and blue at the top. At the end of a week all agars are colorless at the bottom of the tubes, red in the center, and blue toward the top. Growth is abundant. At the end of 2 weeks the colony begins to turn red.

STARCH AGAR.—There is no diastasic action on starch.

INDOL.—Indol production is feeble.

NITRATE BOUILLON.—No gas is produced in fermentation tubes. Nitrates are not reduced.

AMMONIA.—Ammonia production is moderate.

HYDROGEN SULPHID.—No hydrogen sulphid is produced. Tests were made with lead-acetate paper over broth and with lead-carbonate agar.

OPTIMUM REACTION AND TOLERATION LIMITS.—By the use of sodium hydroxid and hydrochloric acid, using phenolphthalein as indicator, beef-peptone bouillon was adjusted to each of the following reactions: +25, +20, +15, +5, 0, -5, -6, -13, -15, and -22. These were uniformly inoculated from broth cultures and kept at 24° C. In 24 hours there was clouding in all except +20 and +25. At the end of 3 days there was clouding in all except +25. The clouding in +20 was slight. At the end of 1 week there was no growth in +25, light clouding in +20, -15, and -22, and heavy clouding in all the other reactions, with precipitation and surface growth. In 3 weeks there was clearing in -15 and -22, but a viscid yellow precipitate. There was never any growth in +25. The optimum reaction for growth is +5 Fuller's scale.

GAS FORMATION AND AEROBISM.—Tests were made in fermentation tubes in the presence of the following carbon compounds: dextrose, saccharose, lactose, maltose, mannit, and glycerin. A 2 per cent solution of each was made in a 2 per cent water solution of Difco peptone. *Bacillus coli* Escherich was used as a control and produced gas in each solution. No gas was produced by the yellow organism. There was clouding in the open arm of all tubes in 2 days, the heaviest growth being in saccharose and maltose. In 3 days clouding began in the closed arm of tubes containing saccharose and mannit. At the end of a week there was clouding in the closed arm of all tubes—heavy in glycerin and mannit, light in dextrose, and moderate in the others. Tests for ammonia with Nessler's reagent gave a positive reaction in all sugars—slight in glycerin, and moderate in the others. Titrations with phenolphthalein as indicator showed no acid production. The hydrogen-ion concentrations were

determined by the colorimetric method at the end of 6 weeks. The P_H for dextrose was for maltose 5 to 5.2, for saccharose 4.6, for lactose 7, for glycerin 4.8, and for mannit 6. Controls and *Bacillus coli* Escherich showed a P_H of 4.8 throughout.

TEMPERATURE RELATIONS.—The maximum temperature for growth is above 38° C. The minimum temperature for growth is 3°. The optimum temperature for growth is 24° to 25°. The thermal death point is 48° to 50°. Tests were made by the same methods as those used for the halo organisms.

VITALITY ON CULTURE MEDIA.—The organism lives for 2 months on beef-peptone agar at room temperatures. It is nonpathogenic.

GROUP NUMBER.—The group number is 221.3333533, according to the descriptive chart of the Society of American Bacteriologists.

TECHINAL DESCRIPTION

A motile rod, with rounded ends, one polar flagellum or several, single or occasionally in short chains; average measurement 3.5 by 1.4 μ ; no spores, pseudozoogloae, or involution forms; facultative anaerobic. On beef-peptone agar the colonies are round, raised, smooth, lemon-yellow with entire translucent margins; deep colonies, lens-shaped and opaque. Liquefaction of gelatin begins in 2 days and is complete in 40 days. There is reduction in litmus milk in 24 hours and delayed curdling without subsequent peptonization; milk is curdled in 3 weeks without subsequent peptonization; ammonia production moderate; indol production feeble; does not produce hydrogen sulphid or other gas; no diastasic action on starch; grows moderately in Uschinsky's solution, and very copiously in Fermi's solution. Growth slight in Cohn's solution. Maximum temperature for growth is above 38° C., minimum 3°, optimum 24 to 25°, thermal death point 48° to 50°. Tolerates sodium hydroxid to below -22 Fuller's scale, and hydrochloric acid to +20 Fuller's scale. The optimum reaction for growth is +5 Fuller's scale. Gram-negative; not acid-fast; stains readily with carbol fuchsin, gentian violet, and methylene blue. Nonpathogenic to oats.

OVERWINTERING AND DISSEMINATION

There is evidence from three sources that the organism causing halo-blight winters over on the seed: (1) the presence of typical halo lesions on the glumes and lemmas of maturing spikelets (Pl. 29); (2) the early appearance of the disease on seedlings grown on soil not previously sown to oats (Pl. 28); and (3) the great difference in amount of blight in oat plots from treated and untreated seed.

(1) NATURAL AND ARTIFICIAL INFECTIONS OF SPIKELETS

In 1918 at the time the oat plants were heading out it became evident from observations of the plot of Wisconsin No. 14 and from artificial inoculation of Wisconsin No. 7 that the spikelets were also susceptible to infection with the halo organism. After the Wisconsin No. 7 plants had headed out a number of uninjured heads were sprayed with a water suspension of the organism. Another bundle of heads, bruised by drawing between the fingers, was similarly sprayed; and both were covered with glassine bags for two days. When the bags were removed infections were already appearing on the bruised spikelets as light green

discolorations on the glumes. A week after inoculation every spikelet of these panicles showed distinct typical halo lesions. Many halo lesions also appeared on the uninjured spikelets. Injured and uninjured controls sprayed with sterile water and treated in a similar way showed no halo lesions.

Early in July natural infections on the spikelets of Wisconsin No. 14 oats were observed. Flag leaves were found which showed either scattered halos or yellow halo tissue the length of the blade and sheath. Where sheaths surrounding the heads were badly haloed, every spikelet in the panicle showed infection. If there is one single lesion on a glume it appears as a typical light green to yellow halo about the point of infection. When the whole glume is infected the tissue becomes yellow and translucent between the veins. Only a few such complete infections of panicles were found. Further observations showed that infections on a small percentage of the spikelets in a panicle were not uncommon even when there were no lesions on the sheaths below. Wind and rain might easily spread the infection directly from lower leaves to panicles. Isolations from the glumes showing these lesions and from the parts inside the glumes gave typical halo organisms. Table I, which records the counts on 42 panicles in one corner of a Wisconsin No. 14 plot, will give some idea of the percentage of blighted spikelets.

TABLE I.—Number of blighted and blasted spikelets on oats naturally infected with halo-blight

Panicle No.	Number of spikelets per panicle.	Number of blighted spikelets per panicle.	Number of blasted spikelets per panicle.	Panicle No.	Number of spikelets per panicle.	Number of blighted spikelets per panicle.	Number of blasted spikelets per panicle.
1.....	58	0	6	24.....	67	2	17
2.....	54	0	11	25.....	33	0	8
3.....	77	1	5	26.....	80	0	12
4.....	66	0	14	27.....	65	4	14
5.....	55	0	22	28.....	45	0	7
6.....	55	0	12	29.....	72	0	10
7.....	55	0	17	30.....	85	12	1
8.....	60	0	11	31.....	46	0	0
9.....	42	0	14	32.....	50	25	47
10.....	64	1	13	33.....	55	0	8
11.....	90	2	16	34.....	45	0	7
12.....	51	1	9	35.....	71	29	4
13.....	61	0	22	36.....	65	0	14
14.....	79	36	25	37.....	109	5	6
15.....	18	18	23	38.....	52	0	0
16.....	87	0	4	39.....	69	8	8
17.....	50	0	13	40.....	66	1	6
18.....	39	0	21	41.....	60	3	13
19.....	54	4	34	42.....	5	21
20.....	50	5	35				
21.....	55	2	14	Total.....	2,387	165	587
22.....	62	0	23	Average.....	59+	4	14+
23.....	69	0	20	Per cent.....	6+	24+

In this case 6 per cent of the spikelets are blighted. This accords with the percentage of primary lesions usually observed on seedlings in the field. The sheaths below the panicles numbered 15, 32, and 35 were badly yellowed with halo lesions.

(2) PRIMARY LESIONS ON THE FIRST LEAVES OF SEEDLINGS

These primary lesions have been observed by the writer on more than 30 varieties of oats in Wisconsin in two different years. They may appear as halos on any part of the leaf blade, but they more often occur on the tips or margins of the leaves as shown by Plate 28.

(3) EXPERIMENTS WITH TREATED AND UNTREATED SEED

During the season of 1917 two plots of oats were planted on soil which had not previously been planted to oats. Untreated seed of each of 33 Wisconsin varieties was planted in April, and in May seed of the same 33 varieties was planted after having been soaked for 2½ hours in 1 to 320 formalin (1 pint to 40 gallons). Every one of the 33 varieties from untreated seed showed halo-blight to at least some extent, the amount decreasing as the hot weather came on. Wisconsin No. 14 showed the heaviest blighting, and Wisconsin No. 25 was also heavily spotted. Throughout the season not a single lesion was found on the 33 varieties from treated seed.

In April, 1918, three parallel plots of oats were planted on soil not previously planted to oats. Thirty-three Wisconsin varieties of untreated 1916 seed were planted in the first plot, 44 Wisconsin varieties of untreated 1917 seed were planted in the second plot, and 44 Wisconsin varieties of treated 1917 seed were planted in the third plot. Also treated seed of Wisconsin No. 14 was planted as a fourth plot on the experimental ground where oats were grown in 1917. This seed was treated by soaking for 3 hours previous to planting in 1 to 320 formalin.

Counts of infections appearing in these plots were begun just as the second leaf was coming out. On May 16, 17, and 18 primary lesions were appearing on the first leaves of plots from untreated 1916 and 1917 seed, the number of primary infections varying from less than 1 per cent to 8 per cent in each plot. These primary lesions on the 1916 plot would indicate that the organism may live for two years on the seed. No lesions were found at this time on the plot from 1917 treated seed. Counts were made again in the untreated 1917 plots on May 25, four or five days after heavy driving rains, the normal incubation period for halo lesions. Practically all the first leaves were found to be spotted, and lesions were also appearing on the upper leaves. The condition in the 1916 plot at this time was about the same and continued to parallel that of the 1917 plot. At this same time—9 days after the first appearance of the disease on the untreated plots—scattered halo spots and yellowed leaf tips were beginning to appear on the treated plot, evidently by infection from the

neighboring untreated plots, one of which was only 3 feet away. On May 24 and 25 there were more driving rains, and on the twenty-eighth the effects of these storms were evident. Secondary lesions in the untreated plots were so abundant that no attempt was made to count them. Many of the first leaves were completely yellowed and dead, and lesions on second and third leaves were so numerous that tips, margins, and even whole leaves were becoming yellowed. On varieties where infections were not so abundant the second leaves showed only scattered lesions. On the treated plot the primary lesions were still few, and there was here very striking evidence of the way in which the organism spreads about a center of infection. More or less circular spots of infected plants could be distinguished with the more heavily spotted plants in the center. The amount of infection in this treated plot gradually increased until most of the first and second leaves showed some spotting, but in none of the varieties was there more than half as much blighting as in the untreated plots. In the third treated plot, Wisconsin No. 8 showed only scattered lesions on the lower leaves and none on the upper. In the untreated plot of this variety the lower leaves were practically destroyed and the upper so badly spotted that they showed a yellow-brown color at a distance. There were similar but less marked differences in other varieties. Through June there was very little rain. The amount of blight gradually decreased until at heading time, about the first of July, very few halo lesions could be found, and the upper leaves were practically unspotted.

No halo lesions were observed on the fourth plot from Wisconsin No. 14 treated seed until about the twenty-fifth of the month, when two or three centers of infection began to appear as small yellow spots. These spread rapidly after each rain until one of them stood out as a distinct yellow spot irregularly 5 by 10 feet in diameter. The plants in this spot at heading time were 4 or 5 inches shorter than the more normal plants about them and headed out about a week later. Subsequently scattered lesions occurred on lower leaves throughout the plot and undoubtedly came either from the first infections observed or from the neighboring plots. If these primary infections had been produced by soil organisms they would probably have been much more general. Either sterilization of seed was not complete or else the infection came from the neighboring plots.

An experiment with hot-air treatment of seed gave additional proof that the organism is seed-borne. A plot from Graber oats heated to 100° C. for 30 hours showed no lesions throughout the season. There was not a single spot. The plot from untreated Graber oats showed an abundance of halo lesions through May and June. On every plant there was some spotting and many lower leaves were yellowed and dead.

This early appearance of lesions on seedlings grown on new soil, the appearance of typical halo lesions on the glumes and lemmas of the

developing spikelets from which the halo organism was isolated, and finally, the absence of the disease on plants from sufficiently treated seed all lead to the conclusion that this is a seed-borne disease.

HOSTS OTHER THAN OATS

Field observations and artificial inoculation experiments indicate that the halo-blight organism of oats does not readily infect other hosts. No halo lesions similar to those appearing on oats have been observed in the field on wheat, barley, corn, or timothy. In Jefferson and Dodge Counties, Wis., fields of oats and barley were planted so close together that the plants were intermingled at the margins. In both places the oat plants were heavily spotted with halo lesions, but even where these spotted oat leaves came in contact with the barley leaves not a halo could be found on barley. At Arlington Farm, Va., one halo lesion was found on a rye plant growing among infected oat plants, but no plates were made. The field was half oats and half rye, and although practically all the oat plants were spotted no other lesions could be found on rye.

Six different sets of inoculation experiments were carried on in the greenhouse during the winter of 1917-18 to test the pathogenicity of the halo-blight organism on wheat, rye, barley, and corn. The methods of inoculation were the same as those described above. The organisms used were stock and No. 36. The results are given in Table II.

TABLE II.—*Inoculations on other plants with halo-blight from oats*

Host.	Experiment I, stock.	Experiment II, stock.	Experiment III, stock.	Experiment IV, stock.	Experiment V, stock.	Experiment VI, No. 36.
Wheat.....	—	—	+	—	—	++
Rye.....	—	+++	—	—	+	+
Barley.....	—	+	+	—	—	++
Spelt.....	—	—	—	—	—	—
Corn.....	—	—	—	—	—	—
Oats, Wisconsin 14.....	+++	+++	+++	+++	+++	+++
Controls.....	—	—	—	—	—	—

+ Slight infection.
++ Moderate infection.

+++ Heavy infection.
— No infection.

Halo lesions were obtained on wheat in two different experiments, in the second of which the halo lesions were not so large but almost as numerous as on oats.

In three out of six experiments halo lesions were produced on rye. In the first, infection was so heavy that there was a general wilting of the leaves. Typical white organisms were isolated from these leaves which on reinoculation produced halo lesions on oats but not on rye.

Halos on barley were obtained in three out of six inoculation experiments. There were eight halos in the first experiment and two in the second. In the third experiment, six leaves had one or more halos.

Reisolation from the first halos gave typical white colonies which on sub-culture and reinoculation produced halos on barley and oats.

No halos were obtained on corn in four experiments, and no halos were obtained on broom corn in later experiments. Oat plants inoculated at the same time always showed abundant infection. It is evident that the halo-blight organism may attack wheat, rye, and barley to a slight extent; but in Wisconsin, at least, halo lesions in the field rarely, if ever, appear on anything but oats.

VARIETAL SUSCEPTIBILITY

All observed varieties of cultivated oats are attacked by the halo-blight to some extent. Wisconsin No. 14, both in the field and in the greenhouse, is more susceptible than any other variety and shows more lesions in later stages of development, especially on the flag leaf, rachis, and spikelets. Two varieties, Wisconsin No. 13 and Wisconsin No. 15, grown in the fields on either side of Wisconsin No. 14 during 1917, showed considerable resistance. Although leaves of Wisconsin No. 14 were badly spotted, the leaves of Wisconsin No. 13 and 15, which came in contact with them, showed little spotting. In the first plot (from 1916 untreated seed), described above, Wisconsin No. 128 showed only six primary infections, while Wisconsin No. 124 showed 169. In the second plot (from 1917 untreated seed) some varieties showed only slight secondary infections, others moderate, and some heavy infection.

Inoculation experiments in the greenhouse also brought out differences in varietal resistance. Wisconsin No. 1, 5, and 14 were used for several experiments, Wisconsin No. 14 always showing so much heavier infection than either of the other two that Wisconsin No. 1 and 5 were no longer used. Wisconsin No. 1 showed more resistance to infection than Wisconsin No. 5.

While certain varieties are more susceptible than others under ordinary conditions and show fewer primary lesions at the beginning of the season, as above indicated, the differences are not marked in severe blight years as the season advances.

RELATION OF ORGANISM TO HALOED TISSUE

The oval outline of the halo, its rapid spread from the point of infection, and the fact that the haloed tissue remains normal, apparently, except for loss of color, have led to the conclusion that the discoloration is probably due to some diffusible substance produced by the bacteria rather than to their immediate presence. To determine whether or not the bacteria were equally distributed throughout the lesions, isolations were made from pieces of tissue cut from the centers of lesions and from points at varying distances from the center as shown in the following diagrams. Isolations were made after treatment with mercuric chlorid as described above. The distribution of bacteria throughout the halo lesions is shown in Plate 33 and Table III.

The first two lesions used were produced by artificial inoculation. The last three were natural infections from the experimental plots. In all of the five isolations only the plates from the centers of the lesions showed any growth at all, and these plates were heavily seeded with typical white colonies. The only exception is the one colony on a plate from isolation IV, section 2. In isolation I the broth cultures from sections outside the center did not even cloud. In other isolations where broth cultures from sections outside the center clouded, subsequent plates showed that the clouding was sometimes due to the growth of the halo organism and sometimes to contamination.

The bacteria are evidently abundant only in the centers of the lesions, and if any do occur outside in the halo they are very few in number. This indicates that the discoloration of the halo-tissue is due only indirectly to the presence of bacteria, and that some enzym or toxic by-product destroys the chlorophyl. A suggestion of what this by-product might be was obtained from some plates of potato-dextrose agar on which colonies of the blight organism were growing. When colonies of the stock organism were 3 days old distinct halos appeared in the agar about the colonies as illustrated in Plate 32, B. The agar around these colonies was less translucent than that outside the halos and was distinct in outline. These halos in the agar increased in diameter from day to day, showing the concentric circles of growth illustrated in the plate and characteristic of the lesions on oat leaves. Acetic acid dropped on the agar-plate halos cleared them in a minute or two. Drops of ammonium carbonate $[(\text{NH}_4)_2\text{CO}_3]$ and ammonium chlorid $[\text{NH}_4\text{Cl}]$ on sterile plates of the same potato agar produced in a few minutes halos similar in size and appearance to those produced by the colonies of bacteria. Acetic acid also cleared these halos. Litmus was added to melted potato agar at the rate of one drop of a saturated solution to 10 cc. of the agar, and plates were poured. Streaks of stock were made across the agar as soon as it had hardened. Similar streaks on plain potato agar produced distinct halos about them in two days. In the same time the litmus potato agar had turned a distinct blue for 1 cm. or more on all sides of the growth. It seems probable, therefore, that the ammonia produced by the blight organism is responsible for the destruction of the chlorophyl and for the halolike lesions produced in the oat plants.

Stained sections of haloed leaf tissue also show bacteria only in the center of the lesion. The bacteria at first are intercellular, but later they destroy the cell walls and cause the collapse of the tissue. The collapsed tissue is evident as the dead brown centers of lesions. (See Pl. 35, C.)

COMPARISON WITH OTHER SIMILAR BACTERIAL DISEASES

Seasons of excessive rainfall and of abnormal conditions in the oat fields similar to those of 1918 have been recorded for 1890 and 1907-8. For the earlier record we are indebted to Galloway and Southworth, of the United States Department of Agriculture (1), and for the later work to Thomas F. Manns, of the Ohio Experiment Station (3).

WORK OF GALLOWAY AND SOUTHWORTH

In 1890 Galloway and Southworth (1) published a preliminary note on what they termed "a new and destructive oat disease." This disease appeared in May and June of that season and was so widespread and severe as to threaten to destroy the entire oat crop of the eastern and central States. The signs described were a browning of the tips of the lower leaves, which spread until in a short time all the leaves were dead and brown. Bacteria were found in these lesions. The account of the disease by these authors, however, is too meager to afford any basis for judgment as to whether or not it was the disease here described.

During the seasons of 1906-1909 blade-blight of oats was recorded again over a fairly wide area, and in 1907 it was so severe in some fields as to occasion a loss of from one-half to two-thirds of the crop. In 1908 the blight was threatening at one time but eventually caused little loss. The accounts of the disease from southern Canada and central and eastern States are of the same general kind. They mention a general yellowing of the lower leaves of young plants, the yellow color changing to a brown or red under weather conditions unfavorable to the organism, such as a sudden change from cool, cloudy weather to bright sunshine and higher temperature. The fields are often described as having a rusted appearance because of this reddening of the blades. The trouble was attributed to various causes—to insects, to bacteria, to fungi, and to unfavorable weather conditions.

In 1908 Dr. Erwin F. Smith discovered this disease at Arlington Farm, Va., photographed it, cut sections, and made cultures of the organism on various media, but did not publish upon it nor make any inoculations, although it is quite certain from the type of the disease and the nature of the cultures that he had the same organism here described. This was perhaps its first isolation in pure culture.

No other serious research work was undertaken until Thomas F. Manns carried on his investigations during the seasons of 1908-9 at the Ohio Experiment Station.

WORK OF THOMAS F. MANNS, 1906-1909

Manns (3) states that—

the disease manifests its presence by changes in color varying from a light yellowing, which apparently checks but little the growth of the oats, to a pronounced reddening, which in severe cases kills the blades, leaving only the younger leaves and the central axes alive.

The primary yellowing sooner or later changes to a mottled red or brown. In another place he says:

The preliminary effects of this disease is a yellowing, beginning either as small, round lesions on the blade, or as long, streak lesions extending throughout the blade or even the whole length of the culm and blade. Occasionally it begins at the tips and works back into the culm; again the upper leaves often break down through a weakened condition of the plant from defoliation below.

When lesions work back from the leaves to the culm a general yellowing and collapse of all the foliage may result. In 1909—

the disease in the majority of infected leaves began as small yellow spots on different parts of the blades. When these points of infection were numerous, the infected areas quickly became confluent, and the collapsed leaf showed a brownish mottled appearance.

These brief statements are the only references in the bulletin (exclusive of Pl. XIII) to anything at all corresponding to the lesions characteristic of the blight here described, and there is much that is contradictory. His colored figures as well as most of his text indicate an entirely different disease, but his Plate XIII shows that this halo-disease formed at least a part of the phenomenon under consideration. The distinct reddening which he describes and which he illustrates in Plates X and XI was not observed anywhere in Wisconsin even in the worst blight year, 1918. A distinct reddening of oat leaves was observed in our plots but was not due to the halo-blight. Two unsuccessful attempts were made by the writer to isolate bacteria from these reddened leaves. Manns attributes the severity of the outbreak in 1907 to the abnormally low temperatures of April, May, June, and July and to the unusual amount of rainfall during those months and gives convincing climatological data in support of his conclusion. He states that the results of artificial inoculation in the greenhouse also support this theory that cool, humid weather conditions favor the disease.

Through isolation and inoculation experiments Manns came to the conclusion that the blade-blight of oats was due to two species of bacteria living in symbiotic relations within the host tissue (*Pseudomonas avenae* Manns and *Bacillus avenae* Manns). His isolations were made by sterilizing the blades in 2 to 1,000 mercuric chlorid solutions for 1 to 1½ minutes and following this by four washings in sterile water. He states that in practically all isolations from diseased oats these two bacteria were found to be more or less abundant, and when occurring together they could be plainly seen on the agar poured plates in from 2 to 3 days. The yellow organism (*Bacillus avenae* Manns) always appeared first. As a rule, the white organism predominated.

Inoculations were made by Manns in several ways: (1) Directly from crushed leaves; (2) by hypodermic injection, using separate pure cultures of the white and the yellow organism; (3) by hypodermic injection, using the two cultures mixed (3, Pl. X); (4) by spraying mixed

cultures on injured and uninjured leaves; (5) by root inoculations without wounds, using mixtures of the two organisms; and (6) by means of grain aphids.

He reports that inoculations in the field and in the greenhouse showed that the yellow organism when used alone produced no lesions and that the white organism when used alone produced only "limited and non-typical lesions," which formed slowly, extended from $\frac{1}{2}$ to 1 inch from the point of infection, and then remained checked. When a mixture of the two organisms was used the lesions appeared in from 10 to 12 days and spread rapidly. From these results he concludes that the disease is a symbiosis, the white organism requiring the presence of the yellow organism to be actively pathogenic.

He also states that the virulence and viability of the white organism on artificial culture media depend greatly upon association with the yellow organism and that the pathogenic action of the white organism was more marked when carried over winter in mixed culture with the yellow organism than when carried over separately. After nine months in pure culture the white organism failed in several instances to grow.

Manns states that endospores occur. These were stained with hot carbol fuchsin from 2-months-old cultures. The figure of these spores in his Plate IX is too indistinct to be of any value in verifying his statement.

His white organism is described as a short motile rod with polar flagella. These are three to five times the length of the rods in his Plate IX, fig. 4, and one to six times those in his text figure No. 1. The rods measure in the majority of cases 0.75 by 1.5 μ . They are rarely in chains of three to four.

The thermal death point is 60° C. The optimum temperature is 20° to 30°. He states that his organism is pathogenic on oats, corn, timothy, barley, wheat, and bluegrass.

The group number for his white organism is given as 111.2223032. Manns' yellow organism is a bacillus with the group number 222.2223532.

Manns suggests the probability of the organism's wintering over in the soil and so being distributed to the leaves by spattering rains. He states that there is no doubt that on seedlings lesions sometimes start on the roots or on that part of the stem in contact with the soil. He does not describe these lesions. The possibility that the disease is seed-borne is not mentioned.

Manns' descriptions of individual lesions are so meager and his descriptions of general signs so inclusive as to lead to grave doubt about his having worked with a single bacterial disease. There is no doubt, however, that he sometimes had typical halo-blight lesions, because of his Plate XIII, but with this exception there is no conclusive evidence from either his text or figures that he had this disease under observation; and the

result of his inoculations as indicated on his colored plates is quite contradictory.

The chief differences between the two white organisms *Pseudomonas avenae* Manns and *Bacterium coronafaciens*, n. sp., are summarized below:

PSEUDOMONAS AVENAE MANNS.

1. Produces typical blight lesions only when used with *Bacillus avenae* Manns (a yellow organism).
2. Spreads throughout the lesion when used alone.
3. Virulence and viability on artificial media dependent upon association with *Bacillus avenae* Manns.
4. Viability and virulence greatly reduced by a number of transfers.
5. Growth feeble on artificial media. (See 3, Pl. VIII, fig. 3.)
6. Liquefaction of gelatin stabs begins in 7 to 12 days.
7. Pitting of gelatin colonies begins in 7 days.
8. Visible growth in broth in 3 days.
9. Manns does not record browning of broth or other media.
10. Milk not coagulated in 30 days.
11. Acid to litmus milk.
12. No reduction of litmus milk recorded.
13. Strictly aerobic.
14. No ammonia produced.
15. Nitrates reduced.
16. Limits of growth, -5 to +15.
17. Thermal death point 60° C.
18. Internal structure of agar colonies amorphous.
19. In hanging drop there are few motile organisms.
20. Growth viscid on agar.
21. Produces clostridium forms in one week on nutrient glucose agar.
22. Produces endospores.
23. Does not form long chains.
24. Shorter and thicker than *Bacterium coronafaciens*. Average size 0.75 by 1.5 μ .
25. Lives over in the soil.
26. Pathogenic on oats, corn, timothy, barley, wheat, and bluegrass.

Group number 111.2223032.

BACTERIUM CORONAFACIENS, N. SP.

1. Produces typical halo-blight lesions when used in pure culture.
2. Found only about the point of infection and not throughout the halo.
3. Virulence and viability not dependent on another organism.
4. Viability and virulence not reduced by transfer.
5. Growth abundant on artificial media. (See Pl. 30, A, B, a, b.)
6. Liquefaction begins in 3 days.
7. Pitting begins in 3 days.
8. Visible growth in 1 day.
9. Broth and other media turned brown.
10. Milk usually coagulated in 5 to 7 days.
11. Alkaline to litmus milk.
12. Litmus milk reduced.
13. Facultative anaerobic.
14. Ammonia produced.
15. Nitrates not reduced.
16. Limits of growth, -18 to +27.
17. Thermal death point 47° to 48° C.
18. Internal structure of agar colonies not amorphous. (See Pl. 31.)
19. Active motile organisms in hanging drop.
20. Growth butyrous.
21. No clostridium forms observed in any medium.
22. Does not produce endospores.
23. Forms chains and long filaments.
24. Average size 0.65 by 2.3 μ .
25. Lives over winter on the seed.
26. Pathogenic on oats, barley, wheat, and rye.

Group number 221.2323023

A bacterial disease producing lesions similar to those of the halo-blight of oats has been described from tobacco (10). The lesions are similar to

the halos of oats in that they form "circular chlorotic areas" 2 to 3 cm. in diameter with minute brown centers. The oat lesions, however, have no water-soaked borders, and the affected tissues do not fall out as in tobacco wildfire. A white organism has been isolated from these lesions which differs from the halo-blight organism in the points mentioned below:

HALO-BLIGHT ORGANISM.	TOBACCO ORGANISM.
One to several polar flagella.	One polar flagellum.
Single to long chains.	Single to chains of five elements.
2.3 by 0.65 μ .	3.3 by 1.2 μ .
Capsules.	No capsules.
Odor in agar stroke.	No odor in agar stroke.
Casein not precipitated in litmus milk.	Casein precipitated in litmus milk.
Ammonia produced.	Ammonia not produced.
Thermal death point 47° to 48° C.	Thermal death point 65° C.

The halo lesion so characteristic of this oat disease does not occur in the blackchaff disease of wheat (6-9) or the bacterial blight of barley (2), while the oat disease lacks the translucent water-soaked stripes of these diseases as well as the exudate so abundant in both. R. H. Rosen has recently published a preliminary note on a bacterial disease of foxtail (4), which he thinks may be similar to the halo-blight of oats. His description of lesions as dark brown spots or streaks, however, makes it probable that if it is similar to either bacterial disease of oats it would resemble stripe-blight rather than halo-blight. The writer has not observed halo lesions on foxtail and in two sets of field inoculations has obtained no infections on foxtail with the halo organism.

CONTROL MEASURES

The evidence that the halo-blight of oats is seed-borne seems conclusive. However, no practical method of seed treatment has, as yet, been found which will entirely control the disease. Treatment with formalin for smut controls halo-blight to a marked extent but not entirely. In 1917, treated seed of 33 Wisconsin varieties did not show a halo lesion throughout the season, while the same untreated varieties all showed some halo-blight. In 1918, 44 treated varieties of Wisconsin oats developed primary lesions which, however, were later and fewer than on the same untreated varieties. Even when the blight was most severe it was only about half as heavy in the treated plots as in the untreated. The plot from Wisconsin No. 14 treated seed showed very few primary lesions and little secondary spotting except in patches about these primary lesions. This would indicate that soaking for three hours in 1 to 320 formalin kills many but not all of the organisms on the seed. In Jefferson County, Wis., where most of the seed was treated for smut, the blight during the 1918 season was much less abundant than in Dodge County, where seed treatment was not general.

Another method of seed treatment is being developed at Wisconsin which in 1918 entirely controlled halo-blight. The treated seed was heated in a gas oven at 100° C. for 30 hours. The plot from this treated seed did not show a single halo lesion even during the time when other oats were most severely attacked. The plot from untreated seed of the same variety showed primary infections on 10 per cent of the plants and 100 per cent secondary infections on the lower leaves during May and the first two weeks in June. While oats in good condition successfully withstand this treatment of 30 hours at 100° C., a similar treatment for a shorter period would perhaps be just as effective. The commercial application of this treatment has not as yet been worked out.

SUMMARY

A bacterial disease known as halo-blight was unusually severe in its attack on oats throughout Wisconsin during the 1918 season, and reports of a similar disease were received from southern Minnesota, Iowa, northern Illinois, and Indiana. Such epidemics occur under particularly favorable weather conditions, disappearing with the advent of weather conditions more favorable to the development of the host plant.

Typical lesions of halo-blight are characterized by halolike margins of chlorotic tissue about a center of dead tissue.

Isolations from these lesions have constantly given a typical white organism. Yellow organisms also appear from isolations when the surface of the tissue has not been sterilized.

Inoculation experiments have shown conclusively that the white organism alone is responsible for the production of typical lesions. The yellow organism is evidently a surface saprophyte.

Since few if any organisms are found outside the central infection area, the halo is thought to be due to a diffusible substance, probably ammonia.

The organisms live over winter on the seed, producing primary lesions on the first leaves of seedlings. From these lesions the organisms are carried to other leaves by wind and rain.

It seems probable that the percentage of blasting on oat panicles varies with the severity of the halo-blight from season to season. This blasting seems to be due to the same unfavorable weather conditions which favor the development of the bacterial blight rather than to the disease itself.

Halo-blight lesions from natural infections have never been observed on any hosts except oats and rye. Artificial inoculations show that the halo organism may be slightly pathogenic on wheat, rye, and barley.

When the halo-blight is not too severe, different varieties of oats show differences in susceptibility to the disease.

The organism isolated and described by the writer has the group number 221.2323023. No other white organism used by the writer has produced anything similar to the halo lesions. Other white organisms have in fact produced no lesions on oats. Three strains of softrot organisms with internal markings very much like those of oat colonies have been used, and also the white organism, *Bacterium atrofaciens* McC., which produces lesions on wheat. The name of *Bacterium coronafaciens* n. sp. is suggested for this white halo-producing organism.

Treatment with 1 to 320 formalin, as for smut, checks but does not entirely control the disease. A hot-air treatment for 30 hours at 100° C. does control the blight.

LITERATURE CITED

- (1) GALLOWAY, B. T., and SOUTHWORTH, E. A.
1890. PRELIMINARY NOTES ON A NEW AND DESTRUCTIVE OAT DISEASE. *In* Jour. Mycol., v. 6, no. 2, p. 72-73.
- (2) JONES, L. R., JOHNSON, A. G., REDDY, C. S.
1917. BACTERIAL BLIGHT OF BARLEY. *In* Jour. Agr. Research, v. 11, no. 12, p. 625-644, illus., 4 pl. (1 col.). Literature cited, p. 643.
- (3) MANNS, THOMAS F.
1909. THE BLADE BLIGHT OF OATS, A BACTERIAL DISEASE. Ohio Agr. Exp. Sta. Bul. 210, 167 p., illus., 15 pl. Literature cited, p. 166.
- (4) ROSEN, H. R.
1919. A PRELIMINARY NOTE ON A BACTERIAL DISEASE OF FOXTAIL. *In* Science, n. s. v. 49, no. 1264, p. 291.
- (5) SMITH, ERWIN F.
1905. BACTERIA IN RELATION TO PLANT DISEASES. v. 1. Washington, D. C. (Carnegie Inst. Washington Pub. 27.)
- (6) ———
1917. BLACK CHAFF OF WHEAT. *In* U. S. Dept. Agr. Bur. Plant Indus. Plant Disease Survey Bul. 2, p. 40.
- (7) ———
1917. A NEW DISEASE OF WHEAT. *In* Jour. Agr. Research, v. 10, no. 1, p. 51-54, pl. 4-8.
- (8) ———
1918. BLACK CHAFF OF WHEAT. *In* U. S. Dept. Agr. Bur. Plant Indus. Plant Disease Survey Bul., v. 2, no. 6, p. 98-99.
- (9) ——— JONES, L. R., and REDDY, C. S.
1919. THE BLACK CHAFF OF WHEAT. *In* Science, n. s. v. 50, no. 1280, p. 48.
- (10) WOLF, F. A., and FOSTER, A. C.
1918. TOBACCO WILDFIRE. *In* Jour. Agr. Research, v. 12, no. 7, p. 449-458, illus., pl. 15-16.

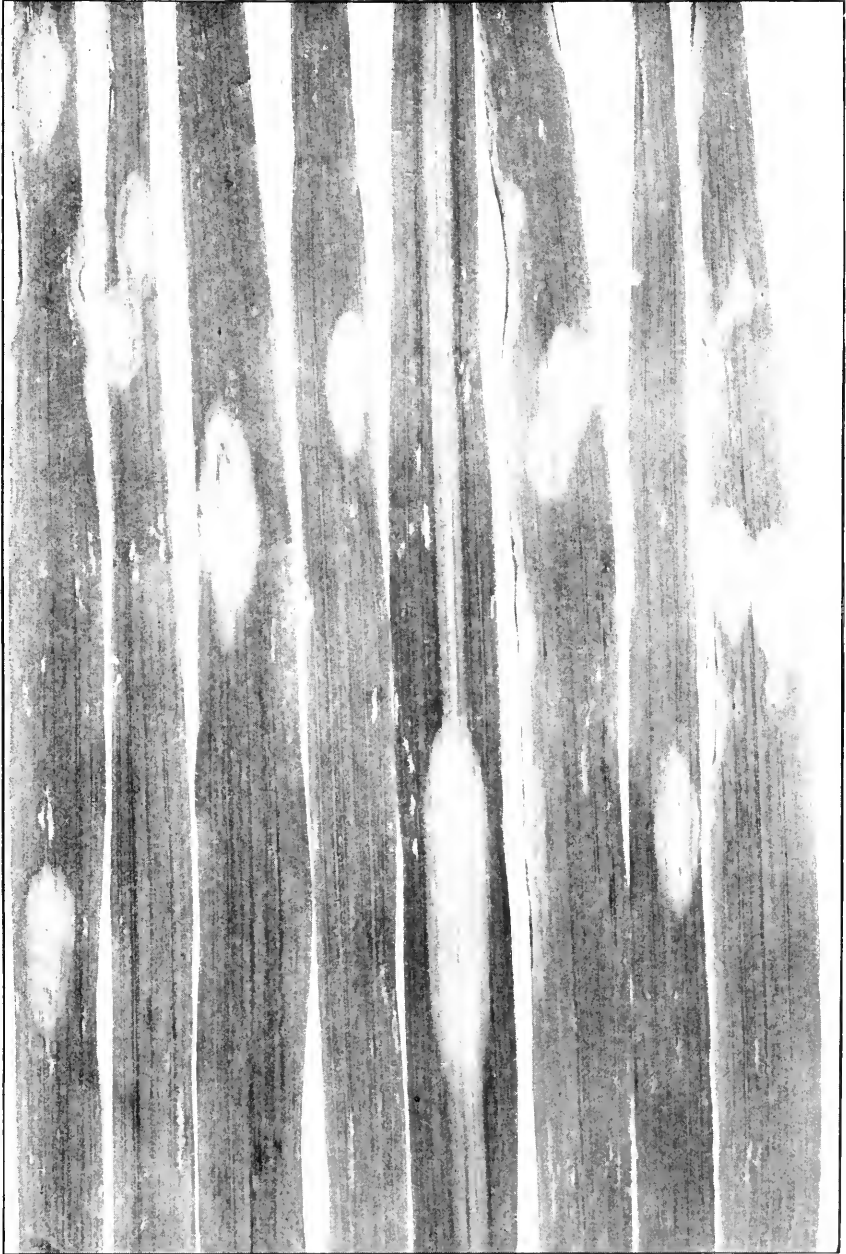

PLATE C

Halo lesions on flag leaves of Wisconsin No. 14 oats. Natural infections from Hill Farm, Madison, Wis. Photographed June, 1917.

PLATE 26

Typical isolated halo lesions. Natural infection on Graber oats. Photographed June 24, 1918. Natural size.



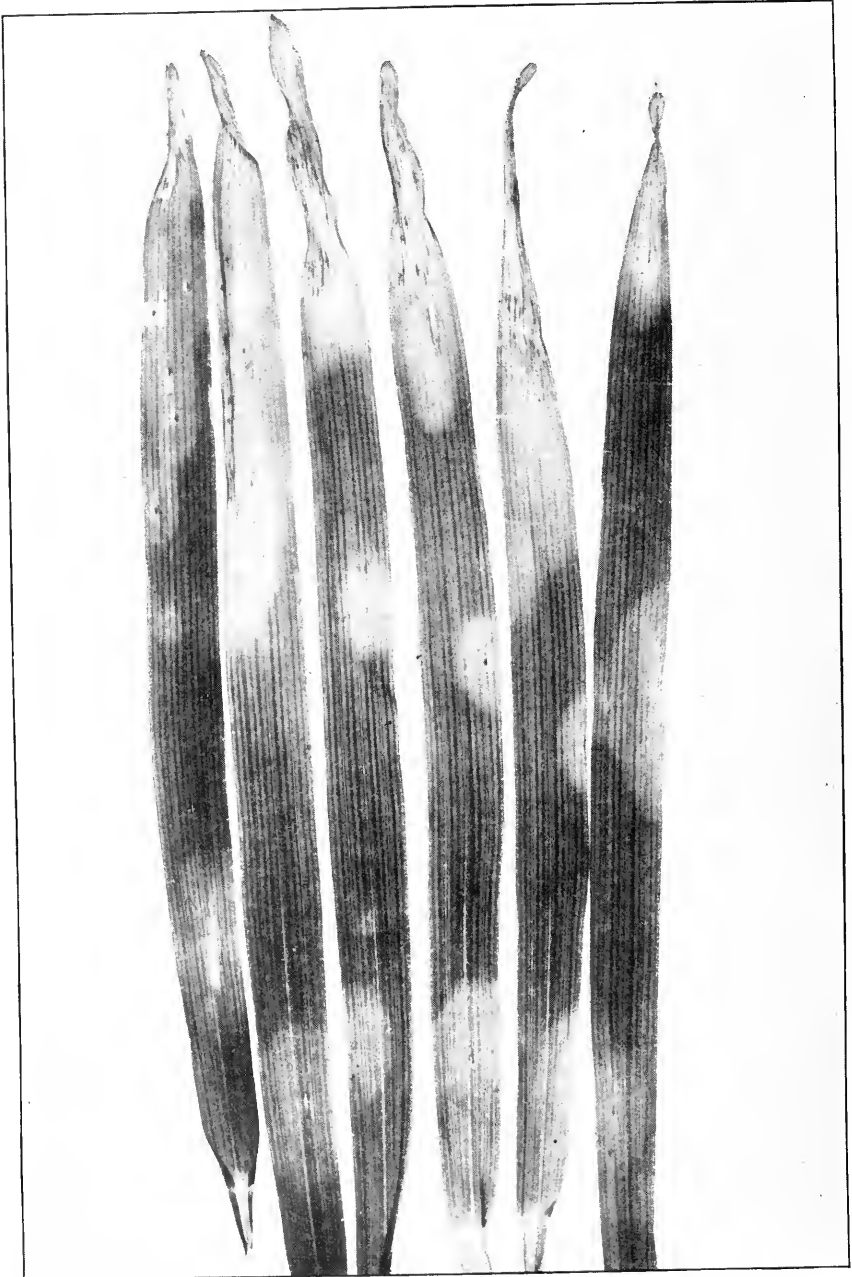
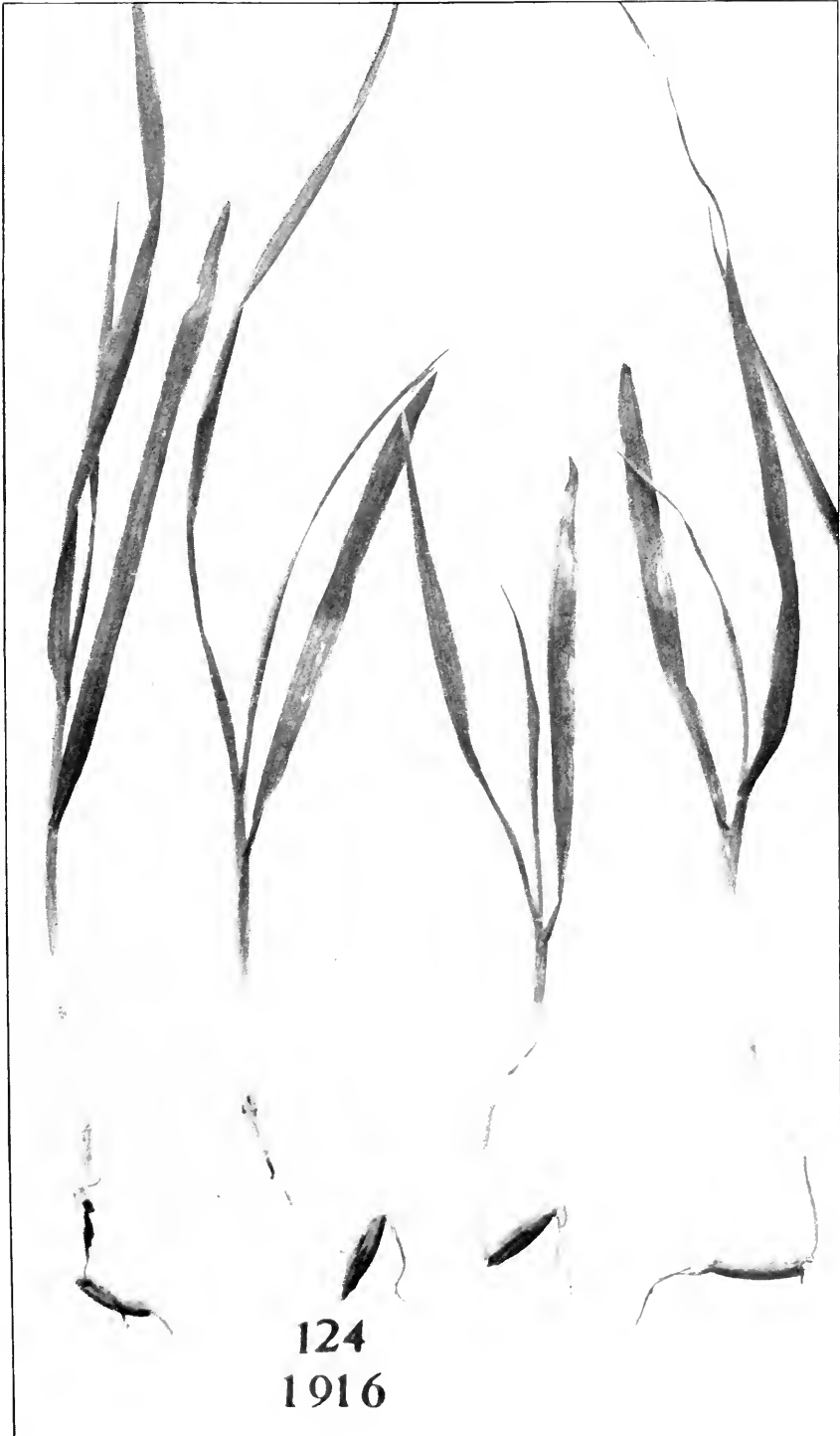

PLATE 27

Halo lesions on Wisconsin No. 14 oats produced by spraying with a water suspension of the stock organism May 26, 1917. Photographed May 31, 1917.

PLATE 28

Infection from untreated 1916 seed of Wisconsin No. 124 oats. Planted April 24, 1918. Photographed May 17, 1918.



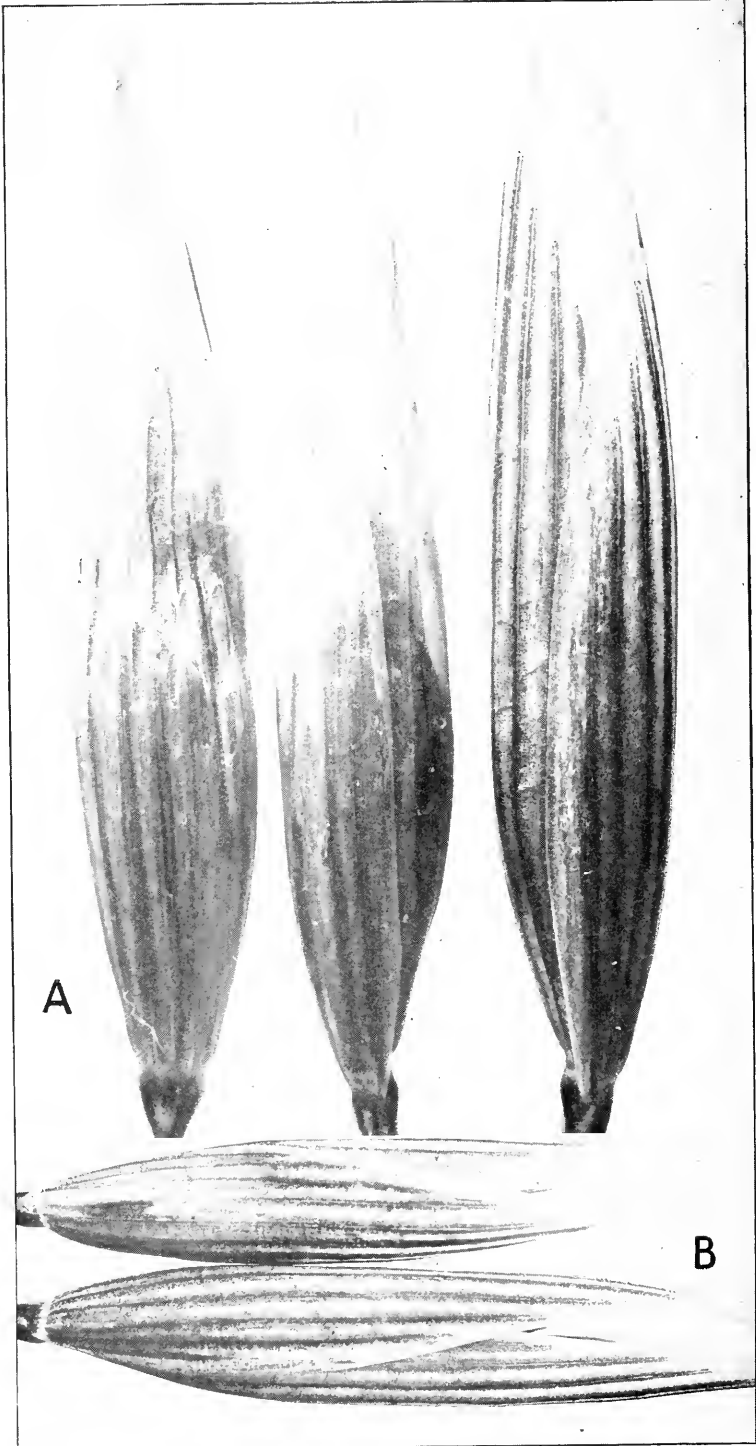

PLATE 29

Spikelets of Wisconsin No. 14 oats:

A.—Left and center spikelets show natural infection with halo-blight. Tips yellowed and translucent. Spikelet at right normal, unspotted. Photographed July 17, 1918.

B.—Upper spikelet shows typical isolated halo lesion near base. Lower spikelet normal, unspotted.

PLATE 30

A.—Two per cent +5 glucose Diico peptone beef bouillon agar slant of No. 36. Three-day colony. Photographed August 29, 1919. Natural size.

B.—Two per cent potato-dextrose agar slants. *a*, No. 36, white culture, consistency butyrous; *b*, stock, white culture, consistency of boiled starch; *c*, No. 39a, yellow culture.

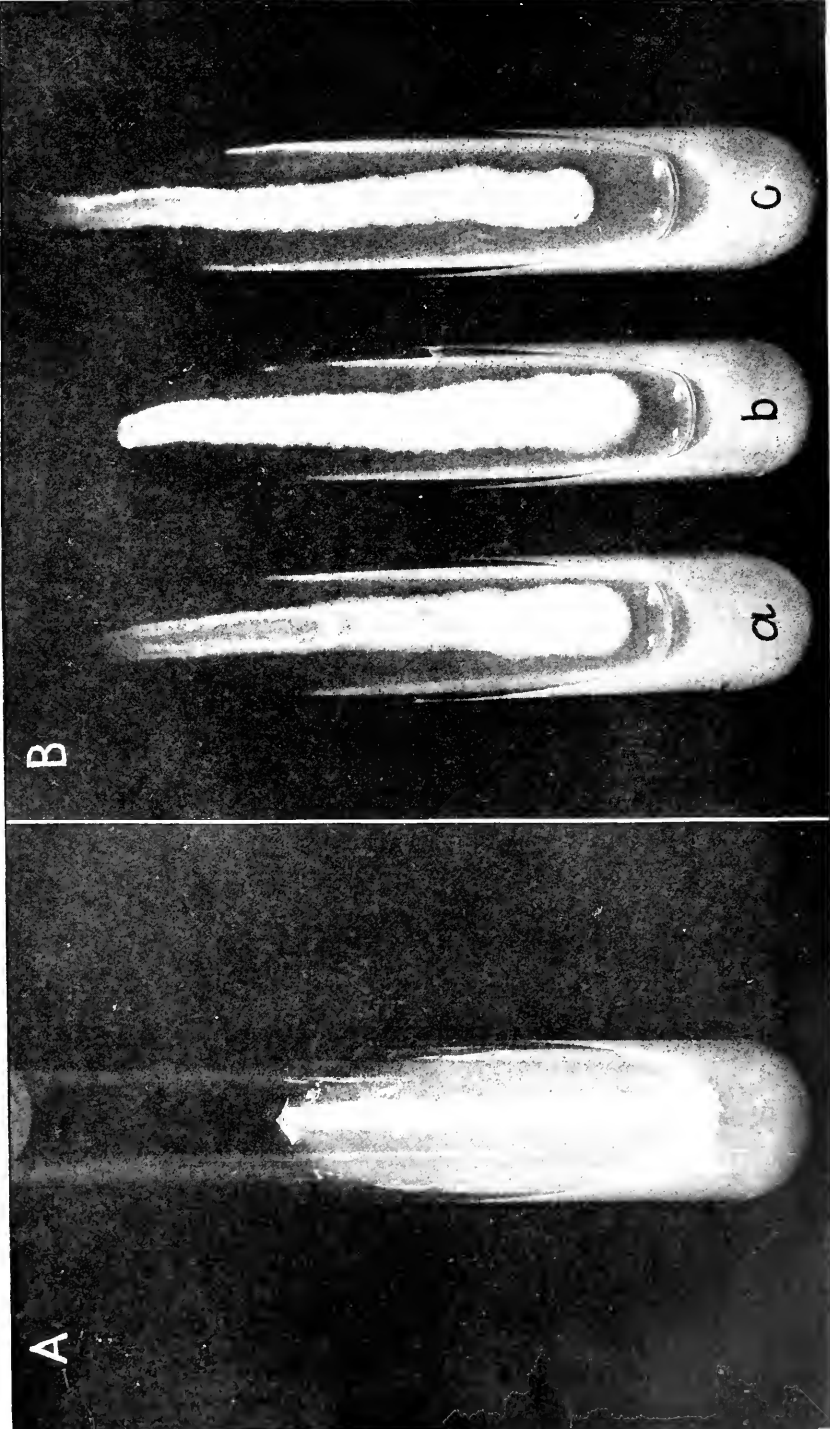

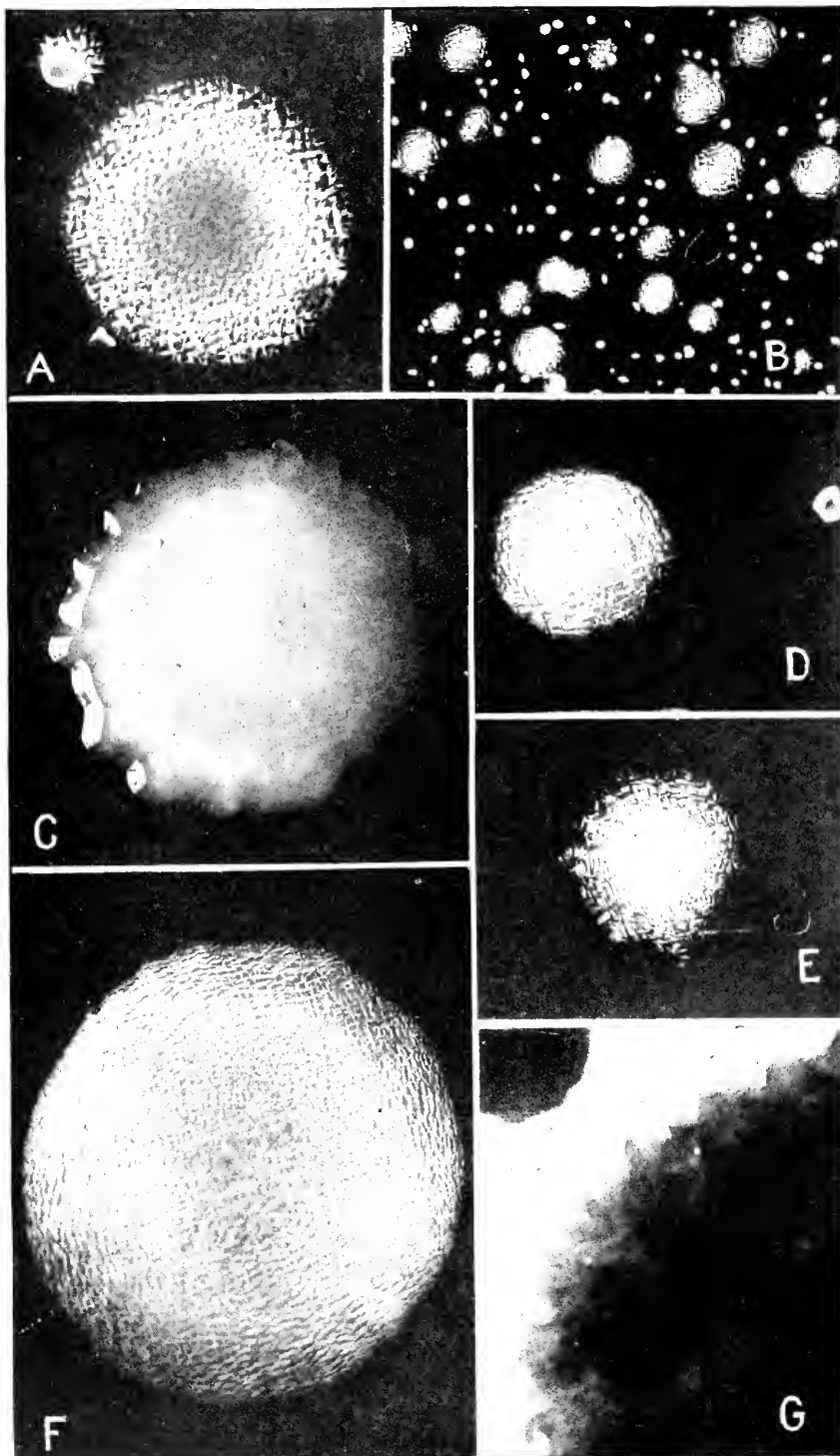

PLATE 31

A.—Three-day colony of stock on 2 per cent dextrose-potato agar. Photographed February 17, 1919, by oblique transmitted light. $\times 10$.

B.—Two-day colonies of stock on + 10 beef-peptone agar. Photographed March 26, 1919, by oblique transmitted light. $\times 10$.

C.—Five-day colony of stock on potato-dextrose agar. Colony of boiled starch consistency. Photographed January, 1918, by reflected light. $\times 7$.

D.—Five-day colony of No. 36 on + 10 beef-peptone agar. Photographed October 1, 1918, by oblique transmitted light. $\times 10$.

E.—Three-day colony of stock on 2 per cent glucose Difco peptone beef bouillon agar. Photographed October 7, 1919, by oblique transmitted light. $\times 10$.

F.—Seven-day colony of stock on + 15 beef-peptone agar. Photographed March 31, 1919, by oblique transmitted light. $\times 10$.

G.—Margin of 3-day colony of stock on + 15 gelatin. Photographed September 30, 1919. $\times 75$.

PLATE 32

A.—Five-day colonies of stock on potato-dextrose agar. Colonies of boiled starch consistency. (For single colony see Pl. 31, C.) Photographed by reflected light. Natural size.

B.—Three-day colony of stock on potato-dextrose agar. Halo about colony. Photographed February 17, 1919, by oblique transmitted light. $\times 5$.

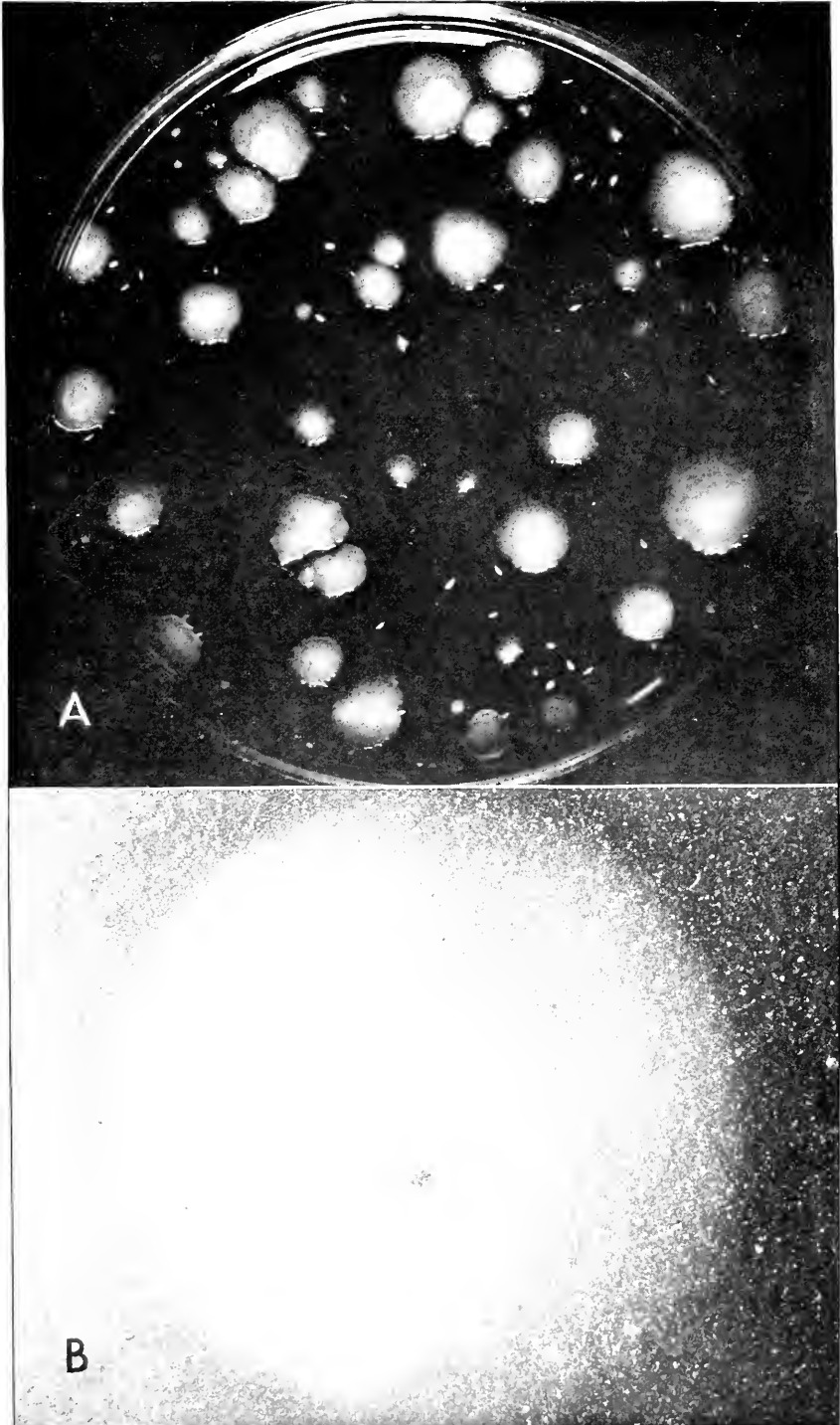

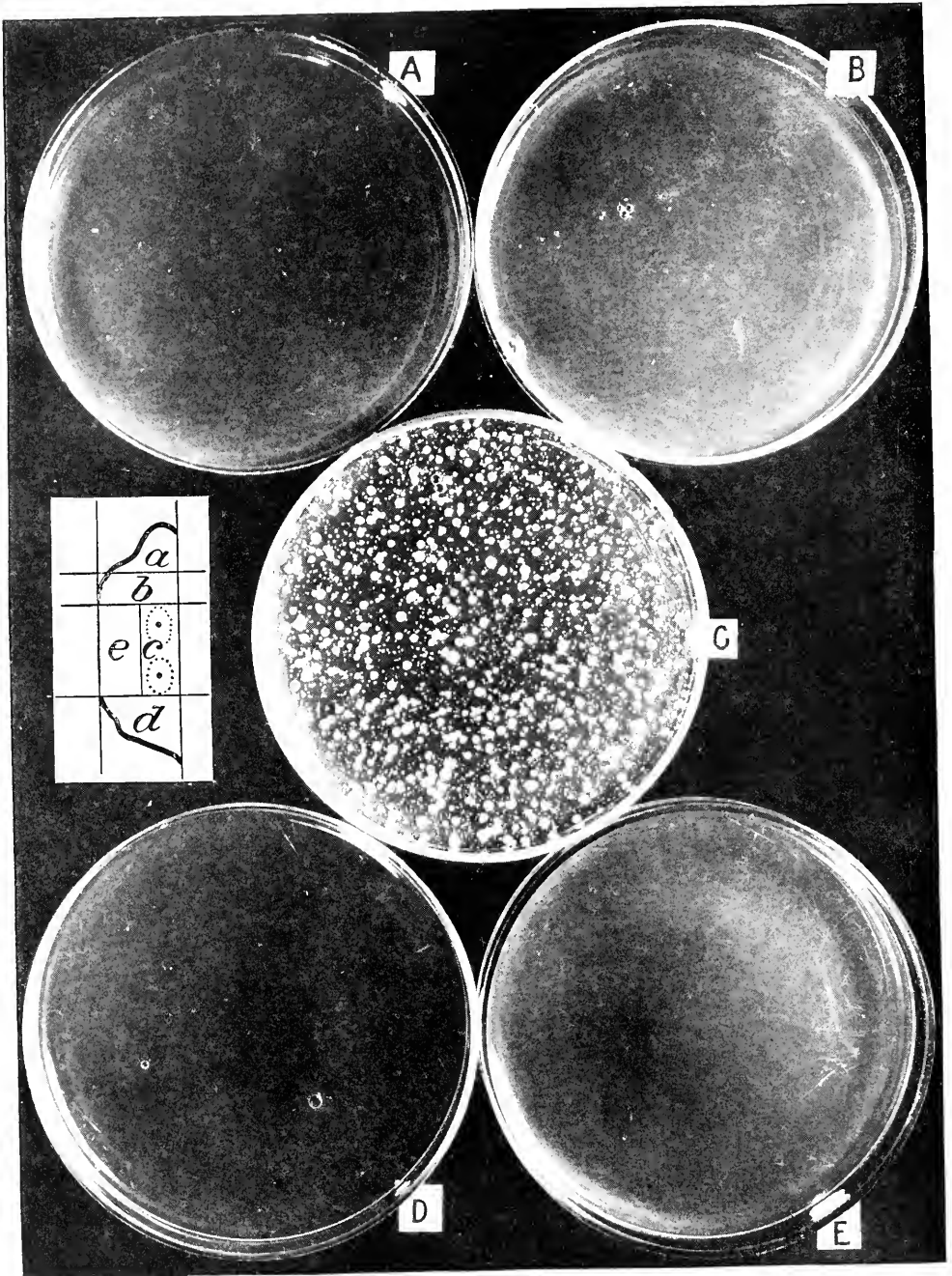

PLATE 33

Isolations from sections of halo lesion. The lesion was from an artificial inoculation with oat stock organism made February 25, 1918. Isolations were made March 13, 1918, on potato agar. The sections were dipped in alcohol and then submerged for one minute in 1 to 1,000 mercuric chlorid. The plate from section *c* is the only one showing colonies of bacteria.

A.—Poured plate of isolation from section *a* of lesion.

B.—Poured plate of isolation from section *b* of lesion.

C.—Poured plate of isolation from section *c* of lesion.

D.—Poured plate of isolation from section *d* of lesion.

E.—Poured plate of isolation from section *e* of lesion.

Photographed March 15, 1918.

PLATE 34

- A.—No. 36 from 24-hour potato-dextrose agar slant; carbol fuchsin stain. $\times 620$.
B.—Stock from 24-hour potato-dextrose agar; Ribbert's capsule stain. $\times 620$.
C.—Stock from 4-day potato-dextrose agar; carbol fuchsin stain, showing long chains. $\times 620$.
D.—Stock from 3-day potato-dextrose agar; Ribbert's capsule stain. $\times 1,550$.
E.—Stock from 1-day + 15 beef-peptone agar; Van Ermengem stain. $\times 1,550$.
F.—No. 36 from 1-day + 5 beef-peptone agar; Caesar-Gil stain. $\times 1,550$.

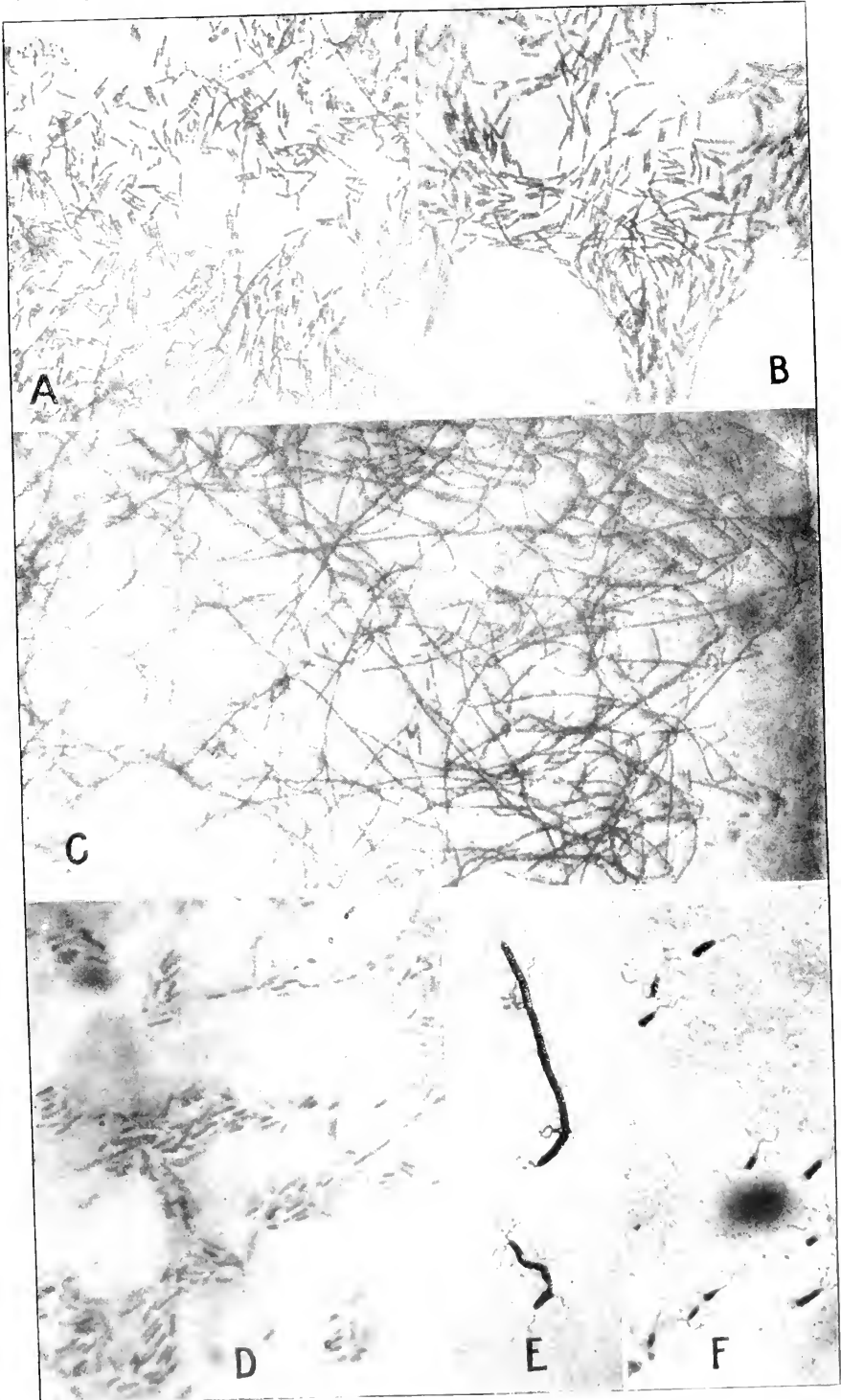

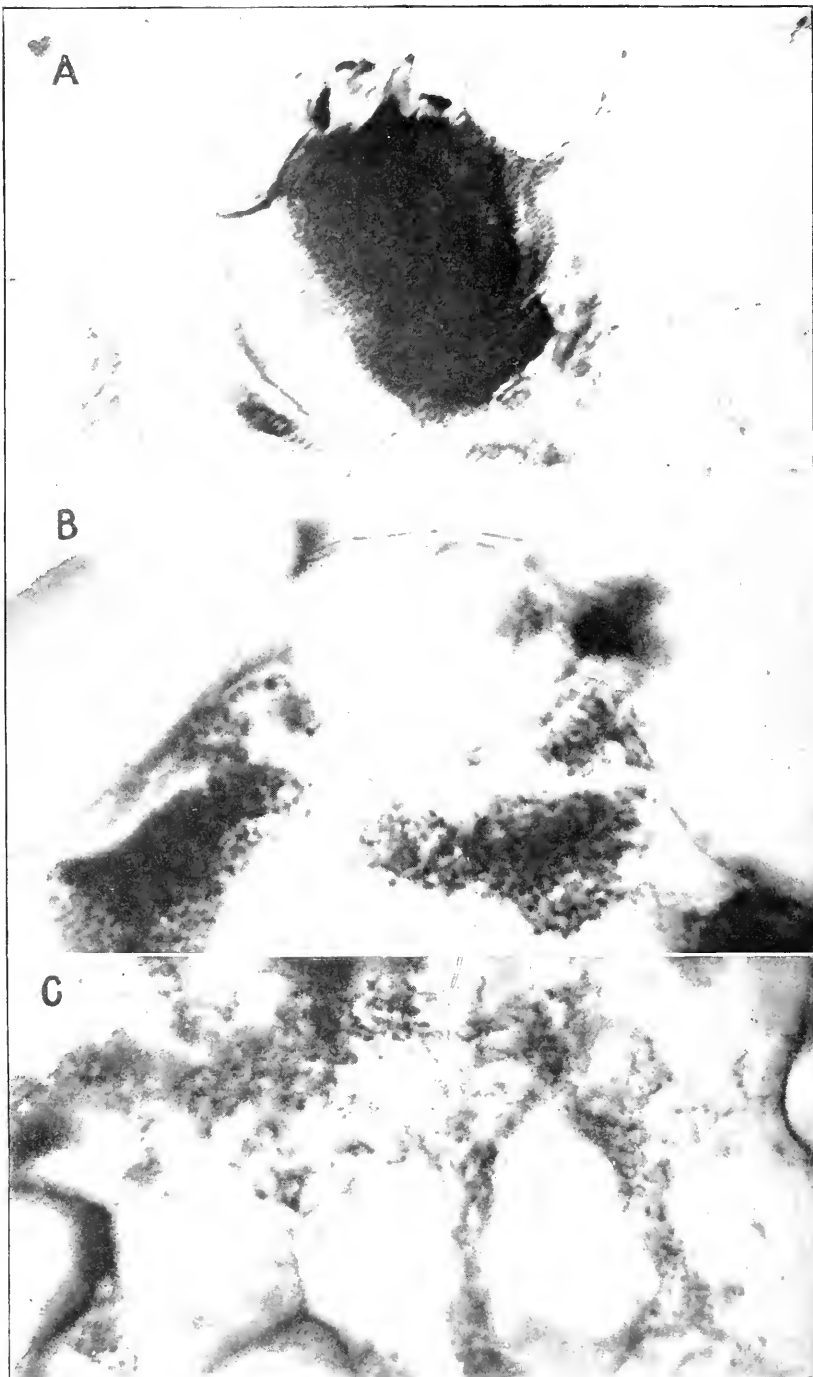

PLATE 35

Sections of oat leaves through halo lesions, showing bacteria in the tissues. Fixed in Gilson's fixative and stained with carbol fuchsin.

A.—Bacteria in substomatal cavity, showing method of entrance of bacteria into the leaf tissue. Cut $15\ \mu$ thick. $\times 700$.

B.—Bacteria in substomatal cavity. Cut $15\ \mu$ thick. $\times 1,650$.

C.—Section of older lesion, showing bacteria between the cells. In the upper part of this section the tissue is disintegrating at about the point of infection.

Photographed August 26, 1919. $\times 1,550$.

INFLUENCE OF FERMENTATION ON THE STARCH CONTENT OF EXPERIMENTAL SILAGE

By ARTHUR W. DOX, *Chief in Chemistry*, and LESTER YODER, *Assistant Chemist*, Iowa
Agricultural Experiment Station

INTRODUCTION

It is not definitely known, though sometimes assumed, that polysaccharoses undergo changes during the formation of silage from green corn. The work reported in this paper was undertaken to determine any changes the starch might undergo together with the nature of these changes and their relation to other important reactions occurring in silage fermentation.

PREVIOUS INVESTIGATIONS

Results of acidity, alcohol, and sugar determinations have been reported by Dox and Neidig (5, 6)¹ and Lamb (9) in investigations extending over initial fermentation periods of 30 days and less. Acids and alcohol are rapidly formed at the expense of the sugar, the rate and extent of the changes depending largely upon the nature of the corn.

Babcock and Russell (2), Hart and Willaman (8), and Esten and Mason (7) have made important contributions bearing upon the common changes occurring in silage.

No investigations concerning the starch of corn silage have been reported. Statements are made in an article by E. J. Russell (13) of the Rothamsted Station to the effect that bacteria are present which attack the less resistant celluloses and that the disappearance of some less resistant celluloses is a characteristic silage change.

EXPERIMENTAL METHODS

The plan followed by the writers provided for the examination of normal experimental silage at various stages of fermentation. Field corn still green, dented, and about at its glazing stage, cut at about 9 a. m., was taken in bags from the farm silage cutter, brought to the laboratory, and further chopped in the laboratory feed cutter. The chopped silage was then thoroughly mixed, and 2.5 kgm. were packed uniformly into each of 10 wide-mouthed glass jars at 3 p. m. of the same day. The jars were then covered, sealed with paraffin, provided with a valve escape for gases, placed in a large box, and well insulated from exterior temperature influences. On the first day the temperature of the silage rose to 29° C. It remained there for two days, then dropped gradually to room temperature by the seventh day.

¹ Reference is made by number (italic) to "Literature cited," pp. 178-179.

Immediately after the jars were filled a sample of the original chopped corn was examined. Thereafter a jar of the silage was opened and examined on the second, fourth, sixth, eighth, twelfth, eighteenth, twenty-ninth, forty-fourth, sixty-sixth, and ninetieth days. Determinations were made for moisture, total acidity, alcohol, total sugar, and starch. As a matter of expediency, qualitative tests were made for the transitional products of starch hydrolysis, namely, soluble starch and dextrins.

Although similar data upon total acidity, alcohol, and sugars have been published, this work was repeated because the amount of these products varies so widely in silage made of corn from different sources that correlation with starch changes in this silage would be impracticable. Furthermore, the determinations serve to show that fermentation was normal; and when arranged in series to show changes beyond the first month, they may furnish information not available hitherto.

METHODS OF ANALYSIS

Determinations of constituents soluble in water were made in centrifuged and filtered juice pressed from 2 kgm. of the silage with an hydraulic press.

MOISTURE.—Four hundred gm. of silage were oven-dried at 100° C. to constant weight.

TOTAL ACIDITY.—Twenty-five cc. of silage juice were diluted to volume in a 100-cc. graduated flask with neutral 95 per cent alcohol, mixed and filtered. A 50-cc. aliquot was pipetted into about 300 cc. of neutralized distilled water and titrated with *N/10* barium hydroxid and phenolphthalein indicator.

ALCOHOL.—The aeration method of Dox and Lamb (4) was used. Twenty-five cc. of silage juice in a 100-cc. cylinder, saturated with ammonium sulphate, were aerated by aspirating air for 24 hours through the alcoholic solution from a dichromate oxidizing solution and through two cylinders, the first containing about 18 cc. and the second about 8 cc. concentrated sulphuric acid. The sulphuric-acid alcohol solution was then transferred to a 500-cc. distilling flask with water free from carbon dioxide, and after the addition of 5 gm. sodium dichromate, it was distilled through a Hopkins trap. The distillate was titrated and the weight of alcohol calculated from its acetic-acid equivalent.

SUGARS.—Determinations were made in preserved samples of the juice. Seventy-five cc. of silage juice were neutralized in a 150-cc. graduated flask with calcium carbonate and made up to volume with absolute alcohol and stored. Of this mixture 100 cc. were diluted to volume in a 250-cc. graduated flask with 95 per cent alcohol. From this point the alcohol extraction method published by Bryan, Given, and Straughn (3) was followed, and sugar was determined by the copper method of Munson and Walker.

STARCH.—After much preliminary work it was found that even by grinding the undried silage in the best grinder available for the purpose a degree of fineness could not be obtained which would give as high results as those secured by drying the silage and then reducing it with a Merker mill till it would pass through a 30-mesh sieve. It was also found that the polarimetric method of Lintner as modified by Porst and Crown (11) gave dependable and highly accurate results.

Five gm. of the powdered silage prepared from the residue of the moisture determination were mixed with 20 cc. of water in a mortar and cooled in ice water. To this there were added 40 cc. concentrated hydrochloric acid previously cooled. The mixture was kept at 20° C. for one-half hour. The contents of the mortar were then transferred to a 200-cc. graduated flask with hydrochloric acid of specific gravity 1.125, and 8 cc. of 4 per cent phosphotungstic acid were added. At this point it was found necessary to add charcoal (norite) decolorizer. The mixture in the flask was made up to the mark at 20° with hydrochloric acid of specific gravity 1.125 and kept at 20° for one-half hour. It was then filtered and exactly 15 minutes after filtering (1 hour and 15 minutes after the addition of the 40 cc. concentrated acid) the reading was taken at 20°. From the rotation of 5 gm. pure starch the percentage of starch in the silage was calculated.

Corrections for the zero reading and for optically active substances other than starch were made as follows: A 5-gm. sample was placed in a 200-cc. graduated flask; 100 cc. of 50 per cent alcohol were added; and the whole was boiled for one hour on the steam bath, then cooled and made up to volume with 95 per cent alcohol, mixed and filtered. A 100-cc. portion of the filtrate was evaporated almost to dryness, diluted to about 20 cc. with water, and cooled. The modified Lintner procedure was then followed as outlined above.

QUALITATIVE TESTS.—(1) For soluble starch the test was made by applying the ordinary starch test with iodine to the centrifuged and filtered juice. (2) The dextrin test consisted in adding a sufficient amount of warm saturated solution of barium hydroxid to produce a flocculent precipitate, quickly cooling and filtering, then precipitating the barium in the filtrate with carbon dioxide, refiltering, and adding a slight excess of hydrochloric acid and dilute iodine solution. The presence of dextrans was shown by a red coloration above that of the iodine solution.

EXPERIMENTAL RESULTS

The results were all calculated to the wet basis of the original silage. No correction is made for the specific gravity of the silage juice, since for all practical purposes this error is entirely negligible.

The data for acidity, alcohol, and sugar given in Table I are similar to data obtained by others. A discussion of these is not an object of

this paper except as they relate to starch changes. These results when compared with similar results obtained by previous investigators with silage produced in silos indicated that the silage was normal in every respect.

The silage of each jar examined had a characteristic silage aroma and was free from molds. The fermentation had passed its maximum activity by the eighth day and continued after the first month at a barely appreciable rate.

TABLE I.—*Analysis of experimental silage at different stages of fermentation*

Age of silage.	Moisture.	Total acidity, ^a	Ethyl alcohol.	Total sugar, as invert.	Starch.
<i>Days.</i>	<i>Per cent.</i>		<i>Per cent.</i>	<i>Per cent.</i>	<i>Per cent.</i>
0.25.....	65.56	38.0	0.01	2.94	10.67
2.....	65.87	126.5	.12	1.84	10.30
4.....	66.75	211.5	.11	.82	9.93
6.....	66.00	262.4	.16	.47	10.41
8.....	66.38	266.6	.10	.55	9.54
12.....	66.62	279.8	.15	.50	9.62
18.....	65.63	288.8	.19	.42	10.01
29.....	66.38	294.7	.26	.32	9.87
44.....	65.50	291.9	.28	.33	10.77
66.....	67.12	316.8	.36	.48	9.54
90.....	66.00	298.3	.39	.48	10.10

^a Expressed in cubic centimeters of *N/10* barium hydroxid required to neutralize 100 gm. of silage.

MOISTURE.—Factors usually affecting the moisture content of silage are seepage and excessive respiration accompanied by decomposition of sugar or higher carbohydrates, as studied by Appleman (1) in picked sweetcorn, seepage resulting in a decrease of moisture, and respiration resulting in an increase. Moisture loss by seepage occurs only in silage having an abnormally high water content. The moisture content of the silage in this case was normal and remained constant at about 66 per cent. No excessive decomposition of carbohydrates by respiration is therefore indicated.

TOTAL ACIDITY.—The silage solution, the medium in which fermentation takes place and which is in contact with the silage starch granules, reached a *N/0.4* concentration by the eighth day and almost *N/0.5* by the sixty-sixth day. Most of this acidity is due to lactic and acetic acids which are little dissociated and leave after all a small concentration of acid. To bring starch into solution in an acid mixture more or less drastic treatment is necessary; strong acids must be used and their dilute solutions must be heated.

ALCOHOLS.—The formation of alcohol in silage is due to both bacterial growth and enzymic action, their combined effects upon the alcohol production being such that alcohol is not present in uniform quantities

throughout the fermentation period. Appreciable increases in alcohol occurred up to the third month, finally reaching a concentration of 0.39 per cent. That there was no marked maximum production of alcohol at any time was due probably at first to oxidation to acetic acid and later to esterification.

SUGAR.—A maximum loss of sugar from the silage occurred by the sixth day, when the sugar had dropped from 2.94 to 0.47 per cent. After the eighth day the results were quite constant, indicating exhaustion of sugar and the presence of reducing substances which were unfermentable under the conditions existing in this silage. Unless the rate of fermentation equals the rate of formation of sugar no formation of sugar from higher carbohydrates is indicated after the eighth day.

SOLUBLE STARCH AND DEXTRINS.—At no time were positive tests obtained for these products in the silage juice. If they are transitional in the decomposition of starch in the silage, they are so rapidly changed to simpler decomposition products that they are never present in reacting quantities even in green corn. Only in cases of rapid gelatinization of relatively large quantities of starch would tests for these constituents be positive in a medium like that existing in silage. Their absence indicates that the insolubility of the silage starch is the limiting factor in such a series of transitional changes in silage and that no extensive hydrolysis of starch occurred.

Microscopic examination of sections of kernels, leaves, and stems showed no difference in the appearance of the starch granules either with or without stains. No change was discernible in the amount of polarization and in the reaction of the granules with chloral hydrate iodine, enzymes, acids, and alkalies as used by Reichert (12) in his chemical differentiation of the starches.

STARCH.—It would have been desirable to include determinations of starch in the undried and fresh silage. Accurate methods for the starch determination, however, require the sample to be in a fine state of division, and such a condition could not be obtained without consequent deterioration of the silage. It was also found that what actually happens when silage is being dried in a drying oven at 100° C. is not gelatinization and hydrolysis with the acids present, as would ordinarily occur in water mixtures of starch at 100°, but rapid desiccation at a temperature below the gelatinization point of corn starch, which is above 65°. The reason for this is apparent from the fact that the evaporating surface is tremendous and the cooling effect due to vaporization is proportional to the amount of water present. When the free water content approaches zero, then the gelatinization and hydrolytic tendencies of starch also approach zero. The partially dried silage gave no positive tests for soluble starch or erythrodextrin, and the sugar content was not greater than that calculated from the determination of sugar in the juice of the fresh silage.

The Lintner method gave almost identical duplicates even when these were run on different days. The variations in the percentages of starch are within 1.23 per cent and are such that no decrease or synthesis of starch is indicated. The lack of consistency in the variations and their correlation with the other fermentation changes gives further evidence that starch is not changed.

SUMMARY

A study of experimental silage at different stages of fermentation which was normal as regards development of aroma and changes in acidity, alcohol, and sugar content leads to the following conclusions:

(1) Changes in total acidity, alcohol, and sugar are entirely independent of the starch content of the ensiled corn and of the silage produced from it.

(2) The first intermediate products resulting from the decomposition of starch are not present in demonstrable quantities.

(3) The starch content remains constant throughout the fermentation process.

(4) The starch granules remain intact, undergoing no physical change that can be detected by microscopic examination.

(5) Since starch constitutes about 10 per cent of the corn plant at the time of ensiling and represents over 400 calories of available energy per kilogram, the fact that no loss occurs during fermentation is an additional argument in favor of silage as an economical feed.

LITERATURE CITED

- (1) APPLEMAN, Charles O.
1918. RESPIRATION AND CATALASE ACTIVITY IN SWEET CORN. *In Amer. Jour. Bot.*, v. 5, no. 4, p. 207-209.
- (2) BABCOCK, S. M., and RUSSELL, H. L.
1900-1901. CAUSES OPERATIVE IN THE PRODUCTION OF SILAGE. *In Wis. Agr. Exp. Sta. 17th Ann. Rpt. [1899]/1900*, p. 123-141, fig. 17, 1900; 18th Ann. Rpt. [1900]/01, p. 177-184, fig. 44, 1901.
- (3) BRYAN, A. Hugh, GIVEN, A., and STRAUGHN, M. N.
1911. EXTRACTION OF GRAINS AND CATTLE FOODS FOR THE DETERMINATION OF SUGARS . . . U. S. Dept. Agr. Bur. Chem. Circ. 71, 14 p.
- (4) DOX, Arthur W., and LAMB, A. R.
1916. AN ACCURATE AERATION METHOD FOR THE DETERMINATION OF ALCOHOL IN FERMENTATION MIXTURES. *In Jour. Amer. Chem. Soc.*, v. 38, no. 11, p. 2561-2568.
- (5) ——— and NEIDIG, Ray E.
1912. THE VOLATILE ALIPHATIC ACIDS OF CORN SILAGE. *Iowa Agr. Exp. Sta. Research Bul.* 7, 32 p.
- (6) ———
1913. LACTIC ACID IN CORN SILAGE. *Iowa Agr. Exp. Sta. Research Bul.* 10, p. 363-378, 4 fig.
- (7) ESTEN, W. M., and MASON, Christie J.
1912. SILAGE FERMENTATION. *Conn. Storrs Agr. Exp. Sta. Bul.* 70, 40 p. Bibliography, p. 37-40.

-
- (8) HART, E. B., and WILLAMAN, J. J.
1912. VOLATILE FATTY ACIDS AND ALCOHOLS IN CORN SILAGE. *In Jour. Amer. Chem. Soc.*, v. 34, no. 11, p. 1619-1625.
- (9) LAMB, Alvin R.
1917. THE RELATIVE INFLUENCE OF MICROORGANISMS AND PLANT ENZYMES ON CORN SILAGE FERMENTATION. *Iowa Agr. Exp. Sta. Research Bul.* 40, p. 311-332, 13 fig. Bibliography, p. 331-332.
- (10) NEIDIG, Ray E.
1914. CHEMICAL CHANGES DURING SILAGE FORMATION. *Iowa Agr. Exp. Sta. Research Bul.* 16, 22 p.
- (11) PORST, Christian E. G., and CROWN, Harry A.
1913. RESEARCH ON LINTNER'S POLARIMETRIC METHOD FOR THE DETERMINATION OF STARCH. *In Orig. Commun. 8th Internat. Cong. Appl. Chem.*, v. 13, sect. VIa, p. 213-218.
- (12) REICHERT, Edward TYSON.
1913. THE DIFFERENTIATION AND SPECIFICITY OF STARCHES IN RELATION TO GENERA, SPECIES, ETC. . . . pt. 1. Washington, D. C. (Carnegie Inst. Washington Pub. 173.)
- (13) RUSSELL, Edward J.
1908. THE CHEMICAL CHANGES TAKING PLACE DURING THE ENSILAGE OF MAIZE. *In Jour. Agr. Sci.*, v. 2, no. 4, p. 395-410.

EFFECT OF PREMATURE FREEZING ON COMPOSITION OF WHEAT

By M. J. BLISH¹

Assistant Chemist, Montana Agricultural Experiment Station

INTRODUCTION

A consideration of the effects of freezing temperatures upon the chemical composition of the immature wheat kernel is of general interest from a biochemical standpoint and of special interest to those engaged in the study and handling of wheat and its milling products, particularly in the spring-wheat sections. It is of economic importance, especially during the present high prices of wheat and its products, that a large amount of what is popularly called "frosted wheat" is annually classed as fit for nothing better than chicken feed.

This paper presents results of an investigation of the effect of premature freezing on the more important chemical constituents of the wheat kernel, paying special attention to the nitrogen compounds, from which the gluten is formed. Consideration of some of the effects of freezing on the milling and bread-making value of wheat will be taken up in later publications.

Harper (4)² made some analyses of "rusted and frosted" Minnesota wheats in 1889. He reported that the average protein content for rusted and frosted wheats was more than 2 per cent greater than that for the graded wheats, while the ratio of total nitrogen to albuminoid nitrogen was about the same in the damaged and undamaged wheats. The damaged wheat was higher in ash, fat, and fiber but lower in water and carbohydrates than the sound wheat. Different results of analyses of frozen wheat are reported by Foster and Merrill (3, *p.* LXVI) in connection with some Utah samples. Their figures show the total protein to be about 3 per cent lower in frozen than in sound wheat. The frozen wheat samples contained more fiber, fat, and water than the sound wheat. Shutt (5, *p.* 117), in a report of the analyses of Canadian samples of frozen and sound wheats in 1892, found the frozen samples higher in water, fat, fiber, and ash than the sound samples. The percentages of total nitrogen were very nearly the same in both the sound and frozen wheats. In 1907 Shutt (6) determined the albuminoid and nonalbuminoid nitrogen in samples of sound, frosted, and badly frosted wheat

¹ The writer is indebted to Mr. W. F. Day, of the Montana State Grain Laboratory, for milling the wheat samples dealt with in these experiments, and especially to Mr. Edmund Burke, chemist of the Experiment Station, for helpful criticism and advice.

² Reference is made by number (*italic*) to "Literature cited," p. 138.

by the Stutzer method. In badly frosted wheats he found that from 10 to 16 per cent of the nitrogen was in the nonalbuminoid form. There was practically no difference in the relative amounts of these constituents in the flours milled from these wheats, a fact which will be discussed later in this paper.

Analyses for the crude food constituents, conducted along the conventional lines, have brought out several facts. Frozen wheat runs higher in fiber, ash, and crude fat than sound wheat, although the differences are not always great. The carbohydrate content of frozen wheat is lower than that of sound wheat. The total nitrogen content may be higher or lower, depending probably on some other factors. The moisture content varies with storage conditions but is undoubtedly greater in frozen wheat at the normal time of cutting than in sound wheat.

EXPERIMENTAL WORK

In order to obtain samples of sound and frozen wheat of the same varieties and grown as nearly as possible under the same conditions, plots were seeded at intervals of a week, starting at the beginning of the normal seeding period and ending about two months later. This insured the likelihood of securing samples frozen at different stages of growth. Marquis wheat was used in the experiments discussed in this paper. A series of plots was seeded in 1917, beginning May 12 and ending June 30. One $\frac{1}{40}$ -acre plot was seeded each week during the interval, making a total of eight plots. The same procedure was followed in 1918, starting April 29 and ending June 18. Two series of samples were thus obtained. The soil used was a black sandy loam on the grounds of the Montana Agricultural Experiment Station. All plots were irrigated in the middle of July and obviously were not at the same stage of development when irrigated. In all plots the wheat was cut either shortly after maturity or immediately after the first killing frost.

It will be noted that in each series of samples only the last two plots seeded were badly frozen. In the first series the plot seeded last was severely frozen when in the late milk stage, and in the second series the wheat from the corresponding plot was less severely frozen when in the early dough stage. In the two most severely frozen samples a large percentage of the kernels were green, shrunken, and "blistered." These two samples may be considered to represent very extreme cases, and such instances are likely to occur only under the most exceptional climatic conditions. The plots seeded next to the last ones are probably more typical of conditions which are likely to occur in actual farming practice, the one in the 1917 series being more severely frosted than that in 1918. Although it is difficult to measure the exact degree of frosting or freezing in a given sample of wheat between certain limits, these samples present an appearance quite similar to the majority of frosted wheat samples

which habitually come under the observation of the State Grain Laboratory. The kernels were not shrunken, nor was there more than a small percentage of green kernels. The large majority of kernels from the 1917 series, however, had the well-known blistered appearance extending over the entire surface of the kernel, which is usually conclusive evidence that the grain has been badly frozen before reaching maturity. The wheat from the corresponding plot of the 1918 series was much less blistered than that from the 1917 series. All the other samples presented the appearance of mature wheat and had been cut before the first killing frost. The samples just discussed may be readily identified in the tables which follow.

Special attention is invited to the manner in which the grain from each series was handled after cutting, since there is strong evidence from the chemical analyses that the two different methods of handling and storage exerted a very appreciable effect on the biological activities within the kernel, aside from the effects of freezing. The wheat from the 1917 series was brought to the granary shortly after cutting and thrashed when dry enough to permit. Samples for subsequent analyses were then stored in a room near the college heating plant where the temperature was abnormally high and where the grain soon became drier than grain stored under normal conditions. It remained there for more than a year before being analyzed. The grain from the 1918 series, however, was allowed to remain in the field, after it was cut and shocked, until late in the following January, when it was taken to the granary and later thrashed. This grain was therefore subjected to several months of severe weathering in the field, and after being thrashed a considerable portion of it presented the bleached appearance which is characteristic of grain which has stood in the shock and undergone weathering. In the discussion of the analytical results which follow, attention will be called to chemical differences which have apparently been caused by the different methods of handling the grain from the two series of experimental plots.

EFFECT OF FREEZING ON NITROGEN COMPOUNDS

In studying the chemical composition of the wheat frozen at different stages of growth, particular attention was directed to the effect of freezing on the nitrogen compounds, since it is the gluten-forming proteins of wheat that give flour its bread-making power. The influence of the other constituents of normal wheat flour on its baking strength are for the most part considered to be indirect and are of importance only in so far as they affect the gluten. In order to estimate the extent to which premature freezing arrests the building up of the proteins from the less complex nitrogen compounds, determinations of the amounts of total nitrogen, nonprotein nitrogen, α -amino nitrogen, amid nitrogen, and

ammonia nitrogen were made on the respective samples of sound and frozen wheat, as well as on straight flours milled from the wheats. The extraction of the nonprotein nitrogen and its quantitative separation from the proteins, as well as its concentration to enable the estimation of the various forms in which it exists, was satisfactorily carried out by methods previously published by the writer (2).

Table I shows the distribution of the various forms of nitrogen in the two series of wheat samples described in preceding paragraphs.

In a previous paper (2) it has been shown that while the proteins themselves are completely removed in the method for determining nonprotein nitrogen there still remain some peptids in the solution. Therefore the figures for a-amino nitrogen reported in the tables include the "exposed" a-amino nitrogen of these peptids as well as the a-amino nitrogen of the amino acids. By far the greater part, however, is from the amino acids rather than from the peptids.

It will be noted that the most severely frozen wheat contains two to three times as much total nonprotein nitrogen as the sound wheat. The increase in ammonia and amid nitrogen is proportional to the increase in nonprotein nitrogen, the percentage of these two constituents in terms of the total nonprotein nitrogen remaining practically constant in each series. In the samples of frozen wheat a much larger percentage of the nonprotein nitrogen is in the a-amino form than in the matured samples. In the most severely frozen sample of the 1917 series nine times as much of the total nitrogen of the wheat is in the a-amino form as in the sample which matured earliest.

It is to be noted that the nitrogen in the a-amino and amid forms, as well as total nonprotein nitrogen, runs higher in the mature samples of the 1918 series than in corresponding samples of the 1917 series, while the a-amino nitrogen runs lower in the frozen samples of the 1918 series than in the corresponding samples of the 1917 series. There is much less difference, however, in the figures for total nonprotein nitrogen in the two series, there being nearly the same percentage in the most severely frozen samples of both series. It is strongly suspected that these differences are due to chemical changes caused by allowing the wheat from the 1918 series to stand in the field several months after cutting. Such treatment frequently occurs to Montana wheat in actual farming practice, and its effect on the composition of the kernel will be more thoroughly investigated in the near future, as well as its influence on the baking quality of the flour.

TABLE I.—*Effect of freezing on nitrogen compounds of immature Marquis wheat*

	1917 series, sample No.—				1918 series, sample No.— ^a				
	1.	6.	7.	8.	1300.	1304.	1305.	1306.	1307.
Date sowed	May 12.....	June 16.....	June 23.....	June 30.....	Apr. 29.....	May 29.....	June 3.....	June 10.....	June 18.....
Date of first killing frost	Oct. 17.....	Oct. 17.....	Oct. 17.....	Oct. 17.....	Oct. 8.....	Oct. 8.....	Oct. 8.....	Oct. 8.....	Oct. 8.....
Stage of development	Mature.....	Mature.....	Immature.....	Late milk stage.	Matured but bleached from lying in field after cutting.	Same as 1300.	Same as 1300.	Slightly immature.	Early dough stage.
Percentage of total nitrogen in wheat	2.59	2.67	2.61	2.44	2.59	2.38	2.39	2.17	2.21
Percentage of nonprotein nitrogen in total nitrogen	4.17	4.34	7.05	13.98	7.72	5.88	6.09	10.70	13.20
Percentage of amino nitrogen in total nitrogen	.55	.65	1.84	5.05	1.23	1.00	1.07	1.84	3.25
Percentage of ammonia nitrogen in nonprotein nitrogen	13.52	15.18	26.08	36.06	16.00	17.14	17.58	17.24	24.65
Percentage of amid nitrogen in nonprotein nitrogen	.54	3.45	3.04	3.28	4.20	2.00	2.74	3.62	4.32
Percentage of amid nitrogen in total nitrogen	.54	.52	.88	1.51	1.10	.80	.90	1.81	1.92
Percentage of amid nitrogen in nonprotein nitrogen	12.96	12.07	12.48	10.82	14.28	14.00	14.90	16.90	14.55

^a The wheat from the plots harvested in the fall of 1918 was left in the field until late January, 1919, when it was thrashed and stored.

Table II shows analyses of straight flours milled from the more important samples referred to in Table I. The samples in Table II are designated by the same numbers as those in Table I, each number followed by the letter "F."

TABLE II.—*Effect of freezing on nitrogen compounds of straight flour from Marquis wheat*

	1917 series, sample No.—			1918 series, sample No.—		
	1 F.	7 F.	8 F.	1300 F.	1306 F.	1307 F.
Percentage of total nitrogen in flour.....	2.39	2.46	2.31	2.37	2.11	2.11
Percentage of nonprotein nitrogen in total nitrogen.....	1.84	4.40	10.56	3.05	3.60	5.12
Percentage of a-amino nitrogen in total nitrogen.....	.27	1.29	4.85	.57	.53	1.20
Percentage of a-amino nitrogen in nonprotein nitrogen.....	14.54	29.44	45.90	19.90	14.74	23.33
Percentage of ammonia nitrogen in nonprotein nitrogen.....	3.20	4.54	2.87	3.40	2.30	2.60
Percentage of amid nitrogen in nonprotein nitrogen.....	12.73	12.31	10.33	12.64	12.90	10.69
Percentage of amid nitrogen in total nitrogen.....	.23	.54	1.09	.38	.46	.55

Table II shows that the percentage of total nonprotein nitrogen is in all cases considerably less in the flour than in the whole wheat, although it is much greater in the frozen sample than in the matured ones, especially in the 1917 series. This is not entirely in agreement with the findings of Shutt (6), who used Stutzer's method and reported that flour milled from frosted wheat contained as high a percentage of its total nitrogen in the albuminoid form as flour from sound wheat, although the frozen whole wheat contained a larger percentage in the nonalbuminoid form than did the sound wheat. His conclusion is that the nonalbuminoid nitrogen compounds are practically all removed by the milling process and may therefore be considered to be located in the bran and germ.

The findings of Shutt agree much more closely with the 1918 series than with the 1917 series. Inspection of the figures for total nonprotein nitrogen in Table II shows that a much greater proportion of the nonprotein nitrogen compounds was removed by milling in the 1918 series than in the 1917 series. This indicates that either the freezing was of such a nature that in one season it affected chiefly the nitrogen compounds in the bran and germ, while in the other it affected the whole kernel, or the difference has been caused by the different methods by which the crops from the two series were handled after cutting, as has previously been discussed in this paper.

EFFECT OF FREEZING ON THE CARBOHYDRATES

A brief study of the effects of premature freezing on the carbohydrates of the wheat kernel was made. To this end wheat samples from both series were analyzed by the methods of Stone (7). The results of these analyses are presented in Table III.

TABLE III.—*Some effects of freezing on carbohydrates of Marquis wheat*

	1917 series, sample No. —				1918 series, sample No.—			
	1.	6.	7.	9.	1300.	1305.	1306.	1307.
Reducing sugars.....	<i>Per cent.</i> 0.02	<i>Per cent.</i> 0.09	<i>Per cent.</i> 0.30	<i>Per cent.</i> 1.86	<i>Per cent.</i> 0.09	<i>Per cent.</i> 0.11	<i>Per cent.</i> 0.16	<i>Per cent.</i> 2.40
Sucrose.....	1.63	1.35	1.72	1.64	1.65	1.53	1.08	1.27
Dextrin and soluble starch.....	1.66	1.87	2.10	2.34	1.87	1.75	2.08	2.17

The data in Table III show that the percentage of reducing sugars increases with the severity of the freezing, as would be anticipated. The figures for reducing sugars in the most severely frozen samples of both series offer further evidence that either the freezing in the 1917 series was far more severe than in the 1918 series or the different methods of handling the two series after cutting resulted in different biochemical activities within the kernel. Also, as would be expected, there is more soluble starch and dextrin in the frozen samples than in the matured ones. There seems to be no apparent relationship between the sucrose content and the severity of freezing.

EFFECT OF FREEZING ON ACIDITY

The general effect of freezing on the acidity of the samples of wheat and flour used in these experiments was briefly studied by titrating water extracts with *N/0.05* alkali, using phenolphthalein, although electrometric titrations with the hydrogen electrode might be preferable. With reference to acidimetric titrations of cereal extracts, Birckner (1) has recently shown that the addition of alcohol to water extracts containing amino compounds increases the acidity of the extracts in proportion to the amount of amino compounds present. Water extracts of the wheat and flour samples in question were therefore titrated with and without alcohol. According to Birckner the difference between the two titrations should be an index to the amino compounds present, and a comparison of these differences with results obtained by the use of Van Slyke's microapparatus (see Tables I and II) should be of interest. In the alcoholic titrations the water extracts were diluted with equal volumes of neutral alcohol. The results are set forth in Table IV.

In examining the values expressed by the differences between the titrations with and without alcohol for the respective samples, it may readily be seen that not only do these values increase as the severity of freezing increases but the extent of the increase in almost all instances keeps pace with the figures for nonprotein and α -amino nitrogen as actually determined and shown in Tables I and II. This is in close agreement with the findings of Birckner (1).

TABLE IV.—*Acidimetric titrations of wheat and flour extracts with and without alcohol*

[50-cc. portions of water extract used, representing 4 gm. of sample]

	1917 series, sample No.—						1918 series, sample No.—					
	I.	7.	8.	1F.	7F.	8F.	1300.	1306.	1307.	1300 F.	1306 F.	1307 F.
Cubic centimeters of <i>N</i> /0.05 sodium hydroxid neutralized without alcohol.....	3.5	4.6	6.8	1.4	2.0	4.1	3.1	3.8	4.0	1.5	1.1	1.7
Cubic centimeters of <i>N</i> /0.05 sodium hydroxid neutralized with alcohol.....	6.0	8.4	14.4	2.2	4.4	10.0	6.1	7.0	8.8	3.0	2.5	4.0
Difference due to amino compounds.....	2.5	3.8	7.6	0.8	2.4	5.9	3.0	3.2	4.8	1.5	1.4	2.3
Percentage of nonprotein nitrogen in total nitrogen ^a	4.17	7.05	13.98	1.84	4.40	10.56	7.72	10.70	13.20	3.05	3.60	5.12
Percentage of a-amino nitrogen in nonprotein nitrogen ^a	13.52	26.08	36.06	14.54	29.44	45.50	16.00	17.24	24.65	19.90	14.74	23.33

^a Figures taken from Tables I and II.

SUMMARY

(1) Premature freezing affects the chemical composition of wheat and the flour milled therefrom.

(2) Frozen wheat contains larger amounts of nonprotein nitrogen, reducing sugars, and acid-reacting constituents than does sound wheat.

(3) The nonprotein nitrogen of frozen wheat carries a considerably higher percentage of a-amino nitrogen than that of sound wheat.

LITERATURE CITED

- (1) BIRCKNER, Victor.
1919. ACIDIMETRIC TITRATION OF GRAIN EXTRACTS AND AMINO-ACIDS IN THE PRESENCE OF ALCOHOL. *In Jour. Biol. Chem.*, v. 38, no. 2, p. 245-254, 2 fig.
- (2) BLISH, M. J.
1918. A STUDY OF THE NON-PROTEIN NITROGEN OF WHEAT FLOUR. *In Jour. Biol. Chem.*, v. 33, no. 3, p. 551-559.
- (3) FOSTER, Luther, and MERRILL, Lewis A.
1900. SHEEP FEEDING EXPERIMENT. *Utah Agr. Exp. Sta.*, 11th Ann. Rpt. [1899]/1900, p. lxiii-lxviii.
- (4) HARPER, D. N.
1889. ON THE CHEMISTRY OF WHEAT. *Minn. Agr. Exp. Sta.*, Bul. 7, p. 65-84.
- (5) SHUTT, Frank T.
1893. REPORT OF THE CHEMIST. PART I. FODDERS. *In Canada Exp. Farms Rpt.*, 1892, p. 114-121.
- (6) ———
1908. REPORT OF THE CHEMIST. FROSTED WHEAT. *In Canada Exp. Farms Rpt.* [1907]/08, p. 140-143.
- (7) STONE, Winthrop E.
1896. THE CARBOHYDRATES OF WHEAT, MAIZE, FLOUR, AND BREAD. . . . U. S. Dept. Agr. Off. Exp. Stas. Bul. 34, 32 p.

JOURNAL OF AGRICULTURAL RESEARCH

CONTENTS

Behavior of the Citrus-Canker Organism in Soil	- -	Page 189
H. ATHERTON LEE (Contribution from Bureau of Plant Industry)		
Decline of Pseudomonas citri in the Soil	- - - -	207
H. R. FULTON (Contribution from Bureau of Plant Industry)		
Variation of Individual Pigs in Economy of Gain	- -	225
R. C. ASHBY and A. W. MALCOMSON (Contribution from Minnesota Agricultural Experiment Station)		
Production of Conidia in Gibberella saubinetii	- -	235
JAMES G. DICKSON and HELEN JOHANN (Contribution from Bureau of Plant Industry and Wisconsin Agricultural Experiment Station)		

**PUBLISHED BY AUTHORITY OF THE SECRETARY OF AGRICULTURE,
WITH THE COOPERATION OF THE ASSOCIATION OF
LAND-GRANT COLLEGES**

WASHINGTON, D. C.

**EDITORIAL COMMITTEE OF THE
UNITED STATES DEPARTMENT OF AGRICULTURE AND
THE ASSOCIATION OF LAND-GRANT COLLEGES**

FOR THE DEPARTMENT

KARL F. KELLERMAN, CHAIRMAN

*Physiologist and Associate Chief, Bureau
of Plant Industry*

EDWIN W. ALLEN

Chief, Office of Experiment Stations

CHARLES L. MARLATT

*Entomologist and Assistant Chief, Bureau
of Entomology*

FOR THE ASSOCIATION

J. G. LIPMAN

*Dean, State College of Agriculture, and
Director, New Jersey Agricultural Experi-
ment Station, Rutgers College*

W. A. RILEY

*Entomologist and Chief, Division of Ento-
mology and Economic Zoology, Agricul-
tural Experiment Station of the University
of Minnesota*

R. L. WATTS,

*Dean, School of Agriculture, and Director,
Agricultural Experiment Station, The
Pennsylvania State College*

All correspondence regarding articles from the Department of Agriculture should be addressed to Karl F. Kellerman, Journal of Agricultural Research, Washington, D. C.

All correspondence regarding articles from State Experiment Stations should be addressed to J. G. Lipman, New Jersey Agricultural Experiment Station, New Brunswick, N. J.

JOURNAL OF AGRICULTURAL RESEARCH

VOL. XIX

WASHINGTON, D. C., JUNE 1, 1920

No. 5

BEHAVIOR OF THE CITRUS-CANKER ORGANISM IN THE SOIL¹

By H. ATHERTON LEE

*Pathologist, Fruit—Disease Investigations, Bureau of Plant Industry,
United States Department of Agriculture*

INTRODUCTION

It is a commonly accepted idea among fruit growers and horticulturists that the citrus-canker organism, *Pseudomonas citri* Hasse, lives and multiplies in the soil. There has been considerable field evidence to support this view. Frequently after an infected tree has been cut or burned down, young shoots have come up from the roots and have been found to be cankered. Thus Wolf² writes—

That it [*P. citri*] remains alive in the soil is indicated by the appearance of diseased sprouts from the roots of diseased trees which are burned.

Stevens³ in 1915 reported the successful cultivation of *P. citri* in sterilized soil, and this has been accepted by a number of horticulturists as sufficient evidence to conclude that the canker organism is a soil inhabitant.

The presence or absence of the canker organism in the soil is an important question, and the use of many of the eradication and quarantine methods depends upon a knowledge of the behavior of the canker organism in the soil. The question resolves itself into three points: (1) whether

¹The investigations reported in this paper were carried on at the Lamao Agricultural Experiment Station of the Philippine Bureau of Agriculture. The writer is greatly indebted to Col. Adrian Hernandez, Director, and Mr. S. Apostol, Chief, Plant Industry Division of the Philippine Bureau of Agriculture, for the facilities afforded at Lamao and for much other assistance. Thanks are also due Mr. Francisco Calang, Superintendent of the Station at Lamao, for helpfulness at all times.

Deep appreciation is here expressed to Mr. E. D. Merrill, botanist, of the Philippine Bureau of Science, for the use of the very extensive laboratory facilities in Manila and for many other kindnesses. The photographs reproduced here were taken by the photographer of the Philippine Bureau of Science from the material of the writer.

²WOLF, Frederick A. CITRUS-CANKER. In *Jour. Agr. Research*, v. 6, no. 2, p. 69-100, 8 fig., pl. 9-11. 1916. Literature cited, p. 98-99.

³STEVENS, H. E. CITRUS-CANKER-III. *Fla. Agr. Exp. Sta. Bul.* 128, 20 p., 6 fig. 1915.

JUN 1 1920

P. citri is able to live actively—that is, increase and multiply within the soil; (2) whether it exists simply passively and does not increase and multiply; or (3) whether it is killed within the soil.

The problem has been attacked previously by the writer and other investigators by attempting to plate out soil samples and thus show the presence of the canker organism in the soil. These attempts have usually given negative results. However, such negative results have been inconclusive because of the large number of the soil organisms which would appear in the plates, making it difficult to identify *P. citri* even if it were present. Investigations were therefore undertaken at Lamao, P. I., with the purpose of attacking this question with different experimental methods.

EXPERIMENT I

Fifty-five culture tubes of orchard soil from Lamao were prepared. These were autoclaved twice, one hour each time, at 45 pounds pressure, 24 hours intervening between periods of steaming. Fifty-five tubes of the same soil were prepared but were not sterilized. Each tube of sterilized soil was inoculated with 2 cc. of a heavy infusion of *P. citri* in sterile water, precautions being used as far as possible to avoid contamination. The tubes of unsterilized soil were inoculated each with 2 cc. of the same infusion, all processes being identical except that one series of tubes was sterilized while the other was not.

Five of the sterilized tubes and 5 of the unsterilized tubes were taken; portions were removed from each with a spatula (a separate spatula being used for each tube); and infusions were then made from each of these 10 portions. These infusions were made in dry sterilized test tubes, but tap water was used for the liquid medium. Inoculations from each infusion were made upon the upper and lower surfaces of five young, actively growing pummelo¹ leaves, *Citrus maxima* (syn. *C. grandis*, *C. decumana*). Forty punctures were made in each leaf. The leaves were then bound in waxed paper with wet cotton to maintain a moist atmosphere. The whole was covered with opaque paper to prevent burning by the sun.

This procedure was repeated each day for a period of 15 days, a new series of five tubes of sterilized soil and a new series of tubes of unsterilized soil being used each day. The inoculation data and results are given in Tables I and II. The percentages expressed are based upon the number of positive takes resulting from the total of 200 punctures on 5 leaves. Where stomatal infections occur they are counted as wound infections.

¹ Following the usage of W. T. Swingle in Bailey's Standard Cyclopedia of Horticulture, the term pummelo is used in its usual East Indian sense to include varieties of *Citrus grandis* distinct from the grapefruit group of the West Indies and the United States.

TABLE I.—Inoculations on young pummelo leaves from infusions of untreated soil in tubes made on consecutive days after inoculation with *P. citri*

Leaves No.	Infusion tube No.	Number of days after inoculation of tubes.	Date of inoculation from tubes to leaves.	Infections from 200 punctures.	Date of observation.
1 to 5	1	2	Oct. 23, 1918	0.3 per cent positive	Nov. 2, 1918.
6 to 10	2	2	do.	3.0 per cent positive	Do.
11 to 15	3	2	do.	do.	Do.
16 to 20	4	2	do.	2.2 per cent positive	Do.
21 to 25	5	2	do.	61½ per cent positive	Do.
26 to 30	6	3	Oct. 24, 1918	51½ per cent positive	Nov. 4, 1918.
31 to 35	7	3	do.	6 per cent positive	Do.
36 to 40	8	3	do.	1.2 per cent positive	Do.
41 to 45	9	3	do.	4½ per cent positive	Do.
46 to 50	10	3	do.	All negative	Do.
51 to 55	11	4	Oct. 25, 1918	½ of 1 per cent positive.	Do.
56 to 60	12	4	do.	All negative	Do.
61 to 65	13	4	do.	3 per cent positive	Do.
66 to 70	14	4	do.	½ of 1 per cent positive.	Do.
71 to 75	15	4	do.	3 per cent positive	Do.
76 to 80	16	5	Oct. 26, 1918	All negative	Nov. 5, 1918.
81 to 85	17	5	do.	½ of 1 per cent positive.	Do.
86 to 90	18	5	do.	All negative	Do.
91 to 95	19	5	do.	½ of 1 per cent positive.	Do.
96 to 100	20	5	do.	1 per cent positive	Do.
101 to 105	21	7	Oct. 28, 1918	All negative	Nov. 9, 1918.
106 to 110	22	7	do.	do.	Do.
111 to 115	23	7	do.	do.	Do.
116 to 120	24	7	do.	do.	Do.
121 to 125	25	7	do.	do.	Do.
126 to 130	26	9	Oct. 30, 1918	do.	Nov. 20, 1918.
131 to 135	27	9	do.	do.	Do.
136 to 140	28	9	do.	do.	Do.
141 to 145	29	9	do.	9½ per cent positive	Do.
146 to 150	30	9	do.	All negative	Do.
151 to 155	31	11	Nov. 1, 1918	do.	Do.
156 to 160	32	11	do.	do.	Do.
161 to 165	33	11	do.	do.	Do.
166 to 170	34	11	do.	do.	Do.
171 to 175	35	11	do.	do.	Do.
176 to 180	36	14	Nov. 4, 1918	do.	Do.
181 to 185	37	14	do.	do.	Do.
186 to 190	38	14	do.	do.	Do.
191 to 195	39	14	do.	do.	Do.
196 to 200	40	14	do.	do.	Do.
201 to 205	41	14	do.	do.	Do.
206 to 210	42	14	do.	do.	Do.
211 to 215	43	14	do.	do.	Do.
216 to 220	44	14	do.	do.	Do.
221 to 225	45	14	do.	do.	Do.
226 to 230	46	14	do.	do.	Do.
231 to 235	47	14	do.	do.	Do.
236 to 240	48	14	do.	do.	Do.
241 to 245	49	14	do.	do.	Do.
246 to 250	50	14	do.	do.	Do.

TABLE II.—*Inoculations on young pummelo leaves from infusions of autoclaved soil in tubes made on consecutive days after inoculation with P. citri*

Leaves No.	Infusion tube No.	Number of days after inoculation of tubes.	Date of inoculation from tubes to leaves.	Infections from 200 puuctures.	Date of observation.
1 to 5	1	2	Oct. 23, 1918	100 per cent positive..	Nov. 2, 1918.
6 to 10	2	2do.....	99½ per cent positive..	Do.
11 to 15	3	2do.....	100 per cent positive..	Do.
16 to 20	4	2do.....do.....	Do.
21 to 25	5	2do.....do.....	Do.
26 to 30	6	3	Oct. 24, 1918do.....	Nov. 4, 1918.
31 to 35	7	3do.....do.....	Do.
36 to 40	8	3do.....do.....	Do.
41 to 45	9	3do.....do.....	Do.
46 to 50	10	3do.....do.....	Do.
51 to 55	11	4	Oct. 25, 1918do.....	Do.
56 to 60	12	4do.....do.....	Do.
61 to 65	13	4do.....do.....	Do.
66 to 70	14	4do.....do.....	Do.
71 to 75	15	4do.....do.....	Do.
76 to 80	16	5	Oct. 26, 1918do.....	Nov. 5, 1918.
81 to 85	17	5do.....do.....	Do.
86 to 90	18	5do.....do.....	Do.
91 to 95	19	5do.....do.....	Do.
96 to 100	20	5do.....do.....	Do.
101 to 105	21	7	Oct. 28, 1918do.....	Nov. 9, 1918.
106 to 110	22	7do.....do.....	Do.
111 to 115	23	7do.....do.....	Do.
116 to 120	24	7do.....do.....	Do.
121 to 125	25	7do.....do.....	Do.
126 to 130	26	9	Oct. 30, 1918do.....	Nov. 20, 1918.
131 to 135	27	9do.....do.....	Do.
136 to 140	28	9do.....do.....	Do.
141 to 145	29	9do.....do.....	Do.
146 to 150	30	9do.....do.....	Do.
151 to 155	31	11	Nov. 1, 1918do.....	Do.
156 to 160	32	11do.....do.....	Do.
161 to 165	33	11do.....do.....	Do.
166 to 170	34	11do.....do.....	Do.
171 to 175	35	11do.....do.....	Do.
176 to 180	36	14	Nov. 4, 1918do.....	Do.
181 to 185	37	14do.....do.....	Do.
186 to 190	38	14do.....do.....	Do.
191 to 195	39	14do.....	92½ per cent positive..	Do.
196 to 200	40	14do.....	100 per cent positive..	Do.

SUMMARY OF EXPERIMENT I

Inoculations made upon young pummelo leaves from infusions made from autoclaved soil tubes inoculated with *P. citri* were uniformly 100 per cent positive or nearly so for 14 days following the inoculation of the soil tubes with *P. citri*. Inoculations from infusions from tubes of unsterilized soil in which *P. citri* was inoculated gave uniformly positive results on young pummelo trees during the first 3 days. Thereafter the percentages of positive results were low upon the fourth, fifth, and seventh days. On the ninth day there were but a few positive results

from a total of 1,000 punctures, and on the eleventh and fourteenth days 4,000 puncture inoculations from the infusions were entirely negative.

The evidence of this experiment therefore points to a gradual dying out of the canker organism in unsterilized soil, although in the sterilized soil the canker bacteria are very active.

EXPERIMENT II

This experiment was undertaken to obtain all possible information upon the condition of *P. citri* in orchard soils.

Rain had fallen intermittently every day for 15 days. The Ellen grapefruit tree selected for this experiment showed 100 per cent of the leaves cankered, and in many cases the leaves had over 50 cankers apiece—that is to say, the tree was badly affected with canker and a drop of water could hardly fall to the ground from this tree without having been in contact with cankers.

During a violent shower, rain dripping from the leaves of this tree was collected in five culture tubes. These tubes were then carried to the isolation plots where citrus-canker had been excluded. From each tube of the rain water five young, actively growing grapefruit leaves were inoculated on upper and lower surfaces, each leaf being punctured at the same time with 40 needle stabs. The heavily cankered grapefruit tree was then cut down and removed, and all fallen leaves were removed from the ground. Soil from beneath the tree was then placed in five culture tubes, infusions were made and taken to the isolation plots, and five leaves were inoculated from each infusion. Forty punctures were made on each leaf, and both upper and lower surfaces were coated.

The twigs bearing the leaves inoculated with the infusion as well as those inoculated from the drip water were wrapped in paraffin paper with a piece of moistened cotton. The paraffin paper was then covered with opaque paper. A muslin tent was spread over the soil about the stump of the Ellen grapefruit tree after all fallen leaves had been removed. The tent prevented infected leaves from being blown upon the soil but allowed active play of rain and air as under normal conditions. The percentages of infection are given in Tables III and IV.

TABLE III.—*Inoculations on young pummelo leaves from rain water collected from the leaves of a badly cankered grapefruit tree*

Leaves No.	Infusion tube No.	Date of inoculation on leaves.	Infections from 200 punctures.	Date of observation.
1 to 5	1	July 20, 1918	3 per cent positive.....	July 31, 1918.
6 to 10	2do.....	All negative.....	Do.
11 to 15	3do.....	4½ per cent positive.....	Do.
16 to 20	4do.....	19½ per cent positive.....	Do.
21 to 25	5do.....	36½ per cent positive.....	Do.

TABLE IV.—*Inoculations on young pummelo leaves made immediately after rain and on consecutive days following the rain from infusions of orchard soil from beneath a heavily infected grapefruit tree*

Leaves No.	Infusion tube No.	Number of days between rain and inoculation.	Date of inoculation on leaves.	Infections from 200 punctures.	Date of observation.
1 to 5	1	Immediately after rain.	July 20, 1918	All negative . . .	July 31, 1918.
6 to 10	2do.....do.....	8½ per cent positive.	Do.
11 to 15	3do.....do.....	4½ per cent positive.	Do.
16 to 20	4do.....do.....	12½ per cent positive.	Do.
21 to 25	5do.....do.....	1 per cent positive.	Do.
26 to 30	6	1	July 21, 1918	All negative . . .	Do.
31 to 35	7	1do.....	½ of 1 per cent positive.	Do.
36 to 40	8	1do.....	All negative . . .	Do.
41 to 45	9	1do.....do.....	Do.
46 to 50	10	1do.....do.....	Do.
51 to 55	11	2	July 22, 1918	½ of 1 per cent positive.	Do.
56 to 60	12	2do.....	All negative . . .	Do.
61 to 65	13	2do.....do.....	Do.
66 to 70	14	2do.....do.....	Do.
71 to 75	15	2do.....do.....	Do.
76 to 80	16	3	July 23, 1918do.....	Aug. 2, 1918.
81 to 85	17	3do.....do.....	Do.
86 to 90	18	3do.....do.....	Do.
91 to 95	19	3do.....do.....	Do.
96 to 100	20	3do.....do.....	Do.
101 to 105	21	4	July 24, 1918do.....	Do.
106 to 110	22	4do.....do.....	Do.
111 to 115	23	4do.....do.....	Do.
116 to 120	24	4do.....do.....	Do.
121 to 125	25	4do.....do.....	Do.
126 to 130	26	5	July 25, 1918do.....	Aug. 3, 1918.
131 to 135	27	5do.....do.....	Do.
136 to 140	28	5do.....do.....	Do.
141 to 145	29	5do.....do.....	Do.
146 to 150	30	5do.....do.....	Do.
151 to 155	31	7	July 27, 1918do.....	Aug. 16, 1918.
156 to 160	32	7do.....do.....	Do.
161 to 165	33	7do.....do.....	Do.
166 to 170	34	7do.....do.....	Do.
171 to 175	35	7do.....do.....	Do.
176 to 180	36	9	July 29, 1918do.....	Do.
181 to 185	37	9do.....do.....	Do.
186 to 190	38	9do.....do.....	Do.
191 to 195	39	9do.....do.....	Do.
196 to 200	40	9do.....do.....	Do.

SUMMARY OF EXPERIMENT II

Inoculations made from rain water collected from the foliage of a heavily infected grapefruit tree gave positive results upon young pummelo leaves. Inoculations made from infusions of the soil beneath such a heavily infected tree also gave positive results on pummelo leaves immediately following the rain. On the first day after the rain there

was one positive result and on the second day following the rain there was a positive result. Thereafter on the third, fourth, fifth, seventh, and ninth days the results were entirely negative. On these days a total of 125 leaves, or 5,000 punctures were inoculated with the soil infusion, and all remained negative.

The conclusion is reached, then, that although the canker organism was present immediately following the rain, in this case the citrus-canker organism has died out in the orchard soil.

REPETITION OF EXPERIMENTS I AND II

The field data have been very extensive in support of the theory that the canker bacteria can exist and multiply in the soil. Since the idea has been so firmly held by growers and horticulturists that the canker organism does live in the soil, and because the data presented in the two preceding experiments indicate the contrary to be the case, both these experiments were repeated.

Experiment I was repeated, and the original results were entirely corroborated. It was found that *P. citri* was abundant in the unsterilized soil tubes during the first, second, and third days; during the fourth, fifth, seventh, and ninth days the inoculations were but very slightly positive; on the fourteenth day the organism showed three positive results from a total of 4,000 punctures. In the sterilized soil tubes *P. citri* gave almost uniformly 100 per cent results up to and including the fourteenth day.

Experiment II was carried through three times. The first trial has been reported here in detail. For the second and third trials the same methods were used. In a second trial the water dripping from the foliage of an infected grapefruit tree was shown to contain *P. citri* in a large percentage of cases. The soil beneath the tree, immediately following the rain, also gave a large number of positive results. On the second day after the rain and thereafter for four days inoculations from the soil beneath the same tree gave entirely negative results on the pummelo leaves. In a third trial no tests were made with the rain water on the leaves, but immediately following the rain a large number of positive results were obtained on pummelo leaves from inoculations with the soil infusion from beneath the cankered foliage. On the first day after the rain a few positive results were obtained from the soil infusions, but on the second day none of the inoculations resulted positively. On the third and eighth days there were again a few positive results, but on the tenth day 2,000 inoculations made from the soil upon the pummelo leaves remained entirely negative. These second and third trials entirely corroborate the experiments reported above and indicate that the citrus canker organism is entirely killed in orchard soils.

The tests of orchard soil were carried on at different seasons of the year and are representative of the conditions in the soil in very different

climatic periods in the Philippines. Two of the series of inoculations with orchard soil infusions were carried on in the middle of the rainy season when the soil was kept constantly wet by the rains. The third series of inoculations was carried on at the beginning of the dry season when the soil dried out and became dusty to a considerable extent. The attempt was made to secure the soil for each day's infusion at different depths. Soil was frequently taken from the surface and just as frequently from a depth of 10 inches. It is thought that the inoculations shown here were made from soil infusions which are entirely representative of the different conditions in the Lamao soils.

Inasmuch as the question of the existence or nonexistence of *P. citri* in the soil is an important point in canker control work, the following test was undertaken to corroborate further the preceding experiments.

EXPERIMENT III

INOCULATED SOIL IN BOXES

Orchard soil was autoclaved twice, one hour each time at 45 pounds pressure. The soil was placed in thin layers on plates, so that the steam would penetrate easily. The autoclaved soil was placed in a seed-house flat which measured 18 by 24 by 5 inches. The soil was air-dried and was inoculated with 1,500 cc. of an infusion of *P. citri* in sterile water. This flat was then placed at a level with the soil and covered with cheesecloth to prevent animals from disturbing it. The flat received the full play of sun, wind, and rain and was exposed to the same conditions as exist beneath a tree in the orchard.

Another flat of the same size containing unsterilized soil was inoculated with an equal amount of an identical infusion. This flat was placed under identical conditions with the flat of sterilized soil but at several yards' distance to prevent distribution of the canker organism too easily; it was also covered with cheesecloth.

On the first day after inoculation, a small portion of the inoculated soil from the autoclaved flat was removed with a spatula to a clean dry-sterilized culture tube. To this about 10 cc. of tap water were added; the tube was shaken vigorously for several minutes; and the resulting infusion was spread upon the upper and lower surfaces of five actively growing pummelo leaves. Each leaf was then punctured 40 times with a new needle, and a new coating of the infusion was spread over the leaves and over the punctures. For this spreading of the infusion small cotton swabs such as are used for collecting diphtheria cocci from suspected cases were used. A new swab was used for each tube of infusion.

Five infusions were made each successive day from the flat of inoculated autoclaved soil. On each successive day five infusions were made in the same way from the unsterilized inoculated soil, and each of these was spread upon five actively growing leaves, each leaf being subsequently punctured 40 times.

Thus inoculations were made each day from 10 infusions of soil. These 10 infusions were identical in every way except that 5 were made from a flat of soil which had been inoculated with *P. citri* after being sterilized while the other 5 were made from a flat of soil which had been inoculated without being sterilized. Tables V and VI give the results of the inoculations.

TABLE V.—*Inoculation of young pummelo leaves from infusions of untreated soil in a box made on consecutive days after inoculation with P. citri. The inoculated soil was placed in the orchard to simulate field conditions*

Leaves No.	Infusion tube No.	Number of days after inoculation into soil.	Date of inoculation on leaves.	Infections from 200 punctures.	Date of observation.
1 to 5	1	1	Oct. 23, 1918	77 per cent positive..	Nov. 2, 1918.
6 to 10	2	1do.....	80 per cent positive...	Do.
11 to 15	3	1do.....	87 per cent positive ..	Do.
16 to 20	4	1do.....	100 per cent positive.	Do.
21 to 25	5	1do.....	53½ per cent positive.	Do.
26 to 30	6	2	Oct. 24, 1918	22 per cent positive..	Nov. 4, 1918.
31 to 35	7	2do.....	28 per cent positive..	Do.
36 to 40	8	2do.....	54½ per cent positive.	Do.
41 to 45	9	2do.....	78½ per cent positive.	Do.
46 to 50	10	2do.....	73 per cent positive..	Do.
51 to 55	11	3	Oct. 25, 1918	16½ per cent positive.	Do.
56 to 60	12	3do.....	8½ per cent positive..	Do.
61 to 65	13	3do.....	18½ per cent positive.	Do.
66 to 70	14	3do.....	15½ per cent positive.	Do.
71 to 75	15	3do.....	21 per cent positive..	Do.
76 to 80	16	4	Oct. 26, 1918	All negative.....	Nov. 5, 1918.
81 to 85	17	4do.....do.....	Do.
86 to 90	18	4do.....	1½ per cent positive.	Do.
91 to 95	19	4do.....	All negative.....	Do.
96 to 100	20	4do.....	6 per cent positive ...	Do.
101 to 105	21	6	Oct. 28, 1918	All negative.....	Nov. 9, 1918.
106 to 110	22	6do.....do.....	Do.
111 to 115	23	6do.....do.....	Do.
116 to 120	24	6do.....do.....	Do.
121 to 125	25	6do.....do.....	Do.
126 to 130	26	8	Oct. 30, 1918do.....	Nov. 20, 1918.
131 to 135	27	8do.....do.....	Do.
136 to 140	28	8do.....do.....	Do.
141 to 145	29	8do.....do.....	Do.
146 to 150	30	8do.....do.....	Do.
151 to 155	31	10	Nov. 1, 1918do.....	Do.
156 to 160	32	10do.....do.....	Do.
161 to 165	33	10do.....do.....	Do.
166 to 170	34	10do.....do.....	Do.
171 to 175	35	10do.....do.....	Do.
176 to 180 ^a	36	12do.....do.....do.....
181 to 185	37	12	Nov. 3, 1918	All negative.....	Nov. 20, 1918.
186 to 190	38	12do.....do.....	Do.
191 to 195	39	12do.....do.....	Do.
196 to 200	40	12do.....do.....	Do.

^a Leaves 176 to 180 were inoculated and then found to be already naturally infected at insect injuries. These leaves were therefore cut off Nov. 3, 1918, and were not carried in the experiment.

TABLE V.—*Inoculation of young pummelo leaves from infusions of untreated soil in a box made on consecutive days after inoculation with P. citri. The inoculated soil was placed in the orchard to simulate field conditions—Continued*

Leaves No.	Infusion tube No.	Number of days after inoculation into soil.	Date of inoculation on leaves.	Infections from 200 punctures.	Date of observation.
201 to 205	41	14	Nov. 5, 1918	All negative.....	Nov. 20, 1918.
206 to 210	42	14	do.....	do.....	Do.
211 to 215	43	14	do.....	do.....	Do.
216 to 220	44	14	do.....	do.....	Do.
221 to 225	45	14	do.....	do.....	Do.
226 to 230	46	14	do.....	do.....	Do.
231 to 235	47	14	do.....	do.....	Do.
236 to 240	48	14	do.....	do.....	Do.
241 to 245	49	14	do.....	do.....	Do.
246 to 250	50	14	do.....	do.....	Do.
251 to 255	51	14	do.....	do.....	Do.
256 to 260	52	14	do.....	do.....	Do.
261 to 265	53	14	do.....	do.....	Do.
266 to 270	54	14	do.....	do.....	Do.
271 to 275	55	14	do.....	do.....	Do.

TABLE VI.—*Inoculations on young pummelo leaves from infusions of autoclaved soil in a box made on consecutive days after inoculation with P. citri. The inoculated soil was placed in the orchard to simulate field conditions*

Leaves No.	Infusion tube No.	Number of days after inoculation into soil.	Date of inoculation on leaves.	Infections from 200 punctures.	Date of observation.
1 to 5	1	1	Oct. 23, 1918	96 per cent positive ..	Nov. 2, 1918.
6 to 10	2	1	do.....	do.....	Do.
11 to 15	3	1	do.....	98 per cent positive ..	Do.
16 to 20	4	1	do.....	95½ per cent positive ..	Do.
21 to 25	5	1	do.....	99 per cent positive ..	Do.
26 to 30	6	2	Oct. 24, 1918	100 per cent positive ..	Oct. 30, 1918.
31 to 35	7	2	do.....	do.....	Do.
36 to 40	8	2	do.....	do.....	Do.
41 to 45	9	2	do.....	do.....	Nov. 4, 1918.
46 to 50	10	2	do.....	do.....	Do.
51 to 55	11	3	Oct. 25, 1918	do.....	Do.
56 to 60	12	3	do.....	do.....	Do.
61 to 65	13	3	do.....	99½ per cent positive ..	Do.
66 to 70	14	3	do.....	100 per cent positive ..	Do.
71 to 75	15	3	do.....	do.....	Do.
76 to 80	16	4	Oct. 26, 1918	do.....	Nov. 5, 1918.
81 to 85	17	4	do.....	96 per cent positive ..	Do.
86 to 90	18	4	do.....	100 per cent positive ..	Do.
91 to 95	19	4	do.....	do.....	Do.
96 to 100	20	4	do.....	do.....	Do.
101 to 105	21	6	Oct. 28, 1918	95½ per cent positive ..	Nov. 9, 1918.
106 to 110	22	6	do.....	100 per cent positive ..	Do.
111 to 115	23	6	do.....	99 per cent positive ..	Do.
116 to 120	24	6	do.....	100 per cent positive ..	Do.
121 to 125	25	6	do.....	94½ per cent positive ..	Do.

TABLE VI.—*Inoculations on young pummelo leaves from infusions of autoclaved soil in a box made on consecutive days after inoculation with P. citri. The inoculated soil was placed in the orchard to simulate field conditions—Continued*

Leaves No.	Infusion tube No.	Number of days after inoculation into soil.	Date of inoculation on leaves.	Infections from 200 punctures.	Date of observation.
126 to 130	26	8	Oct. 30, 1918	100 per cent positive	Nov. 9, 1918.
131 to 135	27	8do.....do.....	Do.
136 to 140	28	8do.....do.....	Do.
141 to 145	29	8do.....	76 per cent positive.	Do.
146 to 150	30	8do.....	100 per cent positive.	Do.
151 to 155	31	10	Nov. 1, 1918do.....	Nov. 20, 1918.
156 to 160	32	10do.....do.....	Do.
161 to 165	33	10do.....do.....	Do.
166 to 170	34	10do.....	99½ per cent positive.	Do.
171 to 175	35	10do.....	100 per cent positive	Do.
176 to 180	36	12	Nov. 3, 1918do.....	Do.
181 to 185	37	12do.....	85½ per cent positive.	Do.
186 to 190	38	12do.....	100 per cent positive	Do.
191 to 195	39	12do.....	93½ per cent positive.	Do.
196 to 200	40	12do.....	96 per cent positive	Do.
201 to 205	41	14	Nov. 5, 1918	100 per cent positive.	Do.
206 to 210	42	14do.....do.....	Do.
211 to 215	43	14do.....do.....	Do.
216 to 220	44	14do.....do.....	Do.
221 to 225	45	14do.....do.....	Do.

SUMMARY OF EXPERIMENT III

It will be seen that inoculations made from the untreated soil were highly positive on the first day following inoculation with *P. citri*. On the second day there was a slight diminution of the positive results, and on the third day the percentages of positive results were very much lower. On the fourth day the larger part of the inoculations were entirely negative. On the sixth, eighth, tenth, twelfth, and fourteenth days following inoculation, all inoculations were entirely negative. That is, six days after the inoculation with a heavy infusion of *P. citri* in untreated soil, 170 leaves were inoculated, each with 40 punctures, or a total of 6,800 punctures; all remained negative. At the same time inoculations made on consecutive days following inoculations of autoclaved soil with *P. citri* were highly positive the first day, increased to almost uniformly 100 per cent positive results on the second day, and continued at 100 per cent for 14 days.

The full significance of this may perhaps be grasped more readily by a brief recapitulation. A dense infusion of virulent active canker organisms was heavily inoculated into a box of soil entirely untreated and but recently removed from the orchard. This box of inoculated but otherwise untreated soil was kept under orchard conditions during the experiment.

Six days after the inoculation with the heavy infusion no indications of the organism could be obtained from this soil. As a control upon the conditions a similar box of soil, alike in every detail except that it had been autoclaved, was inoculated; it showed the continuance of the canker bacteria throughout 14 days, and the bacteria were apparently as numerous on the fourteenth day as on the first.

These experimental results, as well as those with the tubed soils, indicate that the canker organism does not increase and multiply or live even a passive existence in the normal soil but is quickly killed out. Inasmuch, however, as it will live in soil from which all other organisms are excluded, there is indication that in unsterilized soil the activities of the normal soil organisms are antagonistic to the existence of *P. citri*.

The following results obtained by a different experimental procedure still further corroborate the previous conclusions.

EXPERIMENT IV

This experiment was conducted to show the persistence or absence of the canker bacteria by growing susceptible plants in inoculated soils.

Ten bamboo pots were autoclaved and subsequently filled with soil twice autoclaved. These soil pots were then heavily inoculated with a dense infusion of *P. citri* in sterile water. On the same day 30 bamboo pots filled with unsterilized soil were inoculated with the canker organism from similar infusions.

Pots 1 to 5 of sterilized, inoculated soil were immediately planted each with 10 seeds from *Citrus trifoliata* fruits; pots 11 to 20 of unsterilized, inoculated soil were also immediately planted each with 10 seeds of *C. trifoliata*. After an interval of 5 days 10 more pots of unsterilized, inoculated soil were planted each with 10 seeds; and after an interval of 10 days 10 pots of unsterilized soil and 5 more pots of sterilized soil were planted, each pot with 10 *C. trifoliata* seeds.

It was the intention, of course, that the *Citrus trifoliata* seedlings resulting would be very susceptible and in growing through the inoculated soil would become infected if the canker organism still remained alive within the soil.

Running parallel with these series of inoculated soil pots, a series of orchard soil pots was operated as follows: Ten pots were filled with soil taken from beneath a heavily infected grapefruit tree, immediately following a rain, and each pot was planted with *Citrus trifoliata* seeds. The tree was cut down and all sources of infection were removed from the soil; then 10 days later 10 more pots were filled with the same soil and similarly planted.

All pots, those containing orchard soil naturally infected and those artificially inoculated, were covered with cheesecloth after planting to prevent the ingress and egress of insects which might spread infection.

The two series of pots were kept separated in the dense tropical woods at Lamao. The inoculation and planting data with results are given in Tables VII and VIII.

TABLE VII.—*Results of sprouting seeds and growing young plants of Citrus trifoliata in pots of soil artificially inoculated with canker bacteria*

Pot No.	Treatment of soil.	Date of inoculation.	Date of planting.	Results.	Date of examination.
1	Sterilized ..	Oct. 22, 1918	Oct. 22, 1918	No trees.	Jan. 16, 1919.
2 to 5do.....do.....do.....	9 trees, no infections.	Do.
6 to 10do.....do.....	Nov. 1, 1918	10 trees, no infections.	Do.
11 to 20	Unsterilizeddo.....	Oct. 22, 1918	31 trees, no infections.	Do.
31 to 33do.....do.....	Oct. 27, 1918	7 trees, no infections.	Do.
34do.....do.....do.....	No trees.	Do.
35 to 40do.....do.....do.....	19 trees, no infections.	Do.
51 to 58do.....do.....	Nov. 1, 1918do.....	Do.
59 to 61do.....do.....do.....	No trees.	Do.

TABLE VIII.—*Results of sprouting seeds and growing young plants of Citrus trifoliata in pots of soil naturally infected with canker bacteria in the orchard*

Pot No.	Condition of soil	Length of time after rain.	Date of planting.	Results.	Date of examination.
21 to 22	Naturally infected.	Immediately after rain.	Oct. 23, 1918	No trees.	Jan. 16, 1919.
23 to 30do.....do.....do.....	15 trees, no infections.	Do.
41 to 42do.....	5 days.	Oct. 28, 1918	No trees.	Do.
43 to 50do.....do.....do.....	18 trees, no infections.	Do.
62 to 66do.....	13 days.	Nov. 5, 1918	No trees.	Do.
67 to 69do.....do.....do.....	4 trees, no infections.	Do.
70do.....do.....do.....	No trees.	Do.
71do.....do.....do.....	1 tree, no infections.	Do.

SUMMARY OF EXPERIMENT IV

One hundred and thirty-three seedling *Citrus trifoliata* trees were sprouted in soil pots. These pots had been inoculated with the canker organism, either by artificial or natural means, from 35 to 40 days previous to the sprouting of the seeds. None of the seedlings at any time showed canker, although they were kept for 45 days after they appeared above the ground. The seedlings were from seed taken from heavily infected *C. trifoliata* fruits on badly infected *C. trifoliata* trees; there can be no doubt as to the general susceptibility of the stock. The strain of the organism used in inoculating the soil was the same as that which produced lesions

upon the lansones (*Lansium domesticum*), and there can be no question as to its virulence. The temperatures and humidity were at all times favorable for the development of canker.

Theoretically, criticism of the results of this experiment might be raised, since none of the trees, even the controls in sterilized inoculated soil, showed canker. Practically, however, there is a very good explanation. The seeds did not begin to sprout and the young shoots to push through the soil until the first week in December—that is, 35 days after soil was inoculated. During this time the sterilized soil pots were exposed in the Lamao woods, protected only from contamination by coarse cheesecloth. Under these conditions it could be expected that a few weeks after being placed in the woods the soil in the pots would be well inoculated with the ordinary soil flora and the canker organism would then be killed out. Another explanation might be that the normal young seedlings of *Citrus trifoliata* are possibly resistant to citrus canker infection, in which event the value of this method of testing for soil infection would be lessened.

SUMMARY OF RESULTS OF EXPERIMENTS

It has been shown in two separate experiments that *P. citri* lives and may even increase in culture tubes of sterilized soil throughout a period of 14 days or more. On the other hand, tubes of identical soil, handled in an identical manner with the exception of not being autoclaved, showed the canker organism to be entirely killed out within a period of 6 days.

In three similar experiments, representing two distinct seasonal periods, it was shown that the canker organism can be found in the soil beneath a heavily infected tree on the day immediately following the raia and on the second and third days following. Thereafter there is no indication of the canker organism in the soil.

In another experiment a box of soil was autoclaved and then inoculated with *P. citri*. This box, placed in the orchard to simulate field conditions, showed no decrease in the activity of the canker organism during a period of 14 days after inoculation. A box of similar soil, treated in an identical manner with the exception of not being autoclaved, showed the canker organism to be entirely killed out within a period of 6 days.

In the last experiment seeds were planted in nonsterile soil which had been inoculated with a heavy infusion of *P. citri*. The seeds which germinated and pushed through the soil 40 days after inoculation never showed any sign of canker although they were kept for 45 days after their appearance above the soil.

The results of each series of experiments point to the dying out of the canker organism in untreated soils. The indication is that the normal soil organisms are antagonistic in some way to the existence of *P. citri* in the soil.

The soil at Lamao is a sandy loam and seems to be of alluvial origin. There is little or no indication of decaying organic matter in the soil

and there is no reason to base a supposition for unusual bacterial activity on such grounds. The soil used in the experiments was taken from directly beneath trees of the Ellen grapefruit variety and was plowed, cultivated, and hoed according to usual orchard practices. The treatment of the soil differed very little from that usually practiced in the United States.

APPLICATION OF RESULTS

The writer would prefer that any applications of these findings be made by the field men, who are in the best position to judge the merits of different methods in eradication work. The following suggestion might be made, however, from a theoretical viewpoint.

It is frequently stated that canker is carried from orchard to orchard upon muddy feet or in the earth upon farm implements. These statements appear to be based upon a wrong conception of the character of the canker organism, and it would seem probable that the disease bacteria are carried upon dry portions of clothing and implements rather than in the earth. These experiments should therefore serve not to decrease the vigilance of quarantine measures but to increase the precautions to eliminate all sources for reinfection and dissemination of canker; for inasmuch as these experiments indicate that the canker organism does not live in the soil, field data which seem to indicate that *P. citri* is a soil inhabitant must be explained as indications of a source of reinfection overlooked or of a careless transfer of the organisms by farm animals or man.

SOME POSSIBLE SOURCES FOR REINFECTION BY THE CANKER ORGANISM

It has been demonstrated by Peltier and Neal¹ that the canker organism may overwinter in the bark tissue of citrus trees. The following observations may supplement their findings as to the means of overwintering or survival.

In the Philippine Islands lesions very much resembling those of citrus-canker were observed upon the mature wood of grapefruit trees (*Citrus maxima*) and lime (*C. aurantifolia*). These lesions were of a slightly lighter brown color than the normal bark and consisted of eruptions of tissue very similar to cankers upon leaves. Examinations of frozen sections of such eruptions revealed the typical structure of citrus-canker and the masses of bacteria distributed as in leaf cankers. *P. citri* was subsequently isolated from these lesions. Photographs (Pl. 36) show these mature wood cankers better than a description. The mature wood cankers were also observed upon navel orange trees (*C. sinensis*) in orchards in Japan.

Close examination has revealed that these mature wood cankers are by no means uncommon on lime, grapefruit, and sweet orange trees;

¹ PELTIER, George L., and NEAL, David C. OVERWINTERING OF THE CITRUS-CANKER ORGANISM IN THE BARK TISSUE OF HARDY CITRUS HYBRIDS. *In Jour. Agr. Research*, v. 14, no. 11, p. 523-524, pl. 58. 1918.

and their manner of occurrence indicates that wounds are not necessary for infection. They are commonly to be found upon branches as large as 2 or even 3 inches in diameter, the wood of which has entirely hardened and matured. One case has been observed of such cankers on the trunk of a lime tree 6 inches in diameter. Such cankers have never been seen on species other than the lime, the sweet orange, and the grapefruit. Cankers occurring in this way do not cause the killing of the limbs or branches, their seriousness consisting chiefly in affording constant sources for reinfection of foliage and fruit. Such cankers are also easily overlooked, inasmuch as they are small and of the same color as the normal bark.

The presence of such cankers suggested that cankers might also occur upon the roots of trees. Inoculations were therefore attempted upon roots with *P. citri* by means of needle punctures. The inoculations reacted slowly, but in 30 days examination showed that some of the punctures were undoubtedly positive. Control punctures with tap water were negative. The inoculations were then made repeatedly. The best series of results is selected here for presentation in Table IX. A photograph (Pl. 37, A) also shows some of these results. Mature trees, actively growing and thrifty, were selected for inoculation.

TABLE IX.—Results of inoculations with *P. citri* by means of needle punctures into roots of *Citrus sinensis*

Inoculation No.	Inoculum.	Diameter of root.	Date of inoculation.	Result.	Date of examination.
119	<i>P. citri</i> culture.....	Mm. 4	Dec. 5, 1917..	Positive.....	Feb. 15, 1918.
120do.....	4do.....do.....	Do.
121do.....	4do.....do.....	Do.
122do.....	4do.....do.....	Do.
123do.....	4do.....do.....	Do.
124do.....	4do.....do.....	Do.
125do.....	4do.....do.....	Do.
126do.....	4do.....do.....	Do.
127do.....	4do.....do.....	Do.
128do.....	4do.....do.....	Do.
129	Tap water.....	4do.....	Negative.....	Do.
130do.....	4do.....do.....	Do.
131do.....	4do.....do.....	Do.
132do.....	4do.....do.....	Do.
133do.....	4do.....do.....	Do.
134do.....	8do.....do.....	Do.
135do.....	8do.....	Swelling (no eruption).	Do.
136do.....	8do.....	Lost.....	Do.
137do.....	8do.....	Negative.....	Do.
138do.....	8do.....do.....	Do.

The inoculations were made with a needle, and the punctures were covered with moist cotton and wrapped in paraffin paper, then in opaque paper, and covered with earth.

From such positive results of inoculations *P. citri* was several times reisolated; and such cultures reinoculated on leaves of *Citrus maxima* gave positive results. There is therefore a possibility, considered however to be small, that the canker organism is carried on the roots.

In digging in the soil beneath citrus trees in the Philippines, leaves have been uncovered upon which cankers were found. These leaves were skeletonized by the soil organisms, the lignified tissues apparently resisting the action of the soil organisms while the cellulose parts of the leaf blade had entirely disappeared. Canker lesions upon such buried leaves also seem to resist the dissolving action of the soil bacteria. Photographs (Pl. 37, B) show the persistence of cankers upon such buried skeletonized leaves. Whether cankered leaves which have been buried and subsequently uncovered may possibly furnish another means of carrying the canker organism over in spite of control measures is a question that deserves special experimental investigation.

In Florida there have been many cases of seemingly thorough eradication of the disease followed by a new outbreak, even after considerable periods of inactivity. Such outbreaks at the time have been the cause for considerable conjecture and speculation. It is possible that the results presented here may point to hitherto overlooked sources of new infection occurring after a period of latency.

SUMMARY

(1) Experimental evidence is given to show that *P. citri* disappears from unsterilized soil in tubes and boxes usually within six days after they are inoculated. *P. citri* inoculated in sterilized soil increases and multiplies. Since the main difference in this latter case is the exclusion of the normal soil organisms, the disappearance of *P. citri* seems to be ascribable to the antagonistic effect of such soil inhabitants.

(2) In soil under orchard conditions, the canker organism is found to disappear even more rapidly than in the soil confined in boxes or culture tubes.

(3) Seeds were planted in pots of soil naturally infected with the canker organism and in pots of soil artificially inoculated. The seedlings came through the soil and developed normally without any canker, thus corroborating the conclusion that the canker bacteria are killed out in normal soils.

(4) Cankers upon mature wood of citrus trees and positive inoculations upon the roots of citrus trees are shown. Cankers upon buried leaves and mature wood and roots as possible sources of holding over the canker organism are suggested.

PLATE 36

A.—Citrus-cankers on mature wood of trunk of *Citrus aurantifolia*. Slightly reduced.

B.—Citrus-cankers on mature wood of branches of *Citrus aurantifolia*. Natural size.

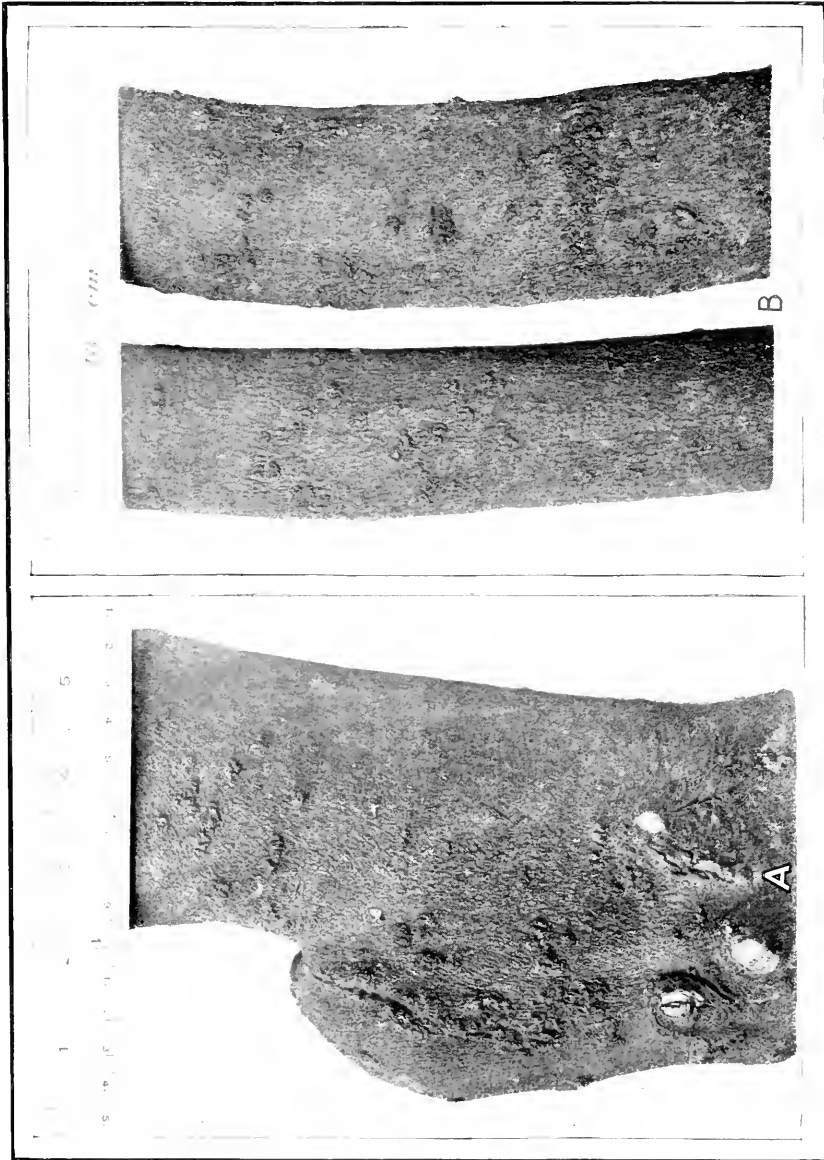

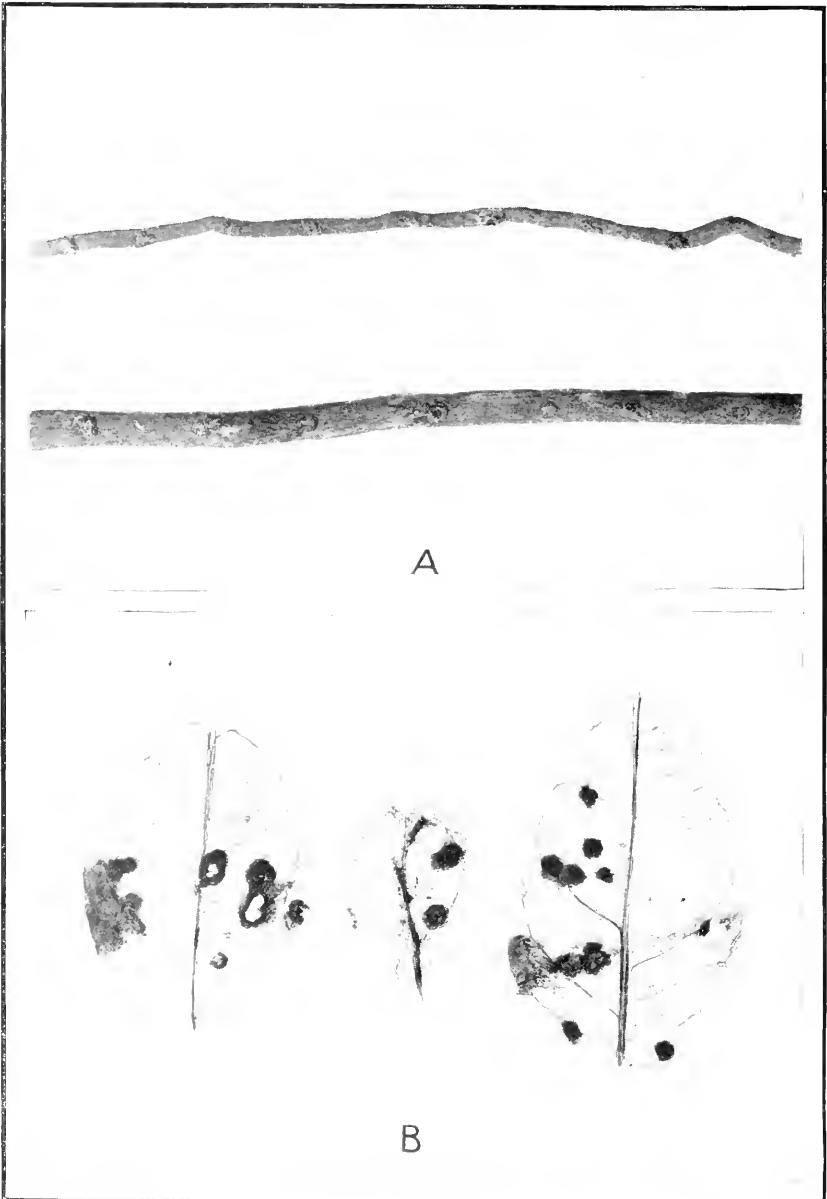

PLATE 37

A.—Results of inoculations with *Pseudomonas citri* upon roots of sweet orange (*Citrus sinensis*). Natural size.

B.—Skeletonized leaves of Ellen grapefruit recovered from buried soil. The leaf blade is entirely decomposed, leaving only the lignified veins and the cankered tissue. Natural size.



DECLINE OF PSEUDOMONAS CITRI IN THE SOIL

By H. R. FULTON

*Pathologist, Fruit-Disease Investigations, Bureau of Plant Industry, United States
Department of Agriculture*

This investigation was undertaken primarily to determine whether or not the citrus-canker organism, *Pseudomonas citri* Hasse, is capable of persisting in the soil to such an extent as to make the soil an important medium in holding over or disseminating the organism.

EXPERIMENTAL METHODS

The work has been conducted in an isolated greenhouse near Washington, D. C. During the tests the soils were kept in ordinary 4- or 6-inch earthenware flower pots in duplicate, triplicate, or quadruplicate sets for each test. For the original inoculation of the soil it was found most satisfactory to use washings from potato cylinder cultures 2 to 10 days old. One such culture tube diluted with 200 cc. of water would give heavy inoculation in a 4-inch pot. The bacterial suspension was well mixed with the upper 3 inches of the soil, and samples were taken from this portion from at least three different points.

Because of the preponderance of more rapidly growing soil organisms, ordinary plating methods are inadequate for determining the abundance of *P. citri* in soil samples, and recourse was had to inoculation of punctured mature grapefruit leaves with graded dilutions of washings from the soil to be tested. The procedure was as follows: A sample of about 20 gm. of the soil was removed with a sterile spoon to a sterile Petri dish, and enough sterile distilled water was added to give an excess of about 10 cc. beyond saturation. This was well stirred, and 1 cc. of the soil solution was transferred to another Petri dish in which 9 cc. of sterile distilled water had been previously placed. The first washing described above is referred to as the 1/1 dilution in this paper, and the second as the 1/10 dilution. In a similar way dilutions of 1/100, 1/1,000 or beyond were made from the original soil wash water. Small wefts of sterile absorbent cotton were placed in each dish, one for each leaf to be inoculated. The grapefruit seedlings used were grown in 2, 2½, or 3 inch pots. They averaged 6 or 8 inches in height and had as a rule 8 to 12 leaves. Usually 5 leaves per plant were used for inoculation, and each leaf was punctured at 100 points. A simple device for making these punctures rapidly and accurately was improvised by inserting 10 sewing needles through a small cork stopper. This "punch" was readily sterilized by flaming the needles, was convenient to handle, made the punctures in a uniform group pattern, and thus contributed materially to the rapidity

and accuracy of the work. A leaf was inoculated by wiping both under and upper surface of the freshly punctured portion with a cotton swab from a dilution dish, the swab being finally left on the upper surface. The inoculated plant was wrapped in paraffin paper, which served to retain moisture and to prevent accidental contamination from outside sources. Other plants were inoculated with pure cultures of *P. citri* as controls, and others were set up with the swabs merely wet with sterile water. The series were held at least a week in glass inoculation cases where conditions were near the optimum for canker development; later they were removed to the greenhouse benches. The first observations and records were made as a rule two to four weeks after inoculation. Final records were deferred until four to eight weeks after inoculation in order to insure the detection of any unusually slow development of infection such as occurred when the inoculum contained only a few organisms. The records show that between 90 and 95 per cent of the infections were apparent at the first observation and that no material increase was secured by holding beyond the second observation.

Variations of this method were tried out during its evolutionary development and to some extent in routine work as special considerations seemed to warrant. In many of the earlier series absorbent cotton wicks from small bottles of sterile water were placed in contact with the inoculation swabs on the leaves. This precaution to secure a prolonged moist condition proved to be unnecessary. An inoculum of mud paste, made by adding only a little water to the soil sample and applied with a backing of cloth or cotton as a sort of poultice over the punctured area, gave distinctly fewer infections than the soil solution in much greater dilutions. In cases where a large quantity of liquid inoculum could be prepared, a very effective method of inoculation was to dip the whole top of the test plant with its punctured leaves, keeping it submerged for an hour or longer, with several shakings during the period. In a few instances the test plants were so placed that the punctured leaves remained buried in the soil of the pots for a day or two. Tests were made of placing the plants under an air exhaust after soil water had been applied to their leaf surfaces. The soil solution was centrifuged to concentrate the canker organisms when they were very few, but this was without definitely satisfactory results. Still another method¹ employed was to atomize the leaves with sterile water, sift over them the rather dry soil to be tested, and keep the leaf surfaces moist for several days by holding the plants in a moist chamber and by repeatedly atomizing them with sterile water.

It was not apparent that any of the modifications of testing procedure could be relied upon to give a larger percentage of infections than the standard method, or to show the presence of *P. citri* when the standard method failed to give positive results.

¹ This method was first used by Miss Clara H. Hasse, of this office.

SENSITIVENESS OF DILUTION METHOD OF TESTING

In various tests involving several thousand plants, the standard testing method, which employs graded dilutions of the soil washing for inoculation on punctured grapefruit leaves, has proved reasonably sensitive in detecting the presence of viable *P. citri* in the soil. It is satisfactory for securing a rather definite idea of the relative numbers of this organism at the various times of sampling.

To test the efficiency of the method, dilutions in decimal series were made from a loopful of potato cylinder culture of *P. citri* distributed in the requisite number of cubic centimeters of sterile distilled water and were carried well beyond the vanishing point. One-cc. portions from each dilution were plated in beef agar for *P. citri* counts. Cotton swabs were dipped in the remainder of each dilution and applied to grapefruit leaves having 100 punctures each. Measurement showed these swabs to carry an average of 0.7 cc. of the liquid. The results of two independent tests are given in Table I.

TABLE I.—Comparison between number of infections on grapefruit leaves and counts on poured plates, using graded dilutions of *P. citri*

TEST A							
	1/10,000	1/100,000	1/1,000,000	1/10,000,000	1/100,000,000	1/1,000,000,000	1/10,000,000,000
Average number of infections, 20 leaves tested.....	76	14	2	0.2	0	0	0
Average count for 1 cc. inoculum, 5 plates.....	22,300	2,500	300	32	1	0	0
Average number of organisms applied per leaf.....	15,600	1,750	210	22
Average number of organisms per infection.....	205	125	105	110
TEST B							
Average number of infections, 16 leaves tested.....	69	9	1.4	0.13	0	0	0
Average count for 1 cc. inoculum, 6 plates.....	25,000	2,500	277	28	2.3	0.5	0.2
Average number of organisms applied per leaf.....	17,500	1,750	194	20
Average number of organisms per infection.....	253	194	139	154

The method apparently gives evidence of something like 30 organisms per cubic centimeter of inoculum, provided as many as 20 test leaves with 100 punctures each are used. The upper limit of sensitiveness would evidently be reached when numbers of bacteria are sufficient to infect practically all punctures, and diminution of sensitiveness would appear earlier. The ratio between infections per leaf and bacteria

applied is seen to be fairly uniform for the more critical lower ranges in both tests and lies between 1 to 100 and 1 to 200.

On the mature grapefruit leaves used for the tests there was practically no infection except at the freshly made punctures, and the counts are therefore free from errors that might have arisen from secondary spread if the unwounded tissue had been highly susceptible.

Two things are involved in the causation of infection by very dilute inoculum: (1) the chance for the organisms to reach the punctures and (2) the average number of organisms required to initiate infection successfully at a given point. In using cotton swabs, a considerable proportion of the organisms would be held at a distance from the leaf surface, and of those actually in the surface moisture film many would be at relatively great distances from punctures. On the other hand, motility of the organism and the possibility of rapid numerical increase by division would increase the chance for infection. As to the minimum number of *P. citri* organisms necessary to set up infection on reaching a given puncture, further careful experiments must be conducted before an opinion can be ventured.

PERSISTENCE IN VARIOUS TYPES OF SOIL

To secure as great diversity as possible with types of soil conveniently at hand the following kinds were selected: (1) stiff clay subsoil thrown out from an excavation several months previously; (2) leaf mold screened from ground surface in forest; (3) rotting compost of sod and manure thoroughly decayed; (4) garden soil, a clay loam of moderate fertility. Four-inch pots were used in duplicate for each soil type. The inoculum for each pot amounted to 10 cc. of a 2-day beef bouillon culture of *P. citri* mixed with about one-fifth of the washing from a 6-day potato cylinder culture, the whole being diluted to 100 cc. and evenly mixed with the upper 3 inches of soil in the pot. Inoculations were made on August 14, 1918. The pots were held in the greenhouse shaded from direct sunlight, and were given ordinary watering. Each percentage in Table II is based on the number of infections developed in 17 days in a total of 600 leaf punctures and represents the average of duplicate pots of each soil type.

TABLE II.—Percentages of infection on grapefruit leaves inoculated with graded dilutions of solutions from four types of soil made at various intervals after the soil had been inoculated with *P. citri*

Number of days between inoculation and sampling.	Clay subsoil.				Leaf mold.				Compost.				Garden soil.			
	1/1	1/10	1/100	1/1,000	1/1	1/10	1/100	1/1,000	1/1	1/10	1/100	1/1,000	1/1	1/10	1/100	1/1,000
0.....	28	52	15	0.3	55	63	13	2	35	16	8.3	3	60	33	32	2.3
2.....	9.2	11	0.8	0	17	8.7	0.8	0	11	22	57	4.7	60	33	28	14
5.....	.3	0	0	0	0.5	.2	0	0	38	32	5.2	.7	57	38	6.7	.5
9.....	0	0	0	0	.2	0	0	0	8.0	0.2	.2	0	3.5	0.7	0	.2
14.....	0	0	0	0	0	0	0	0

P. citri evidently decreased very rapidly in all these soils and apparently reached the vanishing point in all in less than 14 days. The rate of decrease was most rapid for the clay subsoil, slightly less so for the leaf mold, and distinctly slower for the compost and garden soil.

A second test was begun September 7, 1918, with new lots of soil from the same sources with the addition of well-washed sand from a creek bed, and a mixture of equal parts of the leaf mold and garden soil used in the earlier experiment. The initial inoculation was about 50 per cent heavier than in the preceding series. In order of rapidity of decrease clay subsoil proved again to be first, followed by leaf mold, sand, compost, garden soil, and mixture of leaf mold and compost. At the termination of this test, 14 days after inoculation, the red clay was the only one giving negative results; and the percentages for the leaf mold, compost, and garden soil were approximately those given for the ninth day in Table I. This longer persistence in the second test may reasonably be attributed to the higher initial inoculation of the soil.

In other experiments the following citrus soils from Florida were used: (1) from Orlando, intermediate between high and low pine soil types, unusually rich in humus; (2) similar to (1) but naturally poor; (3) similar to (2) but from a poorly drained spot; (4) from Bradentown, low pine land of low fertility; (5) from Bradentown, typical muck, extremely rich in humus; (6) from Winter Park, high hammock type; (7) from Winter Park, low hammock type. The samples, as a rule, reached the laboratory and were set up before becoming dry. The usual dilutions to 1/1,000 were run, but for brevity the percentages from the 1/1 dilution only are given in Table III. At the higher dilutions the commencement of decline was evident at the second sampling for all types, whereas this decline is not evident from the 1/1 figures of the table until the fifth or sixth day. The tests were made during September and October, 1918, in three distinct series, as indicated in the table. The second and third were conducted by Miss Clara H. Hasse, of this office, through whose courtesy the results have been furnished for this publication. The percentages are based on infection development from 600 punctures.

TABLE III.—Percentages of infection on grapefruit leaves inoculated with 1/1 soil solution at various intervals after the soil had been inoculated with *P. citri*

Number of days between inoculation and sampling.	Series 1.			Series 2.			Series 3.		
	Soil 1.	Soil 2.	Soil 3.	Number of days between inoculation and sampling.	Soil 4.	Soil 5.	Number of days between inoculation and sampling.	Soil 6.	Soil 7.
0.....	88	93	80	0.....	31	62	0.....	92	83
2.....	90	93	88	3.....	61	98
5.....	45	50	33	6.....	48	60	6.....	34	41
9.....	6.3	5.3	0.7	10.....	2.2	2.8	10.....	6.8	4.5
14.....	2.5	0	.5	16.....	.3	3.7	15.....	4.8	1.5
.....	48.....	1.0	7.1	22.....	.2	.5
.....	56.....	0	4.2	52.....	.2	0

There is a marked decline preceding the tenth day in all of the soils of Table III. But scattering infections are apparent over a much longer period, and no one of these soils could be safely declared free of *P. citri* at the times of discontinuance of the respective tests. It is a fact that regular watering of the pots was overlooked during the latter part of the longer tests, and the dry condition probably contributed to the long persistence. Special evidence on this point is given later in this paper.

Florida soils were also used in a number of other special tests, accounts of which follow throughout this paper.

Samples of soil from citrus plantings at Biloxi and Big Point, Miss., were artificially inoculated and tested at 6-day intervals for persistence of *P. citri*. The results were negative on the twelfth day and afterwards.

INFLUENCE OF DEGREE OF INITIAL SOIL INOCULATION

A series was set up September 16, 1918, using three degrees of inoculum, one five times and another one-fifth the usual medium degree. Unfortunately this series was discontinued on the twelfth day, just when the decline from the heavy inoculation was beginning to be pronounced. A second test was begun October 20, 1919. Greenhouse potting soil was used. The medium inoculation consisted of 0.4 of the washings from a potato cylinder culture for each of the duplicate pots. The heavy inoculation was 10 times this, and the light inoculation one-tenth. The pots were kept in the greenhouse, were shaded, and were given ordinary watering. Each percentage given in Table IV is based on 2,000 inoculated punctures.

TABLE IV.—Percentages of infection on grapefruit leaves inoculated with graded dilutions of soil solution at various intervals after the soil had been inoculated with *P. citri* in different degrees

Number of days between inoculation and sampling.	Heavy inoculation.				Medium inoculation.				Light inoculation.			
	1/1	1/10	1/100	1/1,000	1/1	1/10	1/100	1/1,000	1/1	1/10	1/100	1/1,000
0.....	62	23	5.8	0	9.8	4.8	0.3	0.6	6.0	0	0	0
2.....	33	30	5.5	1.0	9.1	3.0	.4	.2	1.0	0.1	0	0.05
4.....	11	3.5	1.6	.4	1.4	0	.05	0	0	.05	0	0
7.....	4.6	1.0	.4	0	0	0	0	0	0	0	0	0
9.....	.3	0	0	0	0	0	0	0	0	0	0	0
11.....	.05	0	0	0	0	0	0	0	0	0	0	0
14.....	.3	.05	0	0	0	0	0	0	0	0	0	0
18.....	0	0	0	0	0	0	0	0	0	0	0	0
23.....	.2	0	0	0	0	0	0	0	0	0	0	0
30.....	0	0	0	0	0	0	0	0	0	0	0	0

It is not understood why all the initial soil inoculations in this series turned out to be so far below the expected degree. What was intended for heavy soil inoculation ran considerably below that ordinarily used in other experi-

mental tests. At the same time it is probably as high as would be encountered in citrus plantings under infected trees; and the whole series may be regarded as representing high, medium, and low degrees of soil infection under natural conditions.

The differences are apparently not so much in rate of decline as in time required to reach the zero level from the different initial levels of inoculation.

INFLUENCE OF SOIL TEMPERATURE ON PERSISTENCE

The test for low temperature effect, series 1, which is reported in Table V, was made by exposing the inoculated potting soil to outdoor temperatures, beginning October 11, 1918. During the test the minimum daily readings ranged from 60° to 23° F., and the maximum daily readings from 83 to 58°. For moderate temperatures, exposure was made in the greenhouse, with daily means averaging about 15° higher than outside. Series 2 was begun October 20, 1919, using an incubator at 95° for the high range and the greenhouse for the moderate. The actual soil temperatures 2 inches below the surface were taken, the high temperature test ranging from 86° to 90° and the moderate from 68° to 72°. Percentages for series 1 are based on 600 inoculated punctures, and for series 2 on 2,000.

TABLE V.—Percentages of infection on grapefruit leaves inoculated with graded dilutions of soil solutions at various intervals after the soil had been inoculated with *P. citri* and had been held at different temperatures

Days between inoculation and sampling.	Series 1.								Days between inoculation and sampling.	Series 2.							
	Moderate temperature.				Low temperature.					Moderate temperature.				High temperature.			
	1/1	1/10	1/100	1/1,000	1/1	1/10	1/100	1/1,000		1/1	1/10	1/100	1/1,000	1/1	1/10	1/100	1/1,000
0.....			66	7.2			53	12	0.....	9.8	4.8	0.3	0.6	5.8	1.4	1.3	0.3
3.....	97	62		9.5	68	60	42		2.....	9.1	3.0	.4	.2	0.1	0	0	0
7.....		3.3	3.3	1.8			73	50	4.....	1.4	0	.05	0	.3	0	0	0
10.....	24	2.0	.3	1.7	45	90	37	14	7.....	0	0	0	0	0	0	0	0
15.....	0.3	.3	0		24	90	25		9.....	0	0	0	0	0	0	0	0
19.....			^a 1.3				^a 21		11.....	0	0	0	0	0	0	0	0
28.....			^a .2				^a 3.1		14.....	0	0	0	0	0	0	0	0
36.....			^a 0				^a 0		18.....	0	0	0	0	0	0	0	0
42.....			^a 0				^a 0		23.....	0	0	0	0	0	0	0	0

^a Inoculated by dipping plant top in liquid.

There is a very evident retardation of the rate of decline at the lower temperatures. A second series of October 23, 1918, confirms this for a still lower range of temperature. The higher temperatures seem to accelerate the decline, but the unfortunate low initial inoculation of the soil requires a repetition of the test. At the time of handling series 1, the influence of soil dryness in prolonging persistence had not been determined,

and too little attention was given to watering the pots regularly during the latter part of the experiment. But the outside pots retained moisture much better than those inside, and any difference would have been against longer persistence in them.

INFLUENCE OF SOIL MOISTURE ON PERSISTENCE

A test was begun September 2, 1918, using ordinary potting soil. Inoculation was with a mixture of beef bouillon and potato cylinder cultures. One set of duplicate pots was kept near the saturation point by watering thoroughly every other day. A second lot was restored at each watering to the halfway point between saturation and the original air-dry condition of the soil. The third set was left unwatered. The percentages in Table VI are based on 600 inoculated punctures.

TABLE VI.—Percentages of infection on grapefruit leaves inoculated with graded dilutions of soil solution at various intervals after the soil had been inoculated with *P. citri* and had been held at three moisture contents

Number of days between inoculation and sampling.	Soil continuously saturated.				Soil moderately watered.				Soil air dry.			
	1/1	1/10	1/100	1/1,000	1/1	1/10	1/100	1/1,000	1/1	1/10	1/100	1/1,000
0.....	62	70	77	68	68	55	80	47	43	80	85	57
1.....	54	23	38	32	57	38	18	43	55	83	47	42
3.....	53	72	37	8.7	67	60	45	21	67	78	71	70
5.....	48	55	23	11	75	48	43	4.3	65	53	7.2	7
7.....	2.2	0.8	0.2	0	10	4.2	1	0	11	3.3	1.2	0
12.....	1.5	.7	.3	0	0.3	.2	0	0	1.8	4.5	.8	0
17.....	0	.52	0	3.5	.2

The foregoing test shows no very pronounced or definite differences in rate of decrease. The slight differences tend toward lag with decrease of moisture, the moderately watered soil showing possibly less rapid decline than the saturated, and the air-dry soil showing still greater retardation.

Further tests of moderately wet soil as compared with dry were made at different times with three lots of Florida soil and are reported in Table VII. The soil for series 1 was from a "sand-soak" spot at Estero, Fla.; for series 2, from high pine land near Leesburg, Fla.; and for series 3, from intermediate pine land at Orlando, Fla. These tests were made by Miss Clara H. Hasse, of this office, during October and November, 1918, and through her courtesy are presented here. Only the 1/1 dilutions are included in Table VII, since in each series the results from higher dilutions were in accord with these. The percentages are based on inoculation of 600 punctures.

The first series indicates distinctly a retarded decline and prolonged persistence in the dry soil. The second series, with another type, shows no decided difference between the wet and dry. In the third series the initial decline was more rapid in the dry than in the wet soil.

TABLE VII.—Percentages of infection on grapefruit leaves inoculated with 1/1 solutions of three Florida soils at various intervals after the soils had been inoculated with *P. citri* and had been held at two moisture contents

Number of days between inoculation and sampling.	Series 1.		Series 2.		Series 3.	
	Wet.	Dry.	Wet.	Dry.	Wet.	Dry.
0.....	98	98	100	97	95	100
3.....	98	100	100	95	86	19
6.....	83	74	77	90	8.8	0.5
9.....	82	94	90	64	5.7	.7
14 or 15 ^a	9.7	93	63	23	0	.3
21.....	6.3	40	1.8	1.7
44 or 43.....	0	18	0	0
50 to 54.....	0	0	0	0	0	0

^a Where two numbers appear for days they indicate slight differences in the sampling periods for the several series.

In Table VIII two series, one set up June 12 and one July 8, 1919, are compared. Both were with soil from Orlando, Fla., of the same type but collected at different times. The inoculum for each 6-inch pot in the two series was from four potato cylinder cultures. The first series was kept well watered. The second was dried overnight after the original inoculation and kept air-dry thereafter. The percentages for the first series are averaged for four similar pots and are based on 4,000 inoculated punctures; those for the second are for three pots and are based on 3,000 inoculated punctures. These series were set up and conducted for approximately the first two months by Miss Clara H. Hasse.

TABLE VIII.—Percentages of infection on grapefruit leaves inoculated with graded dilutions of soil solution at various intervals after the soil had been inoculated with *P. citri* and had been held at two moisture contents

Number of days between inoculation and sampling.	Series 1, moist soil.				Series 2, dry soil.			
	1/1	1/10	1/100	1/1,000	1/1	1/10	1/100	1/1,000
0.....	50	73	70	60	94	97	98	73
2.....	66	93	87	92	22	7.5	2.4	0.4
4.....	40	17	50	13	11	2.0	2.9	.1
7, 6 ^a	44	44	11	3.9	2.6	2.1	.4	0
9, 8.....	17	14	2.5	1.6	3.9	2.1	.5	0
11, 10.....	13	8.3	3.0	1.0	23	4.6	.8	0
13.....	2.1	2.4	.6	.02	30	4.0	.9	.3
18.....	2.8	1.2	.3	.2	16	2.7	.4	12
21, 23.....	.6	.4	.03	0	32	9.6	.9	.3
33, 34.....	0	.03	0	20	1.7	.1	0
40, 43.....	.03	0	0	3.7	1.1	.3
52, 54.....	0	.03	06	.2	.03
60, 62.....	0	0	0	1.7	.5
60, 71.....	0	0	1.5	.6
78, 80.....	0	3.0	.9
88, 90.....	04
97, 99.....	01
106, 108.....	01
116, 118.....	0	1.05
125, 133.....	01
....., 166.....1

^a Where two numbers appear for days the first applies to series 1 and the second to series 2.

Heavy initial inoculation, frequent samplings over a long period, and inoculation at each sampling of 40 or 30 grapefruit leaves with 100 punctures each for the respective series render the results in these series especially noteworthy. In the moist series, after the fourth day, one notes a general equality of percentages on diagonals extending downward and to the left from any of the $1/1,000$ figures. For example, the $1/1,000$ dilution on the fourth day, the $1/100$ on the seventh, the $1/10$ on the ninth, and the $1/1$ on the eleventh are approximately the same, indicating a nine-tenths loss in actual numbers in the soil for each sampling interval as compared with the preceding one; and this seems to hold true until the fortieth day. It may be explained that the moist series suffered much from the dropping of leaves heavily infected from the early samplings, and the resulting figures are somewhat erratic.

In the dry series there is a decided drop following the initial drying immediately after inoculation. Then follows a slow decline followed by an inexplicable increase between the tenth and thirty-fourth days. Afterwards there is an extremely gradual decline, if any, extending to the one hundred and sixty-sixth day.

On October 27, 1919, the one hundred and twelfth day of the test, a portion of the soil was removed from each of the three dry pots and moistened with sterile distilled water. The following tabulation shows the results of inoculation tests made from these moistened lots in comparison with the original dry soil. Two thousand punctures were inoculated from each lot of soil, making 6,000 for each test of moistened or of dry soil. The figures are total infections from 6,000 punctures.

	Date of sampling.						
	Oct. 29.	Oct. 31.	Nov. 3.	Nov. 5.	Nov. 7.	Nov. 10.	Nov. 17.
Dry soil.....	2	6	3	8	9	0	6
Moistened soil.....	0	0	0	0	0	0	0

The application of sterile distilled water seemingly resulted in prompt and complete extinction of *P. citri* in this dry soil which had constantly shown the presence of at least small numbers of the organism during almost four months. A repetition of the test, begun November 14, 1919, confirms these results.

That this extinction was not due to any toxic property peculiar to the distilled water was shown by a second test begun December 13, 1919, in which spring water and deep well water were used for wetting the soil. Tests on the third and seventh days were negative for all lots of moistened soil, while the dry soil continued to show the usual trace of *P. citri*.

That rate of drying would have an influence on the residuum of *P. citri* is to be expected and probably accounts for some of the irregularities

already noted in the behavior of the dry soil series when no control was exercised over the rate of drying. In a preliminary test, comparisons were made of the infective power of soil samples similarly inoculated and air-dried with different rates of rapidity at approximately the same rather warm temperature. A sample dried in less than one day gave 1.5 per cent infection, one dried in two days gave 0.1 per cent infection, and one dried in seven days gave no infection in tests made in each case immediately after drying.

An extended test of persistence in air-dry soil was made by Miss Clara H. Hasse. On October 22, 1918, soil from Winter Park, Fla., was heavily inoculated and dried as quickly as possible, in about one hour. Tests for infectiveness were made by several methods, usually by dusting the dry soil over punctured leaves which were atomized with water, the plants being later held in moist chambers. The total punctures inoculated in each test ranged from 600 to 5,000. The following percentage results were obtained:

	Date of sampling.									
	Oct. 22, 1918.	Oct. 25, 1918.	Oct. 28, 1918.	Nov. 1, 1918.	Nov. 8, 1918.	Jan. 2, 1919.	June 11, 1919.	Aug. 8, 1919.	Sept. 23, 1919.	Dec. 26, 1919.
Percentage of infection	94.1	68.3	8.5	2.3	1.5	0.1	0.24	0.22	0.48	0.05

On December 22, 1919, a portion of this soil was moistened with tap water from a deep well and was tested on the fourth and seventh days in comparison with the part remaining dry. In these tests the moistened soil gave no infection, while the dry soil continued to show traces.

PERSISTENCE IN SOILS MADE ARTIFICIALLY ALKALINE AND ACID

Greenhouse potting soil was used in 6-inch pots. Duplicate pots were watered each with 400 cc. of water containing 1.6 cc. sulphuric acid. Two pots were watered with 400 cc. of water containing 224 cc. clear lime water prepared by slaking 25 gm. quicklime and making up to 1,000 cc. A titration test showed this lime water to be sufficient to neutralize the quantity of acid applied to the other pots. A third pair of pots was watered with 400 cc. distilled water. After standing three days all pots were equally inoculated with *P. citri*. On each sampling date litmus paper tests of the 1/1 soil washings were made, and such small amounts of lime water or diluted acid were added as seemed necessary to maintain approximately the original distinct acidity in one set and distinct alkalinity in the other. The watering of all sets was equalized. The percentage results given in Table IX are based on infections out of 2,000 inoculated punctures.

TABLE IX.—Percentages of infection on grapefruit leaves inoculated with graded dilutions of three soil solutions at various intervals after the soils had been treated with lime water, dilute sulphuric acid, and distilled water, respectively, and inoculated with *P. citri*

Number of days between inoculation and sampling.	1. Alkaline soil.				2. Normal soil.				3. Acid soil.			
	1/1	1/10	1/100	1/1,000	1/1	1/10	1/100	1/1,000	1/1	1/10	1/100	1/1,000
0.....	80	95	70	33	93	100	46	26	16	80	50	24
2.....	69	84	67	49	83	70	46	23	7.5	22	3.8	1.5
4.....	56	46	38	8.9	41	40	30	3.0	.6	.5	.5	0
7.....	9.1	5.1	2.9	.6	3.8	2.1	.6	.2	0	0	0	0
9.....	2.7	.4	.2	.1	.5	.2	0	0	0	0	0	0
11.....	.1	0	0	.05	0	0	0	0	0	0	0	0
14.....	0	.3	0	0	.05	0	0	0	0	0	0	0
18.....	.2	.5	0	.05	0	0	0	.05	0	0	0	0
23.....	0	0	0	0	0	0	0	0	0	0	0	0
30.....	0	0	0	0	0	0	0	0	0	0	0	0
37.....	0	0	0	0	0	0	0	0	0	0	0	0
46.....	0	0	0	0	0	0	0	0	0	0	0	0

This preliminary and very artificial series indicates a slight retardation of decline in the alkaline soil and a distinct acceleration in the acid soil. In the latter, one notes the low infection percentages for the 1/1 dilution as compared with the 1/10 of the same series, or with the 1/1 of the other two series. While there is quite generally a tendency for the 1/1 dilution to give unexpectedly low results, the present instance suggests that the rather high acidity of the first wash water vehicle may play a part here in preventing infection. This matter calls for further experimentation. Since the tendency of most citrus soils is toward acidity, the evidence presented in Table IX is reassuring as to the decline of *P. citri* in such soils, notwithstanding the very unnatural conditions of the experiment.

PERSISTENCE DEEP IN THE SOIL

The tests for downward penetration were made by placing partially dry soil in open pasteboard cylinders 3 inches in diameter and watering the surface with a strong *P. citri* suspension until the whole was saturated. Sections were made at proper intervals and samples taken with proper precautions from the axis of the soil column. For vertical ascent the cylinders were placed in a shallow pan containing the suspension of *P. citri*.

In an 8-inch column of Florida sandy soil sampled at 2-inch intervals on November 20, 1918, downward penetration was shown to be very uniform throughout. A 15-inch column of greenhouse potting soil was tested October 1, 1919, with similar practically uniform penetration, as shown by sampling at 3-inch intervals.

In Florida soil tested for vertical ascent, the capillary rise was 6 inches during four hours. Two-inch samplings showed *P. citri* to be uniformly distributed.

While testing experimental methods, it was found that the organism is readily carried in the capillary current along an absorbent cotton wick at least 10 inches.

The indication that *P. citri* may readily penetrate deep into the soil raises the question of whether conditions deep in the soil may influence the persistence of the organism differently from those near the surface. A test was made by burying 4-inch pots of inoculated potting soil in large containers, so that the pots were completely surrounded by 8 inches of soil. Samplings were made at approximately 5-day intervals. No decided difference was noted between the buried pots and similarly inoculated ones held on the greenhouse bench.

PERSISTENCE IN AUTOCLAVED SOIL

Greenhouse potting soil in 4-inch pots was autoclaved July 15, 1918, for one hour with steam at 12 pounds pressure. When the soil was cold four autoclaved pots were inoculated, as well as four others containing similar soil not autoclaved. The percentage results in Table X are based on infection out of 1,200 inoculated punctures.

TABLE X.—Percentages of infection on grapefruit leaves inoculated with graded dilutions of solutions from unautoclaved and autoclaved soils at various intervals after the soils had been inoculated with *P. citri*

Number of days between inoculation and sampling.	Unautoclaved soil.				Autoclaved soil.			
	1/1	1/10	1/100	1/1,000	1/1	1/10	1/100	1/1,000
0.....	73	73	16	0.9	44	3.4	6.2	0.3
4.....	60	35	7.8	3.7	60	68	13	15
9.....	0.9	0.7	.1	0	28	17	75	40
14.....	0	0	0	0	9.5	4.3	.8	.7
18.....	.1	.2	0	0	9.2	13	9.4	1.3
24.....	0	.1	0	0	1.9	1.9	2.1	.2
29.....	0	0	0	0	.8	.3	.3	.2
35.....	0	0	0	0	.4	.1	0	.1
44.....	0	0	0	0

The pots were kept on the greenhouse bench, each covered with paper. No special precautions were adopted to insure continued sterility in the autoclaved pots, if indeed the original steaming was sufficient for complete sterilization. Platings on agar at the end of the test showed miscellaneous bacteria in these pots in apparently as great numbers as in the unautoclaved ones. The autoclaved soil shows a decided lag in the decline of *P. citri*. A second series run two months later confirms this result.

PERSISTENCE IN WATER

Water was held in cotton-stoppered flasks in 200-cc. quantities. Water from a local spring was used in comparison with distilled water. Unfortunately the flasks of autoclaved distilled water became contaminated,

as was shown by Petri dish platings soon after the series was begun, and the results from them are not included in the tabulation. The percentages in Table XI are based on infection in 1,500 punctures.

TABLE XI.—Percentages of infection on grapefruit leaves inoculated with graded dilutions of distilled water, autoclaved spring water, and unautoclaved spring water at various intervals after the water had been inoculated with *P. citri*

Number of days between inoculation and sampling.	Distilled water.				Spring water, autoclaved.				Spring water, not autoclaved.			
	1/1	1/10	1/100	1/1,000	1/1	1/10	1/100	1/1,000	1/1	1/10	1/100	1/1,000
0.....	100	97	43	14	97	87	51	8.2	100	96	58	13
2.....	0.1	0	0	0	72	8.2	5.8	.3	1.7	0.5	0.5	0
4.....	0	0	0	0	85	28	5.1	.8	0	0	0	0
7.....	0	0	0	0	90	60	12	0	0	0
11.....	0	0	58	25	0	0
16.....	0	34	0
21.....	0	44	0
30.....	0	40	0

Two other series confirmed the very rapid decline noted above in either distilled or ordinary surface water when it is nonsterile. Contrasted with this is the long persistence of moderately reduced numbers of the organism in the sterilized spring water.

The question is sharply raised, does autoclaving promote the persistence of *P. citri* in soil or water by destroying something that is deleterious or by producing something that is favorable? Autoclaving, in general, has its greatest effect in destroying the organic fauna and flora of the medium, and a subsidiary one in modifying the nutritive materials contained in it. The supposition that starvation may be the cause of the normal decline and that autoclaving the soil supplies enough available nutriment for a greatly prolonged persistence does not seem reasonable because of the disproportion between the changes that could possibly be brought about by autoclaving and the effects observed on *P. citri* persistence. Furthermore, this supposition of starvation is not adequate to explain the extinction of *P. citri* in air-dry soil when moistened.

INHIBITORS

The deleterious effects of organisms on the development of *P. citri* is frequently observed in poured plates when fungus or bacterial contaminants entirely inhibit the development of *P. citri* for considerable distances from their limits of growth. The behavior of some of these inhibitors has been made the subject of special preliminary study.

A series of plates was prepared September 13, 1919, from beef agar rather heavily and uniformly inoculated with *P. citri*. When hard, they were inoculated in addition with a bacterium, designated inhibitor A, previously obtained from a chance contamination on a poured plate. On some plates two streaks of the inhibitor were made at right angles

across the plates; in others it was planted at the center and at four spots near the circumference; in still others it was planted abundantly over the plate. Seven days later *P. citri* was seen growing in triangular areas between the limbs of the crosses, in isolated patches with concave borders between the spots, and not at all on the plates with numerous colonies of the inhibitor. It appeared only where the distance was at least 15 to 18 mm. from the nearest border of an inhibiting colony. A hand lens and the low power of the microscope brought within range of vision two successive graded zones each about 3 mm. wide of smaller *P. citri* colonies edging the clearly visible areas. The average distance from the edge of the inhibiting colony to the *P. citri* colonies of microscopic size was about 10 mm. Repeated attempts to cultivate *P. citri* from bits of agar from this clear 10-mm. zone failed, although the abundance of the original inoculation would have made it easy to recover the organism at any point, if it were still alive. It was recovered in culture from the microscopic and the clearly visible zones, and no extension of the killing effect could be determined after a further lapse of seven days, during which time there was no apparent growth of the inhibiting colonies.

The testing of some 40 miscellaneous soil bacteria and fungi on beef agar plates by the streak or the spot method showed about one-fourth of the number to have some degree of inhibiting effect, while three seemed to stimulate or accelerate the development of *P. citri* colonies, at least at the beginning of their development.

On other media the effects of certain of these inhibitors differed from those exhibited on beef agar, the inhibiting effect being reduced or entirely lost on certain media.

Tests in the soil itself must be conducted before definite statements can be made as to the part such potential inhibitors or destroyers actually play in the decline of *P. citri* under soil conditions. However, the hypothesis that the deleterious effects on *P. citri* are brought about by certain organisms in the soil is in harmony with the experimental evidence thus far obtained and seems to be a reasonable explanation of the phenomenon.

It seems reasonable to suppose that *P. citri* can persist in dry soil partly at least because of suspended activity of deleterious organisms, and that the addition of water makes possible a renewal of their unfavorable activity.

INFECTION OF GRAPEFRUIT ROOTS BY *P. CITRI*

The question naturally arises as to whether roots of citrus species are highly susceptible to citrus-canker infection. The following tests bear on this point.

On May 20, 1918, eight pots of soil were inoculated heavily with *P. citri* culture and planted with grapefruit seed, about 50 per pot. Eight other pots were similarly prepared without inoculation. In another set both seed and soil were inoculated, and in still another only the seeds were

inoculated. After two months the seedlings in all had made good growth, and there was no evidence of citrus-canker lesions on any part of the plants. In the light of present knowledge it would not have been expected that a single soil inoculation at the time of planting would persist long enough to become very effective.

On July 10, 1918, a series of pots was planted with grapefruit seed and given frequent waterings with *P. citri* suspension, on July 10, 13, 17, 20, 24, 27, and August 2. By this time the seedlings had emerged above ground, and before each subsequent watering several cuts were made through the soil with a knife to produce root wounds. Further applications of *P. citri* suspension were made August 5, 8, 10, 14, and 16. On August 31 the seedlings were removed, washed, and examined with a hand magnifier. No canker lesions were apparent on any part of the 40 plants thus examined. A test performed on grapefruit leaves with soil from these pots which had received 12 applications of heavy inoculum at close intervals gave negative results.

Direct inoculation of the roots of potted grapefruit seedlings was made as follows: On July 27, 1918, potted plants were selected with vigorous roots of about $\frac{3}{16}$ inch diameter extending $\frac{1}{2}$ to 3 inches through the drainage holes of the pots. These roots were punctured at 10 points each, wrapped in cotton wet with *P. citri* suspension, and later placed in flats of moist, clean sand. Two weeks later infection was 40 per cent. Microscopic sections showed typical canker lesions involving the cortex. Pure cultures of *P. citri* were readily obtained by plating, and grapefruit leaves were infected therefrom. Four months later no extension of infection was apparent on the roots, most of them having continued their growth to all appearance normally. In several, however, the roots were broken at old lesions apparently following secondary decay. The plants as a whole had not suffered.

The indications are that young grapefruit roots are not readily infected except through direct wound inoculation and that the plants do not suffer from a moderate number of lesions so produced.

SUMMARY

(1) The method of using graded dilutions of soil washings for inoculating punctured grapefruit leaves proved satisfactory for indicating the relative abundance of *P. citri* in the soil at times of sampling.

(2) Tests on many types of soil, including representative ones from citrus regions, show a very rapid decline of *P. citri* in all.

(3) This decline was retarded slightly by rendering the soil alkaline with lime water or by lowering its temperature, and more decidedly by withholding water or by previous sterilizing with steam.

(4) An extremely long persistence, in very small numbers, is noted in soil held in air-dry condition; but the organism seemingly suffers prompt extinction when water is again added.

(5) The decline is accelerated decidedly by the addition of dilute sulphuric acid or by a moderate rise in temperature.

(6) *P. citri* may easily penetrate the soil to depths ordinarily cultivated, but the normal decline seems to occur at such depths.

(7) In water the decline is more rapid than in soil. Previous sterilizing of the water has a decided effect in prolonging persistence.

(8) Certain bacteria found commonly in soils have a marked deleterious effect on *P. citri* in artificial culture media both by inhibiting growth and by killing.

(9) The presence of such deleterious organisms in soils would probably be concerned in producing a decline of *P. citri*.

(10) Young roots of grapefruit seedlings seem not to be readily infected by *P. citri* except through wounds.

CONCLUSION

The main question at issue is whether or not *P. citri* can persist in the soil to a sufficient degree or for a long enough time to be a source of danger in the dissemination or holding over of the citrus-canker disease. The experimental evidence shows clearly that the organism undergoes a rapid and continuous decline in numbers under soil conditions that would obtain in agricultural practice. As a rule, this decline reaches the vanishing point for *P. citri* in about two weeks by the test methods employed, and it is only reasonable to suppose that the downward trend continues rapidly in such cases to absolute extinction. The potential ability of certain soil organisms to destroy *P. citri*, as shown in certain artificial culture media, lends weight to this latter supposition. Even where long-time persistence has been induced experimentally, the conditions necessary to bring it about are too extreme to make a duplication probable under natural conditions. Furthermore, the experimental methods employed for testing the infectiveness of the soil are many times more severe than would obtain under most favorable natural conditions for the spread of infection from soil to plants. All these considerations suggest that agricultural soils probably can not long retain a dangerous possibility of disseminating the citrus-canker organism.

VARIATION OF INDIVIDUAL PIGS IN ECONOMY OF GAIN¹

By R. C. ASHBY and A. W. MALCOMSON, *Division of Animal Husbandry, Minnesota Agricultural Experiment Station*²

When the initial tests with self-feeders were undertaken in 1914 the question at once arose, "What variations will appear in rations as selected by individual pigs?" To answer it 10 pigs were self-fed individually during the summer of 1915. A study of their rations has been published.³ But in tabulating the data another factor presented itself—namely, material variations in economy of gain by the different individuals. Two similar tests have been continued in order to gain further information on this point. It is our purpose to report here the results thus far obtained.

While marked variations have been found with all groups tested, no attempt is made to explain them, because facilities have been entirely inadequate to permit a fundamental study. In one instance the junior author has made thorough type and conformation studies of 15 individuals. His data will appear in thesis form.

To date 67 individuals, representing 14 litters, have been fed individually. The experiments have been conducted during three summers and are reported as tests A, B, and C. As explained later this report includes the data on 63 pigs.

TEST A, FEEDING PERIOD 128 DAYS

As mentioned, the records of the pigs fed in 1915 are already available. A summary for nine pigs is presented here, No. 11 being omitted because of its low final weight. For the nine pigs the average initial weight was 47.42 pounds and the average final weight 267.33 pounds. A comparison of the pigs is given in Table I.

Classified according to the degree of variation from the mean or normal grain requirement for the group:

- 1 pig shows a variation from the mean of more than 10 per cent.
- 2 pigs show a variation from the mean of between 5 and 10 per cent.
- 6 pigs show a variation from the mean of less than 5 per cent.

¹ Published with the approval of the Director as Paper No. 152, Journal Series, Minnesota Agricultural Experiment Station.

² The authors express to Prof. H. K. Hayes their appreciation for assistance in arranging and verifying the correlation table, and to Dr. C. W. Gay and Miss Alice McFeely for helpful suggestions.

³ ASHBY, R. C. SELF-BALANCED RATIONS BY INDIVIDUAL PIGS. *In Amer. Soc. Anim. Prod. Proc.* 1915/16 p. 197-209, illus. 1917.

TABLE I.—*Grain required to produce 100 pounds gain in pigs of test A*
 [Average initial weight, 47.42 pounds; average final weight, 267.33 pounds]

Litter.	Pig No.	Daily gain.	Grain for 100 pounds gain.	Variation from mean grain for 100 pounds gain.	
		Pounds.	Pounds.	Pounds.	Per cent.
1.....	4	1.908	402.04	+ 7.24	0.183
1.....	2	1.890	380.21	-14.59	3.695
1.....	4	2.063	376.71	-18.09	4.582
1.....	6	1.492	423.04	+28.24	7.152
1.....	7	1.668	404.38	+ 9.58	2.426
2.....	10	1.603	430.70	+35.96	9.108
2.....	12	1.369	397.99	+ 3.19	.808
2.....	13	1.635	395.60	+ .80	.202
2.....	14	1.835	355.31	-39.49	10.002
Mean grain for 100 pounds gain.....			394.80		

TEST B, FEEDING PERIODS 84 AND 100 DAYS

In 1916, 26 pigs were fed individually. Six of these which were fed on pasture plots make up group 1. Of the remaining 20, 7 which averaged 193.71 pounds each at the close of the test constitute group 2. The remaining 13 were younger pigs, except DJ 37 and P 72, which started on feed at lighter weights and averaged only 137 pounds at the close. These 13 made up group 3. The data of test B are given in Tables II to IV.

TABLE II.—*Grain required to produce 100 pounds gain in pasture-fed pigs of test B, group 1*

[Average initial weight, 34.2 pounds; average final weight, 156.5 pounds]

Litter.	Pig No.	Daily gain.	Grain for 100 pounds gain.	Variation from mean grain for 100 pounds gain.	
		Pounds.	Pounds.	Pounds.	Per cent.
DJ.....	33	1.357	371.70	+28.59	8.332
DJ.....	35	1.514	346.20	+ 3.09	.900
PY.....	3	1.315	289.20	-53.91	15.712
DJ.....	46	1.294	365.80	+22.69	6.613
PD.....	2	1.250	325.00	-18.11	5.278
PD.....	6	1.238	364.10	+20.99	6.117
Mean grain for 100 pounds gain.....			343.11		

TABLE III.—*Grain required to produce 100 pounds gain in dry-lot pigs of test B, group 2*

[Average initial weight, 42.07 pounds; average final weight, 193.71 pounds]

Litter.	Pig No.	Daily gain.	Grain for 100 pounds gain.	Variation from mean grain for 100 pounds gain.	
		Pounds.	Pounds.	Pounds.	Per cent.
DJ.....	30	1.417	455.20	+46.85	11.473
DJ.....	31	1.080	456.30	+47.95	11.742
DJ.....	32	1.900	425.00	+16.05	4.070
DJ.....	34	1.287	408.80	+ .45	.110
DJ.....	36	1.940	382.30	-26.05	6.379
PY.....	5	1.577	367.20	-41.15	10.077
PY.....	6	1.724	383.40	-24.95	6.109
Mean grain for 100 pounds gain.....			408.35		

TABLE IV.—Grain required to produce 100 pounds gain in dry-lot pigs of test B, group 3
[Average initial weight, 29.6 pounds; average final weight, 137 pounds]

Litter.	Pig No.	Daily gain.	Grain for 100 pounds gain.	Variations from mean grain for 100 pounds gain.	
		Pounds.	Pounds.	Pounds.	Per cent.
DJ.....	38	1.380	361.70	-18.09	4.763
DJ.....	39	1.326	379.20	- .59	.155
DJ.....	41	1.258	399.60	+19.81	5.216
DJ.....	42	1.198	392.20	+12.41	3.267
DJ.....	43	1.397	406.10	+26.31	6.927
DJ.....	44	1.040	383.10	+ 3.31	.871
PD.....	1	1.452	363.30	-16.49	4.341
PD.....	3	1.282	392.30	+12.51	3.293
PD.....	4	1.052	378.20	- 1.59	.418
PD.....	5	1.175	431.40	+51.61	13.589
DJ.....	37	1.157	358.70	-21.09	5.553
PY.....	2	1.177	340.30	-39.40	10.307
Mean grain for 100 pounds grain.....			379.79		

If the three groups are combined, the pigs may be classified as follows on the basis of degree of variation from their respective means:

- 6 pigs show a variation from the mean of more than 10 per cent.
- 9 pigs show a variation from the mean of between 5 and 10 per cent.
- 10 pigs show a variation from the mean of less than 5 per cent.

TEST C

In 1917 three tests were conducted. As before, 6 pigs were fed on pasture and 9 were carried on individual self-feeders in dry lot. In addition 16 pure-bred pigs intended for breeding animals were selected for individual feeding. Of the 15 market pigs 2 were very small at the beginning of the test and much lighter than the others at the close. For that reason they are omitted. The data for the three groups are given in Tables V to VII.

TABLE V.—Grain required to produce 100 pounds gain in pasture-fed pigs of test C, group 1, fed 118 days

[Average initial weight, 35.8 pounds; average final weight, 172.84 pounds]

Litter.	Pig No.	Daily gain.	Grain for 100 pounds gain.	Variations from mean grain for 100 pounds gain.	
		Pounds.	Pounds.	Pounds.	Per cent.
PB.....	6	1.030	419.98	+49.81	13.457
PB.....	7	1.118	364.84	- 5.31	1.433
PB.....	16	1.239	365.26	- 4.90	1.324
PY.....	1	1.220	386.25	+16.08	4.345
PY.....	4	1.197	320.94	-49.21	14.296
Mean grain for 100 pounds gain.....			370.16		

TABLE VI.—*Grain required to produce 100 pounds gain in dry-lot pigs of test C, group 2, fed 118 days*

[Average initial weight, 43.62 pounds; average final weight, 185.46 pounds]

Litter.	Pig No.	Daily gain.	Grain for 100 pounds gain.	Variations from mean grain for 100 pounds gain.	
		<i>Pounds.</i>	<i>Pounds.</i>	<i>Pounds.</i>	<i>Per cent.</i>
PB.....	1	1.42	420.91	+36.82	9.586
PB.....	3	1.00	473.57	+89.48	23.296
PB.....	9	1.26	363.43	-20.66	5.378
PB.....	15	1.15	343.85	-40.24	10.476
DJ.....	12	1.47	370.85	-13.24	3.447
DJ.....	13	1.05	410.12	+35.03	9.120
PV.....	2	1.11	340.13	-43.96	11.445
PV.....	3	1.05	342.31	-41.78	10.877
Mean grain for 100 pounds gain.....			384.09		

The degrees of variation from the group means classify thus:

6 pigs show a variation from the mean of more than 10 per cent.

3 pigs show a variation from the mean of between 5 and 10 per cent.

4 pigs show a variation from the mean of less than 5 per cent.

TABLE VII.—*Grain required to produce 100 pounds gain in pasture-fed pigs of test C, group 3, fed 79 days*

[Average initial weight, 63.6 pounds; average final weight, 147.3 pounds]

Litter.	Pig No.	Daily gain.	Grain for 100 pounds gain.	Variations from mean grain for 100 pounds gain.	
		<i>Pounds.</i>	<i>Pounds.</i>	<i>Pounds.</i>	<i>Per cent.</i>
PC.....	2	0.94	309.78	-55.18	15.119
PC.....	3	1.01	394.50	+29.54	8.093
PC.....	6	.88	321.42	-43.54	11.931
PC.....	8	1.06	315.89	-49.07	13.445
DJ.....	2	1.15	332.96	-32.00	8.768
DJ.....	3	1.18	396.15	+31.19	8.546
DJ.....	5	1.06	394.40	+29.44	8.066
DJ.....	6	.81	327.81	-37.15	10.170
DJ.....	7	1.21	367.91	+2.95	.808
DJ.....	8	1.45	335.39	-29.57	8.102
DJ.....	10	1.35	461.57	+96.61	26.471
DJ.....	11	1.14	308.81	-56.15	15.385
PC.....	13	.84	442.83	+77.87	21.336
PC.....	14	.83	451.73	+86.77	23.775
PC.....	15	1.00	309.93	-55.03	15.079
PC.....	16	.89	362.25	-2.71	.742
Mean grain for 100 pounds gain.....			364.96		

Note that both extremes are found in the same litter, DJ 10 and DJ 11. Wide variations appear here, but because of the comparatively short feeding period of 79 days and the low final average weight these results can not be accepted on a par with those from the preceding groups. Tabulating the results for group 3 on the basis of extent of variation from the mean, we have:

- 3 pigs showing a variation from the mean of more than 20 per cent.
- 3 pigs showing a variation from the mean of between 15 and 20 per cent.
- 3 pigs showing a variation from the mean of between 10 and 15 per cent.
- 5 pigs showing a variation from the mean of between 5 and 10 per cent.
- 2 pigs showing a variation from the mean of less than 5 per cent.

The occurrence and scope of variation are further emphasized by Table VIII in which the extremes from 11 litters are compared.

TABLE VIII.—Extremes of daily gain and weight of grain required to produce 100 pounds gain in 11 litters.

Litter.	Pig No.	Daily gain.	Grain for 100 pounds gain.
		Pounds.	Pounds.
I.....	4	2. 06	376. 71
I.....	6	1. 49	423. 04
2.....	10	1. 60	430. 76
2.....	14	1. 83	355. 31
PD.....	2	1. 25	325. 00
PD.....	6	1. 23	364. 10
DJ.....	30	1. 41	455. 20
DJ.....	36	1. 94	382. 30
DJ.....	38	1. 38	361. 70
DJ.....	43	1. 39	406. 10
PY.....	1	1. 22	386. 25
PY.....	4	1. 19	320. 94
DJ.....	12	1. 47	370. 85
DJ.....	13	1. 05	419. 12
PC.....	2	. 94	309. 78
PC.....	3	1. 01	394. 50
PC.....	14	. 83	451. 73
PC.....	15	1. 09	309. 93
DJ.....	3	1. 18	396. 15
DJ.....	6	. 81	327. 81
DJ.....	10	1. 35	461. 51
DJ.....	11	1. 14	308. 81

Of the 65 pigs an unexpectedly large number show marked variation from the normal or mean grain requirement per unit of gain.

Summing up all groups, we find:

- 22 pigs showing a variation from the mean of more than 10 per cent.
- 19 pigs showing a variation from the mean of between 5 and 10 per cent.
- 22 pigs showing a variation from the mean of less than 5 per cent.

On a percentage basis:

- 34.92 per cent exceeded 10 per cent variation.
- 30.15 per cent showed between 5 and 10 per cent variation.
- 34.92 per cent showed less than 5 per cent variation.

As stated before, no attempt is now made to explain these differing requirements, but the question of a possible correlation between the rate of gain and economy of gain naturally suggests itself. In fact, a casual inspection of the groups leads one to expect such a correlation.

In Tables IX to XV the individuals are ranked in order of efficiency both as to daily rate of gain and economy of gain.

TABLE IX.—Rank of pigs of test A in rate and economy of gain

Rate of gain.		Economy of gain.		Rate of gain.		Economy of gain.	
Rank.	Pig No.	Rank.	Pig No.	Rank.	Pig No.	Rank.	Pig No.
1.....	4	1.....	14	6.....	13	6.....	1
2.....	1	2.....	4	7.....	10	7.....	7
3.....	2	3.....	2	8.....	6	8.....	6
4.....	14	4.....	13	9.....	12	9.....	10
5.....	7	5.....	12				

TABLE X.—Rank of pigs of test B, group 1, in rate and economy of gain

Rate of gain.		Economy of gain.		Rate of gain.		Economy of gain.	
Rank.	Pig No.	Rank.	Pig No.	Rank.	Pig No.	Rank.	Pig No.
1.....	DJ 35	1.....	PY 3	4.....	DJ 46	4.....	PD 6
2.....	DJ 33	2.....	PD 2	5.....	PD 2	5.....	DJ 46
3.....	PY 3	3.....	DJ 35	6.....	PD 6	6.....	DJ 33

TABLE XI.—Rank of pigs of test B, group 2, in rate and economy of gain

Rate of gain.		Economy of gain.		Rate of gain.		Economy of gain.	
Rank.	Pig No.	Rank.	Pig No.	Rank.	Pig No.	Rank.	Pig No.
1.....	DJ 36	1.....	PY 5	5.....	DJ 30	5.....	DJ 32
2.....	DJ 32	2.....	DJ 36	6.....	DJ 34	6.....	DJ 30
3.....	PY 6	3.....	PY 6	7.....	DJ 31	7.....	DJ 31
4.....	PY 5	4.....	DJ 34				

TABLE XII.—Rank of pigs of test B, group 3, in rate and economy of gain

Rate of gain.		Economy of gain.		Rate of gain.		Economy of gain.	
Rank.	Pig No.	Rank.	Pig No.	Rank.	Pig No.	Rank.	Pig No.
1.....	PD 1	1.....	PY 2	7.....	DJ 42	7.....	DJ 44
2.....	DJ 43	2.....	DJ 37	8.....	PY 2	8.....	DJ 42
3.....	DJ 38	3.....	DJ 38	9.....	PD 5	9.....	PD 3
4.....	DJ 39	4.....	PD 1	10.....	DJ 37	10.....	DJ 41
5.....	PD 3	5.....	PD 4	11.....	PD 4	11.....	DJ 43
6.....	DJ 41	6.....	DJ 39	12.....	DJ 44	12.....	PY 5

TABLE XIII.—Rank of pigs of test C, group 1, in rate and economy of gain

Rate of gain.		Economy of gain.		Rate of gain.		Economy of gain.	
Rank.	Pig No.	Rank.	Pig No.	Rank.	Pig No.	Rank.	Pig No.
1.....	PB 16	1.....	PY 4	4.....	PB 7	4.....	PY 1
2.....	PY 1	2.....	PB 7	5.....	PB 6	5.....	PB 6
3.....	PY 4	3.....	PB 16				

TABLE XIV.—Rank of pigs of test C, group 2, in rate and economy of gain

Rate of gain.		Economy of gain.		Rate of gain.		Economy of gain.	
Rank.	Pig No.	Rank.	Pig No.	Rank.	Pig No.	Rank.	Pig No.
1.....	DJ 12	1.....	PY 2	5.....	PY 2	5.....	DJ 5
2.....	PB 1	2.....	PY 3	6.....	PB 3	6.....	DJ 13
3.....	PB 9	3.....	PB 15	7.....	PY 3	7.....	PB 1
4.....	PB 15	4.....	PB 9	8.....	DJ 13	8.....	PB 8

TABLE XV.—Rank of pigs of test C, group 3, in rate and economy of gain

Rate of gain.		Economy of gain.		Rate of gain.		Economy of gain.	
Rank.	Pig No.	Rank.	Pig No.	Rank.	Pig No.	Rank.	Pig No.
1.....	DJ 8	1.....	DJ 11	9.....	DJ 5	9.....	PC 16
2.....	DJ 10	2.....	PC 2	10.....	PC 3	10.....	DJ 7
3.....	DJ 7	3.....	PC 15	11.....	PC 2	11.....	DJ 5
4.....	PJ 3	4.....	PC 8	12.....	PC 16	12.....	PP 3
5.....	DJ 2	5.....	PC 6	13.....	PC 6	13.....	DJ 3
6.....	DJ 11	6.....	DJ 6	14.....	PC 13	14.....	PC 13
7.....	PC 15	7.....	DJ 2	15.....	PC 14	15.....	PC 14
8.....	PC 8	8.....	DJ 8	16.....	DJ 6	16.....	DJ 10

Selecting approximately the top half of each group, on the basis of rate of gain, we have 4 top pigs from test A; 3 from test B, group 1; 3 from test B, group 2; 6 from test B, group 3; 3 from test C, group 1; 4 from test C, group 2; and 8 from test C, group 3; making a total of 31 pigs. Of this number 19 were placed in the corresponding top halves of their respective economy columns.

In other words, slightly more than 60 per cent of the fastest-growing pigs were also distinctly economical producers. This would indicate that slightly more than one-half of the fastest-growing pigs in an average group would qualify on an economy basis.

The foregoing comparison is independent of litter relationships. Selecting and comparing the fastest-growing pig with the slowest-gainer from the same litter, we find the following results from 12 litters:

- In 6 cases the fastest growing pig was most economical.
- In 3 cases the fastest growing pig was least economical.

- In 3 cases the fastest growing pig was moderately economical.
 In 2 cases the slowest-growing pig was most economical.
 In 5 cases the slowest-growing pig was least economical.
 In 5 cases the slowest-growing pig was moderately economical.

Apparently this indicates a certain degree of correlation between the characters under discussion. As a more accurate determination of correlation between rate of gain and economy of gain the data are correlated in Table XVI. For this purpose the variations, both in rate of gain and economy of gain, are reduced to a percentage basis.

XVI.—Correlation between rate of gain and economy of gain

Rate of gain (in percentages of the mean).

Economy of gain (in percentages of the mean.)	Rate of gain (in percentages of the mean).													Total.	
	70	75	80	85	90	95	100	105	110	115	120	125	130		135
85.....					1		2	2	1						6
90.....		1		1	1	3	1	1	1					1	10
95.....						2		1	3	1	1	2			10
100.....			2	3		3		2	1	2					13
105.....				1		3	1	2	1		1				9
110.....	1				2	2	2		1		1				9
115.....					1	1									2
120.....				1											1
125.....			1		1								1		3
Total.....	1	1	4	5	6	14	6	8	8	3	3	2	1	1	...

$$r = -0.452 \pm 0.068.$$

The resultant coefficient of correlation ($r = -0.452 \pm 0.068$) shows a distinct negative correlation between rate of gain and economy of gain, entirely disproving the apparent relation shown by Tables IX to XV. The differing requirements per unit of gain are of much practical moment. As has been noted, the variation in rate of gain shows a standard deviation in percentage of 9.57 ± 0.58 and an average deviation of 8.01 per cent.

POSSIBLE APPLICATION

Pointing out applications before establishing final conclusions is as dangerous as selling property without possession of title, but a consideration of probabilities is ever in order.

It is safe to emphasize again the danger of conclusions based on feeding trials where small groups are the experimental units. If average individual variations of 7 per cent are at all common, a statement in a former Oregon Experiment Station bulletin¹ that—

the reader should therefore hesitate at putting too much weight on differences amounting to less than 10 per cent

carries much weight.

¹ WITHEYCOMBE, James, POTTER, Ermine L., and SAMSON, George R. EXPERIMENTS IN SWINE FEEDING. Oreg. Agr. Exp. Sta. Bul. 127, p. 5. 1915.

However, our main interest lies in the possibility of utilizing this factor of variation, making it a definite factor in the breeder's support. Is it a hereditary character? How is it transmitted? Can the breeder through careful testing and selective mating develop or produce a strain that is more economical in feeding or pure for the quality of economy in production? Can he produce a line that is homozygous for this characteristic? Extreme results are not to be expected, but even a moderate saving, if constant, would be a marked achievement.

In this connection a feature of Danish agricultural practice is very interesting. An article¹ describing it came to hand as our data were being tabulated, and a brief quotation is pertinent in this connection:

There is, however, quite another group of qualities which must be kept in mind in connection with swine-breeding, but which cannot be estimated with sufficient accuracy with the naked eye, namely, the quality of the bacon and the thrivingness and growing energy of the pigs.

The Experimental Laboratory has, during a long period of years, carried out experiments with regard to the offspring of stud animals in the breeding centers which afford reliable and helpful information as to the powers of transmission of qualities possessed by the stud animals in regard to the qualities mentioned. It is the breeding centers which supply the material for these experiments.

The owner of each recognized breeding center is bound to supply on an average two young pigs from selected sow annually to the Experiment Stations, and as there are about 900 selected sows (757 Danish and 147 Yorkshire), the stations have at their disposal a good deal of material. For pecuniary and other reasons they have found it necessary to confine themselves to about 1,000 test animals per annum. Nevertheless, the experiments are on a big scale such as is scarcely equalled elsewhere.

The young pigs are supplied at the age of seven or eight weeks. Each experiment pen contains four full-blooded sisters and brothers. All the pens receive the same food mixture in weighed proportions, and the animals themselves are weighed at regular intervals. The experiments finish when the abattoir weight is reached . . . The result is made use of in the selection of stud animals, those being preferred whose descendants have shown the highest degree of thrivingness and growth energy and the best bacon.

This is a good plan and doubtless characteristic of the results obtained through Danish agricultural cooperative organization, though just how each pen could contain four litter mates when only two pigs are sent from each litter is a bit puzzling.

Of recent years the possibility of a "register of merit" for meat animals has received considerable attention. If more thorough investigation corroborates our results and should it be found possible to develop families or strains that are more economical producers, no sounder basis of preferment could be desired.

If selection along this line will achieve results, we believe it desirable to put the work on an individual basis from the start. The Danish plan deals with pen averages which our data show to be somewhat unreliable so far as indicating the true performance of the individuals concerned.

¹MÖRKEBERG, Peter AUG. THE PRESENT POSITION AND FUTURE PROSPECTS OF SWINEBREEDING IN DENMARK. *In* Dept. Agr. and Tech. Instr. Ireland Jour., v. 17, no. 1, p. 46-47. 1916.

But since the "breeding centers" have been a factor for at least 20 years, and doubtless the "experimental laboratory" has been in operation a good part of that time, the continuation of the plan attests its efficiency. By adopting the individual as the unit we eliminate the probable inaccuracy of pen averages and hope to have taken at least one step in devising a practical method for measuring the efficiency of meat-producing animals.

PRODUCTION OF CONIDIA IN *GIBBERELLA SAUBINETII*¹

By JAMES G. DICKSON, *Pathologist, Office of Cereal Investigations, Bureau of Plant Industry, United States Department of Agriculture*, and Assistant Professor of Plant Pathology, University of Wisconsin, and HELEN JOHANN, *Assistant Pathologist, Office of Cereal Investigations, Bureau of Plant Industry, United States Department of Agriculture*.

The scab fungus *Gibberella saubinetii* (Mont.) Sacc., which attacks wheat, corn, rye, barley, and oats, has been considered as having a vegetative stage and two spore stages. The conidial and perithecial development terminates the active vegetative period. Strains producing abundant perithecia have been described as developing only a few conidia in scattered, sporodochia-like masses.

Cultural studies with a large number of strains of *G. saubinetii* show that in nature, as well as in artificial culture, this species produces conidia at two different periods during its development. Wollenweber² suggests this when he states that—

on steamed potato tuber the conidia form a short-lived pionnotes. The conidia of this pionnotes rapidly swell, separate into cells, germinate, and produce new conidia, which anastomose and form a stroma, while in the other species mentioned the conidia remain perfect, dry out, and are long-lived.

The first period of conidial production is in connection with the early mycelial growth of the culture, while the second occurs at the termination of the vigorous vegetative development. These later conidia are produced in definite sporodochia and are the only conidia generally described for this species. The production of perithecia is the final stage in the development of the culture.

During the summer of 1919, single-spore cultures were made by the authors from sporodochial conidia and ascospores taken from stock cultures and from wheat heads, wheat culms, and cornstalks collected in the field. These specimens were obtained from a number of widely separated points in the central and eastern States. Spores from all sources were placed in hanging drops of distilled water and sterile tap water, on poured plates of potato-dextrose agar and soil decoction agar, and on sterile soil. The subsequent development of the fungus was then studied at frequent intervals.

¹ The investigations upon which this paper is based were conducted as a cooperative project between the Office of Cereal Investigations of the Bureau of Plant Industry and the Wisconsin Agricultural Experiment Station.

² WOLLENWEBER, H. W. IDENTIFICATION OF SPECIES OF *FUSARIUM* OCCURRING ON THE SWEET POTATO, *IPOMOEA BATATAS*. In Jour. Agr. Research, v. 2, no. 4, p. 278. 1914.

The spores, both conidia and ascospores, behaved alike in germination. They germinated, as described by Wollenweber, by imbibing water, increasing the number of septa (fig. 1, A, C), and forming several mycelial strands from the different cells (fig. 1, C). When the cultures were grown in a saturated atmosphere, conidia were cut off from lateral branches of mycelial strands in 24 hours (fig. 1, B, D). In 48 hours a copious conidial production took place in definite sporodochia-like clusters (fig. 1, E). On extremely moist plates these clumps occasionally massed together to form a pionnotes. As mycelial development

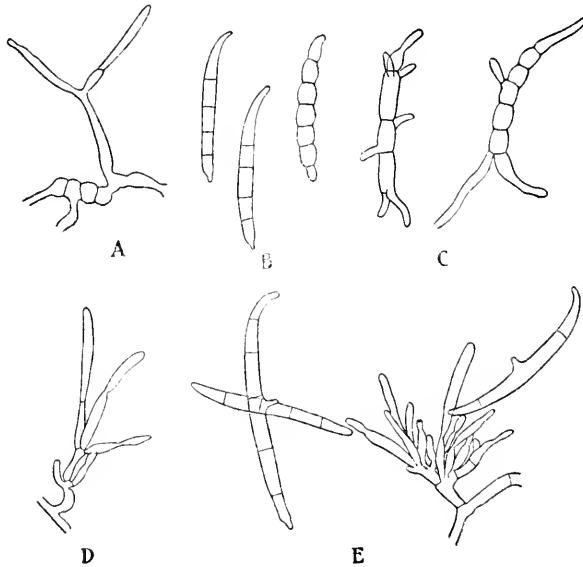

FIG. 1.—Conidial production in *Gibberella saubinetii* (Mont.) Sacc.: A, Ascospores from cornstalk, germinated in distilled water, producing conidia in three days; B, D, typical conidia and conidiophore from a 28-hour-old hanging drop culture from a conidium from A; C, germinating conidia from a 52-hour-old plate culture; E, conidiophore and germinating conidia from a 47-hour-old colony in a Van Tiegham cell. This colony was three generations from an ascospore. Potato-dextrose agar acidified with lactic acid was used unless otherwise stated.

progressed, new conidial masses developed and thus gradually increased the size of the pionnotes.

The conidia were pushed off the conidiophore before septation was completed, and new conidia formed in their place (fig. 1, E). Septation was completed after the conidia had been separated from the conidiophore. The conidia became swollen, septation increased, and germination took place in from 6 to 12 hours after leaving the conidiophore (fig. 1, B, C, E). When the cultures were moderately crowded and moisture and temperature conditions were suitable, all these conidia germinated, forming a stroma; and conidia development ceased until the final development of sporodochial conidia several weeks later. If, however, the conidia were transferred to a suitable medium and were not

overcrowded, they germinated, forming hyphae which bore masses of conidia within two days as previously described for the sporodochial conidia and ascospores. This conidial production went on indefinitely, if the culture did not dry or become crowded. The ninth generation of conidia from a single ascospore was produced in 20 days by transferring each successive generation to new plates of potato-dextrose agar. These conidia were produced only when the spores were transferred to a favorable medium and kept in a moist, warm atmosphere. When the temperature was lowered or when the culture became dry the conidia did not germinate but remained inert on the surface of the culture. Spores kept in this manner were rather resistant to both desiccation and low temperatures. Germination was obtained after several weeks' storage at temperatures of about 3° to 4° C., as well as when stored under dry conditions at room temperature.

Conidia were produced in two days from mycelium plated from infected root and stem tissues as well as from plated conidia and ascospores. Tissues infected with *G. saubinetii* were surface-sterilized and placed on potato-dextrose agar in poured plates. Conidia appeared on the developing mycelium two days after plating and were present in conspicuous sporodochia-like masses the third day. These conidia were identical with those formed on the mycelium from either ascospores or conidia.

The conidia formed during the vegetative development were 4 to 5 septate (fig. 1, B, E) and were of the same shape and size as the sporodochial conidia.

Inoculations on wheat plants showed that these conidia were as virulent in producing scab on wheat as were either sporodochial conidia or the vegetative mycelium. The spores germinated and caused infection within the same temperature range as the sporodochial conidia.

The work here reported shows that repeated crops of conidia of *G. saubinetii* can be produced in abundance in short periods of time from ascospores, sporodochial conidia, vegetative conidia, or mycelium, when favorable moisture and temperature conditions obtain. This ability of the wheat-scab organism to produce virulent spores in abundance in short periods of time has an important bearing on the development of wheat-scab epidemics.

JOURNAL OF AGRICULTURAL RESEARCH

CONTENTS

	Page
Effect of Manure-Sulphur Composts upon the Availability of the Potassium of Greensand - - - - -	239
A. G. McCALL and A. M. SMITH	
(Contribution from Maryland Agricultural Experiment Station)	

Rust in Seed Wheat and Its Relation to Seedling Infec- tion - - - - -	257
CHARLES W. HUNGERFORD	
(Contribution from Bureau of Plant Industry)	

PUBLISHED BY AUTHORITY OF THE SECRETARY OF AGRICULTURE,
WITH THE COOPERATION OF THE ASSOCIATION OF
LAND-GRANT COLLEGES

WASHINGTON, D. C.

**EDITORIAL COMMITTEE OF THE
UNITED STATES DEPARTMENT OF AGRICULTURE AND
THE ASSOCIATION OF LAND-GRANT COLLEGES**

FOR THE DEPARTMENT

KARL F. KELLERMAN, CHAIRMAN

*Physiologist and Associate Chief, Bureau
of Plant Industry*

EDWIN W. ALLEN

Chief, Office of Experiment Stations

CHARLES L. MARLATT

*Entomologist and Assistant Chief, Bureau
of Entomology*

FOR THE ASSOCIATION

J. G. LIPMAN

*Dean, State College of Agriculture, and
Director, New Jersey Agricultural Experi-
ment Station, Rutgers College*

W. A. RILEY

*Entomologist and Chief, Division of Ento-
mology and Economic Zoology, Agricul-
tural Experiment Station of the University
of Minnesota*

R. L. WATTS

*Dean, School of Agriculture, and Director,
Agricultural Experiment Station, The
Pennsylvania State College*

All correspondence regarding articles from the Department of Agriculture should be addressed to Karl F. Kellerman, Journal of Agricultural Research, Washington, D. C.

All correspondence regarding articles from State Experiment Stations should be addressed to J. G. Lipman, New Jersey Agricultural Experiment Station, New Brunswick, N. J.

JOURNAL OF AGRICULTURAL RESEARCH

VOL. XIX

WASHINGTON, D. C., JUNE 15, 1920

No. 6

EFFECT OF MANURE-SULPHUR COMPOSTS UPON THE AVAILABILITY OF THE POTASSIUM OF GREENSAND

By A. G. McCALL, *In Charge of Soil Investigations*, and A. M. SMITH, *Chemist, Soil Investigations, Maryland Agricultural Experiment Station*

INTRODUCTION

The greensands and the greensand marl deposits of the eastern United States have long been regarded as a possible source of potassium for agricultural purposes. The literature of the last half of the nineteenth century contains many reports of the success that has followed the application of greensand marls to soils in Maryland, New Jersey, and other eastern States. Since many of these marls contain a high percentage of calcium carbonate, it is probable that the good results that followed their use was due in many cases to their lime content rather than to the potassium which they contained.

During the continuance of the war with Germany, the scarcity and the consequent high price of readily soluble potassium salts has served to direct attention in this country to the possibility of utilizing for agricultural purposes the potassium of these greensand deposits and has indicated the desirability of devising some efficient method of treatment that would render the potassium more available. At the suggestion of the fertilizer committee of the National Research Council, the Department of Soil Investigations of this Station has studied the effect of composting greensand with sulphur, manure, and other materials with a view to making available the potassium contained in the greensand. It is the purpose of this paper to report the results of this investigation.

HISTORICAL

As early as 1830 Thomas Gordon called attention to the great benefits that farmers in New Jersey were deriving from the use of marl. In a geological report published in 1868, Cook (6)¹ gives the analyses of a number of samples of marl from New Jersey and states that the use of this material has raised the land from a low state of exhaustion to a high stage of agricultural development. He states that some of these marls are so acid that heavy applications of as much as 50 tons to the acre

¹ Reference is made by number (*italic*) to "Literature cited," p. 255-256.

have been known to destroy all vegetation and advises that the use of such marls should be confined to well-limed land or that they should be composted with lime before being applied. In 1906 Patterson (12) published the results of the examination of 95 samples of Maryland marl. In summing up the results of his experimental work covering a period of 11 years this writer concludes that the shell marls of Maryland have very little commercial value because of the great bulk of worthless material contained in them but that they should have considerable local agricultural value, both as a source of lime and also for the potassium which they contain. He concludes that while much of the potassium in marls will become slowly available to plants through weathering, the change necessary to liberate the potassium could readily be brought about by burning the calcareous marls and slaking the product.

In a popular discussion of the agricultural value of greensand marl Blair (3) concludes that since potassium is of especial value to grass and to potatoes, the striking benefits derived from the use of marl on these crops would lead to the belief that such crops can use the potassium of the marl to a considerable extent.

From pot experiments carried out with crushed quartz and Shive's cultural solution as a basis, True and Geise (13, p. 492) conclude that—

greensands and greensand marls from Virginia and New Jersey are able to supply sufficient potassium to satisfy the demands of Turkey Red wheat and red clover during the first two months of their growth.

They secured a greater dry weight of tops from cultures containing greensand marl than from those in which the potassium demand was supplied by potassium chlorid, potassium sulphate, or potassium phosphate. These results are in harmony with those reported by Lipman and Blair (8) who found that soybean plants fertilized with greensand produced as great a yield of hay as those receiving an application of soluble potassium salts, although the former failed to produce seed. These last-mentioned authors hold that their results seem to furnish proof of the ease with which the soybean gets its potash from slowly available sources up to the time the beans are forming and maturing. In the same report these writers describe another experiment in which Canada field peas and soybeans growing in sand cultures were given a general fertilizer treatment to which was added marl containing 6.5 per cent of potash. Two pots in this series received 20 gm. of marl, while two additional pots received in addition to the 20 gm. of marl, 3 gm. of sulphur each, with the thought that the oxidation of the sulphur might result in making more of the potash of the marl available. The Canada field peas were grown as the first crop, followed by the soybeans as a second crop. Both pots receiving the sulphur treatment gave very much decreased yields of field peas, and in one of the duplicates the soybeans that followed the peas failed completely. The other duplicate, however, gave a yield of soybeans slightly in excess of that produced by any of the other treat-

ments, including the pots receiving 2 gm. of potassium chlorid. In their conclusions they suggest—

the possibility of utilizing the potash of greensand marl and the potash of natural soil materials by growing soybeans and possibly certain other crops, which could be returned to the soil and thus furnish available potash for those crops which can not readily utilize potash from these natural sources.

Lipman, McLean, and Lint (10) composted 100-gm. portions of sea sand, sassafras loam, and greenhouse soil with manure, sulphur, and floats. At the end of 30 weeks analyses for water-soluble phosphoric acid showed increases in all the mixtures to which both sulphur and floats had been added. In one case 85 per cent of the total phosphorus in the floats had been made available, the increase in available phosphorus paralleling the oxidation of the sulphur as measured in terms of sulphates. In experiments conducted under field conditions, two of these authors (9) have shown that the sulphur-floats-soil compost may be utilized in making available the phosphorus of floats or raw ground phosphate rock. They suggest that this compost could be employed to advantage as a substitute for acid phosphate. Further studies at the New Jersey Experiment Station by McLean (11) led to the conclusion that the most economical combination for the production of available phosphoric acid is a compost composed of 100 parts soil, 120 parts sulphur, and 400 parts floats.

Brown and Warner (5) found that by composting floats with manure and sulphur it was possible to obtain a remarkable increase in the amount of available phosphoric acid. The increase was greater where the sulphur and floats were intimately mixed with the manure than where the material was arranged in alternate layers.

Experimenting with two Iowa soils, Brown and Gwinn (4) found that while applications of manure alone increased the availability of raw rock phosphate, the increase was much greater when sulphur was used in connection with the manure. They bring out the fact that there is a definite relationship existing between the sulphofying power of the soil and the production of available phosphorus.

Ames and Richmond (2) found that in an acid soil oxidation of sulphur proceeded vigorously, approximately 50 per cent of the sulphur being changed to the form of sulphate. In a basic soil the acidity resulting from sulphofication was partly neutralized, so that the solvent action on the rock phosphate was much less than occurred in the acid medium.

Since the inauguration of our work, Ames and Boltz (1) have published additional data concerning the effect of sulphur on soils and crops. These investigators found that both the nitrification of dried blood and the oxidation of sulphur in soil mixtures resulted in the liberation of potassium. They conclude that the liberation of the potassium was brought about by the salts formed rather than by the direct action of acidity on the insoluble potassium compounds.

PURPOSE AND PLAN OF THE INVESTIGATION

With the foregoing results in mind the present investigation was undertaken for the purpose of determining the effect of different composts upon the availability of the potassium of greensand. The investigation consisted of composting greensand with sulphur, soil, and manure in varying proportions, taking samples from time to time, extracting these samples with distilled water and analyzing the water extracts for the acidity, sulphate, and potassium contained.

Two series of composts were conducted, one series containing a greensand from Sewell, N. J., having a relatively high percentage of potassium, and the other a greensand from Crownsville, Md., having a rather low percentage of potassium. Each compost contained as a basis 1,500 gm. of greensand. The materials added were the same for each series and were as follows:

COMPOST NO.	MATERIALS ADDED TO GREENSAND.
1 and 8.....	Nothing.
2 and 9.....	500 gm. sulphur.
3 and 10.....	500 gm. sulphur; 500 gm. manure.
4 and 11.....	500 gm. sulphur; 250 gm. manure; 250 gm. soil.
5 and 12.....	500 gm. sulphur; 500 gm. soil.
6 and 13.....	500 gm. sulphur; 500 gm. soil; 0.02 per cent aluminum sulphate ($\text{Al}_2(\text{SO}_4)_3$) 0.18 H_2O ; 0.02 per cent ferrous sulphate (FeSO_4) 0.7 H_2O .
7 and 14.....	500 gm. sulphur; 250 gm. soil; 250 gm. manure; 10 gm. calcium carbonate (CaCO_3).

Commercial flowers of sulphur, partially rotted yard manure air-dried and ground fine, Collington sandy loam, and precipitated calcium carbonate were used. The aluminum and ferrous sulphates were added to composts 5 and 12 in order to determine whether these salts would exert a stimulating effect upon the rate and amount of sulphofication. McLean (11) found that, under certain conditions, these salts in combination exerted a marked stimulating action on sulphur oxidation processes when present in small amounts. He advocated the use of 0.4 pound per ton, or 0.02 per cent, of each for sulphur-floats composts. It was thought desirable to ascertain whether this effect would be obtained with sulphur-greensand composts.

METHODS OF PROCEDURE

The air-dry materials for each compost were weighed and thoroughly mixed. Similar smaller amounts of the same materials were mixed in the same proportions, from which the moisture-holding capacity of each compost was determined according to the Hilgard method (7, p. 209).

After being mixed, each compost was placed in a glazed pot, and water was added to one-half the determined water-holding capacity. The samples for the first analyses, showing the amounts of water-soluble

acidity, sulphate, and potassium at the start, were then taken, after which each compost was inoculated with the sulphofying organisms, and the aluminum and ferrous sulphates were added in solution to composts 6 and 13.¹

The period of composting was 23 weeks. Once each week the amount of water lost by evaporation was added, and the composts were removed from the pots and mixed, in order to provide thorough aeration.

The composts were kept in the greenhouse throughout the entire period and were covered at all times with a double thickness of white muslin to protect them from direct sunlight. The temperature of the greenhouse ranged from 50° to 100° F.

For the water extraction a 75-gm. sample was weighed from each compost, air dried, and 50 gm. of the air-dry material were shaken every half hour for 8 hours with 500 cc. of distilled water in a 1-liter Pyrex flask. After standing over night, the contents of the flasks were again shaken and filtered rapidly through folded No. 3 Whatman filter papers. The first 100 cc. of filtrate were poured back. The filtrates obtained were absolutely clear and free from sediment.

The acidity was determined by boiling aliquots of the water extract to expel carbon dioxid, cooling, and titrating with *N/10* sodium hydroxid, in terms of which the results are stated. Phenolphthalein was the indicator used. Titration was continued until all soluble iron, aluminum, and silica were precipitated and the clear solution retained the pink color for one minute.

Sulphur was determined by acidifying aliquots of the water extract with 2 cc. of concentrated hydrochloric acid and precipitating at the boiling point with barium chlorid. The results are expressed as sulphur trioxid (SO₃).

The potassium determinations were made gravimetrically by the platinic chlorid method from aliquots of the water extract, first eliminating the soluble organic matter, silicates, iron, aluminum, and phosphorus by evaporation with sulphuric acid, ignition, and subsequent precipitation. The determination for composts 1 and 8 throughout and the first three determinations for the other composts not containing manure were made colorimetrically because of the small amounts of potassium present.

Moisture determinations were made by heating separate 5-gm. portions of the air-dry compost for 15 hours at 105° C. All results reported in this paper are calculated to the moisture-free basis. No duplicate determinations were made, the idea being that one series of compost treatments would act as a control for the other in regard to the general trend of the reaction and that any serious error in analysis would

¹ Cultures containing sulphofying organisms were supplied by Dr. J. C. Lipman and Prof. A. W. Blair, of the New Jersey Experiment Station.

readily be shown and offset by the frequency with which the analyses were made.

The greensands, soil, and manure used were analyzed at the beginning of the investigation. The results are given in Table I. The potassium determinations were made by the official fusion method.

TABLE I.—Composition of materials used (dry basis)

Materials.	Moisture at 105° C.	Insoluble residue.	Ferric oxid (Fe ₂ O ₃), aluminum oxid (Al ₂ O ₃), phosphorus pentoxid (P ₂ O ₅).	Calcium oxid (CaO).	Magnesium oxid (MgO).	Potassium (K).
	<i>Per cent.</i>	<i>Per cent.</i>	<i>Per cent.</i>	<i>Per cent.</i>	<i>Per cent.</i>	<i>Per cent.</i>
New Jersey greensand.....	5.46	53.12	31.66	0.16	1.05	5.88
Maryland greensand.....	1.57	87.83	8.38	.13	.25	1.42
Collington sandy loam.....	1.20	89.54	7.54	.18	.22	.83
Manure ^a	6.3049

^a Loss on ignition, 69.67 per cent.

Determinations made by the Veitch method showed that the New Jersey greensand required 4,200 pounds of calcium carbonate per 2,000,000 pounds, the Maryland greensand 3,400 pounds, and the Collington sandy loam 1,400 pounds.

The texture of the greensands and soil is shown in Table II, which gives the mechanical analyses of the materials used in the composts.

TABLE II.—Mechanical analyses of greensands and soil

Constants.	New Jersey greensand.	Maryland greensand.	Collington sandy loam.
	<i>Per cent.</i>	<i>Per cent.</i>	<i>Per cent.</i>
Fine gravel.....	4.94	1.49	0.53
Coarse sand.....	30.26	1.77	10.14
Fine sand.....	45.22	9.15	26.27
Very fine sand.....	15.14	83.65	43.93
Silt and clay.....	4.11	3.86	18.72

PRESENTATION AND DISCUSSION OF RESULTS

ACIDITY

In Table III is shown the acidity of the water extract from each compost as determined at the end of each 1-week period for the first 9 weeks and thereafter at the end of each 3 weeks for a total period of 23 weeks. The results are expressed in terms of *N/10* sodium hydroxid required to neutralize the acidity in the water extract from 10-gm. of compost on the dry basis.

TABLE III.—Accumulation of water-soluble acidity

Basis.	Com- post No.	Materials added to 1,500 gm. greensand.	Cubic centimeters N/10 sodium hydroxide required to neutralize acidity of water extract from 10 gm. of compost (dry basis) after—														
			0 weeks.	1 week.	2 weeks.	3 weeks.	4 weeks.	5 weeks.	6 weeks.	7 weeks.	8 weeks.	0 weeks.	1 1/2 weeks.	15 weeks.	17 weeks.	20 weeks.	23 weeks.
New Jersey greensand.	1	None.	.05	.075	.075	.075	.075	.10	.05	.05	.05	.075	.05	.05	.05	.05	.075
	2	Sulphur 500 gm.	.05	.075	.10	.50	1.05	1.20	2.30	1.35	1.90	2.30	2.85	3.50	3.50	3.00	4.50
	3	Sulphur 500 gm.; manure 500 gm.	.05	.60	.70	3.50	8.05	17.20	36.75	59.15	151.35	156.50	146.25	126.20	151.00	157.85	159.20
	4	Sulphur 500 gm.; manure 250 gm.; soil 250 gm.	.05	.25	.45	3.55	7.10	15.30	29.54	37.20	42.90	45.70	79.70	95.65	97.05	94.10	96.60
	5	Sulphur 500 gm.; soil 500 gm.	.05	.075	.10	.65	1.35	1.90	2.55	3.10	3.70	4.80	7.30	12.15	18.95	25.10	35.45
	6	Sulphur 500 gm.; soil 500 gm.; H ₂ O; 0.02 per cent Al ₂ (SO ₄) ₃ 0.18 H ₂ O; 0.02 per cent FeSO ₄ 0.7	.05	.075	.10	1.00	2.45	3.15	4.45	5.10	5.85	7.25	10.20	17.10	24.80	28.00	33.35
	7	Sulphur 500 gm.; soil 250 gm.; manure 250 gm.; CaCO ₃ 10 gm.	Alk.	.50	.60	1.50	38.25	65.00	62.10	59.80	61.25	64.40	97.65	105.40	104.95	102.80	101.35
	8	None.	.05	.05	.05	.05	.075	.10	.075	.10	.05	.075	.05	.05	.05	.05	.05
	9	Sulphur 500 gm.	.05	.05	.075	.35	.70	.95	1.30	1.30	1.90	2.05	2.80	3.75	4.35	4.05	5.15
	10	Sulphur 500 gm.; manure 500 gm.	.05	.70	.65	1.25	6.65	17.65	37.45	50.90	141.30	156.55	147.80	126.65	135.05	132.65	134.15
	11	Sulphur 500 gm.; manure 250 gm.; soil 250 gm.	.05	.75	.70	2.90	7.30	18.05	30.40	37.80	42.95	73.20	112.85	111.10	114.35	110.55	116.85
	12	Sulphur 500 gm.; soil 500 gm.	.05	.05	.15	.90	1.75	2.40	3.95	4.00	4.70	5.85	9.15	14.80	24.05	32.40	41.00
	13	Sulphur 500 gm.; soil 500 gm.; H ₂ O; 0.02 per cent Al ₂ (SO ₄) ₃ 0.18 H ₂ O; 0.02 per cent FeSO ₄ 0.7	.05	.075	.10	.45	1.55	2.10	2.80	3.45	4.25	5.10	8.55	15.20	24.30	28.25	36.20
	14	Sulphur 500 gm.; soil 250 gm.; manure 250 gm.; CaCO ₃ 10 gm.	Alk.	.075	.75	1.30	6.55	10.90	26.70	57.50	103.90	104.00	103.35	107.40	108.75	108.85	112.15

Attention is called to the fact that, although both greensands showed a high lime requirement when tested by the Veitch method, neither of them gave evidence of more than a trace of acidity in the water extract. The addition of sulphur to the greensand in the proportion of 3 parts greensand to 1 part sulphur caused a gradual accumulation of water-soluble acidity, because of the slow oxidation of the sulphur. Composts 3 and 10, in which both sulphur and manure were mixed with the greensand, show a slight and gradual accumulation of water-soluble acidity up to the end of the fifth week, after which there is a very rapid rise for three weeks. For the remainder of the period the acidity fluctuates at a high and practically constant level. When one-half of the manure is replaced by an equal quantity of soil, as in composts 4 and 11, the acidity is greatly reduced, the maximum for the Maryland greensand being reached at the end of the 12-week period and for the New Jersey greensand after 15 weeks. When the manure was entirely replaced by soil, the acidity increased gradually throughout the entire period, as shown by composts 5 and 12; but the amount developed was only about one-third as much as when equal weights of soil and manure were used. This indicates rather strongly that in composts made up with a greensand deficient in calcium carbonate the rate of development and the amount of acidity depend very largely on the amount of organic matter present. A further comparison of composts 5 and 12 with 2 and 9 seems to substantiate this conclusion, in that the soil used contained a small amount of organic matter.

The acidity titrated did not, of course, at any time consist entirely of free sulphuric acid. As sulphofication progressed and the amounts of free sulphuric acid and sulphates increased, an increasing amount of acid silicates was obtained in the water extract and was precipitated upon titration with the alkali. Careful inspection of several titrations, made after the maximum acidity had been attained, seemed to indicate that from 45 to 55 per cent of the acidity titrated was due to free sulphuric acid, the remainder of the acidity being due to acid silicates and other acid salts.

Under the conditions of our experiment the addition of ferrous sulphate and aluminum sulphate when used at the rate recommended by McLean (11) for sulphur-floats composts has had no appreciable effect, as may be seen by a comparison of composts 6 and 13 with 5 and 12. The addition of 10 gm. of calcium carbonate to the sulphur-manure-soil compost had a marked stimulating effect, beginning about the third week in the New Jersey greensand compost and two weeks later in the Maryland greensand compost. In the former the stimulating action persisted up to the end of the experiment, while in the latter the effect of the calcium carbonate had entirely disappeared at the end of 12 weeks. A cause for this difference is found when the lime requirement of the New Jersey greensand is

compared with that of the Maryland greensand. As was previously mentioned, the lime requirement of the New Jersey material is 4,200 pounds of calcium carbonate, while for the Maryland greensand the requirement is only 3,400 pounds. The results recorded in Table III would appear to justify the conclusion that an initial acidity corresponding to a lime requirement of 3,400 pounds of calcium carbonate exerts a slightly depressing effect upon sulphofication, and that an acidity corresponding to a lime requirement of 4,200 pounds of calcium carbonate is less favorable. Ames and Boltz (1) found that calcium carbonate when added in excess of the lime requirements exercised a depressing effect upon the oxidation of sulphur in their soil-sulphur compost. When they reduced the application to half, the oxidation of sulphur increased but was less than when no carbonates were added.

SOLUBLE SULPHATES

A comparison of the results recorded in Table IV with those given in Table III shows that the accumulation of water-soluble sulphates parallels very closely the development of acidity.

It will be observed that the sulphur trioxid determinations fluctuate somewhat after having attained a maximum at the end of about 12 weeks. These fluctuations are probably due to variations in the moisture content and the temperature of the composts, since such variations are known to have an effect upon colloidal silicates, which in turn might exercise, through adsorption, an appreciable effect upon the soluble sulphur trioxid obtained in the water extraction. A calculation shows that at the end of our 23-week period, approximately 15 per cent of the total sulphur used in composts 3 and 10 had been oxidized, while for the composts in which one-half of the manure had been replaced by soil about 11 per cent of the total sulphur had been oxidized. These figures show that the amount of sulphur used was in excess of the amount necessary to secure the most economical results.

SOLUBLE POTASSIUM

The amount of water-soluble potassium in each compost at stated intervals is given in Table V.

A comparison of these figures with those given in Tables III and IV brings out the fact that with the increase in acidity and the accumulation of sulphur trioxid there is a corresponding increase in the amount of potassium in the water extract. The potassium, however, continues to increase for some weeks after the acidity and sulphur trioxid have reached a maximum. It seems necessary for a certain degree of acidity to be developed before any appreciable amount of potassium is made water soluble, the larger amounts of acidity and soluble sulphate breaking down the greensand more rapidly.

TABLE IV.—Accumulation of water-soluble sulphate

Com- post No.	Basis.	Milligrams water-soluble sulphur trioxid (SO ₃) in 10 gm. of compost (dry basis) after—																			
		0 weeks.	1 week.	2 weeks.	3 weeks.	4 weeks.	5 weeks.	6 weeks.	7 weeks.	8 weeks.	9 weeks.	12 weeks.	15 weeks.	17 weeks.	20 weeks.	23 weeks.					
New Jersey greensand.	1	None.....	0.68	1.36	1.79	1.58	1.69	1.87	1.94	1.51	1.73	1.91	1.61	1.73	1.76						
	2	Sulphur 500 gm. ; manure 500 gm. ; soil 250 gm. ;	1.07	8.45	11.94	13.59	14.69	15.84	17.63	18.01	22.09	25.33	26.93	27.47	31.92	31.09					
	3	Sulphur 500 gm. ; manure 500 gm. ;	4.68	22.70	34.67	68.59	133.60	206.60	298.98	660.99	714.69	908.09	638.28	740.72	811.80	812.09					
	4	Sulphur 500 gm. ; manure 250 gm. ; soil 250 gm.	2.57	7.72	17.75	64.44	106.41	156.44	187.47	213.53	224.87	382.81	408.39	473.47	475.67	485.74					
	5	Sulphur 500 gm. ; soil 500 gm. ;	1.07	1.49	2.98	14.38	18.01	21.32	24.88	28.04	32.10	42.28	61.76	89.13	116.35	161.87					
	6	Sulphur 500 gm. ; soil 500 gm. ; 0.02 per cent Al ₂ (SO ₄) ₃ 0.18 H ₂ O ; 0.02 per cent FeSO ₄ 0.7 H ₂ O.	1.07	2.41	2.56	13.00	19.00	24.40	30.32	34.90	40.01	56.24	81.63	114.93	130.62	152.77					
	7	Sulphur 500 gm. ; soil 250 gm. ; ma- nure 250 gm. ; CaCO ₃ 10 gm.	3.50	23.25	47.61	59.66	213.11	320.30	313.29	309.21	317.44	330.69	492.98	543.58	549.24	546.50	535.55				
	8	None.....	.42	.91	.84	1.69	1.47	1.65	1.79	1.82	2.43	2.00	2.56	2.46	2.14	2.31	2.14				
	9	Sulphur 500 gm. ; manure 500 gm. ;	.98	1.57	2.28	7.88	9.91	11.38	13.40	15.01	16.55	17.43	21.41	25.64	27.57	26.31	30.66				
	10	Sulphur 500 gm. ; manure 500 gm. ;	4.84	26.16	34.30	46.64	84.99	136.33	211.75	266.28	609.33	753.14	674.56	632.02	673.54	668.98	672.47				
	11	Sulphur 500 gm. ; manure 250 gm. ; soil 250 gm.	2.53	14.39	21.90	42.52	66.57	107.93	158.88	186.82	212.95	359.96	522.00	544.68	558.13	542.11	568.02				
	12	Sulphur 500 gm. ; soil 500 gm. ;	.87	1.81	4.91	11.35	16.54	19.63	23.05	27.71	31.89	35.34	47.69	71.78	107.82	143.76	178.12				
	13	Sulphur 500 gm. ; soil 500 gm. ; 0.02 per cent Al ₂ (SO ₄) ₃ 0.18 H ₂ O ; 0.02 per cent FeSO ₄ 0.7 H ₂ O.	.80	2.09	3.10	8.47	14.62	17.52	22.45	25.14	29.24	32.30	44.18	72.85	109.26	135.09	158.08				
	14	Sulphur 500 gm. ; soil 250 gm. ; ma- nure 250 gm. ; CaCO ₃ 10 gm.	4.21	26.92	51.58	55.80	85.87	107.19	153.91	291.09	478.97	506.35	516.51	544.41	551.75	558.37	577.65				

TABLE V.—Accumulation of water-soluble potassium

Basis.	Com- post No.	Material added to 1,500 gm. green- sand.	Milligrams water-soluble potassium in 10 gm. of compost (dry basis) after—																			
			0 weeks.	1 week.	2 weeks.	3 weeks.	4 weeks.	5 weeks.	6 weeks.	7 weeks.	8 weeks.	9 weeks.	12 weeks. ^a	15 weeks.	17 weeks.	20 weeks.	23 weeks.					
New Jersey greensand	1	None.....	0.19	0.30	0.22	0.24	0.18	0.41	0.45	0.46	0.41	0.31	0.42	0.41	0.49	0.45					
	2	Sulphur 500 gm.....	.24	.29	.45	.52	8.98	.87	1.45	1.12	1.12	1.20	1.26	1.30	1.17	1.43					
	3	Sulphur 500 gm.; manure 500 gm.	2.99	5.75	7.43	9.57	8.53	11.57	10.11	11.68	14.77	17.64	40.04	48.46	62.56	64.11					
	4	Sulphur 500 gm.; manure 250 gm.; soil 250 gm.	1.47	2.70	3.50	5.55	4.68	5.85	5.99	6.10	8.98	8.18	25.91	31.25	30.10	32.77					
	5	Sulphur 500 gm.; soil 500 gm.....	.32	.32	.48	.72	1.10	.87	.91	.96	1.07	1.02	1.30	2.08	3.18	3.36					
	6	Sulphur 500 gm.; soil 500 gm.; 0.02 per cent $Al_2(SO_4)_3$ 0.18 H_2O .	.34	.34	.44	.75	1.05	.87	.97	1.17	1.10	1.27	1.34	2.25	3.10	3.36					
	7	Sulphur 500 gm.; soil 250 gm.; ma- nure 250 gm.; $CaCO_3$ 10 gm.	1.78	3.08	5.41	5.35	5.13	10.03	9.42	9.53	11.08	10.36	29.89	31.94	39.39	33.74					
Maryland greensand	8	None.....	.16	.21	.29	.27	.41	.48	.46	.52	.5041	.46	.48	.48						
	9	Sulphur 500 gm.....	.26	.24	.50	.52	7.96	.72	.90	.99	.93	.9684	1.28	1.02	1.08					
	10	Sulphur 500 gm.; manure 500 gm.	3.09	7.18	8.57	8.35	7.96	10.00	10.95	11.39	15.51	16.53	33.62	39.65	39.23	47.11					
	11	Sulphur 500 gm.; manure 250 gm.; soil 250 gm.	2.54	3.48	4.15	5.35	4.37	5.80	6.04	6.31	9.25	8.36	23.74	28.02	26.75	28.16					
	12	Sulphur 500 gm.; soil 500 gm.....	.30	.30	.64	.65	1.03	.85	1.02	1.03	.88	1.1096	1.58	1.17	1.21					
	13	Sulphur 500 gm.; soil 500 gm.; 0.02 per cent $Al_2(SO_4)_3$ 0.18 H_2O .	.28	.30	.50	.70	.84	.70	.84	.91	1.00	.9993	1.26	.95	.82					
	14	Sulphur 500 gm.; soil 250 gm.; ma- nure 250 gm.; $CaCO_3$ 10 gm.	2.30	4.22	6.27	5.86	4.77	6.90	5.71	6.35	11.97	10.22	23.46	25.26	25.33	26.53					

^a No analyses made.

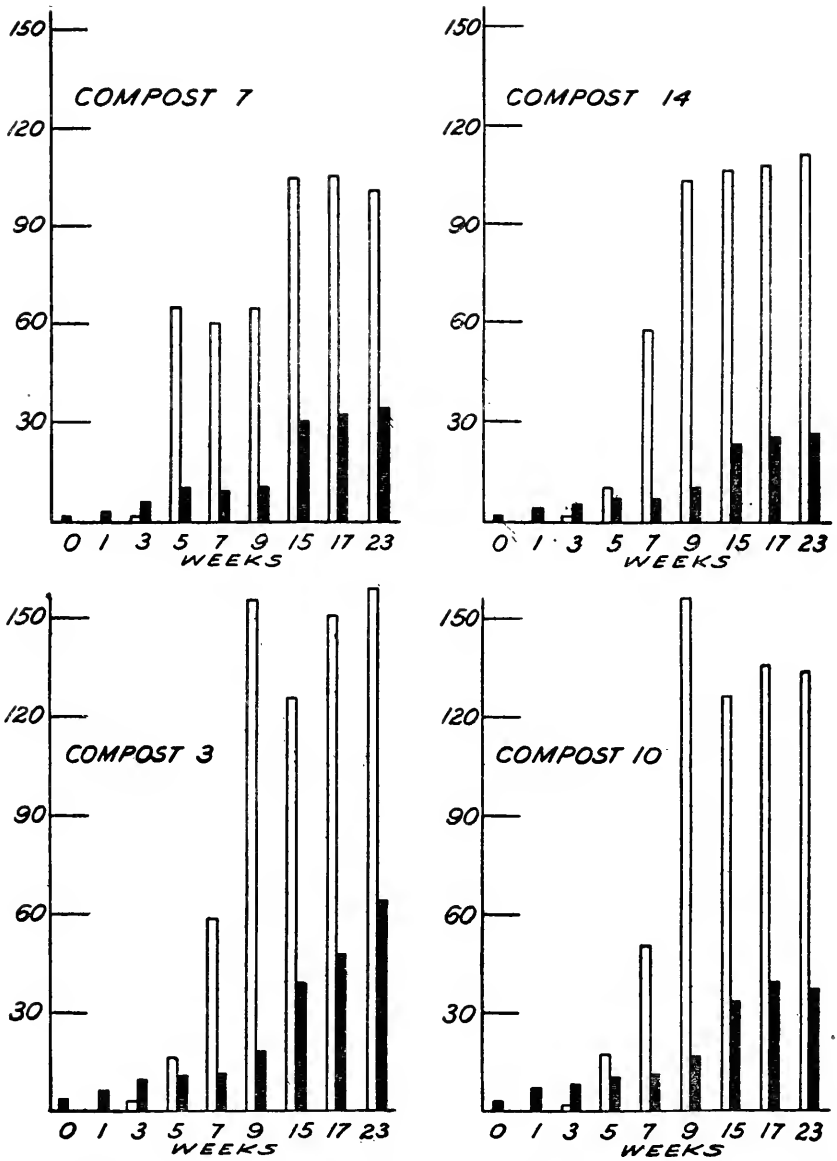

FIG. 1.—Diagrams showing relation of the water-soluble acidity to the water-soluble potassium at different time periods for different greensand composts. The open columns indicate the number of cubic centimeters of $N/10$ sodium hydroxid required to neutralize 10 gm. of compost on moisture-free basis, and the solid columns indicate the number of milligrams of water-soluble potassium obtained from 10 gm. of compost on moisture-free basis.

The diagrams of figure 1 give a graphic representation of the relation of the water-soluble acidity to the water-soluble potassium at different time periods for the greensand-sulphur-manure composts and for the greensand-sulphur-soil-manure composts to which were added 10 gm. of calcium carbonate.

A comparison of compost 3 with compost 7 and compost 10 with compost 14 brings out the fact that the replacement of one-half of the manure by soil has reduced the acidity and at the same time decreased the amount of potassium in the water extract. No. 7 and 14 show also the stimulation in acidity during the early weeks due to the addition of calcium carbonate.

The degree of acidity and the amount of sulphates and of potassium in the water extracts at the beginning of the period and at the end of 23 weeks for all the composts are shown in Table VI, which is a summary of Tables III, IV, and V.

TABLE VI.—*Water-soluble acidity, sulphate, and potassium in water extract from 10 gm. of moisture-free compost at beginning and after 23 weeks of composting*

Basis.	Compost No.	Acidity (cc. <i>N</i> / ₁₀ sodium hydroxid required).		Sulfate (sulphur trioxid).		Potassium.	
		After 0 weeks.	After 23 weeks.	After 0 weeks.	After 23 weeks.	After 0 weeks.	After 23 weeks.
New Jersey greensand.	1	0.05	0.075	<i>Mgm.</i> 0.68	<i>Mgm.</i> 1.76	<i>Mgm.</i> 0.19	<i>Mgm.</i> 0.45
	2	.05	4.50	1.07	31.92	.24	1.43
	3	.05	159.20	4.68	812.09	2.99	64.11
	4	.05	96.60	2.57	485.74	1.47	32.77
	5	.05	35.45	1.07	161.87	.32	3.36
	6	.05	33.35	1.07	152.77	.34	3.36
	7	Alkaline	101.35	3.50	535.55	1.78	33.74
	8	.05	.05	.42	2.14	.16	.48
	9	.05	5.15	.98	30.66	.26	1.08
	10	.05	134.15	4.84	672.47	3.09	37.11
Maryland greensand.	11	.05	116.85	2.53	568.02	2.54	28.16
	12	.05	41.00	.87	178.12	.30	1.21
	13	.05	36.20	.80	158.08	.28	.82
	14	Alkaline	112.15	4.21	577.65	2.30	26.53

Attention is called to the fact that the potassium liberated from the New Jersey greensand is much greater than that recovered from the Maryland greensand. This is to be expected, since the former had an initial potassium content of 5.88 per cent, while the latter contained only 1.42 per cent of potassium, as shown in Table I. It will be seen that the largest amount of potassium was extracted from compost 3, containing the New Jersey greensand, and the second largest amount from compost 10, which is the corresponding mixture made with Maryland greensand. The fact that both of these composts have twice the amount of manure contained in No. 4, 7, 11, and 14 would indicate that

comparatively large amounts of organic matter favor sulphofication and the liberation of potassium under the conditions of this experiment. These results are not in accord with those reported by McLean (11), who, working with sulphur-floats-soil composts, came to the conclusion that a compost is more efficient in the producing of available phosphorus in the absence of large amounts of organic material.

In Table VII the total potassium present in each compost, the water-soluble potassium at the start, and the maximum water-soluble potassium present at any one time during the period of 23 weeks are computed on the basis of the initial weights of the composts.

TABLE VII.—Total potassium made water-soluble (dry basis)

Compost No.	Material added to 1,500 gm. greensand.	Total number grams potassium in compost.	Water-soluble potassium at start (percentage of total).	Maximum water-soluble potassium present.	
				Gm.	Percentage of total.
1	None.....	83.38	0.037	0.070	0.084
2	Sulphur 500 gm.....	83.38	.055	.275	.330
3	Sulphur 500 gm.; manure 500 gm.....	85.68	.832	15.28	17.83
4	Sulphur 500 gm.; manure 250 gm.; soil 250 gm.....	86.58	.408	7.87	9.10
5	Sulphur 500 gm.; soil 500 gm.....	87.48	.088	.812	.928
6	Sulphur 500 gm.; soil 500 gm.; 0.02 per cent $Al_2(SO_4)_3$ 0.18 H_2O ; 0.02 per cent $FeSO_4 \cdot 0.7 H_2O$	87.48	.094	.812	.928
7	Sulphur 500 gm.; soil 250 gm.; manure 250 gm.; $CaCO_3$ 10 gm.....	86.58	.494	9.46	10.93
8	None.....	20.97	.112	.070	.333
9	Sulphur 500 gm.....	20.97	.243	.251	1.20
10	Sulphur 500 gm.; manure 500 gm.....	23.27	3.22	9.62	41.34
11	Sulphur 500 gm.; manure 250 gm.; soil 250 gm.....	24.17	2.57	6.88	28.50
12	Sulphur 500 gm.; soil 500 gm.....	25.07	.295	.389	1.55
13	Sulphur 500 gm.; soil 500 gm.; 0.02 per cent $Al_2(SO_4)_3$ 0.18 H_2O ; 0.02 per cent $FeSO_4 \cdot 0.7 H_2O$	25.07	.275	.310	1.24
14	Sulphur 500 gm.; soil 250 gm.; manure 250 gm.; $CaCO_3$ 10 gm.....	24.17	2.33	6.49	26.85

Reference to the last two columns of Table VII will show that, while the actual amount of soluble potassium which formed in the composts containing the Maryland greensand was much smaller than that which formed in the composts containing the New Jersey greensand, the percentage of the total potassium made water-soluble in the former was much greater than in the latter. One of the causes for this difference is to be found in Table II, which shows the mechanical analyses of the two greensands. The individual particles are much smaller in the Maryland than in the New Jersey greensand, thus exposing a much greater surface to the solvent action of the acids. Also, the glauconite particles of the

former were softer than those of the latter and seemed to be more soluble, as is shown by composts 1 and 8 in Table V. These figures show that although the New Jersey greensand contains more than four times as much potassium as the Maryland greensand, the amount of water-soluble potassium is the same.

In considering Table VII it is pertinent to ask to what extent the manure has contributed to the total amount of potassium recovered in the water extract. To answer this question Table VIII has been prepared upon the assumption that all the potassium in the manure was made soluble and was recovered in the water extract.

TABLE VIII.—*Relation of potassium content of the manure to the water-soluble potassium obtained*

Compost No.	Total soluble potassium obtained from compost.	Total potassium in manure.	Maximum amount of potassium from manure. ^a
	<i>Gm.</i>	<i>Gm.</i>	<i>Per cent.</i>
3	15.28	2.30	15.05
4	7.87	1.15	14.62
7	9.46	1.15	12.16
10	9.62	2.30	23.91
11	6.88	1.15	16.72
14	6.49	1.15	17.72

^a The percentages in this column are based on the assumption that all the potassium in the manure was made water-soluble.

From the last column of Table VIII it will be seen that even on this basis it is possible in only one case to account for more than 17 per cent of the potassium as coming from the manure. It is evident, therefore, that from 80 to 90 per cent of the potassium found in the water extract must have come from the greensand or from the soil and greensand.

Referring again to the manure composts in Table VII, it will be seen that the total amount of potassium recovered by water extracts from these composts varies from 9.1 per cent to as much as 41.3 per cent of the total initial amount present.

It is important to consider the relation between the oxidation of sulphur and the liberation of potassium. This relation is a converging ratio, which was rather wide during the period of greatest oxidation of sulphur and diminished rapidly as the potassium was released. While it was not expected that this ratio would be resolved to a constant figure for all of the composts, because of the different materials used, in each series the composts containing manure do show a rather uniform relation between these processes. On the basis of the initial weights of the composts, Table IX shows the maximum number of grams of sulphur oxidized and of water-soluble potassium obtained, and their ratio, as determined from the water extracts.

TABLE IX.—*Relation between number of grams of sulphur oxidized and number of grams of potassium made water-soluble*

Compost No.	Sulphur oxidized.	Potassium made water-soluble.	Ratio of grams sulphur oxidized to grams water-soluble potassium.
	<i>Gm.</i>	<i>Gm.</i>	
3	77.43	15.28	5.07:1
4	46.65	7.87	5.92:1
7	52.79	9.46	5.58:1
10	70.15	9.62	7.29:1
11	55.51	6.88	8.07:1
14	56.52	6.49	8.70:1

In the New Jersey greensand composts, approximately $5\frac{1}{2}$ gm. of sulphur were oxidized for each gram of potassium made water soluble. For the Maryland greensand composts, the ratio is approximately 8 to 1. The ratio varies with the materials used, the high-potassium greensand having a lower ratio than the low-potassium greensand, and the composts containing 20 per cent manure having a lower ratio than those containing 10 per cent manure. For the composts in which soil was substituted for all the manure the figures are not shown, but the ratio is much wider, the amount of sulphur oxidized not being sufficient to make water soluble any large amount of potassium.

The results of this investigation would indicate that the composting of greensand, or of soil rich in potassium, with sulphur and manure may prove to be a practical and efficient method for obtaining available potassium from comparatively insoluble materials.

SUMMARY

Two greensands, one containing 5.88 per cent of potassium and the other 1.42 per cent, were used in studying the effect of sulphofication upon the solubility of the potassium. The outstanding results of the investigation are summarized in the following paragraphs.

(1) In composts consisting of greensand, manure, and soil in different proportions, an appreciable amount of the potassium of the greensand was made water-soluble through sulphofication.

(2) The composts containing the largest proportion of manure developed the highest degree of acidity, oxidized the greatest amount of sulphur, and produced the largest quantity of water-soluble potassium.

(3) The composts in which soil was substituted for a part of the manure developed less acidity, oxidized less sulphur, and produced a smaller amount of soluble potassium.

(4) When all the manure was replaced by soil, the rate of sulphofication was so slow that at the end of 23 weeks only a very small amount of acidity had developed and very little potassium had been made soluble.

(5) When no organic matter was added, the amounts of acidity and soluble sulphates were no greater than might be accounted for by the natural oxidation of the sulphur.

(6) The addition of small amounts of ferrous and aluminum sulphates failed to stimulate sulphofication.

(7) Calcium carbonate added to the sulphur-manure-soil compost produced a stimulating effect during the early part of the period but failed to increase the acidity, soluble sulphates, or potassium above the maximum reached by the corresponding compost in which no calcium carbonate was used.

(8) More water-soluble potassium was formed in the composts containing the high-potassium greensand, but a larger percentage of the total potassium present was liberated in the composts containing the low-potassium greensand.

(9) In the composts containing manure, the total amounts of potassium recovered in the water extracts varied from 9.1 per cent to a maximum of 41.3 per cent of the total initial amount present.

(10) Our results indicate that the composting of greensand, or of soil rich in potassium, with sulphur and manure may prove to be a practical and efficient method for obtaining available potassium from comparatively insoluble materials.

LITERATURE CITED

- (1) AMES, J. W., and BOLTZ, G. E.
1919. EFFECT OF SULPHOFICATION AND NITRIFICATION ON POTASSIUM AND OTHER SOIL CONSTITUENTS. *In Soil Sci.*, v. 7, no. 3, p. 183-195. References, p. 195.
- (2) ——— and RICHMOND, T. E.
1918. EFFECT OF SULPHOFICATION AND NITRIFICATION ON ROCK PHOSPHATE. *In Soil Sci.*, v. 6, no. 5, p. 351-364. References, p. 364.
- (3) BLAIR, A. W.
1916. THE AGRICULTURAL VALUE OF GREENSAND MARL. *N. J. Agr. Exp. Sta. Circ.* 61, 13 p., 1 fig.
- (4) BROWN, P. E., and GWINN, A. R.
1917. EFFECT OF SULPHUR AND MANURE ON AVAILABILITY OF ROCK PHOSPHATE IN SOIL. *Iowa Agr. Exp. Sta. Research Bul.* 43, p. 369-389, 4 fig. Bibliography, p. 389.
- (5) ——— and WARNER, H. W.
1917. THE PRODUCTION OF AVAILABLE PHOSPHORUS FROM ROCK PHOSPHATE BY COMPOSTING WITH SULPHUR AND MANURE. *In Soil Sci.*, v. 4, no. 4, p. 269-282, 3 fig. References, p. 282.
- (6) COOK, George H.
1868. GEOLOGY OF NEW JERSEY . . . xxiv, 899 p., illus., 1 fold. col. map. Newark, N. J.
- (7) HILGARD, E. W.
1906. SOILS, THEIR FORMATION, PROPERTIES, COMPOSITION, AND RELATIONS TO CLIMATE AND PLANT GROWTH IN THE HUMID AND ARID REGIONS. xxvii, 593 p., illus. New York, London.

- (8) LIPMAN, Jacob G., and BLAIR, A. W.
1918. VEGETATION EXPERIMENTS ON THE AVAILABILITY OF PHOSPHORUS AND POTASSIUM COMPOUNDS. *In* N. J. Agr. Exp. Sta. 38th Ann. Rpt. [1916]/17, p. 353-368.
- (9) ——— and McLEAN, Harry C.
1918. EXPERIMENTS WITH SULPHUR-PHOSPHATE COMPOSTS CONDUCTED UNDER FIELD CONDITIONS. *In* Soil Sci., v. 5, no. 3, p. 243-250.
- (10) ——— and LINT, H. Clay.
1916. SULPHUR OXIDATION IN SOILS AND ITS EFFECT ON THE AVAILABILITY OF MINERAL PHOSPHATES. *In* Soil Sci., v. 2, no. 6, p. 499-538, 5 fig. Literature cited, p. 535-538.
- (11) McLEAN, Harry C.
1918. THE OXIDATION OF SULFUR BY MICROORGANISMS IN ITS RELATION TO THE AVAILABILITY OF PHOSPHATES. *In* Soil Sci., v. 5, no. 4, p. 251-290. References, p. 287-290.
- (12) PATTERSON, H. J.
1906. RESULTS OF EXPERIMENTS ON THE LIMING OF SOILS. Md. Agr. Exp. Sta. Bul. 110, 56 p.
- (13) TRUE, Rodney, and GEISE, Fred W.
1918. EXPERIMENTS ON THE VALUE OF GREENSAND AS A SOURCE OF POTASSIUM FOR PLANT CULTURE. *In* Jour. Agr. Research, v. 15, no. 9, p. 483-492 pl. 33-34.

RUST IN SEED WHEAT AND ITS RELATION TO SEEDLING INFECTION¹

By CHARLES W. HUNGERFORD

Assistant Pathologist, Office of Cereal Investigations, Bureau of Plant Industry, United States Department of Agriculture

INTRODUCTION

The fact that the mycelium of rust fungi in some cases may enter the seed and seed parts of various plants and produce spore bodies there has been known for many years and has been referred to by various writers. Differences of opinion have existed, however, as to the importance of this phenomenon in the dissemination of the rust concerned. Aside from the occurrence of rust in and upon these plant organs, other facts have seemed to indicate that rust might be transmitted by means of seed. A number of cases are on record where the uredinial and telial stages of various rusts have suddenly appeared in regions where the aecial host was unknown. Lagerheim (17)² found *Puccinia coronata* Cda. on oats in Ecuador, and since no species of *Rhamnus* known to bear the aecia of this rust occur there he concluded that the rust was probably introduced by means of oats brought from Europe. He also reported stemrust doing great damage in Ecuador, although barberry bushes were not present there. According to McAlpine (18, p. 60), *P. graminis* is common in Australia, while only a very few hedges of barberry exist and the aecial stage of this rust has never been found occurring naturally upon that continent. Bolley and Pritchard (5, p. 647) quote McAlpine as saying that he is convinced that certain grass seeds secured by him from the United States Department of Agriculture introduced certain rusts into Australia. Among these he named *P. coronata* Cda. on the grass *Beckmannia erucaeformis* and *P. montanensis* Ell. on wild rye (*Elymus canadensis*). Numerous other similar instances could be cited.

The widespread occurrence of rust epidemics has not been satisfactorily explained, to some pathologists at least, by our present knowledge of the overwintering of the uredinial stage or by our present knowledge of the importance of infection of wheat by aeciospores from the barberry. These conditions have caused a number of writers to attempt to explain sporadic attacks of rust by a theory of seed transmission. The idea is

¹ The investigations reported in this paper were carried on at Madison, Wis., under the direction of the Office of Cereal Investigations, United States Department of Agriculture, Washington, D. C. The writer wishes especially to thank Dr. L. R. Jones and Dr. A. G. Johnson, of the Department of Plant Pathology of the University of Wisconsin, and Dr. H. B. Humphrey, of the Office of Cereal Investigations, United States Department of Agriculture, for helpful suggestions and criticisms during the progress of the work and in the preparation of the manuscript.

² Reference is made by number (italic) to "Literature cited," p. 275-277.

not new that certain fungous parasites may exist in the vegetative state in the seeds of their hosts and be thus transmitted from one generation to another. Even before this was established for certain of the cereal smuts, various workers had endeavored to show this condition for the cereal rusts. The discovery that certain smuts were systemic in their infection gave impetus to further research along this line.

The purpose of the investigations reported here was to determine whether or not *Puccinia graminis tritici* Erkiss. and Henn. can be transmitted to the seedling by being carried over with the seed grain.

OCCURRENCE OF RUST IN SEEDS AND SEED PARTS OF VARIOUS PLANTS

The earliest report that the writer has been able to find that stemrust may attack the seed and seed parts of grain was made by W. G. Smith in 1885 (23). He found telia of *Puccinia graminis* in the pericarp of oat kernels and figured teliospores within the oat grains lying inside the aleurone layer and between that and the endosperm. His drawings and notes, however, leave much to be desired. In 1886 (24) the same author figured aecia embedded in the fruits of the barberry. Maddox (18, p. 20) noted rust infection upon—

the young half-grown grain . . . before it had started to go out of the milk stage.

He does not state to which rust he refers. Pritchard (22, p. 151) in 1911 figured stemrust upon wheat kernels and stated that telia and fragments of mycelium were found in abundance in the pericarp of wheat kernels and that seed infection occurs very frequently even in rust-free years. Other reports have been made of *P. graminis* upon the caryopses of wheat, oats, barley, and various grasses, and the writer has observed this condition upon all of the above-mentioned hosts.

Puccinia glumarum (Schm.) Erikss. and Henn. is also known to occur commonly upon the caryopses of wild and cultivated Gramineae. Beauverie (1, 2) has recently reported at length upon this phenomenon and states that if the seed is hulled the sori are produced upon the interior of the glumule, while if the seed is naked they are formed in the pericarp. He found this rust more or less abundant in the caryopses of *Triticum vulgare*, *Hordeum vulgare*, *Brachypodium pinnatum*, *Agropyron caninum*, and *Bromus mollis*. He also reports finding *P. simplex* on barley kernels and *P. coronata agropyri*¹ on *Agropyron repens*. Blaringhem (3, p. 86) found somewhat the same conditions reported by Beauverie. Eriksson and Henning (10, p. 199, pl. 7, 9)) fully describe and give excellent figures of whole kernels and cross sections of kernels infected with *P. glumarum*.² Various other rusts have been reported as occurring upon seeds and seed parts of various plants. Carleton (6, p. 28-29) has reported the occur-

¹ It is not clear what rust is referred to by this name.

² These authors cite several former observations of *P. glumarum* upon kernels of wheat, the earliest of which was by Schmidt (10, p. 454) in 1819.

rence of Euphorbia rust (*Uromyces euphorbiae* C. and P.) upon seeds of *Euphorbia dentata*. Various writers have noted *P. malvacearum* Mont. on hollyhock seeds. Other examples of a similar nature could be given. The discussion of the practical importance of this occurrence in relation to subsequent infection of seedlings will be taken up in a later paragraph.

ABUNDANCE OF KERNEL INFECTION IN WHEAT

In order to learn to what extent seed wheat may become infected with *Puccinia graminis tritici* a large number of wheat samples were examined by the writer. These samples were secured from various sources and from the crops of the two years 1915 and 1916. During the fall and winter of 1915-16 samples of wheat were secured from various points in North and South Dakota, from western Minnesota, from grain commission firms in Minneapolis, and from wheat grown in the rust nursery at the University Farm, St. Paul, Minn. In all, several hundred samples of wheat were examined, all of which came from fields known to be badly rusted or from localities where it was known that rust epidemics had occurred. During the fall of 1916 a large number of samples of wheat were obtained from the same regions as in the previous year. In those regions there occurred that year an unusually severe rust epidemic. It would seem, therefore, that under these conditions there would be as large an amount of seed infection as ever occurs.

It was found at once that the task of determining the percentage of infection was not so easy as it at first appeared. In some cases the kernels were found to be but slightly infected, having only one sorus on the hilum, or germ end. In such cases it was impossible to see that these were infected at all except by means of examination under considerable magnification. In other cases the general appearance of the kernels seemed to indicate to the unaided eye that there was rust infection, but upon examination under the microscope no rust was found. Indications were that such discolorations were caused by some other agency. *Alternaria* and *Helminthosporium* species were often found to be associated. In general, it was found impossible to tell in every case whether or not a kernel was infected by rust except by microscopic examination. However, in many cases, especially after some experience, many of the rust-infected kernels could be easily detected by the unaided eye.

The large majority of the rust-infected kernels, when mature, were found to bear only telia,¹ which appeared as glistening black specks on the hilum, or the germ end, or a short distance down the groove of the kernel. Sometimes sori were noted a short distance from the hilum with no surface connections between these and the ones at the hilum (see Pl. 39, B). Upon sectioning similar kernels, however, the mycelial connections were found. If the hilar end of an infected kernel is scraped with a sharp knife or scalpel, teliospores in abundance can be secured.

¹ Uredinia were noted on immature kernels at various times.

In order to learn the percentage of infection and also to be absolutely certain that all seed used in experimental work was infected with rust, the following method of selecting rusted kernels was employed. The samples of wheat to be examined were spread out in a shallow dish where the light was good, and the discolored kernels were taken out one by one by means of small forceps. A common 5-inch reading glass usually was used to facilitate making the selections. These discolored kernels were then placed one by one under a low-power binocular microscope where it could be easily determined at a glance if any rust sori occurred on their germ ends. As will be shown later, some infected kernels may have been missed, for sometimes the sori on the germ ends are broken off with the flowering glumes in thrashing.

Bolley and Pritchard (5, p. 646) state that—

in some samples of wheat in the rust-infected crop of 1904 as high as 30 per cent of all grains harvested showed such rust infection.

Pritchard (22, p. 153) also states that in 1910, a rust-free year, wheat from elevators at Brookings, S. Dak., showed some rusted kernels in every sample and many in some varieties, especially Bluestem. The writer's observations do not agree with this. In all the hundreds of samples examined the largest percentage of kernels found in any one sample showing rust sori was only about 1 per cent of the total. Many samples were examined in which no infected kernels could be found. In fact, even in 1916, a very bad rust year, the varieties having kernel infection were the exception rather than the rule. Moreover, varieties of the durum wheat were the ones which most often were found to be infected. This was the case in both years and seems to be consistently so. One sample of mixed wheat from Reeder, N. Dak., collected in 1916, contained about 1 per cent of infected kernels. Although the sample contained Marquis, durum, and Bluestem in the mixture, only durum kernels were found infected. This has been found to be the case in many mixed samples examined. Only in a few cases have any number of infected kernels of other varieties been found. This may be due to the fact that the spike of durum wheat is so compact that it dries very slowly after rains or heavy dews and these moist conditions favor infection by rust. It is a well-known fact that durum varieties are very susceptible to *Fusarium* scab, possibly for the same reason.

To illustrate this point the following observation is of interest. The writer noted in 1916 at Dickinson, N. Dak., that all the durum wheats were more or less badly rusted on the heads. (See Pl. 38.) This was especially true of the Kubanka strain known as selection No. 8, C. I. No. 4063 (Pl. 38). A large number of heads of this variety were collected which were literally covered with stemrust sori (Pl. 39, A). Mr. Ralph Smith, of the Office of Cereal Investigations, stationed at Dickinson, kindly furnished the writer some of the seed of this variety when the plots were thrashed. This seed was all examined carefully, and it was

found that only about one kernel in a thousand showed any evidence of rust infection.

METHOD OF KERNEL INFECTION

There are two possible methods by which kernel infection takes place. First, the kernel itself may become infected by urediniospores lodging upon its surface under the glumes; or, second, the infection may spread from sori produced upon the inclosing glumes, upon the rachis or the rachilla. Since there probably are no stomatal openings upon the kernel itself and since uredinial infection takes place only through the stomata, the first possibility seems to be eliminated. Cobb (7) reports finding urediniospores of stemrust in abundance in the brush of the kernel of a large number of varieties of wheat, even after the wheat was thoroughly cleaned. He also reports finding stomata near the brush end and concludes that infection of the kernel may take place at this point. He found sori common on wheat kernels but does not say anything with regard to their location.

The writer has never found sori of stemrust produced near the brush end of wheat kernels nor has he been able to find stomata upon wheat kernels at any time in their development. As previously stated the writer has found rust sori on wheat kernels at or near the germ end. This would indicate that infection takes place by the spread of rust mycelium to the caryopsis from infection which had previously taken place at the base of the glumes or on the rachilla. Indeed, our experiments have confirmed this. When kernels were examined in the wheat head and were found to be infected, it was found that one or more of the flowering glumes always bore sori; and frequently several sori on the rachis, rachilla, and glumes were found to be confluent and extending over to the base of the kernel. The tissue of the hilar region of the kernel is similar in its structure to leaf tissue, and therefore infection of this region might be expected. In samples of thrashed grain kernels with adhering pieces of glumes often had rust sori extending from the base of the glume to the kernel itself. The glumes seemed to be held thus by the fungus (Pl. 39, B).

That infection may spread from the glumes to the kernel hilum was shown as a result of artificial inoculation experiments. These were carried out as follows. Artificial inoculations of wheat heads with urediniospores of stemrust were made in the greenhouse during the winter of 1915-16. The first set of inoculations was made when the kernels were less than half grown. Urediniospores were dusted in abundance inside the glumes, and the heads were sprayed with distilled water, inclosed in large test tubes, and kept for two days. Wet cotton was kept in the bottoms of the tubes and the mouths were plugged with cotton, thus giving the conditions necessary for infection. The first attempt was a failure, either because too many spores were used or

because the kernels were not developed far enough to survive the invasion of the parasite, and the infection was so great that none of the kernels developed. The glumes and rachis at the base of the spikelet in each case were covered with sori 20 days after inoculation and the inner surfaces of the glumes were filled with urediniospores.

These results appear to confirm Johnson's (15) observations regarding the effect of rust infection upon floret sterility in wheat. He found floret sterility increased 20.03 per cent when wheat heads were sprayed with a water suspension of a mixture of urediniospores of *Puccinia graminis* and *P. triticina*. His conclusions were that when the rust attacks the ovary early enough it prevents its development, and other semiparasitic fungi complete the process of destruction, while if it attacks the embryo after it is fertilized and has begun to enlarge, a rusted kernel results. Table I shows the outcome of a second set of inoculations. Kubanka wheat (C. I. No. 1440) was used for these experiments. The glumes were opened, and a very few spores were placed at the base of the inside of the glumes with a fine platinum needle. The heads were then sprayed with distilled water and inclosed in a test tube as before. Every spikelet in each head, with the exception of the smallest ones at the tip, was thus inoculated.

TABLE I.—Results of artificial inoculation of wheat ovaries at different stages of development

Host No.	Condition of ovaries.	Date of inoculation.	Number of heads inoculated.	Date thrashed.	Number of infected kernels.	Number of healthy kernels.
5	Ovaries two-thirds grown.	Nov. 15, 1915	2	Jan. 11, 1916	3	8
6do.....	Nov. 18, 1915	1do.....	2	1
7	Ovaries size of pinhead.....do.....	1do.....	0	0
8do.....do.....	1do.....	0	1
9	Ovaries somewhat larger than above.do.....	10do.....	0	2
10	Kernels two-thirds grown.	Nov. 15, 1915	4do.....	3	5
11do.....	Dec. 5, 1915	3do.....	15	8

It will be noted from Table I that in no case was kernel infection obtained when inoculations were made while the ovary was very small. On the other hand, when the inoculations were delayed until the kernels had attained about two-thirds of their normal size at maturity, the kernels were able to continue development, and a high percentage of rusted ones resulted. It would seem, therefore, that the amount of kernel infection each year does not depend alone upon the amount of rust occurring upon the heads of the wheat but also upon the time when this infection takes place and whether the kernels are at the right stage of development to become infected. The weather conditions where the kernels are at the right stage of development are also a very important factor.

EFFECT OF KERNEL INFECTION UPON GERMINATION

Large numbers of rust-infected wheat kernels were germinated and grown to various stages of development for the purpose of making histological studies. Parallel series of unruined kernels from the same seed lot were germinated and grown for comparison. In these series it was noted that the rusted and unruined seed gave practically identical percentages of germination.

RUST TRANSMISSION WITH SEED GRAIN

HISTORICAL DISCUSSION

From the vast amount of work which has been done upon this problem it is possible to separate three main theories. Briefly stated, these theories are as follows: (1) Mycoplasma theory of Eriksson; (2) dormant mycelium in the seed carrying infection to the seedling; and (3) seed-borne spores causing infection of the seedling.

MYCOPLASM THEORY OF ERIKSSON

Eriksson (9) in 1897 announced his well-known mycoplasma theory. He states that in the summer of 1893, upon microscopical examinations of sections of very young sori of yellow-rust (*Puccinia glumarum*) upon wheat leaves, he found adjacent to these sori, besides the usual cell elements, peculiar, elongated, mostly faintly curved, plasmatic corpuscles. He concluded (*p.* 193, translation) that—

these plasma corpuscles, at first freely swimming in the protoplasm, constitute a phase of the fungus, the primary phase, wherein the fungus by its independent appearance makes itself visible. The fungus has for weeks, months, possibly even years, previously led a latent existence in an invisible form and alongside the protoplasm of the host plant, forming a kind of mycoplasma-symbiosis between host and parasite.

Although Eriksson describes this mycoplasma in detail and figures it in various stages of development, very few later writers have accepted his evidence as being in any way conclusive. While it is not the present purpose to give a detailed criticism of the theory, yet, in the judgment of the writer, it seems that Eriksson's experimental evidence does not establish his contention in regard to the existence of the so-called mycoplasma. Nothing similar has been encountered in any of the hundreds of sections which the writer has made. More will be said later of this experimental evidence upon which Eriksson based his conclusions. Ward (25, *p.* 353) sums the matter up very well when he states that Eriksson merely—

inverts all the stages of the fungus attack on the cell, and supposes the last stage to be the first and that this error and misrepresentation of the microscopic appearance account for the whole wearisome persistence in an inherently improbable hypothesis.

Detailed criticisms of Eriksson's theory are given by Bolley (4), Zukal (26), Ward (25), and Massee (20). Others could be added to this list,

but it is sufficient to say that no pathologist of note has for any length of time accepted this explanation of rust dissemination.

DORMANT MYCELIUM THEORY

There has been more support, and probably more ground for support, for the theory that the mycelium of rusts may live over in the seed or seed parts of the plant in a dormant state and then infect the young seedlings at the time of germination. A number of writers have suggested this possibility, among whom W. G. Smith (24) was probably the first. He says:

If apparently healthy leaves of corn are taken, and apparently healthy leaves of Barberry, and these leaves are microscopically examined, fungus mycelium will be commonly found inside the leaves. Neither is the mycelium confined to the leaves, for it invades the seeds of both plants, and these seeds are frequently planted with the mycelium in their tissues. A diseased progeny is the result.

Zukal (26), in 1899, published observations which seemed to indicate to him that rust was transmitted by mycelium in seed grain. He concluded that rust mycelium might live over in the wheat kernels because the rust appeared so early on the young seedlings. He found septate mycelium at the base of the sheath, in the culms, and at the nodes in the parenchyma cells just under the epidermis. He concluded that the mycelium lived over in the seed and in the spring grew through the scutellum into the embryo and developed with the plant.

Pritchard (22, p. 152), in 1911, found mycelium in the roots, in both central cylinder and epidermis, in the stem, and between the leaf sheaths in plants grown from rusted wheat kernels. This mycelium resembled rust mycelium which he found at the base of the sori upon the germ end of the kernel of wheat from which the plants were grown. He states that the mycelium was abundant in the young stem, filling the intercellular spaces and freely penetrating cell walls as well. More will be said later in regard to Pritchard's work.

SEED-BORNE SPORES THEORY

Massee (20) secured evidence which seemed to indicate to him that seed-borne urediniospores or urediniospores in the soil might cause infection of young wheat plants. More recently Blaringhem (3) and Beauverie (1) have published extensive observations which they have made. They conclude that *Puccinia glumarum* may be transmitted by urediniospores borne in the pericarp of the seed. As stated above, they found uredinia in abundance in the pericarp of various grains and grasses and concluded that these spores, so protected, may retain their viability until the germination of the seed, when they become free from the sori through the rupturing of the pericarp and may infect the young plant at this time. Their conclusions, in the writer's judgment, are based upon insufficient experimental evidence, and, although the theory is interesting in itself, certainly it should be supported by more careful experiments.

EXPERIMENTS OF VARIOUS WORKERS

A number of workers have grown plants from rusted seeds of various kinds under various degrees of isolation. The results of these experiments are rather variable. The writer has assembled the results and the methods used in several of these experiments in Table II, which includes the experiments of nine men conducted at different times in different countries. None of these writers claimed to have secured normal conditions for the growth of the host plants, and in no case was any record taken of the atmospheric conditions inside the devices used to secure isolation.

TABLE II.—*Summary of results obtained by other investigators in experiments on seed transmission of rusts*

Experimenter.	Year.	Place of experiment.	Rust involved.	Means of isolation.	Kind of seed used.	Results.
Eriksson (9)...	1892-1898	Sweden...	<i>P. glumarum</i> , <i>P. graminis</i> .	Ventilated glass frames.	Barley, wheat	Few positive.
Klebahn (16)...	1899	Germany...	<i>P. graminis</i> , <i>P. glumarum</i> .	Glass cages.....do.....	Uncertain.
Zukal (26).....	1898	Austria....	<i>P. glumarum</i>	Isolated garden..	Wheat.....	Negative.
Linhart ^a	1898do.....do.....	Glass inclosures..do.....	Do.
Hayman (12)...	1903-1907	India.....	<i>P. glumarum</i> , <i>P. triticea</i> .	Glass cages.....do.....	Uncertain.
Bolley (4).....	1905	North Dakota.	<i>P. graminis</i>do.....do.....	Negative.
Massee (20)....	1894	England....	<i>P. glumarum</i>	Bell jars.....do.....	Positive.
Nowikoff ^b	Russia.....	<i>P. coronata</i> , <i>P. glumarum</i> .	Isolated cages....	Oats, barley..	Negative.
Jaczewski (14).	1902-1906do.....do.....	Glass cages.....	Oats, rye.....	Do.

^a Reference is made to Linhart's work by Zukal (26); original work not published.
^b Referred to by Jaczewski (14); original not seen

Eriksson carried on experiments for seven years and secured only a very few infections upon plants grown inside his "isolation frame." This frame was made of glass with wooden corner posts and an iron roof. Ventilation was secured by drawing air through a cotton filter. At best a cotton filter is not very satisfactory, and it is to be noted that Eriksson secured his positive results after the cages had been used three or four years. Grove (11, p. 45-47) makes an interesting comment upon Eriksson's work. He says (p. 45)—

on some of his "protected" plants aphides also made their appearance, yet this does not seem to have suggested to him [Eriksson] that the zooplasm of the aphides must also have been latent in the seed. If the aphides got in, so would fungus spores, since it has been proved that uredospores are carried by them and other insects.

Klebahn repeated Eriksson's experiments and found one plant infected with *Puccinia graminis* in his glass cages. He explains this (16) by the fact that this infection did not appear until a few days after he had been working with *P. graminis* near this cage. The time which had elapsed was about the normal incubation period for this rust. It seems very likely, therefore, that the one infection noted originated from spores accidentally introduced.

Hayman (12) repeated his experiments for five years and grew 195 plants to maturity. The conditions inside his cages were abnormal at all times, although an effort was made to control conditions by means of a blacksmith bellows and cotton filters. Two pustules of rust appeared in the fifth year, but the author himself was not satisfied with this result as is evidenced by the fact that he states that the tar used to coat the inside of the cages had oozed through the cracks in the cage in which the plant was found to be infected.

Massee, the only other worker who secured positive results, used bell jars placed upon cotton wool with a cotton plug in the opening at the top. He sowed wheat inside these jars, which was known to be shriveled by *Puccinia glumarum*, and as controls he sowed plump seed of the same variety. Sixty per cent of the infected seed germinated, and when the plants were 3 inches high rust appeared in each pot. When the plants were 5 inches high 26 per cent of them were rusted. Of the plump seed sown under the same conditions 96 per cent germinated, and all remained perfectly free from rust. These results are striking, and the problem with this rust is highly deserving of further investigation.

Pritchard (21) grew 60 wheat plants from rusted seed in glass cages in the open and later repeated the experiment in the greenhouse. No rust appeared on any of the plants. He states that the plants headed and blossomed but no kernels developed because the temperature and moisture conditions were abnormal. He also refers to an experiment where wheat sown at different dates was inoculated with both aeciospores and urediniospores of stemrust. Rust did not appear abundantly, however, until the wheat began to head, when each sowing became thoroughly rusted. He states that it is possible to attribute this peculiar behavior to infection through the seed with a long subsequent incubation period in the growing plant. It seems to the writer that this conclusion is entirely unwarranted, since it is well known that infection with stemrust is much more easily obtained and more noticeable during the heading period of the plant when stemrust does such great damage by attacking the neck of the stalk. This is a period of rapid growth of the plant and a period when urediniospores are usually present in abundance in the air. If climatological conditions are favorable—that is, if high relative humidity and comparatively low temperatures prevail during this period—a severe rust epidemic is almost sure to follow if the infection material is present. A study of the climatological conditions during the last of June and the first of July in the spring-wheat belt shows that these conditions existed in the years when rust epidemics were severe and did not exist in the years when rust was not prevalent. These conditions are sufficient to explain any such peculiar behavior as Pritchard refers to and also help to explain rust epidemics in the spring-wheat region.

EXPERIMENTAL DATA

It is seen from the foregoing review that a number of workers have grown rust-infected seed grain under various degrees of isolation and with more or less conflicting results. The evidence of this kind as to the transmission of *Puccinia graminis* by means of seed seems to be largely negative. Nevertheless some positive results have been reported. The one conclusive way to prove the contention that rust can be carried on seed grain must be to produce the disease upon plants grown under controlled conditions from seed known to be infected with the rust. While histological evidence is valuable from the standpoint of interpretation, yet no amount of such work by itself is fully convincing in connecting seed infection with the appearance of the disease upon the leaves unless plants can be grown from infected seed under controlled conditions and the disease be produced upon these plants. The writer's experimental investigations were along three lines: (1) Greenhouse experiments in which rusted kernels of wheat in large numbers were sown under isolated conditions and the resulting plants watched for infection; (2) field experiments in which rusted wheat kernels were sown in the fields and watched to learn if infection occurred upon the resulting plants sooner than upon plants grown from clean seed; and (3) histological investigations in which rusted wheat kernels were germinated under various conditions and the resulting seedlings examined histologically for spread of rust infection from the kernel to the seedling.

GREENHOUSE EXPERIMENTS

The writer determined to test this matter thoroughly by growing a large number of wheat plants from kernels known to bear sori of stemrust, under conditions of isolation and at the same time under conditions normal for the development of the host. In order to meet these requirements a room in the pathological greenhouses at the University of Wisconsin was equipped as shown in Plate 40. The room was examined carefully and every crack and opening sealed. Double doors were constructed with a space between, which could be sprayed each time before the room was entered. An adjustable shade was placed upon the roof in such a way that a spray of water could be thrown upon the glass underneath the shade to aid in cooling the room, and a system of forced circulation of washed air was installed, as shown in figure 1. Thermograph and hygrograph records were kept at all times when the plants were growing, and it was found easily possible to control the temperature and humidity within normal limits for growth of wheat plants. Plants grown in this house were entirely normal in appearance and produced plump kernels in every head. The accompanying photographs (Pl. 41) taken at different times during the period when the experiments were in progress, show the normal, healthy condition of the plants. In order to test the efficacy of this air-washing apparatus, about a pint

of smut spores were thrown up into the opening at *i* in figure 1, and an attempt was made to catch any which went through the drum upon moistened sterile cotton held at *h*. This cotton was then washed and the water carefully examined with the microscope. No spores could be found upon this cotton, although the experiment was repeated several times. Every time the room was entered the space between the double

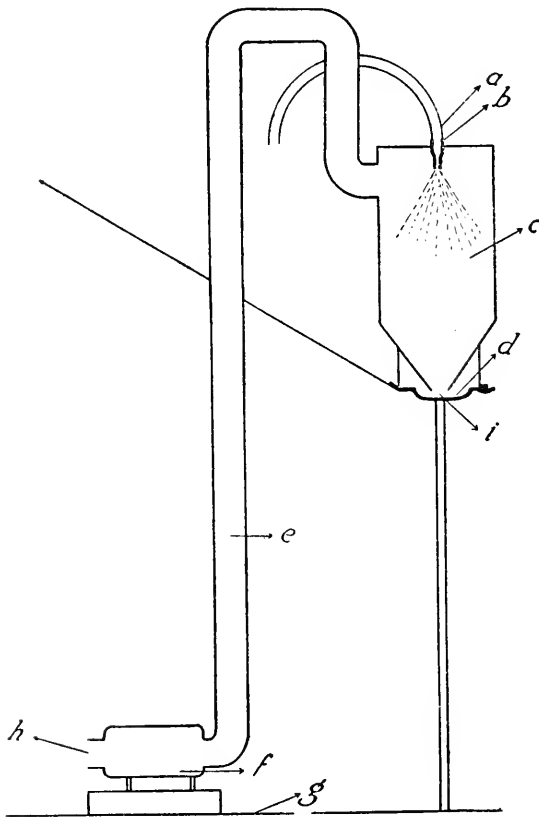

FIG. 1.—Diagram of air-washing apparatus for isolated room used for growing rust-infected seed: (a) Hose connection; (b) spray nozzle; (c) galvanized iron cylinder; (d) greenhouse gutter into which the water from spray drained; (e) connection pipe from cylinder to blower; (f) electric blower; (g) floor of greenhouse; (h) mouth of the blower where air entered the room; (i) air intake.

doors was thoroughly sprayed, and a rubber coat which was kept hanging in this antechamber was put on. Although wheat was grown in the adjacent houses and became badly infected with mildew (*Erysiphe graminis*) none appeared on that grown inside of the isolated room. Neither did any aphids, which were plentiful at various times in other rooms in the greenhouse, make their way into the isolated room.

The soil used in these experiments was in every case sterilized, and only boiled water was used for watering until after the lake from which the water supply was derived was frozen over.

Four different lots of rusted seed were grown at different times in this

house. Each lot was sown in flats 12 inches wide, 24 inches long, and 6 inches deep. These experiments will now be considered in the order in which they were performed.

EXPERIMENT 1.—Seed for this experiment was selected from lots of wheat obtained from the following sources: Four varieties of durum from the cereal-disease plots at Madison, Wis.; one lot of Marquis from Maynard, Iowa; one mixed lot of wheat from Leith, N. Dak.; one lot of durum from Brookings, S. Dak.; one mixed lot of unknown source from a

grain elevator in Minneapolis, Minn.; one lot of durum from Hagen, N. Dak.; and one mixed lot from Fargo, N. Dak. From all of these wheats rusted seed was selected and sown on November 8, 1915, in the isolated room. Seven hundred and six plants were obtained from this seed and grown to maturity. No rust appeared upon any of the plants at any time. On the primary leaf of two different plants lesions appeared from which cultures of *Helminthosporium* sp. were obtained. No other infection of any kind appeared upon any of these plants. Plate 41, B, shows three flats of plants from this experiment just after the plants were well headed.

EXPERIMENT 2.—Experiment 1 was carried on during the winter months, and it was thought advisable, therefore, to duplicate the work in the spring and sow the seed at the time spring wheat normally would be sown in the field. The same precautions were taken as in experiment 1, and the same room was used. Seed was secured from the following sources: Three lots of mixed seed of unknown source from Minneapolis, Minn.; two lots of mixed seed of unknown origin from Minneapolis, Minn.; three lots of durum from the rust nursery, University Farm, St. Paul, Minn.; one lot of durum from Clark, S. Dak.; two lots of durum from the cereal-disease plots at Madison, Wis.; one lot of Marquis from Maynard, Iowa; one lot of durum from Leith, S. Dak.; one lot of mixed seed from Armour, S. Dak. Rusted kernels from these sources were sown on March 19, 1916, and 730 plants emerged and were grown to maturity. No rust appeared on any of these plants at any time. The experiment was discontinued when the wheat became mature.

EXPERIMENT 3.—The experiment was repeated during the winter of 1916-17, when 760 plants were grown to maturity under the same conditions as outlined above. Seed for this experiment was obtained from various places in North and South Dakota and Minnesota. No rust appeared upon these plants at any time. The experiment was concluded when the plants were mature.

EXPERIMENT 4.—It was thought possible that soil temperatures at the time of the germination of the seed might affect the ability of the fungus to penetrate the young embryo and that the temperature in the isolated room might have been too high for successful infection at the time of germination. In order to simulate more closely natural conditions of germination and growth of the plants, infected wheat kernels were germinated in soil in an Altmann incubator at different temperatures as indicated in Table III.

When the seedlings were about 1½ inches long, they were carefully transferred to pots of sterilized soil and grown in the isolated room until the plants were mature. Twenty-five kernels of wheat were used for each temperature indicated. No rust appeared upon these plants at any time.

TABLE III.—Temperatures at which infected wheat kernels were germinated

Date of germination.	Number of plants	Temperatures.	Date of transfer to greenhouse.
Dec. 12, 1916	21	-2° C. alternated with 15° C.....	Dec. 30, 1916.
Do.....	20	7° C. alternated with 15° C.....	Dec. 26, 1916.
Do.....	20	12° C. continuously.....	Do.
Do.....	23	2° C. alternated with 21° C.....	Do.
Do.....	24	10° C. alternated with 18° C.....	Do.
Do.....	24	15° C. continuously.....	Do.

EXPERIMENT 5.—A number of writers have suggested the possibility of rust infection taking place from spores on the surface of the seed. To test this possibility, several flats of wheat were sown with seed that had been literally covered with viable urediniospores of stemrust. Preston wheat (C. I. No. 3081) was used for this experiment. In all, about 200 plants were grown. No rust infection appeared upon any of them at any time.

FIELD EXPERIMENTS

EXPERIMENT 1.—In the spring of 1916 rusted wheat from various sources was sown in the field along with clean seed and rusted seed treated with the modified hot-water treatment. These plots were examined every few days from the first appearance of rust infection. After June 27 the plants were examined every other day. Table IV gives the methods employed and results obtained in the experiment.

The groups of plots numbered 1 to 4, 5 to 9, 10 to 13, and 14 to 18 were grown in different locations on the University Farm at Madison, Wis.

Stemrust was noted upon *Hordeum jubatum* near two of the plots on July 3, 12 days before it appeared upon the wheat in these plots.¹ Infection also had been common upon adjacent barberries for some time previously. It will be noted that the plants grown from badly rusted samples of seed did not develop rust any earlier or any more severely than those grown from clean seed or from rusted seed which had been treated with the modified hot-water treatment.

Recently the writer has had opportunity to consult the notes on an unpublished experiment somewhat similar to field experiment No. 1, as described above. The work was done by E. C. Johnson, at that time Pathologist in Charge of Cereal Disease Investigations in the Bureau of Plant Industry, and carried on at the University Farm, St. Paul, Minn., in 1912. The experiment is described and results are given in Mr. Johnson's report, a copy of which is on file in the Office of Cereal Investigations, Department of Agriculture, Washington, D. C.

¹By inoculating wheat plants in the greenhouse this was found to be *Puccinia graminis tritici*.

TABLE IV.—Development of rusts on plants grown in the field from treated and untreated rust-infected seed and rust-free seed in 1916

Plot No.	Description of seed.	Date sown.	Treatment of seed.	Size of plots.	Date on which plants emerged.	Date on which plants headed.	Date of appearance of—		Abundance of infection by—			
							Leaf-rust.	Stem-rust.	Leaf-rust.		Stem-rust.	
									Date.	Per-cent- age.	Date.	Per-cent- age.
1	Marquis, many rusted pieces of glumes, some rust-tipped seed.	May 15	Untreated.	5 rows 10 feet long...	May 20	July 14	June 10	July 14	June 16	1+	July 25	5+
2	do.	do.	Treated.	do.	do.	do.	do.	do.	do.	1+	do.	5+
3	Durum wheat, 1 per cent infection of kernels.	do.	Untreated.	do.	do.	do.	June 12	July 18	do.	1-	do.	Trace.
4	do.	do.	Treated.	do.	do.	do.	June 10	July 15	do.	1	do.	5-
5	Same seed as No. 1.	May 23	Untreated.	5 rows 1 rod long.	May 28	July 20	June 12	do.	June 19	2	do.	3
6	Marquis (C. I. No. 3647), rust-free seed.	do.	do.	do.	do.	do.	do.	July 14	do.	2	do.	5
7	Mixed seed from very badly rusted field, 1 per cent seed infection.	do.	do.	do.	do.	do.	do.	July 15	do.	15	do.	10
8	do.	do.	do.	do.	do.	do.	do.	do.	do.	15	do.	10
9	Preston (C. I. No. 3087), rust-free seed.	do.	do.	do.	do.	do.	June 14	do.	do.	15	do.	6
10	Same as No. 7.	May 3	do.	6 feet by 15 rods.	May 9	July 22	June 6	do.	do.	5	do.	6
11	do.	do.	Treated.	do.	do.	do.	do.	do.	June 16	1	do.	25
12	Durum seed, 1 per cent infection.	do.	Untreated.	do.	do.	do.	do.	July 14	do.	1	do.	20
13	do.	do.	Treated.	do.	do.	do.	do.	July 15	do.	1	do.	20
14	Mixed seed, 1 per cent rusted kernels.	May 18	Untreated.	5 rows 25 feet long.	May 21	July 15	June 12	do.	do.	1	do.	20
15	do.	do.	Treated.	do.	do.	do.	do.	do.	June 20	1	do.	5
16	Same as No. 3.	do.	do.	do.	do.	do.	do.	do.	do.	7	do.	1
17	Same as No. 1.	do.	do.	do.	do.	do.	do.	July 15	do.	2	do.	5-
18	Same as No. 6.	do.	do.	do.	May 22	do.	do.	July 16	do.	3	do.	5-
								July 19 ^a		5		8-

^a Two sori appeared on one plant in this plot on this date.

Nine different varieties of wheat seed were sown, and the plants were examined for rust every four or five days. Leafrust appeared on all the plots on June 5, and stemrust appeared from July 17 to July 29. Johnson sums up the results as follows: Rusted durum, Fife, and Bluestem kernels produced plants showing no earlier or more severe development of rust than adjacent plants from clean, uninfected seed.

EXPERIMENT 2.—On April 12, 1916, rusted kernels of wheat were sown in separate flats in the greenhouse. About 25 kernels were used from each of the following varieties: Allora (C. I. No. 1698), Kubanka (C. I. No. 1440), and Marquis (C. I. No. 3641). These flats were transferred to the pathological garden May 11, and were at that time in the fifth or sixth leaf. They were headed about June 22, and stemrust did not develop upon them until July 13, when a few leaves of the Marquis wheat, which still remained green, bore sori of *Puccinia graminis*. It will be noted by reference to Table IV that this was about the date upon which stemrust developed upon wheat in the field plots and was indeed about the date when stemrust appeared upon all the wheat in the vicinity. The season was very backward, and rust did not make its appearance nearly so early as usual.

HISTOLOGY OF SEEDS AND SEEDLINGS

HISTOLOGY OF SEED.—The general appearance of the exterior of wheat kernels infected with stemrust has been previously described. In order to examine the interior of these kernels two methods were found to be fairly satisfactory: One, in which the grains of wheat were boiled in water and then sectioned on the freezing microtome; the other, a modification of the glycerin method described by Howard (13). This latter method was found to be satisfactory, and good sections of mature wheat kernels were obtained. After sectioning, Pianzeze stain was used with good results.

When sections of infected kernels were examined with a microscope it was found that not all the sori appeared upon the surface. In some instances the entire hilar region of the kernel was found to be filled with sori, of which from 1 to 12 were found in a single kernel. These sori often were found facing inward against the aleurone layer which was very much distorted by the pressure (Pl. 42). Other sori were found, nearly spherical in form, entirely embedded in the pericarp tissue. There seemed to be no regular arrangement, although the sori were often arranged in a circle around the hilum. This is what would be expected, for many of them undoubtedly were connected with infection on the rachilla before the kernel was broken away from the point of attachment. Plate 43 is a longitudinal section through the hilum of an infected kernel and shows the hilum nearly cut off by a large sorus, which probably was formed from several sori that had become confluent. Plate 44 is a cross

section of a mature wheat kernel with telia upon the ventral surface. Plate 45 is an enlarged portion of the same.

Internal rust sori of wheat kernels were noted and described also by Pritchard (22). More recently Colley (8) has listed 11 reports of internal rust sori upon various hosts. He concludes that these are rather common teratological phenomena having no especial morphological significance and can be expected to occur whenever the point at which the sorus begins to form is located beneath a layer of tissue which is too resistant for the sorus to break through. Plates 46 and 47 also show internal sori.

HISTOLOGY OF SEEDLINGS.—Rusted kernels of wheat were germinated under various conditions and for various lengths of time. These were fixed, sectioned, and examined for spread of infection from mycelium or spores embedded in the tissues. Various materials were used for fixing these young seedlings, but it was found that Juel's fixative penetrated the embryonic parts better than any other which was tried, although Fleming's medium fixative gave fairly satisfactory results. After sectioning, either triple stain with excess of Orange G or Pianezze stain was found to be satisfactory for differentiating host and fungus tissue.

Infected seed was germinated under the following conditions. Seed from lot 1 was germinated in compartments of an Altmann incubator kept at 2°, 12°, and 17° C., respectively. Part of these were fixed when the plumule was about ½ inch long, and the rest when the first leaf was just beginning to unfold. Seed from lot 2 was germinated in compartments of the Altmann incubator at temperatures of 2° alternated with 17° and 11° alternated with 21°. The experiments with lots 1 and 2 were conducted twice—once in November, 1915, and again in April, 1916, after the infected seed had been kept in a cool place over winter. Lot 3 was sown in pots which were placed in small chambers in the greenhouse where the soil temperature was kept between 11° and 15° by the use of ice. When the plants were about 3 or 4 inches tall they were fixed, and a portion of each was sectioned and examined. Lot 4 was germinated and buried out of doors in the ground at seeding time in the spring. The plants were treated as were those in lot 3.

Hundreds of sections were prepared from the material described above. In no case was there any positive evidence of spread of infection from the infected seed to the young plant.

Plates 46 and 47 illustrate this fact. Plate 46 represents a longitudinal section through a wheat embryo in a very early stage of development. There is no indication of any spread of rust mycelium from the sori seen in the infected hilar region at *x*. Plate 47 also represents a longitudinal section of a wheat embryo. In this case development has progressed considerably further than that shown on Plate 46. There is, however, absolutely not the slightest indication of spread of rust mycelium from the large sorus shown at *x*.

From all appearances the rust mycelium was dead in the sori of the germinated kernels shown in Plates 46 and 47. The same was true of the rust mycelium in wheat kernels that had been stored for some time. All such mycelium was devoid of normal protoplasmic content. This fact together with the apparent inability of this mycelium to spread to the developing seedling indicates clearly to the writer that this mycelium was dead. In fact, only in fresh kernels which were not fully matured were any living rust mycelia found. Numerous efforts were made also to germinate the teliospores found in sori upon the hilar portions of wheat kernels, but all were unsuccessful.

Hyphae of other organisms were present in abundance everywhere in the pericarp of many kernels and in some cases were found to penetrate the embryo. These hyphae were much larger and of an appearance different from the rust hyphae found at the base of the sori in the hilar portions of the kernels, as previously described. They penetrated directly through the cell walls of the host and broke down the cell structure to a much greater extent than rust infection was found to do. Plate 48 shows an oblique longitudinal section of a secondary root of a wheat seedling being invaded by this type of parasite. This was probably some species of *Helminthosporium*, for typical *Helminthosporium* spores were found on the germ end of the kernel from which this section was made. Mycelium of the same type was found in the root, stem, and sheath of a number of seedlings which were grown from kernels of wheat having a distinct browning of the hilar ends somewhat similar to the general appearance of rust-infected kernels. It seems not entirely unlikely, therefore, that the apparently similar mycelium referred to by Pritchard (21) may have been of this type, especially since he states that the mycelium he noted also was intracellular.

The writer did not find any "palmella-like" developments from the teliospores, as described by Pritchard. However, no seed over 1 year old was used, and since Pritchard used seed 5 years old this may to some extent account for the difference.

SUMMARY

(1) Uredinia and telia of *Puccinia graminis tritici* Erikss. and Henn. have been found embedded in the pericarp on the hilar end of kernels of wheat and sometimes along the ventral groove as far up as the middle of the kernel. Infected kernels have black hilar ends, and groups of telia appear as shining black specks under either the hand lens or the binocular microscope.

(2) Only a small percentage of infection was found by examination of the hundreds of samples of wheat from the crops of 1915 and 1916. A little over 1 per cent was the largest quantity found in any sample. The durum wheats were found most commonly infected.

(3) Infection undoubtedly spreads to the kernel from original infection on the rachis, rachilla, or glumes.

(4) The germinating power of the seed apparently is not impaired by this rust infection.

(5) When rusted kernels of wheat were sown in the field, no earlier or more severe rust infection occurred on the resulting plants than on those grown in adjacent plots which were sown either with clean seed or with rust-infected seed which had been treated with the modified hot-water treatment.

(6) More than 2,500 plants were grown from rusted seed in a specially constructed room in the pathological greenhouse at the University of Wisconsin, and no rust infection appeared upon any of them at any time. The conditions of growth of these plants were normal, and they produced plump grain.

(7) No spread of infection from the pericarp to the young plant was found by examination histologically, although infected seed were germinated under various conditions, simulating as nearly as possible natural conditions in the field.

(8) No infection appeared upon plants grown from seed which had been covered with viable urediniospores of stemrust before sowing.

(9) The results of the experimental work here reported indicate that stemrust is not transmitted from one wheat crop to the next by means of infected seed grain. Further, in the writer's judgment, the occurrence of stemrust sori in the pericarp of the caryopses of grains and grasses has no especial significance, but the infection spreads to these tissues just as it does from an infection point in any of the vegetative parts of the plant.

LITERATURE CITED

- (1) BEAUVERIE, Jean.
1913. FRÉQUENCE DES GERMES DE ROUILLE DANS L'INTÉRIEUR DES SEMENCES DE GRAMINÉES. *Compt. Rend. Acad. Sci. [Paris]*, t. 157, no. 18, p. 787-790.
- (2) ———
1914. LES GERMES DE ROUILLES DANS L'INTÉRIEUR DES SEMENCES DE GRAMINÉES. *In Rev. Gén. Bot.*, v. 25 (bis), p. 11-27, illus.
- (3) BLARINGHEM, T.
1914. SUR LA PROPAGATION DES ROUILLES DE CÉRÉALES EN SUEDE ET EN FRANCE. *Bul. Soc. Bot. France*, t. 61, no. 1/3, p. 86-94.
- (4) BOLLEY, H. L.
1898. EINIGE BEMERKUNGEN ÜBER DIE SYMBIOTISCHE MYKOPLASMATHEORIE BEI DEN GETREIDEROST. *In Centbl. Bakt. [etc.]*, Abt. 2, Bd. 4, p. 887-896, 1 fig.
- (5) ——— and PRITCHARD, F. J.
1906. RUST PROBLEMS; FACTS, OBSERVATIONS AND THEORIES. POSSIBLE MEANS OF CONTROL. *N. Dak. Agr. Exp. Sta. Bul.* 68, p. 607-672, 30 fig.
- (6) CARLETON, M. A.
1904. INVESTIGATIONS OF RUSTS. *U. S. Dept. Agr. Bur. Plant Indus. Bul.* 63, 32 p., 2 col. pl.

- (7) COBB, N. A.
1902. COMPARATIVE OBSERVATIONS ON THE BRUSH OF ABOUT FIFTY VARIETIES OF WHEAT. *In Agr. Gaz. N. S. Wales*, v. 13, no. 6, p. 647-649, 3 fig.
- (8) COLLEY, R. H.
1917. DISCOVERY OF INTERNAL TELIA PRODUCED BY SPECIES OF *CRO-NARTIUM*. *In Jour. Agr. Research*, v. 8, no. 9, p. 329-332, pl. 88. Literature cited, p. 332.
- (9) ERIKSSON, Jakob.
1897. DER HEUTIGE STAND DER GETREIDEROSTFRAGE. *In Ber. Deut. Bot. Gesell.*, Bd. 15, Heft 3, p. 183-194. Reprinted.
- (10) ——— and HENNING, Ernst.
1896. DIE GETREIDEROSTE ... 463 p., 5 fig., 13 col. pl. Stockholm. Literaturverzeichnis, p. 446-457.
- (11) GROVE, W. B.
1913. THE BRITISH RUST FUNGI ... 412 p., illus. Cambridge, [Eng.]. Bibliography, p. 393-397.
- (12) HAYMAN, J. M.
1907. RUST IN WHEAT. *In Rpt. Cawnpore Agr. Sta. United Prov. [India]*, 1907, p. 54-57.
- (13) HOWARD, B. J.
1903. SECTIONING OF WHEAT KERNELS. *In Jour. Appl. Micros. and Lab. Methods*, v. 6, no. 9, p. 2498-2499, 1 fig.
- (14) JACZEWSKI, A. von.
1910. STUDIEN ÜBER DAS VERHALTEN DES SCHWARZROSTES DES GETREIDES IN RUSSLAND. *In Ztschr. Pflanzenkrank.*, Bd. 20, Heft 6, p. 321-359, 8 fig.
- (15) JOHNSON, Edw. C.
1911. FLORET STERILITY OF WHEATS IN THE SOUTHWEST. *In Phytopathology*, v. 1, no. 1, p. 18-27.
- (16) KLEBAHN, H.
1899. EIN BEITRAG ZUR GETREIDEROSTFRAGE. *In Ztschr. Pflanzenkrank.*, Bd. 8, Heft 6, p. 321-342, illus., pl. 6.
- (17) LAGERHEIM, G.
1893. UEBER DAS VORKOMMEN VON EUROPÄISCHEN UREDINEEN AUF DER HOCHEBENE VON QUITO. *In Bot. Centbl.*, Bd. 54, No. 11, p. 324-327.
- (18) McALPINE, D.
1906. RUSTS OF AUSTRALIA ... 349 p., 5 pl. (partly col.) Melbourne. Literature, p. 213-221.
- (19) MADDIX, Frank.
1897. NOTES AND RESULTS ON AGRICULTURAL EXPERIMENTS CARRIED OUT UNDER THE AUSPICES OF THE COUNCIL OF AGRICULTURE OF TASMANIA, AT EASTFIELD, NEWNHAM. 90 p., illus. Launceston.
- (20) MASSEE, Geo.
1899. THE CEREAL RUST PROBLEM.—DOES ERIKSSON'S MYCOPLASMA EXIST IN NATURE? *In Nat. Sci.*, v. 15, no. 93, p. 337-346. References, p. 346.
- (21) PRITCHARD, Frederick J.
1911. A PRELIMINARY REPORT ON THE YEARLY ORIGIN AND DISSEMINATION OF PUCCINIA GRAMINIS. *In Bot. Gaz.*, v. 52, no. 3, p. 169-192, pl. 4. Literature cited, p. 190-192.
- (22) ———
1911. THE WINTERING OF PUCCINIA GRAMINIS TRITICI E. & H. AND THE INFECTION OF WHEAT THROUGH THE SEED. *In Phytopathology*, v. 1, no. 5, p. 150-154, 2 fig., pl. 22.

- (23) SMITH, W. G.
1885. CORN MILDEW. *In Gard. Chron.*, n. s. v. 24, no. 608, p. 245, fig. 53.
- (24) ———
1886. CORN MILDEW AND BARBERRY BLIGHT. *In Gard. Chron.*, n. s. v. 25, no. 636, p. 309-310, fig. 58-60.
- (25) WARD, H. Marshall.
1903. "ON THE HISTOLOGY OF UREDO DISPERSA, ERIKSS., AND THE 'MYCOPLASM' HYPOTHESIS." (Abstract.) *In Proc. Roy. Soc. London*, v. 71, no. 473, p. 353-354.
- (26) ZUKAL, Hugo.
1899. UNTERSUCHUNGEN ÜBER DIE ROSTPILZKRANKHEITEN DES GETREIDES IN OESTERREICH-UNGARN. (I. REIHE). *In Sitzber. K. Akad. Wiss. [Vienna], Math. Naturw. Kl., Abt. 1, Bd. 108, Heft 6/7, p. 543-562.*

PLATE 38

Heads of Kubanka durum wheat heavily infected with stemrust. Collected at Dickinson, N. Dak., in 1916.

(278)

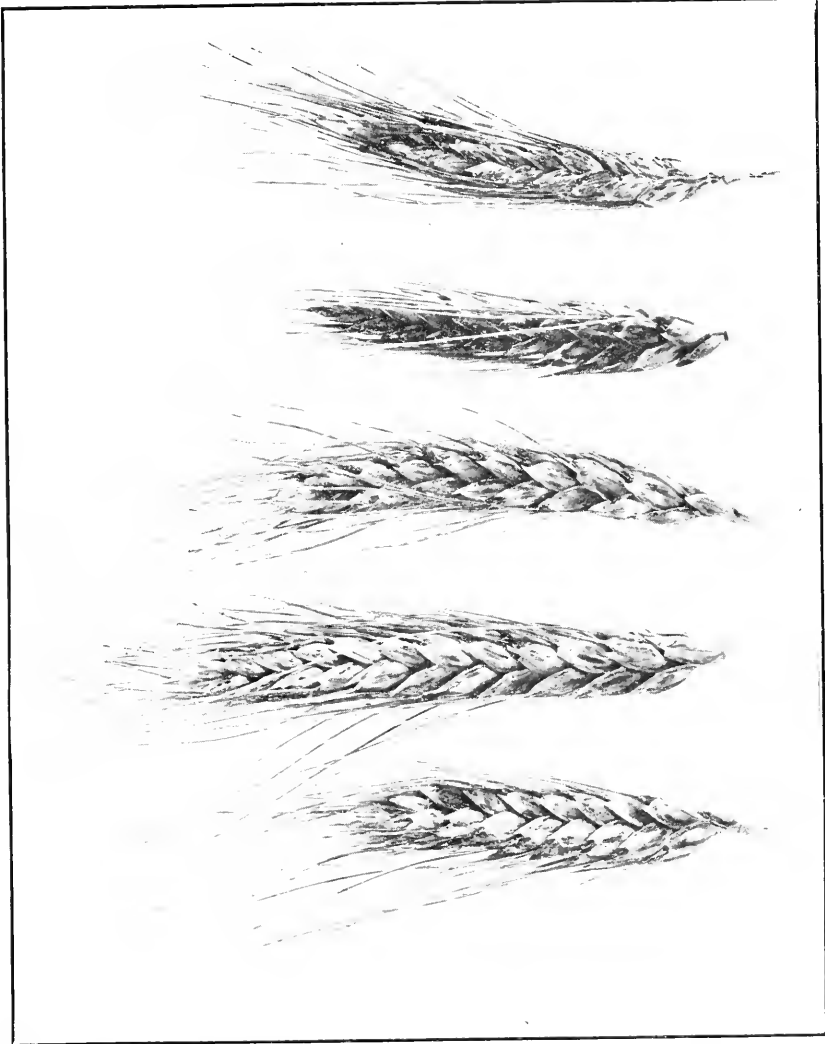

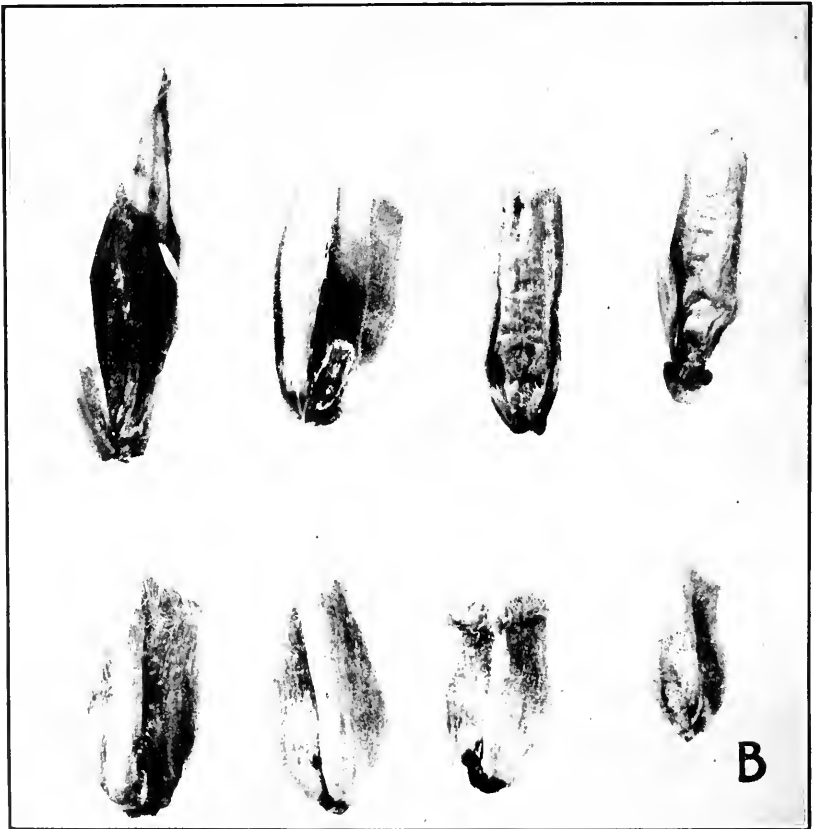
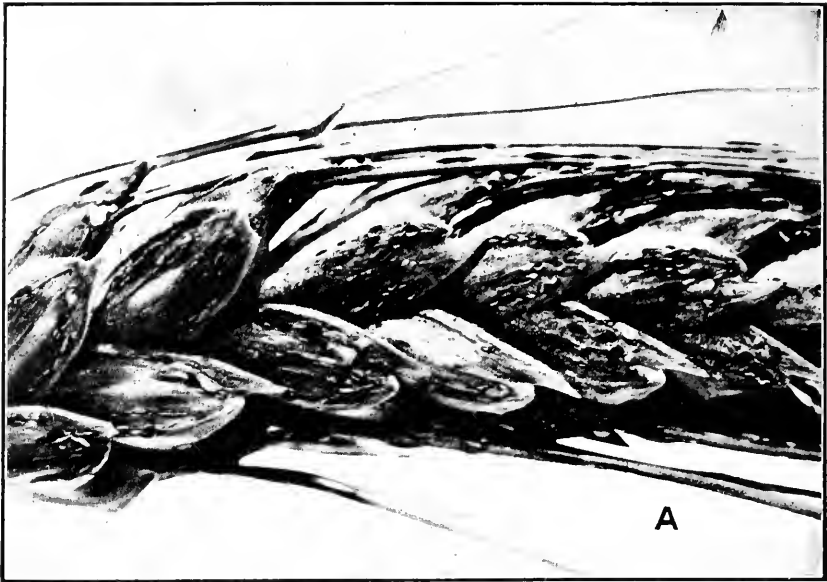

PLATE 39

A.—Portion of one of the heads shown in Plate 38. $\times 3.6$.

B.—Wheat kernels showing typical stemrust infection. Abundant infection occurs at the base of the attached paleae on the upper row of kernels. In the lower row rust sori occur at the hilar end and along the ventral groove. $\times 6$.

PLATE 40

Exterior view of isolated room in the pathological greenhouse at the University of Wisconsin, showing (*a*) the exterior portion of air-washing apparatus used to wash all air drawn into the room, (*b*) the canvas curtain used for shading on warm days, and (*c*) the sprinkling attachment used to throw spray of water over the roof to aid in keeping the room cool. (See fig. 1 and description of apparatus in text.)

A.—Greenhouse with canvas curtain rolled up.

B.—Greenhouse with canvas curtain rolled down.

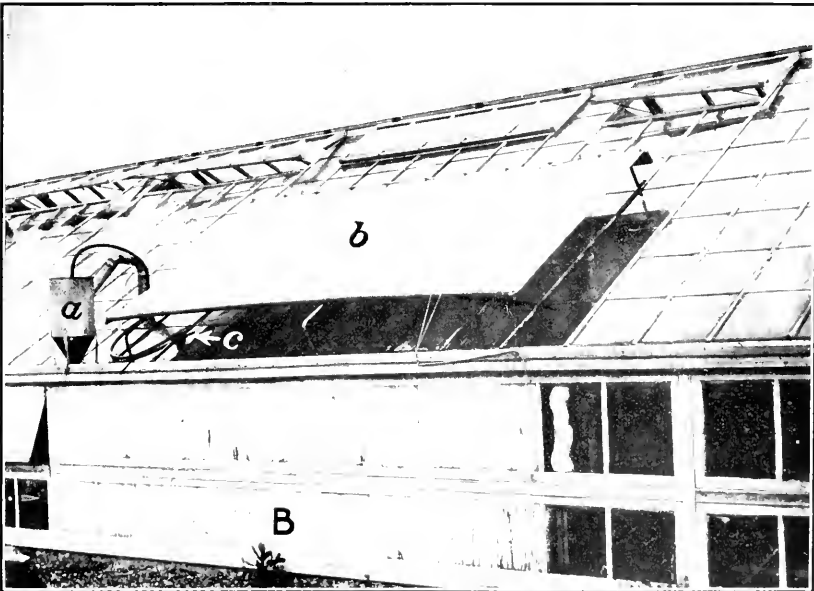
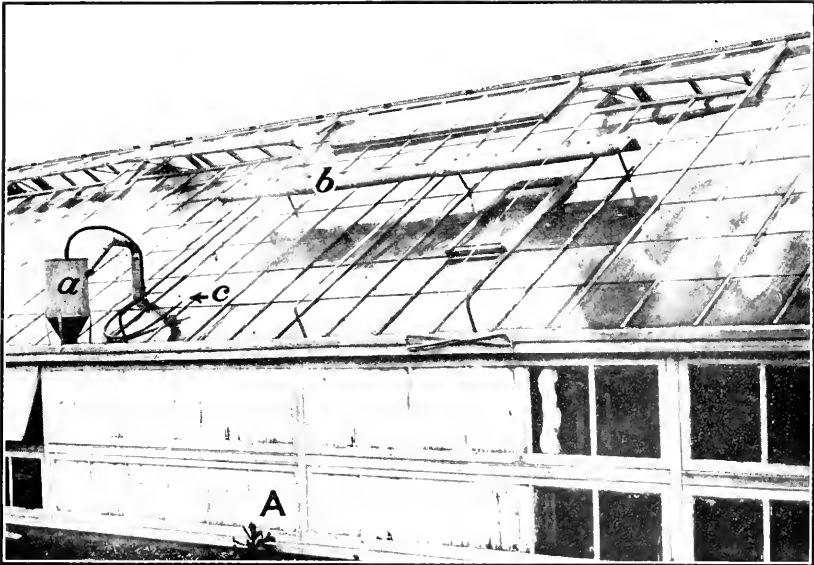



PLATE 41

A.—Photograph of wheat grown in flats in isolated room in greenhouse at the University of Wisconsin. The healthy, vigorous growth of the plants indicates that normal growing conditions prevailed in the greenhouse.

B.—Same plants as A, when well headed. Plump kernels of wheat were harvested from all these plants.

PLATE 42

Longitudinal section through hilar portion of an immature wheat kernel, showing sorus of stemrust. Abundance of living rust mycelium is shown at the base of the sorus. Note (at left) the aleurone layer which has been forced inward. No evidence of mycelial penetration into aleurone layer of cells. $\times 245$.



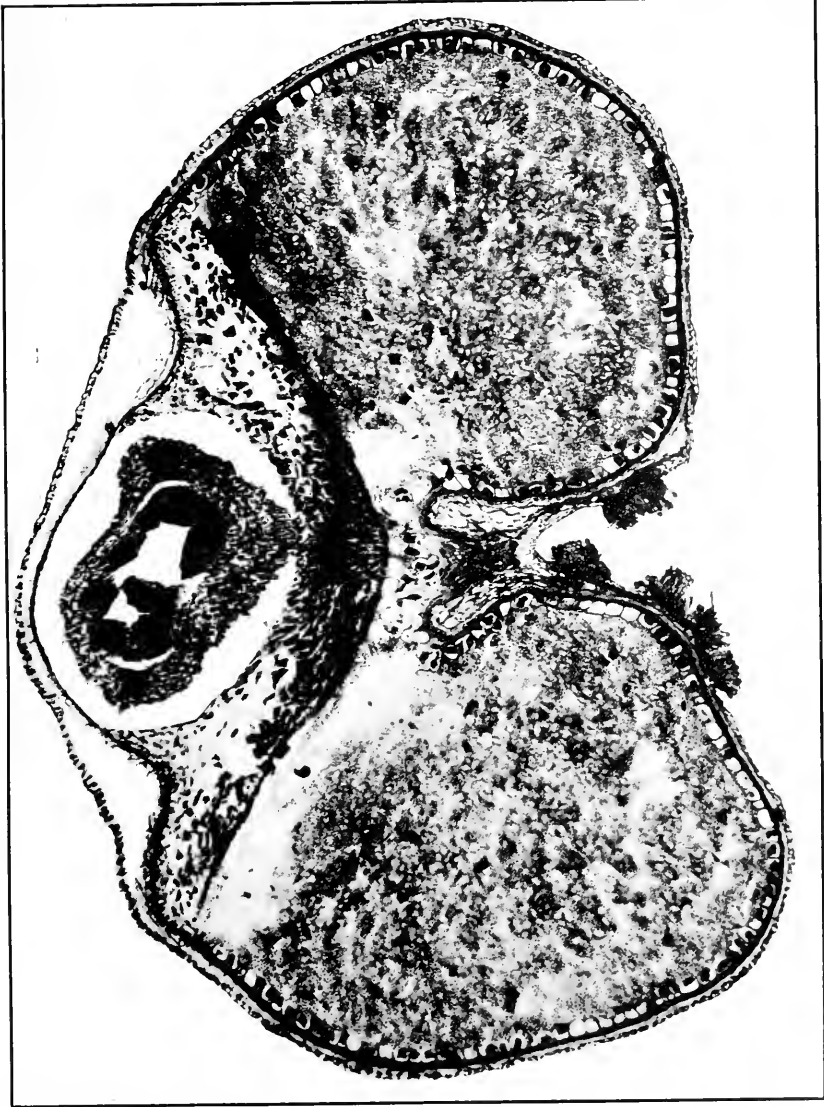

PLATE 43

Longitudinal section through the hilum of a wheat kernel infected with stemrust, showing unusually large internal sori extending nearly across the kernel. Both external and internal sori are shown. No evidence of invasion of aleurone cells was found. $\times 85$.

PLATE 44

Cross section of a mature wheat kernel infected with stemrust, showing telia in the ventral groove. Note the normal appearance of the cells of the aleurone layer immediately beneath the sori. $\times 50$.



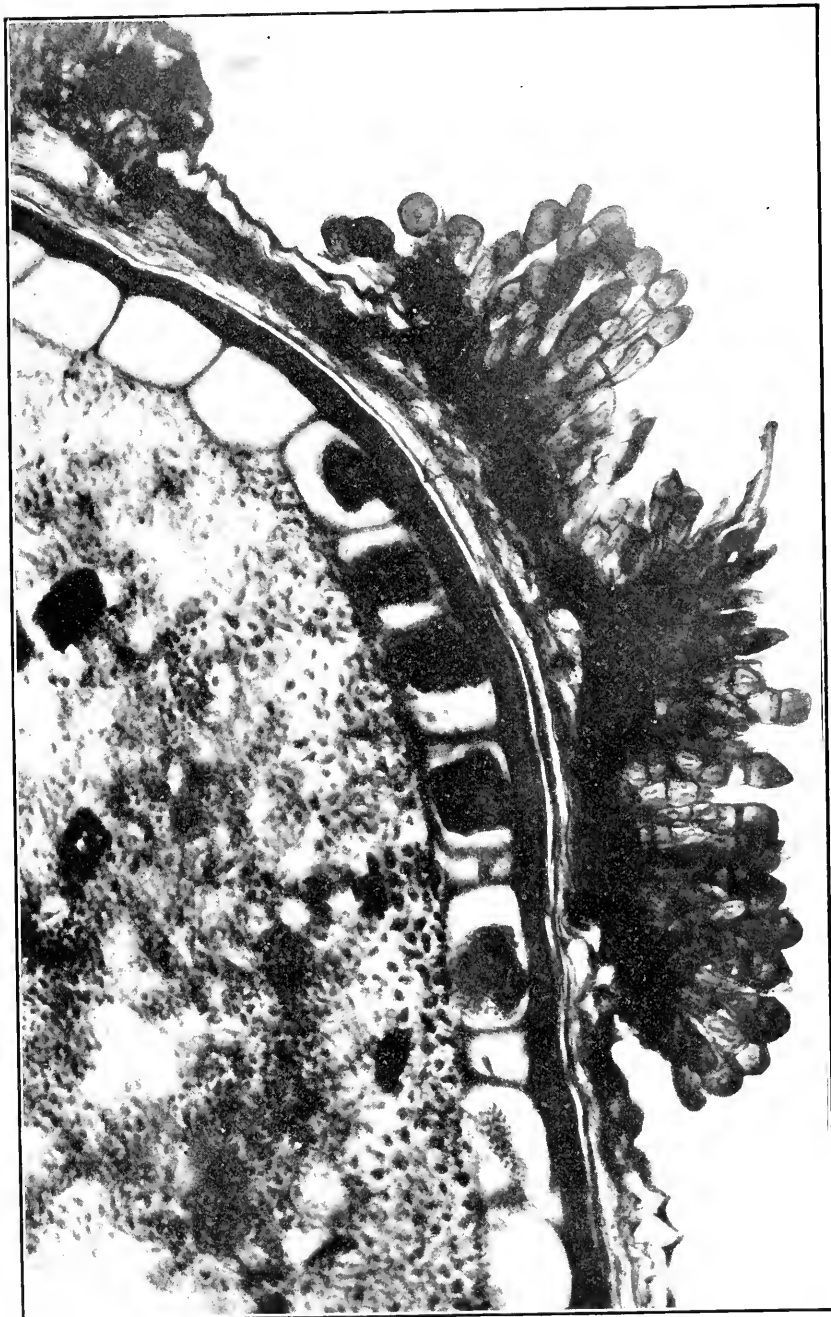

PLATE 45

Enlarged portion of section shown in Plate 44, showing telia on surface of ventral groove. No evidence of penetration into aleurone cells exists. $\times 278$.

PLATE 46

Longitudinal section of embryo of germinated wheat kernel showing large internal rust at *x* in hilar tissue at base of embryonic tissue. Hundreds of such sections were examined without evidence of spread of rust infection to the embryo. $\times 65$.





PLATE 47

Longitudinal section of the embryo further advanced in development than that shown in Plate 50. Internal hilar sorus shown at *x*. No evidence of infection of embryonic tissues. $\times 67$.

175344°—20—4

PLATE 48

Longitudinal section through young secondary root of wheat embryo, showing presence of intracellular mycelium. The fungus here is probably a species of *Helminthosporium*. This mycelium is larger and more vacuolated and breaks down the cells of the host much more completely than does the rust mycelium. (See Pl. 42 for comparison.) $\times 255$.



JOURNAL OF AGRICULTURAL RESEARCH

CONTENTS

Practical Universality of Field Heterogeneity as a Factor Influencing Plot Yields - - - - -	Page 279
--	-------------

J. ARTHUR HARRIS

(Contribution from Bureau of Plant Industry)

Transmission of the Mosaic Disease of Irish Potatoes -	315
--	-----

E. S. SCHULTZ and DONALD FOLSOM

(Contribution from Bureau of Plant Industry and
Maine Agricultural Experiment Station)

PUBLISHED BY AUTHORITY OF THE SECRETARY OF AGRICULTURE,
WITH THE COOPERATION OF THE ASSOCIATION OF
LAND-GRANT COLLEGES

WASHINGTON, D. C.

**EDITORIAL COMMITTEE OF THE
UNITED STATES DEPARTMENT OF AGRICULTURE AND
THE ASSOCIATION OF LAND-GRANT COLLEGES**

FOR THE DEPARTMENT

KARL F. KELLERMAN, CHAIRMAN

*Physiologist and Associate Chief, Bureau
of Plant Industry*

EDWIN W. ALLEN

Chief, Office of Experiment Stations

CHARLES L. MARLATT

*Entomologist and Assistant Chief, Bureau
of Entomology*

FOR THE ASSOCIATION

J. G. LIPMAN

*Dean, State College of Agriculture, and
Director, New Jersey Agricultural Experiment
Station, Rutgers College*

W. A. RILEY

*Entomologist and Chief, Division of Ento-
mology and Economic Zoology, Agricul-
tural Experiment Station of the University
of Minnesota*

R. L. WATTS

*Dean, School of Agriculture, and Director,
Agricultural Experiment Station, The
Pennsylvania State College*

All correspondence regarding articles from the Department of Agriculture should be addressed to Karl F. Kellerman, Journal of Agricultural Research, Washington, D. C.

All correspondence regarding articles from State Experiment Stations should be addressed to J. G. Lipman, New Jersey Agricultural Experiment Station, New Brunswick, N. J.

JOURNAL OF AGRICULTURAL RESEARCH

VOL. XIX

WASHINGTON, D. C., JULY 1, 1920

No. 7

PRACTICAL UNIVERSALITY OF FIELD HETEROGENEITY AS A FACTOR INFLUENCING PLOT YIELDS

By J. ARTHUR HARRIS

*Collaborator, Office of Western Irrigation Agriculture, Bureau of Plant Industry,
United States Department of Agriculture*

INTRODUCTION

With the development of a more intensive agriculture there must be a wider use and a progressive refinement of the method of plot tests in agronomic experimentation. Betterment of the method of plot tests must be sought along two lines, (1) the perfection of biological technic and (2) the more extensive use of the modern higher statistical methods in the analysis of the results.

In 1918 Mr. C. S. Scofield, in charge of the Office of Western Irrigation Agriculture, and Prof. E. C. Chilcott, in charge of the Office of Dry-Land Agriculture, asked the writer to undertake an investigation of the statistical phases of the problem of the accuracy of plot tests. The present paper deals with one aspect only of the general problem, that of the lack of uniformity of the experimental field. This is both the most potent cause of variation in plot yields and the chief difficulty in their interpretation.

Many of the careful writers on field experimentation have noted the existence of soil heterogeneity. Few have, however, sufficiently recognized and none have adequately emphasized the importance of this factor.

The problem of field heterogeneity is twofold. First, some measure of the amount of its influence upon crop yields must be obtained. Second, some means of avoiding or of correcting for its influence must, if possible, be secured.

An exact measure of the influence of field heterogeneity, and not merely a vague notion that it may influence experimental results, is the first and most fundamental step in the closer analysis of the factors determining the variability of plot yields. If the application of such a criterion to results obtained by practised agriculturalists from fields selected for their uniformity shows no evidence of heterogeneity, plot tests may be carried out along conventional lines with confidence that

with reasonable precautions reliable results will be obtained. If, on the other hand, the application of such a criterion shows a high degree of irregularity in fields selected for their uniformity by experienced agriculturalists, it is evident that very special precautions must be taken to obtain trustworthy results. Some quantitative measure, and some probable error of this measure, of the amount of irregularity of the soil of a field, as shown by actual capacity for crop production, and not merely a demonstration of its existence is, therefore, required.

The purpose of this paper is to show by the analysis of the actual yields of test plots reported by agricultural experts that the securing of fields suitable for a direct comparison of yields is, practically speaking, an impossibility. The results show that unless special precautions are taken irregularities in the field may have greater influence upon the numerical results of an experiment than the factors in crop production which the investigator is seeking to compare.

The results of this study may seem to be altogether negative—destructive rather than constructive. The unbiased student must, however, admit that a full evaluation of all the sources of error is an essential prerequisite to constructive work. Furthermore, large expenditures of public funds are being devoted to fertilizer tests, variety tests, and rotation experiments. It is preeminently worth while to ascertain to what extent results derived from methods now in use may be considered reliable.

Subsequent papers will treat other phases of the problem.

FORMULAE

A criterion of field homogeneity (or heterogeneity) to be of the greatest value should be universally applicable, be comparable from species to species, character to character, or experiment to experiment, and be easy to calculate.

In 1915 the suggestion was made (5)¹ that we may proceed as follows: Suppose a field divided into N small plots, all sown to the same variety of plants. Let p be the yield of an individual plot. The variability of p may be due purely and simply to chance, since the individuals of any variety are variable and the size of the plots is small, or it may be due in part to the diversity of conditions of the soil. If irregularities in the experimental field are so large as to influence the yield of areas larger than single plots,² they will tend to bring about a similarity of adjoining plots, some groups tending to yield higher than the average, others lower.

Now let the yields of these units be grouped into m larger plots, C_n , each of n contiguous ultimate units, p . The correlation between the

¹ Reference is made by number (italic) to "Literature cited," p. 313-314.

² Irregularities of soil influencing the plants of only a single small plot may in most work be left out of account, since they are of the kind to which differences between individuals are to a considerable extent due and are common to all the plots of a field.

p 's of the same combination plot, C_n , will furnish a measure (on the scale of 0 to ± 1) of the heterogeneity of the field as expressed in capacity for crop production. If this correlation be sensibly 0 (under conditions such that spurious correlation is not introduced), the irregularities of the field are not so great as to influence in the same direction the yields of neighboring small plots. As heterogeneity becomes greater the correlation will also increase. The value of the coefficient obtained will depend somewhat upon the nature of the characters measured, somewhat upon the species grown, somewhat upon the size of the ultimate and combination plots, and to some degree upon the form of the combination plots.

Knowledge of the values of the correlations to be expected must be obtained empirically.

Let S indicate summation for all the ultimate or combination plots of the field under consideration, as may be indicated by C_n or p . Let \bar{p} be the average yield of the ultimate plots and σ_p their variability, and let n be constant throughout the m combination plots. Using the formulae of an earlier memoir (3) in a notation which is as much simplified as possible for the special purposes of this discussion,

$$r_{p_1 p_2} = \frac{\{[S(C_n^2) - S(p^2)] / m[n(n-1)]\} - \bar{p}^2}{\sigma_p^2}.$$

This formula assumes the combination plots to be of uniform size—that is, to contain each the same number, n , of ultimate plots. It may be desirable or necessary to have some of the combination plots smaller than the others.

Such cases are frequently met in practical work. For example, the wheat field of Mercer and Hall is laid out in a 20 by 25 fold manner. This permits only 2 by 5, 4 by 5, or 5 by 5 combinations of the same size throughout. One of Montgomery's experiments with wheat covered an area of 16 by 14 plots which may be combined in only 2 by 2 or 4 by 2 fold groupings to obtain equal areas suitable for calculation. In each of these cases other groupings are desirable.

The formulae are quite applicable to such cases; the arithmetical routine is merely a little longer. The formula is as above, but \bar{p} and σ_p are obtained by a $(n-1)$ -fold weighting of the plots,¹ where n is the variable number of ultimate plots in the combination plot to which any p may be assigned—that is,

$$\bar{p} = S[(n-1)p] / S[n(n-1)],$$

$$\sigma_p^2 = \frac{S[(n-1)p^2]}{S[n(n-1)]} - \left(\frac{S[(n-1)p]}{S[n(n-1)]} \right)^2.$$

¹ That is, each ultimate plot is multiplied by the number less one of the plots in the combination plot to which it is assigned.

Ample illustration of the arithmetical routine has been given in the original paper.

The formulae employed assume the symmetry of the correlation surface. It has been shown elsewhere (4) that spurious values of the correlation coefficient may arise in such cases. Since both $\bar{p}_1\bar{p}_2$ and $\sigma_{p_1}\sigma_{p_2}$ take the maximum values when, because of the symmetry of the correlation surfaces, $\bar{p}_1=\bar{p}_2$, $\sigma_1=\sigma_2$, it is clear that the limiting value of the spurious correlation will be 0.

Thus it is possible that heterogeneity exists even when $r_{p_1p_2}=0$, but a field can not be considered homogeneous if $r_{p_1p_2}$ has a value which is statistically significant in comparison with its probable error.

Practically, little difficulty will arise from this source, and it can usually be easily avoided by the exercise of a little care in the selection of the proper grouping in doubtful cases.

According to the foregoing conception the relationship between the yield of associated plots is expressed on the universally comparable scale of r , ranging from 0 to ± 1 .

When symmetrical tables are used—that is, when each plot is used once as a first and once as a second member of the associated pair— $\bar{p}_1=\bar{p}_2$, $\sigma_{p_1}=\sigma_{p_2}$, and the regression slope is identical with the correlation coefficient.

Thus, if one ultimate plot, p_1 , of a combination plot be known, the most probable deviation of another plot will be $p_2-\bar{p}=(p_1-\bar{p})r$.

Concretely, if the yield of a first plot of a combination plot be 10 pounds above the average of the field as a whole and if the interplot correlation be $r_{p_1p_2}=0.60$, the most probable yield of a second plot will be 6 pounds above the average.

Similar reasoning applies throughout. Those who have difficulty in thinking in terms of correlation coefficients can most easily grasp the significance of the results by remembering that in this case the correlation coefficients multiplied by 100 gives the most probable percentage of deviation of the yield of an associated plot when the deviation of one plot of the group from the general average is known.

INFLUENCE OF SOIL HETEROGENEITY ON YIELD OF FIELD CROPS

In the paper in which these formulae were suggested it was shown that yield of straw and grain and the nitrogen content of wheat, yield of roots and tops of mangolds, and yield of timothy hay are markedly influenced by irregularities in the carefully selected fields upon which plot cultures have been carried out by agriculturalists.

We have now to ascertain whether this is a general phenomenon or whether it is merely a chance result of these particular cultures. The suggestion has been made that the latter is the case, that with the exercise of a little care uniform fields may be secured, and that substratum

heterogeneity was overemphasized as a factor influencing plot tests. This question can be answered only by actually determining the degree of heterogeneity existing in the fields which have passed the criticism of agricultural experts.

It will be conducive to brevity to have a definite system by which the arrangement of the plots in a field may be described. We shall consider the plots arranged as soldiers in ranks and files. The worker inspects the plot records of a field as recorded on a map or table. By ranks we understand the horizontal rows of plots, by files the vertical rows.

1.80	1.83	2.00	1.91	1.90	1.89	1.79	1.75	2.03	1.83	2.18	1.93	1.77	1.86
1.80	2.07	1.77	1.90	1.70	1.79	1.90	2.04	1.95	1.83	2.06	1.76	1.86	1.79
1.93	1.96	1.83	1.92	1.69	1.90	1.80	1.89	1.83	1.85	2.00	2.13	1.82	1.83
1.89	1.96	1.92	1.86	1.79	1.86	1.79	1.94	1.92	1.80	1.97	2.00	1.87	1.73
2.00	2.01	1.89	1.77	1.97	1.85	1.97	2.10	1.99	1.83	2.00	1.92	1.79	1.89
1.96	1.96	2.00	1.82	1.93	1.82	1.87	1.87	1.92	1.99	1.87	1.83	1.92	1.96
1.89	2.11	1.99	1.87	1.86	1.84	2.06	1.90	1.90	1.82	1.81	1.97	1.79	1.89
2.03	1.86	1.80	1.86	2.06	1.72	1.86	1.72	2.07	1.82	1.84	1.97	1.96	2.01
1.83	1.82	1.82	1.75	1.77	1.72	1.90	1.83	1.90	1.83	1.90	1.85	1.76	2.07
1.87	2.14	1.96	1.87	1.97	1.90	1.90	2.13	1.80	1.83	1.90	2.06	1.94	1.87
1.90	1.94	1.94	1.77	1.89	1.86	1.82	1.87	1.80	1.84	1.87	2.04	1.94	1.89
1.94	1.76	1.96	1.99	1.87	2.04	1.93	1.77	1.74	1.89	1.93	1.96	2.04	1.97
1.83	1.99	1.97	2.08	1.99	1.96	2.15	1.82	1.78	1.83	1.98	1.89	1.85	1.87
1.85	1.87	1.85	1.82	1.92	1.89	2.13	1.82	1.73	1.83	1.96	2.04	1.86	2.08
2.10	1.83	1.85	1.96	2.01	1.92	1.68	1.89	1.85	1.85	1.83	1.85	2.07	1.75
1.93	1.86	1.93	1.87	1.90	1.86	1.99	1.89	1.83	1.82	1.96	1.99	1.99	2.06

FIG. 1.—Montgomery's diagram of 5.5 by 5.5 foot plots of Turkey wheat, showing variations in the percentage of nitrogen in the grain.

Thus figure 1, showing the nitrogen content of wheat plots 5.5 by 5.5 feet given by Montgomery (17), may be considered made up of 16 ranks and 14 files.

In considering rearrangements or combinations of plots we shall refer to the ranks and then to the files—an order easily carried in mind by remembering the trite expression "rank and file." Thus in referring to a 2 by 5 fold combination we mean that two adjacent ranks and five adjacent files of plots were combined. Individual plots may be easily designated. Thus, the plot belonging to the sixth rank¹ and the fifth file in the nitrogen contents of wheat yields contained 1.93 per cent nitrogen.

¹ Ranks are numbered from the top of map, files from the left.

1.—MANGOLDS

The yields of 200 plots of mangolds studied by Mercer and Hall (15) may be grouped into combination plots in a 2 by 2 fold manner. When this is done, the correlation between the yields of associated plots has been shown¹ to be as follows:

For weight of roots, $r = 0.346 \pm 0.042$,² $r/E_r = 8.24$.

For weight of leaves, $r = .466 \pm .037$, $r/E_r = 12.5$.

Thus, if one plot of a combination plot is higher or lower than the general average by a given amount, an associated plot may be expected to deviate from the general average by 35 to 40 per cent of this amount.

2.—POTATOES

Lyon (14) gives the yield in pounds for each of six sections of a series of 34 rows of potatoes. This crop was harvested from "a piece of apparently uniform land." Each section was 72 feet 7 inches in length. The distance between rows was 34 inches.

Combining yields of rows and of sections of rows by twos, we reduce the field from a 34 by 6 fold to a 17 by 3 fold combination. The correlations between the sections of the rows is then found to be

$$r_{p_1 p_2} = 0.311 \pm 0.043, r/E_r = 7.30.$$

Yield of potatoes in this field is, therefore, markedly influenced by irregularities of soil conditions.

For data on a second test on the influence of field heterogeneity on the yield of potatoes we may avail ourselves of the valuable records of yields of individual hills reported by Stewart (19). Since these are recorded in quadruplets for the purpose of determining the influence of missing hills upon yield,³ it is not feasible to group them into plots. The influence of heterogeneity may be tested by determining the correlation between the yields of the plants of a quadruplet.⁴

¹ For original data see Mercer and Hall (15, p. 100); also Harris (5, p. 434-436).

² The probable errors have in all cases been computed on the basis of the actual, not of the weighted, number of ultimate plots as N .

³ The planting scheme adopted was

$$0 \quad a_1 \quad a'_1 \quad b'_1 \quad b_1 \quad 0 \quad a_2 \quad a'_2 \quad b'_2 \quad b_2 \quad 0 \quad a_3 \quad a'_3 \quad b'_3 \quad b_3 \quad \dots$$

where a and a' are the two halves of the same tuber and b and b' are two halves of another tuber. Thus halves a and b were grown adjoining missing hills and were subject to competition on one side only, whereas halves a' and b' were subject to competition from two adjacent plants.

⁴ Since a and a' are halves of the same tuber and b and b' are halves of another, the correlations $r_{aa'}$, $r_{bb'}$ might be due to a specific physiological influence of the characters of the tuber upon both plants developing from the corresponding half tubers rather than to an influence of differences in soil conditions. We have, therefore, determined the correlations between the plants occupying the same relative position in the quadruplet but derived from different parent tubers, that is r_{ab} , $r_{a'b'}$. Hence r_{ab} represents the correlation between the two outside tubers and $r_{a'b'}$ the correlation between the two inside tubers of the quadruplet. As a control on the results the correlations between one outside and one inside plant have been determined. These are $r_{ab'}$ and $r_{ba'}$.

The data given by Stewart are number of tubers and total weight of tubers per plant. These two characters permit the determinations of the average weight per tuber.

When all the pairs are omitted which have been omitted by Stewart¹ or have been designated as affected by leafroll, there remain 139 quadruplets. Determining the correlations between the yield of the two plants derived from different tubers but exposed to the same conditions for growth, we have the following correlations:

For number of tubers per hill—

$$r_{ab} = 0.318 \pm 0.051, r/E_r = 6.19.$$

$$r_{ab'} = .138 \pm .056, r/E_r = 2.46.$$

$$r_{a'b} = .230 \pm .054, r/E_r = 4.26.$$

$$r_{a'b'} = .220 \pm .054, r/E_r = 4.04.$$

For total weight of tubers per hill—

$$r_{ab} = 0.457 \pm 0.045, r/E_r = 10.10.$$

$$r_{ab'} = .312 \pm .052, r/E_r = 6.00.$$

$$r_{a'b} = .427 \pm .047, r/E_r = 9.09.$$

$$r_{a'b'} = .290 \pm .052, r/E_r = 5.53.$$

For average weight of tubers—

$$r_{ab} = 0.237 \pm 0.054, r/E_r = 4.39.$$

$$r_{ab'} = .104 \pm .057, r/E_r = 1.82.$$

$$r_{a'b} = .054 \pm .057, r/E_r = .95.$$

$$r_{a'b'} = .117 \pm .056, r/E_r = 2.07.$$

The correlations are positive throughout and generally statistically significant with regard to their probable errors. They show, therefore, that this experimental plot was heterogeneous to an extent that influenced in a very measurable degree the number of tubers, the total weight of tubers, and the average weight of tubers of neighboring hills. For all four measures of interdependence the coefficients are lowest for average weight of tubers and highest for total weight of tubers, while the correlations for number of tubers produced are intermediate in value.

The values of r_{ab} are consistently higher than those for $r_{a'b'}$, notwithstanding the fact that a' and b' are more closely associated than a and b . The measures of interrelationship between the yields of pairs of plants, one of which occupies an inside and the other an outside position in the quadruplet, are sometimes intermediate between r_{ab} and $r_{a'b'}$ and sometimes less than $r_{a'b'}$. On the assumption that the correlation is due solely to environmental influence one would expect the highest

¹ Records have been abstracted from Stewart's Table I. Prof. Stewart has kindly furnished some additional information in regard to certain entries in this table.

correlation between the most closely associated plants—that is $r_{a'b'} > r_{ab}$. Apparently the reverse condition, $r_{a'b'} < r_{ab}$, is due to some influence of the open space adjoining a and b , which allows the fuller development of those plants and in consequence renders them more representative of the extremely localized soil influences to which they are subjected.¹

III		II	
b	a	b	a
230	305	290	305
180	290	240	290
200	310	300	340
210	265	285	355
200	260	300	325
225	285	280	345
215	285	275	365
220	235	270	285
255	235	285	285
210	230	280	260
240	245	300	285
235	235	265	265
230	270	270	295
210	260	270	285
225	260	315	340
225	235	320	330
220	240	275	315
230	200	285	350
255	225	295	340
265	255	310	295
235	225	320	305
250	280	310	315
240	265	310	280

FIG. 12.—Diagram showing yield of alfalfa in first cutting, 1913, on the Huntley experimental tract. The yield is expressed in pounds per half plot.

cases been harvested in subplots of 0.085 acre when the division has been into halves, of 0.0567 acre when the division has been

3.—TIMOTHY HAY

The records of plot yields of timothy hay published by Holtmark and Larsen (8) have been shown elsewhere (5) to present a correlation between the yield of ultimate plots, combined in a 2 by 2 fold manner, of

$$r = 0.611 + 0.027, r/E_r = 22.4.$$

Clearly the field was highly heterogeneous.

4.—ALFALFA HAY

Records of the yields of a series of 46 plots on the Huntley Experiment Farm, Montana, may be used to test further the influence of heterogeneity on the yields of alfalfa hay. Data were kindly placed at my disposal by Mr. C. S. Scofield.

Alfalfa should be of especial interest in the present discussion since it is a deep-rooted perennial herb, whereas all other herbaceous crops investigated have been annuals, or at most biennials.

In field B of this experimental farm there are two series, II and III, each of 23 plots. The 46 plots form a solid block which has been planted each year to one crop just as if it were an ordinary field.

The two series of plots are separated from each other only by a temporary irrigation ditch. Each plot is $23\frac{1}{3}$ feet wide, 317 feet long, and contains approximately 0.17 acre. These plots have in certain

¹ Possibly competition between closely associated a' and b' plants tends to make the yield of one low when that of the other is high.

into thirds, and of 0.0425 acre when the division has been into quarters of plots.

In the spring of 1912 the whole field was uniformly seeded to alfalfa; only one crop was harvested, and yields were recorded for the entire

III				II			
b		a		b		a	
70	95	125	135	135	155	135	175
110	75	85	160	145	125	125	165
80	90	125	110	165	155	150	160
100	65	130	130	145	180	145	180
115	95	110	125	135	165	100	140
115	125	135	135	125	185	130	155
110	95	120	115	145	175	100	155
120	90	100	115	140	150	100	180
100	90	80	105	125	150	45	150
95	95	105	120	125	140	60	145
115	80	95	100	120	140	65	110
115	90	90	105	125	145	120	60
110	100	110	130	120	140	110	115
115	85	120	165	130	150	100	130
105	105	100	145	130	150	145	140
150	95	100	95	100	150	110	115
135	115	90	105	95	110	100	130
155	125	120	100	65	130	115	115
145	130	145	95	120	120	100	115
170	135	155	105	95	135	95	115
135	125	155	95	110	120	115	110
140	115	160	120	110	145	115	130
150	100	120	160	85	150	105	85

FIG. 3.—Diagram showing yield of alfalfa in second cutting, 1913, on the Huntley experimental tract. The yield is expressed in pounds per quarter plot.

plots only. In 1913 and 1914 three cuttings were made. The first cutting was harvested in half plots. The second cutting of 1913 and the first and second cuttings of 1914 were harvested in quarter plots. The

third cutting of 1913 was lost because of a heavy wind which mixed the plot yields at harvest time, so that it was impossible to secure

III				II			
b		a		b		a	
85	85	130	120	130	150	140	165
105	100	105	120	135	150	140	185
100	80	105	110	120	150	170	165
105	110	95	130	165	155	150	170
100	100	105	130	120	140	145	185
100	105	100	125	120	175	195	155
90	100	100	120	155	155	115	200
90	100	105	120	85	155	145	170
120	95	90	120	115	140	170	165
85	95	75	110	155	130	105	155
75	95	85	105	85	130	125	240
60	110	90	100	120	140	160	135
75	100	75	140	95	120	120	130
55	100	75	140	120	130	125	165
75	95	85	125	120	130	140	145
85	100	60	115	125	120	140	160
85	105	100	105	120	135	135	150
115	100	65	115	115	140	155	130
115	125	85	125	150	125	140	130
85	135	95	120	135	135	135	135
105	120	105	105	130	140	165	145
100	115	125	135	140	160	170	140
100	115	140	120	135	120	115	120

FIG. 4.—Diagram showing yield of alfalfa in first cutting, 1914, on the Huntley experimental tract. The yield is expressed in pounds per quarter plot.

accurate weights on any of the plots. The third cutting for 1914 was harvested in subplots one-third the size of the original plots.

The actual yield of these subdivisions is indicated in figure 2¹ for the first cutting and figure 3 for the second cutting in 1913 and in figure 4

¹ Diagrams are set in type instead of being drawn to scale.

for the first cutting, figure 5 for the second cutting, and figure 6 for the third cutting in 1914.

III				II			
b		a		b		a	
100	110	135	125	120	145	145	140
80	85	110	120	130	145	175	155
70	110	140	115	170	155	195	170
70	140	115	125	160	190	145	165
85	125	85	125	180	190	155	175
55	125	95	100	190	175	185	185
65	105	115	115	225	155	200	195
65	110	95	110	190	190	180	165
70	105	100	135	140	155	155	165
110	120	60	100	110	120	100	175
100	110	85	125	95	125	70	140
95	120	120	95	75	100	145	105
110	135	125	135	100	75	125	145
130	120	95	150	135	85	90	170
115	115	100	140	115	125	105	170
130	130	80	115	95	110	95	140
135	115	65	110	110	85	90	150
110	115	80	120	120	130	95	180
145	160	75	135	120	125	105	140
140	135	80	125	105	145	155	100
135	135	90	120	115	155	140	125
120	155	110	130	130	130	135	130
90	160	110	115	120	130	120	75

FIG. 5.—Diagram showing yield of alfalfa in second cutting, 1914, on the Huntley experimental tract. The yield is expressed in pounds per quarter plot.

For the yield of alfalfa on quarter plots for the second cutting in 1913 and the first and second cuttings for 1914 and in third plots for the third cutting for 1914 the correlations are

$$1913, \text{ second cutting, } r = 0.182 \pm 0.048, r/E_r = 3.79.$$

1914, first cutting, $r=0.432 \pm 0.040$, $r/E_r=10.7$.
 1914, second cutting, $r= .449 \pm .040$, $r/E_r=11.3$.
 1914, third cutting, $r= .311 \pm .052$, $r/E_r= 5.99$.

III			II		
x	y	z	x	y	z
230	190	225	160	240	180
220	170	130	220	220	165
215	150	130	200	205	190
175	150	115	205	190	215
175	155	125	205	220	170
155	155	105	175	160	175
190	130	125	160	175	165
155	145	115	170	165	165
170	105	110	160	155	160
140	120	100	150	120	180
155	90	140	95	160	145
125	125	120	125	165	155
210	100	125	145	160	150
175	140	110	180	165	140
155	145	155	180	195	165
140	115	155	165	185	125
150	125	155	170	170	120
115	120	150	170	150	135
160	150	165	150	165	150
140	165	140	150	165	160
155	155	155	165	195	150
150	175	170	175	160	185
185	150	140	90	155	135

FIG. 6.—Diagram showing yield of alfalfa in third cutting, 1914, on the Huntley experimental tract. The yield is expressed in pounds per third plot.

It will be noted that the results are in very close agreement indeed for 1914. The second cutting for 1913 differs significantly from the others, but no explanation can be suggested.

Grouping all yields in two comparable subplots, we find

1913, first cutting,	$r = 0.407 \pm 0.059$,	$r/E_r = 6.93$.
1913, second cutting,	$r = .343 \pm .062$,	$r/E_r = 5.52$.
1914, first cutting,	$r = .602 \pm .045$,	$r/E_r = 13.4$.
1914, second cutting,	$r = .657 \pm .040$,	$r/E_r = 16.4$.

We note that all the correlations are higher for a 2-fold division than for a 4-fold division. The coefficients for the second cutting of 1913 are again lower than the other values.

The foregoing results are based upon weightings of single cuttings only. It is now desirable to determine the correlations for yield of first and second cuttings combined.

If the combined yield be considered in quarter plots as ultimate units in 1914 we find

$$r = 0.517 \pm 0.036, r/E_r = 14.2.$$

Combining to obtain total yield in half plots in both 1913 and 1914, we have the following correlations between the yields of the two half plots:

$$\text{For 1913, } r = 0.387 \pm 0.060, r/E_r = 6.46.$$

$$\text{For 1914, } r = .709 \pm .035, r/E_r = 20.2.$$

5.—STRAW AND GRAIN IN WHEAT

The data of the Rothamsted wheat plots,¹ analyzed in an earlier paper (5, p. 436-440, 443-444), show the following correlations when the 500 plots are grouped in 2 by 2 fold manner for the first 22 files and in a 2 by 3 fold manner for the twenty-third to the twenty-fifth file:

$$\text{For yield of grain, } r = 0.336 \pm 0.027, r/E_r = 12.5.$$

$$\text{For yield of straw, } r = .483 \pm .023, r/E_r = 20.9.$$

6.—STRAW AND GRAIN IN RAGI, ELEUSINE CORACANA

Lehmann (12) has given a series of data derived from the yields of grain and straw of ragi cultivated on the dry-land tract of the Experimental Farm at Hebbel, near Bangalore, Mysore State. The plots used were of 1/10-acre area.

The land was previously owned by several raiyats who have naturally treated it somewhat differently in regard to manuring and cultivation. The various pieces used as garden lands are of course in much better condition than those used for ordinary dry crops. This causes considerable temporary differences to exist in some of the plots in addition to probably slight permanent differences. (12, 6th Rpt., p. 2.)

From these conditions one would expect a high degree of heterogeneity in the series of plots. The data permit the testing of the possibility of a decrease in heterogeneity due to uniformity of crop and treatment for three years.

¹ For data see Mercer and Hall (15, p. 110); also Map B of Harris (5).

These data are, furthermore, of particular interest since they consist of the records of yields for three successive years of the same crop on a series of unirrigated plots in a region where crop production is subject to many uncertainties because of inadequate rainfall.

Fortunately for our present purposes the meteorological conditions during the three years covered by this experiment were very different from year to year. The values of the most significant factor, the July to October rainfall, are given in Table I. This shows that the rainfall in 1906 was practically twice as heavy as in either of the other two years.¹

TABLE I.—Rainfall at Hebbel, near Bangalore, Mysore State, India

Month.	1905	1906	1907	Average of 10 years.
	<i>Inches.</i>	<i>Inches.</i>	<i>Inches.</i>	<i>Inches.</i>
July.....	1.77	7.09	4.17	3.04
August.....	6.75	9.98	1.50	4.32
September.....	1.47	5.50	5.66	8.14
October.....	5.76	8.51	.81	5.97
Total.....	15.75	31.08	12.14	21.47

Maps of the fields are given in the sixth annual report for 1904-1905. Further descriptive detail is given in the seventh, eighth, and ninth reports for 1905-1908. The yield of grain and straw in plots of 1/10 acre grown in 1905 is given in the seventh report. The eighth report gives detail of the crop of 1906 but does not contain the yields, which are summarized for the years 1905, 1906, and 1907 in Tables I and II of the ninth report.

Unfortunately the yields of a considerable number of the plots have had to be omitted from maps I and II of Lehmann's report. In combining in a 2 by 2 fold manner it is necessary either to disregard all combination plots in which there are not four ultimate plots or to weight properly in using those containing 2 or 3 plots only. The course followed has been to group the plots by fours and to determine the correlation by the formulae for a variable number of plots when all of the ultimate plots were not planted.

The following table shows the correlation between the yield of grain, of straw, and of grain and straw:

	1905	1906	1907
Grain.....	0.735 ± 0.031	0.138 ± 0.065	0.716 ± 0.032
Straw.....	.424 ± .055	.164 ± .065	.573 ± .045
Total yield.....	.415 ± .055	.145 ± .065	.636 ± .040

¹ A discussion of the growth of these crops in relation to the distribution of the rainfall appears in Lehmann's ninth report (12, p. 2-7).

The results are of unusual interest. In 1905 and 1907 the correlation between yields of grain are unusually high, falling only slightly below three-fourths of perfect correlation. The correlations for yields of straw and for both grain and straw are of medium value in those two years. In 1906, however, the correlations for all the characters are of a very low order; and any one of them taken alone might not be considered significant in comparison with its probable error, which has been calculated on the basis of 103 plots, the number actually involved in the calculations.

Apparently the unusual moisture conditions of 1906 tended to obliterate the differences in the field to which the individuality of adjoining plots was due.

That the unusual weather had a profound influence on the yield of the plots is shown by Table II, in which the means, standard deviations, and coefficients of variation for the yield of the individual plots are set forth.¹

TABLE II.—Means, standard deviations, and coefficients of variation for the yield of ragi at Hebbel, near Bangalore, Mysore State, India

[Yield expressed in pounds per 1/10-acre plot]

Year.	Grain.			Straw.			Total yield.		
	Mean.	Standard deviation.	Coefficient of variation.	Mean.	Standard deviation.	Coefficient of variation.	Mean.	Standard deviation.	Coefficient of variation.
1905.....	192.8	31.5	16.3	360.8	148.8	41.2	553.5	190.3	34.4
1906.....	136.6	47.1	34.5	191.6	82.0	42.8	328.1	127.4	38.8
1907.....	165.0	48.3	29.3	295.4	80.2	27.1	460.4	126.9	27.6

The means show that yield of both grain and straw was much lower in the abnormally wet year than in either of the others. The standard deviations are of course largely influenced by the actual magnitudes of the yields and are, in consequence, difficult of interpretation. The relative variabilities, as measured by the coefficients of variation, are more orderly. They show that for grain, straw, and total yield the variability of the individual plot yields is greater in the wet year.

Thus the influence of the wet season has not been to make the yield of all the plots alike. It has tended to decrease yield and to increase relative variability from plot to plot. But at the same time it has tended to screen certain factors which in drier years have a marked influence on the individuality of the plots.

Further analysis is not desirable without more detailed information concerning the plots. From the information at hand it seems quite

¹ These constants are obtained by weighting in an (n-1)-fold manner, since this was the method followed in obtaining the constants for the heterogeneity coefficient.

clear that the innate differences in different parts of the field do not in some seasons exert their full influence upon crop yield because of the weight of other factors. The practical conclusion to be drawn from this result is that an experimental field which might be demonstrated to be sensibly uniform for one crop plant or for one season might not prove to be so for another crop or in a different season.

7.—KHERSON OATS

Kiesselbach (10, 11) has given records of yield for 207 1/30-acre plots of Kherson oats. He says:

These plats were planted . . . upon a seemingly uniform field for the purpose of studying variation in plat yield as a source of experimental error. The entire field had been cropped uniformly to silage corn for a period of eight years. It had been plowed each year and was also plowed in preparation for the oats in 1916. The oats were drilled during two successive days in plats 16 rods by 66 inches . . . The plats were separated by a space of 16 inches between outside drill rows. A wide discard border of oats was grown around the outer edge of the field, so that all plats should have a similar exposure.

Love (13) has shown the existence of heterogeneity in this field.

Grouping the entries of Kiesselbach's Table 27 in a 3 by 1 fold manner the heterogeneity coefficient is found to be

$$r = 0.495 \pm 0.035, r/E_r = 14.$$

For data on a second test of the influence of heterogeneity on the yields of experimental plantings of oats we turn to a small experiment by Montgomery (17), who has given the yields of thrashed grain in grams from 100 consecutive rows of Kherson oats (17, p. 35, Table XIII) each 12.5 feet in length.

The plat chosen for this test was quite uniform and the appearance of the plat at harvest was very satisfactory.

Combining by twos, we find for the correlation between adjacent rows

$$r = 0.339 \pm 0.060, r/E_r = 5.65.$$

8.—GRAIN AND NITROGEN CONTENT IN WHEAT

Montgomery (17, p. 37, fig. 10) has given the yield of grain in grams on 224 blocks each 5.5 feet square. Combining in a 2 by 2 fold manner we deduce

$$r = 0.391 \pm 0.038, r/E_r = 10.2.$$

Again, Montgomery (17, p. 21-22, fig. 7) has given the values of nitrogen content from 224 Turkey wheat plots of the same size. These values are quoted in figure 1 of this paper. The correlation between the plots is found to be

$$r = 0.020 \pm 0.045, r/E_r = 0.44.$$

Finally, Montgomery (16) has given data for both yield of grain and nitrogen content on 224 plots of wheat grown at the University of Nebraska in 1911. The plot (77 by 88 feet) had been sown continuously to Turkey winter wheat for three years.

The plat was of about average uniformity and fertility.

When grouped in a 2 by 2 fold manner these plots of wheat have been shown (5, p. 440-441, map C) to give the following correlations:

For yield of grain, $r = 0.603 \pm 0.029, r/E_r = 21.$

For percentage of nitrogen, $r = .115 \pm .044, r/E_r = 2.59.$

Yield of grain per plot is clearly influenced by irregularities of the experimental field, notwithstanding the fact that the plots are only 5.5 by 5.5 feet in area. The correlation for percentage of nitrogen is not certainly significant.

9.—HOPS

Stockberger (20) has given a series of yields for 30 rows of hops which he believes to be quite typical of many thousands of acres in the Sacramento Valley in California. The yields of these rows cover the period of 1909 to 1914. Combining the rows by twos and determining the correlation between the yield of the adjacent rows of the 15 pairs for each of the years, we obtain the following constants:

Year.	Correlation.	$r/E_r.$
1909.....	0.444 ± 0.099	4.50
1910.....	.695 ± .064	10.91
1911.....	.061 ± .123	8.50
1912.....	.326 ± .110	2.97
1913.....	.606 ± .078	7.79
1914.....	.386 ± .105	3.69
Average.....	.419	5.06

Without exception the coefficients are positive in sign. In general they are fairly large and indicate a substantial degree of heterogeneity in this limited area. Probably the heterogeneity would have been shown to be greater had it been possible to work with yields from the sections of the long rows instead of with the rows as a whole.

10.—UNHUSKED RICE

Coombs and Grantham (2) give the yield in gantangs of a series of 54 square plots 1/2 by 1/2 chain in dimension.

These plots are arranged in 18 ranks and 3 files. They were harvested from a field of standing rice on which—

the crop was extremely regular, as judged before the cutting, and it had not been subjected to any attack of borer or any devastation of rats or birds.

The yields of the original plots are shown in figure 7. These may be combined in a 2 by 1 fold manner to give a correlation of

$$r = 0.344 \pm 0.081, r/E_r = 4.25.$$

These rice yields taken from a field described as "extremely regular" show that as a matter of fact the field is heterogeneous and that this irregularity influences in a measurable degree the yields of the plots.

13.6	12.0	11.4
14.6	14.0	12.2
14.8	14.4	12.0
13.0	12.4	12.8
15.0	12.0	12.0
13.4	13.8	14.0
14.2	12.2	13.0
14.0	12.0	12.8
14.0	12.0	13.4
14.0	14.0	12.4
15.0	14.0	12.6
14.8	14.0	12.4
14.0	14.0	12.0
14.4	13.6	12.4
12.6	13.0	12.0
12.2	14.0	12.8
11.6	12.0	11.8
12.4	14.0	12.4

FIG. 7.—Diagram showing yield of unhusked rice on Coombs and Grantham's 54 plots $\frac{1}{2}$ by $\frac{1}{2}$ chain square. The yield is expressed in gautangs per plot.

II.—EAR CORN

Smith (18) has published a series of corn yields for three years on plots of $\frac{1}{10}$ acre. The yields are given in his original paper. He has kindly supplied the map showing the relative positions of these plots, which are arranged thus:

101, 201, . . . , 601
 102, 202, . . . , 602

 120, 220, . . . , 620

Combining yields in a 2 by 1 fold manner, we find for the correlation between the yields of adjacent 1/10-acre plots

For 1895, $r = +0.830 \pm 0.019, r/E_r = 43.4.$

For 1896, $r = +.815 \pm .021, r/E_r = 39.6.$

For 1897, $r = +.606 \pm .039, r/E_r = 15.5.$

It is evident that the field was rather highly heterogeneous.

III				II			
b		a		b		a	
133	132	138	142	136	132	148	140
141	141	132	138	145	135	162	156
135	109	125	135	133	116	147	130
132	153	131	131	130	123	155	150
132	137	135	140	137	112	131	129
135	132	135	131	134	126	126	135
131	128	121	125	126	115	122	136
135	125	128	131	121	115	129	137
133	125	125	130	131	124	129	131
137	124	117	131	127	125	129	132
130	117	119	127	132	129	122	141
134	122	115	125	133	123	119	132
129	122	120	132	130	125	136	137
123	118	125	130	124	124	123	136
129	126	134	129	122	126	127	136
134	124	120	121	126	130	132	136
128	125	115	115	122	123	140	135
128	121	110	110	116	115	125	123
127	124	119	107	114	116	110	115
134	112	121	123	122	126	116	125
145	148	133	125	132	127	126	134
149	154	165	160	162	144	137	130
168	169	165	152	158	169	143	108

FIG. 8.—Diagram showing yield of ear corn, 1915, on the Huntley experimental tract. The yield is expressed in pounds per quarter plot.

For a second test of the influence of field heterogeneity on the yield of ear corn we turn to the Huntley data.

III				II			
b		a		b		a	
78	94	104	128	110	121	132	150
73	81	104	118	116	116	140	142
66	77	84	110	113	102	128	138
66	73	80	99	115	113	128	139
77	79	79	103	116	118	126	127
71	73	86	82	100	110	108	132
76	59	86	90	110	117	111	151
94	65	86	100	102	105	118	116
98	75	80	100	111	101	104	118
88	76	74	99	108	92	102	113
91	82	69	80	100	97	101	101
97	87	83	90	103	92	88	96
75	81	80	107	96	78	96	106
67	76	73	117	95	70	90	117
98	85	74	103	98	84	100	116
111	88	76	97	97	92	110	110
108	88	73	84	84	86	104	115
115	97	66	89	100	87	98	123
104	120	86	100	94	94	97	119
110	106	92	99	96	100	83	104
118	110	100	98	114	108	113	120
108	100	105	110	93	99	117	104
108	98	95	100	103	99	114	98

FIG. 9.—Diagram showing yield of ear corn, 1916, on the Huntley experimental tract. The yield is expressed in pounds per quarter plot.

In 1915 and 1916 corn was grown on the Huntley experimental plots, described above, and was harvested in quarter plots. The yields for the two series are shown in figure 8 for 1915 and in figure 9 for 1916. These records are of special interest in view of the fact that these are irrigated

fields, whereas the data provided by Smith are based on corn grown without irrigation.

Retaining the original division into quarter plots, we deduce for the correlation between the subplots

$$\text{For 1915, } r = 0.498 \pm 0.037, r/E_r = 13.4.$$

$$\text{For 1916, } r = .436 \pm .040, r/E_r = 10.8.$$

The results for the two years can not, with due regard to their probable errors, be considered to differ significantly. They indicate a degree of heterogeneity in these Huntley plots quite comparable with that of fields planted to various crops by other observers.

If the quarter plots be combined by adjacent twos and the correlation between the half plots be determined, we find

$$\text{For 1915, } r = 0.494 \pm 0.053, r/E_r = 9.29.$$

$$\text{For 1916, } r = .0431 \pm .057, r/E_r = 7.53.$$

The measure of heterogeneity has been only slightly lowered by dividing the plots into halves instead of into quarters.

INFLUENCE OF SUBSTRATUM HETEROGENEITY ON YIELD OF ORCHARD CROPS

In the preceding illustrations the crops considered have been herbaceous plants which are generally fairly superficial in their relation to the soil and most of which complete their development in one or two seasons. It seems of particular interest to extend the studies, as Batchelor and Reed (1) have done, to the yield of large individual plants, such as orchard trees.

For the purpose we employ the splendid series of data of Batchelor and Reed. They say of their various groves (1, p. 251):

The fruit plantations herein discussed, to judge by the surface soil, size, and condition of the trees, as well as their apparent fruitfulness, appeal to the observer as uncommonly uniform. All the orchards studied are situated in semiarid regions and are artificially irrigated during the summer months. This fact is believed to be a distinct advantage for the purpose of reducing the variability of one year's yield compared with another, since it insures a fairly uniform water supply for the soil and reduces one of the variants inevitable in nonirrigated localities.

In the case of the Arlington navel oranges grouped in 8-tree plots as the ultimate unit the authors (1, p. 264) report a correlation between plots of $r = 0.533 \pm 0.085$ when the plots are combined by fours.

It has seemed desirable to test the homogeneity of the soil in each of the orchards studied by them. In determining the following coefficients the individual tree has in each case been the ultimate unit.¹

Consider first the relationship between the yields of adjacent trees of two navel orange groves.

¹ Yields are reported in pounds per tree of ungraded product.

Grouping the yield of the 1,000 trees at Arlington, shown in figure 1 of Batchelor and Reed, in a 2 by 2 fold manner we find

$$r = 0.517 \pm 0.016, r/E_r = 33.1.$$

A navel orange grove of 495 trees at Antelope Heights, mapped as figure 2 by Batchelor and Reed, when combined in a 3 by 3 fold manner gives

$$r = 0.375 \pm 0.026, r/E_r = 14.4.$$

Grouping the 240 Valencia orange trees of the grove shown in figure 3 of Batchelor and Reed in a 2 by 2 fold manner, we find for the correlation between yields

$$r = 0.306 \pm 0.039, r/E_r = 7.75.$$

For the yield in pounds per tree of Eureka lemons as shown in figure 4 of the authors cited, we find for a 2 by 2 fold grouping

$$r = 0.448 \pm 0.028, r/E_r = 15.8.$$

This last result is of particular interest, since Batchelor and Reed say of this plantation—

This grove presents the most uniform appearance of any under consideration. The land is practically level, and the soil is apparently uniform in texture. The records show a grouping of several low-yielding trees; yet a field observation gives one the impression that the grove as a whole is remarkably uniform.

Notwithstanding this apparent homogeneity there is a heterogeneity coefficient of over 0.4.

Taking the yields of seedling walnuts in pounds per tree as given in figure 5 of Batchelor and Reed and grouping in a 2 by 2 fold manner, we find

$$r = 0.232 \pm 0.038, r/E_r = 6.09.$$

Finally, if the yields in pounds per tree of the Jonathan apple trees mapped by Batchelor and Reed in their figure 6 be treated in a 2 by 2 fold grouping, the coefficient is

$$r = 0.214 \pm 0.043, r/E_r = 4.97.$$

Without exception these groves show material values of the heterogeneity coefficients which are statistically significant in comparison with their probable errors throughout.

PHYSICAL AND CHEMICAL BASIS OF THE HETEROGENEITY OF EXPERIMENTAL FIELDS

In foregoing sections it has been shown that when tracts of land are judged by their capacity for crop production the yields are such as to indicate that heterogeneity is a practically universal characteristic of the

fields which may be used for fertilizer tests, variety trials, or any other experimental purpose involving plot yields. In the vast majority of cases the heterogeneity is so great as to leave open to question conclusions drawn from experiments not carried out with all biological precautions and interpreted with due regard to probable errors.

While the actual demonstration of differences in crop yields from one portion of the field to another is the result of final importance from the agronomic standpoint, and while it furnishes all but conclusive evidence that this heterogeneity in yield is due to irregularities in the soil itself, it seems desirable to show that such heterogeneity does actually obtain in the physical and chemical properties of the soil which are determining factors in plant growth.

The desirability of determining the extent to which heterogeneity, in the sense to which the term is used here, obtains in the physical and chemical properties of the soil of experimental fields is emphasized by the following sentences from one of the pioneer papers (21) on the variability of soil samples.

A number of papers have appeared dealing with the variation in the weight of the crop produced over different parts of an apparently uniform field. Such variations reflect the variability of the soil, serving simply as a substratum for the growth of plants, but it is evident that the variations between such measurements as those given do not depend upon the soil as the only variable factor.

At the outset we must recognize that many factors may determine differences in yield. Even if one could secure a tract initially uniform in soil and exposure it is not always possible to be sure that it has all been in the same crop in preceding years. Previous cultures may influence tilth and soil composition by organic remains, by infection with disease-producing organisms, or by differences in the demand of various crops for certain of the plant foods.¹ Such sources of heterogeneity are not readily detected by the eye or by physical or chemical analysis. Even if the experimenter secures a field of sensibly uniform texture, chemical composition, and previous cultural treatment, the uniformity may be readily destroyed in planting or tillage. Rain may interrupt the ploughing, thus exposing the soil of the different portions of the field to air and light for different lengths of time and affecting the physical condition very profoundly. Such sources of error are particularly great in the planting of large experiments. Thus the sources of field heterogeneity can never be fully determined in any case, although individual factors may be demonstrated.

To determine whether an experimental field is heterogeneous with respect to physical or chemical factors, actual measurements of these factors should be made over the field and the heterogeneity coefficient applied. As a first illustration we take a series of soil-moisture

¹ These are factors of particular importance in rotation experiments.

determinations uniformly distributed over a plot on a field at the San Antonio Experimental Farm of the Office of Western Irrigation Agriculture.

Hastings (6) has given a condensed account of the soil conditions of the San Antonio region. A map of the experimental farm by Hastings (7, p. 2) shows the location of field C₃ in which this plot of borings was located¹ and gives meteorological conditions prevailing in 1915, the year in which the borings were made.

Mr. C. S. Scofield kindly informs me that field C₃ had been uniformly treated for some time previously and was in apparently uniform condition. It is nearly level but with a gradual slope to the south and east.

The soil has the superficial appearance of uniformity, but we know from experience that the subsoil, which is usually characterized by a high lime content, is in some

1	2	3	4	5	6	7	8	9	10	11	12	13
14	15	16	17	18	19	20	21	22	23	24	25	26
27	28	29	30	31	32	33	34	35	36	37	38	39
40	41	42	43	44	45	46	47	48	49	50	51	52
53	54	55	56	57	58	59	60	61	62	63	64	65
66	67	68	69	70	71	72	73	74	75	76	77	78
79	80	81	82	83	84	85	86	87	88	89	90	91
92	93	94	95	96	97	98	99	100				

FIG. 10.—Diagram showing location of sample areas examined for soil moisture in a field at the San Antonio Experimental Farm.

places much closer to the surface than in others. However, from a general agronomic standpoint, this field would be regarded as extremely uniform, and observation of it during the growing season would tend to confirm this view.

Borings were made 6 feet in depth and were sampled at every foot.² Figure 10 shows the form of this field.

In order to reduce the 100 sample areas to 2 by 2 fold combinations we have discarded the right file and a portion of one rank, retaining only those which can be grouped into fours as indicated by the cross lines. The percentages of moisture content of these 100 sample areas appear in Table III.³

¹ The northern border of the sampled area is a line 60 feet south of the north line of the field and parallel to it.

² The samples were all taken between March 31 and April 9. During this period there was no rain. Between March 15 and April 10 there were only two rains, one on March 17 of 0.2 inch, the other on March 29 of 0.01 inch. Neither of these was sufficient to affect the soil moisture conditions, since in this region a precipitation of less than 0.25 inch scarcely penetrates the surface-soil mulch. Thus moisture changes during the course of the work can hardly influence the results.

³ The 12 sample areas which were omitted because of impossibility of combining by fours are starred (*).

TABLE III.—Moisture content of 100 sample areas of a field at the San Antonio Experimental Farm

[Expressed in percentages]

Sample area No.	First foot.	Second foot.	Third foot.	Fourth foot.	Fifth foot.	Sixth foot.
1	20.2	19.1	17.5	13.1	9.7	8.9
2	23.7	21.6	19.8	16.8	15.0	15.9
3	20.9	20.5	19.4	16.1	15.0	15.1
4	21.5	20.3	18.3	16.0	15.4	14.2
5	23.3	22.4	20.6	19.3	16.1	15.8
6	25.0	24.1	19.7	17.6	16.5	15.3
7	22.8	23.0	20.8	17.0	14.8	14.8
8	24.6	24.3	20.7	18.5	15.8	14.8
9	25.6	25.3	25.3	25.5	23.7	18.7
10	22.9	25.8	26.0	26.2	23.5	18.6
11	28.0	30.4	30.6	29.8	26.8	21.5
12	25.2	25.7	24.5	26.8	24.0	21.2
13*	22.1	22.0	20.1	20.1	16.0	14.9
14	20.2	19.7	17.0	14.5	11.4	9.1
15	22.1	21.3	18.1	14.6	13.8	12.7
16	25.1	21.2	20.0	16.3	15.5	14.1
17	21.8	21.0	19.2	16.6	15.1	14.9
18	23.4	22.4	20.0	16.1	15.7	15.4
19	20.5	20.8	19.6	15.6	13.5	12.5
20	24.0	22.0	19.5	15.1	11.5	9.4
21	20.4	20.7	18.7	13.0	8.1	8.2
22	24.3	24.0	21.0	23.7	21.3	15.2
23	21.3	22.2	21.8	21.7	20.5	16.7
24	24.3	25.7	24.0	22.4	18.3	14.9
25	23.6	23.2	24.4	24.5	22.2	18.4

TABLE III.—*Moisture content of 100 sample areas of a field at the San Antonio Experimental Farm—Continued*

[Expressed in percentages]

Sample area No.	First foot.	Second foot.	Third foot.	Fourth foot.	Fifth foot.	Sixth foot.
26*	24.2	23.7	23.0	20.7	19.1	17.8
27	21.1	19.7	18.7	14.7	14.5	17.7
28	21.2	19.6	18.4	17.6	15.2	15.0
29	21.2	20.5	19.6	18.9	17.5	17.1
30	22.9	22.0	19.9	17.5	15.0	14.8
31	21.0	20.7	19.6	16.2	14.0	16.4
32	23.4	21.6	19.3	18.6	16.8	15.9
33	22.2	21.8	20.1	16.6	14.0	14.1
34	23.9	22.7	20.4	17.0	14.6	14.2
35	21.6	20.9	19.2	16.8	15.3	16.3
36	21.4	21.6	20.6	20.0	18.4	16.8
37	25.3	25.6	25.6	24.9	22.2	17.9
38	26.7	29.2	27.0	25.9	23.0	19.1
39*	26.2	29.8	30.4	28.6	26.1	21.5
40	21.8	20.0	19.3	15.7	15.7	16.3
41	19.9	19.4	19.0	15.3	14.8	14.9
42	21.6	20.0	18.2	14.1	15.5	15.0
43	19.6	21.7	19.0	14.7	14.2	13.9
44	21.6	21.7	19.4	15.6	15.3	15.4
45	21.6	20.5	19.3	16.3	7.5	14.2
46	22.6	21.3	12.2	16.2	14.4	14.3
47	21.0	22.0	19.3	15.9	14.7	15.0
48	22.0	21.5	19.8	19.8	14.7	15.2
49	22.7	22.1	20.0	19.5	16.2	16.2
50	21.9	23.3	21.0	19.1	16.2	16.5

TABLE III.—*Moisture content of 100 sample areas of a field at the San Antonio Experimental Farm—Continued*

[Expressed in percentages]

Sample area No.	First foot.	Second foot.	Third foot.	Fourth foot.	Fifth foot.	Sixth foot.
51	20.0	20.3	19.0	17.6	15.7	17.2
52*	29.6	28.4	27.3	22.0	13.2	16.2
53	20.6	19.8	18.5	15.7	15.9	15.6
54	21.2	20.7	18.8	15.1	14.3	14.5
55	19.3	20.0	18.9	16.3	14.1	14.9
56	21.2	20.8	18.9	16.3	14.1	14.9
57	22.1	21.0	19.5	15.7	15.1	15.7
58	22.7	21.6	19.7	18.3	14.7	15.8
59	21.2	21.0	19.7	17.4	15.2	16.4
60	23.2	22.5	20.7	19.1	16.5	16.5
61	19.4	21.3	19.7	17.8	16.9	17.2
62	22.6	21.3	18.6	18.6	15.0	17.1
63	21.3	20.6	19.3	17.5	17.3	17.9
64	21.7	20.1	18.9	15.8	15.5	16.6
65*	22.5	21.0	20.2	16.7	17.0	20.8
66	20.6	21.2	17.9	17.1	15.8	15.0
67	18.9	19.2	18.2	15.0	14.4	15.0
68	23.4	14.5	19.0	17.7	15.5	15.5
69	21.2	20.4	18.8	17.0	14.0	13.9
70	21.4	20.1	18.4	17.0	15.8	16.0
71	21.0	21.1	18.9	15.6	14.5	15.3
72	22.8	21.4	20.0	16.5	15.5	14.3
73	21.9	21.6	20.2	16.2	14.4	17.9
74	22.8	21.8	20.3	18.0	15.5	17.9
75	21.3	22.8	22.1	21.6	17.7	15.1

TABLE III.—*Moisture content of 100 sample areas of a field at the San Antonio Experimental Farm—Continued*

[Expressed in percentages]

Sample area No.	First foot.	Second foot.	Third foot.	Fourth foot.	Fifth foot.	Sixth foot.
76	21.5	22.0	19.7	17.3	17.2	16.9
77	21.4	21.0	19.7	15.8	15.6	18.0
78*	22.4	21.0	19.2	17.0	16.2	15.6
79	18.5	18.8	18.4	17.0	15.2	15.1
80	20.3	19.6	18.5	15.2	15.0	15.8
81	20.3	20.2	18.8	16.5	14.6	15.5
82	21.5	21.7	18.6	15.8	14.8	14.1
83	20.0	20.4	18.7	15.7	16.3	15.4
84	20.3	20.0	18.9	17.5	14.7	14.7
85	22.4	21.8	21.4	17.1	15.9	14.8
86	23.2	22.0	19.6	16.0	15.7	15.0
87*	21.8	21.6	20.8	19.1	17.2	16.5
88*	23.7	21.8	20.2	16.4	16.9	16.4
89*	28.0	21.6	20.2	18.3	17.0	18.5
90*	23.2	21.7	19.1	16.3	16.3	16.6
91*	22.3	22.9	21.7	19.3	18.5	18.6
92	20.2	19.7	18.2	17.4	14.7	15.0
93	19.0	19.3	18.5	16.1	15.4	15.9
94	22.0	20.4	18.3	16.0	14.9	14.0
95	21.5	19.7	18.8	14.9	14.9	14.5
96	20.8	20.3	18.7	16.3	14.4	15.4
97	20.1	19.5	19.1	17.9	15.0	16.3
98	22.6	20.3	19.4	15.3	15.0	15.3
99	20.4	20.3	18.6	16.4	14.6	14.5
100*	22.0	21.6	19.4	17.5	16.3	15.0

To determine whether the distribution of soil moisture in these plots is such that it might bring about a correlation between the yields of adjacent plots due to heterogeneity in regard to this physical factor in

the field we have merely to determine the correlations between the percentages of water content of associated plots. These are

Depth.	Correlation.	$r/Er.$
First foot.	0.317 ± 0.065	4.9
Second foot.529 ± .052	10.2
Third foot.542 ± .051	10.7
Fourth foot.704 ± .036	19.4
Fifth foot.607 ± .045	13.4
Sixth foot.484 ± .055	8.8

The correlations are of a very substantial order, ranging from 0.317 to 0.704. Notwithstanding the fact that there are only 88 stations upon which the probable errors are based, the constants may in every case be considered significant in comparison with their probable errors.

Thus, notwithstanding the fact that we are dealing with a field only 150 by less than 264 feet,¹ there is a marked and statistically significant heterogeneity in respect to so important a factor in plant growth as soil moisture at each level in the upper 6 feet of soil.

This result seems of very real importance in its relation to the practical phases of plot-test work. It shows beyond all dispute that at least under soil conditions such as are found at the San Antonio Experimental Farm, substratum heterogeneity may be very great at levels of the soil which are ordinarily left entirely out of account in the selection of fields which are to be used for plot tests but which are not below the extensions of the roots of the deeper-penetrating crops and not too deep to serve as reserves of soil moisture for the higher layers of the soil in the case of crops which draw their water from more superficial levels.

It is of some interest to determine whether the correlations at one level in the field may be looked upon as sensibly higher than those at other levels. We have, therefore, determined the differences between the correlations at the different depths. These are given with their probable errors, and in relation to their probable errors, in Table IV.

In the table the positive signs indicate higher correlations at lower levels. Of the 10 possible comparisons between the correlations of the first 5 feet, all but one show greater heterogeneity at the lower levels. The sixth foot seems to be somewhat more homogeneous than the second to the fifth foot. A number of the differences are apparently significant in comparison with their probable errors. Thus there is apparently a real difference in the amount of heterogeneity of this field at different levels. Heterogeneity is least at the surface and greatest at a depth of 4 feet.

The significance of this result will perhaps be apparent at once. A field might be reasonably uniform for the surface foot of soil and hence

¹ The total length is 264 feet, but this is reduced by discarding the right file.

fairly well suited to the testing of shallow-rooted crops. Below this it might show a higher degree of heterogeneity. Possibly this heterogeneity of lower-lying strata is the explanation of the large correlations obtained for the yields of neighboring trees in groves planted on apparently uniform soil.

TABLE IV.—Differences and criteria of trustworthiness of differences in the correlation of adjacent plots in soil moisture determinations at various levels

Depth.	Second foot.		Third foot.		Fourth foot.		Fifth foot.		Sixth foot.	
	r .	r/Er .	r .	r/Er .	r .	r/Er .	r .	r/Er .	r .	r/Er .
First foot.....	+0.212 ± .083	2.56	+0.226 ± .082	2.74	+0.387 ± .074	5.22	+0.291 ± .079	3.68	+0.167 ± .085	1.97
Second foot.....			+ .013 ± .073	.18	+ .175 ± .063	2.76	+ .078 ± .069	1.14	- .045 ± .076	.60
Third foot.....					+ .161 ± .062	2.58	+ .065 ± .068	.96	- .059 ± .074	.79
Fourth foot.....							- .096 ± .058	1.66	- .220 ± .066	3.34
Fifth foot.....									- .124 ± .071	1.74

We can pursue this question of the relationship between the water content of the plots somewhat further. If the factors which determine the similarity in the moisture contents of the combination plots affect more than a single layer, we should expect a correlation between the contents of the first and second foot, and so on, in the same boring. The possible correlations have been worked out for the first foot and the remaining layers and are as follows:

Depth.	Correlation.	r/Er .
First and second feet.....	+0.748 ± 0.032	23.59
First and third feet.....	+ .669 ± .040	16.84
First and fourth feet.....	+ .648 ± .042	15.53
First and fifth feet.....	+ .578 ± .048	12.06
First and sixth feet.....	+ .353 ± .063	5.62

There is a statistically significant and even high correlation between the water content of successive levels in the same boring.

When we turn to the problem of chemical heterogeneity, we find that while a number of soil chemists have noted the desirability of considering the variability of the soil in taking samples, the available data suitable for testing the degree of heterogeneity of experimental fields are not extensive.

Kaserer's series of determinations (9) is not sufficiently large or properly distributed over the field to make desirable an attempt to measure heterogeneity. Fortunately Waynick and Sharp (22) have given four excellent series, two for nitrogen and two for carbon, derived from two California fields.

Their samples were taken over a total area of a little more than 1.3 acres on two fields of very different character—a silty clay loam at Davis and a blow sand at Oakley.

The fields were both selected for their apparent uniformity, both being nearly level with no change in the soil mass from one part of the field to another great enough to be detected by the usual field methods. Both fields were practically free from vegetation when selected, and before the samplings were made in March, 1918, all extraneous material had been carefully removed.

Altogether they took 80 samples distributed at 30-foot intervals over the entire area. These samples were arranged in an 8 by 10 fold manner. The original data are given in their Tables 3 and 4. Arranging these in the order of the map of the borings given in their figure 1 and combining in a 2 by 2 fold manner, we derive the following heterogeneity coefficients:

For the silty clay loam at Davis—

For carbon, $r = 0.417 \pm 0.063$, $r/E_r = 6.67$.

For nitrogen, $r = .498 \pm .057$, $r/E_r = 8.75$.

For the blow sand at Oakley—

For carbon, $r = 0.317 \pm 0.068$, $r/E_r = 4.65$.

For nitrogen, $r = .230 \pm .072$, $r/E_r = 3.20$.

All these values are statistically significant in comparison with their probable errors. Although the total number of samples is rather small, they indicate in each case a distinct heterogeneity for these important constituents of the soil. Apparently the two fields differ in their heterogeneity, the coefficients for both carbon and nitrogen being distinctly lower on the blow sand at Oakley than on the silty clay loam at Davis. The average carbon content at Oakley is only 0.444 as compared with 1.109 at Davis, while the nitrogen at Oakley is 0.033 as compared with 0.101 at Davis. Probably greater heterogeneity would be expected on general physical considerations on the silt loam than on the blow sand.

The analysis may profitably be carried one step farther. If these fields are heterogeneous in respect to the soil constituents here under consideration, one might anticipate a correlation between the carbon and the nitrogen content of the samples distributed over these fields. The results are

For the Davis loam, $r_{nc} = 0.785 \pm 0.029$, $r/E_r = 27$.

For the Oakley blow sand, $r_{nc} = .744 \pm .034$, $r/E_r = 22$.

Both constants are large. They show that the field is not merely heterogeneous but that portions which are high in nitrogen are high also in carbon and vice versa.

Waynick (21) has given a series of 81 determinations of nitrification in samples of soil drawn from a field on the University of California farm at Davis.

The field had been planted to corn in 1914, to Sudan grass in 1915, and to grain sorghum in 1916. In 1917 it had lain fallow and was without vegetation when the samples were taken October 20.

The particular area chosen was apparently as uniform as one could well find, being level, of uniform texture and color, and free from small local depression of any kind.

These samples were taken on eight radii of a circle 100 feet in diameter. The samples were separated by a radial distance of 5 feet. Disregarding the one central sample, we may group the remainder by twos in order to determine whether there is a correlation between adjacent samples. The coefficients thus obtained will, of course, not be comparable with those deduced for cases in which the yields or soil samples were uniformly distributed over the field. They will, however, serve to indicate whether or not this field is heterogeneous in the sense that differences prevailed sufficiently large to influence the properties of adjacent samples in a manner to make them more similar than pairs of samples taken at random over the field. His samples were drawn in two series—the first from the superficial 6 inches, the second from the deeper-lying level, 6 to 24 inches.

Waynick's Table 1 gives the residual nitrate in soil as sampled. From it we deduce

For the upper 6 inches, $r = 0.404 \pm 0.063$, $r/E_r = 6.4$.

For the subsoil, $r = .596 \pm .049$, $r/E_r = 12.2$.

Table 2 gives the nitrate produced from the soil's own nitrogen after 28 days' incubation. We deduce

For the upper 6 inches, $r = 0.065 \pm 0.075$, $r/E_r = 0.86$.

For the subsoil, $r = .059 \pm .075$, $r/E_r = .79$.

Table 3 shows the nitrate produced from 0.2 gm. of ammonium sulphate in 100 gm. of soil. The correlation coefficients are

For the upper 6 inches, $r = 0.298 \pm 0.069$, $r/E_r = 4.34$.

For the subsoil, $r = .351 \pm .066$, $r/E_r = 5.31$.

Finally, Table 4 shows the nitrate produced from 0.2 gm. of blood in 100 gm. of soil. The results in this case are

For the upper 6 inches, $r = 0.120 \pm 0.074$, $r/E_r = 1.62$.

For the subsoil, $r = .297 \pm .069$, $r/E_r = 4.32$.

The coefficients show that for both the upper and lower soil layers there is a correlation of about medium value between adjacent samples for the residual nitrate in the soil. These coefficients are unquestionably significant in comparison with their probable errors.

While the coefficients for nitrogen produced from soil nitrogen after incubation are both positive in sign, neither can be considered statistically trustworthy in comparison with its probable error. When nitrogen is added to the soil, in the form of either ammonium sulphate or of blood, the correlations between the nitrogen produced on incubation are larger. All are positive in sign, and three of the four may be reasonably considered statistically significant.

Thus it is clear that this plot, only 100 feet in diameter, shows distinct heterogeneity in residual nitrate and in the amount of nitrification occurring on incubation after the addition of nitrogen.

SUMMARY AND CONCLUSIONS

The purpose of this paper, which is one of a series on the statistical phases of the problem of plot tests, is to show the extent to which the heterogeneity of experimental fields may influence plot yields.

By heterogeneity we understand differences in capacity for crop production throughout the field of such a magnitude as to influence in like manner, but not necessarily to like degree, the yield of adjacent small plots. Thus, variability of plot yields does not necessarily indicate the heterogeneity of the fields upon which tests are made but may be due to other factors.

Heterogeneity is measured by a coefficient which shows the degree of correlations between the yields of associated ultimate plots, grouped in combination plots.

This coefficient has been determined for a relatively large series of experimental fields widely distributed throughout the world and planted to a considerable variety of crops, for which a number of different kinds of yields have been measured. The results show that in every field the irregularities of the substratum have been sufficient to influence, and often profoundly, the experimental results.

It might be objected that by chance, or otherwise, the illustrations are not typical of what ordinarily occurs in plot cultures. But the series considered practically exhaust the available data for such purposes. Furthermore the records are in large part drawn from the writings of those who are recognized authorities in agricultural experimentation and who have given their assurance of the suitability of the fields upon which the tests were made.

For example, Mercer and Hall (15) state the purpose of their research to be—

to estimate the variations in the yield of various sized plots of ordinary field crops which had been subjected to no special treatment and appeared to the eye sensibly uniform.

Their mangolds—

looked a uniform and fairly heavy crop for the season and soil,

while in their wheat field—

a very uniform area was selected.

The data of Larsen were drawn from an experiment—

auf einer dem Auge sehr gleichmassig erscheinenden, 3 Jahre alten Timotheegraswiese.

Montgomery's data were secured from a plot of land only 77 by 88 feet in size, which had been sown continuously to Turkey wheat for three years—

and was of about average uniformity and fertility.

Coombs and Grantham selected a field on which—

the crop was extremely regular as judged before the cutting and it had not been subjected to any attack of borer or any devastation of rats or birds.

Lyon's potato field was selected from—

a piece of apparently uniform land.

Mr. C. S. Scofield kindly informs us that the Huntley tract was selected for apparent uniformity and that prior to the calculation of the constants presented in this paper there was no reason, from general observation, to suspect irregularities in the field. Batchelor and Reed have assured me that their orchards are to all appearances uncommonly uniform. Kiesselbach emphasizes the apparent uniformity of his oat field.

Nothing could more emphasize the need of a scientific criterion for substratum homogeneity than the fact that correlations between the yields of adjacent plots ranging from $r = +0.020$ to $r = +0.830$ can be deduced from the data of fields which have passed the trained eyes of agricultural experimenters as satisfactorily uniform.

A second phase of this investigation has been to ascertain whether the physical or chemical requisites for plant growth are so distributed over experimental fields that they may be reasonably looked upon as the source of the demonstrated heterogeneity in yield.

The heterogeneity coefficients for percentage of water content for the upper 6 feet on the Experimental Farm of the Office of Western Irrigation Agriculture at San Antonio, Tex., range from $+0.32$ to $+0.70$ and are statistically significant for each of the 6 upper feet of soil. Heterogeneity is least at the surface and greatest at a depth of 4 feet. The surface layer of soil might, therefore, be apparently uniform in water content while underlying layers might differ greatly from one part of the field to another. This may be the explanation of the correlation between the yields of adjacent trees in groves planted in an apparently uniform locality.

Analysis of the data of Waynick and Sharp shows that there is a correlation of from $+0.23$ to $+0.50$ between adjacent borings for so important soil constituents as nitrogen and carbon. The correlation

between nitrogen content and carbon content of samples from two different soils is of the order $+ 0.75$.

It is interesting to note that these coefficients for water content and for chemical composition of the soil are of about the same order as those found for crop yields. While these results do not prove that the heterogeneity of experimental fields in their capacity for crop production is directly due to these and other physical and chemical factors, there can be little doubt that this is actually the case.

The references here made to the existence of significant heterogeneity in fields passed by agricultural experts as satisfactorily uniform must not be interpreted as a criticism of the work of these investigators. There is, indeed, every evidence of care and thoroughness. The result merely illustrates the inadequacy of personal judgment concerning the uniformity in physical characters or in crop-producing capacity of fields under consideration for experimental work.

The demonstration that the fields upon which plot tests have been carried out in the past are practically without exception so heterogeneous as to influence profoundly the yields of the plots emphasizes the necessity for greater care in agronomic technic and more extensive use of the statistical method in the analysis of the data of plot trials if they are to be of value in the solution of agricultural problems.

To other phases of the problem we shall return in subsequent papers.

LITERATURE CITED

- (1) BATCHELOR, I. D., and REED, H. S.
1918. RELATIONSHIP OF THE VARIABILITY OF YIELDS OF FRUIT TREES TO THE ACCURACY OF FIELD TRIALS. *In Jour. Agr. Research*, v. 12, no. 5, p. 245-283, 11 fig. Literature cited, p. 282-283.
- (2) COOMBS, G. E., and GRANTHAM, J.
1916. FIELD EXPERIMENTS AND THE INTERPRETATION OF THEIR RESULTS. *In Agr. Bul. Fed. Malay States*, v. 4, no. 7, p. 206-216, 1 fig.
- (3) HARRIS, J. Arthur.
1913. ON THE CALCULATION OF INTRA-CLASS AND INTER-CLASS COEFFICIENTS OF CORRELATION FROM CLASS MOMENTS WHEN THE NUMBER OF POSSIBLE COMBINATIONS IS LARGE. *In Biometrika*, v. 9, pt. 3/4, p. 446-472.
- (4) ———
1914. ON SPURIOUS VALUES OF INTRA-CLASS CORRELATION COEFFICIENTS ARISING FROM DISORDERLY DIFFERENTIATION WITHIN THE CLASSES. *In Biometrika*, v. 10, pt. 2/3, p. 412-416.
- (5) ———
1915. ON A CRITERION OF SUBSTRATUM HOMOGENEITY (OR HETEROGENEITY) IN FIELD EXPERIMENTS. *In Amer. Nat.*, v. 49, no. 583, p. 430-454.
- (6) HASTINGS, S. H.
1916. THE WORK OF THE SAN ANTONIO EXPERIMENT FARM IN 1915. U. S. Dept. Agr. Bur. Plant Indus. West. Irrig. Agr. 10 (Misc. Pub.), 17 p., 1 fig.
- (7) ——— and BLAIR, R. E.
1915. HORTICULTURAL EXPERIMENTS AT THE SAN ANTONIO FIELD STATION, SOUTHERN TEXAS. U. S. Dept. Agr. Bul. 162, 26 p., 8 fig.

- (8) HOLTSMARK, G., and LARSEN, B. R.
1906. ÜBER DIE FEHLER, WELCHE BEI FELDVERSUCHEN DURCH DIE UNGLEICHARTIGKEIT DES BODENS BEDINGT WERDEN. *In Landw. Vers. Stat.*, Bd. 65, Heft 1/2, p. 1-22.
- (9) KASERER, Hermann.
1910. BEITRAG ZUR FRAGE DER FESTELLUNG DES NÄHRSTOFFGEHALTES EINER ACKERPARZELLE. *In Ztschr. Landw. Versuchsw. Oesterr.*, Jahrg. 13, Heft 8, p. 742-747, 1 fig.
- (10) KIESSELBACH, T. A.
1918. STUDIES CONCERNING THE ELIMINATION OF EXPERIMENTAL ERROR IN COMPARATIVE CROP TESTS. *Nebr. Agr. Exp. Sta. Research Bul.* 13, 95 p., 20 fig.
- (11) ———
1919. EXPERIMENTAL ERROR IN FIELD TRIALS. *In Jour. Amer. Soc. Agron.*, v. 11, no. 6, p. 235-241.
- (12) LEHMANN, A.
1901-1909. SECOND TO NINTH ANNUAL REPORTS OF THE AGRICULTURAL CHEMIST. Department of agriculture, Mysore State [India]. 1900/01-1907/08.
- (13) LOVE, H. H.
1919. THE EXPERIMENTAL ERROR IN FIELD TRIALS. *In Jour. Amer. Soc. Agron.*, v. 11, no. 5, p. 212-216.
- (14) LYON, T. L.
1912. SOME EXPERIMENTS TO ESTIMATE ERROR IN FIELD PLAT TESTS. *In Proc. Amer. Soc. Agron.*, v. 3, p. 89-114, 5 fig.
- (15) MERCER, W. B., and HALL, A. D.
1911. THE EXPERIMENTAL ERROR OF FIELD TRIALS. *In Jour. Agr. Sci.*, v. 4, pt. 2, p. 107-132, 10 fig.
- (16) MONTGOMERY, E. G.
1912. VARIATION IN YIELD AND METHOD OF ARRANGING PLOTS TO SECURE COMPARATIVE RESULTS. *In Nebr. Agr. Sta. 25th Ann. Rpt.*, [1911]/12, p. 164-180, 4 fig.
- (17) ———
1913. EXPERIMENTS IN WHEAT BREEDING: EXPERIMENTAL ERROR IN THE NURSERY AND VARIATION IN NITROGEN AND YIELD. U. S. Dept. Agr. Bur. Plant Indus. Bul. 269, 61 p., 22 fig., 4 pl.
- (18) SMITH, Louie H.
1910. PLOT ARRANGEMENT FOR VARIETY EXPERIMENTS WITH CORN. *In Proc. Amer. Soc. Agron.*, v. 1, 1907/09, p. 84-89.
- (19) STEWART, F. C.
1919. MISSING HILLS IN POTATO FIELDS: THEIR EFFECT UPON THE YIELD. N. Y. Agr. Exp. Sta. Bul. 459, p. 45-69, 3 fig.
- (20) STOCKBERGER, W. W.
1916. RELATIVE PRECISION OF FORMULAE FOR CALCULATING NORMAL PLOT YIELDS. *In Jour. Amer. Soc. Agron.*, v. 8, no. 3, p. 167-175.
- (21) WAYNICK, D. D.
1918. VARIABILITY IN SOILS AND ITS SIGNIFICANCE TO PAST AND FUTURE SOIL INVESTIGATIONS. I. A STATISTICAL STUDY OF NITRIFICATION IN SOILS. *Univ. Cal. Pub. Agr. Sci.*, v. 3, no. 9, p. 243-270, 2 fig.
- (22) ——— and SHARP, L. T.
1919. VARIABILITY IN SOILS AND ITS SIGNIFICANCE TO PAST AND FUTURE SOIL INVESTIGATIONS. II. VARIATIONS IN NITROGEN AND CARBON IN FIELD SOILS AND THEIR RELATION TO THE ACCURACY OF FIELD TRIALS. *Univ. Cal. Pub. Agr. Sci.*, v. 4, no. 5, p. 121-139, 1 fig.

TRANSMISSION OF THE MOSAIC DISEASE OF IRISH POTATOES¹

By E. S. SCHULTZ, *Pathologist, Office of Cotton, Truck, and Forage Crop Disease Investigations, Bureau of Plant Industry, United States Department of Agriculture*, and DONALD FOLSOM, *Assistant Plant Pathologist, Maine Agricultural Experiment Station*

INTRODUCTION

In a previous publication² evidence was presented that mosaic of the Irish potato is a transmissible disease. In view of the fact that a large number of the experiments establishing the transmissibility of this disease were conducted in the greenhouse, it was considered advisable to confirm those results under field conditions. Furthermore, in connection with these experiments in the field additional contributions to our knowledge of mosaic of potatoes were secured. It will be the purpose of the following pages to present these results, which, unless otherwise indicated, have been obtained in northern Maine.

TUBER TRANSMISSION

MODIFICATION OF SEVERITY FROM YEAR TO YEAR

It is well known² that mosaic of Irish potatoes (*Solanum tuberosum* L.) is transmitted from one generation of plants to another through the tubers. It has been shown² that there may be great variation in the severity of the symptoms shown by the progeny of a given stock, strain, hill, or tuber.

Progeny of hills which appeared healthy during 1918 while growing in plots which contained some mosaic hills and which were situated near all-mosaic plots were grown and observed during the season of 1919. Most were of the Green Mountain, some of the Bliss Triumph, and a few of the Irish Cobbler variety. Each of the various lots contained some mosaic hills, the percentage varying from 12 to 76. Altogether there were over 4,000 hills, of which 1,200, or 30 per cent, were mosaic. In view both of results reported previously² and of the abundance of aphids in 1918, it seems that these mosaic hills represent cases of tuber transmission following aphid transmission occurring so late in the season of 1918 that no symptoms were apparent. The severity of the symptoms

¹ Conducted as one of the cooperative projects between the Office of Cotton, Truck, and Forage Crop Disease Investigations of the Bureau of Plant Industry, United States Department of Agriculture, and the Department of Plant Pathology of the Maine Agricultural Experiment Station.

² SCHULTZ, E. S., FOLSOM, DONALD, HILDEBRANDT, F. M., and HAWKINS, LOU A. INVESTIGATIONS ON THE MOSAIC DISEASE OF THE IRISH POTATO. *In Jour. Agr. Research*, v. 17, no. 6, p. 247-273, pl. A-B, 25-30. 1919. Literature cited, p. 272-273.

shown by the diseased hills of any lot averaged either "slight plus," "medium," or "medium plus," although it was usually "slight" for many hills and often "bad" for some. "Slight" indicates characteristic mottling sufficiently rare to require careful search; "slight plus" means that mottling is readily apparent but is unaccompanied by wrinkling, "medium" represents both conspicuous mottling and some wrinkling, becoming "medium plus" with marked ruffling and more or less dwarfing; "bad" stands for extreme ruffling and dwarfing which may sometimes cause the mottling to be obscured.

Another similar series of small lots was grown in a second plot. In these the percentage of mosaic hills varied from 4 to 63, being 40 per cent for the 800 hills altogether. The severity of the symptoms shown by the diseased hills was about the same as for the lots in the first plot.

In addition to the healthy hill selections described above, stocks were grown from hills that showed mosaic in 1918. These contained 1,100 hills, of which only 5 had not yet shown mottling by July 30. These 5, of which 4 came from one tuber, were not observed later. It is possible that this healthy tuber, supposedly from an Irish Cobbler hill with bad mosaic, was formed by a long rhizome of a neighboring healthy hill, such as is seen occasionally, and was included with the tubers of the mosaic hill in spite of the precautions usually taken. The severity of the symptoms in the mosaic stocks is indicated in Table I.

TABLE I.—Comparison of mosaic stocks in 1918 and 1919

Variety.	Number of hills.		Severity of symptoms, 1918.	Severity of symptoms, 1919.	
	1918.	1919.		Variation between hills.	Average.
Green Mountain.....	25	204	Slight.....	Slight to slight plus....	Slight.
Bliss Triumph.....	34	269do.....	Slight to bad.....	Do.
Green Mountain.....	50	400	Medium.....	Slight plus to bad....	Medium.
Bliss Triumph.....	18	112	Bad.....	Medium plus to bad...	Medium plus.
Green Mountain.....	20	77do.....do.....	Bad.
Irish Cobbler.....	17	65do.....do.....	Do.

Evidently there was, in the stocks described in Table I, a tendency for the disease to change very little in severity as a result of transmission through the tubers from 1918 to 1919.

Two larger plots, one Green Mountain and one Bliss Triumph, were planted with stock from plots entirely mosaic in 1918. While the percentages of mottled plants on July 9 were, respectively, 67 and 89, all plants were mottled by the last of July. Although in magnitude the plants and yield were inferior to those of comparatively healthy lots, the appearance of the plants and of the plot as a whole was no worse than for the same stock during the three previous seasons.

The foregoing results indicate that mosaic in northern Maine does not necessarily change much from year to year in any diseased stock after the first appearance of the effects of infection. The conditions which determine the severity of the initial symptoms are not yet understood.

RELATION TO NUMBER OF TUBERS IN A HILL

The tubers from 10 Bliss Triumph hills and 130 Green Mountain hills, healthy in 1918 but grown near to diseased hills, were all planted uncut in hill lots in 1919. In Table II these hill lots are classified according to the number of tubers in a hill, and the percentage of tubers of each class that transmitted the disease is given.

TABLE II.—*Relation of the number of tubers in a hill to mosaic transmission*

Number of tubers per hill.....	2	3	4	5	6	7	8	9	10	11	12
Number of tubers planted.....	14	27	80	90	180	161	136	81	20	33	12
Percentage of tubers mosaic.....	86	60	32	53	38	46	46	41	30	36	41

There is a high percentage for the classes with two or three tubers to a hill, but otherwise no consistent relation obtains between number of tubers and percentage of mosaic. The results are not modified appreciably if the Bliss Triumph hill lots are disregarded. It thus seems that the increase of mosaic could be reduced by the selection of hills according to yield only if the hills with very low yields were discarded.

RELATION TO RELATIVE SIZE OF TUBERS

In connection with the problem of control, the question has arisen whether the selection of tubers according to size would have any effect in regard to the increase of mosaic. Consequently each of the 140 hill lots which are considered in the preceding section was planted in the order of decreasing apparent size of the tubers. With regard to mosaic 69 were mixed—that is, with both mosaic and apparently healthy plants in the same hill lot. In Table III the tubers of mixed lots are classified according to their relative rank, No. 1 being the largest. In addition, the percentage of tubers of each class that transmitted the disease is indicated.

TABLE III.—*Relation of the relative size of tubers in a hill to mosaic transmission*

Rank of tuber in size.....	1	2	3	4	5	6	7	8	9	10	11
Number of tubers planted.....	69	60	67	65	54	43	29	14	8	3	1
Percentage of tubers mosaic.....	67	48	42	46	44	42	38	36	38	33	0

The percentage is high for the group of tubers consisting of the largest ones in the hills and tends to decrease, being 48 per cent for No. 2, 45 per cent on the average for No. 3 to 6, and 36 per cent on the average for No. 7 to 10.

Another way in which to interpret the results is to consider all tubers of a hill lot as occupying equal parts of a line and to determine the "center of disease," which is the point on the two sides of which there are equal numbers of diseased and, if also possible, of healthy tubers. This center of disease was found, for the 69 hill lots described above, to be on the average closer to the large-tuber end of the hill-lot line, 44 per cent of the line being between the two. That is, there was a greater tendency to show mosaic as the relative size of the tuber was greater. However, this tendency is not marked enough to make it seem desirable to experiment further by selecting tubers according to absolute weight or size.

Of 357 hill lots planted in another plot, only the 2 to 6 largest tubers of each were planted, in order of decreasing apparent size. On July 22 to 26, 98 of the hill lots were mixed—that is, partly affected with mosaic. The results are similar to those given in Table III, the percentages being 57, 44, 48, and 35, respectively, for groups 1, 2, 3, and 4. The average center of disease is 46 per cent of the distance from the large-tuber end of the hill-lot line. Before this, on July 2 to 14, only 42 hill lots were mixed; and later, on August 22 to 25, a number of hill lots were either dead or too mature to show mosaic distinctly.

RELATION TO POSITION OF SEED PIECE IN THE TUBER

On July 29, 1918, 18 tuber units were observed which had been planted with quartered tubers and were mixed. Of the hills from stem-end quarters, 45 per cent were mosaic, while 62 per cent of those from bud-end quarters were diseased. Likewise there were 24 mixed tuber units of six plants each. Of the hills from stem-end sixths, middle-part sixths, and bud-end sixths, mosaic hills constituted, respectively, 43, 54, and 61 per cent. No attempt was made to sterilize the knife used to cut the tubers.

In 1919 each tuber was cut by means of one of several knives used in rotation and kept, when unused, with blades immersed in 4 per cent formaldehyde solution. Observations made June 28 to July 14 disclosed 44 tuber units, out of 1,109 observed, to be mixed. In these, 48 per cent of the plants from stem-end quarters and 51 per cent of those from bud-end quarters were mosaic. This slight difference had become more marked at the time of the next observation on July 22 to 26, when 84 tuber units, out of 1,348 observed, were mixed. At that time 28 per cent of the plants from stem-end quarters were mosaic, while 61 per cent of those from bud-end quarters were diseased. This difference was reduced slightly when it was found on August 22 to 25 that 20 more of the tuber units were mixed. The preponderance of mosaic in bud-end hills is of no value in the problem of control because of the small percentage of tuber units that are mixed. Its cause is not understood.

CONCLUSIONS REGARDING TUBER TRANSMISSION

Tubers from mosaic hills may be expected to transmit mosaic. In addition, at least part of those from apparently healthy hills growing near diseased plants will transmit the disease; and they tend to do so more when the parent hill contains only two or three tubers, when the relative size of the tuber in the parent hill is greater, and when the seed piece is nearer the bud end. However, hill selection results in discarding the hills with few tubers. The relation of relative size to mosaic transmission is not sufficiently marked or consistent to justify attempting tuber selection for the elimination of mosaic.

TRANSMISSION BY GRAFTING

TUBER GRAFTS

Grafting was attempted with a few tubers by bringing into contact the freshly cut surface of half a mosaic tuber and half a tuber from an apparently healthy hill. In 14 cases the nongrafted half of the supposedly healthy tuber remained healthy, and in 3 of these 14 cases the corresponding grafted half produced mosaic shoots. The three cases of apparent transmission were the only ones of the attempted grafts which established organic union. The failure of transmission in the 11 other cases indicates that mere proximity in a hill was not sufficient for transmission. Furthermore, the small number of successful grafts apparently was due to the fact that relatively old tubers were used.

DISEASED SCIONS UPON HEALTHY STOCKS

Since transmission by grafting had been somewhat effective both in the field with insects uncontrolled and in the greenhouse with insects controlled,¹ the same method was finally used in the field with insects excluded by means of cages. Three tuber units were used, each consisting of three hills. The untreated plants, the first hill of each unit, remained healthy until dug. In each other hill two or three stalks, from 14 to 17 inches high, were cut down and split, mosaic scions inserted, and contact established with the help of cord and adhesive tape. Soon after the dates of grafting, June 28 and July 2, 1919, the scions died because of shading in the cages; but the branches of the stocks made good growth, and by July 28 a branch in each of two grafted hills was mottled. By August 9 a number of shoots in each cage were mottled and were tagged. At the time of harvest, August 26, these were found to belong to the grafted hills. Healthy stalks also came from these hills but were ungrafted, one even coming from the same seed-piece eye as a grafted stalk.

As the Irish Cobbler variety had not been used for this kind of grafting, six mosaic scions were grafted upon uncaged stalks when the latter were

¹ SCHULTZ, E. S., FOLSOM, DONALD, HILDEBRANDT, F. M., and HAWKINS, LOU A. OP. CIT.

6 inches high, on June 25, 1919. One scion died immediately, and the hill remained entirely healthy. In the other cases branches from the grafted stalks showed mosaic dwarfing with wrinkling and streak necrosis and some slight mottling in the leaves, while the nongrafted ones remained healthy.

TRANSMISSION WITH PLANT JUICE

STOCKS TREATED IN 1918

Although several methods of artificial inoculation performed in 1918 apparently had no effect,¹ the high percentages of mosaic shown by some of the 1919 progeny of the treated plants indicate that certain methods were effective. Of 76 plants, progeny of control plants treated with water, 24 per cent were diseased, probably because of aphid transmission in 1918; and of 463 plants, progeny of inoculated plants, 38 per cent were diseased, most of them probably because of aphid transmission. Of one lot of 53 hills, 77 per cent were mosaic. Those developed from progeny of plants which in 1918 were inoculated by means of capillary glass tubes inserted into the petioles immediately after these capillary tubes were taken from a similar position on diseased vines. All of another lot of 28 hills were mosaic. These were progeny of plants whose stems were split and partly immersed for several days in the juice expressed by crushing the tubers of mosaic plants. These two methods may be regarded as promising effective transmission if used in more extensive trials.

STOCKS TREATED IN 1919

In view of the fact that mosaic of potato was transmitted by transferring juice from diseased plants to the rubbed and crushed leaves of healthy plants first under greenhouse conditions,¹ it was considered advisable to confirm these results with a larger number of plants and under field conditions. Consequently, during the season of 1919 a series of similar inoculation experiments was conducted in field experimental plots, both in the open and under insect cages.

INOCULATIONS WITHIN THE SAME VARIETY IN THE OPEN

The first inoculation was made when the plants had reached a height of from 3 to 8 inches. The juice was expressed from the vines in a grinder and was separated at once from the pulp by straining through cheesecloth. At each treatment the undiluted juice was applied to the leaves after they had been bruised with the fingers. At each inoculation the controls were treated with juice from healthy vines before the plants to be treated with juice from mosaic vines were operated upon. One set of

¹ SCHULTZ, E. S., FOLSOM, Donald, HILDEBRANDT, F. M., and HAWKINS, Lon A. *op. cit.*

instruments was used for the controls and another for the virulent juice. In these experiments the Green Mountain, Bliss Triumph, and Irish Cobbler varieties were used. In each case the juice was taken from vines of the same variety.

The plants of the Green Mountain and Bliss Triumph varieties used in this experiment developed from progeny which in 1918 showed from 11 to 15 per cent of mosaic, eliminated in three roguing. In view of the fact that, with the exception of the Irish Cobbler variety, these were planted by using four seed pieces from a tuber, it was possible to inoculate two of the hills in a tuber unit and have two additional hills of the same tuber unit remaining as uninoculated controls. In each tuber unit the plants in the second and third hills were inoculated—that is, a hill from a stem-end quarter and one from a bud-end quarter. In Table IV are given the results of these inoculations.

From Table IV it is apparent that plants not infected in 1918 if treated with juice from healthy vines remained healthy to the end of the season. (See Pl. 49-51.) As indicated, the exceptions to this result, where some tuber units produced plants which became mottled with mosaic after being treated with juice from healthy plants, were due to the fact that such units had become infected in 1918 in the field but did not present any evidence of infection at the time of the first treatment in 1919.

Plants inoculated with juice from mosaic-diseased vines showed the first mosaic mottling upon the newly developed leaves July 14. At this time aphids were just beginning to appear at the rate of a few individuals to a plant, so that those agents of dissemination can be disregarded as a factor in transmission in these open-field inoculations. It will be noted that with virulent juice a certain number of tuber units showed mottling throughout within a few days after the first inoculation, indicating that the tubers had become infected in 1918. In the remaining inoculated hills every hill, with the exception of one of Bliss Triumph, showed distinct mosaic mottling, while the untreated hills of these same units remained healthy to the end of the season.

In addition to the mosaic mottling, distinct spotting and streaking of the leaves, petioles, and stems obtained by July 25, so that at this time some of the lower leaves began to die. Furthermore, a marked ruffling and dwarfing of the leaves also became apparent, so that many of the plants appeared like those in the medium plus or bad stage, indicating that in a single season plants may develop an aggravated form of this disease if inoculated properly. (Pl. 52.)

TABLE IV.—*Inoculations with juice from plants of the same variety*

Variety inoculated.	Source of juice.	Date of inoculation.	Number of tuber units.	Noninoculated hills.		Inoculated hills.			
				Total number.	Number mosaic due to 1918 infection.	Total number.	Number mosaic due to 1918 infection.	Number mosaic due to 1919 inoculation.	Per centage mosaic due to 1919 inoculation.
Green Mountain	Healthy Green Mountain	June 20 and 27; July 5 and 12	5	10	4	4	0	0	0
Bliss Triumph	Healthy Bliss Triumph	do.	5	10	3	3	0	0	0
Irish Cobbler	Healthy Irish Cobbler	June 25; July 5 and 12		8	0	8	0	8	0
Do.	Mosaic Irish Cobbler	do.				12	1.2	1.2	100
Green Mountain	Mosaic Green Mountain	June 20 and 27; July 5 and 12	10	20	8	8	0	1.2	100
Bliss Triumph	Mosaic Bliss Triumph	do.	10	20	8	8	0	1.2	91
Irish Cobbler	Mosaic Irish Cobbler	June 24, one inoculation only				12	0	1.2	100

Application of Juice from Plants Showing the Bad Stage of Mosaic

In order to determine whether juice taken from plants badly diseased with mosaic and introduced into healthy plants would induce bad mosaic symptoms in the latter, plants of the Green Mountain, Bliss Triumph, and Irish Cobbler varieties were inoculated in the same manner as those mentioned in Table IV. Three applications at weekly intervals were made upon plants of the same variety as that from which the juices were expressed. The height of the vines at the time of the first inoculation varied from 2 to 8 inches. Plants of five Green Mountain hills, three Bliss Triumph hills, and five Irish Cobbler hills were treated. At the same time also two Green Mountain, three Bliss Triumph, and two Irish Cobbler hills were treated with but a single inoculation.

On July 28, 16 days after the first treatment, the first mosaic mottling was noted upon the inoculated Irish Cobbler vines. By August 15 every inoculated plant, regardless of variety, showed distinct mosaic mottling as well as streaking and ruffling of the leaves as in the bad stage of mosaic; and by August 28 most of the leaves on the lower half of the stems were dead. The plants subjected to but a single inoculation showed symptoms similar to those given three successive treatments, indicating that a single treatment may be sufficient to induce the disease (Pl. 56).

INOCULATIONS WITHIN THE SAME VARIETY UNDER INSECT CAGES

Early Repeated Application

Juice from crushed mosaic plants (not necessarily mottled at the time of the first inoculation but from stock all mosaic in 1918) was applied to the bruised leaves of two hills in each of three caged tuber units on June 13, 20, and 27, and on July 5. As a control, the third hill in each cage was left untreated; also juice from apparently healthy plants was applied to the bruised leaves of two hills of each of three other caged tuber units on the same dates. In all these cases the plants were from 1 to 6 inches high at the first treatment. On July 9 the topmost leaves of the treated hills in the former three units began to show mottling, which was slight to medium by July 15. On July 30 mosaic branches in these units were tagged and were found at digging time, August 26, to belong to the treated hills, which had no healthy stalks. The tuber units upon which the juice from healthy plants was used remained green and healthy until digging time, while those died which became mosaic.

Late Application

On July 14 two hills in each of two caged tuber units were treated with juice from mosaic plants in the same manner as those described in the two preceding sections. Before August 20 the upper leaves of the treated hills became mottled and streaked.

INOCULATIONS FROM ONE VARIETY TO ANOTHER IN THE OPEN

Early Repeated Application of Juice

In order to determine whether the juice of a mosaic plant of one variety could induce the disease when introduced into a plant of a different variety of potato, intervarietal inoculations were made under open field conditions. The procedure of inoculation practiced in this connection was similar to that followed with the inoculations indicated in Table IV. In this experiment the control plants always were treated before mosaic juice was used, and a separate set of unstruments was employed for each distinct variety and for juice from each source. Green Mountain, Bliss Triumph, and Irish Cobbler varieties were used. These were subjected to four successive treatments at weekly intervals, as indicated in Table V.

The results given in Table V show that mosaic juice from one variety of potato may produce the disease when introduced into the plants of another variety. In these inoculations the effect upon the treated plants was fully as severe as that obtained when juice was introduced into plants of the same variety, as explained in connection with Table IV. In fact, in many cases the inoculated plants behaved like those in the late or bad stage of the disease. (Pl. 53-55.)

From Table V it is apparent that a large percentage of the plants had become infected in 1918. In view of the fact that such tuber units did not show the mosaic mottling at the time of the first inoculation, when the plants varied in height from 2 to 8 inches, it was impossible to restrict inoculation to healthy units. However, in this connection it is interesting to note that the hills infected in 1918 and inoculated in this experiment showed the disease like the plants in the bad stage whenever the uninoculated control hills in the same tuber units showed but slight or medium infection, so that apparently inoculation with juice increased the severity of the infection which had resulted from transmission in the field the previous season.

Since a considerable number of the plants in this experiment apparently had become infected in 1918, the evident objection might be offered that, in the course of the inoculation, infectious juice was carried from diseased to healthy plants of the same variety and thus caused infection. This objection can be eliminated. Inoculations always were commenced at the same end of the plot and row, and hence the respective tuber units were operated upon in the same consecutive order. In all cases, with the exception of Bliss Triumph inoculations with mosaic Irish Cobbler juices, the inoculated hills of the tuber unit treated first in each of the different varieties became diseased while the uninoculated hills of this unit remained healthy during the course of the experiment. Furthermore, a number of mosaic tuber units, apparently infected in 1918, were among the controls, or the units treated with juice from healthy plants.

TABLE V.—Inoculations with juice from one variety to another

Variety inoculated.	Source of juice.	Date of inoculation.	Number of tuber units.	Noninoculated hills.		Inoculated hills.			
				Total number.	Number mosaic due to 1918 infection.	Total number.	Number mosaic due to 1918 infection.	Not mosaic due to 1918 infection.	
								Total number.	Number mosaic due to inoculation.
Green Mountain.....	Healthy Bliss Triumph.....	June 20 and 27; July 5 and 12.....	5	10	4	10	4	6	0
Do.....	Healthy Irish Cobbler.....	June 25; July 5 and 12.....	5	10	6	10	6	4	0
Bliss Triumph.....	do.....	do.....	5	10	6	10	6	6	0
Do.....	do.....	do.....	5	12	0	12	0	4	0
Irish Cobbler.....	Healthy Green Mountain.....	do.....	9	0	9	0	12	0
Do.....	Healthy Bliss Triumph.....	do.....	20	3	20	3	18	17
Green Mountain.....	Mosaic Bliss Triumph.....	June 20 and 27; July 5 and 12.....	10	20	10	20	10	4	100
Do.....	Mosaic Irish Cobbler.....	do.....	10	20	10	20	10	6	100
Bliss Triumph.....	Mosaic Green Mountain.....	June 28; July 5 and 12.....	10	10	6	10	6	4	100
Do.....	Mosaic Irish Cobbler.....	do.....	5	10	6	10	6	4	100
Irish Cobbler.....	Mosaic Green Mountain.....	June 26, one inoculation only.....	12	0	12	0	12	100

In no case did any healthy units become infected even though they happened to be treated immediately after a diseased plant had been operated upon. This indicates that infection does not carry very readily from one plant to another by merely rubbing the leaves of one plant and subsequently practicing the same operation upon a neighboring plant.

Late Application

On July 12, 1919, six healthy Green Mountain hills representing three different tuber units were inoculated with juice from mosaic Irish Cobbler vines. A second application was made upon these same plants a week later, when the vines were in blossom.

On August 15 distinct mottling was in evidence on the upper leaves of the vines in each of the six treated hills, and by August 22 some of the leaves were dying in spots and streaks as in the bad stage of mosaic.

Inoculations similar to the foregoing were made July 20 upon the vines of four hills in as many separate tuber units of the Irish Cobbler variety with juices from mosaic-dwarf Green Mountain vines. The plants at the time of the first inoculation had just finished blossoming. By August 20 slight mottling was noted upon the upper leaves of the inoculated vines and also slight streaking of the leaves as in bad mosaic stages. The results in these experiments indicate that plants can be inoculated successfully at the time of blossoming and later, as well as earlier in their development. Also, as stated previously in connection with insect transmission, even though mottling may not be in evidence in the season when infection occurs, nevertheless such plants will not fail to show distinct mottling under favorable environmental conditions during the following season.

INSECT TRANSMISSION

GREENHOUSE EXPERIMENT WITH APHIDS

Green Mountain tubers furnished by C. I. Gilbert were used at Orono with aphids in a greenhouse experiment because they were expected to be disease-free. This stock was used later in two plots. One consisted of 70 tuber units, of which only 1 was diseased early, evidently as the result of infection in 1918. The other, grown and observed in southern Maine by Dr. W. J. Morse, consisted of 1,357 hills, of which less than three-fourths of 1 per cent were mosaic. In the greenhouse experiment 10 tubers were each cut lengthwise with a flamed knife into four sets and planted on March 17. Half the plants from each tuber were inclosed with insect cages, into each of which about 150 individuals of the common green peach aphid, or spinach aphid (*Myzus persicae* Sulz.) from mosaic potato plants were introduced on April 13 to 16, when the plants were from 2 to 9 inches high. To 15 plants aphids were introduced on leaves on a stick thrust into the soil so that they dispersed without contact between the diseased leaves and the treated plant. To 5 plants they

were introduced on terminal-shoot buds in a flask laid upon the soil. The aphids were killed by nicotine fumigation on April 21. All plants appeared healthy when observed by one of the writers on April 21, when from 10 to 25 inches high. Between April 21 and June 2¹ mosaic symptoms appeared on all of the 15 plants to which the aphids were introduced on sticks. Of the 5 plants to which the aphids were introduced in the flask only 1 became mottled, on July 8. When introduced in the flask many aphids had been injured or killed by water condensing on the interior of the flask following transpiration by the bud. Nineteen of the 20 untreated plants remained healthy; 1 showed slight symptoms on July 9. This plant was the only one found on or before April 28 with uncontrolled aphids upon it—possibly from a mosaic plant or a plant treated with virulent aphids. It was again found to be infested on May 19 and 26. In the case of the 15 plants treated with the stick method of introducing aphids, the percentage showing infection and the average length of the period between treatment and the appearance of the symptoms were greater than in the case of plants treated similarly in a previous greenhouse experiment,² probably because in the later trial the plants elongated to heights of from 44 to 72 inches and thus offered for a longer period a chance for the initial display of mottling in the young leaves.

FIELD EXPERIMENTS WITH CAGES

EFFECT OF THE USE OF CAGES IN 1918

Although the cages for the control of insects in 1918 did not inhibit completely the dispersal of aphids, nevertheless their use materially checked transmission of mosaic. The effect of these cages upon transmission of mosaic is indicated in Table VI.

TABLE VI.—*Effect of cages on transmission of mosaic*

Variety.	Number of hills selected in 1918.	Number of tubers selected for 1919 planting.	Treatment in 1918.	Percentage of mosaic in 1919.
Green Mountain.....	9	32	Uncaged.....	49
Do.....	3	6	Caged with mosaic hill.....	100
Do.....	22	50	Caged.....	0
Bliss Triumph.....	31	66	Uncaged.....	35
Do.....	20	54	Caged.....	0

The number of hills reported in Table VI includes only a small percentage, a representative lot, of the total number planted in 1918. However, each hill indicated was grown under a separate cage. While these

¹ Observations after May 1 were made weekly by Viola L. Morris, laboratory assistant, and finally by Dr. W. J. Morse, neither having any information regarding the previous treatment of any plant.

² SCHULTZ, E. S., FOLSOM, DONALD, HILDEBRANDT, F. M., and HAWKINS, LOU A. OP. CIT.

results might be interpreted as suggesting that some insect besides aphids was a deciding factor, it is possible for the aphids observed in the cages late in the 1918 season to have come from a very few which did not carry mosaic, and as yet no other insect is known to transmit mosaic of potato.

EXPERIMENTS WITH APHIDS

Small colonies of the peach aphid were brought from Orono May 1 on radish and mosaic potato plants. Both increased while feeding on these plants. On June 7, when the vines were from 1 to 4 inches high, 9 caged plants of 3 tuber units were treated with aphids from radish plants, about 150 to each hill. These 3 units were regarded as controls, since the aphids had lived for a number of generations on radish plants and were supposed to be free from a mosaic virus. Three caged plants of a fourth tuber unit were treated with aphids from a mosaic potato plant; 2 plants were left in each hill and the aphids, about 100 to a hill, were introduced on leaves on a stick thrust into the soil near each hill. On June 30 and July 5, when aphids were very numerous, these 12 plants were sprayed with a solution of soap and nicotine sulphate. The plants used came from the Gilbert stock, already described as exceptionally healthy. On July 28 the fourth tuber unit was slightly mosaic in some branches of 1 hill, and by August 9 it was dead, as the result of excessive aphid infestation. The 3 controls remained healthy until dug on August 26.

On June 17, nine half-tuber sets from stock caged in 1918 were planted under three cages. On June 28, when the vines were from 1 to 3 inches high, the plants were treated with aphids from mosaic plants; several hundred aphids were introduced by each hill with the stick method described above. They were sprayed on July 5 and 8. On August 9 one hill showed some mosaic. When dug on August 26, this hill was all mosaic, while two other hills—one in the same cage—were each mosaic in the upper leaves of one stalk. The untreated plants from the other nine half tubers were grown in the field and remained healthy throughout the season.

Four tuber units of the Gilbert stock, comprising 12 hills, were treated on July 12, when the plants were large enough to press against the tops of the cages. The first unit was treated with hundreds of aphids from radish plants and the others with aphids from mosaic potato plants. In the latter case several thousand aphids were left on the diseased leaves and stems in a flower-pot saucer set at the base of each of the first and third hills, whence they dispersed within a few days. The first tuber unit remained healthy throughout the season. The other three were still healthy on August 9, but when dug on August 26 two hills were mosaic, each in the upper leaves of one branch of a stalk.

EXPERIMENT WITH FLEA BEETLES

Three caged tuber units (9 hills) of the Gilbert stock were treated with flea beetles (*Epitrix cucumeris* Harris) on June 13, 1919, when a few inches high. The middle hill of each unit was covered with a cylindrical cage set inside the larger cubical one; the other two hills were treated with several hundred flea beetles. These insects were collected from small potato vines which developed from 100 per cent mosaic stock. On June 20 the cylindrical cages were removed and most of the flea beetles, which had damaged the plants considerably, were driven out of the cages or killed by hand. On June 16 two more similar tuber units were treated likewise. All the hills remained healthy until dug on August 27.

As controls, four similar tuber units were treated in the same way, except that the beetles were taken from plots of mostly healthy potatoes or, in one unit, from bushes near the potato field. All the hills remained healthy until dug on August 26.

EXPERIMENT WITH COLORADO POTATO BEETLES

Five caged tuber units (15 plants) of the Gilbert stock were treated with Colorado potato beetles (*Leptinotarsa decemlineata* Say.) on July 3, 1919, when they reached nearly to the tops of the cages. The insects were gathered with brush and pan from plants in all-mosaic plots when from 2 days old to two-thirds full grown. Two stalks were left in a hill, and the first and third hills in every cage were treated with over 100 of the larvæ each. These were shaken from the gathering pan upon a cloth and were either rolled upon the leaves or left on the cloth while it was laid on the plant. Within 24 hours the plants had been damaged rather severely. They were sprayed with an arsenical poison, which soon caused the death of the larvæ. All the plants remained healthy until dug on August 26 and 27.

Three similar tuber units were treated likewise on July 7, except that the larvæ were obtained from plants in plots almost disease-free. These also remained healthy until dug on August 27.

FIELD OBSERVATIONS WITHOUT CAGES

GREENHOUSE STOCKS

Tubers from the 53 plants used in the first aphid experiment performed in the greenhouse at Orono¹ were planted whole. All of the 37 tubers from plants which became mosaic after the introduction of aphids from mosaic potatoes produced diseased hills, except 2 which came from a plant with 3 out of 7 stalks apparently healthy. The 2 healthy tubers were probably produced by the 3 healthy stalks. All of the 10 tubers from plants which remained apparently healthy until harvested, although they were fed upon by aphids from mosaic plants, were

¹ SCHULTZ, E. S., FOLSOM, Donald, HILDERBRANDT, F. M., and HAWKINS, Lon A. OP. CIT. P. 25-30.

mosaic. None of the 38 tubers from caged untreated plants or of the 15 from plants fed upon by aphids from a healthy potato plant were mosaic. Of the 34 tubers from uncaged and untreated plants 1 was mosaic; it came from a half-tuber hill that early showed ruffling and chlorosis along the veins but no typical mosaic mottling such as was shown, in addition to these incomplete symptoms, by the corresponding half-tuber hill after treatment with virulent aphids. Of the 37 tubers from plants fed upon by aphids from radish plants 4, or 11 per cent, were mosaic; these 4 came from 2 plants recorded as having been fumigated to eliminate a few aphids which were found on them and which were of unknown origin, possibly from neighboring diseased plants.

These results agree essentially with those which were secured previously with the first generation of the same stocks and which were described to prove the possibility of transmission by aphids. They also indicate that (1) mosaic mottling may be restricted to the parts of the leaf along the veins, (2) a plant with three stalks healthy and four mosaic may produce three mosaic tubers and two healthy ones, thus explaining the partial infection of hill lots, (3) plants treated with virulent aphids may appear healthy but produce progeny that are all mosaic, as shown previously by the writers,¹ and (4) apparently healthy plants inspected often for aphids and fumigated to eliminate these insects as soon as they are discovered may produce progeny of which a small percentage is mosaic.

In connection with the experiment just considered it was necessary to treat a number of control plants by laying a mosaic leaf upon each. These were kept in a different greenhouse room where aphids were more abundant, and they were never caged. Of 45 tubers from these, and also of 25 tubers from similar plants with no leaf laid on, 20 per cent were mosaic, all coming from plants recorded as being fumigated to eliminate uncontrolled aphids found upon them.

PROXIMITY STUDIES WITH PLOTS

In 1918, plots 1, 2, and 3 were each rogued of mosaic hills three times. Stocks from the first two, Green Mountain and Bliss Triumph, respectively, each showed mosaic in 20 per cent of the hills in 1919, while that from No. 3, Green Mountain, next to No. 4, a Green Mountain plot with 45 per cent of the hills diseased, showed mosaic in 30 per cent of the hills. In 1919, each of the stocks was rogued several times and grew between similar stocks. All these plots in both years were each $\frac{1}{4}$ acre in area. The greater percentage of mosaic in 1919 in stock from plot 3 can be explained best by the greater proximity in 1918 to a half-mosaic plot and by consideration of the apparently greater ease of dispersal of aphids, which were numerous in 1918, from the half-mosaic plot to No. 3. Plots 1, 2, and 3 were planted with stocks A, B, and C, respectively, described in Table VII.

¹ SCHULTZ, E. S., FOLSOM, DONALD, HILDEBRANDT, F. M., and HAWKINS, LOU A. OP. CIT.

INTERSEASONAL INCREASE

It was very apparent that aphids, which seemed as abundant as the flakes in an ordinary snowstorm when they were migrating in the late summer, were unusually numerous in 1918. Consequently it is of interest to compare the relative interseasonal increase in mosaic in the same stocks from 1917 to 1918 with that from 1918 to 1919. It has been demonstrated in several greenhouse experiments already discussed that aphids may transmit mosaic without the symptoms being shown until the progeny of the inoculated plants is grown the following season. It is considered that they may do likewise in the field during the latter half of the summer, which is usually the only time when they are abundant on potatoes in northern Maine, although there are more species in the field than were used in the various experiments.

Previous experiments seemed to indicate that the percentage of mosaic in susceptible varieties could be materially reduced by roguing the diseased plants from the plots as soon as the mottling appeared upon the vines. However, before it was fully demonstrated that insects were capable of transmitting mosaic the plots usually were arranged in such a manner that insect transfer could take place very readily. In view of this situation, it is possible to note the effects of those agents of transmission upon the performance of a few of the plots, each including ¼ acre, which were rogued during the last three seasons. Table VII records the observations on these plots.

TABLE VII.—Relation of aphids to increase of mosaic from season to season

Variety.	Stock.	1917.				Number of aphids.
		Location.	Percentage of mosaic.	Treatment.		
Green Mountain...	A	Next to 100 per cent mosaic stock..	32	Rogued three times...	Few.	
Bliss Triumph.....	Bdo.....	44do.....	Do.	
Green Mountain...	Cdo.....	49	Rogued once.....	Do.	

Variety.	Stock.	1918.				1919.
		Location.	Percentage of mosaic.	Treatment.	Number of aphids.	Percentage of mosaic.
Green Mountain ..	A	Six rows from 45 per cent mosaic stock.	11	Rogued three times.	Very abundant	20
Bliss Triumph....	B	Nine rows from 45 per cent mosaic stock.	16do.....do.....	20
Green Mountain..	C	Next to 45 per cent mosaic stock.	13do.....do.....	30

It will be noted in Table VII that in 1917 certain factors seemed to be more favorable for the spread of mosaic than in 1918—namely, higher percentage of diseased hills (rogued) in the plots, greater proximity of unrogued mosaic stock, and higher percentage of mosaic in the nearest unrogued diseased plot. However, there was less spread in 1917 than in 1918, as shown by the lower percentage of mosaic in 1918 than in 1919, in correlation with the greater abundance of aphids in 1918. Furthermore, these observations indicate how difficult the problem is of producing perfectly mosaic-free stocks from susceptible varieties wherever these agents of transmission exist.

EFFECT OF VARIATION IN THE TIME OF HARVESTING IN 1918

It was expected that if aphids were a deciding factor in mosaic transmission the lots of tubers harvested at progressively later dates during their increase in numbers would show an increasing percentage of mosaic. Seventy-eight healthy hills (66 Green Mountain and the rest Bliss Triumph or Irish Cobbler) were selected in 1918 in a plot containing many small lots all with more or less mosaic. Aphids became noticeable on potatoes the last part of July and increased in numbers so that they were very numerous about the middle of August and more excessively abundant as the end of the month was approached. Tubers about an inch in diameter were harvested on August 8 but did not keep with the methods used. Another set of tubers was harvested on August 15 and a third on August 26, one tuber being removed from every hill on each date. On September 12 the remaining tubers—321 in all—were harvested. The tubers were planted uncut in 1919 and transmitted 6, 14, and 50 per cent of mosaic, respectively, for the three lots. Apparently some of the infection occurred before August 15, but most of it was too late to affect many of the tubers harvested by August 26. This difference can be explained best by the great increase of aphids during August, together with the results obtained in the experiments on aphid transmission.

TEST OF THE SEED-CUTTING KNIFE

In 1919 stock was available from 1918 all-mosaic plots and rogued plots. One hundred tubers from the former were divided by three parallel transverse cuts so that no two cut surfaces joined in a seed piece, while 100 tubers from the latter were quartered by a transverse and a longitudinal cut so that each seed piece had two cut surfaces joining at a right angle. The same knife was used, cutting alternately tubers from the two lots. The 800 sets were left mixed in the same sack for over a day and planted by hand at 15-inch intervals in two rows. Another mixture was prepared in the same way with 200 tubers from the same two barrels, but in this case the pieces from the all-mosaic lot were sorted

out and discarded and only the others were planted. The latter occupied the third row, and the fourth row was used for a control lot prepared similarly except that no all-mosaic stock was used. Upon examination of the four rows on July 23 the control row was found to contain 85 mosaic hills, the third row 72, and the first two 475—that is, 75 excluding the 400 from all-mosaic stock. No change in the number of mosaic hills was found on August 18. A $\frac{1}{4}$ -acre plot of the rogued stock was planted elsewhere and contained 80 mosaic hills in each 400. Evidently the furnishing of conditions apparently optimum for knife transmission had no effect upon the mosaic percentage.

It was thought in 1918 that the partial infection of tuber units might be due to knife transmission. As stated before (p. 318), in 1919 when tuber units were planted three knives were used in rotation, each one being immersed in a 4 per cent formaldehyde solution when not in use. However, the partial infection of tuber units and hill lots was as common as before.

TESTS OF EFFECTS OF CONTACT

GREENHOUSE EXPERIMENTS

As has been reported,¹ out of nine healthy plants kept in contact with mosaic plants in a greenhouse one showed mosaic, but not until after a few uncontrolled aphids, possibly from mosaic plants, were discovered upon it. At about the same time, March 13, 1919, each of 12 tubers was split into three sets and planted in small pots. The plants from 4 tubers became mottled by April 1 when from 3 to 13 inches tall. The other 24 were transplanted about April 1 into large pots, 2 from each tuber into steam-sterilized soil and the third into soil containing a mosaic plant. The transfer was made by knocking off the bottom of the small pot and setting it into a hole formed by a small empty pot put in when the mosaic set was planted. The method used permitted the mingling of the roots of the two plants while it kept the two sets of tubers mostly apart and facilitated harvesting them separately. The vines of the two plants were twisted and tied together. All of the 24 plants remained healthy until July 9.² They had ceased to elongate by this time and soon afterwards were dug. The tubers were not planted, because of the abundance of aphids on the plants in July.

FIELD EXPERIMENTS WITH INSECT CAGES

Nine tubers of the Gilbert stock were planted halved in 1919, each two sets being separated by a mosaic set and all three caged. On July 30 three of the mosaic hills were dead or nearly so. The Gilbert hills all remained healthy until August 9 and when dug on August 27

¹ SCHULTZ, E. S., FOLSOM, Donald, HILDEBRANDT, F. M., and HAWKINS, LOU A. OP. CIT.

² Observations after May 1 were made weekly by Viola L. Morris, Laboratory Assistant, and finally by Dr. W. J. Morse.

were entirely healthy except for mosaic mottling in the few uppermost leaves of several branches of a stalk in one hill. These leaves appeared young. They had evidently been pushed hard against the inside of the cage and had a very few aphid skins and aphids clinging to them. They may have been infected as the result of contact before aphids entered the cage, by aphids on the outside of the cloth against which the leaves were pressed, or by aphids that came from mosaic plants in the next row and that entered through a small hole that was found to have been made accidentally in the cloth.

FIELD EXPERIMENTS WITHOUT CAGES

As was pointed out in a previous section regarding the test of the seed-cutting knife, the mixing of all-mosaic stock and rogued stock in two rows was not followed by a higher mosaic percentage for the rogued stock than was shown by it in a control row. The negative results in this case do not disprove the possibility of infection occurring too late to be evident during the current season—that is, after the roots and vines have become intertwined.

In 1918 five Green Mountain hill lots were found to be partly mosaic. The healthy hills were harvested separately, were classified according to their proximity in the row to a mosaic hill, and the tubers were planted uncut in 1919. Twenty-eight tubers were progeny of plants each of which grew between two mosaic hills, and 54 per cent of them were mosaic. Eighty-nine were progeny of hills each of which was between a mosaic hill and a healthy hill, and of these 63 per cent were mosaic. On the other hand, 40 per cent of the 220 tubers from hills each of which grew between two healthy hills were diseased. If these 220 tubers are arranged in five groups, H₁, H₂, H₃, H₄, and H₅, according to the increasing number of healthy hills between the parent and the nearest mosaic plant in the row, the groups contained, respectively, 75, 53, 41, 33, and 18 tubers, with 56, 24, 54, 24, and 17 per cent of them diseased. Since being next to a mosaic plant in the same row seemed to increase the chance of infection as much as 54 or 63 per cent is greater than 40 per cent, it evidently is a contributing factor in mosaic transmission; but judging from the varying percentages of infection among the classes of plants which were not next to mosaic hills in the same row, it probably aids in the spread of the disease only by aiding aphid transmission.

A slightly different type of experiment consisted in comparing the progeny of three small 1-row Green Mountain lots, of from 100 to 200 hills each, from which the mosaic hills (respectively, 6, 16, and 30 per cent) were removed on August 1, 1918, with two similar lots from which the mosaic hills (respectively, 6 and 18 per cent), together with each healthy hill next in the row to a mosaic one, were removed

August 1. In spite of the differences in contact with diseased hills, the progeny of the two lots were 27 and 35 per cent mosaic, respectively, and the progeny of the three lots were from 25 to 35 per cent mosaic. Aphid dispersal from neighboring mosaic plots was easy, and it apparently nullified any effect that the difference in contact might have had.

TEST OF SOIL HARBORING

GREENHOUSE EXPERIMENT

At harvesting time in 1918 one tuber was taken from each healthy hill in two hill-selected lots. At Orono on January 14, 1919, these tubers were split with a flamed knife, and one set was planted in steam-sterilized soil and the other in soil from which a mosaic plant had been removed on December 30 or January 13. Nineteen pairs of half tubers were used, and the plants from 7 pairs were mosaic by February 22, when from 1 to 20 inches high. The plants from the other 12 pairs reached their maximum height about March 5 and remained healthy until dug in April. The second generation of the 12 healthy pairs was grown and found to be entirely free from mosaic. It is clear that there was no transmission by the soil in which mosaic plants had just been grown, all mosaic that was shown evidently being transmitted by the tubers.

FIELD EXPERIMENTS

The greenhouse experiment described in the previous paragraph was not concerned with certain factors in the possible soil-harboring of mosaic in fields—namely, old stalks, volunteer potato plants, and insects. There is no doubt, when the proofs of transmission by aphids are remembered, but that volunteer mosaic plants may contribute to the infection of healthy stocks planted where mosaic stocks were grown the preceding season if they are not discovered and removed before the appearance of aphids. Even if they are, other factors might cause the infection of healthy plants.

To test this supposition, three rows of Green Mountain stock from a plot rogued in 1918 were planted across the location of a 1918 20 per cent diseased Green Mountain plot and a wholly diseased one. Each mosaic hill was dug and the seed piece examined. If volunteers are disregarded, 28 per cent of the 142 hills grown upon the ground of the all-diseased plot were mosaic as were 28 per cent of the 481 plants grown upon the ground which had produced the 20 per cent mosaic plots. This evidently was from infection the previous season, since 27 per cent of the hills were mosaic by July 15.

A similar but more extensive test consisted in planting 19 rows of the same stock across the ground which had produced 14 of the 1918 plots. Similar examination of the mosaic plants on July 30 showed 22 per cent

of the 4,466 hills to be mosaic. Although this stock was retarded in its development by being frozen nearly to the ground on June 23, only 1 per cent of the hills developed mosaic between July 30 and August 18. The nature of the various 1918 plots and the percentages of mosaic on the same ground in 1919 are given in Table VIII.

TABLE VIII.—*Nature of 1918 plots and percentage of mosaic hills in the parts of the 1919 plot grown upon the same ground*

Section No.	1918.		1919.	
	Variety.	Disease.	Total number of hills.	Percentage of mosaic hills from seed pieces.
1	Green Mountain.....	11 per cent mosaic.....	424	24
2	Bliss Triumph.....	15 per cent mosaic.....	432	23
3	Green Mountain.....	13 per cent mosaic.....	454	22
4do.....	45 per cent mosaic.....	422	26
5do.....	46 per cent mosaic.....	375	18
6	Roxbury Wilson.....	10 per cent mosaic.....	281	23
7	Bliss Triumph.....	100 per cent mosaic.....	350	23
8	Green Mountain.....do.....	458	22
9do.....	11 per cent mosaic.....	140	28
10	Irish Cobbler.....	No leafroll.....	143	22
11do.....	All leafroll.....	105	22
12do.....	No leafroll.....	169	15
13	Miscellaneous.....	Leafroll and mosaic.....	140	23
14do.....do.....	573	24

It will be noted that there are few marked deviations from the percentage for the whole plot, which was 23 per cent. These consist of one deviation upward and one downward for the ground occupied by two half-mosaic plots (4 and 5) and of the same for two comparatively mosaic-free plots (9 and 12) and therefore are without significance in regard to soil-harboring of the disease.

SUMMARY

(1) Transmission of potato mosaic by means of tubers, grafting, plant juice, and aphids was effected under various conditions, including those essentially of the field with insects controlled.

(2) Infection was obtained with intervarietal transfer of juice.

(3) Transmission was attempted, but without success so far as could be ascertained in the same season, by means of flea beetles, Colorado potato beetles, the seed-cutting knife, and contact of seed pieces, of roots, and of vines.

(4) Preliminary observations indicate that infection does not result from growth in soil that produced mosaic potato plants the previous season.

(5) It appears impossible either for infected plants to recover or, so long as diseased stock is not far off and insect carriers exist, to assure the maintenance of health of susceptible varieties by roguing plots or by selecting hills, tubers, or seed pieces.

(6) Isolation of plants by means of insect cages, as well as elimination of insects in the greenhouse, have maintained stocks disease-free, indicating that control of aphids and possibly of some other kinds of insects as well, is the most important means of checking the spread of potato mosaic among susceptible varieties.

PLATE 49

Vines of Green Mountain variety inoculated with juice from healthy foliage of the same variety. No mottling and no ruffling of leaves.

(338)





PLATE 50

Vines of Bliss Triumph variety inoculated with juice from healthy foliage of Irish
Cobbler variety. No mosaic mottling.

PLATE 51

Vines of Irish Cobbler variety inoculated with juice from healthy foliage of the same variety. No mosaic.





PLATE 52

Vines of Green Mountain variety inoculated with juice from mosaic foliage of the same variety. Distinct mosaic mottling and ruffling of young leaves on top of stalks. For control see Plate 49.

PLATE 53

Vines of Green Mountain variety inoculated with juice from mosaic foliage of Bliss Triumph variety. Distinct mottling and ruffling of upper leaves and early dying of lower leaves. Condition of control plants same as vines in Plate 49.





PLATE 54

Vines of Green Mountain variety inoculated with juice from mosaic foliage of Irish Cobbler variety. Distinet mottling and ruffling of upper leaves, early dying of lower leaves. Condition of control plants same as vines in Plate 49.

177285°—20—5

PLATE 55

Vines of Bliss Triumph variety inoculated with juice from mosaic foliage of Irish Cobbler variety. Mosaic mottling of upper leaves, early dying of lower leaves. For control see Plate 50.





PLATE 56

Vines of Irish Cobbler variety inoculated with juice from mosaic foliage of the same variety showing bad stage of mosaic. Distinct mottling of young leaves and early dying of foliage. For control see Plate 51.

ADDITIONAL COPIES
OF THIS PUBLICATION MAY BE PROCURED FROM
THE SUPERINTENDENT OF DOCUMENTS
GOVERNMENT PRINTING OFFICE
WASHINGTON, D. C.
AT
25 CENTS PER COPY
SUBSCRIPTION PRICE, \$1.50 PER YEAR
△

JOURNAL OF AGRICULTURAL RESEARCH

CONTENTS

	Page
Relative Susceptibility to Citrus-Canker of Different Species and Hybrids of the Genus Citrus, Including the Wild Relatives - - - - -	339

GEORGE L. PELTIER and WILLIAM J. FREDERICH

(Contribution from Alabama Agricultural Experiment Station and Bureau of Plant Industry)

Presoak Method of Seed Treatment: A Means of Preventing Seed Injury Due to Chemical Disinfectants and of Increasing Germicidal Efficiency - - - -	363
--	------------

HARRY BRAUN

(Contribution from Bureau of Plant Industry)

**PUBLISHED BY AUTHORITY OF THE SECRETARY OF AGRICULTURE,
WITH THE COOPERATION OF THE ASSOCIATION OF
LAND-GRANT COLLEGES**

WASHINGTON, D. C.

EDITORIAL COMMITTEE OF THE
UNITED STATES DEPARTMENT OF AGRICULTURE AND
THE ASSOCIATION OF LAND-GRANT COLLEGES

FOR THE DEPARTMENT

KARL F. KELLERMAN, CHAIRMAN

*Physiologist and Associate Chief, Bureau
of Plant Industry*

EDWIN W. ALLEN

Chief, Office of Experiment Stations

CHARLES L. MARLATT

*Entomologist and Assistant Chief, Bureau
of Entomology*

FOR THE ASSOCIATION

J. G. LIPMAN

*Dean, State College of Agriculture; and
Director, New Jersey Agricultural Experi-
ment Station, Rutgers College*

W. A. RILEY

*Entomologist and Chief, Division of Ento-
mology and Economic Zoology, Agricul-
tural Experiment Station of the University
of Minnesota*

R. L. WATTS,

*Dean, School of Agriculture, and Director,
Agricultural Experiment Station, The
Pennsylvania State College*

All correspondence regarding articles from the Department of Agriculture should be addressed to Karl F. Kellerman, Journal of Agricultural Research, Washington, D. C.

All correspondence regarding articles from State Experiment Stations should be addressed to J. G. Lipman, New Jersey Agricultural Experiment Station, New Brunswick, N. J.

RECEIVED
JULY 15 1920
U. S. DEPARTMENT OF AGRICULTURE
WASHINGTON, D. C.

JOURNAL OF AGRICULTURAL RESEARCH

VOL. XIX

WASHINGTON, D. C., JULY 15, 1920

No. 8

RELATIVE SUSCEPTIBILITY TO CITRUS-CANKER OF DIFFERENT SPECIES AND HYBRIDS OF THE GENUS CITRUS, INCLUDING THE WILD RELATIVES ¹

By GEORGE L. PELTIER, *Plant Pathologist, Alabama Agricultural Experiment Station, and Agent, Bureau of Plant Industry, United States Department of Agriculture,* and WILLIAM J. FREDERICH, *Assistant Pathologist, Bureau of Plant Industry, United States Department of Agriculture* ²

INTRODUCTION

In a preliminary report (6)³ the senior author briefly described the results obtained under greenhouse conditions for a period of six months on the susceptibility and resistance to citrus-canker of a number of plants including some of the wild relatives, Citrus fruits, and hybrids of the genus Citrus. Since that time the plants reported on have been under close observation; a third experiment has been started, and many inoculations have been made in the isolation field in southern Alabama during the summers of 1917, 1918, and 1919. Many more plants have been successfully inoculated; others have proved to be extremely susceptible; while some of those tested still show considerable resistance. The results obtained up to November 1, 1919, are described in this report.

EXPERIMENTAL METHODS

In the greenhouse, the methods used and the conditions governing the inoculations described in the preliminary report were closely followed. The same strain of the organism was used and was applied in the

¹ Published with the approval of the Director of the Alabama Agricultural Experiment Station. The paper is based upon cooperative investigations between the Office of Crop Physiology and Breeding Investigations, Bureau of Plant Industry, United States Department of Agriculture, and the Department of Plant Pathology, Alabama Agricultural Experiment Station.

² The writers wish to acknowledge their indebtedness to Dr. K. F. Kellerman, Associate Chief, Bureau of Plant Industry, United States Department of Agriculture; to Mr. W. T. Swingle, Physiologist in Charge, Crop Physiology and Breeding Investigations; to Mr. T. R. Robinson, Physiologist of the same office, for their cooperation and many helpful suggestions; and to Dr. O. F. E. Winberg, of the Alabama State Board of Horticulture, for valuable assistance and suggestions in the field work.

³ Reference is made by number (*italic*) to "Literature cited," pp. 361-362.

AUG 30 1920

same manner—that is, infusions of 48-hour-old cultures of *Pseudomonas citri* Hasse in beef bouillon were sprayed on the foliage of the plants by means of an atomizer. In no cases were punctures made, but wounds and scratches were present on some of the leaves. The plants all received identical treatments and were under approximately the same conditions.

The plants in experiment I were inoculated August 27 and September 12, 1917, and those in experiment II were inoculated October 23 and November 9. On March 23, 1918, the plants were all trimmed or cut back to force new growth, and some new numbers were placed in the screen cases together with the others. All of these were then inoculated in the usual manner. On the same date, the plants in experiment III were inoculated and have remained in the glass cases. Thus, after initial infection was obtained, natural inoculations of the remainder of the plants were counted on entirely. Therefore, natural infection took place on the greater part of the plants reported on in the following pages, especially on the more resistant plants.

In the isolation field, plantings were made in 1917, 1918, and 1919. Some of the nonhardy relatives and Citrus fruits were killed by hard winters of 1917–18 and 1918–19, but the majority of the plants survived. Inoculations in the field were started in September, 1917, by Mr. D. C. Neal and were later continued by Mr. J. Matz up to November 1, 1918, when the plants were banked for the winter. During the 1919 season the inoculations and observations in the field were made by the junior author.¹ Some of the plants were inoculated only once or twice, while others were sprayed with the inoculum regularly every week throughout the season. The time chosen for inoculation varied, but as a rule the late afternoon was chosen. A large number of natural infections took place after canker had been established on some of the plants.

The seasons of 1917 and 1918 were normal so far as climatic conditions were concerned. However, during the 1919 season the temperature was high, and together with an excessive and frequent rainfall it afforded not only ideal conditions for plant growth but also for the most rapid infection and development of canker.

Unless otherwise stated, all the plants reported on were in a good growing condition, and the organism was reisolated from the doubtful canker spots, especially in the case of the wild relatives. It must also be borne in mind that the plants used were for the most part small seedlings or nursery stock. Thus, the size of the plants and the conditions under which the inoculations were carried out made them more susceptible to canker. Plants reported here as susceptible would probably show more resistance under orchard conditions. No doubt maximum susceptibility was obtained with the plants experimented upon.

¹ The senior author is solely responsible for all conclusions drawn from the results of the three years' work.

SUSCEPTIBILITY OF NONRUTACEOUS PLANTS

Melia azedarach L., China berry, in field, 1919.

Inoculations were attempted on this plant in the field for the reason that it is the native host of the Citrus white fly. Needle prick and spray inoculations in the field under the most favorable conditions for the development of canker were negative.

Lee and Merrill (5) have reported successful inoculations of the stem and petioles of *Lansium domesticum* with *Pseudomonas citri*. This plant belongs to the same family as the China berry.

SUSCEPTIBILITY OF WILD RELATIVES OF THE GENUS CITRUS

RUTACEOUS PLANTS NOT CLOSELY RELATED TO THE GENUS CITRUS

Xanthoxylum sp. (CPB 11269, seedling), III.¹

So far no canker spots have been found on the plants.

Casimiroa edulis Lav. and Lex. White sapote (CPB 7923, seedlings), I, II,² in field, 1919.³

At the October, 1918, readings a few nontypical spots were observed on several of the young leaves of the plant in experiment I. They occurred only at the wounds and scratches, no spots being found on the unbroken surface of the leaves. New spots have appeared from time to time, but in all cases they have occurred at wounds and remained unruptured. The spots (Pl. 57) are small (about 0.5 mm. in diameter), light colored, slightly raised, compact, and unruptured. They do not have an oily outline. No yellow zone is present. No positive infections were obtained in the field.

As there are three varieties of the white sapote being grown in California and Florida for its fruit, it is of interest to note that it can be successfully inoculated under greenhouse conditions, although it does show considerable resistance to citrus-canker.

Glycosmis pentaphylla DC. (CPB 2905, seedlings), II, III,² in field, 1918.

This is one of the few relatives tested which has, so far, remained immune to canker in both the greenhouse and field.

Clauca lansium Skeels. Wampi (CPB 7936, seedlings), I, II,² in field, 1917 and 1918.

A few small, nontypical, oily spots appeared on the leaves of the plants in both experiments. The spots are typical of those found on the wild relatives. Repeated inoculations in the field gave negative results.

Chalcas exotica Millsp. (*Murraea exotica* L.). Orange jessamine (CPB 7975A, seedlings), I, II, in field, 1917 and 1918.

During July, 1918, a few nontypical spots were observed on the young leaves of the plants in experiment II.

The spots resemble those on *Casimiroa edulis* in general appearance, except that they are somewhat larger and of a more oily character. A few new spots have developed since that time. The plants are only very weakly positive, and the period of incubation is rather long. The spots in all cases were at wounds and unruptured. In no case were positive results obtained in the field in spite of repeated inoculations.

RUTACEOUS PLANTS BELONGING TO TRIBE CITREAE

SUBTRIBE AEGLINAE (HARDSHELL FRUITS)

Aegle marmelos Correa. Bael fruit (CPB 7983, seedlings), I, II, in field, 1918.

During the summer months these plants made a splendid growth and produced an abundance of new foliage. At the July, 1918, reading several small spots typical of

¹ Roman numerals refer to the number of the inoculation experiment in the greenhouse.

² Included in experiments of March 21, 1918.

³ Date of planting in the isolation field.

those found on *Casimiroa edulis* were observed, occurring at wounds and scratches. Spots have appeared occasionally since that time, but in every case they were observed along scratches and wounds and remained unruptured. All inoculations in the field were negative even at wounds.

Aeglopsis Chevalieri Swingle. (CPB 7633 and 7772, seedlings and cuttings), II and I,¹ in field, 1918.

The plants, although producing an abundance of new growth, have remained free from canker, in both the greenhouse and field.

Chaetospermum glutinosum (Blanco) Swingle (*Limonia glutinosa*, Blanco). Tabog (CPB 7799 and 7814, seedlings), I, II and I,¹ II,¹ III, in field, 1917 and 1918.

An abundance of new foliage was produced by all the plants, and thus they have been in an excellent condition for infection. All five of the plants have developed canker. The spots first appeared in April, 1918, three weeks after the last inoculation. The spots were at first small and nontypical (Pl. 58 A), but as they increased in numbers they became more and more typical. At the last reading the percentage of infected leaves ranged from 10 to 30, and from a few small, oily, unruptured spots (Pl. 58, B) to many medium-sized, ruptured spots (Pl. 58, C). No spots have been found on the twigs.

The small, unruptured spots generally appeared at wounds or scratches and resemble those described for *Casimiroa edulis*. The more normal spots are medium-sized, of a brick color, almost flat, compact, and slightly corky. They do not break through the upper surface but appear as a flat, discolored spot. The oily outline is very indistinct around the unbroken spots, and the yellow zone is absent. Vigorous colonies of *Pseudomonas citri* were isolated from these ruptured spots.

Unfortunately these plants are very susceptible to low temperatures and have been killed in the field each season, so that no thorough test of their susceptibility has been made. However, judging from the susceptibility shown in the greenhouse, they should be successfully inoculated in the field under favorable conditions. No positive results have been obtained so far, although the plants were repeatedly inoculated during the summers of 1917 and 1918.

Balsamocitrus Dawei Stapf. (CPB 2920, on *Aeglopsis Chevalieri*), III, in field, 1917 and 1918.

This is a large tree found in the forests of east central Africa at an altitude of 2,000 to 3,000 feet. The plant, although making a rapid growth, has remained free from canker in the field and the greenhouse.

SUBTRIBE FERONINAE (HARDSHELL FRUITS)

Feronia limonia (Corr.) Swingle (*F. elephantum* Corr.). Wood-apple (CPB 2763, seedlings), I, II, in field, 1917 and 1918.

A few oily, unruptured spots were observed at the July, 1918, reading. The spots have become more numerous and are scattered over the new foliage, especially at wounds, but remain small and unruptured. They are typical in all respects to those described for *Casimiroa edulis*. No positive results have been obtained in the field.

Feroniella lucida Swingle. Kavista Batu (CPB 7882, seedlings), I, II, in field, 1917 and 1918.

Some small, very slow-growing, oily spots are scattered over the new foliage. They resemble in all respects those found on *Feronia limonia*. Repeated inoculations in the field have been negative.

¹Included in experiments of March 21, 1918.

SUBTRIBE LAVANGINAE

Hesperthusa crenulata Roem. Naibel (CPB 2759, seedlings), II, III, in field, 1917 and 1918.

Because the spots produced were so nontypical the susceptibility of these plants was doubted until cankers developed on the twigs and branches. The spots (Pl. 59, B) are small and nontypical, although 90 per cent of the new leaves on the plants are infected. On the twigs they are rather numerous, flat, very oily, and apparently ruptured. In the field the few spots formed on the twigs have remained unruptured, very oily, and slightly raised. On the leaves the spots are nontypical, few, and in some cases slightly ruptured.

Triphasia trifolia P. Wilson. Lime berry (CPB 2689A and 7780, seedlings), I, II, and II, in field, 1918.

The plants have remained free from canker in both the field and greenhouse.

Severinia buxifolia Ten. (CPB 2760, cuttings and seedlings), I, II, in field, 1917, 1918, and 1919.

Like *Triphasia*, the plants are apparently immune.

SUBTRIBE CITRINAE

Citropsis Schweinfurthii Swingle and M. Kellerman. African cherry orange (CPB 11260, seedlings), I,¹ II, in field, 1917 and 1918.

Several small spots have developed along a wound on one leaf, while several small, scattering, and unruptured spots were found on a few young leaves. The spots are typical of those found on *Casimiroa edulis*. No positive results have been obtained in the field.

Atalantia citrioides Pierre. (CPB 7534, cuttings), I, II (2 plants), III, in field, 1918.

Canker spots first appeared on the plants in experiment I in May, 1918: Since that time all plants have become infected, the spots being well distributed over the new foliage.

The spots (Pl. 59, A) are small to medium, of a brick color, round, flat, and sometimes breaking out in a corky mass. Only a slight depression is visible on the upper surface. The oily outline is very distinct, and no yellow margin is present. The spots are somewhat similar to those described for *Chaetospermum*, and the plants are almost as susceptible. During 1918 no positive results were obtained on the few plants in the field.

Atalantia ceylonica Oliver (*Rissoa ceylonica*, Arn.). (CPB 11225, seedling), III.

A few oily spots (Pl. 59, A, center) have been produced on all the leaves of the plant. They are present also on the twigs. The spots are identical with those described on *A. citrioides*, although the plant is slightly more susceptible.

Poncirus trifoliata (L.) Raf. (*Citrus trifoliata* L.). Trifoliolate orange (Seedlings, Alabama), I, II, III, in field, 1917.

All the plants (Pl. 65, A) included in the experiments have proved to be extremely susceptible in both the field and the greenhouse. In experiment III the plant was killed outright by the heavy canker infection. Leaves, thorns, twigs, branches, and even the old wood were attacked. As a rule, all the spots on the leaves are small to medium sized and very numerous, while on the stem they are large, girdling, and corky.

Poncirus trifoliata is extremely susceptible and therefore will always be a menace to complete eradication of canker in Alabama, especially since it has been found

¹ Included in experiments of March 21, 1918.

that canker may lie dormant in the bark tissues of the old wood and overwinter for a period of six months (7).

Eremocitrus glauca (Lindl.) Swingle (*Triphasia glauca* Lindl.; *Atalantia glauca* Benth.). Australian desert kumquat (CPB 7239 and 7397, seedlings), I, II, and III, in field, 1917.

All plants have shown infection, varying with their condition. Canker (Pl. 59, D) has been observed on the leaves, thorns, twigs, and old wood. A considerable degree of susceptibility is shown; and, under favorable conditions, the species should be successfully inoculated in the field, although such attempts have proved negative so far.

Fortunella margarita (Lour.) Swingle (*Citrus margarita* Lour.). Oval kumquat (CPB 7597, seedlings), I, II, III, in field, 1918.

Fortunella crassifolia Swingle. Meiwa kumquat (CPB 11047, seedlings), I, II (2 plants), III, in field, 1917 and 1918.

Fortunella japonica (Thunb.) Swingle (*Citrus japonica* Thunb.). Round kumquat (CPB 11301, seedlings), I, III, in field, 1918.

Fortunella Hindsii (Oliver) Swingle (*Sclerostylis Hindsii* Champ., *Atalantia Hindsii* Oliver). Hongkong wild kumquat (CPB 11046C and 11046A, seedlings), I, II, III, and I,¹ in field, 1917 and 1918.

All four species of kumquats have been successfully inoculated, although in all cases with some difficulty. From the results so far obtained no one of the first three species appears to be more susceptible than the other, the amount of infection depending on the growing condition of the individual. Judging from the type and number of spots (Pl. 60, C) *Fortunella Hindsii* is the most susceptible in that the spots are ruptured and corky.

As a rule, the spots on the other three species are characterized by being small, slow-growing, scattering, very dark, compact, and unruptured (Pl. 60, A). A few slightly ruptured, corky spots have been found on the plants, but usually at wounds.

Three plants of *Fortunella Hindsii* have been successfully inoculated in the field. A few minute infections were obtained on *Fortunella margarita* and *Fortunella japonica* during August, 1919. Plants of the oval kumquat, budded on *Poncirus trifoliata*, were inoculated in the field every week during the growing season of 1918 with negative results.

Microcitrus australasica (Muell.) Swingle (*Citrus australasica*, Muell.). Finger lime (CPB 7600 and 7600B, cuttings and seedlings), I, II, III, and II, in field, 1917.

Microcitrus australasica var. *sanguinea* Swingle. (CPB 7775B, cutting), II.

Microcitrus Garrowayi (Bail.) Swingle (*Citrus Garrowayi*, Bail.). Garroway's finger lime (CPB 11008, cuttings), I, II, III.

Microcitrus australis (Planch.) Swingle (*Citrus australis*, Planch.). Dooja (CPB 7307 and 7427, cuttings and seedlings), I, II, in field, 1917.

The last two species have proved to be quite easily infected with canker, but it was not until quite recently that *Microcitrus australasica* and its variety *sanguinea* became infected. Here infection is limited to a few scattering, small, slow-growing, dark, oily spots with an occasional spot on the thorns and twigs. On *M. australis* and *M. Garrowayi* from 30 to 90 per cent of the leaves have tiny, scattering, compact spots (Pl. 59, C), which do not penetrate through the leaf. Thorn, twig, and stem infections are also severe, the spots being ruptured and of a girdling type, resembling

¹ Included in experiments of March 21, 1918.

somewhat the loose, corky spots on *Poncirus trifoliata*. During the 1919 season *M. australis* was severely infected in the field, leaves, twigs, and branches being attacked. This species has shown almost as much susceptibility as *P. trifoliata*. Some leaf and stem cankers have also developed on *M. australasica*. However, it is much more resistant than *M. australis*.

In Table I the data on the susceptibility of the wild relatives of Citrus obtained by Lee (4) are listed for comparison with those reported on by the senior author. Lee worked in the open under field conditions at the Lamao Experiment Station, P. I., while the senior author, using the same type of plants, carried on his inoculation experiments in the green-houses at Auburn, Ala. None of the field results are included in the table, since with few exceptions they were of a negative nature.

TABLE I.—Findings of Lee and Peltier on the susceptibility of the Citrus relatives to citrus-canker

Genus and species.	Lee's results.	Peltier's results.	Remarks.
RUTACEOUS PLANTS NOT CLOSELY RELATED TO THE GENUS CITRUS.			
<i>Xanthoxylum rhetsa</i>	Negative.....	Not tested.....	Immune.
<i>Xanthoxylum</i> sp.....	Not tested.....	Negative.....	Do.
<i>Evodia ridleyei</i>	Positive.....	Not tested.....	Leaves and stem positive.
<i>Evodia latifolia</i>	do.....	do.....	Stem only.
<i>Melicope triphylla</i>	do.....	do.....	Do.
<i>Casimiroa edulis</i>	Not tested.....	Positive.....	Leaves only.
<i>Toddalia asiatica</i>	Positive.....	Not tested.....	Leaves and stem positive.
<i>Glycosmis pentaphylla</i>	Not tested.....	Negative.....	Immune.
<i>Chalcas exotica</i>	Positive.....	Positive.....	Lee, petioles and stem weakly positive; Peltier, leaves weakly positive.
<i>Clauena lansium</i>	do.....	do.....	Do.
TRIBE CITREAE. Subtribe Aeglinae.			
<i>Aegle marmelos</i>	Negative.....	Positive.....	Leaves only.
<i>Aeglopsis Chevalieri</i>	Not tested.....	Negative.....	Do.
<i>Chaetochermum guttinosum</i>	Positive.....	Positive.....	Susceptible.
<i>Balsamocitrus gabonensis</i>	Negative.....	Not tested.....	Immune.
<i>Balsamocitrus Dawsoni</i>	Not tested.....	Negative.....	Do.
Subtribe Feroninae.			
<i>Feronia limonia</i>	Positive.....	Positive.....	Lee, leaves and stem positive; Peltier, leaves only.
<i>Feroniella lucida</i>	do.....	do.....	Lee, stems only positive; Peltier, leaves only.
Subtribe Lavanginae.			
<i>Hesperethusa crenulata</i>	Positive.....	Positive.....	Susceptible.
<i>Triphasia trifoliata</i>	Negative.....	Negative.....	Immune.
<i>Paramignya longipedunculata</i>	Positive.....	Not tested.....	Leaves and stems positive.
<i>Severinia buxifolia</i>	Negative.....	Negative.....	Immune.
Subtribe Citrinae.			
<i>Citropsis Schweinfurthii</i>	Positive.....	Positive.....	Lee, leaves and stems positive; Peltier, leaves only positive.
<i>Atlantia citrioides</i>	do.....	do.....	Lee, leaves and stems positive; Peltier, leaves very easily infected.
<i>Atlantia ceylonica</i>	Not tested.....	do.....	Leaves and stems easily infected.
<i>Atlantia disticha</i>	Positive.....	Not tested.....	Leaves and stems only weakly positive.
<i>Poncirus trifoliata</i>	Not tested.....	Positive.....	Extremely susceptible.
<i>Eremocitrus glauca</i>	Positive.....	do.....	Susceptible.
<i>Fortunella margarita</i>	Not tested.....	do.....	Resistant.
<i>Fortunella japonica</i>	Positive.....	do.....	Do.
<i>Fortunella crassifolia</i>	Not tested.....	do.....	Do.
<i>Fortunella Hindsi</i>	Positive.....	do.....	Susceptible.
<i>Microcitrus australasica</i>	do.....	do.....	Somewhat susceptible.
<i>Microcitrus</i> var. <i>sanguinea</i>	Not tested.....	do.....	Do.
<i>Microcitrus Garrowayi</i>	do.....	do.....	Susceptible.
<i>Microcitrus australis</i>	Positive.....	do.....	Do.

Not only the conditions governing the inoculations but even the methods used were widely different in the two experiments. Lee (4) describes his method of inoculating as follows:

In making the inoculations an infusion of the organism was painted upon the leaf blade, midrib, petiole, or stem, as the case might be, with a small camel's-hair brush, and then the tissue was punctured through the coating of infusion with a needle. The inoculated twig was maintained in a moist condition by wrapping it in paraffin paper, including with the twig also a small piece of moistened cotton.

The senior author of the present paper, on the other hand, used infusions of the canker organism, which were sprayed directly on the plants in the screened cases by means of an atomizer. In no case were punctures resorted to, although wounds and scratches were present at all times on some of the leaves. It should also be noted that natural infections took place from the more susceptible plants to the majority of the wild relatives. (See dates of inoculations, p. 340.) Natural infections could be counted on in the greenhouse cases, because the plants were set close together and intermixed, and in addition a thorough syringing with a strong water pressure was applied whenever the plants were watered. No infections occurred on any of the rather remote wild relatives of *Citrus* until several weeks after the last inoculation. This may be due either to the resistance of the plants and the subsequent period of accommodation of the organism to the host or to the rather extended period of incubation. The last statement appears to be more nearly correct and is substantiated by Lee's results.

Of the rutaceous plants not closely related to the genus *Citrus* positive infections have been obtained on *Casimiroa edulis*, *Chalcas exotica*, and *Claucena lansium*. Lee has successfully inoculated the last two plants and, in addition, *Evodia ridleyei*, *E. latifolia*, *Melicope triphylla*, and *Toddalia asiatica*. Both of us have failed to produce any infection on *Xanthoxylum* spp., while so far *Glycosmis pentaphylla* has remained immune.

Jehle (1, 2) reports successful needle-prick inoculations on *Xanthoxylum fagara* (L.) Sarg. and *X. clava-hercules* (L.) Sarg. He also obtained watery swelling on *Chalcas (Murraea) exotica*. In all cases, a few non-typical, unruptured spots have been produced at wounds or scratches only. (Pl. 59.) Of the plants infected, *Chalcas exotica* responds the least, and the period of incubation is long. Lee likewise obtained only a very weak reaction.

No doubt other plants widely removed from the genus *Citrus* will be successfully inoculated under certain conditions, although it is extremely doubtful if any of the plants in this group will prove susceptible enough to warrant any attention except to be of interest from a scientific standpoint.

In the subtribe Aeglinae, of the tribe Citreae, *Chaetospermum glutinosum* is susceptible enough to rank with some of the *Citrus* fruits in

susceptibility. This confirms the observations of Lee (4) in the Philippines, where he has found *Chaetospermum* generally infected under field conditions. The spots (Pl. 58, C) produced on this plant are ruptured, corky, and more or less typical of those found on the plants in the genus *Citrus*. They occur on the leaves in the absence of wounds. *C. glutinosum* is the most distantly removed relative so far found which is quite susceptible and produces canker spots typical of those found on *Citrus* spp.

It is rather peculiar that the other plants tested in this subtribe are immune or nearly so, especially *Balsamocitrus* and *Aeglopsis*. A few small, nontypical, unruptured spots have been found on *Aegle marmelos*, but only at wounds. Thus *Aegle* can be classed with the first group discussed in its resistance to canker. Lee (4) failed to obtain any infection on *Aegle*. This is the only plant of the whole group tested by us where Lee's results and mine failed to check.

On both *Feronia limonia* and *Feroniella lucida* positive infections have been obtained. While the spots are typical of those described for the rutaceous group, they can develop in the absence of wounds on the leaves.

Of the plants tested in the subtribe Lavanginae, *Triphasia trifolia* and *Severinia buxifolia* have remained free from canker. Lee (4) has likewise failed to obtain infection on these plants after repeated trials. No doubt, both species will prove immune to canker. *Hesperthusia crenulata*, on the other hand, is quite susceptible, in fact, almost as much so as *Chaetospermum*. While both leaves and twigs are attacked in the absence of wounds, the spots (Pl. 59, B) do not resemble those found on any other host. They are flat, and though they rupture, there is no evidence of the corky tissue so typical of the canker spots on *Citrus*.

Citropsis Schweinfurthii, in the subtribe Citrinae, ranks with the rutaceous plants in susceptibility, in that infections occur only at wounds and the spots are small, nontypical, and unruptured. *Atalantia citrioides* and *A. ceylonica* have proved quite susceptible. The spots (Pl. 59, A) are medium-sized, ruptured, corky, and resemble somewhat those found on *Chaetospermum*. Lee reports *A. citrioides* and *A. disticha* rather resistant.

Poncirus trifoliata is without doubt the most susceptible of the wild relatives. Somewhat less susceptible is *Eremocitrus glauca*. Canker spots (Pl. 59, D) have appeared on the leaves, thorns, branches, and stems of this plant. The spots are small but ruptured and corky, while on the branches they are of a girdling type, resembling the stem cankers on *P. trifoliata*, except in size. Equally susceptible and with the same type of canker spots are *Microcitrus australis* and *M. Garrowayi*. *M. australasica* and its variety *sanguinea* are more resistant, although spots of the same type occur on the leaves, thorns, and twigs.

Of the kumquats, *Fortunella Hindsii* is susceptible. Lee (4) reports that canker occurs naturally on the wild plants on the mountains near Hongkong. The canker spots (Pl. 60, C) on *F. Hindsii* are ruptured,

raised, and corky, resembling those found on Citrus. The other three species of kumquats tested are equally resistant. While infection has been more or less general in the greenhouse on the young foliage the spots with but few exceptions have remained unruptured.

Thus, outside the subtribe Citrinae, only two susceptible plants, *Hesperthusia crenulata* and *Chaetosperrum glutinosum*, have been found under greenhouse conditions. The rest of the plants which were successfully inoculated all produced nontypical, unruptured spots at wounds. To this group can be added *Citropsis Schweinfurthii*. The plants reported free from canker will probably remain immune, while other plants not tested may prove susceptible when inoculated. The remaining plants in the subtribe Citrinae have all been successfully inoculated.

In the field successful inoculation both natural and artificial have been produced on *Hesperthusia crenulata*, *Poncirus trifoliata*, *Fortunella Hindsii*, *F. margarita*, *F. japonica*, *Microcitrus australasica*, and *M. australis*. Of these *P. trifoliata* and *M. australis* are very susceptible. No doubt under favorable conditions *Atalantia citrioides*, *A. ceylonica*, *Eremocitrus glauca*, and *Chaetosperrum glutinosum* can be successfully inoculated in the field. However, none of them will prove as susceptible as *P. trifoliata*.

Thus, only the relatives most susceptible under greenhouse conditions have been successfully inoculated in the field. So far as the menace of citrus-canker to the Citrus industry in the United States is concerned, with the exception of *Poncirus trifoliata*, none of the relatives, native or introduced, discussed above are susceptible enough to warrant further attention.

The index of susceptibility to citrus-canker of these plants should be based not on the ability to successfully produce canker infections through needle pricks or wounds, under abnormal conditions, but rather on the ability of the organism to gain entrance into the tissues through natural openings of the leaves in the absence of both artificial and natural wounds. Therefore, the senior author believes that even though he has been able to inoculate a large number of the wild relatives the results have no bearing on the eradication program. It is purely of scientific interest to know that *P. citri* is not limited to the genus Citrus but can produce, under certain conditions, infections on a wide range of plants in the family Rutaceae to which Citrus belongs.

The senior author has devoted considerable attention to a study of the various types of spots produced on the various hosts, hoping to be able to correlate the type of spot with resistance. In brief, the spots as observed on the relatives can be classed as follows: Small, slow growing, nontypical, unruptured spots (Pl. 57) occurring only at wounds on rutaceous plants; same type of spots, but occurring on the leaves in the absence of wounds (on *Feronia limonia*); more typical spots (Pl. 60, A) which are unruptured except at wounds (on *Fortunella margarita*); and typical, ruptured, corky spots (Pl. 63, D) (on *Poncirus trifoliata*.)

SUSCEPTIBILITY OF CITRUS FRUITS

Citrus hystrix DC. (CPB 7872 and 2881, seedlings), I, II, III, in field, 1917 and 1918. "Cabayao" (CPB 7831, seedlings), I, II.

Two types of these plants have been tested. One group has pointed leaves while the second has rounded ends. Very little infection has been found on the plants with the pointed leaves, either in the field or the greenhouse (Pl. 61). However, 70 to 100 per cent of the leaves having rounded tips were infected with small to large and scattering to many spots. Some defoliation occurred. Rather large spots of a girdling type are common on thorns, twigs, branches, and old wood.

Lee (3) finds that of the numbers tested by him in the Philippines seven were severely infected, three moderately so, one slightly, while canker was not observed on four, and one proved resistant. As the group is obscure, although a large one, some forms may be found resistant to canker. However, the majority, especially those with rounded leaves, will prove to be almost as susceptible as grapefruit.

Citrus medica L. Citron of commerce (CPB 7768 and 7836, cuttings and seedlings), I, II, and III. "Sidro" (CPB 7816, seedlings), II. "Nana" (CPB 11281, seedlings), II, III. "Odorata" (CPB 11294, seedlings), II, III. "Etrog" (CPB 11178, seedling), I, ¹ II.

Of the citrons tested, the "Etrog" proved to be the most susceptible. All the leaves were infected and some defoliation occurred. Twig and stem infections were also present. A few twig and stem spots were found on CPB 7768, 7836, and 11281. On the other numbers canker was limited to the foliage, the percentage of leaf infection varying from 30 to 100, with little defoliation.

The spots were, for the most part, small and scattering and very distinct in character. No doubt the texture of the leaves has a direct influence on the type of spot produced and also on the susceptibility of the leaves. The citrons, as a whole, while rather easily infected, are not as susceptible as grapefruit but are more so than Satsuma, (*Citrus nobilis* var. *unshiu* Swingle).

Lee (3) tested 14 numbers in the Philippines and found 1 resistant, 5 on which canker was not observed, 5 with medium infection, and 3 severely infected. He is of the opinion that some of the citrons may be considered as canker-resistant.

Citrus sp. Small lemon (CPB 7833, seedlings), I, ¹ II. Sweet lemon (CPB 1158, seedlings), I, II. "Davo lemon" (CPB 7837, seedlings), II, III. Limon real 18 (CPB 7819, seedling), II.

The plants of the lemon group so far tested have all proved more susceptible than the citrons. All the plants in the experiments have few to many large twig and stem spots, while 50 to 100 per cent of the leaves are infected. Canker also caused some defoliation of the plants.

Two types of spots are produced on the foliage. Where the texture of the leaf resembles that of the citron the same kind of spot is produced, except that it is larger. On the plants with smooth leaves the spots resemble those found on grapefruit (Pl. 62). In the scale of susceptibility, the lemons so far tested rank just below grapefruit.

Lee's results (3) also show that the lemons are fairly susceptible under Philippine conditions.

Citrus sp. Ichang lemon (CPB 11291 and 11204, seedlings), I, II, III, and I, II, ¹ III, in field, 1918.

The Ichang lemon was not considered under the lemon group because it appears to be a natural hybrid, possibly between lemon and pummelo. The plants are very susceptible, for from 30 to 100 per cent of the leaves are infected and several plants have severe twig and stem infections. All three plants in the isolation field were reported infected during September, 1918, and August, 1919. However, all spots were localized on the leaves.

¹ Included in experiments of March 21, 1918.

The spots resemble those on grapefruit leaves (Pl. 62), but the plants rank with the lemons in susceptibility to canker.

Citrus aurantifolia (Auct.) Swingle (*C. limetta* Auct., not Risso). Sour lime (CPB 7338, seedlings), I, II.

Only a small percentage of the leaves are infected with canker. The spots are also very small and scattering. No twig or stem infections have ever developed.

The spots (Pl. 60, E) resemble those on citron to some extent. However, they are smaller, more compact, less corky, and darker in color. While the plants are rather easily infected, the spots increase slowly in size and are few in number. The sour lime is much more resistant than either the citrons or lemons, almost approaching Satsuma in resistance. Lee (3) reports that the limes, with the possible exception of the "Tahiti," are very susceptible in the Philippines.

Citrus grandis (L.) Osbeck (*C. decumana* L.). Grapefruit (CPB 11170, 7834 and Duncan (Alabama), seedlings), I, II; I, II; and II, III. Grapefruit (Duncan budded on *Poncirus trifoliata*), I, II. Chinese pummelo (CPB 11061, seedlings), I, III. Hirado Buntan(?) pummelo (CPB 7993, seedlings), I, II. Indian pummelo (CPB 11166 and 2968A, seedlings), I, III, and I, III. Siamese pummelo (CPB 11201 and 6111, seedlings and on *C. Schweinfurthii*), I, III, and II.

With possibly two exceptions, all the grapefruit plants tested in the greenhouse have proved to be extremely susceptible. Approximately 100 per cent leaf infection occurred, with considerable defoliation. Twig and stem infections were also severe, the spots being large and of a girdling type. Several shoots have been killed by the girdling spots.

The "Hirado Buntan," reported very susceptible in the preliminary report, has stood up very well, and at the November, 1918, reading only 5 to 10 per cent of the leaves were infected, with few or no spots on the twigs. The Siamese pummelo, especially the number budded on *Citropsis Schweinfurthii*, shows some resistance to canker.

In the field, severe infections have been obtained on grapefruit seedlings (1919), grapefruit (Duncan) budded on *Poncirus trifoliata* (1917), Sullivan grapefruit (CPB 11001 and 11054) (1918), Mark's Chinese pummelo (CPB 11061, 11217F, and 11217 G) (1918), Roeding's Indian pummelo (CPB 2968A and 11166) (1918), Florida Shaddock (CPB 11255) (1918), Orangedale Chinese pummelo (CPB 11212 U) (1918), French Martin's Chinese pummelo (CPB 11213 J) (1919), and pummelo (CPB 11219 I) (1918). (See Pl. 62.)

Only slight leaf infections have been obtained on the Hirado Buntan pummelo (CPB 7993 and 11021) and recently on the Siamese pummelo (CPB 11201 and 6111) although these plants have been in the isolation field for the past two seasons and surrounded by badly infected plants.

Mr. Swingle reports that in Japan the Hirado Buntan is quite resistant, whereas Lee (3) states that the Siamese pummelo is the only variety of *Citrus grandis* tested by him which gives any promise of being resistant.

Citrus sinensis Osbeck (*C. Aurantium* Lour. and Auct. not Linn.). Grenadine orange (CPB 7773, seedlings), I, ¹ III. Parson Brown orange (CPB 11324, seedlings), I, ¹ III. "Naranja" (CPB 7929, seedlings), II, in field, 1918. Orange (CPB 66A seedlings), I, ¹ III.

With the exception of a few small, scattering spots on the twigs of two plants, canker is limited to the foliage of the plants in this group. Apparently the Parson Brown orange is the most susceptible, followed by CPB 66A. The "Naranja" and Grenadine oranges are somewhat more resistant in that only a small percentage of the leaves are infected, the spots are fewer and smaller, and no twig infections are present.

¹ Included in experiments of March 21, 1918.

All the plants of this group tested in the isolation field have been successfully inoculated. The following numbers were represented: CPB 11196 Narute, CPB 11164 Temple, CPB 11028 South Carolina, CPB 11198 Japanese No. 1, and CPB 11199 Japanese No. 2. The spots in all cases resembled those found on grapefruit.

In susceptibility this group ranks just above the citrons in that twig and stem infections are of more general occurrence. Lee (3) has observed that the Mediterranean varieties are less susceptible than the others. This fact has also been pointed out by other investigators.

Citrus nobilis Lour. King of Siam (CPB 2105, seedlings), I, III. "Naranjita" (?) (CPB 7830, seedlings), II, III, var. *deliciosa* Swingle. Tangarine (CPB 11195, seedlings), I, III. Cleopatra tangerine (CPB 11338, seedlings), I, II, III, var. *unshiu* Swingle. Satsuma (on *Poncirus trifoliata* Alabama), II, III.

Twig infection, consisting of small, unruptured, scattering spots, is limited to one plant (Naranjita) of this group. The spots (Pl. 63, B, at left) on the leaves are small to medium-sized, and, as a rule, rather scattering. The King of Siam orange is apparently the most susceptible. The Satsuma plants are the most resistant.

The spots (Pl. 63, B) found on the plants of the *Citrus nobilis* group are very characteristic, resembling to some extent those produced on kumquats. They are of medium size, dark, raised, compact, mostly unruptured, with a distinctly oily outline and some yellow zone. Ruptured spots are only slightly corky.

Recent investigations by Tanaka (9) and Scott (8) show that there are a number of distinct strains of Satsuma in Japan, of which three have been found in Alabama. Experiments are now under way to determine the relative susceptibility and resistance of these strains under field conditions. Successful inoculations have been made in the field on Satsuma (Pl. 64) and the Cleopatra tangerine. However, these plants are not easily attacked, canker being limited to the foliage.

All the plants tested in this group are very resistant. The writers believe that under field conditions suitable for Satsuma culture, and with no interplanting of susceptible varieties, this orange can be grown with little or no loss from canker even when the disease is prevalent. From the results so far obtained all the plants of the *Citrus nobilis* group can be placed in this class. In the investigations on susceptibility and resistance any variety showing as much resistance to canker as the Satsuma has been classed as promising.

Citrus mitis Blanco. Calamondin orange (CPB 11265, 44305, and 7065 seedlings), I, II,¹ II, III, and I,¹ II,¹ III, in field, 1917, 1918, and 1919.

Scattering stem infections and some defoliation have occurred on two of the seven plants tested. From 20 to 90 per cent of the foliage of the other plants have small to large, scattering spots.

The spots (Pl. 63, E) are altogether characteristic, and for the most part are unruptured. They are round, raised, compact, and oily, somewhat like the spots described for kumquat. When ruptured the spots are flat and have very little cork.

In the field canker is limited to the foliage, and the plants are more resistant than Satsuma. Lee (3) also finds that in the open *Citrus mitis* is truly resistant, and he thinks that it is apparently more so than Satsuma.

Citrus sp. Kansu (Yuzu) orange (CPB 11242, seedlings), I,¹ II, III, in field, 1918 and 1919.

The Kansu orange, collected by Mr. Frank N. Meyer in north China several years ago, is considered by Dr. T. Tanaka² to be the same as the well-known "Yuzu" used in Japan for many years as a stock.

Under both field and greenhouse conditions the plants have proved resistant. Apparently the leaves are quite easily infected, but the spots rarely increase in size,

¹ Included in experiments of March 21, 1918.

² The data are unpublished.

although they commonly rupture (Pl. 60, D). The spots do not penetrate to the upper surface. The plants are much more resistant than *Poncirus trifoliata*, which the writers understand has to a large extent replaced Yuzu as stock for Satsuma in Japan. Other conditions being equal, Yuzu is to be preferred to *P. trifoliata* from the standpoint of canker susceptibility.

Citrus sp. Natsu-mikan (CPB 11184, seedlings), I, II, III, in field, 1918 and 1919.

In some ways this plant resembles the hybrids between the grapefruit and loose-skinned oranges, such as the tangerine, known in this country as tangelos.

All plants of the Natsu-mikan in the greenhouse and field have been rather severely infected. Some twig and stem infections have been found, and from 50 to 100 per cent of the leaves have medium to large and scattering to many spots. The spots, although larger and more corky, resemble those found on Satsuma. Some defoliation has taken place, due to canker.

If the Natsu-mikan is closely related to the mandarin orange it is very much more susceptible than any of the plants so far studied in this group. Lee (3) reports the Natsu-mikan as susceptible in the Philippines.

Citrus excelsa Wester. (CPB 11280, seedlings), I, III.

From 90 to 100 per cent of the foliage of the two plants is infected with many large spots. Some few spots on the twigs are also present. Because of the citron-like texture of the leaves, the spots resemble those on the citron, except in size. Apparently it is not quite as susceptible as grapefruit.

In the Citrus fruits, where so many species and varieties were tested with more or less varying results, it is extremely hard to classify the susceptibility of these plants, especially where so many factors must be taken into consideration. Probably the most important and vexing factor is the physiological condition of the plant. In looking over the notes taken approximately each month on the plants in the experiments, it is found that there are certain cycles of canker infection which coincide with the growth periods of the plants. Thus, one or two observations on inoculated plants in the greenhouse or on those exposed to natural infection in the field are not sufficient to determine accurately the exact susceptibility or resistance of a plant. Some of the points to be reckoned with under the factor of the physiological condition of the plant are the rate of growth, not only of the plant but of the leaves themselves, age and size of the plant and leaves, leaf texture, and rate of maturation of the leaves. All these have an important relation to canker susceptibility and resistance.

Leaf texture with its various ramifications probably plays an important rôle in determining resistance in many cases. This can be best illustrated by comparing an infected kumquat leaf (Pl. 60, A) with an old grapefruit leaf (Pl. 60, B). The leaves are apparently very similar in texture, and a close study of the spots produced on the two shows that they are identical. In other words, while an ordinary grapefruit leaf is still thin and light green in color, it is very susceptible, large corky spots being produced. However, if an old leaf is taken which has apparently the same texture as a leaf of the kumquat, it is as hard to infect as the kumquat, and small, rounded, glistening spots are formed.

When no twig or stem infection occurs and only small, scattering, unruptured spots appear on the leaves, the plants show enough resistance to be classed as resistant. An intermediate group can be formed where the spots are larger, ruptured, and more general on the leaves, with occasional twig and stem infections. Plants placed in this group might be found promising under certain conditions. Plants which show large, ruptured spots on the leaves, severe enough to cause defoliation, and large girdling cankers on the twigs and stem should be classed as extremely susceptible. With these remarks in mind, the writers will attempt to rank the Citrus fruits, provisionally, in groups according to their susceptibility to citrus-canker.

The plants of the grapefruit and pummelo group are extremely susceptible. However, the Siamese and possibly the Hirado Buntan pummelos give promise of showing some resistance to canker.

Of the numbers tested belonging to *Citrus hystrix*, those with rounded leaves are as susceptible as grapefruit. The plants with pointed leaves are apparently more resistant to canker. More study is needed to determine whether this will hold for all forms of *Citrus hystrix* in the Philippines.

All numbers of the lemons tested, including the Ichang lemon, show about equal susceptibility, which is slightly less than that of grapefruit.

The plants of the sweet-orange group vary somewhat in susceptibility. Leaf infections are severe, and twig and stem cankers are common. As a whole, they are not as susceptible as the lemons.

Citrus excelsa and the Natsu-mikan are equally as susceptible as the plants of the sweet orange group.

Since only one number of the limes was tested, the position which the limes should take in the scale of susceptibility is doubtful. The sour lime tested proved to be somewhat resistant. However, Lee finds that with one exception the limes are susceptible.

While the citrons tested are easily infected, the spots are small, increasing very slowly in size. Twig infection occurs only occasionally and is the exception rather than the rule.

Citrus mitis, at least seedling plants such as were used in the inoculation experiments in the greenhouse, while showing some resistance are more susceptible than in the field. Leaf infections are scattering, and twig cankers are rarely produced.

The Kansu (Yuzu) orange so far has proved decidedly resistant. No twig cankers have occurred, and only small, scattering spots have developed on the foliage.

All numbers of the *Citrus nobilis* group tested have proved to be decidedly resistant, and, no doubt, all of these plants, if not mixed with susceptible varieties, could be grown under canker conditions. That does not mean that it would be economical or at all advisable to allow canker to persist even in unmixing plantings of Satsuma or other varieties of *C. nobilis*.

SUSCEPTIBILITY OF CITRUS HYBRIDS

Faustrime¹ (*Citrus aurantifolia*, West Indian lime, × *Microcitrus australasica*). (CPB 49819, 49823, and 49835, cuttings), II; II and III.

Faustrimon (*Citrus limonia*, lemon, × *Microcitrus australasica*). (CPB 49841, 49843, and 49844, cuttings), II; II and III.

Faustrimedín (*Citrus mitis*, calamondin, × *Microcitrus australasica*). (CPB 47431, cuttings), I, III, in field, 1918.

From 30 to 90 per cent of the foliage of these plants is infected with scattering spots (Pl. 63, A). Some defoliation from canker has taken place. Thorn, twig, and stem cankers are common (Pl. 63, A). The spots are similar to those found on *Microcitrus australasica*, except that they are larger and more ruptured. The spots on the twigs and stem are of a girdling nature. The last number has been tested in the field with positive results on the foliage only. These hybrids are more susceptible than *M. australasica*.

Citrangé (*Poncirus trifoliata*, × *Citrus sinensis*). Seedlings.

Two or more plants of each number of the following citrangsés have been given a thorough test in both the greenhouse and the field: Colman (CPB 7896 and 772 AC), Rusk (CPB 7956, 11030, 7895, and 716), Rustic (CPB 7934 A), Sanford (CPB 7963 and 1423 AB), Savage (CPB 7961 and 1423 AB), Willits (CPB 7897 B, 7960, and 777 AB), Etonia (CPB 749 AB), and citrangsés (CPB 1425 AB, 1416, 43931, 43480, and 43434).

The percentage of leaf infection has varied from 10 to 100 per cent, depending on the condition of the plant. The majority showed over 50 per cent of infected leaves. Defoliation of the leaves due to canker was common. Large girdling spots have appeared on the stems of most of the plants. The spots (Pl. 63, D) on the leaves and twigs are similar to those produced on *Poncirus trifoliata*.

While some variations have occurred in the susceptibility of the different numbers, the results as a whole show that all the citrangsés (Pl. 65, B) are equally as susceptible as *Poncirus trifoliata* (Pl. 65, B). Thus none of the citrangsés tested are of any promise in the search for a resistant stock.

Citrumelo (*Citrus grandis*, Bowen grapefruit, × *Poncirus trifoliata*). (CPB 4493, 4554, 4564, and 4475, seedlings), I, II; I, II (2 plants); I and I, III.

Almost 100 per cent leaf infection, with some defoliation, occurred on all the plants. The spots (Pl. 63, D) are large, scattering to many, and resemble those produced on *Poncirus trifoliata* except in size. Girdling spots of various sizes occurred on most of the plants, not only on the twigs and branches but even on the old wood.

The citrumelos (Pl. 65, C) are even more susceptible than *Poncirus trifoliata* and, therefore, are of no economic value from the standpoint of their behavior to citrus-canker.

Citradia (*Poncirus trifoliata*, × *Citrus aurantium*, sour orange). (CPB 50850, seedlings), I, II.

While from 40 to 80 per cent of the leaves have been infected with small, scattering, typical spots, no spots have been produced on the twigs or branches. Apparently, the citradia (Pl. 65, D) is a slower grower than the rest of the *Poncirus trifoliata* hybrids. The susceptibility of these plants, however, is sufficient to bar them from further tests.

Citrandarín (*Citrus nobilis* × *Poncirus trifoliata*). Seedlings.

In the greenhouse, plants of the following numbers have been given a thorough trial. CPB 40210, 40303, 40315, 40368 B, and 48529. All of these numbers are hybrids

¹ The hybrids were supplied by Mr. Walter T. Swingle, who informs me that they were labeled with the laboratory names, for the most part still unpublished. Citrangé, limequat, and tangelo have been published, but citrunshu, citrumelo, citradia, citrandarin, faustrime, faustrimedín, citrangédin, citrangarin, citranguma, citrangequat, limelo, bigaraldin, orangelo, orangequat, clemelo, siameló, satsumelo, siamor, calarin, and calashu are tentative laboratory names that may not be used in the reports which may later be issued concerning hybrids. Many hybrids which in this paper are given separate names will in later reports be grouped under some one name.

of the King of Siam orange with *Poncirus trifoliata*. In the field, CPB numbers 40175 A, 49720, 49721, 49722, 49724, and 49726 (cross between King of Siam orange and *Poncirus trifoliata*), 49624, 49625, 49629, 49644, 49663, and 49644 (cross between Clementine orange and *P. trifoliata*), 49686, 49688, 49695, 49699, and 49712 (cross between Oneco tangerine and *P. trifoliata*), 49732, 49735, 49737, 49746, and 49748 (cross between a tangerine and *P. trifoliata*) were tested.

Some individual variation in susceptibility due to the condition of the plants occurred in the greenhouse. However, all plants proved susceptible. From 30 to 100 per cent leaf infection, with some defoliation, was observed on the majority of the plants. Some scattering twig infections occurred on all but one number. Rather large, girdling spots on the old wood were found on several of the plants.

In the isolation field, all the plants have been successfully infected. An abundance of spots occurred not only on the leaves but on the twigs, branches, and old wood. No differences were noted in the susceptibility of the plants having different *Citrus nobilis* varieties as one parent. The *Poncirus trifoliata* blood predominates, in that all the leaves of the above numbers are like this plant and all have the same leaf texture. All the citrandarins (Pl. 65, E) are about as susceptible as their parent, *P. trifoliata*.

Citrunshu (*Citrus nobilis* var. *unshiu*, Satsuma, × *Poncirus trifoliata*). Seedlings and on *P. trifoliata*.

These plants are very similar to the citrandarins, and their behavior towards citrus-canker is likewise the same. Of the nine numbers (CPB 51102, 49607, 49608, 49611, 49615, 49616, 49619, 49620, and 49623) tested in the field, all proved equally susceptible. Leaf infection was common, and some stem cankers were present. They are more resistant than the citrandarins, although further tests may show them to be as susceptible. The type of spot produced on all these plants is identical to those on *Poncirus trifoliata*.

Cicitrangle (*Poncirus trifoliata* × Colman citrange, and *P. trifoliata* × Sanford citrange). (CPB 48290 and 48316A, seedlings), I, II, and I, II, III.

These plants have shown considerable susceptibility to canker throughout the course of the inoculation experiments; in fact, one plant was killed by canker, while the others have been severely attacked. Without question, the cicitrangles (Pl. 65, F) are equally as susceptible as *Poncirus trifoliata*.

Citrangedin (a citrange × *Citrus mitis*, calamondin). Seedlings and on *Poncirus trifoliata*.

All plants in the greenhouse (CPB 48045) and isolation field (CPB 50485, 50486, 50493, 50495, 50500, and 50501) have been successfully infected. The spots are rather small and scattering on the leaves. Few twig and stem cankers have been observed. The spots are not typical of those produced on the citranges but resemble more those on *Citrus mitis*. The fact that these plants are more resistant to canker and that the spots themselves are not similar to those on the citranges can be traced back primarily to a difference in the leaf texture of the two hybrids. The citrangedins are more susceptible than *C. mitis*, but they are more resistant than the citranges. While the leaves still retain their trifoliolate character, the size, shape, and texture of the leaflets are different. They are also a darker green, and apparently mature faster than the leaves of the citranges.

Citrangarin (Sanford citrange × *Citrus nobilis* var. *deliciosa*, Oneco tangerine). Seedlings.

A plant (CPB 48776) of this hybrid was tested in the isolation field and has been successfully infected with a few scattering spots resembling those on Satsuma. While the leaves of this plant are trifoliolate, they have a texture similar to that of the

tangerine. It is interesting to compare the susceptibility of the citrangarin and the citrandarin. The latter was found to be as susceptible as *Poncirus trifoliata* and was very similar in character. The citrangarin, on the other hand, while it retains the trifoliolate character, has a leaf texture more like the second parent and is much more resistant.

Citranguma (*Citrus nobilis* var. *unshiu*, Satsuma, × Morton citrange). Seedlings.

The citranguma (Pl. 65, G) is possibly slightly more susceptible than the Satsuma. Leaf infections have been secured in both the greenhouse (CPB 48055, and 48055A) and field (CPB 49773). An occasional spot has been found on the smaller twigs of these plants in the greenhouse and field.

The leaf texture and type of spot are similar to those found on the Satsuma. However, the leaves do not reach maturity so soon. There is a decided tendency in the citranguma plants for the leaves to revert from the trifoliolate to a single leaf. This is especially noticeable on the new growth.

Citrangquat (Willits citrange × *Fortunella margarita*, oval kumquat). Seedlings.

The citrangquat, without question, is the most promising hybrid so far tested. No natural infections have ever been obtained in the field (CPB 48010E and 48010F). Under greenhouse conditions (CPB 48010 and 48010D) only several tender leaves have been infected with tiny, compact, unruptured spots (Pl. 63, C). So far, the citrangquat has shown more resistance than any of its parents.

These plants (Pl. 65, H) make a splendid, rapid, straight growth. The rate of growth is more rapid than that of *Poncirus trifoliata*, and the plants are much better adapted for budding purposes. The trifoliolate leaves are rather small and retain considerable of the leaf texture of the kumquat. The maturation of the leaves is also as rapid as in the kumquat. The leaves, especially those on the new growth, have a tendency to revert to the single leaf of the kumquat.

Limequat (*Citrus aurantifolia*, West Indian lime, × *Fortunella japonica*, round kumquat). Seedlings.

All plants in the greenhouse (CPB 48787A, 48787B, 49787E, 49792E, and 48798E) and isolation field (CPB 48792E) have been infected. Leaf, twig, thorn, branch, and stem spots are common. In fact the limequat is more susceptible than either parent.

Several plants have died in the greenhouse experiments from overwatering, although plants next to them have thrived. On the whole, the limequat plants (Pl. 66, B) worked with have not been strong nor altogether healthy. The rate of growth of these plants has also been slow. It may be that strong, healthy plants growing under ideal conditions would show more resistance to canker. However, judging from the results obtained with the plants available, the limequat is somewhat susceptible.

Limelo (*Citrus aurantifolia*, West Indian lime, × *C. grandis*, sour pummelo). (CPB 40502, 40526A, and 40567B, seedlings), I, II; I, III, and I, II.

All limelos (Pl. 66, A) tested have proved to be equally as susceptible as grapefruit, so that they are of no practical importance from their ability to resist canker under orchard conditions.

Bigaraldin (*Citrus aurantium*, sour orange, × *C. mitis*, calamondin). On *Poncirus trifoliata*.

Only one plant (CPB 50352) of this hybrid was included in the field. It was successfully infected and no doubt will prove as susceptible as the sour orange.

Orangelo (*Citrus grandis*, Bowen grapefruit, × *C. sinensis*, Lamb summer orange). Seedlings.

All three plants (CPB 1668A) in the isolation field have been successfully infected. Spots are limited to the leaves. No twig or stem cankers have developed. Judging from the type of spot produced and the leaf texture, this hybrid will prove rather susceptible.

Orangequat (*Citrus sinensis*, Hartley mandarin, × *Fortunella margarita*, oval kumquat). On *Poncirus trifoliata*.

The one plant (CPB 50312) in the isolation field was easily infected. A few twig and stem cankers have appeared. Judging from the leaf texture and type of spot, it may prove susceptible.

Clemelo (*Citrus nobilis*, Clementine orange, × *C. grandis*, grapefruit). On *Poncirus trifoliata*.

Both the plants in the greenhouse (CPB 49006, 49012, 49013, 49025, and 49038) and those in the field (CPB 49029, 49032, and 49049) have been easily infected. From 50 to 100 per cent leaf infection with some defoliation has occurred. Most of the plants in the greenhouse have large, girdling stem cankers. The spots in all cases resemble those on grapefruit. The clemelos (Pl. 67, B, at left) are as susceptible as grapefruit and therefore can not be considered promising.

Siamelo (*Citrus nobilis*, King of Siam orange, × *C. grandis*, grapefruit). Seedlings and on *C. grandis*.

The behavior of the siamelos (Pl. 67, A) (CPB 47255B, 51588, 51598, 59852, 52007N2, 52013S9, and 52021A5) in the greenhouse, and 50320, 52007N2, 52007B3, and 51947 in the field, toward canker is about like that of the clemelos. However, they are not quite as susceptible, in that less twig and stem infections occurred.

Satsumelo (*Citrus nobilis* var. *unshiu*, Satsuma, × *C. grandis*, grapefruit.) On *Poncirus trifoliata* and *C. grandis*.

Many numbers of this hybrid have been tested in the field (CPB 50304) and greenhouse (CPB 50304, 52009A 2, 52009G 5, 52011, and 52011G 4). Thus far, the satsumelos react to citrus-canker in the same manner and extent as the siamelos (Pl. 67, B, center).

Siamor (*Citrus nobilis*, King of Siam orange, × *C. sinensis*. (CPB 52029E 2, seedling), III.

The plant included in the greenhouse experiment has proved to be extremely susceptible to canker. Heavy defoliation and severe stem cankers occurred soon after inoculation. Leaf texture and the type of spot are identical with those of grapefruit. The plant is likewise as susceptible.

Tangelo (*Citrus nobilis* var. *deliciosa*, tangerine, × *C. grandis*, Florida grapefruit). Seedlings, and on *C. grandis*.

Besides the Thornton (CPB L715, and 11034 greenhouse and L714B field) and Sampson (CPB L789A and 7664 greenhouse, and 7664 and 11037 field) tangelos, which are now being grown to a small extent in Florida, about a dozen numbers (CPB 1230, 1257A, L16, 7161, 7675C, 1191, 1348A, 1262B, 40971A, 52018C2, and 52018E2 in the greenhouse and CPB 52016E4 in the field) were tested. Plants of all numbers have been infected. From 20 to 100 per cent leaf infection has occurred in the greenhouse. Twigs and stem infections have not been general but are rather the exception than the rule. In the field, canker has been limited to the foliage. The spots in all cases resemble those on grapefruit. Careful observations have shown that those plants (Pl. 68, B) with leaves resembling the tangerine are more resistant than the numbers with grapefruit leaves. For the present the tangelos can be considered somewhat promising but not quite so resistant as the Satsuma.

Calarin (*Citrus mitis*, calamondin, \times *C. nobilis* var. *deliciosa*, tangerine). On *Poncirus trifoliata*.

The one plant (CPB 50314) tested proved to be easily infected in the field. However, no twig or stem spots have been observed. Further trials are necessary before the susceptibility of the plant can be definitely judged.

Calashu (*Citrus mitis*, calamondin, \times *C. nobilis* var. *unshiu*, Satsuma.) On *Poncirus trifoliata*.

The plant (CPB 50309) in the isolation field has reacted to canker in about the same degree as the calarin.

Among the numerous crosses of Citrus fruits made by Mr. Swingle *Poncirus trifoliata* was used as one parent in the hope of obtaining hybrids more resistant to low temperatures than the ordinary Citrus fruits. Thus, *P. trifoliata* has been crossed with sweet orange, sour orange, grapefruit, King of Siam orange, tangerine, Clementine orange, Satsuma, and citrange. While all of the resulting hybrids have proved to be quite resistant to low temperatures they are equally as susceptible to citrus-canker as *P. trifoliata*; in fact, the citrumelos are even more so. The hybrids all resemble *P. trifoliata* in size, shape, and texture of leaves, so that the more or less resistant mandarin group has had no influence on the character or resistance of the hybrid. Thus, it can be safely predicted that all crosses with *P. trifoliata* will yield a hardy hybrid resembling *P. trifoliata* and equally susceptible.

On the other hand, the citranges, while equally as susceptible as *Poncirus trifoliata*, when crossed with calamondin, tangerine, Satsuma, and kumquat, yield hybrids which are hardy and at the same time resistant to citrus-canker. In fact, the citrangequat is even more resistant than the kumquats themselves, in spite of the fact that it is a rather rank and rapid grower. The citrangarins and citranguma, while not as resistant as the citrangequat, are decidedly more resistant than the citrandarin and citrunshu, the corresponding hybrids with *P. trifoliata*.

These hybrids, while still retaining the trifoliate character of *Poncirus trifoliata*, are more like the resistant parent in texture of the leaves. In the case of the citranguma and citrangequats there is also a tendency for the leaves to revert to a single leaf. Thus, any plant resistant to canker when crossed with the citranges will be hardy and resistant, or even more so than the original resistant parent, as shown by the behavior of the citrangequat, even though the citranges are equally as susceptible to canker as *P. trifoliata*.

The limequat and the orangequat, while more resistant than the lime or orange, are not as resistant to canker as the kumquat. The leaves resemble those of lime and orange, respectively, in size and shape, but the leaf texture resembles more that of the kumquat. The citrangequat is much more resistant to canker than the two hybrids named above, in spite of the fact that the citrange is much more susceptible than either the lime or orange.

The influence of pummelo on the second parent varies. As is to be expected, pummelo crossed with lime and orange produced hybrids which are as susceptible as grapefruit. Hybrids between pummelo and Clementine orange, King of Siam orange, tangerine, and Satsuma are susceptible to some extent, variation in susceptibility depending more or less on whether the leaf is of the grapefruit or the mandarin type.

The calarin, hybrid between calamondin and tangerine, and the calashu, hybrid between calamondin and Satsuma, so far give promise of being as resistant as their parents.

FALSE HYBRIDS

A rather large number of "false hybrids" or nucellar bud sports, the results of Mr. Swingle's crosses with varieties of Chinese pummelo and American grapefruit were tested in both the field and the greenhouse. The plants were vigorous growers and produced abundance of new growth. Most of these false hybrids resemble the Chinese pummelo.

All proved extremely susceptible, in fact, even more so than grapefruit (Pl. 68, A). Leaf infections were so severe as to cause defoliation. The spots on the twigs and stems were large and of a girdling nature. A number of twigs and several plants were killed outright by complete girdling. The spots in all cases resembled those found on grapefruit. Thus, all the false hybrids tested are extremely susceptible in both the field and the greenhouse, and no one of them gives any promise of canker resistance.

SUMMARY

(1) The investigations on the susceptibility and resistance to *Pseudomonas citri* Hasse of the wild relatives, Citrus fruits, and hybrids of the genus Citrus reported on in a preliminary paper have been continued in both the field and greenhouse. Many more numbers have been successfully inoculated, others have proved to be extremely susceptible, while some still show considerable resistance.

(2) The successful inoculation of a large number of wild relatives in the greenhouse shows that *Pseudomonas citri* has a wide range of hosts and is not limited to the genus Citrus.

(a) Of the rutaceous plants not closely related to Citrus, positive infections have been obtained on *Casimiroa edulis*, *Chalcas exotica*, and *Claucaena lansium*. *Xanthoxylum* sp., and *Glycosmis pentaphylla* have remained immune. In all cases a few nontypical, unruptured spots have been produced, but only at wounds or scratches on the leaves. *Chalcas exotica* responded the least, and the period of incubation was long.

(b) Of the tribe Citreae, subtribe Aeglinae, *Chaetospermum glutinosum* is the most distantly removed relative, so far found, that is quite susceptible and on which canker spots are more like those found on Citrus. *Aegle marmelos* has been only slightly infected, while *Balsamocitrus Dawei* and *Aeglopsis Chevalieri* have remained immune.

(c) Both *Feronia limonia* and *Feroniella lucida* of the subtribe *Feroninae* have been successfully inoculated. While the spots are typical of those described for the rutaceous group, they can develop in the absence of wounds.

(d) Of the plants tested in the subtribe *Lavanginae*, *Hesperthusa crenulata*, while producing very nontypical spots, is quite susceptible in that infection can take place on the leaves and twigs. *Triphasia trifolia* and *Severinia buxifolia* have remained immune.

(e) All plants of the subtribe *Citrinae* which have been tested have been infected. *Citropsis Schweinfurthii* is weakly positive; *Atalantia citrioides* and *A. ceylonica* are easily infected; *Eremocitrus glauca*, *Microcitrus australasica*, *M. australasica* var. *sanguinea*, *M. australis* and *M. Garrowayi*, plants native to Australia, are rather susceptible in that leaves, twigs, thorns, and branches are attacked; all four species of kumquat have been successfully infected; *Fortunella margarita*, *F. japonica*, and *F. crassifolia* exhibited considerable resistance, while *F. Hindsii* is very susceptible; and *Poncirus trifoliata* is extremely susceptible.

(f) Although working under entirely different conditions and using different methods of inoculating plants, Lee's results with the wild relatives check with those obtained by the senior author in the greenhouse, with one exception.

(g) In the field, only the wild relatives which were most susceptible under greenhouse conditions have been successfully inoculated. Of these *Poncirus trifoliata* and *Microcitrus australis* have proved to be susceptible, while *M. australasica* and *Fortunella Hindsii* are somewhat susceptible. *Hesperthusa crenulata* reacts to canker in about the same degree in the field as in the greenhouse.

(h) So far as the menace of citrus-canker to the Citrus industry of the United States is concerned, with the exception of *Poncirus trifoliata*, none of the wild relatives, native or introduced, now growing in the Citrus districts are susceptible enough to have any bearing on the eradication program.

(3) Little or no change in the susceptibility or resistance to citrus-canker has been noted among the Citrus fruits from that previously indicated. All plants tested have been successfully inoculated.

(a) The plants of the grapefruit and pummelo group are extremely susceptible, with the exception of the Hirado Buntan and Siamese pummelos.

(b) Of the numbers tested belonging to *Citrus hystrix*, those with rounded leaves are as susceptible as grapefruit. The plants with pointed leaves are apparently more resistant.

(c) All numbers of lemons tested, including the Ichang lemon, show about equal susceptibility, which is slightly less than that for grapefruit.

(d) As a whole, the plants of the sweet-orange group are slightly less susceptible than the lemons. *Citrus excelsa* and the Natsu-mikan can be classed with the sweet orange in susceptibility.

(e) The sour lime tested proved to be somewhat resistant.

(f) While the citrons are easily infected, the spots are small and increase slowly in size. Twig infection is not common.

(g) *Citrus mitis*, while showing some resistance, is more susceptible than has been reported from the Philippines.

(h) The Kansu (Yuzu) orange has proved somewhat resistant. No twig infection has occurred, and only scattering spots have developed on the foliage.

(i) All numbers of *Citrus nobilis* and its varieties have proved to be rather resistant to canker.

(4) All hybrids are attacked by citrus-canker in varying degrees.

(a) The citranges, citrumelos, citradias, citrandarins, citrunshus, and cicitranges, all having *Poncirus trifoliata* as one parent, are extremely susceptible. Apparently all crosses with *P. trifoliata* will yield hardy but susceptible hybrids.

(b) The citrangedins, citrangarins, citrangumas, and citrangequats, with susceptible citranges as one parent, are not only hardy, but decidedly resistant to canker; in fact, the citrangequat is practically immune in spite of the fact that it is a rapid grower.

(c) The limequats and orangequats are somewhat susceptible.

(d) Limelos and orangelos are as susceptible as grapefruit, while clemelos, siamelos, satsumelos, and tangelos are not so resistant as the mandarin oranges.

(e) The calarins and calashus are as resistant as either parent, while siamors and bigaraldins are susceptible.

(5) All false hybrids are extremely susceptible.

(6) Leaf texture is apparently an important factor in influencing resistance to *Pseudomonas citri* by its host plants. This phase deserves further investigation.

LITERATURE CITED

- (1) JEHLE, R. A.
1917. SUSCEPTIBILITY OF NON-CITRUS PLANTS TO BACTERIUM CITRI. *In* Phyto. pathology, v. 7, no. 5, p. 339-344, 3 fig.
- (2) ———
1918. SUSCEPTIBILITY OF ZANTHOXYLUM CLAVA-HERCULES TO BACTERIUM CITRI. *In* Phytopathology v. 8, no. 1, p. 34-35.
- (3) LEE, H. A.
1918. FURTHER DATA ON THE CITRUS CANKER AFFECTION OF THE CITRUS SPECIES AND VARIETIES AT LAMAO. *In* Philippine Agr. Rev., v. 11, no. 3, p. 200-206, pl. 9-15.
- (4) ———
1918. FURTHER DATA ON THE SUSCEPTIBILITY OF RUTACEOUS PLANTS TO CITRUS-CANKER. *In* Jour. Agr. Research, v. 15, no. 12, p. 661-665, pl. 60-63.
- (5) ——— and MERRILL, R. I.
1919. THE SUSCEPTIBILITY OF A NON-RUTACEOUS HOST TO CITRUS CANKER. *In* Science, n. s. v. 49, no. 1273, p. 497-500.

- (6) PELTIER, George L.
1918. SUSCEPTIBILITY AND RESISTANCE TO CITRUS-CANKER OF THE WILD RELATIVES, CITRUS FRUITS, AND HYBRIDS OF THE GENUS CITRUS. *In Jour. Agr. Research*, v. 14, no. 9, p. 337-357, pl. 50-53.
- (7) ——— and NEAL, D. C.
1918. OVERWINTERING OF THE CITRUS-CANKER ORGANISM IN THE BARK TISSUE OF HARDY CITRUS HYBRIDS. *In Jour. Agr. Research*, v. 14, no. 11, p. 523-524, pl. 58.
- (8) SCOTT, L. B.
1918. VARIETIES OF THE SATSUMA ORANGE GROUP IN THE UNITED STATES. U. S. Dept. Agr. Bur. Plant Indus. Hort. and Pom. Invest. Cir. 1, 7 p.
- (9) TANAKA, Tyozaburo.
1918. VARIETIES OF THE SATSUMA ORANGE GROUP IN JAPAN. U. S. Dept. Agr. Bur. Plant Indus. Crop Physiol. and Breeding Invest. Circ. 5, 10 p., 2 fig.

PLATE 57

Leaf of *Casimiroa edulis*, with naturally occurring spots from the greenhouse inoculations. Note that the spots are small, unruptured, and occur only along scratches. Natural size.

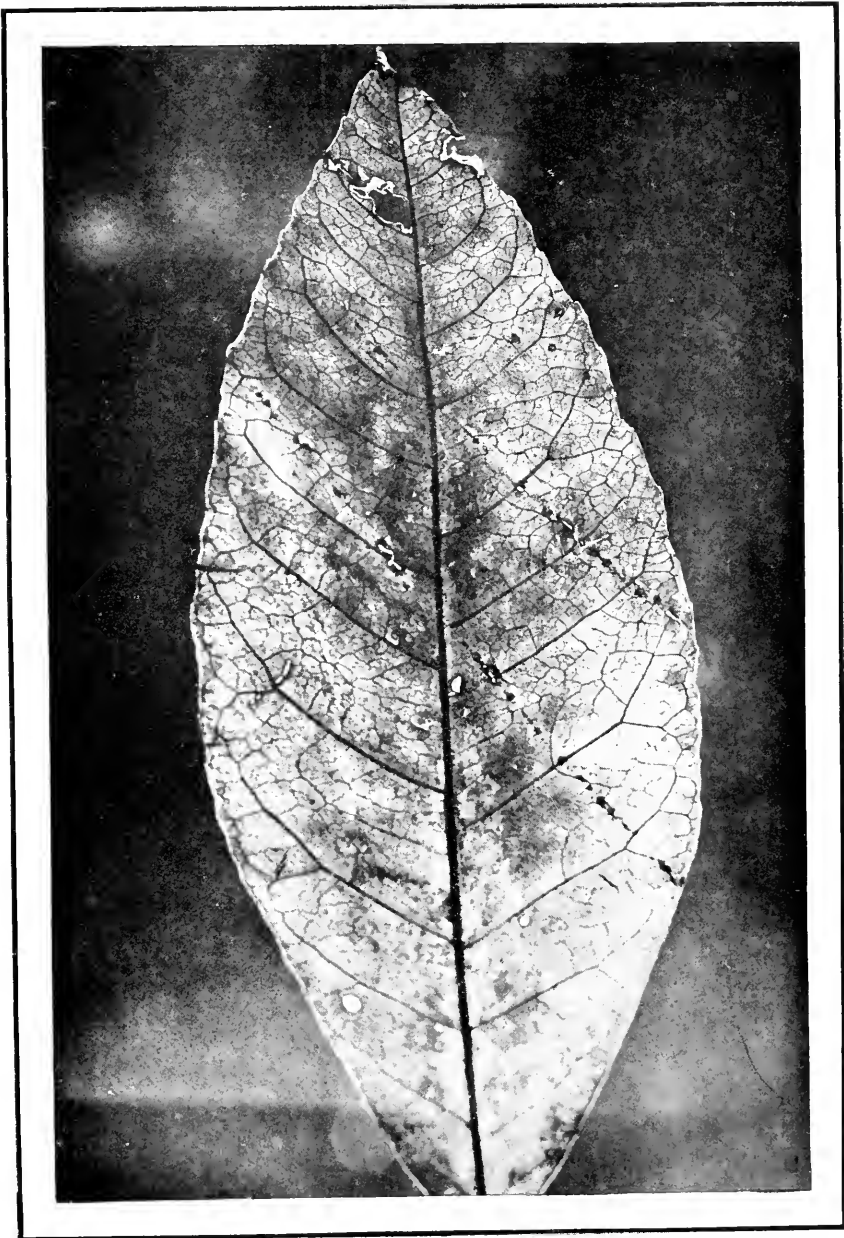

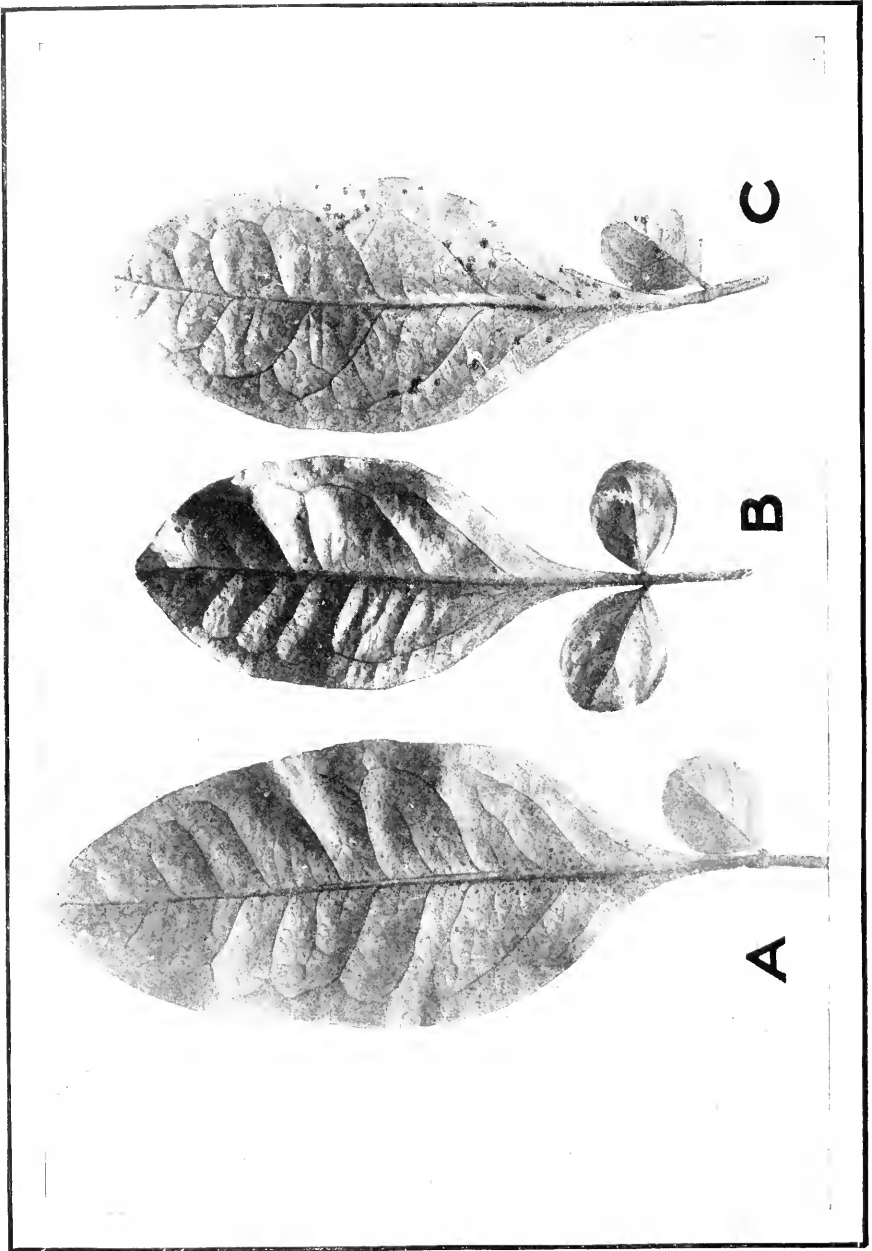

PLATE 58

Infected leaves from plants of *Chaetospernum glutinosum* in the greenhouse experiments, showing the types of canker spots produced:

A.—Spots extremely small and nontypical.

B.—Spots small, oily, raised, and unruptured.

C.—Spots of medium size, ruptured, and slightly corky.

Natural size.

PLATE 59

A.—Leaves of *Atalantia citrioides* and *A. ceylonica* (center) from plants in the greenhouse experiments, showing the canker spots typically produced on these plants. Natural size.

B.—Compound leaf of *Hesperthusa crenulata* from isolation field, with naturally occurring canker spots on two of the leaves. Natural size.

C.—Leaves of *Microcitrus Garrowayi* from plants in the greenhouse experiments, with different types of canker spots. These spots are characteristic of all found on *Microcitrus* spp. $\times 2$.

D, E.—Infected leaves from twigs of *Eremocitrus glauca* from greenhouse plants, showing the large flat spots on the leaves and the rather corky spots on the twig and thorn. $\times 3$.

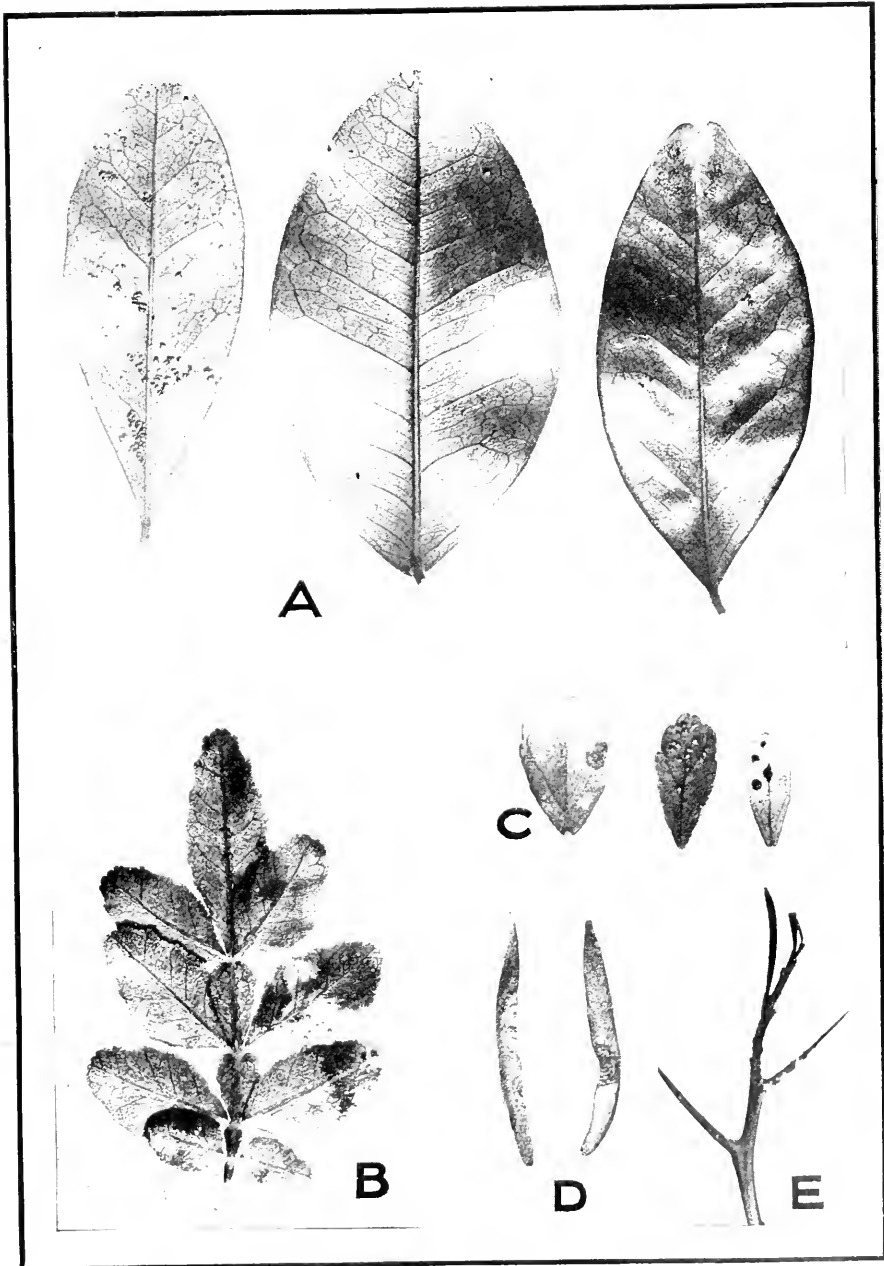

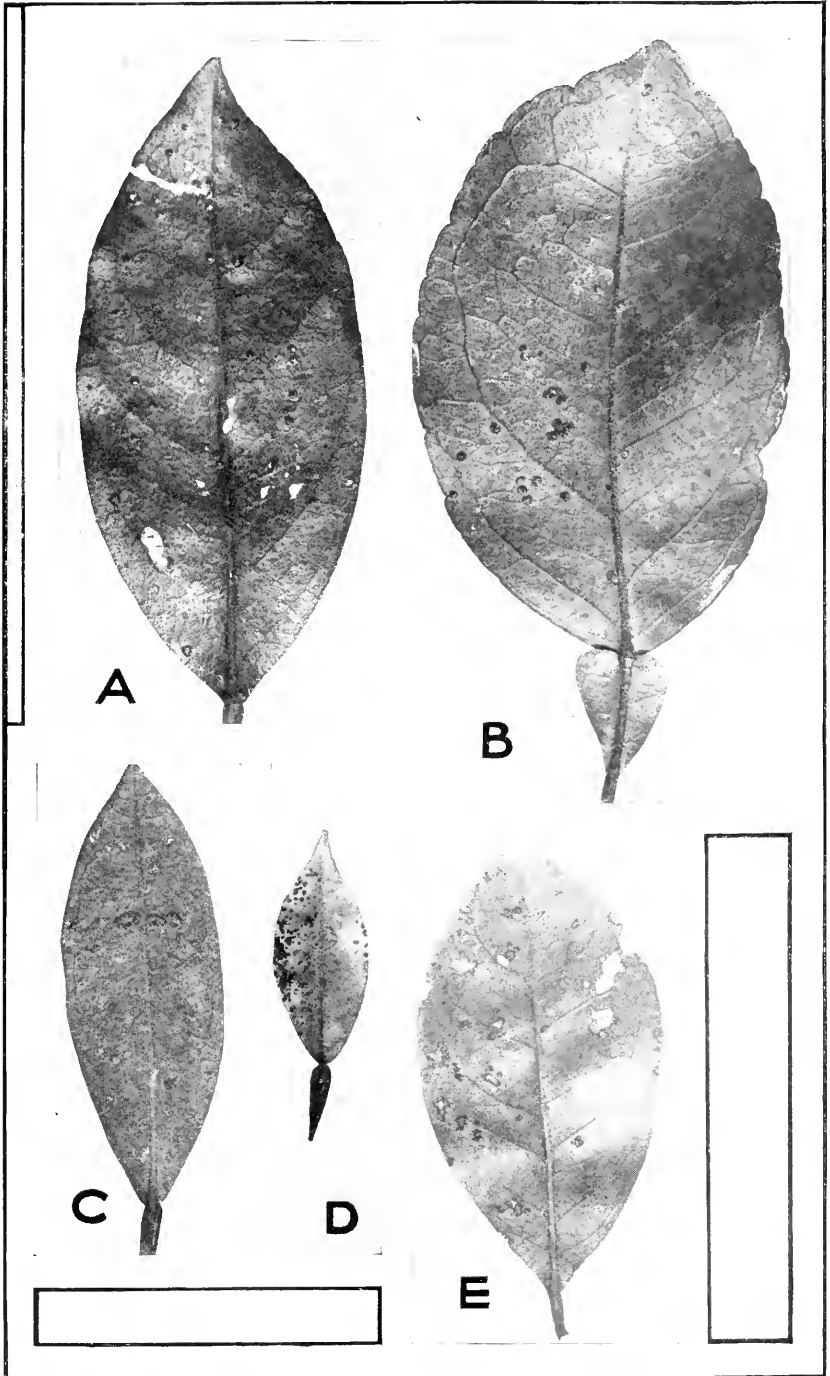

PLATE 60

A.—Typically infected leaf of *Fortunella margarita*.

B.—Old leaf of *Citrus grandis*, with raised, compact, oily, unruptured spots. Compare leaf texture and type of spots with those of *Fortunella margarita*.

C.—*Fortunella Hindsii*, with ruptured corky spots. Compare with the spots found on *F. margarita*.

D.—*Citrus* sp, Kansu or Yuzu orange. Small spots produced on the leaves of these plants are numerous but never increase in size.

E.—*Citrus aurantifolia*, showing typical infections. All natural size and from greenhouse experiments.

PLATE 61

Upper and lower leaf surfaces of a *Citrus hystrix* leaf with a heavy natural canker infection. The yellow zone around the spots is very distinctly shown. Natural size.

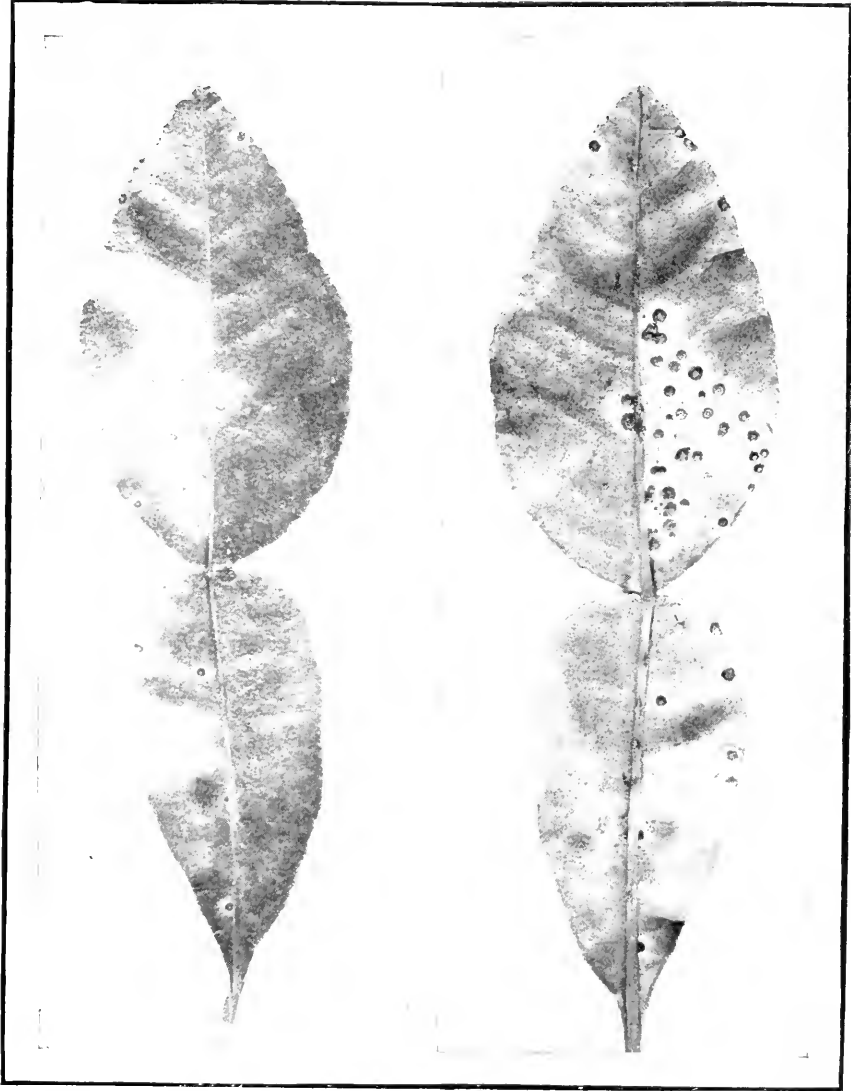

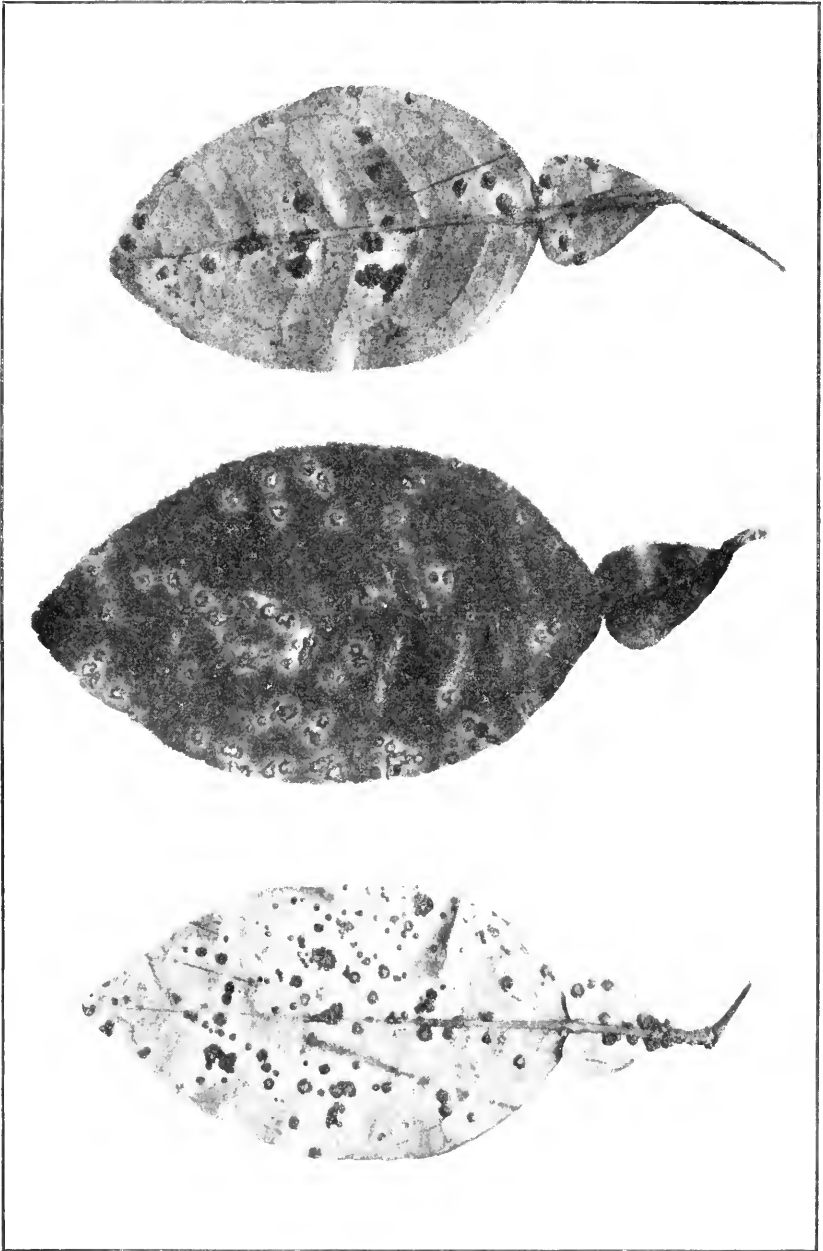

PLATE 62

Typically infected leaves of *Citrus grandis* from field plants showing extreme susceptibility. Note number, size, and corkiness of spots, also the rather large zone surrounding the spots. $\times \frac{2}{3}$.

PLATE 63

A.—Leaves and twigs of faustrime from greenhouse experiment with typical spots. Compare with those on *Microcitrus australis*.

B.—Types of spots found on *Citrus nobilis* (King of Siam, Naranjita, and tangerine). $\times \frac{1}{2}$.

C.—Leaf of the citrangequat from greenhouse experiment. The spots here are extremely small and never increase in size. This is one of the few leaves that have been successfully inoculated.

D.—Citrumelo leaf with typical canker spots. All hybrids of *Poncirus trifoliata* have the same type of spot.

E.—Upper and lower surface of a naturally infected leaf of *Citrus mitis* in the field. Practically all spots occur along the midrib.

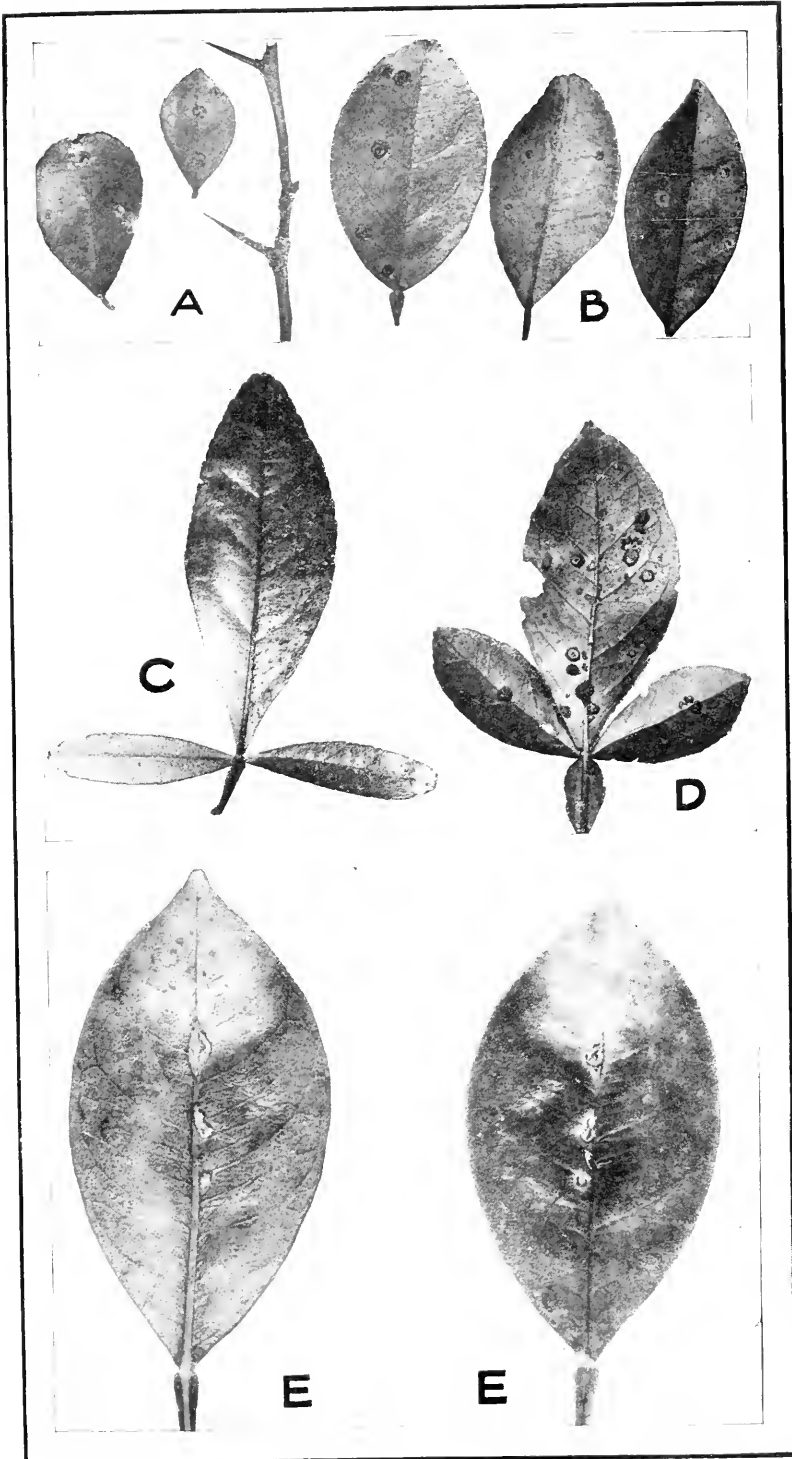

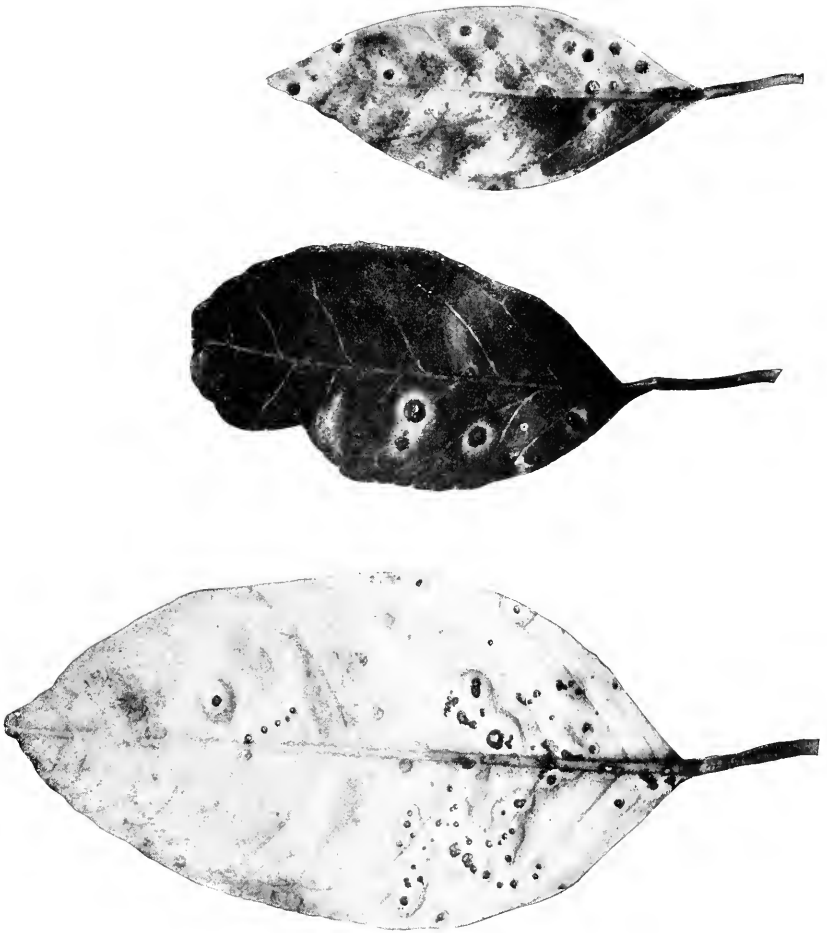

PLATE 64

Naturally infected leaves of *Citrus nobilis* var. *unshiu* from the field, showing various types of spots produced. As a rule the spots on the leaf to the left are found most frequently. All leaves represent rather severe infections. $\times \frac{3}{4}$.

177286°—20—3

PLATE 65

Some of the hybrids of *Porcirus trifoliata*, showing vigor, type of growth, leaf characters, and relative susceptibility to citrus-canker, arranged in order of their susceptibility:

- A.—*P. trifoliata*.
- B.—Rusk citrange.
- C.—Citrumelo.
- D.—Citradia.
- E.—Citrandarin.
- F.—Cicitrangle.
- G.—Citranguma.
- H.—Citrangequat.

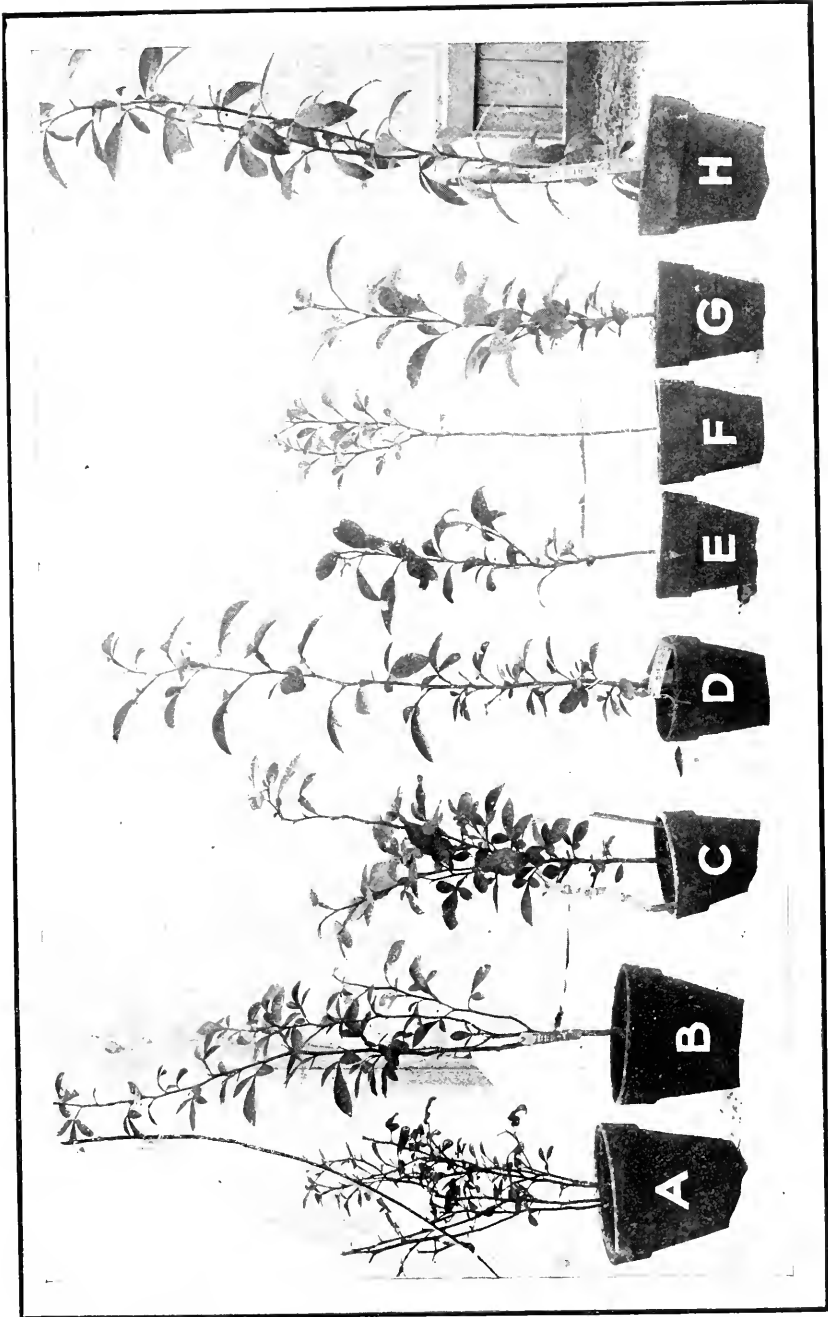

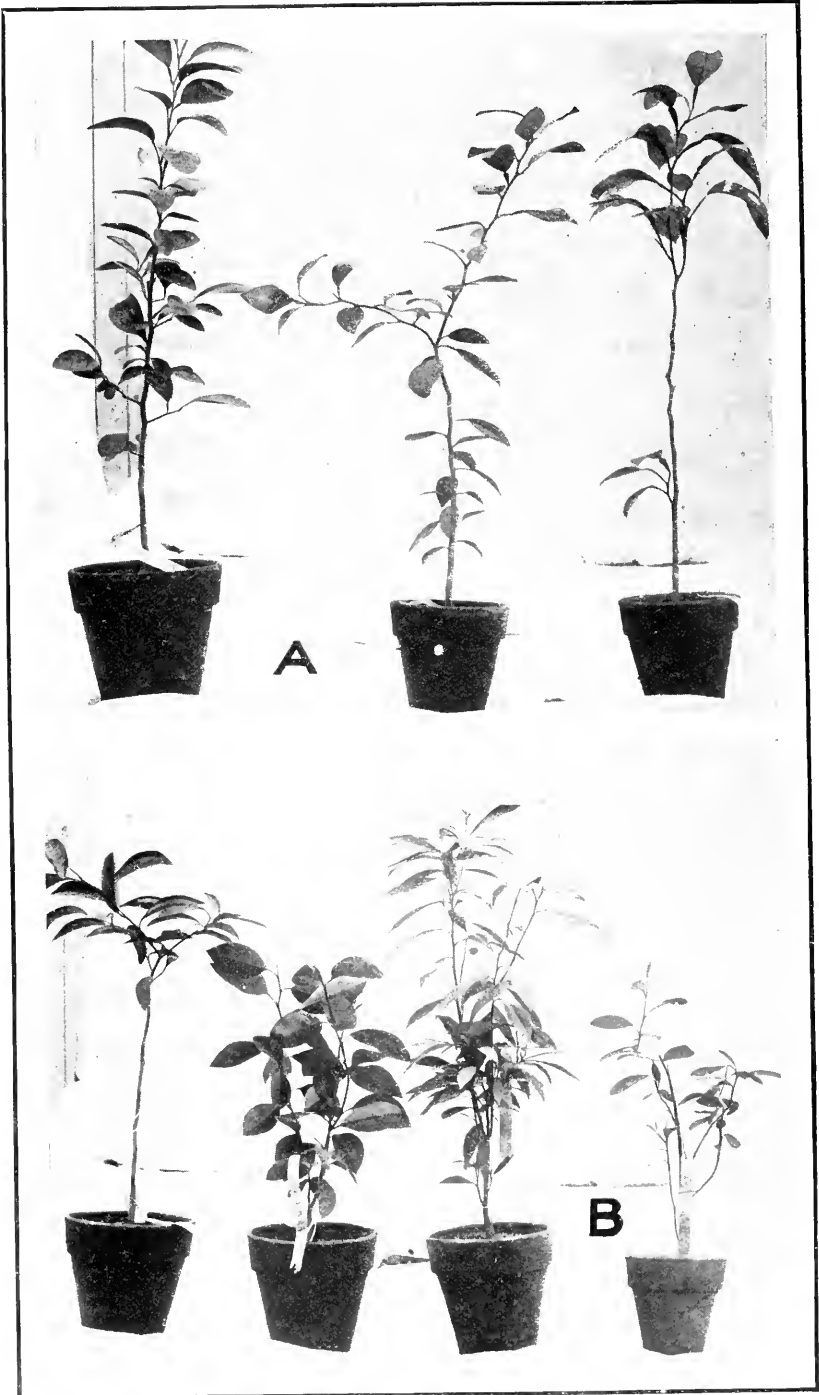

PLATE 66

A.—Limelos in the greenhouse inoculation experiments, showing type of growth, leaf characters, and susceptibility to citrus-canker.

B.—Limequats in the greenhouse inoculation experiments, showing type of growth, character of leaves, and susceptibility to citrus-canker. The large, broad leaf forms at the left are more susceptible than the narrower leaf forms at the right.

PLATE 67

A.—Siamelos in the greenhouse inoculation experiments, showing type of growth, leaf characters, and susceptibility to citrus-canker.

B.—Comparison of type of growth, leaf characters, and susceptibility to citrus-canker in clemelo, satsumelo, and tangelo in the greenhouse inoculation experiments.



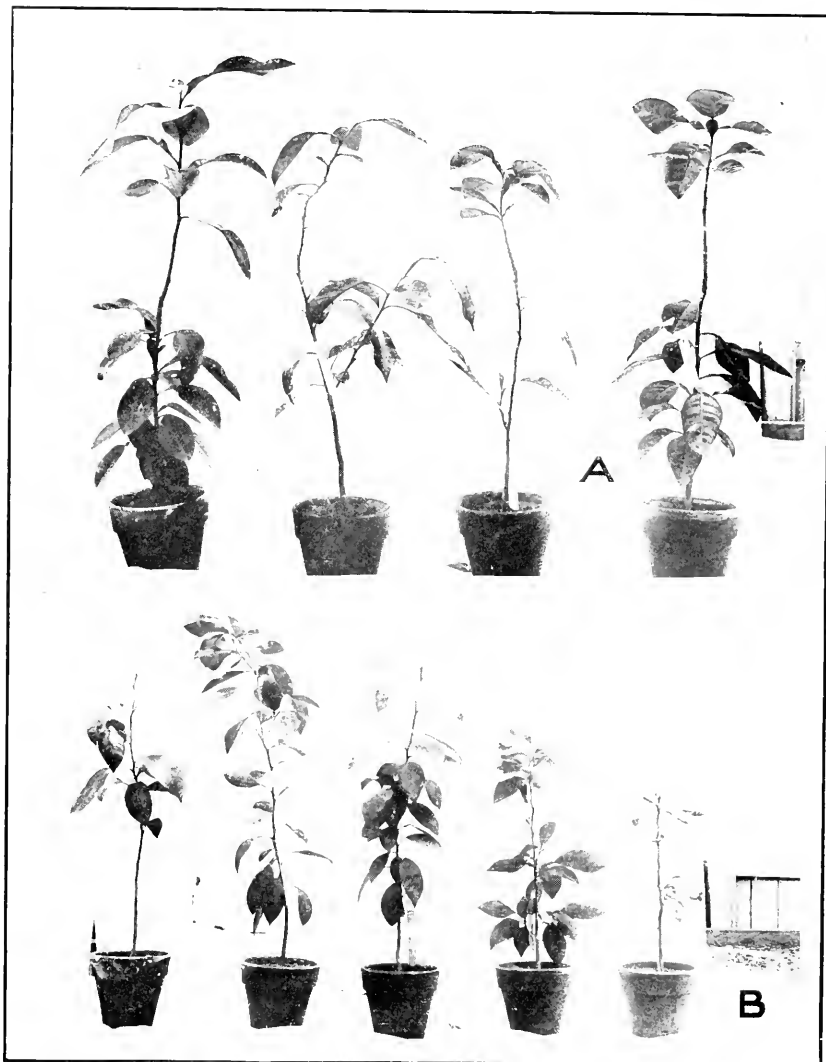
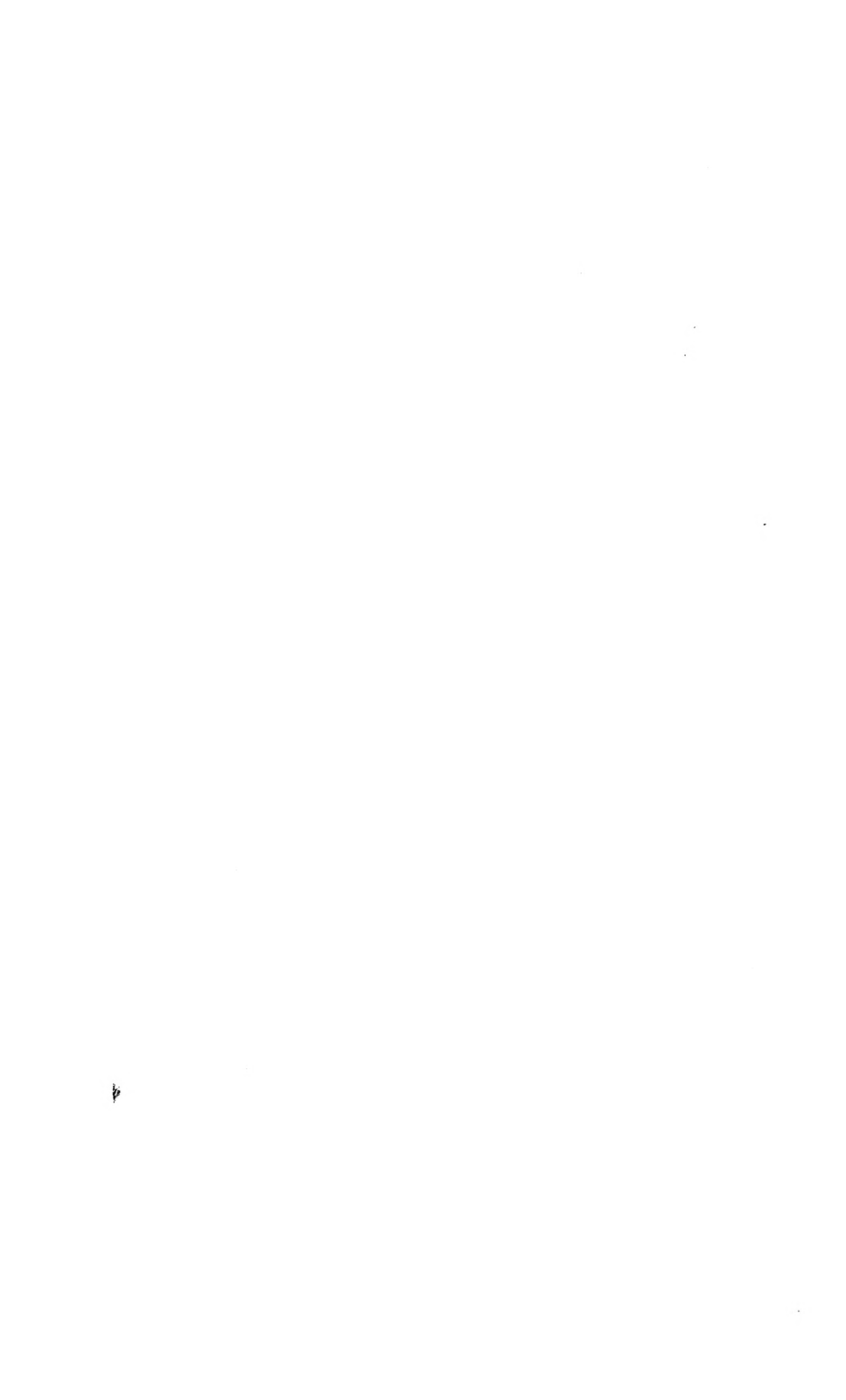

PLATE 68

A.—Results of the greenhouse inoculations with some of the false hybrids. Note defoliation and heavy stem infection.

B.—Tangelos in the greenhouse inoculation experiments, showing type of growth, leaf character, and susceptibility to citrus-canker.



PRESOAK METHOD OF SEED TREATMENT: A MEANS OF PREVENTING SEED INJURY DUE TO CHEMICAL DISINFECTANTS AND OF INCREASING GERMICIDAL EFFICIENCY

By HARRY BRAUN¹

Scientific Assistant, Laboratory of Plant Pathology, Bureau of Plant Industry, United States Department of Agriculture

INTRODUCTION

The widespread use of formalin, copper sulphate, and other germicides in seed treatment for the control of seed-transmitted diseases is generally attended by decreased and retarded seed germination. Pathogens on the seed coats, present as dry bacteria, fungus spores, or dormant mycelium, are usually in a resting stage and as such require the use of disinfectants in a fairly strong concentration—1 to 80 for copper sulphate (CuSO_4) and 1 to 200 or 1 to 320 for formalin (CH_2O)—which often act very detrimentally on the germinating seed. Even much weaker solutions—1 to 200 for copper sulphate and 1 to 400 for formalin—exhibit retarding and killing effects when used on wheat. The use of lime after copper sulphate, while beneficial to some extent, does not entirely prevent seed injury, nor has the detrimental effect of formalin been so far fully counteracted. The economic importance of the annual loss of grain due to seed treatment is such that during the recent war it occasioned an elaborate series of tests of standard grain disinfectants by the War Emergency Board of the American Phytopathological Society.

In fact (3)²—

the difficulty of avoiding injury to the seed from treatment that is too severe or from improper drying after treatment has undoubtedly had more influence in preventing the general spread of the practice of disinfecting seed grain than has the cost of materials or the difficulty of the treatment itself.

In the course of investigations on the blackchaff bacterial disease of wheat (5, 6, 7, 8), under the direction of Dr. Erwin F. Smith, a new treatment (1) of seed wheat with formalin and copper sulphate has been discovered whereby seed injury due to these disinfectants is either entirely eliminated or is reduced to a negligible minimum, while at the same time the bacteria are rendered more susceptible to the action of the disinfectant. The result has been accomplished by a correlation of two

¹ The author wishes to acknowledge his indebtedness to Dr. Erwin F. Smith for helpful criticism and advice throughout the course of this investigation.

² Reference is made by number (*italic*) to "Literature cited," p. 392.

fundamental principles of bacteriology and physico-chemistry: First, the established fact that microorganisms in an active vegetative condition or just resuming activity are more susceptible to destructive agents than when in a dry or dormant state; second, the law governing the diffusion of dissolved substances whereby a solvent has a diluting effect on any solute diffusing into it from a stronger solution.

EXPERIMENTAL METHODS

Numerous experiments with the use of dry heat (90° to 110° C. for various periods) for the control of the blackchaff disease had indicated that it was attended either with serious seed injury or else with incomplete control of the bacteria so as to render it unsatisfactory for field use. Exposure to 105° C. for one hour killed all the bacteria, but it also killed a very considerable part of the seeds, while in every case exposure to temperatures between 90° and 100° C. failed to kill all the bacteria. Earlier experiments with mercuric chlorid (1:1,000) and with copper sulphate (1:1,000) begun by Dr. Smith were abandoned because many seeds were killed by the mercuric chlorid and not quite all the bacteria were killed by the copper sulphate. A number of experiments to determine whether the formalin treatment for cereals might also be applicable as a means of controlling the blackchaff disease showed marked injury to the seeds but gave a fairly satisfactory control. The lesser amount of seed injury growing out of long exposures as compared with short exposures is what led to the discovery of the treatment described in the present paper.

Two parallel series of experiments were carried out—one, to determine the effects on the blackchaff organism of various treatments, the other to observe the effects of the same treatments on the germination of wheat. Nine of the most widely grown wheat varieties were used in the latter series: Turkey, Fultz, Marquis, Bluestem, China, Preston, Poole, Fife, and Fulcaster, obtained through the courtesy of the Office of Cereal Investigations.

Treatments for the seed-germination tests were made as follows, except as otherwise stated. Seeds counted out in sets of 100 were placed in loose cheesecloth bags and soaked thoroughly for 10 minutes in the solution to be tested. The surplus liquid was then drained off, and the seeds were placed in covered moist chambers containing several layers of filter paper previously rinsed with the same solution. After definite periods of time the seeds were removed, spread out to dry overnight, and planted the next day in flats or pots in the greenhouse. Untreated seeds were also planted as controls. Later in the course of the work treated seeds were planted outdoors at the Arlington Experimental Farm.

The effect of the various treatments on the blackchaff organism was determined by the following method, devised by Dr. Smith. Wheat seeds in lots of 100 or more were placed in double envelopes of filter paper and sterilized by dry heat at 150° to 160° C. for three hours, in order to kill all internal and surface organisms. After they had cooled, the envelopes were opened with aseptic precautions and the seeds were thoroughly coated with blackchaff bacteria taken from 2- to 4-day-old nutrient agar or potato cultures and used as a heavily clouded bacterial suspension in sterile tubes of tap water. In this way five isolations of the blackchaff organism from as many States were tested. The seeds, after soaking in the bacterial suspension for 20 minutes, were replaced in the envelopes and allowed to dry overnight. By this method each kernel was coated with a dry film of live bacteria such as would occur on badly infected seed under natural conditions. The next day the inoculated and dried seeds were dropped into sterile test tubes containing the disinfectant to be tested. The liquid was drained off after it had acted 10 minutes. The tubes containing the seeds, which now had a thin layer of the solution around each kernel, were placed in moist chambers previously rinsed with the same solution. After definite periods the seeds, still moist, were replaced in the sterile envelopes to dry overnight. The next day they were transferred to nutrient agar previously determined to be suitable for the organism, in poured plates, 10 seeds per plate. Each seed was handled with forceps which had been dipped in alcohol and flamed. Control seeds which had been inoculated but not subsequently treated were also planted on this agar. After at least nine days the final records were made. The controls usually developed a typical blackchaff colony around each kernel. Treated seeds, if all the bacteria thereon were killed by the solution used, remained sterile unless contaminated by other organisms or slowly produced blackchaff colonies if the disinfectant had not been fully effective. This method is a good index of the effect on the bacteria of the various treatments studied. The seeds are sterilized by dry heat externally and internally without leaving any antiseptic residue such as might be left by chemical sterilization. The treatment under consideration is performed upon dried but live bacteria which are found on the seed coat exactly as they would occur in field practice, except that ordinarily they would be less viable and there would be fewer of them. The subsequent exposure on agar plates to optimum conditions for bacterial growth reveals the effect of the treatment, in that the bacteria on the seeds, if uninjured by the treatment, are enabled to develop characteristic colonies, the slowness of their development being a very good index of the proportion killed. Over 5,500 seeds were treated in this manner in the course of the investigation.

EXPERIMENTAL STUDIES

EFFECT OF FORMALIN TREATMENT ON BACTERIUM TRANSLUCENS VAR. UNDULOSUM SMITH, JONES, AND REDDY

As the bacterial blackchaff disease has often been found together with the covered smut of wheat in western fields, experiments were first performed to determine whether the formalin treatment for smut would at the same time control the blackchaff disease. Following the procedure above outlined, sterilized wheat seeds were inoculated with virulent isolations of the blackchaff organism and then treated for various periods with formalin 1 to 200 and 1 to 400 (1 part of 36.6 per cent formalin to 200 or 400 parts sterile tap water) and finally dried and planted on agar plates. The results of treatments of over 3,000 wheat seeds in four experiments are summarized in Table I.

TABLE I.—*Effect of formalin treatment on blackchaff bacteria on wheat seeds*

Treatment.	Total number of seeds used.	Percentage developing typical blackchaff colonies.	Percentage remaining sterile.	Percentage contaminated with fungi or bacteria other than blackchaff.
Formalin 1:200 overnight.....	294	0.0	82.3	17.7
Formalin 1:400 for 3 hours.....	1,000	.1	92.6	7.3
Formalin 1:400 for 6 hours.....	1,000	.0	96.7	3.3
Formalin 1:400 for 12 hours.....	597	.0	84.7	15.3
Controls inoculated but not treated.....	320	82.6	16.2	1.2

The data show that the blackchaff bacteria, dried on wheat seeds as under natural conditions, can be held under control by the formalin 1 to 400 treatment, especially when exposed for six hours or longer.

Since all the formalin used in treating the seeds had evaporated during the overnight drying, no residual solution could have been left on the seeds in the plates to prevent bacterial growth. Neither did 24 to 48 hours' drying after inoculation kill the organisms, as was shown by growth in the controls, which acted as an index of the viability of the dried organisms as well as of the suitability for bacterial growth on the part of the particular lot of media used. The conclusion is evident that absence of blackchaff bacterial growth around treated seeds was due only to the effect of the treatment.

GREENHOUSE EXPERIMENTS WITH FORMALIN AND COPPER SULPHATE

EFFECT OF FORMALIN TREATMENT ON GERMINATION OF WHEAT SEED

Parallel with the experiments made to determine the effect on the bacteria, a series was carried out to determine the effect of the two formalin solutions, as used above, on the germination of wheat seed. The 1 to 200 strength formalin was not tried after the second test because

it appeared too injurious to germination to be of any practical value in the field. A total of 6,300 seeds of three varieties was treated in this series and planted in flats in the greenhouse. Records of germination, counting all seedlings above ground on the seventh day after planting for experiment I and those above ground on the ninth day for experiments II and III, are given in Table II.

TABLE II.—*Effect of formalin treatment on germination of wheat seed*

Treatment.	China.				Bluestem.				Turkey.			
	Average percentage of germination.				Average percentage of germination.				Average percentage of germination.			
	Exp. I.	Exp. II.	Exp. III.	Average.	Exp. I.	Exp. II.	Exp. III.	Average.	Exp. I.	Exp. II.	Exp. III.	Average.
Control.....	78	63	63	68	50	53	43	49	56	63	75	65
Formalin 1:400 for 3 hours.....	56	48	40	48	24	26	31	27	42	45	65	51
Formalin 1:400 for 6 hours.....	53	40	45	46	25	34	35	31	48	53	62	54
Formalin 1:400 for 12 hours.....	74	53	46	58	39	33	40	37	50	54	68	57
Formalin 1:200 for 3 hours.....	39	15	27	9	19	14	23	31	27
Formalin 1:200 for 6 hours.....	37	33	35	13	17	15	17	32	25
Formalin 1:200 for 12 hours.....	57	29	43	9	16	13	34	36	35

The preceding table shows grave injury to germination where the stronger solution was used. There was also marked retardation of germination. Formalin 1 to 400, while much less harmful, caused an appreciable decrease in germination as compared with the controls. It was observed, however, that the 12-hour treatment (1:400) invariably produced less retardation and loss in germination than the 3-hour treatment. This was repeatedly evident for each variety (Pl. 69). A fourth test for Turkey wheat (part of experiment IV), using 400 seeds treated with formalin 1 to 400 for 1 hour, 400 seeds treated 12 hours, and 100 seeds untreated, gave on the sixth day after planting 45 per cent germination for the 1-hour treatment, 59 per cent for the 12-hour treatment, and 62 per cent for the controls. These results, so contrary to what might have been expected, led to the experiments to be described. A search of the literature after these results had been obtained disclosed a similar condition in a number of cases not commented on by the authors—that is, less injury from long exposures than from short ones.

Such a condition is found in an analysis which I have made of the data presented by a subcommittee of the War Emergency Board of Plant Pathologists (4) on the effect of formalin 1 to 320 acting for various periods on different cereal seeds. With wheat, in 18 tests out of 25

the short 2-hour treatment shows more injury than a longer treatment; with barley, 14 out of 19 tests show more injury from the short treatment; and so with oats in 29 out of 41 tests and with rye in 2 out of 3 tests. In some cases there is a steady decrease of injury as the treatment period lengthens.

A study of the tables given by Stuart (9) in his paper on the effect of formalin on oat germination shows almost invariably greater injury to germination caused by 2-hour treatment than by 4-hour treatment of seeds, and a similar effect on the final yield of grain and straw—a fact not commented on by that writer.

These facts led to the conjecture that the formaldehyde content in the seeds at the end of 3 hours was really stronger than in the 12-hour treated seeds. Such a condition might be explained by the hypothesis that the dry seeds absorb the formaldehyde itself more rapidly than they do the water and that by diffusion later this is diluted to a strength more like the original solution through continued absorption of water by the cell walls and cells.

Theoretically, therefore, if the 3-hour treatment could be made in such a way that the final solution content of the seeds would be comparable in amount and dilution with that finally present in 12-hour treated seeds, the effects on germination should also be similar. By impregnating the cell walls and cells of dry seeds with water and then treating with formalin for three hours, it appeared as if this result might be attained; for, in accordance with the laws of diffusion of dissolved substances, the formalin should be diluted as it diffused into the water-saturated seed tissues.

Acting on this hypothesis, wheat seeds were first soaked in tap water for 10 minutes, drained, and kept moist for 9 hours, then soaked thoroughly in formalin 1 to 400 for 10 minutes, drained, and kept moist for 3 hours in order that the water absorbed during the first 9 hours might weaken the full strength solution diffusing into the cells during the next 3 hours and might result in less injury than was caused by the 3-hour treatment of dry seeds. Following this, numerous experiments were made, varying the length of time during which the seeds were kept moist but starting out always with a preliminary short plunge into water. This method—short exposure under water followed by varying lengths of exposure to moist air (covered)—has been designated throughout this paper as the “presoak” method of seed treatment. In the same way, whenever exposure to formalin is mentioned it means always that the seeds were plunged into the formalin water solution for a short period only (usually 10 minutes) and then kept moist (covered) for the designated number of hours.

The seeds of two varieties so treated were planted in the greenhouse with 12-hour treated seeds and controls. Table III records the results observed.

TABLE III.—Effect of 9 hours' presoaking followed by formalin 1 : 400 treatment

Treatment.	Percentage of germination.					Marquis, Exp. VI.
	China.	Blue-stem.	China.			
			Exp. V.	Exp. VI.	Average.	
Control.....	70	78	46	50	48	59
Formalin 1:400 for 10 minutes, covered 12 hours.....	60	60	40	43	42	56
Formalin 1:400 for 10 minutes, covered 3 hours.....			35	23	29	49
Water for 10 minutes, covered 9 hours, formalin 1:400 for 10 minutes, covered 3 hours.....	67	72	45	42	44	58

Table III shows for the presoaked seeds not only a decrease in injury over the 3-hour treated seeds as previously observed but also a decided increase in germination over the seeds treated 12 hours with formalin. The latter show a loss of 10 to 18 per cent, the former a loss of only 3 to 6 per cent. At the same time the presoaked seeds produced larger and more vigorous plants than the controls.

Very clearly the presoak treatment followed by 3 hours of formalin treatment showed a distinct advantage over the usual formalin treatment. As this appeared to be a promising method of reducing formalin injury, a thorough test was then made with all the varieties of wheat at hand. It appeared possible that for some varieties a 9-hour presoak might begin germination before treatment, thus rendering the seeds very susceptible to injury, whereas, a formalin-treatment period longer than 3 hours appeared desirable for control purposes. For these reasons, the presoak period was reduced to 6 hours, followed by a 6-hour treatment with formalin.

EFFECT OF 6 HOURS' PRESOAKING FOLLOWED BY FORMALIN 1 TO 400 TREATMENT ON GERMINATION OF WHEAT SEED

The presoak treatment in every instance was given by soaking the seeds 10 minutes in water, then draining off the surplus water and keeping the seeds in moist chambers 6 hours, allowing the seeds to absorb the surface moisture film during this period. After shaking off all possible surface water, the next step was to soak the seeds thoroughly in a 1 to 400 formalin solution, stirring and rinsing up and down to bring the solution in contact with each kernel. After 10 minutes in this solution the seeds were removed, drained, and kept moist for 6 hours in moist chambers previously rinsed with the same solution. After treatment the seeds were dried overnight and planted in the greenhouse, 100 seeds per pot, in duplicate or triplicate.

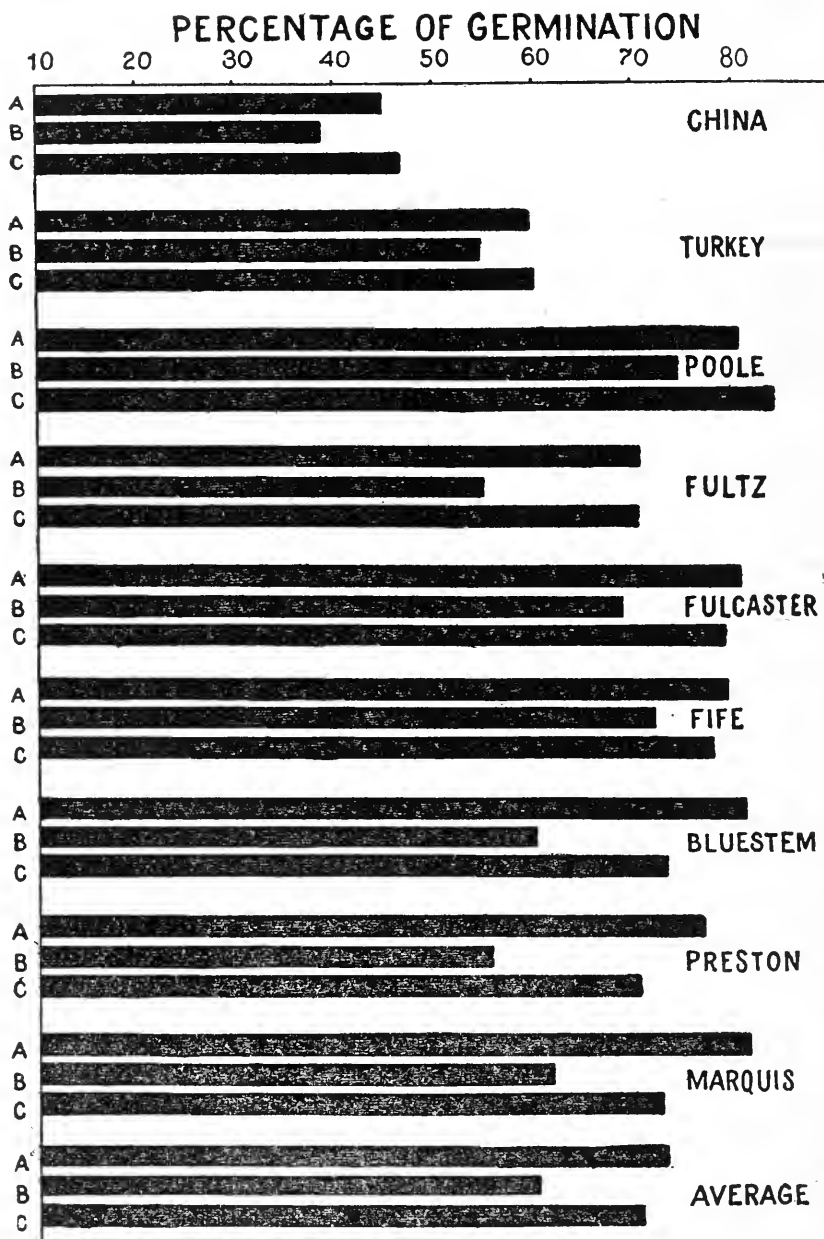

FIG. 1.—Graph showing effect of formalin 1 to 400 treatments with and without presoaking: A, control, untreated; B, seeds soaked in formalin 1 to 400 for 10 minutes, drained, and kept moist (covered) 12 hours, dried overnight, and planted; C, seeds soaked in water 10 minutes, drained, and kept moist (covered) 6 hours, soaked in formalin 1 to 400 for 10 minutes, drained, and kept moist (covered) 6 hours, dried overnight, and planted. Records of germination were taken on the sixth day after planting in the greenhouse.

Using a 6-hour presoak followed immediately by a 6-hour treatment with formalin 1 to 400, 6 experiments were carried on in the greenhouse with 23,700 seeds of nine varieties, the test for each variety being repeated several times. Table IV and figure 1 show the data obtained on the sixth day after planting in each test, this date being chosen as showing not only the relative percentage of germination but particularly revealing any retardation or acceleration. At the same time, the effect of this method on the blackchaff bacteria was determined, as discussed later.

TABLE IV.—Effect of 6 hours' presoaking followed by formalin 1 : 400 treatment on germination of wheat seed

Treatment.	Average percentage of germination.											
	Fife.				Bluestem.				Preston.			
	Exp. V.	Exp. VI.	Exp. VII.	Average.	Exp. V.	Exp. VI.	Exp. VII.	Average.	Exp. V.	Exp. VI.	Exp. VII.	Average.
Control.....	89	74	75	79	83	79	82	81	79	75	77	77
Formalin 1:400 for 10 minutes, covered 12 hours.....	75	66	75	72	61	54	66	60	53	51	63	56
Water for 10 minutes, covered 6 hours, formalin 1:400 for 10 minutes, covered 6 hours.....	77	71	86	78	74	64	82	73	66	64	82	71

Treatment.	Average percentage of germination.										
	Marquis.				China.			Turkey.			
	Exp. V.	Exp. VI.	Exp. VII.	Average.	Exp. V.	Exp. VI.	Average.	Exp. V.	Exp. VI.	Average.	
Control.....	82	79	84	82	52	38	45	60	61	61	
Formalin 1:400 for 10 minutes, covered 12 hours.....	54	62	70	62	44	34	39	60	52	56	
Water for 10 minutes, covered 6 hours, formalin 1:400 for 10 minutes, covered 6 hours.....	61	75	82	73	50	44	47	71	50	61	

Treatment.	Average percentage of germination.											
	Poole.				Fultz.							
	Exp. VIII.	Exp. IX.	Exp. X.	Average.	Exp. VIII.	Exp. IX.	Exp. X.	Average.	Exp. VIII.	Exp. IX.	Exp. X.	Average.
Control.....	72	80	92	81	55	83	74	71	71	71	71	71
Formalin 1:400 for 10 minutes, covered 6 hours.....	67	85	70	74	57	70	57	61	61	61	61	61
Formalin 1:400 for 10 minutes, covered 12 hours.....	65	82	79	75	42	66	62	57	57	57	57	57
Water for 10 minutes, covered 6 hours, formalin 1:400 for 10 minutes, covered 6 hours.....	76	89	89	88	60	78	76	71	71	71	71	71

TABLE IV.—Effect of 6 hours' presoaking followed by formalin 1 : 400 treatment on germination of wheat seed—Continued

Treatment.	Fulcaster.				Turkey.			
	Exp. VIII.	Exp. IX.	Exp. X.	Average.	Exp. VIII.	Exp. IX.	Exp. X.	Average.
Control.....	82	84	79	82	41	74	64	59
Formalin 1 : 400 for 10 minutes, covered 6 hours.....	62	67	60	63	^a 56	64	48	56
Formalin 1 : 400 for 10 minutes, covered 12 hours.....	68	72	69	70	35	67	61	54
Water for 10 minutes, covered 6 hours, formalin 1 : 400 for 10 minutes, covered 6 hours...	77	80	83	80	46	71	65	57

^a Result from one pot only, the other having been overturned.

For each variety of wheat used the result is the same—a marked decrease in retardation and injury to germination where the presoak method

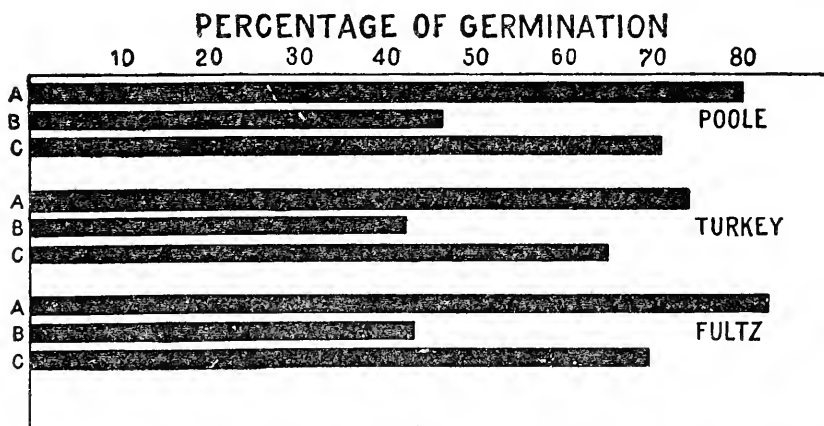

FIG. 2.—Graph showing effect of formalin 1 to 200 treatments with and without presoaking: A, control, untreated; B, seeds soaked in formalin 1 to 200 for 10 minutes, drained, and kept moist (covered) 6 hours, dried overnight, and planted; C, seeds soaked in water 10 minutes, drained, and kept moist (covered) 6 hours, then soaked in formalin 1 to 200 for 10 minutes, drained, and kept moist (covered) 6 hours, dried overnight, and planted. Records of germination were taken on the sixth day after planting in the greenhouse.

of treatment was used, as compared with the 6- or 12-hour formalin treatment without presoaking. In the case of the three varieties most susceptible to formalin—Bluestem, Preston, and Marquis—germination of the presoak-treated seeds is within 6 to 9 per cent of the controls, while there is a reduction of 20 to 21 per cent in the seeds treated without presoaking. The other six varieties show practically all injury eliminated by the presoak treatment. The relative appearance of controls, treated plants, and presoak-treated plants on the sixth day is shown in Plates 70 and 71. A very noticeable stimulation in vigor was observed in

all of the presoak-treated seeds as compared with the controls. This is brought out also in Plate 72.

EFFECT OF 6 HOURS' PRESOAKING FOLLOWED BY FORMALIN 1 TO 200 TREATMENT ON GERMINATION OF WHEAT SEED

The beneficial effect of the presoak method is strikingly shown in an experiment where a much stronger solution of formalin was used. Seeds of three varieties were treated for 10 minutes with formalin 1 to 200 and were then kept moist (covered) for 6 hours, dried overnight, and planted in the greenhouse. Another set of seeds received the same treatment but were first soaked in water 10 minutes, drained, and kept moist 6 hours before receiving the formalin treatment. This strength of 1 to 200 had previously been found to cause a very considerable injury to germination. Table V and figure 2 show the percentage of germination on the sixth day.

TABLE V.—*Effect of 6 hours' presoaking followed by formalin 1 : 200 treatment on germination of wheat seed*

Treatment.	Average percentage of germination.		
	Poole.	Turkey.	Fultz.
Control.....	80	74	83
Formalin 1 : 200 for 6 hours.....	46	42	43
Water for 6 hours, formalin 1 : 200 for 6 hours.....	71	65	70

Here the 6-hour formalin 1 to 200 treatment reduced germination 32 to 40 per cent below that of the controls, while the reduction was only 9 to 13 per cent where the same treatment was preceded by 6 hours' water presoak (Pl. 73.)

EFFECT OF 6 HOURS' PRESOAKING FOLLOWED BY FORMALIN 1 TO 320 TREATMENT ON GERMINATION OF WHEAT SEED

Formalin 1 to 320, or one pound of formalin to 40 gallons of water, was next used, since that is the strength now recommended for the cereal smuts. Besides the presoak procedure so far followed, a test was made (experiment XI) of the effect of an actual soaking in water for 5 hours, followed by thorough draining for a few minutes, then 10 minutes' soaking in the formalin 1 to 320, then covering for 7 hours before drying and planting. Experiment XII was conducted to test the effect of an actual soaking in water for 4 hours, followed by thorough draining for a few minutes, then soaking in formalin 1 to 320 for 10 minutes, draining, covering 6 hours, drying, and planting. The results obtained are shown in Table VI and figure 3.

TABLE VI.—Effect of 6 hours' presoaking followed by formalin 1 : 320 treatment on germination of wheat seed under greenhouse conditions

Treatment.	Average percentage of germination.					
	Poole.			Fife.		
	Exp. XI.	Exp. XII.	Average.	Exp. XI.	Exp. XII.	Average.
Control.....	94	85	90	79	83	81
Formalin 1 : 320 for 10 minutes, drained, covered 6 hours.....	66	55	61	59	62	61
Formalin 1 : 320 for 10 minutes, drained, covered 12 hours.....	67	71	69	58	64	61
Water for 10 minutes, covered 6 hours, formalin 1 : 320 for 10 minutes, drained, covered 6 hours..	90	88	89	80	90	85
Actual soaking in water 5 hours, formalin 1 : 320 for 10 minutes, covered 7 hours.....	88	88	77	77
Actual soaking in water 4 hours, formalin 1 : 320 for 10 minutes, covered 6 hours.....	79	79	85	85

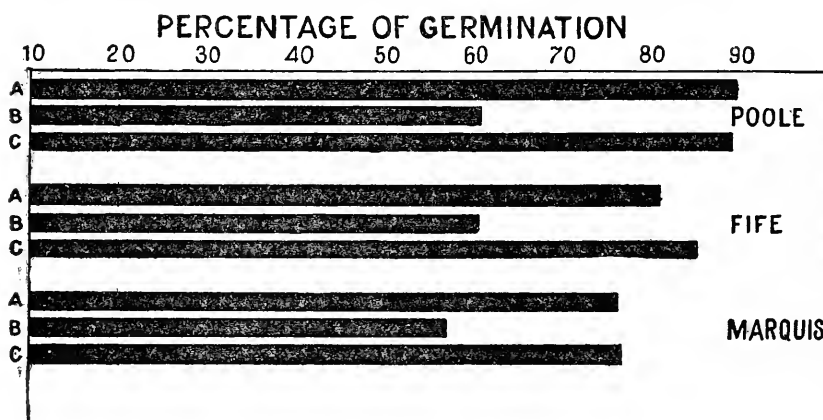

FIG. 3.—Graph showing effect of formalin 1 to 320 with and without presoaking: A, control, untreated; B, seeds soaked in formalin 1 to 320 for 10 minutes, drained, kept moist (covered) 6 hours, dried overnight, and planted; C, seeds soaked in water 10 minutes, drained, kept moist (covered) 6 hours, soaked in formalin 1 to 320 for 10 minutes, drained, kept moist (covered) 6 hours, dried overnight, and planted. Records of germination were taken on the sixth day after planting in the greenhouse.

A marked retardation and diminished germination is shown by both formalin treatments without presoaking. The 6-hour formalin treatment preceded by 6 hours' presoaking yielded plants similar to the controls in percentage of germination, and they were very evidently stimulated, as shown in Plates 74, 75, and 76. Actual soaking in water did not appear to be so beneficial to the vigor of the seedlings as the procedure of merely keeping the seeds moist for 6 hours before treating with formalin. (See Pl. 75, fig. 3.)

EFFECT OF PRESOAKING WHEN USED WITH COPPER SULPHATE FOR WHEAT AND BARLEY SEED

The striking reduction in formalin injury to seed germination when the presoak method was used led to trials of this method in conjunction with copper sulphate. Six hundred wheat seeds of Fife and Fulcaster varieties were soaked in a very strong copper-sulphate solution (1:80, or 1 pound to 10 gallons of water) for 10 minutes, drained 20 minutes, dipped for a moment in milk of lime, and dried. A like number of seeds received the same treatment except that they were kept moist for 8 hours after

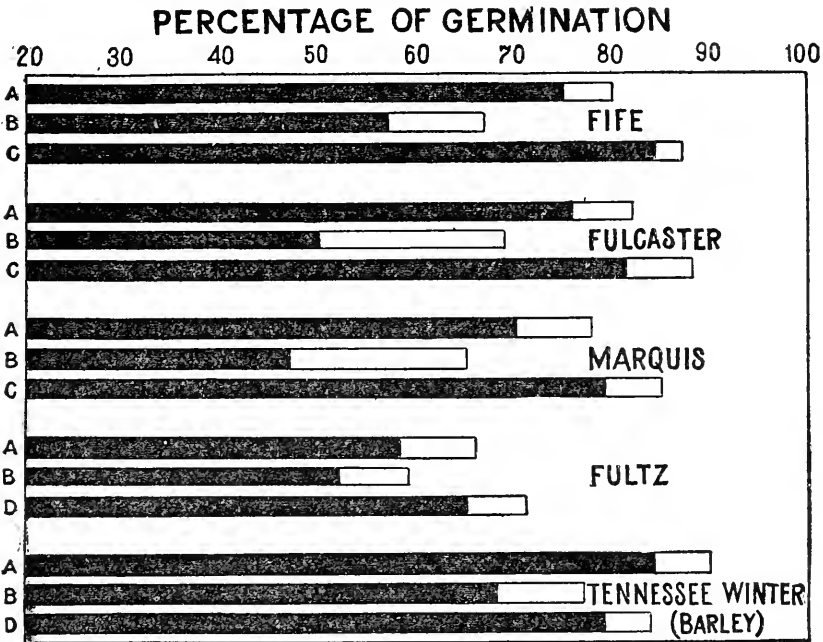

FIG. 4.—Graph showing effect of copper sulphate 1 to 80, with and without presoaking, on wheat and barley seed germination: A, control, untreated; B, seeds soaked in copper sulphate 1 to 80 for 10 minutes, drained, kept moist 20 minutes, then limed, dried overnight, and planted; C, seeds first soaked in water 10 minutes, drained, and kept moist (covered) for 8 hours, then treated as in B; D, seeds first soaked in water 10 minutes, drained, kept moist (covered) for 6 hours, then limed, dried overnight and planted. Records of germination were taken on the fifth and seventh days after planting in the greenhouse.

soaking 10 minutes in tap water. Four hundred seeds were used as controls. All seeds were planted in the greenhouse after drying overnight. The experiment was later repeated, using barley also and wheat seeds of Fultz and Marquis varieties, kept moist in the manner described for 6 hours before treatment. The photographs (Pl. 76, 77) and figure 4 show the results obtained.

In these experiments the injury produced by the copper-sulphate treatment was prevented by the use of the 6- or 8-hour presoak. The 6-hour presoak appears preferable, because a longer period, by starting

seed germination, may render the seed unusually susceptible to the subsequent copper-sulphate treatment and thus defeat its purpose.

A marked increase in the percentage of germination was observed in the presoak-treated seeds over the controls. This was probably due not only to the lack of injury in the former but to the residual effect of the copper sulphate and lime, which, by preventing seed infection through soil organisms, enabled more seeds to germinate. There was also a marked stimulating effect on the growth of the seedlings.

The use of the presoak method of treatment also reduces copper-sulphate injury in barley, as shown in Plate 76, figure 3. The fact that the presoak method can reduce seed injury from formalin and copper sulphate, two disinfectants of widely different chemical nature, suggests the possibility of its use in conjunction with mercuric chlorid also, another commonly used seed disinfectant.

FIELD EXPERIMENTS WITH FORMALIN AND COPPER SULPHATE

EFFECT OF 6 HOURS' PRESOAKING FOLLOWED BY FORMALIN 1 TO 320 TREATMENT ON GERMINATION OF WHEAT SEED UNDER FIELD CONDITIONS

That formalin injury to germination can be greatly decreased under field conditions when the presoak method is used is shown by the following experiment. Using seven wheat varieties, 16,800 seeds were planted on a uniform level plot at the Arlington Experimental Farm. For each variety 12 rows of 200 seeds each were distributed as follows: four rows of controls, four rows of seeds treated with formalin 1 to 320 for 6 hours, and four rows of seeds similarly treated but presoaked 6 hours. The results were striking. In each variety the central four rows, which received the usual treatment recommended for smut, showed a marked decrease in germination (27 to 53 per cent, averaging 38 per cent for the seven plots) while in each case the four rows receiving the presoak formalin treatment scarcely differed in appearance from the controls (Pl. 78). Table VII and figure 5 give the data obtained.

TABLE VII.—Effect of 6 hours' presoaking followed by formalin 1:320 treatment on germination of wheat seed under field conditions

Treatment.	Average percentage of germination.													
	Fulcaster		* Fiie.		Turkey.		Poole.		China.		Bluestem.		Marquis.	
	10th day.	20th day.	10th day.	20th day.	10th day.	20th day.	10th day.	20th day.	10th day.	20th day.	10th day.	20th day.	10th day.	20th day.
Control.....	60.0	66.3	58.4	59.6	40.6	50.4	60.2	64.3	26.1	32.6	62.2	63.0	50.2	53.9
Formalin 1:320 for 10 minutes, covered 6 hours.....	32.1	36.8	31.0	41.8	24.2	28.6	20.4	29.8	14.5	21.1	32.5	44.5	24.2	39.1
Presoaked in water, 10 minutes, kept moist 6 hours, formalin 1:320 for 10 minutes, covered 6 hours.....	52.5	56.4	56.2	58.3	40.8	51.2	53.5	58.3	30.8	35.4	43.6	53.6	46.8	51.6

The results obtained in the field fully corroborate the greenhouse experiments as to the beneficial effect of the presoak method and show that in actual field practice wheat seed injury caused by the formalin treatment recommended for covered smut can be practically eliminated by allowing the seeds to absorb water in the manner prescribed for six hours

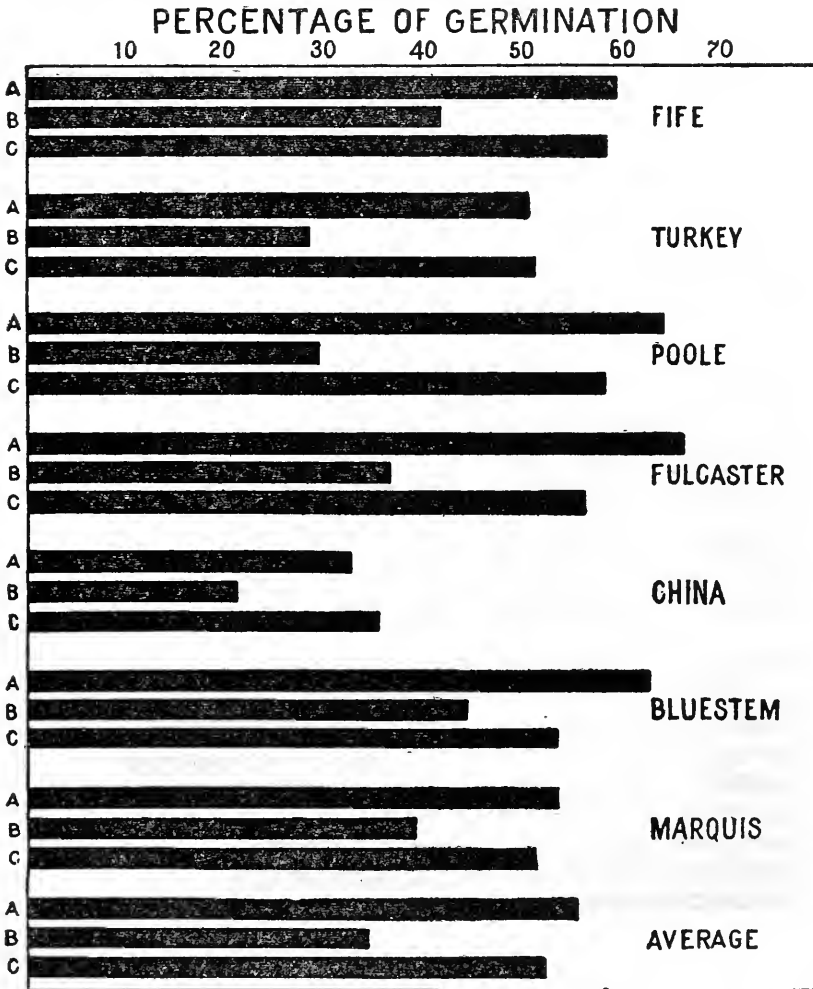

FIG. 5.—Graph showing effect of formalin 1 to 320, with and without presoaking, on wheat seed germination under field conditions: A, control, untreated; B, seeds soaked in formalin 1 to 320 for 10 minutes, drained, kept moist (covered) 6 hours, dried overnight, and planted; C, seeds soaked in water 10 minutes, drained, kept moist (covered) 6 hours, soaked in formalin 1 to 320 for 10 minutes, drained, kept moist (covered) 6 hours, dried overnight, and planted.

before receiving this treatment. The effect of the presoak method of treatment in also eliminating retardation of germination is an important factor in preventing the attack of soil fungi on seeds or very young seedlings unduly delayed in germination. Plate 78 shows the appearance of the field plots on the sixteenth day after planting.

EFFECT OF SIX HOURS' PRESOAKING FOLLOWED BY FORMALIN AND COPPER-SULPHATE TREATMENTS ON HALF-BUSHEL LOTS OF WHEAT SEED

The next series of experiments was made to determine (1) the effect of the presoak method of treatment, using wheat seed in half-bushel lots

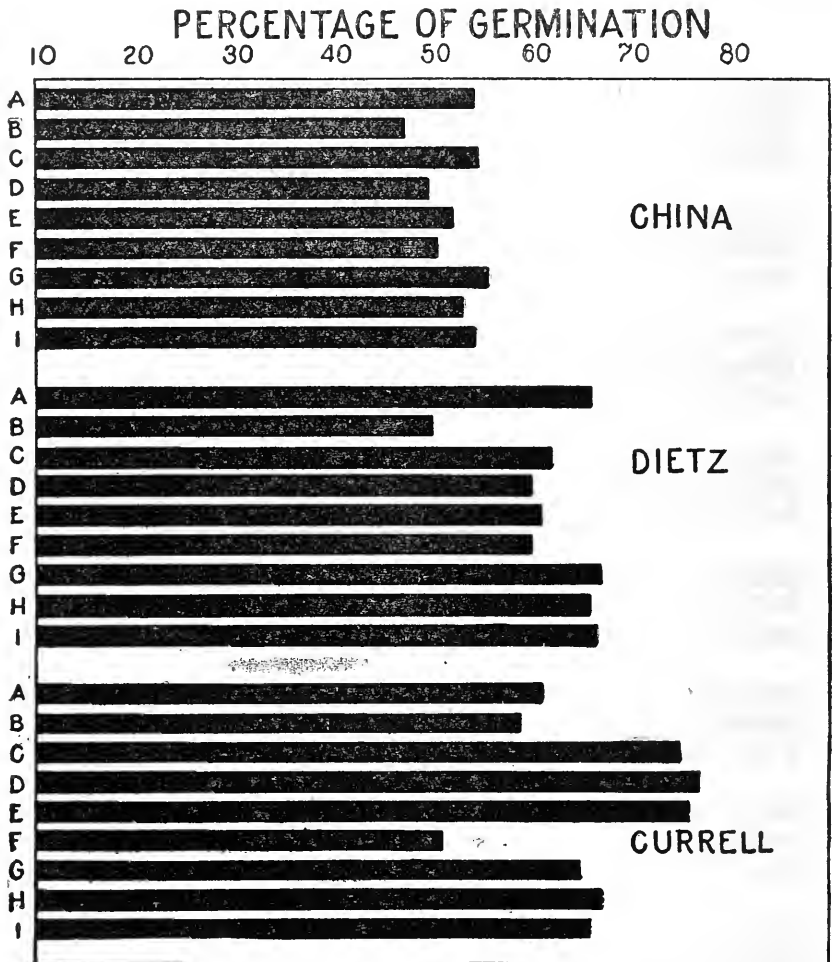

FIG. 6.—Graph showing effect of formalin and copper-sulphate presoak treatments of $\frac{1}{2}$ -bushel wheat seed lots: A, control, untreated; B, seeds soaked in formalin 1 to 320 for 10 minutes, drained, covered 6 hours, dried, and planted; C, seeds soaked in water 10 minutes, drained, covered 6 hours, then treated with formalin as in B, and seeds from upper one-fourth planted; D, seeds from central part of same lot as C; E, average germination of C and D; F, seeds soaked in copper sulphate 1 to 80 for $\frac{1}{2}$ hour, followed by milk of lime, and dried; G, seeds soaked in water 10 minutes, drained, covered 6 hours, then treated with copper sulphate as in F, and seeds from upper one-fourth planted; H, seeds from central part of same lot as G; I, average germination of G and H. In the Currell variety the same procedure was used except that the seeds were sprinkled instead of soaked.

as in practical usage; (2) the relative effects of soaking and sprinkling; (3) the result of a possible lack of aeration and accumulation of carbon dioxide in the center of the presoak-treated mass of seeds.

A half bushel each of Dietz and China wheats in bushel bags were soaked in water 10 minutes, drained, and covered 6 hours, then soaked in formalin 1 to 320 for 10 minutes, drained, and covered 6 hours. A similar treatment was made on like quantities of seed, using copper sulphate 1 to 80 for $\frac{1}{2}$ hour after the 6 hours' presoaking, followed by milk of lime. The upper and central parts of each half bushel were dried, and each of the eight lots thus obtained was planted in 10 rows of 300 seeds each. Suitable controls and seeds treated without presoaking were also planted.

At the same time, a bushel of Currell wheat, piled up on canvas, was sprinkled with water and covered for 6 hours. Half of this was then sprinkled with formalin 1 to 320 and covered for 6 hours. The other half was sprinkled with copper sulphate 1 to 80, covered $\frac{1}{2}$ hour, and limed. Seeds from top and center were dried and planted, along with controls and seeds sprinkled without presoaking. The results obtained a month after planting are recorded in figure 6.

The presoak-treated seeds again showed a marked improvement in germination over seeds treated without presoaking. Seeds from the center of the bag are apparently affected to some extent, probably through lack of aeration and the accumulation of carbon dioxide; but the average germination of the presoak-treated seeds is better than that of the seeds treated without presoaking.

The sprinkling method at first sight appears to possess a distinct advantage over the soaking method. In the former, compared to controls, there is a marked increase in germination of seeds sprinkled first with water and after six hours with the disinfectant. This is most probably due to the incompleteness of the sprinkling method, since the disinfectant can not reach each kernel as in the soaking method. Hence a large number of seeds, affected only by the water vapor of the preliminary sprinkling, receive the stimulation due merely to the absorption of water and drying before planting.

EFFECT OF PRESOAK METHOD ON BACTERIUM TRANSLUCENS VAR. UNDULOSUM

EFFECT OF SIX HOURS' PRESOAKING FOLLOWED BY FORMALIN 1 TO 400 TREATMENT ON BLACKCHAFF BACTERIA ON SEEDS PLANTED ON NUTRIENT AGAR

A series of experiments was carried out parallel with the germination experiments, using 2,360 seeds, to determine whether the 6-hour formalin treatment when preceded by a 6-hour presoak would destroy or prevent the growth of the blackchaff bacteria. Heat-sterilized wheat seeds were heavily inoculated, using four virulent isolations of the blackchaff organism, and dried overnight as before described. The next day the seeds were placed in tubes of sterile tap water, which was drained off after 10 minutes. The tubes containing the seeds were placed in moist

chambers for 6 hours to maintain a thin film of moisture around each kernel throughout this period. The subsequent treatment with a formalin solution, 1 to 400, in sterile tap water was made in the same manner—that is, by pouring the formalin solution on the seeds, draining it off after 10 minutes and placing the tubes in moist chambers rinsed with a formalin 1 to 400 solution. After 6 hours' treatment the seeds were replaced in sterile envelopes, dried overnight, and planted on agar plates. Control seeds, inoculated but not treated, were also planted. Observations were made after 9 to 15 days and are recorded in Table VIII.

TABLE VIII.—Effect of 6 hours' presoaking followed by formalin 1:400 treatment on black-chaff bacteria on seeds placed on nutrient agar

Experiment No.	Treatment.	Number of seeds used.	Percentage developing typical black-chaff colonies.	Percentage sterile.	Percentage contaminated with fungi or bacteria other than black-chaff.
I.	Inoculated seeds presoaked 6 hours, formalin 1:400 for 10 minutes, covered 6 hours.	400	0.0	65.5	34.5
	Controls inoculated but not treated.	160	72.0	19.3	8.7
II.	Inoculated seeds presoaked 6 hours, formalin 1:400 for 10 minutes, covered 6 hours.	400	.0	87.3	12.7
	Controls inoculated but not treated.	200	77.0	2.0	21.0
III.	Inoculated seeds presoaked 6 hours, formalin 1:400 for 10 minutes, covered 6 hours.	800	.2	97.7	2.1
	Controls inoculated but not treated.	400	98.7	1.3	.0
Summary.	Inoculated seeds presoaked 6 hours, formalin 1:400 for 10 minutes, covered 6 hours.	1,600	.1	87.0	12.9
	Controls inoculated but not treated.	760	86.6	5.9	7.5

Only 2 out of 1,600 inoculated seeds treated by the presoak method developed typical blackchaff colonies. The controls, which had been inoculated and dried two days, showed 86.6 per cent of the kernels developing the typical colonies when planted on the nutrient agar, thus demonstrating that the absence of growth in the treated seeds was due not to drying of the bacteria but to the treatment as practiced (Pl. 79, 80). The presoaking, then, while limiting to a striking degree retardation of seed growth and loss due to failure to germinate, does not reduce the effectiveness of the subsequent formalin treatment as a means of treating diseased seed. In fact, it tends to increase its efficiency in this respect, as will be brought out in the discussion.

EFFECT OF SIX HOURS' PRESOAKING FOLLOWED BY FORMALIN 1 TO 320 AND COPPER SULPHATE 1 TO 80 ON ARTIFICIALLY INFECTED WHEAT SEEDS PLANTED IN THE SOIL UNDER FIELD CONDITIONS

Several field tests were made with seeds of Currell, China, and Dietz varieties artificially infected with blackchaff bacteria, dried, and treated with formalin 1 to 320 and copper sulphate 1 to 80, after a presoaking of six hours. The percentages of infection in the young seedlings two to three weeks after planting are given in Table IX.

TABLE IX.—Effect of presoak method of treatment on inoculated wheat seeds under field conditions

Treatment.	Experiment of Aug. 9.			Experiment of Aug. 22.			Experiment of Sept. 7.		
	Variety of wheat used.	Isolation number of <i>Bact. translucens</i> var. <i>undulosum</i> .	Percentage of infection of seedlings.	Variety of wheat used.	Isolation number of <i>Bact. translucens</i> var. <i>undulosum</i> .	Percentage of infection of seedlings.	Variety of wheat used.	Isolation number of <i>Bact. translucens</i> var. <i>undulosum</i> .	Percentage of infection of seedlings.
Seeds soaked in bacterial suspension 20 minutes, dried, planted at same time as treated seeds below.	Currell.	^a 850	92.6	Currell.	^a 271-A	85.5	Currell.	^b 213	68.9
	China..	^c 318	90.1	China..	394	91.0	China..	271-A	82.0
	Dietz..	^c 394	95.1	Dietz..	850	80.3
Seeds soaked in bacterial suspension 20 minutes, dried overnight, soaked in water 10 minutes, covered 6 hours, soaked in formalin 1:320 for 10 minutes, covered 6 hours, dried, and planted.	Currell.	850	1.0	Currell.	271-A	.7	Currell.	213	.0
	China..	318	.5	China..	394	.4	China..	271-A	.5
	Dietz..	394	.3	Dietz..	850	.0
Seeds soaked in bacterial suspension 20 minutes, dried overnight, soaked in water 10 minutes, covered 10 hours, soaked in copper sulphate 1:80 for 1/2 hour, then in milk of lime 1:80 a moment, dried, and planted.	Currell.	850	.8	Currell.	271-A	.9	Currell.	213	.8
	China..	318	1.5	China..	394	.3	China..	271-A	.6
	Dietz..	394	.9	Dietz..	850	.0

^a From Kansas.

^b From Colorado.

^c From Montana.

Bacterial infection was prevented to a very marked degree in the treated seeds. The controls, infected with five isolations of *Bacterium translucens* var. *undulosum* from different localities, showed from 69 to 95 per cent infection, considerably more than would usually occur in naturally diseased seed, owing to the heavy artificial inoculation and brief drying period before planting. Infection of these seeds, heavily inoculated as they were, was reduced from 0 to 1.5 per cent by the presoak method, used with both formalin and copper sulphate. The application of this method, then, to the control of blackchaff on the farm is evident. The only doubt that can be entertained is in cases where the bacteria have penetrated the seed coats. Fortunately, in most such cases at least, the seeds are more or less shriveled and of light weight so that they may be screened out in advance of treatment.

RESULTS OF PRESOAK TREATMENTS ON NATURALLY INFECTED WINTER WHEAT PLANTED IN THE WHEAT FIELDS OF IOWA AND KANSAS

The first extensive field trial of this method was made in 1919 at three places in the middle western wheat belt—Ames, Iowa, and Hays and Abilene, Kans.,¹ where Kharkoff and Kanred from infected fields, screened and unscreened, was treated and drilled in after two to nine days' drying. The treatments used were (1) presoak copper-sulphate treatment, in which seeds were soaked 10 minutes in water, covered 6 hours, soaked $\frac{1}{2}$ hour in copper sulphate 1 to 80, limed, dried, and planted; (2) presoak formalin treatment, in which the seeds were soaked 10 minutes in water, covered 6 hours, soaked 10 minutes in formalin 1 to 320, covered 6 hours, dried, and planted. Notes on the amount of infection on the seedlings were first made four to seven weeks after planting, since infection at this time would represent mostly primary infections due to diseased seed, before general dissemination from infection centers could set in. The results are summarized in Table X.

TABLE X.—Preliminary results of presoak treatments of infected winter wheat in the Middle West, 1919

Locality.	Wheat variety.	Treatment.	Size of plot.	Date treated, 1919.	Date planted, 1919.	Date observed, 1919.	Number of plants examined.	Number of plants infected.	Percentage of infection.
Ames, Iowa..	Kanred ^a .	No treatment, unscreened.	1/20 acre.	Sept. 27	Nov. 7	312	28	8.9
	..do.....	Presoak copper sulphate treatment, unscreened.	..do....	Sept. 18	..do...	..do...	360	2	.6
	..do.....	Presoak formalin treatment, unscreened.	..do....	..do...	..do...	..do...	343	0	.0
Hays, Kans..	Kharkoff.	No treatment, screened.	1/10 acre ^b	Sept. 24	Nov. 10	218	17	7.8
	Kanred ..do.....	..do.....	..do ^bdo.....	..do.....	250	23	9.2
	Kharkoff.	Presoak formalin treatment, screened.	..do....	Sept. 22	..do...	..do...	312	0	.0
	Kanred ..do.....	..do.....	..do.....	..do.....	..do.....	..do.....	321	1	.3
Abilene, Kans.	..do.....	No treatment, screened.	45 acres.	Oct. 6 to 10	Nov. 9	200	23	11.5
	..do.....	Presoak formalin treatment, screened.	15 acres.	Oct. 1	..do...	..do...	360	60	.0

^a A very susceptible variety.

^b Part of main field.

^c One diseased plant was found; but, judged by its advanced stage of growth, it was a volunteer and was therefore not from the treated seeds.

The seedlings at the time of observation bore two to five leaves, with infection visible on the first leaf of diseased plants verified by microscopic examination. In untreated areas, from 7.8 to 11.5 per cent infection was present; in treated areas, from 0 to 0.6 per cent, as shown in

¹ The author is indebted to Dr. I. E. Melhus, at Ames, and to Mr. Swanson, at Hays, for cooperation and assistance at these localities.

the table, indicating so far a satisfactory degree of control under actual field conditions through the use of the presoak method as formulated.

Plants collected from the western experimental plots March 27 to April 3, 1920, were examined microscopically for the presence of oozing bacteria in suspected blackchaff lesions and in dead leaves. Platings were made later from similar lesions where abundant oozing bacteria were found, and these developed the typical blackchaff colonies. Table XI summarizes the results obtained.

TABLE XI.—Condition of western experimental plots in the spring of 1920

Locality.	Treatment.	Date observed, 1920.	Number of plants examined.	Number with bacteria oozing from cut sections.	Percentage of infection.
Abilene, Kans.....	{ Kanred wheat, untreated, 45 acres.	Mar. 27	212	46	21.7
	{ Presoak formalin treated plot, ^a 15 acres; plants collected from half of plot farthest from untreated area.	...do....	185	9	4.8
	{ Same treated plot; plants collected from other half, near untreated area.	...do....	196	12	6.1
Hays, Kans.....	{ Kharkoff wheat, untreated.....	Mar. 30	141	24	17.0
	{ Kharkoff wheat, presoak formalin treated plot. ^a	...do....	231	7	3.0
	{ Kanred wheat, untreated.....	...do....	192	49	25.5
Ames, Iowa.....	{ Kanred wheat, presoak formalin treated plot. ^a	...do....	218	9	4.1
	{ Kanred wheat, untreated.....	Apr. 3	285	53	18.5
	{ Kanred wheat, presoak formalin treated plot. ^a	...do....	221	6	2.7
	{ Kanred wheat, presoak copper-sulphate treated plot. ^b	...do....	236	5	2.1

^a Seeds presoaked 6 hours, then treated with formalin 1 to 320 for 10 minutes, drained, covered 6 hours and dried.

^b Seeds presoaked 6 hours, then treated with copper sulphate 1 to 80 for half hour (soaked), and dried after dipping a moment in milk of lime.

A marked increase in blackchaff was observed in the untreated plots, evidently due to wind and rain spreading the disease during the resumption of growth. The spreading effect was especially noted in the Abilene plots where the treated area adjoins the untreated. Other treated areas at Hays and Ames, more isolated, show from 2 to 4 per cent of infection, as compared with 17 to 25.5 per cent in untreated plots.

Observations made at Hays and Abilene, Kans., in the latter part of May, 1920, are summarized in Table XII. At Abilene the plants were 1 to 2 feet tall, at Hays over 2 feet high. Heads had not yet emerged. Microscopic examination and confirmation of diagnoses by platings were

made as previously indicated. Typical yellow colonies of the blackchaff organism, concentrically striated by oblique light, were readily obtained in poured plates from blackchaff leaf lesions, which at this stage appeared characteristically as brown, water-soaked linear areas, narrow and extending for various lengths along the edges or centers of the second, third, or fourth leaves from the top, with clouds of oozing bacteria in cut sections. *Septoria* was also found in the oldest leaves, distinguished by wider lesions and characteristic black dots of pycnidia.

TABLE XII.—*Condition of experimental plots in May, 1920*

Locality and date.	Plot.	Number of plants examined.	Number with bacteria oozing from cut sections.	Percentage of infection.
Abilene, Kans., May 15, 1920.	Kanred, untreated.	312	87	27.8
	Kanred, western area, presoak formalin treated.	386	26	6.7
Hays, Kans., May 22, 1920.	Kanred, untreated.	293	98	33.4
	Kanred, presoak formalin treated.	356	33	9.2
	Kharkoff, untreated.	266	72	27.0
	Kharkoff, presoak formalin treated.	298	22	7.3

There is an evident increase in the amount of secondary infection during April and May. It was also observed that most of the lesions on leaves from treated plots were small, 2 to 8 mm. long, consisting of from 1 to 3 spots on the second or third leaf from the top, and were evidently fairly recent infections. Leaves from control plots showed similar lesions but also a larger proportion of more advanced lesions up to 30 mm. long on the older leaves. No lesions were observed in the young heads, which were still inclosed in the sheath.

EFFECT OF MODIFYING THE TREATMENT PERIODS UNDER FIELD CONDITIONS

A shortening of the entire treatment period appeared desirable after field experience with the method so far described, mainly for the purpose of facilitating drying after treatment. Three greenhouse germination experiments were made with Currell wheat seed, using a shorter presoak time and a longer (varying) soak in formalin 1 to 320, followed by very short periods during which the seeds were kept moist, the entire process covering various periods from 5½ to 8 hours as outlined in figure 7.

Formalin treatments involving a soaking longer than previously used—that is, of 15 to 30 minutes—followed by immediate drying or involving a short moist period of 1 to 3 hours decreased the germination considerably. The same treatments preceded by a 5-hour presoak (in one case a 6-hour presoak) resulted in no injury whatever to germination and in fact caused distinct acceleration. The effect of the various periods upon germination was determined for infected wheat seed also.

Currell wheat seed was inoculated with a bacterial suspension of *Bacterium translucens* var. *undulosum*, isolation No. 850, treated with formalin for the periods given in Table XIII, planted outdoors, and the percentage of infected seedlings determined 27 days after planting.

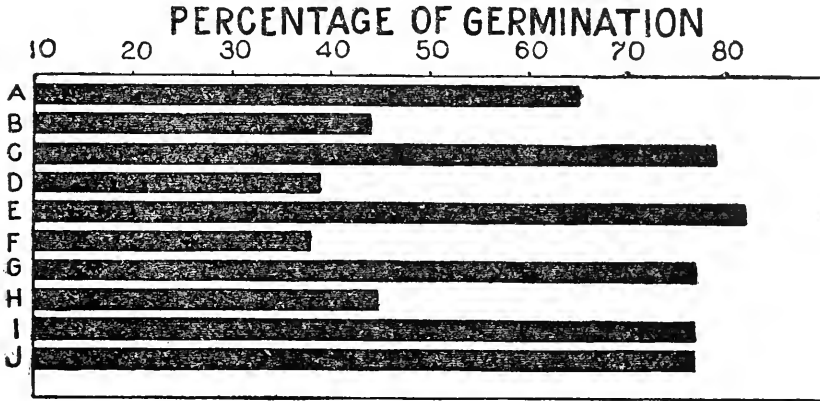

FIG. 7.—Graph showing effect of formalin 1 to 320 treatments for various periods, with and without presoaking: A, control, untreated; B, seeds soaked in formalin 1 to 320 for 15 minutes, drained, covered 2 hours, dried overnight, and planted; C, seeds soaked in water 10 minutes, covered 5 hours, then treated with formalin as in B; D, seeds soaked in formalin 1 to 320 for 15 minutes, drained, covered 3 hours, and dried overnight; E, seeds soaked in water 10 minutes, covered 5 hours, then treated with formalin as in D; F, seeds soaked in formalin 1 to 320 for 30 minutes, drained, covered 1 hour, and dried overnight; G, seeds soaked in water 10 minutes, covered 5 hours, then treated with formalin as in F; H, seeds soaked in formalin 1 to 320 for 30 minutes, drained, and dried overnight; I, seeds soaked in water 10 minutes, covered 5 hours, then treated with formalin as in H; J, seeds soaked in water 10 minutes, covered 6 hours, then treated with formalin as in H. Records of germination were made on the sixth day after planting and are the averages of three experiments.

TABLE XIII.—Effect of shortened presoak method of treatment on infected wheat seed under field conditions

Treatment.	Number of plants examined.	Number of plants infected.	Percentage of infection after 27 days.
Inoculated seeds dried and planted without further treatment.....	221	40	18.2
Inoculated seeds soaked in water 10 minutes, drained, covered 5 hours, soaked in formalin 1:320 for 15 minutes, covered 2 hours, dried, and planted.....	215	4	1.8
Inoculated seeds soaked in water 10 minutes, drained, covered 5 hours, soaked in formalin 1:320 for 15 minutes, covered 3 hours, dried, and planted.....	196	1	.5
Inoculated seeds soaked in water 10 minutes, drained, covered 5 hours, soaked in formalin 1:320 for 30 minutes, covered 1 hour, dried, and planted.....	231	0	0
Inoculated seeds soaked in water 10 minutes, drained, covered 5 hours, soaked in formalin 1:320 for 30 minutes, dried, and planted.....	211	2	.9
Inoculated seeds soaked in water 10 minutes, drained, covered 6 hours, soaked in formalin 1:320 for 30 minutes, dried, and planted.....	246	3	1.2

The best control in this experiment was obtained with a presoak of 5 hours, followed by 30 minutes' formalin soak, then covering 1 hour. Such a process, requiring 6½ hours in all, would be particularly desirable because of the ease in subsequently drying the seeds by spreading them in the sun on the day of treatment, Further field repetition of this experiment, which was suspended at this time by the advent of winter,

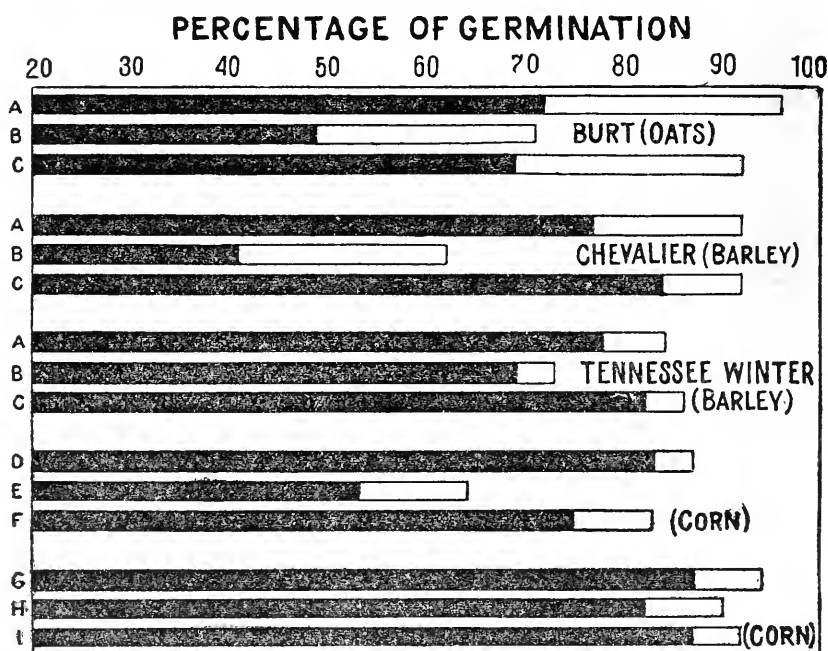

FIG. 8.—Graph showing effect of formalin 1 to 320 and 1 to 200 on germination of corn, barley, and oats with and without presoaking: A, controls; B, seeds soaked in formalin 1 to 320 for 10 minutes, drained, kept moist (covered) 6 hours, dried overnight, and planted; C, seeds soaked in water 10 minutes, drained, and kept moist (covered) 6 hours, then soaked in formalin 1 to 320 for 10 minutes, drained, and kept moist (covered) 6 hours, dried overnight, and planted; D and G, controls; E and H, seeds soaked in formalin 1 to 200 for 10 minutes, drained, kept moist (covered) 4 hours, dried overnight, and planted; F, seeds soaked in water 10 minutes, drained, kept moist (covered) 10 hours, then soaked in formalin 1 to 200 for 10 minutes, drained, kept moist (covered) 4 hours, dried overnight, and planted; I, seeds soaked in water 10 hours, drained thoroughly a few minutes, then soaked in formalin 1 to 200 for 10 minutes, drained, kept moist (covered) 4 hours, dried overnight, and planted. Records of the germination were made on the fifth and seventh days after planting in the greenhouse.

is necessary, however, before definite recommendations on this modification can be made.

EFFECT OF THE PRESOAK METHOD ON OTHER CEREALS

The uniform results obtained on nine different varieties of wheat by the presoak method of treatment with formalin and copper sulphate and a consideration of the underlying principles governing its salutary action, as will be discussed later, suggested that it might be generalized for the treatment of all seed-transmitted diseases of economic importance amen-

able to control by formalin and copper sulphate. So far, this method has been tested on the germination of oats, barley, and maize with results similar to those obtained for wheat. Copper-sulphate injury can be prevented for Tennessee winter barley as shown above. The results thus far obtained with the presoak method of treatment, using formalin 1 to 320 on oats and barley and formalin 1 to 200 on maize, are given in figure 8. Oats and barley were soaked in water 10 minutes, drained, and kept moist 6 hours, then soaked in formalin 1 to 320 for 10 minutes, and covered 6 hours. Maize, which absorbs water much more slowly than wheat, oats, or barley and is also less susceptible to formalin injury, was given a 10-hour presoak—that is, 10 minutes in water, draining and covering for 10 hours, followed by 4 hours' formalin 1 to 200 treatment.

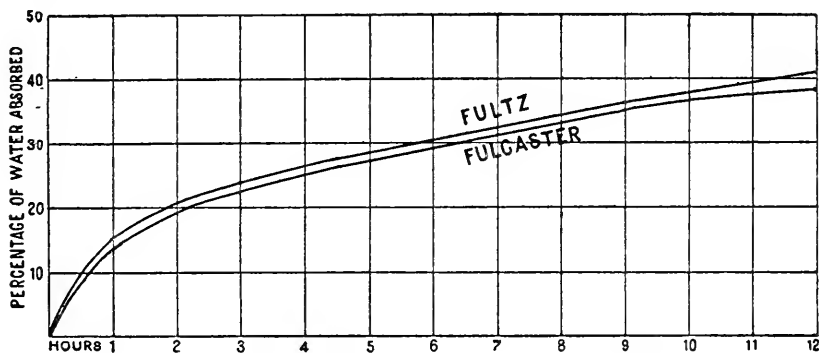

FIG. 9.—Curve showing rate of absorption of water by dry wheat seeds.

In another case it was given a 10-hour actual soaking in water, followed by the treatment.

The presoak method is evidently applicable to these cereals also, as a means of preventing seed injury due to disinfectants (Pl. 81, 82); and the possibility of its application for other kinds of seeds is obvious.

GENERAL DISCUSSION

As a result of these experiments several facts stand out clearly. First, in all cases, with each variety of wheat, barley, oats, and maize tested, the presoak method minimized or eliminated the injury to seed germination due to the use of formalin and copper sulphate. Second, as shown in the illustrations, a marked stimulation of growth was usually produced. Third, the presoak method proved fully efficient as a means of destroying or preventing the growth of the bacteria of the blackchaff disease borne on the seed and can undoubtedly be applied for the prevention of other diseases. Fourth, the method is simple and adapted to field conditions, since any farmer can apply it.

The cause of the first-mentioned effect of the presoak treatment may be partly accounted for upon an analysis of figure 9. This represents the rate of absorption of water by 10 gm. each of dry seeds of two wheat

varieties, soaked 10 minutes in water, drained, and kept moist for 12 hours, with periodical weighings after blotting off all surface water each time. The excess weight above 10 gm. represents the amount of water absorbed. The curve rises rapidly in the first 3 hours, then slows down somewhat to a more gradual rise. At the end of 6 hours, about 30 per cent by weight of water has been absorbed; during the next 6 hours, about 10 per cent more is absorbed. The 6 hours' presoaking, as practiced, consequently impregnates the cell walls and cells of the seed with water, increasing the size and adding about 30 per cent by weight to the seeds. The next 6 hours' treatment with water containing formalin in solution adds only one-third as much more; and the formalin solution as it diffuses into the seeds is consequently greatly diluted by the amount of water already present in the tissues. Moreover, the amount of formalin solution which can enter the tissues in the 6 hours after presoaking is only one-third of what enters during a 6-hour formalin treatment without presoaking. Should the subsequent formalin treatment last much longer than 6 hours, an equilibrium would finally be established between the strength of solution within the seeds and that on the surface, resulting in both cases in a solution weaker than the original, in accordance with the laws of diffusion of dissolved substances. Removing the presoaked seeds after 6 hours' formalin treatment leaves them with a solution content considerably more dilute than that finally present in air-dry seeds directly treated with the full-strength solution; consequently the weakened solution within the presoaked seeds resulted in a very marked decrease in seed injury, as observed throughout the experiments.

As for the stimulation observed in presoaked seeds, this may be due partly or wholly to the well-known stimulating effect of a toxic agent in minimum dose, such as would finally be present in the presoaked seeds.

In considering the effect of the presoak method on the blackchaff bacteria on the seed coat, the dominant factor involved is the established principle that microorganisms in an active vegetative condition are more susceptible to the action of destructive agents than when dormant. Presoaking the seeds, and consequently the bacteria on them, for a period of six hours at room temperature causes the bacteria to begin to resume vegetative activity before seed germination commences, because the moisture and temperature conditions are ample for bacterial growth and division to begin during this period. Subsequently exposed to the direct action of the formalin solution applied full strength to the surface of the seeds, the bacteria are naturally much more susceptible to destruction in this active condition. As a result, the disinfectant must act with greater efficiency than in the usual treatment, where it acts on dried and dormant bacteria. The six hours' presoak, on the other hand, is not sufficient to cause wheat-seed germination, which would produce a condition extremely susceptible to formalin injury.

The method of treatment discussed has, therefore, a two-fold advantage. On the one hand, wheat-seed injury due to the use of formalin and copper sulphate is eliminated or reduced to a minimum. On the other hand, the blackchaff organisms on the seed coats are rendered particularly sensitive to the action of the disinfectant by being previously brought into a vegetative condition.

The same physiological principles discussed above should hold true for the general problem of seed treatment for various seed-borne pathogens. The consistency of the results obtained by this method with nine varieties of wheat and with other cereals, using formalin and copper sulphate, indicates the possibility of the use of the presoak method with other kinds of seeds as a means of minimizing or preventing seed disinfectant injury. Similarly, other pathogenic organisms, bacteria, or fungus spores, may be stimulated by the presoak method into increased susceptibility to the disinfectant.

The presoak method of seed treatment with chemical disinfectants may be formulated for general purposes as consisting of two parts: First, the presoak period, in which seeds are soaked in water for 10 minutes, drained, and kept covered and moist for a definite period of time, which is 6 hours for wheat, barley, and oats and 10 to 18 hours for maize—in no case sufficient to begin seed germination; second, the disinfectant-treatment period immediately following, in which the disinfectant is applied exactly as now practiced. The relative time of the presoak and subsequent treatment for other diseases, probably varying with each kind of seed and pathogen, is dependent on the following factors:

- (1) Susceptibility of the kind of seed used to the disinfectant.
- (2) Susceptibility of the pathogen to the disinfectant.
- (3) Rate of absorption of water by the seeds.
- (4) Time at which seed germination begins.
- (5) Time at which vegetative activity of the pathogen begins.

A proper balance of these factors must be obtained, such that the optimum seed germination and the optimum germicidal efficiency are secured, as reported for the blackchaff disease of wheat.

The length of the presoak period should not exceed half or two-thirds of the period necessary for seed germination to begin, since germination before treatment with the disinfectant would result in extreme sensitiveness to injury. On the other hand, the pathogen, especially if bacterial in nature, usually has a much shorter germination period, which should come within the limit of the time of presoak and thus render it susceptible long before the seed has begun to germinate. The period necessary for the absorption of about 30 per cent by weight of water appears to be sufficient, and in the case of the cereals so far tried seems to counteract disinfectant injury. In wheat, oats, and barley this is five to six hours. The length of time necessary for other kinds of seeds to absorb about 30 per cent of water is suggested as the presoak period when not conflicting with the other factors involved.

Actual soaking in water throughout the presoak period does not appear to be so favorable for wheat-seed treatment as the procedure of soaking 10 minutes in water and merely keeping moist for 6 hours.

For use in farm practice this method does not involve any radical change in present procedure other than to keep the seeds moist for a definite time before treating. In controlling the blackchaff disease of wheat, seeds should first be screened to remove shriveled grain. Then the seeds in sacks or bags, in quantities of not more than $\frac{1}{2}$ bushel each, can be soaked early in the morning in water for 10 minutes, drained, and set away in the bags while moist. Six hours later, at about noon, the seeds should be thoroughly soaked for 10 minutes in a formalin solution of 1 pound to 40 or 50 gallons of water, drained, and left in the bags for 6 hours. In the evening the seeds should be spread out to dry overnight and are ready for planting the next morning.

The use of formaldehyde vapor recently proposed by Thomas (10) for seed treatment, while eminently suitable for the disinfection of small seed lots which are not to be planted immediately, is open to the serious objection of lack of penetration throughout the seed mass and is not so well adapted as the presoak method for the treatment of seeds in large masses in farm practice. His experiments indicate that the vapor, while efficient on surface seeds, does not reach seeds at a depth of $\frac{1}{2}$ inch, so that these remain as badly contaminated as untreated controls. In the presoak method, every seed is surrounded by a film of the disinfectant acting on the pathogens which previously have been brought into a vegetative condition by the long exposure to moisture at room temperature.

The presoak method used with copper sulphate, if efficient for controlling the cereal smuts,¹ would be particularly adapted for the grain sections of the Northwest. Extensive soil infection in this area renders the use of copper sulphate preferable to formalin because of its residual germicidal effect; and, as here shown, copper-sulphate injury may be prevented by a 6-hour presoak.

The general application of the presoak method, extremely simple in itself, to the formalin and copper-sulphate treatments of the cereal diseases amenable to control by seed disinfection should, if the results here recorded are confirmed for other diseases by subsequent careful

¹ A paper by Heald (2), first brought to the writer's attention in Nov. 14, 1919, when these experiments were completed and the manuscript was prepared for the press, shows some interesting data on a somewhat similar method used for treatment of barley smut. Heald soaked barley seeds in water 4 hours, covered them 8 hours longer, then treated them with formalin 1 to 288 for 10 minutes and then kept them covered 2 hours. No statement as to the manner of arriving at the use of this procedure is made. His figures indicate for this treatment (1) less injury to germination than for any other formalin treatment which he used, (2) effective control of barley smut—0.93 per cent smut in a plot treated in this manner and 0.73 per cent in a somewhat similarly treated copper-sulphate plot compared to an average of 33.02 per cent smut in three untreated plots. This corroborates for barley smut the work reported on blackchaff with the presoak method. Heald does not appear to have followed up his work, which was clearly a rule of thumb, nor did he recommend this particular method for general use with other methods. He made no allowance for loss in number of seeds per bushel through swelling, otherwise he must have obtained results which would have indicated to him clearly the importance of the method, since he must then have obtained larger yields than by any other method which he used. Moreover, my method differs from Heald's in that it gives only a short plunge in water rather than a long one, and this is an important difference.

research, result in a saving of a large percentage of seeds destroyed by the usual treatments or delayed in germination and thus longer exposed to the attack of soil fungi, giving at the same time a more efficient germicidal action on the pathogens involved.

SUMMARY

(1) The use of formalin and copper sulphate as now practiced usually causes retardation and injury to seed germination.

(2) Greenhouse and field experiments here reported have shown that this detrimental effect can be eliminated for standard varieties of wheat by allowing the seeds to absorb water for six hours before submitting them to the treatment with formalin or copper sulphate. Soaking for a short period (10 minutes) and covering for 6 hours, here designated the presoak method, is better than leaving in water for 6 hours. Similar results were obtained in experiments with barley, oats, and corn.

(3) The saturation of the seed cells and cell walls with water during the presoak period appears to be the factor counteracting the injurious effect on seed germination by diluting the disinfectant beyond the point of injury as it diffuses into the tissues and also by considerably decreasing the amount of water plus disinfectant solution which may enter the tissues after presoaking as compared to what may enter without any presoaking.

(4) Actual stimulation of germination has been observed repeatedly in presoak-treated seeds, a factor which by shortening germination minimizes the danger of exposure to the attack of soil organisms during this susceptible period.

(5) The bacterial blackchaff disease of wheat can be controlled without any injury to seed germination by a 6-hour presoak of surface-infected seeds in water followed by a 6-hour treatment with formalin 1 to 400 in the manner prescribed.

(6) In practice, wheat seeds after being screened should be soaked with water for 10 minutes at about 6 o'clock in the morning, drained, covered, and set away moist till noon, then soaked with formalin 1 to 400 for 10 minutes, drained, covered, and set away moist till 6 o'clock in the evening, when they should be spread out to dry overnight to be ready for planting the next day.

(7) In planting, an allowance must always be made for the fact that there are fewer treated seeds in a bushel than there are of dry untreated ones. In general, it is recommended to sow about 25 per cent more bulk than is usual of the dry grain, otherwise fewer seeds will be actually planted and the yield will be reduced correspondingly.

(8) The use of the presoak method tends to increase the efficiency of the disinfectant, in that the presoaking stimulates dormant bacteria and possibly fungi into vegetative activity, thereby rendering them extremely susceptible to the subsequent action of the disinfectant.

(9) The general use of the presoak method of treatment in farm practice for other diseases involves no radical change in present procedure,

the only deviation being to keep the seeds moist for a definite period before giving them the disinfectant treatment.

(10) In applying the principles here utilized to other kinds of seeds, the determination of the lengths of the two parts of this method—(1) the presoak period, (2) the subsequent disinfectant treatment period—must be governed by the following factors: (a) the rate of absorption of water by the seeds, (b) the susceptibility of the seeds and pathogens to the disinfectant, and (c) the respective periods necessary for the beginning of seed germination and of vegetative activity of the pathogen. In no case must the presoak period be continued until seed germination begins. The length of time necessary for the seeds to absorb about 30 per cent of their weight of water is suggested as the length of the presoak period when not conflicting with the other factors involved.

(11) The presoak method of treatment, as here formulated, is proposed as a basis for the reinvestigation of practical seed treatment for all seed-transmitted diseases of economic importance amenable to control by formalin and copper sulphate as a means of eliminating seed injury and at the same time increasing germicidal efficiency.

LITERATURE CITED

- (1) BRAUN, Harry.
1919. PRESOAKING AS A MEANS OF PREVENTING SEED INJURY DUE TO DISINFECTANTS AND OF INCREASING GERMICIDAL EFFICIENCY. *In Science*, n. s. v. 49, no. 1275, p. 544-545.
- (2) HEALD, F. D.
1908. SEED TREATMENT FOR THE SMUTS OF WINTER BARLEY. *In Neb. Agr. Expt. Sta. 21st. Ann. Rpt. [1907]/08*, p. 45-53, illus.
- (3) HUMPHREY, H. B., and POTTER, A. A.
1918. CEREAL SMUTS AND THE DISINFECTION OF SEED GRAIN. U. S. Dept. Agr. Farmers' Bul. 939, 28 p., 16 fig.
- (4) JOHNSON, A. G., STAKMAN, E. C., and POTTER, Alden A.
1918. TABULAR COMPILATIONS AND PRELIMINARY REVIEW OF RESULTS ON SEED INJURY TESTS WITH STANDARD DISINFECTANTS. Prepared in Off. Cereal Invest. Bur. Plant Indus. U. S. Dept. Agr. for the War Emergency Bd. of Amer. Plant Path. Mimeographed.
- (5) SMITH, Erwin F.
1917. BLACK CHAFF OF WHEAT. *In U. S. Dept. Agr. Bur. Plant. Indus. Plant Disease Survey, Plant Disease Bul. v. 1, no. 2*, p. 40.
- (6) ———
1917. A NEW DISEASE OF WHEAT. *In Jour. Agr. Research*, v. 10, no. 1, p. 51-54, pl. 4-8.
- (7) ———
1918. BLACK CHAFF OF WHEAT. *In U. S. Dept. Agr. Bur. Plant Indus. Plant Disease Survey, Plant Disease Bul. v. 2, no. 6*, p. 98-99.
- (8) ——— JONES, L. R., and REDDY, C. S.
1919. THE BLACK CHAFF OF WHEAT. *In Science*, n. s. v. 50, no. 1280, p. 48.
- (9) STUART, William.
1901. FORMALIN AS A PREVENTATIVE OF OAT SMUT. *Ind. Agr. Exp. Sta. Bul. 87*, 26 p.
- (10) THOMAS, C. C.
1919. SEED DISINFECTION BY FORMALDEHYDE VAPOR. *In Jour. Agr. Research*, v. 17, no. 1, p. 33-39, illus.

PLATE 69

Relative injury to wheat-seed germination caused by short and long formalin treatments:

A.—Effect of formalin 1 to 400 and 1 to 200 treatment for 3, 6, and 12 hours on China variety:

- Row 1, formalin 1 to 400 for 3 hours, 56 per cent germination;
- Row 2, formalin 1 to 400 for 6 hours, 53 per cent germination;
- Row 3, formalin 1 to 400 for 12 hours, 74 per cent germination;
- Row 4, control, 78 per cent germination;
- Row 5, formalin 1 to 200 for 3 hours, 39 per cent germination;
- Row 6, formalin 1 to 200 for 6 hours, 37 per cent germination;
- Row 7, formalin 1 to 200 for 12 hours, 57 per cent germination.

B.—Effect of formalin 1 to 400 and 1 to 200 treatment for 3, 6, and 12 hours on Turkey variety:

- Row 1, formalin 1 to 400 for 3 hours, 42 per cent germination;
- Row 2, formalin 1 to 400 for 6 hours, 48 per cent germination;
- Row 3, formalin 1 to 400 for 12 hours, 50 per cent germination;
- Row 4, control, 56 per cent germination;
- Row 5, formalin 1 to 200 for 3 hours, 23 per cent germination;
- Row 6, formalin 1 to 200 for 6 hours, 17 per cent germination;
- Row 7, formalin 1 to 200 for 12 hours, 34 per cent germination.

Note increased vigor and germination of 12-hour treated seeds compared with 3-hour or 6-hour treated seeds.

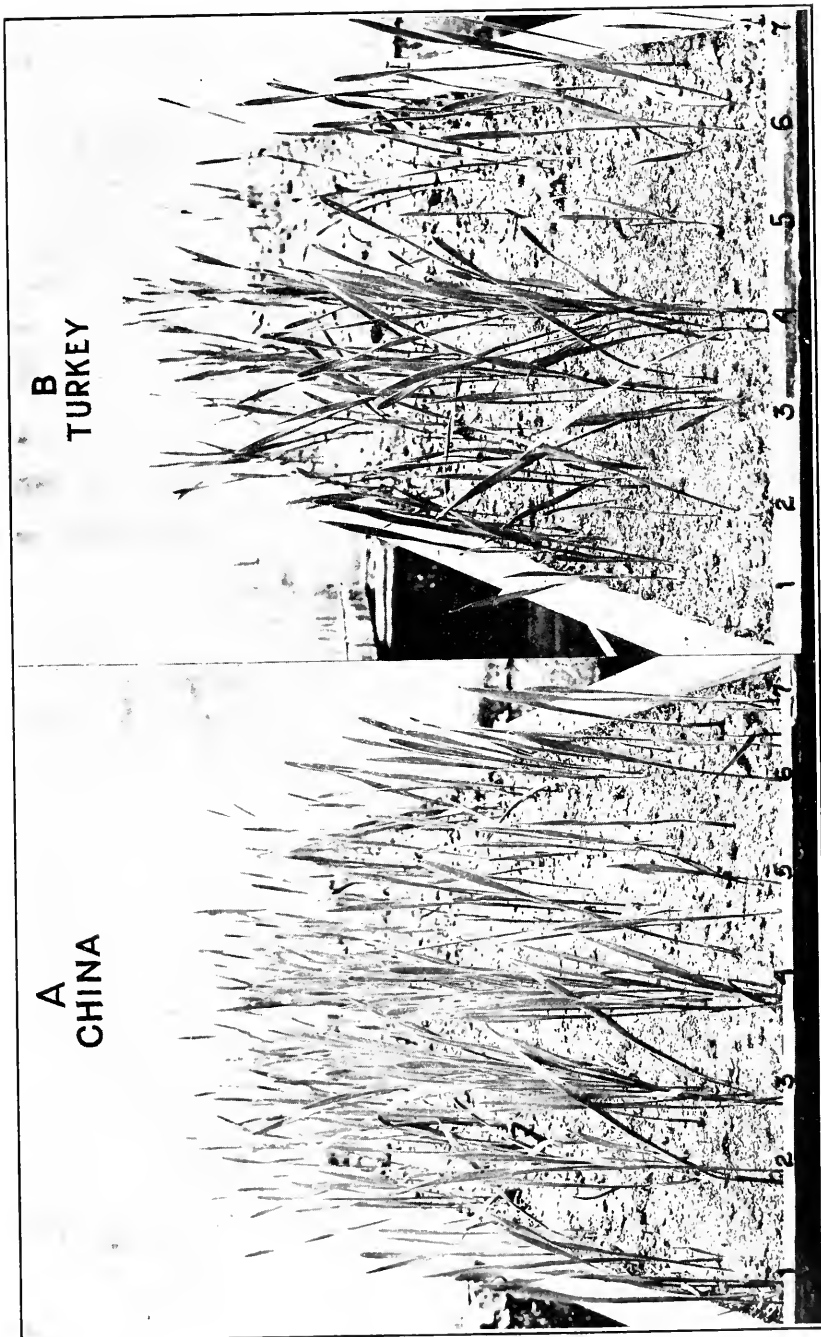

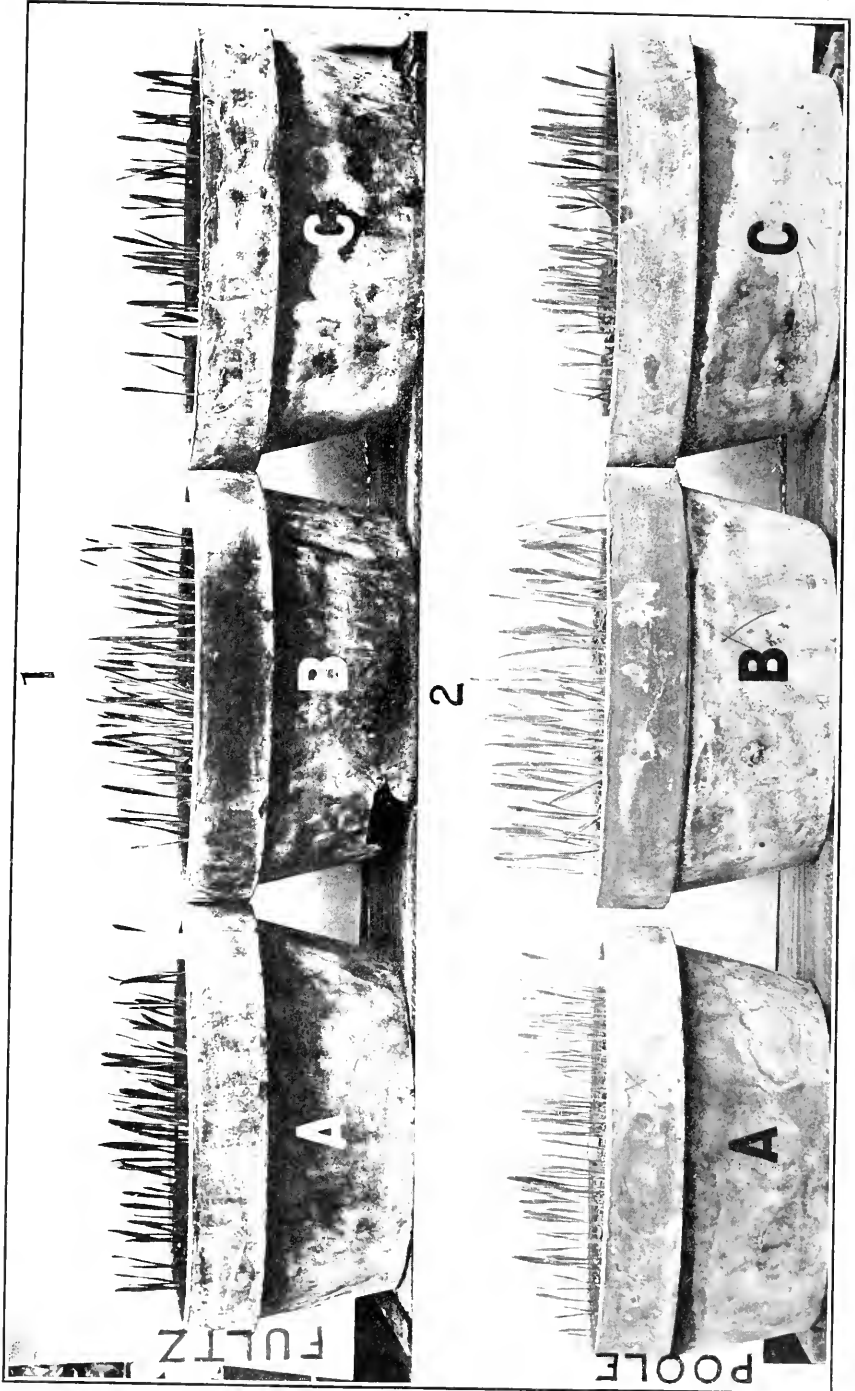

PLATE 70

Effect of formalin 1 to 400 treatment for 6 hours, with and without 6-hour presoak:

1. Fultz wheat: A, control, 76 per cent germination; B, seeds presoaked 6 hours, then formalin 1 to 400 for 6 hours, 79 per cent germination; C, seeds treated with formalin 1 to 400 for 6 hours, not presoaked, 57 per cent germination, plants dwarfed.

2. Poole wheat: A, control, 90 per cent germination; B, seeds presoaked 6 hours, then formalin 1 to 400 for 6 hours, 89 per cent germination; C, seeds treated with formalin 1 to 400 for 6 hours not presoaked, 67 per cent germination, plants dwarfed.

PLATE 71

Effect of formalin 1 to 400 treatment for 6 hours, with and without 6-hour presoak:

1. Fulcaster wheat: A, control, 71 per cent germination; B, seeds presoaked 6 hours, then formalin 1 to 400 for 6 hours, 83 per cent germination; C, seeds treated with formalin 1 to 400 for 6 hours, not presoaked, 54 per cent germination, plants dwarfed.
2. Turkey wheat: A, control, 61 per cent germination; B, seeds presoaked 6 hours then formalin 1 to 400 for 6 hours, 68 per cent germination; C, seeds treated with formalin 1 to 400 for 6 hours without presoaking, 50 per cent germination, plants dwarfed.

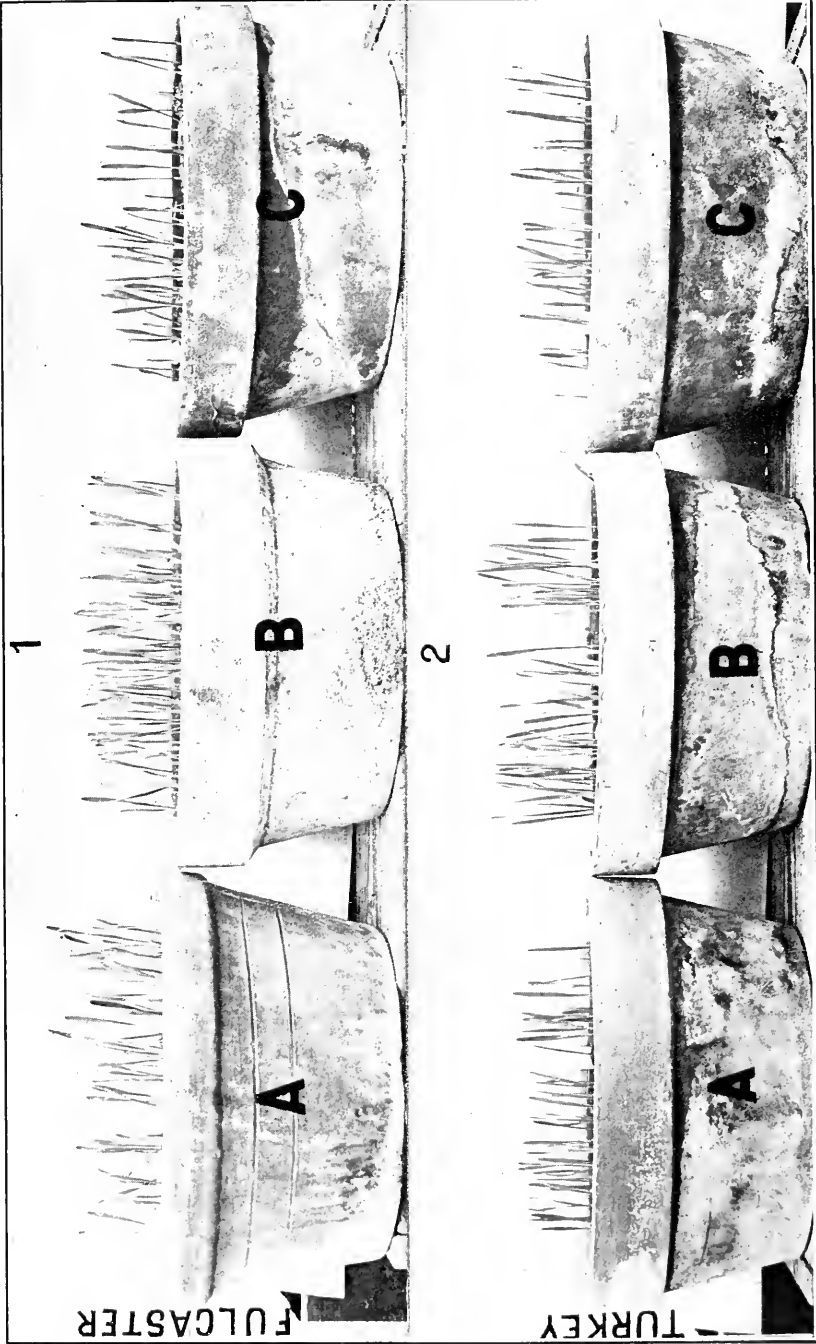

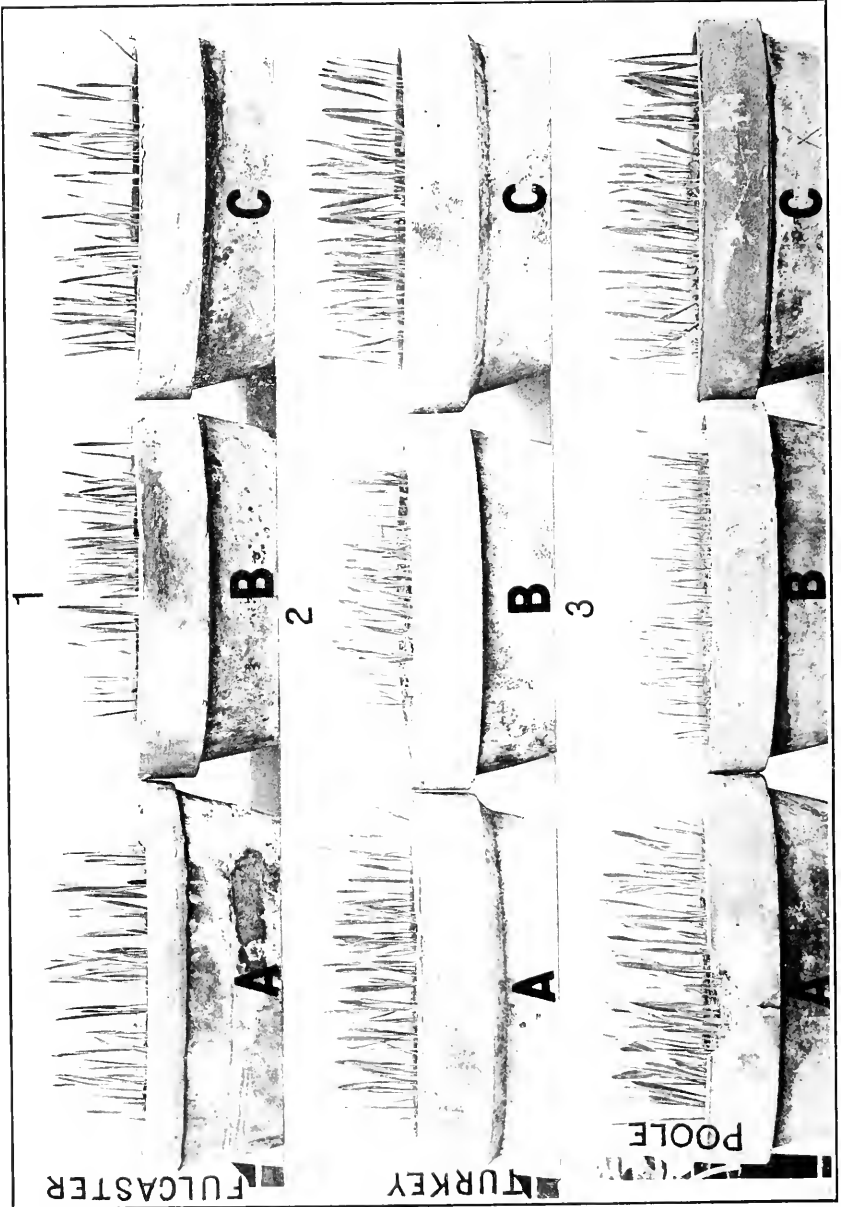

PLATE 72

Stimulating effect of the presoak method of treatment with formalin 1 to 400. (Repetition of experiments shown in Pl. 70, 71):

1. Fulcaster wheat: A, C, seeds presoaked 6 hours, then formalin 1 to 400 for 6 hours, 84 per cent germination, plants stimulated; B, control, 87 per cent germination.

2. Turkey wheat: A, C, seeds presoaked 6 hours, then formalin 1 to 400 for 6 hours, 64 per cent germination; B, control, 67 per cent germination. Note stimulation in presoak-treated plants.

3. Poole wheat: A, C, seeds presoaked 6 hours, then formalin 1 to 400 for 6 hours, 88 per cent germination; B, control, 94 per cent germination. Note increased vigor and stimulation in presoak-treated plants.

PLATE 73

Effect of formalin 1 to 200 treatment for 6 hours, with and without 6-hour presoak:

1. Fultz wheat: A, seeds treated with formalin 1 to 200 for 6 hours without presoak, 43 per cent germination; B, control, 86 per cent germination; C, seeds presoaked 6 hours, then formalin 1 to 200 for 6 hours, 70 per cent germination.

2. Poole wheat: A, seeds treated with formalin 1 to 200 for 6 hours without presoak, 46 per cent germination; B, control, 81 per cent germination; C, seeds presoaked 6 hours, then formalin 1 to 200 for 6 hours, 71 per cent germination. Note stimulation in presoak-treated plants.

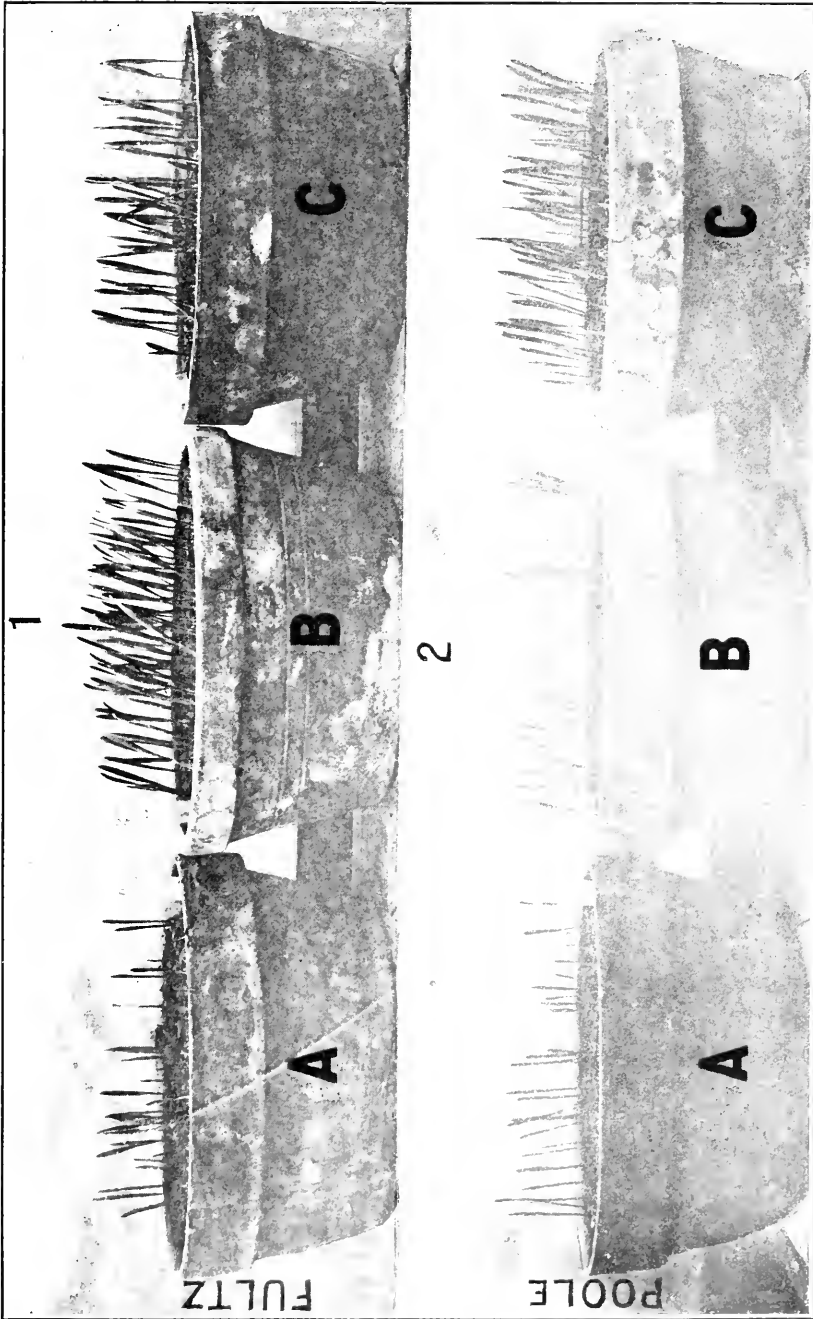

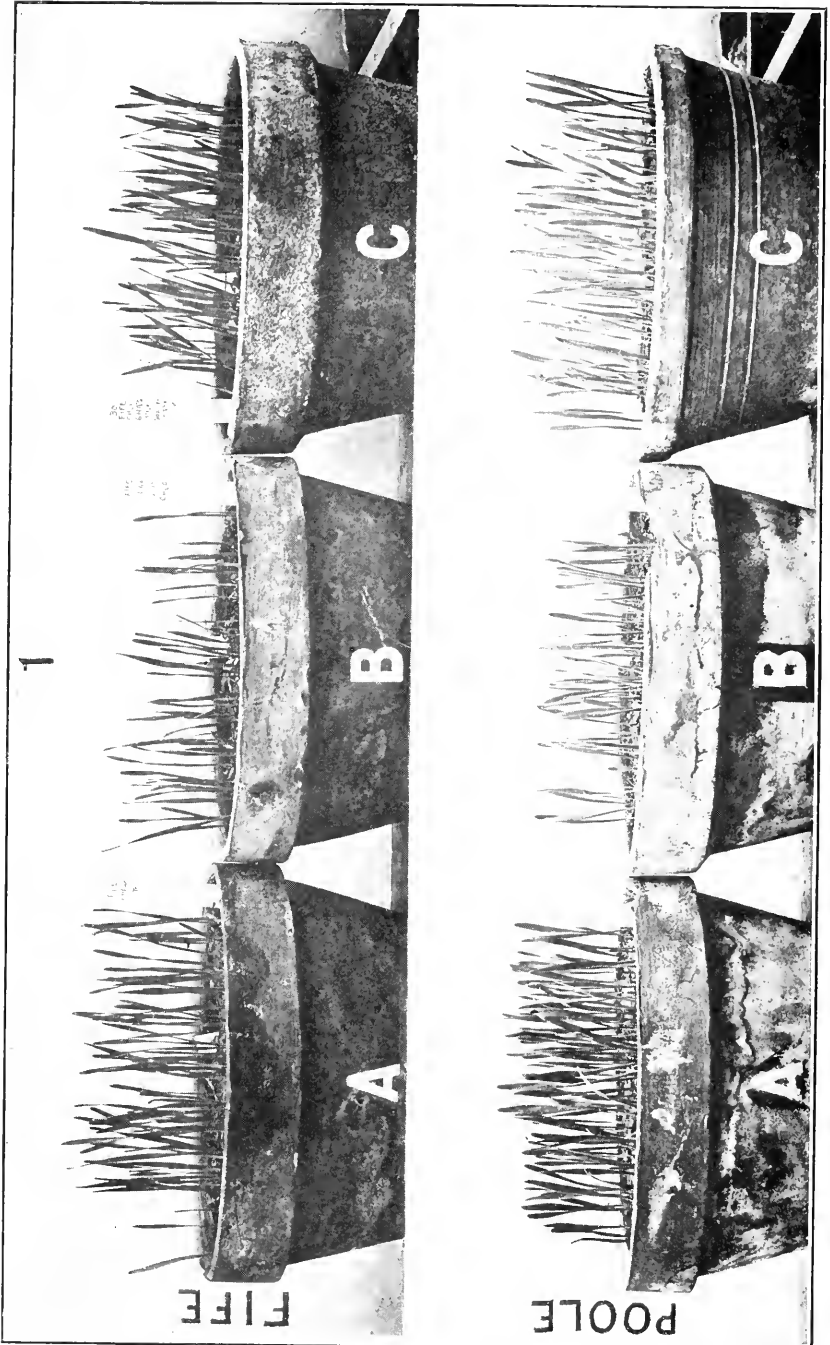

PLATE 74

Effect of formalin 1 to 320 treatment for 6 hours, with and without 6-hour presoak:

1. Fife wheat: A, control, 79 per cent germination; B, seeds treated with formalin 1 to 320 for 6 hours, 53 per cent germination; C, seeds presoaked 6 hours, then formalin 1 to 320 for 6 hours, 82 per cent germination.

2. Poole wheat: A, control, 88 per cent germination; B, seeds treated with formalin 1 to 320 for 6 hours, 70 per cent germination; C, seeds presoaked 6 hours, then formalin 1 to 320 for 6 hours, 86 per cent germination.

PLATE 75

1. Fife wheat: A, B, control, 83 per cent germination; C, D, seeds treated with formalin 1 to 320 for 3 hours, 62 per cent germination; E, F, seeds presoaked 6 hours, then formalin 1 to 320 for 6 hours, 90 per cent germination.

2. Poole wheat: A, B, control, 85 per cent germination; C, D, seeds treated with formalin 1 to 320 for 6 hours, 55 per cent germination; E, F, seeds presoaked 6 hours, then formalin 1 to 320 for 6 hours, 88 per cent germination.

3. Effect of soaking in water throughout presoak period, compared with procedure of keeping moist 6 hours: A, B, Fife wheat; C, D, Poole wheat; A, C, seeds soaked in water 5 hours, then treated with formalin 1 to 320 for 7 hours; B, D, seeds soaked in water 10 minutes, drained, and kept moist 6 hours, then treated with formalin 1 to 320 for 6 hours. Note the greater stimulation in B and D.

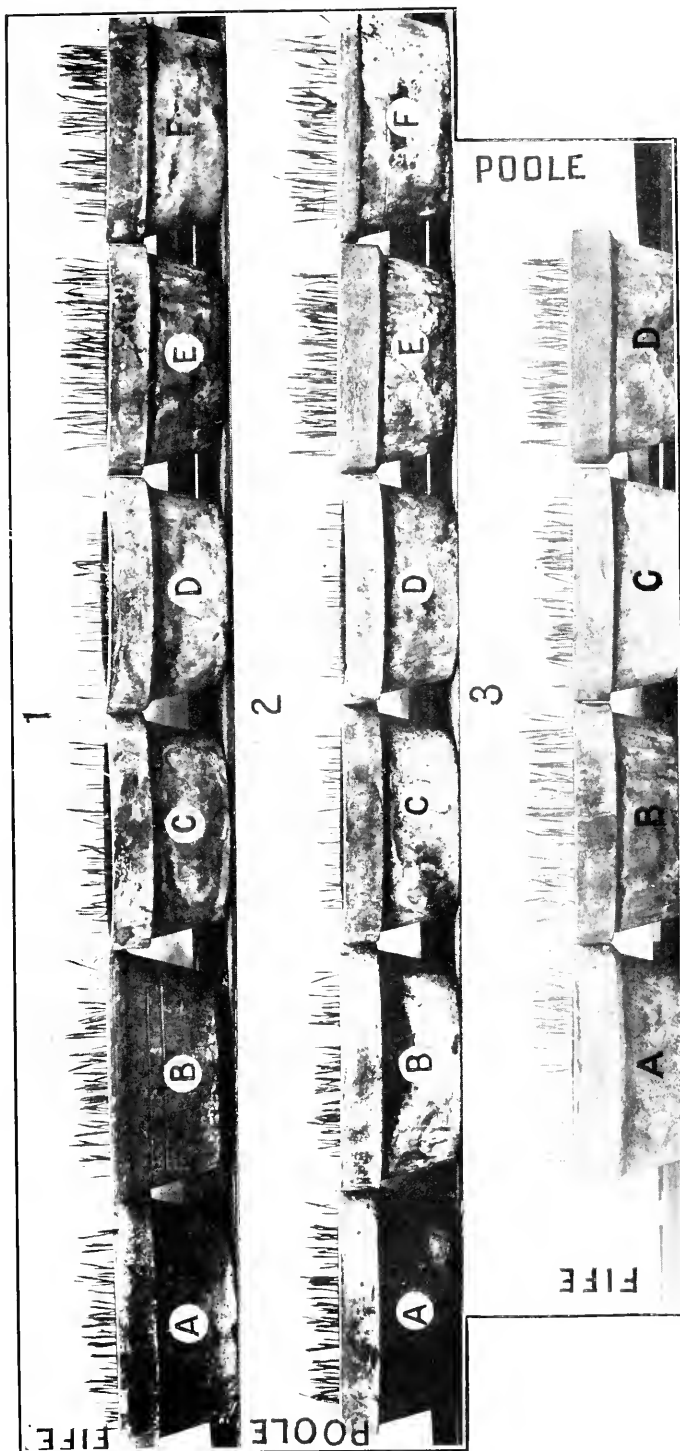

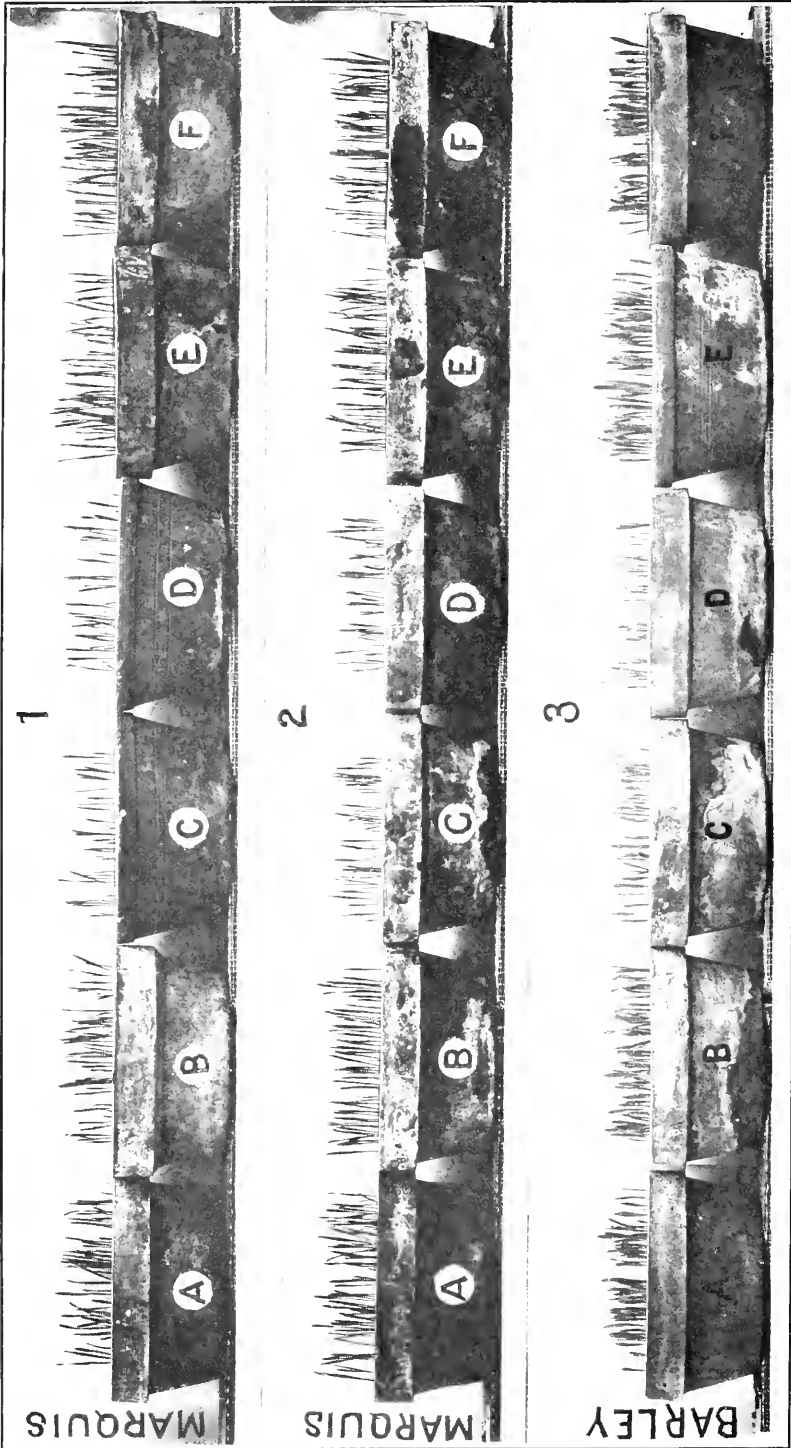

PLATE 76

Effect of formalin and copper sulphate on wheat and of copper sulphate on barley, with and without presoaking:

1. Marquis wheat: A, B, control, 76 per cent germination; C, D, seeds treated with formalin 1 to 320 for 6 hours, 57 per cent germination; E, F, seeds presoaked 6 hours, then formalin 1 to 320 for 6 hours, 77 per cent germination.

2. Marquis wheat: A, B, control, 84 per cent germination; C, D, seeds treated with copper sulphate 1 to 80 for $\frac{1}{2}$ hour, and limed, 65 per cent germination; E, F, seeds presoaked 6 hours, then copper sulphate 1 to 80 for $\frac{1}{2}$ hour, and limed, 79 per cent germination.

3. Tennessee winter barley: A, B, control, 89 per cent germination; C, D, seeds treated with copper sulphate 1 to 80 for $\frac{1}{2}$ hour, and limed, 72 per cent germination; E, F, seeds presoaked 6 hours, then copper sulphate 1 to 80 for $\frac{1}{2}$ hour, and limed, 83 per cent germination.

PLATE 77

Effect of presoak method used with copper-sulphate treatment of wheat:

1. Fulcaster wheat: A, B, control, 81 per cent germination; C, D, seeds treated with copper sulphate 1 to 80 for $\frac{1}{2}$ hour, and limed, 57 per cent germination; E, F, seeds presoaked 8 hours, then copper sulphate 1 to 80 for $\frac{1}{2}$ hour, and limed, 82 per cent germination.

2. Fife wheat: A, B, control, 79 per cent germination; C, D, seeds treated with copper sulphate 1 to 80 for $\frac{1}{2}$ hour, and limed, 52 per cent germination; E, F, seeds presoaked 8 hours, then copper sulphate 1 to 80 for $\frac{1}{2}$ hour, and limed, 81 per cent germination.

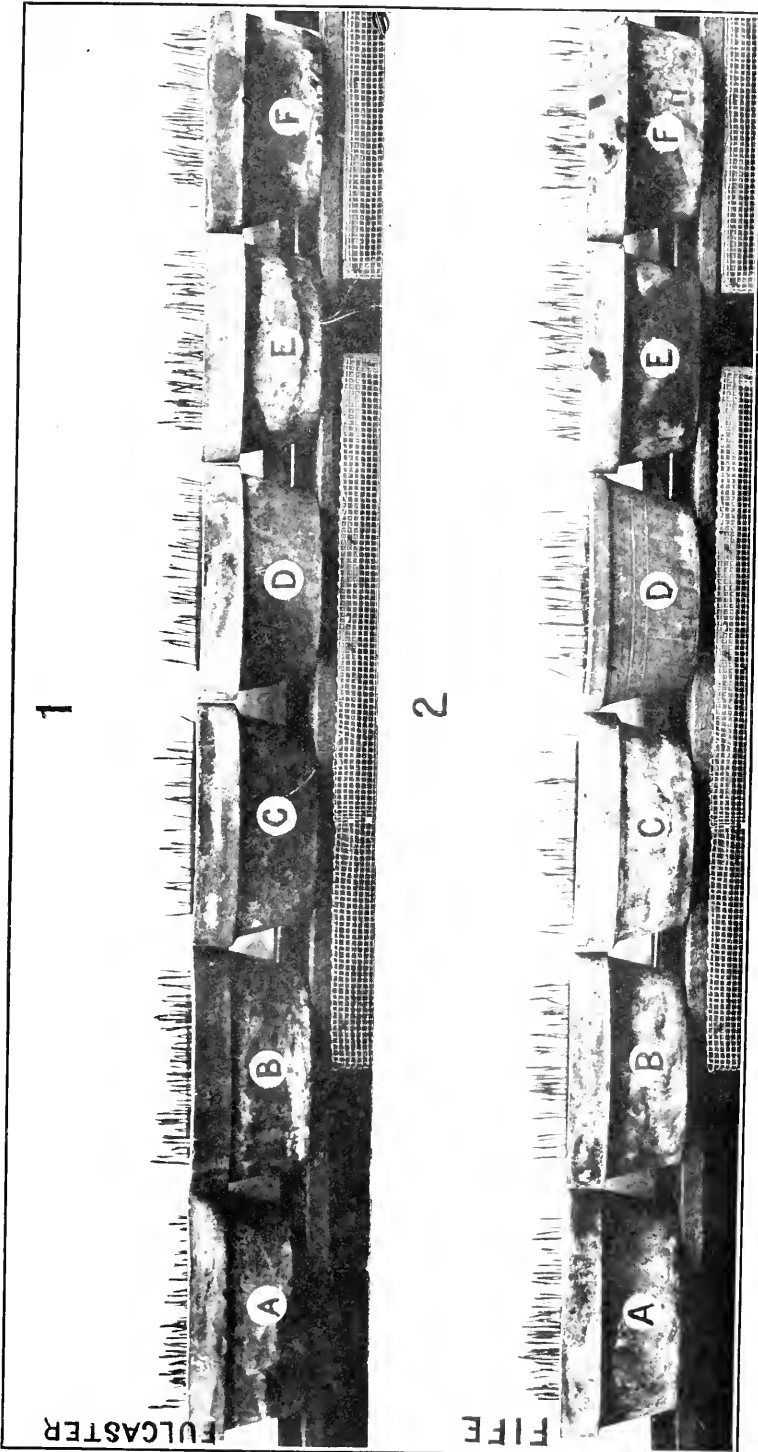

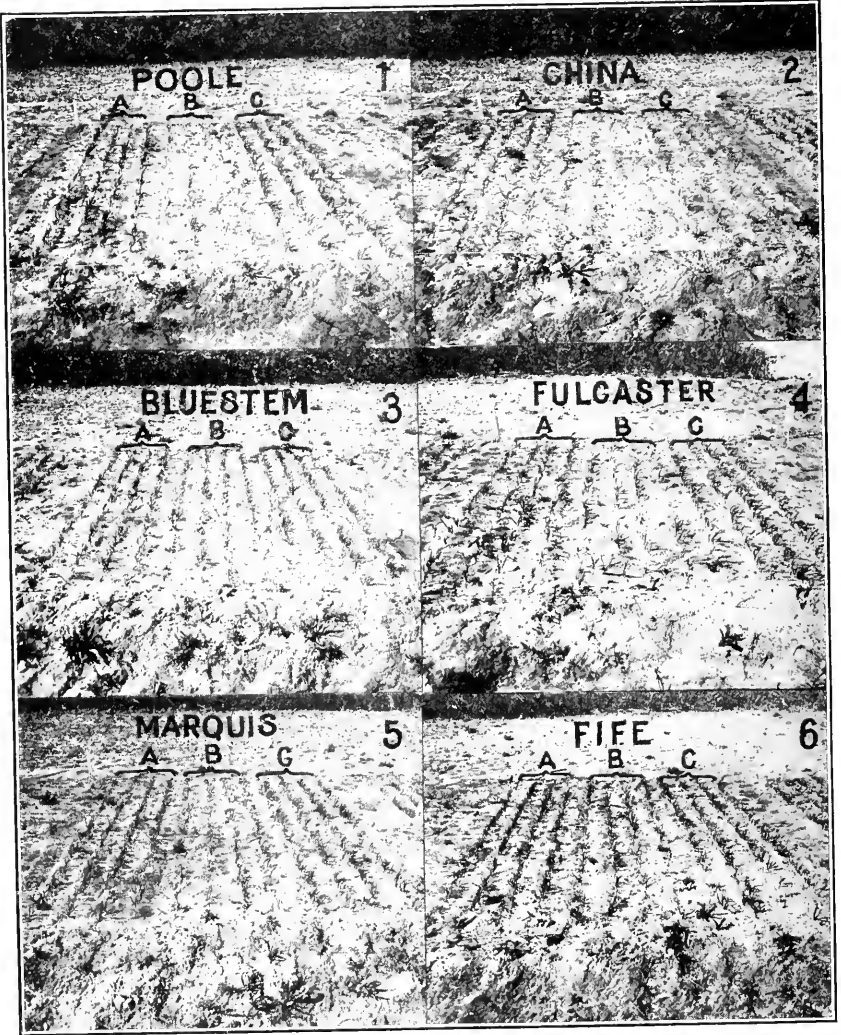

PLATE 78

Effect of presoak method used with formalin 1 to 320 on wheat under field conditions:

1. Poole; 2. China; 3. Bluestem; 4. Fulcaster; 5. Marquis; 6. Fife.

A.—Eight hundred seeds in four rows, soaked in water 10 minutes, kept moist 6 hours, soaked in formalin 10 minutes, kept moist 6 hours, dried overnight.

B.—Eight hundred seeds in four rows, soaked in formalin 1 to 320 for 10 minutes, kept moist 6 hours, dried overnight.

C.—Eight hundred seeds in four rows, control.

PLATE 79

Effect of presoak method used with formalin 1 to 400 on blackchaff bacteria:

A.—Controls, dry-heat sterilized wheat seeds inoculated with blackchaff isolation No. 377 from South Dakota, dried, and planted on agar without further treatment.

B.—Sterilized wheat seeds inoculated with isolation No. 377, dried overnight, then soaked in sterile tap water 10 minutes and kept moist 6 hours, then soaked in formalin 1 to 400 for 10 minutes and kept moist 6 hours, dried, and planted.

Note bacterial growth around untreated seeds and absence of growth in presoaked formalin-treated seeds. Two Petri dishes photographed out of a set of 120 dishes in experiment III on tenth day.

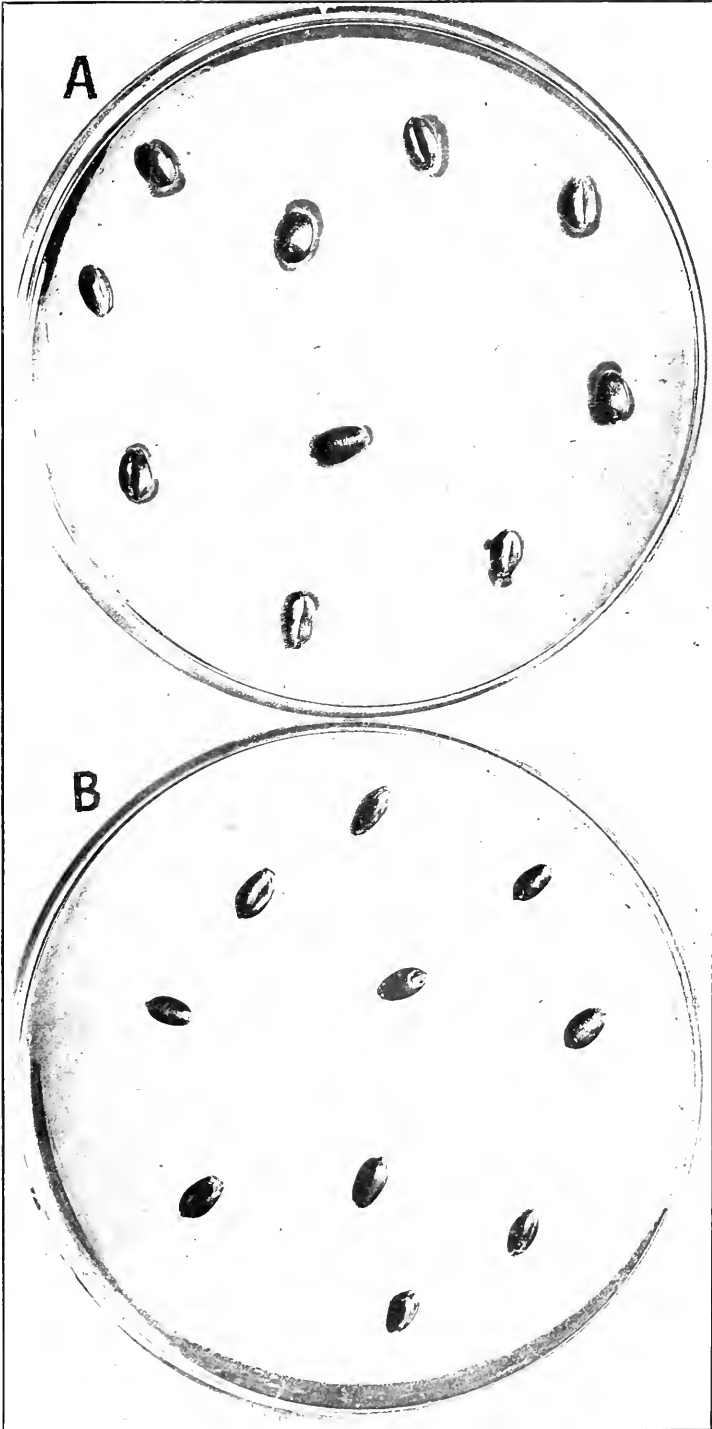

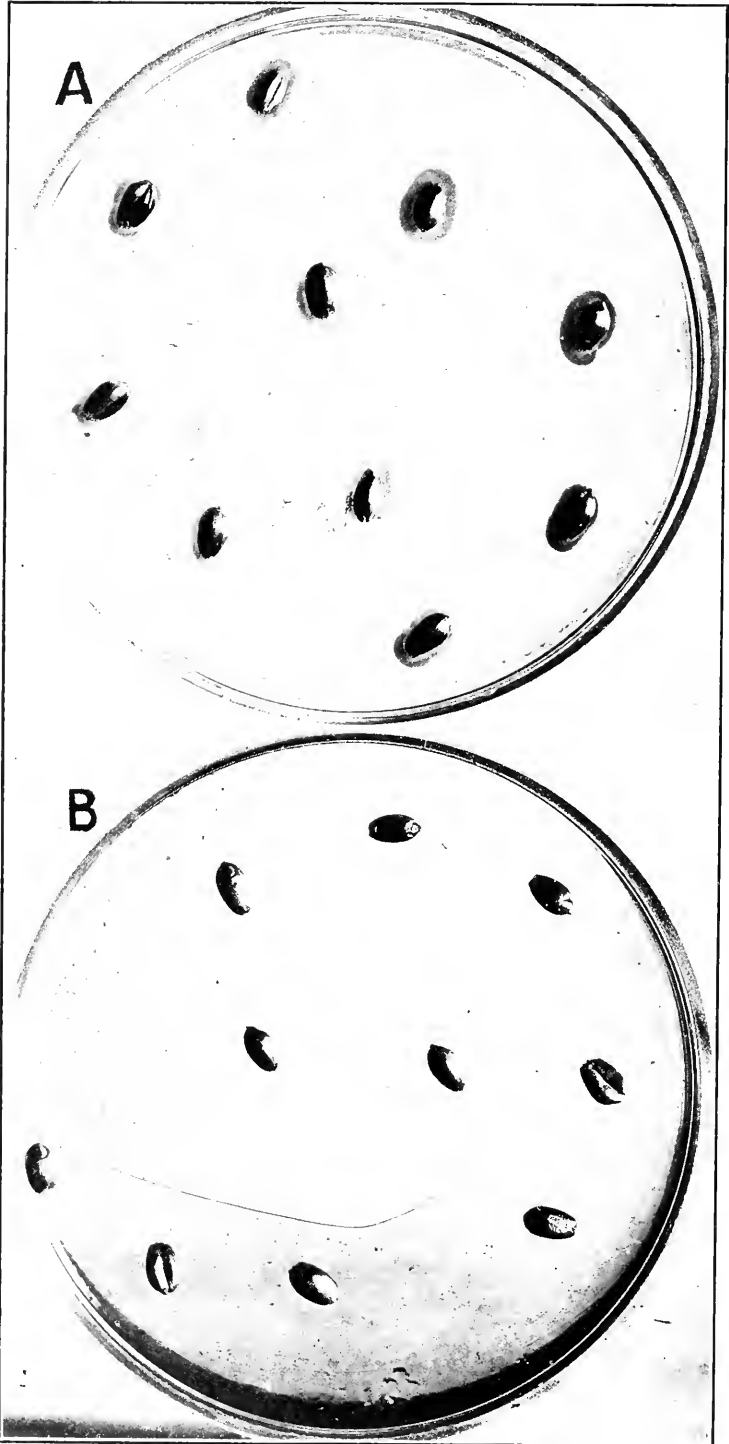

PLATE 80

Effect of presoak method used with formalin 1 to 400 on blackchaff bacteria:

A.—Controls, dry-heat sterilized wheat seeds inoculated with blackchaff isolation No. 373 from North Dakota, dried, and planted on agar without further treatment.

B.—Sterilized wheat seeds inoculated with isolation No. 373, dried overnight, then soaked in sterile tap water 10 minutes, kept moist 6 hours, then soaked in formalin 1 to 400 for 10 minutes, drained, kept moist 6 hours, dried, and planted.

Note bacterial growth around untreated seeds and absence of growth in presoaked formalin-treated seeds. Two Petri dishes photographed out of a set of 120 dishes in experiment III on tenth day.

PLATE 81

Effect of presoak method on barley and oats:

1. Chevalier barley: A, control, 92 per cent germination; B, seeds treated with formalin 1 to 320 for 6 hours, 58 per cent germination; C, seeds presoaked 6 hours, then formalin 1 to 320 for 6 hours, 91 per cent germination.

2. Burt oats: A, control, 94 per cent germination; B, seeds treated with formalin 1 to 320 for 6 hours, 66 per cent germination; C, seeds presoaked 6 hours, then treated with formalin 1 to 320 for 6 hours, 94 per cent germination.

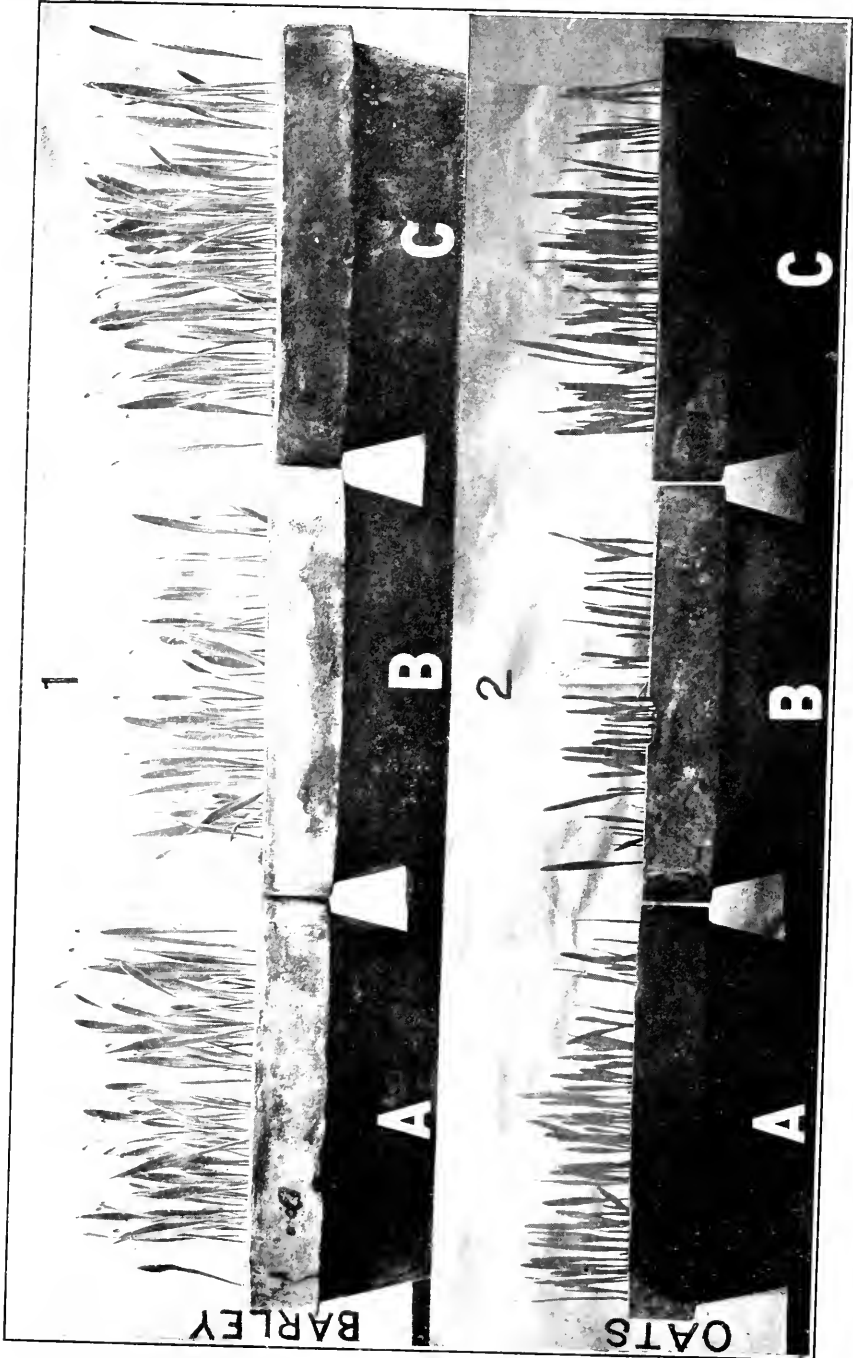

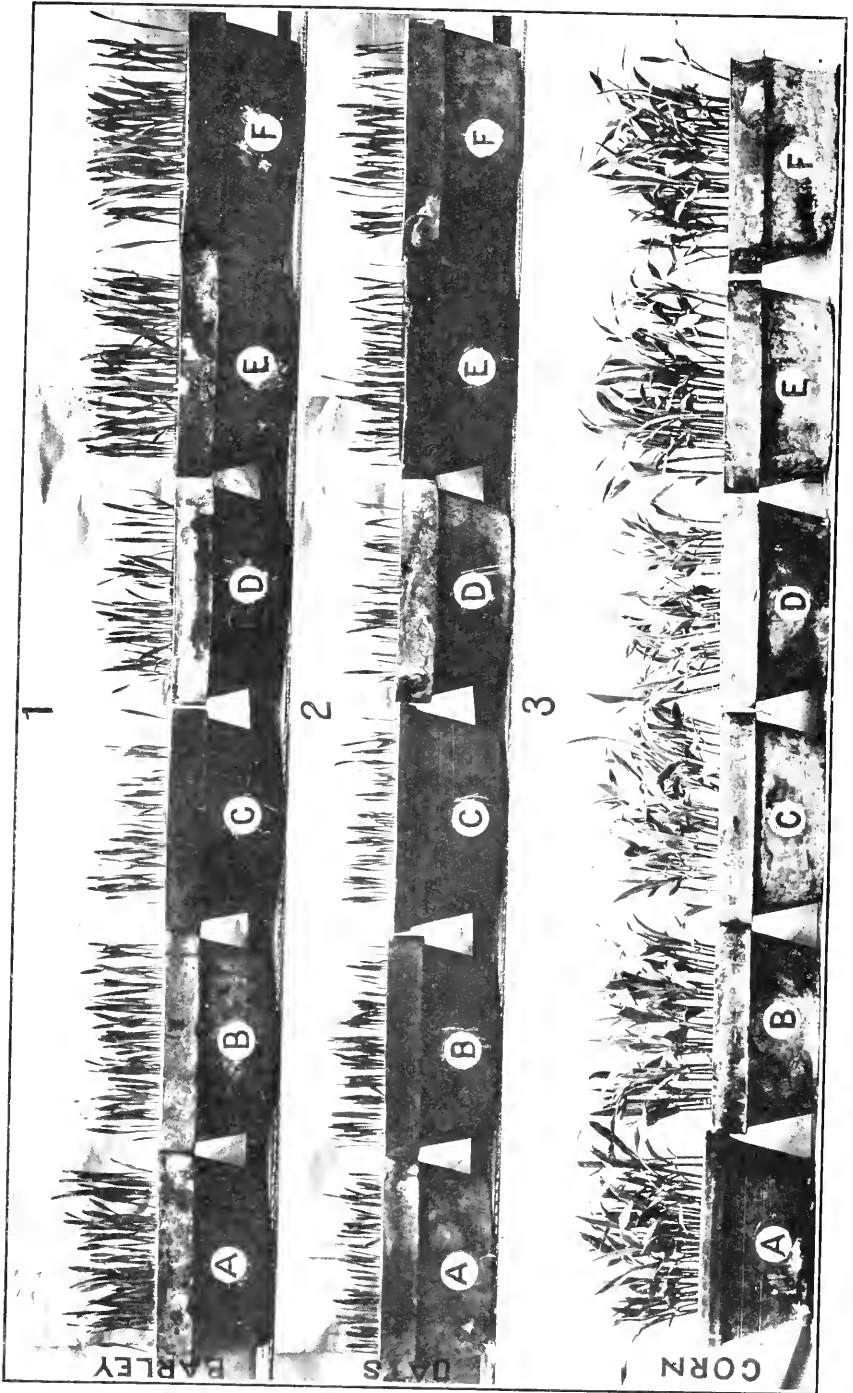

PLATE 82

Effect of presoak method used on barley, oats, and corn:

1. Chevalier barley: A, B, control, 92 per cent germination; C, D, seeds treated with formalin 1 to 320 for 10 minutes, then kept moist (covered) 6 hours, 62 per cent germination; E, F, seeds presoaked 6 hours, then formalin 1 to 320 for 6 hours, 92 per cent germination. Photographed on seventh day.

2. Burt oats: A, B, control, 96 per cent germination; C, D, seeds treated with formalin 1 to 320 for 6 hours, 71 per cent germination; E, F, seeds presoaked 6 hours, then formalin 1 to 320 for 6 hours, 92 per cent germination. Photographed on seventh day.

3. Bantam Evergreen corn: A, B, control, 94 per cent germination; C, D, seeds treated with formalin 1 to 200 for 4 hours, 90 per cent germination; E, F, seeds actually soaked in water 10 hours, then treated with formalin 1 to 200 for 4 hours, 92 per cent germination. Count taken on twelfth day, photographed on sixteenth day. The presoaked seeds are stimulated.

ADDITIONAL COPIES
OF THIS PUBLICATION MAY BE PROCURED FROM
THE SUPERINTENDENT OF DOCUMENTS
GOVERNMENT PRINTING OFFICE
WASHINGTON, D. C.
AT
25 CENTS PER COPY
SUBSCRIPTION PRICE, \$1.50 PER YEAR

JOURNAL OF AGRICULTURAL RESEARCH

CONTENTS

Daily Development of Kernels of Hannchen Barley from Flowering to Maturity at Aberdeen, Idaho	Page 393
--	-------------

HARRY V. HARLAN

(Contribution from Bureau of Plant Industry and Idaho
Agricultural Experiment Station)

Development of Barley Kernels in Normal and Clipped Spikes and the Limitations of Awnless and Hooded Varieties	431
---	-----

HARRY V. HARLAN and STEPHEN ANTHONY

(Contribution from Bureau of Plant Industry and Idaho
Agricultural Experiment Station)

**PUBLISHED BY AUTHORITY OF THE SECRETARY OF AGRICULTURE,
WITH THE COOPERATION OF THE ASSOCIATION OF
LAND-GRANT COLLEGES**

WASHINGTON, D. C.

**EDITORIAL COMMITTEE OF THE
UNITED STATES DEPARTMENT OF AGRICULTURE AND
THE ASSOCIATION OF LAND-GRANT COLLEGES**

FOR THE DEPARTMENT

KARL F. KELLERMAN, CHAIRMAN

*Physiologist and Associate Chief, Bureau
of Plant Industry*

EDWIN W. ALLEN

Chief, Office of Experiment Stations

CHARLES L. MARLATT

*Entomologist and Assistant Chief, Bureau
of Entomology*

FOR THE ASSOCIATION

J. G. LIPMAN

*Dean, State College of Agriculture, and
Director, New Jersey Agricultural Experiment
Station, Rutgers College*

W. A. RILEY

*Entomologist and Chief, Division of Ento-
mology and Economic Zoology, Agricul-
tural Experiment Station of the University
of Minnesota*

R. L. WATTS

*Dean, School of Agriculture, and Director,
Agricultural Experiment Station, The
Pennsylvania State College*

All correspondence regarding articles from the Department of Agriculture should be addressed to Karl F. Kellerman, Journal of Agricultural Research, Washington, D. C.

All correspondence regarding articles from State Experiment Stations should be addressed to J. G. Lipman, New Jersey Agricultural Experiment Station, New Brunswick, N. J.

JOURNAL OF AGRICULTURAL RESEARCH

VOL. XIX

WASHINGTON, D. C., AUGUST 2, 1920

No. 9

DAILY DEVELOPMENT OF KERNELS OF HANNCHEN BARLEY FROM FLOWERING TO MATURITY AT ABERDEEN, IDAHO¹

By HARRY V. HARLAN

Agronomist in Charge of Barley Investigations, Office of Cereal Investigations, Bureau of Plant Industry, United States Department of Agriculture

INTRODUCTION

Several years ago the author made a few elementary experiments on the function of the awn in barley. In these studies the awns were clipped from some spikes and not from others. The effect on the development of the kernels was so striking that in 1915 a more elaborate experiment was carried out by the author and Stephen Anthony. The development of kernels on normal and clipped spikes was determined from flowering to maturity. The method of study proved so satisfactory that it led to other investigations in which it offered the same possibility of application. The development of barley on dry land and on irrigated land, the response to irrigation water, and the differences in varietal behavior have all been studied by this means. The last study has been undertaken since the resignation of Mr. Anthony. In these studies, kernel growth has been used as an index of effect. Yield and size of mature kernels, while probably a safe summary of the effects of variations of treatment or differences of types, do not throw much light on the time when the effect occurred, or always on the reasons therefor. This group of studies has been carried on with the idea that variations from a basic growth curve showing the inception, duration, and degree of response would be much more illuminating than the single observation of the final result.

A number of studies have been completed, and it is the intention to publish the results of the special projects from time to time. The results represent a normal growth curve. It is intended that this curve shall form the basis of comparison in the later studies and that it shall

¹ These studies were made on the Aberdeen Substation, Aberdeen, Idaho, in connection with cereal experiments conducted cooperatively by the Idaho Agricultural Experiment Station and the Office of Cereal Investigations, Bureau of Plant Industry, United States Department of Agriculture.

be a connecting link between the various studies. In this paper the results with the Hannchen variety are given in full for one year at Aberdeen, Idaho. The Hannchen variety was chosen for this basic statement because it has been used more extensively than any other variety. The growth at Aberdeen is selected both because of the fact that most of the studies made and projected are located there and because of the remarkable uniformity of growth of plants at that place from season to season. In three different years the period from flowering to maturity has extended over exactly 26 days. This uniformity, coupled with accurate sampling, has made it possible to take samples at intervals as short as 24 hours or even less and still show consistent growth. In no previous studies on cereal crops, either here or abroad, have samples been taken more frequently than at 3-day intervals, yet it is readily seen in figure 1 that most of the growth in length is completed in a period of three days. The measurements of kernel dimensions are an important index of development which seems to have been generally ignored.

HISTORICAL REVIEW

The published data on kernel development have little relation to the various lines of investigation at Aberdeen, Idaho. Differences of location and variety make anything but general comparisons difficult in this connection.

The studies of kernel development previously reported in the cereals have been the outcome of a wide range of experiments and are too numerous to be reviewed in detail. Kudelka (4),² Lermer and Holzner (5), and many others have published on the origin and development of tissues in the caryopsis as a whole, or even in the entire plant. Some investigations have been specifically devoted to tissues of the pericarp. Johannsen (3), Brenchley (1), Schjerning (6, 7), and numerous others have investigated the chemical changes of growth and maturation. The work of these investigators is referred to later. Their experiments were carried on under relatively unfavorable conditions. The contrast is remarkable between the humid climates of Denmark and England, with their frequent storms and days of low activity, and the arid climate of Aberdeen. Schjerning had a difference of 12 days in the maturity of his plots in two succeeding years.

The detail of the experiment at Aberdeen is more nearly like those of Brenchley (1), Schjerning (6, 7), and Johannsen (3) than those of the other investigators. It differs from these in a reduction of the period between samples and in the extensive study of the physical indices of length and diameter of kernel. The chemical and morphological phases are not comparable with those of Schjerning and Johannsen.

² Reference is made by number (*italic*) to "Literature cited," p. 429.

EXPERIMENTAL METHODS

Such success as has been obtained in reducing the interval of sampling is due in large part to the accuracy of tagging spikes at the same stage of development. This, in turn, rests on an observation made several years

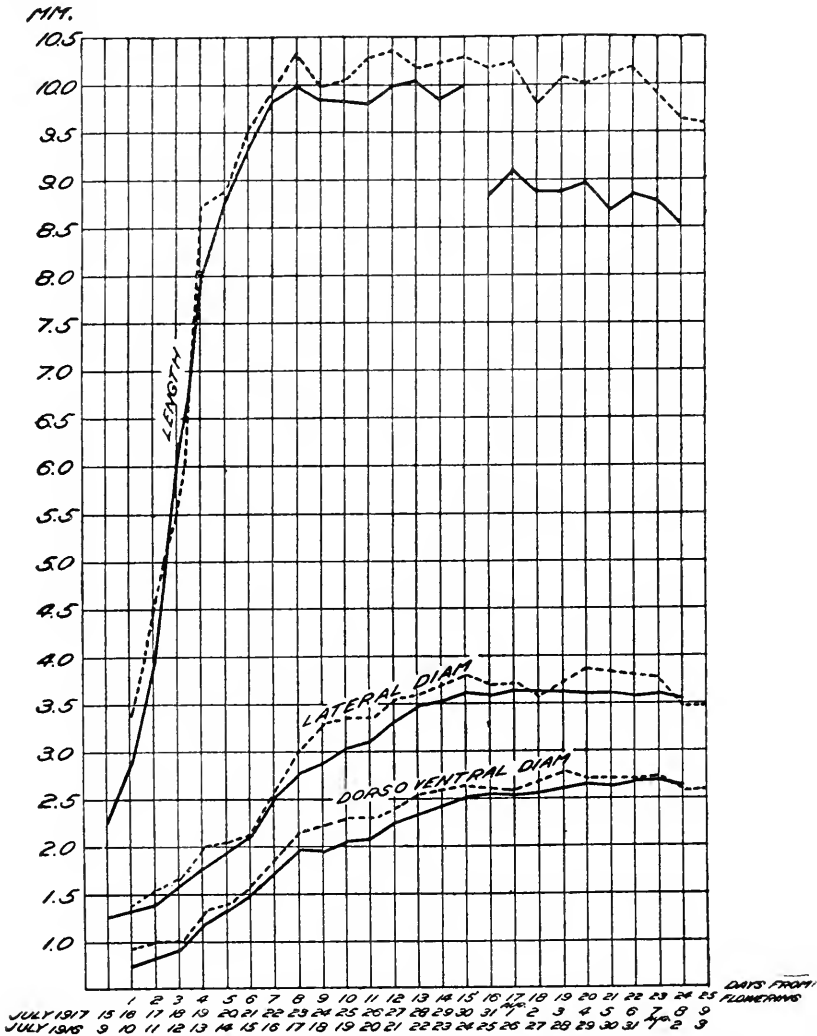

FIG. 1.—Graph showing length, lateral diameter, and dorsoventral diameter of barley kernels for the 25 days following flowering. The broken lines give the data for 1916, the solid lines the data for 1917.

before the work was started. In agronomic notes taken upon cereal varieties, the time of heading and the time of ripening have always been considered to be important statements of development. Of these, the time of heading is thought to be especially valuable, because drouth and other climatic factors that greatly influence maturity have usually affected the plant but little up to this stage.

While time of heading in barley is doubtless significant, it is very difficult to determine. A barley spike may be visible two or three days before it is fully exerted from the sheath. In some varieties the spikes are never completely exerted. In a study of this difficulty it was noticed that the emergence of the awns offered opportunity for a tangible observation. Upon trial it was found to be a very accurate index of the stage of the development of the spike. With the observation as a basis, spikes tagged as uniform before flowering were of so nearly the same stage of development that, despite individual fluctuations, growth in as short periods as 12 hours was evident in the data for many days; and almost until maturity the individual variations in samples of only two spikes did not obscure the growth in 24-hour periods. The accuracy of the method and the spectacular uniformity of Idaho seasons is well shown in figure 2, where the percentages of moisture in kernels in the seasons of 1916 and 1917 essentially coincide throughout the entire period of growth.

Three or four days after the tips of the awns are visible on the earliest culms a large number of culms are to be found with tips visible. At this time the plots are carefully inspected and the requisite number of culms is marked. The marking is done by tying a piece of wool yarn about the culm. Culms are selected in which the awns are protruding $\frac{1}{4}$ to $\frac{1}{2}$ inch above the sheath of the uppermost leaf. A sufficient number of culms is tagged to insure against accident. As soon as the spikes are partially exerted a sample is taken. This sample and the one on the following day usually have several florets which have not yet been fertilized. The samples taken in the first few days consist of three spikes in order to secure a greater quantity of material, but later the number is reduced to two per sample. In most cases only one sample is taken each day, but in the cases furnishing the data reported in Table I two samples were taken, one in the morning and one in the evening. The samples are taken in the field by cutting the culms near the ground. These culms and spikes are wrapped in a moist towel and taken to the laboratory. As a protection against evaporation in the laboratory the spikelets are removed one at a time, the remainder of the spike being left in the towel. To secure the data rapidly and satisfactorily two men work on the same sample. The kernels are taken from the florets by the operator of the calipers, who measures the length, lateral diameter, and dorsoventral diameter in tenths of millimeters and records these measurements. The kernels are then passed to the operator of the balance and weighed to tenths of milligrams. Only the kernels on a single side of each spike are measured and weighed individually. The kernels of the other side of the spike are added to those measured individually and weighed to obtain a larger sample. These are placed in small vials and dried in a water-jacket oven. The vials are then corked, and the material is preserved for later analysis.

EXPERIMENTAL MATERIAL

Most of the data presented herein were obtained in 1917, but many of the graphs contain curves of the data for 1916 as well. The curves for 1916 are added merely for comparison and to give an idea of the

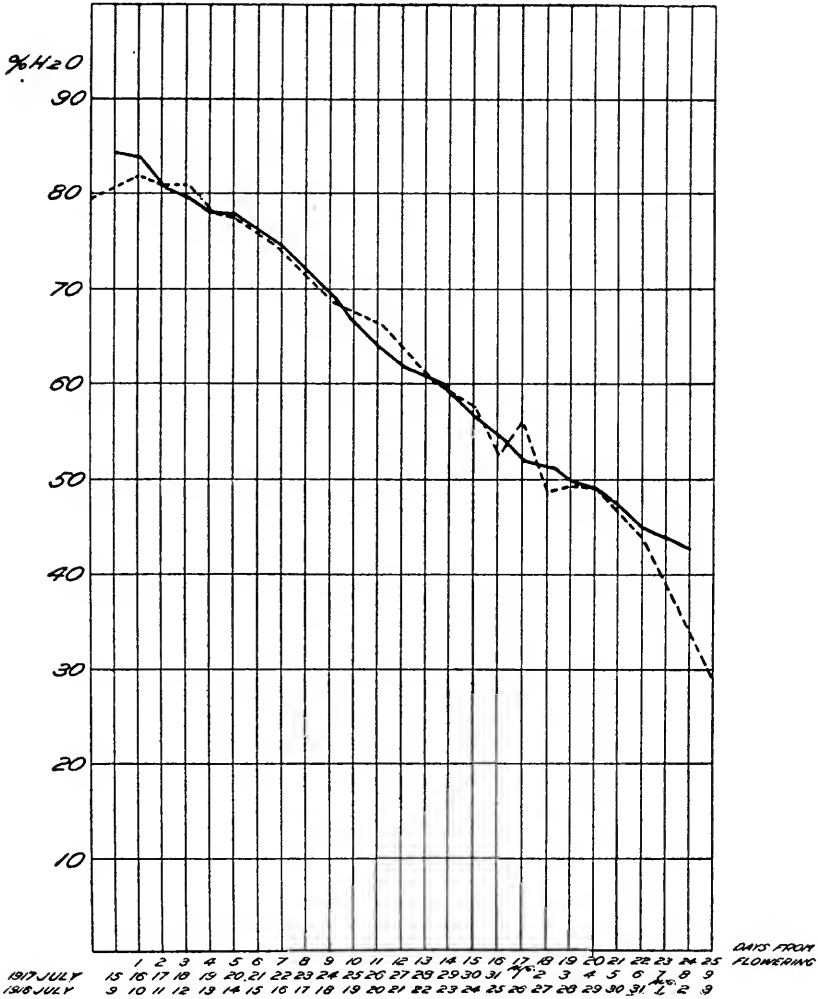

FIG. 2.—Graph showing percentage of moisture per kernel from date of flowering. The broken line gives the data for 1916, the solid line the data for 1917.

range of annual fluctuations. The larger growth in 1916 was due, doubtless, to the more generous application of water in that year. The plots were in flower a week earlier in 1916 than in 1917 and may have had some advantage of season. In figure 3 the maximum and mean temperatures for the two years are shown. These are of interest later in their relation to daily fluctuation. In both years the barley was

grown under irrigation and was watered sufficiently often to insure a satisfactory growth. In 1916, only one sample was taken per day, and no samples were taken on Sunday. In 1917, samples were taken morning and evening, on Sundays as well as on week days; and the series is thus more nearly complete than in the previous year.

DAILY INCREMENT OF VOLUME

The data on the daily increment of volume, as shown by the increased length, lateral diameter, dorsoventral diameter, and wet weight of kernels, fall into two classes, which will be treated separately. The measurements

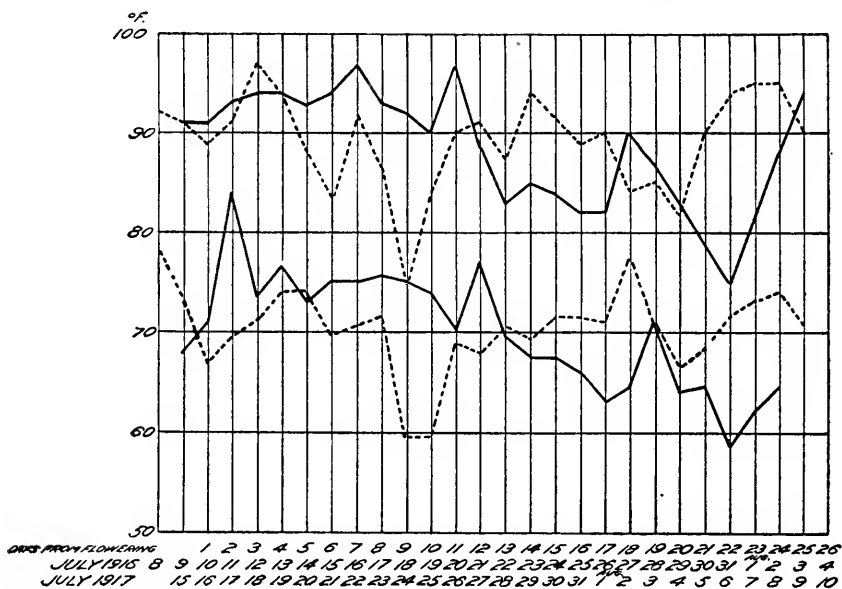

FIG. 3.—Graph showing maximum and mean daily temperatures recorded at Aberdeen, Idaho, from July 8 to August 4, 1916 (broken line), and from July 15 to August 10, 1917 (solid line). In both years these temperatures are for 26 days following flowering of Hannchen barley.

of volume are observations immediately obtainable in the field and will be first reported. The chemical constituents of the kernels are determined in the laboratory and will be referred to later.

Table I shows the weights and measurements of the individual kernels on one side of each spike in the samples. The samples were taken at approximately 6 a. m. and 7 p. m. These hours marked the beginning and the end of effective sunshine. The morning samples on each date are on the left half of the table and evening samples on the right half. The florets are numbered from the base of the spike toward the tip, so that the figures in each column represent a spike with the base toward the top of the page. In the earlier samples where three spikes were taken, the record of one spike has been omitted from this table because of lack of space. While the number of data makes it difficult

to visualize the changes that take place from day to day, the nature of the individual spikes can be seen only in this table. The averages do not give a correct indication of the condition of a single spike. The variations between kernels are reduced by averages, and the difficulty of securing such averages is not apparent in the absence of the complete data. It is readily seen in the table that in instances where the spike is short it is often a question which kernel should be considered the third or the fourth. Such decisions affect the averages, and they must be made by some arbitrary method, since the actual number of sterile nodes at the base can not be used successfully as a basis. The curve of the kernels of a single spike usually is better than the average of two spikes unless the two spikes have the same number of kernels. The extremes of the curves are especially liable to distortion in averages. Of course, the curve of the growth by days is much improved by the use of averages. The same process that reduces the fluctuation in the record of a spike increases the gap between samples.

TABLE I.—Normal growth of Hannchen barley in 12-hour periods from flowering to maturity, at Aberdeen, Idaho, in 1917

JULY 15

Kernel No. from base of spike.	6 a. m.								7 p. m.							
	Weight of kernel on spike—		Length of kernel on spike—		Lateral diameter of kernel on spike—		Dorso-ventral diameter of kernel on spike—		Weight of kernel on spike—		Length of kernel on spike—		Lateral diameter of kernel on spike—		Dorso-ventral diameter of kernel on spike—	
	A.	B.	A.	B.	A.	B.	A.	B.	A.	B.	A.	B.	A.	B.	A.	B.
	Gm.	Gm.	Mm.	Mm.	Mm.	Mm.	Mm.	Mm.	Gm. ^a	Gm. ^b	Mm.	Mm.	Mm.	Mm.	Mm.	Mm.
1																
2									b ₀ .0005	b ₀ .0007	1.9	1.9				
3									b ₀ .0012	.0013	1.9	2.0				
4									.0014	.0015	2.1	2.2	1.2	1.2		
5									.0018	.0020	2.1	2.4	1.2	1.2		
6									.0020	.0020	2.2	2.3	1.3	1.2		
7									.0022	.0025	2.5	2.7	1.3	1.3		
8									.0025	.0026	2.5	2.8	1.4	1.3		
9									.0027	.0026	2.7	2.6	1.4	1.3		
10									.0026	.0027	2.5	2.7	1.3	1.2		
11									.0023	.0025	2.3	2.6	1.3	1.3		
12									.0019	.0019	2.2	2.3	1.2	1.3		
13									.0014	.0014	2.1	2.3	1.2	1.1		
14									b ₀ .0005			1.0				

JULY 16

Kernel No.	S	S	S	S	S	S	S	S	S	S	S	S	S	S	S	S	S
1																	
2	b ₀ .0011	b ₀ .0005	2.0	1.6													
3	.0022	.0014	2.6	2.0	1.3	1.2			0.0009	0.0007	1.9	1.6	1.3	0.8	0.6	0.5	
4	.0019	.0020	2.4	2.4	1.3	1.2		0.7	.0023	.0012	3.1	1.8	1.4	1.1	.8	.6	
5	.0020	.0025	2.3	2.5	1.3	1.3		.8	.0031	.0018	3.0	2.2	1.4	1.2	.8	.7	
6	.0023	.0032	2.4	3.0	1.3	1.4		.8	.0033	.0025	3.4	2.5	1.3	1.3	.8	.7	
7	.0024	.0032	2.5	3.2	1.3	1.4	0.7	.8	.0042	.0029	3.7	3.0	1.4	1.4	.8	.8	
8	.0028	.0033	2.7	3.2	1.3	1.3	.8	.8	.0041	.0028	3.7	3.0	1.4	1.4	.8	.7	
9	.0030	.0035	3.2	3.3	1.4	1.4	.8	.8	.0045	.0030	4.0	3.1	1.4	1.4	.8	.8	
10	.0029	.0039	2.7	3.6	1.3	1.4	.8	.8	.0043	.0030	4.0	3.0	1.3	1.4	.8	.8	
11	.0027	.0036	2.9	3.2	1.3	1.5	.7	.8	.0039	.0023	4.0	2.4	1.4	1.2	.8	.7	
12	.0023	.0029	2.6	3.1	1.4	1.3	.7	.7	.0029	S	3.4	S	1.3	S	.7	S	
13	.0017	.0018	2.3	1.9	1.1	1.3	.5	.7									

^a The letter S indicates a sterile spikelet.

^b Unfertilized.

TABLE I.—Normal growth of Hannchen barley in 12-hour periods from flowering to maturity, at Aberdeen, Idaho, in 1917—Continued

JULY 17																	
Kernel No. from base of spike.	6 a. m.								7 p. m.								
	Weight of kernel on spike—		Length of kernel on spike—		Lateral diameter of kernel on spike—		Dorso-ventral diameter of kernel on spike—		Weight of kernel on spike—		Length of kernel on spike—		Lateral diameter of kernel on spike—		Dorso-ventral diameter of kernel on spike—		
	A.	B.	A.	B.	A.	B.	A.	B.	A.	B.	A.	B.	A.	B.	A.	B.	
	Gm.	Gm.	Mm.	Mm.	Mm.	Mm.	Mm.	Mm.	Gm.	Gm.	Mm.	Mm.	Mm.	Mm.	Mm.	Mm.	
1																	
2		0.0012		2.1			1.0		0.6	0.0029	0.0033	2.8	3.5	1.4	1.4	0.8	0.8
3	0.0022	0.0023	2.4	2.6	1.2	1.3	0.7	0.7	0.0045	0.0051	3.6	3.9	1.3	1.4	0.8	0.8	
4	0.0025	0.0030	2.7	3.2	1.2	1.3	0.7	0.8	0.0055	0.0052	4.4	4.2	1.4	1.5	0.9	0.9	
5	0.0033	0.0034	2.9	3.3	1.3	1.4	0.8	0.8	0.0058	0.0056	4.6	4.8	1.6	1.5	0.9	0.9	
6	0.0033	0.0037	3.0	3.5	1.4	1.4	0.8	0.8	0.0061	0.0064	4.9	5.0	1.5	1.4	0.9	0.9	
7	0.0038	0.0039	3.1	3.7	1.5	1.4	0.9	0.8	0.0069	0.0071	5.0	5.5	1.4	1.4	0.9	0.9	
8	0.0036	0.0043	3.5	3.8	1.5	1.4	0.9	0.9	0.0076	0.0068	5.6	5.5	1.4	1.5	0.9	0.9	
9	0.0038	0.0043	3.2	4.3	1.4	1.5	0.9	0.9	0.0062	0.0068	4.7	5.6	1.6	1.5	0.8	0.9	
10	0.0038	0.0043	3.2	4.1	1.5	1.3	0.9	0.8	0.0071	0.0069	5.7	5.5	1.5	1.5	0.9	0.9	
11	0.0039	0.0043	3.1	3.7	1.3	1.3	0.8	0.8	0.0067	0.0062	5.4	5.1	1.4	1.5	0.9	0.8	
12	0.0031	0.0029	3.0	3.4	1.4	1.3	0.8	0.7	0.0057	0.0050	4.8	4.7	1.4	1.4	0.8	0.8	
13	0.0025		2.8		1.3												
14	0.0018		2.1		1.3			0.6						1.3		0.7	

JULY 18																
Kernel No.	A.	B.	A.	B.	A.	B.	A.	B.	A.	B.	A.	B.	A.	B.	A.	B.
	Gm.	Gm.	Mm.	Mm.	Mm.	Mm.	Mm.	Mm.	Gm.	Gm.	Mm.	Mm.	Mm.	Mm.	Mm.	Mm.
1																
2	0.0046	0.0035	3.8	3.6	1.5	1.3	0.9	0.8	0.0048	0.0054	4.0	4.5	1.5	1.5	0.9	0.8
3	0.0076	0.0047	5.2	4.0	1.6	1.4	0.9	0.9	0.0073	0.0075	5.6	5.6	1.5	1.6	0.9	0.9
4	0.0088	0.0056	6.3	4.6	1.6	1.4	0.9	0.9	0.0079	0.0086	5.9	6.1	1.6	1.6	0.8	0.9
5	0.0094	0.0060	6.4	4.7	1.6	1.4	0.9	0.9	0.0083	0.0089	6.3	6.9	1.6	1.7	0.9	0.9
6	0.0095	0.0067	6.8	5.4	1.5	1.6	0.9	0.9	0.0082	0.0095	6.2	6.7	1.6	1.6	0.9	1.0
7	0.0100	0.0075	6.9	5.9	1.6	1.5	0.9	0.9	0.0098	0.0096	7.0	6.8	1.6	1.7	1.0	1.0
8	0.0097	0.0079	7.1	6.1	1.6	1.6	1.0	0.9	0.0102	0.0108	7.0	7.5	1.7	1.6	1.0	1.1
9	0.0093	0.0076	6.8	5.9	1.6	1.5	0.9	0.9	0.0104	0.0092	7.4	6.9	1.7	1.7	1.0	1.0
10	0.0089	0.0074	6.8	5.9	1.6	1.5	0.9	0.8	0.0096	0.0096	7.3	6.6	1.6	1.7	1.0	0.9
11	0.0089	0.0073	6.5	5.9	1.5	1.5	0.8	0.8	0.0083	0.0086	6.7	6.5	1.6	1.6	0.9	0.9
12	0.0068	0.0064	6.0	5.5	1.5	1.5	0.8	0.8	0.0075	0.0068	6.3	5.7	1.6	1.6	0.8	0.8

JULY 19																
Kernel No.	A.	B.	A.	B.	A.	B.	A.	B.	A.	B.	A.	B.	A.	B.	A.	B.
	Gm.	Gm.	Mm.	Mm.	Mm.	Mm.	Mm.	Mm.	Gm.	Gm.	Mm.	Mm.	Mm.	Mm.	Mm.	Mm.
1	0.0023		2.8		1.3		0.7		0.1000	0.0084	7.0	6.2	1.7	1.7	1.0	0.9
2	0.0070	0.0050	5.5	4.8	1.5	1.5	0.8	0.8	0.0100	0.0109	8.0	7.3	1.8	1.7	1.2	1.0
3	0.0091	0.0090	6.4	6.6	1.7	1.6	0.9	0.9	0.0125	0.0122	8.7	8.1	1.8	1.8	1.2	1.0
4	0.0100	0.0108	6.7	7.7	1.7	1.7	1.0	1.1	0.0142	0.0142	9.1	8.4	1.9	1.8	1.2	1.2
5	0.0114	0.0128	7.9	8.3	1.7	1.7	1.1	1.2	0.0151	0.0131	9.0	8.3	1.9	1.7	1.2	1.2
6	0.0123	0.0132	8.3	8.2	1.8	1.8	1.1	1.3	0.0160	0.0136	9.1	8.4	1.9	1.8	1.3	1.3
7	0.0128		8.0		1.8		1.2		0.0170	0.0149	9.3	8.8	2.0	1.9	1.3	1.3
8	0.0129	0.0151	8.3	8.5	1.8	1.8	1.1	1.3	0.0166	0.0146	9.3	8.7	1.9	1.9	1.4	1.3
9	0.0127	0.0156	8.0	8.6	1.8	2.0	1.2	1.4	0.0154	0.0160	8.8	8.9	1.9	1.9	1.3	1.3
10	0.0124	0.0153	8.2	8.7	1.8	2.0	1.1	1.3	0.0157	0.0150	8.8	8.8	1.8	1.9	1.2	1.2
11	0.0116	0.0141	7.8	8.2	1.7	1.9	1.1	1.4	0.0147	0.0138	8.5	8.8	1.8	1.8	1.2	1.1
12	0.0102	0.0132	7.7	8.0	1.7	1.8	1.0	1.2		0.0108		7.8		1.6		1.1
13	0.0082	0.0115	6.5	7.5	1.6	1.8	1.0	1.1								

JULY 20																
Kernel No.	A.	B.	A.	B.	A.	B.	A.	B.	A.	B.	A.	B.	A.	B.	A.	B.
	Gm.	Gm.	Mm.	Mm.	Mm.	Mm.	Mm.	Mm.	Gm.	Gm.	Mm.	Mm.	Mm.	Mm.	Mm.	Mm.
1		0.0060		5.6			1.6		0.8	0.0046			4.9			0.6
2	0.0098	0.0133	7.1	8.0	1.8	1.9	1.0	1.2	0.0099	0.0132	7.0	8.3	1.7	1.8	1.0	1.1
3	0.0107	0.0163	7.3	9.0	1.8	1.9	1.1	1.3	0.0107	0.0145	7.1	8.8	1.8	1.9	1.0	1.2
4	0.0138	0.0176	9.0	9.0	1.9	2.0	1.2	1.4	0.0136	0.0178	8.2	8.4	1.9	2.0	1.2	1.4
5	0.0150	0.0178	9.0	9.0	1.9	2.0	1.3	1.4	0.0151	0.0192	9.0	9.6	1.9	2.1	1.2	1.5
6	0.0170	0.0188	9.5	9.1	2.0	2.1	1.3	1.5	0.0162	0.0206	8.8	9.9	2.0	2.2	1.2	1.5
7	0.0177	0.0198	9.1	9.7	2.0	2.2	1.3	1.6	0.0165	0.0204	8.8	9.7	2.0	2.2	1.3	1.5
8	0.0174	0.0208	9.5	9.7	1.9	2.1	1.3	1.5		0.0196		9.6		2.1		1.5
9	0.0159	0.0200	9.1	9.6	2.0	2.2	1.3	1.5	0.0164	0.0194	9.0	9.1	2.0	2.1	1.4	1.5
10	0.0165	0.0176	9.0	9.3	2.0	2.1	1.3	1.5	0.0152	0.0168	8.7	9.2	1.8	2.0	1.3	1.4
11	0.0150	0.0165	8.8	8.8	1.9	2.0	1.3	1.4	0.0133	0.0151	8.4	8.6	1.8	1.9	1.2	1.4
12	0.0126	0.0125	8.1	8.2	1.8	1.8	1.2	1.2	0.0121		8.0		1.7		1.2	

TABLE I.—Normal growth of Hannchen barley in 12-hour periods from flowering to maturity, at Aberdeen, Idaho, in 1917—Continued

Kernel No. from base of spike.	6 a. m.								7 p. m.							
	Weight of kernel on spike—		Length of kernel on spike—		Lateral diameter of kernel on spike—		Dorso-ventral diameter of kernel on spike—		Weight of kernel on spike—		Length of kernel on spike—		Lateral diameter of kernel on spike—		Dorso-ventral diameter of kernel on spike—	
	A.	B.	A.	B.	A.	B.	A.	B.	A.	B.	A.	B.	A.	B.	A.	B.
	Gm.	Gm.	Mm.	Mm.	Mm.	Mm.	Mm.	Mm.	Gm.	Gm.	Mm.	Mm.	Mm.	Mm.	Mm.	Mm.
1
2	0.0093	0.0124	6.8	7.9	1.7	1.9	1.0	1.3	0.0123	8.1	1.9	1.2
3	0.0139	0.0165	8.3	8.8	1.8	1.9	1.2	1.3	0.0157	0.0179	8.7	8.3	2.0	2.1	1.4	1.5
4	0.0170	0.0184	9.1	9.3	2.0	1.9	1.3	1.5	0.0199	0.0209	9.4	9.5	2.2	2.2	1.5	1.4
5	0.0181	0.0202	9.0	9.6	2.0	2.1	1.4	1.5	0.0210	0.0225	10.0	9.7	2.1	2.2	1.5	1.6
6	0.0182	0.0195	9.3	9.6	2.1	2.1	1.4	1.4	0.0227	0.0250	10.0	10.4	2.1	2.3	1.6	1.7
7	0.0195	0.0209	9.4	10.0	2.0	2.0	1.5	1.5	0.0230	0.0257	10.1	10.2	2.2	2.4	1.6	1.6
8	0.0199	0.0216	9.3	10.0	2.1	2.1	1.5	1.6	0.0218	0.0259	9.8	10.1	2.2	2.4	1.5	1.7
9	0.0195	0.0206	9.5	9.6	2.0	2.0	1.5	1.5	0.0248	0.0275	10.0	10.0	2.3	2.5	1.7	1.8
10	0.0170	0.0186	8.9	9.4	1.9	1.9	1.5	1.6	0.0216	0.0233	10.1	9.8	2.3	2.4	1.5	1.7
11	0.0158	0.0169	8.8	1.9	2.0	1.3	1.4	0.0212	0.0234	9.3	9.1	2.3	2.4	1.5	1.8
12	0.0187	0.0237	9.2	9.6	2.2	2.4	1.5	1.7
13	0.0168	0.0193	8.6	8.6	2.0	2.2	1.4	1.5

JULY 22

1	0.0160	8.9	2.0	1.5
2	0.0190	0.0200	9.2	9.6	2.2	2.3	1.4	1.5	0.0190	0.0205	9.1	9.5	2.2	2.3	1.4	1.5
3	0.0248	0.0225	9.9	10.1	2.3	2.4	1.6	1.6	0.0232	0.0253	9.9	10.0	2.4	2.4	1.6	1.7
4	0.0272	0.0282	10.2	10.5	2.5	2.5	1.7	1.8	0.0270	0.0264	10.2	10.5	2.6	2.5	1.6	1.6
5	0.0291	0.0294	10.2	10.3	2.6	2.6	1.9	1.8	0.0278	0.0289	10.2	10.5	2.5	2.8	1.8	1.9
6	0.0279	0.0293	10.1	10.3	2.6	2.5	1.9	1.8	0.0284	0.0289	10.4	10.4	2.6	2.6	1.8	1.9
7	0.0276	0.0289	9.8	10.2	2.7	2.6	1.8	1.8	0.0280	0.0284	10.0	10.5	2.7	2.6	1.8	1.8
8	0.0283	0.0282	9.5	10.1	2.7	2.5	1.9	1.8	0.0271	0.0287	9.6	10.0	2.6	2.8	1.7	1.8
9	0.0256	0.0306	9.5	10.1	2.5	2.6	1.6	1.6	0.0282	0.0282	9.6	10.2	2.6	2.7	1.8	1.8
10	0.0248	0.0277	9.3	9.9	2.5	2.6	1.8	1.8	0.0266	0.0270	9.4	9.9	2.6	2.5	1.7	1.9
11	0.0203	0.0257	8.8	9.8	2.4	2.6	1.5	1.7	0.0241	0.0253	9.4	9.7	2.5	2.5	1.7	1.7
12	0.0237	9.6	2.5	1.7	0.0217	0.0258	8.9	10.0	2.3	2.6	1.6	1.7
13	0.0195	9.0	2.3	1.5	0.0220	8.8	2.5	1.7

JULY 23

1	0.0084	7.4	1.7	1.2
2	0.0265	0.0223	9.9	10.0	2.7	2.3	1.7	1.5
3	0.0282	0.0219	10.0	9.3	2.8	2.3	1.8	1.7	0.0321	0.0270	10.3	10.0	2.8	2.7	1.8	1.8
4	0.0333	0.0270	10.2	10.1	2.7	2.6	1.9	1.8	0.0335	0.0316	10.1	10.2	3.0	2.7	2.0	1.9
5	0.0303	0.0294	10.3	10.5	3.0	2.7	2.0	1.9	0.0359	0.0249	10.3	9.5	3.0	2.7	1.9	1.9
6	0.0373	0.0316	10.3	10.5	3.1	2.8	2.2	2.0	0.0359	0.0368	10.6	10.2	3.0	2.8	2.0	1.9
7	0.0340	0.0334	9.9	10.5	3.0	2.9	1.9	1.9	0.0352	0.0320	10.7	10.1	2.8	2.8	2.0	2.0
8	0.0354	0.0334	10.1	10.3	2.9	2.9	2.0	2.0	0.0372	0.0334	10.6	10.0	3.0	2.8	2.1	1.9
9	0.0339	0.0312	9.9	9.7	2.8	2.8	2.1	1.9	0.0343	0.0298	9.9	9.9	3.0	2.8	2.0	1.8
10	0.0294	0.0300	9.4	10.3	2.8	2.8	1.8	1.9	0.0348	0.0319	10.0	10.1	3.1	2.9	2.0	1.8
11	0.0292	0.0309	9.3	9.7	2.8	2.8	1.9	2.0	0.0315	0.0291	9.6	9.5	2.9	2.8	1.9	1.8
12	0.0246	0.0275	8.6	9.5	2.6	2.6	1.8	1.8	0.0299	0.0250	9.7	9.1	2.9	2.6	2.0	1.8

JULY 24

1	0.0173	8.5	2.0	1.6
2	0.0142	0.0212	8.4	9.0	2.3	2.4	1.4	1.5	0.0291	9.6	9.4	2.7	2.8	1.8	2.0
3	0.0285	0.0302	9.9	10.2	2.3	2.8	1.7	1.8	0.0335	0.0333	10.3	10.0	3.0	2.8	2.0	2.1
4	0.0323	0.0328	9.8	10.2	2.9	2.8	1.8	1.9	0.0361	0.0372	10.0	10.2	3.0	3.1	2.0	2.0
5	0.0346	0.0345	10.4	10.3	2.9	2.8	1.9	1.8	0.0371	0.0383	10.2	10.4	3.0	3.0	2.0	2.0
6	0.0359	0.0345	10.3	10.5	3.0	2.9	1.9	1.9	0.0353	0.0387	10.0	10.2	2.9	3.0	2.0	2.2
7	0.0357	0.0342	10.2	10.3	2.9	2.9	1.8	2.0	0.0379	0.0381	10.1	10.1	3.0	3.2	2.0	2.0
8	0.0355	0.0342	9.9	10.2	2.9	2.8	2.0	2.0	0.0322	0.0398	10.1	10.0	2.9	3.1	1.9	2.0
9	0.0328	0.0340	9.8	10.4	3.0	2.8	1.8	2.0	0.0338	0.0384	9.6	10.1	2.8	3.1	1.9	2.0
10	0.0342	0.0333	9.1	9.9	3.0	2.9	1.9	2.1	0.0344	0.0303	9.3	9.3	3.0	3.0	2.0	2.1
11	0.0319	0.0328	9.4	10.2	3.0	2.9	1.6	2.0	0.0278	0.0351	9.3	9.6	2.8	2.9	2.0	1.9
12	0.0276	0.0304	9.0	9.7	2.9	2.8	1.8	2.0	0.0278
13	0.0284	8.8	2.8	1.9	0.0325	9.9	2.8	1.8

TABLE I.—Normal growth of Hannchen barley in 12-hour periods from flowering to maturity, at Aberdeen, Idaho, in 1917—Continued

		AUGUST 2															
		6 a. m.								7 p. m.							
Kernel No. from base of spike.	Weight of kernel on spike—		Length of kernel on spike—		Lateral diameter of kernel on spike—		Dorso-ventral diameter of kernel on spike—		Weight of kernel on spike—		Length of kernel on spike—		Lateral diameter of kernel on spike—		Dorso-ventral diameter of kernel on spike—		
	A.	B.	A.	B.	A.	B.	A.	B.	A.	B.	A.	B.	A.	B.	A.	B.	
	Gm.	Gm.	Mm.	Mm.	Mm.	Mm.	Mm.	Mm.	Gm.	Gm.	Mm.	Mm.	Mm.	Mm.	Mm.	Mm.	
1																	
2	0.0302		7.7		2.8		2.0		0.0404		8.1		3.3		2.3		
3	0.0500	0.0528	8.9	9.1	3.6	3.4	2.4	2.4	0.0426	0.0483	8.3	8.7	3.3	3.6	2.5	2.3	
4	0.0617	0.0596	9.6	9.4	3.8	3.8	2.5	2.6	0.0546	0.0543	8.8	9.0	3.6	3.7	2.7	2.5	
5	0.0611	0.0620	9.6	9.5	3.8	3.8	2.6	2.7	0.0553	0.0571	9.4	9.1	3.9	3.8	2.6	2.6	
6	0.0620	0.0644	9.8	9.6	3.8	3.8	2.6	2.7	0.0566	0.0566	9.1	9.1	3.7	3.6	2.5	2.6	
7	0.0579	0.0600	9.4	9.3	3.7	3.6	2.5	2.6	0.0546	0.0586	9.0	9.0	3.7	3.8	2.5	2.7	
8	0.0601	0.0610	8.8	9.4	3.7	3.6	2.5	2.6	0.0558	0.0561	9.0	9.1	3.6	3.7	2.6	2.8	
9	0.0577	0.0592	9.1	9.2	3.7	3.7	2.6	2.7	0.0547	0.0548	9.1	8.7	3.6	3.5	2.5	2.7	
10	0.0595	0.0572	9.0	9.0	3.8	3.8	2.8	2.7	0.0508	0.0500	8.7	8.6	3.5	3.5	2.5	2.5	
11	0.0574	0.0515	9.2	8.8	3.5	3.5	2.5	2.5	0.0465	0.0464	8.1	8.3	3.5	3.5	2.5	2.5	
12	0.0476	0.0521	8.7	8.7	3.5	3.5	2.5	2.7	0.0371	0.0387	7.8	7.5	3.2	3.2	2.4	2.2	
13	0.0489	0.0429	8.5	8.0	3.5	3.3	2.5	2.4									
		AUGUST 3															
		6 a. m.								6.45 p. m.							
Kernel No.	Weight of kernel on spike—		Length of kernel on spike—		Lateral diameter of kernel on spike—		Dorso-ventral diameter of kernel on spike—		Weight of kernel on spike—		Length of kernel on spike—		Lateral diameter of kernel on spike—		Dorso-ventral diameter of kernel on spike—		
	A.	B.	A.	B.	A.	B.	A.	B.	A.	B.	A.	B.	A.	B.	A.	B.	
	Gm.	Gm.	Mm.	Mm.	Mm.	Mm.	Mm.	Mm.	Gm.	Gm.	Mm.	Mm.	Mm.	Mm.	Mm.	Mm.	
1																	
2	0.0363		8.0		3.3		2.2		0.0521	0.0425	9.2	7.9	3.3	3.3	2.5	2.5	
3	0.0510	0.0510	9.2	8.8	3.6	3.5	2.3	2.5	0.0399	0.0548	9.1	9.0	3.8	3.7	2.7	2.7	
4	0.0560	0.0572	9.5	9.0	3.5	3.8	2.4	2.6	0.0644	0.0565	9.4	9.0	4.0	3.6	2.7	2.6	
5	0.0573	0.0595	9.2	9.6	3.6	3.8	2.6	2.6	0.0650	0.0588	9.6	8.8	3.7	3.6	2.6	2.5	
6	0.0621	0.0608	9.2	9.2	3.7	3.8	2.7	2.7	0.0511	0.0511	9.4	9.0	3.8	3.6	2.5	2.5	
7	0.0580	0.0602	9.0	9.3	3.6	3.8	2.6	2.5	0.0633	0.0554	9.3	8.7	3.8	3.7	2.8	2.6	
8	0.0573	0.0579	9.1	9.2	3.6	3.5	2.5	2.5	0.0651	0.0540	9.3	8.5	3.9	3.6	2.8	2.7	
9	0.0602	0.0583	8.8	9.0	3.6	3.5	2.5	2.6	0.0629	0.0513	9.2	8.0	3.8	3.5	2.6	2.8	
10	0.0600	0.0577	8.7	8.9	3.7	3.8	2.7	2.6	0.0599	0.0476	9.1	7.8	3.7	3.3	2.7	2.5	
11	0.0531	0.0545	8.7	8.7	3.5	3.7	2.6	2.6	0.0591	0.0437	8.8	7.6	3.7	3.4	2.7	2.5	
12	0.0531	0.0504	8.7	8.4	3.6	3.7	2.6	2.6	0.0536								
13	0.0532	0.0507	8.5	8.8	3.6	3.2	2.7	2.3									
14	0.0452		8.2		3.2		2.6										
		AUGUST 4															
		5.45 a. m.								6.45 p. m.							
Kernel No.	Weight of kernel on spike—		Length of kernel on spike—		Lateral diameter of kernel on spike—		Dorso-ventral diameter of kernel on spike—		Weight of kernel on spike—		Length of kernel on spike—		Lateral diameter of kernel on spike—		Dorso-ventral diameter of kernel on spike—		
	A.	B.	A.	B.	A.	B.	A.	B.	A.	B.	A.	B.	A.	B.	A.	B.	
	Gm.	Gm.	Mm.	Mm.	Mm.	Mm.	Mm.	Mm.	Gm.	Gm.	Mm.	Mm.	Mm.	Mm.	Mm.	Mm.	
1																	
2	0.0454	0.0409	8.0	8.3	3.4	3.4	2.4	2.3	0.0300	0.0386	7.8	8.2	2.8	3.1	2.0	2.1	
3	0.0537	0.0550	8.7	8.9	3.6	3.7	2.4	2.6	0.0567	0.0623	9.0	9.3	3.7	3.7	2.6	2.7	
4	0.0594	0.0600	9.1	9.3	3.7	3.8	2.7	2.5	0.0656	0.0668	9.3	9.7	3.9	3.8	2.7	2.6	
5	0.0605	0.0596	9.3	9.6	3.7	3.7	2.8	2.6	0.0629	0.0675	9.6	9.8	3.7	3.7	2.8	2.7	
6	0.0577	0.0626	9.2	9.6	3.6	3.7	2.6	2.7	0.0629	0.0645	9.3	9.6	3.8	3.7	2.8	2.7	
7	0.0580	0.0617	9.1	9.6	3.5	3.8	2.6	2.9	0.0660	0.0655	9.2	9.4	3.7	3.7	2.9	2.7	
8	0.0539	0.0592	9.0	9.0	3.4	3.8	2.5	2.6	0.0614	0.0660	9.4	9.4	3.7	3.8	2.8	2.8	
9	0.0556	0.0557	8.8	9.1	3.7	3.5	2.7	2.7	0.0614	0.0633	9.1	9.1	3.7	3.7	2.8	2.7	
10	0.0539	0.0565	9.0	9.0	3.7	3.5	2.8	2.8	0.0546	0.0617	9.0	9.1	3.5	3.8	2.7	2.7	
11	0.0475	0.0550	8.2	9.0	3.5	3.5	2.6	2.7	0.0546	0.0596	8.9	9.0	3.7	3.7	2.5	2.8	
12	0.0400	0.0480	7.8	8.3	3.2	3.4	2.4	2.6	0.0532	0.0582	8.5	9.0	3.5	3.7	2.6	2.7	
13									0.0448	0.0548	7.9	8.5	3.3	3.5	2.6	2.8	
14									0.0483		8.3		3.4			2.6	

TABLE I.—Normal growth of Hannchen barley in 12-hour periods from flowering to maturity, at Aberdeen, Idaho, in 1917—Continued

AUGUST 8

Kernel No. from base of spike.	6 a. m.								6.40 p. m.							
	Weight of kernel on spike—		Length of kernel on spike—		Lateral diameter of kernel on spike—		Dorso-ventral diameter of kernel on spike.		Weight of kernel on spike—		Length of kernel on spike—		Lateral diameter of kernel on spike—		Dorso-ventral diameter of kernel on spike—	
	A.	B.	A.	B.	A.	B.	A.	B.	A.	B.	A.	B.	A.	B.	A.	B.
1	Gm. 0.0363	Gm. 0.0243	Mm. 7.7	Mm. 6.7	Mm. 3.0	Mm. 2.7	Mm. 2.1	Mm. 1.9
2	0.0595	0.0532	8.6	8.0	3.6	3.6	2.7	2.5	0.0440	7.8	3.2	2.5
3	0.0613	0.0618	8.8	8.7	3.6	3.8	2.6	2.8	0.0502	0.0571	8.4	8.4	3.5	3.5	2.7	2.6
4	0.0655	0.0634	9.3	8.9	3.8	3.7	2.9	2.7	0.0578	0.0609	8.6	9.0	3.6	3.6	2.7	2.7
5	0.0682	0.0647	9.2	9.2	3.6	3.8	2.7	2.8	0.0590	0.0570	9.0	8.8	3.6	3.6	2.7	2.6
6	0.0659	0.0624	9.0	8.7	3.7	3.7	2.7	2.8	0.0569	0.0576	8.8	8.8	3.6	3.5	2.6	2.6
7	0.0659	0.0626	9.0	8.6	3.6	3.6	2.8	2.8	0.0581	0.0554	8.8	8.9	3.6	3.5	2.7	2.6
8	0.0634	0.0615	8.9	8.6	3.6	3.7	2.7	2.8	0.0565	0.0553	8.6	8.5	3.5	3.5	2.6	2.7
9	0.0642	0.0604	8.6	8.4	3.7	3.7	2.8	2.7	0.0508	0.0539	8.6	8.6	3.4	3.4	2.5	2.6
10	0.0607	0.0590	8.2	8.4	3.6	3.7	2.8	2.8	0.0511	0.0507	8.4	8.4	3.5	3.5	2.6	2.7
11	0.0585	0.0500	8.6	8.0	3.5	3.5	2.7	2.4	0.0423	0.0412	7.8	7.6	3.2	3.1	2.4	2.5
12	0.0546	0.0453	8.1	7.7	3.4	3.3	2.7	2.4
13	0.0420	7.7	3.1	2.5

The course of growth is more apparent in Table II, where the results have been summarized in 24-hour periods. That is, the weights and measurements of all the kernels on each spike of the two samples have been averaged and these averages placed opposite the dates. No summary was made for the data in 12-hour periods, because the daily changes of dimension after the first few days were too slight to be shown in so short a period. Growth in length in the early stages, however, is perfectly apparent in 12 hours.

TABLE II.—Average wet weight, length, lateral diameter, and dorsoventral diameter of kernels of Hannchen barley in 24-hour periods from flowering to maturity at Aberdeen, Idaho, in 1917

Date.	Wet weight.	Length.	Lateral diameter.	Dorso-ventral diameter.	Date.	Wet weight.	Length.	Lateral diameter.	Dorso-ventral diameter.
July 15	Mgm. 1.9	Mm. 2.27	Mm. 1.26	July 28	Mgm. 48.2	Mm. 10.02	Mm. 3.47	Mm. 2.33
16	3.0	2.88	1.32	0.74	29	49.0	9.84	3.50	2.42
17	4.5	3.93	1.39	.82	30	53.0	9.99	3.59	2.50
18	8.0	6.05	1.57	.90	31	52.2	8.83	3.56	2.54
19	12.7	7.91	1.79	1.16	Aug. 1	54.8	9.10	3.62	2.51
20	15.8	8.78	1.94	1.30	2	53.3	8.87	3.59	2.54
21	19.2	9.32	2.10	1.48	3	55.8	8.87	3.61	2.59
22	25.7	9.81	2.51	1.71	4	56.3	8.96	3.60	2.64
23	31.0	9.96	2.80	1.90	5	55.9	8.66	3.60	2.62
24	32.7	9.83	2.86	1.90	6	56.6	8.78	3.57	2.67
25	36.0	9.80	3.02	2.05	7	58.0	8.77	3.60	2.68
26	38.2	9.77	3.09	2.06	8	56.1	8.53	3.53	2.64
27	44.6	9.98	3.30	2.25

The significance of the data in Table II is, perhaps, more easily seen in figure 1. The most surprising feature shown by this figure is the remarkably rapid growth in length following fertilization. In the two days from the second to the fourth after fertilization, half the growth in length occurs. The insufficiency of 3-day intervals in sampling at this stage is obvious. Distinct growth is shown in 12-hour periods, and it is probable that consistent increase would be revealed in 6-hour periods. The kernel reached its maximum length by the end of 7 days in each year. After the peak of length is reached, there is a gradual decrease to maturity. This is discussed later in connection with figure 4.

The lateral diameter exhibits its most rapid increase as soon as the rate of the growth in length diminishes. This increase continues until about the fifteenth day, after which the lateral diameter remains more or less stationary. The dorsoventral diameter, on the other hand, continues to increase almost until maturity. The increase is somewhat less than in the lateral diameter, there being a greater divergence in the growth curves at the end of the growing period than at the beginning. The effect of the better irrigation in 1916 is apparent throughout the period of growth. There is a possibility that the 1916 samples are a few hours farther advanced throughout the series because of differences in temperature or other factors at flowering time. While growth itself is not so easily affected, fertilization is often hastened or delayed many hours by conditions in the environment.

During the early growth of the kernel the ovary tip undergoes a sympathetic development. When the kernel is first developing, the growth is largely in the pericarp. Some of the tissues surrounding the embryo sac and the ovary walls of the same region develop rapidly and are to be found in the ripened caryopsis. For some reason, the tissues above the embryo sac are temporarily stimulated, forming a body at the end of the kernel, which is referred to here as the ovary tip. This growth, which may be seen in Plates 83 and 84, is of importance because it introduces an error in the measurement of length. After the growth of the first few days, this organ remains stationary in size for a while and finally is largely resorbed. In figure 1 it will be seen that it was possible to measure the kernel proper without this tip by the fifteenth day after flowering. The records of lengths until that time included the ovary tip. The lateral and dorsoventral diameters of the ovary tip are shown in figure 4. It is probable that the length of the kernel proper increased somewhat after it had apparently reached its maximum by invading the tissues of the ovary tip. This tissue is probably partially responsible for the difference of measurements in the first 15 days of the two years. A second factor in the error lies in the softness of the structure at the base of the kernel. In the early stages of growth it is exceedingly difficult to place the caliper bar at exactly the right point, and in 1917 the kernels may have been measured more closely than in 1916. The difference of the

two years, however, is less than 0.5 mm., so that the data coincide far beyond any reasonable expectation.

The reason that errors in this connection are suggested is that it is not plausible that the differences in soil or water would affect the kernels by

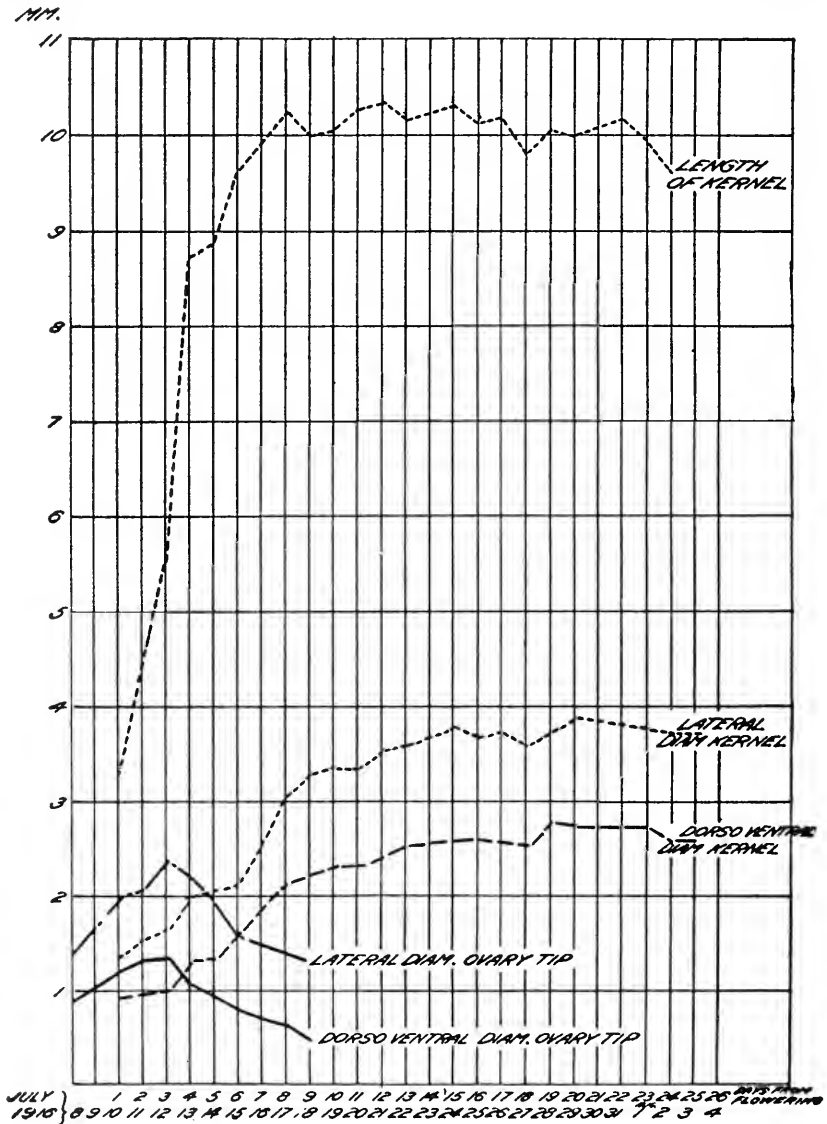

FIG. 4.—Graph showing lateral and dorsoventral diameters of the ovary tip as compared with length, lateral diameter, and dorsoventral diameter of the kernel for the 26 days following flowering in 1916.

this time, since there obviously is no insufficiency of nutrients for this primary growth. These data have an incidental bearing on the value of observations on the length and diameter of kernels. Such observations are used frequently to identify varieties. In 1914, the author (2) stated

that length was more dependable than lateral diameter and that lateral diameter was more dependable than dorsoventral diameter in the description of types. The same observations have been made, presumably, by many others. The growth curves confirm this opinion. The length is quickly attained and should vary little with season. The lateral diameter reaches its maximum more slowly than the length, but much sooner than the dorsoventral diameter, which is dependent upon conditions throughout the growing season for the fulfillment of its maximum possibilities.

As has been inferred before, the kernels at the base and the tip of the spike are more variable than those near the center. With the increase of the number of kernels on the spike those at the extremes are likely to suffer from competition. On any spike, if nutrition at any time becomes insufficient, the basal and the apical kernels are the first to be affected. Averages which include these kernels show greater fluctuations than those from which they are excluded. This variation was overcome partially by including in the averages no basal kernels which weighed less than half as much as the kernel next above. Since this does not entirely overcome the difficulty the average length, lateral diameter, and dorsoventral diameter of kernels 6, 7, and 8 are plotted in figure 5 as an illustration of the behavior of more typical kernels. It will be seen that the daily fluctuations are much reduced.

EFFECT OF POSITION OF KERNEL ON GROWTH

There are two main factors that affect the relative size of kernels. These are age and the position of the kernel on the spike. The relative importance of these factors varies with the stage of growth. The age of the kernel depends on the time of flowering. The florets of a spike are not all fertilized on the same day. The earliest flowers usually are those located about two-thirds the distance from the base of the spike to the tip. The last to fertilize are the extreme basal and apical florets. The largest florets are found one-third the length of the spike from the base. Presumably, the kernels found in these florets receive more nourishment than those at the tip, especially toward the end of the growing period. The length of each kernel on one side of the spike is shown by days in figure 6. The growth is practically completed in these eight days. As will be seen, florets 8, 9, and 10 are the first to fertilize and to begin growth. By the third day these three kernels have reached their greatest relative advancement. After the second day there is a gradual shift in the peak of the curve as the basal kernels approach the others in total length. By the fourth day kernels 8, 9, and 10 are no longer prominent, and on the fifth day the curve is extremely regular. By the eighth day the length growth is complete and the longest kernels are the fifth and sixth. The curve of the eighth is thought to be more typical than that of the seventh.

The data for the lateral diameter are shown in the same way in figure 7. The same progress of size from the eighth, ninth, and tenth kernels toward the base is to be seen as was found in the length. Here also, the fifth and sixth kernels have exceeded the upper ones by the eighth day

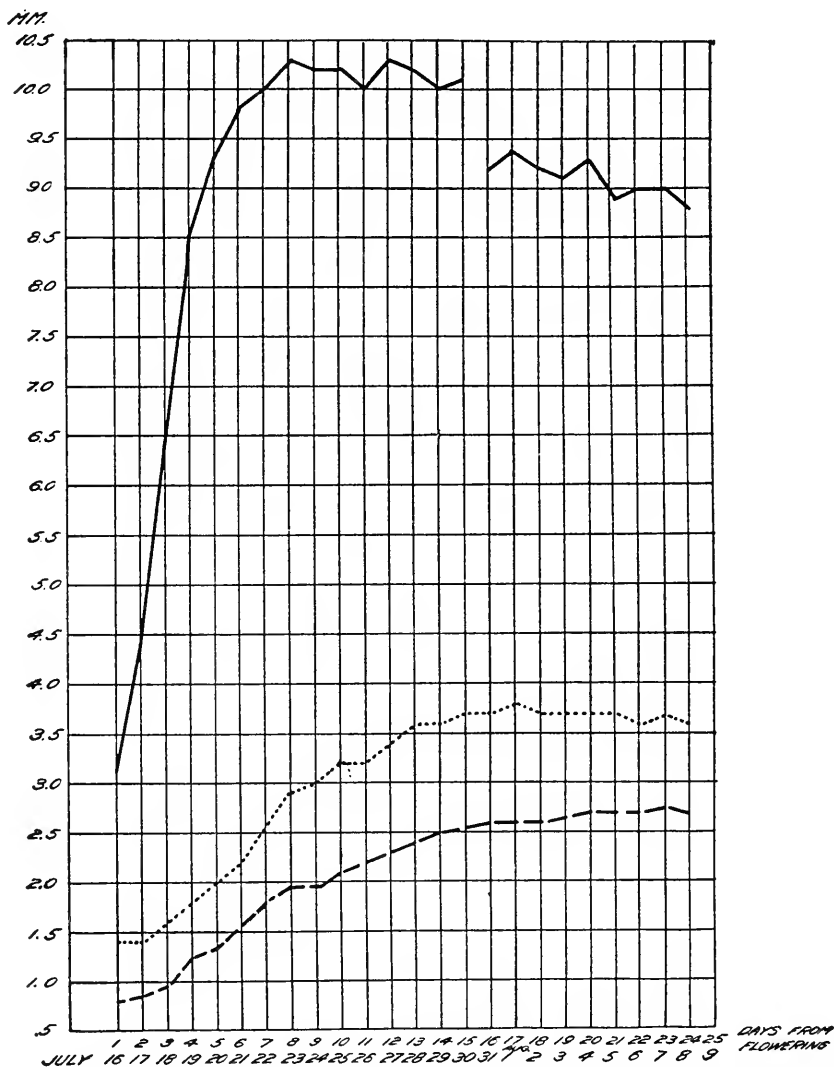

FIG. 5.—Graph showing average length of kernels 6, 7, and 8 (solid line), average lateral diameter (dotted line), and average dorsoventral diameter (broken line) from plot 1 in 1917.

after flowering. The growth in lateral diameter has been practically completed by the sixteenth day. The measurements after the tenth day are given only on alternate days, because the daily increase is so small that the inclusion of all days causes the lines to become confused.

The dorsoventral diameter continues to increase for a longer period. As may be seen in figure 8, the full growth is attained on the twenty-third day after flowering. The greatest diameters in the early growth

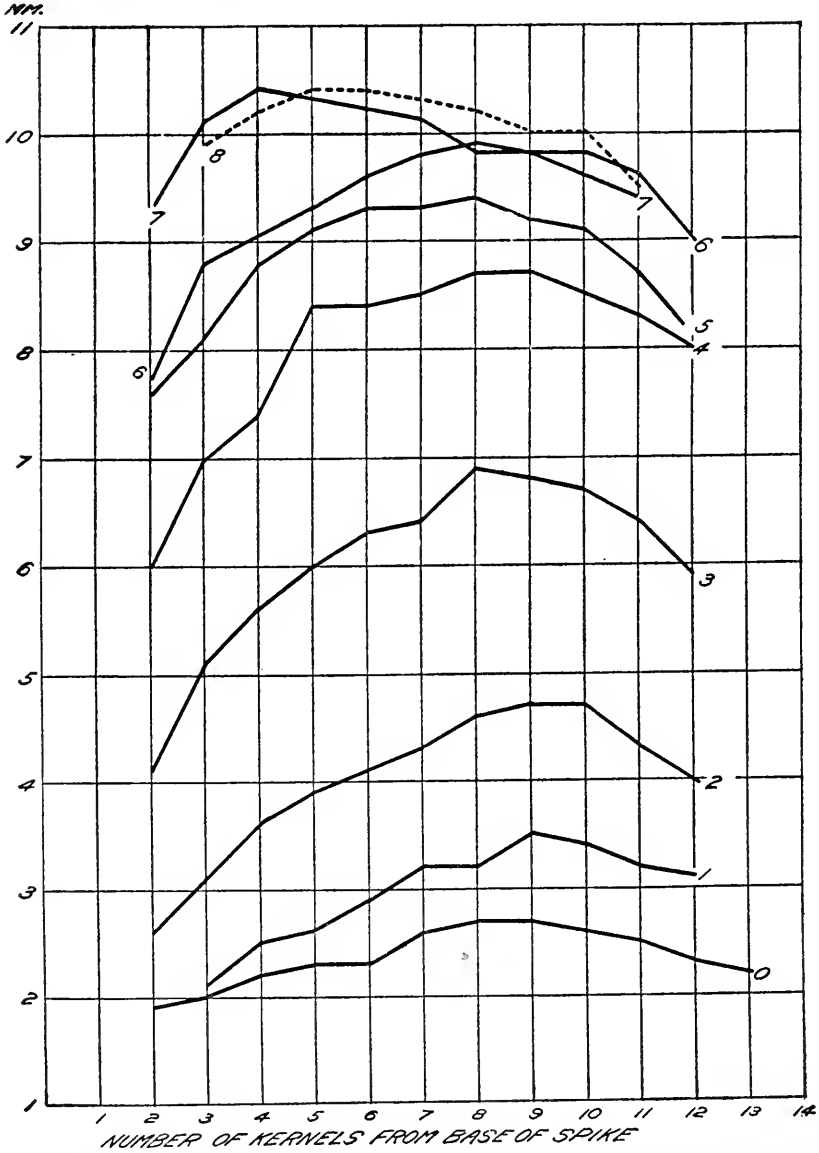

FIG. 6.—Graph showing average length of barley kernels, including ovary tip, from flowering to near maximum development in plot 1 in 1917. Numerals at ends of lines indicate days from flowering.

are to be found in kernels 8, 9, and 10, as was the case in the length and in the lateral diameter. On the fourth, fifth, and sixth days after flowering these kernels are conspicuously in advance of the rest of the spike.

Again, as in the length and the lateral diameter, the kernels toward the base increase more rapidly. The fourth kernel never becomes as prominent as it does in the other measurements. After the growth in length and lateral diameter has been completed, there is a tendency toward a greater permanent increase in the kernels near the center of the spike.

As a whole, the progress of kernel growth is significantly indicated by these three measurements. After the peak is reached there is a slight decrease as maturity approaches. This is especially true in the length

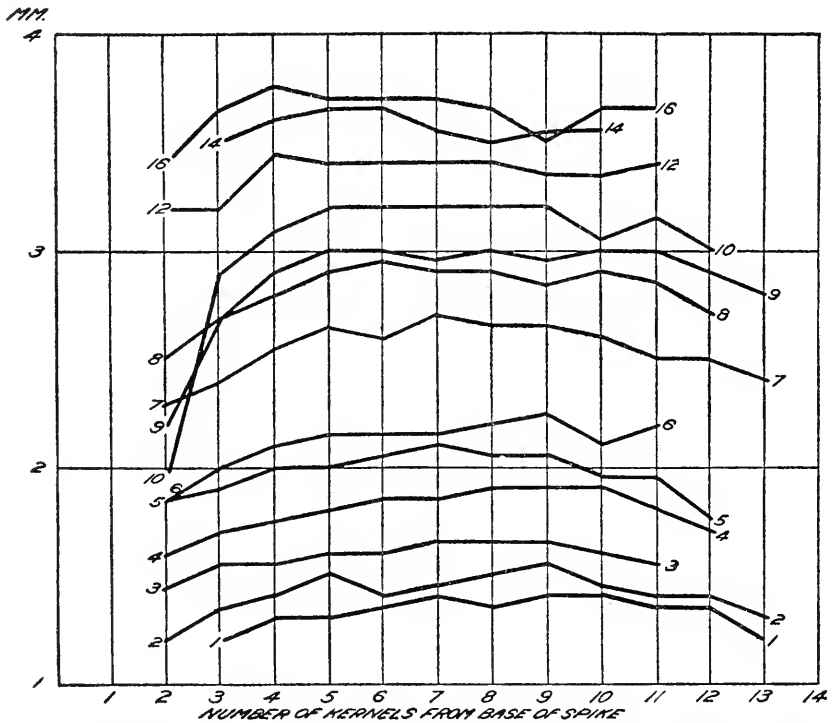

FIG. 7.—Graph showing average lateral diameter of barley kernels from flowering until near maximum development, plot 1, 1917. Numerals at end of lines indicate days from flowering.

and in the lateral diameter. This fact will be referred to again when the course of water content is discussed.

COURSE BY DAYS OF DRY MATTER, WATER, NITROGEN, AND ASH IN THE KERNEL FROM FLOWERING TO MATURITY

The chemical phase of the study is based on the laboratory determinations made on the same samples from which the measurements were secured. In 1916 the material was analyzed by Mr. Anthony. The analyses in 1917 were made by the Bureau of Chemistry of the United States Department of Agriculture. While the chemical investigations involved no such elaborate determinations as those of Schjerning, the results are parallel with those from his work and that of Wheldale.

Table III is a summary of the results obtained and computed on each spike of each sample for 1917. In each sample the material from one spike was used for nitrogen determinations and the material from the

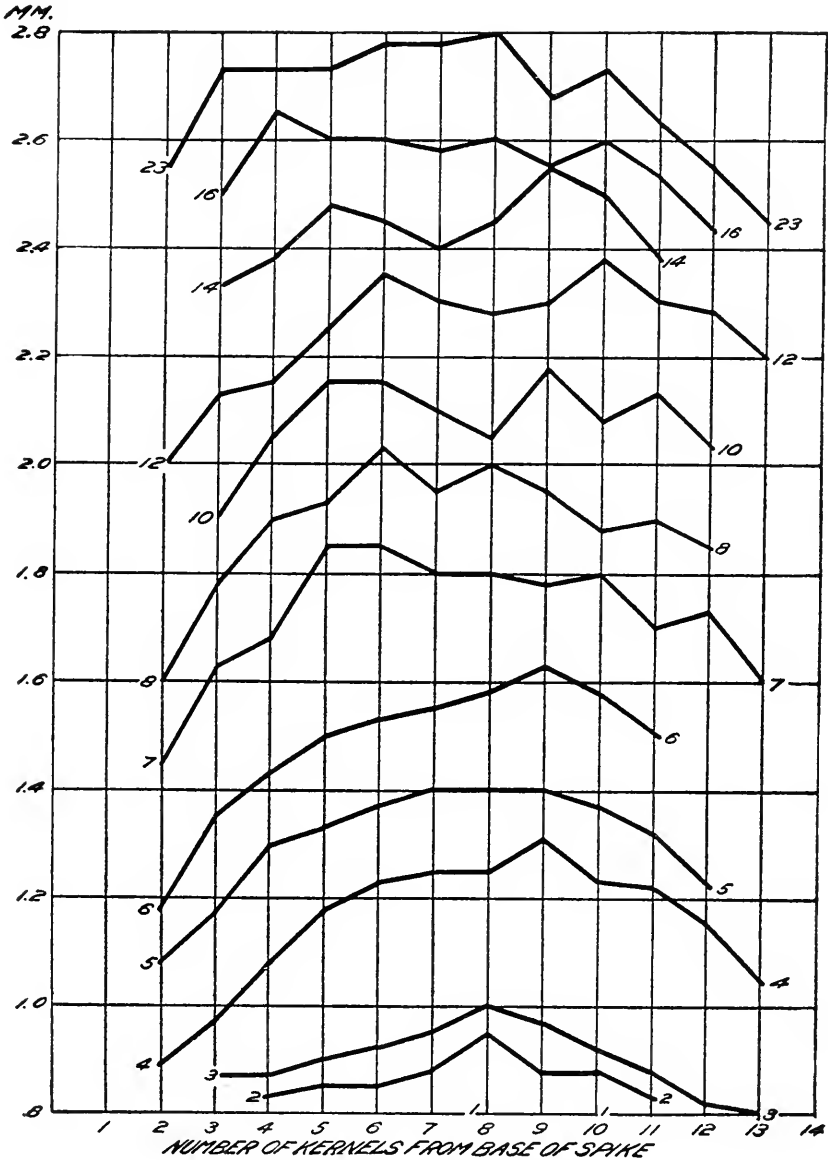

FIG. 8.—Graph showing dorsoventral diameters of barley kernels from flowering until near maximum development. Numerals at ends of lines indicate days from flowering.

other for ash determinations. In the early growth a third spike was sometimes added, but these third spikes are not in the summary, since they were not reported in Table I. Because of the limited amount of

material, the analyses are not always dependable. This is true especially for the first few days after flowering. As may be seen from the table, the weight of the individual kernels was greater at maturity than the weight of all the kernels of a spike at flowering time. In some cases where the analyses were obviously incorrect, the results are omitted. But, despite the small samples, the trend of the analyses is surprisingly uniform and, as the results of the two years are in such close agreement, the results are significant. The nitrogen determination is naturally the least dependable. The results in the ash determinations are more accurate, and there is no reason why the dry matter content should not be absolutely so. The dry weight, nitrogen, and ash per kernel are computed by means of the percentages secured in the whole spike.

TABLE III.—Summary of data on weight, dry matter, water, nitrogen, and ash in individual spikes of Hannchen barley in 12-hour periods at Aberdeen, Idaho, in 1917

Time.	Spike.	Wet weight.	Dry weight.	Dry matter.	Water.	Nitrogen in dry matter.	Ash in dry matter.	Wet weight per kernel.	Dry weight per kernel.	Nitrogen per kernel.	Ash per kernel.
		<i>Gm.</i>	<i>Gm.</i>	<i>Per ct.</i>	<i>Per ct.</i>	<i>Per ct.</i>	<i>Per ct.</i>	<i>Mgm.</i>	<i>Mgm.</i>	<i>Mgm.</i>	<i>Mgm.</i>
July 15:											
7 p. m.	A	0.0441	0.0064	14.5	85.5	3.75	1.875	0.272	0.010
7 p. m.	B	0.0494	0.0085	17.2	82.8	1.802	0.320
July 16:											
6 a. m.	A	0.0578	0.0093	16.1	83.9	4.19	2.275	0.366	0.015
6 a. m.	B	0.0657	0.0084	12.8	87.2	2.650	0.339
7 p. m.	A	0.0745	0.0126	16.9	83.1	4.45	3.400	0.575	0.026
7 p. m.	B	0.0778	0.0139	17.9	82.1	7.91	3.550	0.635	0.050
July 17:											
6 a. m.	A	0.0807	0.0149	18.5	81.5	3.00	3.050	0.564	0.017
6 a. m.	B	0.0795	0.0145	18.2	81.8	8.96	3.400	0.619	0.056
7 p. m.	A	0.1360	0.0270	19.9	80.1	3.11	5.909	1.176	0.037
7 p. m.	B	0.1395	0.0273	19.6	80.4	5.86	5.592	1.096	0.064
July 18:											
6 a. m.	A	0.1767	0.0341	19.3	80.7	8.500	1.641
6 a. m.	B	0.1477	0.0274	18.6	81.4	6.57	6.418	1.194	0.078
6 a. m.	C	0.1964	0.0385	19.6	80.4	5.71	7.650	1.499	0.086
7 p. m.	A	0.1940	0.0406	20.9	79.1	8.391	1.754
July 19:											
6 a. m.	A	0.2652	0.0540	20.4	79.6	10.883	2.220
6 a. m.	B	0.2940	0.0637	21.7	78.3	3.77	12.327	2.675	0.101
6 a. m.	C	0.2389	0.0516	21.6	78.4	4.26	11.590	2.503	0.107
7 p. m.	A	0.2829	0.0651	23.0	77.0	14.720	3.386
7 p. m.	C	0.2744	0.0619	22.6	77.4	4.20	13.027	2.944	0.124
July 20:											
6 a. m.	A	0.3216	0.0723	22.5	77.5	14.672	3.301
6 a. m.	B	0.3508	0.0798	22.7	77.3	4.51	16.370	3.716	0.168
6 a. m.	C	0.3863	0.0878	22.7	77.3	3.08	16.417	3.727	0.115
7 p. m.	A	0.3026	0.0678	22.4	77.6	2.27	13.900	3.114	0.071
7 p. m.	B	0.3452	0.0756	21.9	78.1	4.63	17.600	3.854	0.178
July 21:											
6 a. m.	A	0.3356	0.0760	22.6	77.4	3.14	16.820	3.801	0.119
6 a. m.	B	0.3772	0.0875	23.2	76.8	3.54	18.560	4.306	0.152
7 p. m.	A	0.4192	0.1060	25.3	74.7	20.655	5.226
July 22:											
6 a. m.	A	0.5163	0.1328	25.7	74.3	2.33	25.460	6.543	0.152
6 a. m.	B	0.5996	0.1558	26.0	74.0	3.21	26.142	6.797	0.218
7 p. m.	A	0.5445	0.1395	25.6	74.4	2.33	25.555	6.542	0.152
7 p. m.	B	0.6373	0.1635	25.7	74.3	3.79	25.492	6.551	0.248
July 23:											
6 a. m.	A	0.6429	0.1800	28.0	72.0	2.18	32.160	9.005	0.196
6 a. m.	B	0.5810	0.1602	27.6	72.4	4.18	29.030	8.178	0.342
7 p. m.	A	0.7469	0.2194	29.4	70.6	1.95	33.345	9.803	0.191
7 p. m.	B	0.6699	0.1944	29.0	71.0	3.09	3.09	28.891	8.378	0.259
July 24:											
6 a. m.	A	0.6979	0.2150	30.8	69.2	2.08	31.200	9.610	0.200
6 a. m.	B	0.7856	0.2277	29.0	71.0	3.07	31.483	9.130	0.280
7 p. m.	A	0.6967	0.2197	31.5	68.5	2.17	33.720	10.622	0.230
7 p. m.	B	0.8496	0.2741	32.3	67.7	2.77	34.592	11.173	0.309
July 25:											
6 a. m.	A	0.8208	0.2718	33.1	66.9	1.96	37.055	12.265	0.240
6 a. m.	B	0.8024	0.2496	31.1	68.9	2.88	35.482	11.035	0.318
7 p. m.	A	0.7131	0.2618	36.7	63.3	1.92	34.527	12.071	0.243
7 p. m.	B	0.6832	0.2285	33.4	66.6	2.93	37.100	12.391	0.363

TABLE III.—Summary of data on weight, dry matter, water, nitrogen, and ash in individual spikes of Hannchen barley in 12-hour periods at Aberdeen, Idaho, in 1917—Continued

Time.	Spike.	Wet weight.	Dry weight.	Dry matter.	Water.	Nitrogen in dry matter.	Ash in dry matter.	Wet weight per kernel.	Dry weight per kernel.	Nitrogen per kernel.	Ash per kernel.
		<i>Gm.</i>	<i>Gm.</i>	<i>Per ct.</i>	<i>Per ct.</i>	<i>Per ct.</i>	<i>Per ct.</i>	<i>Mgm.</i>	<i>Mgm.</i>	<i>Mgm.</i>	<i>Mgm.</i>
July 26:											
6 a. m.	A	0.7677	0.2668	34.0	66.0	2.04		36.640	12.458	0.254	
6 a. m.	B	.7302	.2630	36.0	64.0		2.62	36.660	13.198		0.346
7 p. m.	A	.7955	.3000	37.7	62.3	1.87		39.860	15.027	.281	
7 p. m.	B	.8527	.3164	37.1	62.9		2.72	39.682	14.722		.400
July 27:											
6 a. m.	A	1.0141	.3712	36.6	63.4	2.04		43.200	15.811	.323	
6 a. m.	B	.9320	.3405	36.5	63.5		2.61	45.364	16.558		.432
7 p. m.	A	1.1596	.4435	38.2	61.8	2.02		44.731	17.087	.345	
7 p. m.	B	.8451	.3205	37.9	62.1		2.84	45.130	17.104		.486
July 28:											
6 a. m.	A	1.1301	.4025	35.6	64.4	2.09		45.550	16.216	.339	
6 a. m.	B	1.2476	.4902	39.3	60.7		2.41	49.300	19.375		.467
7 p. m.	A	1.0862	.4515	41.6	58.4	1.86		48.991	20.380	.379	
7 p. m.	B	1.1338	.4674	41.2	58.8		2.42	48.775	20.095		.486
July 29:											
6 a. m.	A	.9978	.4061	40.7	59.3	1.86		49.570	20.175	.375	
6 a. m.	B	.9214	.3922	39.2	60.8		2.49	47.180	18.495		.461
7 p. m.	A	.9233	.3847	41.7	58.3	2.19		49.590	20.679	.453	
7 p. m.	B	.9841	.4237	43.1	56.9		2.43	49.540	21.352		.519
July 30:											
6 a. m.	A	.9350	.4015	42.9	57.1	2.02		52.811	22.656	.458	
6 a. m.	B	1.1415	.4725	41.4	58.6		2.10	50.091	20.738		.435
7 p. m.	A	1.3826	.6008	43.5	56.5	2.00		56.708	24.668	.493	
7 p. m.	B	1.0599	.4701	44.4	55.6		2.28	52.320	23.230		.530
July 31:											
6 a. m.	A	1.1090	.4837	43.6	56.4	2.09		50.600	22.062	.461	
6 a. m.	B	1.3637	.6065	44.5	55.5		2.41	52.777	23.486		.566
6:30 p. m.	A	1.1058	.5098	46.1	53.9	2.14		55.580	25.622	.548	
6:30 p. m.	B	1.0597	.5038	47.5	52.5		2.22	49.909	23.707		.526
August 1:											
6 a. m.	A	1.3393	.6261	46.7	53.3	1.89		53.862	25.154	.475	
6 a. m.	B	1.2231	.5814	47.5	52.5		2.27	56.204	26.725		.607
6:30 p. m.	A	1.2283	.5928	48.3	51.7	2.08		54.973	26.552	.552	
6:30 p. m.	B	1.2051	.6012	49.9	50.1		2.25	53.933	26.913		.606
August 2:											
6 a. m.	A	1.2996	.6071	46.8	53.2	1.82		54.508	25.510	.464	
6 a. m.	B	1.2460	.5969	47.9	52.1		1.94	56.609	27.116		.526
6:30 p. m.	A	.9942	.4974	50.0	50.0	1.97		50.800	25.430	.501	
6:30 p. m.	B	.9693	.4818	49.7	50.3		2.12	51.027	25.300		.538
August 3:											
6 a. m.	A	1.3453	.6846	50.9	49.1	1.85		54.062	27.518	.509	
6 a. m.	B	1.1579	.5711	49.3	50.7		2.10	56.200	27.707		.582
6:45 p. m.	A	1.3575	.6850	50.5	49.5	2.04		61.309	30.961	.632	
6:45 p. m.	B	1.0280	.5161	50.2	49.8		2.00	51.670	25.938		.519
August 4:											
5:45 a. m.	A	1.0870	.5380	49.5	50.5	1.85		53.236	26.352	.488	
5:45 a. m.	B	1.1618	.5690	49.0	51.0		1.97	55.836	27.360		.539
6:45 p. m.	A	1.3289	.6795	51.1	48.9	2.18		56.175	28.705	.626	
6:45 p. m.	B	1.5152	.8077	53.3	46.7		1.97	59.777	31.861		.628
August 5:											
6 a. m.	A	1.1586	.5882	50.8	49.2	1.86		60.322	30.644	.570	
6 a. m.	B	.9911	.5175	52.2	47.8		1.93	53.220	27.781		.536
6:30 p. m.	A	1.3447	.7412	55.1	44.9	1.91		54.817	30.204	.577	
6:30 p. m.	B	1.1599	.6146	53.4	46.6		1.94	55.320	29.541		.573
August 6:											
6 a. m.	A	1.3166	.6978	53.0	47.0	2.03		60.909	32.282	.655	
6 a. m.	B	1.2923	.6779	52.5	47.5		1.83	57.118	29.987		.549
6:40 p. m.	A	1.3166	.7470	56.7	43.3	1.97		56.991	31.314	.637	
6:40 p. m.	B	1.0200	.5997	57.9	42.1		1.95	51.480	29.807		.581
August 7:											
6 a. m.	A	1.5329	.8254	53.8	46.2	2.27		61.608	33.145	.752	
6 a. m.	B	1.2783	.7104	55.6	44.4		1.93	59.127	32.875		.634
7 p. m.	A	1.0927	.6367	58.3	41.7			54.964	31.044		
7 p. m.	B	1.3444	.7723	57.6	42.4		1.93	56.342	32.453		.626
August 8:											
6 a. m.	A	1.4838	.8217	55.4	44.6	2.28		58.923	32.643	.744	
6 a. m.	B	1.3004	.7457	57.3	42.7		1.98	58.573	33.562		.665
6:40 p. m.	A	1.0100	.5903	58.4	41.6			53.633	31.322		
6:40 p. m.	B	1.0614	.6083	57.3	42.7		1.77	53.310	30.547		.541

The material in Table III is summarized in Table IV. In the first part of Table IV the spikes of each sample are combined so as to give the average growth in 12-hour periods. In the second part of the table the

morning and evening averages are united to give the average growth in 24-hour periods. While many points of interest are perfectly apparent in the table, it is more convenient to discuss these data under the headings of the separate constituents, where the results are represented graphically.

TABLE IV.—Average percentage of dry matter and water per kernel in *Hannchen* barley, percentage of nitrogen and ash in dry matter, and actual total weight, weight of dry matter, water, nitrogen, and ash at 12-hour and 24-hour periods at Aberdeen, Idaho, in 1917

		12-HOUR PERIODS								
Time.		Dry matter.	Water.	Nitrogen in dry matter.	Ash in dry matter.	Wet weight.	Dry matter.	Water.	Nitrogen.	Ash.
		<i>Per ct.</i>	<i>Per ct.</i>	<i>Per ct.</i>	<i>Per ct.</i>	<i>Mgm.</i>	<i>Mgm.</i>	<i>Mgm.</i>	<i>Mgm.</i>	<i>Mgm.</i>
July	15, p. m.	15.9	84.1	3.75	1.9	0.3	1.6	0.01
	16, a. m.	14.5	85.5	4.19	2.5	.4	2.1	.02
	16, p. m.	17.4	82.6	4.45	7.91	3.5	.6	2.9	.03	0.05
	17, a. m.	18.4	81.6	3.00	8.06	3.2	.6	2.6	.02	.05
	17, p. m.	19.8	80.2	3.11	5.86	5.8	1.1	4.6	.04	.07
	18, a. m.	19.2	80.8	6.14	7.5	1.4	6.109
	18, p. m.	20.9	79.1	8.4	1.8	6.6
	19, a. m.	21.2	78.8	4.02	11.6	2.5	9.110
	19, p. m.	22.8	77.2	4.20	13.9	3.2	10.713
	20, a. m.	22.6	77.4	3.80	15.8	3.6	12.214
	20, p. m.	22.2	77.8	2.27	4.63	15.8	3.5	12.3	.08	.16
	21, a. m.	22.9	77.1	3.14	3.54	17.7	4.1	13.6	.13	.14
	21, p. m.	25.3	74.7	20.7	5.2	15.4
	22, a. m.	25.9	74.1	2.33	3.21	25.8	6.7	19.1	.16	.21
	22, p. m.	25.7	74.3	2.33	3.79	25.5	6.5	19.0	.15	.25
	23, a. m.	27.6	72.2	2.18	4.18	30.9	8.6	22.3	.19	.36
	23, p. m.	29.2	70.8	1.95	3.09	31.1	9.1	22.0	.18	.28
	24, a. m.	29.9	70.1	2.08	3.07	31.3	9.4	22.0	.20	.29
	24, p. m.	31.9	68.1	2.17	2.77	34.2	10.9	23.3	.24	.30
	25, a. m.	32.1	67.9	1.96	2.88	36.3	11.7	24.6	.23	.34
	25, p. m.	35.1	64.9	1.92	2.93	35.8	12.5	23.3	.24	.37
	26, a. m.	35.0	65.0	2.04	2.62	36.7	12.8	23.8	.26	.34
	26, p. m.	37.4	62.6	1.87	2.72	39.8	14.9	24.9	.28	.41
	27, a. m.	36.6	63.4	2.04	2.61	44.3	16.2	28.1	.33	.42
	27, p. m.	38.1	61.9	2.02	2.84	44.9	17.1	27.8	.35	.49
	28, a. m.	37.5	62.5	2.09	2.41	47.4	17.8	29.6	.37	.43
	28, p. m.	41.4	58.6	1.86	2.42	48.9	20.2	28.6	.38	.49
	29, a. m.	40.0	60.0	1.86	2.49	48.4	19.3	29.0	.36	.48
	29, p. m.	42.4	57.6	2.19	2.43	49.6	21.0	28.5	.46	.51
	30, a. m.	42.2	57.8	2.02	2.10	51.5	21.7	29.8	.44	.46
	30, p. m.	45.0	55.0	2.00	2.28	54.5	23.9	30.6	.48	.55
	31, a. m.	44.1	55.9	2.09	2.41	51.7	22.8	28.9	.48	.55
	31, p. m.	46.8	53.2	2.14	2.22	52.7	24.7	28.1	.53	.55
Aug.	1, a. m.	47.1	52.9	1.89	2.27	55.1	25.9	29.1	.49	.59
	1, p. m.	49.1	50.9	2.08	2.25	54.5	26.7	27.7	.56	.60
	2, a. m.	47.4	52.6	1.82	1.94	55.9	26.3	29.2	.48	.51
	2, p. m.	49.9	50.1	1.97	2.12	50.9	25.4	25.5	.50	.54
	3, a. m.	50.1	49.9	1.85	2.10	55.1	27.6	27.5	.51	.58
	3, p. m.	50.4	49.6	2.04	2.00	56.5	28.5	28.0	.58	.57
	4, a. m.	49.3	50.7	1.85	1.97	54.5	26.9	27.7	.50	.53
	4, p. m.	52.2	47.8	2.18	1.97	58.0	30.3	27.7	.66	.60
	5, a. m.	51.5	48.5	1.86	1.93	56.8	29.2	27.6	.54	.56
	5, p. m.	54.3	45.7	1.91	1.94	55.1	29.9	25.1	.57	.58
	6, a. m.	52.8	47.2	2.03	1.83	59.0	31.1	27.9	.63	.57
	6, p. m.	57.3	42.7	1.97	1.95	54.2	31.1	23.1	.61	.61
	7, a. m.	54.7	45.3	2.27	1.93	60.4	33.0	27.4	.75	.64
	7, p. m.	58.0	42.0	1.93	55.7	32.3	23.462
	8, a. m.	56.4	43.6	2.28	1.98	59.0	33.1	25.6	.76	.66
	8, p. m.	57.9	42.1	1.77	53.4	30.9	22.555

TABLE IV.—Average percentage of dry matter and water per kernel in Hannchen barley, percentage of nitrogen and ash in dry matter, and actual total weight, weight of dry matter, water, nitrogen, and ash in 12-hour and 24-hour periods at Aberdeen, Idaho¹ in 1917—Continued

24-HOUR PERIODS

Time.	Dry matter.	Water.	Nitrogen in dry matter.	Ash in dry matter.	Wet weight.	Dry matter.	Water.	Nitrogen.	Ash.
	Per ct.	Per ct.	Per ct.	Per ct.	Mgm.	Mgm.	Mgm.	Mgm.	Mgm.
July 15.....	15.9	84.1	3.75	1.9	0.3	1.6	0.01
16.....	16.0	84.0	4.32	7.91	3.0	.5	2.5	.02	0.05
17.....	19.1	80.9	3.06	7.41	4.5	.9	3.6	.03	.06
18.....	20.1	79.9	6.14	8.0	1.6	6.409
19.....	22.0	78.0	4.11	12.7	2.8	9.912
20.....	22.4	77.6	2.27	4.22	15.8	3.5	12.3	.08	.15
21.....	24.1	75.9	3.14	3.54	19.2	4.6	14.5	.13	.14
22.....	25.8	74.2	2.33	3.50	25.7	6.6	19.1	.15	.23
23.....	28.5	71.5	2.07	3.64	31.0	8.8	22.2	.18	.32
24.....	30.9	69.1	2.13	2.92	32.7	10.1	22.6	.22	.30
25.....	33.6	66.4	1.94	2.01	36.0	12.1	24.0	.23	.35
26.....	36.2	63.8	1.96	2.67	38.2	13.9	24.4	.27	.37
27.....	37.4	62.6	2.03	2.73	44.6	16.6	28.0	.34	.45
28.....	39.5	60.5	1.98	2.42	48.2	19.0	29.1	.37	.46
29.....	41.2	58.8	2.03	2.46	49.0	20.2	28.8	.41	.50
30.....	43.6	56.4	2.01	2.19	53.0	22.8	30.2	.46	.50
31.....	45.5	54.5	2.12	2.32	52.2	23.7	28.5	.50	.55
Aug. 1.....	48.1	51.9	1.99	2.26	54.8	26.3	28.4	.52	.59
2.....	48.7	51.3	1.90	2.03	53.3	25.9	27.4	.49	.52
3.....	50.3	49.7	1.95	2.05	55.8	28.1	27.8	.55	.58
4.....	50.8	49.2	2.02	1.97	56.3	28.6	27.7	.58	.56
5.....	52.9	47.1	1.89	1.94	55.9	29.5	26.4	.56	.57
6.....	55.1	44.9	2.00	1.89	56.6	31.1	25.5	.62	.59
7.....	56.4	43.6	2.27	1.93	58.0	32.6	25.4	.75	.63
8.....	57.2	42.8	2.28	1.88	56.1	32.0	24.1	.76	.60

CHANGES IN WET WEIGHT PER KERNEL

The trend of the wet weight is indicated in Table III and is summarized in Table IV. The course of development is more apparent in figure 9, where the growth of kernels 5, 8, and 10 is represented graphically. The most rapid increase occurs in the first 16 days. After this time the loss of water is almost equal to the increase in dry matter. The fifth, eighth, and tenth kernels represent different sections of the spike. The order of weight is reversed during the period of growth. The tenth kernel was the first of the three to be fertilized, and it reaches a constant weight some time before the fifth kernel does.

The shift of wet weight is much more evident in figure 10, where the weights of all kernels are shown. The trend of development in the wet weight is quite parallel to that of the length, lateral diameter, and dorsoventral diameter shown in figures 6, 7, and 8. The shift here proceeds toward the base until the fourth kernel is the heaviest, and it is only toward the last that the fifth and sixth kernels become the highest in weight. The wet weight, owing to the difference of moisture content

between the kernels at the base of the spike and those at the tip, is not an accurate indication of the storage of nutrient material. The curve of wet weight is quite similar to that published by Brenchley (1). The losses after maturity found by Brenchley were not evident at Aberdeen, because the sampling was not carried to the same point. Brenchley included the glumes in the weights, while at Aberdeen these were removed. As the glumes can not be removed after maturity, their removal shortens the period of study. On the other hand, the glumes themselves change



FIG. 9.—Graph showing wet weight of individual kernels 5, 8, and 10, by days, from date of flowering to near maturity in 1917.

materially in character between flowering and maturity, and their elimination removes one source of error.

INCREASE IN DRY MATTER

The daily growth of the kernel is summarized in the daily increment of dry matter. While there are gradual changes in the percentages of the various substances for days of the same week, the added constituents bear a more or less uniform relation to each other. The sum of the daily additions is the increase in dry matter. This increase has been so uniform at Aberdeen as to indicate that the plants were working very nearly at

their highest capacity. In figure 11 are given the dry-matter contents of kernels in 1916 and 1917. For the first 17 days after flowering the curves of the two years practically coincide. After the seventeenth day the rate of deposit decreases in 1917 but is maintained for several days in 1916. This is due, probably, to lack of sufficient water after this date in 1917, the effect of which is noticeable in all the results reported. The gain is surprisingly uniform for the most part. In each season, the curve is essentially a straight line from the sixth until the eighteenth

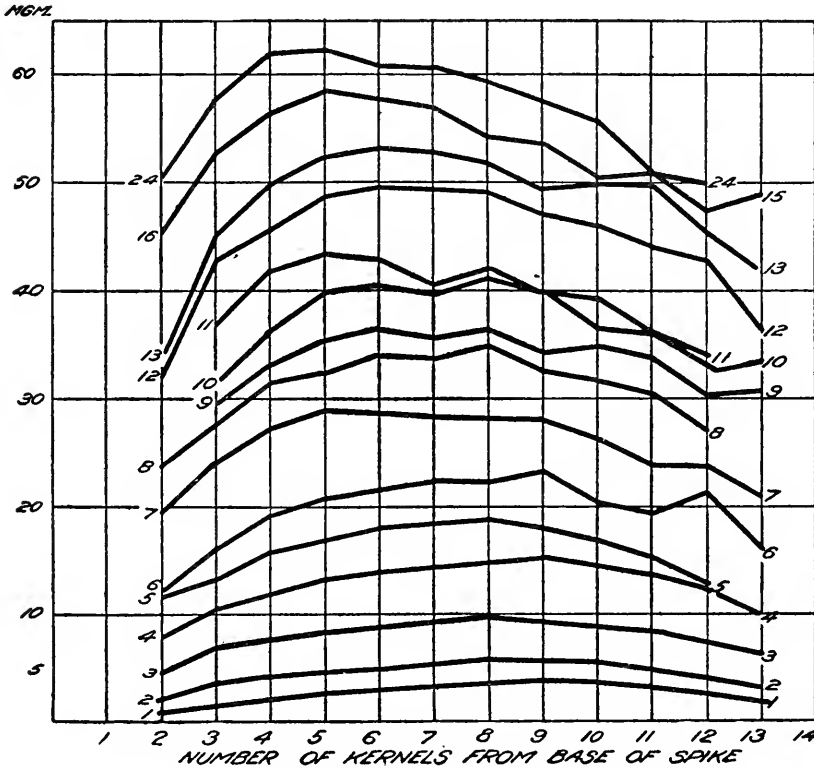

FIG. 10.—Graph showing average wet weights of kernels from flowering to maturity in plot 1 in 1917. Numerals at ends of lines indicate days from flowering.

day. This is interesting in its relation to the general laws of plant growth. In a developing plant, where the new tissue added becomes immediately productive of nutrient material for growth, the increase is accelerated in geometrical ratio. The curve of growth, in this case, can be reduced to a straight line in plotting by the use of logarithmic paper. In the case of kernel growth, by the fourth or fifth day after flowering, the maximum leaf and sheath surface is exposed. The plant food metabolized is diverted to the storage tissues of the kernel, and, since the productive tissues remain constant in amount, the curve of kernel growth is a straight line.

The uniformity of the Aberdeen seasons and the accuracy of the method of sampling used is nowhere more evident than in figure 12. In this figure the dry matter per kernel is plotted in 12-hour periods. For the first 14 days neither the error of sampling nor the differences in rate of growth of individual spikes, separately or together, exceeds the growth

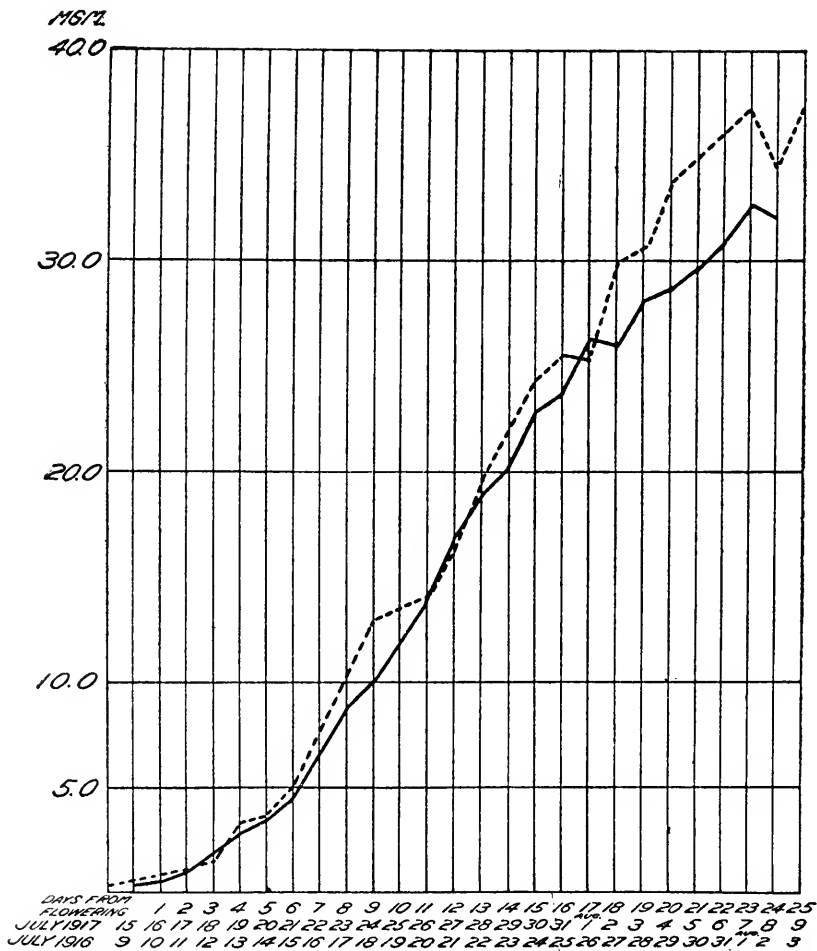

FIG. 11.—Graph showing dry matter per kernel from date of flowering to near maturity in 1916 (dotted line) and in 1917 (solid line).

in 12 hours. There is an apparent reversal of the curve in the fifth and seventh days after flowering, but the larger of these losses is less than 0.2 mgm., and in each case is due to the abnormalities of a few kernels on the spike. When this curve is plotted from the data of the more representative sixth, seventh, and eighth kernels, these irregularities disappear. It is only when the fourteenth day is reached that fluctuations

become common. After this date results are not consistent in such short periods as 12 hours.

The original purpose of the 12-hour interval was to discover, if possible, whether or not growth occurred during the night. For this reason, the periods are not quite equal. The day period consisted of about 13 hours at the beginning. As the days grew shorter this was reduced slightly. This period was thought to include the hours of effective sunlight. In figure 13 the gains and losses for the day and night periods are indicated graphically. The disadvantage of such presentation lies in the magnification of the fluctuations. For instance, the night sample of July 26 shows a decrease of 120 points, not because it is smaller than the sample of July

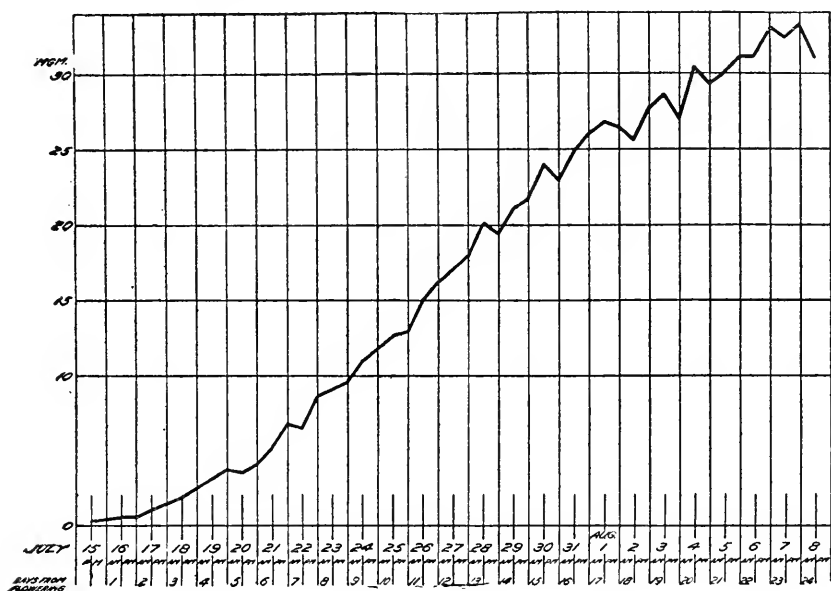

FIG. 12.—Graph showing dry matter per kernel at 12-hour intervals from flowering to maturity.

25, but because it is the same size and, therefore, no gain is registered. For the first 10 days after flowering the day and night gains appear to be nearly equal. From this time until maturity the day gain is obviously greater. The author has no interpretation to suggest, but there are two facts which may be noted. The night gains are most prominent before starch infiltration has become very active. The temperatures, after the first 10 days, are lower, the first night without gain being recorded on July 26, when the mean temperature first falls to 70° F. It is not known whether these facts have any essential relation to the results obtained or not. During the latter part of the growth period, the variation of individual spikes makes the results inconclusive.

The significant features of the data on dry-matter content are (1) the long period of daily gains following the completion of length growth,

which results in a straight line through a considerable portion of the curve when plotted, and (2) the unusual uniformity of increase which permits the taking of samples which show growth in 12-hour periods for two weeks

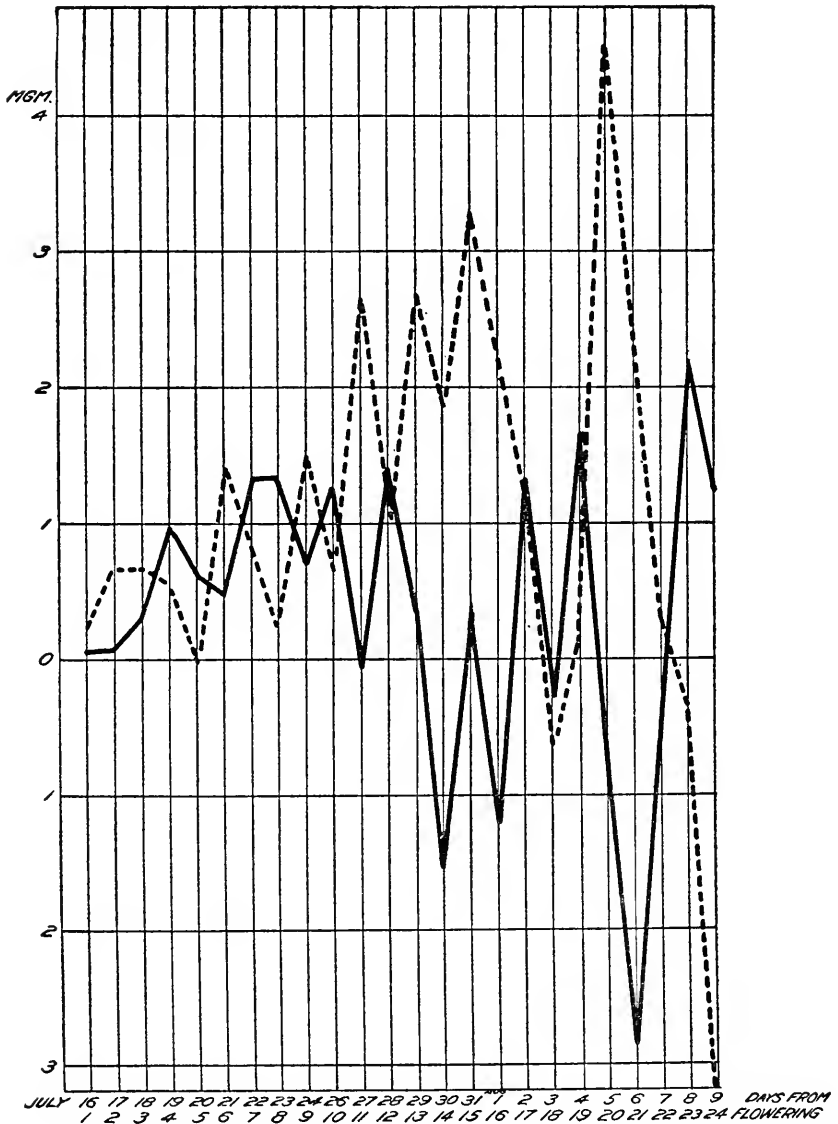

FIG. 13.—Graph showing dry-weight gain of kernels 6, 7, and 8 in 12-hour periods. Gain during the day is shown by the broken line and that during the night by the solid line.

after flowering. The curve of growth as found by Brenchley was quite similar to that shown in figure 11. The same straight line is apparent during the period of rapid starch infiltration, despite the fact that she took samples only every third day. The results seem to agree in a general

way with those of Schjerning, but inasmuch as his samples were less frequently taken, close comparison is not readily made.

CHANGES IN WATER CONTENT

The percentage of water in the kernel is highest at flowering time, when over 80 per cent of the caryopsis is water. From flowering until maturity the percentage of water constantly decreases. At maturity the water content has fallen to about 40 per cent. The decrease in percentage is very uniform, as may be seen in figure 2. The curves of 1916

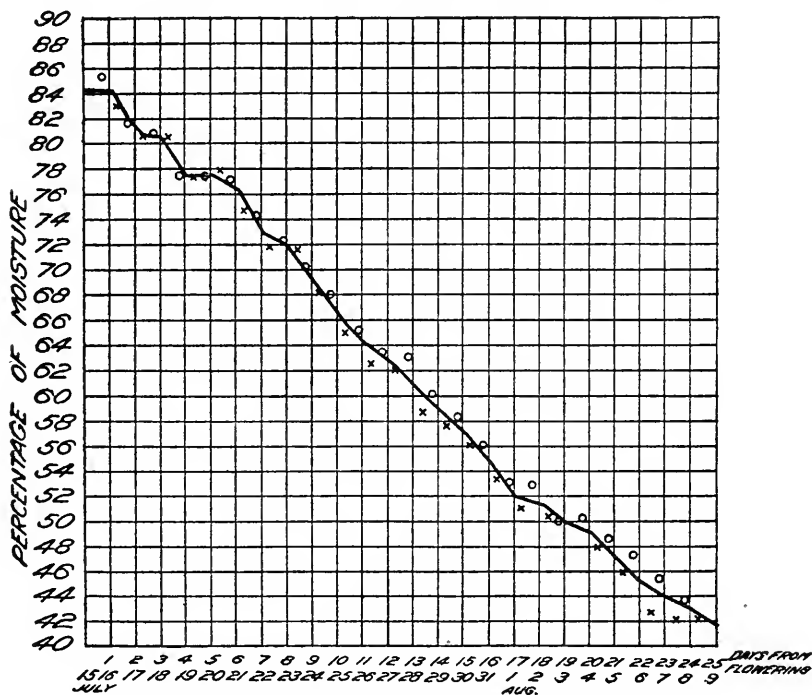

FIG. 14.—Graph showing percentage of moisture in morning and evening samples of Hannchen barley in 1917. The average for the day is indicated by the line. The average morning determinations are indicated by circles, and evening determinations by crosses.

and 1917 are essentially identical. As previously remarked, the coincidence of these curves is evidence of the exceptional opportunity afforded at Aberdeen for comparative studies in development.

The loss of water in percentage is much more rapid than in the results obtained by Brenchley. At Aberdeen the rate is almost 2 per cent a day. At Rothamsted the rate during infiltration was in the neighborhood of 1 per cent a day, although the rate was higher than this at times.

The effect of evaporation during the day was noticeable. The morning sample usually showed a gain in percentage of moisture over that of the night before. The loss of water during the day was rapid, evidently exceeding the normal loss, due to the incident of growth. This extra-normal loss and its recovery are shown in figure 14.

INCREASE IN NITROGEN CONTENT

The nitrogen determinations are the least satisfactory of the studies made. The samples were so small that microchemical methods had to

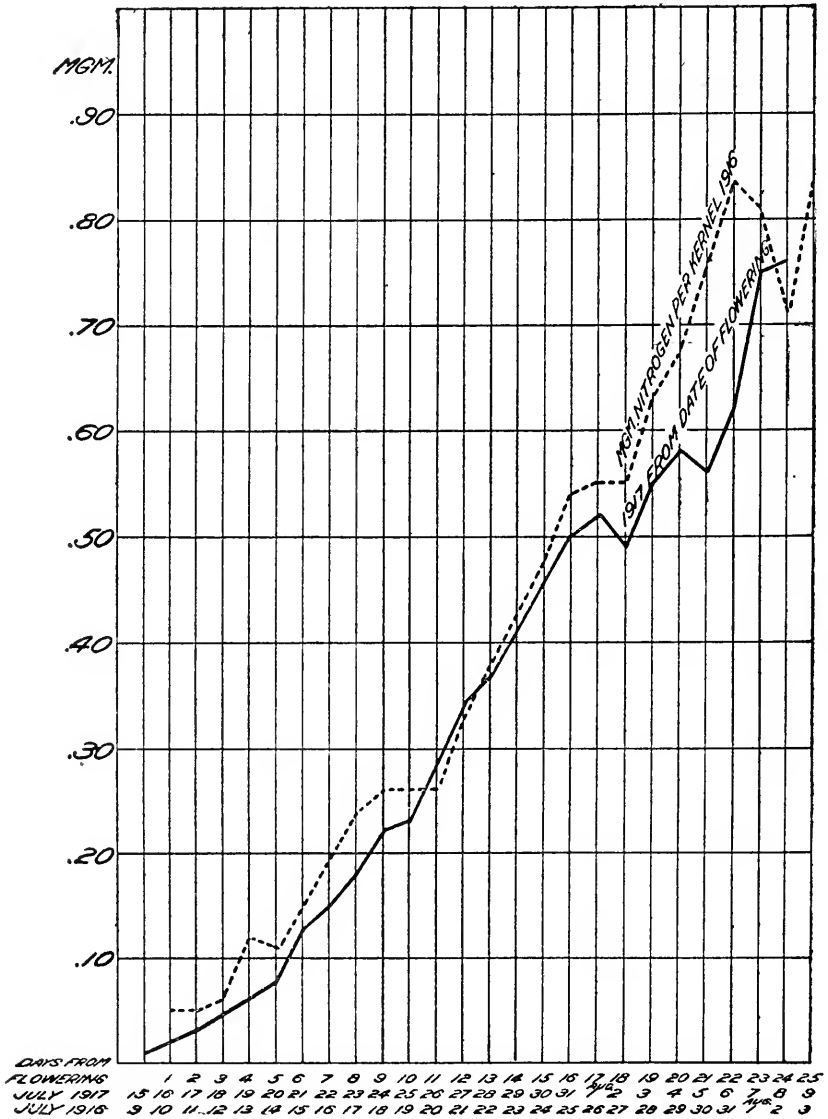

FIG. 15.—Graph showing nitrogen per kernel from date of flowering in 1916 (broken line) and in 1917 (solid line).

be used in the early stages of growth. While the material itself was probably fairly uniform, the determinations are not delicate enough to show a uniform progression in percentage. When the percentages are computed on the dry weight to obtain the milligrams of nitrogen per

grain, the results are much more uniform. In figure 15 is given the total nitrogen per kernel in both 1916 and 1917. The curves are essentially identical. The divergence after the seventeenth day is due to the lesser gain in dry matter after that time in 1917. The divergence in nitrogen content is about the same as in the dry matter shown in figure 11. The results obtained agree very closely with those of Schjerning in Denmark and Brenchley in England.

INCREASE IN ASH

The percentage of ash in the kernel decreases uniformly from flowering to maturity. At the time of fertilization the percentage is high, and for 48 hours after flowering it is more than 7 per cent. The decrease in percentage from that time is not due to loss of ash, as may be seen in figure 16, but to the more rapid increase of other materials. In other experiments, to be reported later, it has been found that the ash content is in fairly close relation to the amount of water available for the use of the plant. The curves of the ash content of 1916 and 1917 again indicate that the irrigation of 1917 was insufficient. The greater growth of 1916 has been mentioned previously; and while a part of it may have been due to better soil in 1916 a part was certainly due to the more generous irrigation of that year, coupled with the fact that the soil used in 1916 absorbed water somewhat more readily than that used in 1917.

PERIODS OF DEVELOPMENT

The Hannchen barley at Aberdeen exhibits a development which is very uniform from year to year. This development, while steadily progressive from flowering to maturity, varies considerably in its nature. The first five days after fertilization are marked by an extremely rapid growth in length. The kernel has reached its maximum in this respect by the seventh day. About the time the growth in length ceases the rapid gain in dry matter begins and continues for about two weeks. Thus the fifth or sixth day marks a change in the character of growth. About the ninth or tenth day a sticky substance is formed in the outer layers of the caryopsis, which causes the glumes to adhere thereafter to the developing kernel. The nature of this substance has not been included in this study, but its origin is evidently in the caryopsis and not in the glumes. This has been demonstrated in the making of hybrids. In this process the upper part of the florets is removed. At maturity the tips of the projecting kernels are often found stuck fast to the paper in which the spike was wrapped. The appearance of this adhesive substance on the ninth or tenth day would seem to mark a second stage of development. Since the inner tissues of the kernel are very soft, it is difficult, from this time until the kernel has somewhat hardened, to remove the glumes without tearing the kernel. This hardening occurs

about the fifteenth or sixteenth day at Aberdeen. It is accompanied by several other phenomena as well. The lemma begins to lose its color in the center of the dorsal surface. The awns of the Hannchen variety,

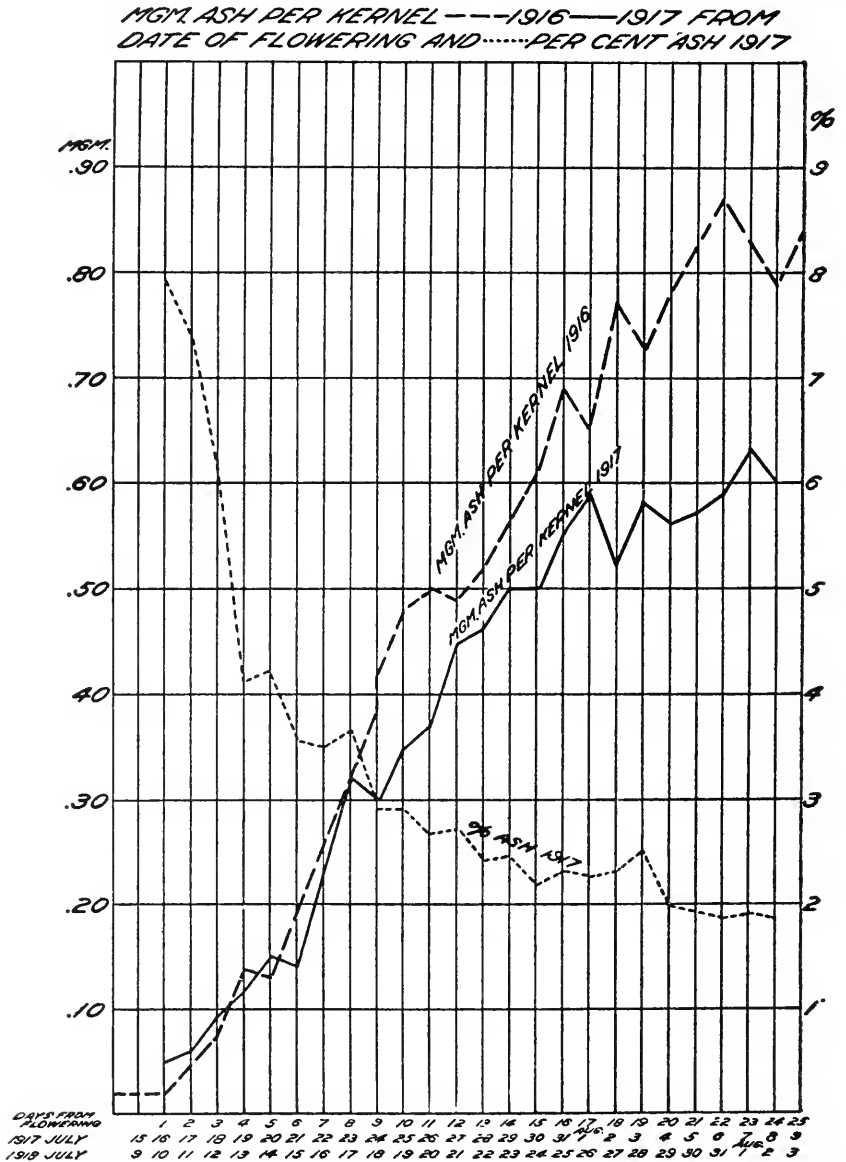

FIG. 16.—Graph showing ash per kernel from date of flowering in 1916 (broken line) and in 1917 (solid line) and the percentage of ash in 1917 (dotted line).

which are more or less deciduous, drop off in large numbers. The tissues of that part of the ovary above the embryo sac have been resorbed until it is possible at this stage to measure the kernel without including this

structure. The fifteenth or sixteenth day marks what probably is the most important change in the course of development. Among the internal changes, this date coincides with the maximum water content of the kernel and the end of the period of most rapid increase in dry matter and ash. Schjerning found a drop in the soluble nitrogen present in the kernel at about this time.

From the fifteenth or sixteenth day until maturity the changes are gradual and all in the same direction, differing only in degree. The only point now apparent, which might mark a change of nutrition, is to be found in those varieties which develop anthocyanin colors in the

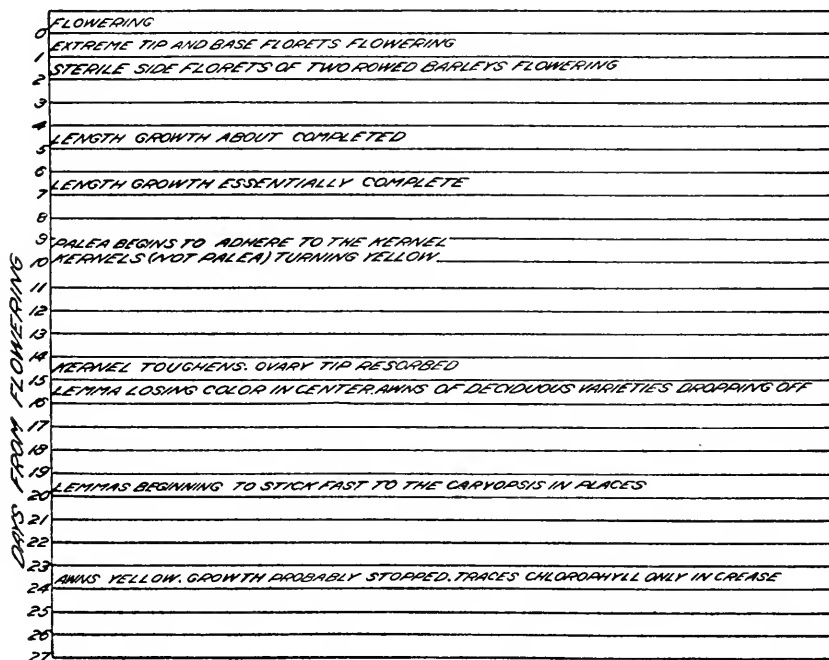

FIG. 17.—Periods of development of the barley kernel as indicated by records during three years at Aberdeen, Idaho.

external layers a few days before maturity. This is probably a very minor phase of metabolism, and at present it is not known to be associated with any vital phase of growth or maturation. The various external indices of internal changes are shown in figure 17.

MORPHOLOGICAL CHANGES

Microscopical examination of the kernel was made to determine the progress of the internal modifications that must accompany development. The starch infiltration is shown in various stages in Plates 85 to 91. Starch was found on the fourth day. This had increased perceptibly on the sixth day. The starch grains up to this time seemed

to be of a very much lower density than normal barley starch. They did not stain readily and were indefinite in outline. Rapid infiltration of starch began about the time that rapid growth of length ceased. By the ninth day after flowering the starch grains were of very uniform appearance. From this time the development was more irregular, not all the grains continuing to increase in size. By the fourteenth day small grains were apparent among the larger ones, as though new starch grains were forming. These small grains are found in the cells from this time until maturity. The fifteenth and sixteenth days represent a period when the awns are likely to drop off. The dropping of the awns, apparently, coincides with the completion of a stage of starch infiltration. From this time on, although the rate of starch deposit holds up fairly well, the accumulation is made by the continued development of only a part of the large grains and the packing of the interstices between the larger grains with smaller ones, rather than a uniform development of all grains as at first.

The first starch was found in the older cells in the middle of the flanks. It is probable that new cells are added about the periphery of the endosperm and especially near the furrow for some time. It is unlikely that new cells are added to the periphery after the fifteenth day from flowering. The new cells added near the furrow develop in a way entirely comparable to the first cells of the starch endosperm. Such cells are shown in Plate 91. After the first two weeks the transportation of food material to the sides remote from the furrow may not be so readily accomplished. Here the cells last formed may remain nearly free from starch at maturity, although the development of the cell walls demonstrates that the cells are not young.

SUMMARY

This paper presents data showing the growth of the Hannchen variety of barley from flowering to maturity, taken at 12-hour intervals. In the early stages of development, measurable growth occurs during 12-hour intervals, and during 24-hour intervals until near maturity. The period from flowering to maturity in three successive years at Aberdeen has been 26 days.

Measurements were taken of the length, lateral diameter, and dorsoventral diameter of the kernel. The growth immediately after flowering is so rapid that the increase in length is readily measurable at 12-hour intervals. The length growth is completed by the seventh day, and as soon as the rate of growth in length decreases the lateral diameter shows its most rapid increase. The dorsoventral diameter continues to increase almost until maturity. The increase in dry matter in the kernel is very uniform throughout the period of growth. The percentage of water decreases uniformly from flowering to maturity. During

growth the carbohydrates increase most rapidly and the ash least rapidly.

There are several well-marked steps in development. About the fifth or sixth day after flowering the growth in length is checked and a rapid gain in dry matter begins. About the ninth or tenth day a sticky substance is secreted, which causes the glumes to adhere to the kernel. About the fifteenth or sixteenth day the kernel toughens, the lemma begins to lose color in the dorsal surface, some of the awns drop off, and the kernel has reached its maximum water content.

Maturation occurs gradually. The cells about the furrow continue active longer than elsewhere. The actual date when growth ceases, even where the external conditions are unusually uniform, as they are at Aberdeen, must depend on the temperature and humidity at the time of ripening.

LITERATURE CITED

- (1) BRECHLEY, Winifred E.
1912. THE DEVELOPMENT OF THE GRAIN OF BARLEY. *In Ann. Bot.*, v. 26, no. 103, p. 903-928, 22 fig.
- (2) HARLAN, Harry V.
1914. SOME DISTINCTIONS IN OUR CULTIVATED BARLEYS WITH REFERENCE TO THEIR USE IN PLANT BREEDING. U. S. Dept. Agr. Bul. 137, 38 p., 16 fig. Literature cited, p. 37-38.
- (3) JOHANNSEN, W. L.
1884. OM FRØHVIDEN OG DENS UDVIKLING HOS BYG. *In Meddel. Carlsberg Lab.*, bd. 2, hefte 3, p. 103-134, 3 pl. French résumé, p. 60-77.
- (4) KUDELKA, Felix.
1875. UEBER DIE ENTWICKELUNG UND DEN BAU DER FRUCHT- UND SAMENSCHALE UNSERER CEREALIEN. *In Landw. Jahrb.*, Bd. 4, p. 461-478, pl. 5-6. Also reprinted.
- (5) LERMER, and HOLZNER, George.
1888. BEITRÄGE ZUR KENNTNIS DER GERSTE. 106 p., 51 pl. München.
- (6) SCHJERNING, H.
1906. ON THE PROTEIN SUBSTANCES OF BARLEY, IN THE GRAIN ITSELF AND DURING THE BREWING PROCESSES. *In Compt. Rend. Trav. Lab. Carlsberg*, v. 6, livr. 4, p. 229-307, 2 tab.
- (7) ———
1914. ON THE PROTEID SUBSTANCES OF BARLEY, IN THE GRAIN ITSELF AND DURING THE BREWING PROCESSES. *In Compt. Rend. Trav. Lab. Carlsberg*, v. 11, livr. 2, p. 45-145. Literature cited, p. 146-147.

- A.—Fertilized ovary.
- B.—Kernel 1 day old.
- C.—Kernel 2 days old.
- D.—Kernel 3 days old.

PLATE 83

(430)

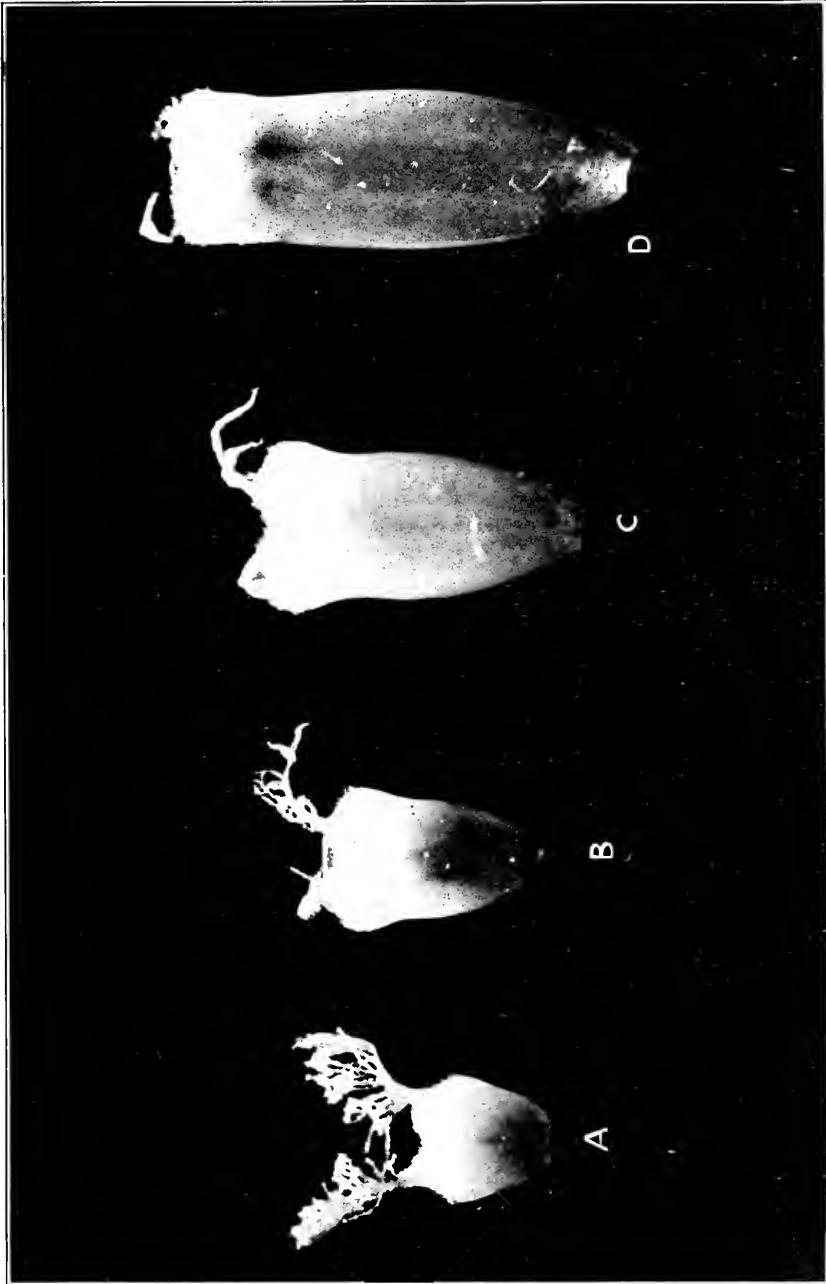

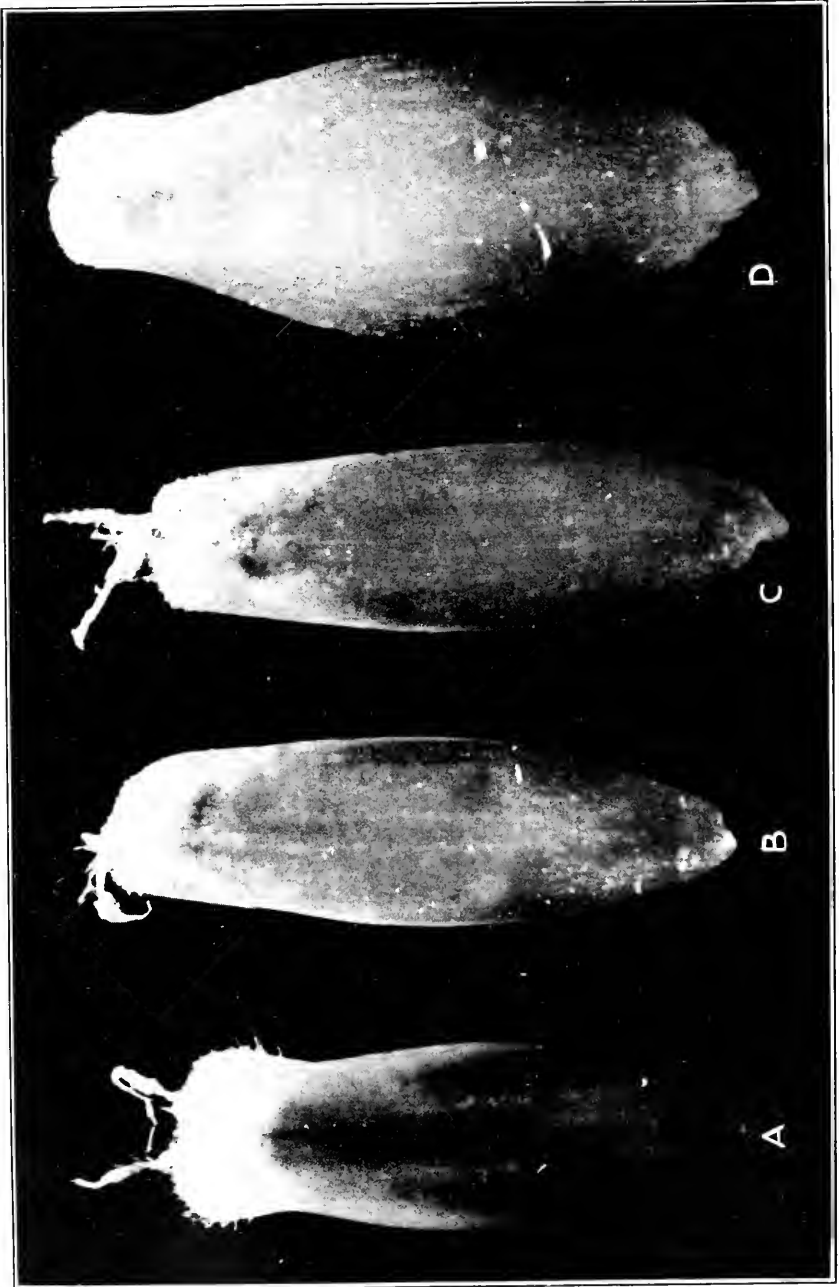

PLATE 84

- A.—Kernel 4 days old.
- B.—Kernel 5 days old.
- C.—Kernel 6 days old.
- D.—Kernel at later stage of development.

PLATE 85

Kernel 5 days after fertilization. Starch grains are apparent.



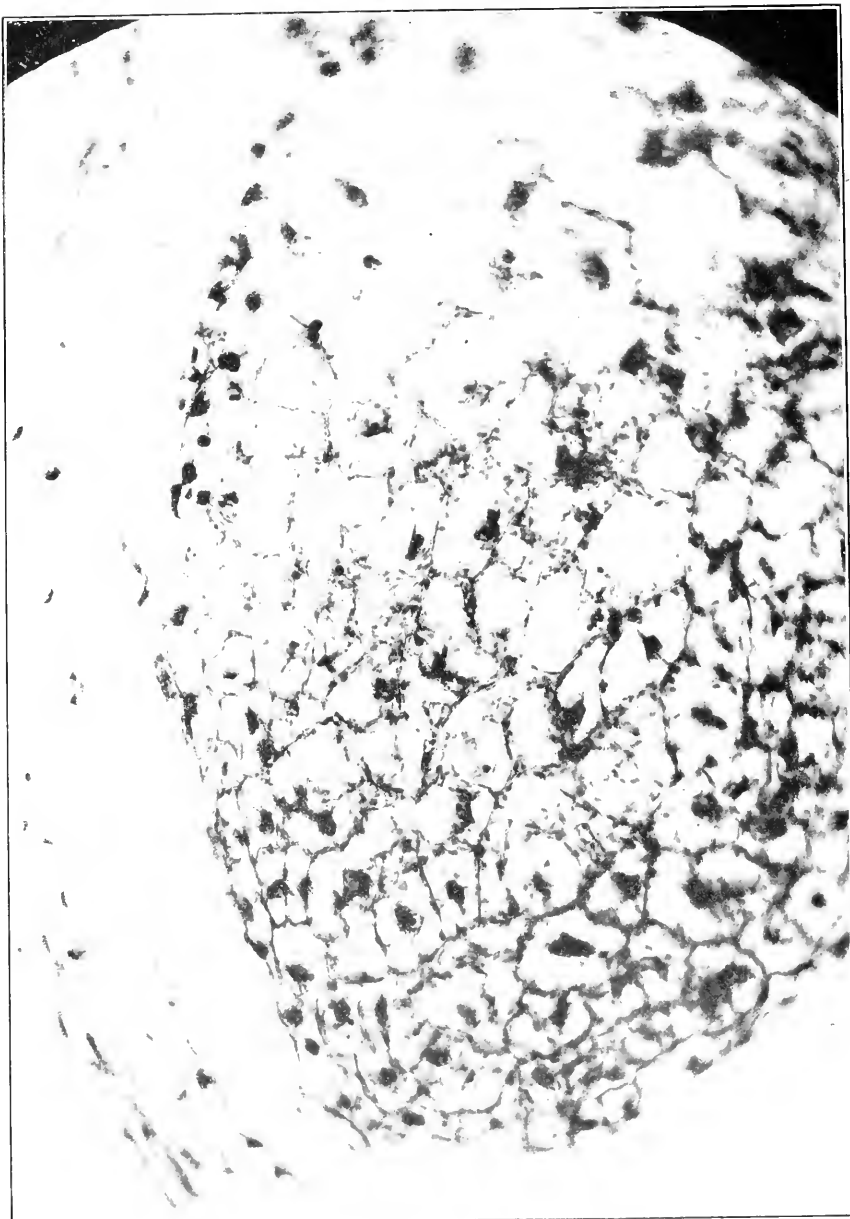

PLATE 86

Kernel 6 days after fertilization. Starch grains have increased greatly in numbers.

PLATE 87

Kernel 9 days after fertilization. The cells are well filled with starch grains of uniform size.

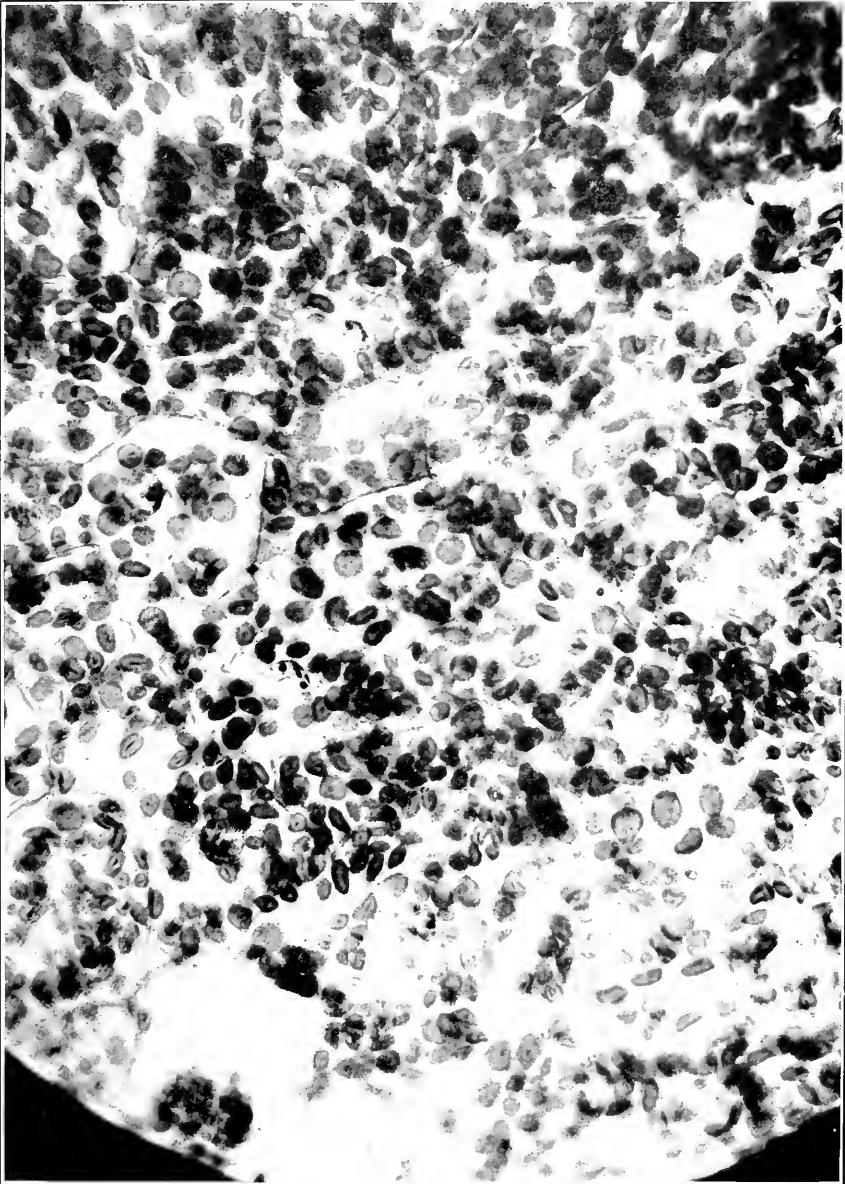

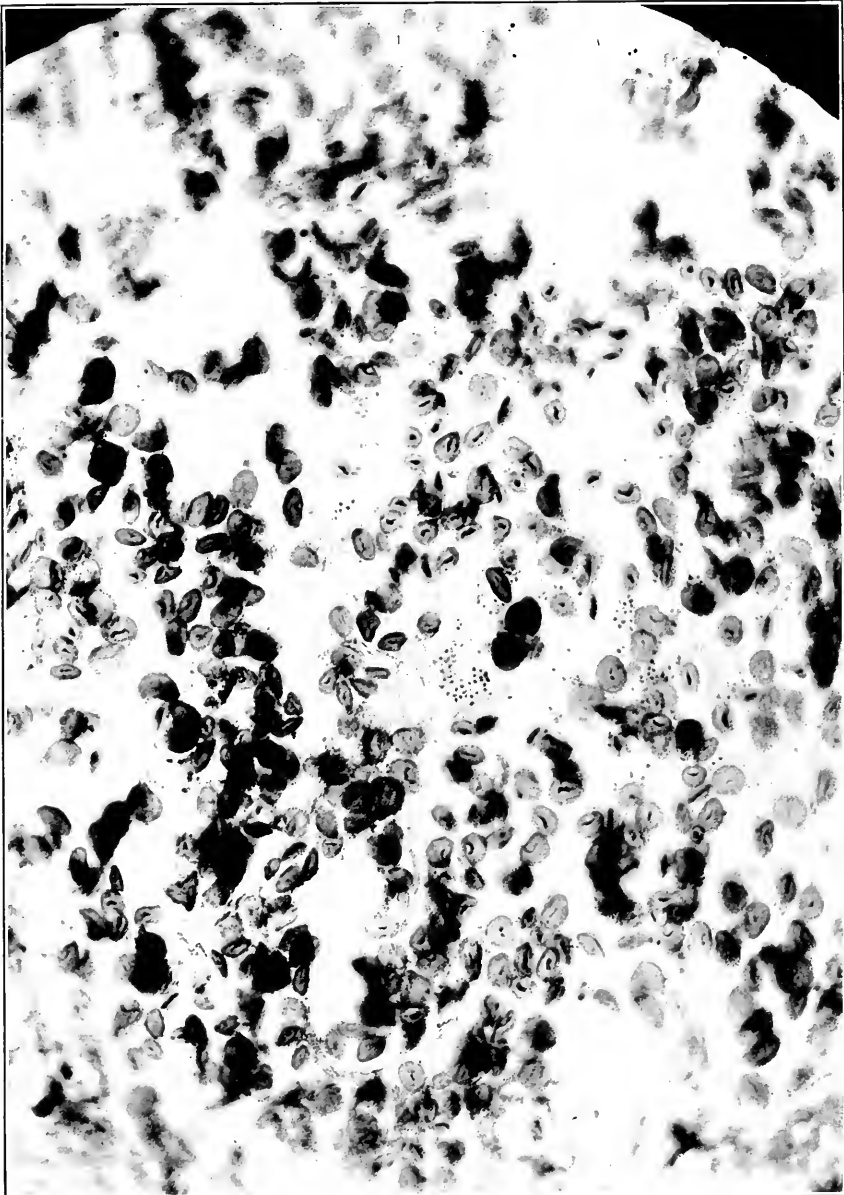

PLATE 88

Kernel 14 days after flowering. Both large and small starch grains are present.

PLATE 89

Kernel 20 days after fertilization, at which time growth was nearly completed.



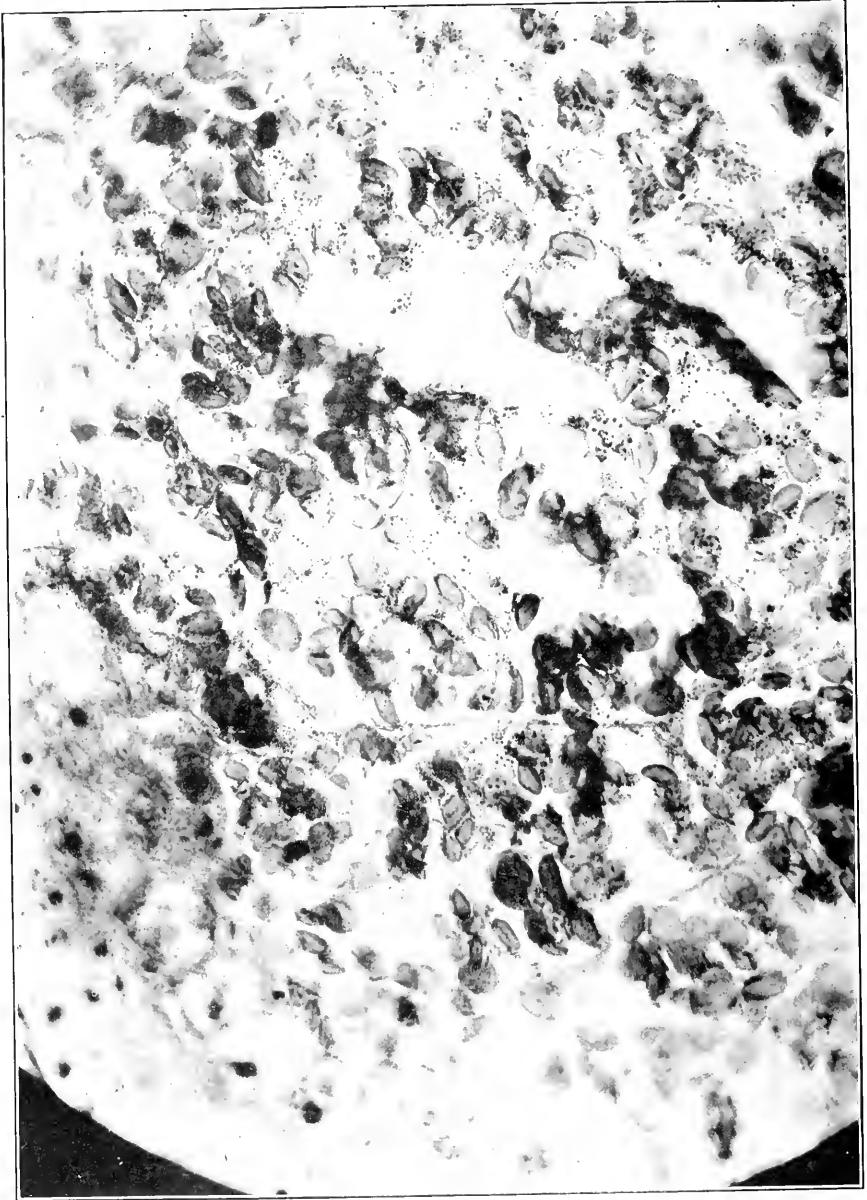

PLATE 90

Kernel 25 days after fertilization, growth completed.

PLATE 91

Section of a nearly mature kernel, showing cells next the furrow. These cells were formed more recently than those of the main starch endosperm.



DEVELOPMENT OF BARLEY KERNELS IN NORMAL AND CLIPPED SPIKES AND THE LIMITATIONS OF AWNLESS AND HOODED VARIETIES¹

By HARRY V. HARLAN, *Agronomist in Charge of Barley Investigations*, and STEPHEN ANTHONY, *formerly Technologist in Barley Investigations, Office of Cereal Investigations, Bureau of Plant Industry, United States Department of Agriculture*

INTRODUCTION

The studies reported in this paper were made in an effort to obtain some light on one of the farm problems in barley production. Among the farmers of the United States there is a strong prejudice against the growing of barley because the long, rough awns make the crop disagreeable to handle. The beards in barley straw and hay often cause sore mouths in stock. Barley straw and barley hay are also undesirable for feeding to sheep because the awns work into the wool. It is only the high acre yield in pounds of feed that has maintained the acreage of this crop, but this acreage is far below that which would be devoted to barley if the awns were lacking.

Certain types of barley are free from the harsh awns. One of these, the Nepal, produces hoods in the place of awns. This variety, under various names, has been more frequently introduced and more widely tested than any other. Many hybrids have been made and distributed. That they have failed to measure up to the expectations is evident in the annual inquiry of seedsmen as to where they can secure seed of "bald" barley.

The only apparent explanation of the failure of the Nepal barley is the lack of awns. The field records of the Office of Cereal Investigations, extending over many years, indicate that the Nepal compares favorably with other varieties only in the high altitudes and in dry years in the northern part of the Great Plains area. As a rule, varieties of this type have yielded less than the awned sorts and have shattered badly. It is evident that the awn is an organ that is functional under most conditions, and especially in those sections where humid weather prevails at ripening time.

Zoehl and Mikosch² in 1892 showed that the awn of barley was an organ of transpiration. Schmid³ in 1898 and Perlitus⁴ in 1903 elaborated the experiments of Zoehl and Mikosch. All agreed that the awn was an organ of transpiration and all showed the effect of its removal on both the rate of transpiration and the kernel.

¹ These studies were made on the Aberdeen Substation, Aberdeen, Idaho, in connection with cereal experiments conducted cooperatively by the Idaho Agricultural Experiment Station and the Office of Cereal Investigations, Bureau of Plant Industry, United States Department of Agriculture.

² ZOEHL, A., and MIKOSCH, C. DIE FUNCTION DER GRANNEN DER GERSTENÄHRE. In Sitzber. K. Akad. Wiss. [Vienna], Math. Naturw. Cl., Bd. 101, Abt. 1, Heft 9/10, p. 1033-1060. 1892.

³ SCHMID, B. BAU UND FUNKTIONEN DER GRANNEN UNSERER GETREIDEARTEN. In Bot. Centbl., Bd. 76, p. 39, 75, 119, 218, 305-307. 1898.

⁴ PERLITUS, LUDWIG. EINFLUSS DER BEGRANNUNG AUF DIE WASSERVERDUNSTUNG DER ÄHREN UND DIE KORNGUALITÄT. 77 p., 3 pl. Breslau, 1903.

EXPERIMENTAL METHODS AND MATERIAL

The first experiment by the present writer was a very elementary one made in Minnesota in 1911. It included yield only. Plants from which the awns were clipped produced only 75 per cent of the yield of normal plants.

In this and the later experiments, sufficient spikes of the same age were tagged on the same day. The method used was that described in an earlier paper.¹ The awns on half the spikes were removed even with the top of the upper most sheath as fast as they appeared. In clipping the awns it was necessary to examine the heads each day for three or four days.

It is apparent that mechanical injuries might result from this operation which would affect the later growth of the spike. For this reason it was thought desirable to trace the growth throughout the period from flowering to maturity. The number tagged was sufficient for a sample of two or three spikes per day from both the clipped and the normal plants for a period of 30 days. In a preliminary experiment at Arlington Farm, Va., in May, 1915, it was found that the taking of daily samples was practicable. In July, 1915, a complete experiment was conducted with the Manchuria barley at University Farm, St. Paul, Minn., and in the summer of 1916 a similar experiment was conducted at Aberdeen, Idaho, with Hannchen barley. The weights, lengths, and diameters of the kernels of the samples were obtained daily. The kernels were later analyzed to determine the nitrogen and ash. The results from the two varieties will be presented separately.

EFFECT OF REMOVING THE AWNS FROM MANCHURIA BARLEY IN MINNESOTA

The Manchuria is a 6-rowed variety of barley. It is awned, a vigorous grower, and adapted to fairly humid climatic conditions. It cannot be grown in the arid districts with success. The first sample at Minnesota was taken on July 1, 1915; and samples were taken daily until August 7, with the exception of five days. This was the only study conducted in Minnesota. Table I shows the data obtained at St. Paul, Minn., in a humid district, with the variety of barley best adapted to that district. The samples taken in Minnesota differ from those taken at Aberdeen in that they consist of a single spike each day. The weights and measurements of the individual lateral and central kernels on one side of the spike were taken under each of the headings "weight," "length," etc., in Table I. The first column contains the weight and measurement of a lateral kernel, the second contains those of the central kernel, and the third contains those of the remaining lateral kernels at the same rachis node. The kernels were studied in order from the base of the spike upward. In the first line under each date are the data from the first fertile florets at the base of the spike. In the second line are the observations on the florets at the node above. The last line contains the data on the last fertile florets at the tip of the spike.

¹ HARLAN, HARRY V. DAILY DEVELOPMENT OF KERNELS OF HANNCHEN BARLEY FROM FLOWERING TO MATURITY AT ABERDEEN, IDAHO. *In Jour. Agr. Research*, v. 19, no. 9, p. 393-430. 1920.

TABLE I.—Development of kernels of Manchuria barley from flowering to maturity in normal and clipped spikes at St. Paul, Minn., 1915

JULY 1

Normal spikes.												Clipped spikes.																				
Weight.			Length.			Lateral diameter.			Dorsoventral diameter.			Weight.			Length.			Lateral diameter.			Dorsoventral diameter.											
Lat- eral ker- nel.	Cent- ral ker- nel.	Gm.	Lat- eral ker- nel.	Cent- ral ker- nel.	Mm.	Lat- eral ker- nel.	Cent- ral ker- nel.	Mm.	Lat- eral ker- nel.	Cent- ral ker- nel.	Mm.	Lat- eral ker- nel.	Cent- ral ker- nel.	Gm.	Lat- eral ker- nel.	Cent- ral ker- nel.	Mm.	Lat- eral ker- nel.	Cent- ral ker- nel.	Mm.	Lat- eral ker- nel.	Cent- ral ker- nel.	Gm.	Lat- eral ker- nel.	Cent- ral ker- nel.	Mm.	Lat- eral ker- nel.	Cent- ral ker- nel.	Mm.			
.0007	.0011	.0007	.0009	.0011	1.9	.0009	.0011	1.9	.0007	.0009	1.8	.0007	.0009	1.8	.0007	.0009	1.8	.0007	.0009	1.8	.0007	.0009	1.8	.0007	.0009	1.8	.0007	.0009	1.8	.0007	.0009	1.8
.0009	.0011	.0009	.0009	.0009	2.0	.0009	.0011	2.0	.0009	.0011	1.9	.0009	.0011	1.9	.0009	.0011	1.9	.0009	.0011	1.9	.0009	.0011	1.9	.0009	.0011	1.9	.0009	.0011	1.9	.0009	.0011	1.9
.0010	.0012	.0010	.0012	.0010	2.0	.0010	.0012	2.0	.0010	.0012	1.9	.0010	.0012	1.9	.0010	.0012	1.9	.0010	.0012	1.9	.0010	.0012	1.9	.0010	.0012	1.9	.0010	.0012	1.9	.0010	.0012	1.9
.0012	.0014	.0012	.0014	.0012	1.7	.0012	.0014	1.7	.0012	.0014	2.2	.0012	.0014	2.2	.0012	.0014	2.2	.0012	.0014	2.2	.0012	.0014	2.2	.0012	.0014	2.2	.0012	.0014	2.2	.0012	.0014	2.2
.0008	.0011	.0007	.0009	.0011	2.0	.0008	.0011	2.0	.0008	.0011	1.8	.0008	.0011	1.8	.0008	.0011	1.8	.0008	.0011	1.8	.0008	.0011	1.8	.0008	.0011	1.8	.0008	.0011	1.8	.0008	.0011	1.8
.0007	.0011	.0008	.0011	.0008	2.2	.0007	.0011	2.2	.0007	.0011	1.5	.0007	.0011	1.5	.0007	.0011	1.5	.0007	.0011	1.5	.0007	.0011	1.5	.0007	.0011	1.5	.0007	.0011	1.5	.0007	.0011	1.5

JULY 2

.0009	.0014	.0009	.0012	.0012	2.1	.0009	.0012	2.1	.0009	.0012	1.7	.0009	.0012	1.7	.0009	.0012	1.7	.0009	.0012	1.7	.0009	.0012	1.7	.0009	.0012	1.7	.0009	.0012	1.7	.0009	.0012	1.7
.0012	.0017	.0012	.0015	.0015	1.9	.0012	.0015	1.9	.0012	.0015	2.1	.0012	.0015	2.1	.0012	.0015	2.1	.0012	.0015	2.1	.0012	.0015	2.1	.0012	.0015	2.1	.0012	.0015	2.1	.0012	.0015	2.1
.0012	.0019	.0015	.0015	.0015	2.2	.0012	.0015	2.2	.0012	.0015	2.2	.0012	.0015	2.2	.0012	.0015	2.2	.0012	.0015	2.2	.0012	.0015	2.2	.0012	.0015	2.2	.0012	.0015	2.2	.0012	.0015	2.2
.0013	.0021	.0013	.0013	.0013	2.2	.0013	.0013	2.2	.0013	.0013	2.0	.0013	.0013	2.0	.0013	.0013	2.0	.0013	.0013	2.0	.0013	.0013	2.0	.0013	.0013	2.0	.0013	.0013	2.0	.0013	.0013	2.0
.0012	.0022	.0012	.0012	.0012	1.7	.0012	.0012	1.7	.0012	.0012	1.7	.0012	.0012	1.7	.0012	.0012	1.7	.0012	.0012	1.7	.0012	.0012	1.7	.0012	.0012	1.7	.0012	.0012	1.7	.0012	.0012	1.7
.0012	.0019	.0015	.0015	.0015	2.2	.0012	.0015	2.2	.0012	.0015	2.2	.0012	.0015	2.2	.0012	.0015	2.2	.0012	.0015	2.2	.0012	.0015	2.2	.0012	.0015	2.2	.0012	.0015	2.2	.0012	.0015	2.2
.0013	.0018	.0014	.0014	.0014	2.3	.0013	.0014	2.3	.0013	.0014	2.4	.0013	.0014	2.4	.0013	.0014	2.4	.0013	.0014	2.4	.0013	.0014	2.4	.0013	.0014	2.4	.0013	.0014	2.4	.0013	.0014	2.4
.0014	.0018	.0013	.0013	.0013	2.3	.0014	.0013	2.3	.0014	.0013	2.3	.0014	.0013	2.3	.0014	.0013	2.3	.0014	.0013	2.3	.0014	.0013	2.3	.0014	.0013	2.3	.0014	.0013	2.3	.0014	.0013	2.3
.0012	.0017	.0012	.0012	.0012	2.4	.0012	.0012	2.4	.0012	.0012	1.9	.0012	.0012	1.9	.0012	.0012	1.9	.0012	.0012	1.9	.0012	.0012	1.9	.0012	.0012	1.9	.0012	.0012	1.9	.0012	.0012	1.9
.0011	.0013	.0012	.0012	.0012	1.7	.0011	.0012	1.7	.0011	.0012	2.0	.0011	.0012	2.0	.0011	.0012	2.0	.0011	.0012	2.0	.0011	.0012	2.0	.0011	.0012	2.0	.0011	.0012	2.0	.0011	.0012	2.0
.0003	.0006	.0003	.0003	.0003	1.1	.0003	.0003	1.1	.0003	.0003	1.2	.0003	.0003	1.2	.0003	.0003	1.2	.0003	.0003	1.2	.0003	.0003	1.2	.0003	.0003	1.2	.0003	.0003	1.2	.0003	.0003	1.2

TABLE I.—Development of kernels of Manchuria barley from flowering to maturity in normal and clipped spikes at St. Paul, Minn., 1915—Con.

Normal spikes.												Clipped spikes.																			
Weight.				Length.				Lateral diameter.				Dorsoventral diameter.				Weight.				Length.				Lateral diameter.				Dorsoventral diameter.			
Lat- eral ker- nel.	Cent- ral ker- nel.	Lat- eral ker- nel.	Cent- ral ker- nel.	Lat- eral ker- nel.	Cent- ral ker- nel.	Lat- eral ker- nel.	Cent- ral ker- nel.	Lat- eral ker- nel.	Cent- ral ker- nel.	Lat- eral ker- nel.	Cent- ral ker- nel.	Lat- eral ker- nel.	Cent- ral ker- nel.	Lat- eral ker- nel.	Cent- ral ker- nel.	Lat- eral ker- nel.	Cent- ral ker- nel.	Lat- eral ker- nel.	Cent- ral ker- nel.	Lat- eral ker- nel.	Cent- ral ker- nel.	Lat- eral ker- nel.	Cent- ral ker- nel.	Lat- eral ker- nel.	Cent- ral ker- nel.	Lat- eral ker- nel.	Cent- ral ker- nel.	Lat- eral ker- nel.	Cent- ral ker- nel.		
Gm.	Gm.	Gm.	Gm.	Mm.	Mm.	Mm.	Mm.	Mm.	Mm.	Mm.	Mm.	Mm.	Mm.	Gm.	Gm.	Gm.	Gm.	Mm.	Mm.	Mm.	Mm.	Mm.	Mm.	Mm.	Mm.	Mm.	Mm.	Mm.	Mm.		
0.0012	0.0017	0.0006	0.0013	1.9	2.2	1.2	0.5	0.0	0.0	0.0010	0.0015	0.0012	0.0013	1.9	2.2	0.7	0.7	0.7	0.7	0.7	0.7	0.7	0.7	0.7	0.7	0.7	0.7	0.7	0.7		
0.0013	0.0020	0.0013	0.0014	2.0	2.3	2.0	0.7	0.7	0.7	0.0012	0.0022	0.0012	0.0013	2.0	2.4	0.8	0.8	0.8	0.8	0.8	0.8	0.8	0.8	0.8	0.8	0.8	0.8	0.8	0.8		
0.0014	0.0023	0.0014	0.0014	2.1	2.5	2.1	0.8	0.7	0.7	0.0014	0.0023	0.0014	0.0016	2.1	2.5	0.9	0.9	0.9	0.9	0.9	0.9	0.9	0.9	0.9	0.9	0.9	0.9	0.9	0.9		
0.0014	0.0018	0.0014	0.0014	2.0	2.2	2.1	0.8	0.7	0.7	0.0017	0.0028	0.0017	0.0017	2.4	2.8	1.0	1.0	1.0	1.0	1.0	1.0	1.0	1.0	1.0	1.0	1.0	1.0	1.0	1.0		
0.0014	0.0018	0.0013	0.0014	2.1	2.3	2.0	0.6	0.6	0.6	0.0015	0.0020	0.0015	0.0016	2.1	2.5	0.8	0.8	0.8	0.8	0.8	0.8	0.8	0.8	0.8	0.8	0.8	0.8	0.8	0.8		
0.0014	0.0018	0.0014	0.0014	2.1	2.0	1.9	0.7	0.7	0.7	0.0010	0.0019	0.0010	0.0015	2.1	2.4	0.9	0.9	0.9	0.9	0.9	0.9	0.9	0.9	0.9	0.9	0.9	0.9	0.9	0.9		
0.0014	0.0018	0.0014	0.0014	1.9	1.8	1.7	0.9	0.7	0.7	0.0015	0.0018	0.0015	0.0015	2.0	1.9	0.8	0.8	0.8	0.8	0.8	0.8	0.8	0.8	0.8	0.8	0.8	0.8	0.8	0.8		
0.0012	0.0016	0.0009	0.0014	2.3	2.0	2.0	0.8	0.8	0.8	0.0012	0.0016	0.0012	0.0012	1.8	2.1	0.7	0.7	0.7	0.7	0.7	0.7	0.7	0.7	0.7	0.7	0.7	0.7	0.7	0.7		
0.0004	0.0007	0.0007	0.0007	1.4	1.4	S	0.4	S	S	0.0012	0.0016	0.0012	0.0012	1.8	2.1	0.8	0.8	0.8	0.8	0.8	0.8	0.8	0.8	0.8	0.8	0.8	0.8	0.8	0.8		
0.0014	0.0025	0.0014	0.0014	2.1	2.7	2.2	0.7	0.7	0.7	0.0014	0.0031	0.0014	0.0015	2.2	2.9	0.7	0.7	0.7	0.7	0.7	0.7	0.7	0.7	0.7	0.7	0.7	0.7	0.7	0.7		
0.0018	0.0029	0.0018	0.0018	2.3	2.8	2.2	0.6	0.6	0.6	0.0021	0.0038	0.0021	0.0019	2.5	3.0	0.8	0.8	0.8	0.8	0.8	0.8	0.8	0.8	0.8	0.8	0.8	0.8	0.8	0.8		
0.0018	0.0030	0.0026	0.0026	2.2	3.0	2.3	0.6	0.6	0.6	0.0022	0.0037	0.0022	0.0022	2.9	3.6	0.9	0.9	0.9	0.9	0.9	0.9	0.9	0.9	0.9	0.9	0.9	0.9	0.9	0.9		
0.0018	0.0031	0.0019	0.0019	2.3	2.4	2.4	0.7	0.7	0.7	0.0028	0.0040	0.0028	0.0029	2.4	2.8	1.0	1.0	1.0	1.0	1.0	1.0	1.0	1.0	1.0	1.0	1.0	1.0	1.0	1.0		
0.0018	0.0029	0.0019	0.0019	2.3	2.1	2.3	0.7	0.7	0.7	0.0025	0.0039	0.0025	0.0025	2.6	3.3	0.9	0.9	0.9	0.9	0.9	0.9	0.9	0.9	0.9	0.9	0.9	0.9	0.9	0.9		
0.0016	0.0029	0.0016	0.0016	2.1	2.3	2.2	0.7	0.7	0.7	0.0030	0.0039	0.0030	0.0025	3.2	3.2	1.0	1.0	1.0	1.0	1.0	1.0	1.0	1.0	1.0	1.0	1.0	1.0	1.0	1.0		
0.0016	0.0023	0.0016	0.0016	2.1	2.5	2.1	0.7	0.7	0.7	0.0027	0.0037	0.0027	0.0025	2.5	2.5	0.9	0.9	0.9	0.9	0.9	0.9	0.9	0.9	0.9	0.9	0.9	0.9	0.9	0.9		
0.0013	0.0019	0.0014	0.0014	1.9	2.3	1.9	0.8	0.7	0.7	0.0020	0.0027	0.0020	0.0020	1.9	2.3	0.9	0.9	0.9	0.9	0.9	0.9	0.9	0.9	0.9	0.9	0.9	0.9	0.9	0.9	0.9	
S	S	S	S	S	S	S	S	S	S	0.0016	0.0020	0.0016	0.0014	2.2	2.1	0.8	0.8	0.8	0.8	0.8	0.8	0.8	0.8	0.8	0.8	0.8	0.8	0.8			
S	S	S	S	S	S	S	S	S	S	0.0006	0.0009	0.0006	0.0006	1.3	1.4	0.6	0.6	0.6	0.6	0.6	0.6	0.6	0.6	0.6	0.6	0.6	0.6	0.6	0.6		

a The letter S indicates a sterile spikelet.

JULY 7

0.0050	0.0098	0.0045	4.1	5.6	3.6	1.4	1.6	1.3	1.0	1.2	0.9	0.0048	0.0078	0.0032	3.7	4.5	3.8	1.4	1.8	1.3	1.1	1.1	1.0
0.0052	0.0108	0.0055	4.4	5.2	4.1	1.6	1.8	1.5	1.0	1.3	0.8	0.0057	0.0102	0.0064	4.1	5.7	4.3	1.5	1.7	1.5	1.0	1.1	1.0
0.0073	0.123	0.0070	4.7	6.4	4.5	1.6	2.0	1.5	1.0	1.2	1.1	0.0075	0.0085	0.0069	4.7	4.6	4.5	1.6	1.6	1.6	1.2	1.2	1.0
0.0079	0.126	0.0069	4.6	6.1	4.3	1.6	1.9	1.6	1.0	1.2	1.1	0.0075	0.0088	0.0074	4.4	4.7	4.6	1.6	1.6	1.6	1.2	1.2	1.0
0.0081	0.125	0.0070	5.0	6.1	4.6	1.7	1.9	1.6	1.2	1.2	1.1	0.0069	0.0092	0.0072	4.1	4.8	4.3	1.4	1.7	1.6	1.0	1.1	1.2
0.0087	0.116	0.0072	4.9	5.7	4.3	1.7	1.8	1.5	1.0	1.1	1.1	0.0070	0.0082	0.0072	4.1	4.8	4.3	1.5	1.5	1.5	1.1	1.2	1.1
0.0087	0.121	0.0072	4.0	5.3	3.7	1.7	1.8	1.4	1.1	1.1	1.0	0.0060	0.0079	0.0046	4.1	4.3	4.3	1.4	1.5	1.4	1.0	1.1	1.1
0.0037	0.074	0.0037	2.8	4.0	2.7	1.2	1.6	1.3	0.9	1.1	1.0	0.0030	0.0073	0.0030	2.5	4.8	2.5	1.2	1.4	1.2	0.9	1.1	0.9
0.0034	0.038	0.0030	3.1	2.8	2.4	1.3	1.3	1.2	0.8	0.9	0.9	0.0023	0.0032	0.0021	2.7	2.5	2.3	0.8	1.2	0.7	0.9	1.0	0.6

JULY 8

0.0051	0.0095	0.0047	3.9	5.3	3.8	1.4	1.7	1.4	1.0	1.1	0.9	0.0023	0.0048	0.0020	2.2	3.7	2.2	1.0	1.3	1.0	0.7	0.8	0.7
0.0080	0.100	0.0057	4.9	5.6	4.1	1.6	1.8	1.4	1.0	1.1	1.1	0.0033	0.0072	0.0016	3.0	4.7	3.4	1.2	1.7	1.4	0.8	1.0	0.8
0.0085	0.100	0.0057	4.9	4.8	4.1	1.6	1.7	1.4	1.1	1.1	1.1	0.0049	0.0081	0.0031	3.9	4.8	4.0	1.4	1.7	1.4	1.0	1.0	0.8
0.0088	0.102	0.0066	4.7	5.1	4.2	1.5	1.7	1.6	1.0	1.2	1.1	0.0041	0.0083	0.0044	4.5	4.8	3.7	1.6	1.8	1.3	1.1	1.1	1.0
0.0092	0.110	0.0082	5.0	5.2	4.5	1.5	1.7	1.7	1.2	1.2	1.2	0.0050	0.0027	0.0063	3.5	2.3	4.3	1.5	0.7	1.3	0.8	0.8	1.0
0.0095	0.106	0.0080	4.0	4.2	4.5	1.4	1.6	1.7	1.1	1.2	1.1	0.0054	0.0063	0.0051	4.0	4.1	3.6	1.5	1.4	1.5	1.0	1.1	1.0
0.0096	0.096	0.0059	4.1	4.1	3.8	1.4	1.5	1.5	1.0	1.2	1.0	0.0052	0.0062	0.0043	3.8	3.8	3.7	1.5	1.5	1.5	1.1	1.1	1.1
0.0056	0.095	0.0045	3.8	4.0	3.8	1.5	1.5	1.5	1.0	1.1	1.0	0.0046	0.0064	0.0049	3.7	4.1	3.8	1.4	1.5	1.5	1.1	1.0	1.0
0.0041	0.061	0.0026	3.4	4.1	2.6	1.3	1.5	1.2	0.8	1.1	0.7	0.0038	0.0065	0.0026	3.0	4.0	2.7	1.3	1.4	1.1	1.0	1.0	0.9
0.0019	0.019	0.0019	2.6	2.6	2.6	1.0	1.0	1.0	0.7	0.7	0.7	0.0024	0.0028	0.0025	2.5	2.5	2.5	1.1	1.2	1.1	0.8	1.0	0.8
0.0017	0.017	0.0017	2.1	2.1	2.1	0.9	0.9	0.9	0.7	0.7	0.7	0.0014	0.0021	0.0014	2.1	2.4	2.2	0.7	0.9	0.9	0.7	0.7	0.6
0.0014	0.014	0.0014	1.7	1.7	1.7	0.8	0.8	0.8	0.7	0.7	0.7	0.0014	0.0021	0.0014	1.7	2.4	2.2	0.7	0.9	0.9	0.7	0.7	0.6

JULY 9

0.0068	0.0074	0.0066	4.4	4.7	4.2	1.6	1.8	1.5	1.0	0.9	0.9	0.0066	0.0100	0.0068	5.1	5.0	4.9	1.6	1.7	1.7	0.9	1.0	1.0
0.0080	0.095	0.0083	4.9	5.4	5.1	1.7	1.8	1.8	1.0	1.2	1.1	0.0084	0.0117	0.0072	5.6	6.5	6.5	1.6	1.9	1.7	0.9	1.0	1.1
0.0082	0.126	0.0099	4.9	6.4	5.7	1.7	2.0	1.8	1.2	1.3	1.1	0.1009	0.0068	0.0088	6.2	6.5	5.9	1.8	1.8	1.8	1.0	1.3	1.1
0.0089	0.137	0.0084	5.4	6.9	4.9	1.8	1.8	1.8	1.2	1.2	1.2	0.1006	0.1023	0.1005	6.3	6.0	5.8	2.0	1.9	1.9	1.1	1.2	1.1
0.0087	0.099	0.0084	5.0	5.1	4.9	1.8	1.8	1.9	1.2	1.2	1.2	0.1009	0.1030	0.0091	6.0	6.4	6.0	2.0	1.9	1.9	1.1	1.2	1.1
0.0085	0.104	0.0103	5.0	5.7	5.5	1.8	1.9	2.1	1.2	1.3	1.2	0.1020	0.1035	0.0085	6.7	6.7	5.0	1.9	1.8	1.6	1.1	1.2	1.2
0.0086	0.105	0.1001	4.7	6.1	5.6	1.7	1.9	1.9	1.2	1.3	1.2	0.0882	0.1046	0.0088	4.7	7.2	5.0	1.5	2.0	1.7	1.1	1.3	1.2
0.0072	0.102	0.0047	4.2	5.0	3.3	1.5	1.7	1.4	1.1	1.3	0.9	0.0888	0.1042	0.0079	5.2	7.3	5.0	1.5	2.0	1.6	1.0	1.2	1.1
0.0049	0.049	0.0037	2.9	3.4	2.8	1.3	1.4	1.4	0.9	0.9	0.9	0.0049	0.0087	0.0049	3.6	5.0	3.8	1.4	1.7	1.3	1.0	1.2	0.9
0.0017	0.017	0.0010	1.7	2.1	1.6	0.8	0.8	0.9	0.7	0.7	0.7	0.0013	0.0037	0.0014	1.7	2.0	1.9	0.8	1.0	0.9	0.5	0.8	0.5

AUGUST 5

0.0457	0.0402	7.9	9.0	7.8	3.7	3.9	3.5	2.8	3.1	2.5	0.0295 ^a	0.0446	0.0317	8.1	8.9	7.9	3.0	3.4	3.1	2.3	2.8	2.2	2.1
0.0458	0.0403	8.6	9.0	8.2	3.7	4.3	3.5	3.0	3.5	2.8	0.0310	0.0490	0.0355	7.8	8.7	7.9	3.2	3.7	3.4	2.3	2.9	2.2	2.1
0.0459	0.0404	8.8	9.6	8.9	3.8	4.4	3.8	3.1	3.4	3.0	0.0344	0.0572	0.0392	8.5	9.3	8.4	3.2	3.9	3.2	2.3	2.9	2.2	2.1
0.0460	0.0405	8.8	9.6	8.8	3.9	4.2	3.8	3.1	3.3	3.0	0.0410	0.580	0.0431	8.3	9.1	8.1	3.3	3.7	3.4	2.6	2.9	2.2	2.1
0.0461	0.0406	9.2	10.2	9.1	3.9	4.2	4.0	3.2	3.4	3.1	0.0432	0.0477	0.0319	8.4	9.5	8.2	3.4	3.4	3.1	2.4	2.5	2.4	2.4
0.0462	0.0407	8.9	10.2	9.1	3.8	4.2	3.8	3.1	3.5	3.2	0.0452	0.0652	0.0419	8.7	9.9	8.2	3.0	3.9	3.5	2.2	2.9	2.2	2.1
0.0463	0.0408	8.8	10.3	9.1	3.5	4.2	3.6	2.6	3.5	2.8	S	0.0611	S	S	10.2	8.9	S	S	S	S	S	S	S
0.0464	0.0409	9.1	10.5	S	S	4.0	S	S	2.9	S	0.0512	S	0.0618	8.7	10.2	9.2	3.7	4.1	3.8	S	S	S	S
0.0465	0.0410	S	S	S	S	S	S	S	S	S	S	S	S	S	S	S	3.7	S	S	S	S	S	S

AUGUST 6

0.0466	0.0309	7.6	9.0	7.9	2.8	3.2	S	2.2	2.5	S	0.0235	0.0158	0.0247	8.0	8.2	7.5	2.8	3.2	2.8	2.2	2.5	2.1	
0.0467	0.0310	8.1	8.6	7.9	3.0	3.5	3.1	2.3	2.7	2.4	0.0257	0.0143	0.0195	7.9	9.0	7.6	2.8	3.2	2.6	2.0	2.3	1.8	
0.0468	0.0311	8.6	9.6	8.2	3.3	3.6	3.3	2.5	2.8	2.5	0.0302	0.0178	0.0331	8.0	9.1	7.8	3.0	3.4	3.0	2.3	2.7	2.3	
0.0469	0.0312	8.7	9.6	8.3	3.4	3.8	3.2	2.6	2.9	2.6	0.0370	0.0516	0.0357	8.4	9.4	8.3	3.2	3.5	3.2	2.4	2.8	2.4	
0.0470	0.0313	8.6	9.7	8.2	3.5	3.8	3.4	2.5	3.0	2.5	0.0297	0.0515	0.0421	8.3	9.2	8.2	2.9	3.3	3.4	2.3	2.8	2.5	
0.0471	0.0314	8.8	10.0	8.4	3.6	3.7	3.5	2.6	2.9	2.8	0.0423	0.0682	0.0417	8.4	9.7	9.0	3.2	3.7	3.3	2.7	3.0	2.5	
0.0472	0.0315	8.8	10.0	8.0	3.6	3.4	S	2.5	2.6	2.6	0.0420	0.0659	0.0594	8.7	9.9	8.8	3.3	3.8	3.7	2.5	2.9	2.7	
0.0473	0.0316	8.0	9.7	8.0	3.2	3.4	S	2.4	2.6	S	0.0393	0.0435	0.0548	8.7	9.0	9.0	3.1	3.2	3.7	2.3	2.5	2.2	
0.0474	0.0317	7.8	9.7	7.8	3.0	3.3	S	S	2.5	1.9	0.0352	0.0670	0.0384	8.4	9.8	8.5	S	S	3.2	2.1	2.9	S	
0.0475	0.0318	S	S	S	S	S	S	S	S	S	S	S	S	S	S	S	S	S	S	S	S	S	S

AUGUST 7

0.0476	0.0362	8.0	7.8	7.7	3.0	3.3	3.3	2.4	2.5	2.3	0.0191	0.0128	0.0215	7.9	8.7	7.6	2.5	3.2	2.7	1.9	2.4	2.0	
0.0477	0.0363	8.4	8.5	8.0	2.8	3.6	3.2	2.3	2.8	2.6	0.0283	0.0179	0.0286	8.1	8.7	8.1	2.9	3.3	2.9	2.3	2.5	2.2	
0.0478	0.0364	8.5	9.1	8.6	3.3	3.6	3.3	2.7	2.8	2.6	Dis.	0.0230	0.0286	Dis.	9.0	Dis.	Dis.	2.9	3.3	2.9	2.3	2.1	
0.0479	0.0365	8.5	9.5	8.6	3.4	3.9	3.4	2.7	3.0	2.7	0.0238	0.0332	0.0340	8.2	9.0	8.1	2.7	2.8	2.8	2.1	1.9	1.9	
0.0480	0.0366	8.9	9.6	8.5	3.4	3.5	3.4	2.7	2.7	S	0.0374	0.0391	0.0370	8.7	9.3	8.7	3.2	4.2	3.2	2.5	2.5	2.4	
0.0481	0.0367	8.9	9.6	8.5	3.7	4.0	3.5	2.8	2.8	S	0.0370	0.0377	0.0347	8.6	9.1	8.1	3.2	4.2	3.3	2.4	2.5	2.4	
0.0482	0.0368	8.8	9.6	8.5	3.7	4.0	3.5	2.6	3.0	2.7	0.0372	0.0500	0.0347	8.4	9.7	8.1	3.2	3.5	3.2	2.5	2.7	2.4	
0.0483	0.0369	8.8	9.6	8.2	3.5	4.0	3.5	2.6	3.0	2.7	0.0347	0.0436	0.0338	8.7	9.9	8.9	3.0	3.1	3.1	2.3	2.5	2.3	
0.0484	0.0370	8.8	9.6	8.2	3.5	3.4	S	S	2.7	S	0.0347	0.0476	0.0351	8.5	9.6	8.4	3.1	3.4	3.0	2.3	2.7	2.3	
0.0485	0.0371	S	S	S	S	S	S	S	S	S	S	S	S	S	S	S	S	S	S	S	S	S	S

^a Diseased.

The use of a single spike and the great change of climatic conditions from day to day in Minnesota resulted in a much less uniform trend to the results than was the case with the Hannchen barley previously reported.¹ A sample should consist of more than one spike; but, entirely aside from the smallness of the sample, Minnesota is not a desirable place to make a study of this kind. There are many cold, dark days in which little growth occurs, while frequent storms break the culms and cause lodging. The lodging was so bad during the latter part of the experiment that many of the culms started to decay near the base. The resultant irregularities are quite apparent in Table II, where the data presented in Table I are summarized.

TABLE II.—Average wet weight, length, lateral diameter, and dorsoventral diameter of kernels from normal and clipped spikes of Manchuria barley at St. Paul, Minn., in 1915

		Wet weight.				Length.				Lateral diameter.				Dorsoventral diameter.			
Date.		Lateral kernel.	Central kernel.	Lateral kernel.	Average.	Lateral kernel.	Central kernel.	Lateral kernel.	Average.	Lateral kernel.	Central kernel.	Lateral kernel.	Average.	Lateral kernel.	Central kernel.	Lateral kernel.	Average.
		Mgm.	Mgm.	Mgm.	Mgm.	Mm.	Mm.	Mm.	Mm.	Mm.	Mm.	Mm.	Mm.	Mm.	Mm.	Mm.	Mm.
July	1	0.9	1.2	0.9	1.0	1.9	2.1	1.8	1.9	0.7	0.7	0.7	0.7	0.7
	2	1.1	1.7	1.2	1.3	2.0	2.3	2.0	2.1	.7	.8	.7	.7
	3	1.3	1.8	1.2	1.4	2.0	2.1	1.9	2.0	.7	.8	.7	.7
	5	1.7	2.7	1.8	2.1	2.2	2.5	2.2	2.3	.8	1.0	.9	.9	0.6	0.8	0.6	0.7
	7	6.3	10.2	5.7	7.4	4.2	5.2	3.8	4.4	1.5	1.7	1.4	1.5	1.0	1.1	1.0	1.0
	8	6.7	8.2	5.9	6.9	4.3	4.6	4.0	4.3	1.5	1.6	1.5	1.5	1.0	1.1	1.0	1.0
	9	7.0	9.3	7.1	7.8	4.3	5.0	4.4	4.6	1.6	1.7	1.7	1.7	1.1	1.2	1.1	1.1
	10	10.7	14.7	10.3	11.9	5.9	7.2	5.8	6.3	1.8	2.1	1.8	1.9	1.2	1.3	1.1	1.2
	11	17.3	20.1	16.2	17.9	8.2	8.5	7.8	8.2	2.3	2.2	2.2	2.2	1.5	1.5	1.5	1.5
	12	21.1	27.0	19.3	22.5	8.9	9.7	8.6	9.1	2.3	2.6	2.2	2.4	1.6	1.7	1.5	1.6
	13	22.7	29.9	23.8	25.5	8.9	9.7	8.9	9.2	2.4	2.7	2.5	2.5	1.7	1.8	1.7	1.7
	14	31.1	40.7	33.3	35.0	9.4	10.3	9.5	9.7	2.9	3.1	2.9	3.0	2.0	2.2	2.1	2.1
	15	41.1	49.3	38.1	42.8	9.5	10.2	9.5	9.7	3.3	3.5	3.2	3.3	2.2	2.3	2.1	2.2
	16	39.2	48.0	36.5	41.2	9.6	10.0	9.7	9.8	3.2	3.6	3.2	3.3	2.2	2.4	2.1	2.2
	17	39.2	51.1	40.6	43.6	9.4	10.4	9.6	9.8	3.4	3.6	3.4	3.5	2.2	2.5	2.3	2.3
	19	44.3	58.5	42.4	48.4	9.4	10.1	9.5	9.7	3.5	3.8	3.4	3.6	2.4	2.8	2.3	2.5
	20	45.5	56.6	44.1	48.7	9.4	10.0	9.3	9.6	3.5	3.7	3.4	3.5	2.4	2.6	2.3	2.4
	21	41.4	54.5	42.0	46.0	9.3	10.0	9.3	9.5	3.4	3.8	3.5	3.6	2.4	2.7	2.4	2.5
	22	48.9	61.3	48.8	53.0	9.4	10.1	9.3	9.6	3.8	4.0	3.7	3.8	2.6	2.9	2.6	2.7
	23	51.8	60.2	50.5	54.2	9.3	9.8	9.3	9.5	3.8	3.9	3.7	3.8	2.6	2.8	2.5	2.6
	24	44.0	54.2	45.6	47.9	9.4	10.0	9.3	9.6	3.5	3.8	3.6	3.6	2.4	2.7	2.4	2.5
	26	41.9	59.3	51.1	50.8	8.9	9.7	9.1	9.2	3.4	3.8	3.7	3.6	2.3	2.7	2.6	2.5
	27	50.5	67.3	51.7	56.5	9.2	9.9	8.9	9.3	3.7	4.1	3.7	3.8	2.6	2.9	2.7	2.7
	28	50.0	61.0	48.3	53.1	8.5	9.3	8.6	8.8	3.6	3.9	3.7	3.7	2.6	2.9	2.6	2.7
	29	54.2	72.2	53.2	59.9	8.8	9.5	8.8	9.0	3.7	4.2	3.7	3.9	2.8	3.3	2.8	3.0
	30	46.0	63.8	51.6	53.8	8.8	9.6	8.9	9.1	3.5	4.0	3.7	3.7	2.6	3.0	2.7	2.8
	31	49.7	67.1	53.2	56.6	8.8	9.7	9.1	9.2	3.6	4.0	3.7	3.8	2.7	3.1	2.8	2.9
Aug.	2	59.2	74.9	59.1	64.4	8.9	9.7	8.9	9.2	3.8	4.2	3.8	3.9	3.0	3.3	3.0	3.1
	4	55.8	73.0	49.8	59.5	8.8	9.7	8.8	9.1	3.8	4.2	3.7	3.9	2.8	3.2	2.7	2.9
	5	57.5	77.1	57.2	63.9	8.8	9.9	8.7	9.1	3.8	4.2	3.7	3.9	3.0	3.3	2.9	3.1
	6	39.4	49.2	38.3	42.3	8.5	9.4	8.3	8.7	3.3	3.5	3.2	3.3	2.4	2.7	2.5	2.5
	7	43.1	52.4	41.2	45.6	8.7	9.2	8.4	8.8	3.3	3.7	3.4	3.5	2.6	2.8	2.6	2.7

¹ HARLAN, Harry V., OP. CIT.

TABLE II.—Average net weight, length, lateral diameter, and dorsoventral diameter of kernels from normal and clipped spikes of Manchuria barley at St. Paul, Minn., in 1915—Continued

CLIPPED SPIKES

Date.	Wet weight.				Length.				Lateral diameter.				Dorsoventral diameter.			
	Lateral kernel.	Central kernel.	Lateral kernel.	Average.	Lateral kernel.	Central kernel.	Lateral kernel.	Average.	Lateral kernel.	Central kernel.	Lateral kernel.	Average.	Lateral kernel.	Central kernel.	Lateral kernel.	Average.
	Mgm.	Mgm.	Mgm.	Mgm.	Mm.	Mm.	Mm.	Mm.	Mm.	Mm.	Mm.	Mm.	Mm.	Mm.	Mm.	Mm.
July 2	1.5	2.3	1.5	1.8	2.2	2.5	2.3	2.3	0.8	0.9	0.7	0.8
3	1.4	2.1	1.5	1.7	2.1	2.4	2.1	2.2	.7	.8	.7	.7
4	2.1	3.2	2.0	2.4	2.4	2.6	2.3	2.4	1.1	1.2	1.1	1.1	0.8	0.8	0.8	0.8
5	5.6	7.9	5.6	6.4	3.8	4.5	3.8	4.0	1.4	1.6	1.4	1.5	1.0	1.1	1.0	1.0
6	4.0	5.6	3.9	4.5	3.3	3.7	3.3	3.4	1.3	1.4	1.3	1.3	.9	1.0	.9	.9
7	8.5	11.4	7.8	9.2	5.2	6.1	4.8	5.4	1.6	1.8	1.6	1.7	1.0	1.2	1.0	1.1
8	10.8	15.8	10.1	12.2	6.4	7.7	6.2	6.8	1.8	2.3	1.8	2.0	1.2	1.4	1.2	1.3
9	14.8	18.4	13.6	15.6	7.3	8.0	7.0	7.4	2.0	2.2	1.9	2.0	1.4	1.5	1.3	1.4
10	20.2	24.5	20.8	21.8	8.3	9.0	8.5	8.6	2.3	2.5	2.3	2.4	1.6	1.7	1.6	1.6
11	28.3	38.6	28.6	31.8	9.1	10.0	9.1	9.4	2.7	3.1	2.8	2.9	1.8	2.1	1.8	1.9
12	29.0	39.5	29.5	32.7	9.0	10.2	8.9	9.4	2.8	3.3	2.9	3.0	1.9	2.2	2.0	2.0
13	32.4	38.4	35.8	35.5	9.1	9.6	9.3	9.3	3.0	3.2	3.1	3.1	1.9	2.1	2.1	2.0
14	35.6	43.2	35.9	38.2	9.3	10.0	9.3	9.5	3.2	3.4	3.2	3.3	2.0	2.3	2.0	2.1
15	39.5	53.3	40.7	44.5	9.3	10.3	9.3	9.6	3.4	3.7	3.2	3.4	2.4	2.6	2.2	2.4
16	39.5	50.7	39.7	43.3	9.2	9.8	9.4	9.5	3.4	3.7	3.5	3.5	2.3	2.5	2.3	2.4
17	35.8	49.4	42.5	42.6	8.6	9.3	8.8	8.9	3.3	3.7	3.5	3.5	2.1	2.5	2.3	2.3
18	40.2	52.7	42.2	45.0	8.8	9.7	9.1	9.2	3.5	3.8	3.6	3.6	2.3	2.6	2.4	2.4
19	50.3	62.7	53.5	57.5	9.4	9.7	9.2	9.4	3.8	4.0	3.8	3.9	2.9	2.9	2.8	2.9
20	41.0	55.5	35.9	44.1	8.9	9.7	8.5	9.0	3.4	3.8	3.3	3.5	2.3	2.6	2.3	2.4
21	45.2	57.2	42.3	48.2	8.9	9.7	8.9	9.2	3.6	3.8	3.5	3.6	2.5	2.8	2.5	2.6
22	40.8	56.8	43.9	47.2	8.8	9.5	8.8	9.0	3.5	3.7	3.5	3.6	2.3	2.6	2.5	2.5
23	45.7	64.7	48.2	52.9	8.6	9.3	8.7	8.9	3.6	4.0	3.7	3.8	2.5	3.0	2.6	2.7
24	41.8	52.1	36.9	43.0	8.9	9.4	8.6	9.0	3.4	3.6	3.3	3.4	2.3	2.6	2.2	2.4
25	39.8	50.8	37.1	42.6	8.6	9.4	8.5	8.8	3.3	3.5	3.2	3.3	2.4	2.7	2.4	2.5
26	48.4	58.7	49.4	52.2	8.5	9.2	8.6	8.8	3.6	3.8	3.6	3.7	2.7	2.9	2.7	2.8
27	34.6	54.1	44.0	44.2	8.7	9.7	8.8	9.1	3.1	3.7	3.4	3.4	2.2	2.7	2.5	2.5
28	57.5	67.5	56.7	60.6	9.1	10.0	9.1	9.4	3.8	4.0	3.8	3.9	2.9	3.1	2.9	3.0
29	39.0	39.1	33.6	33.9	8.6	9.4	8.7	8.9	3.0	3.3	3.1	3.1	2.0	2.3	2.2	2.2
30	37.7	56.9	40.7	45.1	8.4	9.5	8.4	8.8	3.3	3.7	3.3	3.4	2.4	2.9	2.5	2.6
31	34.2	51.7	38.8	41.6	8.3	9.3	8.3	8.6	3.0	3.5	3.2	3.2	2.3	2.7	2.4	2.5
Aug. 1	31.3	37.2	32.2	33.6	8.4	9.2	8.4	8.7	3.0	3.3	3.1	3.1	2.3	2.4	2.3	2.3

In both the tables and the figures it is apparent that fertilization did not occur until about July 5; therefore, the measurements and weights before that date are of the ovary. Six-rowed barleys do not flower so uniformly as 2-rowed barleys. The central florets flower before the lateral ones. For this reason the curve of growth is less abrupt at the beginning than is the case with the 2-rowed varieties. Even with the prolonged period of flowering the length increases very rapidly after fertilization, as may be seen in figure 1.

The effect of the clipping is evident in both figure 1 and figure 2. Although there is little difference in length near maturity, the lateral diameters and the dorsoventral diameters of the kernels from clipped spikes are noticeably smaller than those of normal spikes. The difference is even more conspicuous in the wet weights per kernel. The question of mechanical injury from clipping is answered by a study of the growth by days. There is no such injury. For two weeks after clipping, the kernels in the clipped spikes develop as rapidly in size and weight as do those in

normal spikes. The graphs of wet weights per kernel coincide essentially until the fourteenth day after the experiment started. If there were a mechanical injury it would probably most seriously affect the kernel immediately after the injury.

After the fourteenth day the kernels in the normal spikes increase more rapidly in weight and size than do those in the clipped spikes. On only two days after July 14 do the clipped spikes exceed the normal ones, and these excesses are unquestionably due to the error of sampling which comes from the use of a single spike for this purpose.

The difference in rate of development begins to be noticeable about the time that the growth in length is completed. This coincides roughly with the beginning of the period of rapid starch infiltration. Whether

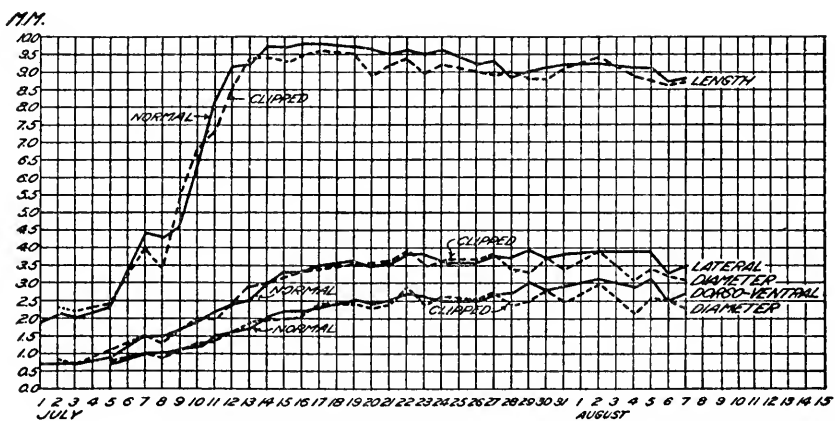

FIG. 1.—Graph showing growth in length, lateral diameter, and dorsoventral diameter of kernels of Maurchuria barley in normal and clipped spikes.

this indicates a loss, in the clipped spikes, of the photosynthetic products of the awn, as well as lower transpiration, as indicated by Zoebl and Mikosch, is not shown by the data. At first the difference is more apparent in the weights than in the dimensions. After the twenty-seventh day from the beginning of the experiment the lateral diameter of the kernels from the clipped spikes begins to decrease. This is probably due to the rate of loss of water in maturation, which here exceeds the rate of deposit of dry matter. In the normal spikes the two changes about balance each other so far as their effect on the lateral diameter is concerned. The dorsoventral diameter continues to increase until full maturity in the normal spikes, while it is slightly less than maintained by the clipped spikes in the latter days. At the very last the kernels in the clipped spikes ripen faster than those in the normal spikes. This is apparent in both figure 2 and figure 3.

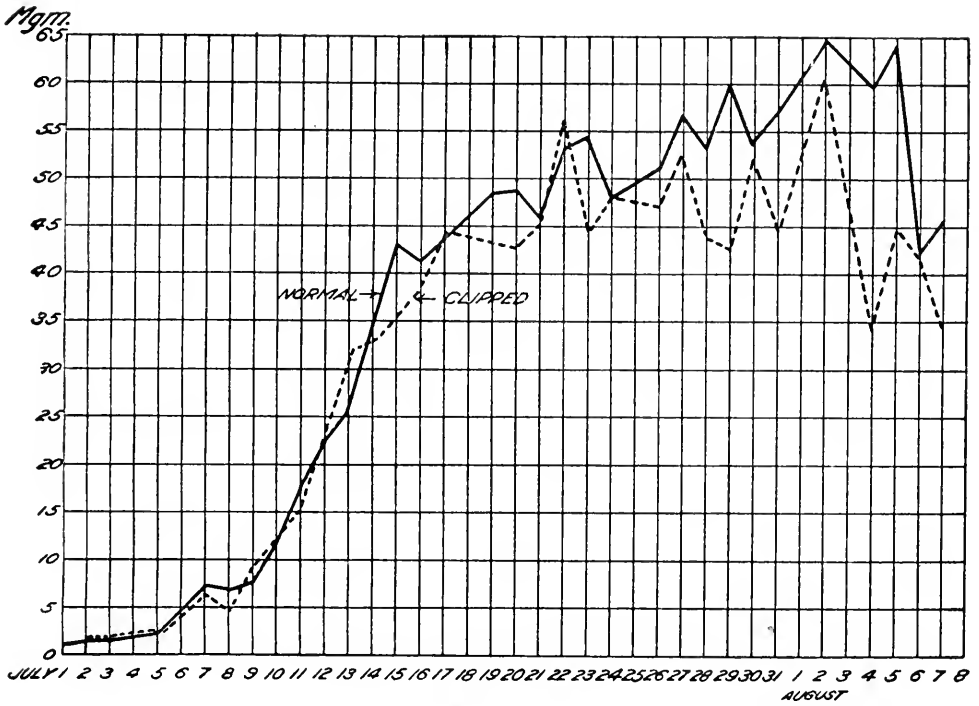

FIG. 2.—Graph showing wet weight of kernels of Manchuria barley from normal and clipped spikes.

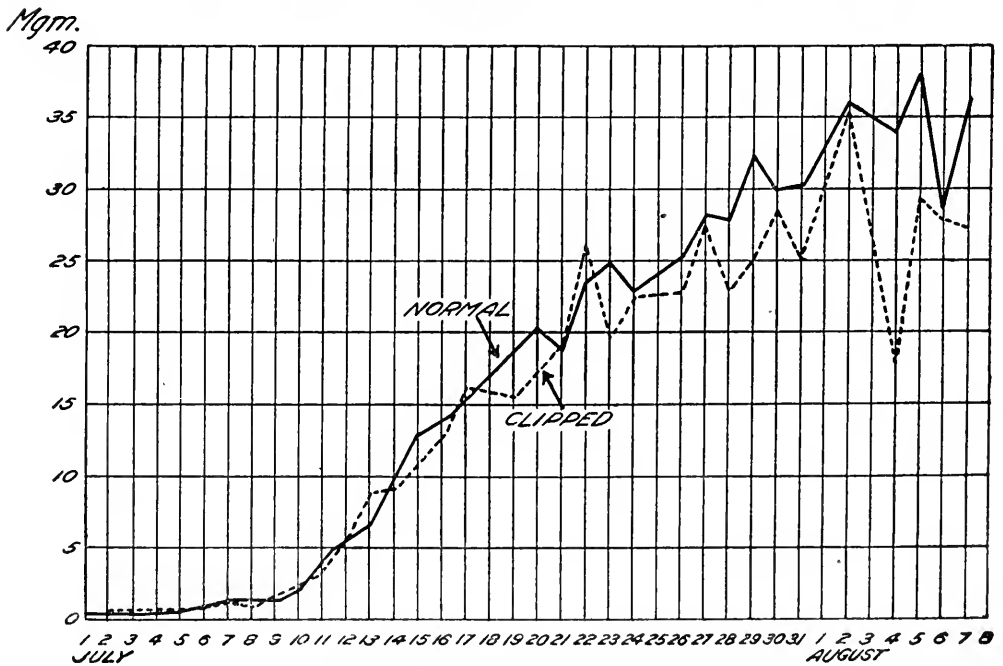

FIG. 3.—Graph showing dry matter in kernels of Manchuria barley from normal and clipped spikes.

The nitrogen, ash, and water were determined in all samples. Inasmuch as the glumes were removed, the difference between the total of these substances and the dry weight would approximate the sum of the carbohydrates and fats. This calculation has not been made. Its trend would be similar to that of the dry weight. The results of the analyses

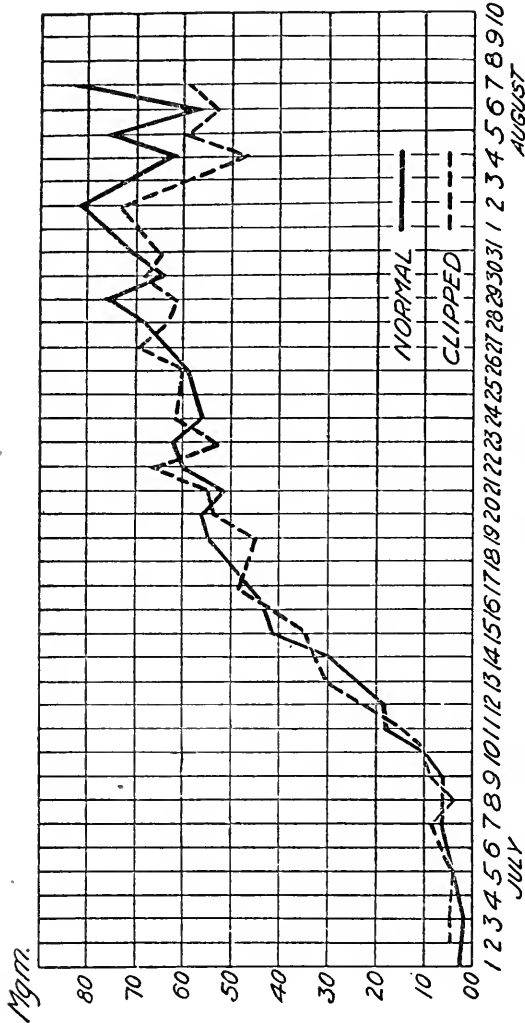

FIG. 4.—Graph showing total ash in kernels of Manchuria barley from normal and clipped spikes.

are given in Table III. The cause of the addition or loss of each substance determined is evident in the tables. Comparisons, however, are much more easily made in figures 3, 4, 5, and 6.

The graph of the dry weight is quite similar to that of the wet weight. In each case there is a marked reduction of the rate of growth of the kernels from clipped spikes in the latter half of the period of growth.

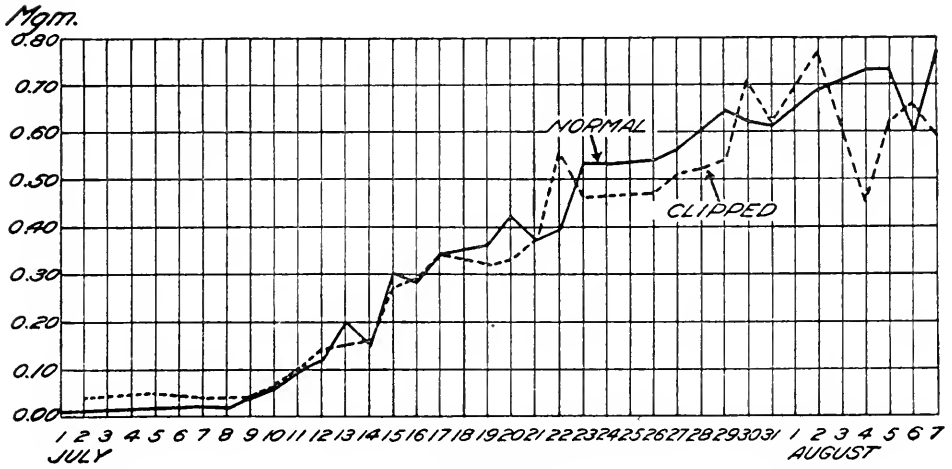

FIG. 5.—Graph showing total nitrogen in kernels of Manchuria barley from normal and clipped spikes.

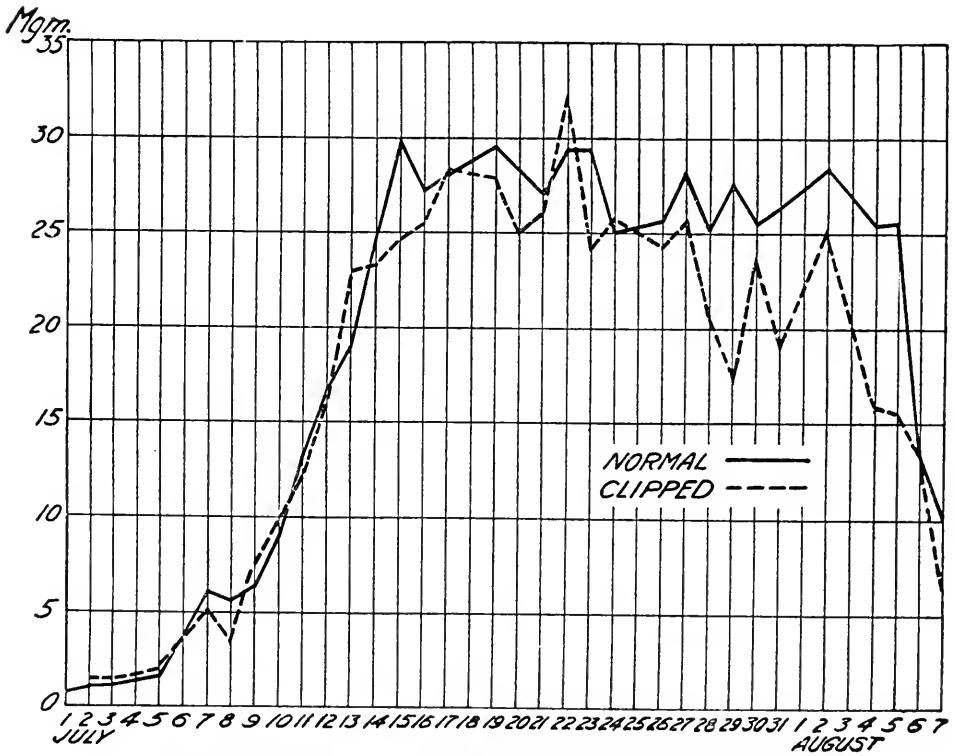

FIG. 6.—Graph showing water in kernels of Manchuria barley from normal and clipped spikes.

TABLE III.—Average percentage and weight per kernel of dry matter, water, nitrogen, and ash in kernels from normal and clipped spikes of Manchuria barley at St. Paul, Minn., in 1915

NORMAL SPIKES

Date.	Dry matter.	Water.	Nitrogen.	Ash.	Wet weight per kernel.	Dry Weight per kernel.	Water per kernel.	Nitrogen per kernel.	Ash per kernel.
	Per cent.	Per cent.	Per cent.	Per cent.	Mgm.	Mgm.	Mgm.	Mgm.	Mgm.
July 1	22.88	77.12	5.93	17.02	1.0	0.2	0.8	0.01	0.03
2	22.82	77.18	1.3	.3	1.0
3	21.43	78.57	7.33	1.4	.3	1.102
5	21.88	78.12	8.93	2.1	.5	1.604
7	18.12	81.88	1.51	5.40	7.4	1.3	6.1	.02	.07
8	19.08	80.92	1.31	5.60	6.9	1.3	5.6	.02	.07
9	18.36	81.64	2.80	5.07	7.8	1.4	6.4	.04	.07
10	19.27	80.73	2.70	4.37	11.9	2.3	9.6	.06	.10
11	22.79	77.21	2.32	4.24	17.9	4.1	13.8	.10	.17
12	24.16	75.84	2.28	3.38	22.5	5.4	17.1	.12	.18
13	25.99	74.01	3.10	3.45	25.5	6.6	18.9	.20	.23
14	28.58	71.42	1.54	2.94	35.0	10.0	25.0	.15	.29
15	30.15	69.85	2.30	3.15	42.8	12.9	29.9	.30	.41
16	33.68	66.32	2.05	3.11	41.2	13.9	27.3	.28	.43
17	35.49	64.51	2.22	3.06	43.6	15.5	28.1	.34	.47
19	38.87	61.13	1.92	2.90	48.4	18.8	29.6	.36	.55
20	41.61	58.39	2.08	2.76	48.7	20.3	28.4	.42	.56
21	40.97	59.03	1.96	2.79	46.0	18.8	27.2	.37	.52
22	44.62	55.38	1.65	2.55	53.0	23.6	29.4	.39	.60
23	45.73	54.27	2.15	2.48	54.2	24.8	29.4	.53	.62
24	47.78	52.22	2.33	2.46	47.9	22.9	25.0	.53	.56
26	49.48	50.52	2.14	2.36	50.8	25.1	25.7	.54	.59
27	49.76	50.24	1.98	2.25	56.5	28.1	28.4	.56	.63
28	52.23	47.77	2.16	2.46	53.1	27.7	25.4	.60	.68
29	53.75	46.25	1.99	2.36	59.9	32.2	27.7	.64	.76
30	52.47	47.53	2.19	2.32	53.8	28.2	25.6	.62	.65
31	53.15	46.85	2.01	2.37	56.6	30.1	26.5	.61	.71
Aug. 2	55.89	44.11	1.91	2.24	64.4	36.0	28.4	.69	.81
4	56.92	43.08	2.14	1.81	59.5	33.9	25.6	.73	.61
5	59.83	40.17	1.91	1.96	63.9	38.2	25.7	.73	.75
6	67.89	32.11	2.10	2.01	42.3	28.7	13.6	.50	.58
7	77.90	22.10	2.16	2.27	45.6	35.5	10.1	.77	.81

CLIPPED SPIKES

July 2	21.13	78.87	9.70	11.76	1.8	0.4	1.4	0.04	0.05
3	22.82	77.18	12.22	1.7	.4	1.305
5	19.91	80.09	9.16	8.46	2.4	.5	1.9	.05	.04
7	16.68	83.32	3.61	7.09	6.4	1.1	5.3	.04	.08
8	17.40	82.60	6.53	4.5	.8	3.705
9	17.51	82.49	2.68	5.55	9.2	1.6	7.6	.04	.09
10	19.11	80.89	2.79	4.30	12.2	2.3	9.9	.06	.10
11	21.04	78.96	3.02	4.44	15.6	3.3	12.3	.10	.15
12	24.89	75.11	2.57	3.80	21.8	5.4	16.4	.14	.21
13	27.48	72.52	1.77	3.44	31.8	8.7	23.1	.15	.30
14	28.41	71.59	1.69	3.48	32.7	9.3	23.4	.16	.32
15	30.48	69.52	2.46	3.12	35.5	10.8	24.7	.27	.34
16	33.61	66.39	2.23	3.19	38.2	12.8	25.4	.29	.41
17	36.26	63.74	2.14	2.98	44.5	16.1	28.4	.34	.48
19	35.64	64.36	2.05	2.89	43.3	15.4	27.9	.32	.45
20	41.10	58.90	1.90	3.01	42.6	17.5	25.1	.33	.53
21	42.30	57.70	1.95	2.83	45.0	19.0	26.0	.37	.54
22	44.93	55.07	2.16	2.50	57.5	25.8	31.7	.56	.65
23	44.77	55.23	2.33	2.62	44.1	19.7	24.4	.46	.52
24	46.94	53.06	2.04	2.70	48.2	22.6	25.6	.46	.61

TABLE III.—Average percentage and weight per kernel of dry matter, water, nitrogen, and ash in kernels from normal and clipped spikes of Manchuria barley at St. Paul, Minn., in 1915—Continued

CLIPPED SPIKES

Date.	Dry matter.	Water.	Nitrogen.	Ash.	Wet weight per kernel.	Dry Weight per kernel.	Water per kernel.	Nitrogen per kernel.	Ash per kernel.
	<i>Per cent.</i>	<i>Per cent.</i>	<i>Per cent.</i>	<i>Per cent.</i>	<i>Mgm.</i>	<i>Mgm.</i>	<i>Mgm.</i>	<i>Mgm.</i>	<i>Mgm.</i>
July 26	48.61	51.39	2.04	2.60	47.2	22.9	24.3	0.47	0.60
27	51.70	48.30	1.88	2.48	52.9	27.3	25.6	.51	.68
28	52.60	47.40	2.27	2.76	43.6	22.9	20.7	.52	.63
29	58.56	41.44	2.17	2.48	42.6	24.9	17.7	.54	.62
30	54.39	45.61	2.51	2.38	52.2	28.4	23.8	.71	.68
31	56.49	43.51	2.46	2.59	44.2	25.0	19.2	.62	.65
Aug. 2	58.30	41.70	2.17	2.07	60.6	35.3	25.3	.77	.73
4	52.44	47.56	2.51	2.64	33.9	17.8	16.1	.45	.47
5	64.99	35.01	2.11	2.02	45.1	29.3	15.8	.62	.59
6	66.90	33.10	2.36	1.90	41.6	27.8	13.8	.66	.53
7	81.18	18.82	2.15	2.12	33.6	27.3	6.3	.59	.58

The deposition of ash, on the other hand, is maintained in the kernels of clipped spikes for a much longer period. It is only in the final days of maturation that the total ash per kernel of the normal spikes exceeds that of the kernels of the clipped spikes. In Table III it will be seen that in percentage of ash the case is reversed. The kernels of the clipped spike have an appreciably higher percentage of ash. That the total is higher in the kernels of normal spikes is due to the greater weight of those kernels. In the experiment with Hannchen barley at Aberdeen several other determinations of ash were made, and a discussion of the significance of the ash content is better made after the results from that variety have been presented.

The nitrogen content per kernel is shown graphically in figure 5. During more than half the period of growth there is little difference in the rate of the deposit of nitrogenous materials in the spikes. From July 23 to July 29 there is apparently a more active deposit in the normal spikes. The graphs become confused as the kernels ripen. As a whole, there is not much difference between the two. As there is a definite difference in the dry weight, the deposit of carbohydrates must be decidedly greater in the normal spikes during the last half of the growing period.

The water per kernel is a good index of development. In normal development the water rapidly increases after fertilization and quickly attains its maximum. It then remains stabilized, or nearly so, as long as growth is efficiently maintained. When growth is checked or maturation begins, the water content drops slowly until complete ripeness occurs. After complete ripeness it drops still more rapidly for two or three days. It will be seen in figure 6 that the water content of the kernels from clipped spikes is about equal to that of the kernels from normal spikes

until July 25. After that date the kernels from clipped spikes exhibit a rapid loss of water which becomes accelerated about August 2.

In general, the differences in the development of the kernels from normal and clipped spikes are largely evident in the tables and figures. Certain observations and deductions seem justified. The discussion of the significance of the results at Minnesota, however, has been placed with that of results at Aberdeen, Idaho.

TABLE IV.—Growth of kernels of *Hannchen barley* in awned and clipped spikes at Aberdeen, Idaho, in 1916

Normal spikes.								Clipped spikes.							
Weight.		Length.		Lateral diameter.		Dorso-ventral diameter.		Weight.		Length.		Lateral diameter.		Dorso-ventral diameter.	
A.	B.	A.	B.	A.	B.	A.	B.	A.	B.	A.	B.	A.	B.	A.	B.
Gm.	Gm.	Mm.	Mm.	Mm.	Mm.	Mm.	Mm.	Gm.	Gm.	Mm.	Mm.	Mm.	Mm.	Mm.	Mm.
0.0007	0.0007	2.4	1.9	0.6
0.0011	0.0010	2.2	1.8	0.8	.9
0.0012	0.0012	2.3	2.3	.6	1.0
0.0012	0.0013	2.3	2.0	.7	.9
0.0013	0.0017	2.4	2.2	.9	1.1
0.0014	0.0017	2.1	2.4	.8	1.1
0.0014	0.0017	2.3	2.2	.8	1.0
0.0014	0.0017	2.5	2.1	.8	1.0
0.0017	0.0017	2.3	2.4	.9	1.0
0.0017	0.0017	2.3	2.0	1.1	1.2
0.0013	0.0017	2.4	2.5	.9	1.0
0.0011	0.0014	2.2	2.3	.8	1.0
0.0011	0.0012	2.4	2.4	.6	1.0
0.0011	0.0009	2.2	2.1	.7	.8
0.0008	0.0008	1.9	1.8	.6	.7

JULY 10															
Normal spikes.		Clipped spikes.		Normal spikes.		Clipped spikes.		Normal spikes.		Clipped spikes.		Normal spikes.		Clipped spikes.	
A.	B.	A.	B.	A.	B.	A.	B.	A.	B.	A.	B.	A.	B.	A.	B.
Gm.	Gm.	Mm.	Mm.	Mm.	Mm.	Mm.	Mm.	Gm.	Gm.	Mm.	Mm.	Mm.	Mm.	Mm.	Mm.
0.0009	0.0019	2.1	2.6	0.7	1.2	0.5	0.7	0.0015	0.0015	2.2	2.4	0.9	0.7	0.7	0.7
0.0025	0.0030	2.5	2.4	1.2	1.3	.9	1.0	0.0026	0.0027	2.7	2.9	1.2	1.2	.8	.7
0.0031	0.0039	2.7	3.4	1.4	1.5	1.0	1.0	0.0033	0.0032	2.6	2.7	1.4	1.2	1.0	.8
0.0039	0.0045	3.1	3.5	1.5	1.6	1.0	1.0	0.0035	0.0035	2.8	3.3	1.4	1.4	1.0	.8
0.0041	0.0047	3.3	3.5	1.4	1.5	1.0	1.0	0.0037	0.0038	3.2	3.2	1.3	1.4	1.0	.9
0.0048	0.0047	3.7	3.7	1.4	1.4	1.0	1.1	0.0043	0.0043	3.4	3.5	1.5	1.3	.9	.9
0.0049	0.0051	3.7	4.0	1.6	1.5	1.1	1.0	0.0047	0.0042	3.4	3.4	1.5	1.4	1.0	1.0
0.0059	0.0053	4.3	4.5	1.5	1.4	1.0	1.0	0.0052	0.0047	3.7	3.7	1.4	1.4	1.0	.9
0.0058	0.0054	4.2	4.2	1.5	1.5	1.1	1.0	0.0049	0.0044	3.5	3.5	1.4	1.5	1.0	.9
0.0052	0.0054	3.9	4.2	1.4	1.5	1.0	1.0	0.0048	0.0044	4.2	3.7	1.4	1.4	.8	.9
0.0048	0.0047	4.0	3.8	1.5	1.4	1.0	.9	0.0045	0.0041	3.7	3.4	1.3	1.4	1.0	1.0
0.0045	0.0039	4.1	3.9	1.4	1.5	1.0	.8	0.0036	0.0035	3.0	2.8	1.2	1.3	1.0	.7
0.0034	0.0037	3.3	3.6	1.4	1.3	.9	1.0	0.0032	0.0032	3.1	3.1	1.4	1.4	.9	.9
0.0019	0.0025	2.3	2.8	1.1	1.3	.8	.8	0.0017	0.0025	2.2	2.8	1.0	1.2	.6	.9
.....	0.0017	1.8	1.07	0.0021	2.8	1.17
.....	0.0015	1.9	1.16

JULY 11															
Normal spikes.		Clipped spikes.		Normal spikes.		Clipped spikes.		Normal spikes.		Clipped spikes.		Normal spikes.		Clipped spikes.	
A.	B.	A.	B.	A.	B.	A.	B.	A.	B.	A.	B.	A.	B.	A.	B.
Gm.	Gm.	Mm.	Mm.	Mm.	Mm.	Mm.	Mm.	Gm.	Gm.	Mm.	Mm.	Mm.	Mm.	Mm.	Mm.
0.0026	0.0045	2.6	3.8	1.4	1.5	0.8	0.9	0.0038	0.0014	3.4	1.8	1.4	0.8	0.9	0.6
0.0048	0.0068	4.1	4.8	1.4	1.7	1.0	1.0	0.0051	0.0042	4.2	3.7	1.4	1.6	1.0	.9
0.0062	0.0074	4.6	5.2	1.5	1.5	1.0	.9	0.0060	0.0055	4.6	4.1	1.6	1.6	1.0	.9
0.0069	0.0081	5.1	5.7	1.6	1.6	1.2	1.0	0.0073	0.0063	5.3	4.9	1.5	1.5	.8	1.0
0.0073	0.0084	5.4	5.8	1.5	1.7	1.1	1.0	0.0077	0.0076	5.6	5.5	1.7	1.6	1.0	1.0
0.0075	0.0086	5.4	5.7	1.7	1.6	1.1	1.0	0.0078	0.0081	5.5	5.4	1.8	1.6	1.0	1.0
0.0081	0.0094	5.8	6.5	1.7	1.7	1.0	1.0	0.0081	0.0080	6.3	5.6	1.6	1.6	1.0	1.0
0.0084	0.0094	5.8	6.4	1.6	1.7	1.1	1.1	0.0084	0.0082	6.1	6.1	1.7	1.6	1.0	1.0
0.0079	0.0089	5.8	6.4	1.7	1.7	1.0	1.0	0.0083	0.0082	6.1	6.2	1.6	1.6	1.0	1.0
0.0074	0.0087	5.8	6.4	1.6	1.7	.9	1.0	0.0083	0.0082	6.5	5.9	1.6	1.7	1.0	1.0
0.0068	0.0084	5.1	6.4	1.6	1.8	.9	1.0	0.0074	0.0079	5.9	5.9	1.6	1.5	1.0	.9
0.0058	0.0074	4.4	5.7	1.5	1.6	1.0	1.0	0.0069	0.0071	5.7	5.5	1.5	1.5	1.0	1.0
0.0042	0.0066	4.0	5.2	1.5	1.6	.9	1.0	0.0054	0.0057	5.0	4.5	1.4	1.4	.9	1.0
0.0032	0.0055	3.1	4.9	1.4	1.4	.9	1.0	0.0041	0.0048	4.1	4.3	1.4	1.3	.8	.9
.....	0.0039	3.7	1.49	0.0036	3.7	1.39

TABLE IV.—*Growth of kernels of Hannchen barley in awned and clipped spikes at Aberdeen, Idaho, in 1916—Continued*

JULY 12

Normal spikes.								Clipped spikes.							
Weight.		Length.		Lateral diameter.		Dorso-ventral diameter.		Weight.		Length.		Lateral diameter.		Dorso-ventral diameter.	
A.	B.	A.	B.	A.	B.	A.	B.	A.	B.	A.	B.	A.	B.	A.	B.
<i>Gm.</i>	<i>Gm.</i>	<i>Mm.</i>	<i>Mm.</i>	<i>Mm.</i>	<i>Mm.</i>	<i>Mm.</i>	<i>Mm.</i>	<i>Gm.</i>	<i>Gm.</i>	<i>Mm.</i>	<i>Mm.</i>	<i>Mm.</i>	<i>Mm.</i>	<i>Mm.</i>	<i>Mm.</i>
0.0020	0.0037	2.8	3.2	1.2	1.4	0.7	1.0	0.0023	0.0042	2.6	3.4	1.2	1.5	0.8	0.8
0.0044	0.0065	3.7	4.6	1.4	1.5	.9	1.0	0.0058	0.0055	4.6	4.5	1.5	1.7	.9	1.0
0.0055	0.0073	4.3	4.9	1.7	1.7	1.0	1.0	0.0075	0.0074	5.6	5.3	1.7	1.6	.9	.9
0.0074	0.0086	5.2	6.0	1.6	1.7	1.0	.9	0.0090	0.0083	6.5	5.7	1.6	1.7	.9	1.1
0.0074	0.0090	5.3	5.9	1.6	1.8	1.0	1.1	0.0088	0.0091	6.7	6.6	1.7	1.7	.9	1.0
0.0081	0.0096	6.6	6.4	1.8	1.8	1.0	1.0	0.0098	0.0099	6.9	6.9	1.7	1.7	.9	1.0
0.0085	0.0098	6.0	6.5	1.8	1.8	1.0	1.0	0.0096	0.0098	6.9	6.9	1.8	1.7	1.0	1.0
0.0092	0.0098	6.3	6.5	1.7	1.7	1.0	1.0	0.0097	0.0102	7.3	7.1	1.7	1.8	1.0	1.1
0.0092	0.0099	6.5	6.7	1.8	1.7	1.0	1.0	0.0100	0.0100	7.3	6.9	1.7	1.8	1.0	1.1
0.0092	0.0098	6.6	7.0	1.8	1.7	1.0	1.1	0.0090	0.0104	7.0	7.4	1.8	1.7	1.0	1.1
0.0087	0.0097	6.9	6.6	1.7	1.8	1.0	1.0	0.0089	0.0097	6.9	7.1	1.7	1.5	1.0	1.1
0.0085	0.0085	6.3	6.3	1.8	1.7	1.0	1.0	0.0080	0.0082	6.4	6.1	1.6	1.6	1.0	1.0
0.0077	0.0028	6.2	S.	1.7	1.0	0.0069	0.0073	5.8	5.5	1.6	1.6	.8	.9
0.0068	0.0062	5.7	5.3	1.6	1.4	1.0	1.0	0.0052	0.0062	4.9	5.5	1.4	1.5	.1	.8
0.0050	0.0044	4.3	4.2	1.5	1.4	1.0	.9	0.0050	4.7	1.58

JULY 13

0.0102	0.0071	6.8	5.4	1.9	1.7	1.1	1.0	0.0037	0.0064	4.8	5.3	1.6	1.5	0.7	0.9
0.0130	0.0114	8.2	7.5	1.9	1.8	1.2	1.1	0.0103	0.0094	7.2	6.6	1.8	1.7	1.0	1.0
0.0146	0.0121	8.6	7.5	1.9	1.8	1.2	1.1	0.0140	0.0116	8.3	7.5	1.9	1.7	1.3	1.2
0.0153	0.0145	9.2	8.5	2.0	1.9	1.4	1.2	0.0155	0.0125	8.8	8.3	2.0	1.7	1.4	1.1
0.0160	0.0146	9.3	8.9	2.0	1.9	1.4	1.2	0.0169	0.0141	9.2	8.5	2.0	1.9	1.5	1.2
0.0175	0.0157	9.6	8.8	2.2	1.9	1.5	1.4	0.0184	0.0145	9.5	8.8	2.1	2.0	1.5	1.4
0.0187	0.0168	10.0	9.1	2.2	2.0	1.4	1.4	0.0184	0.0144	9.4	8.7	2.1	1.8	1.5	1.3
0.0188	0.0162	10.0	9.3	2.1	2.0	1.4	1.4	0.0179	0.0149	9.0	8.8	2.0	1.9	1.4	1.3
0.0184	0.0172	9.9	9.6	2.2	2.0	1.5	1.5	0.0178	0.0145	9.2	8.4	2.2	1.9	1.5	1.4
0.0173	0.0167	9.5	9.3	2.2	2.0	1.4	1.4	0.0196	0.0147	9.0	8.5	2.3	1.9	1.5	1.2
0.0175	0.0149	9.6	9.1	2.1	1.9	1.5	1.4	0.0160	0.0149	9.0	8.5	2.0	1.9	1.4	1.3
0.0158	0.0137	9.3	8.7	2.1	1.9	1.4	1.4	0.0138	0.0137	8.7	8.5	1.9	1.9	1.4	1.3
0.0135	0.0129	8.6	8.5	1.9	1.8	1.3	1.2	0.0126	0.0127	8.5	8.3	1.9	1.9	1.2	1.3
0.0126	0.0103	8.5	7.3	1.9	1.7	1.4	1.1	0.0086	0.0106	7.0	7.7	1.6	1.7	1.1	1.2
0.0105	0.0085	7.7	6.9	2.0	1.5	1.1	1.0	0.0082	6.7	1.68
0.0076	6.3	1.79

JULY 14

0.0069	0.0104	5.3	7.3	1.7	1.9	0.9	1.1	0.0094	0.0098	7.3	7.3	1.7	1.8	1.0	1.2
0.0117	0.0153	7.6	8.4	1.8	2.1	1.1	1.3	0.0139	0.0108	8.6	9.1	1.8	2.1	1.4	1.4
0.0151	0.0161	8.7	9.0	2.1	2.1	1.3	1.4	0.0167	0.0200	9.3	9.4	1.9	2.2	1.6	1.5
0.0154	0.0179	9.0	9.1	2.0	2.1	1.3	1.5	0.0173	0.0207	9.6	9.8	2.0	2.0	1.5	1.5
0.0177	0.0196	9.4	9.4	2.1	2.3	1.4	1.6	0.0191	0.0220	9.6	9.9	2.1	2.2	1.5	1.6
0.0182	0.0199	9.5	9.6	2.2	2.1	1.4	1.6	0.0189	0.0227	9.7	10.2	2.0	2.3	1.6	1.6
0.0180	0.0203	9.7	9.7	2.0	2.1	1.4	1.5	0.0196	0.0244	9.9	10.4	2.3	2.3	1.5	1.7
0.0185	0.0208	9.4	9.5	2.1	2.1	1.5	1.7	0.0195	0.0250	9.9	10.5	2.3	2.4	1.5	1.7
0.0186	0.0208	10.0	9.9	2.2	1.9	1.5	1.6	0.0194	0.0247	9.6	10.4	2.2	2.5	1.6	1.6
0.0171	0.0209	9.4	10.0	2.1	2.3	1.5	1.5	0.0193	0.0242	9.6	9.9	2.3	2.5	1.5	1.7
0.0159	0.0192	9.5	9.6	1.9	2.3	1.4	1.6	0.0164	0.0236	9.4	10.3	1.9	2.6	1.4	1.6
0.0134	0.0179	8.8	9.3	1.9	2.2	1.3	1.5	0.0146	0.0222	8.8	10.0	1.9	2.3	1.3	1.7
0.0110	0.0152	8.0	8.7	1.7	2.0	1.1	1.4	0.0138	0.0205	8.9	10.0	1.8	2.3	1.4	1.5
0.0094	0.0128	7.5	8.5	1.8	1.9	1.1	1.2	0.0100	0.0171	7.8	9.5	1.7	2.1	1.2	1.4
.....	0.0090	7.3	1.6	1.2	0.0145	8.5	2.0	1.4

TABLE IV.—Growth of kernels of Hannchen barley in awned and clipped spikes at Aberdeen, Idaho, in 1916—Continued

JULY 15

Normal spikes.								Clipped spikes.							
Weight.		Length.		Lateral diameter.		Dorso-ventral diameter.		Weight.		Length.		Lateral diameter.		Dorso-ventral diameter.	
A.	B.	A.	B.	A.	B.	A.	B.	A.	B.	A.	B.	A.	B.	A.	B.
Gm.	Gm.	Mm.	Mm.	Mm.	Mm.	Mm.	Mm.	Gm.	Gm.	Mm.	Mm.	Mm.	Mm.	Mm.	Mm.
0.0682	0.0045	6.4	5.0	1.8	1.5	0.9	0.7	0.0041	0.0058	4.8	5.5	1.4	1.5	0.7	0.8
0.0158	0.0017	8.7	8.8	1.9	2.1	1.3	1.4	0.0144	0.0145	8.8	8.8	1.9	1.9	1.4	1.3
0.0193	0.0213	9.6	9.5	2.1	2.2	1.4	1.6	0.0207	0.0144	9.5	9.6	2.3	2.2	1.5	1.5
0.0215	0.0248	10.0	9.8	2.1	2.1	1.5	1.6	0.0251	0.0212	10.1	9.3	2.3	2.2	1.8	1.5
0.0230	0.0261	10.0	10.2	2.3	2.3	1.6	1.6	0.0253	0.0215	10.1	9.5	2.2	2.3	1.7	1.5
0.0261	0.0265	10.4	10.0	2.3	2.0	1.4	1.7	0.0263	0.0230	10.0	9.5	2.4	2.4	1.8	1.5
0.0258	0.0284	10.1	10.4	2.4	2.4	1.6	1.9	0.0264	0.0246	10.0	9.7	2.5	2.3	1.7	1.8
0.0253	0.0282	10.1	10.4	2.3	2.6	1.6	1.8	0.0275	0.0243	10.0	9.6	2.5	2.4	1.7	1.6
0.0259	0.0269	10.0	10.0	2.5	2.5	1.6	1.7	0.0267	0.0248	10.0	10.0	2.6	2.3	1.9	1.7
0.0250	0.0266	10.3	10.0	2.2	2.0	1.7	1.6	0.0260	0.0235	9.9	9.3	2.5	2.3	1.7	1.5
0.0229	0.0253	10.0	10.0	2.0	2.2	1.5	1.5	0.0250	0.0210	9.7	9.3	2.2	2.4	1.5	1.5
0.0212	0.0231	9.5	9.7	2.0	2.2	1.5	1.8	0.0237	0.0180	9.5	9.3	2.2	2.0	1.5	1.5
0.0183	0.0213	9.5	9.0	2.0	2.0	1.5	1.7	0.0206	0.0134	9.1	8.5	2.2	1.9	1.5	1.4
0.0172	0.0169	9.3	9.0	2.0	2.1	1.5	1.5	0.0175	0.0175	9.2	2.0	1.5
0.0141	0.0135	8.7	8.2	1.6	1.8	1.4	1.3	0.0119	7.7	1.8	1.3

JULY 17

0.0167	0.0293	9.2	10.3	2.3	2.7	1.4	2.0	0.0223	0.0225	9.5	8.3	2.6	1.9	1.5	1.4
0.0334	0.0323	10.2	10.5	2.8	2.9	2.2	2.2	0.0340	0.0254	10.4	10.0	3.0	2.5	2.0	1.8
0.0370	0.0363	10.6	10.6	2.9	3.0	2.1	2.1	0.0366	0.0298	10.0	10.2	3.0	2.8	2.0	1.8
0.0411	0.0396	10.9	11.2	3.1	3.0	2.3	2.1	0.0398	0.0339	10.4	10.0	3.2	3.0	2.2	2.1
0.0404	0.0400	11.1	10.6	3.1	3.1	2.3	2.2	0.0384	0.0351	10.0	10.0	3.2	3.0	2.2	2.0
0.0436	0.0413	11.0	10.2	3.2	3.0	2.2	2.1	0.0388	0.0368	9.8	10.5	3.2	3.2	2.0	2.1
0.0436	0.0423	11.2	10.3	3.3	3.3	2.3	2.2	0.0385	0.0362	9.7	9.2	3.2	3.2	2.1	2.1
0.0442	0.0406	11.1	10.5	3.2	3.2	2.3	2.2	0.0393	0.0344	9.8	9.4	3.2	3.0	2.2	2.2
0.0447	0.0413	10.6	10.2	3.4	3.2	2.3	2.2	0.0385	0.0349	9.7	9.8	3.2	3.0	2.2	2.0
0.0422	0.0392	10.5	10.3	3.3	3.0	2.4	2.0	0.0384	0.0315	9.8	9.5	3.4	3.0	2.3	1.9
0.0405	0.0392	10.6	10.0	3.3	3.1	2.3	2.0	0.0339	0.0299	9.7	9.1	3.0	3.0	2.1	2.0
0.0387	0.0375	10.4	9.8	3.3	3.0	2.2	2.1	0.0316	0.0277	8.9	8.9	3.1	2.9	2.0	1.9
0.0365	0.0343	10.0	9.5	3.1	3.0	2.2	2.2	0.0298	0.0245	9.0	8.6	2.8	2.7	1.9	1.0
0.0314	0.0320	9.7	9.8	2.8	2.9	2.0	2.1	0.0255	0.0166	9.1	7.9	2.5	2.5	1.6	1.6
0.0260	0.0287	9.5	9.0	2.6	2.8	1.8	2.0	0.0201	8.2	2.5	1.6

JULY 13

0.0253	0.0279	9.3	9.3	2.7	2.9	1.6	1.8	0.0283	0.0191	10.0	8.7	2.8	2.3	1.8	1.6
0.0390	0.0395	10.5	10.7	3.2	3.0	2.1	2.2	0.0326	0.0317	10.3	10.2	2.8	2.7	1.8	1.7
0.0405	0.0450	10.4	10.3	3.3	3.4	2.1	2.2	0.0368	0.0360	10.0	10.7	3.1	3.0	2.1	2.0
0.0450	0.0466	10.2	10.0	3.4	3.3	2.2	2.3	0.0386	0.0410	10.3	10.4	3.2	3.3	2.0	2.2
0.0439	0.0478	11.0	10.5	3.2	3.4	2.2	2.4	0.0417	0.0430	10.1	10.2	3.1	3.2	2.3	2.2
0.0455	0.0508	10.7	10.4	3.3	3.6	2.3	2.5	0.0423	0.0434	10.2	10.1	3.0	3.3	2.2	2.2
0.0465	0.0504	10.1	10.7	3.5	3.5	2.2	2.6	0.0418	0.0427	10.0	9.3	3.2	3.3	2.2	2.2
0.0458	0.0500	10.5	10.8	3.4	3.6	2.3	2.4	0.0408	0.0441	9.6	10.2	3.3	3.2	2.2	2.2
0.0439	0.0431	9.5	10.2	3.4	3.6	2.0	2.4	0.0388	0.0454	9.8	10.2	3.2	3.3	2.2	2.5
0.0430	0.0468	9.7	10.1	3.4	3.4	2.1	2.4	0.0390	0.0415	9.7	9.7	3.2	3.3	2.3	2.4
0.0419	0.0431	10.1	9.5	3.3	3.5	2.3	2.4	0.0334	0.0402	9.2	10.1	3.2	3.2	2.0	2.1
0.0383	0.0416	9.7	9.1	3.3	3.4	2.3	2.4	0.0305	0.0387	9.2	9.6	3.0	3.1	2.0	2.3
0.0324	0.0383	9.3	9.3	2.8	3.3	1.9	2.2	0.0271	0.0353	8.7	9.7	2.8	3.2	1.7	2.2
0.0311	0.0350	8.6	9.2	2.9	3.1	2.0	2.2	0.0197	0.0330	7.8	9.2	2.5	3.0	1.5	2.1
.....	0.0279	8.4	2.8	1.9

TABLE IV.—*Growth of kernels of Hannchen barley in awned and clipped spikes at Aberdeen, Idaho, in 1916—Continued*

JULY 19

Normal spikes.								Clipped spikes.							
Weight.		Length.		Lateral diameter.		Dorso-ventral diameter.		Weight.		Length.		Lateral diameter.		Dorso-ventral diameter.	
A.	B.	A.	B.	A.	B.	A.	B.	A.	B.	A.	B.	A.	B.	A.	B.
Gm.	Gm.	Mm.	Mm.	Mm.	Mm.	Mm.	Mm.	Gm.	Gm.	Mm.	Mm.	Mm.	Mm.	Mm.	Mm.
0.0205	0.0337	9.2	9.7	2.5	3.1	1.7	2.1	0.0137	0.0253	7.5	9.5	2.2	2.9	1.5	1.7
0.0301	0.0437	10.1	10.6	3.2	3.3	2.1	2.2	0.0324	0.0374	9.8	9.5	2.8	3.2	2.0	2.0
0.0366	0.0475	10.4	10.5	3.3	3.4	2.1	2.5	0.0380	0.0499	10.1	10.2	3.2	3.3	2.2	2.3
0.0445	0.0511	9.9	10.8	3.3	3.5	2.3	2.3	0.0408	0.0422	10.1	10.2	3.4	3.3	2.3	2.1
0.0457	0.0481	10.4	10.7	3.4	3.7	2.3	2.5	0.0397	0.0441	10.1	10.2	3.4	3.4	2.3	2.3
0.0473	0.0489	10.3	10.5	3.4	3.5	2.3	2.3	0.0429	0.0455	10.4	10.4	3.3	3.5	2.4	2.4
0.0465	0.0486	10.3	10.4	3.4	3.6	2.5	2.5	0.0431	0.0435	9.6	9.7	3.3	3.4	2.4	2.2
0.0462	0.0488	9.6	10.8	3.5	3.5	2.5	2.4	0.0409	0.0443	9.6	9.7	3.2	3.4	2.4	2.3
0.0467	0.0483	10.2	10.0	3.4	3.5	2.4	2.5	0.0382	0.0434	9.7	9.6	3.3	3.4	2.2	2.4
0.0495	0.0459	10.2	10.0	3.4	3.4	2.2	2.2	0.0391	0.0402	9.6	9.9	3.4	3.5	2.1	2.2
0.0448	0.0457	9.7	9.7	3.5	3.4	2.3	2.5	0.0373	0.0388	9.2	9.6	3.4	3.4	2.1	2.2
0.0400	0.0438	9.6	10.1	3.2	3.4	2.4	2.3	0.0343	0.0361	8.7	9.6	3.2	3.3	2.1	2.1
0.0381	0.0375	9.6	9.2	3.2	3.3	2.3	2.3	0.0311	0.0328	8.9	8.6	3.0	3.2	2.1	2.2
0.0356	0.0345	9.2	9.6	3.3	3.2	2.3	2.1	0.0266	0.0264	8.2	8.7	2.8	3.0	1.8	1.9
0.0278	9.0	3.0	2.2	0.0193	8.0	2.6	1.6

JULY 20

0.0117	0.0356	7.6	10.7	2.1	3.1	1.3	2.2	0.0395	0.0359	10.8	9.8	3.2	3.1	2.0	2.3
0.0419	0.0421	10.3	11.0	3.3	3.4	2.3	2.3	0.0435	0.0497	10.4	10.2	3.3	3.3	2.3	2.3
0.0477	0.0422	10.3	10.2	3.6	3.2	2.5	2.2	0.0315	0.0437	9.9	10.5	3.0	3.2	1.6	2.4
0.0492	0.0447	10.6	11.0	3.6	3.3	2.5	2.3	0.0510	0.0442	10.8	10.8	3.5	3.1	2.5	2.3
0.0521	0.0467	10.7	11.0	3.8	3.2	2.4	2.3	0.0478	0.0460	10.4	10.4	3.5	3.4	2.1	2.4
0.0500	0.0455	10.8	10.9	3.6	3.3	2.4	2.3	0.0491	0.0456	10.5	10.4	3.5	3.3	2.5	2.1
0.0505	0.0440	10.7	10.6	3.7	3.2	2.4	2.2	0.0433	0.0450	10.4	10.1	3.4	3.3	2.3	2.5
0.0514	0.0458	10.4	10.3	3.6	3.3	2.5	2.5	0.0470	0.0430	10.2	10.1	3.5	3.3	2.2	2.2
0.0492	0.0444	10.0	10.5	3.5	3.3	2.5	2.3	0.0442	0.0400	10.2	9.3	3.5	3.0	2.4	2.1
0.0495	0.0443	10.4	10.0	3.6	3.3	2.5	2.3	0.0410	0.0403	10.2	9.8	3.4	3.0	2.2	2.0
0.0475	0.0419	10.0	10.4	3.5	3.3	2.4	2.3	0.0392	0.0384	9.9	9.7	3.2	2.9	2.3	2.1
0.0455	0.0409	10.0	9.7	3.4	3.2	2.4	2.2	0.0365	0.0322	9.8	9.7	3.2	3.1	2.2	2.1
0.0411	0.0363	9.7	9.7	3.5	3.2	2.3	2.0	0.0320	0.0293	9.3	8.9	3.2	2.9	2.0	2.0
0.0382	0.0331	9.6	9.8	3.3	2.8	2.3	2.0	0.0247	0.0199	9.0	8.5	2.9	2.7	1.8	1.7
0.0326	0.0280	9.3	9.1	2.8	2.8	2.0	2.0

July 21

0.0200	0.0228	8.9	9.3	2.4	2.6	1.7	1.8	0.0257	0.0355	9.4	9.8	2.8	3.2	1.9	1.9
0.0446	0.0420	10.6	10.3	3.4	3.2	2.2	2.2	0.0427	0.0433	10.0	10.2	3.5	3.5	2.4	2.3
0.0522	0.0492	10.7	11.0	3.5	3.5	2.3	2.3	0.0462	0.0411	10.6	10.4	3.4	3.5	2.3	2.2
0.0538	0.0505	10.8	11.0	3.7	3.6	2.4	2.2	0.0465	0.0488	10.2	10.5	3.3	3.5	2.2	2.3
0.0566	0.0527	10.6	10.6	3.9	3.6	2.4	2.5	0.0508	0.0489	10.3	10.8	3.5	3.7	2.5	2.3
0.0487	0.0505	10.7	10.6	3.7	3.4	2.4	2.5	0.0492	0.0473	9.4	10.1	3.7	3.5	2.4	2.3
0.0542	0.0517	10.7	11.0	3.8	3.6	2.5	2.5	0.0477	0.0463	10.0	9.8	3.5	3.5	2.4	2.3
0.0555	0.0517	10.7	10.6	3.8	3.4	2.6	2.4	0.0456	0.0461	10.3	10.3	3.5	3.5	2.3	2.3
0.0555	0.0514	10.8	10.3	3.8	3.7	2.5	2.5	0.0454	0.0455	10.0	9.7	3.5	3.4	2.3	2.2
0.0509	0.0490	10.4	10.3	3.8	3.5	2.5	2.4	0.0439	0.0429	9.5	9.9	3.5	3.5	2.3	2.4
0.0489	0.0481	10.3	10.5	3.7	3.5	2.6	2.4	0.0416	0.0416	10.0	9.8	3.5	3.1	2.1	2.2
0.0475	0.0442	10.1	10.3	3.7	3.5	2.5	2.4	0.0387	0.0419	9.0	9.5	3.1	3.3	2.1	2.3
0.0434	0.0412	10.1	9.6	3.6	3.4	2.4	2.3	0.0359	0.0356	9.6	9.3	3.2	3.3	2.3	2.1
0.0412	0.0373	10.0	9.7	3.4	3.3	2.2	2.2	0.0333	0.0350	9.1	9.0	3.2	3.2	2.2	2.0
0.0339	0.0289	9.5	9.1	3.2	3.1	2.3	2.0	0.0212	8.4	2.7	1.9

TABLE IV.—Growth of kernels of Hannchen barley in awned and clipped spikes at Aberdeen, Idaho, in 1916—Continued

JULY 26

Normal spikes.								Clipped spikes.							
Weight.		Length.		Lateral diameter.		Dorso-ventral diameter.		Weight.		Length.		Lateral diameter.		Dorso-ventral diameter.	
A.	B.	A.	B.	A.	B.	A.	B.	A.	B.	A.	B.	A.	B.	A.	B.
Gm.	Gm.	Mm.	Mm.	Mm.	Mm.	Mm.	Mm.	Gm.	Gm.	Mm.	Mm.	Mm.	Mm.	Mm.	Mm.
0.0304	0.0382	9.2	9.2	3.0	3.3	1.8	2.0	0.0394	0.0368	9.0	9.0	3.3	3.0	2.0	1.8
0.0569	0.0588	9.7	10.8	3.5	3.8	2.6	2.5	0.0542	0.0614	10.8	10.0	3.7	3.5	2.3	2.5
0.0619	0.0640	9.7	10.8	3.9	3.5	2.4	2.5	0.0614	0.0642	10.5	10.5	3.7	3.5	2.7	2.7
0.0660	0.0700	10.7	10.8	3.8	3.9	2.7	2.6	0.0670	0.0669	10.7	10.8	3.8	3.7	2.5	2.7
0.0708	0.0659	10.7	10.5	4.0	4.0	2.8	2.6	0.0655	0.0652	10.6	10.5	3.7	3.7	2.6	2.5
0.0669	0.0672	10.7	10.9	3.8	4.0	2.8	2.8	0.0658	0.0624	10.5	10.5	3.7	3.8	2.8	2.5
0.0650	0.0673	10.2	10.7	3.7	3.9	2.6	2.8	0.0651	0.0657	10.7	10.5	3.7	3.7	2.8	2.8
0.0696	0.0671	10.8	11.0	3.9	3.9	2.7	2.6	0.0665	0.0643	10.5	10.2	3.9	3.9	2.8	2.7
0.0681	0.0645	10.2	10.3	3.8	3.8	2.6	2.6	0.0650	0.0600	10.3	10.0	3.8	3.7	2.6	2.5
0.0654	0.0634	10.4	10.3	3.7	3.6	2.6	2.5	0.0653	0.0600	10.3	10.0	3.7	3.8	2.7	2.6
0.0640	0.0626	10.4	10.4	3.8	3.8	2.7	2.6	0.0602	0.0568	10.0	10.0	3.8	3.4	2.7	2.5
0.0607	0.0557	10.0	9.7	3.9	3.7	2.5	2.5	0.0588	0.0530	10.0	9.5	3.6	3.5	2.7	2.5
0.0607	0.0540	10.0	9.6	3.7	3.6	2.5	2.6	0.0505	0.0486	9.5	9.2	3.2	3.5	2.5	2.5
0.0546	0.0485	9.5	8.9	3.5	3.5	2.5	2.6	0.0456	0.0353	9.0	8.7	3.5	3.2	2.3	1.9
0.0502	9.5	3.5	2.5	0.0332	8.0	3.3	2.0

JULY 27

0.0541	0.0427	10.0	9.3	3.5	3.0	2.5	2.1	0.0275	0.0357	8.5	9.5	2.5	3.0	2.0	2.0
0.0558	0.0614	10.3	10.2	3.7	3.2	2.5	2.4	0.0458	0.0618	9.8	10.0	3.5	3.9	2.2	2.6
0.0604	0.0653	10.5	10.5	3.5	3.6	2.5	2.5	0.0538	0.0662	10.0	10.5	3.5	3.6	2.5	2.8
0.0620	0.0685	10.5	10.5	3.8	3.8	2.6	2.7	0.0581	0.0622	10.1	10.0	3.7	3.8	2.3	2.7
0.0609	0.0655	10.0	10.5	3.8	3.8	2.5	2.4	0.0583	0.0656	10.2	10.2	3.7	3.5	2.8	2.8
0.0592	0.0664	10.0	10.2	3.6	3.8	2.5	2.6	0.0552	0.0637	10.2	10.3	3.2	3.9	2.5	2.7
0.0583	0.0656	9.6	10.4	3.6	3.8	2.6	2.7	0.0567	0.0656	9.4	9.6	3.4	3.7	2.4	2.6
0.0600	0.0622	9.6	10.0	3.6	3.7	2.5	2.6	0.0579	0.0615	9.8	10.2	3.6	3.7	2.7	2.7
0.0554	0.0629	9.3	10.0	3.5	3.5	2.5	2.5	0.0538	0.0619	9.8	9.8	3.4	3.7	2.6	2.6
0.0562	0.0627	9.6	9.5	3.7	3.9	2.6	2.6	0.0516	0.0579	9.8	10.0	3.4	3.6	2.3	2.7
0.0530	0.0603	9.2	9.0	3.5	3.6	2.5	2.7	0.0487	0.0564	9.0	9.2	3.5	3.4	2.5	2.3
0.0488	0.0589	9.2	9.5	3.4	3.7	2.3	2.7	0.0486	0.0518	9.6	9.0	3.5	3.3	2.6	2.4
0.0457	0.0545	9.0	9.2	3.2	3.5	2.3	2.4	0.0416	0.0471	9.0	9.5	3.3	3.5	2.2	2.4
.....	0.0475	8.8	3.3	2.4	0.0224	0.0343	8.3	9.2	2.7	3.2	1.8	2.1

JULY 28

0.0345	0.0190	8.5	7.2	3.2	2.5	1.8	1.6	0.0362	0.0233	9.1	7.7	3.4	2.7	2.1	1.8
0.0589	0.0574	10.5	10.0	3.6	3.5	2.5	2.7	0.0530	0.0552	9.8	10.0	3.7	3.4	2.3	2.8
0.0640	0.0637	10.8	10.0	4.0	3.8	2.6	2.7	0.0602	0.0619	10.0	10.5	3.8	3.8	2.7	2.5
0.0652	0.0651	11.0	10.6	3.8	3.8	2.6	2.8	0.0614	0.0603	10.0	10.5	3.7	3.7	2.5	2.6
0.0688	0.0671	10.7	10.0	4.0	4.0	2.7	2.8	0.0642	0.0632	10.7	10.5	3.8	3.7	2.7	2.5
0.0667	0.0658	10.6	11.0	3.8	3.8	2.8	2.7	0.0625	0.0638	10.0	10.0	3.8	3.7	2.7	2.8
0.0657	0.0688	10.0	10.5	3.8	3.7	2.9	2.8	0.0619	0.0600	9.9	10.0	3.8	3.5	2.8	2.8
0.0625	0.0683	10.5	10.2	3.8	4.0	2.7	2.8	0.0604	0.0610	9.8	10.2	3.8	3.7	2.8	2.7
0.0608	0.0695	9.6	10.4	3.8	4.0	2.7	2.9	0.0585	0.0600	10.0	10.0	3.7	3.5	2.8	2.7
0.0618	0.0657	10.0	10.0	3.7	3.9	2.6	2.8	0.0578	0.0585	9.3	10.2	3.8	3.7	2.5	2.6
0.0578	0.0620	9.8	9.5	3.5	3.7	2.7	2.7	0.0560	0.0560	10.0	10.1	3.7	3.7	2.7	2.6
0.0542	0.0602	10.0	10.0	3.7	3.8	2.6	2.8	0.0512	0.0572	9.0	10.0	3.5	3.7	2.3	2.8
0.0502	0.0575	9.7	9.7	3.7	3.7	2.5	2.6	0.0504	0.0528	9.0	9.4	3.4	3.5	2.4	2.6
0.0452	0.0502	9.2	9.4	3.5	3.6	2.5	2.6	0.0441	0.0485	8.7	9.0	3.4	3.3	2.4	2.6
.....	0.0489	9.2	3.6	2.5	0.0279	0.0427	8.0	8.5	2.8	3.4	1.9	2.5

TABLE IV.—Growth of kernels of Hannchen barley in awned and clipped spikes at Aberdeen, Idaho, in 1916—Continued

JULY 29

Normal spikes.								Clipped spikes.							
Weight.		Length.		Lateral diameter.		Dorso-ventral diameter.		Weight.		Length.		Lateral diameter.		Dorso-ventral diameter.	
A.	B.	A.	B.	A.	B.	A.	B.	A.	B.	A.	B.	A.	B.	A.	B.
Gm.	Gm.	Mm.	Mm.	Mm.	Mm.	Mm.	Mm.	Gm.	Gm.	Mm.	Mm.	Mm.	Mm.	Mm.	Mm.
0.0360	0.0454	9.0	9.2	3.3	3.5	2.1	2.3	0.0523	0.0500	9.8	10.0	3.5	3.5	2.3	2.3
0.0686	0.0685	10.3	10.5	3.9	3.7	2.7	2.7	0.0650	0.0616	10.2	10.0	3.8	3.7	2.7	2.6
0.0727	0.0739	11.0	10.0	4.0	3.9	2.8	2.8	0.0682	0.0633	10.4	9.9	3.7	3.8	2.7	2.6
0.0806	0.0719	11.4	10.7	4.2	4.0	2.9	2.8	0.0718	0.0640	10.4	10.0	3.9	3.7	2.7	2.6
0.0750	0.0739	10.4	10.0	4.1	4.0	2.8	2.9	0.0709	0.0637	10.0	10.5	4.0	3.7	2.7	2.5
0.0785	0.0683	10.8	11.0	4.2	3.8	3.0	2.8	0.0688	0.0629	10.0	10.0	3.8	3.8	2.7	2.7
0.0752	0.0692	10.0	10.0	4.2	4.0	2.8	2.8	0.0697	0.0610	10.5	10.2	4.0	3.8	2.8	2.5
0.0765	0.0667	10.1	10.0	4.0	3.9	2.9	2.7	0.0690	0.0621	10.1	10.2	3.9	3.8	2.7	2.6
0.0764	0.0648	10.1	10.0	4.1	3.8	2.9	2.8	0.0670	0.0572	9.5	9.3	3.8	3.7	2.6	2.6
0.0713	0.0641	10.6	10.2	3.8	3.8	2.8	2.7	0.0651	0.0540	9.2	9.5	3.7	3.5	2.6	2.5
0.0724	0.0574	10.0	9.6	4.0	3.7	2.8	2.6	0.0622	0.0548	9.8	9.0	3.7	3.6	2.7	2.6
0.0650	0.0597	9.2	9.5	4.0	3.7	2.8	2.7	0.0629	0.0487	9.5	8.8	3.7	3.5	2.7	2.5
0.0634	0.0540	10.0	8.7	3.8	3.7	2.8	2.6	0.0571	0.0455	9.6	9.0	3.6	3.4	2.6	2.4
0.0580	0.0460	9.5	8.5	3.8	3.5	2.7	2.4	0.0550	0.0374	9.4	9.0	3.6	3.3	2.7	2.2
0.0537	9.7	3.6	2.5	0.0525	9.0	3.5	2.6
.....	0.0445	8.6	3.5	2.3

JULY 31

0.0218	0.0513	7.9	9.5	2.8	3.5	1.7	2.3	0.0250	0.0451	8.4	9.5	2.8	3.4	1.8	2.3
0.0600	0.0735	9.9	11.7	3.8	4.0	2.7	2.8	0.0592	0.0566	9.8	10.0	3.7	3.7	2.5	2.4
0.0689	0.0785	10.5	11.5	3.9	4.0	2.7	2.9	0.0625	0.0620	10.0	10.3	3.7	3.5	2.5	2.5
0.0677	0.0726	10.5	11.0	3.9	4.0	2.8	2.8	0.0624	0.0672	10.1	9.8	3.8	3.8	2.6	2.6
0.0735	0.0740	10.6	10.0	3.9	4.0	2.8	2.7	0.0633	0.0643	10.3	10.1	3.7	3.7	2.6	2.7
0.0743	0.0660	11.0	9.8	4.0	3.7	2.9	2.6	0.0651	0.0642	10.3	10.4	3.8	3.7	2.8	2.6
0.0704	0.0687	11.0	10.5	3.9	3.9	2.9	2.8	0.0636	0.0625	10.2	9.7	3.7	3.7	2.6	2.7
0.0692	0.0725	10.4	10.8	4.0	3.8	2.8	2.8	0.0622	0.0631	10.2	10.0	3.7	3.7	2.6	2.7
0.0656	0.0689	10.4	10.5	3.8	3.7	2.7	2.8	0.0590	0.0608	9.7	10.2	3.7	3.7	2.6	2.6
0.0689	0.0679	10.0	10.5	3.9	3.8	2.8	2.8	0.0588	0.0590	9.9	10.0	3.8	3.7	2.6	2.7
0.0630	0.0685	10.0	10.8	3.8	3.8	2.7	2.8	0.0588	0.0554	9.5	9.6	3.7	3.7	2.7	2.6
0.0627	0.0668	10.0	10.5	3.7	3.9	2.7	2.8	0.0570	0.0504	9.3	9.5	3.7	3.6	2.5	2.5
0.0582	0.0649	9.7	10.2	3.7	3.7	2.6	2.7	0.0511	0.0468	9.4	10.0	3.6	3.5	2.5	2.5
0.0517	0.0605	9.5	9.6	3.5	3.6	2.5	2.6	0.0493	0.0459	9.3	9.2	3.5	3.4	2.5	2.4
0.0518	0.0550	8.8	9.2	3.5	3.5	2.6	2.6	0.0422	0.0429	8.6	8.9	3.4	3.3	2.4	2.4
0.0430	0.0388	8.6	8.0	3.4	3.1	2.5	2.3	0.0217	8.0	2.7	2.0

AUGUST 1

0.0447	0.0494	9.5	9.5	3.2	3.4	2.4	2.4	0.0488	0.0330	9.6	8.3	3.5	3.1	2.5	2.1
0.0655	0.0641	10.0	10.0	3.8	3.8	2.8	2.7	0.0644	0.0589	10.3	10.0	3.7	3.7	2.7	2.6
0.0664	0.0692	10.2	10.4	3.8	3.9	2.8	2.7	0.0634	0.0636	10.3	10.7	3.7	3.8	2.7	2.7
0.0694	0.0682	10.7	10.5	4.0	3.9	2.7	2.7	0.0648	0.0653	10.5	9.8	3.7	3.9	2.7	2.7
0.0704	0.0660	10.7	10.8	3.9	3.8	2.6	2.8	0.0659	0.0603	10.5	10.1	3.7	3.9	2.6	2.8
0.0713	0.0632	10.4	10.4	3.8	3.7	2.7	2.7	0.0650	0.0666	10.3	10.0	3.7	3.8	2.7	2.8
0.0705	0.0650	10.5	10.0	3.9	3.8	2.9	2.7	0.0627	0.0611	10.4	10.0	3.7	3.7	2.8	2.6
0.0687	0.0675	10.0	10.4	3.9	3.9	2.8	2.6	0.0592	0.0623	9.8	9.9	3.7	3.7	2.7	2.6
0.0678	0.0601	10.0	10.2	3.9	3.8	2.9	2.7	0.0588	0.0612	10.1	9.9	3.7	3.7	2.7	2.7
0.0650	0.0655	10.5	10.0	3.8	3.8	2.9	2.8	0.0578	0.0568	10.2	10.0	3.7	3.6	2.7	2.6
0.0639	0.0651	10.0	9.9	3.8	3.8	2.8	2.8	0.0519	0.0540	9.6	9.3	3.7	3.6	2.6	2.6
0.0590	0.0625	9.9	10.1	3.8	3.8	2.8	2.8	0.0539	0.0500	9.0	9.0	3.7	3.5	2.7	2.6
0.0627	0.0544	9.7	9.5	3.8	3.5	2.8	2.8	0.0511	0.0104	9.0	9.2	3.7	3.4	2.5	2.5
0.0571	0.0588	9.5	9.3	3.7	3.7	2.8	2.8	0.0500	0.0101	9.0	9.8	3.6	3.5	2.5	2.5
0.0490	0.0510	9.5	8.0	3.6	3.6	2.7	2.7	0.0511	0.0143	9.1	8.5	3.4	3.2	2.5	2.3
0.0376	0.0424	8.5	8.3	3.3	3.4	2.4	2.0	0.0342	9.5	3.2	2.4

TABLE IV.—*Growth of kernels of Hannchen barley in awned and clipped spikes at Aberdeen, Idaho, in 1916—Continued*

AUGUST 2

Normal spikes.								Clipped spikes.							
Weight.		Length.		Lateral diameter.		Dorso-ventral diameter.		Weight.		Length.		Lateral diameter.		Dorso-ventral diameter.	
A.	B.	A.	B.	A.	B.	A.	B.	A.	B.	A.	B.	A.	B.	A.	B.
Gm.	Gm.	Mm.	Mm.	Mm.	Mm.	Mm.	Mm.	Gm.	Gm.	Mm.	Mm.	Mm.	Mm.	Mm.	Mm.
0.0561	0.0404	9.8	9.0	3.7	3.2	2.6	2.3	0.0439	0.0232	9.1	7.7	3.2	2.7	2.3	1.6
0.0605	0.0600	10.0	9.6	3.7	3.6	2.6	2.7	0.0614	0.0577	10.0	10.0	3.7	3.7	2.6	2.5
0.0606	0.0617	10.5	10.7	3.8	3.7	2.7	2.6	0.0632	0.0614	10.3	11.0	3.7	3.7	2.7	2.6
0.0604	0.0631	9.7	10.5	3.7	3.7	2.6	2.7	0.0612	0.0625	10.0	10.0	3.5	3.7	2.7	2.7
0.0564	0.0654	10.3	10.3	3.6	3.8	2.6	2.8	0.0598	0.0580	9.5	10.3	3.5	3.5	2.7	2.6
0.0542	0.0633	9.7	10.5	3.6	3.7	2.5	2.8	0.0600	0.0564	9.3	10.3	3.6	3.5	2.6	2.5
0.0545	0.0605	9.8	10.1	3.5	3.7	2.6	2.8	0.0557	0.0562	9.6	10.1	3.6	3.5	2.6	2.6
0.0541	0.0585	10.2	10.0	3.5	3.7	2.6	2.8	0.0525	0.0514	9.5	9.7	3.5	3.4	2.8	2.6
0.0512	0.0484	9.5	10.0	3.5	3.2	2.7	2.5	0.0482	0.0459	8.8	9.2	3.4	3.4	2.7	2.5
0.0430	0.0518	9.5	9.4	3.3	3.4	2.5	2.7	0.0460	0.0420	9.1	9.5	3.4	3.3	2.7	2.5
0.0500	0.0485	9.2	9.0	3.4	3.4	2.6	2.7	0.0418	0.0440	8.7	9.0	3.4	3.4	2.6	2.5
0.0493	0.0455	8.8	8.9	3.2	3.4	2.4	2.6	0.0380	0.0363	8.2	9.2	3.2	3.1	2.5	2.1
0.0310	0.0373	8.5	8.6	2.9	3.2	2.5	2.5	0.0334	0.0339	8.0	8.5	3.2	3.1	2.5	2.3
.....	0.0250	7.5	2.5	2.0	0.0218	7.0	2.7	2.3

AUGUST 3

0.0275	0.0484	7.6	9.4	2.8	3.4	1.9	2.4	0.0360	0.0418	8.7	8.6	3.2	3.2	2.1	2.3
0.0636	0.0639	10.0	10.3	3.7	3.7	2.7	2.7	0.0561	0.0511	10.0	9.6	3.6	3.6	2.5	2.5
0.0634	0.0650	10.1	10.0	3.7	3.7	2.7	2.7	0.0550	0.0532	10.1	10.1	3.5	3.4	2.6	2.5
0.0648	0.0644	10.1	10.7	3.7	3.6	2.8	2.6	0.0580	0.0542	10.4	10.1	3.5	3.5	2.6	2.6
0.0627	0.0650	10.0	10.5	3.7	3.5	2.7	2.7	0.0559	0.0534	9.8	9.8	3.5	3.4	2.7	2.6
0.0606	0.0645	9.8	10.6	3.6	3.7	2.7	2.7	0.0508	0.0440	9.1	9.8	3.4	3.2	2.7	2.5
0.0583	0.0645	9.4	10.3	3.5	3.7	2.6	2.7	0.0476	0.0460	9.9	9.7	3.4	3.3	2.6	2.6
0.0508	0.0614	9.5	10.0	3.6	3.6	2.6	2.7	0.0485	0.0445	9.7	9.2	3.4	3.3	2.6	2.5
0.0508	0.0540	9.5	10.1	3.4	3.5	2.6	2.6	0.0434	0.0425	9.3	9.0	3.3	3.2	2.6	2.5
0.0433	0.0527	9.0	10.7	3.3	3.4	2.6	2.6	0.0419	0.0407	9.0	9.5	3.3	3.2	2.6	2.5
0.0418	0.0505	8.8	9.8	3.2	3.5	2.5	2.6	0.0400	0.0385	9.3	8.2	3.2	3.2	2.5	2.5
0.0428	0.0482	9.2	9.4	3.4	3.5	2.6	2.6	0.0374	0.0362	8.4	8.4	3.2	3.2	2.5	2.3
0.0395	0.0402	9.0	8.6	3.4	3.3	2.5	2.4	0.0315	0.0333	8.8	8.1	3.0	3.0	2.2	2.3
0.0311	0.0390	8.9	8.8	3.1	3.4	2.3	2.5	0.0287	0.0302	8.2	8.3	3.0	3.0	2.2	2.3
.....	0.0330	8.1	3.2	2.4	0.0202	6.8	2.6	1.8
.....	0.0233	7.0	2.7	2.0

EFFECT OF REMOVING THE AWNS FROM HANNCHEN BARLEY AT ABERDEEN, IDAHO

Both the material and the conditions were more favorable for satisfactory investigations at Aberdeen than in Minnesota.

The Hannchen is a 2-rowed, awned variety of barley that grows very well under irrigation. The lateral florets are infertile, and this removes the complication of prolonged flowering and the great range of variation which is present when the small lateral kernels are developing. The normal development of Hannchen barley has been discussed in an earlier paper.¹

The growth under irrigation in Idaho is much more uniform than that in Minnesota. There are few cloudy days and fewer days in which the humidity is at all high. Storms which break the culms are very rare, and diseases which affect the leaves or culms are entirely negligible.

¹ HARLAN, HARRY V. OP. CIT.

The samples at Aberdeen consisted of at least two spikes. Just after flowering, when the kernels were small, three spikes were used. In Table IV only two of these are reported because the inclusion of the third makes the table even more cumbersome. In this table the steady growth of the kernel is apparent. Even when not averaged, the maximum kernel weights during the early part of the period constitute a very uniform series. The difference between the clipped and unclipped spikes becomes increasingly apparent as growth progresses.

The average weights and measurements in Table V are more easily studied than are the unsummarized data in Table IV. Table V gives the average by days. In some instances abnormal kernels have been thrown out, because they introduce variations that may as well be excluded. The kernels from the clipped spikes often exceed those of the normal spikes in weight and dimensions during the first week after flowering. As was the case in Minnesota, the normal spikes soon outstrip the clipped ones and maintain their advantage until maturity. The comparative development is illustrated in figures 7 and 8.

TABLE V.—Average wet weight, length, lateral diameter, and dorsoventral diameter of kernels from normal and clipped spikes of Hannchen barley from flowering to maturity, at Aberdeen, Idaho, in 1916

UNCLIPPED SPIKES

Date.	Wet weight.	Length.	Lateral diam-eter.	Dorso-ventral diam-eter.	Date.	Wet weight.	Length.	Lateral diam-eter.	Dorso-ventral diam-eter.
	<i>Mgm.</i>	<i>Mm.</i>	<i>Mm.</i>	<i>Mm.</i>		<i>Mgm.</i>	<i>Mm.</i>	<i>Mm.</i>	<i>Mm.</i>
July 10	3.8	3.35	1.37	0.93	July 22	51.2	10.17	3.58	2.52
11	5.8	4.53	1.53	.97	24	57.3	10.27	3.77	2.61
12	7.4	5.58	1.65	1.00	25	56.5	10.16	3.67	2.57
13	14.9	8.74	1.98	1.33	26	60.6	10.22	3.72	2.56
14	16.0	8.87	2.03	1.38	27	58.3	9.79	3.58	2.51
15	21.9	9.57	2.14	1.57	28	60.2	10.05	3.74	2.75
17	37.1	10.31	3.03	2.13	29	65.8	10.00	3.86	2.72
18	41.7	9.99	3.29	2.21	31	64.4	10.16	3.76	2.70
19	42.3	10.01	3.34	2.30	Aug. 1	61.5	9.92	3.75	2.72
20	43.5	10.27	3.34	2.30	2	51.9	9.61	3.47	2.59
21	46.9	10.35	3.51	2.36	3	52.2	9.57	3.47	2.58

CLIPPED SPIKES

July 10	3.3	3.00	1.27	0.85	July 22	47.1	9.80	3.47	2.27
11	6.7	5.13	1.55	.97	24	52.9	9.95	3.64	2.45
12	7.8	5.81	1.58	.92	25	52.3	9.99	3.50	2.41
13	13.8	8.28	1.89	1.27	26	57.4	9.98	3.59	2.50
14	18.3	9.41	2.12	1.48	27	52.6	9.66	3.45	2.44
15	21.6	9.46	2.24	1.57	28	55.6	9.72	3.60	2.58
17	31.9	9.49	2.91	1.95	29	59.6	9.71	3.68	2.57
18	36.4	9.71	3.05	2.07	31	56.4	9.73	3.61	2.54
19	37.1	9.56	3.22	2.15	Aug. 1	55.6	9.75	3.62	2.60
20	39.8	10.00	3.21	2.17	2	49.7	9.38	3.42	2.55
21	41.9	9.83	3.36	2.23	3	43.5	9.17	3.27	2.40

The graphs of the growth in length essentially coincide for six days after flowering. For some reason not apparent, the kernels in the normal spikes reach a greater length than those of the clipped spikes. This greater length is still in evidence at maturity. The difference is only $\frac{1}{2}$

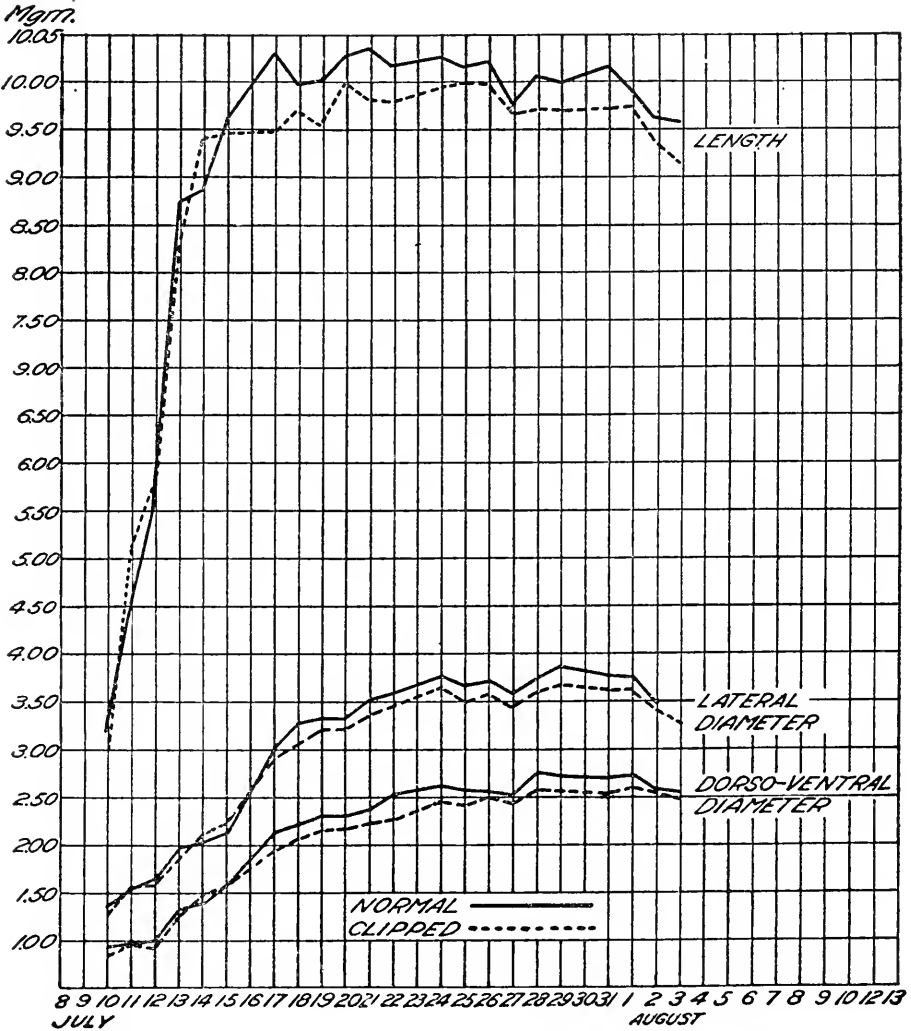

FIG. 7.—Graph showing growth in length, lateral diameter, and dorsoventral diameter of kernels of Hanchen barley in normal and clipped spikes.

mm., but it occurred in both Minnesota and Idaho. A part of the difference seems to have been due to the greater water content of the normal kernels, for the graphs of kernel lengths approach each other again at maturity.

At Aberdeen, the course of the development of the lateral diameter is much like that of the dorsoventral diameter. Seven or eight days after

flowering, the diameters of the normal kernels are larger than those from clipped spikes, and they then continue larger for the remainder of the period of development. In Minnesota, there is little difference between the kernels of the two classes of spikes until near maturity. As maturation approaches, the normal kernels are found to be uniformly greater in diameter than are those from the clipped spikes.

The graph of the wet weight is much more uniform at Aberdeen than at St. Paul. As in Minnesota, there is no difference between the clipped and normal spikes in the first few days. The period of equality is shorter

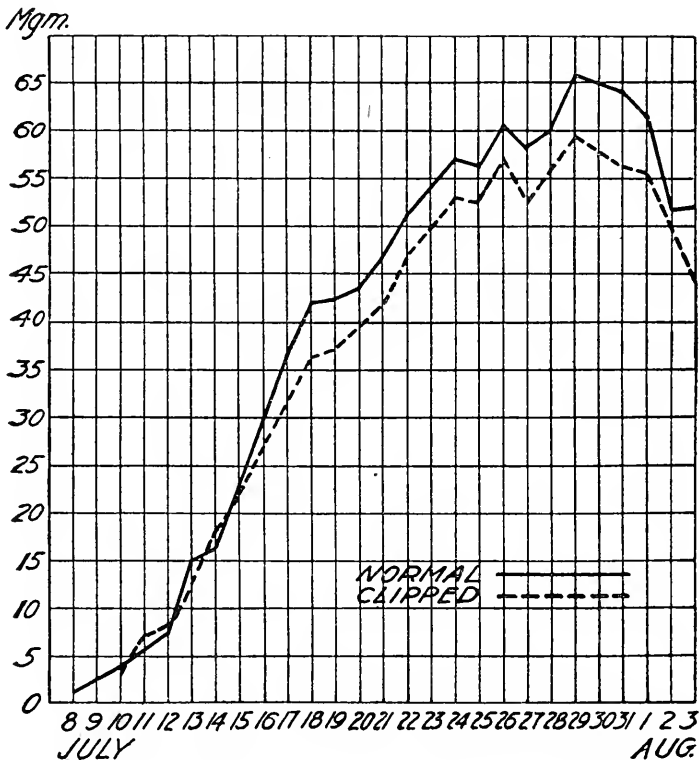

FIG. 8.—Graph showing wet weight of kernels of Hannehen barley from normal and clipped spikes.

at Aberdeen, however. After July 15 the average wet weight of the kernels from clipped spikes here never equals the wet weight of the kernels from normal spikes.

The wet weight includes a variable amount of water, which increases during the first half of the growing period and decreases during the second half. For this reason the curve of the wet weight differs greatly from the curve of the dry weight. The dry weights are shown in figure 9. In Minnesota, the trend of increase in dry weight was quite uniform, as was shown in figure 3. In Idaho, the graph of the dry weight is almost a straight line. It would seem that in both the normal and clipped

spikes the rate of growth was very nearly at its maximum. If this is true, the maximum of the clipped is less than that of the normal spike, for after July 15 the dry matter per kernel is always less.

The percentage and weight per kernel of the dry matter are given in detail in Table VI. This table also includes the data on water, nitrogen,

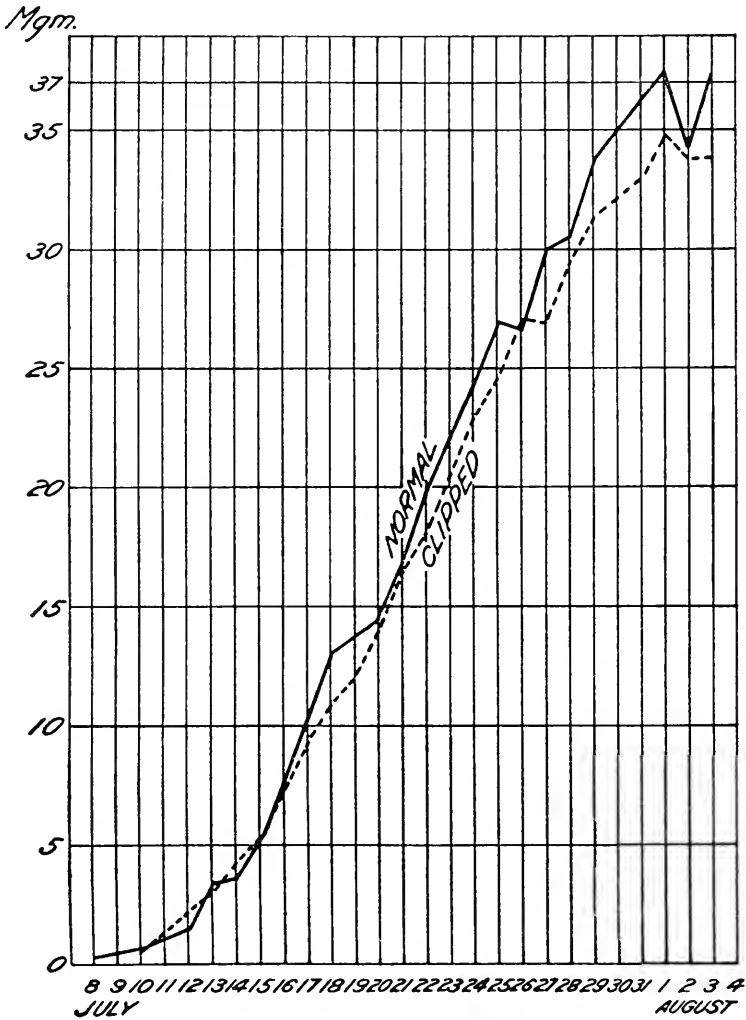

FIG. 9.—Graph showing dry matter in kernels of Hannchen barley from normal and clipped spikes.

and ash. These figures were obtained from the analyses of the samples reported in Tables IV and V. Most of the data on the percentages of the various substances have not been included in the figures. An inspection of the tables shows a surprisingly uniform decrease in the percentage of water and, of course, an equally uniform increase in the percentage of

dry matter. The difference between the percentage of materials present in the kernels of normal and clipped spikes is necessarily in direct relation to the actual quantities.

TABLE VI.—Average percentage and weight per kernel of dry matter, water, nitrogen, and ash in kernels from normal and clipped spikes of Hannchen barley at Aberdeen, Idaho, in 1916

NORMAL SPIKES									
Date.	Dry matter.	Water.	Nitrogen in dry matter.	Ash in dry matter.	Wet weight per kernel.	Dry weight per kernel.	Water per kernel.	Nitrogen per kernel.	Ash per kernel.
	Per cent.	Per cent.	Per cent.	Per cent.	Mgm.	Mgm.	Mgm.	Mgm.	Mgm.
July 8	20.48	79.52	7.46	1.4	0.3	1.1	0.02
10	18.18	81.82	7.33	3.40	3.8	.7	3.1	0.05	.02
11	19.23	80.77	4.61	4.21	5.8	1.1	4.7	.05	.05
12	19.10	80.90	4.16	5.47	7.4	1.4	6.0	.06	.08
13	22.03	77.97	3.56	4.33	14.9	3.3	11.6	.12	.14
14	22.76	77.24	3.15	3.74	16.0	3.6	12.4	.11	.13
15	23.87	76.13	2.94	3.69	21.9	5.2	16.7	.15	.19
17	28.41	71.59	2.33	3.06	37.1	10.5	26.6	.24	.32
18	31.06	68.94	2.01	3.21	41.7	13.0	28.7	.26	.42
19	32.47	67.53	1.91	3.52	42.3	13.7	28.6	.26	.48
20	33.21	66.79	1.80	3.45	43.5	14.4	29.1	.26	.50
21	36.21	63.79	1.92	2.87	46.9	17.0	29.9	.33	.49
22	38.92	61.08	1.93	2.63	51.2	19.9	31.3	.38	.52
24	42.38	57.62	1.97	2.50	57.3	24.3	33.0	.48	.61
25	47.59	52.41	2.02	2.56	56.5	26.9	29.6	.54	.69
26	43.96	56.04	2.06	2.45	60.6	26.6	34.0	.55	.65
27	51.37	48.63	1.83	2.60	58.3	29.9	28.4	.55	.78
28	50.69	49.31	2.06	2.35	60.2	30.5	29.7	.63	.72
29	50.99	49.01	2.03	2.32	65.8	33.6	32.2	.68	.78
31	56.01	43.99	2.33	2.41	64.4	36.1	28.3	.84	.87
Aug. 1	60.96	39.04	2.17	2.20	61.5	37.5	24.0	.81	.83
2	65.81	34.19	2.07	2.30	51.9	34.2	17.7	.71	.79
3	71.91	28.09	2.25	2.25	52.2	37.5	14.7	.84	.84

CLIPPED SPIKES

July 10	17.8	82.2	5.43	6.63	3.3	0.6	2.7	0.03	0.04
11	19.0	81.0	4.14	4.17	6.7	1.3	5.4	.05	.05
12	28.0	72.0	3.73	4.80	7.8	2.2	5.6	.08	.11
13	21.6	78.4	3.52	4.28	13.8	3.0	10.8	.11	.13
14	23.5	76.5	3.04	4.08	18.3	4.3	14.0	.13	.18
15	24.6	75.4	2.56	3.76	21.6	5.3	16.3	.14	.20
17	29.2	70.8	2.59	3.36	31.9	9.3	22.6	.24	.31
18	30.1	69.9	2.02	3.18	36.4	11.0	25.4	.22	.35
19	32.4	67.6	2.00	2.89	37.1	12.0	25.1	.24	.35
20	35.3	64.7	2.03	3.00	39.8	14.0	25.8	.28	.42
21	39.4	60.6	2.03	2.93	41.9	16.5	25.4	.33	.48
22	38.5	61.5	1.90	3.00	47.1	18.1	29.0	.34	.54
24	43.3	56.7	1.97	2.69	52.9	23.0	29.9	.45	.62
25	47.1	52.9	2.06	2.54	52.3	24.6	27.7	.49	.62
26	47.2	52.8	2.06	2.80	57.4	27.1	30.3	.56	.76
27	51.2	48.8	2.10	2.45	52.6	26.9	25.7	.56	.66
28	52.8	47.2	2.15	2.39	55.6	29.4	26.2	.63	.70
29	52.6	47.4	2.15	2.48	59.6	31.3	28.3	.67	.78
31	58.4	41.6	2.06	2.08	56.4	32.9	23.5	.68	.68
Aug. 1	62.5	37.5	2.17	2.27	55.6	34.8	20.8	.76	.79
2	67.9	32.1	2.24	2.31	49.7	33.7	16.0	.75	.78
3	77.6	22.4	1.98	2.26	43.5	33.8	9.7	.67	.76

The ash was determined in more organs at Aberdeen than at St. Paul. The percentage of ash in the rachis, paleae, and awns is shown in figure 10, as well as the ash in the kernel. The analysis of the other structures throws much light on the problem. The awn contains a surprising amount of ash. At flowering time 10 per cent of its dry weight is ash, while at maturity 33 per cent of the dry weight is ash.

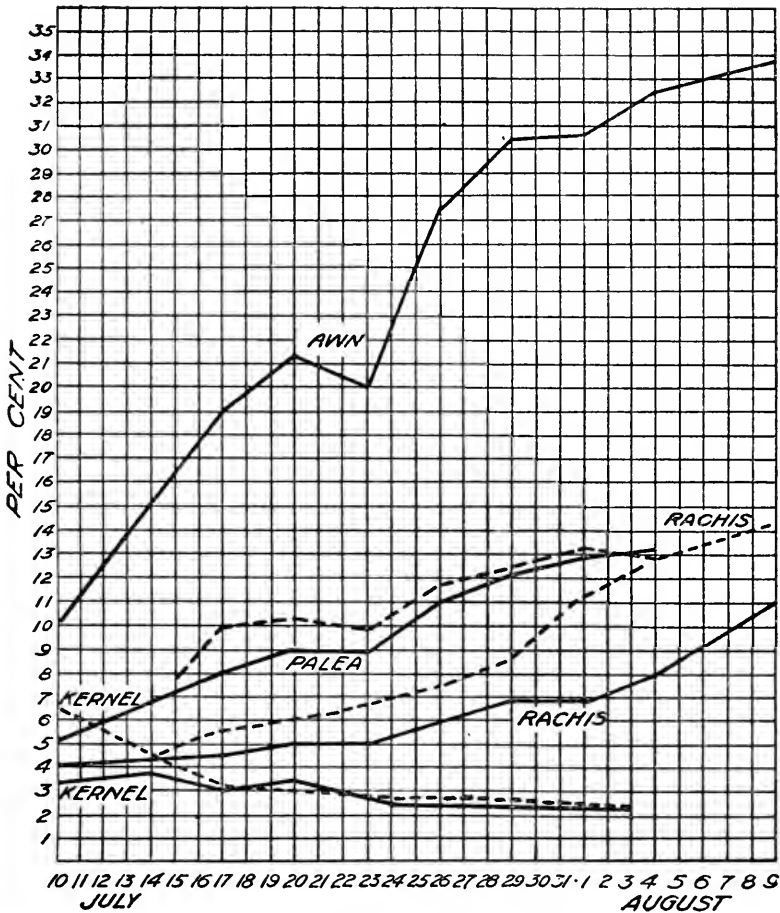

FIG. 10.—Graph showing percentage of ash in the kernels, rachises, paleae, and awns of normal spikes of Hannchen barley and in the kernels, rachises, and paleae of clipped spikes.

The total amount of ash present is considerable. The percentage of ash in the kernels of the clipped spikes is about the same as in those of the normal spikes. The paleae of the clipped spikes contain more ash than those of the normal spikes.

It is in the rachis that the greatest and most significant difference occurs. The rachises of the clipped spikes contain 25 per cent more ash than the rachises of the normal spikes. It would seem that much

of the mineral content that usually goes into the awn remains in the rachis of the clipped spike. These rachises were found to be brittle, while the normal ones were not. Both in Minnesota and in Idaho the clipped spikes had a tendency to shatter, while the normal spikes exhibit

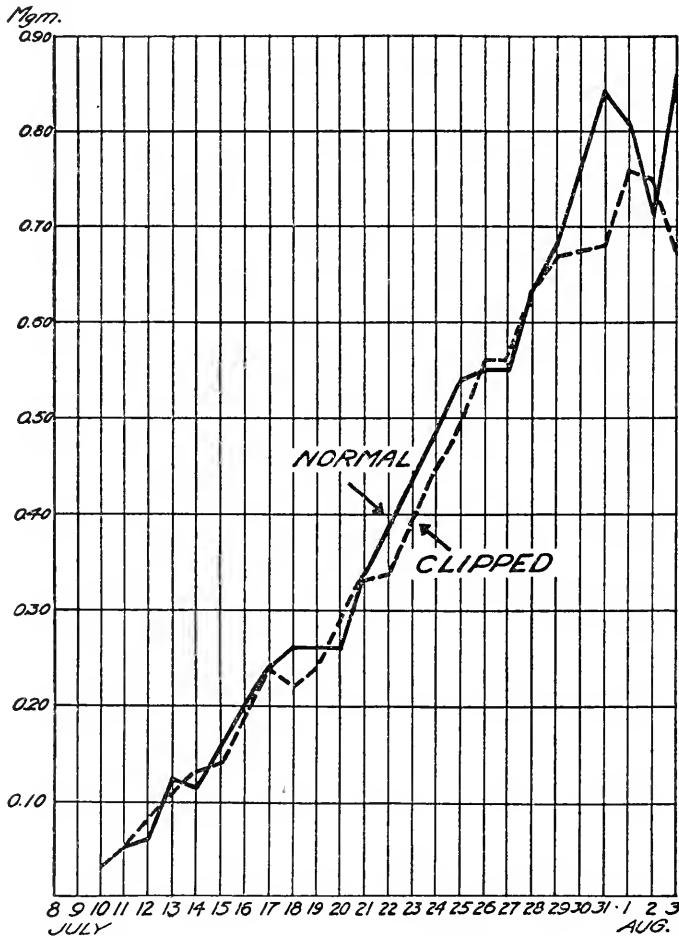

FIG. 11.—Graph showing total nitrogen in kernels of Hannchen barley from normal and clipped spikes.

no such tendency. The divergence in ash content is surprisingly large and widens consistently throughout the period of growth.

The increase in nitrogen per kernel in Idaho is similar to that found in Minnesota. The amount of nitrogen in the kernels from clipped spikes is almost as large as that in the kernels from normal spikes. The average is slightly less, but as a whole the content of nitrogen is nearly equal in the two, as may be seen in figure 11.

The difference in water content shown in figure 12 is more striking at Aberdeen than at Minnesota. After July 15 the kernels from clipped

spikes never contain as much water as those from normal spikes. This is in full accord with the results obtained at St. Paul, but the greater uniformity of the development at Aberdeen emphasizes the difference of behavior by removing the confusion of abnormal samples.

In a preliminary experiment conducted at Arlington Farm, Va., the relation of the length of the awn to the weight of kernel was studied. The awns increase in length from the base of the spike for about one-third the distance to the tip. The spikelets on the upper two-thirds of

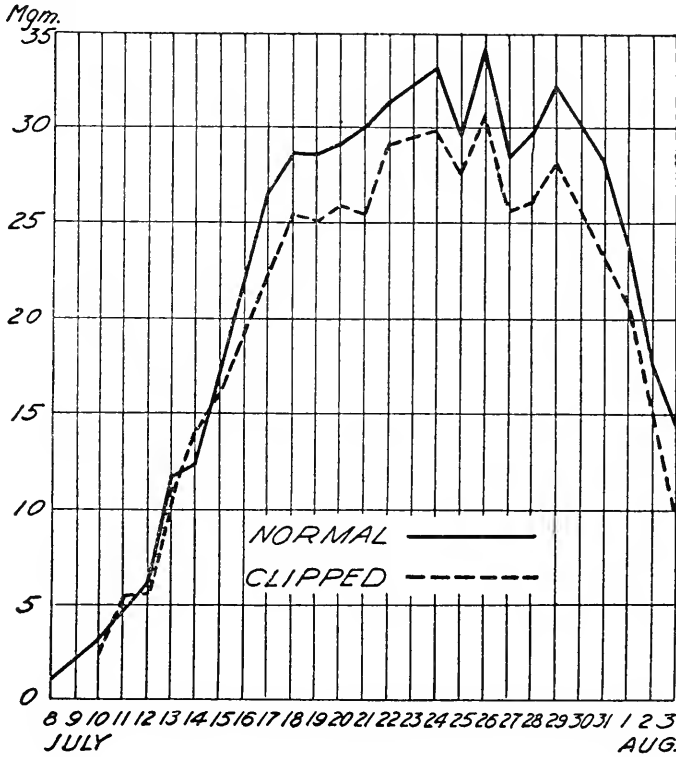

FIG. 12.—Graph showing water in kernels of Hannchen barley from normal and clipped spikes.

the spike exhibit a gradual decrease in awn length, the shorter awn occurring on the apical spikelet.

Figure 13 shows a composite spike resulting from the average of the data obtained. In this case the node numbers include both sides of the spike and are alternate. The weights used are the average of the kernels at two adjacent nodes. It will be seen in the figure that the greatest difference in weight results from the removal of the longest awns. The removal of the short awns near the tip affects the yield only slightly. If the curve of the clipped kernels is taken as showing that the normal peak due to nutrition occurs at about node 9 or 10, the greater length of awn on node 6 is seen to move the peak of the

kernels from awned spikelets nearer to the base of the spike than is the case in the clipped spikelets.

DISCUSSION OF RESULTS

The results in both Minnesota and Idaho have a direct bearing on the two chief field problems in the production of hooded and awnless barleys. These barleys have not yielded as well as the bearded sorts, and they have shattered.

The barleys from which the awns were removed did not give as high yield in these experiments as the awned plants growing beside them. This conforms to the experience of Zoebel and Mikosch, Schmid, Perlitus,

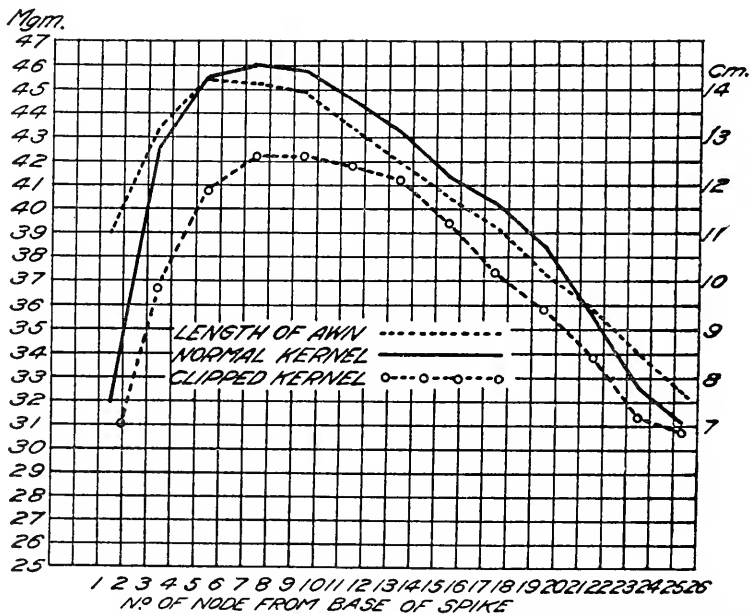

FIG. 13.—Graph showing relation of length of awn to weight of clipped kernels and unclipped spikelets on a 2-rowed barley grown at Arlington Farm, Va.

and some other investigators. In this study it was evident that the reduction in yield was not due to any injury to the plant, as the difference in growth was not apparent for several days after the awns had been removed. The early growth of the kernels in clipped and normal spikes was equally vigorous. It was only when starch infiltration became rapid that the awned spikes showed greater activity. The difference in ultimate weight was largely due to the difference in the quantity of starch present. There was little difference in the quantities of ash and nitrogen. Zoebel and Mikosch looked upon the awn as an organ of transpiration. Whether the reduction of transpiration alone is sufficient to account for the lower rate of starch production is a question. That transpiration has an influence on the behavior of the hooded

barleys is indicated in the field experiments. These barleys have proved relatively better in dry years on the northern plains than in wet years. In the "good" years the hooded varieties have been far inferior to the best bearded sorts, but in "bad" years they often have been better.

In any case, these two experiments show that the awn has a function, and the loss of the awn has resulted in a reduced yield.

The second field problem is that of shattering. The common hooded and awnless varieties have a tendency to shatter at maturity. The clipped spikes of Manchuria and Hannchen barleys showed a tendency in this direction; the normal spikes did not. The spikes from which the awns were removed proved to be fragile, and many of them fell to pieces as maturity approached.

An explanation of this behavior was found in the determination of ash in the awns, rachises, and paleae. The ash that normally went into the awn was deposited largely in the rachis of the clipped spikes. The additional ash seems to have been sufficient to cause the rachis to be brittle. It would seem that the awn also served as a place in which to store the excess of ash. More mineral matter probably is taken up in growth than is needed by the plant. There is no method of elimination. The extra mineral is deposited in cells which probably serve little purpose other than storage. The removal of tissues and organs containing cells which can be devoted to this end must, in itself, cause some derangement of the normal processes of development.

From the experiments conducted, it would seem that awnless and hooded barleys are limited by the loss of the awns. It appears that high yields are not to be expected from such varieties. It is to be expected that such sorts will shatter more than awned kinds. This has been the experience in breeding also. For the most part awnless hybrids have been brittle and of low yielding capacity. It is thought that there is little use in attempting to secure valuable awnless or hooded varieties by means of hybrids with most varieties. One possible method of breeding has been indicated by experiments not yet published. Some varieties of awned barley have normally a much lower content of ash in the rachis than others. It is possible that the progeny of crosses with these and the hooded sorts may yield well in semiarid climates and that they will not shatter. One or two such hybrids are now giving promise.

When the first elementary experiment conducted in Minnesota indicated the physiological difficulties in the way of producing desirable varieties of hooded and awnless barleys, work was amplified in another line. Several hundred hybrids with smooth awns have been produced and tested. Much of this work has been done in the cooperative experiments with the Minnesota Agricultural Experiment Station, but many strains have been tried elsewhere. Several of these give promise of good yielding capacity.

The awns of these hybrids are smooth. All the large scabrous teeth on the basal two-thirds of the awn have been eliminated. The tips of the awns are slightly rough, but this roughness is not sufficient to be objectionable to either growers or feeders of barley. Whether varieties of this type can be made to yield equally as well as the awned sorts remains to be determined.

SUMMARY

The removal of the awns from a barley spike has a marked effect on the development of the kernels of the spike.

Kernels from clipped spikes have smaller volume and a lower weight of dry matter at maturity than do those from normal spikes.

The difference is not due to the injury or shock of removing the awns; the kernels in the clipped spikes develop as rapidly as those in the normal spikes for several days after the awns are clipped.

About one week after flowering the deposit of dry matter in the kernels of the normal spikes begins to exceed that in the kernels of the clipped spikes. This is about the time that rapid starch infiltration begins.

The daily deposit of nitrogen and ash is more nearly equal in the two classes of spikes than is the deposit of starch.

In normal spikes at Aberdeen, Idaho, the awns contained more than 30 per cent of ash at maturity. When the awns were removed a part of this ash apparently was deposited in the rachis. The rachises of the clipped spikes contained about 25 per cent more ash than the rachises of the normal spikes.

The additional ash in the rachises of the clipped spikes probably was responsible for the tendency of these spikes to break. The indications are that the elimination of the awns results not only in lower yields but in shattering as well.

Hooded and awnless barleys generally yield less and shatter more than awned varieties, and there seem to be physiological reasons for this fact.

It may be possible to produce nonshattering hooded and awnless sorts by using parents which normally have a low percentage of ash in the rachises. It may be possible to obtain strains that will give good yields under arid conditions. Under humid conditions it is likely that the objections to the awns are more easily met by the use of strains with smooth awns, which, so far as known at present, have no physiological limitations.

JOURNAL OF AGRICULTURAL RESEARCH

CONTENTS

Investigations in the Ripening and Storage of Bartlett Pears - - - - - Page 473

J. R. MAGNESS

(Contribution from Bureau of Plant Industry)

Further Data on the Orange-Rusts of Rubus - - - 501

L. O. KUNKEL

(Contribution from Bureau of Plant Industry)

Germ-Free Filtrates as Antigens in the Complement-Fixation Test - - - - - 513

WILLIAM S. GOCHENOUR

(Contribution from Bureau of Animal Industry)

Mosaic Disease of Corn - - - - - 517

E. W. BRANDES

(Contribution from Bureau of Plant Industry)

PUBLISHED BY AUTHORITY OF THE SECRETARY OF AGRICULTURE,
WITH THE COOPERATION OF THE ASSOCIATION OF
LAND-GRANT COLLEGES

WASHINGTON, D. C.

**EDITORIAL COMMITTEE OF THE
UNITED STATES DEPARTMENT OF AGRICULTURE AND
THE ASSOCIATION OF LAND-GRANT COLLEGES**

FOR THE DEPARTMENT

KARL F. KELLERMAN, CHAIRMAN
*Physiologist and Associate Chief, Bureau
of Plant Industry*

EDWIN W. ALLEN
Chief, Office of Experiment Stations

CHARLES I. MARLATT
*Entomologist and Assistant Chief, Bureau
of Entomology*

FOR THE ASSOCIATION

J. G. LIPMAN
*Dean, State College of Agriculture, and
Director, New Jersey Agricultural Experiment
Station, Rutgers College*

W. A. RILEY
*Entomologist and Chief, Division of Entomology
and Economic Zoology, Agricultural
Experiment Station of the University
of Minnesota*

R. L. WATTS
*Dean, School of Agriculture, and Director,
Agricultural Experiment Station, The
Pennsylvania State College*

All correspondence regarding articles from the Department of Agriculture should be addressed to Karl F. Kellerman, Journal of Agricultural Research, Washington, D. C.

All correspondence regarding articles from State Experiment Stations should be addressed to J. G. Lipman, New Jersey Agricultural Experiment Station, New Brunswick, N. J.

JOURNAL OF AGRICULTURAL RESEARCH

VOL. XIX

WASHINGTON, D. C., AUGUST 16, 1920

No. 10

INVESTIGATIONS IN THE RIPENING AND STORAGE OF BARTLETT PEARS¹

By J. R. MAGNESS²

Scientific Assistant, Horticultural and Pomological Investigations, Bureau of Plant Industry, United States Department of Agriculture

INTRODUCTION

Physiological studies carried on in connection with the development, ripening, and storage of the Bartlett pear reveal the fact that the factors involved are somewhat different from those connected with the handling of most other fruits. Pears of this variety are not usually allowed to ripen on the tree but are picked as soon as they have attained suitable size for marketing and have reached the condition at which experience has shown they will ripen off the tree without shriveling. The exact tests and sizes that are usually used to determine this degree of development vary somewhat in different sections. Usually no fruit is harvested until it reaches $2\frac{1}{4}$ to $2\frac{3}{8}$ inches in diameter; and such factors as the ease with which the stem separates from the branch, the plumpness of the fruit, or the degree to which the blossom end is smoothly rounded out, the extent to which the sides of the locules or seed cavities have drawn away from the seeds, and the depth to which the tissue crushes when pressed in by the finger are used to determine when the fruit has developed sufficiently to ripen in good condition if removed from the tree. Bartlett pears, when "ripe" off the tree, become soft and full yellow in color. This is the condition referred to by the term "ripe" in this paper.

In the Rogue River district of Oregon a mechanical pressure test (*g*)³ has been used to some extent during the past year to determine the time of picking, but in the other pear districts of the Pacific coast the methods enumerated above have been followed.

If the pears are left on the trees until they are fully ripe, they are of a very inferior quality. Very often the inside is soft and decayed before

¹ This paper gives the result of a portion of the work carried on under the project "Factors Affecting the Storage Life of Fruit."

² The writer wishes to express appreciation to W. S. Ballard, Pathologist, United States Department of Agriculture, for the use of apparatus and for many helpful suggestions.

³ Reference is made by number (*italic*) to "Literature cited," pp. 499-500.

the outside becomes yellow; or, if the inside does remain sound, it becomes coarse and granular and has a very inferior texture.

However, in most sections there is a period of from six weeks to over two months between the time at which the first commercial picking is now made and the time the fruit becomes ripe on the tree. Consequently, there is a possibility of considerable variation in the time at which the fruit may be removed from the tree in a green, firm condition and still ripen without shriveling. A consideration of these facts shows the importance of knowing what effect removing the fruit from the tree at varying times has on the keeping quality and on the comparative chemical composition from which the food value and eating quality may be judged.

REVIEW OF LITERATURE

Of much interest in this connection is the work of various investigators who have studied the chemical composition of pears. Some studies have been made of the influence of various environmental factors on the chemical composition of the fruit, which are of sufficient interest to warrant discussing in some detail.

Kulisch (7) concluded, among other things, that the age and shape of the tree and the size of the crops borne have an effect on the composition of the fruit. He found higher sugar content and larger size of fruit correlated in trees that had a light crop as compared to those with a heavy yield. He suggests that with a light crop there is an abundance of carbohydrate material for the full development of the fruit, while a heavy crop tends to draw from other organs of the tree, and even then the crop is cut down in size by an insufficient amount of carbohydrate material.

Ewert (4), in studying the influence on the fruit of the presence of well-developed seeds as compared to parthenogenetic fruit, made analyses of both kinds in several varieties of pears at intervals just previous to and including the time of ripening. In the late fall varieties with which he worked he found a marked increase in sugar as both seeded and seedless pears approached maturity, while the acids appeared to fluctuate somewhat. He found very little starch present in either seeded or seedless fruit. Cane sugar was very rarely present in ripe pears in the varieties studied. He found no very marked and constant differences due to the presence or absence of seeds, the results in this respect apparently varying with the variety.

Kelhofer (6) analyzed the various portions of the fruit of one variety, Siebenmannsbienen, for sugar, acid, and tannin. He found both sugar and acid to be higher in the central flesh portion as compared to the outer or peel region and the inner or core region. The greatest amount of tannin was in the outside or peel region, and there was very little in the core region. Analyses at succeeding dates from time of picking until soft ripe show a slight gain in sugars, a marked loss in acid, and a very marked

loss in tannin material. Analyses of the blossom-end, central, and stem-end portions of the fruit showed slightly more of both sugar and acid in the blossom end, with a slight decrease in the middle and somewhat greater decrease in the stem-end regions.

Ritter (11) carried on numerous investigations in the ripening processes of fruit. He found that growing fruit in the dark, so long as the fruit only was darkened, had no effect on the chemical composition; but where the surrounding branches and leaves were kept in darkness or semidarkness, there was a marked reduction, not only in carbohydrates but also in most of the other compounds in the fruit. His figures, however, are based on total grams of the various substances rather than on a percentage basis. He records a progressive increase in the amount of sugar present at successive dates throughout the season and a corresponding decrease in acid. These conclusions are based on work with several varieties of apples and pears.

Riviere and Bailasche (12) also record an increase in sugar and a decrease in acid in pears, based on analyses at intervals from June until the fruit is ripe. They found further (13) that defoliating spurs decreased the size of the fruit while the defoliation decreased the sugar content and increased the acid content slightly.

Analyses of pears have been made to a limited extent in this country. Dunbar and Bigelow (3) determined the acid present in a number of fruits, concluding that in Bartlett, Idaho, Le Conte, and Kieffer pears citric acid predominates, while for all other varieties malic is the main acid present.

Thompson and Whittier (17) identified and determined the proportion of the sugars present in a large number of fruits. In Bartlett pears they found levulose to predominate, with some sucrose and a relatively small percentage of glucose. They found, however, that the relative amounts of the various sugars present varied with the state of maturity of the fruit when analyzed.

Recently Cruess and Stone (2) made rather detailed studies in connection with Bartlett pear ripening in California. Fruit was secured from several sections of California at intervals during the picking season and was tested for size, soluble solids (Balling test), acids, starch, length of time to ripen from date of picking, and general quality of the ripened product. In general, the later pickings gave a slightly higher Balling reading than the earlier ones, and the same lots gave a somewhat higher reading when ripe than when fresh picked from the tree. The acid test tended to fluctuate a great deal, so much so that it is rather hard to see a correlation between time of picking and acidity. The amount of starch present in the last pickings, as shown by the iodine test, did not seem to be appreciably less than in the earlier pickings. There was a progressive shortening of the time required to ripen the fruit when stored at a constant temperature of 68° F. It was concluded, as a result of a season's work,

that Balling and starch tests were not satisfactory as a means of determining the proper picking conditions for pears.

Considerable work has been done in connection with the storage of Bartlett pears, and the effects of temperatures of storage and the methods of handling are fairly well established. Powell and Fulton (10) investigated the effect of storing of Bartlett and Kieffer pears under different temperatures and with different methods of handling. The Bartletts were grown in western New York. The effect of wrapping was tested, and temperatures of 32° and 36° F. were used for storage. Storing immediately, as compared to leaving four days out of storage, was also tried. Fruit stored within 48 hours at 32° kept in prime condition for six weeks, while that delayed four days showed considerable loss in the same length of time. Bartlett pears stored at 32° kept longer and in much better condition than those stored at 36°. Small, well-ventilated packages gave better results than barrels. Wrapped fruit kept in better condition than unwrapped lots. It was found that if the fruit is not too ripe when removed from low temperature storage it will remain sound as long after being removed as will fruit in the same degree of maturity that has not been stored at low temperatures.

Stubenrauch and Ramsey (15), working with precooling and storage in the Rogue River Valley of Oregon, picked fruit at three different stages of maturity, packed it, and placed it in a precooling room at 20° F. The room was held at this temperature until the outer fruit in the packages reached 32°; then the room temperature was allowed to rise to 30° or 32°. Their conclusions were that the later picks gave much less physiological decay than the earlier ones, and that by allowing the fruit to remain on the trees fully two weeks longer than was usually done it is possible to hold fruit in storage four weeks at the temperature indicated, if stored promptly, then to ship in iced refrigerator cars and still have the fruit reach the market in good condition. At least 12 to 14 days are required to market fruit from the Rogue River Valley section, if the destination is Atlantic coast cities.

Lewis, Magness, and Cate (8) carried on picking and storage investigations in the Rogue River Valley during the summer of 1916. Bartlett pears from three orchards were picked at frequent intervals and the lots divided for the following types of storage: At 70° F. in both humid and dry, or ventilated, storage; at about refrigerator-car temperature, or from 50° to 60°; and in cold storage at 32° and 36°. The results obtained show that in the Rogue River Valley there is a marked increase in size of fruit from week to week even during the picking season, and delaying picking increased the size very markedly. The later pickings were of the highest quality when ripened up. There was a direct correlation between low temperature and length of storage season. A temperature of 32° gave a much longer period during which the fruit remained in good condition than did 36°, while 50° to 60° and 70° gave correspondingly shorter

storage seasons. For storage at 60° or above—that is, common storage—the earliest pickings gave the longest storage season; but when the lower temperature was used the maximum season was obtained in the later picks of more fully matured fruit. This agrees with Stubenrauch and Ramsey in their precooling work. No important correlation could be established between specific gravity of the juice and time of picking, or between starch, as shown by iodine test, and time of picking. Chemical analyses for sugar, acid, and moisture, made under rather unfavorable conditions, were also rather conflicting in results but showed a tendency toward an increase in sugar as the season advanced.

Further work (16) carried on in the Rogue River region gave further detailed evidence of marked increase in size of the fruit during the picking season. The influence of time of picking and temperature of storage upon keeping quality correlated closely with that obtained the year before. A “pressure test,” or the measure of the amount of pressure necessary to make a depression of certain size in a pear at various stages of development and maturity was followed through the season; and a marked correlation was established between the time of picking and the resistance of the fruit to pressure, the resistance growing less the longer the fruit remained on the tree.

Some work has been done recently on the effect of storing Bartlett pears at high temperature. Shamel (14) placed a box of pears in a lemon-curing room, held at a temperature of about 90° F. and at a humidity averaging 85° to 90°. The pears kept perfectly and without ripening for a month. Upon removal from the storage they ripened normally and were of good quality. Shamel attributed these results to the high humidity.

Taylor and Overholzer (16), following Shamel's work, stored small lots of Bartletts at temperatures ranging from 69° to 104° F., with one lot at 32° storage as a control. High humidity and normal dryness of air were compared at each temperature. Fruit held at 69° to 85° ripened most quickly. When the storage temperature was above 85°, the ripening of the fruit was retarded. Fruit stored at 104° was two to three weeks later in ripening than that stored at 85°. Humidity had no effect other than that of preventing shriveling at the high temperatures.

From a summary of all the storage work that has been done on Bartlett pears it is apparent that the lower the temperature used, down to 31° or 32° F.—the lowest temperatures of storage used in these experiments—the longer the storage season will be. Most rapid ripening is attained at a temperature of 70° to 80°, while either higher or lower temperatures tend to retard ripening. It is not definitely known just why these higher temperatures should retard ripening, but it is of interest to note that many of the processes concerned with the ripening of fruit are chemical reactions brought about by enzyme action. It is well known that there are minimum, optimum, and maximum temperatures for enzyme

action; and it is an interesting possibility that the temperatures which retard ripening may be sufficient to inhibit enzymes. It is well known that plant growth, in which many of the processes are similar to those in the ripening fruit, is inhibited by high temperatures.

From the foregoing summary of the work that has been done on pear ripening and storage it is apparent that for the varieties tested there has generally been found an increase in sugars as the season advanced. The data regarding acid are rather more conflicting. The work on storage and time of picking of Bartletts has shown that the later pickings have given a longer low temperature storage season and a higher quality in the ripened product.

In this investigation it has been the purpose to make a careful study of the changes that take place in Bartlett pears from the Pacific coast regions during the time they are developing, including the commercial picking season and extending somewhat beyond it. The effect of the time of removing the fruit from the tree on its content of acid, sugar, starch, and moisture has been studied. It has also been the purpose to determine the changes that take place in the fruit between the time of picking from the tree and the time the fruit is in prime eating condition—that is, soft and full yellow ripe—and to see if the temperature at which the fruit is held during ripening has any appreciable effect upon its composition.

The principal part of the work was carried on with fruit from two important pear sections of California. One lot was secured from an orchard at Sacramento. This orchard is typical of the large Sacramento River pear district and is grown on reclaimed, irrigated soil adjacent to the river. The summer here is warm and dry, but abundant water is available for irrigation.

Fruit from a ranch near Suisun, Calif., was also used. This section is slightly higher and nearer the coast than the Sacramento district. Fruit from this section is quite representative of much of the central California pear region away from the Sacramento River. Fruit from both of these orchards was picked at frequent intervals from early June, almost a month before commercial picking started, until after the close of the shipping season.

For purposes of comparison, fruit was secured from Medford, Oreg. This is representative of well-grown fruit on heavy soil in a typical irrigated Rogue River Valley orchard. Three boxes were secured from this orchard, one picked July 19, about 18 days before commercial picking started, one August 8, representing the beginning of the shipping season, and one August 28, at the end of the shipping season for Bartletts.

Fruit was also secured from the Selah section of the Yakima Valley, Wash. The first fruit from this section was picked July 28, 1919, followed by a shipment August 13, at the beginning of the shipping

season. Fruit picked August 23 was representative of the late shipments. Because of trouble from the fruit breaking down while in transit in former years, shippers from this section endeavored to reduce the later shipments to a minimum, and much of the late fruit was marketed through the canneries. This accounts for the relatively short shipping season in this section.

The fruit was picked, packed, and shipped by express to the laboratory at Watsonville, Calif. Fruit from Suisun usually arrived in 1 day, from Sacramento in $1\frac{1}{2}$ days, from Medford, Oreg., in 2 days, and from Selah, Wash., in 4 days. Consequently, a somewhat longer time elapsed between the time of picking and time of storing the Washington pears than was the case with other districts.

As soon as the fruit arrived at the laboratory, each picking was divided into four lots. One lot was sampled for immediate analysis, while the remaining three were placed in storage until ripe. One of these was held at from 65° to 70° F., approaching the temperature at which pears ripen most quickly. One was stored at a fluctuating temperature of 34° to 50° , averaging a little above 40° . This is not far from representative of conditions in an iced refrigerator car in transit, although at a slightly lower temperature. The third lot was held at a temperature ranging from 28° to 32° and representing about the minimum temperature at which the pears could be held without the formation of ice in the fruit. The average temperature was slightly below 30° , though some of the time it was down to 28° , with no apparent bad results. It was impossible to allow the fruit to reach full maturity in this storage because of the length of time it would require, so part of all lots was removed October 14, after being from $1\frac{1}{2}$ to $3\frac{1}{2}$ months in storage. It was allowed to ripen at laboratory temperature and was analyzed.

In this way it has been possible to get a comparison between fruit when it is fresh picked from the tree and the same lot of fruit when ripened at temperatures approximating 70° , 40° , and 30° F. In planning the work it was not the thought to develop the storage phase primarily, but it has been possible to compare the length of the storage season with results attained by other investigators.

ANALYTICAL METHODS

SAMPLING.—A sample comprising portions of 15 pears was used for each lot. The fruit was first halved longitudinally and then a section from two opposite sides was removed, the cut being made from the core outward so that a fair proportion of the tissue from all the different regions of the fruit was secured. Any adhering portions of core were removed, and the peel was taken off with as little of the fleshy portion as possible. Sections of sufficient size were taken from each of the 15 pears to make a composite sample of over 300 gm.

The whole sample was then run through a sampling press, constructed on the principle described by Clark (16). In this press the tissue was forced through fine perforations which left it in a finely divided state. It was then very thoroughly mixed by stirring and carefully weighed out in six 50-gm. portions. By this method there is a very slight loss in moisture due to evaporation; but by working as rapidly as possible after the sample is run through the press this loss is reduced to a minimum and is closely comparable in all cases. The method of sampling employed was very satisfactory from the standpoint of giving close checks on such duplications as were run.

SUGARS AND ACID-HYDROLYZABLE REDUCING MATERIAL.—Duplicate samples were prepared for these determinations, but only one was run through. The 50-gm. samples were covered with about 100 cc. of 95 per cent alcohol, 3 to 5 drops of ammonia were added to neutralize the acid, then the samples were immediately put on the steam bath and boiled vigorously for a few minutes. Most of the excess ammonia was driven off by the boiling. Preliminary tests of glucose solution treated in this manner with dilute ammonia showed no measurable breaking down of the sugar. The alcohol was then filtered off through an alundum thimble, and the sample was extracted with alcohol in a Soxhlet extractor for about 12 hours. The extract was then added to the original alcohol filtrate, and the sample was made up to 500 cc. with distilled water. Fifty cc. of this were cleared with neutral lead acetate and were made up to 250 cc. The excess lead was removed, and the sugars were determined in 20 cc. of the cleared solution, according to Mathews's¹ modification of Munsen and Walker's and Bertrand's methods. Duplicate titrations with permanganate solution were checked to within 0.2 cc.

Fifty cc. of the cleared solution were inverted in 3.5 per cent hydrochloric-acid solution, standing about 20 hours at room temperature. The total reducing substances were then determined in this solution.

The residue in the thimble from the Soxhlet extraction was removed quantitatively, was dried, and 125 cc. of 2.5 per cent hydrochloric acid were added for hydrolysis by the modified Sachsse method.² Reducing substances were determined as outlined above and were figured as dextrose. This alcohol-insoluble acid-hydrolyzable material probably consists mainly of starch, galactans, hemicelluloses, and pectin in the green fruit fresh from the tree. In the ripe fruit there is no starch present, as shown by the iodine test, and the reducing material must come almost entirely from such sources as the galactans, hemicelluloses, and pectins. Much of the reducing material

¹ MATHEWS, A. P., *PHYSIOLOGICAL CHEMISTRY*...ed. 2, p. 994. New York, 1916.

² WILEY, H. W., ed. *OFFICIAL AND PROVISIONAL METHODS OF ANALYSIS, ASSOCIATION OF OFFICIAL AGRICULTURAL CHEMISTS*. As compiled by the committee on revision of methods. U. S. Dept. Agr. Bur. Chem. Bul. 107 (rev.), p. 53. 1908.

formed may be pentoses, but calculating all reducing substances as dextrose gives a satisfactory comparison.

ACID.—Two 50-gm. portions of the sample were weighed into beakers, about 150 cc. of distilled water were added, and this was immediately boiled to render the cells permeable. After the portions cooled they were made up to 500 cc., 2 cc. of toluol were added to each as a preservative, and they were allowed to stand with frequent shaking for 3 days. One hundred cc. of the supernatant liquid were then drawn off for titration with *N/10* sodium hydroxid. Duplicate samples made by this method checked very closely.

DRY WEIGHTS.—Two 50-gm. samples were weighed directly into evaporating dishes. These were then dried down on the steam bath sufficiently to prevent growth of microorganisms; then when a sufficient number accumulated, they were put in a vacuum oven at 70° F., dried five days, removed and weighed, then returned to the oven for two days. During the last two days the decrease in weight was about 50 mgm.; but, since all lots were run in exactly the same manner, the results are closely comparable. All dry weight determinations were made in duplicate, and the figures presented are averages. While considerable variation occurs in successive determinations, duplicates in all cases checked very closely.

PRESENTATION OF DATA

The results of all the analyses are summarized in Tables I to IV. Table I includes all the data of fruit from the Sacramento orchard, Table II those from the Willota Orchard at Suisun, Calif., Table III those from Medford, Oreg., and Table IV those from Yakima, Wash.

TABLE I.—Chemical analyses of Bartlett pears from Sacramento River Valley, Calif., in 1919

Lot No.	Date of picking.	Acid as malic.			Reducing sugar as glucose.			Total sugar as glucose.			Alcohol-insoluble, acid-hydrolyzable substances as glucose.			Dry weight.		
		Green fruit.	Same lot ripe after storage.		Green fruit.	Same lot ripe after storage.		Green fruit.	Same lot ripe after storage.		Green fruit.	Same lot ripe after storage.		Green fruit.	Same lot ripe after storage.	
			70° F.	40° F.		30° F.	70° F.		40° F.	30° F.		70° F.	40° F.		30° F.	70° F.
1	June 12	P. ct.	P. ct.	P. ct.	P. ct.	P. ct.	P. ct.	P. ct.	P. ct.	P. ct.	P. ct.	P. ct.	P. ct.	P. ct.	P. ct.	P. ct.
2	June 18	0.3445	0.2561	0.2992	3.70	6.28	5.11	4.32	7.15	5.61	3.76	2.15	2.37	16.60	16.93	15.86
3	July 5	0.3386	0.3334	0.2869	3.86	6.55	5.03	4.40	7.40	6.13	3.85	1.94	1.96	16.57	15.87	14.99
4	July 12	0.3666	0.3899	0.3198	5.49	7.33	6.31	6.00	8.37	7.00	3.77	1.67	1.99	16.03	15.72	15.20
5	July 23	0.3328	0.4084	0.3378	5.53	7.43	6.50	6.07	8.34	7.05	3.40	1.71	1.99	16.17	15.71	15.94
6	Aug. 13	0.3258	0.3954	0.3278	6.25	7.39	6.40	6.65	8.87	7.33	2.73	1.56	1.87	16.02	15.98	15.54
		0.2568	0.2630	0.2554	7.12	7.64	7.70	8.35	10.10	9.40	2.36	1.20	1.24	17.37	15.98	17.15

TABLE II.—Chemical analyses of Bartlett pears from Suisun, Calif., in 1919

Lot No.	Date of picking.	Acid as malic.			Reducing sugar as glucose.			Total sugar as glucose.			Alcohol-insoluble, acid-hydrolyzable substances as glucose.			Dry weight.		
		Green fruit.	Same lot ripe after storage.		Green fruit.	Same lot ripe after storage.		Green fruit.	Same lot ripe after storage.		Green fruit.	Same lot ripe after storage.		Green fruit.	Same lot ripe after storage.	
			70° F.	40° F.		30° F.	70° F.		40° F.	30° F.		70° F.	40° F.		30° F.	70° F.
1	June 10	P. ct.	P. ct.	P. ct.	P. ct.	P. ct.	P. ct.	P. ct.	P. ct.	P. ct.	P. ct.	P. ct.	P. ct.	P. ct.	P. ct.	P. ct.
2	July 1	0.4288	0.3176	0.3215	2.48	4.55	3.62	3.20	5.05	4.04	3.87	2.95	3.05	16.08	17.58	17.72
3	July 10	0.3100	0.3106	0.2264	4.79	7.01	4.87	5.20	6.67	5.38	3.70	2.13	1.76	15.56	16.39	14.18
4	Aug. 22	0.2402	0.2670	0.2148	5.75	8.05	6.37	6.37	8.90	7.60	3.66	1.99	1.99	17.63	18.08	18.08
5	Aug. 6	0.3301	0.2486	0.2107	6.34	7.45	6.45	6.00	9.05	7.70	2.94	1.56	1.59	16.61	16.46	15.83
					6.78	7.63	6.95	8.22	9.98	8.67	1.79	1.04	1.18	15.50	17.31	15.40

TABLE III.—Chemical analyses of Bartlett pears from Rogue River Valley, Oreg., in 1919

Lot No.	Date of picking.	Acid as malic.		Reducing sugar as glucose.		Total sugar as glucose.		Alcohol-insoluble, acid-hydrolyzable substances as glucose.		Dry weight.		
		Green fruit.	Same lot ripe after storage.	Green fruit.	Same lot ripe after storage.	Green fruit.	Same lot ripe after storage.	Green fruit.	Same lot ripe after storage.	Green fruit.	Same lot ripe after storage.	
												70° F.
1.....	July 19	P. ct. 0.3249	P. ct. 0.2798	P. ct. 5.59	P. ct. 6.60	P. ct. 6.97	P. ct. 7.15	P. ct. 7.60	P. ct. 1.55	P. ct. 1.64	P. ct. 15.50	P. ct. 15.91
2.....	Aug. 8	P. ct. 0.3263	P. ct. 0.3039	P. ct. 6.29	P. ct. 7.41	P. ct. 6.95	P. ct. 7.33	P. ct. 8.72	P. ct. 1.03	P. ct. 1.41	P. ct. 15.27	P. ct. 16.10
3.....	Aug. 28	P. ct. 0.3570	P. ct. 0.3516	P. ct. 7.95	P. ct. 7.87	P. ct. 7.98	P. ct. 9.35	P. ct. 10.00	P. ct. 1.35	P. ct. 1.44	P. ct. 17.70	P. ct. 17.95

TABLE IV.—Chemical analyses of Bartlett pears from Yakima Valley, Wash., in 1919

Lot No.	Date of picking.	Acid as malic.		Reducing sugar as glucose.		Total sugar as glucose.		Alcohol-insoluble, acid-hydrolyzable substances as glucose.		Dry weight.		
		Green fruit.	Same lot ripe after storage.	Green fruit.	Same lot ripe after storage.	Green fruit.	Same lot ripe after storage.	Green fruit.	Same lot ripe after storage.	Green fruit.	Same lot ripe after storage.	
												70° F.
1.....	July 28	P. ct. 0.2790	P. ct. 0.2385	P. ct. 4.95	P. ct. 5.05	P. ct. 5.38	P. ct. 6.50	P. ct. 6.50	P. ct. 1.24	P. ct. 1.51	P. ct. 14.40	P. ct. 14.22
2.....	Aug. 13	P. ct. 0.3510	P. ct. 0.3335	P. ct. 6.35	P. ct. 6.74	P. ct. 6.80	P. ct. 7.70	P. ct. 8.20	P. ct. 1.29	P. ct. 1.49	P. ct. 15.70	P. ct. 15.05
3.....	Aug. 23	P. ct. 0.4435	P. ct. 0.4300	P. ct. 7.43	P. ct. 7.50	P. ct. 9.07	P. ct. 8.65	P. ct. 9.35	P. ct. 1.29	P. ct. 1.38	P. ct. 16.88	P. ct. 17.24

For purposes of comparison and discussion, however, the results are also presented as a series of curves, in which it is possible to bring similar substances under the varied treatments into direct comparison.

INFLUENCE OF TIME OF PICKING UPON SUGAR CONTENT OF FRUIT

Figures 1 to 4, inclusive, summarize the data on the development of sugars in the fruit at the various intervals at which pickings were made

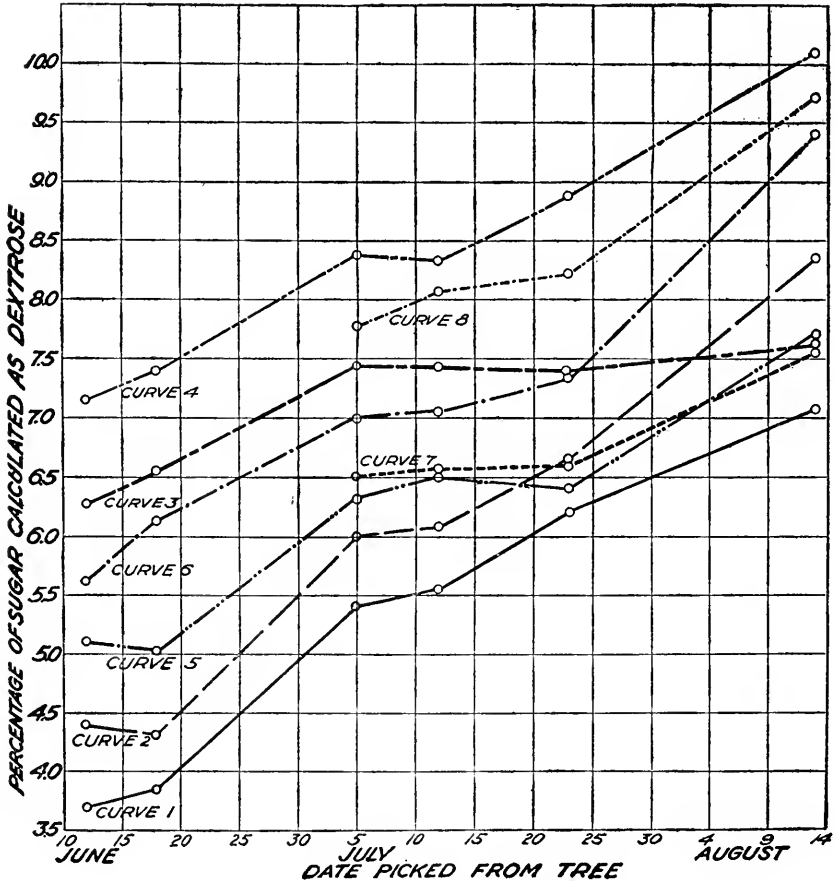

FIG. 1.—Sugars in Bartlett pears from Sacramento, Calif.: Curve 1, reducing sugars in green fruit when picked from the tree; curve 2, total sugars in green fruit when picked from the tree; curve 3, reducing sugars in collateral lots after ripening at 70° F.; curve 4, total sugars in collateral lots after ripening at 70°; curve 5, reducing sugars in collateral lots after ripening at 40°; curve 6, total sugars in collateral lots after ripening at 40°; curve 7, reducing sugars in collateral lots after ripening at 30°; curve 8, total sugars in collateral lots after ripening at 30°.

and the influence of various types of storage upon the sugar content of the fruit picked at these same intervals. Curve 1 in each figure represents the reducing material present, figured to percentage of green weight in the fruit fresh picked from the tree. According to Thompson

and Whittier (17) this consists mainly of levulose, but it has been figured as dextrose here because comparative results are of primary interest. Curve 2 represents the total sugar or reducing material after inversion, so that the distance between curves 1 and 2 represents the amount of

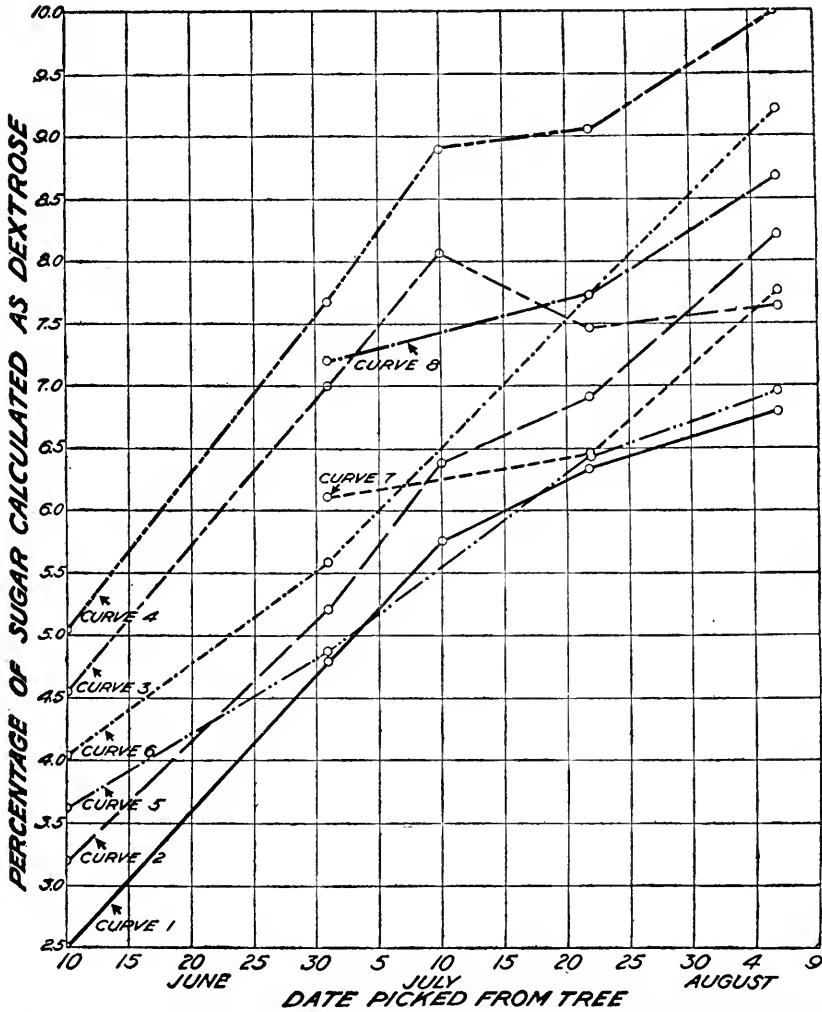

FIG. 2.—Sugars in Bartlett pears from Suisun, Calif.: Curve 1, reducing sugars in green fruit when picked from the tree; curve 2, total sugars in green fruit when picked from the tree; curve 3, reducing sugars in collateral lots after ripening at 70° F.; curve 4, total sugars in collateral lots after ripening at 70°; curve 5, reducing sugars in collateral lots after ripening at 40°; curve 6, total sugars in collateral lots after ripening at 40°; curve 7, reducing sugars in collateral lots after ripening at 30°; curve 8, total sugars in collateral lots after ripening at 30°.

sucrose present. There is in every case a marked increase in the amount of reducing sugar present at successive dates of picking. This increase is somewhat more rapid early in the season, although a distinct increase occurs as long as any pickings are made. It is unfortunate that it was

impossible to secure even later pickings to see if this increase in reducing sugar continues until the fruit is fully ripe on the tree.

The amount of sucrose remains nearly constant at less than 1 per cent throughout the early season. In the late season there was an increase in the amount of sucrose to $1\frac{1}{2}$ per cent in the late picks of California

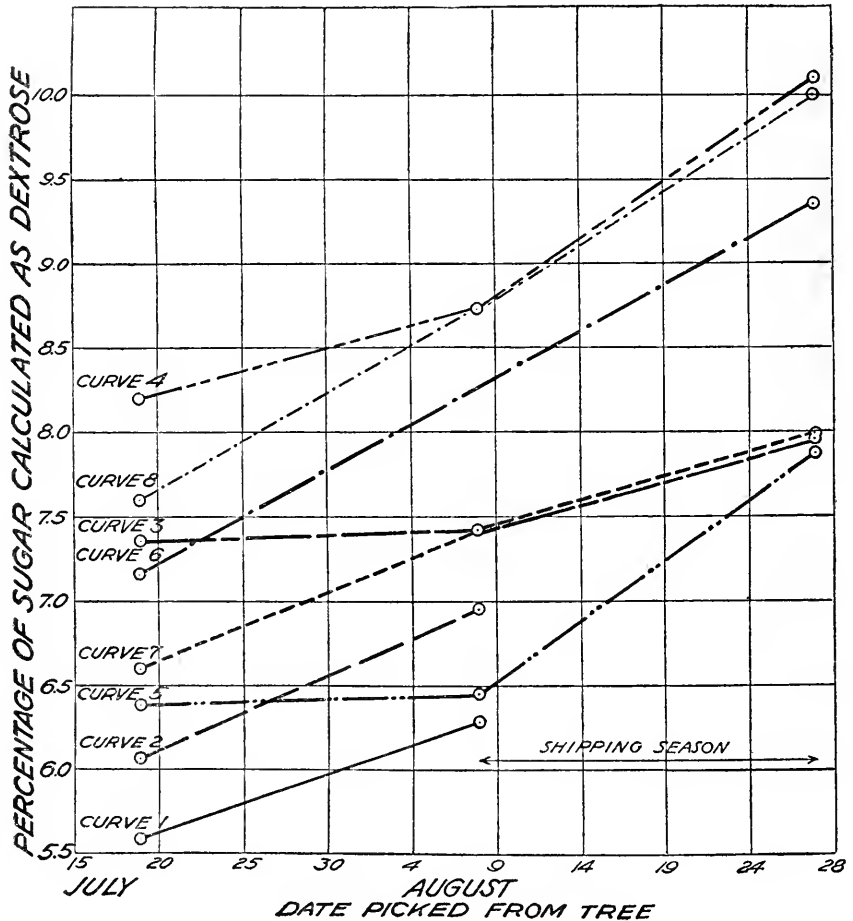

FIG. 3.—Sugars in Bartlett pears from Medford, Oreg.: Curve 1, reducing sugars in green fruit when picked from the tree; curve 2, total sugars in green fruit when picked from the tree; curve 3, reducing sugars in collateral lots after ripening at 70° F.; curve 4, total sugars in collateral lots after ripening at 70° ; curve 5, reducing sugars in collateral lots after ripening at 40° ; curve 6, total sugars in collateral lots after ripening at 40° ; curve 7, reducing sugars in collateral lots after ripening at 30° ; curve 8, total sugars in collateral lots after ripening at 30° .

fruit. The increase in sucrose in the late pickings is such that the increase in total sugar shows no falling off in rate up to the date of the last pickings secured. The less rapid increase in reducing sugar is counteracted by the increase in sucrose.

Curves 3 and 4 in each figure represent reducing and total sugar, respectively, when the fruit reached prime eating condition in a storage

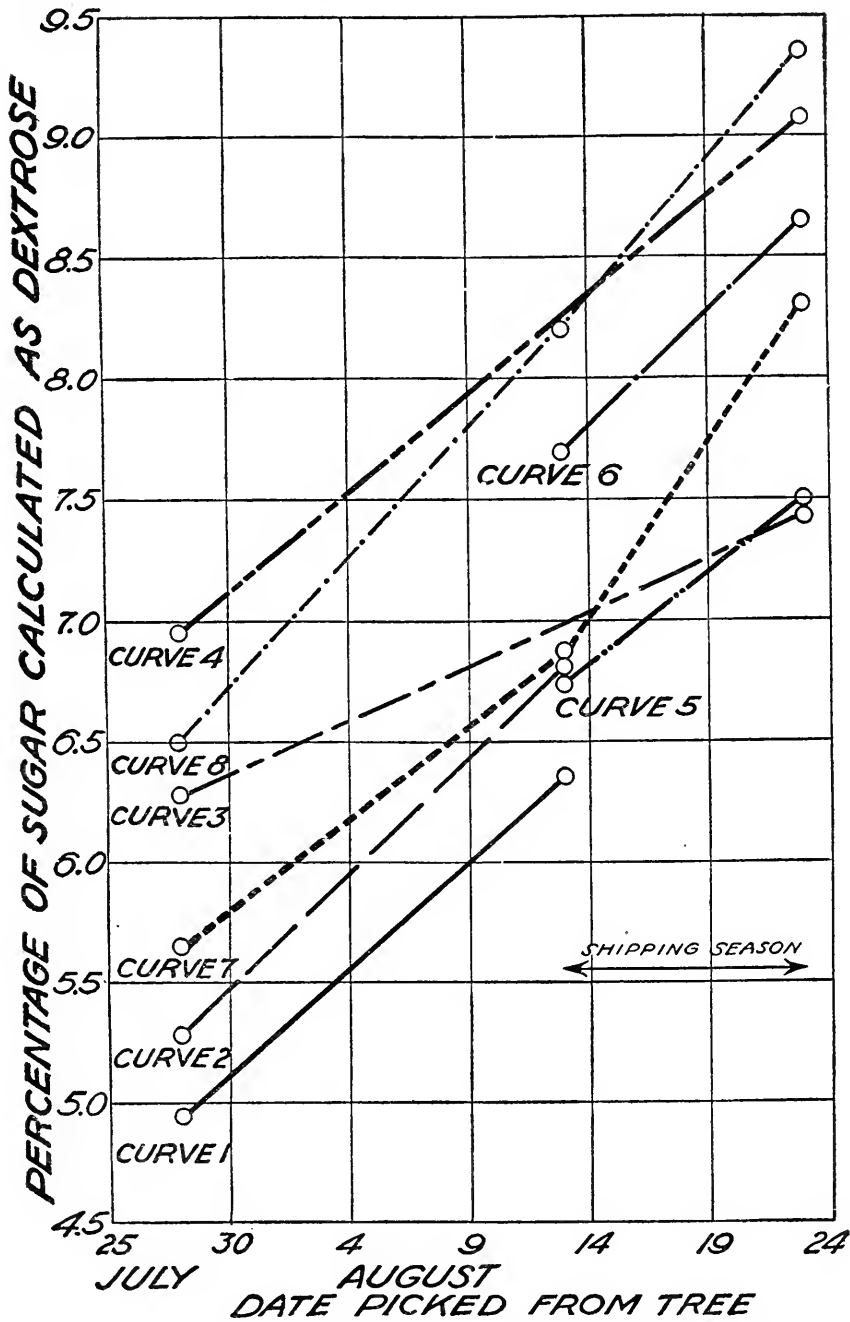

FIG. 4.—Sugars in Bartlett pears from Yakima, Wash.: Curve 1, reducing sugars in green fruit when picked from the tree; curve 2, total sugars in green fruit when picked from the tree; curve 3, reducing sugars in collateral lots after ripening at 70° F.; curve 4, total sugars in collateral lots after ripening at 70°; curve 5, reducing sugars in collateral lots after ripening at 40°; curve 6, total sugars in collateral lots after ripening at 40°; curve 7, reducing sugars in collateral lots after ripening at 30°; curve 8, total sugars in collateral lots after ripening at 30°.

temperature from 65° to 70° F., curves 5 and 6 in 40° storage, and curves 7 and 8 in 30° storage. The distance between these curves and curves 1 and 2, at the various dates, represents the increase in sugar as the fruit ripened in the different storages. It will be noted that the sugar runs uniformly highest in the fruit ripened at 70°. This is true for both total and reducing sugar in fruit picked at all the different dates. Apparently, either the loss of sugar from respiration is less, or more substances insoluble or nonreducing in the green fruit are changed to soluble reducing material when the fruit is ripened at this optimum ripening temperature than when ripened at lower temperatures.

In every lot, regardless of the section from which it came or the date at which it was picked, fruit held at 30° F. was higher in sugar than that stored until ripe at 40°. It must be borne in mind, however, that the 30° fruit was not completely ripened in storage but was held for periods of from a little over three months in the early picked lots to a little over six weeks for the last lots from Oregon and Washington. Then it was removed and held at warm room temperature until ripe, the time required being four to six days. This may have made some difference in the analytical results. Also, at one period, because of a sudden drop in temperature, the fruit picked in the earlier lots was partly frozen. It was thawed very gradually, and no ill effects of the freezing were noticeable afterwards. The fact that the frozen lots and those of the later pickings that did not freeze showed no marked difference in analyses other than that to be expected from the results with the same lots in other storages is also evidence that the carbohydrates of the fruit were not materially affected by the freezing.

The general effect of storage upon the sugar content of the fruit was very similar, however, in fruit from the different sections. The curves for total sugar—No. 2, 4, 6, and 7—cross in only one point in all the figures, showing that the relative amounts of sugar in the different storages run the same in all cases. It seems well established, therefore, that the highest amount of sugar will be secured by holding the fruit at optimum temperature for ripening. In case it is necessary to prolong the time of keeping the fruit, holding it at very low temperature until near the time it is needed and then ripening it up at optimum temperature gives a higher sugar content than holding it at a temperature just low enough to retard the ripening processes. From the results obtained by Gore (5) on the respiration activity of fruits at different temperatures, it would be expected that respiration would occur at least three times as rapidly in the 70° as in the 40° F. The number of days required to ripen the fruit in the two storages was about in the proportion of three days at 40° to one at 70°, so the total respiration activity would seem to be about equal. If this is true, it would seem that certain factors other than respiration must enter into the relative amounts of sugar present in the different storage lots.

RELATION OF SUCROSE TO REDUCING SUGAR DURING STORAGE

There is a marked increase in sucrose during the time between picking and the full ripening of the same fruit. This is shown by a comparison of the distance between curves 1 and 2, representing the sucrose in the fruit fresh from the tree, and between curves 3 and 4, showing the sucrose in the same fruit when ripe. There is a very marked increase in sucrose during storage in the earlier pickings, and this increase is even more marked in the late pickings. The late pickings show very little increase in reducing sugar between the time of picking and the time the fruit was ripened, while the increase in sucrose was very marked, being sufficient to make the total sugar increase between the time of picking and full ripeness practically as much in late-picked as in early picked fruit. There seems to be little relation between temperature and kind of sugar in the fruit, the 70°, 40°, and 30° F. storage lots being quite similar in the proportion of sucrose to reducing sugar.

A review of all the curves indicates that, whereas in the early picked fruit almost all of the sugar is in the form of reducing substances, the increase in reducing sugars in successive lots, as the season progresses, is much less marked than is the increase of sucrose. In all the lots, reducing sugar in the late picks seemed to run to between 7 and 8 per cent of the green weight of the fruit, after which there was very little increase in reducing substances, while sucrose continued to increase rapidly until after the last pickings were made.

RELATION OF ACIDITY TO TIME OF PICKING

In the relation of acidity to the time of picking there is not so distinct a correlation in all cases as there is for the sugars. Fruit from different districts seemed to respond somewhat differently in this regard, though certain general tendencies hold for all regions. Figures 5 to 8 summarize the results on acidity, computed as malic acid in terms of percentage of wet weight of the fruit. Curve 1 in each plot represents acid in the green fruit, curve 2 in fruit ripened at 70° F., curve 3 in fruit ripened at 40°, and curve 4 in fruit ripened at 30°.

In fruit from Suisun, Calif., (fig. 6) there is a constant decrease in acid in the green fruit from the time of the first picking until the last. On the other hand, in fruit from Sacramento (fig. 5) there is a slight rise until July 5, about the opening of the picking season, followed by a drop toward the end of the season. In fruit from the more northern sections, however, there is an increase in acid instead of a decrease. The increase is rather slight in the Medford pears (fig. 7), but very marked in those from Yakima (fig. 8). It is interesting to note that, whereas the acidity of the fruit decreased in the California sections, fruit from the Medford section showed a slight increase, and that from the still more northern Yakima section showed a very marked increase

as the season advanced. While the data are much too limited to justify the assumption that this relation of acidity to latitude generally holds, the results of the one year's work are of sufficient interest to warrant further study along this line.

EFFECT OF STORAGE UPON ACIDITY

A somewhat greater uniformity exists in the relation of temperature of storage to the acidity of the ripened product than was found in connection with the time of picking. In the first place, it will be noted

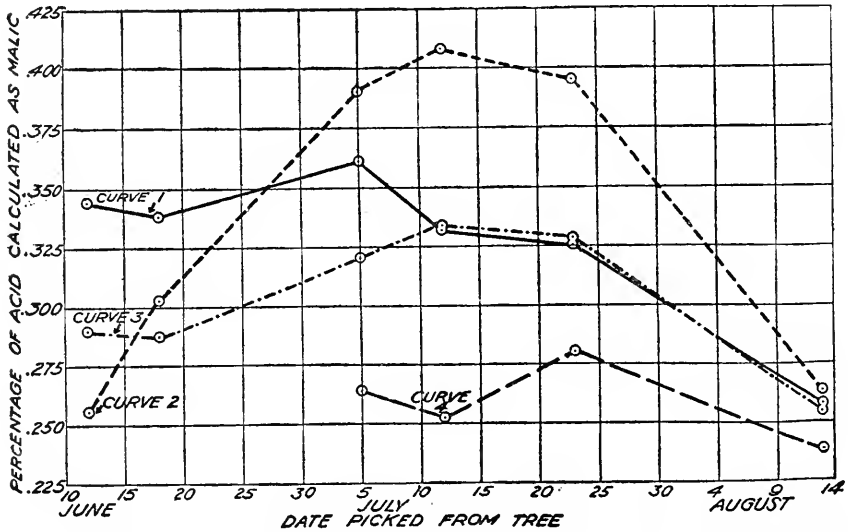

FIG. 5.—Acids in Bartlett pears from Sacramento, Calif.: Curve 1, acid in green fruit when picked from the tree; curve 2, acid in collateral lots after ripening at 70° F.; curve 3, acid in collateral lots after ripening at 40°; curve 4, acid in collateral lots after ripening at 30°.

that in the early picks there is a wide variation in amount of acid, due to the temperature of the storage used; and in most cases there is a greater amount of acid in the green fruit than in the ripened fruit, regardless of the temperature at which it was held. Fruit picked in a very immature condition has less acid when ripened than at the time of picking. (Curves 1-4, fig. 5-6, early pickings.)

Fruit picked at about the time of the opening of the commercial season, however, behaved somewhat differently. In every case the fruit ripened at 70° F. contained a higher percentage of titratable acid than did the same fruit when picked from the tree. This is of interest especially in connection with the question of whether fruit acids are synthesized in the fruit itself or whether they are carried to the fruit from the leaves. The fact that there is an increase in the acid between the time the fruit is removed from the tree and the time of its becoming ripe is evidence that there is an actual synthesis of acid in the fruit itself.

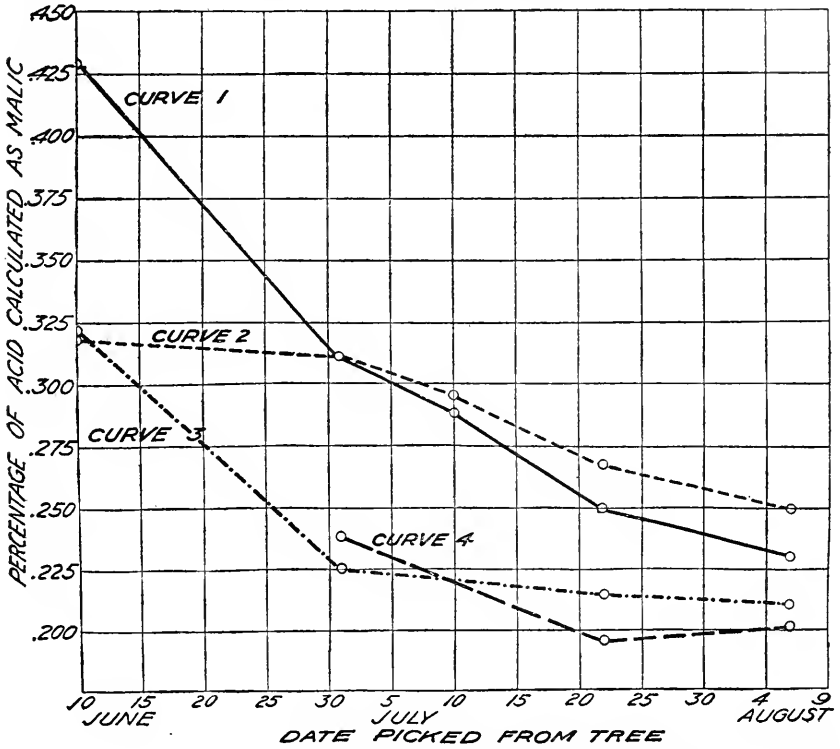

FIG. 6.—Acids in Bartlett pears from Suisun, Calif.: Curve 1, acid in green fruit when picked from the tree; curve 2, acid in collateral lots after ripening at 70° F.; curve 3, acid in collateral lots after ripening at 40°; curve 4, acid in collateral lots after ripening at 30°.

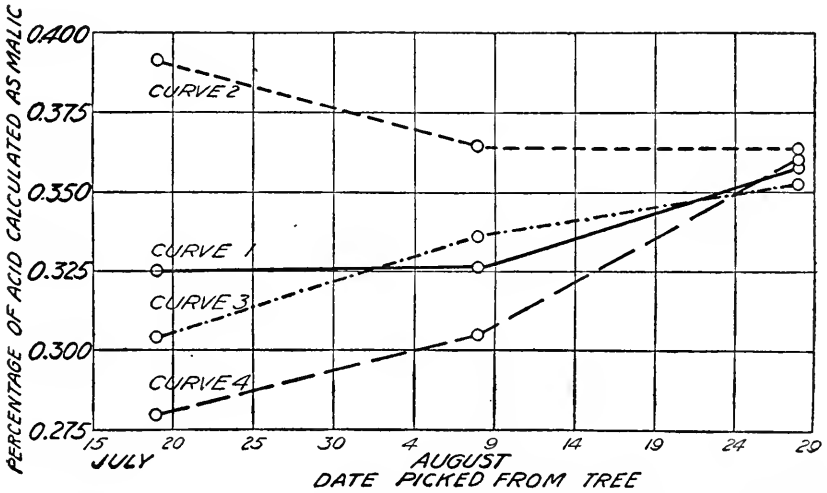

FIG. 7.—Acids in Bartlett pears from Medford, Oreg.: Curve 1, acid in green fruit when picked from the tree; curve 2, acid in collateral lots after ripening at 70° F.; curve 3, acid in collateral lots after ripening at 40°; curve 4, acid in collateral lots after ripening at 30°.

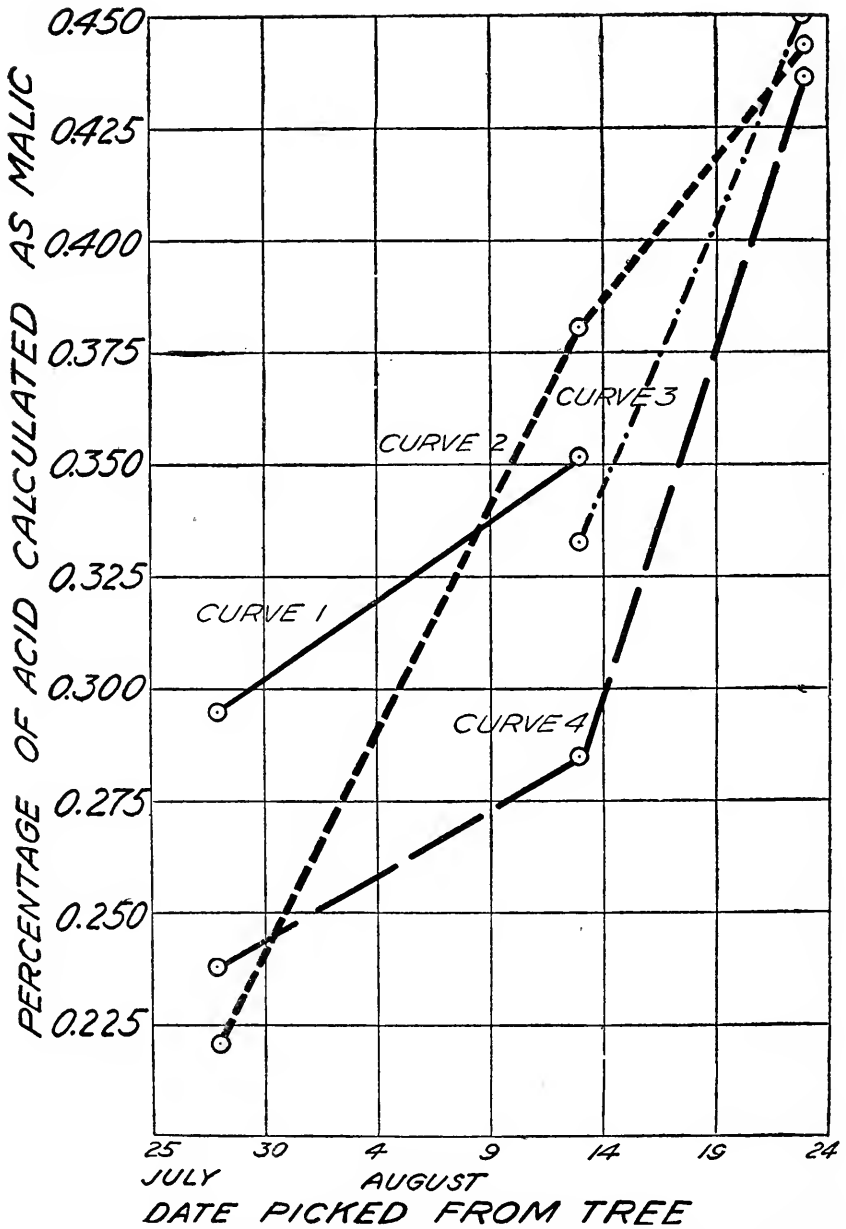

FIG. 8.—Acids in Bartlett pears from Yakima, Wash.: Curve 1, acid in green fruit when picked from the tree; curve 2, acid in collateral lots after ripening at 70° F.; curve 3, acid in collateral lots after ripening at 40°; curve 4, acid in collateral lots after ripening at 30°.

It was almost invariably true that fruit held at 30° F. had a lower acid content than that held in either 40° or 70° storage. This is especially interesting in connection with the fact that the sugars were much higher in the 30° storage lots than in the 40° pears. (Curves 2, 3, 4, fig. 5-8.)

In the latest picked lots from all sections the acid was very nearly the same, both in the green fruit and in the ripened fruit, regardless of the temperature of storage used. The acid content seems to become more nearly stabilized in the late season. It will be noted, however, that whereas the acid content in the California pears was very low at this time, in the fruit from the northern regions it was higher than at any other time during the season.

The question as to why the acid content should remain more nearly constant in late-picked than in early picked fruit is naturally suggested by these results, but until something more is known of the synthesis of the acids and the rôle they play in fruit and plant respiration a solution seems improbable.

ALCOHOL-INSOLUBLE, ACID-HYDROLYZABLE REDUCING SUBSTANCES

Results of analyses made as these were, by hydrolyzing the residue from an alcohol extraction with dilute acid and determining the reducing substances present, have usually been reported as starch. That this may be very misleading is shown by the fact that ripe pears contain no starch, as proved by iodine tests, yet the residue from the alcohol extraction after being hydrolyzed contained a considerable amount of reducing material. It is almost certain that an equal or even greater amount of such material found in the green fruit is also made up of substances other than starch. For this reason the percentage weight of this group of substances has been figured as dextrose, and the figure includes starch, together with certain hemicelluloses, galactans, pectin materials, etc., which may be present in varying amounts.

A study of the data presented in Tables I to IV shows that these reducing substances run highest in the earliest lots when first picked from the tree. There is a decreasing amount in the green fruit at successive pickings, until the last lots contain only about two-thirds as high a percentage of these substances as do the earliest pickings.

There is a very marked drop in the amount of alcohol-insoluble, acid-hydrolyzable reducing substances present in the storage-ripe fruit as compared to the similar lots when picked. Compare column 15, green, with columns 16 and 18, ripe. This, of course, is natural, since all the starch and probably some of the other material have disappeared. It is interesting to note, however, that there is also a decrease in the amount of these reducing substances in the ripe fruit from late pickings as compared to ripe fruit from early pickings. This decrease in many cases amounts to 50 per cent of the total and seems to indicate that as the fruit develops on the tree much material other than starch changes over to sugar or is in condition to change over after picking.

These results are interesting when considered in connection with the findings of Lewis, Murneek, and Cate (9) on the decreasing resistance of

the pear tissue to pressure as the season advances. The pectose material is generally thought to be largely responsible for the thickening and cementing together of the cell walls and hence for the firm texture of fruit. The association of the decrease in amount of this and related material with decreasing resistance of the tissue to pressure is evidence in support of this theory.

The temperature at which the fruit was stored has no marked influence on this material. A comparison of the lots picked at the same time and stored under the different temperature conditions (Tables I-IV, columns 16-18) shows little variation.

INFLUENCE OF TIME OF PICKING AND TEMPERATURE OF STORAGE UPON
PERCENTAGE OF DRY WEIGHT

In this report, sugars and acids have been figured to percentage of the wet weight, as it is considered that wet weight rather than dry weight percentage will give the most accurate index of quality. The data for total dry matter in the fruit are of much importance, however, especially in connection with the pear dehydration industry, and for the purpose of throwing light upon the question of how much shrinkage, due to loss of moisture, occurs in the fruit during storage.

From the data on dry weights presented in Tables I to IV it will be noted that while considerable variation seems to occur in various individual lots, one or two things stand out as of special interest. In the California fruit, in which the first pickings were made much in advance of the commercial season and when the fruit was very immature, the percentage of dry weight was higher in the earliest lots than it was in those lots picked during the main commercial shipping season, a month later. (Tables I and II, columns 19-22.) Toward the end of the season, however, the percentage of dry matter increased until the last pickings gave the highest dry-weight figures of all lots. The first pickings of the Oregon and Washington fruit (Tables III and IV) were made at a somewhat later relative date than the first pickings from California, so the fact that the earliest pickings show a low dry weight is in accord with the data for California sections.

Thus it is at once apparent that, for purposes of dehydration, pears left on the tree as long as possible will give not only the greatest tonnage, because of the size of the fruit, but will also give the greatest weight of the dried product per pound of green weight. Consequently, it is of special importance that pears intended for drying be left on the trees as long as possible.

If the dry weight of the fruit at the time of picking is compared with the dry weight of the same lots when they come from storage fully ripe it is seen that for well-matured fruit there is very little moisture loss during storage. A comparison of the earliest lots from Suisun and from Sacramento (Tables I and II) is interesting in that the Sacramento fruit was wrapped, whereas that from Suisun was loose in the box and unwrapped. There is no increase in dry weight in the Sacramento fruit,

while the early lots from Suisun show a marked increase during storage. This indicates the value of wrapping in preventing loss of moisture from fruit.

Examination of somewhat later lots picked during the commercial season shows no increase in dry weight while the fruit is in storage, and in many cases it shows an actual decrease. All the storages used were comparatively high in humidity, otherwise there might have been a loss due to more rapid evaporation from the fruit.

An examination of the lenticels of the fruit of the different lots was made as the fruit was freshly picked. A number of pears were put in methylene blue solution and after soaking a short time were removed and the lenticels examined under a microscope. It was found that the methylene blue readily penetrated the lenticels of the immature, early picked fruit. Fruit picked at the opening of the commercial season, however, had a layer of brown, suberized tissue formed in the lenticel, which prevented the penetration of the blue solution. Later in the season pears immersed for a considerable length of time and then rinsed in water showed only a very faint blue ring about the outside of the lenticel. The corky layer had apparently almost completely stopped penetration of the solution. Even when an immersed pear was placed under reduced pressure for a time and then under full atmospheric pressure the solution did not penetrate the lenticels.

With practice, this condition of the lenticels can be detected by the brown color of the corky growth without the use of a microscope and dye solution. It appears that this change in the lenticels may be a valuable aid to present methods of determining when the fruit is in condition to pick and handle without danger of shriveling or wilting.

EFFECT OF TIME OF PICKING UPON LENGTH OF TIME FRUIT MAY BE STORED

Table V shows the number of days between the time the fruit was picked from the tree and the time of full yellow ripeness. The Yakima fruit is not included, since the number of days in transit and the fact that one lot was delayed en route makes an accurate comparison impossible.

TABLE V.—Number of days required for fruit to become soft, yellow ripe at different temperatures of storage

Sacramento, Calif.			Suisun, Calif.			Medford, Oreg.		
Date of picking.	Number of days at 70° F.	Number of days at 40° F.	Date of picking.	Number of days at 70° F.	Number of days at 40° F.	Date of picking.	Number of days at 70° F.	Number of days at 40° F.
June 12	14	48	June 10	15	49	July 19	13	31
18	14	45	July 1	15	41	Aug. 8	13	26
July 5	14	32	10	14	28	11	23
12	14	33	22	13	32
Aug. 13	12	24	Aug. 6	12	28

The variations in the length of time required for the fruit from the different localities to become ripe in 40° F. storage may be due in part to the different lengths of time spent in transit to place of storage.

From this it is apparent that the results attained are similar to those found by other investigators—namely, that at the higher temperatures of storage, early picking gave somewhat longer keeping time than later picking. It has been impossible in this work to determine the relative keeping time at temperatures lower than 40° F. because of the necessity of removing the fruit from storage before it reached a full ripe condition.

At the 40° F. storage it was found, however, that the early fruits tended to scald and become brown rather than to ripen in good condition, while the later pickings ripened to full yellow and prime condition with practically no scald. Another very important observation was that although late-picked fruit tends to become yellow more quickly than early picked lots, it remains in firm, prime eating condition for a much longer period after becoming yellow than the fruit picked early.

GENERAL DISCUSSION OF RESULTS AS APPLIED TO COMMERCIAL HANDLING

The disposition of the commercial pear crop of the Pacific coast may be grouped under three divisions, which include practically the entire output—namely, (1) fresh shipment, for consumption as fresh fruit or for home canning; (2) commercial canning; and (3) drying or dehydration. The method of handling must, of necessity, be varied considerably, depending upon which of these methods of marketing is to be followed.

When pears are to be shipped fresh, certain factors other than those which determine the very highest quality of fruit must be considered. Fruit picked comparatively early in the season will remain sound somewhat longer, even at the lowest temperatures that it is possible to secure while the fruit is in transit, than will that picked too late; and this must always be an important consideration in determining the time to pick for fresh shipment. It must be remembered, however, that late-picked fruit is richer in sugar and of much higher dessert quality than fruit picked and shipped very early. Furthermore, while late-picked fruit, especially in the relatively high temperatures necessary in cars in transit, comes to prime eating condition in a shorter length of time, it remains in prime condition for a longer period, a consideration of much importance to the retail trade.

In the cannery and dehydrated fruit trades, it is possible to sacrifice something in keeping quality for a higher dessert quality product. Most of the fruit is utilized near the point of production. In the cannery industry the largest problem is to secure a good product and at the

same time to plan so that the tremendous tonnage that comes on within a short period is utilized before the fruit becomes overripe and breaks down. Almost every year canners lose a considerable quantity of pears because the fruit becomes overripe before the cannery can handle it.

The first consideration of the canner should be the securing of a high quality product by leaving the fruit on the trees until well developed. Pears picked very early are low in the natural fruit sugars and are of very inferior quality, whether eaten fresh or canned. A high-grade canned product can be secured only by using a high quality of fruit.

If this is done, it becomes practically necessary for the cannery man to store part of his season's supply. If certain conditions of storage are carried out, the keeping of Bartlett pears in storage, even up to two months, and still securing a high-quality product is a practical certainty. These conditions may be summarized briefly as follows:

(1) Use only well-developed fruit for storage. Early pickings tend to "scald" or turn brown and decay and break down much faster when removed from storage.

(2) Put fruit into storage immediately after it is picked. The maximum time that should elapse between picking and storing should not be more than three or four days. The cannery man will know the capacity of his plant; and, if more tons are being picked each day than he can handle, unless some go directly into storage, he can be sure that his cannery will be "flooded" when the fruit ripens. The fruit should go to the storage as soon as picked, rather than when it begins to soften. Much loss in pears in cold storage occurs because the fruit is in an almost soft-ripe condition when put in.

(3) Fruit should be cooled as quickly as possible after being placed in storage. It is especially desirable that a room with a large amount of direct expansion or brine piping be used, so that the temperature can be reduced quickly to 30° F. The fruit will cool somewhat more slowly than the air, although, if the fruit is loose in lug boxes, it will follow the air temperature rather closely.

(4) An even temperature should be maintained. If the storage rooms are large, it will be well worth while to use certain rooms for cooling down the fruit when it arrives, after which it may be transferred to other rooms for holding. This eliminates putting warm fruit into a room in which other fruit, already cooled, is being held. While this necessitates an extra handling, it is well worth while if it is desired to hold the fruit for some time. Especially is this system desirable if certain rooms having greater cooling capacity can be utilized for this precooling.

(5) The temperature should be held down to 28° or 30° F. if a long storage period is desired. Well-developed Bartlett pears will store at that temperature, ripen in excellent condition if removed at any time up to two or three months, and give a high-quality product. If it is desired

to hold the fruit for only a few weeks, somewhat higher temperatures are permissible; but even for short storage periods a low temperature, followed by the removal of the fruit and ripening at outside air temperature, gives a better product.

(6) The cooling capacity of the storage plant should not be overtaxed. It is possible in the case of Bartlett pears to "store on the tree" to a very marked extent. Two weeks' time on the tree makes only a small difference in the length of time pears will remain sound after removing from the tree, so for cannery trade it is not necessary to pick the entire crop within a very short time. Of course, other factors, such as amount of drop, load on the trees, etc., must be considered.

The foregoing suggestions presuppose a very close working agreement between producer, canner, and cold storage; and this is essential for successful handling of Bartlett pears through cold storage. The fruit must be sent to the storage plant quickly if it is to be held in storage, and the cooling capacity must be such that the fruit can be cooled down within a short time. The temperature and storage recommendations apply only to Bartlett pears, since other varieties have been found to give different responses under storage treatment (8, 9).

For the dehydration of Bartlett pears, if a drying plant is used, the same principles apply as for canning. On the other hand, if sun drying is used, the problem is much simplified, as the fruit can be handled in almost any quantity within a short time. For drying, however, it is of twofold importance that the fruit remain on the trees as long as possible, for the quality is not only improved but the accumulation of sugars gives an increase in the weight of dried product per pound of green fruit.

SUMMARY

There is a marked and quite uniform increase in total sugar in Bartlett pears from early summer until after the time of the close of the commercial picking season. The increase during the latter part of the season is mainly due to an accumulation of sucrose, while the earlier increase is due mainly to reducing sugar.

A distinct relationship was found between the total amount of sugar present in the ripe fruit and the temperature of the storage at which it had been held from the time of removing from the tree until ripe. Pears ripened at 70° F. contained the highest percentage of sugar, those ripened at 40° possessed the lowest total sugar content, and those held at 30° for from 6 to 14 weeks and then ripened at room temperature were intermediate in amount of total sugar. There was no marked relation between temperature of storage and relative amount of sucrose and reducing sugar.

Percentage of titratable acid in the fruit tended to decrease in fruit from the California sections as the season advanced, while it tended to

increase in that from Oregon and Washington. There was an increase in acid between the time of picking and the time of full ripening of the fruit when held at 70° F. There was much less acid in fruit ripened at 40° than in that ripened at 70°, and still less in fruit that had been held at 30°. The acid content of the fruit that was allowed to become well matured on the tree remained nearly constant during storage,

There was a progressive reduction in the alcohol-insoluble, acid-hydrolyzable reducing material as the season advanced, not only in the fruit fresh picked from the tree, but also in the same fruit after ripening. There is a marked reduction in these substances between the time when the fruit is first picked and the time when the same fruit becomes ripe.

The percentage of total solids is lowest at about the opening of the commercial season. This tends to increase with the accumulation of sugar in the late-picked lots.

With proper precautions of picking, handling, and storing, Bartlett pears can be held two to three months in storage and then taken out in good condition.

LITERATURE CITED

- (1) CLARK, W. BLAIR.
1917. A SAMPLING PRESS. *In Jour. Indus. and Engin. Chem.*, v. 9, no. 8, p. 788-790.
- (2) CRUESS, W. V., and STONE, P. M.
1916. PRELIMINARY OBSERVATIONS ON THE RIPENING OF BARTLETT PEARS. *In Mo. Bul. State Com. Hort. [Calif.]*, v. 5, no. 12, p. 425-429.
- (3) DUNBAR, P. B., and BIGELOW, W. D.
1913. THE ACID CONTENT OF FRUITS. (Abstract.) *In Science*, n. s. v. 38, no. 983, p. 639-640.
- (4) EWERT.
1910. DIE KORRELATIVEN EINFLÜSSE DES KERNES BEIM REIFEPROZESS DER FRÜCHTE. *In Landw. Jahrb.*, Bd. 39, Heft 3, p. 471-486, pl. 12-13.
- (5) GORE, H. C.
1911. STUDIES ON FRUIT RESPIRATION. U. S. Dept. Agr. Bur. Chem. Bul. 142, 40 p., 17 fig.
- (6) KELHOFER.
1899. WEITERE UNTERSUCHUNGEN ÜBER DIE VERTEILUNG VON ZUCKER, SÄURE UND GERBSTOFF IN DEN BIRNENFRÜCHTEN. *In VI. & VII. Jahresb. Deut. Schweiz. Vers. Sta. u. Schule Obst-, Wein- u. Gartenbau Wädensweil*, 1895/96-1896/97, p. 68-71.
- (7) KULISCH, P.
1892. BEITRÄGE ZUR KENNTNISS DER CHEMISCHEN ZUSAMMENSETZUNG DER AEPFEL UND BIRNEN MIT BESONDERER BERÜCKSICHTIGUNG IHREK VERWENDUNG ZUR OBSTWEINBEREITUNG. *In Landw. Jahrb.*, Bd. 21, p. 427-444.
- (8) LEWIS, C. I., MAGNESS, J. R., and CATE, C. C.
1918. PRELIMINARY REPORT OF PEAR HARVESTING INVESTIGATIONS IN ROGUE RIVER VALLEY. *Oreg. Agr. Exp. Sta. Bul.* 154, 24 p.
- (9) ——— MURNEEK, A. E., and CATE, C. C.
1919. PEAR HARVESTING AND STORAGE INVESTIGATIONS IN ROGUE RIVER VALLEY. (Second report.) *Oreg. Agr. Exp. Sta. Bul.* 162, 39 p., 10 fig.

- (10) POWELL, G. Harold, and FULTON, S. H.
1903. COLD STORAGE, WITH SPECIAL REFERENCE TO THE PEAR AND PEACH. U. S. Dept. Agr. Bur. Plant Indus. Bul. 40, 26 p., 7 pl. (partly col.).
- (11) RITTER, George.
1910. UEBER DEN CHEMISCHEN REIFUNGSPROZESS DER FRÜCHTE, MIT BESONDERER BERÜCKSICHTIGUNG DES OBSTES. *In* Deut. Obstbauztg., Jahrg. 1910, Heft 31, p. 429-435.
- (12) RIVIÈRE, Gustave, and BAILHACHE, Gabriel.
1908. ÉTUDE RELATIVE A LA PROGRESSION ASCENDANTE DU SUCRE ET A LA PROGRESSION DESCENDANTE DE L'ACIDITÉ, DANS LES FRUITS POIRIER, DEPUIS LEUR FORMATION JUSQU'À LEUR MATURITÉ. *In* Jour. Soc. Nat. Hort. France, s. 4, t. 9, p. 284-289.
- (13) —————
1910. DE L'INFLUENCE DES FEUILLES QUI ACCOMPAGNENT IMMÉDIATEMENT LES FRUITS DU POIRIER, SUR LEUR ACCROISSEMENT EN POIDS ET SUR LEUR COMPOSITION CHIMIQUE. *In* Jour. Soc. Nat. Hort. France, s. 4, t. 11, p. 678-680.
- (14) SHAMEL, A. D.
1917. SOME OBSERVATIONS UPON THE RELATION OF HUMIDITY TO THE RIPENING AND STORAGE OF FRUITS. *In* Mo. Bul. State Com. Hort. [Calif.], v. 6, no. 2, p. 39-41.
- (15) STUBENRAUCH, A. V., and RAMSEY, H. J.
1913. BARTLETT PEAR PRECOOLING AND STORAGE INVESTIGATIONS IN THE ROGUE RIVER VALLEY. *In* U. S. Dept. Agr. Bur. Plant Indus. Circ. 114, p. 19-24.
- (16) TAYLOR, R. H., and OVERHOLZER, E. L.
1919. SOME EFFECTS OF HIGH TEMPERATURE AND HUMIDITY UPON THE KEEPING QUALITY OF BARTLETT PEARS. *In* Mo. Bul. State Com. Hort. [Calif.], v. 8, no. 3, p. 118-125.
- (17) THOMPSON, Firman, and WHITTIER, A. C.
1913. FORMS OF SUGAR FOUND IN COMMON FRUITS. *In* Proc. Soc. Hort. Science, 9th Ann. Meeting, 1912, p. 16-22.

FURTHER DATA ON THE ORANGE-RUSTS OF RUBUS

By L. O. KUNKEL¹

Pathologist, Cotton, Truck, and Forage Crop Disease Investigations, Bureau of Plant Industry, United States Department of Agriculture

In 1916 the writer showed that there exists in the United States two orange-rusts on species of *Rubus* (1).² Morphologically these rusts closely resemble each other in their caeoma stages, but in the behavior of the orange spores when germinated and in life cycle they were shown to differ. During the last two seasons further observations were made on the orange-rusts, and it is the object of the present paper to report the results obtained in this study.

Atkinson (2) has performed some experiments which to him seemed to indicate that there is only one orange-rust on species of *Rubus* in the United States. He admits that the orange spores show two distinct methods of germination but attributes this to the influence of temperature. According to his view, promycelia are produced at high temperatures and germ tubes at low temperatures. He suggests that this may explain the behavior of the orange-rusts in different parts of the country. In the north and in mountainous regions where the spring temperatures are relatively low the aeciospores produce germ tubes, while in southern sections of the country where temperatures are high they produce promycelia.

The writer (7) has previously reported the behavior of the aeciospores of the two orange-rusts when germinated side by side at a room temperature of about 25° C. This experiment seemed to show conclusively that the aeciospores of the two rusts differ in manner of germination. Nevertheless, in view of Atkinson's results some further germination tests have been made.

GYMNOCONIA INTERSTITIALIS ON BLACK RASPBERRY

In the fall of 1916 the writer collected the telia of *Gymnoconia interstitialis* on leaves of wild black raspberry plants growing on the Virginia side of the Potomac River near Washington, D. C. These telia showed that the long-cycled rust is present in the locality just mentioned. Since that time many collections of orange-rust have been made from both wild and cultivated *Rubus* plants in the vicinity of the city of Washington. A study of these specimens has shown that the rust on the black raspberry is always long-cycled while the rust on the blackberry and

¹ The writer wishes to acknowledge here the help he has received from many colleagues who have offered suggestions or have sent him living specimens of the rusts.

² Reference is made by number (italic) to "Literature cited," p. 512.

dewberry plants, so far as has been observed, is short-cycled in this region. Wild blackberry and black raspberry plants occur abundantly along the Potomac River in both Maryland and Virginia. They are frequently intermingled with each other, and often both are infected with orange-rust. During the springs of 1917 and 1918 the two rusts were many times found growing close to each other, and during both seasons the telia of *Gymnoconia* were found occurring sparingly on leaves of wild black raspberry plants. The telia were always found on or near those plants that had borne caeomas of *Gymnoconia*. They were never found on any blackberry host. Many cultivated blackberry and black raspberry fields in the vicinity of Washington are troubled with orange-rust. In every instance the germination tests have shown that the raspberry plants are infected with the long-cycled rust. Rust found in the cultivated blackberry fields is always the short-cycled form.

Plate 92 shows the way the aeciospores of the two rusts germinate on Beyerinck agar at room temperature (about 25° C.). The spores shown in Plate 92, A, were taken from leaves of wild black raspberry at West Falls Church, Va. They have produced long germ tubes. Those shown in Plate 92, B, were collected at the same place on wild blackberry. They have produced promycelia-bearing sporidia.

INFLUENCE OF TEMPERATURE ON GERMINATION

In order to study the effect of temperature on germination numerous collections were made from both wild and cultivated blackberry and raspberry plants. The spores were germinated in Petri dishes on water and on Beyerinck agar. The cultures were incubated at temperatures varying by 5° intervals and ranging from 0° to 30° C. None of the spores of either rust germinated at 0°. At 5° excellent germination was obtained, but growth was slow. At all of the higher temperatures—10°, 15°, 20°, 25°, and 30°—the spores of the two rusts germinated equally well. It was noted that at low temperatures such as 5° and 10° the spores of the long-cycled rust began to germinate somewhat sooner than those of the short-cycled rust. Germination in cultures of both kinds of spores took place more rapidly at 30° than at any of the lower temperatures. Fewer spores germinated, however, at this temperature than at the lower temperatures. The spores of both rusts germinated well at all the temperatures tested between 0° and 30°.

Spores taken from blackberry leaves always produced promycelia, while those from the black raspberry leaves produced long germ tubes. Mature aeciospores of the two rusts collected at the same time and often within a few feet of each other and incubated at the same temperatures and on the same media always showed the same differences in manner of germination. The promycelia produced by the spores from blackberry leaves are typical in every way. They become divided into

four or more cells, and usually four of these contain one nucleus each. Each nucleated cell is capable of producing a sporidium. The germ tubes arising from spores borne on raspberry leaves are long and sinuous. By suitable methods of staining they have been shown to contain two nuclei. At an early stage in germination they may be distinguished from promycelia by their smaller diameter and more rapid longitudinal growth. Temperature, within the range tested, has no effect on the manner in which the aeciospores of these two rusts germinate. In the vicinity of Washington, D. C., at Mountain Lake, Va., and at French Creek, W. Va., both rusts occur side by side under the same conditions of temperature and climate. The writer is, therefore, unable to accept the theory that temperature determines whether spores of a given orange-rust specimen will produce germ tubes or promycelia.

COLOR OF SPORES IN MASS

The finding of the two orange-rusts growing within a short distance of the laboratories of the Bureau of Plant Industry made it easy for the writer to compare them more carefully than was possible when they had to be brought from different parts of the country. The comparison of the rusts as they occur side by side on their living hosts has brought to light certain differences that were not noticed earlier. One of the most important of these is the color of the spores in mass.

It soon became evident that the spores of the short-cycled rust are lighter in color than those of *Gymnoconia*. The spore colors of the two rusts were matched on Ridgeway's color chart. According to this chart the spores of the short-cycled rust are cadmium orange, while those of the long-cycled rust are xanthine yellow. These two colors do not differ greatly from each other and stand side by side in the chart. Nevertheless they can be easily distinguished after one has once noted the difference between them. It is surprising that this difference was not seen earlier, especially since account was taken of the color of the spores in mass. It seems that failure in this regard was due to the fact that the color of the spores of both rusts begins to fade within a few weeks after they are collected, and differences in shade of color were attributed to fading.

It was at first thought that the difference in color between the spores on raspberry and on blackberry leaves might be due to the difference in host. In order to test this hypothesis a number of collections were made during the spring of 1917 and 1918. The long-cycled rust was collected on both wild and cultivated black raspberry at French Creek, W. Va. It was collected on wild blackberry (identified as *Rubus alleghaniensis*) at Mountain Lake, Va. Numerous collections were made in the Adirondack Mountains near Old Forge, N. Y., and in the White Mountains near Glen and Jackson, N. H. It was also collected

on black raspberry at Rouses Point, N. Y. Collections of the short-cycled rust were made on wild dewberry and wild blackberry at French Creek, W. Va., on wild dewberry at Mountain Lake, Va., and on wild blackberry and dewberry plants at many other points.

The material collected in 1917 and 1918 was brought together for comparison at the end of each season and before there was serious fading in the color of the spores. This comparison has shown that for the material at hand the two orange-rusts exhibit the same color differences regardless of the hosts on which they occur or the localities from which they are collected. The color difference makes it possible to identify the two rusts in the field without resort to spore germination.

Plate D illustrates the difference in the color of the spores in mass. Figure 1 shows an infected black raspberry leaf, figure 2 an infected blackberry leaf.

MORPHOLOGY OF AECIOSPORES

In a former paper the writer (7) has pointed out that no morphological differences could be observed between the aeciospores of certain specimens of the two orange-rusts. While this statement was true for the specimens under study, it does not hold when larger numbers of specimens of the two rusts are compared. A study of more than 100 different collections has shown that the spores of the two rusts differ considerably from each other both in size and in shape. While a few specimens may not reveal this fact, a more extended study shows that the aeciospores of the two rusts are, on the whole, morphologically different.

In order to show this difference more clearly than is possible by description, an outline drawing has been made of a few typical aeciospores from a number of different specimens of the two rusts. The drawings were made with the aid of a camera lucida. The same magnification was used for all spores, so that the different drawings may be readily compared. There is always a certain amount of variation in the size and shape of the spores of a given specimen. This is greater for some specimens than for others, and it was not always easy to select spores that would be typical. Before material for drawing was chosen, spores from several mature caeomas on each specimen were transferred to separate drops of water on glass slides. They were then observed under the microscope, and a group was finally chosen that seemed to be typical for the specimen in question. Table I gives information regarding the place and time of collection, host, manner of germination, and color of spores in mass for most of the specimens collected in 1917 and 1918. Numbers given in the last column of the table indicate the drawings in Plates 93 and 94, which show an average sample of spores for each specimen.

TABLE I.—Place and time of collection, host, manner of germination, and color of the aeciospores in mass for most of the specimens collected in 1917 and 1918

Place of collection.	Time of collection.	Host.	Manner of germination.	Color of spores in mass.	Plate No.
Falmouth, Mass.	June 20, 1918	Wild dewberry	Promyelia	Cadmium orange.	93, fig. 1
Arlington, Va.	June, 1918	Wild blackberry	do.	do.	93, fig. 2
Massachusetts	June 27, 1917	do.	do.	do.	93, fig. 3
Berlin, Md.	June 8, 1917	Cultivated blackberry	do.	do.	93, fig. 4
Hyattsville, Md.	June 15, 1918	Wild dewberry	do.	do.	93, fig. 5
West Falls Church, Va.	May 21, 1918	do.	do.	do.	93, fig. 6
Auburn, Ala.	Apr. 27, 1918	do.	do.	do.	93, fig. 7
Fayetteville, Ark.	June 7, 1917	Wild blackberry	do.	do.	93, fig. 8
Potomac Heights, D. C.	June, 1917	do.	do.	do.	93, fig. 9
Morgantown, W. Va.	June 7, 1918	Cultivated blackberry, variety Eldorado.	do.	do.	93, fig. 10
Blacksburg, Va.	June 11, 1918	Cultivated blackberry, variety Iceberg.	do.	do.	93, fig. 11
Ithaca, N. Y.	June 4, 1918	Wild blackberry	do.	do.	93, fig. 12
Blacksburg, Va.	May 25, 1917	do.	do.	do.	93, fig. 13
West Falls Church, Va.	May 21, 1918	do.	do.	do.	93, fig. 14
Gainesville, Fla.	Mar. 25, 1918	<i>Rubus cuneifolius</i>	do.	do.	93, fig. 15
Ithaca, N. Y.	June, 1918	Wild blackberry	do.	do.	93, fig. 16
Chico, Calif.	May 1, 1918	<i>R. ursinus</i>	do.	do.	93, fig. 17
Ithaca, N. Y.	June 4, 1918	Wild dewberry	do.	do.	93, fig. 18
Arlington, Va.	June, 1918	Wild blackberry	do.	do.	93, fig. 19
Berkeley, Calif.	Mar. 30, 1918	<i>R. parviflorus</i>	do.	do.	93, fig. 20
Hammononton, N. J.	June 20, 1918	Wild blackberry	do.	do.	93, fig. 21
Fayetteville, Ark.	June 7, 1917	Cultivated blackberry	do.	do.	93, fig. 22
West Falls Church, Va.	May 21, 1918	do.	do.	do.	93, fig. 23
French Creek, W. Va.	June 8, 1918	Wild dewberry	do.	do.	93, fig. 24
Congress Heights, D. C.	May 20, 1918	Wild blackberry	do.	do.	93, fig. 25
Connellsville, Pa.	June 6, 1918	do.	do.	do.	93, fig. 26
Chico, Calif.	May 19, 1918	<i>R. ursinus</i>	do.	do.	93, fig. 27
Vienna, Va.	May 21, 1918	Wild blackberry	do.	do.	93, fig. 28
Bryan, Ohio.	June 12, 1918	Cultivated blackberry	Germination very poor.	Color faded.	93, fig. 29
Cameron, N. C.	June 4, 1918	Wild blackberry	Promyelia	Cadmium orange.	93, fig. 30
Athens, Ohio.	June 11, 1918	do.	do.	do.	93, fig. 31
Blacksburg, Va.	do.	Cultivated blackberry, variety Early King.	do.	do.	93, fig. 32
Chico, Calif.	May 1, 1918	<i>R. ursinus</i>	do.	do.	93, fig. 33
Arlington, Va.	June, 1918	Wild blackberry	do.	do.	93, fig. 34
Ithaca, N. Y.	do.	Wild dewberry	do.	do.	93, fig. 35
Mountain Lake, Va.	June 11, 1918	<i>R. americanus</i>	do.	do.	93, fig. 36
French Creek, W. Va.	June 8, 1918	Wild dewberry	do.	do.	93, fig. 37
Blacksburg, Va.	June 11, 1918	Cultivated blackberry	do.	do.	93, fig. 38
Do.	do.	Cultivated blackberry, variety Mersereau.	do.	do.	93, fig. 39
Vienna, Va.	do.	Cultivated blackberry	do.	do.	93, fig. 40
Ithaca, N. Y.	June 4, 1918	Wild blackberry	do.	do.	93, fig. 41
Blacksburg, Va.	June 11, 1918	Cultivated blackberry, variety Ancient Britain.	do.	do.	93, fig. 42
Janassee Junction, Ga.	May 14, 1918	Wild blackberry	do.	do.	93, fig. 43
Thunderbolt, Ga.	Mar. 17, 1918	<i>R. procumbens</i>	do.	do.	93, fig. 44
Hyattsville, Md.	June 15, 1918	Wild dewberry	do.	do.	93, fig. 45
Do.	do.	Wild blackberry	do.	do.	93, fig. 46
Blacksburg, Va.	June 11, 1918	Cultivated blackberry	do.	do.	93, fig. 47
Vienna, Va.	May 29, 1918	Wild blackberry	do.	do.	93, fig. 48
Willard, N. C.	June 26, 1917	do.	do.	do.	93, fig. 49
Connellsville, Pa.	June 8, 1918	do.	do.	do.	93, fig. 50
Auburn, Ala.	Mar. 4, 1918	do.	do.	do.	93, fig. 51
Butte Creek Canyon, Calif.	May 19, 1918	<i>R. ursinus</i>	do.	do.	93, fig. 52
Stark, Fla.	1917	Wild blackberry	do.	do.	93, fig. 53
Blacksburg, Va.	June 11, 1918	do.	do.	do.	93, fig. 54
Thunderbolt, Ga.	Mar. 17, 1918	<i>R. hispidus</i>	do.	do.	93, fig. 55
Hyattsville, Md.	June 15, 1918	Wild blackberry	do.	do.	93, fig. 56
Blacksburg, Va.	May 25, 1917	do.	do.	do.	93, fig. 57
Hammond, La.	Mar. 29, 1918	do.	do.	do.	93, fig. 58
Orlando, W. Va.	June 8, 1918	do.	do.	do.	93, fig. 59
Ithaca, N. Y.	June 4, 1918	do.	do.	do.	93, fig. 60
Blacksburg, Va.	June 12, 1918	do.	do.	do.	93, fig. 61
West Falls Church, Va.	May 21, 1918	Cultivated blackberry	do.	do.	93, fig. 62
Arlington, Va.	June, 1918	Wild blackberry	do.	do.	93, fig. 63
Do.	do.	do.	do.	do.	93, fig. 64
French Creek, W. Va.	June 8, 1918	do.	do.	do.	93, fig. 65
Madrid, Me.	July 3, 1917	do.	Germ tubes.	Xanthine yellow.	94, fig. 1
French Creek, W. Va.	June 8, 1918	Black raspberry	do.	do.	94, fig. 2
Glen, N. H.	June 22, 1917	<i>R. nigrobaccus</i>	do.	do.	94, fig. 3

TABLE I.—Place and time of collection, host, manner of germination, and color of the aeciospores in mass for most of the specimens collected in 1917 and 1918—Continued

Place of collection.	Time of collection.	Host.	Manner of germination.	Color of spores in mass.	Plate No.
West Falls Church, Va.	May 21, 1918	Cultivated raspberry.	Germ tubes.	Xanthine yellow.	94, fig. 4
Vienna, Va.	do.	do.	do.	do.	94, fig. 5
Old Forge, N. Y.	June 27, 1918	<i>R. canadensis</i> .	do.	do.	94, fig. 6
Glen, N. H.	June 22, 1918	Wild blackberry.	do.	do.	94, fig. 7
Mountain Lake, Va.	June 11, 1918	<i>R. alleghaniensis</i> .	do.	do.	94, fig. 8
West Falls Church, Va.	May 21, 1918	Cultivated black raspberry.	do.	do.	94, fig. 9
Portland, Me.	June 24, 1917	<i>R. canadensis</i> .	do.	do.	94, fig. 10
Madison, Wis.	June 4, 1918	Wild blackberry.	do.	do.	94, fig. 11
Phillips, Me.	July 3, 1917	do.	do.	do.	94, fig. 12
Portland, Me.	June 24, 1917	<i>R. canadensis</i> .	do.	do.	94, fig. 13
East Lansing, Mich.	June 30, 1917	Wild blackberry.	do.	do.	94, fig. 14
Sebago Lake, Me.	June 23, 1917	<i>R. triflorus</i> .	do.	do.	94, fig. 15
Michigan.	June, 1917	Wild blackberry.	do.	do.	94, fig. 16
Old Forge, N. Y.	June 26, 1918	<i>R. canadensis</i> .	do.	do.	94, fig. 17
Madison, Wis.	July 17, 1917	Wild blackberry.	do.	do.	94, fig. 18
Old Forge, N. Y.	June 27, 1918	<i>R. canadensis</i> .	do.	do.	94, fig. 19
West Falls Church, Va.	May 21, 1918	Wild black raspberry.	do.	do.	94, fig. 20
Do.	July 4, 1917	Cultivated black raspberry.	do.	do.	94, fig. 21
Do.	May 21, 1918	do.	do.	do.	94, fig. 22
Glen, N. H.	June 22, 1917	<i>R. canadensis</i> .	do.	do.	94, fig. 23
Mountain Lake, Va.	June 11, 1918	<i>R. alleghaniensis</i> .	do.	do.	94, fig. 24
French Creek, W. Va.	June 8, 1918	Black raspberry.	do.	do.	94, fig. 25
Portland, Me.	June 24, 1917	<i>R. canadensis</i> .	do.	do.	94, fig. 26
Smugglers Notch, Vt.	July 11, 1917	<i>R. strigosus</i> .	do.	do.	94, fig. 27
Madrid, Me.	July 3, 1917	Wild blackberry.	do.	do.	94, fig. 28
Old Forge, N. Y.	June 27, 1918	<i>R. canadensis</i> .	do.	do.	94, fig. 29
Smugglers Notch, Vt.	July 11, 1917	do.	do.	do.	94, fig. 30
Bancroft, Wis.	July, 1917	<i>R. hispidus</i> .	do.	do.	94, fig. 31
Julet, N. Y.	June 26, 1918	<i>R. canadensis</i> .	do.	do.	94, fig. 32
French Creek, W. Va.	June 6, 1917	Black raspberry.	do.	do.	94, fig. 33
Old Forge, N. Y.	June 26, 1918	<i>R. canadensis</i> .	do.	do.	94, fig. 34
Madison, Wis.	June 4, 1918	Wild blackberry.	do.	do.	94, fig. 35
Portland, Me.	June 24, 1917	<i>R. triflorus</i> .	do.	do.	94, fig. 36
Sebago Lake, Me.	June 23, 1917	do.	do.	do.	94, fig. 37
Smugglers Notch, Vt.	July 11, 1917	<i>R. canadensis</i> .	do.	do.	94, fig. 38
Sebago Lake, Me.	June 23, 1917	<i>R. triflorus</i> .	do.	do.	94, fig. 39
Rousses Point, N. Y.	June 29, 1918	Black raspberry.	do.	do.	94, fig. 40
Sebago Lake, Me.	June 23, 1917	Wild blackberry.	do.	do.	94, fig. 41
Mountain Lake, Va.	June 11, 1918	<i>R. alleghaniensis</i> .	do.	do.	94, fig. 42
Bound Brook, N. J.	June 17, 1918	Black raspberry.	No germination.	do.	94, fig. 43
Glen, N. H.	June 22, 1916	<i>R. canadensis</i> .	Germ tubes.	Color faded.	94, fig. 44

Plate 93 shows spores from 65 different specimens of the short-cycled orange-rust. Figures 1 to 44 on Plate 94 show spores from 44 different specimens of the long-cycled rust. The figures on these plates demonstrate that, on the whole, the aeciospores of the two rusts are morphologically different. The spores of the short-cycled rust are smaller than those of the long-cycled. They are also more angular and more elongated. Their shape is more irregular. It will be seen that the size and shape of the aeciospores from different specimens of the two rusts vary considerably. On this account it is not always possible by observing spores under the microscope to determine with certainty to which group a given specimen may belong. On the other hand, spore characters do make possible a rather accurate separation of specimens belonging to the two rusts. It is difficult to say just how accurate such determinations will be. Much depends on the specimens at hand and on the judgment of the one who undertakes such a task. The writer's determinations by this means have proved to be correct in about 85

per cent of the specimens studied. By this method it is possible to identify with a fair degree of accuracy orange-rust specimens in herbaria long after the spores are dead and have lost their color. It must be remembered, however, that it is always necessary to have a liberal quantity of mature spores in order to make determinations of value.

The figures on Plate 93 show the variation in the size and shape of spores from different collections of the short-cycled rust. The spores shown in most of the figures are relatively small and angular. Those shown in figures 9, 13, 39, 45, and 55 are large and round. They look like the spores of the long-cycled rust, but their color and manner of germination prove that they belong to the short-cycled rust. Figures 3, 10, 28, 29, 33, 35, 36, 44, and 57 show spores that resemble somewhat those of the long-cycled rust. The specimens from which these aeciospores were taken can not be satisfactorily identified on the basis of spore characters. The spores shown in all of the other figures on Plate 93 are characteristic for the short-cycled rust; but even in such cases one can not be absolutely sure that they belong to this fungus, for occasionally a specimen of the long-cycled rust bears spores like those shown in figure 35 of Plate 94. The aeciospores shown in this figure are small and angular; they do not look like spores of the long-cycled rust. Spores shown in figures 4, 6, 8, 9, 19, 25, 42, and 43 of Plate 94 resemble to a certain degree spores of the short-cycled rust. On the whole, however, aeciospores from different samples of the long-cycled rust are more uniform as regards size and shape than are those of the short-cycled rust.

GENETIC RELATIONSHIP BETWEEN THE TWO ORANGE-RUSTS

Although the two orange-rusts differ from each other in several characters, it must not be denied that they are alike in many respects. They are both systemic on species of *Rubus*. Their caeomas look much alike, and in many specimens the aeciospores are quite similar. These points of resemblance suggest a genetic relationship. Along with the further evidence that the two rusts are distinct and different from each other have come certain facts that strengthen this suggestion. In an earlier paper the writer mentioned finding a promycelium in a culture of aeciospores of the long-cycled rust. It was thought at the time that the spore producing the promycelium might have entered as a contamination. During the spring of 1917 and 1918 aeciospores of *Gymnoconia* collected in different parts of the country were germinated in great numbers. Each culture was carefully examined under the microscope. In many cultures only germ tubes could be found. A few promycelial germinations have been obtained, however, from spores of every collection of *Gymnoconia* which the writer made during the last two seasons. Sometimes such germinations are exceedingly rare,

but if enough spores are germinated the promycelia will be found. The spores of some collections produce them more often than those of other collections. In general it may be said that promycelia are produced more abundantly by aeciospores collected late in the season. They are not entirely absent, however, from cultures made with spores collected early in the season. The possibility of these promycelia being produced by spores of the short-cycled rust that have contaminated the cultures has been excluded in most instances. In order to do this, the aeciospores were taken from caeomas that had not yet opened. Moreover, many of the spores were collected and germinated in parts of the country where the short-cycled rust is not known to occur. If the promycelia appeared only in cultures from aeciospores collected in the South where the short-cycled rust is abundant, mixed infection might offer a possible explanation. But since they also occur in cultures of spores collected in the North where the short-cycled rust has never been found, this explanation is unsatisfactory. In the vicinity of Glen, N. H., orange-rust has been collected each spring since 1913. Spores taken from a number of different places in this vicinity have been germinated, but the short-cycled rust has not been found. In both 1917 and 1918, cultures made at Glen were studied and found to contain a few promycelia. Promycelia have also been observed in cultures of the aeciospores of the long-cycled rust collected at Old Forge, N. Y., where several seasons' search has failed to reveal the presence of the short-cycled rust. They have been found in cultures of aeciospores taken from the black raspberry at Rouses Point, N. Y., French Creek, W. Va., and at points in the vicinity of Washington, D. C. Promycelia were also found in cultures of aeciospores collected at Mountain Lake, Va., on *Rubus alleghaniensis*.

When spores of the short-cycled rust are incubated at room temperature (about 25° C.) on a favorable medium, they produce promycelia-bearing sporidia within 24 hours. Spores of the long-cycled rust placed under similar conditions produce long germ tubes within 24 hours. Promycelia have seldom been found in these cultures after so short a time. They occur in cultures of *Gymnoconia* only after a rather long period of incubation. They can usually be found after 3 or 4 days. In order to study the production of promycelia by the aeciospores of *Gymnoconia*, it is best to incubate cultures at a fairly low temperature. Temperatures varying from 10° to 15° are favorable. Promycelia are always slow to make their appearance in cultures of this rust. If incubation temperatures are high, many germ tubes die before they have time to develop into promycelia. Moreover, cultures kept at high temperatures are usually overgrown by saprophytic mold fungi and bacteria after a few days. Low temperatures check the growth of these organisms. Promycelia can be found most easily in

cultures of aeciospores kept at about 10° for a week or longer. It must be understood, however, that they are not produced very abundantly even under favorable conditions. Sometimes 1,000 germinated spores may be observed without the finding of a single promycelium, but usually several promycelia will be found for each 1,000 spores observed if the cultures are more than 4 days old. In some cultures they occur more abundantly.

It is interesting to note that most of the promycelia developing in cultures of the aeciospores of the long-cycled rust are abnormal, though normal ones are also present. Many of the abnormal promycelia produce one or more normal sporidia, and there can be no doubt regarding their true nature. The abnormal promycelia and their tardy appearance in the cultures seem to the writer to suggest that nuclear fusions and the subsequent reduction divisions are steps accomplished with difficulty in these spores. It would be highly interesting to study these phenomena cytologically, but the relatively small number of promycelial germinations makes such a task rather difficult.

From a study of many abnormal promycelia the writer has come to recognize certain structures as indicating an attempt at the production of sporidia. Some of these are cross walls, branches, especially those having a diameter less than that of the germ tube, and sporidia-like processes borne on structures that show more or less resemblance to sterigmata. In cultures of the aeciospores of the long-cycled orange-rust it is possible to find all gradations between normal promycelia and germ tubes that can hardly be recognized as promycelia at all. In order to show some of the stages between these two extremes a few drawings have been made of abnormal promycelia.

Figure 53 of Plate 94 shows a tube with two rather typical sporidia borne on typical sterigmata. No cross walls occur in this tube. Figure 49 shows a branched germ tube. A cross wall occurs just below the branch. No sporidia are borne on this tube, but there can be little doubt that this is an attempt at promycelium production. Figure 51 shows a germ tube with one cross wall and forked branches. One of these branches has produced a rather long club-shaped tube, while the other has developed into a sterigma-like process bearing a typical sporidium. A tube with one cross wall and several branches of small diameter is shown in figure 50. One of these branches is pointed like a sterigma and bears a spore that resembles a sporidium. Figure 45 represents a tube having one cross wall and several short branches. One of these branches is considerably enlarged toward its distal end and presents curves that suggest those of the normal sporidium. A short tube is shown in figure 47. This tube has one short branch which bears a sporelike body having curves that closely resemble those of a sporidium. The curves of the upper end of this body are especially like those of the

upper part of normal sporidia. Another short tube is shown in figure 46. This bears a branch with an enlarged end resembling a sporidium. A constriction at the point of the first bend in the branch would give rise to a fairly normal sporidium. Figure 48 shows a similar branch, but this time it arises from a very long germ tube. An unbranched tube is shown in figure 54. The diameter of the distal end of this tube is much less than that of the average diameter of germ tubes. Such a decrease in diameter frequently accompanies cross-wall production, branching, and other indications of an attempt at the production of sporidia. Figure 52 shows a tube with a branch of small diameter and one cross wall. The end cell has broken away from the remainder of the tube.

It must not be supposed that abnormal promycelia are uncommon in cultures of the short-cycled orange-rust or in cultures of germinating teliospores in general. Abnormal promycelia much like those described above have occasionally been found in cultures of the short-cycled rust. They are not common, however, under ordinary conditions of germination. In cultures of the aeciospores of *Gymnoconia*, on the other hand, most of the promycelia produced are abnormal.

The production of promycelia by the aeciospores of *Gymnoconia interstitialis* seems to the writer to be strong evidence that a close genetic relationship exists between the two orange-rusts. One of them is a typical short-cycled rust. It produces three kinds of spores: Spermata, aeciospores, and sporidia. So far as the writer has observed it possesses one and only one life cycle. There is nothing unusual about this rust. The other orange-rust is long-cycled, but it is not a typical long-cycled rust. It is unusual in that it possesses two life cycles. In addition to the long cycle there is a much repressed short cycle, as shown by the occasional production of promycelia. We know that the germ tubes produced by these spores reinfect *Rubus* leaves. It is not known whether the sporidia can cause infection. Some of the sporidia have been seen to germinate. They appear normal in every way, and there seems to be no reason why they should not function.

So far as the writer knows no one has yet observed the production of promycelia in cultures of the European orange-rust of *Rubus*. Both Fischer (4) and Lindfors (8) have recently studied the manner of germination of the spores of this rust and have observed only germ tubes. Fischer, however, has shown a branch of small diameter coming from the end of one of his germ tubes. This suggests an attempt at promycelium production and leads the writer to believe that if large numbers of aeciospores of the European orange-rust are germinated and carefully observed promycelia will be found.

The findings of an occasional promycelium in cultures of the aeciospores of *Gymnoconia interstitialis* at once raised the question as to whether or not such a performance is usual among the rusts. It is not possible to

get much information on the question from the literature on the germination of rust spores. Most workers have not germinated aeciospores in large numbers, and a few promycelia in their cultures might easily have been overlooked. In order to settle this point it would be necessary to germinate the aeciospores of many different rusts in large numbers, and the writer has not undertaken this task. Nevertheless, it has seemed desirable to make a thorough study of the aeciospore germination of some other rust. For this study the aeciospores of *Aecidium fraxini* were chosen. These aeciospores are produced in large numbers and germinate readily on both water and Beyerinck agar. *A. fraxini* was found in abundance on black ash trees growing along the shore of Lake Champlain near Rouses Point, N. Y. Many cultures were made with aeciospores of this rust. The germinations were carefully observed, but not a single promycelium was ever found. Long, wavy germ tubes were produced. No cross walls or branches were observed. These spores produce germ tubes only.

Promycelia in cultures of the aeciospores of *Gymnoconia interstitialis* indicate that the two nuclei which ordinarily pass out into the germ tube and remain apart through many nuclear and cell divisions occasionally fuse in the spore or perhaps in the young germ tube. If we assume that reduction in chromosome number occurs here as in other promycelia and that the sporidia produced are capable of reinfesting the host, then *G. interstitialis* has a double life cycle such as has not been demonstrated for any other rust.

It is not believed that promycelia are commonly produced even in small numbers by the aeciospores of most rusts. On the other hand, it seems probable that other rusts will be found that possess double life cycles. Eriksson (3) has reported that the aecia of *Aecidium graveolens* which occur on species of *Berberis* are able to reproduce themselves, although they may also infect *Avena elatior* and give rise to *Puccinia arrhenatheri*. This strange behavior, which has never been accounted for, may be due to the production of promycelia by a certain number of the aeciospores. Recently Klebahn (5) reports that the aecia of *Periderinium pini* reproduce themselves on the pine. He states that the aeciospores give germ tubes, but a further study may show that some of them produce promycelia.

In an earlier paper (6) the writer expressed the opinion that the short-cycled orange-rust is more primitive than the long-cycled one. The fact that the long-cycled rust has a double life cycle is further evidence in favor of this view.

Arthur (1) considers the differences between the two orange-rusts sufficient to place them in separate genera. Moreover, these genera are widely separated in his classification. It would seem that the evidence of a genetic relationship between these rusts should be given consideration in any natural system of classification.

LITERATURE CITED

- (1) ARTHUR, J. C.
1917. ORANGE RUSTS OF RUBUS. *In Bot. Gaz.*, v. 63, no. 6, p. 501-515, map.
- (2) ATKINSON, George F.
1918. SELECTED CYCLES IN GYMNOCONIA PECKIANA. *In Amer. Jour. Bot.*, v. 5, no. 2, p. 79-83.
- (3) ERIKSSON, Jakob.
1898. STUDIEN ÜBER DEN HEXENBESENROST DER BERBERITZE (PUCCINIA ARRHENATHERI KLEB.) *In Beitr. Biol. Pflanz.*, Bd. 8, p. 1-16, 3 pl. Literatur, p. 14-15.
- (4) FISCHER, Ed.
1916. MYKOLOGISCHE BEITRÄGE. *In Mitt. Naturf. Gesell. Bern*, 1915, p. 214-234, 2 fig.
- (5) KLEBAHN, H.
1905. KULTURVERSUCHE MIT ROSTPILZEN. XII. BERICHT (1903 UND 1904). *In Ztschr. Pflanzenkrank.*, Bd. 15, Heft 2, p. 65-108, 4 fig., pl. 3.
- (6) KUNKEL, L. O.
1914. NUCLEAR BEHAVIOR IN THE PROMYCELIA OF CAEOMA NITENS BURRILL AND PUCCINIA PECKIANA HOWE. *In Amer. Jour. Bot.*, v. 1, no. 1, p. 37-47, pl. 3. Bibliography, p. 45-46.
- (7) ———
1916. FURTHER STUDIES OF THE ORANGE RUSTS OF RUBUS IN THE UNITED STATES. *In Bul. Torrey Bot. Club*, v. 43, no. 10, p. 559-569, 5 fig.
- (8) LINDFORS, Thore.
1918. MYKOLOGISCHE NOTIZEN. *In Svensk Bot. Tidskr.*, bd. 12, no 2, p. 221-227, 4 fig.



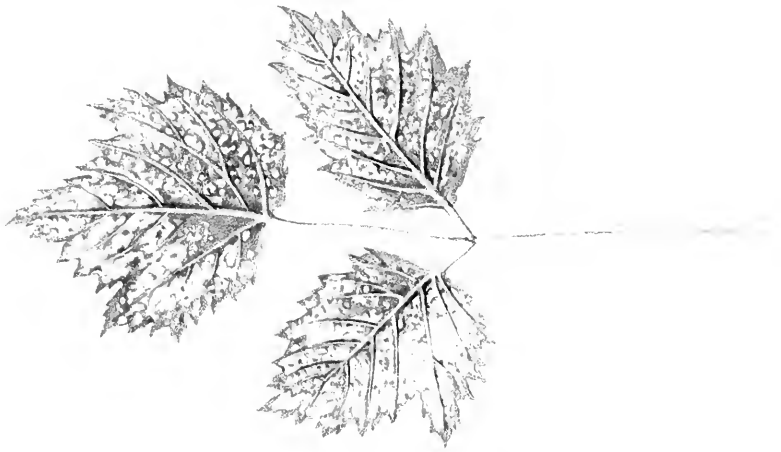

1

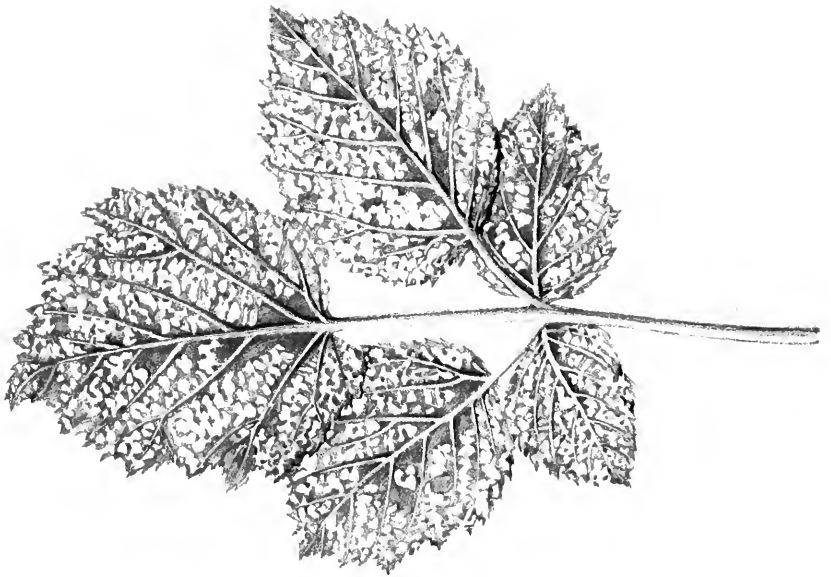

2

PLATE D

1.—Infected black raspberry leaf covered with the caeomas of *Gymnoconia interstitialis*. The spores in mass are xanthine yellow.

2.—Blackberry leaf infected with the short-cycled orange-rust. The spores of this rust are cadmium orange in color.

PLATE 92

Manner of germination of the spores of the two orange-rusts. The spores were collected at the same time, placed in Beyerinck agar, and incubated at about 25° C.

A.—Spores taken from leaves of the black raspberry, showing long, wavy germ tubes. $\times 38$.

B.—Spores taken from wild blackberry leaves, showing promycelia and numerous sporidia. $\times 85$.

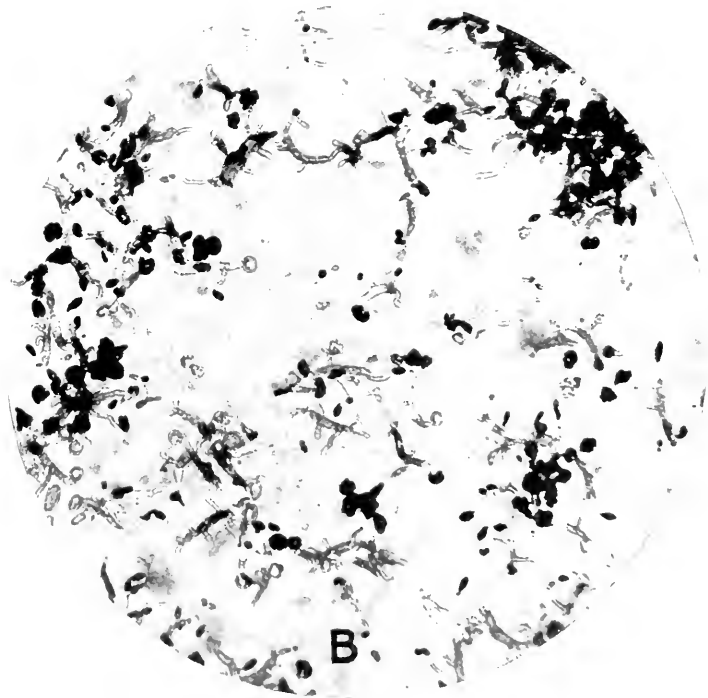
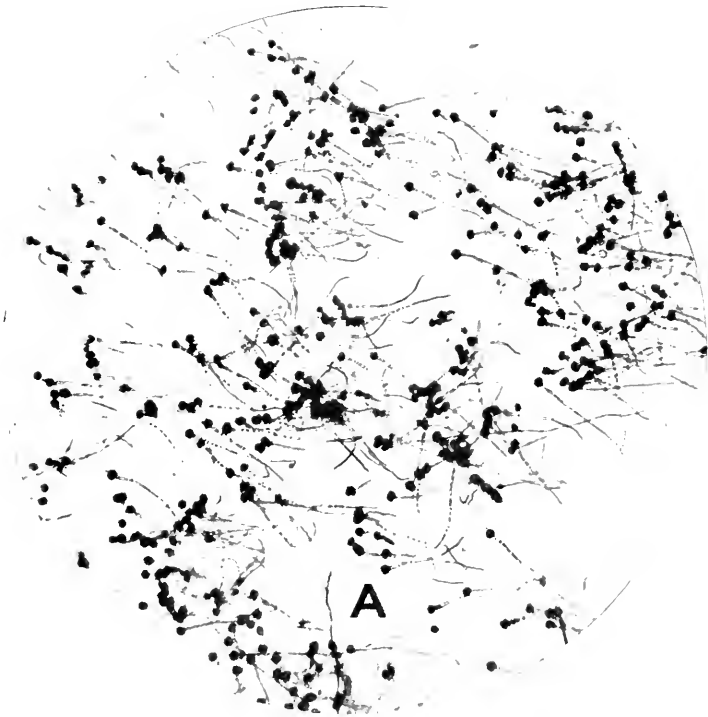

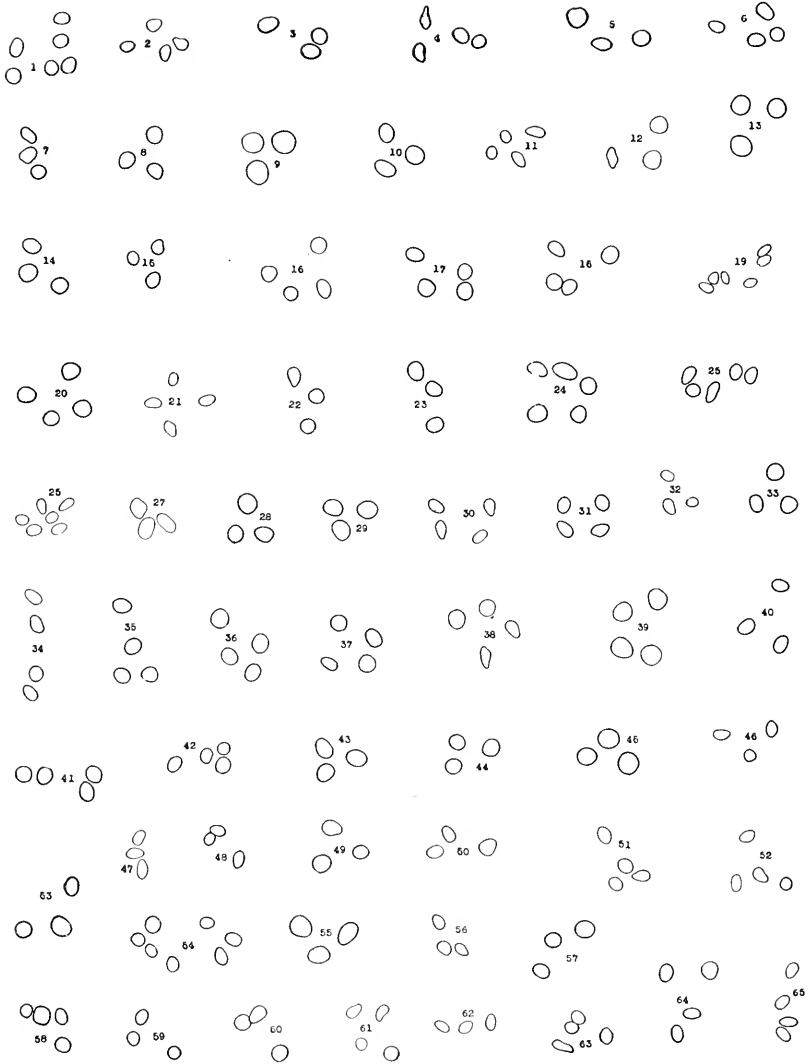

PLATE 93

Short-cycled orange-rust. $\times 100$.

- 1.—Spores collected at Falmouth, Mass., on wild dewberry.
- 2.—Spores collected at Arlington, Va., on wild blackberry.
- 3.—Spores collected in Massachusetts on wild blackberry.
- 4.—Spores collected at Berlin, Md., on cultivated blackberry.
- 5.—Spores collected at Hyattsville, Md., on wild dewberry.
- 6.—Spores collected at West Falls Church, Va., on wild dewberry.
- 7.—Spores collected at Auburn, Ala., on wild dewberry.
- 8.—Spores collected at Fayetteville, Ark., on wild blackberry.
- 9.—Spores collected at Potomac Heights, D. C., on wild blackberry.
- 10.—Spores collected at Morgantown, W. Va., on cultivated blackberry, variety Eldorado.
- 11.—Spores collected at Blacksburg, Va., on cultivated blackberry, variety Iceberg.
- 12.—Spores collected at Ithaca, N. Y., on wild blackberry.
- 13.—Spores collected at Blacksburg, Va., on wild blackberry.
- 14.—Spores collected at West Falls Church, Va., on wild blackberry.
- 15.—Spores collected at Gainesville, Fla., on *Rubus cuneifolius*.
- 16.—Spores collected at Ithaca, N. Y., on wild blackberry.
- 17.—Spores collected at Chico, Calif., on *R. ursinus*.
- 18.—Spores collected at Ithaca, N. Y., on wild dewberry.
- 19.—Spores collected at Arlington, Va., on wild blackberry.
- 20.—Spores collected at Berkeley, Calif., on *R. parviflorus*.
- 21.—Spores collected at Hammonton, N. J., on cultivated blackberry.
- 22.—Spores collected at Fayetteville, Ark., on wild blackberry.
- 23.—Spores collected at West Falls Church, Va., on wild blackberry.
- 24.—Spores collected at French Creek, W. Va., on wild dewberry.
- 25.—Spores collected at Congress Heights, D. C., on wild blackberry.
- 26.—Spores collected at Connellsville, Pa., on wild blackberry.
- 27.—Spores collected at Chico, Calif., on *R. ursinus*.
- 28.—Spores collected at Vienna, Va., on wild blackberry.
- 29.—Spores collected at Bryan, Ohio, on cultivated blackberry.
- 30.—Spores collected at Cameron, N. C., on wild blackberry.
- 31.—Spores collected at Athens, Ohio, on wild blackberry.
- 32.—Spores collected at Blacksburg, Va., on cultivated blackberry, variety Early King.
- 33.—Spores collected at Chico, Calif., on *R. ursinus*.
- 34.—Spores collected at Arlington, Va., on wild blackberry.
- 35.—Spores collected at Ithaca, N. Y., on wild dewberry.
- 36.—Spores collected at Mountain Lake, Va., on wild dewberry.
- 37.—Spores collected at French Creek, W. Va., on wild dewberry.
- 38.—Spores collected at Blacksburg, Va., on cultivated blackberry.
- 39.—Spores collected at Blacksburg, Va., on cultivated blackberry, variety Mersereau.
- 40.—Spores collected at Vienna, Va., on cultivated blackberry.
- 41.—Spores collected at Ithaca, N. Y., on wild blackberry.
- 42.—Spores collected at Blacksburg, Va., on cultivated blackberry, variety Ancient Britain.
- 43.—Spores collected at Janassee Junction, Ga., on wild blackberry.

- 44.—Spores collected at Thunderbolt, Ga., on *R. procumbens*.
- 45.—Spores collected at Hyattsville, Md., on wild dewberry.
- 46.—Spores collected at Hyattsville, Md., on wild blackberry.
- 47.—Spores collected at Blacksburg, Va., on cultivated blackberry.
- 48.—Spores collected at Vienna, Va., on wild blackberry.
- 49.—Spores collected at Willard, N. C., on wild blackberry.
- 50.—Spores collected at Connellsville, Pa., on wild blackberry.
- 51.—Spores collected at Auburn, Ala., on wild blackberry.
- 52.—Spores collected at Butte Creek Canyon, Calif., on *R. ursinus*.
- 53.—Spores collected at Stark, Fla., on wild blackberry.
- 54.—Spores collected at Blacksburg, Va., on wild blackberry.
- 55.—Spores collected at Thunderbolt, Ga., on *R. hispidus*.
- 56.—Spores collected at Hyattsville, Md., on wild blackberry.
- 57.—Spores collected at Blacksburg, Va., on wild blackberry.
- 58.—Spores collected at Hammond, La., on wild blackberry.
- 59.—Spores collected at Orlando, W. Va., on wild blackberry.
- 60.—Spores collected at Ithaca, N. Y., on wild blackberry.
- 61.—Spores collected at Blacksburg, Va., on wild blackberry.
- 62.—Spores collected at West Falls Church, Va., on cultivated blackberry.
- 63.—Spores collected at Arlington, Va., on wild blackberry.
- 64.—Spores collected at Arlington, Va., on wild blackberry.
- 65.—Spores collected at French Creek, W. Va. on wild blackberry.

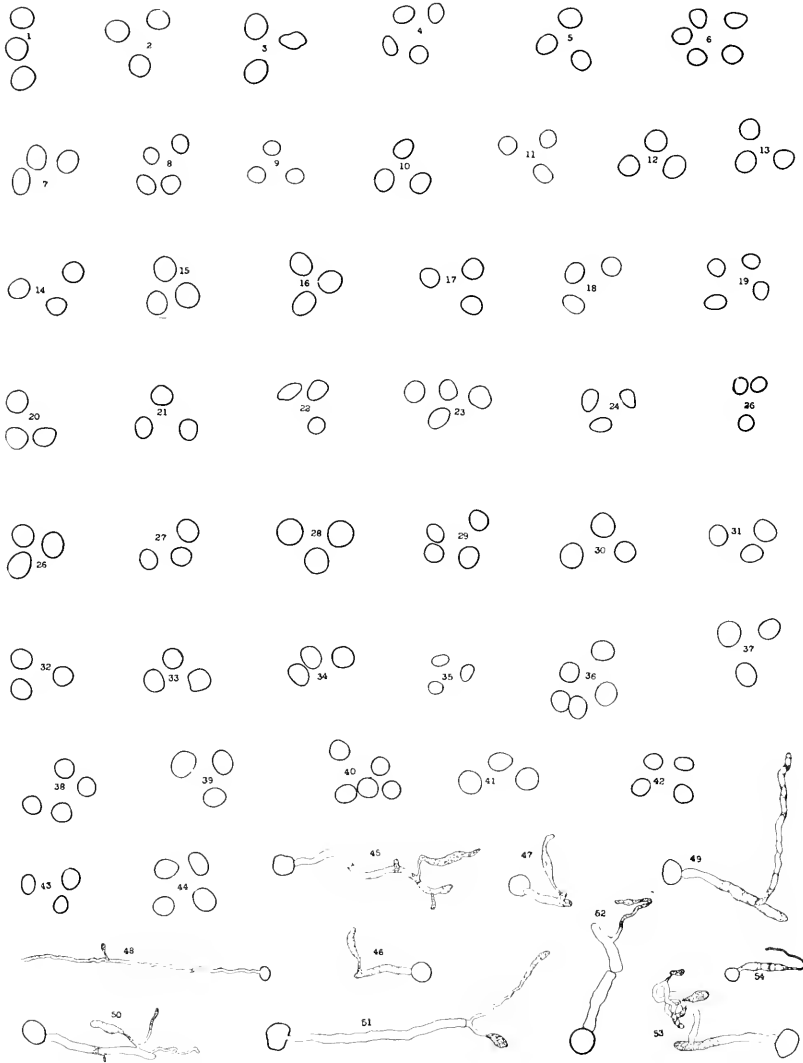

PLATE 94

Gymnoconia interstitialis. $\times 100$, except figures 48 and 54, which are $\times 53\frac{1}{2}$.

- 1.—Spores collected at Madrid, Me., on wild blackberry.
- 2.—Spores collected at French Creek, W. Va., on wild black raspberry.
- 3.—Spores collected at Glen, N. H., on *Rubus nigrobaccus*.
- 4.—Spores collected at West Falls Church, Va., on cultivated black raspberry.
- 5.—Spores collected at Vienna, Va., on cultivated black raspberry.
- 6.—Spores collected at Old Forge, N. Y., on *R. canadensis*.
- 7.—Spores collected at Glen, N. H., on wild blackberry.
- 8.—Spores collected at Mountain Lake, Va., on *R. alleghaniensis*.
- 9.—Spores collected at West Falls Church, Va., on cultivated black raspberry.
- 10.—Spores collected at Portland, Me., on *R. canadensis*.
- 11.—Spores collected at Madison, Wis., on wild blackberry.
- 12.—Spores collected at Phillips, Me., on wild blackberry.
- 13.—Spores collected at Portland, Me., on *R. canadensis*.
- 14.—Spores collected at East Lansing, Mich., on wild blackberry.
- 15.—Spores collected at Sebago Lake, Me., on *R. triflorus*.
- 16.—Spores collected in Michigan on wild blackberry.
- 17.—Spores collected at Old Forge, N. Y., on *R. canadensis*.
- 18.—Spores collected at Madison, Wis., on wild blackberry.
- 19.—Spores collected at Old Forge, N. Y., on *R. canadensis*.
- 20.—Spores collected at West Falls Church, Va., on wild black raspberry.
- 21.—Spores collected at West Falls Church, Va., on cultivated black raspberry.
- 22.—Spores collected at West Falls Church, Va., on cultivated black raspberry.
- 23.—Spores collected at Glen, N. H., on *R. canadensis*.
- 24.—Spores collected at Mountain Lake, Va., on *R. alleghaniensis*.
- 25.—Spores collected at French Creek, W. Va., on black raspberry.
- 26.—Spores collected at Portland, Me., on *R. canadensis*.
- 27.—Spores collected at Smugglers Notch, Vt., on *R. strigosus*.
- 28.—Spores collected at Madrid, Me., on wild blackberry.
- 29.—Spores collected at Old Forge, N. Y., on *R. canadensis*.
- 30.—Spores collected at Smugglers Notch, Vt., on *R. canadensis*.
- 31.—Spores collected at Bancroft, Wis., on *R. hispidus*.
- 32.—Spores collected at Juliet, N. Y., on *R. canadensis*.
- 33.—Spores collected at French Creek, W. Va., on black raspberry.
- 34.—Spores collected at Old Forge, N. Y., on *R. canadensis*.
- 35.—Spores collected at Madison, Wis., on wild blackberry.
- 36.—Spores collected at Portland, Me., on *R. triflorus*.
- 37.—Spores collected at Sebago Lake, Me., on *R. triflorus*.
- 38.—Spores collected at Smugglers Notch, Vt., on *R. canadensis*.
- 39.—Spores collected at Sebago Lake, Me., on *R. triflorus*.
- 40.—Spores collected at Rouses Point, N. Y., on black raspberry.
- 41.—Spores collected at Sebago Lake, Me., on wild blackberry.
- 42.—Spores collected at Mountain Lake, Va., on *R. alleghaniensis*.
- 43.—Spores collected at Bound Brook, N. J., on black raspberry.
- 44.—Spores collected at Glen, N. H., on *R. canadensis*.
- 45.—Spores collected at Glen, N. H., on *R. canadensis*.
- 46.—Spores collected at Chain Bridge, near Washington, D. C., on black raspberry.
- 47.—Spores collected at Chain Bridge, near Washington, D. C., on black raspberry.
- 48.—Spores collected at Chain Bridge, near Washington, D. C., on black raspberry.
- 49.—Spores collected at Glen, N. H., on *R. canadensis*.
- 50.—Spores collected at Glen, N. H., on *R. canadensis*.
- 51.—Spores collected at Glen, N. H., on *R. canadensis*.
- 52.—Spores collected at West Falls Church, Va., on black raspberry.
- 53.—Spores collected at Vienna, Va., on black raspberry.
- 54.—Spores collected at West Falls Church, Va., on black raspberry.

GERM-FREE FILTRATES AS ANTIGENS IN THE COMPLEMENT-FIXATION TEST

By WILLIAM S. GOCHENOUR

Veterinary Inspector, Pathological Division, Bureau of Animal Industry, United States Department of Agriculture

In the production of germ-free blackleg filtrates, to insure uniformly good results it is of prime importance to check or control properly each lot of culture flasks, so as to know definitely that the blackleg organism alone has been growing therein. After the culture flasks have been inoculated and have been incubated for from six to nine days it is quite simple to remove one or more cubic centimeters of the culture and test it for the presence or absence of aerobic organisms. The detection of foreign anaerobes, however, should any be present, is not at all a simple procedure. Moreover, it would be quite impracticable to resort to the complicated process of anaerobic plating or fishing in the search of contaminating anaerobic microorganisms as a routine procedure with each lot of culture flasks. For this reason serological studies were made with pure germ-free blackleg filtrates to ascertain whether they would act as antigens in the complement-fixation test and, if so, what range of specificity could be obtained therewith, using the results as an index to what a satisfactorily produced product should possess.

Accordingly, blackleg filtrates were prepared, and a horse was repeatedly injected with them at intervals extending over a period of approximately three months. Blood serum drawn from this animal constituted the positive or immune serum. Antigenic titrations were then made, using 0.2 cc. of positive and 0.2 cc. of negative (normal horse) serum; and grading amounts of the germ-free filtrate were added as the antigen. The titration given in Table I will exemplify the character of reaction that has been obtained.

When the filtrate is concentrated over sulphuric acid in vacuo to one-half or one-third its original volume, the antigenic unit and the anticomplementary dose are reduced in the same ratio.

So far as the writer is able to learn by search through the literature, the use of a germ-free filtrate as an antigen in the complement-fixation test is an entirely new phenomenon; and it promises to serve a very important rôle in the separation and differentiation of the spore-bearing anaerobes. With this purpose in mind it is contemplated to parallel this reaction with the other pathogenic spore-bearing anaerobes as *Bacillus edematiens*, vibriion septique, *B. tetanus*, *B. botulinus*, etc.; and evidence of the feasibility of doing this is shown in the tests already made with

B. botulinus filtrate. Good fixations were obtained by using *B. botulinus* (type B) filtrate with *B. botulinus* (type B) immune serum, but type B filtrate and type A serum would not produce a fixation, nor would type A filtrate produce a fixation with type B serum. Considering that type B immune serum does not protect guinea pigs against type A filtrate, which contains the type A toxin, and vice versa, the absence of fixation when using one type of serum and the other type of filtrate as antigen is quite important from a differential standpoint and also serves to indicate the specificity of the reaction obtainable by this method.

TABLE I.—Titration of germ-free blackleg filtrate antigen

Tube No.	Serum.		Physiological salt solution.	Antigen. ^c	Complement.		Hemolytic rabbit serum and sheep corpuscle. ^d	Result. ^e
	Positive. ^a	Negative. ^b						
	Cc.	Cc.	Cc.	Cc.	Cc.		Cc.	
I.....	0.2	2	0.05	I	Incubated 1 hour at 37° C.	2	+
1.....	.2	2	.1	I		2	+
3.....	.2	2	.2	I		2	+
4.....	.2	2	.3	I		2	+
5.....	.2	2	.4	I		2	+
6.....	.2	2	.5	I		2	+
7.....	.2	2	.6	I		2	+
8.....	.2	2	.7	I		2	+
9.....	.2	2	.8	I		2	+
10.....	.2	2	1.0	I		2	+
11.....	.2	2	2.0	I		2	+
12.....	.2	2	I		2	-
1.....	0.2	2	.05	I		2	-
2.....2	2	.1	I		2	-
3.....2	2	.2	I	2	-	
4.....2	2	.3	I	2	-	
5.....2	2	.4	I	2	-	
6.....2	2	.5	I	2	-	
7.....2	2	.6	I	2	-	
8.....2	2	.7	I	2	±	
9.....2	2	.8	I	2	+	
10.....2	2	1.0	I	2	+	
11.....2	2	2.0	I	2	+	
12.....2	2	I	2	-	
13.....2	2	I	2	-	
14.....2	2	2	+	

^a Horse serum hyperimmunized to germ-free blackleg filtrate.

^b Normal horse serum.

^c Germ-free blackleg filtrate.

^d Hemolytic system employed consisted of a 3 per cent suspension of sheep red cells, 2½ units of hemolytic amboceptor, and 1½ units of complement, the latter being titrated against the amboceptor and sheep cells.

^e + indicates complete inhibition of hemolysis; ±, partial inhibition of hemolysis; and -, no inhibition of hemolysis.

Since a blackleg filtrate produced from a pure culture of *Bacillus chauveaui* and grown under favorable conditions will possess antigenic value in the quantities shown in the preceding table, if a filtrate were encountered that failed to approximate such a titre then only would it

seem necessary to resort to the anaerobic cultural examination of the culture flasks. Calves inoculated with blackleg filtrate showing a satisfactory antigenic value were rendered sufficiently immune, after a period of three to four weeks, to withstand intramuscular injections of 100 to 200 mgm. of virulent blackleg muscle powder, a quantity sufficient to kill unvaccinated calves in two to three days.

Failure of a blackleg filtrate to possess an antigenic titre of from 1/10 to 1/20 the anticomplementary dose should arouse the suspicion that the blackleg organism did not grow under favorable conditions, that some contamination is present, or that the organism being used was not the blackleg organism at all.

CONCLUSION

From the data at hand it can be said that—

(1) A blackleg filtrate produced under favorable conditions will possess a distinct antigenic value demonstrable by the complement-fixation test.

(2) Those blackleg filtrates that conferred a solid immunity on calves were found to possess a high antigenic titre.

(3) The complement-fixation reaction should be of much value as a laboratory control test to determine whether the filtrate has been produced under conditions favorable to the blackleg organism or whether the blackleg organism has been supplanted in part or wholly by contaminating anaerobic microorganisms.

(4) Botulinus filtrate also acts as an antigen in the complement-fixation test when type B serum is used with type B filtrate but fails to cause fixation when one type of serum is used with the other type of filtrate as antigen.

(5) The phenomenon of germ-free filtrates acting as antigens in the complement-fixation test is new and promises to play an important part in the differentiation of the spore-bearing anaerobes, more especially those having closely similar cultural characteristics.

MOSAIC DISEASE OF CORN ¹

By E. W. BRANDES

*Pathologist, Office of Sugar-Plant Investigations, Bureau of Plant Industry,
United States Department of Agriculture*

DISTRIBUTION

In connection with an investigation of the mosaic disease of sugar cane, a similar disease of corn has been observed by the writer on several occasions in widely separated regions.² On April 18, 1919, corn of an unknown variety was seen to be affected with typical mosaic symptoms in a field just west of Peñuelas, P. R. The percentage of affected plants was small, however, only 20 individuals being found in the field of some 5 acres. The corn averaged about 24 inches in height at this time and was planted between rows of sugar-cane stubble which had not been completely killed out in preparing the land for the corn. All the sugar cane was affected with mosaic. In July, 1919, corn of the White Creole variety was seen at the Sugar Experiment Station, New Orleans, La., in which the same condition was apparent. This corn was more than half grown, and the typical streaking of the leaves was somewhat obscured by certain leafspot diseases, among them the leafspot caused by *Physoderma zae-maydis*, by which the corn was severely attacked. About 10 per cent of the plants in the field were affected with mosaic. In adjoining fields of sugar cane nearly 100 per cent of the plants were affected with the sugar-cane mosaic. In 1920 corn of the same variety was examined early in the season, and a much more serious infestation was found. The corn had been planted following sugar cane, and occasional diseased stools of the latter not killed by the plow were found all through the corn field. More than 30 per cent of the corn plants were affected. The cases were more abundant in the vicinity of the sugar-cane stools referred to above, but cases could be found many rods from any living cane. Of course, it is possible that a stool of cane had sprouted between the rows in such a situation and later had been killed by the cultivator. In May, 1920, identical cases of mosaic were seen in a field of corn near Cairo, Ga. As in the cases reported previously, a neighboring field of sugar cane was slightly infested with mosaic.

¹ The study of this disease was undertaken on account of its relation to sugar-cane mosaic.

² BRANDES, E. W. THE MOSAIC DISEASE OF SUGAR CANE AND OTHER GRASSES. U. S. Dept. Agr. Bul. 829, 26 p., 5 fig., 1 col. pl. 1919.

Diseases of corn bearing a decided resemblance to the one in question have been reported from other countries. Dr. H. L. Lyon states¹ that in the Hawaiian Islands a disease of corn which resembles sugar-cane mosaic is very serious. William H. Weston² describes a disease of corn in Guam which may be identical with the one under discussion. He mentions yellowing and dwarfing among the symptoms and states that the leaves exhibited mottling and striping.

VARIETAL SUSCEPTIBILITY

Just enough work has been done on varietal susceptibility to prove that all varieties of corn do not respond in the same way. The writer has never seen such excessive injury as that described for the unknown variety in Guam by Weston. In Louisiana the injury to corn of the White Creole variety, while marked in some individuals, was not excessive, excepting when the plants were infected early in the spring. The variety U. S. Select No. 182 is very susceptible to mosaic, but is not especially injured by it. Golden Bantam sweetcorn could not be infected in the greenhouse by methods which were successful with U. S. Select No. 182. Golden Bantam was planted unprotected in a greenhouse with hundreds of infected sugar-cane and sorghum plants. The corn aphid quickly migrated to the young corn plants from diseased sorghum in great numbers, but no cases appeared among the Golden Bantam seedlings. It seems probable that this variety is immune.

IMPORTANCE

No figures are available on the amount of loss sustained on account of injury to corn. The writer is inclined to believe that in this country no great damage has been done thus far. Probably the disease was introduced on sugar cane within comparatively recent years, in which case it may become more important in the future. At present, however, our chief concern is with its relation to the sugar-cane crop. Corn is almost invariably used in the rotation on sugar-cane land, so that no plantation is ever without corn in some of its fields. This means, of course, that the possibility for spread of the disease is greatly increased. Overwintering by the virus has been demonstrated only in the vegetative portions of the sugar-cane plant, but the existence of other graminaceous hosts certainly complicates the problem of control.

SYMPTOMS

In corn as in sugar cane the most conspicuous symptom of mosaic is the streaked and irregularly mottled appearance of the leaves. In corn, however, the lower, older leaves have a greater tendency to resume their normal color, so that it is sometimes difficult to demonstrate the

¹ In verbal communication, January, 1920.

² WESTON, W. H. REPORT ON THE PLANT DISEASE SITUATION IN GUAM. Guam Agr. Exp. Sta. Rpt. 1917, p. 45-62. 1918.

mosaic patterns in such leaves. In the youngest leaves, either the normal dark green or the pallid, affected tissue may predominate in a given specimen, but the latter condition is most frequently met with. In such cases the areas which remain normal are in the shape of broken or interrupted streaks or lines extending in the general direction of the long axis of the leaf (Pl. 95), and the contrast in color between these areas and the surrounding pallid areas is very decided. The streaks vary greatly in size, ranging from mere points to elongated "islands" of dark green 2 or 3 cm. or more long and several millimeters wide. The margins of such streaks may be straight or undulating. In most cases the mosaic pattern is more prominent at the base of the leaf, where it diverges from the leaf sheath. Where the normal dark green is predominant, the light green, affected tissue appears usually as a very fine mottling or as irregular elongated streaks on the darker background. From the foregoing description it can be seen that the patterns vary considerably, and yet they have certain general characteristics which make it almost impossible to confuse this condition with any other affecting the leaves.

Infected plants are always lighter in color than healthy plants. When viewed from a distance such plants can be picked out with a fair degree of accuracy on this account. The top of the plant is especially pale, much more so than normal freshly unrolled young leaves. In some cases the color becomes decidedly yellow. In this connection it must be stated that the pallid color referred to heretofore as characteristic of the diseased areas is not a yellowish green but a lighter or more dilute tint of the normal green. In plants which become markedly yellow a decided stunting of the whole plant takes place. At no time has a case been observed to terminate fatally, but certainly considerable injury results from the lack of functioning chloroplastids, and where a large percentage of the plants are affected the loss due to decreased size of ears is appreciable. When infection takes place early in the growing season, partial or complete sterility of the ears results. This serious feature of the disease was first noticed in Louisiana in 1920. In May, 1920, the writer tagged 20 diseased and 10 healthy plants in a field of White Creole corn. The diseased and healthy plants were equally vigorous to all appearances at that time and were in the same rows, alternate diseased and healthy plants in the same row being selected as far as it was practicable. When the crop was harvested in August, 17 of the diseased plants were found to be completely sterile, while 3 of them had set a few scattered kernels. The 10 healthy plants were normal, excepting for slight corn earworm injury, and produced large well-filled ears (Pl. 96).

During the course of experiments in the greenhouse several cases of apparent recovery have been observed. Plants which became infected and exhibited the typical symptoms resumed their normal color after several weeks. These plants were held under observation until the ears were mature, but there was no recurrence of the mosaic symptoms.

This interesting behavior was also noted in stools of crabgrass (*Syntherisma sanguinalis*) and foxtail (*Chaetochloa lutescens*). There were no changes of growing conditions that could be correlated with these apparent recoveries. In this connection it may not be out of place to record that suckers from diseased stools of sugar cane and sorghum have been observed to come up with no sign of mosaic. These instances are by no means common, but several have been seen in both plants mentioned.

INSECT TRANSMISSION OF CORN MOSAIC

The manner in which corn mosaic is transmitted to healthy plants and the relation of this disease to mosaic in other grasses was demonstrated by the following experiments.

EXPERIMENT 1.—On March 12, 1920, 12 corn plants of the variety U. S. Select No. 182 were placed in each of two insect-proof cages. All of the plants were from the same lot of seed furnished by the Office of Cereal Investigations. The seed had been planted in one flat, and the seedlings were replanted in 5-inch pots on the date of removal to the cages. They were then 12 inches tall. About 12 individuals of *Aphis maydis* were carefully removed by means of a small camel's-hair brush from sorghum plants affected with mosaic to each corn seedling in one of the cages. The sorghum plants had been infected by aphids from mosaic sugar cane. Twelve aphids were transferred in the same way from healthy sorghum to each of the corn seedlings in the adjoining control cage. On March 28, 6 of the 12 corn seedlings in the first cage showed typical signs of mosaic in the two youngest leaves. On April 6, 8 of the plants, or 66 $\frac{2}{3}$ per cent, were typical cases. The 12 control plants remained healthy up to the time of removal several weeks later.

EXPERIMENT 2.—On April 6, 1920, 20 corn seedlings, variety U. S. Select No. 182, in 5-inch pots were placed in each of two insect-proof cages in the greenhouse. Several specimens of *Aphis maydis* were transferred from infected corn plants to each corn seedling in the first cage. Aphids from healthy corn in another greenhouse were placed on each corn plant in the second control cage, which was used as a control. On May 4, 7 of the corn seedlings in the first cage were found to be infected. On May 28, 15 of the 20 plants were observed to be unmistakable cases. The aphids had increased enormously in both cages. Not a single case could be found in the control cage, nor had any appeared up to June 25, although the plants had been repotted twice and were approaching maturity.

These experiments demonstrate conclusively that provision is made for almost unlimited dispersal of the virus through the medium of the corn aphid. There is no reason for supposing that transmission in nature is limited to this insect or to this method. It is not yet known whether the virus can survive the winter in seed, but experiments are now under

way that may throw some light on this phase of the problem. It has been proved that the virus of corn mosaic is identical with that of sugar-cane and sorghum mosaic, so that even if it is found not to be seed-borne, perpetuation of the disease in the perennial grasses would explain its appearance on corn in the spring.

Artificial transmission of the disease by means of inoculation with expressed cell sap of affected plants has not been attempted for corn. This method has proved successful in sugar cane, however,¹ and there is little doubt that the infectious material is contained in the cell sap of corn. Just what this infectious material is can not be stated definitely, but the evidence points strongly toward a living organism. No evidence incompatible with this view has been put forward for any mosaic disease, excepting the failure to demonstrate any visible organism.

CONTROL

Control measures for this disease must be based fundamentally on the removal of sources of the inoculum. So far as is known the only sources of inoculum are the living host plants. Destruction of these plants, then, will effectively eradicate the disease from any region. Practically, the destruction of all affected host plants presents almost unsurmountable obstacles. An immense amount of sugar cane is now infected in the River District of Louisiana and in southern Georgia. Destruction of large numbers of plants by roguing or plowing up is viewed with great concern by the planters, most of whom oppose any plan to control the disease by eradication. The substitution of immune varieties of corn as well as cane does not offer any immediate solution, since the most susceptible varieties happen to be the ones most esteemed. Elimination of this disease is dependent upon the education of the planter to an understanding of its seriousness. When this is accomplished public sentiment will permit of the passage of compulsory roguing and quarantine laws, which will be necessary before any hope can be entertained of eliminating the disease.

¹ BRANDES, E. W. ARTIFICIAL AND INSECT TRANSMISSION OF SUGAR-CANE MOSAIC. *In Jour. Agr. Research*, v. 19, no. 3, p. 131-138. 1920. Literature cited, p. 138.

PLATE 95

Mosaic disease of corn:

The first leaf at the left shows the typical interrupted streaks of normal green in a pallid green background. The next leaf shows a more irregular, mottled pattern. In these specimens the normal green was similar to "nickel green" and the pallid green was similar to "rejame green" in Ridgeway.¹ The two leaves at the right are from a healthy plant and are presented for comparison.

¹ RIDGEWAY, Robert. COLOR STANDARDS AND COLOR NOMENCLATURE. 43 p., 53 col. pl. Washington, D. C., 1912.

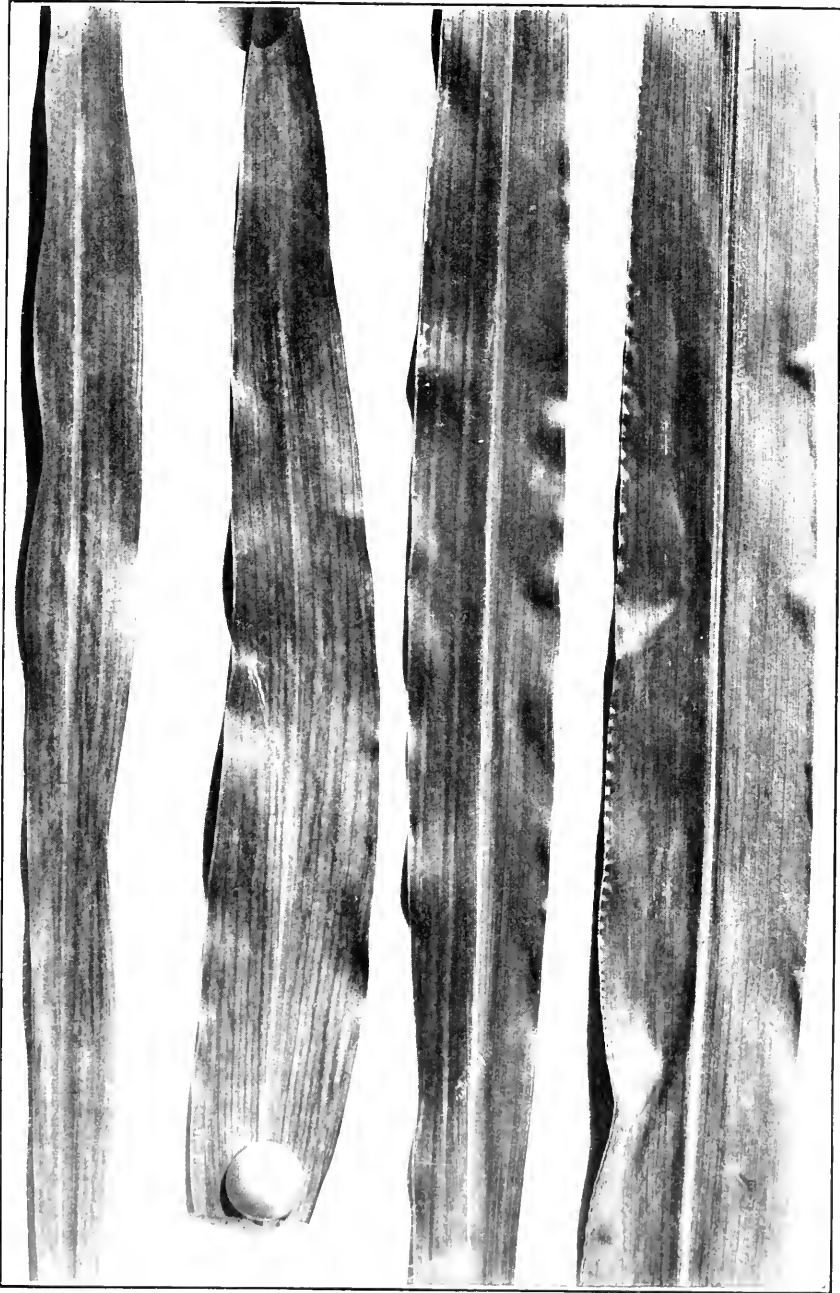

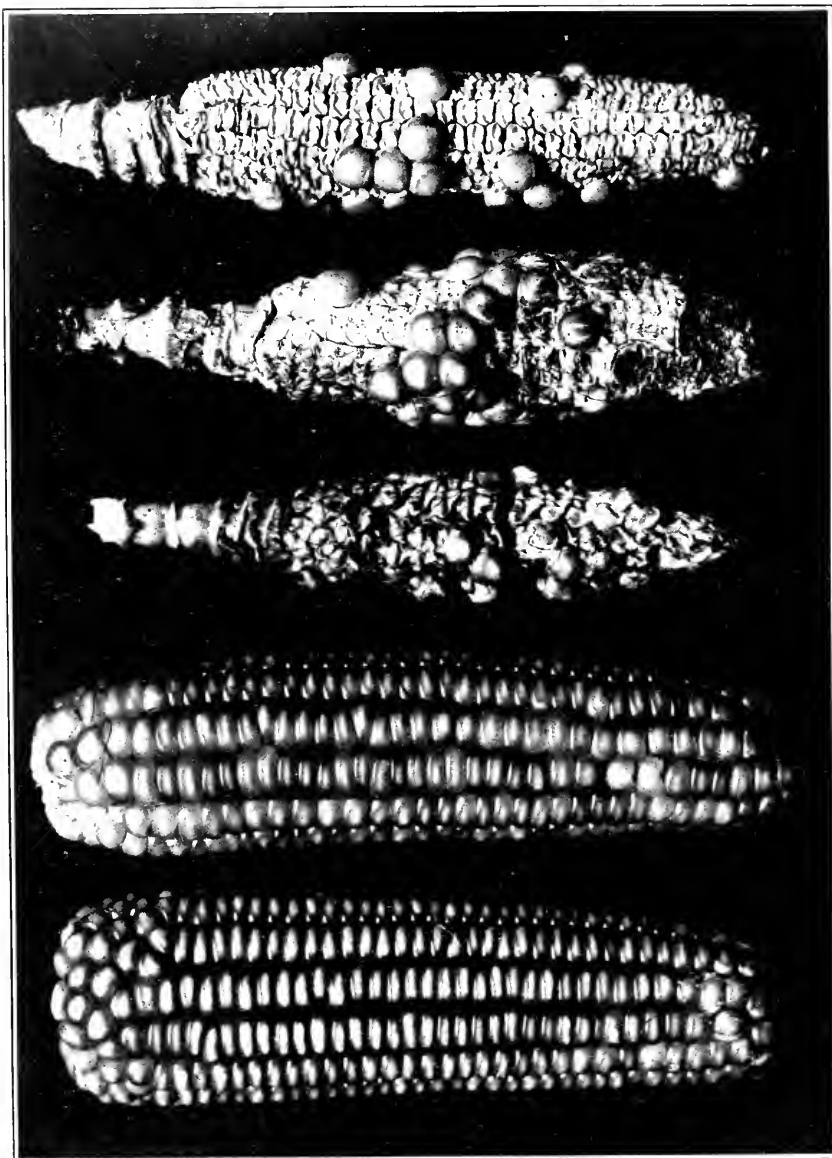

PLATE 96.

Mosaic disease of corn: Effect of early infection on the ear. White Creole variety.

The three ears at the top were produced by plants naturally infected in the field. In 17 out of 20 marked plants no kernels at all were developed.

The two lower ears are typical of all ears produced by healthy plants in the same row with the diseased plants.

ADDITIONAL COPIES
OF THIS PUBLICATION MAY BE PROCURED FROM
THE SUPERINTENDENT OF DOCUMENTS
GOVERNMENT PRINTING OFFICE
WASHINGTON, D. C.
AT
25 CENTS PER COPY
SUBSCRIPTION PRICE, \$1.50 PER YEAR

△

JOURNAL OF AGRICULTURAL RESEARCH

CONTENTS

	Page
Genetics of Rust Resistance in Crosses of Varieties of Triticum vulgare with Varieties of T. durum and T. dicoccum - - - - -	523

H. K. HAYES, JOHN H. PARKER, and CARL KURTZWEIL

(Contribution from Minnesota Agricultural Experiment Station and Bureau of Plant Industry)

Line-Selection Work with Potatoes - - - - -	543
---	-----

O. B. WHIPPLE

(Contribution from Montana Agricultural Experiment Station)

Occurrence of the Fixed Intermediate, Hordeum intermedium haxtoni, in Crosses between H. vulgare pallidum and H. distichon palmella - - - - -	575
---	-----

HARRY V. HARLAN and H. K. HAYES

(Contribution from Bureau of Plant Industry and Minnesota Agricultural Experiment Station)

PUBLISHED BY AUTHORITY OF THE SECRETARY OF AGRICULTURE,
WITH THE COOPERATION OF THE ASSOCIATION OF
LAND-GRANT COLLEGES

WASHINGTON, D. C.

**EDITORIAL COMMITTEE OF THE
UNITED STATES DEPARTMENT OF AGRICULTURE AND
THE ASSOCIATION OF LAND-GRANT COLLEGES**

FOR THE DEPARTMENT

KARL F. KELLERMAN, CHAIRMAN

*Physiologist and Associate Chief, Bureau
of Plant Industry*

EDWIN W. ALLEN

Chief, Office of Experiment Stations

CHARLES L. MARLATT

*Entomologist and Assistant Chief, Bureau
of Entomology*

FOR THE ASSOCIATION

J. G. LIPMAN

*Dean, State College of Agriculture, and
Director, New Jersey Agricultural Experiment
Station, Rutgers College*

W. A. RILEY

*Entomologist and Chief, Division of Entomology
and Economic Zoology, Agricultural Experiment
Station of the University of Minnesota*

R. L. WATTS,

*Dean, School of Agriculture, and Director,
Agricultural Experiment Station, The
Pennsylvania State College*

All correspondence regarding articles from the Department of Agriculture should be addressed to Karl F. Kellerman, Journal of Agricultural Research, Washington, D. C.

All correspondence regarding articles from State Experiment Stations should be addressed to J. G. Lipman, New Jersey Agricultural Experiment Station, New Brunswick, N. J.

JOURNAL OF AGRICULTURAL RESEARCH

VOL. XIX

WASHINGTON, D. C., SEPTEMBER 1, 1920

NO. 11

GENETICS OF RUST RESISTANCE IN CROSSES OF VARIETIES OF TRITICUM VULGARE WITH VARIETIES OF T. DURUM AND T. DICOCCUM¹

By H. K. HAYES, *Head of Section of Plant Breeding, Division of Agronomy and Farm Management, Department of Agriculture, University of Minnesota*, JOHN H. PARKER, *Scientific Assistant*, and CARL KURTZWEIL,² *Assistant Pathologist, Office of Cereal Investigations, Bureau of Plant Industry, United States Department of Agriculture*

INTRODUCTION

The black stemrust (*Puccinia graminis*) of small grains causes enormous losses. Reduction in yield of from 10 to 50 per cent of the wheat crop is common. At irregular intervals the black stemrust of wheat causes almost complete failure, especially in the spring-wheat area of the upper Mississippi Valley. Control of this disease, which develops into such terrific epidemics, is impossible by any method now available to the individual grower. For this reason the development of resistant varieties assumes great importance. While the barberry eradication campaign now being carried on over a wide area will certainly reduce the amount of rust, local outbreaks may perhaps be expected even after barberries have apparently been eradicated. The attempt to develop resistant varieties, therefore, should continue. There is every reason to hope that the stemrust problem can be solved by barberry eradication and the development of resistant wheat varieties.

When the present study was outlined, the evidence seemed to show that parasitic action of the rust was constant. Recent extensive studies (22, 23)³ have confirmed this view and indicate that the bridging hypothesis (*IT*), which was supposed to account for the increase or decrease in

¹ Published with the approval of the Director as Paper 187, Journal Series, Minnesota Agricultural Experiment Station. Cooperative investigation between the Minnesota Agricultural Experiment Station and the Office of Cereal Investigations, Bureau of Plant Industry, United States Department of Agriculture.

² The breeding of spring wheat for rust resistance was begun by Dr. E. M. Freeman and E. C. Johnson in 1908 and has been continued without interruption until the present time. The present cooperative arrangement between the Division of Plant Pathology and Botany and the Section of Plant Breeding, Division of Agronomy and Farm Management, of the University of Minnesota, was made in the spring of 1916. The writers wish to acknowledge the helpful cooperation of Dr. E. M. Freeman and Dr. E. C. Stakman in this investigation.

³ Reference is made by number (*italic*) to "Literature cited," pp. 541-542.

virulence of the rust, is probably incorrect. More recent investigations of the wheatrust fungus have shown that there are numerous biologic forms (25) which can be differentiated only by their action on various pure-line wheat varieties. This is a very serious obstacle to the production of rust-resistant varieties by breeding, although the fact that Khapli (C I 4013),¹ an emmer imported from India, is resistant to all biologic forms so far isolated shows that the problem is not entirely hopeless.

Former breeding investigations have determined which varieties of wheat are commonly resistant to stemrust at University Farm, St. Paul, and have also indicated the behavior of rust resistance in crosses. In the light of this information it was decided to make a careful genetic study of one or two crosses, hoping thus to solve the plant-breeding phase of the rust-resistance problem. The second generation of the crosses reported in this paper had already been studied before it was known that there were sometimes numerous biologic forms of the rust in the same locality. It seemed worth while to complete the study of inheritance of rust resistance in these crosses by growing a small F_3 family of each F_2 plant which produced viable seed. All barberry bushes were removed from the immediate vicinity of the rust plot early in the spring of 1918, and the artificially induced epidemic was produced with a known racial strain of the biologic form *Puccinia graminis tritici* Erikss. and Henn. Therefore, the greater part, if not all, of the rust infection present during the season of 1918 was due to this one biologic form. One uredinium found on Kanred (C I 5146), which is known to be resistant to the strain which was used to induce the epidemic, proved to belong to another biologic form.

The present paper is a report of the inheritance of rust resistance in its correlation with botanical and morphological characters of crosses between *Triticum vulgare* with varieties of *T. durum* and *T. dicoccum*.

SOME PREVIOUS CROSSES OF WHEAT SPECIES

Because of the many differential characters and the great economic importance of the crop, wheat has been frequently used in studies of the laws of inheritance. Vilmorin (26, 27) reported quite extensive tests of crosses between *Triticum sativum* L., *T. turgidum*, *T. durum* Desf., *T. polonicum* L., and *T. spelta*. From the Mendelian standpoint the results obtained are interesting. He observed remarkable uniformity in the F_1 generation, wide diversity in the F_2 generation, and states that the predominating force after the F_3 generation is that of heredity, which compels the plants to reproduce their characters in their immediate descendants. Vilmorin placed spelt and common wheats in one group and poulard and durum in another, because he found that either spelt or common crossed with poulard or durum produced all four types in the

¹ Cereal investigations number.

segregating generations. These types were easily fixed after several years of selection. The four types were believed to have a common ancestry and to belong to one botanical species. Unsuccessful attempts were made to cross these species with *T. monococcum* L. This led Vilmorin to conclude that *T. monococcum* belonged to a separate species.

Tschermak (25) confirmed Vilmorin's conclusions regarding the production of common, durum, spelt, and poulard forms from crosses when the groups differed in the solid and hollow stem character. He stated that the polonicum type was obtained only when it was used as one of the parents. Relationships were illustrated on a factor hypothesis by assuming (1) that *Triticum polonicum* contained two dominant factors, (2) that common wheat lacked these factors, and (3) that durum contained one of these factors but not the other. Tschermak also thinks that *T. monococcum* is different from other wheat species. He obtained hybrids between *T. monococcum* and *T. vulgare* and one F_2 plant, which soon died.

Blaringhem (6), however, succeeded in crossing *Triticum durum* and *T. polonicum* with *T. monococcum*. Sterility was at first of frequent occurrence in these crosses, but in later generations it was much less common.

Explorations by Aaronsohn in 1906 (1) confirm the experimental evidence cited above. A wild emmer, *Triticum dicoccum dicoccoides*,¹ found in 1906, is interesting because it tends to confirm the report that such an emmer was collected as early as 1885.

Crosses between Black Winter emmer and Fultz-Mediterranean (15) had strongly keeled glumes with hard, adherent chaff in the F_1 generation. The F_2 plants varied widely in type and exhibited transgressive segregation for some characters. There was considerable sterility in this cross. The hairy chaff and black color of the emmer parent were linked in inheritance.

Freeman (12) found evidence of linkage between high ratio of width to thickness of head and hardness of grain in a cross between durum wheat and a variety of bread wheat. The bread wheat parent had a square head with soft, opaque grains, while the durum parent had a much flattened head and produced hard, translucent grains.

In a recent article on heredity of quantitative characters in wheat (13) a cross between durum and common wheat is reported. It gave normally vigorous plants in the F_1 generation. In the F_2 generation, however, many seeds failed to germinate; and among those with a normal vegetative development were found plants exhibiting every degree of sterility, from perfectly sterile to fertile plants.

Linkage has been reported by Engledow and Biffen in crosses between Rivet, *Triticum turgidum*, and common Fife wheat. Gray glume color

¹ From a cross between durum and common varieties, Love and Craig have produced a form which closely resembles the wild emmer. LOVE, H. H., and CRAIG, W. T. THE SYNTHETIC PRODUCTION OF WILD WHEAT FORMS. *In Jour. Hered.*, v. 10, no. 2, p. 51-64, illus.

(4) was always found associated with hairy chaff, and partial linkage (10) was found between the factors for black color and the factors for glabrous chaff.

Since sterility has been found by many investigators in wheat crosses and has been confirmed by the results presented in this paper, it seems rather difficult to reach any conclusion regarding linkage, because some combinations may be eliminated.

The inheritance of the principal botanical characters of our cultivated wheats is well known and, therefore, need not be summarized in this paper. The inheritance of beards will be mentioned in connection with our results on sterility. In crosses between the so-called beardless wheats such as Marquis and Bluestem and a bearded variety, the F_1 generation has intermediate awns and in the F_2 generation a 1 to 2 to 1 ratio is obtained. Fully bearded plants breed true in the F_3 generation. Howard and Howard (14) found that there are two classes of wheats with short awns which, when crossed, give fully bearded plants in the F_2 generation and breed true in the F_3 generation. Likewise, crosses between bearded and true beardless forms gave 1 fully bearded plant in the F_2 generation out of 16 plants. The fact of interest for our studies is that fully bearded plants breed true for this character.

PREVIOUS STUDIES ON INHERITANCE OF RUST RESISTANCE

The most successful attempt to breed rust-resistant wheats was made by Biffen (2, 3, 5), who found that resistance to striperust (*Puccinia glumarum* Erikss. and Henn.) was a recessive character. Definite segregation occurred in the F_2 generation, and forms bred true in the F_3 generation, the ratio of resistant to susceptible in the segregating families being 1 to 3. From the practical standpoint these experiments have been very valuable. A new variety, Little Joss, was produced, which, because of its rust resistance, yields more on the average than susceptible sorts and has desirable milling characters.

Nilsson-Ehle (20) has likewise made studies of the inheritance of resistance to striperust. Distinct dominance of susceptibility was seldom found. Ordinarily the F_1 generation was intermediate, and in other cases resemblance to one or the other parent was observed. Segregation was obtained in the F_2 generation, but without definite ratios. Transgressive segregation occurred, forms being obtained which were more susceptible than the susceptible parent and others which were more resistant than the resistant parent. The results were explained on the basis of multiple factors.

While many observations have been made on resistance of wheat varieties, the two experiments cited above are the only carefully controlled studies so far reported which show the mode of inheritance.

METHODS OF STUDYING INHERITANCE OF RUST RESISTANCE

In the studies here recorded crosses were made between Marquis and resistant durum and emmer wheats. Precautions were taken to protect the emasculated heads from foreign pollen. The F_1 plants were grown in individually spaced plots, and seed from each F_1 plant was grown separately. The F_2 families of crosses between the same parent varieties gave similar results and were considered as a single cross. No effort was made with either the F_1 or F_2 plants to protect them from natural crossing, and an error was thus introduced which will be discussed later.

The correlation between resistance in the F_1 and the F_2 generations gave unusual results which indicated that some uncontrolled factor was causing complications. For example, the F_1 cross between emmer and Marquis which was grown in 1916 appeared resistant, while in the F_2 generation which was grown in 1917 the number of resistant plants was much smaller than would be expected if resistance were a dominant character. This led to the belief that very likely more than one biologic form of stemrust was present in 1917.

Each F_2 plant which produced viable seed was tested in 1918. As previously mentioned, the barberry bushes were removed from the immediate vicinity of the rust plot early in the spring of 1918. An epidemic was obtained with a known strain of *Puccinia graminis tritici* which had been cultured in the greenhouse by the Section of Plant Pathology for several generations. This strain had been tested repeatedly on varieties of wheat and proved to be constant.

The 1918 results have been used to determine the resistance or susceptibility of F_2 plants which have been grown the previous season. The F_3 as well as the F_2 data have been used as a basis for placing the F_2 plants in certain botanical groups, for the problem was chiefly to determine the mode of inheritance and correlation of resistance or susceptibility with those botanical characters which are commonly used in differentiating wheat species, some of which are also of economic importance.

STERILITY IN THE CROSSES OF MARQUIS WITH DURUM AND EMMER VARIETIES

In order to determine whether there is any interrelation between botanical characters and rust resistance, the data for each F_2 plant were taken in a correlated manner. The practical significance is obvious. For example, if durum head and seed characters were rather closely linked with rust resistance in inheritance, it would be necessary to grow a larger F_2 population to obtain the desired form than if each character were inherited independently. In deciding regarding possible linkage it is important to know whether sterility is involved in the crosses.

Sterility might cause the elimination of certain gametic or zygotic combinations, thus actually eliminating the sort desired. Zygotic combinations are sometimes eliminated as is the case with the homozygous yellow mouse combination (7, 17) and with lethal factors in *Drosophila* (19). In some cases gametic combinations are eliminated. Such eliminations occur as a result of pollen or ovule abortion.

POLLEN ABORTION

The presence of shriveled or abortive pollen grains is one means of recognizing sterility. The method here used was to shake out pollen from the heads upon a clean glass slide and then place a minute drop of fuchsin on the pollen, then a drop of lactic acid, and a cover glass.¹ By this method pollen was preserved for several weeks and could be studied when it was convenient.

The parent plants and F_1 crosses were grown in 6-inch pots in the greenhouse. A small percentage of small, globular, clear pollen grains were observed. These, together with the occasional shriveled grains, were counted as sterile. The results of these counts are given in Table I.

TABLE I.—Counts of sterile pollen grains in wheat species and F_1 crosses between them

	Variety.	Good pollen.	Poor pollen.
Parental species:			
<i>Triticum vulgare</i>	Marquis.....	513	4
<i>Triticum durum</i>	Mindum.....	135	2
<i>Triticum durum</i>	Kubanka (C I 2094).....	122	3
<i>Triticum dicoccum</i>	Emmer (Minn. 1165).....	169	0
F_1 crosses:			
Marquis × emmer (Minn. 1165).....	475	19
Emmer (Minn. 1165) × Marquis.....	340	37
Kubanka (C I 2094) × Marquis.....	113	9
Marquis × Kubanka (C I 2094).....	151	20
Marquis × Mindum.....	101	12

These results show that there is a larger percentage of shriveled and abortive grains in the crosses than in the parental varieties. There is also an indication of more pollen abortion in the durum-Marquis crosses than in the cross between emmer and Marquis.

COMPARISON OF NUMBER OF SEEDS SET IN F_1 GENERATION AND PARENTS

As a further test of sterility, counts were made of the number of barren florets in several F_1 crosses and their parents.

There are two or more flowers in each wheat spikelet, and usually two or three kernels mature. The outer florets of each spikelet are usually most vigorous, and when only two florets per spikelet produce kernels these are usually the outside ones. Therefore, the two outer florets of

¹ Outlined to the writers by Dr. C. O. Rosendahl, Professor of Botany, University of Minnesota.

each spikelet were examined. The result of this examination, together with the percentage of barren florets, is summarized in Table II.

TABLE II.—Number of florets not setting seed in *Triticum vulgare*, *T. durum*, *T. dicoccum*, and F_1 crosses of *T. vulgare* with *T. durum* and *T. dicoccum*

Variety or cross.	Classification.	Number of heads.	Number of florets examined.	Number of good seed.	Number of very badly shriveled seed.	Percentage of barren florets.
Marquis.	<i>Vulgare</i>	15	369	341	14	3.8
Preston (Minn. 188).	do.	17	528	500	1	5.1
Pioneer.	do.	26	804	761	1	5.2
Average.						4.7
D-4.	<i>Durum</i>	16	538	499	13	4.8
Iumillo (C I 1736).	do.	16	494	464	1	5.9
Kubanka (C I 2094).	do.	25	898	864	2	3.6
Acme.	do.	18	622	604	0	2.9
Average.						4.3
Emmer (Minn. 1165).	<i>Dicoccum</i>	22	630	611	6	2.1
Kubanka (C I 2094) × Marquis.	<i>Durum</i> × <i>vulgare</i>	12	426	206	9	49.5
Acme × Preston.	do.	3	104	62	5	35.6
D-4 × Pioneer.	do.	9	262	97	17	56.5
Average.						47.2
Marquis × Kubanka (C I 2094).	<i>Vulgare</i> × <i>durum</i>	49	1,692	704	97	52.7
Marquis × Iumillo (C I 1736).	do.	4	135	84	9	31.1
Pioneer × D-4.	do.	9	296	128	11	53.0
Preston × Acme.	do.	10	348	167	10	49.1
Average.						46.5
Emmer × Marquis.	<i>Dicoccum</i> × <i>vulgare</i>	14	410	299	17	22.9
Emmer × Preston.	do.	13	446	293	25	28.7
Average.						25.8
Marquis × emmer.	<i>Vulgare</i> × <i>dicoccum</i>	9	270	184	10	28.2
Preston × emmer.	do.	3	94	62	4	29.8
Average.						29.0

The main spike of individual plants of the parent and crosses was used for this study. There was an average of 4.7 per cent of barren florets in three varieties of *Triticum vulgare*. In four varieties of *T. durum* there was an average of 4.3 per cent, while emmer (Minnesota 1165) produced only 2.1 per cent of florets which formed no kernels. Since these are presumably homozygous, it seems fair to conclude that the percentages given show the average number of florets which did not set seed on account of causes other than sterility.

Three F_1 crosses were studied in which a durum sort was the female parent and four in which durum was the male parent. The average

percentages of barren florets were 47.2 and 46.5, respectively. There was about the same percentage of barrenness in emmer \times Marquis, emmer \times Preston, and reciprocals—namely, 25.8 when emmer was the female parent and 29 when emmer was the male parent. Thus, there is apparently more sterility in the durum-Marquis cross than in the cross between emmer and Marquis.

Although no cytological examination was made to determine the time of degeneration, it seems very likely that there is ovule as well as pollen abortion. Barren florets, however, might be due to incompatibility of certain genetic combinations or to slow growth of the pollen tube which has been shown to occur in some species crosses (8, 9).

NATURAL CROSSES AS A POSSIBLE INDICATION OF STERILITY

In 1917 the F_2 generation of durum \times Marquis and durum \times Haynes Bluestem, as well as the parent sorts, were grown together. Marquis is an awnless, glabrous chaffed wheat, Bluestem is an awnless wheat and has pubescent chaff, while the durum varieties used have glabrous chaff and are bearded. In the F_2 generation of the durum-Marquis cross there were a few individual plants with hairy chaff. Since these may have been the result of natural hybridization, these plants were eliminated from further consideration.

In the F_3 families of the durum-Marquis cross, each of which came from an individual F_2 plant, there were some hairy-chaffed plants. In some families the number of plants with hairy chaff was rather large, and counts were made to determine the frequency of their occurrence. Fully bearded plants have always been found to breed true for this character (14). This fact supports the view that natural crossing may be the cause of the hairy plants found in several of the F_3 families.

The most convincing evidence of natural crossing comes from the F_3 generation grown from glabrous-chaffed, bearded F_2 plants of crosses between Iumillo or Kubanka with Marquis. Table III records the number of plants produced in different families as well as the number of bearded smooth, hairy, intermediate-awned, and intermediate-awned glabrous-chaffed plants. It is significant that all plants with hairy chaff had intermediate awns. This would be expected in the F_1 generation of a cross between bearded wheats and so-called awnless varieties such as Marquis or Bluestem. It is apparent that the amount of natural crossing varies in different families. For example, 196-26 produced 7 bearded, glabrous-chaffed plants and 7 intermediate-awned, hairy-chaffed plants, while family 214-35 produced 60 bearded plants.

The progeny of a few selected glabrous-chaffed, intermediate-awned F_2 plants of the cross between Marquis and durum are classified in Table IV. The parent F_2 sorts were classified as glabrous-chaffed, intermediate-awned. All such plants produced both bearded, awnless, and intermediate-awned plants in the F_3 generation. Numerous hairy-chaffed

plants were observed. None of these were bearded, all having either intermediate or very short-tipped awns like those of the Marquis parent. The evidence points to the conclusion that the hairy-chaffed plants obtained in the F_3 generation were the result of natural hybrids in the F_2 generation.

TABLE III.—Number of hairy-chaffed intermediate-awned plants, glabrous-chaffed intermediate-awned plants, and glabrous-chaffed bearded plants in F_3 families grown from bearded glabrous-chaffed F_2 plants of crosses between *Triticum durum* and *T. vulgare*.

Cross.	Number of plants.			
	Total.	Bearded, glabrous.	Intermediate-awned, hairy.	Intermediate-awned, glabrous.
Iumillo × Marquis:				
196-5.....	37	37	0	0
196-26.....	14	7	7
196-34.....	131	114	16	1
198-21.....	66	54	9	3
199-8.....	48	27	19	2
199-9.....	74	56	17	1
225-24.....	47	41	6
227-4.....	114	93	12	9
228-24.....	19	8	9	2
228-35.....	31	30	1
229-21.....	15	15
232-13.....	37	9	26	2
232-14.....	51	33	10	8
Average of 26 lines.....	381	302	73	6
Marquis × Kubanka (C I 2094):				
208-4.....	10	4	6
203-10.....	40	39	1
211-23.....	43	40	2	1
214-35.....	60	60
217-18.....	35	29	5	1
218-1.....	36	26	10
221-14.....	34	19	10	5
222-10.....	36	36
222-33.....	36	30	3	3
Average of 30 lines.....	495	412	54	29

TABLE IV.—Number of hairy-chaffed plants and glabrous-chaffed plants in the F_3 families grown from intermediate-awned glabrous-chaffed F_2 plants of cross between *Triticum vulgare* and *T. durum*

Plant No.	Number glabrous chaffed.	Number hairy-chaffed.
223-7.....	32	22
218-8.....	65	4
217-5.....	28	4
211-22.....	49	27
209-4.....	37	9
203-38.....	26	19
203-3.....	95
214-21.....	39

The fact that natural crossing often occurs in species crosses shows the necessity for caution in analyzing data; and unless unusual methods are employed to protect parent plants, the ancestry of the progeny can not be known with certainty.

EXPERIMENTS IN INHERITANCE OF RUST RESISTANCE

The 1918 data are considered most reliable in drawing conclusions on the inheritance of rust resistance. This is due first to the fact that all barberry bushes were removed from the immediate vicinity of the rust plot early in the spring of 1918, and second to the fact that the epidemic was induced by hand spraying with inoculations of rust spores from a known greenhouse culture of *Puccinia graminis tritici*.¹

RUST INFECTION OF THE F₁ GENERATION COMPARED WITH THAT OF PARENTS

The epidemic in the rust plots was satisfactory, although there was but little rust in other wheat fields on University Farm.

A considerable number of F₁ crosses between resistant durum and emmer wheats and Marquis, Preston, and Pioneer were grown in the rust plot. The percentages of steurust infection on the F₁ and parent sorts are given in Table V.

TABLE V.—Rust notes on parental varieties and F₁ crosses between resistant and susceptible wheats, 1918

Variety or cross.	Percentage of stemrust.	Cross.	Percentage of stemrust.
Marquis	40 to 70	Marquis×Acme (C I 5284)	70
Preston	70	Preston×Acme (C I 5284)	70
Pioneer	40	Acme×Marquis	70
Acme	10	D-4×Pioneer	40
D-4	10	Acme×Preston	70
Kubanka (C I 2094)	20	Marquis×emmer	10
Iumillo (C I 1736)	15	Emmer×Marquis	10
Emmer (Minn. 1165)	0	Emmer×Preston	15
Marquis×Iumillo (C I 1736)	40	Preston×emmer	15
Marquis×Kubanka (C I 2094)	40 to 70		

Four durum varieties were tested. The highest percentage of rust infection was 20 on Kubanka (C I 2094), while there was only 10 per cent on D-4 and Acme. On all of these durum varieties the uredinia were smaller than on the common wheats, such as Marquis and Preston, which were very susceptible. Pioneer was also susceptible, but since it matures earlier than either Marquis or Preston, the percentage of infection was lower.

¹ The details of production of the epidemic were directed by J. G. Leach, a graduate student assistant of the Pathology Division. Mr. Leach had previous experience in this work at the Tennessee Agricultural Experiment Station.

The crosses between resistant durum wheats and Marquis, Preston, and Pioneer gave similar results, the F_1 generation being rusted as badly as the susceptible common wheat parent.

Different results were obtained in the F_1 crosses of emmer (Minnesota, 1165) with Marquis and Preston. The emmer parent is practically immune from this form of *Puccinia graminis tritici* as determined both by field data and experiments in the greenhouse. Two crosses, Marquis \times emmer and Preston \times emmer, and reciprocals were studied. While a few small uredinia developed on the F_1 generation, all plants observed were as free from rust as the resistant durum varieties. (See Pl. 97.)

That susceptibility is a dominant character in crosses between resistant durums and susceptible common wheats and a recessive character in crosses between resistant emmer and susceptible common wheats is obvious from these results. These facts bear out the observation made in the agronomy nursery in 1916—namely, that an F_1 cross between emmer (Minnesota 1165) and Marquis was resistant, while in an adjacent row an F_1 generation of a cross between a resistant durum and Marquis was severely infected.

CORRELATION BETWEEN RUST RESISTANCE AND BOTANICAL HEAD CHARACTERS

For the purpose of determining possible interrelation between inheritance of rust resistance and other differential characters, correlated individual plant data were taken on each F_2 plant.

DURUM-COMMON CROSSES.—Notes were taken on length of head, number of spikelets, breadth of head in face and side views, average length of internode, condition of awns, and rust infection on each individual F_2 plant. These plants were then classified into six groups—namely, emmerlike with seed inclosed by the glumes, durum, near-durum, intermediate, near-common, and common.

After the elimination of the emmerlike types the principal basis for classification was the appearance of the keel of the outer glume. In durum varieties the glumes are prominently and sharply keeled, while in the common wheats the outer glumes of the spikelets are only slightly keeled. The F_1 generation of a cross between durum and common wheats was intermediate for this character (Pl. 98). This one character determined whether the plant in question approached more closely the durum or the common type. The breadth of head in face and side views, the presence or absence of the depression in the center of the outer glume, and the condition of the collar were used in making the final classification. The depression is characteristic of common wheats. In most durum wheats the collar at the base of the lower spikelet extends all around the neck of the culm, while in common wheats it extends only part way around. Since progeny of the F_2 plants were grown in the F_3 generation, mistakes in classification were rectified. The individuals finally placed

in the durum, common, and emmer groups were those which bred true. Some of the near-durums may actually belong in the durum group, but there was no attempt to rectify unimportant mistakes in these classes.

The plants were placed in four rust infection groups: group 1, practically immune, 0 to 5 per cent infection; group 2, resistant, 10 to 20 per cent infection, uredinia smaller than in the normally susceptible varieties; group 3, susceptible, 25 to 40 per cent infection; and group 4, heavily infected. These groups were based on the behavior in the F_3 generation of the progeny of each F_2 plant.

In the F_2 generation some spikes with glumes resembling common wheat were as compact as those of the durum parents or more so. These were very similar to the club wheats and were placed in the common group. Likewise, lax-headed, sharply keeled wheats were obtained which were placed in the durum group. No differentiation was made between emmer and spelt, all plants with adherent glumes being placed together. Forms were obtained, however, which closely resembled true spelt.

The results from Marquis \times Lumillo and Marquis \times Kubanka were similar, and the data were combined. In the final summary in Table VI each plant is classified as resistant or susceptible. The writers believe that the plants classified as resistant would not be seriously injured in a severe epidemic of this rust form. However, there is considerable variation within each group. The resistant plants belong to either class 1 or 2 for rust infection.

There were two classes of susceptible F_2 plants, those which produced all susceptible progeny in the F_3 generation and those which produced both resistant and susceptible progeny. All resistant plants bred true in the F_3 generation; at least this was the criterion used to determine whether a particular F_2 plant was really resistant.

Several conclusions can readily be drawn from Table VI. This is a tabulation of 404 F_2 plants, each of which was tested in the F_3 generation. Of these 404 plants 4, 81, and 33 bred true to the botanical head type respectively of emmer, common, and durum. All 4 emmers and 8 out of 33 durums were resistant, while 81 F_2 common segregates were all susceptible. This strongly indicates that in these crosses resistance and susceptibility are linked in transmission with the botanical head characters which differentiate durum and common wheats. The results again show that it is easy to obtain resistant durums, while it is much more difficult, if not impossible, to obtain resistant common wheats.

As has already been mentioned, both lax and dense durumlike segregates (Pl. 99) as well as compact keelless common wheats were obtained. There seems, however, to be a relation between average length of internode and the botanical classes. Thus, the average mean head densities¹ of the five groups, durum, near-durum, intermediate,

¹ Density was calculated by dividing the length of the head in millimeters by the number of spikelets less one.

near-common, and common are 3.30, 3.77, 4.08, 3.94, and 4.40, respectively. A correlation coefficient of $+0.244 \pm 0.028$ for density and head characters was obtained.

TABLE VI.— F_2 Marquis \times Lumillo (CI 1736) and Marquis \times Kubanka (CI 2094)¹
[R=resistant to stemrust. S=susceptible to stemrust]

Density.	Durum.		Near-durum.		Inter-mediate.		Near-common.		Common.		Emmer.	
	R.	S.	R.	S.	R.	S.	R.	S.	R.	S.	R.	S.
<i>Mm.</i>												
2.5.....	3	4	2	12	9	12	4					
3.0.....	3	8	5	28	3	20	6	1				
3.5.....	2	5	2	29	6	19	14					
4.0.....		4	6	22	2	26	19					
4.5.....		4	3	20	2	21	14					
5.0.....				9	1	18	7					
5.5.....			1	5		9	5					
6.0.....				3		8	1					
	8	25	19	128	14	130	2	93	0	81	4	0
Ratio.....	1:3.1		1:6.7		1:9.3		1:46.5		0:81		4:0	

¹ The coefficient of correlation between density of head and classes for durum, near-durum, intermediate, near-common, and common is $+0.244 \pm 0.028$.

F_2 generations in which the resistant durum parent was the female are given in Table VII, a total of 632 plants being classified on the basis of the F_3 breeding test. Of these F_2 plants 100 bred true to durum habit, 47 resembled common, while 3 were emmerlike. Sixteen out of 100 durumlike plants were resistant, while only 2 out of 47 classified as common were resistant. Of the three emmerlike plants, one was susceptible and the other two were resistant. Here, again, as with the reciprocal cross, there is an indication of linkage between common wheat head characters and susceptibility to stemrust. One intermediate susceptible F_2 plant was grown in the F_3 generation, and several plants were obtained with common head characters. One of these was very resistant and vigorous (Pl. 99).

The average densities of the durum, near-durum, intermediate, near-common, and common segregates were 3.76, 3.53, 4.06, 4.38, and 4.60, respectively, although both durum and common wheats were found in the extreme dense and lax groups. The coefficient of correlation between density and head type was $+0.330 \pm 0.024$.

In order to confirm field observations, a study was made in the greenhouse of the more resistant and susceptible durum, common, and emmer segregates obtained from the durum-common crosses. For head characters of types studied see Plate 101. Seedlings of F_3 plants were

inoculated with the form of *Puccinia graminis tritici* which was used in obtaining the field epidemic. Three different tests of resistant and susceptible segregates of emmer, common, and durum F_3 lines were made. The results are given in Table VIII. (See Pl. 102.)

TABLE VII.— F_2 *Iumillo* (C I 1736) \times *Marquis* and *Kubanka* (C I 2094) \times *Marquis*¹

[R=resistant to stemrust. S=susceptible to stemrust]

Density.	Durum.		Near-durum.		Intermediate.		Near-common.		Common.		Emmer.	
	R.	S.	R.	S.	R.	S.	R.	S.	R.	S.	R.	S.
<i>Mm.</i>												
2.5.....	1	7	4	19	2	11	2	15	3	1
3.0.....	8	24	11	40	22	2	15	2	I
3.5.....	3	18	6	27	2	30	1	8	1	6
4.0.....	2	7	3	22	2	47	1	24	6
4.5.....	10	1	19	2	43	1	21	7
5.0.....	1	13	1	9	31	16	6	1
5.5.....	2	2	2	20	1	6
6.0.....	1	3	1	6	6	9
	16	84	26	139	8	192	5	112	2	45	2	1
Ratio....	1:5.3		1:5.3		1:24.0		1:22.4		1:22.5		1:0.5	

¹ The coefficient of correlation between density and type as durum, near-durum, intermediate, near-common, and common is $+0.330 \pm 0.024$.

TABLE VIII.—Comparison of resistant and susceptible F_3 lines with *Marquis*, *Kubanka* (C I 2094), and *Iumillo* (C I 1736)¹

Source.	Plant No.	Type.	Number inoculated.	Number infected.	Remarks.
<i>Marquis</i>	Minn. 1239.....	Common..	10	10	Extremely susceptible.
<i>Kubanka</i>	C I 2094.....	Durum....	12	10	Moderately susceptible with slight chlorosis under infected areas.
<i>Kubanka</i> \times <i>Marquis</i> F_3	222-32.....	Emmer....	18	8	Extremely resistant; uredinia minute, surrounded by sharp hypersensitive areas; 8 plants were strongly flecked.
<i>Kubanka</i> \times <i>Marquis</i> F_3	222-30.....	do.....	11	10	Highly susceptible; infection normal.
<i>Iumillo</i> \times <i>Marquis</i> F_3	181-24.....	Common..	14	12	Highly susceptible; infection normal.
<i>Iumillo</i> \times <i>Marquis</i> F_3	186-13-5.....	do.....	21	4	Infection moderate with slight chlorosis under infected areas; 7 plants were strongly flecked.
<i>Iumillo</i> \times <i>Marquis</i> F_3	228-37.....	Durum....	17	8	Moderately resistant with chlorosis under infected areas; 2 plants were distinctly flecked.
<i>Iumillo</i> \times <i>Marquis</i> F_3	186-15.....	do.....	20	19	Highly susceptible; infection normal.
<i>Iumillo</i>	C I 1736.....	do.....	22	11	Slightly susceptible; 4 plants were distinctly flecked with slight chlorosis under some infected areas.

¹ The authors wish to express their thanks to M. N. Levine, Assistant Pathologist, Office of Cereal Investigations, Bureau of Plant Industry, United States Department of Agriculture, for preparing Table VIII and Plate 101 and for conducting the greenhouse experiment on which they are based.

These families were selected in the field as examples of resistant and susceptible F_3 lines. Since the inoculation results in the greenhouse corroborate the field observations, there is good reason for believing that the field observations are reliable. This greenhouse experiment shows clearly that transgressive segregation occurred. Common, durum, and emmer sorts were obtained with a higher degree of resistance than that of either of the durum parents.

These results show that, if the numbers are sufficiently large, it is possible to obtain resistant wheats with common head characters by crossing resistant durum and susceptible common varieties. In the F_2 generation, out of a total of 128 common segregates only 2 were rust-resistant, and both of these were of little commercial value. However, several resistant plants with the head characters of common wheats were obtained in the F_3 generation.

EMMER-COMMON CROSSES.—Only a few plants were available for the study of crosses between emmer and common varieties. Two different white spring emmers (Minnesota 1165 and C I 1524) were used in this study. Minnesota 1165 is a very vigorous variety which was practically immune from the form of stemrust experimented with, both in the field and in the greenhouse. C I 1524 is quite similar to Minnesota 1165, except that it occasionally produces small uredinia.

The difference between emmer and common wheat is greater than that between durum and common wheat. The shape of the head of the emmer parent, which is proportionally very narrow in face view, together with the strongly keeled glumes, differentiates it from the Marquis parent. The kernels of emmer are tightly inclosed by the glumes, and recognition is easy.

The F_1 generation of the cross between emmer and common is intermediate for the differential characters mentioned above as separating the parent sorts (Pl. 98). The keels of the F_1 generation are intermediate, but they more closely resemble those of the emmer parent. The head shape of the F_1 generation is likewise more nearly emmerlike. Fifty-six per cent of the kernels were naked and 44 per cent had adherent glumes after they were thrashed in an individual plant thrasher. The emmer parent produced 19 per cent naked kernels and 81 per cent hulled kernels. The F_1 generation (Table V) is nearly as resistant as the emmer parent. Thus, the F_1 generation more nearly resembles emmer.

Fifty F_2 plants of the cross between Marquis and emmer (Minnesota 1165) were grown in the F_3 generation. Of this number 5 plants were emmers, and 1 was a very susceptible, lax, common type. The progeny of 5 F_2 plants thrashed like common wheats in the F_3 generation, but the heads were very compact (Pl. 100). Two F_2 plants bred true to the common keel condition and segregated, producing compact, intermediate,

and lax heads. Thirty-seven produced progeny consisting of types with inclosed emmerlike kernels, intermediates for thrashing, and common plants. Of these 37 F_3 lines, 17 produced progeny of only two sorts, emmerlike for thrashing and compact keelless (Pl. 100).

It is, of course, impossible to determine the actual factors involved in this cross, because some gametes or zygotes were eliminated by sterility.

The cross in which emmer (C I 1524) was the female parent gave results similar to those obtained when emmer was used as the male parent. This is shown in Table IX. One family, 169-5, which was grown from an intermediate F_2 plant, produced emmers, intermediates, and common-headed sorts and was quite resistant (Pl. 100).

TABLE IX.—Classification of crosses between emmer (Minnesota 1165 and C I 1524) with Marquis on the basis of rust class in the F_2 generation as determined by the F_2 and F_3 generations, and the main character differences separating emmer from common wheats as determined by the F_2 and F_3 generations

MARQUIS × EMMER 1165

Rust class.	Emmer.	Segre- gating emmer to common.	With nonadherent glumes.			Total.
			Compact.	Segre- gating.	Common.	
1.....	4	9	1	1	15
2.....	1	21	22
3.....	7	4	1	1	13
Total.....	5	37	5	2	1	50

EMMER (C I 1524) × MARQUIS

Rust class.	Emmer.	Segre- gating emmer to common.	With nonadherent glumes.		Total.	
			Compact.	Segre- gating.		
1.....	3	3	4	10	
2.....	6	2	1	9
3.....	2	2	4	
Total.....	3	11	8	1	23	

It is interesting that out of a total of 73 plants from these two crosses, 8 bred true to the emmer habit for thrashing and for head shape. Of these 8, 7 plants were put in rust class 1 while 1 was practically resistant, the progeny in the F_3 generation being placed in rust class 2. Only one lax, common plant was obtained in the F_2 generation, and this was susceptible. Several plants were obtained in the F_3 generation which were not only rust-resistant but also resembled common wheat.

These facts show that it is possible to transfer the rust resistance of emmer wheats to common wheats by crossing and subsequent selection. There is, however, an apparent partial linkage between rust resistance and the emmer head type which makes it essential to grow large numbers in the F_2 and F_3 generations.

SUMMARY

(1) Recent studies of the parasitism of the black stemrust of wheat (16, 18, 21, 24) have shown that there are many biologic forms of *Puccinia graminis* which can be differentiated only by their action on pure line wheat hosts. This seriously complicates the breeding of wheat for rust resistance. In the light of this knowledge differences of infection of certain crosses in 1917, as compared with 1916 or 1918, show that the conflicting results may be explained logically by supposing that more than one biologic form was present in the rust nursery in 1917.

(2) Sterility is a factor which must be considered in a study of crosses between common wheats and durum or emmer varieties. Sterility was shown in three ways: (a) pollen abortion; (b) the fact that F_1 florets of durum-common crosses set nearly 50 per cent less kernels than the parent sorts, while F_1 emmer-common crosses produced about 25 per cent of barren florets; and (c) the large number of natural crosses which occurred in some F_2 plants as shown by the F_3 results.

(3) Crosses between durum and common wheats produced many different forms in the F_2 generation, such as compact keelless commons resembling club wheats, lax sharply keeled durums, both emmer and spelt, as well as types which resembled the poulard group. Lax and compact durum, common, and emmerlike forms were obtained which bred true in the F_3 generation. The segregation in the F_2 generation of emmer-common crosses was not so wide as in the durum-common cross, although both lax and compact keelless wheats which bore naked kernels, as well as lax and compact wheats with adherent-glumed kernels, were obtained.

(4) The study of inheritance of rust resistance was made in a specially prepared disease plot. Because of the conflicting results of 1916 and 1917 all barberry bushes were removed early in the spring of 1918 from the immediate vicinity of the rust plot and the epidemic was induced with a known form of rust. The data on rust infection are based on these 1918 results.

(5) The following species and varieties were used in the study: *Triticum vulgare*, varieties Preston, Marquis, and Pioneer; *Triticum durum*, varieties Acme, D-4, Kubanka (C I 2094), and Iumillo (C I 1736); *Triticum dicoccum*, White Spring emmer (Minnesota 1165 and C I 1524).

The three common wheats were susceptible, the durums were commercially resistant, Kubanka (C I 2094) being somewhat less resistant

than Iumillo (C I 1736), while Acme and D-4 were slightly more resistant than either of the other durum sorts. The emmer varieties were very resistant, Minnesota 1165 being practically immune.

(6) The F_1 generation of crosses between durum and common varieties was as susceptible as the common parent, while F_1 crosses between the practically immune emmer parents and susceptible commons were about as resistant as the durum varieties. Thus, in the cross where emmer is one parent, resistance is partially dominant, while in the durum-common cross susceptibility is completely dominant over resistance.

(7) Each F_2 plant which produced viable seed was tested in the F_3 generation for both rust infection and botanical characters. These F_3 notes were used to determine the genotypic nature of individual F_2 plants. In the crosses between durum and common in which Marquis was the female parent, 404 F_2 plants were tested in the F_3 generation and no rust-resistant common wheats were obtained. Likewise, no plants in the F_3 generation seemed especially promising for both common wheat characters and rust resistance. In the crosses in which durum was the female, one or two F_2 common-headed plants were resistant; but their progeny were worthless from a practical agronomic standpoint. In one F_3 family which was grown from a susceptible F_2 plant, a number of resistant, vigorous plants were obtained which had common head characters. There is an indication of linkage of durum or emmer characters and rust resistance, since the production of rust-resistant durums or emmers in the F_2 and F_3 generations is comparatively easy and the production of resistant common wheats much more difficult.

(8) Resistant and susceptible plants obtained either in the F_2 or F_3 generation from crosses of durum and common parents were selected. Resistant and susceptible common, emmer, and durum wheats were available for this study. Greenhouse inoculation studies with a known strain of *Puccinia graminis tritici* showed that durum, common, and emmer type plants were obtained in the F_2 or F_3 generation which were more resistant than the resistant durum parents. Thus, we have transgressive segregation for rust resistance.

(9) The number of plants available for a study of inheritance between resistant emmer parents and Marquis was not very great. In the F_3 generation several lax-headed wheats were obtained which had the head shape and naked kernels of common wheats and which were rust-resistant. This shows that rust-resistant common wheats can be obtained by crossing susceptible common varieties with resistant emmers.

(10) The mode of inheritance of rust resistance seems entirely comparable with the general Mendelian manner of inheritance of botanical and morphological characters. The technic of breeding for rust resistance is similar to that of breeding for agronomic characters.

LITERATURE CITED

- (1) AARONSOHN, Aaron.
1910. AGRICULTURAL AND BOTANICAL EXPLORATIONS IN PALESTINE. U. S. Dept. Agr. Bur. Plant Indus. Bul. 180, 64 p., illus., 9 pl.
- (2) BIFFEN, R. H.
1907. STUDIES IN THE INHERITANCE OF DISEASE-RESISTANCE. *In Jour. Agr. Sci.*, v. 2, pt. 2, p. 109-128.
- (3) ———
1912. STUDIES IN THE INHERITANCE OF DISEASE RESISTANCE. II. *In Jour. Agr. Sci.*, v. 4, pt. 4, p. 421-429.
- (4) ———
1916. THE SUPPRESSION OF CHARACTERS ON CROSSING. *In Jour. Genetics*, v. 5, no. 4, p. 225-228.
- (5) ———
1917. SYSTEMATIZED PLANT BREEDING. *In Seward, A. C.*, ed. Science and the Nation. . . . p. 146-175. Cambridge, [Eng.]
- (6) BLARINGHEM.
1914. SUR LA PRODUCTION D'HYBRIDES ENTRE L'ENGRAIN (TRITICUM MONOCOCCUM L.) ET DIFFÉRENTS BLÉS CULTIVÉS. *In Compt. Rend. Acad. Sci.* [Paris], t. 158, no. 5, p. 346-349, 1 fig.
- (7) CASTLE, W. E., and LITTLE, C. C.
1910. ON A MODIFIED MENDELIAN RATIO AMONG YELLOW MICE. *In Science*, n. s. v. 32, no. 833, p. 868-870.
- (8) DORSEY, M. J.
1919. A STUDY OF STERILITY IN THE PLUM. *In Genetics*, v. 4, no. 5, p. 417-488, 5 pl. Literature cited, p. 481-487.
- (9) EAST, E. M., and PARK, J. B.
1918. STUDIES ON SELF-STERILITY. II. POLLEN-TUBE GROWTH. *In Genetics*, v. 3, no. 4, p. 353-366. Literature cited, p. 365-366.
- (10) ENGLEADOW, F. L.
1915. REPULSION IN WHEAT. *In Amer. Nat.*, v. 49, no. 578, p. 127.
- (11) EVANS, I. B. Pole.
1911. SOUTH AFRICAN CEREAL RUSTS, WITH OBSERVATIONS ON THE PROBLEM OF BREEDING RUST-RESISTANT WHEATS. *In Jour. Agr. Sci.*, v. 4, pt. 1, p. 95-104. Bibliography, p. 104.
- (12) FREEMAN, George F.
1917. LINKED QUANTITATIVE CHARACTERS IN WHEAT CROSSES. *In Amer. Nat.*, v. 51, no. 611, p. 683-689.
- (13) ———
1919. THE HEREDITY OF QUANTITATIVE CHARACTERS IN WHEAT. *In Genetics*, v. 4, no. 1, p. 1-93. Literature cited, p. 93.
- (14) HOWARD, Albert, and HOWARD, Gabrielle L. C.
1915. ON THE INHERITANCE OF SOME CHARACTERS IN WHEAT. II. *In Mem. Dept. Agr. India Bot. Ser.*, v. 7, no. 8, p. 273-285, 8 pl.
- (15) KEZER, Alvin, and BOYACK, Breeze.
1918. MENDELIAN INHERITANCE IN WHEAT AND BARLEY CROSSES. *Colo. Agr. Expt. Sta. Bul.* 249, 139 p., 10 fig., 9 col. pl.
- (16) LEVINE, M. N., and STAKMAN, E. C.
1918. A THIRD BIOLOGIC FORM OF PUCCINIA GRAMINIS ON WHEAT. *In Jour. Agr. Research*, v. 13, no. 12, p. 651-654.
- (17) LITTLE, C. C.
1919. A NOTE ON THE FATE OF INDIVIDUALS HOMOZYGOUS FOR CERTAIN COLOR FACTORS IN MICE. *In Amer. Nat.*, v. 53, no. 625, p. 185-187.

- (18) MELCHERS, Leo E., and PARKER, J. H.
1918. ANOTHER STRAIN OF PUCCINIA GRAMINIS. *Kansas Agr. Exp. Sta. Circ.* 68, 4 p.
- (19) MULLER, Hermann J.
1918. GENETIC VARIABILITY, TWIN HYBRIDS AND CONSTANT HYBRIDS, IN A CASE OF BALANCED LETHAL FACTORS. *In Genetics*, v. 3, no. 5, p. 422-499. Literature cited, p. 497-498.
- (20) NILSSON-EHLE, H.
1911. KREUZUNGSUNTERSUCHUNGEN AN HAUFER UND WEIZEN. II. *Lunds Univ. Årsskr.*, n. F. Afd. 2, Bd. 7, No. 6, 82 p.
- (21) STAKMAN, E. C., and PIEMEISEL, F. J.
1917. A NEW STRAIN OF PUCCINIA GRAMINIS. (Abstract.) *In Phytopathology*, v. 7, no. 1, p. 73.
- (22) ——— PARKER, J. H., and PIEMEISEL, F. J.
1918. CAN BIOLOGIC FORMS OF STEMRUST ON WHEAT CHANGE RAPIDLY ENOUGH TO INTERFERE WITH BREEDING FOR RUST RESISTANCE? *In Jour. Agr. Research*, v. 1, no. 2, p. 111-123, pl.
- (23) ——— PIEMEISEL, F. J., and LEVINE, M. N.
1918. PLASTICITY OF BIOLOGIC FORMS OF PUCCINIA GRAMINIS. *In Jour. Agr. Research*, v. 15, no. 4, p. 221-249, pl. 17-18.
- (24) ——— LEVINE, M. N., and LEACH, J. G.
1919. NEW BIOLOGIC FORMS OF PUCCINIA GRAMINIS. *In Jour. Agr. Research*, v. 16, no. 3, p. 103-105.
- (25) TSCHERMAK, Erich v.
1913. ÜBER SELTENE GETREIDEBASTARDE. *In Beitr. Pflanzenzucht*, Heft 3, p. 49-61, fig. 10.
- (26) VILMORIN, M. H.
1880. ESSAIS DE CROISEMENT ENTRE BLÉS DIFFÉRENTS. *In Bul. Soc. Bot. France*, t. 27 (s. 2, t. 2), p. 356-361, pl. 6-7.
- (27) ———
1883. EXPÉRIENCES DE CROISEMENT ENTRE DES BLÉS DIFFÉRENTS. *In Bul. Soc. Bot. France*, t. 30 (s. 2, t. 5), p. 58-63.

PLATE 97.

- A.—Pollen grains of Marquis wheat.
B.—F₁ Marquis×Kubanka (C I 2094), showing sterile grains.
C.—Pollen grains of Kubanka (C I 2094).
D.—Stems of Kubanka (C I 2094) grown under rust-epidemic conditions. Note absence of rust infection.
E.—F₁ Kubanka (C I 2094)×Marquis, showing normal uredinia.
F.—Marquis, the susceptible parent.
H.—F₁ emmer (Minnesota 1165)×Marquis, showing no normal uredinia.
I.—Minnesota 1165, the resistant emmer parent. Note that in the durum-common cross the F₁ generation is susceptible while in the emmer-common cross the F₁ generation is resistant.

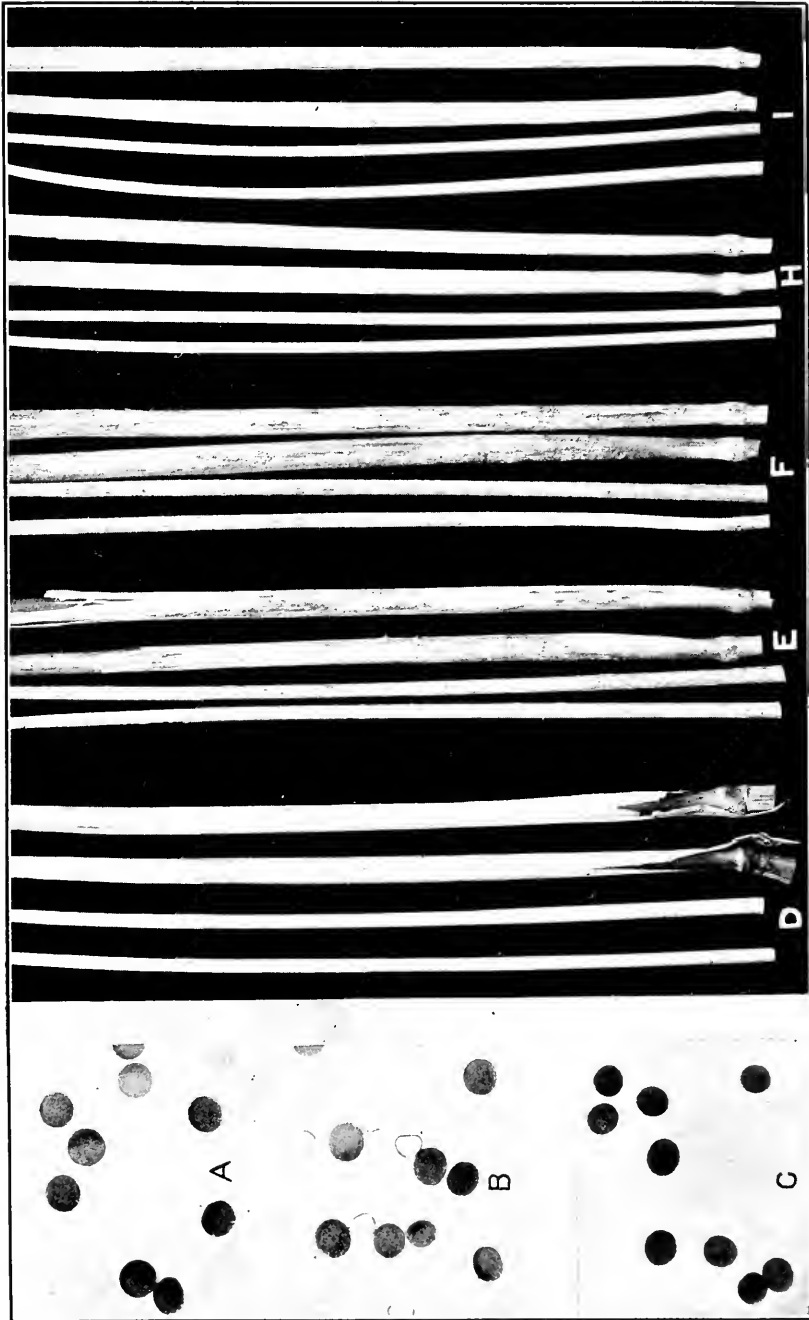

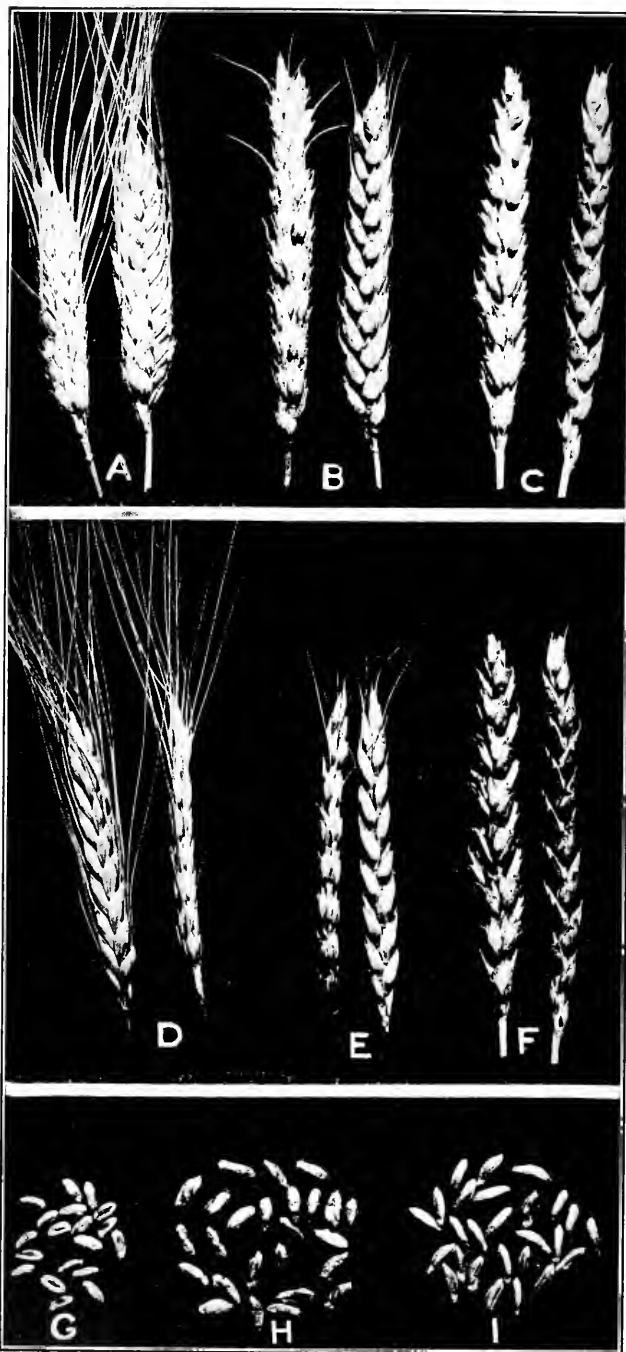

PLATE 98.

A, B, C.—Face and side views, respectively, of heads of Iumillo (C I 1736), F_1 Iumillo \times Marquis, and Marquis. The F_1 heads are intermediate in density and have tipped awns. The outer glumes are keeled, although not so strongly as Iumillo.

D, E, F.—Face and side views, respectively, of heads of emmer, Minnesota 1165, F_1 emmer \times Marquis, and Marquis. The F_1 generation approaches the emmer in some head characters and has intermediate awns.

G, H, I.—Kernels of Marquis, F_1 emmer \times Marquis, and emmer. The F_1 kernels are longer than Marquis, approaching those of the emmer parent in average length.

PLATE 99.

Representative heads of F_3 families of the cross between durum and Marquis.

A, B, C, D.— F_3 families which were classified as durums. Note that these represent all types of head density.

E.—Heads of an awnless F_3 emmer family.

F.—Four heads of an F_3 plant which resembles common wheat in head shape and is rust-resistant.

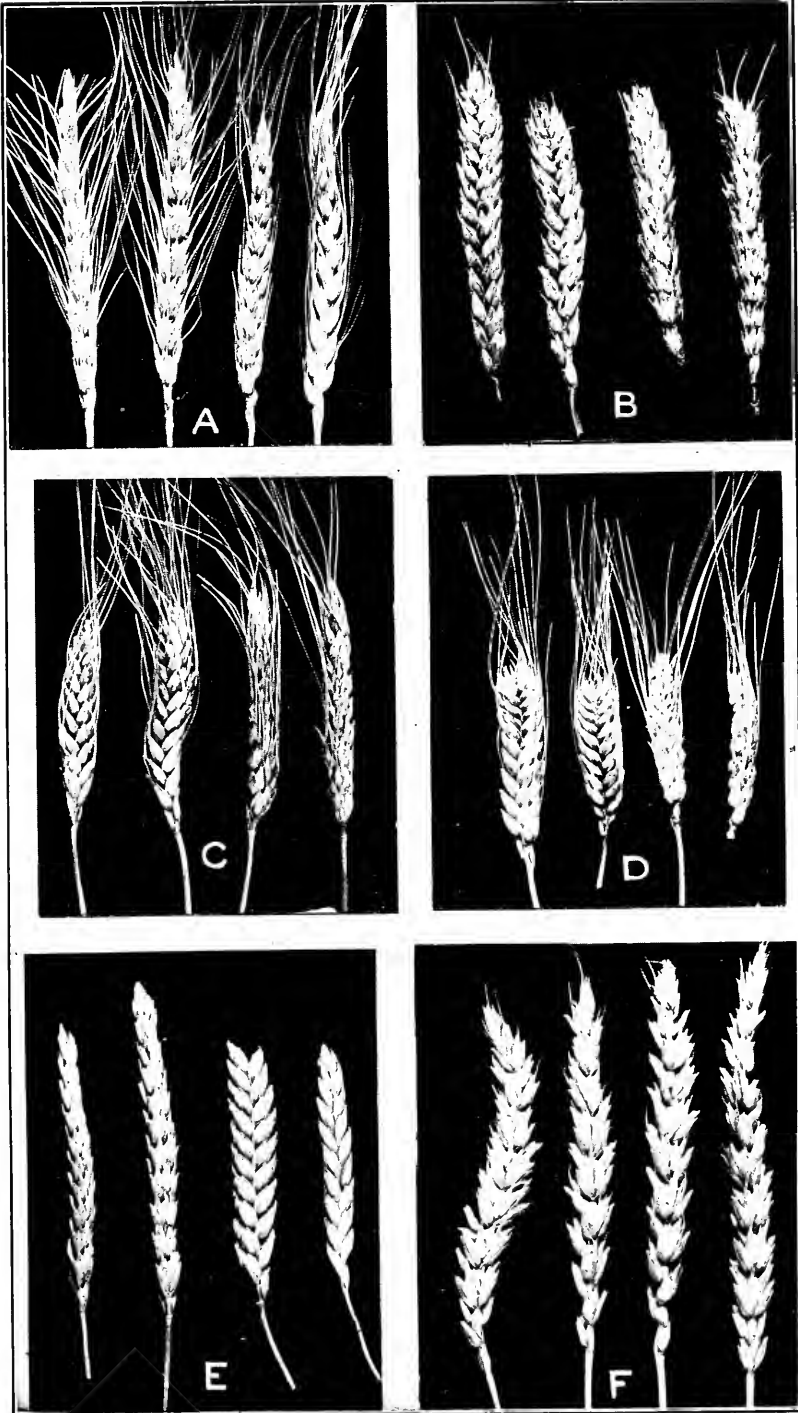

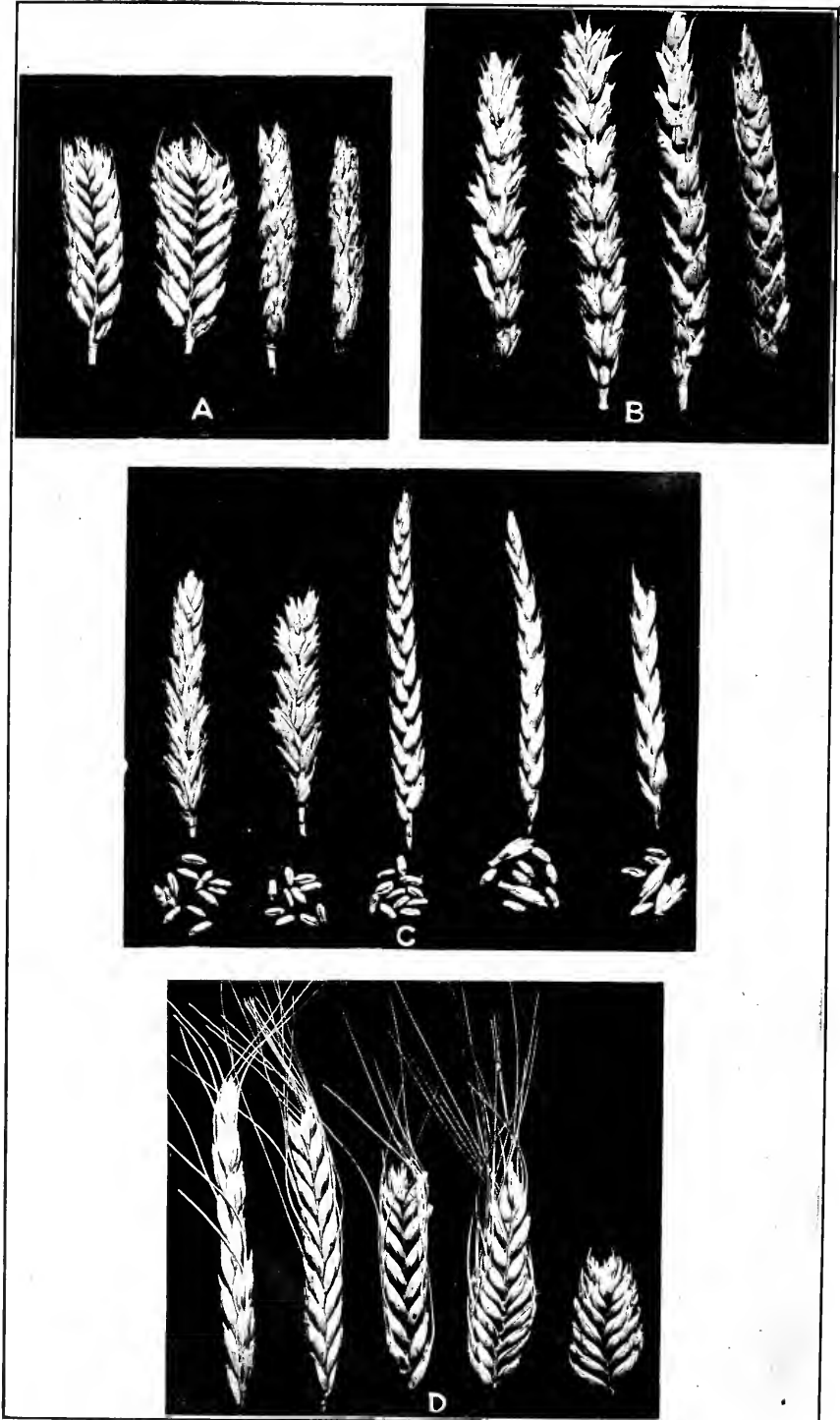

PLATE 100.

A.— F_3 family of a cross between emmer (Minnesota 1165), and Marquis, showing face and side view. This family proved rust-resistant and was also pure for keelless, compact heads and thrashed like common wheat.

B.—Heads of an F_3 family which resembled common wheat. It was rust-susceptible.

C.—Heads of different plants of an F_3 family of a cross between emmer (C I 1524) and Marquis. The plants varied from emmerlike and intermediate forms to those resembling common wheat as shown at the left. This family bred true for rust resistance.

D.—Represents a very frequent sort of segregation obtained in the F_3 generation. Many families gave only emmerlike and keelless, compact headed sorts which thrashed like common wheat.

PLATE 101.

Heads of resistant and susceptible wheat obtained in the F_3 generation from the cross between Marquis and durum:

A.—Head representing resistant emmer type F_3 family 222-32, Kubanka \times Marquis.

B.—Head representing susceptible emmer F_3 family 222-30, Kubanka \times Marquis.

C.—Susceptible common F_3 family 181-24, Iumillo \times Marquis.

D.—Resistant individual plant 186-13-5 which was obtained in the F_3 generation of the cross between Iumillo \times Marquis.

E.—Resistant durum F_3 family 228-37, Iumillo \times Marquis.

F.—Susceptible durum F_3 family 186-15, Marquis \times Iumillo.

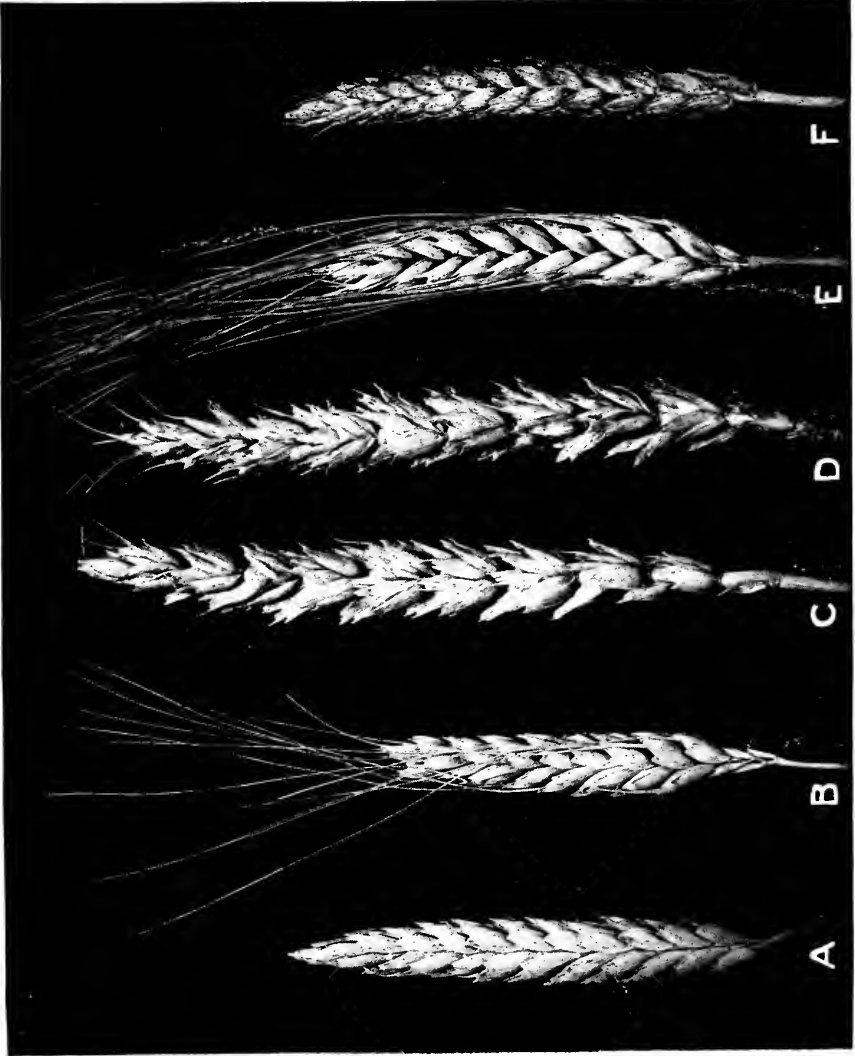

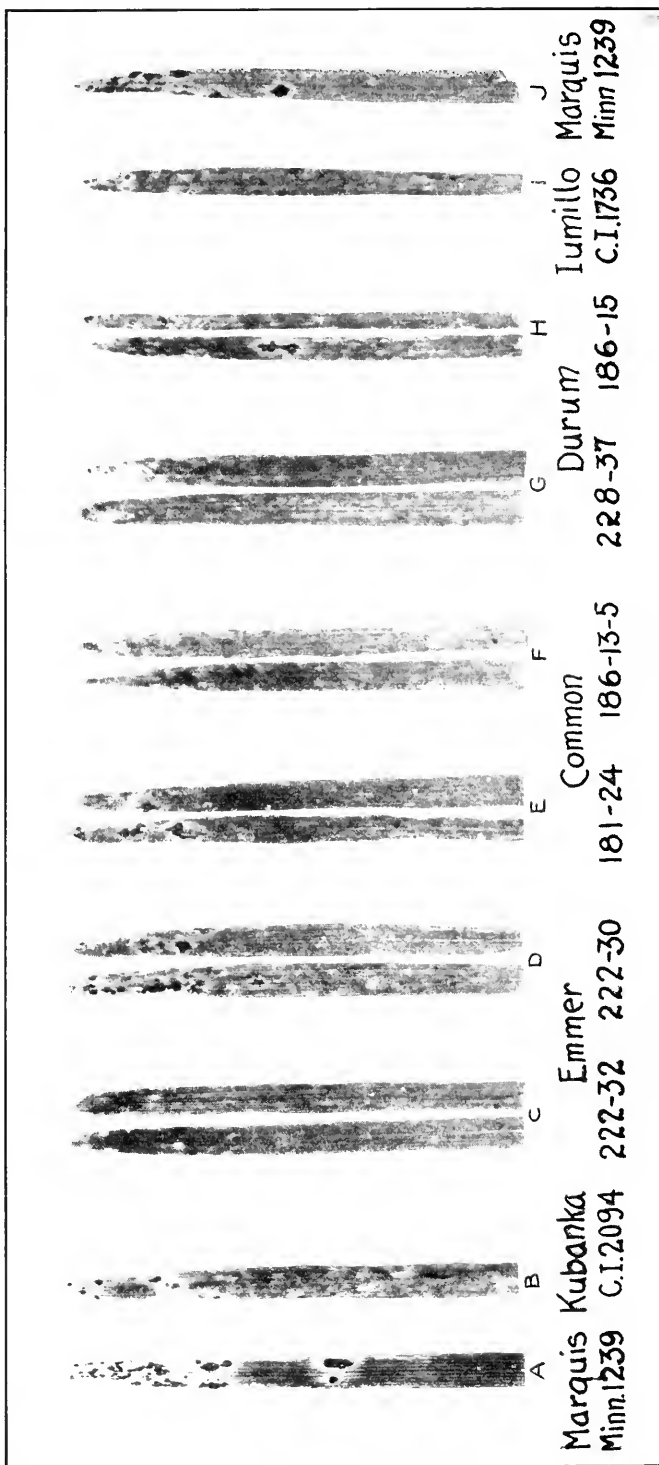

PLATE 102.

Greenhouse experiment:

- A.—Marquis, single blade, showing extreme susceptibility.
B.—Kubanka (C I 2094), single blade; moderately susceptible with slight chlorosis.
C.—Kubanka × Marquis (222-32 F₃ emmerlike family); extremely resistant; **uredinia** minute surrounded by hypersensitive areas, or flecks.
D.—Kubanka × Marquis (222-30 F₃ emmerlike family); very susceptible.
E.—Iumillo × Marquis (181-24 F₃ common family); very susceptible.
F.—Iumillo × Marquis (186-13-5, an individual common plant of F₃ family 186-13); moderately resistant with infected areas chlorotic.
G.—Iumillo × Marquis (228-37 F₃ durum family); moderately resistant with **infected** areas chlorotic.
H.—Iumillo × Marquis (186-15 F₃ durum family); fairly susceptible.
I.—Iumillo (C I 1736), single blade; slightly susceptible.
J.—Marquis (Minnesota 1239), single blade; highly susceptible.

The rust form used in the greenhouse experiment was the same as that used for the 1918 field epidemic.

LINE-SELECTION WORK WITH POTATOES

By O. B. WHIPPLE

Horticulturist, Montana Agricultural Experiment Station

The data and discussions presented here have to do with the subject of potato-seed improvement through tuber selection. As such it deals with the improvement of existing varieties and may be contrasted with another type of potato breeding which, through the mediums of fertilization, production of seed, and growing of seedlings, aims at the origin of new varieties.

In the language of the plant breeder potato varieties are termed clons or clonal varieties. To him they differ from varieties of wheat, barley, or corn in that they are propagated from vegetative parts. Sexual reproduction or the use of seeds is resorted to only as a means of originating new varieties, not as a means of perpetuating existing ones. Varieties of wheat, barley, or corn reproduce true from seed, while clonal varieties do not. In other words, if we plant pure seed of yellow corn or blue barley, we harvest yellow corn or blue barley, but if we should plant seeds of red apples or red potatoes it is very doubtful if we should harvest either red apples or red potatoes. Few, if any, will doubt the value of potato-breeding work which has for its object the origin of new varieties from seed. Most of our potato varieties have originated as seedlings, either chance seedlings or those resulting from carefully planned breeding work. This phase of potato breeding is still attracting the attention of both scientific and amateur plant breeders, and new seedlings are constantly being introduced for trial. Some of these are real additions to potato culture, and others prove of only local and passing interest.

The improvement of clonal varieties through bud selection has been the subject of much discussion and the basis for much experimental study. In propagation, the horticulturist deals largely with clons or varieties which must be perpetuated by transplanting vegetative parts. Fruit trees, small fruits, many ornamental plants, nut trees, bulbous and tuberous plants, and many flowers, particularly greenhouse specialties, fall in this class. This line of plant breeding is of just as vital importance as the other which aims at improvement through crossing and hybridization and the growing of new seedlings. Potatoes have been the subject of much study along this line, the work of East,¹ Eustace,²

¹ EAST, Edward M. A STUDY OF THE FACTORS INFLUENCING THE IMPROVEMENT OF THE POTATO. III. *Agr. Exp. Sta. Bul.* 127, p. 375-456, 10 fig. 1908. Bibliography, p. 450-456.

— THE TRANSMISSION OF VARIATIONS IN THE POTATO IN ASEQUAL REPRODUCTION. *In Conn. Agr. Exp. Sta. Rpt.* 1909/10, p. 119-160, 5 pl. 1910.

² EUSTACE, H. J. AN EXPERIMENT ON THE SELECTION OF "SEED" POTATOES: PRODUCTIVE VS. UNPRODUCTIVE HILLS. *In Proc. Soc. Hort. Sci.*, 1903/04, p. 60-62. 1905.

Waid,¹ and Zavitz² being the most important of that reported in America. It is safe to say, however, that the work done so far has not by any means cleared up the subject of selection within clonal varieties. At present we can not say that we have a clear vision of the possibilities or the limitations along this line of plant breeding. Since plants within clonal varieties vary, we have assumed that there is opportunity for improvement through selection just as in varieties that are propagated from seed. But to what extent we can make use of selection to perpetuate desirable variations within the clon and in this way improve these varieties is still a question.

The plant breeder recognizes in plants three types of variations: (1) fluctuations or modifications, (2) segregations or combinations, and (3) mutations. Fluctuations are such variations as appear as a result of variable environmental conditions and are by many considered non-heritable or nontransmittable from one generation to another, regardless of whether perpetuation is through seeds or vegetative parts. In other words, if we accept this theory of the nonheritability of fluctuations due to environment we can not expect to increase the average vigor of a potato variety by selecting seed tubers from especially vigorous hills so long as the variation in vigor might be attributed to environmental conditions. Segregations are heritable differences resulting from segregation and recombination of hereditary units. This type of variation appears within the population of new hybrids and crosses perpetuated by seeds rather than by vegetative multiplication. Among potatoes we could expect such variations to appear only among seedlings, and for this reason segregation can not be considered among the possibilities for improving potato varieties which are perpetuated vegetatively. Mutations are heritable variations which do not depend upon segregation and recombination. Mutations are supposed to be much rarer than the other variations mentioned. Among horticultural plants many clonal varieties have arisen in this way and have for many years been perpetuated true to type through vegetative multiplication. An excellent example of a mutant among potatoes is the Pearl, which originated as a mutation, or in common language, as a bud sport from the Blue Victor. This has occurred not only once but several times. In our own Blue Victor seed plot of 1918 there appeared such a variation. This mutant was a perfect Blue Victor with the exception that it was white instead of blue in color. In other words, it was a perfect Pearl. In this seed plot, seed pieces from each tuber were planted in consecutive hills. The hills were thinned to single stems, and just one

¹ GREEN, W. J., and WAID, C. W. POTATO INVESTIGATIONS. SPRAYING AND SEED SELECTION EXPERIMENTS; VARIETY TESTS. Ohio Agr. Exp. Sta. Bul. 174, p. 251-289, 18 fig. 1906.

WAID, C. W. RESULTS OF HILL SELECTION OF SEED POTATOES. *In* Amer. Breeders' Assoc. Rpt., v. 3, p. 191-199. 1907.

² ZAVITZ, C. A. [REPORT OF THE DEPARTMENT OF FIELD HUSBANDRY.] *In* 31st Ann. Rpt. Ontario Agr. Exp. Col. and Exp. Farm, 1905, p. 165-220. 1905.

plant appeared with white potatoes. This means that one eye from a typical Blue Victor tuber produced a plant which bore white potatoes while all other eyes from the same tuber produced plants with blue potatoes true to type. This hill of white potatoes will, if planted, give plants bearing only white potatoes, for these simple bud sports or simple vegetative mutants may be perpetuated by propagation from vegetative parts. Here, then, we have an excellent example of how new varieties appear by mutation, but apparently such bud sports do not appear frequently.

If we purpose to champion the cause of selection within potato clons we must either show that high-yielding mutants, less striking than the one just mentioned and possibly for this reason more often unobserved, frequently appear within the clon and form the basis for selection, or we must break down, so far as clonal varieties are concerned, the theory that all fluctuations, or modifications are nonheritable. The greater part of the data here presented is the result of work begun with the intent of throwing light upon the first question. Experiments are also under way bearing upon the heritability of fluctuations, but as yet the data are not sufficient to warrant publication.

No one, I think, will doubt the value of certain lines of potato seed-selection work. For instance, there is abundant evidence to show that under anything like favorable environmental conditions the yielding power of a variety may be maintained by careful selection. In other words, a system of seed-tuber production which aims at the annual elimination of diseased or degenerate hills will, except under the most unfavorable environmental conditions, maintain a high-yielding population of any variety. But aside from the elimination of these weak hills we may question whether any practical results will come from further effort. In this case we are eliminating the hills that are below the average in vigor, the loss of vigor being due to attacks of disease or to degeneration. A very satisfactory method of procedure in such selection efforts is well outlined in Circular 73 of this Station.¹ The extent to which yields are increased by such selection is largely determined by the stock started with, its susceptibility to disease, and the tendency of the particular variety to degeneration under existing climatic and soil conditions. Starting with a variety population containing a large percentage of degenerate or diseased plants, proper selection will bring about a marked increase in yield. In growing a variety that has degenerate tendencies under certain environmental conditions, such a system of selection will be found very helpful in maintaining the yielding power of the variety. For the purpose of illustration, some examples may be cited. Russet Burbank, as it has been grown at Bozeman, is a very stable variety. Very few diseased hills appear in the plots, and very

¹ WHIPPLE, O. B., A SEED PLOT METHOD OF POTATO IMPROVEMENT. *Mont. Agr. Exp. Sta. Circ. 73, p. 71-73. 1917.*

few degenerate plants are found. Irish Cobbler and Early Triumph have behaved in just the opposite way, at least so far as degeneration is concerned. Within the last two varieties, as grown under our conditions, intelligent selection will give surprising results. With the Russet Burbank, profitable increase in yield might result from selection, but the improvement would be in no way spectacular. This type of selection work aims at increased production through the elimination of plants yielding below the average of the population.

The first work in line selection was undertaken in 1913 with the selection from the crop of that year of a few high-yielding hills of Russet Burbank (hills 201 to 206) and Rural New Yorker (hills 207 to 212). These have now been tested for five years, and a summary of the results is given in Table I. While these data do not represent a very large amount of experimental evidence, I believe that the results indicate what can be expected when effort is made to isolate high-yielding clonal lines by hill selection and maintain them by mass selection based upon tuber characteristics. Every effort was made to eliminate experimental errors. Seed pieces were dropped 15 inches apart in rows 3 feet 9 inches apart. Single-row plots were used with outside or guard rows in every case. In 1914, these plots were necessarily small. In 1915, 1/40-acre plots were used, and since 1915 plots of approximately 1/20-acre have been grown. No special effort has been made to control the size of the seed piece; but in 1914, 1915, and 1916 the plots were thinned to single-stemmed hills. This method gives promise of being as reliable as one based on the planting of uniform-sized seed pieces, for size of seed piece appears to influence yield only in so far as it is correlated with the number of stems produced in the hill. In other years the size of seed pieces could not have varied greatly, since the plan of cutting tubers of certain sizes to so many seed pieces was followed, without reference to number of eyes. The hills selected in 1913 were single-stemmed hills and were chosen on yield and tuber characteristics entirely. Of a large number of hills dug with a fork, those were selected which gave the greatest weight of tubers of good form. Tubers considered of good form were those long for the variety, full and rounded at both ends, and oval rather than round in cross section. In choosing seed by mass selection, the same form characteristics were considered; and the seed was picked after the digger. The seed for control plots was chosen by mass selection from the population of the variety from which the hills originally came, selection being based upon the same tuber characteristics. Single-plot tests were employed.

In Table I, I wish to call attention not so much to the 5-year performance record of the hill lines as to the very marked variation between their yields in 1914 and 1915 when compared with the control plots. If we take the 5-year average as a reliable indicator, some of these lines are apparently better yielders than others. I believe, however, that an-

other 5 years added to these performance records will go a long way toward blotting out these apparent differences. It will be noted that all these hills gave a very large increase over the control plots in 1914. But the interesting feature of the records is that following mass selection in 1914, the average yield of these lines immediately falls, in 1915, to the level of that of the control plot. In this connection it should be borne in mind that these two varieties are very stable under conditions at the Station and that neither has shown any serious tendency toward degeneration. The increased production in 1914 can not be accounted for on the theory that degenerate or weak hills were common in the control plots in 1914, nor can the decrease in yield in 1915 be accounted for on the theory that mass selection introduced into these lines degenerate types which tended to lower the yield of 1915. I believe the data clearly indicate that hill selection brings only temporary increases in yield and that such selection does not isolate high-yielding lines which may be maintained as high-yielding population by mass selection based on tuber characteristics alone.

TABLE I.—Five-year summary of yields of marketable tubers per acre from hills selected in 1913

Hill No.	1914	1915	1916	1917	1918	5-year average.
	<i>Pounds.</i>	<i>Pounds.</i>	<i>Pounds.</i>	<i>Pounds.</i>	<i>Pounds.</i>	<i>Pounds.</i>
201.....	14,764	13,350	8,552	23,580	10,849	14,219
202.....	19,446	12,461	7,456	20,537	13,497	14,579
203.....	18,409	12,543	8,880	23,394	13,660	15,377
204.....	19,924	10,930	8,515	23,464	13,033	15,173
205.....	18,207	12,947	7,572	18,724	10,756	13,641
206.....	13,839	11,898	7,744	18,353	12,958
Average.....	17,431	12,354	8,119	21,342	12,359	14,341
Control.....	11,836	12,947	8,766	19,143	17,424	14,023
207.....	14,157	11,823	7,509	21,675	14,961	14,025
208.....	12,251	14,278	5,406	19,514	16,425	13,574
209.....	18,513	9,873	6,969	22,511	20,490	15,071
210.....	17,936	8,566	6,218	20,932	15,007	13,731
211.....	17,616	8,826	16,090	21,141	15,918
212.....	18,315	7,700	20,328	11,685	14,507
Average.....	16,464	10,177	6,525	20,175	16,618	14,571
Control.....	10,257	9,961	6,069	20,165	17,214	12,733

In 1916 work of similar nature was undertaken upon a more extended scale. With the selection of 108 tuber units each of Green Mountain, Rural New Yorker, and Early Six Weeks, 324 tuber lines were established, which have now been carried through three seasons. Eight of these lines were thrown out from the Early Six Weeks as variety mixtures, most of the 8 being Early Rose, so the summary on this variety covers only 100 tuber lines. Rural New Yorker has been previously referred to as quite

stable. Green Mountain, as grown at Bozeman, has rather strong degenerate tendencies, but Early Six Weeks would be classed as almost as stable as Rural New Yorker, since no rapid decline in yield followed selection based upon tuber characteristics. Since in this work every effort has been made to overcome the possibility of error, a discussion of methods will be in order.

Tuber units were selected from the bin in the spring of 1916. In each variety these tubers were cut to a uniform weight by slicing off the stem end. The Green Mountain tubers were cut to 7 ounces, the Rural New Yorker to $8\frac{3}{4}$ ounces, and the Early Six Weeks to $6\frac{1}{2}$ ounces. The remaining portion of the tuber was then quartered lengthwise. Since 1916 seed pieces have been cut with a special cutter which cuts a seed piece approximately hemispherical in shape, $1\frac{1}{4}$ inches across the face and $\frac{3}{4}$ inch deep. Such seed pieces weigh approximately $\frac{1}{3}$ ounce, or about 11 gm. Because of variation in depth of eyes, these seed pieces will differ somewhat in weight, the maximum variation within a variety usually not exceeding 2 gm. and in many cases not exceeding 1 gm. Groups of 20 seed pieces seldom show variation of over 15 gm. While these seed pieces may appear small, they have apparently given just as strong plants as seed pieces cut in the usual manner and weighing $1\frac{1}{2}$ ounces. Seed pieces have been planted by hand and covered to a uniform depth of 3 inches. Single-plot tests have been used entirely. Such tests carried on over a series of years should give just as reliable results as duplicate or triplicate tests conducted for a shorter period. Duplicating plots complicates the work of seed selection. It is not safe to select seed from any one plot to continue the line the following season, and it is difficult to select a small composite sample from two or three plots. It is for this reason that the single-plot test was decided upon.

The 1916 plots consisted of 4 hills, and the 1917 and 1918 plots of 20 hills. The latter is the standard-sized plot adopted here for this work. The selections from each variety are arranged in a group with from 9 to 12 plots in a row and from 9 to 12 rows. There is no space between plots in the rows. The control plot consists of a single row near the center of the group running the length of the group of plots. Hills are planted 15 inches apart in rows 3 feet 9 inches apart. Seed is chosen from the plots before the tubers are assembled, and in this way it is secured from different portions of the plot. To illustrate, from a standard-sized plot 5 seed tubers are selected. Four seed pieces from each tuber are planted the following season in adjacent hills, and when this crop is harvested, effort is made to select one seed tuber from each group of four hills, or from each unit, as they are called later. The plots receive rather deep cultivation, are well ridged, and are commonly irrigated once. At any rate they all receive the same cultivation and irrigation. All hills are thinned to single stems as soon as the vines are strong enough to pull, or from five to six weeks after planting.

Since these small seed pieces give an average of only about $1\frac{1}{2}$ stems per hill, the thinning is not a very great task. Careful records are kept of the number and weight of marketable tubers and culls. Yields are computed upon the basis of a perfect stand. Naturally this favors the plot with an imperfect stand, for a missing hill tends to raise the yield of adjacent hills. Stand records are kept, showing the position of missing hills. As yet there is no basis upon which to apply such records in correcting yields, but I hope to make use of these later. Careful notes are also kept upon vine characteristics. We are particularly interested in those that indicate degeneration. Three general types of vines—vigorous, semi-curlydwarf or with curlydwarf tendencies, and curlydwarfs—are recognized.

The results of three seasons' work upon this project are presented here, not with the idea of proving the presence or the absence of high-yielding tuber lines within these 316 selections but rather for the purpose of calling attention to the difficulty of interpreting these performance records. If such a method of seed improvement is to be of real and practical value, especially in the hands of the average potato grower, it would seem that a 3-year test should give rather definite and dependable results. If the process is to be a longer one than this, then the method should be proposed for the potato specialist rather than for the rank and file of potato growers.

GREEN MOUNTAIN TUBER LINES 300 TO 408

In variety tests at this Station, the Green Mountain types have on an average given the highest yields of all varieties grown. Varieties belonging to this group have, however, varied rather widely in yields. They are more susceptible to scab, more inclined to degeneration, and produce tubers less desirable as to commercial form than the Rural New Yorker; but withal the type is a very promising main-crop commercial potato.

In Table II will be found the 3-year performance records of the 108 Green Mountain lines, expressed in yields of pounds per acre. Of the three groups of tuber lines, these have given the most noticeable variations in yields.

Line 332 ranks first with a 3-year average yield of 27,849 pounds per acre, while line 344 has a 3-year average of 3,841 pounds. When ranked on 3-year average tuber production by weight, the 20 highest-yielding lines assembled in the last column of Table III have given an average yield of 25,000 pounds per acre, while the 20 lowest-ranking, appearing in the last column of Table IV, have averaged 12,083 pounds.

In Tables III and IV it will be noticed that only a few of the lines appear as consistent high or low yielders. Several numbers will be found in both tables, showing that lines have swung from one extreme to the other.

TABLE II.—Three-year summary of yields of marketable tubers per acre from 108 Green Mountain tuber lines

Tuber line No.	1916	1917	1918	3-year average.
	Pounds.	Pounds.	Pounds.	Pounds.
300.....	10,453	20,442	26,017	18,970
301.....	10,453	23,230	16,261	16,648
302.....	11,034	22,300	19,071	17,468
304.....	12,776	26,946	14,247	17,989
305.....	13,357	22,553	15,486	17,132
306.....	15,680	30,199	29,340	25,073
307.....	11,615	21,836	14,402	15,951
308.....	6,069	27,411	11,873	15,417
309.....	12,776	26,017	11,615	16,802
310.....	13,938	20,442	26,482	20,287
311.....	11,615	23,230	21,603	18,816
312.....	12,195	19,513	13,938	15,215
313.....	9,872	25,553	13,795	16,376
314.....	11,034	26,482	10,840	16,118
315.....	11,615	31,128	16,626	19,789
316.....	15,668	24,623	11,736	17,322
317.....	15,099	33,915	23,472	24,162
318.....	13,938	30,199	10,269	18,135
319.....	13,938	17,190	21,371	17,499
320.....	15,099	22,765	30,663	22,842
321.....	9,292	22,300	15,099	15,563
322.....	11,615	26,017	16,626	18,086
323.....	13,938	32,057	13,938	19,977
324.....	15,680	37,168	21,836	24,894
325.....	11,615	29,734	19,164	20,171
326.....	11,034	34,380	20,907	22,107
327.....	10,453	37,632	14,807	20,984
328.....	10,453	15,796	10,453	12,234
329.....	10,453	28,340	13,936	17,576
330.....	9,292	27,876	30,318	22,495
331.....	7,549	26,946	23,230	19,241
332.....	15,099	39,026	29,424	27,849
333.....	14,518	37,632	25,320	25,823
334.....	10,453	24,623	10,221	15,099
335.....	11,615	33,915	16,028	20,519
336.....	11,034	36,238	14,670	20,647
337.....	12,195	15,331	7,665	11,730
338.....	19,164	29,269	22,738	23,723
339.....	12,195	19,513	10,513	14,073
340.....	13,357	28,340	24,262	21,986
341.....	5,807	29,269	8,595	14,557
342.....	6,909	23,230	11,615	13,938
343.....	12,195	35,309	26,249	24,584
344.....	1,742	9,292	489	3,841
345.....	15,680	14,402	1,366	10,482
346.....	9,292	10,685	8,001	9,326
347.....	10,453	17,654	6,968	11,691
348.....	14,518	18,584	30,715	21,272
349.....	8,130	23,230	12,776	14,712
350.....	10,453	24,159	15,796	16,802
351.....	13,938	27,875	15,099	18,970
352.....	14,518	28,495	19,048	20,687
353.....	12,195	26,946	20,674	19,938
354.....	17,422	33,451	31,128	27,333
355.....	14,518	22,765	20,293	19,192
356.....	10,453	10,048	8,362	12,621
357.....	12,776	18,584	18,351	16,570
358.....	10,453	23,694	11,751	15,299
359.....	11,034	27,876	13,936	17,615

TABLE II.—Three-year summary of yields of marketable tubers per acre from 108 Green Mountain tuber lines—Continued

Tuber line No.	1916	1917	1918	3-year average.
	<i>Pounds.</i>	<i>Pounds.</i>	<i>Pounds.</i>	<i>Pounds.</i>
360.....	13, 936	25, 553	20, 674	20, 054
361.....	11, 615	22, 300	26, 714	20, 202
362.....	11, 615	31, 592	29, 966	24, 399
363.....	12, 195	32, 766	30, 807	25, 251
364.....	7, 549	21, 836	9, 292	12, 896
365.....	10, 453	23, 230	11, 150	14, 944
366.....	9, 292	34, 380	14, 670	19, 447
367.....	8, 130	27, 876	19, 745	18, 583
368.....	11, 034	23, 230	9, 808	14, 690
369.....	9, 292	22, 300	13, 692	15, 094
370.....	10, 453	16, 261	7, 824	11, 512
371.....	11, 034	31, 128	17, 604	19, 922
372.....	13, 357	30, 321	31, 296	24, 991
373.....	15, 099	34, 845	24, 295	24, 716
374.....	6, 388	20, 442	5, 342	10, 724
375.....	11, 613	29, 343	11, 980	17, 645
376.....	9, 872	33, 915	30, 073	24, 620
377.....	8, 516	33, 849	22, 997	21, 787
378.....	6, 969	27, 411	19, 513	17, 964
379.....	10, 453	22, 765	15, 099	16, 105
380.....	12, 195	25, 553	13, 274	17, 007
381.....	8, 130	21, 020	7, 433	12, 197
382.....	13, 938	27, 876	19, 100	20, 394
383.....	12, 195	35, 309	22, 983	23, 495
384.....	8, 711	26, 017	16, 261	16, 996
385.....	5, 807	21, 371	4, 181	10, 453
386.....	12, 776	32, 522	13, 008	19, 435
387.....	14, 518	23, 230	12, 079	16, 609
388.....	16, 261	38, 581	27, 873	27, 571
389.....	9, 872	24, 941	12, 714	15, 842
390.....	15, 099	32, 522	28, 362	25, 327
391.....	16, 259	30, 663	32, 986	26, 636
392.....	12, 776	24, 623	12, 079	16, 492
393.....	13, 357	25, 088	13, 241	17, 228
394.....	7, 549	34, 380	20, 674	20, 867
395.....	5, 807	34, 722	12, 079	17, 536
396.....	7, 549	36, 238	25, 088	22, 958
397.....	10, 065	21, 836	19, 513	17, 138
398.....	8, 130	30, 663	28, 572	22, 455
399.....	9, 872	29, 260	22, 997	20, 712
400.....	8, 130	28, 590	29, 269	21, 996
401.....	9, 292	23, 694	11, 873	14, 953
402.....	7, 549	20, 907	6, 504	11, 653
403.....	6, 388	26, 017	13, 203	15, 202
404.....	15, 099	34, 845	22, 713	24, 219
405.....	11, 615	30, 663	15, 159	19, 145
406.....	12, 776	30, 199	22, 005	21, 660
407.....	11, 613	23, 694	18, 584	17, 963
408.....	9, 291	19, 298	11, 615	13, 401
Yearly average.....	11, 335	26, 595	17, 493	18, 474

TABLE III.—Twenty highest annual rankings and 3-year average rankings from 108 Green Mountain tuber lines^a

1918		1917		1916		3-year average.	
Line No.	Yield.	Line No.	Yield.	Line No.	Yield.	Line No.	Yield.
	Pounds.		Pounds.		Pounds.		Pounds.
391.....	32, 986	332.....	39, 026	*338.....	19, 165	*332....	27, 849
*372.....	31, 296	388.....	38, 582	354.....	17, 423	***388....	27, 571
***354.....	31, 128	333.....	37, 633	388.....	16, 261	***354....	27, 333
*363.....	30, 807	*327.....	37, 633	391.....	16, 259	**391.....	20, 636
348.....	30, 715	**324.....	37, 168	306.....	15, 680	*333....	25, 823
**320.....	30, 663	*306.....	36, 239	*316.....	15, 680	**390.....	25, 327
*330.....	30, 318	*336.....	36, 239	*345.....	15, 680	*363.....	25, 256
*376.....	30, 073	343.....	35, 310	324.....	15, 680	**306.....	25, 073
*362.....	29, 966	*383.....	35, 310	317.....	15, 099	*372.....	24, 991
***332.....	29, 424	**404.....	34, 845	373.....	15, 099	**324.....	24, 894
*306.....	29, 340	**373.....	34, 845	404.....	15, 099	**373.....	24, 716
*400.....	29, 269	*395.....	34, 723	332.....	15, 099	**376.....	24, 620
*398.....	28, 572	*394.....	34, 380	390.....	15, 099	**343.....	24, 584
**390.....	28, 362	*366.....	34, 380	320.....	15, 099	*362.....	24, 391
***388.....	27, 873	*326.....	34, 380	333.....	14, 519	**404.....	24, 219
*361.....	26, 714	376.....	33, 916	*387.....	14, 519	**317.....	24, 162
*310.....	26, 482	*335.....	33, 916	*355.....	14, 519	*338.....	23, 723
**343.....	26, 249	**317.....	33, 916	*352.....	14, 519	*383.....	23, 495
*300.....	26, 017	*377.....	33, 849	348.....	14, 519	**320.....	22, 842
***333.....	25, 320	354.....	33, 451	310.....	13, 938	*330.....	22, 495
				*318.....	13, 938		
				*319.....	13, 938		
				*323.....	13, 938		
				*351.....	13, 938		
				*382.....	13, 938		

^a The number of stars indicates how many times the line has appeared among the 20 highest-yielding lines. Lines not starred in columns 3 and 5 appear and are starred elsewhere in the table. Four lines appear three times, 12 appear twice, and 29 appear only once.

TABLE IV.—Twenty lowest annual rankings and 3-year average rankings from 108 Green Mountain tuber lines^a

1918		1917		1916		3-year average.	
Line No.	Yield.	Line No.	Yield.	Line No.	Yield.	Line No.	Yield.
	Pounds.		Pounds.		Pounds.		Pounds.
**344.....	489	344.....	9, 292	341.....	5, 808	**344.....	3, 841
**345.....	1, 368	346.....	10, 686	385.....	5, 808	**346.....	9, 326
***385.....	4, 181	345.....	14, 403	*395.....	5, 808	***385....	10, 453
***374.....	5, 342	337.....	15, 332	374.....	6, 388	**345.....	10, 482
***402.....	6, 524	328.....	15, 796	*403.....	6, 388	***374....	10, 724
**347.....	6, 968	*330.....	16, 261	*378.....	6, 969	*370.....	11, 512
***381.....	7, 433	*319.....	17, 190	*342.....	6, 969	***402....	11, 653
**337.....	7, 665	347.....	17, 655	*308.....	6, 969	**347.....	11, 691
*370.....	7, 824	*348.....	18, 584	402.....	7, 550	**337.....	11, 730
316.....	8, 001	*357.....	18, 584	364.....	7, 550	*381....	12, 197
**356.....	8, 362	356.....	19, 049	*394.....	7, 550	**328.....	12, 234
**341.....	8, 575	*408.....	19, 299	*306.....	7, 550	**356.....	12, 621
***364.....	9, 292	339.....	19, 513	*331.....	7, 550	**364.....	12, 802
*368.....	9, 808	*312.....	19, 513	*349.....	8, 131	*408.....	13, 401
*334.....	10, 221	*310.....	20, 442	*307.....	8, 131	*342.....	13, 938
*318.....	10, 269	*357.....	20, 442	*398.....	8, 131	**339.....	14, 073
**328.....	10, 453	*300.....	20, 442	*400.....	8, 131	**341.....	14, 557
**339.....	10, 513	402.....	20, 907	381.....	8, 131	*368.....	14, 690
*314.....	10, 840	381.....	21, 029	*377.....	8, 517	*349.....	14, 712
*365.....	11, 150	385.....	21, 372	*384.....	8, 711	*365.....	14, 944

^a The number of stars indicates how many years the line has appeared among the 20 lowest-yielding lines. Lines not starred in columns 3 and 5 appear and are starred elsewhere in the table. Four appear three times, 10 appear twice, and 28 appear only once.

If with these records before us we attempt to point out apparently promising lines, we must base our judgment either upon the frequency with which the line appears among the high-yielding lines or upon its performance as indicated by the 3-year average. The following 1918 field notes are upon the lines that have appeared at least two out of the three seasons among the 20 highest or that rank with the 20 highest according to the 3-year average.

LINE NO.	REMARKS.
332.	First two units lacking in vigor but others vigorous. Variations may be due to soil.
388.	Fourth unit a typical semi-curlydwarf.
354.	First unit semi-curlydwarf.
391.	A good vigorous type.
333.	A good vigorous type.
390.	A good vigorous type.
363.	A good vigorous type; third unit inclined to semi-curlydwarf.
306.	First unit curlydwarf; others fairly vigorous.
372.	A good vigorous type.
324.	A fairly good type; a few weak plants, but these may possibly be due to soil.
373.	Variable as to vigor; some plants with curlydwarf tendencies, though all are fairly vigorous.
343.	A good vigorous type with exception of first unit.
362.	A good vigorous type.
404.	A good vigorous type.
317.	A good vigorous type.
338.	A good vigorous type.
383.	A very good type; some variation as to vigor, but this may possibly be due to soil.
320.	Vigorous with exception of third unit, which is a typical semi-curlydwarf.
330.	A good vigorous type.
348.	Units 1, 4, and 5, very vigorous; other two very good type.
310.	First unit with curlydwarf tendencies; others very vigorous.

Of these 22 lines, only 9 were noted as having uniformly good vine characteristics in 1918. Eight contained four or more hills with degenerate tendencies, and 5 showed variations in vigor which possibly might have been attributed to soil but which may, on the other hand, turn out to be the first signs of degeneration. Yield records do not promise to be very effective in dealing with degeneration. It is true that those lines which have appeared frequently among the lowest-yielding are typical degenerates, but degenerate tendencies are also noticeable among the high-yielding ones. On the other hand, 7 of the 19 lines noted with good vine characteristics in 1918 have each appeared once among the low-yielding 20 in Table IV. This indicates that low yields are not always associated with degeneration.

The number of tubers produced in the hill is often suggested as a point worth considering in making seed-potato selections. In Table V will be found a summary of numerical tuber production in the 108 Green Mountain tuber lines. There is a maximum variation in the 3-year averages of 3.45 tubers per single-stemmed hill. The 20 ranking highest in

numerical tuber production (Table VI) have as a group a 3-year average record of 4.04 tubers per hill, while the 20 ranking lowest (Table VII) have averaged for the 3-year period 2.40 tubers per hill. The number of tubers produced in the hills varies from year to year, as will be shown in the yearly averages of the different lines. The 108 Green Mountain lines averaged 1.96 tubers per hill in 1916, 3.97 in 1917, and 2.78 in 1918. Variable soil moisture conditions during the setting period are no doubt responsible for a goodly portion of this fluctuation in tuber production, although delayed thinning may have contributed to the low yields of 1916. In a general way, numerical tuber production and production by weight rise and fall together, but this is by no means a fixed rule. Lines of this variety show the greatest variance in numerical tuber production, but this is no doubt accounted for by the more pronounced degenerate tendencies among a larger proportion of these lines. Degenerate lines do not fall off so much in total number of tubers produced, but a larger proportion of the tubers grade below marketable size. Once degeneration begins in this variety, the line rapidly loses in vitality and yielding power. To illustrate this we might call attention to the record of line 345. This yielded 15,680 pounds per acre in 1916, while the average of all Green Mountain lines for that year was 11,335 pounds. In 1917 it yielded 14,402 pounds as compared with an average of 26,595 for all Green Mountain lines; and in 1918 it yielded 1,366 pounds, as compared with an average of 17,494 for all these lines. Expressed in plus and minus variations, this line yielded 4,345 pounds above the average in 1916, 12,193 below the average in 1917, and 16,127 below the average in 1918.

TABLE V.—Three-year average numerical production of marketable tubers per hill from 108 Green Mountain tuber lines

Line No.	Yield.	Line No.	Yield.	Line No.	Yield.	Line No.	Yield.
300.....	3.56	328.....	3.12	355.....	3.69	382.....	3.95
301.....	3.22	329.....	3.65	356.....	2.79	383.....	4.27
302.....	3.22	330.....	4.18	357.....	3.40	384.....	3.05
304.....	3.30	331.....	3.29	358.....	2.90	385.....	2.13
305.....	2.88	332.....	4.64	359.....	3.04	386.....	3.11
306.....	3.74	333.....	4.36	360.....	2.83	387.....	2.72
307.....	2.13	334.....	2.75	361.....	3.06	388.....	3.72
308.....	2.92	335.....	3.54	362.....	3.84	389.....	2.71
309.....	2.95	336.....	3.02	363.....	3.37	390.....	3.63
310.....	3.75	337.....	2.79	364.....	3.20	391.....	3.97
311.....	3.50	338.....	4.06	365.....	3.45	392.....	2.93
312.....	2.88	339.....	2.65	366.....	3.13	393.....	3.20
313.....	3.06	340.....	3.21	367.....	3.50	394.....	3.81
314.....	3.16	341.....	2.90	368.....	2.57	395.....	3.57
315.....	3.11	342.....	3.02	369.....	2.44	396.....	3.93
316.....	3.30	343.....	3.84	370.....	2.16	397.....	2.83
317.....	3.48	344.....	1.10	371.....	3.11	398.....	3.68
318.....	3.34	345.....	1.95	372.....	3.42	399.....	3.36
319.....	3.36	346.....	2.95	373.....	4.32	400.....	3.62
320.....	3.88	347.....	2.59	374.....	2.70	401.....	3.16
321.....	2.78	348.....	3.40	375.....	3.14	402.....	2.40
322.....	3.16	349.....	2.56	376.....	4.41	403.....	3.30
323.....	3.50	350.....	3.09	377.....	3.53	404.....	4.43
324.....	3.75	351.....	3.30	378.....	3.38	405.....	3.23
325.....	3.27	352.....	2.87	379.....	2.68	406.....	3.86
326.....	3.61	353.....	2.93	380.....	2.78	407.....	2.83
327.....	3.43	354.....	3.93	381.....	1.86	408.....	2.30

TABLE VI.—Twenty highest-yielding of 108 Green Mountain tuber lines when ranked on 3-year average numerical production of marketable tubers per hill^a

Line No.	Yield.	Line No.	Yield.	Line No.	Yield.	Line No.	Yield.
*332.....	4. 64	*383.....	4. 27	396.....	3. 93	*362.....	3. 84
*404.....	4. 43	*330.....	4. 18	*354.....	3. 93	394.....	3. 81
*376.....	4. 41	*338.....	4. 06	*320.....	3. 88	*324.....	3. 75
*333.....	4. 36	*391.....	3. 97	406.....	3. 86	310.....	3. 75
*373.....	4. 32	382.....	3. 95	*343.....	3. 84	*306.....	3. 74

^aThe 15 starred lines also appear among the 20 highest-yielding when ranked on the 3-year average production of marketable tubers by weight. Ten of these lines, printed in bold-face type, appear among the 19 lines selected in 1918 as having uniformly good vine characteristics. Average of group, 4.40 tubers per hill.

TABLE VII.—Twenty lowest-yielding of 108 Green Mountain tuber lines when ranked on 3-year average numerical production of marketable tubers per hill^a

Line No.	Yield.	Line No.	Yield.	Line No.	Yield.	Line No.	Yield.
*344.....	1. 19	*370.....	2. 16	*368.....	2. 57	389.....	2. 71
*381.....	1. 86	*408.....	2. 30	*347.....	2. 59	387.....	2. 72
*345.....	1. 95	*402.....	2. 40	*339.....	2. 65	334.....	2. 75
*385.....	2. 13	369.....	2. 44	379.....	2. 68	321.....	2. 78
307.....	2. 13	*349.....	2. 56	*374.....	2. 70	380.....	2. 78

^aThe 12 lines starred also appear among the 20 ranking lowest in weight of marketable tubers. None of these 20 low-yielding lines have good vine characteristics. Average of group, 2.40 tubers per hill.

The 19 lines selected in 1918 as having uniformly good vine characteristics have been grouped in Table VIII. The 1918 average of these 19 lines is 26,260 pounds. In Table IX appear an equal number of the heaviest-yielding lines of 1918, with an average production for the year of 29,267 pounds. The 108 Green Mountain lines gave an average yield of 17,493 pounds in 1918. It will be noted that selection based upon vine characteristics alone came very near isolating the high-yielding lines for that season. The 19 lines appearing in Table VIII have as a group a 3-year average record of 23,270 pounds of marketable tubers per acre. The 19 lines standing highest when ranked on their 3-year average yield of marketable tubers have as a group an average of 25,131 pounds. The variation between the two groups, 1,861 pounds per acre, hardly seems sufficient to repay the labor involved in keeping yield records.

TABLE VIII.—Yields of 19 Green Mountain lines chosen upon vine characteristics alone as the best of the 108 lines of this variety in 1918^a

Line No.	Yield.	Line No.	Yield.	Line No.	Yield.	Line No.	Yield.
	<i>Pounds.</i>		<i>Pounds.</i>		<i>Pounds.</i>		<i>Pounds.</i>
300.....	26, 071	*338.....	22, 738	*372.....	31, 296	394.....	20, 674
*317.....	23, 472	340.....	24, 262	377.....	22, 997	396.....	25, 088
*330.....	30, 318	348.....	30, 715	*383.....	22, 983	400.....	29, 269
*332.....	29, 424	355.....	20, 293	*390.....	28, 362	*404.....	22, 713
*333.....	25, 320	*362.....	29, 966	*391.....	32, 989		

^aThe lines starred appear among the 20 highest-yielding lines when ranked on the 3-year average production by weight of marketable tubers. Average of group, 26,260 pounds per acre.

TABLE IX.—Nineteen highest-yielding of 108 Green Mountain lines in 1918^a

Line No.	Yield.	Line No.	Yield.	Line No.	Yield.	Line No.	Yield.
	<i>Pounds.</i>		<i>Pounds.</i>		<i>Pounds.</i>		<i>Pounds.</i>
391.....	32,986	320.....	30,603	306.....	29,340	361.....	26,714
372.....	31,296	330.....	30,318	400.....	29,269	310.....	26,482
354.....	31,128	376.....	30,073	398.....	28,572	343.....	26,249
303.....	30,807	362.....	29,966	390.....	28,362	300.....	26,017
348.....	30,715	332.....	29,424	388.....	27,873		

^a The lines printed in bold-face type also appear in the group with good vine characteristics. This leaves 10 of the 19 lines with vines suggesting degenerate tendencies. Average of group, 29,267 pounds per acre.

RURAL NEW YORKER TUBER LINES 409 TO 516

Rural New Yorker has ranked very high in the variety tests conducted at this Station. Experience would lead to the belief that, with the possible exception of Russet Burbank, no main crop variety tested in these experiments will give more uniformly satisfactory results upon heavy types of irrigated land. Usually little difficulty is experienced in maintaining good, vigorous stock where the seed is carefully selected after the digger. The average yield of all strains of Rural tested in 1916, 1917, and 1918 was 13,449 pounds of marketable tubers per acre. It will be noted that the average yield of the 108 tuber lines for the same period was 16,820 pounds. The 3-year performance record of these lines is presented in Table X. Here, as well as in Table II, it is interesting to note the variation in the average annual yield of all lines for the three seasons. Within any one season the variation between tuber lines is not so pronounced as it is in Green Mountain; but as yet none of these lines has reached the final stage of degeneration as several Green Mountain lines have. No effort is made to draw conclusions from Table X as a whole, but in Tables XI and XII an effort has been made to present a portion of the data included in Table X in such form that we may get some idea of the value of a 3-year performance record in isolating high-yielding lines.

TABLE X.—Three-year summary of yields of marketable tubers per acre from 108 Rural New Yorker tuber lines

Tuber line No.	1916	1917	1918	3-year average.
	<i>Pounds.</i>	<i>Pounds.</i>	<i>Pounds.</i>	<i>Pounds.</i>
409.....	12,776	22,007	17,422	17,401
410.....	9,872	20,907	18,351	16,376
411.....	9,292	22,300	22,956	18,182
412.....	13,357	26,327	24,939	21,541
413.....	9,292	27,876	15,648	17,605
414.....	9,872	23,230	20,585	19,895
415.....	12,776	25,919	23,961	20,885
416.....	12,776	21,371	28,108	20,751
417.....	8,130	24,623	22,683	18,478
418.....	4,065	17,869	14,867	12,267
419.....	11,034	24,159	20,442	18,545
420.....	7,549	24,159	20,442	17,383
421.....	8,711	25,088	18,584	17,461

TABLE X.—Three-year summary of yields of marketable tubers per acre from 108 Rural New Yorker tuber lines—Continued

Tuber line No.	1916	1917	1918	3-year average.
	<i>Pounds.</i>	<i>Pounds.</i>	<i>Pounds.</i>	<i>Pounds.</i>
422.....	11, 615	28, 340	17, 190	19, 048
423.....	12, 776	23, 230	14, 867	16, 957
424.....	11, 615	27, 386	24, 049	21, 017
425.....	8, 711	21, 836	28, 362	19, 636
426.....	8, 711	24, 159	21, 165	18, 011
427.....	10, 453	21, 836	17, 654	16, 647
428.....	1, 742	34, 070	18, 351	18, 054
429.....	7, 742	22, 765	16, 626	15, 711
430.....	6, 388	23, 230	26, 650	18, 756
431.....	6, 388	26, 946	17, 551	16, 961
432.....	9, 291	25, 430	15, 159	16, 626
433.....	9, 872	26, 482	24, 623	20, 325
434.....	6, 969	27, 031	26, 714	20, 238
435.....	7, 549	23, 230	21, 516	17, 431
436.....	6, 969	23, 230	22, 765	17, 654
437.....	8, 130	25, 088	18, 119	17, 112
438.....	6, 388	21, 836	18, 582	15, 602
439.....	6, 388	20, 442	25, 428	17, 419
440.....	9, 292	23, 230	21, 371	17, 964
441.....	6, 969	22, 300	20, 132	16, 467
442.....	6, 388	24, 623	27, 873	19, 628
443.....	10, 453	25, 088	27, 876	21, 139
444.....	10, 453	19, 048	17, 935	15, 512
445.....	11, 615	19, 513	19, 977	17, 035
446.....	11, 615	26, 482	19, 745	19, 280
447.....	9, 292	16, 002	21, 589	15, 627
448.....	13, 938	24, 452	23, 229	20, 539
449.....	12, 776	23, 694	17, 422	17, 964
450.....	12, 195	23, 230	25, 142	20, 189
451.....	11, 034	25, 430	25, 428	20, 630
452.....	11, 034	26, 017	20, 648	19, 233
453.....	6, 388	26, 017	13, 938	15, 447
454.....	5, 807	14, 402	18, 093	12, 767
455.....	10, 453	22, 765	19, 048	17, 422
456.....	11, 615	13, 938	17, 935	14, 196
457.....	12, 195	23, 230	10, 758	15, 394
458.....	9, 292	22, 300	19, 071	16, 887
459.....	9, 292	22, 765	17, 654	16, 570
460.....	11, 034	20, 442	20, 049	17, 175
461.....	9, 292	20, 907	13, 473	14, 557
462.....	10, 453	24, 159	19, 971	17, 894
463.....	11, 034	16, 261	16, 519	14, 604
464.....	8, 711	23, 230	17, 035	16, 325
465.....	8, 130	19, 048	24, 939	17, 372
466.....	8, 130	21, 836	18, 093	16, 019
467.....	7, 549	23, 694	18, 093	16, 445
468.....	5, 807	19, 676	13, 692	13, 058
469.....	9, 872	19, 513	20, 907	16, 764
470.....	5, 807	22, 300	20, 538	16, 215
471.....	19, 977	19, 977	18, 582	14, 595
472.....	7, 549	16, 261	18, 351	14, 053
473.....	5, 807	18, 119	17, 359	13, 761
474.....	7, 549	19, 977	17, 422	14, 982
475.....	6, 969	20, 442	17, 935	14, 815
476.....	8, 130	23, 694	20, 442	17, 422
477.....	5, 807	19, 513	12, 544	12, 621
478.....	8, 130	22, 300	18, 067	16, 165
479.....	8, 711	19, 513	18, 857	15, 693
480.....	10, 453	23, 230	22, 409	18, 697

TABLE X.—Three-year summary of yields of marketable tubers per acre from 108 Rural New Yorker tuber lines—Continued

Tuber line No.	1916	1917	1918	3-year average.
	Pounds.	Pounds.	Pounds.	Pounds.
481.....	10,453	16,725	17,935	14,737
482.....	11,615	18,584	20,538	16,912
483.....	9,292	16,261	11,247	12,266
484.....	8,711	12,195	17,551	12,819
485.....	11,615	20,907	18,119	16,880
486.....	10,453	17,654	24,049	17,385
487.....	9,292	18,119	21,371	16,260
488.....	5,807	19,048	19,048	14,634
489.....	6,909	18,584	22,494	16,015
490.....	10,453	18,584	13,692	14,243
491.....	11,613	22,300	17,887	17,266
492.....	8,711	23,694	23,488	18,631
493.....	11,615	18,584	18,826	16,341
494.....	9,872	20,442	16,260	15,524
495.....	12,195	19,048	19,315	16,852
496.....	13,938	19,513	21,760	18,403
497.....	10,453	23,694	20,674	18,273
498.....	8,130	19,513	22,455	16,699
499.....	8,130	21,029	17,190	15,449
500.....	4,646	22,300	14,670	13,872
501.....	4,646	22,705	22,705	16,725
502.....	6,909	22,705	19,977	16,570
503.....	6,388	20,907	19,513	15,602
504.....	4,646	23,230	20,442	16,106
505.....	9,872	18,584	18,093	15,516
506.....	4,646	24,623	20,049	16,439
507.....	5,226	19,048	21,516	15,203
508.....	7,549	21,371	17,115	15,345
509.....	8,711	21,029	12,389	14,043
510.....	4,646	25,088	25,552	18,428
511.....	8,711	21,836	19,500	16,702
512.....	6,909	22,300	19,500	16,276
513.....	6,909	22,300	20,674	16,647
514.....	6,909	22,300	20,442	16,570
515.....	9,292	22,300	17,654	16,415
516.....	8,130	17,190	20,907	15,499
Average.....	8,831	21,864	19,787	16,820

The data included in these tables indicate that with few exceptions high-yielding lines are not consistent high yielders, neither are all low-yielding lines consistent low yielders. The following brief field notes taken in 1918 do not indicate that yield records will be found very satisfactory in dealing with degeneration. For instance, line 448 has a very good performance record. It ranked first in 1916, appeared among the highest-yielding 20 in 1918, only missed by a narrow margin a place among the best 20 in 1917, and ranks seventh according to the 3-year average. But unless the vine characteristics are very deceiving, its yielding power will drop at least 50 per cent during the next two years. One-third of these lines with promising performance records contained some plants with degenerate tendencies. The field notes of 1918 indicate to what extent degeneration appears among the lines that have appeared for at least two out of three years among the 20 highest-yielding or would be ranked with the 20 highest according to the 3-year average.

TABLE XI.—Twenty highest annual rankings and 3-year average rankings from 108 Rural New Yorker tuber lines^a

1918		1917		1916		3-year average.	
Line No.	Yield.	Line No.	Yield.	Line No.	Yield.	Line No.	Yield.
	<i>Pounds.</i>		<i>Pounds.</i>		<i>Pounds.</i>		<i>Pounds.</i>
*425.....	28, 362	*428.....	34, 070	448.....	13, 938	***412....	21, 541
**416.....	28, 108	**422.....	28, 341	*406.....	13, 938	**443....	21, 139
443.....	27, 876	*413.....	27, 876	412.....	13, 357	*424....	21, 017
442.....	27, 873	424.....	27, 387	415.....	12, 777	*415....	20, 885
**434.....	26, 714	*434.....	27, 031	*449.....	12, 777	**416....	20, 751
*430.....	26, 650	*431.....	26, 947	*423.....	12, 777	**451....	20, 630
*414.....	26, 585	*433.....	26, 482	416.....	12, 777	**448....	20, 539
**510.....	25, 552	**446.....	26, 482	*409.....	12, 777	**433....	20, 325
**451.....	25, 428	412.....	26, 327	*495.....	12, 196	**434....	20, 238
*439.....	25, 438	*453.....	26, 081	*457.....	12, 196	**450....	20, 189
**450.....	25, 142	*452.....	26, 081	450.....	12, 196	*414....	19, 805
*465.....	24, 939	415.....	25, 920	424.....	11, 615	*425....	19, 636
***412.....	24, 939	451.....	25, 430	422.....	11, 615	**442....	19, 628
**433.....	24, 623	*432.....	25, 430	*493.....	11, 615	**446....	19, 280
***424.....	24, 049	510.....	25, 088	*485.....	11, 615	*452....	19, 233
*486.....	24, 049	443.....	25, 088	*482.....	11, 615	**422....	19, 048
***415.....	23, 961	*437.....	25, 088	*456.....	11, 615	*430....	18, 756
*492.....	23, 488	*421.....	25, 088	*455.....	11, 615	480....	18, 607
**448.....	23, 229	442.....	24, 624	446.....	11, 614	*492....	18, 631
*411.....	22, 956	*506.....	24, 624	*491.....	11, 614	419....	18, 545
		*417.....	24, 624				

^a The number of stars indicates how many times the line has appeared among the 20 highest rankings. Lines not starred in columns 3 and 5 appear and are starred elsewhere in the table. Three lines appear three times, 11 lines appear twice, and 35 lines appear only once.

TABLE XII.—Twenty lowest annual rankings and 3-year average rankings from 108 Rural New Yorker tuber lines^a

1918		1917		1916		3-year average.	
Line No.	Yield.	Line No.	Yield.	Line No.	Yield.	Line No.	Yield.
	<i>Pounds.</i>		<i>Pounds.</i>		<i>Pounds.</i>		<i>Pounds.</i>
*457.....	10, 758	*484.....	12, 196	*428.....	1, 742	**483....	12, 266
483.....	11, 247	456.....	13, 938	418.....	4, 065	*418....	12, 267
*509.....	12, 389	*454.....	14, 403	*506.....	4, 646	**477....	12, 621
**477.....	12, 544	*447.....	16, 003	*510.....	4, 646	*454....	12, 767
*461.....	13, 473	*472.....	16, 261	*504.....	4, 646	*484....	12, 819
**468.....	13, 692	463.....	16, 261	*501.....	4, 646	**468....	13, 058
**490.....	13, 692	483.....	16, 261	500.....	4, 646	**473....	13, 761
**453.....	13, 938	481.....	16, 726	507.....	5, 227	**500....	13, 872
**500.....	14, 670	*516.....	17, 190	*471.....	5, 227	*509....	14, 043
***418.....	14, 867	*486.....	17, 665	473.....	5, 808	*472....	14, 053
*423.....	14, 867	418.....	17, 869	*450.....	5, 808	**456....	14, 196
*432.....	15, 159	**473.....	18, 119	468.....	5, 808	**490....	14, 243
*413.....	15, 648	*487.....	18, 119	477.....	5, 808	*461....	14, 557
*494.....	16, 260	*489.....	18, 584	488.....	5, 808	*471....	14, 595
**463.....	16, 519	490.....	18, 584	*470.....	5, 808	**463....	14, 604
*429.....	16, 626	*505.....	18, 584	*442.....	6, 388	**488....	14, 634
**481.....	17, 035	*482.....	18, 584	453.....	6, 388	**481....	14, 737
*464.....	17, 035	*493.....	18, 584	*431.....	6, 388	*475....	14, 815
*475.....	17, 035	*495.....	19, 049	*503.....	6, 388	474....	14, 982
**456.....	17, 035	**488.....	19, 049	*439.....	6, 388	**507....	15, 262
**444.....	17, 035	444.....	19, 049	*430.....	6, 388		
		*465.....	19, 049	*438.....	6, 388		
		**507.....	19, 049				

^a The number of stars indicates how many times the line has appeared among the 20 lowest rankings. Lines not starred in columns 3 and 5 appear and are starred elsewhere in the table. One appears three times, 13 lines appear twice, and 37 lines appear only once.

Of these 21 lines, 7 have curlydwarf tendencies. Twelve appear among the best 33 lines chosen in 1918 on vine characteristics alone. This leaves two, 443 and 452, in the doubtful list.

LINE NO.	REMARKS.
416.	Third unit a curlydwarf; others vigorous though lacking in uniformity.
443.	A very good type; first and second unit not especially vigorous.
442.	A good vigorous type.
434.	A good vigorous type.
510.	A good vigorous type.
451.	A good vigorous type.
450.	Not a very good type.
412.	Uniform and fairly vigorous.
433.	A good vigorous type.
424.	Vines not a good type.
415.	A good type and fairly vigorous.
448.	All have more or less curlydwarf tendency.
422.	Lacking in vigor but type good.
446.	First four units have curlydwarf tendencies.
414.	First unit with curlydwarf tendencies.
425.	Very good and vigorous type.
452.	Not very vigorous but type good.
430.	First unit very vigorous; others good.
480.	Fairly vigorous.
492.	A very good type.
419.	Some curlydwarf tendencies.

In Table XIII data are presented showing the 3-year average numerical production of tubers per single-stemmed hill. In Tables XIV and XV a portion of this data is used to show the lack of correlation between yields in numbers and in weight, as well as the relation between numerical tuber production and good vine characteristics. There is in Table XIII a maximum variation of 1.29 tubers per hill. Between the average of the 20 highest and 20 lowest (Tables XIV and XV) there is a variation of 0.79 tubers per hill. Considering that these are single-stemmed hills, this variation is rather pronounced. But the data are apparently no more reliable than weight records in pointing out promising lines. Low numerical tuber production does not always mean low production by weight, and such records are apparently of little value as a check on degenerate tendencies. Fluctuation in tuber production in different seasons has been even greater than the variation between lines in any one season. These 108 lines averaged 2.05 marketable tubers per hill in 1916, 3.78 in 1917, and 2.44 in 1918.

In Table XVI the 33 lines with promising vine characteristics have been assembled with their 1918 yields of marketable tubers. The average yield of these 33 lines is 21,142 pounds per acre. In Table XVII the 33 heaviest-yielding lines of 1918 are assembled for comparison. Their average yield is 24,109 pounds, while the 1918 average of the 108 Rural New Yorker lines was 19,787 pounds per acre. The lines chosen upon vine

characteristics alone yielded well above the average of the 108 lines but did not equal the 33 heaviest-yielding lines of 1918. Field notes show that 15 of these heavy-yielding lines of 1918 have poor vine characteristics. This means that if mass selection based on tuber characteristics is practiced within these 15 lines their progeny will be almost certain to contain some rather advanced degenerate types that will materially decrease the yield of the lines in 1919. On the other hand, we can be almost sure that no well-advanced or low-yielding degenerates will appear among the 1919 progeny of those with good 1918 vine characteristics. It is interesting to go back beyond the 1918 records and compare the 3-year performance of these lines assembled in Table XVI with the 33 highest-yielding Rural New Yorker lines when ranked upon their 3-year average production. The 33 lines in Table XVI have produced during the 3-year period an average yield of 17,740 pounds per acre. The 33 of the 108 Rural New Yorker lines ranking highest according to the 3-year average production by weight have yielded on an average 19,181 pounds. Between the two groups there is a variation of 1,441 pounds in favor of the 33 lines ranked upon their performance record. But when vine development so nearly foretells the yielding power of the line it would really seem that this is a more practical basis for selection than yields measured in either weight or number of tubers.

TABLE XIII.—Three-year average numerical production of marketable tubers per hill from 108 rural New Yorker tuber lines

Line No.	Yield.	Line No.	Yield.	Line No.	Yield.	Line No.	Yield.
409.....	3.30	436.....	3.29	463.....	3.00	490.....	2.76
410.....	3.47	437.....	3.02	464.....	3.07	491.....	2.79
411.....	3.65	438.....	3.18	465.....	3.02	492.....	3.16
412.....	3.34	439.....	3.00	466.....	2.90	493.....	2.83
413.....	3.25	440.....	2.95	467.....	3.04	494.....	2.69
414.....	2.80	441.....	3.19	468.....	2.60	495.....	2.93
415.....	3.19	442.....	3.48	469.....	3.10	496.....	2.83
416.....	3.31	443.....	2.68	470.....	3.04	497.....	3.25
417.....	2.97	444.....	3.04	471.....	2.65	498.....	2.78
418.....	2.86	445.....	3.09	472.....	3.06	499.....	2.79
419.....	3.63	446.....	3.32	473.....	3.11	500.....	2.83
420.....	3.54	447.....	3.10	474.....	3.06	501.....	3.29
421.....	3.34	448.....	3.07	475.....	3.02	502.....	3.06
422.....	3.56	449.....	2.88	476.....	2.77	503.....	2.72
423.....	2.97	450.....	3.04	477.....	2.95	504.....	2.93
424.....	3.15	451.....	3.21	478.....	3.16	505.....	2.64
425.....	3.53	452.....	3.38	479.....	3.21	506.....	3.60
426.....	3.59	453.....	3.20	480.....	3.04	507.....	3.27
427.....	3.00	454.....	2.93	481.....	3.02	508.....	2.74
428.....	2.55	455.....	2.81	482.....	2.95	509.....	2.60
429.....	3.20	456.....	2.78	483.....	2.55	510.....	3.19
430.....	3.41	457.....	2.86	484.....	2.92	511.....	3.11
431.....	3.28	458.....	3.04	485.....	2.95	512.....	3.09
432.....	3.48	459.....	3.29	486.....	3.19	513.....	3.43
433.....	3.43	460.....	3.16	487.....	2.88	514.....	2.75
434.....	3.74	461.....	2.70	488.....	2.93	515.....	2.79
435.....	3.25	462.....	2.90	489.....	3.02	516.....	2.45

TABLE XIV.—Twenty highest-yielding of 108 Rural New Yorker tuber lines when ranked on 3-year average numerical production of marketable tubers per hill^a

Line No.	Yield.	Line No.	Yield.	Line No.	Yield.	Line No.	Yield.
*434	3. 74	*422	3. 56	410	3. 47	*412	3. 34
411	3. 65	420	3. 54	*433	3. 43	421	3. 34
*419	3. 63	*425	3. 53	513	3. 43	*446	3. 32
506	3. 60	432	3. 48	*430	3. 41	*416	3. 31
426	3. 59	*442	3. 48	*452	3. 38	409	3. 30

^a The 11 lines starred appear among the 20 highest when ranked on 3-year average production by weight of marketable tubers. Nine of these lines (printed in bold-face type) have uniformly good vine characteristics, and the other 11 have vine characteristics which suggest degeneration. Average of group, 3.47 tubers per hill.

TABLE XV.—Twenty lowest-yielding of 108 Rural New Yorker tuber lines when ranked on 3-year average numerical production of marketable tubers per hill^a

Line No.	Yield.	Line No.	Yield.	Line No.	Yield.	Line No.	Yield.
516	2. 45	505	2. 64	503	2. 72	*456	2. 78
*483	2. 55	*471	2. 65	508	2. 74	498	2. 78
428	2. 55	443	2. 68	514	2. 75	491	2. 79
*509	2. 60	*494	2. 69	*490	2. 76	499	2. 79
*468	2. 60	*461	2. 70	476	2. 77	515	2. 79

^a The 7 lines starred appear among the 20 lowest when ranked on 3-year average production by weight of marketable tubers. The 6 lines printed in bold-face type appeared among the 33 chosen in 1918 as having the best vine characteristics, and these 6 have very good 3-year averages for tuber production by weight. Line 428 appeared among the heaviest-yielding 20 in 1918 and only missed by a small margin a place among the 20 heaviest-yielding when ranked on 3-year average production. Average of group, 2.68 tubers per hill.

TABLE XVI.—Yields for 1918 of 33 Rural New Yorker lines chosen upon 1918 vine characteristics alone as the best of the 108 lines of this variety^a

Line No.	Yield.	Line No.	Yield.	Line No.	Yield.	Line No.	Yield.
	<i>Pounds.</i>		<i>Pounds.</i>		<i>Pounds.</i>		<i>Pounds.</i>
*412	24, 939	*442	27, 873	*492	23, 488	504	20, 442
*413	15, 648	*451	25, 428	493	18, 826	506	20, 049
*415	23, 961	465	24, 939	495	19, 315	507	21, 516
*422	17, 190	*480	22, 409	*496	21, 760	508	17, 115
*425	28, 362	486	24, 049	*497	20, 674	*510	25, 552
*428	18, 351	488	19, 048	498	22, 455	513	20, 674
*430	26, 050	489	22, 404	501	22, 765	514	20, 442
*433	24, 623	491	17, 887	503	19, 513	516	20, 907
*434	26, 714						

^a The 16 lines starred appear among the 33 highest-yielding lines when ranked on their 3-year average record. Lines 488 and 507 rank among the 20 lowest-yielding according to the 3-year average. Average of group, 21,142 pounds per acre.

TABLE XVII.—Thirty-three highest-yielding lines of 108 Rural New Yorker tuber lines in 1918^a

Line No.	Yield.	Line No.	Yield.	Line No.	Yield.	Line No.	Yield.
	<i>Pounds.</i>		<i>Pounds.</i>		<i>Pounds.</i>		<i>Pounds.</i>
425	28, 362	451	25, 428	492	23, 488	480	22, 409
416	28, 108	450	25, 142	448	23, 229	496	21, 760
443	27, 876	412	24, 939	411	22, 956	447	21, 589
442	27, 873	465	24, 939	436	22, 765	435	21, 516
434	26, 714	433	24, 623	501	22, 765	507	21, 516
430	26, 650	424	24, 049	417	22, 683	440	21, 371
414	26, 585	480	24, 049	489	22, 494	487	21, 371
510	25, 552	415	23, 961	498	22, 455	426	21, 156
439	25, 428						

^a The 18 lines printed in bold-face type appear in Table XVI. This means that of the 33 highest-yielding Rural New Yorker lines in 1918, 15 have poor vine characteristics. Average of group, 24,109 pounds per acre.

EARLY SIX WEEKS TUBER LINES 517 TO 622

While these lines were selected from stock being grown under the name of Early Six Weeks, they all seem more typical of Red Early Ohio. At first a mixture of Early Ohio and Early Six Weeks was suspected, but observations on vine characteristics have led to the belief that the less vigorous lines, more typical of Early Six Weeks, are nothing more than degenerate types of Early Ohio. Such types are constantly appearing within vigorous dark green lines typical of Early Ohio. With this explanation I will still refer to these as Early Six Weeks lines. Varieties of the Early Ohio types have proved very satisfactory under soil and climatic conditions at the Station, yielding much better than other standard early varieties like Irish Cobbler and Early Triumph, and with less tendency to degeneration.

The 3-year performance record of these 100 lines is presented in Table XVIII. The average annual yield has followed about the same curve as in the other two varieties. There has apparently been ample variation between lines in any one season and in the 3-year average to furnish a basis for selection. As in the other varieties, however, these variations in yield have in many cases been rather inconsistent.

TABLE XVIII.—Three-year summary of yields of marketable tubers per acre from 100 Early Six Weeks tuber lines

Tuber line No.	1916	1917	1918	3-year average.
	Pounds.	Pounds.	Pounds.	Pounds.
517.....	15,099	20,907	19,513	18,506
518.....	16,261	21,681	8,802	15,581
519.....	10,453	24,159	17,654	17,422
520.....	9,872	24,004	11,247	15,041
522.....	12,195	28,340	19,804	20,113
523.....	12,195	20,907	13,602	15,598
524.....	13,357	21,371	13,008	15,912
525.....	14,518	16,958	21,271	17,582
526.....	12,776	23,230	20,293	18,766
527.....	13,357	19,977	11,150	14,828
528.....	11,615	22,300	12,469	15,461
529.....	13,938	26,482	18,351	19,590
530.....	15,099	22,765	15,099	17,654
531.....	12,776	27,505	22,713	21,018
532.....	16,261	22,997	18,584	19,280
533.....	16,261	25,320	21,271	20,950
534.....	11,615	14,402	15,099	13,705
535.....	6,969	22,705	16,725	15,486
536.....	8,711	25,088	18,119	17,306
537.....	11,615	22,300	15,331	16,415
538.....	9,292	19,977	11,615	13,628
539.....	7,549	21,836	19,048	16,144
540.....	8,711	24,159	19,977	17,615
541.....	11,615	22,705	21,603	18,661
542.....	9,292	20,648	18,119	16,019
543.....	12,776	18,351	22,300	17,809
545.....	6,969	17,654	7,652	10,758
546.....	9,872	25,088	22,765	19,308
547.....	9,292	24,624	13,473	15,796
548.....	11,034	26,017	25,320	20,790

TABLE XVIII.—Three-year summary of yields of marketable tubers per acre from 100 Early Six Weeks tuber lines—Continued

Tuber line No.	1916	1917	1918	3-year average.
	Pounds.	Pounds.	Pounds.	Pounds.
549.....	13, 938	25, 553	24, 391	21, 294
550.....	12, 195	21, 528	19, 745	17, 822
551.....	19, 745	24, 623	25, 553	23, 307
552.....	17, 422	25, 088	25, 553	22, 687
553.....	10, 453	14, 228	14, 181	12, 954
554.....	9, 872	25, 553	20, 907	18, 777
555.....	9, 292	19, 745	13, 936	14, 324
556.....	13, 357	20, 540	15, 099	16, 332
558.....	12, 195	26, 186	20, 049	19, 476
559.....	8, 711	17, 654	17, 887	14, 750
560.....	12, 776	17, 422	20, 538	16, 912
561.....	9, 292	20, 442	29, 502	19, 745
562.....	12, 776	19, 978	27, 873	20, 200
563.....	15, 099	13, 473	12, 958	13, 843
564.....	11, 034	23, 694	19, 048	17, 925
565.....	15, 680	23, 229	20, 907	19, 938
566.....	11, 034	19, 745	13, 203	14, 660
568.....	11, 615	37, 942	14, 634	21, 397
569.....	15, 680	16, 725	20, 210	17, 538
570.....	12, 195	18, 584	15, 648	15, 475
571.....	10, 453	18, 816	21, 139	16, 802
572.....	12, 776	22, 300	18, 351	17, 809
573.....	9, 292	15, 331	15, 564	13, 395
574.....	8, 130	21, 836	16, 028	15, 331
575.....	10, 453	21, 139	19, 977	17, 189
576.....	10, 453	17, 190	14, 402	14, 015
577.....	17, 422	26, 017	19, 513	20, 984
578.....	15, 099	20, 907	13, 241	16, 415
579.....	14, 518	21, 371	14, 181	16, 690
580.....	15, 099	23, 694	21, 271	20, 021
581.....	13, 938	22, 300	16, 397	17, 545
582.....	12, 776	24, 452	13, 241	16, 823
583.....	14, 518	25, 553	10, 918	16, 996
584.....	14, 518	33, 683	19, 071	22, 424
585.....	9, 292	32, 986	19, 048	20, 442
586.....	12, 195	26, 017	20, 210	19, 474
588.....	12, 195	28, 908	14, 425	18, 509
589.....	15, 099	31, 360	20, 132	22, 197
590.....	10, 453	23, 230	16, 028	16, 570
591.....	12, 776	24, 159	20, 907	19, 280
592.....	13, 938	24, 623	9, 524	16, 028
593.....	14, 518	28, 968	13, 938	19, 141
594.....	15, 099	26, 548	17, 654	19, 767
595.....	12, 195	30, 663	21, 027	21, 295
596.....	14, 518	30, 199	17, 359	20, 692
597.....	11, 615	28, 340	13, 473	17, 809
599.....	11, 615	25, 088	10, 685	15, 796
600.....	10, 453	26, 017	17, 654	18, 041
601.....	7, 549	27, 876	19, 048	18, 157
602.....	11, 615	25, 533	10, 513	15, 887
603.....	15, 099	28, 853	16, 870	20, 274
604.....	12, 195	30, 810	21, 516	21, 597
605.....	14, 518	29, 343	20, 442	21, 434
606.....	13, 357	28, 340	15, 403	19, 033
607.....	13, 938	29, 966	18, 584	20, 829
608.....	11, 615	30, 199	22, 005	21, 273
609.....	9, 292	29, 734	21, 516	20, 180
610.....	11, 615	27, 876	16, 261	18, 584
611.....	13, 938	24, 623	11, 615	16, 725

TABLE XVIII.—Three-year summary of yields of marketable tubers per acre from 100 Early Six Weeks tuber lines—Continued

Tuber line No.	1916	1917	1918	3-year average.
	<i>Pounds.</i>	<i>Pounds.</i>	<i>Pounds.</i>	<i>Pounds.</i>
612.....	15, 099	29, 734	15, 331	20, 054
613.....	12, 195	25, 088	16, 137	17, 806
614.....	15, 099	29, 269	18, 584	20, 984
615.....	11, 034	25, 088	13, 473	16, 531
616.....	13, 938	25, 919	12, 544	17, 497
617.....	13, 938	27, 876	18, 582	20, 132
618.....	15, 099	30, 663	19, 048	21, 603
619.....	9, 292	25, 088	15, 564	16, 648
620.....	11, 034	21, 518	18, 119	16, 890
621.....	8, 711	16, 725	4, 646	10, 027
622.....	12, 195	26, 485	19, 358	19, 345
Average.....	12, 334	24, 048	17, 344	17, 909

TABLE XIX.—Twenty highest annual rankings and 3-year average rankings from 100 Early Six Weeks tuber lines^a

1918		1917		1916		3-year average.	
Line No.	Yield.	Line No.	Yield.	Line No.	Yield.	Line No.	Yield.
	<i>Pounds.</i>		<i>Pounds.</i>		<i>Pounds.</i>		<i>Pounds.</i>
*561.....	29, 502	*568.....	37, 942	551.....	19, 740	**551.....	23, 307
*562.....	27, 873	**584.....	33, 684	552.....	17, 423	**552.....	22, 687
**552.....	25, 553	*585.....	32, 987	*577.....	17, 423	**584.....	22, 424
**551.....	25, 553	**589.....	31, 361	*518.....	16, 261	**589.....	22, 197
*548.....	25, 320	604.....	30, 810	*532.....	16, 261	**618.....	21, 603
*549.....	24, 391	*595.....	30, 663	533.....	16, 261	**604.....	21, 507
*546.....	22, 765	**618.....	30, 663	565.....	15, 680	**605.....	21, 434
*531.....	22, 713	608.....	30, 119	*569.....	15, 680	*568.....	21, 397
*543.....	22, 300	**596.....	30, 119	*578.....	15, 099	*595.....	21, 295
**608.....	22, 005	*607.....	29, 966	580.....	15, 099	*549.....	21, 294
*541.....	21, 603	609.....	29, 734	*594.....	15, 099	**608.....	21, 273
**609.....	21, 516	**612.....	29, 734	589.....	15, 099	*531.....	21, 018
**604.....	21, 516	**605.....	29, 343	618.....	15, 099	**614.....	20, 984
**580.....	21, 271	**614.....	29, 269	612.....	15, 099	*577.....	20, 984
**525.....	21, 271	**593.....	28, 969	614.....	15, 099	**533.....	20, 950
**533.....	21, 271	*588.....	28, 908	603.....	15, 099	*607.....	20, 829
*571.....	21, 139	**603.....	28, 854	*563.....	15, 099	*548.....	20, 790
*595.....	21, 027	*606.....	28, 341	*530.....	15, 099	**696.....	20, 692
*591.....	20, 907	*597.....	28, 340	*517.....	15, 099	*585.....	20, 442
**565.....	20, 907	*522.....	28, 340	*583.....	14, 518	**603.....	20, 274
*554.....	20, 907			525.....	14, 518		
				*579.....	14, 518		
				584.....	14, 518		
				593.....	14, 518		
				596.....	14, 518		
				605.....	14, 518		

^aThe number of stars indicates how many times the line has appeared among the 20 highest rankings. Lines not starred in columns 3 and 5 appear and are starred elsewhere in the table. None appear three times, 18 appear twice, and 31 appear only once.

In Tables XIX and XX a portion of the data from Table XVIII is assembled for the purpose of a more critical study of the performance of the highest-yielding and lowest-yielding 20 of the 100 lines.

TABLE XX.—Twenty lowest annual rankings and 3-year average rankings from 108 Early Six Weeks tuber lines^a

1918		1917		1916		3-year average.	
Line No.	Yield.	Line No.	Yield.	Line No.	Yield.	Line No.	Yield.
	<i>Pounds.</i>		<i>Pounds.</i>		<i>Pounds.</i>		<i>Pounds.</i>
***021.....	4, 646	563.....	13, 473	*535.....	6, 969	***621....	10, 027
***545.....	7, 652	*553.....	14, 228	545.....	6, 969	***545....	10, 758
*518.....	8, 802	*534.....	14, 402	*601.....	7, 550	*553.....	12, 954
*592.....	9, 524	**573.....	15, 332	*539.....	7, 550	**573.....	13, 395
*602.....	10, 513	*569.....	16, 725	*574.....	8, 131	***538....	13, 628
*599.....	10, 685	621.....	16, 726	*536.....	8, 711	*534.....	13, 705
*583.....	10, 918	*525.....	16, 958	*540.....	8, 711	**563.....	13, 843
*527.....	11, 150	*576.....	17, 190	621.....	8, 711	*576.....	14, 015
**520.....	11, 247	*560.....	17, 422	559.....	8, 711	**555.....	14, 324
*611.....	11, 615	**559.....	17, 654	538.....	9, 292	**560.....	14, 660
***538.....	11, 615	545.....	17, 654	555.....	9, 292	**559.....	14, 750
*528.....	12, 469	*543.....	18, 351	573.....	9, 292	*527.....	14, 828
*616.....	12, 544	*570.....	18, 584	561.....	9, 292	**520.....	15, 041
**563.....	12, 958	*571.....	18, 816	*542.....	9, 292	*574.....	15, 331
*524.....	13, 008	**555.....	19, 745	*609.....	9, 292	*528.....	15, 461
**566.....	13, 203	566.....	19, 746	*585.....	9, 292	*570.....	15, 475
*578.....	13, 241	*527.....	19, 977	*619.....	9, 292	*535.....	15, 486
*582.....	13, 241	538.....	19, 977	547.....	9, 292	*518.....	15, 581
**547.....	13, 473	*562.....	19, 978	*546.....	9, 872	523.....	15, 598
*597.....	13, 473	**561.....	20, 442	*554.....	9, 872	**547.....	15, 796
*615.....	13, 473			*505.....	9, 872	*599.....	15, 796
				520.....	9, 872		

^a The number of stars indicates how many times the line has ranked among the lowest 20. Lines not starred in columns 3 and 5 appear and are starred elsewhere in the table. Three appear three times, 8 appear twice, and 38 appear only once.

It will be noted from Tables XIX and XX that in either case the greater number of these lines have appeared only once in either of these groups. Line 561 appears in the low-yielding groups of 1916 and 1917 but is the highest-yielding line of 1918. It also appears among the 40 lines selected in 1918 as having the best vines. While the performance record may not so indicate, it is undoubtedly one of the good lines of this variety. Aside from this one line, none of those that have ranked twice among the lowest 20 according to the 3-year average appear among those selected in 1918 as having good vine characteristics. We may safely say that the performance record is more reliable as a means of eliminating the lowest-yielding lines than in pointing out the higher-yielding ones. The following 1918 field notes show that in this as well as in the other varieties yield records will not eliminate lines with degenerate tendencies.

LINE NO.	REMARKS.
552.	A good dark green type.
551.	A good dark green type.
608.	A good dark green type.
609.	A good dark green type.
604.	A good dark green type.
580.	A good dark green type.
525.	Third unit lacking in color; others good.
584.	A good dark green type.
589.	First unit not a good type.
618.	A good dark green type.
596.	A good dark green type.
612.	First unit lacking in color.
605.	A good dark green type.
614.	Third, fourth, and fifth units not good type.
593.	Color not good although the line is quite vigorous.
603.	A good dark green type.
568.	Lacking in color but fairly vigorous.
595.	A good dark green type.
549.	A good dark green type.
531.	Last unit showing a tendency to burn.
577.	A good dark green type.
607.	A good dark green type.
548.	A good dark green type.
585.	Last unit light-colored and burning; others very good.

Of these 26 lines which have appeared at least twice among the highest-ranking 20 or would be ranked among the highest 20 on their 3-year average production by weight, 17 have good records as to vine characteristics and 9 contain some vines of a degenerate type. It will be remembered that loss of vitality is indicated in this variety by a loss of color and a tendency for the leaves to burn about the edges in typical degenerates.

In Table XXI will be found data upon the 3-year average numerical tuber production of Early Six Weeks. The maximum variation found is 1.78 tubers per hill. The annual average tuber production shows even greater variation. These 100 tuber lines averaged 2.12 tubers per hill in 1916, 4.04 in 1917, and 2.63 in 1918. The 20 highest and 20 lowest yielding lines when ranked upon tuber production in numbers have been grouped in Tables XXII and XXIII. The first 8 lines starred in Table XXIII are typical degenerates with bad yield records by weight. There are, however, 5 lines in Table XXIII which also appear in Table XXIV among the 40 with good vine characteristics in 1918. Going back to Table XVIII, it will be noticed that these 5 lines have very good records when judged on tuber production by weight. It is true that none of them are high yielders, but they fall very close to the average of the 100 lines. Fourteen of the lines in Table XXII appear in Table XXIV, or among those selected in 1918 as having good vine characteristics.

TABLE XXI.—Three-year average numerical production of marketable tubers per hill from 100 Early Six Weeks tuber lines

Line No.	Yield.	Line No.	Yield.	Line No.	Yield.	Line No.	Yield.
517.....	3.02	543.....	2.77	571.....	3.18	597.....	3.25
518.....	2.41	545.....	2.41	572.....	3.20	599.....	3.22
519.....	2.84	546.....	3.29	573.....	2.70	600.....	3.15
520.....	2.60	547.....	3.25	574.....	3.15	601.....	3.29
522.....	3.00	548.....	3.65	575.....	3.27	602.....	3.27
523.....	3.07	549.....	3.63	576.....	2.84	603.....	3.47
524.....	2.86	550.....	2.92	577.....	3.95	604.....	3.85
525.....	3.23	551.....	3.50	578.....	3.00	605.....	3.25
526.....	2.90	552.....	3.11	579.....	2.86	606.....	3.32
527.....	2.79	553.....	3.17	580.....	3.23	607.....	3.50
528.....	3.16	554.....	3.11	581.....	3.40	608.....	3.95
529.....	3.45	555.....	3.18	582.....	3.48	609.....	3.90
530.....	3.13	556.....	3.23	583.....	3.20	610.....	3.11
531.....	3.27	558.....	3.33	584.....	3.64	611.....	2.97
532.....	3.47	559.....	2.93	585.....	3.50	612.....	3.43
533.....	3.69	560.....	2.86	586.....	3.30	613.....	3.23
534.....	2.72	561.....	3.36	588.....	3.00	614.....	3.40
535.....	3.00	562.....	3.39	589.....	3.78	615.....	2.77
536.....	2.79	563.....	2.65	590.....	3.34	616.....	3.11
537.....	3.43	564.....	3.40	591.....	3.40	617.....	3.16
538.....	2.81	565.....	3.00	592.....	3.29	618.....	3.52
539.....	3.15	566.....	2.74	593.....	3.39	619.....	3.00
540.....	3.12	568.....	3.80	594.....	2.93	620.....	3.02
541.....	3.47	569.....	3.06	595.....	3.81	621.....	2.17
542.....	3.02	570.....	2.79	596.....	3.60	622.....	3.28

TABLE XXII.—Twenty highest of 100 Early Six Weeks tuber lines when ranked on 3-year average numerical production of marketable tubers per hill ^a

Line No.	Yield.	Line No.	Yield.	Line No.	Yield.	Line No.	Yield.
*608.....	3.95	*568.....	3.80	*549.....	3.63	*607.....	3.50
*577.....	3.95	*589.....	3.78	*596.....	3.60	582.....	3.48
609.....	3.90	*533.....	3.69	*618.....	3.52	532.....	3.47
*604.....	3.85	*548.....	3.65	*551.....	3.50	541.....	3.47
*595.....	3.81	*584.....	3.63	*585.....	3.50	*603.....	3.47

^a The lines starred also appear among the 20 highest-yielding when ranked on 3-year average production by weight. Thirteen of these lines (in bold-face type) have uniformly good vine characteristics; the other 7 lines contained plants suggesting degeneration. Average of group, 3.65 tubers per hill.

TABLE XXIII.—Twenty lowest of 100 Early Six Weeks tuber lines when ranked on 3-year average numerical production of marketable tubers per hill ^a

Line No.	Yield.	Line No.	Yield.	Line No.	Yield.	Line No.	Yield.
*621.....	2.17	*573.....	2.70	*527.....	2.79	*576.....	2.84
*518.....	2.41	*534.....	2.72	536.....	2.79	524.....	2.86
*545.....	2.41	*566.....	2.74	*570.....	2.79	560.....	2.86
*563.....	2.65	543.....	2.77	*538.....	2.81	578.....	2.86
*520.....	2.69	615.....	2.77	519.....	2.84	526.....	2.90

^a The lines starred also appear among the 20 lowest yielding when ranked on 3-year average production by weight. The lines printed in bold-faced type appear among the 40 chosen in 1918 as having good vine characteristics. Average of group, 2.71 tubers per hill.

TABLE XXIV.—Yields in 1918 of 40 Early Six Weeks tuber lines chosen upon 1918 vine characteristics alone as the best of the 100 lines of this variety^a

Line No.	Yield.	Line No.	Yield.	Line No.	Yield.	Line No.	Yield.
	<i>Pounds.</i>		<i>Pounds.</i>		<i>Pounds.</i>		<i>Pounds.</i>
517.....	19, 513	* 549.....	24, 391	569.....	20, 210	601.....	19, 048
519.....	17, 654	* 551.....	25, 553	571.....	21, 139	*604.....	21, 516
*522.....	19, 804	* 552.....	25, 553	*575.....	19, 977	*605.....	20, 442
*526.....	20, 293	* 554.....	20, 907	*577.....	19, 513	*607.....	18, 584
*529.....	18, 351	* 558.....	20, 049	*580.....	21, 271	*608.....	22, 005
*532.....	18, 584	560.....	20, 538	*584.....	19, 071	*609.....	21, 516
536.....	18, 119	*561.....	29, 502	*591.....	20, 907	610.....	16, 261
540.....	19, 977	*562.....	27, 873	*594.....	17, 654	*618.....	19, 048
543.....	22, 300	564.....	19, 048	*595.....	21, 027	620.....	18, 119
*548.....	25, 320	565.....	20, 907	600.....	17, 654	*622.....	19, 358

^a The 26 lines starred also appear among the 40 highest-yielding when ranked on the 3-year average tuber production by weight. The others have very good records for the 3-year period. Average of group, 20,713 pounds per acre.

The vine growth of the other 6 lines is reported in the following 1918 field notes:

LINE NO.	REMARKS.
568.	A little lacking in color but fairly vigorous.
589.	A very good type with possible exception of first unit.
533.	First unit light colored and burning; other plants green and vigorous.
596.	A very good green type; first two hills lacking in vigor, but this is possibly due to soil.
585.	Type fair with exception of last unit, which shows some burning.
582.	A light-colored, burning type.
541.	A good green type with exception of first unit, which is distinctly lighter and burning.

In Table XXIV data are assembled to show the relation between good vine characteristics and tuber production in Early Six Weeks. The 40 lines with best vine characteristics gave an average yield of 20,713 pounds per acre in 1918, while the 41 heaviest-yielding lines of 1918 grouped in Table XXV averaged 21,350 pounds. The 1918 average of the 100 Early Six Weeks lines was 17,344 pounds of marketable tubers per acre. In this variety vine growth is almost as reliable as yield records in pointing out high-yielding lines. The 3-year average yield of the 40 lines in Table XXIV was 19,515 pounds per acre, while the 40 lines ranking highest on 3-year average tuber production by weight yielded during the same period an average of 20,455 pounds. Will it pay to keep yield records when 40 per cent of the heaviest-yielding lines chosen with the aid of 3 years' data do not produce 1,000 pounds per acre more than do 40 per cent selected in less than 2 hours upon vine characteristics alone?

TABLE XXV.—*Forty-one highest-yielding of 100 Early Six Weeks lines in 1918*^a

Line No.	Yield.	Line No.	Yield.	Line No.	Yield.	Line No.	Yield.
	<i>Pounds.</i>		<i>Pounds.</i>		<i>Pounds.</i>		<i>Pounds.</i>
561.....	29, 502	604.....	21, 516	560.....	20, 538	550.....	19, 745
562.....	27, 873	609.....	21, 516	605.....	20, 442	517.....	19, 513
551.....	25, 553	525.....	21, 271	526.....	20, 293	577.....	19, 513
552.....	25, 553	533.....	21, 271	569.....	20, 210	622.....	19, 358
548.....	25, 320	580.....	21, 271	586.....	20, 210	584.....	19, 071
549.....	24, 391	571.....	21, 139	580.....	20, 132	539.....	19, 048
546.....	22, 765	595.....	21, 027	558.....	20, 049	564.....	19, 048
531.....	22, 713	554.....	20, 907	540.....	19, 977	585.....	19, 048
543.....	22, 300	565.....	20, 907	575.....	19, 977	601.....	19, 048
608.....	22, 005	591.....	20, 907	522.....	19, 804	618.....	19, 048
541.....	21, 603						

^aThe 31 lines printed in bold-face type also appear in Table XXIV. This leaves 10 of these high-yielding lines with poor vine characteristics. Average of group, 21,350 pounds per acre.

CONCLUSIONS

The data presented, so far as the author is able to judge, do not furnish very strong evidence of the presence of high-yielding lines within the common population of the varieties studied. The real test of the existence of such lines is ability to maintain a high-yielding progeny by indiscriminate mass selection.

Short performance records are fairly reliable in eliminating lines with low-yielding tendencies, but they are not so reliable as a basis upon which to select plus variations if such really exist.

If degenerate tendencies exist within certain clonal lines and not in others, short performance records are of little value in eliminating the undesirable lines.

Degenerate individuals appear with such persistent regularity within line selections as to become a real stumblingblock. If there are no exceptions to this rule, before a hill or tuber line can be increased to a point where it is of real value in commercial potato production it is almost certain to contain degenerate types which soon reduce its yielding power to that of the common population of the variety.

The data presented will not justify an indorsement of the plan of clonal line selection as a practical method of potato-seed improvement. This does not mean that the hill-selection method of choosing potato seed is without merit. Generally speaking, high-yielding hills selected upon production by weight will produce the following season a high-yielding progeny. It does mean, however, that to be effective hill selection becomes an annual task. I believe there is a more practical method of potato-seed improvement.

Since certain vine characteristics are so closely correlated with yields, selection based on vine development alone promises to be more reliable than selection based on tuber production either by weight or number, and much more practical.

At present, selection based chiefly on vine characteristics seems to be the only hope in dealing with degeneration. The success of such selection is measured by one's ability to identify intermediate types as well as typical curlydwarf degenerates.

A special seed plot in which the seed pieces from each tuber are planted in consecutive hills promises to afford the best solution of the problems of degeneration and the maintenance of high-yielding variety populations.

Seed for such a plot may be selected in one of two ways. Especially vigorous hills may be marked in the field during the growing season, and the crop from these may be dug and used for planting the special seed plot of the following season, or seed may be selected in the field at digging time or from the bin. The first method will insure the greater return from the first seed plot, especially if the field from which the seed is selected contains a large percentage of degenerate plants. In selecting seed in the field after the digger or from the bin, one may to a certain extent avoid degenerate types by observing certain tuber characteristics. (1) Choose seed tubers rather above the average size for the variety. (2) Select those that are long rather than short for the variety and with both ends full and rounded, not pointed. (3) Choose those that are oval rather than round in cross section, or, in other words, flattened tubers. (4) Pick tubers with conspicuous and moderately deep eyes.

The seed plot can best be planted by hand. The rows should be spaced the usual distance apart and the hills placed 12 or 15 inches apart in the row. On good, fertile, irrigated land, where the recommendations in regard to thinning are to be carried out, the hills should be spaced at 12 or even 10 inches apart. The tubers should be taken to the field whole and then cut as planted. The seed pieces may be cut rather small if seed is not abundant. Single-eye seed pieces weighing from $\frac{1}{2}$ to 1 ounce will give just as good results as larger pieces. These are conveniently planted with a hoe, and if small should not be covered over 3 inches deep. Each tuber is cut by itself, and the pieces are dropped in consecutive hills. Not only is it important to have the hills from each tuber in a group, but it is desirable to have these groups marked off one from the other. This may be accomplished in several ways. A good way is to drop a hill of corn between the groups. The important point, however, is to have the hills from each tuber in a group. This is the only way if intermediate types are to be eliminated from the seed plot by roguing. Mixtures are also easily detected where the hills are in tuber groups.

The seed plot should be thinned by removing all but one stalk from each hill. Thinning should be done as soon as the vines are large enough to pull, usually from five to six weeks after planting. Proper comparisons can best be made between hills with a uniform number of stems, and this is the real object of thinning. But single-stemmed hills also produce tubers of a more uniform size, and this is desirable, especially if the seed stock is to be offered for sale. Regardless of the merits of the case, the public commonly thinks of good potato seed as uniform-sized stock.

Roguing the seed plot is the most important step in the production of good seed. This consists in going over the field several times during the season and removing undesirable hills. In the first place, there may be variety mixtures in the seed plot. These mixtures are detected chiefly by variations in foliage, color of blossoms, amount of blossoms produced, and dates of ripening. There will also be some weak and degenerate types and diseased hills to be removed. The plot should first be gone over about blooming time, as variety mixtures are then very likely to be most conspicuous. A group of hills may show blossoms that are off type in color, or a certain group of hills may bloom more or less than the other plants in the plot. These hills should be dug and the tubers removed from the field. A little later the plot should be gone over again to catch hills lacking in vigor or infected with disease. In early varieties, this examination should be made just about the time the most vigorous vines show signs of maturing. At this time some vines will be found fully mature. This premature ripening is probably brought on by disease, and the hills should be removed. Such hills most frequently appear at random, but occasionally all the hills from a seed tuber may be diseased. In looking for weak plants, the hills from each tuber should be studied as a group. Weak hills will show a more crinkled foliage and usually less vigorous vines. It is well to remember that the intermediate types are the real trouble makers. They are usually as vigorous as normal hills, but show a slight crinkling of the foliage and are very often of a lighter shade of green.¹ In looking for these weak groups it is best not to work too near the row being examined. First look each row over at close quarters and then from two or three rows distant. In roguing out late varieties, the work must always be done before the vines are touched with frost. Remember that in roguing the tubers as well as the vines must be dug and removed from the seed plot.

If the seed plot has been carefully rogued, the entire crop may be saved for seed. Occasionally a group of hills may produce tubers of poor form, and these may be discarded. The small seed from such a seed plot is just as satisfactory as the large, and in the great majority of cases variations in form are nothing more than fluctuations and as such are not transmitted to the following crop.

In many instances the improvement secured by growing a variety in a special seed plot of this kind for one season may be apparent for two or three years after returning to the practice of selecting seed at random from the field at digging time or from the bin; but permanent improvement can be maintained only by continuing the special seed plot year after year. With most varieties it is allowable, if the roguing is carefully done, to increase the seed secured from the seed plot by planting it in a certain part of the commercial field and then saving

¹WHIPPLE, O. B. DEGENERATION IN POTATOES. *Mont. Agr. Exp. Sta. Bul.* 130, 29 p., 16 fig. 1919.

from this part of the field seed for the entire acreage the following season. But if one is not absolutely sure he can pick out the intermediate types in roguing, this practice may prove disappointing. Once the special seed plot is established, it may well be continued from year to year, the seed for the special seed plot of each year being selected from the seed plot of the year before. It is even advisable to go into the special seed plot and mark especially promising groups of hills to be dug to furnish seed for the seed plot of the following year.

OCCURRENCE OF THE FIXED INTERMEDIATE, *HORDEUM INTERMEDIUM HAXTONI*, IN CROSSES BETWEEN *H. VULGARE PALLIDUM* AND *H. DISTICHON PALMELLA*¹

By HARRY V. HARLAN, *Agronomist, Office of Cereal Investigations, Bureau of Plant Industry, United States Department of Agriculture*, and H. K. HAYES, *Head of Section of Plant Breeding, Division of Agronomy and Farm Management, Minnesota Agricultural Experiment Station*

INTRODUCTION

The cultivated barleys belong to the genus *Hordeum* and are characterized by the presence of three single-flowered spikelets at each node of the rachis. The floret of the central spikelet develops a normal kernel in all forms of barley. The lateral florets, on the other hand, may develop normal or undersized kernels or may be sterile or even abortive. In classifying the varieties, Harlan (2)² recognized four species, basing them on the degree of fertility in the lateral florets. Varieties of three of these species are concerned in the data presented herein. In all varieties mentioned, the central florets are long-awned. The 6-rowed parents in all hybrids belonged to the botanical variety *H. vulgare pallidum*, and include Manchuria, S. P. I. No. 20375, Sex-radigt, Odessa, Reid Triumph, Surprise, and a hybrid 6-rowed × 2-rowed barley. The lateral as well as the central florets of these varieties are long-awned and produce well-developed kernels.

The 2-rowed parents all belong to the variety *H. distichon palmella*. The central florets are long-awned, while the lateral ones are awnless with rounded tips and are sterile. Of the varieties mentioned in the text, Svanhals, Garton, and Primus belong to this group. The intermediates are products of hybridization, and the selections are unnamed. All, however, belong to the botanical variety *H. intermedium haxtoni*. In these the central florets are long-awned and produce normal kernels, while the lateral florets are awnless, as in the 2-rowed barleys, but fertile, producing undersized but viable kernels. The percentage of fertility in these spikelets is not so high as in the 6-rowed, but neither are they infertile, as are the 2-rowed. This form, obviously intermediate in character between the 6-rowed and 2-rowed barleys, has proved to be constant and is as distinct in its genetic behavior as either the 6-rowed or the 2-rowed forms.

The history of the intermediate barleys is very interesting, but not always clear. The first recorded observation found is that of John Haxton (3) in Scotland. In Morton's *Cyclopedia of Agriculture* of 1851 he mentions having observed such a plant in a field of "Bere." At the time

¹ This paper is based upon experiments conducted cooperatively by the Office of Cereal Investigations, Bureau of Plant Industry, United States Department of Agriculture, and the Minnesota Agricultural Experiment Station.

² Reference is made by number (italic) to "Literature cited," pp. 590-591.

of this description he obviously had the heterozygous intermediate or a mixture of this and the homozygous intermediate, since he obtained all types from the seeding. Later, the homozygous form seems to have been isolated. In 1883, Drechsler of Göttingen sent Rimpau an intermediate which he had found in a field of *H. distichon palmella zeocriton* and which apparently bred true from the time of its discovery. Both Rimpau (6, 7) and Körnicke (4) observed the intermediate. According to Körnicke's statement of 1885, he found the intermediate as an accidental hybrid in a field of 2-rowed winter barley. At first the selection was heterozygous, but, according to the statement of his son (5), in 1908, it later became constant. Both Rimpau and Körnicke made mass selections which evidently included heterozygous forms, at least at first. It is probable that homozygous types were eventually obtained.

These four cases of probable isolation of the fixed intermediate all occurred before 1900 and, therefore, before the importance of plant selections in hybrids was generally recognized. It is worthy of note that all four were instances where accidental hybrids were observed, rather than the products of any of the numerous crosses made by those investigators.

The history since 1900 is more surprising than that previous to 1900. The modern methods of breeding lead to the direct and ready isolation of this type, yet, so far as the authors know, it has not been reported. Since 1900, indeed, two plant breeders who have worked extensively with barley have assumed that a fixed intermediate does not occur in crosses between 6-rowed and 2-rowed barleys. Von Tschermak (8) says as late as 1914 that the intermediate form with fertile lateral florets is heterozygous and, therefore, is never constant. Biffin (1), while not so sweeping in his statement, must have held a similar view. In 1907, he reported nine crosses in which a homozygous intermediate might occur. From the F_2 progeny of one of these he selected a considerable number of intermediates of two types and planted them. All proved to be heterozygous. He did not test the progeny of the other crosses but assumed that they would behave in the same way. In the discussion he then states:

The heterozygote, therefore, of forms with hermaphrodite staminate lateral florets is potentially hermaphrodite and of the type known to systematists as *H. intermedium*.

In 1907 J. H. Wilson (9) reported an F_2 generation of Standwell \times Bere, in which he made the following observation:

Examples occurred in which the grains of all six rows were fully developed, but the lateral ones were without awns.

In this case Mr. Wilson probably noticed the homozygous type. It is interesting that he should have used as the 6-rowed parent the variety of barley in which Haxton found the first recorded intermediate.

The observations of the senior author in these studies extend over the past 10 years. In the summer of 1909 he made a large number of hybrids on the grounds of the Minnesota Agricultural Experiment Station. A con-

siderable number of these were between 2-rowed and 6-rowed parents. In 1910 the F_1 generation was grown, and in 1911 the F_2 generation. In the F_1 generation of 1910 the heterozygous intermediate was very vigorous, and a considerable number of selections were grown in 1911 from the small lateral kernels to see if they would produce vigorous plants. In the F_2 generation it was apparent that there were intermediates present which differed from those of 1910, and 56 selections of different types of intermediates were grown in 1912. These came from 12 different crosses and included the progeny of combinations of 10 different 2-rowed and 7 different 6-rowed parents. A number of these proved to be homozygous, and others were isolated from the F_3 generation by further selection. Unfortunately, the records of 1912 are incomplete, and the total number of homozygotes obtained can not be determined. It is also impossible to establish the complete list of crosses from which fixed intermediates were obtained. Beyond all question, from one to five fixed intermediates were obtained from each of five different crosses. These crosses involve three different 2-rowed and five different 6-rowed parents. In these cases original material or complete records of the progeny are still at hand. The crosses were as follows: S. P. I. No. 20375 \times Svanhals, Surprise \times Primus, Primus \times (2-rowed \times 6-rowed), Garton 2-rowed \times Sex-radigt, and Manchuria \times Svanhals. There is a definite statement in the field records that a selection of *zeocriton* \times Manchuria and another of Chevalier \times South African were fixed intermediates, but there are neither specimens nor progeny records to confirm these statements.

It will be seen that in the five crosses where the evidence is complete the 2-rowed parents were dense-spiked. Aside from the fact that those which have been preserved came from such crosses, there is no evidence in the data now at hand that indicates inability to secure intermediates from crosses in which both parents are lax-spiked. The common varieties of lax 2-rowed barleys have less vigorous lateral florets than the common varieties of dense 2-rowed barleys. It is possible that the progeny of crosses where the lax forms were used would be lower in fertility and the intermediates correspondingly less conspicuous. Hence, they would be less desirable and less likely to be retained as specimens.

In 1915, after the junior author became connected with the Minnesota Agricultural Experiment Station, it was decided to repeat one of the crosses from which fixed intermediates had been secured, in order to determine the inheritance and, if possible, to discover an explanation of the occurrence of this form. By making crosses and growing an occasional generation in the greenhouse in Washington in the winter and sowing the seed in Minnesota in the spring several generations have been studied since that date. The cross chosen for this purpose was Manchuria \times Svanhals. The F_2 and F_3 generations are reported in detail. Other crosses were studied in which no intermediates were produced; but since the data are negative, they have not been included,

although reference is made in the discussion to them and their significance.

OCCURRENCE OF *H. INTERMEDIUM* AND OTHER SEGREGATES IN THE PROGENY OF A CROSS OF MANCHURIA AND SVANHALS BARLEYS

The Manchuria parent in this cross is a selection of the common 6-rowed barley of the northern Mississippi Valley. The side florets are fertile and long-awned. The Svanhals parent is a well-known 2-rowed variety with long-awned, fertile, central florets and awnless, rounded, sterile lateral ones. The Manchuria is illustrated in Plate 103, C, and the Svanhals in Plate 104, A. This cross was made in the Washington greenhouse in the spring of 1917, and the F_1 generation was grown the same season at the University of Minnesota. In the fall of 1917, 100 of these F_1 seeds were sown in pots in the Washington greenhouse. Of these, only 87 matured as F_2 plants in the spring of 1918. As soon as the grain was sufficiently mature to harvest seed was again sent to Minnesota, where the F_3 generation was grown.

PHENOTYPIC CLASSES IN THE PROGENY

The data on the F_3 generation are reported in Table I, which needs considerable explanation. In the first place, the material itself is not simple. It is far from easy for a reader unfamiliar with barley to visualize six classes of segregates. Added to this difficulty is the fact that the F_3 classifications are of varying accuracy and are phenotypic in character. The phenotypic classes of the table give a misleading impression by over-emphasizing the importance of the amount of fertility present. There are other characters than fertility which have much significance in the genetic groups. Fertility, however, is a definite, tangible, measurable condition, and the phenotypic classes founded on it are usable. In some instances the phenotypic classes of the F_3 generation coincide with the genetic classes, while in others a phenotypic class contains more than one genetic class. There is a certain amount of unavoidable confusion in describing both phenotypic and genetic classes at the same time. For this reason, until the genetic classes are established the plants exhibiting similar phenotypic classes in their progeny are placed together and referred to as genetic groups. It must be remembered in studying the table that the main object of the F_3 classification was to determine the genetic classes of the F_2 generation. It is well also to recall at this time that all classifications in this paper are based on the nature of the lateral florets, and to avoid endless repetition the modifying adjective is frequently omitted. In such cases the terms sterile, awn-pointed, high fertility, etc., refer to the lateral florets only.

Table I represents the data as taken. The first two columns of the table contain the identification numbers and the description of the F_2 plants. In the remaining columns the F_3 progeny of these plants are classified. These progeny fall into two major divisions, in one of which

all the kernels are of normal size, while in the other they are subnormal or absent. This second division is separated into plants which have lateral florets with awned or awn-pointed lemmas and plants in which the lemmas of the lateral florets are awnless and more or less rounded. Further subdivisions were based on the percentage of fertility of the lateral florets. The nature of the six resulting classes is illustrated in Plates 103 and 104. It is readily apparent in Plate 103 that the three classes with awned or awn-pointed lemmas on the lateral florets are easily separated. It is just as apparent in Plate 104 that the accident of season or nutrition can easily affect the classification of the segregates with rounded lemmas. Errors of classification in this case happen to be unimportant, for, as previously stated, the object of the F_3 classification is only to determine the nature of the F_2 parent. This is made evident in all cases by the classification used. To make this clear, one of the findings must be anticipated. Of the six classes in which the F_3 plants are divided, three are of special importance in the interpretation. These are the fully fertile long-awned, the high-fertility awnless, and the no-fertility awnless classes. These represent the 6-rowed, the *intermedium*, and the 2-rowed barleys. In all cases the classification is sufficiently accurate to determine which of these classes are to be found in the progeny of each F_2 plant.

TABLE I.—Classification of 87 F_2 plants and their F_3 progeny in a cross between *Manchuria* and *Svanhals* barleys according to the nature of their lateral florets

GROUP I, PLANTS WHICH GAVE ONLY 6-ROWED PROGENY

F ₂ parent No.	F ₂ parent type.	Number of individuals in F ₃ progeny, by classes.					Total.
		Kernels normal size, lemmas long-awned, fully fertile (6-rowed).	Kernels subnormal in size or absent.				
			Lemmas awned or awn-pointed.		Lemmas awnless.		
			High fertility (80-100 per cent).	Low fertility (0-79 per cent).	Fertility 5-100 per cent (<i>intermedium</i>).	Fertility less than 5 per cent.	
2	6-rowed	20					20
7	do.	24					24
11	do.	20					20
13	do.	21					21
23	do.	19					19
33	do.	24					24
38	do.	20					20
41	do.	45					45
44	do.	23					23
45	do.	19					19
49	do.	21					21
50	do.	20					20
60	do.	44					44
70	do.	23					23
72	do.	22					22
75	do.	18					18

TABLE I.—Classification of 87 F_2 plants and their F_3 progeny in a cross between Manchuria and Svanhals barleys according to the nature of their lateral florets—Con.

GROUP 1, PLANTS WHICH GIVE ONLY 6-ROWED PROGENY—continued.

F_2 parent No.	F_2 parent type.	Number of individuals in F_3 progeny, by classes.					Total.	
		Kernels normal size, lemmas long-awned, fully fertile (6-rowed).	Kernels subnormal in size or absent.					
			Lemmas awned or awn-pointed.		Lemmas awnless.			
			High fertility (80-100 per cent).	Low fertility (0-79 per cent).	Fertility 5-100 per cent (intermedium).	Fertility less than 5 per cent.		Fertility none (2-rowed).
79do.....	20	20	
82do.....	45	45	
88do.....	34	34	
94do.....	21	21	
97do.....	19	19	
100do.....	15	15	

GROUP 2, PLANTS WHICH GAVE 6-ROWED AND INTERMEDIUM BUT NO 2-ROWED SEGREGATES

29	80 per cent fertile, awned....	12	23	12	47
62	25 per cent fertile, awned....	18	20	6	44
64	90 per cent fertile, awned....	16	20	10	46
85	33 per cent fertile, awned....	7	15	2	10	34
98	90 per cent fertile, awned....	17	13	10	40
99do.....	7	23	1	5	3	39
37	5 per cent fertile, awnless....	7	30	6	43

GROUP 3, PLANTS WHICH GAVE 6-ROWED, INTERMEDIUM, AND 2-ROWED SEGREGATES

12	5 per cent fertile, awned....	15	14	8	0	0	4	41
17	3 per cent fertile, awned....	11	12	7	0	1	10	41
19	None fertile, awned.....	9	6	4	1	0	3	23
25do.....	15	9	11	2	1	11	49
26do.....	14	16	10	0	1	9	50
28do.....	8	13	12	3	0	8	44
31do.....	10	19	5	3	0	8	45
32do.....	16	7	13	0	0	10	46
39do.....	9	12	13	1	2	11	48
40do.....	12	13	8	1	1	12	47
46do.....	12	16	12	2	0	5	47
48do.....	14	5	14	0	1	5	39
55do.....	10	14	4	3	1	15	47
56	9 per cent fertile, awned....	10	16	4	7	1	8	46
58	None fertile, awned.....	17	15	3	4	0	5	44
59do.....	12	17	6	1	2	11	49
69do.....	24	6	13	1	2	4	50
71	13 per cent fertile, awned....	13	6	3	1	0	3	26
74	12 per cent fertile, awned....	10	22	0	0	4	8	44
76	None fertile, awned.....	11	8	15	1	3	7	45
77do.....	9	6	14	1	1	8	39
78do.....	11	1	13	1	0	10	45
81do.....	16	7	16	1	0	7	47
84do.....	15	11	11	1	0	6	44
96do.....	7	10	15	0	0	10	42

TABLE I.—Classification of 87 F₂ plants and their F₃ progeny in a cross between Manchuria and Svanhals barleys according to the nature of their lateral florets—Con.

GROUP 4, PLANTS WHICH GAVE 6-ROWED AND 2-ROWED BUT NO INTERMEDIUM SEGREGATES

F ₂ parent No.	F ₂ parent type.	Number of individuals in F ₃ progeny, by classes.					Total.	
		Kernels normal size, lemmas long-awned, fully fertile (6-rowed).	Kernels subnormal in size or absent.					
			Lemmas awned or awn-pointed.		Lemmas awnless.			
			High fertility (80-100 per cent).	Low fertility (0-79 per cent).	Fertility 5-100 per cent (intermedium).	Fertility less than 5 per cent.		Fertility none (2-rowed).
9	None fertile, awned.....	5	15			4	24	
34do.....	17	19			9	45	
35do.....	6	14			4	24	
36do.....	7	26			11	44	
47do.....	11	25			11	47	
54do.....	12	25			10	47	
65do.....	13	15			19	47	
68do.....	12	16			15	43	
83do.....	7	21			10	38	
86do.....	11	19			13	43	

GROUP 5, PLANTS WHICH GAVE ONLY INTERMEDIUM FORMS

10	10 per cent fertile, awnless.....			47			47
16	None fertile, awnless.....			39	7		46
18do.....			44			44
30do.....			41	5		46
66do.....			38			38
93do.....			45	15		60
95	20 per cent fertile, awnless.....			35			35

GROUP 6, PLANTS WHICH GAVE INTERMEDIUM AND 2-ROWED BUT NO 6-ROWED SEGREGATES

5	None fertile, awnless.....			7		40	47
6do.....			9		38	47
14do.....			10	10	30	50
15do.....			8	9	24	41
24do.....			8	1	11	20
27do.....			6	4	36	46
42do.....			8	5	30	43
51do.....			12	3	33	48
67do.....			11	0	32	43
80do.....			4	0	42	46
92do.....			10	4	29	43

GROUP 7, PLANTS WHICH GAVE ONLY 2-ROWED FORMS

4	None fertile, awnless.....					46	46
8do.....					46	46
22do.....				2	22	24
73do.....					45	45
89do.....					48	48

GENETIC GROUPS INDICATED BY THE PROGENY CLASSES

The F_2 plants in Table I are arranged in groups according to the segregation shown in the F_3 generation.

Group 1 consists of plants which gave only 6-rowed progeny in the F_3 generation. Since the parents were 6-rowed, the plants in this group are unquestionably homozygous for this character.

Group 2 consists of plants which gave 6-rowed and *intermedium* but no 2-rowed forms. The F_2 plants evidently correspond to those in the high-fertility column of the F_3 classification. The classification of the high-fertility group is readily made and is highly accurate. Since this group gave 6-rowed, high-fertility, and *intermedium* segregates in approximately a 1 to 2 to 1 ratio, it is safe to assume that the high-fertility plants are heterozygous for 6-rowed \times *intermedium* which differ by a single factor.

Group 3 gave all three homozygous classes and all heterozygous classes as well. From this it is obvious that this group is comparable to the F_2 generation and is heterozygous for the same factor differences as separate the original 6-rowed \times 2-rowed forms.

Group 4 gave 6-rowed, low-fertility awned, and 2-rowed forms in approximately a 1 to 2 to 1 ratio. Since this low-fertility awned corresponded in appearance to the F_2 parents, it would seem that this group also was heterozygous for 6-rowed \times 2-rowed, which in this instance, however, represents a single factor difference. It gave no *intermedium* forms, nor did it give the high-fertility awned or the low-fertility awnless forms. In other words, the *intermedium* character in both its homozygous and its heterozygous aspects was absent. The fact that this group as well as group 3 is heterozygous for 6-rowed \times 2-rowed, even though more factors are involved in one case than the other, can be reconciled only on the basis that there are two types either of the 6-rowed or of the 2-rowed forms, only one of which carries the possibilities of producing *intermedium* forms.

Group 5 consists entirely of F_2 plants which gave only *intermedium* forms in the F_3 generation. In other words, out of 87 F_2 plants there were 7 homozygous for the type which has been noticed so rarely in barley studies and whose very occurrence has been questioned so frequently. That the F_2 plants showed no higher fertility was doubtless due to their being grown in the greenhouse. Those plants of the F_3 generation falling in the low-fertility class merely show the variation which exists. They do not cast any doubt on the genetic character of the F_2 parents, because there were no 2-rowed segregates from any of the seven F_2 plants.

Group 6 gives homozygous intermediates, low-fertility awnless, and no-fertility awnless. The numbers in the classes are not significant in this case, for some sterile spikes of *intermedium* and the larger part of

one heterozygous group are included with the homozygous 2-rowed as phenotypes. The F₂ plants in group 6, however, unquestionably are heterozygous for *intermedium* × 2-rowed, a single main factor difference separating the *intermedium* and 2-rowed forms.

Group 7 may be considered as composed of plants homozygous for 2-rowed, since with the exception of the two plants noted there was no fertility exhibited in the progeny.

The seven groups just discussed consist of F₂ plants assembled in groups because of their evident similarity of genetic constitution. In other words, these groups are genetic classes in contradistinction to the phenotypic classes of the F₃ generation. In Table II the data on these groups are summarized. The second column of this table gives the genetic constitution of each group. Except for the subdivisions of group 1, this classification was verified in the F₃ generation. In the third column a hypothetical formula is suggested for each group. These formulas are based on a 2-factor difference between the 6-rowed and the 2-rowed forms. The Manchuria 6-rowed parent is supposed to possess both factors, while in the 2-rowed Svanhals parent both supposedly are lacking.

TABLE II.—Summary of F₂ plants of the cross between Manchuria and Svanhals

Group No. as in Table I.	Genetic constitution as shown by progeny.	Hypothetical formulas.	Expected Mendelian ratio.	Expected number on basis of 87 plants.	Number obtained in 87 plants.	Description of F ₂ plants.
1	Homozygous for 6-rowed	AABB	1	} 22	22	{ Lateral florets long-awned, fully fertile, kernels normal size.
1	Heterozygous for 6-rowed × regressive 6-rowed.	AABb	2			
1	Homozygous for regressive 6-rowed.	AAbb	1			
2	Heterozygous for 6-rowed × <i>intermedium</i> .	AaBB	2	11	7	Lateral florets short-awned, highly fertile, kernels small.
3	Heterozygous for 6-rowed × 2-rowed.	AaBb	4	22	25	Lateral florets awn-pointed to short-awned, no fertility to low fertility.
4	Heterozygous for regressive 6-rowed × 2-rowed.	Aabb	2	11	10	Lateral florets awn-pointed to short-awned, no fertility.
5	Homozygous for <i>intermedium</i> .	aaBB	1	5	7	Lateral florets enlarged, awnless, low fertility to no fertility, kernels small.
6	Heterozygous for <i>intermedium</i> × 2-rowed.	aaBb	2	11	11	Lateral florets awnless, somewhat enlarged, no fertility.
7	Homozygous for 2-rowed	aabb	1	5	5	Lateral florets small, awnless, no fertility.

This hypothesis accounts for the results very well. The 2-rowed segregates of group 7 are homozygous in the absence of both factors. The fixed intermediates or *H. intermedium* forms of group 5 are homozygous for the presence of one factor and for the absence of the other. The heterozygous groups, 2, 3, 4, and 6, are all heterozygous for one or both factors. Groups 2, 4, and 6, which are heterozygous for only one factor, give F₃ progeny of limited distribution. Group 3, which is heterozygous for both factors, gives all classes in the F₃ generation.

Group 1 is the only group offering any complications, and these are of no particular complexity. If the 2-factor hypothesis is tenable, group 1 must include three different classes of 6-rowed forms, two of which are homozygous. If the factor AA is considered epistatic to the factor BB, the three classes of group 1 become phenotypic for 6-rowed and may be considered as a single class. In genetic constitution, however, the homozygous 6-rowed segregate AAbb differs from the parent 6-rowed AABB; and, inasmuch as the BB factor has been lost, the form AAbb is referred to here as a regressive 6-rowed. If this regressive 6-rowed AAbb were crossed on the Svanhals parent aabb, there would be no possibility of securing the homozygous intermediate aaBB. Heterozygous types corresponding to such a cross probably are found in group 4, which is supposed to be heterozygous for this regressive 6-rowed AAbb \times the 2-rowed aabb. On the other hand, group 3 is heterozygous for the parent 6-rowed AABB \times the 2-rowed aabb.

It will be seen in Table II that the plants obtained in each group came very close to the expectancy. The numbers of 6-rowed and 2-rowed forms produced coincide exactly with the expected numbers, while the number of fixed intermediates is only two greater than in the calculated ratio.

The nature of the factors is better discussed in connection with the description of the genetic classes which is given in Table II. It will be seen from the table that except in group 1 these various classes differ in appearance as well as in genetic constitution. In some instances the separations are easily made on appearance alone, while in others only a part of the plants belonging to a group can be easily identified. The first four groups have lateral florets, the lemmas of which bear awn points or awns of varying lengths. Group 1, of course, presents no difficulties, for 6-rowed segregates are unmistakable. Group 2 is almost as definite, for there are no other high-fertility segregates with small-kerneled, awn-pointed lateral florets. Group 3 is readily separated from group 2 by the lower fertility of the individuals in group 3. The sterile individuals of group 3, however, are easily confused with the individuals of group 4. Probably 80 per cent of such plants in group 3 can be identified by the more obtuse lemma tip on the lateral florets. Groups 5, 6, and 7 differ from the other groups in the absence of awns on the rounded tips of the lateral florets. These conditions are not absolute, in that an occasional floret may possess an awn. In this case, however, other florets on the same spike have the characteristic rounded obtuse tips. Group 5 is characterized by the possession of lateral florets which, even when sterile, are larger than those of the 2-rowed. Under field conditions higher fertility probably would have been present in the members of this group. When the F_2 material was being studied, it was possible, however, to isolate the sterile spikes of *intermedium* forms by inspection. In group 6 the lateral florets of many individuals are

obviously larger than in the 2-rowed segregates, but as a rule they are not so large as in group 5. Groups 6 and 7 can be accurately separated only by the breeding test.

It will be seen, then, that although fertility is the basic distinction, it is expressed in other ways than in the production or nonproduction of kernels. Indeed, the percentage of fertility probably varies more with environment than do the morphological differences. Such variation, however, does not imply any lack of reliability of the fertility factors.

According to the factor hypothesis, the first four groups have the inherent possibility of producing 6-rowed segregates. Only plants belonging to these four groups have lateral florets the lemmas of which are awned or awn-pointed. The A factor, either as AA or Aa, is found only in these groups. This factor, then, must be associated with the possibility of awns. When A is homozygous, fully fertile, long-awned florets which develop kernels of normal size are produced. When A is heterozygous, all lateral florets are short-awned or awn-pointed. When homozygous, it is epistatic to B, the spike being normal 6-rowed irrespective of the condition B. When heterozygous, A has little effect on fertility, and the amount of fertility present in this case is in direct relation to B. The lateral florets of AaBB are quite fertile, those of AaBb occasionally so, while those of Aabb as a class are sterile. Aa may have a slight effect on fertility, for AaBB has a higher percentage of fertility than aaBB. The factor BB, then, is a fertility factor which at its highest expression produces a lower percentage of fertility than AA. It is not accompanied by the presence of awns. The lateral florets under its stimulation produce undersized kernels, the largest form of floret seeming to be associated with AA.

INDICATION OF A THIRD FACTOR

The presence of a third factor of fertility was first suggested by a study of the data in Table I. Column 2 of that table shows the percentage of fertility of the F_2 parents. In group 2, three plants exhibited a much lower fertility than the other four. Since one of these was abnormal, there were, excluding this plant, two low-fertility and four high-fertility plants. It is difficult to measure the inheritance of these variations in this group. The percentage of fertility of the *intermedium* segregates in the F_3 generation of four lines was studied. The F_3 *intermedium* segregates of the others were missing. Three high-fertility lines gave almost identical fertility of 37+ per cent. One low-fertility line gave 29.5 per cent of fertility. In group 3, five out of twenty-five plants showed some fertility. The F_3 plants were not studied for differences in percentage of fertility.

In group 5, two out of seven plants had fertile lateral florets. In this group the progeny were studied carefully. This is the only group

where this can be done readily, because the others, where the differences in percentage of fertility occur, are heterozygous for one or both main factors. If there is a third factor, the F_2 generation indicates that it is expressed here as a 1 to 3 ratio with the heterozygous forms indistinguishable from those homozygous for the absence of the factor. By the same reasoning, lines 10 and 95 in Table I, which showed fertility, should be homozygous for the presence of the factor and should exhibit a higher percentage of fertility than the progeny of the other five lines. The F_3 progeny of lines 10 and 95 averaged 54.6 and 48.4 per cent of fertility in the lateral florets, while the progeny of the other lines were, respectively, 35.7, 33.2, 30.3, 25, and 17.8 per cent fertile.

The data indicating a third factor in fertility are summarized in Table III. The evidence at hand is not more than an indication of a minor factor, yet the material itself is far more suggestive of such a factor than the evidence.

TABLE III.—Summary of data indicating a third factor of fertility in the cross between Manchuria and Svanhals

Group No.	Genetic constitution as shown by progeny.	Hypothetical formulae.	Expected mendelian ratio.	Number of plants in group.	Expected number of plants by sub-groups.	Number of plants obtained.
2	Heterozygous for 6-rowed \times <i>intermedium</i>	AaBBCC...	2	6	2	4
		AaBBcc...	4		4	
		AaBBcC...	2		2	
3	Heterozygous for 6-rowed \times 2-rowed.....	AaBbCC...	4	25	6	5
		AaBbCc...	8		13	
		AaBbcc...	4		6	
4	Heterozygous for regressive 6-rowed \times 2-rowed.....	AabbCC...	2	10	3	2
		AabbCc...	4		5	
		Aabbcc...	2		3	
5	Homozygous for <i>intermedium</i>	aaBBCC...	1	7	2	2
		aaBBcC...	2		4	
		aaBBcc...	1		2	

DISCUSSION OF RESULTS

FIXED INTERMEDIATE, *H. INTERMEDIUM*

Since the purpose of this study was to gain a better understanding of the occurrence of *H. intermedium*, this form is of greater interest here than any of the other segregates. From the standpoint of historical and present interest there are three questions which can now be answered. There is no doubt that such forms occur; they have been found to be stable; and in the particular cross reported here in detail the ratio of appearance is approximately 1 to 16.

The stability of this form was established by observations on intermediates obtained from several crosses. The field experiences fit in well

with the 2-factor hypothesis suggested. The stability of the homozygous intermediate has been thoroughly tested. Some of these have been grown since 1912 under widely varying conditions with no indication of reverting to either the 6-rowed or 2-rowed parental type. Many hybrids have been made with the *intermedium* form as one parent. There are complete records of the progeny of crosses on five 6-rowed and on two 2-rowed forms. No 2-rowed segregates appeared among the progeny of the 6-rowed \times *intermedium* crosses, and no 6-rowed segregates appeared among the progeny of the *intermedium* \times 2-rowed crosses. Every hybrid studied so far indicates that *H. intermedium* has a genetic rank equal to *H. vulgare* or *H. distichon*.

In field culture there is always variation in the amount of fertility present in the lateral florets of the *intermedium* form. This is true even on a single plant. The earlier, better-nourished spikes in some strains may have as high as 90 per cent of the lateral florets fertile. The later spikes of the same plant usually have a diminishing percentage, while the last-appearing may have lateral florets which are entirely sterile. Such variations, however, are the result of variation in nutrition, for their progeny are uniformly *intermedium* in type.

There are variations of another sort in the *intermedium* forms which have more significance. Frequent mention has been made of the fact that the fertility of the different classes may be expected to vary with the parents used. From crosses showing more vigor in the lateral florets of the segregates than those of the Manchuria \times Svanhals, very vigorous intermediates may be isolated. From those crosses which show less fertility in the segregates, homozygous intermediates probably may be isolated in which only occasional kernels may be produced. Instances may be possible where a potential intermediate may exhibit no fertility whatever.

The form *atterbergii* shown in Plate 106 is probably an infertile *intermedium* barley. This form is somewhat anomalous in the taxonomy of barley. It has never been grown by the authors, but from the statements of those who have grown it, it appears to have shown no fertility. The illustration is a photograph of a spike presented to the United States Department of Agriculture several years ago by Mr. E. S. Beaven. It has greatly enlarged lateral florets which closely resemble those of spikes of *H. intermedium*, in which potentially fertile lateral florets are sterile because of environment.

REGRESSIVE 6-ROWED FORM

The recognition of the two different forms homozygous for the 6-rowed character offers a field for further investigation. The regressive 6-rowed AAbb is apparently not optically distinguishable from the AABB 6-rowed. There is no method known to the authors of separating these by inspection. In hybrids the regressive 6-rowed form should behave quite

differently. If this regressive type were crossed on the *intermedium* form the results, according to the hypothesis advanced, would not be the same as when the Manchuria is so crossed. The Manchuria \times *intermedium* gives 6-rowed, high-fertility, and *intermedium* segregates in a 1 to 2 to 1 ratio in the F_2 generation. The regressive 6-rowed \times the *intermedium* form should give all classes, including 2-rowed forms, in the F_2 generation. On the other hand, if the regressive 6-rowed were crossed on the Svanhals, no *intermedium* segregates would be expected. Unfortunately, neither of these crosses has been made, but the latter condition has been met in other crosses. Strains of Odessa and Reid Triumph when crossed on Svanhals produced no intermediates, indicating that the regressive 6-rowed AAbb does occur. The progeny of these crosses segregates in the same way as the group which is heterozygous for the regressive 6-rowed \times 2-rowed in Table I. Incidentally, there is evidence that the strains used, of both Reid Triumph and Odessa, originated as selections from a previous hybridization. No evidence is at hand to indicate whether or not the regressive 6-rowed type AAbb occurs elsewhere than in the progeny of hybrids.

Because fixed intermediates have been secured from hybrids in which several old agricultural races of 6-rowed barley were used as one parent, it is assumed that forms such as the Manchuria are the normal 6-rowed forms. It is not known how frequently the regressive types occur among our agricultural sorts, nor whether they are associated with other characters than the failure to produce intermediates. Heritable variations in the amount of fertility in the lateral florets of 6-rowed barleys have been noticed, however, and since the conception of a regressive 6-rowed type offers a possible explanation of their behavior, a statement concerning these unusual varieties may be of interest.

In 1909 the senior author noticed a decided tendency to sterility of lateral florets in the agronomic varieties known as Mansfield and Summit. In each case the earliest spikes to appear were normal 6-rowed spikes. The lateral florets were highly fertile, long awned, and produced large kernels. In the later spikes, especially where the plants produced several culms, the lateral florets exhibited increasing sterility. Late spikes, in which none of the lateral florets were fertile, were found in many plants. One of these barleys, Mansfield, was the progeny of a cross between a 6-rowed and a 2-rowed barley, made at Guelph, Ont., in 1891. The peculiar behavior of this variety was so striking that selections of fertile and infertile spikes were made in 1909. These were planted in 1910, but, as would be expected, there was no difference in their inheritance. Owing to seasonal conditions the percentage of spikes with no fertility in the lateral florets was unusually large in 1910, the sterile spikes being approximately equal to the fertile in number. Spikes from a single plant are shown in Plate 105, D. It will be seen that the sterile florets are

long awned and that there is no approach toward the homozygous intermediate. The second variety, Summit, which for other reasons is thought also to be of hybrid origin, produced spikes with infertile lateral florets much more rarely. It is suggested that these barleys may be forms of the 6-rowed segregate AAbbcc, homozygous for the absence of the two secondary factors of fertility.

POSITION OF FERTILE LATERAL SPIKELETS

Aside from the question of the amount of fertility in the lateral florets, the location of fertile florets on the spike is of interest. In the common varieties of barley the largest kernels are produced about one-third of the distance from the base of the spike to the tip, in both the central and the lateral spikelets. The longest awns are attached to these florets, and they exhibit a progressive decrease in length toward the tip of the spike. The fertility of the homozygous intermediate runs in the reverse order. When only a few kernels are produced they are found in the upper third and gradually extend downward from the tip in the more fertile intermediates. The most fertile lateral florets in the Mansfield variety are found near the center of the spike.

ABERRANT LINE NO. 37

In Table I line No. 37 was found to differ greatly from the other members of group 2 in both appearance and fertility. It is much lower in fertility than the other individuals and, with the exception of one or two florets, is similar in appearance to the fixed intermediate. This plant is the only one of the 87 whose appearance is difficult to explain. It is not believed that the hypothesis of its being homozygous for the absence of the third factor is adequate explanation for its wide departure from type. For this reason this line was excluded in the later discussion. It is possible that the supposed F_2 plant is the result of a natural hybrid. The appearance of the forms in any class varies with the parents used. Some combinations result in greater fertility in the various classes, others result in much less. If the F_1 kernel from which this F_2 plant developed had been fertilized by some neighboring 6-rowed variety less vigorous than the Manchuria or by a low-fertility *intermedium* form, such a plant as No. 37 might result. The opportunity for accidental crossing in the F_1 generation is unusually good. The lateral florets of the F_1 plants are much more likely to open at flowering time than are the normal barley florets, and they flower after the spike is exerted. The flowering glumes are less interlocked and open more readily and more widely. The flowers are more frequently deficient in pollen, and those not self-pollinated remain open for hours or even days, affording unusual opportunity for cross pollination.

SUMMARY

H. intermedium is a form of barley in which the awnless lateral florets exhibit a fertility greater than that found in the 2-rowed and less than that occurring in the 6-rowed barleys.

The occurrence of this form as a homozygote has been questioned frequently.

H. intermedium forms which are stable under all conditions of culture have been isolated from numerous crosses reported in this paper. This form appears to be genetically as distinct as either *H. vulgare* or *H. distichon*.

A 2-factor hypothesis for fertility in the lateral florets is suggested. On the presence-and-absence hypothesis the 6-rowed barleys are supposed to be homozygous for the presence of the epistatic factor, the *intermedium* to be homozygous for the presence of the hypostatic factor and for absence of the epistatic factor, and the Svanhals to be homozygous for the absence of both factors.

According to the hypothesis, there are two types of 6-rowed barleys. The Manchuria parent is supposed to be homozygous for the presence of both factors, while certain regressive 6-rowed segregates are thought to be homozygous for the presence of the epistatic factor and for the absence of the hypostatic factor.

There is evidence suggestive of a third factor which affects the vigor of the lateral florets and their percentage of fertility.

LITERATURE CITED

- (1) BIFFIN, R. H.
1907. THE HYBRIDIZATION OF BARLEYS. *In Jour. Agr. Sci.*, v. 2, pt. 2, p. 183-206.
- (2) HARLAN, Harry V.
1918. THE IDENTIFICATION OF VARIETIES OF BARLEY. U. S. Dept. Agr. Bul. 622, 32 p., 4 pl. Literature cited, p. 31-32.
- (3) H[AXTON], J[ohn].
1851. BARLEY. *In* Morton, John C., ed. Cyclopaedia of Agriculture . . . v. 1, p. 176-191. Glasgow, Edinburgh, London.
Article is signed "J. H." and is credited by Körnicke to Haxton. See following reference, p. 173.
- (4) KÖRNICKE, Friedr.
1885. DIE ARTEN UND VARIETÄTEN DES GETREIDES. 470 p., 10 pl. Berlin. (Körnicke, Friedr., and Werner, Hugo. Handbuch des Getreidebaues. v. 1.)
- (5) ———
1908. DIE ENTSTEHUNG UND DAS VERHALTEN NEUER GETREIDEVARIETÄTEN. Hrsg. von M. Körnicke. *In Arch. Biontol.*, Bd. 2, Heft 2, p. 389-437.
- (6) RIMPAU, Wilhelm.
1891. KREUZUNGSPRODUKTE LANDWIRTSCHAFTLICHER KULTURPFLANZEN. *In Landw. Jahrb.*, Bd. 20, p. 335-371.
- (7) ———
1892. DIE GENETISCHE ENTWICKELUNG DER VERSCHIEDENER FORMEN UNSERER SAATGERSTE. *In Landw. Jahrb.*, Bd. 21, p. 699-702.

- (8) TSCHERMAK, Erich von.
1914. DIE VERWERTUNG DER BASTARDIERUNG FÜR PHYLOGENETISCHE FRAGEN
IN DER GETREIDEGRUPPE. *In* Ztschr. Pflanzenzücht., Bd. 2, Heft 3,
p. 291-312.
- (9) WILSON, John H.
1907. THE HYBRIDIZATION OF CEREALS. *In* Jour. Agr. Sci., v. 2, pt. 1, p. 68-88,
pl. 1.

PLATE 103

Individual heads representing the three phenotypic progeny classes in which the lateral florets bear awns:

A.—Low-fertility class.

B.—High-fertility class.

C.—Manchuria parent representing the 6-rowed segregates.





PLATE 104

Individual heads representing the phenotypic progeny classes in which the lemmas of the lateral florets are rounded and awnless:

- A.—The 2-rowed, represented here by the Svanhals parent.
- B.—Low-fertility class.
- C.—*Hordeum intermedium*.

PLATE 105

A.—Awn-pointed individual, heterozygous for regressive 6-rowed and 2-rowed characters.

B.—Short-awned individual, heterozygous for regressive 6-rowed and 2-rowed characters.

C.—Long-awned individual, heterozygous for regressive 6-rowed and 2-rowed characters.

D.—Three spikes of Mansfield barley from the same plant, showing the variations of fertility in the lateral florets.

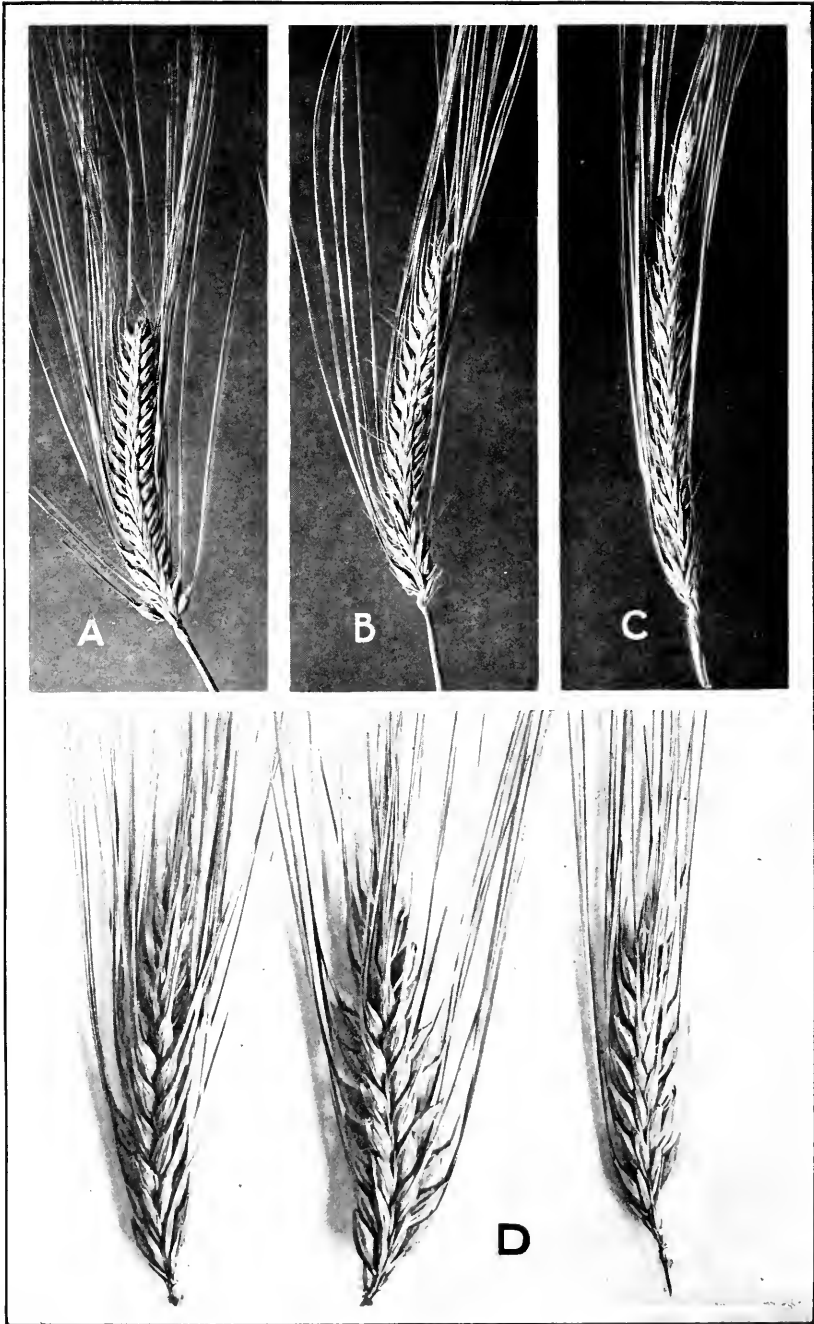

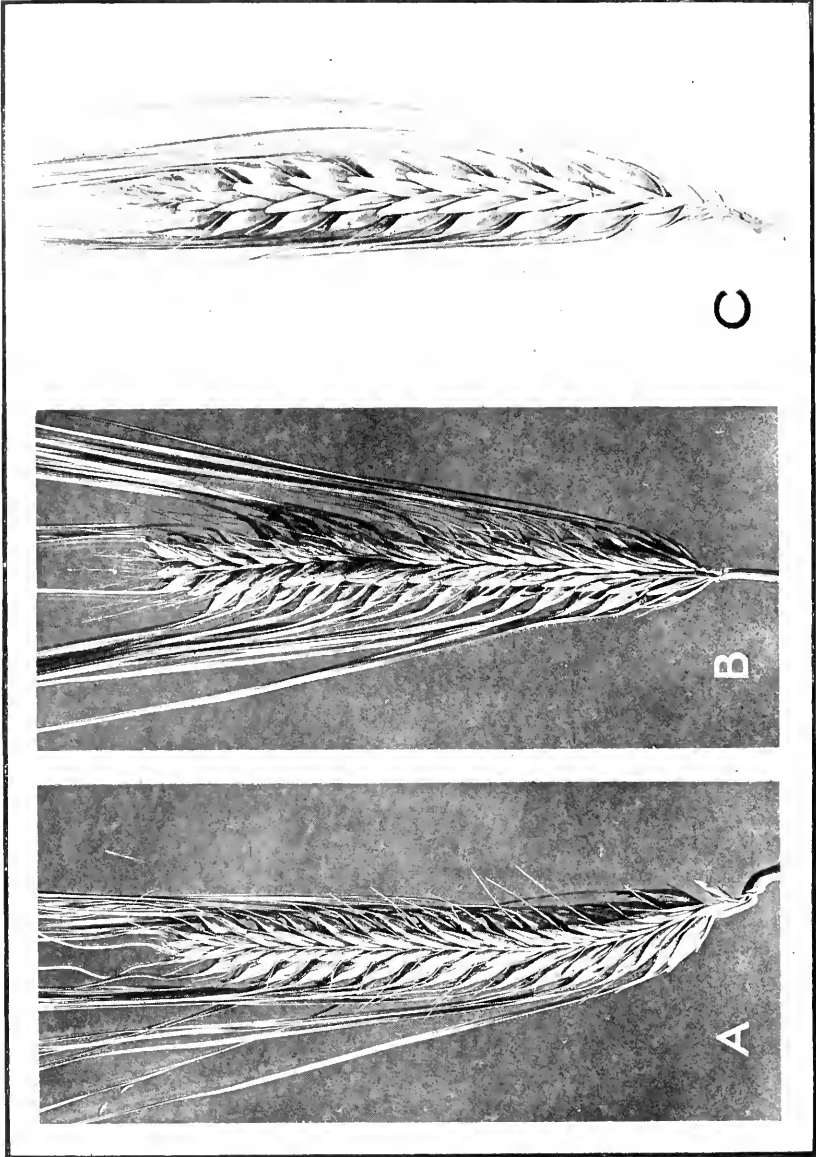

PLATE 106

- A.—Infertile spike of potentially fertile *Hordeum intermedium*.
B.—Fertile spike of *H. intermedium*.
C.—Var. *atterbergii*, probably a sterile *intermedium*.

417°—20—6

ADDITIONAL COPIES
OF THIS PUBLICATION MAY BE PROCURED FROM
THE SUPERINTENDENT OF DOCUMENTS
GOVERNMENT PRINTING OFFICE
WASHINGTON, D. C.
AT
20 CENTS PER COPY
SUBSCRIPTION PRICE, \$1.50 PER YEAR

▽

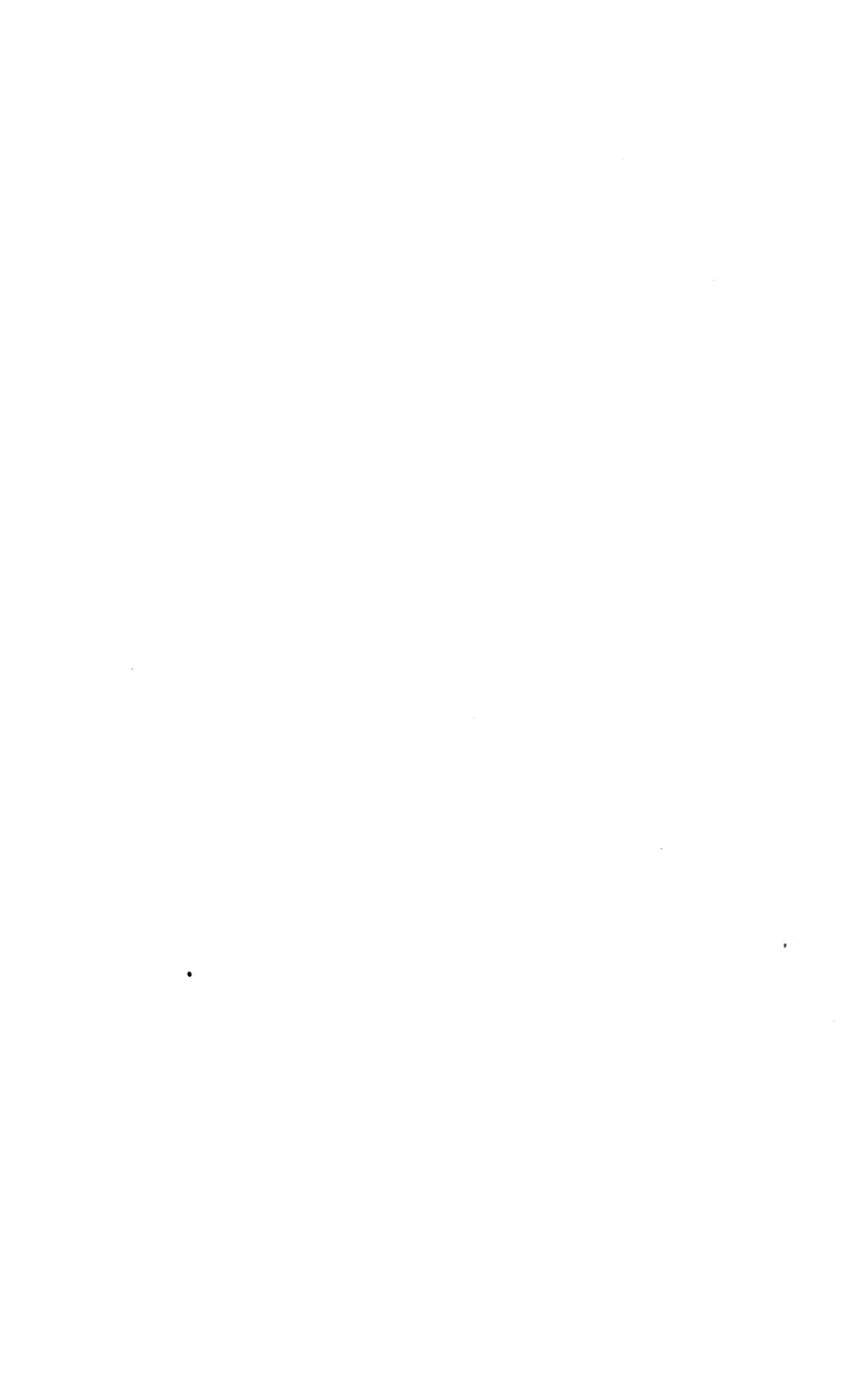

Vol. XIX

SEPTEMBER 15, 1921

No. 12

JOURNAL OF AGRICULTURAL RESEARCH

CONTENTS AND INDEX
OF VOLUME XIX

**PUBLISHED BY AUTHORITY OF THE SECRETARY OF AGRICULTURE
WITH THE COOPERATION OF THE ASSOCIATION OF
LAND-GRANT COLLEGES**

WASHINGTON, D. C.

**EDITORIAL COMMITTEE OF THE
UNITED STATES DEPARTMENT OF AGRICULTURE AND
THE ASSOCIATION OF LAND-GRANT COLLEGES**

FOR THE DEPARTMENT

KARL F. KELLERMAN, CHAIRMAN

*Physiologist and Associate Chief, Bureau
of Plant Industry*

EDWIN W. ALLEN

Chief, Office of Experiment Stations

CHARLES L. MARLATT

*Entomologist and Assistant Chief, Bureau
of Entomology*

FOR THE ASSOCIATION

J. G. LIPMAN

*Dean, State College of Agriculture, and
Director, New Jersey Agricultural Experi-
ment Station, Rutgers College*

W. A. RILEY

*Entomologist and Chief, Division of Ento-
mology and Economic Zoology, Agricul-
tural Experiment Station of the University
of Minnesota*

R. L. WATTS

*Dean, School of Agriculture, and Director,
Agricultural Experiment Station, The
Pennsylvania State College*

All correspondence regarding articles from the Department of Agriculture should be addressed to Karl F. Kellerman, Journal of Agricultural Research, Washington, D. C.

All correspondence regarding articles from State Experiment Stations should be addressed to J. G. Lipman, New Jersey Agricultural Experiment Station, New Brunswick, N. J.

INDEX

	Page		Page
A-amino nitrogen in frozen wheat.....	185-186	Anias. See <i>Andropogon sorghum</i> , var. <i>halapense</i> .	
Acid—		Anthony, Stephen, and Harlan, Harry V. (paper): Development of Barley Kernels in Normal and Clipped Spikes and the Limitations of Awnless and Hooded Varieties.....	431-472
citric, effect on germination and growth....	74-96	Antigens, germ-free filtrates.....	513-515
malic, in Bartlett pears.....	482-499	Antimony, black sulphid, effect on milk and fat production.....	125-130
pbosphoric—		Aphis, corn. See <i>Aphis maidis</i> .	
effect of sulphur on release in greensand .	241	<i>Aphis maidis</i> , carrier of sugar-cane mosaic..	133, 135
effect on germination and growth.....	74-96	<i>Aristida longiseta</i> on northern Great Plains... 65-72	
Acid-hydrolyzable substances in Bartlett pears.....	480-499	Arsenic, effect on milk and fat production..	125-130
Acidity—		<i>Artemisia</i> —	
effect on persistence of <i>Pseudomonas citri</i> in soil.....	217-218	<i>dracunculoides</i> on northern Great Plains... 65-72	
of Bartlett pears.....	489-494	<i>frigida</i> on northern Great Plains.....	65-72
of greensand.....	243-255	<i>gnaphalodes</i> on northern Great Plains.....	65-72
of silage.....	174-176	Artificial and Insect Transmission of Sugar-Cane Mosaic (paper).....	131-135
of wheat, effect of freezing.....	187-188	Ash content of barley kernels—	
Acids, toleration by <i>Bacterium coronafaciens</i>	152-153	change during development.....	412-428
<i>Aegle marmelos</i> , susceptibility to <i>Pseudomonas citri</i>	341-342, 345	from normal and clipped spikes.....	452-469
Aeglinae, susceptibility to <i>Pseudomonas citri</i>	341-342	Ashby, R. C., and Malcomson, A. W. (paper): Variation of Individual Pigs in Economy of Gain.....	225-234
<i>Aeglopsis Chevalieri</i> , immunity to <i>Pseudomonas citri</i>	342, 345	<i>Aster multiflorus</i> on northern Great Plains... 65-72	
Aerobism of <i>Bacterium coronafaciens</i>	157-158	<i>Atalantia</i> —	
<i>Agropyron</i> —		<i>Ceylonica</i> , susceptibility to <i>Pseudomonas citri</i>	343, 345, 347
<i>caninum</i> —		<i>citrioides</i> , susceptibility to <i>Pseudomonas citri</i>	343, 345, 347, 348
host of <i>Puccinia glumarum</i>	258	<i>disticha</i> , susceptibility to <i>Pseudomonas citri</i>	345
on northern Great Plains.....	65-72	<i>glauca</i> . Syn. <i>Eremocitrus glauca</i> .	
<i>repens</i> , host of <i>Puccinia coronata agropyri</i> ... 258		<i>Hindii</i> . Syn. <i>Fortunella Hindii</i> .	
<i>smithii</i> on northern Great Plains.....	65-72	<i>Atterbergii</i> , variety, infertile intermediate barley.....	587
<i>tenerum</i> on northern Great Plains.....	65-72	<i>Avena sativa</i> , halo-blight.....	139-172
Aguingay. See <i>Rotboellia exaltata</i> .		Awnless barley, limitations.....	431-472
Alang-alang grass. See <i>Imperata</i> sp.		<i>Bacillus</i> —	
Alcohol—		<i>avenae</i> , causal organism of blade-blight of oats.....	167
effect on milk and fat production.....	124	<i>botulinus</i> , separation by germ-free filtrates 513-515	
in silage.....	174-177	<i>edematiens</i> , separation by germ-free filtrates. 513	
Alcohol-insoluble substances in Bartlett pears.....	480-499	<i>telanus</i> , separation by germ-free filtrates.... 513	
Alkalinity, effect on persistence of <i>Pseudomonas citri</i> in soil.....	217-218	<i>Bacterium coronafaciens</i> , n. sp.—	
Aloes, effect on milk and fat production.....	124	control.....	170-171
Aluminum—		cultural characters.....	143-153
oxid in greensand.....	241	description of lesions.....	139-140
sulphate, effect on availability of potassium of greensand.....	242-256	geographical distribution.....	140
Amid nitrogen in frozen wheat.....	185-186	isolation No. 36.....	154-155
Ammonia nitrogen in frozen wheat.....	185-186	overwintering and dissemination.....	158-162
Ammonia production by <i>Bacterium coronafaciens</i>	151	stock halo organism.....	143-154
<i>Andropogon</i> —		yellow organism.....	155-158
<i>furcatus</i> on northern Great Plains.....	66-72	<i>Balsamocitrus Dawei</i> , immunity to <i>Pseudomonas citri</i>	342, 345
<i>scoparius</i> on northern Great Plains.....	65-72		
<i>sorghum</i> —			
host of <i>Sclerospora philippinensis</i>	104-122		
var. <i>halapense</i> resistance to <i>Sclerospora philippinensis</i>	104		

	Page		Page
Banana Root-Borer (paper).....	39-46	Carbonate, calcium, effect on availability of potassium of greensand.....	242-256
Barley kernels, development—		<i>Carex</i> —	
daily.....	393-430	<i>filifolia</i> on northern Great Plains.....	65-72
in normal and clipped spikes.....	431-472	<i>heliophila</i> on northern Great Plains.....	65-72
Bartlett pears, ripening and storage.....	473-500	<i>Casimiroa edulis</i> , susceptibility to <i>Pseudomonas citri</i>	341-346
<i>Bacterium translucens</i> var. <i>undulosum</i> , effect of—		Castor oil, effect on milk and fat production..	124
formalin.....	366-379	<i>Chaetospermum glutinosum</i> , susceptibility to <i>Pseudomonas citri</i>	342, 345, 346, 348
presoak method.....	379-392	<i>Chaetochloa lutescens</i> , susceptibility to sugarcane mosaic.....	134
<i>Beckmannia erucaeformis</i> , host of <i>Puccinia coronata</i>	257	<i>Chalcas exotica</i> , susceptibility to <i>Pseudomonas citri</i>	341-346
Beetles—		Chlorid, calcium, effect on germination and growth.....	74-96
Colorado potato. See <i>Leptinotarsa decemlineata</i> .		Cicetrage, susceptibility to <i>Pseudomonas citri</i>	355
flea. See <i>Epitrix cucumeris</i> .		Citradia, susceptibility to <i>Pseudomonas citri</i> ..	354
Behavior of the Citrus-Canker Organism in the Soil (paper).....	189-206	Citrandarin, susceptibility to <i>Pseudomonas citri</i>	354-355
Bicarbonate, sodium, effect on milk and fat production.....	125-130	Citrangarin, susceptibility to <i>Pseudomonas citri</i>	355
Bigaraldin, susceptibility to <i>Pseudomonas citri</i>	356	Citrange, susceptibility to <i>Pseudomonas citri</i> ..	354
Black raspberry, host of <i>Gymnoconia interstitialis</i>	501-507	Citrangedin, susceptibility to <i>Pseudomonas citri</i>	355
Blackberry, host of <i>Gymnoconia interstitialis</i>	505-506	Citrangquat, susceptibility to <i>Pseudomonas citri</i>	356
Blackleg filtrates, germ-free.....	513-515	Citranguma, susceptibility to <i>Pseudomonas citri</i>	356
Blish, M. J. (paper): Effect of Premature Freezing on Composition of Wheat.....	181-188	Citric acid. See Acid, citric.	
Blue grama. See <i>Bouteloua gracilis</i> .		<i>Citropsis Schweinfurthii</i> , susceptibility to <i>Pseudomonas citri</i>	343, 345, 347, 348
<i>Bouteloua</i> —		Citrumelo, susceptibility to <i>Pseudomonas citri</i>	354
<i>curtipendula</i> on northern Great Plains.....	65-72	Citrunshu, susceptibility to <i>Pseudomonas citri</i>	355
<i>gracilis</i> on northern Great Plains.....	65-72	Citrus-canker. See <i>Pseudomonas citri</i> .	
<i>Brachypodium pinnatum</i> , host of <i>Puccinia glumarum</i>	258	<i>Citrus</i> —	
Brandes, E. W. (paper)—		<i>aurantifolia</i> —	
Artificial and Insect Transmission of Sugar-Cane Mosaic.....	131-138	infection resembling <i>Pseudomonas citri</i>	203-204
Mosaic Disease of Corn.....	517-522	susceptibility to <i>Pseudomonas citri</i>	350-361
Braun, Harry (paper): Presoak Method of Seed Treatment: A Means of Preventing Seed Injury Due to Chemical Disinfectants and of Increasing Germicidal Efficiency..	363-392	<i>australasia</i> . Syn. <i>Microcitrus australasia</i> .	
<i>Bromus mollis</i> , host of <i>Puccinia glumarum</i> ...	258	<i>australis</i> . Syn. <i>Microcitrus australis</i> .	
Buffalo grass. See <i>Bulbils dactyloides</i> .		<i>decumana</i> . Syn. <i>Citrus maxima</i> .	
<i>Bulbils dactyloides</i> on northern Great Plains..	66-72	<i>excelsa</i> , susceptibility to <i>Pseudomonas citri</i>	352-361
<i>Calamovilfa longifolia</i> on northern Great Plains.....	65-72	<i>Garrowayi</i> . Syn. <i>Microcitrus Garrowayi</i> .	
<i>Calandra sordida</i> . Syn. <i>Cosmopolites sordidus</i> .		<i>grandis</i> —	
Calarin, susceptibility to <i>Pseudomonas citri</i> ..	358	susceptibility to <i>Pseudomonas citri</i>	350-361
Calashu, susceptibility to <i>Pseudomonas citri</i> ..	358	Syn. <i>Citrus maxima</i> .	
Calcium—		<i>hystrix</i> , susceptibility to <i>Pseudomonas citri</i>	349-361
carbonate, effect on availability of potassium of greensand.....	242-256	<i>japonica</i> . Syn. <i>Fortunella japonica</i> .	
chlorid, effect on germination and growth..	74-96	<i>limetta</i> . See <i>Citrus aurantifolia</i> .	
oxid in greensand.....	244	<i>margarita</i> . Syn. <i>Fortunella margarita</i> .	
phosphate, effect on solubility of soils....	50-51	<i>maxima</i> , effect of inoculation with <i>Pseudomonas citri</i>	190-199
sulphate, effect on solubility of soils.....	47-54	<i>medica</i> , susceptibility to <i>Pseudomonas citri</i> ..	349
Caraway, effect on milk and fat production.....	125-130	<i>mitis</i> , susceptibility to <i>Pseudomonas citri</i>	351-361
Carbohydrates—		<i>nobilis</i> —	
in silage.....	174-178	var. <i>unshu</i> , susceptibility to <i>Pseudomonas citri</i>	349-361
in wheat, effect of freezing.....	186-187	susceptibility to <i>Pseudomonas citri</i>	351-361
Carbon dioxide, effect of calcium sulphate on production in soil.....	51-52		

Citrus—Continued.	Page	Page
<i>sinensis</i> —		
effect of inoculation with <i>Pseudomonas citri</i>	203-204	
susceptibility to <i>Pseudomonas citri</i>	350-361	
<i>trifoliata</i> —		
effect of inoculation with <i>Pseudomonas citri</i>	200-202	
Syn. <i>Poncirus trifoliata</i> .		
<i>Claucaena lansium</i> , susceptibility to <i>Pseudomonas citri</i>	341-346	
Clemelo, susceptibility to <i>Pseudomonas citri</i> ..	357	
Clonal varieties of Irish potatoes.....	543-573	
Cogon. See <i>Imperata cylindracea</i> .		
<i>Coxi</i> —		
<i>lachryma-jobi</i> , resistance to <i>Sclerospora philippinensis</i>	104	
<i>ma yuen</i> , resistance to <i>Sclerospora philippinensis</i>	104	
Collins, G. N., and Kempton, J. H. (paper): A Teosinte-Maize Hybrid.....	1-38	
Colorado potato beetles. See <i>Leptinotarsa decemlineata</i> .		
<i>Comandra pallida</i> on northern Great Plains..	65-72	
Complement-fixation test, germ-free filtrates as antigens.....	513-515	
Composition and Density of the Native Vegetation in the Vicinity of the Northern Great Plains Field Station (paper).....	63-72	
Composts, manure-sulphur, effect on availability of potassium of greensand.....	239-256	
Conidia, production in <i>Gibberella saubinetii</i> ..	235-237	
Copper sulphate, prevention of injury to seeds by presoak method.....	363-392	
Corn. See <i>Zea mays</i> .		
Corn aphid. See <i>Aphis maidis</i> .		
<i>Cosmopolites sordidus</i> —		
control.....	45-46	
description.....	41-44	
history and distribution.....	39-40	
hosts.....	40-41	
life history.....	44-45	
Crabgrass. See <i>Syntherisma sanguinalis</i> .		
Daily Development of Kernels of Hannechen Barley from Flowering to Maturity at Aberdeen, Idaho (paper).....	393-430	
Decline of <i>Pseudomonas citri</i> in the Soil (paper).....	207-223	
Development of Barley Kernels in Normal and Clipped Spikes and the Limitations of Awnless and Hooded Varieties (paper).....	431-472	
Dewberry, host of <i>Gymnoconia interstitialis</i> ..	505-506	
Dextrin and soluble starch in frozen wheat..	187	
Dickson, James G., and Johann, Helen (paper): Production of Conidia in <i>Gibberella saubinetii</i>	235-237	
Dioxid, carbon, effect of calcium sulphate on production in soil.....	51-52	
Dipotassium phosphate, effect on germination and growth.....	74-96	
Downy mildew of maize. See <i>Sclerospora philippinensis</i> .		
Dox, Arthur W., and Yoder, Lester (paper): Influence of Fermentation on the Starch Content of Experimental Silage.....	173-179	
<i>Draeculacephala molipes</i> , failure to carry sugar-cane mosaic.....	134, 135	
Drugs, effect on milk and fat production....	123-130	
Dry matter in kernels from normal and clipped barley spikes.....	452-469	
<i>Echinacea angustifolia</i> on northern Great Plains.....	65-72	
Effect of Calcium Sulphate on the Solubility of Soils (paper).....	47-54	
Effect of Drugs on Milk and Fat Production (paper).....	123-130	
Effect of Manure-Sulphur Composts upon the Availability of the Potassium of Greensand (paper).....	239-256	
Effect of Premature Freezing on Composition of Wheat (paper).....	181-188	
Effect of Reaction of Solution on Germination of Seeds and on Growth of Seedlings (paper)	73-96	
<i>Eleusine coracana</i> , effect of field heterogeneity on yield.....	291-294	
Elliott, Charlotte (paper): Halo-Blight of Oats.....	139-172	
<i>Elymus canadensis</i> , host of <i>Puccinia montanensis</i>	257	
<i>Epitrix cucumeris</i> , failure to transmit potato mosaic.....	329	
Epsom salts, effect on milk and fat production.....	124	
<i>Eremocitrus glauca</i> , susceptibility to <i>Pseudomonas citri</i>	344, 345, 347	
<i>Euchlaena</i> —		
<i>luxurians</i> , host of <i>Sclerospora philippinensis</i>	104-122	
<i>mexicana</i> , hybrid with maize.....	1-38	
<i>Euphorbia dentata</i> , host of <i>Uromyces euphorbiae</i>	259	
<i>Evodia</i> —		
<i>latifolia</i> , susceptibility to <i>Pseudomonas citri</i>	345-346	
<i>ridleyi</i> , susceptibility to <i>Pseudomonas citri</i>	345, 346	
"False hybrids," susceptibility to <i>Pseudomonas citri</i>	359	
Fat production in milk, effect of drugs....	123-130	
Faustrieme, susceptibility to <i>Pseudomonas citri</i>	354	
Faustrimon, susceptibility to <i>Pseudomonas citri</i>	354	
Faustrimedin, susceptibility to <i>Pseudomonas citri</i>	354	
Fennel, effect on milk and fat production..	125-130	
Fermentation, influence on the starch content of experimental silage.....	173-179	
<i>Feronia</i> —		
<i>elephantum</i> . Syn. <i>Feronia limonia</i> .		
<i>limonia</i> , susceptibility to <i>Pseudomonas citri</i>	342, 345	
<i>Feroninae</i> , susceptibility to <i>Pseudomonas citri</i>	342	
<i>Feroniella lucida</i> , susceptibility to <i>Pseudomonas citri</i>	342, 345, 347	
Ferrous oxide in greensand.....	244	
Ferrous sulphate, effect on availability of potassium of greensand.....	242-256	
Fiber, wool, influence of humidity on strength and elasticity.....	55-62	
Filtrates, germ-free, in complement-fixation test.....	513-515	

Page	Page		
Fixed intermediate in barley crosses.....	575-592	Halo-Blight of Oats (paper).....	139-172
Flea beetles. See <i>E pitrix cucumeris</i> .		Hannchen barley, daily development of kernels.....	393-430
Folsom, Donald, and Schultz, E. S. (paper): Transmission of the Mosaic Disease of Irish Potatoes.....	315-338	Hardy, J. I. (paper): Further Studies on the Influence of Humidity upon the Strength and Elasticity of Wool Fiber.....	55-62
Formalin, prevention of injury to seeds by presoak method.....	363-392	Harlan, Harry V. (paper): Daily Development of Kernels of Hannchen Barley from Flowering to Maturity at Aberdeen, Idaho.....	393-430
<i>Fortunella</i> —		Harlan, Harry V., and Anthony, Stephen (paper): Development of Barley Kernels in Normal and Clipped Spikes and the Limitations of Awnless and Hooded Varieties.....	431-472
<i>crassifolia</i> , susceptibility to <i>Pseudomonas citri</i>	344, 345	Harlan, Harry V., and Hayes, H. K. (paper): Occurrence of the Fixed Intermediate, <i>Hordeum intermedium haxtoni</i> , in Crosses between <i>H. vulgare pallidum</i> and <i>H. distichon palmella</i>	575-592
<i>Hindsii</i> , susceptibility to <i>Pseudomonas citri</i>	344, 345, 347, 348	Harris, Arthur J. (paper): Practical Universality of Field Heterogeneity as a Factor Influencing Plot Yields.....	279-314
<i>japonica</i> , susceptibility to <i>Pseudomonas citri</i>	344, 345, 348	Hayes, H. K., and Harlan, Harry V. (paper): Occurrence of the Fixed Intermediate, <i>Hordeum intermedium haxtoni</i> , in Crosses between <i>H. vulgare pallidum</i> and <i>H. distichon palmella</i>	575-592
<i>margarita</i> , susceptibility to <i>Pseudomonas citri</i>	344, 345, 348	Hayes, H. K., Parker, John H., and Kurtzweil, Carl (paper): Genetics of Rust Resistance in Crosses of Varieties of <i>Triticum vulgare</i> with Varieties of <i>T. durum</i> and <i>T. dicoccum</i>	523-542
Foxtail. See <i>Chaetochloa lutescens</i> .		Hays, Frank A., and Thomas, Merton G. (paper): Effect of Drugs on Milk and Fat Production.....	123-130
Frederich, William J., and Peltier, George L. (paper): Relative Susceptibility to Citrus-Canker of Different Species and Hybrids of the Genus <i>Citrus</i> , Including the Wild Relatives.....	339-362	<i>Hesperthusa crenulata</i> , susceptibility to <i>Pseudomonas citri</i>	343, 345, 347, 348
Freezing, effect on—		Heterogeneity in fields—	
<i>Bacterium coronafaciens</i>	153	influence on yield of—	
composition of wheat.....	181-188	alfalfa hay.....	286-291
Fulton, H. R. (paper): Decline of <i>Pseudomonas citri</i> in the Soil.....	207-223	corn.....	296-299
Further Data on the Orange-Rusts of <i>Rubus</i> (paper).....	501-512	hops.....	295
Further Studies on the Influence of Humidity upon the Strength and Elasticity of Wool Fiber (paper).....	55-62	kherson oats.....	294
Gas formation of <i>Bacterium coronafaciens</i> ..	157-158	mangolds.....	284
Genetics of Rust Resistance in Crosses of Varieties of <i>Triticum vulgare</i> with Varieties of <i>T. durum</i> and <i>T. dicoccum</i> (paper).....	523-542	nitrogen content of wheat.....	294-295
Genetics, teosinte-maize hybrid.....	1-38	orchard crops.....	299-300
Gentian, effect on milk and fat production..	125-130	potatoes.....	284-286
Germ-Free Filtrates as Antigens in the Complement-Fixation Test (paper).....	513-515	ragi.....	291-294
Germination of—		rice.....	295-296
<i>Gymnoconia interstitialis</i> , influence of temperature.....	502-503	timothy hay.....	286
seeds, effect of reaction of solution.....	73-96	wheat.....	291
wheat, effect of formalin.....	366-379	physical and chemical basis.....	300-311
<i>Gibberella saubinetii</i> , production of conidia.	235-237	Hooded barley, limitations.....	431-472
Ginger, effect on milk and fat production..	125-130	<i>Hordeum</i> —	
Glucose in Bartlett pears.....	482-499	<i>distichon palmella</i> —	
<i>Glycosmis pentaphylla</i> , immunity to <i>Pseudomonas citri</i>	341-346	cross with <i>H. vulgare pallidum</i>	575-592
Gochenour, William S. (paper): Germ-Free Filtrates as Antigens in the Complement-Fixation Test.....	513-515	<i>zeccriton</i> , intermediate.....	576
Gramma, blue. See <i>Bouteloua gracilis</i> .		<i>intermedium haxtoni</i> , in barley crosses....	575-592
Grapefruit—		<i>jubatum</i> , host of <i>Puccinia graminis tritici</i>	270
infection of roots by <i>Pseudomonas citri</i> ..	221-222	<i>vulgare</i> —	
See <i>Citrus maxima</i> .		host of <i>Puccinia glumarum</i>	258
Grass—		<i>pallidum</i> , cross with <i>H. distichon palmella</i>	575-592
alang-alang. See <i>Imperata</i> sp.		Humidity, effect on strength and elasticity of wool fiber.....	55-62
buffalo. See <i>Bulbtilis dactyloides</i> .			
Greensand, effect of manure-sulphur on availability of potassium.....	239-256		
<i>Gymnoconia interstitialis</i> —			
color of spores.....	503-504		
germination.....	502-503		
morphology of aeciospores.....	504-507		

- | Page | Page | | |
|--|---------|---|--------------------|
| Hungerford, Charles W. (paper): Rust in Seed Wheat and Its Relation to Seedling Infection. | 257-278 | Line-Selection Work with Potatoes (paper). 543-573 | |
| Hybrid, teosinte-maize. | 1-38 | "Loco weed." See <i>Oxytropis lamberti</i> . | |
| Hybrids, "false," susceptibility to <i>Pseudomonas citri</i> | 359 | Magnesium— | |
| Hydroxid, sodium, effect on germination and growth. | 74-96 | oxid in greensand. | 244 |
| <i>Imperata</i> — | | sulphate, effect on germination and growth. | 74-96 |
| <i>cylindracea</i> , resistance to <i>Sclerospora philippinensis</i> | 104 | Magnus, J. R. (paper): Investigations in the Ripening and Storage of Bartlett Pears. | 473-500 |
| sp., resistance to <i>Sclerospora javanica</i> | 105 | Maize— | |
| Indol production by <i>Bacterium coronafaciens</i> | 151 | hybrid with teosinte. | 1-38 |
| Influence of Fermentation on the Starch Content of Experimental Silage (paper). | 173-179 | See <i>Zea mays</i> . | |
| Insect transmission of— | | Malcomson, A. W., and Ashby, R. C. (paper): Variation of Individual Pigs in Economy of Gain. | 225-234 |
| corn mosaic. | 520-521 | Malic acid. See Acid, malic. | |
| sugar-cane mosaic. | 131-138 | Manchuria barley, effect of removing awns. | 432-453 |
| Intermediate, fixed, in barley crosses. | 575-592 | Manure-sulphur composts, effect on availability of potassium of greensand. | 239-256 |
| Investigations in the Ripening and Storage of Bartlett Pears (paper). | 473-500 | McCall, A. G., and Smith, A. M. (paper): Effect of Manure-Sulphur Composts upon the Availability of the Potassium of Greensand. | 239-256 |
| Irish potato. See <i>Solanum tuberosum</i> . | | McCool, M. M., and Millar, C. E. (paper): Effect of Calcium Sulphate on the Solubility of Soils. | 47-54 |
| Johann, Helen, and Dickson, James G. (paper): Production of Conidia in <i>Gibberella saubinetii</i> | 235-237 | McIlvaine, T. C., and Salter, Robert M. (paper): Effect of Reaction of Solution on Germination of Seeds and on Growth of Seedlings. | 73-96 |
| Juniper berries, effect on milk and fat production. | 125-130 | Mealy bug, sugar-cane. See <i>Pseudococcus boninensis</i> . | |
| Kempton, J. H., and Collins, G. N. (paper): A Teosinte-Maize Hybrid. | 1-38 | <i>Melia azedarach</i> , immunity to <i>Pseudomonas citri</i> | 341 |
| Kernels, barley— | | <i>Melicope triphylla</i> , susceptibility to <i>Pseudomonas citri</i> | 345, 346 |
| daily development. | 393-430 | <i>Microcitrus</i> — | |
| development in normal and clipped spikes. | 431-472 | <i>australasica</i> — | |
| <i>Koeleria cristata</i> on northern Great Plains. | 65-72 | susceptibility to <i>Pseudomonas citri</i> | 344, 345, 347, 348 |
| Kumquat. See <i>Fortunella</i> spp. | | var. <i>sanguinea</i> , susceptibility to <i>Pseudomonas citri</i> | 344, 345, 347 |
| Kunkel, L. O. (paper): Further Data on the Orange-Rusts of <i>Rubus</i> | 501-512 | <i>australis</i> , susceptibility to <i>Pseudomonas citri</i> | 344, 345, 347, 348 |
| Kurtzweil, Carl, et al. (paper): Genetics of Rust Resistance in Crosses of Varieties of <i>Triticum vulgare</i> with Varieties of <i>T. durum</i> and <i>T. dicoccum</i> | 523-542 | <i>Garrowayi</i> , susceptibility to <i>Pseudomonas citri</i> | 344, 345, 347 |
| <i>Lacinaria punctata</i> on northern Great Plains. | 65-72 | Mildew, Philippine downy. See <i>Sclerospora philippinensis</i> . | |
| <i>Lactuca sparsifolia</i> on northern Great Plains. | 65-72 | Milk production, effect of drugs. | 123-130 |
| <i>Lansium domesticum</i> , susceptibility to <i>Pseudomonas citri</i> | 341 | Millar, C. E., and McCool, M. M. (paper): Effect of Calcium Sulphate on the Solubility of Soils. | 47-54 |
| <i>Laptinolaria decemlineata</i> , failure to transmit potato mosaic. | 329 | Moisture— | |
| Lavanginae, susceptibility to <i>Pseudomonas citri</i> | 343 | relations of <i>Bacterium coronafaciens</i> | 151 |
| Leafhopper, sharp-headed grain. See <i>Draeculacephala molipes</i> . | | soil, influence on persistence of <i>Pseudomonas citri</i> | 214-217 |
| Lee, H. Atherton (paper): Behavior of the Citrus Canker Organism in the Soil. | 189-206 | Mosaic Disease of Corn (paper). | 517-522 |
| Lime— | | Mosaic— | |
| air-slaked, effect on milk and fat production. | 125-130 | Irish potato— | |
| inefficacy in preventing seed injury from formalin. | 363-392 | transmission by— | |
| milk of, effect on germination of wheat. | 379 | grafting. | 319-320 |
| Lime. See <i>Citrus aurantifolia</i> . | | insects. | 326-332 |
| Limelo, susceptibility to <i>Pseudomonas citri</i> | 356 | plant juice. | 320-326 |
| Limequat, susceptibility to <i>Pseudomonas citri</i> | 356 | soil harboring. | 335-337 |
| <i>Limonia glutinosa</i> . Syn. <i>Chaetospermum glutinosum</i> . | | sugar-cane, artificial and insect transmission. | 131-138 |
| | | Moznette, G. F. (paper): Banana Root-Borer. | 39-46 |

Page	Page
<i>Muhlenbergia cuspidata</i> on northern Great Plains.....	65-72
<i>Murræa exotica</i> . Syn. <i>Chalcas exotica</i> .	
<i>Musa</i> spp., hosts of <i>Cosmopolites sordidus</i>	39-46
Navel orange. See <i>Citrus sinensis</i> .	
Nitrate—	
potassium, effect on germination and growth.....	74-96
sodium, effect on germination and growth.....	74-90
Nitrogen content—	
change during development of barley kernels.....	412-428
of wheat, effect of freezing.....	183-186
of kernels from normal and clipped barley spikes.....	452-469
Nonrutaceous plants, susceptibility of <i>Pseudomonas citri</i>	341
<i>Nux vomica</i> , effect on milk and fat production.....	124
Oats. See <i>Avena sativa</i> ..	
Occurrence of the Fixed Intermediate, <i>Hordeum intermedium haxtoni</i> , in Crosses between <i>H. vulgare pallidum</i> and <i>H. distichon palmella</i> (paper).....	575-592
Oil, castor, effect on milk and fat production..	124
Orange, navel. See <i>Citrus sinensis</i> .	
Orangelo, susceptibility to <i>Pseudomonas citri</i> .	356
Orangequat, susceptibility to <i>Pseudomonas citri</i>	357
Orange-rusts of <i>Rubus</i> . See <i>Gymnoconia interstitialis</i> .	
Oxid—	
aluminum, in greensand.....	244
calcium, in greensand.....	244
ferrie, in greensand.....	244
magnesium, in greensand.....	244
<i>Oxytropis lamberti</i> , on northern Great Plains..	65-72
<i>Panicum dichotomiflorum</i> , susceptibility to sugar-cane mosaic.....	134
<i>Paramignya longipedunculata</i> , susceptibility to <i>Pseudomonas citri</i>	345
Parker, John H., et al. (paper): Genetics of Rust Resistance in Crosses of Varieties of <i>Triticum vulgare</i> with Varieties of <i>T. durum</i> and <i>T. dicoccum</i>	523-542
Pears, Bartlett, ripening and storage.....	473-500
Peltier, George L., and Frederick, William J. (paper): Relative Susceptibility to Citrus-Canker of Different Species and Hybrids of the Genus <i>Citrus</i> , Including the Wild Relatives.....	339-362
Pentoxid, phosphorus, in greensand.....	244
<i>Peronospora maydis</i> . Syn. <i>Sclerospora javanica</i> .	
<i>Petalostemon</i> —	
<i>candidum</i> on northern Great Plains.....	65-72
<i>purpureum</i> on northern Great Plains.....	65-72
Philippine Downy Mildew of Maize (paper). ..	97-122
Phosphate—	
calcium, effect on solubility of soils.....	50-51
dipotassium, effect on germination and growth.....	74-96
Phosphoric acid. See Acid, phosphoric.	
Phosphorus pentoxid in greensand.....	244
Physostigmine—	
effect on milk and fat production.....	124
sulphate, effect on milk and fat production.....	125-130
Pigs, variation in economy of gain.....	225-234
Pilocarpine, effect on milk and fat production	124
Pituitarian, effect on milk and fat production.	124
<i>Polygala alba</i> on northern Great Plains.....	65-72
<i>Poncirus trifoliata</i> , susceptibility to <i>Pseudomonas citri</i>	343, 345, 347, 348
Potassium—	
effect of manure-sulphur composts on availability in greensand.....	239-256
nitrate, effect on germination and growth.	74-96
sulphate, effect on germination and growth.	74-96
Potato, Irish. See <i>Solanum tuberosum</i> .	
Practical Universality of Field Heterogeneity as a Factor Influencing Plot Yields (paper).....	279-314
Presoak Method of Seed Treatment: A Means of Preventing Seed Injury Due to Chemical Disinfectants and of Increasing Germicidal Efficiency (paper).....	363-392
Production of Conidia in <i>Gibberella saubinetii</i> (paper).....	235-237
<i>Pseudococcus boninensis</i> , failure to carry sugar-cane mosaic.....	136
<i>Pseudomonas</i> —	
<i>avenae</i> , causal organism of bladeblight of oats.....	167
<i>citri</i> —	
behavior in soil.....	189-206
decline in the soil.....	207-223
relative susceptibility of species of Citrus.....	339-362
<i>Psoralea argophylla</i> on northern Great Plains.	65-72
<i>Puccinia</i> —	
<i>coronata</i> —	
<i>agropyri</i> , pathogenic on <i>Agropyron repens</i> .	258
pathogenic on oats.....	257, 265
<i>glumarum</i> —	
on caryopses of Gramineae.....	258, 265
resistance of wheats.....	526
<i>graminis</i> —	
in Australia.....	257
resistance of wheat crosses.....	523-542
<i>tritici</i> —	
effect on germination.....	263
effect on growth of seedlings.....	263-275
parasitic on <i>Hordeum jubatum</i>	270
resistance of wheat crosses.....	524-542
<i>malvacearum</i> , pathogenic on hollyhock seeds.....	259
<i>montanensis</i> , pathogenic on <i>Elymus canadensis</i>	257
<i>simplex</i> , pathogenic on barley kernels.....	258
<i>triticea</i> , parasitic on wheat.....	265
Pummelo. See <i>Citrus maxima</i> .	
Ragi. See <i>Eleusine coracana</i> .	
Raspberry, black, host of <i>Gymnoconia interstitialis</i>	501-507
<i>Ratibida columnaris</i> on northern Great Plains.	65-72
Relative Susceptibility to Citrus Canker of Different Species and Hybrids of the Genus <i>Citrus</i> , Including the Wild Relatives (paper).....	339-362

	Page		Page
<i>Rhizobium leguminosarum</i> , critical soil reaction.....	85	Seed treatment, presoak method.....	363-392
Root-borer, banana. See <i>Cosmopolites sordidus</i> .		Seeds, germination, effect of reaction of solution.....	73-96
<i>Rotboellia exaltata</i> , resistance to <i>Sclerospora philippinensis</i>	104	<i>Severinia buxifolia</i> , immunity to <i>Pseudomonas citri</i>	343; 345; 347
<i>Rubus</i> —		Siamelo, susceptibility to <i>Pseudomonas citri</i> ..	357
<i>alleghainensis</i> , host of <i>Gymnoconia interstitialis</i>	506	Siamor, susceptibility to <i>Pseudomonas citri</i> .	357
<i>americanus</i> , host of <i>Gymnoconia interstitialis</i>	505-506	Silage, influence of fermentation on starch content.....	173-179
<i>canadensis</i> , host of <i>Gymnoconia interstitialis</i>	506	Smith, A. M., and McCall, A. G. (paper): Effect of Manure-Sulphur Composts upon the Availability of the Potassium of Greensand.....	239-256
<i>cuneifolius</i> , host of <i>Gymnoconia interstitialis</i>	505-506	Sodium—	
<i>hispidus</i> , host of <i>Gymnoconia interstitialis</i>	505-506	bicarbonate, effect on milk and fat production.....	125-130
<i>nigrobaccus</i> , host of <i>Gymnoconia interstitialis</i>	505-506	hydroxid, effect on germination and growth.....	74-96
<i>parviflorus</i> , host of <i>Gymnoconia interstitialis</i>	505-506	nitrate, effect on germination and growth..	74-96
<i>procumbens</i> , host of <i>Gymnoconia interstitialis</i>	505-506	Soil—	
<i>strigosus</i> , host of <i>Gymnoconia interstitialis</i> ..	506	effect of calcium sulphate on solubility....	47-54
<i>triflorus</i> , host of <i>Gymnoconia interstitialis</i> ..	506	in vicinity of Northern Great Plains Field Station.....	63-64
<i>ursinus</i> , host of <i>Gymnoconia interstitialis</i>	505-506	<i>Pseudomonas citri</i> in.....	189-206, 207-223
spp., hosts of <i>Gymnoconia interstitialis</i>	501-512	<i>Solanum tuberosum</i> —	
Rust in Seed Wheat and Its Relation to Seedling Infection (paper).....	257-278	host of mosaic disease.....	315-338
Rust resistance in wheat crosses.....	523-542	line-selection work.....	543-573
Rutaceous plants, susceptibility to <i>Pseudomonas citri</i>	341	<i>Solidago pulcherrima</i> on northern Great Plains.....	65-72
Rye, wild. See <i>Elymus canadensis</i> .		Solubility of soils, effect of calcium sulphate..	47-54
<i>Saccharum</i> —		Sorghum. See <i>Andropogon sorghum</i> .	
<i>officinatum</i> , resistance to <i>Sclerospora philippinensis</i>	104	Species, new.....	97-122, 139-172
<i>spontaneum</i> , host of <i>Sclerospora</i> sp.....	104	Starch—	
Salter, Robert M., and McIlvaine, T. C. (paper): Effect of Reaction of Solution on Germination of Seeds and on Growth of Seedlings.....	73-96	in experimental silage, influence of fermentation.....	173-179
Salt, common, effect on milk and fat production.....	124	in frozen wheat.....	187
Salts, epsom, effect on milk and fat production.....	124	in silage.....	175-178
Sarvis, J. T. (paper): Composition and Density of the Native Vegetation in the Vicinity of the Northern Great Plains Field Station.	62-72	Stemrust. See <i>Puccinia graminis</i> .	
Satsuma. See <i>Citrus nobilis</i> var. <i>unshiu</i> .		Sterility in wheat crosses.....	527-532
Satsumelo, susceptibility to <i>Pseudomonas citri</i>	357	<i>Stipa</i> —	
Schultz, E. S., and Folsom, Donald (paper): Transmission of the Mosaic Disease of Irish Potatoes.....	315-338	<i>comata</i> on northern Great Plains.....	65-72
<i>Sclerospora</i> —		<i>spartea</i> on northern Great Plains.....	65-72
<i>graminicola</i> —		<i>viridula</i> on northern Great Plains.....	65-72
dissimilarity of <i>Sclerospora philippinensis</i> ..	105	Storage, effect on ripening of Bartlett pears.	473-500
var. <i>andropogonis-sorghii</i> , classification..	119	Striperust. See <i>Puccinia glumarum</i> .	
<i>javanica</i> , hosts.....	105	Sucrose in frozen wheat.....	137
<i>maydis</i> , suspected occurrence on teosinte...	105	Sugar-cane mosaic, artificial and insect transmission.....	131-138
<i>philippinensis</i> , n. sp.—		Sugars—	
causal organism.....	105-122	in Bartlett pears.....	480-499
hosts.....	103-105	in frozen wheat.....	187
<i>sacchari</i> , pathogenicity on sugar cane, maize, and teosinte.....	105	in silage.....	174-177
<i>Sclerostylis Hindsii</i> . Syn. <i>Fortunella Hindsii</i> .		Sulphate—	

Page	Triticum—Continued.	Page
	<i>sativum</i> , crosses.....	524
	<i>spelta</i> , crosses.....	524
	<i>turgidum</i> , crosses.....	524
	<i>vulgare</i> —	
	host of <i>Puccinia glumarum</i>	258
	rust resistance in crosses.....	523-542
	<i>Uromyces euphorbiae</i> , pathogenic on <i>Euphorbia dentata</i>	259
	Variation of Individual Pigs in Economy of Gain (paper).....	225-234
	Vibriion septique, separation by germ-free filtrates.....	513
	<i>Vicia sparsifolia</i> on northern Great Plains....	65-72
	Water—	
	effect on production of carbon dioxide by calcium sulphate in soil.....	51-52
	in barley kernels—	
	change during development of barley kernels.....	412-428
	from normal and clipped barley spikes.....	452-469
	Weed, "loco." See <i>Oxytropis lamberti</i> .	
	Weston, William H., jr. (paper): Philippine Downy of Mildew of Maize.....	97-122
	Wheat, relation of rust to seedling infection.....	257-278
	Whipple, O. B. (paper): Line-Selection Work with Potatoes.....	543-573
	Wild rye. See <i>Elymus canadensis</i> .	
	Wool fiber, influence of humidity on strength and elasticity.....	55-62
	<i>Xanthoxylum</i> —	
	<i>clava-hercules</i> , susceptibility to <i>Pseudomonas citri</i>	346
	<i>fagara</i> , susceptibility to <i>Pseudomonas citri</i>	346
	<i>rhelsa</i> , immunity to <i>Pseudomonas citri</i>	345
	sp., immunity to <i>Pseudomonas citri</i>	341
	Yoder, Lester, and Dox, Arthur W. (paper): Influence of Fermentation on the Starch Content of Experimental Silage.....	173-179
	Zea—	
	<i>mays</i> , host of—	
	mosaic disease.....	517-522
	Philippine downy mildew.....	97-122
	<i>ramosa</i> , growth of branches.....	25
	Sulphid of antimony, black, effect on milk and fat production.....	125-130
	Sulphur, effect on milk and fat production.....	125-130
	Sulphur-manure composts, effect on availability of potassium of greensand.....	239-256
	Sunlight, effect on <i>Bacterium coronafaciens</i>	153
	<i>Syntherisma sanguinalis</i> , susceptibility to sugar-cane mosaic.....	134
	Tangelo, susceptibility to <i>Pseudomonas citri</i>	357
	Temperature—	
	influence on—	
	dry weight of Bartlett pears in storage.....	494-495
	germination of <i>Gymnoconia interstitialis</i>	502-503
	relation to—	
	<i>Bacterium coronafaciens</i>	151
	rust infection.....	269-270
	soil, effect on persistence of <i>Pseudomonas citri</i>	213-214
	Teosinte-Maize Hybrid, A (paper).....	1-38
	Teosinte. See <i>Euchlaena</i> —	
	<i>luxurians</i>	
	<i>mexicana</i>	
	<i>Tetranychus binaculatus</i> , transmission of sugar-cane mosaic.....	133
	Thomas, Merton G., and Hays, Frank A. (paper): Effect of Drugs on Milk and Fat Production.....	123-130
	<i>Toddalia asiatica</i> , susceptibility to <i>Pseudomonas citri</i>	345-346
	Transmission of the Mosaic Disease of Irish Potatoes (paper).....	315-338
	<i>Triphasia</i> —	
	<i>glauca</i> . Syn. <i>Eremocitrus glauca</i>	
	<i>trifolia</i> , immunity to <i>Pseudomonas citri</i>	343, 345-347
	<i>Triticum</i> —	
	<i>dicoccum</i> —	
	<i>dicoccoides</i> , discovery.....	525
	rust resistance in crosses with <i>T. vulgare</i>	523-542
	<i>durum</i> —	
	crosses.....	524
	rust resistance in crosses with <i>T. vulgare</i>	523-542
	<i>polonicum</i> , crosses.....	524



111
2

New York Botanical Garden Library



3 5185 00263 3723

