

JOURNAL
OF THE
ASIATIC SOCIETY OF BENGAL.

—◆—
VOL. LVII.

PART II. (NATURAL HISTORY, &c.)

(Nos. I. TO V.—1888.)

EDITED BY

J. WOOD-MASON, ESQ.,

VICE-PRESIDENT.

~~~~~  
"It will flourish, if naturalists, chemists, antiquaries, philologers, and men of science in different parts of *Asia* will commit their observations to writing, and send them to the Asiatic Society at Calcutta. It will languish, if such communications shall be long intermitted; and it will die away, if they shall entirely cease." SIR WM. JONES.  
~~~~~

CALCUTTA :

PRINTED AT THE BAPTIST MISSION PRESS,

AND PUBLISHED BY THE

ASIATIC SOCIETY, 57, PARK STREET.

1890.

6296





LIST OF CONTRIBUTORS.

	<i>Page</i>
ANDERSON, HENRY H.;— <i>Anoplophrya æolosomatis, a new Ciliate Infusorian parasitic in the Alimentary Canal of Æolosoma chlorostictum</i> W.-M., MSS. (Plate I.),	381
ATKINSON, E. T.;— <i>Notes on Indian Rhynchota; Heteroptera, No. 3,</i>	1
—————;— <i>Notes on Indian Rhynchota; Heteroptera, No. 4,</i>	118
—————;— <i>New or little-known Indian Rhynchota. (Plate XV),</i>	333
BLANFORD, H. F.;— <i>A List of the Ferns of Simla in the N. W. Himalaya between Levels of 4,500 and 10,500 Feet. (Plates XVI—XXI),</i>	294
BLANFORD, W. T.;— <i>Notes on Indian Chiroptera,</i>	260
COLLETT, H.;— <i>On certain Features in the Geological Structure of the Myelat District of the Southern Shan States in Upper Burmah as affecting the Drainage of the Country,</i>	384
CROMBIE, A., & PEDLER, ALEX.;— <i>On recent Tornadoes in Bengal with special reference to the Tornado at Dacca on April 7th, 1888. In two Parts. Part I. A Description of the Meteorological Conditions in Bengal which accompanied the Formation of the Dacca Tornado.—By ALEX. PEDLER, Offg. Meteorological Reporter to the Government of Bengal. Part II. A full Description of the actual Phenomena of the Dacca Tornado.—By A. CROMBIE, M. D., Civil Surgeon of Dacca. (Plates XXIV—XXIX),</i>	184
GILES, G. M.;— <i>Natural History Notes from H. M. Indian Marine Survey Steamer 'Investigator', Commander ALFRED CARPENTER, R. N., D. S. O., Commanding. No. 9. Further Notes on the Amphipoda of Indian Waters. (Plates VI—XII),</i>	220
HAMPSON, G. F.;— <i>The Butterflies of the Nilgiri District, South India,</i>	346
HILL, S. A.;— <i>The Psychrometer and the Condensing Hygrometer,</i> ...	369

	Page
MUKHOPADHYAY, ASUTOSH;— <i>A General Theorem on the Differential Equations of Trajectories</i> ,	72
—————;— <i>On Poisson's Integral</i> . (With a Woodcut),	100
—————;— <i>On the Differential Equation of all Parabolas</i> ,	316
NICE'VILLE, L. DE;— <i>On new or little-known Butterflies from the Indian Region</i> . (Plates XIII—XIV),.....	273
PEDLER, ALEX., & WARDEN, C. J. H.;— <i>On the Nature of the Toxic Principle of the Aroideæ</i> ,	106
PEDLER, ALEX., <i>see</i> CROMBIE, DR. A.	
THOMAS, OLDFIELD;— <i>On Eupetaurus, a new form of Flying Squirrel from Kashmir</i> . (Plates XXII—XXIII.),.....	256
WARDEN, C. J. H., <i>see</i> PEDLER, ALEX.	
WOOD-MASON, J.;— <i>Notes on some Objects from a Neolithic Settlement recently discovered by MR. W. H. P. DRIVER, at Ranchi in the Chota-Nagpore District</i> . (Plates II—V);	387

~~~~~

*Dates of issue of the different numbers of the Journal,  
Part II, 1888.*

- No. I.—Containing pp. 1—117, was issued on June 8th, 1888.
- No. II.—Containing pp. 117—219, with Plates XXIV, XXV, XXVI, XXVII, XXVIII, & XXIX, was issued on July 19th, 1888.
- No. III.—Containing pp. 219—272, with Plates VI, VII, VIII, IX, X, XI, XII, XXII, & XXIII, was issued on October 10th, 1888.
- No. IV.—Containing pp. 273—396, with Plates I, II, III, IV, V, XIII, XIV, XV, XVI, XVII, XVIII, XIX, XX, & XXI, was issued on March 23rd, 1889.
- No. V.—Containing Title-page, Index, &c., to the Volume.
- ~~~~~



LIST OF PLATES.

---

- I. *Anoplophrya ceolosomatis*.  
II. }  
III. } Objects from a Neolithic Settlement at Ranchi.  
IV. }  
V. }  
VI. }  
VII. }  
VIII. }  
IX. } Indian *Amphipoda*.  
X. }  
XI. }  
XII. }  
XIII. } Indian Butterflies.  
XIV. }  
XV. } Indian *Homoptera*.  
XVI. }  
XVII. }  
XVIII. } Simla Ferns.  
XIX. }  
XX. }  
XXI. }  
XXII. } *Eupetaurus cinereus*.  
XXIII. }  
XXIV. }  
XXV. }  
XXVI. } Charts illustrative of the papers on the Dacca Tornado of  
XXVII. } April 7th, 1888.  
XXVIII. }  
XXIX. }
-



# California Academy of Sciences

---

Presented by Asiatic Society of  
Bengal.

April      2      , 1907.



# JOURNAL

OF THE

## ASIATIC SOCIETY OF BENGAL.

Part II.—NATURAL SCIENCE.

No. I.—1888.

I.—Notes on Indian RHYNCHOTA: HETEROPTERA, No. 3.

By E. T. ATKINSON, B. A.

[Received, 25th July :—Read, August 3rd, 1887.]

Family PENTATOMIDÆ (*continued*).

Genus DALPADA (*continued*).

137. DALPADA TRIMACULATA, Westwood.

*Pentatoma 3-maculata*, Westw., Hope, Cat. Het. i, p. 41 (1837).

*Dalpada angulicollis*, Ellenr., Nat. Tijds. Ned. Ind. p. 142, f. 9 (1862); Walker, Cat. Het. i, p. 221 (1867).

*Dalpada triguttata*, Voll., Versl. Ak. Amst. Nat. (2) ii, p. 179 (1868).

*Dalpada trimaculata*, Dallas, List Hem. i, p. 184 (1851); Walker, l. c. p. 219 (1867); Stål, En. Hem. v. p. 44 (1876).

Piceous, punctured; a slender line on sides of pronotum, and a dorsal line with two large spots at basal angles of scutellum and its apex, whitish, posterior angles of pronotum prominulous, subacute: antennæ pale: body beneath luteous, sides broadly piceous (*Westw.*). Long,  $14\frac{1}{2}$  mill.

Reported from Philippines, Java, Borneo, Assam (mihi).

138. DALPADA BULBIFERA, Walker.

*Dalpada bulbifera*, Walker, Cat. Het. i, p. 223 (1867).

Testaceous, nearly fusiform, thickly and somewhat roughly punctured; punctures brown; beneath luteous, with a black stripe on each

side : head lanceolate, as long as the pronotum, with three irregular black stripes, of which the median is forked between the eyes ; tylus extending a little beyond the juga ; eyes very prominent ; rostrum with a black tip, extending rather beyond the last coxæ : antennæ piceous, slender, much more than half the length of the body, first joint not extending to the front ; 2-3 joints with testaceous tips ; second a little longer than the third ; fourth much longer than the third ; and than the fifth, which is testaceous at the base : pronotum, scutellum and hemelytra partly and slightly clouded with brown ; pronotum with a transverse impression, in front of which there are four black spots ; posterior angles black, smooth, shining, globose : scutellum attenuated towards the base : pectus with a black patch on each side containing three testaceous spots : abdomen beneath with a furrow which extends to the posterior margin of the fourth segment, with a piceous apical patch, and with two black stripes which include testaceous lateral spots : legs long, setulose, femora black-speckled, tibiæ piceous towards the tips : membrane cinereous, with broad brown streaks between the veins. Narrower than *D. nodifera*, Walker, with which it agrees in the structure of the posterior angles of the pronotum (*Walker*). Long body, 15 mill.

Reported from N. India.

### 139. DALPADA BREVIVITTA, Walker.

*Dalpada brevivitta*, Walker, Cat. Het. i, p. 224 (1867).

Dingy lurid, elliptical, minutely punctured ; punctures black, which hue here and there forms patches ; beneath dull tawny : head a little shorter than the pronotum ; tylus not extending beyond the juga ; eyes very prominent : rostrum very slender, extending a little beyond the hind border of the first abdominal segment : antennæ very slender, much shorter than the body ; first joint not extending to the front of the head, full half the length of the second, which is a little shorter than the third ; fourth and fifth black, a little longer than the third ; fifth shorter than the fourth : pronotum with the usual transverse impression, between which and the posterior margin is a broad lurid stripe ; posterior angles slightly acute, not prominent : scutellum not extending beyond the posterior angles of the corium : legs rather long and slender ; tarsi and tips of the femora and of the tibiæ black : hemelytra with two blackish patches ; membrane cinereous, with a broad brown streak and an incomplete brown border. Like *D. tecta*, Walker, in structure, but is much darker beneath, and the sides of the pronotum are serrated anteriorly (*Walker*). Long, 15 mill.

Reported from Cachar (Assam).

## 140. DALPADA TECTA, Walker.

*Dalpada tecta*, Walker, Cat. Het. i, p. 224 (1867).

Pale testaceous, elliptical, coarsely, and thickly punctured; punctures æneous, beneath luteous: head very little shorter than the pronotum; tylus hardly extending beyond the juga, a thinly punctured space on the hind border: eyes rather prominent; rostrum black towards the tip, extending a little beyond the fore border of the third abdominal segment: antennæ luteous, slender, black-speckled, first joint not extending to the front of the head; second shorter than the third: pronotum with a smooth longitudinal line, which is dilated on the transverse impression; hind angles obtuse, prominent: scutellum extending rather beyond the angle of the corium, with a smooth interrupted longitudinal line which is dilated on the fore borders at the tip: pectus and underside of abdomen thinly and minutely punctured on each side; punctures black: legs slender, black speckled: hemelytra with a short black stripe on the disc: membrane brown. Shorter than *D. affinis*, Dallas, and the posterior angles of the pronotum are neither convex nor smooth. Long, body, 13 mill.

Reported from Silhat.

## 141. DALPADA CONFUSA, Distant.

*Dalpada confusa*, Distant, Trans. Ent. Soc. p. 121 (1879): Scien. Res. 2nd Yarkand Miss. p. 3, f. 1, (1879).

Luteous, thickly covered with green punctures: head emarginate in front, with the sides reflexed and some small indistinct ochreous markings at the base: antennæ pitchy, each joint luteous at the base, the basal and apical joints smallest, second shorter than third, 3-4 subequal: rostrum just passing beyond the posterior coxæ, with the tip pitchy: pronotum somewhat transversely gibbous at the base, in a line with the lateral angles, after which it is abruptly deflexed towards the head; the lateral angles, prominent, subacute; lateral margins denticulated for about half their length from the apex; the punctuation is very dense along the lateral margins and at the pronotal angles: scutellum somewhat gibbous at the base, deflexed towards the apex, where it is more sparingly punctured: corium with a faint impunctate longitudinal line on the disc, extending from the base to about two-thirds its length, rather widened at the apex: membrane extending beyond the apex of the abdomen, pale fuscous, with the veins dark brown for half the length from the base, followed by a row of four brown spots and a marginal row of six spots of the same colour, the two outer ones being long and linear: underside of body luteous, with the pectoral and abdo-

minal margins broadly punctured with green, sparingly on abdomen and more densely on prostethium; legs luteous, thickly spotted with brown; tarsi luteous, apical joint pitchy (*Distant*). Long ♂, 14, breadth of angles of pronotum,  $6\frac{1}{2}$  mill: long ♀, 15-16; breadth of angles of pronotum,  $7\frac{1}{2}$  mill.

Reported from Murree (Punjab).

Add:—

*Dalpada apicifera*, Walker, Cat. i, p. 222 (1867) from Hong-Kong: much resembles *D. oculata*, but the posterior angles of the pronotum are not globose. Long,  $16\frac{3}{4}$  mill.

*Dalpada nodifera*, Walker, l. c. from Hong-Kong: posterior angles of the pronotum are more globose than those of *D. oculata*, and the first tibiæ are less dilated. Long,  $14\frac{3}{4}$  mill.

*Dalpada consobrina*, Walker, l. c., p. 225, from Siam, distinguishable from *D. clavata* by its larger size and the markings above and beneath. Long,  $16\frac{3}{4}$  mill.

*Dalpada brevis*, Walker, l. c. p. 226, from Hong-Kong: broader than *D. tecta*. Long,  $13\frac{1}{2}$  mill.

*Dalpada cinctipes*, Walker, l. c. p. 229, from N. China: angles of pronotum much less rounded than in *D. oculata* and the scutellum narrower near the tip. Long,  $16\frac{3}{4}$  mill.

#### Genus APODIPHUS, Spinola.

Ess. p. 295 (1837): Dallas, List Hem. p. 190 (1851): includes *Apodiphya*, Am. & Serv., Hist. Nat. Ins. Hém. p. 108 (1843): Fieber, Eur. Hem. p. 337 (1861).

Elongate: head with the juga extending well beyond the tylus and not uniting in front of it: rostrum arising at a little distance from the labrum and always before the antennæ, the third joint somewhat longer than the second, fourth only half of second: antennæ long, second joint twice as long as the first, third one-fourth the length of second, and fourth as long as second: lateral margins of head and abdomen unarmed: pronotum hexagonal; middle of the sides sinuate; anterior half serrate, humeral angles prominent: scutellum long, narrowed behind the middle towards the apex which is obtuse: mesostethium carinate.

#### 142. APODIPHUS AMYGDALI, Germar.

*Halys amygdali*, Germar, Reise Dalm. p. 284, t. 9, f. 4 (1817).

*Halys hellenica*, Lefeb., Mag. Zool. p. 24, t. 24 (1830): Herr. Schöff. Wanz. Ins. v, p. 67, t. 166, f. 512 (1839), and vii, p. 59 (1844): Kolenati, Mel. Ent. iv, p. 43 (1846).

*Halys exsculpta*, Burm. Handb. Ent. ii, p. 362 (1835).



*Apodiphya hellenica*, Am. & Serv. Hist. Nat. Ins. Hém. p. 108 (1843).

*Apodiphys hellenicus*, Spinola, Ess., p. 296 (1837); Dallas, List Hem. p. 190 (1851).

*Apodiphya amygdali*, Fieber, Eur. Hem. p. 337 (1861).

*Apodiphys amygdali*, Muls. & Rey, Pun. France, p. 354 (1866); Walker, Cat. Het. i, p. 232 (1867).

Rusty red, thickly punctured black, giving it a marbled appearance above; below, the black points are much finer: connexivum with four double black lines: a line from the tylus to the scutellum also sides of pectus, lighter rusty or yellow-red. Long, 18-22 mill.

Reported from eastern shores of Mediterranean, Greece, Baghdad (mihi), Assam.

### Genus ERTHESINA, Spinola.

Ess. p. 291 (1837): Am. & Serv. Hist. Nat. Ins. Hém. p. 104 (1843): Dallas, List Hem. i, p. 153 (1851): Walker, Cat. Het. i, p. 217 (1867): Stål, Ofvers. K. V.-A. Förh. p. 510 (1837); En. Hem. v, p. 37, 45 (1876).

Differs from *Halys* in having the first joint of the rostrum extending beyond the bucculæ and the veins of the membrane simple or somewhat furcate. The juga do not extend beyond the tylus, and are even a little shorter than it: first and last tibiæ dilated.

#### 143. ERTHESINA FULLO, Thunberg.

*Cimex fullo*, Thunb. Nov. Ins. Spec. p. 42, t. 2, f. 57 (1783).

*Cimex mucoreus*, Fabr. Ent. Syst. iv, p. 117 (1794).

*Halys mucorea*, Fabr., Syst. Rhyng. p. 183 (1803); Wolff, Ic. Cim. v, p. 185. t. 18, f. 179 (1811); Burmeister, Handb. Ent. ii (i), p. 363 (1835); Herr. Schöff. Wanz, Ins. vii, p. 60 (1844).

*Erthesina mucorea*, Spinola, Ess., p. 291 (1837); Am. & Serv. Hist. Nat. Ins. Hém. p. 104 (1843).

*Erthesina fullo*, Dallas, List Hem. i, p. 183 (1851); Uhler, Proc. Ac. Phil. p. 223 (1860); Walker, Cat. Het. i, p. 217 (1867); Stål, En. Hem. v, p. 45 (1876); Distant, Proc. Ent. Soc. p. lvii, (1878); A. M. N. H. (5 s.), iii, p. 45 (1879); Trans. Ent. Soc. p. 415 (1883).

Antennæ, black (apical joint yellow at the base); clypeus porrect, dentated, deep black, the margin and a median line, white: pronotum crenated, scutellum and hemelytra black, punctured white: wings black, immaculate: body olivaceous; margin of abdomen varied black, and a line before the margin formed of black dots: feet black, femora beneath and tibiæ, annulated white: first pair of tibiæ compressly membranous (*C. mucoreus*, Fabr.).

Head porrect, black, shining, impressly punctured; with a longitudinal line and somewhat raised margins, pale; apex with a small,

straight, impressed line on each side, and before the apex a small tooth; a small oblique pale line on both sides behind the fuscous eyes; beneath black, impressly punctured, a broad, pale, impunctate streak on each side: rostrum 4-jointed, long, subpilose, fuscous, pale at the base, lying between two pale, unidentate plates: antennæ 5-jointed, black, last joint yellow at the base: pronotum almost flat, deeply impressly punctured black; dots and spots, the margin and a longitudinal line somewhat elevated, pale; posterior angles somewhat acute: scutellum longer than half the abdomen, black, punctured like the pronotum but some of the dots large, distinct, callous, and with three larger whitish spots at the base: hemelytra obscurely fuscous, deeply impressly punctured, a large, more distinct, pale spot on the disc; membrane black, striated, shining; wings fuliginous: abdomen above fuscous, margin rounded, prominulous, flavescent, with four deep black ocellar spots on both sides; beneath convex, greyish, shining, with a groove at the base for the rostrum; five black marginal spots on both sides; penultimate segment spotted black: pectus testaceous with black impressed dots and patches, a fuscous speculum between the anterior and intermediate feet: anus entire: feet testaceous, unarmed; femora with two lines and several spots, black: first tibiæ dilated outwards at the apex, all the tibiæ angulate, black at base and apex, subpilose; last tibiæ compressed: tarsi 3-jointed, testaceous, black at the apex, subpilose (*Wolff.*). Long, 20-25 mill.

Reported from Java, Ceylon, Bombay, Bengal, China, Japan. The Indian Museum has specimens from Calcutta (mihi), Sikkim, Assam. Very variable in size and depth of colour and in having bucculæ anteriorly rounded or angulate.

#### 144. *ERTHESINA GUTTATA*, Fabricius.

*Cimex guttatus*, Fabr., Mant. Ins. ii, p. 291 (1787); Ent. Syst. iv, p. 108 (1794).

*Edessa guttata*, Fabr., Syst. Rhyng, p. 151 (1803).

*Erthesina guttata*, Stål, Hem. Fabr. i, p. 23 (1868); En. Hem. v, p. 45 (1876).

Head oblong, greenish, with a dorsal line and margin whitish: pronotum punctured, scarcely spinose, greenish, sprinkled with numerous white dots: scutellum and hemelytra of the same colour as the pronotum: wings, black: margin of abdomen varied green and white: body beneath, flavescent, with greenish streaks and dots: first pair of femora above greenish, beneath flavescent: first tibiæ membranous, black, with a white ring; last femora yellow; last tibiæ, black with a yellow ring (*Fabr.*). Long 23-25 mill.

Reported from Siam, Ceylon, (mihi), India. Differs from *E. fullo*, Thunb. in its larger size, colour above, head broader anteriorly and apex of scutellum pale yellow-whitish.

145. *ERTHESINA ACUMINATA*, Dallas.

*Erthesina acuminata*, Dallas, List, i, p. 183 (1851); Walker, Cat. Het. i, p. 217 (1867); Stål, En. Hem. v, p. 45 (1876).

♂. Above greyish-testaceous, very thickly punctured with brown: head pointed in front, with the lateral margins slightly toothed near the apex; pitchy brown, with the lateral margins, and a median longitudinal impunctate line, testaceous; pronotum with the anterior portion pitchy brown, more thickly punctured than the posterior, with a short impunctate testaceous line continuous with that of the head: scutellum more coarsely punctured than the rest of the surface, the base with three indistinct testaceous spots: membrane brownish, semitransparent: margins of the abdomen variegated with black and yellow: body beneath testaceous, sparingly punctured with brown: abdomen with a transverse black line on each of the sutures; anal plate dark brown: sternum black: legs testaceous; femora with numerous brown points, and with a brown longitudinal streak on each side; tibiæ brownish at the base and the apex; dilatation of the anterior tibiæ triangular; tarsi with the tip of the apical joint, and the claws, brown: rostrum testaceous, with the apical joint and the edges of the groove in the second and third, deep pitchy brown: antennæ brown, with the two apical joints pitchy, the base of the last joint orange (*Dallas*). Long, 21 mill.

Reported from N. Bengal.

## Genus HALYS, Fabricius, Dallas.

Fabr., pt, Syst. Rhyng. p. 103 (1803): Am. & Serv. Hist. Nat. Ins. Hém. p. 108 (1843): Herr. Schöff. Wanz. Ins. vii, p. 54 (1844): Dallas, List Hem. i, p. 153, 187 (1851): Walker, Cat. Het. i, p. 230 (1867): Stål, Hem. Afric. i, p. 80 (1864); Ofvers. K. V.-A. Forh. p. 510 (1867); En. Hem. v, p. 45 (1876).

Head elongated, tapering in front; tylus as long as, or longer than, the jugs; first joint of rostrum not extending beyond the bucculæ: last tibiæ simple, not dilated: apical angles of sixth segment of abdomen rounded at the apex: veins of membrane irregularly ramulose. In *Erthesina*, the last tibiæ are dilated; in *Dalpada*, the head is rounded or truncated at the apex with the sides more or less parallel.

146. *HALYS DENTATA*, Fabricius.

*Cimex dentatus*, Fabr., Syst. Ent. p. 702 (1775); Spec. Ins. ii, p. 346 (1781); Mant. Ins. ii, p. 284 (1787); Ent. Syst. iv, p. 96 (1794); Wolff. Ic. Cim. ii, p. 51, t. 6, f. 48 (1801): Stoll, Punaises, p. 33 t. 6, f. 47 (1788).

*Cimex sulcatus*, Thunberg, Nov. Ins. Spec. ii, p. 43 (1783).

*Halys serrigera*, Westwood, Hope, Cat. Hem. i, p. 23 (1837).

*Halys serricollis*, Westwood, Hope, Cat. Hem. i, p. 23 (1837).

*Halys dentata*, Fabr., Syst. Rhyng. p. 180 (1803); Herr. Schöff. Wanz. Ins. vii, p. 60, t. 233, f. 724 (1844); Dallas, List Hem. i, p. 187 (1851); Walker, Cat. Het. i, p. 230 (1867); Stål, En. Hem. v, p. 45 (1876); Distant, A. M. N. H. (5 s.) iii, p. 45 (1879).

Body cinereous and varied with black: head porrect, unidentate on each side: pronotum spinose and with four small teeth on the margin: abdomen beneath canaliculate (*Fabr.*). Antennæ 5-jointed, fuscous, first joint short, stout, rest rufescent at the apex: head, pronotum, scutellum, hemelytra and pectus, greyish, with numerous fuscous or black points and longitudinal lines: head with a small tooth on each side before the fuscous eyes, and two small, flexuose, longitudinal, fuscous lines on the apex; ocelli distant; rostrum 4-jointed, fuscous, greyish at the base, almost as long as the body, second joint curved: pronotum unequal anteriorly, margin (especially the antero-lateral) serrulate, the posterior angles obtusely spinose, transversely impressed in the middle: scutellum as long as half the abdomen, apiculate, with two small impressed lines in the middle, and other black longitudinal lines, also many impressed fuscous points: hemelytra with many impressed fuscous points and black spots forming abbreviated bands; beneath paler: membrane flavescent adorned with black denticulated lines: wings fuliginous, with a fuscous spot at the apex: abdomen above, fuscous, variegated black; beneath fuscous, shining, very finely impressly punctured, a median longitudinal impressed line from the rostrum, entire to the anus: all the feet unarmed, punctured fuscous; tibiæ angulate (*Wolff.*). Vars. (*a*), pronotum with two black longitudinal streaks: (*b*), teeth on the side of the head, obsolete: (*c*), colour paler. Long, 19-23 mill.

Reported from China, Japan, Assam, Bombay, Tranquebar. The Indian Museum possesses specimens from Arakan, Assam, Sikkim (mihi), Calcutta (mihi), Allahabad, Bombay, Madras. Very variable in size and colour.

#### Genus *ÆSTOPIS*, Distant.

A. M. N. H. (5 s.) iii, p. 48 (1879).

Ovate depressed, head triangular, juga much longer than the tylus, meeting beyond it, but divided at the apex: antennæ 4-jointed; first joint robust, not quite reaching the apex of the head; second joint a little shorter than the third; 3 and 4 subequal; the last somewhat thickened: rostrum reaching the posterior coxæ; apical joint longest: pronotum a little longer than the head, about twice as broad as long, the lateral margins denticulated, the lateral angles prominent; it is

slightly prominent and rounded at the base; deflexed towards the head: scutellum a little longer than broad, extending slightly beyond the base of the membrane, gradually narrowed for two-thirds its length from the base, whence it extends almost straight to the apex, which is narrowed and rounded: membrane with longitudinal veins: abdomen dilated, projecting a little on each side, convex below; abdomen, legs, and sternum unarmed (*Distant*).

The 4-jointed antennæ, length of the juga, and general shape of the body ally this genus to *Atelocera* and *Memmia*.

147.—*Cestopis terra*, Distant.

*Cestopis terra*, Distant, A. M. N. H. (5 s.) iii, p. 49 (1879).

Brownish luteous; corium with a reddish hue, thickly and somewhat regularly covered with darker punctures: head very thickly punctured and somewhat darker in hue: antennæ luteous; apical joint black, luteous at the base: pronotum with the punctures thicker and darker along the lateral and near the anterior margins: scutellum somewhat rugulose, and darker at the base: membrane pale fuscous: abdomen above pitchy; abdominal margin broad and distinct: sternum concolorous with upperside of body; underside of abdomen rather darker, with a faint median longitudinal black line: legs luteous, femora thickly speckled with black (*Distant*). Long, 17; breadth of angles of pronotum, 8 mill.

Reported from Khasiya hills, 4500—6000 feet, (Assam).

Genus *BELOPIS*, Distant.

A. M. N. H. (5 s.) iii, p. 50 (1879).

Broad, ovate: head triangular, juga longer than the tylus, and meeting beyond it, but divided at the apex: antennæ 5-jointed: pronotum rather more than twice broader than long; the lateral angles prominent, subacute, the lateral margins denticulated; deflexed towards the head: scutellum with the length equal to the breadth at the base, gradually narrowed for two-thirds the length, and then extending nearly straight to the apex, which is narrowed and rounded: membrane with longitudinal veins: abdomen dilated above, projecting a little on each side; convex below: sternum and abdomen unarmed; tibiæ moderately sulcated (*Distant*).

148.—*Belopis unicolor*, Distant.

*Belopis unicolor*, Distant, A. M. N. H. (5 s.) iii, p. 50 (1879).

Ochraceous, thickly and finely punctured; punctures somewhat darker on frontal half of pronotum and head: antennæ reddish; second

joint longer than the first, shorter than the fourth, 3 and 5 longest, subequal: scutellum with the median portion punctured, rather darker, lateral edges concolorous with other parts of the upper surface: membrane ochraceous; underside of body and legs concolorous, the former thickly and finely punctured (*Distant*). Long, 14; breadth of angles of pronotum, 10 mill.

Reported from the Khasiya hills (Assam).

Genus ORTHOSCHIZOPS, Spinola.

Gen. In. Art. p. 131 (1852); Stål, Hem. Afric. i, p. 78, 105 (1864); Walker, Cat. Het. i, p. 231 (1867). Stål, En. Hem. v, p. 48, (1876).

Body ovate: head produced; its lateral margins near the eyes armed with a tooth or forming an angle more or less distinct: juga longer than the tylus: bucculæ extended to the base of the head, moderately elevated: rostrum reaching to or extending a little beyond the last pair of feet: antennæ 5-jointed, slender, the first joint not reaching the apex of the head: anterior lateral margins of the pronotum irregularly denticulate: scutellum triangular, lateral margins sinuated in the middle; frena not, or only very slightly, extended behind the middle of the scutellum: membrane reticulated: sterna rather deeply furrowed: venter sometimes slightly furrowed: feet longish, robust, femora unarmed; tibiæ three cornered: corium longer than scutellum, its apical part not so broad (*Stål*).

149.—ORTHOSCHIZOPS ASSIMILIS, Westwood.

*Halys assimilis*, Westwood, Hope, Cat. Hem. i, p. 21 (1837).

*Orthoschizops assimilis*, Walker, Cat. Het. i, p. 232 (1867); Stål, En. Hem. v, p. 49 (1876).

Brunneous fuscous, punctured and variegated, black; head anteriorly sub-bifid; sides of pronotum serrate with some somewhat large spines, posterior angle a little prominent: scutellum whitish at the apex: membrane reticulated black: antennæ and feet fuscous brunneous (*Westw.*). Long, 16—17 mill.

Reported from India.

Add as 25 *b* :—

COPTOSOMA FIMBRIATUM, Distant.

*Coptosoma fimbriatum*, Dist., Trans. Ent. Soc. p. 342 (1887).

Body above, shining black: margin of head (broadly), eyes, ocelli, antennæ, lateral margins of the pronotum, abdominal margin as seen at the base of the scutellum, head beneath, rostrum, legs, margins of the sternum and the abdomen, and anal segment, reddish ochraceous: ab-

domen beneath shining black: sternum dull opaque black. The head is prominent, rounded in front, and not perceptibly sinuated in front of the eyes: the ocelli are situate wide apart, rather nearer to the eyes than to each other: and the tibiæ are sulcated above (*Dist.*). Long, 5; greatest breadth, 5 mill.

Reported from Sikkim (mihi), where it is rather common.

Div. SCIOCORARIA, Stål.

En. Hem. v, p. 49 (1876): *Sciocorides*, pt. Am. & Serv., Hist. Nat. Ins. Hém. p. 118 (1846); *Sciocoridæ*, pt., Dallas, List Hem. i, p. 130 (1851).

Head clypeated, not, or only rarely, a little narrower than the base of the scutellum, foliaceously dilated, amplified before the collum, intra-ocular part broader than the collum: ocelli remote from the small eyes; antenniferous tubercles remote from the sides of the head, not distinguishable from above; first joint of the antennæ not reaching the apex of the head: scutellum gradually, or somewhat so, narrowed, from the base; its sides not, or only very slightly, sinuated: entire lateral margins of the body flattened, laminated (*Stål.*)

Genus SCIOCORIS, Fallen.

Hem. Snec. p. 20 (1829): Dallas, pt., List. Hem. i, p. 131 (1851): Fieb. Eur. Hem. p. 355 (1861); Stål, Hem. Afric. i, p. 79, 120 (1864); Ofvers. K. V. A. Förh. xxix, 3, p. 35 (1872); En. Hem. v, p. 49, 50 (1876).

Body oval, depressed, beneath slightly convex: head longish, flattened, foliaceous, juga longer than the tylus, and anteriorly contiguous: ocelli small: rostrum reaching somewhat the last pair of coxæ, first joint not extending beyond the bucculæ posteriorly, second about equal to the two apical taken together: pronotum anteriorly broadly sinuated, lateral margins flattened: scutellum narrowed hindwards, sides not, or only very slightly, sinuated; frena short: veins of membrane simple: pro- and meso-stethium furrowed: feet moderate: first joint of last tarsi a little shorter than the two apical joints taken together (*Stål.*)

150. SCIOCORIS LATERALIS, Fieber.

*Sciocoris lateralis*, Fieber, Rhynch. p. 21 (1851); Walker, Cat. Het. i, p. 178 (1867); Stål, En. Hem. v, p. 51 (1876).

Oval, grey, thickly punctured brown: pronotum and scutellum with scattered callous spots: head semioval, flat, sides anteriorly almost angular, with a curved transverse impression: rostrum yellowish, terminal joint black: antennæ brownish-yellow, third joint brown above, fourth yellowish at the base, above brown like the entire fifth joint: pronotum  $2\frac{1}{2}$  times broader than long; emargination broad, shallow, curved; the disc equally gradually convex hindward; on the slightly

curve] edges, a longitudinal three-cornered whitish spot whose posterior corner reaches almost the humeral angles, the inner corner resting on the transverse furrow which is rather shallow: apex of scutellum rounded, margin sometimes whitish, basal angle black, with a small callous point: hemelytra uniformly thickly punctured, with some brown transverse streaks and dots; corium a little longer than the scutellum, apex almost acute-angled, a long four-cornered spot at the base, as also the principal vein with an abbreviated streak becoming broader hindward, yellowish-white: suture of membrane almost straight, membrane diaphanous with raised veins having scattered brown dots between them: dorsum black; the two posterior tibiæ with yellowish lateral spots: connexivum at the emarginations with four-cornered black-punctured and often ocellated spots: pectus black between the feet, the sides thickly punctured brown, the acetabula less so: feet coarsely punctured, before the tips of the femora a whitish and black punctured ring: abdomen thickly punctured brown, the median part, a zigzag lateral streak, and a semicircular lateral spot, yellowish-white; both sides of the lateral streak densely punctured; the middle of the base of the sixth abdominal segment and two dots on the third abdominal segment, black. Long,  $4\frac{1}{4}$  mill.

Reported from further India.

#### 151. *SCIOCORIS INDICUS.*

*Sciocoris indicus*, Dallas, List Hem. i, p. 132 (1851); Walker, Cat. Het. i, p. 177 (1867); (?) Stål, En. Hem. v, p. 128 (1876).

♀. Grey, punctured; head subelongate; antennæ fuscous at the apex; feet pale, punctured fuscous; membrane punctured fuscous; body beneath fuscous-grey, apical spot black (*Dallas*). Long  $5\frac{1}{2}$ —6 mill.

Reported from N. India.

#### Div. *MYROCHARIA*, Stål.

En. Hem. v, p. 52 (1876).

Lateral margins of the head and generally also of the pronotum flattened, laminated; the lateral margins of the head posteriorly not, or only obsoletely, sinuated; those of the pronotum entire or very obsoletely crenulate: jugs generally longer than the tylus, and, before the tylus, contiguous; antenniferous tubercles not, or only rarely, very slightly prominulous beyond the sides of the head: first joint of the antennæ not reaching the apex of the head: rostrum moderate or shortish, second joint shorter than the two apical taken together, or at least not longer: mesostethium generally furrowed: femora, at least the first pair, spinose beneath: venter without a furrow, unarmed at the base (*Stål*).



## Genus LAPRIUS, Stål.

Ofvers. K. V.-A. Förh. p. 200 (1861); l. c., p. 505 (1867); En. Hem. v, p. 52 (1876).

Head slightly narrowed forwards, subovate, almost as long as the pronotum; lateral margins not, or but very slightly, sinuate before the eyes; juga not, or but very slightly, extending beyond the tylus, entirely distant from each other; antenniferous tubercles very slightly prominent beyond the lateral margins of the head, with a small spine at the apex externally; first joint of the antennæ not reaching the apex of the head, second joint much longer than the third; ocelli moderate or large, moderately distant from the eyes, much more distant from each other; rostrum extending behind the intermediate pair of feet, second joint shorter than the two apical taken together: pronotum with anterior lateral margins entire, anterior angles not produced to the eyes, lateral angles prominent; anteriorly, between the eyes, broadly sinuate: frena extended beyond the middle of the scutellum which is triangular and gradually narrowed: pro- and meso-stethium distinctly furrowed: apertures of the odoriferous apparatus auriculate.

## 152. LAPRIUS VARICORNIS, Dallas.

*Sciocoris varicornis*, Dallas, List Hem. i, p. 136 (1851); Walker, Cat. Het. i, p. 177 (1867); Scott, A. M. N. H. (4 s.) xiv, p. 289 (1874).

*Laprius varicornis*, Stål, Ofvers. K. V.-A., Förh., p. 623 (1870); En. Hem. v, p. 52 (1876); Distant, A. M. N. H. (5 s.) iii, p. 45 (1879).

♂, ♀. Ovate, pale, brownish grey, very thickly and finely punctured with brown: eyes black: pronotum with the anterior angles acute, somewhat produced anteriorly: scutellum with a small pale impunctate spot in each basal angle: hemelytra more or less ferruginous, membrane brownish: abdomen beneath very thickly punctured with black, the punctures of the margins sometimes colourless; within the line of the stigmata on each side, is a row of short whitish lines: legs testaceous; femora with a few brown points; tibiæ towards the apex and the tarsi brown: rostrum testaceous, with the apex brown: antennæ with the three basal joints red, the apex of the third black; two apical joints black, with the base yellowish. A variety has a red tinge on the upper surface; margins of abdomen beneath, tips of femora, base and tips of tibiæ, and entire third joint of antennæ, red (*Dallas*). Long, ♂, 11 mill; ♀ 11 $\frac{3}{4}$  mill.

Reported from N. India, Rangoon, Philippines, China, Japan, common in Sikkim (mihi).

## 153. LAPRIUS GASTRICUS, Thunberg.

*Cimex gastricus*, Thunb., Hem. Rostr. Cap. ii, p. 1 (1822).

*Paramecocoris gastricus*, Stål, Ofvers. K. V.-A. Förh. p. 182 (1855); *l. c.*, p. 56 (1856); Walker, Cat. Het. i, p. 178 (1867).

*Laprius gastricus*, Stål, En. Hem. v, p. 52 (1876); Distant, Trans. Ent. Soc., p. 415 (1883).

Yellow-testaceous, densely and somewhat deeply punctured black fuscous: head with the sides parallel, oblique from the middle: scutellum furnished on both sides at the base with a yellow testaceous callus, impunctate: membrane fuscous: body beneath with feet, of a weaker colour, less densely punctured; abdomen with a blackish streak on both sides; antennæ rufescent, two last joints fuscous, sordid yellow at the base (*Stål*). Long, 9; broad, 5 mill.

Reported from India, Japan.

Genus *ÆDNUS*, Dallas.

List Hem. i, p. 144 (1851); En. Hem. v, p. 54 (1876).

Head rather short, rounded and slightly emarginate at the apex, with the juga meeting beyond the tylus; eyes prominent; ocelli minute, distant; antennæ about half the length of the body, 5-jointed; basal joint shortest, not reaching the apex of the head; second joint shorter than the third, which is shorter than the fourth; fifth joint longest: rostrum rather short, not reaching the posterior coxæ, slender, inserted about the middle of the under surface of the head; basal joint reaching the base of the head; second joint longest, third longer than the first, fourth shortest: body ovate: pronotum transverse with the anterior angles projecting beyond the eyes: scutellum about two-thirds of the length of the abdomen, becoming narrower from the base to about the middle, then straight to the apex, which is broad and rounded: membrane with 4-5 longitudinal veins which are more or less ramose or somewhat reticulated at the apical margin: abdomen and sternum unarmed: legs moderate: femora with a double row of minute spines or tubercles on the under side, especially towards the apex: tarsi 3-jointed, with the basal and apical joints about equal (*Dallas*). Distinguished by the large size of the scutellum which reaches nearly to the apex of the body and thus gives it a great resemblance to *Podops*.

154. *ÆDNUS* OBSCURUS, Dallas.

*Ædnus obscurus*, Dallas, List Hem. i, p. 145, t. 3, f. 5 (1851); Walker, Cat. Het. i, p. 182 (1867); Stål, Ofvers. K. V.-A. Förh. p. 623 (1870); En. Hem. v, p. 54 (1876).

*Ædnus similis*, Hagl., Stettin Ent. Zeit. xxix, p. 154 (1868); Walker, Cat. Het. iii, p. 539 (1868).

♀. Above pitchy, obscure, very thickly punctured and some-

what rugose; membrane semitransparent, brownish, veins brown; abdomen beneath slightly shining, thickly and finely punctured, with the margins broadly testaceous, and finely punctured brown: legs brown, with the tarsi pale testaceous: rostrum testaceous, antennæ black, with the apical joint pale fulvous (*Dallas*). Long  $8\frac{1}{2}$ — $9\frac{1}{2}$  mill.

♂. Oblong fuscous-lurid, densely and strongly punctured fuscous, beneath shining subæneous: apex of antennæ, rostrum, coxæ and tarsi, also marginal streak on venter obscurely testaceous: membrane brunnescent, veins and margin more obscure: wings fuscous: second joint of antennæ somewhat shorter than the third: rostrum not reaching the last pair of coxæ; sides of pronotum nearly straight (*Haglund*). Long, 9; broad,  $5\frac{1}{4}$ ; exp. hemi., 17 mill.

Reported from Gilolo, Borneo, Java, Philippines, Rangoon.

### 155. *ÆDNUS VENTRALIS*, Dallas.

*Ædnus ventralis*, Dallas, Trans. Ent. Soc. (n. s.) ii, p. 10, t. 1, f. 3 (1852); Stål, En. Hem. v, p. 54 (1876); Distant, A. M. N. H. (5 s.), iii, p. 45 (1879).

Ovate, rather convex, pale greyish brown, very thickly and finely punctured with black: head rather small, very minutely punctured with black above and beneath: eyes pale; ocelli yellowish: antennæ slender, rather sparingly clothed with short hairs; three first joints testaceous, fourth joint pale brown, with the base testaceous; fifth joint, pale brown; rostrum yellow: pronotum very thickly and finely punctured with black, with the punctures more distant on a slightly impressed space which crosses the disc about the middle, forming a pale transverse band; immediately in front of this impressed space are four small tubercles: scutellum very large, reaching very nearly to the apex of the body, constricted a little before the middle; very thickly and finely punctured with black, more thickly punctured and somewhat rugose towards the base, where there is a small smooth whitish point on each side within the basal angles; the basal angles themselves black: pectus rather darker than the upper surface, very thickly and finely punctured with black: legs yellow; femora with numerous black or brown points, the anterior pair with a double row of small black spines on the lower surface: tibiæ with a few brown points, and with a few minute bristles along the edges: the coriaceous portion of the hemelytra rather less thickly punctured than the pronotum and scutellum: membrane transparent, colourless: wings semitransparent, iridescent: abdomen beneath deep shining black, slightly brassy, very thickly and finely punctured; the margins pale griseous, thickly and finely punctured with black; the edges with small black spots at the junctions of the segments

(Dallas). No portion of the inner or apical margin of the corium is covered by the scutellum. Long, 6—7½ mill.

Reported from Hong-Kong, Assam, Sikkim (mihi).

---

Following Stål, I place in the sub-family *Pentatomina* those genera of Dallas' *Pentatomidae* found in India which Stål distributes amongst the following divisions, and which are distinguished by having the tarsi 3-jointed and the scutellum extended to a distance behind the frena. The species are rather numerous and difficult to arrange, but I have no doubt that we shall, in a short time, be able to give a more exact distribution.

#### GROUP A.

*a.* The first group of these divisions includes those genera in which the venter is unarmed at the base, second segment without a spine or tubercle prominulous forwards and reaching, or somewhat so, the metastethium, and sometimes furrowed; margins of furrow, however, neither callously elevated, nor levigate: anterior margin of the pronotum very rarely somewhat elevated, levigate or callous: tibiæ above generally furrowed or flat and margined, except *Agonoscelis*, in which they are without a furrow and rounded: second joint of the antennæ sometimes not extending beyond the apex of the head: orifices entirely margined, or auriculated, or continued in a furrow.

*b.* Corium anteriorly generally confusedly punctured between the costal margin and the intracostal vein, the costal margin anteriorly generally acute or flattened and somewhat laminated, the space between the margin and the vein therefore somewhat broad; this space rarely very narrow (as in *Diploxyis*) with a single row of points: orifices generally continued outwards in a long or somewhat long furrow; basal angles of the scutellum rarely with a spot or levigate, callous streak: juga sometimes much longer than the tylus and acuminate: anterior lateral margins of the pronotum rarely obtusely rounded: second joint of the antennæ sometimes not, or barely, extending beyond the apex of the head.

*c.* Head flat or somewhat so, lateral margins acute and laminated or prominulous before the middle in a straight, tooth-shaped angle; juga generally longer than the tylus, often much longer and contiguous before the tylus: anterior lateral margins of pronotum generally acute, or somewhat so, sometimes laminated; bucculæ not prominulous posteriorly in a lobe: scutellum posteriorly narrow, or somewhat so: frena extended to rather a distance behind the middle of the scutellum: body never greenish: venter not, unless in the second segment, furrowed.

*d.* Basal angles of the scutellum without an impression or with a small somewhat rounded and somewhat obsolete one: sixth ventral segment in ♂ anteriorly rounded: entire second joint of the antennæ extending beyond the apex of the head: body oval or broadly oval; anterior lateral margins of the pronotum entire: third joint of rostrum longer than the fourth: furrow of the orifices moderate or somewhat short, abruptly abbreviated, not continued in a wrinkle or ridge.

This group includes the divisions *Odiaria*, *Tropycorypharia*, *Capæaria*, *Carpocoraria*, *Diploxiaria*, *Eysarcoriaria*, and *Agonosceliaria*.

#### Div. ODIARIA, Stål.

En. Hem. v, p. 55, (1876).

This division includes the genera having the characters given in *a.* to *d.* above.

#### Genus PARAMECUS, Fieber.

Rhynchotographia, p. 34 (1851).

Body elongate, somewhat convex: head elongate, almost equally broad throughout, convex beneath; the juga somewhat longer than the tylus, rounded on the sides, almost right-angled inwards: antennæ one-half the length of the body, joints almost of equal thickness, the third shortest; the second joint a little shorter than either of the two last: the jugular plates very low, as long as the basal joint of the rostrum, and shorter than the head: rostrum rather stout, reaching beyond the intermediate coxæ; second joint longest; third incrassate, half the length of the second; fourth cylindrical, black: prostethium short, not so long as the meso- or meta-stethium which are of equal length: pronotum hexagonal, convex between the humeral angles which are prominent and furnished with a small tooth: scutellum two-thirds the length of the dorsum, the last fourth of the length abruptly narrowed, pointed: hemelytra longer than the scutellum, pointed at the end; membrane reaching beyond the apex of the abdomen, with five furcate veins: tarsi robust, basal joint stouter, and as long as the two following taken together.

#### 156. PARAMECUS RUFICORNIS, Fieber.

*Paramecus ruficornis*, Fieb., Rhynch., p. 35 (1851): Stål, En. Hem. v, p. 71 (1876).

Ochreous-yellow, punctured black; elongate: pronotum anteriorly with two black points: scutellum with a slightly punctured, pale, median streak, and more slightly punctured patch; border line on pronotum and marginal spot, yellowish; two black points anteriorly: antennæ,

base of venter, dorsum beneath, and feet, yellow-ferruginous: membrane sordid, veins darker; stigmata and pectus, black (*Lieber*). Long,  $12\frac{1}{2}$  mill.

Reported from Further India.

Genus PLEXIPPUS, Stål.

Ofvers. K. V.-A. Förh., p. 505 (1867): En. Hem. v, p. 55, 71 (1876).

Head short, much shorter than the pronotum, almost shorter than broad between the eyes, rather narrowed forwards, rounded at the apex, lateral margins scarcely sinuate before the eyes; juga somewhat longer than the tylus, distant; ocelli a little more than twice more distant from each other than from the eyes; first joint of antennæ even with the apex of the head, second joint scarcely as long as the third; rostrum not extending beyond the intermediate feet, short: anterior margin of pronotum obliquely and somewhat broadly truncate behind the eyes, anterior lateral margins slightly rounded, anterior angles obtuse, a little prominulous beyond the eyes: apical angle of corium a little produced, apical margin somewhat sinuate near the apical angle: veins of membrane simple: pro-stethium slightly impressed; meso-stethium, slightly carinate: second ventral segment very slightly convexly elevated in the middle: odoriferous apertures continued in a not long, abruptly abbreviated furrow (*Stål*).

157. PLEXIPPUS DOËSALIS, Stål.

*Plexippus dorsalis*, Stål, Berlin Ent. Zeitsch. xiii, p. 226 (1869): En. Hem., p. 71 (1876).

♀. Subobovate: weakly greyish-flavescent, above rather densely punctured black, these dots are arranged behind the middle of the pronotum and before the middle of the scutellum in short irregular lines: membrane weakly fuscous-greyish, veins more obscure, exterior basal angle fuscous: dorsum of abdomen fuscous-violaceous; connexivum blackish, two last segments obsoletely palely streaked; wings slightly infusate; spiracula narrowly circled black. Like *R. fulvescens*, Dallas. Base of head, at the eyes, marked by an impunctate spot; juga gradually converging, a little distant at the apex: antennæ remotely and briefly setose, second joint more than twice as long as first: pronotum more than half longer than the head, almost more than twice broader than long, anterior margin slightly elevated between the eyes, lateral margins slightly rounded, narrowly black: scutellum sparingly palely punctured at the apex: exterior margin of corium narrowly blackish towards the base: pro-stethium sparingly and palely punctured, exterior margin black: meso-stethium sparingly punctured towards the coxæ

meta-stethium opaque, strigose, posteriorly and outwards shining, posteriorly sparingly punctured: venter aciculate, sparingly punctulate towards the sides, with a broad levigate median streak; second segment slightly convex in the middle, depressed on both sides at the convex part (*Stål*). Long, 15; broad, 8 mill.

Reported from India.

#### Div. TROPYCOEYPHARIA.

En. Hem. v, p. 56 (1876).

*a. b.* as in *Odiaria*, (p. 17).

*c.* Lateral margins of the head and pronotum not or less acute, those of the pronotum never laminated: juga rarely longer than the tylus, then generally acuminate or gradually narrowed: frena generally extended beyond the middle of the scutellum: in those genera in which the juga are longer than the tylus, generally not extending beyond the middle of the scutellum, in which case also the scutellum posteriorly broad, or somewhat so: body sometimes greenish: venter sometimes with a long furrow.

*d.* Head flat, juga rarely somewhat longer than the tylus: scutellum generally posteriorly narrow or moderately broad: frena generally extended behind the middle of the scutellum: entire second joint of the antennæ, or a great part, extending beyond the apex of the head: venter not furrowed.

*e.* First joint of rostrum very rarely extended behind the bucculæ, and if so, the basal angles of the scutellum have a largish, levigate, callous, pallid spot.

*f.* The furrow of the odoriferous apertures continued in a wrinkle or ridge extended beyond the middle of the breadth of the pleuræ, gradually acuminate.

*g.* Connexivum pale, green, or flavescent, without black or aenescent-black spots or bands, occupying the entire breadth of the segments: segments rarely more obscurely punctured anteriorly and posteriorly than in the middle: basal angles of scutellum without a callous spot or with a very minute and very obsolete one.

#### Genus NIPHE, *Stål*.

Ofvers. K. V.-A. Förh., p. 516 (1867): En. Hem. v, p. 56, 73 (1876).

Head gradually distinctly narrowed forwards, lateral margins acute, very slightly or but scarcely sinuate behind the middle; juga a little longer than the tylus, hiscent; bucculæ continued through, slightly raised; ocelli a little more than twice as far from each other than from the eyes; rostrum extended to or between the last pair of coxæ, first

joint about on a level with the bucculæ, second joint longer than the third; antennæ slender, first joint not reaching apex of head: anterior margin of pronotum neither reflexed nor callous, broadly sinuate, truncate behind the eyes, anterior lateral margins straight, very slightly reflexed, lateral angles somewhat obtuse, very slightly prominulous: scutellum moderate, much longer than broad, narrow at the apex, frena extended to third apical part of scutellum: costal margin of corium very slightly rounded, apical angle not produced: meso-stethium carinate: furrow from the odoriferous aperture gradually narrowed and continued in a ridge or wrinkle: abdomen not or hardly broader than the hemelytra, extremity of angles of segments prominulous: body narrowly obovate (*Stål*).

#### 158. NIPHE CEPHALUS, Dallas.

*Pentatoma cephalus*, Dallas, List Hem. i, p. 245 (1851); Walker, Cat. Het. ii, p. 303 (1867).

*Niphe cephalus*, Stål, Ofvers. K. V.-A. Förh., p. 516 (1867); En. Hem. v, p. 73 (1876).

♀. Oblong, ovate, pale yellowish brown, thickly and finely punctured with dark brown: head large, slightly emarginate at the apex, the juga a little longer than the tylus, eyes brown; ocelli yellow: pronotum with the punctures very close along the lateral margins, causing them to appear much darker than the rest of the surface: scutellum with the apex orange: membrane semi-transparent, brownish, with darker veins: abdomen beneath tawny, irregularly and sparingly punctured with black, with a brown spot in the middle of the third segment: pectus of the same colour as the abdomen, rather thickly punctured, with some of the punctures black: legs of the same colour, with numerous black points: rostrum brownish testaceous: antennæ testaceous, with the tip of the third, and apical half of the 4 and 5 joints, black (*Dallas*.) Long, 15—16 mill.

Reported from Java, India.

#### 159. NIPHE ELONGATA, Dallas.

*Pentatoma elongata*, Dallas, List Hem. i, p. 246 (1851); Walker, Cat. Het. ii, p. 299 (1837).

*Niphe elongata*, Stål, Ofvers. K. V.-A. Förh., p. 516 (1867), l. c. p. 625 (1870); En. Hem. v, p. 73 (1876).

♀. Elongate, somewhat oblong, with the sides parallel; testaceous, above thickly and finely punctured with black: head with the tylus as long as the juga; ocelli red: scutellum very long: coriaceous portion of the hemelytra with the outer margin yellowish-white; membrane semi-



transparent, brownish, with the veins a little darker: abdomen beneath testaceous, with the disc impunctate, the sides faintly punctured; stigmata black: pectus rather strongly punctured, with some of the punctures black: legs yellowish; tarsi fulvous: rostrum not passing the intermediate coxæ, pale yellow, with the tip black: antennæ with the three basal joints bright red; fourth black, with the base red; fifth black, with the base and apex red (*Dallas*). Long  $12\frac{1}{2}$ —13 mill.

Reported from Philippines, Rangoon, N. India. Differs from *N. cephalus*, Dallas, in its narrower stature and the costal limbus of the corium being furnished with colourless punctures.

#### Div. CAPPÆARIA.

En. Hem. v, p. 57 (1876).

a. to *f.* as in *Tropycorypharia*, (p. 19).

g. Segments of connexivum black, punctured, adorned with a median band or flavescent marginal spot, generally less densely punctured or somewhat levigate: basal angles of the scutellum marked by a pale, levigate spot, sometimes small and indeterminate and sometimes very large: anterior lateral margins of the pronotum slightly reflexed, sometimes callous, straight or somewhat so, entire, simple: tibiæ above, flat, margined.

#### Genus CAPPÆA, Ellenrieder.

Nat. Tijdskr. Ned. Ind. xxiv, p. 146 (1860); Walker, Cat. Het. ii, p. 144 (1867), Stål, Ofvers. K. V.-A. Förh., p. 514 (1867); En. Hem. v, p. 57, 74 (1876).

Allied to *Halys*, but body shorter, more depressed: head flat, as long as the pronotum, its basal margin broader than the anterior margin of the pronotum; juga shorter than the tylus, margin of juga, rounded, entire; tylus broader towards the apex which is arcuate: eyes small, prominulous; ocelli near the eyes, not very distinct: first joint of the antennæ shorter than the head, scarcely intumescent, 2-5 joints almost equal in length, third joint nodulose at the end, 4 and 5 joints robust: pronotum flattened, slightly sloped hindward behind the posterior interangular line; anterior angles somewhat acute, behind them, on the lateral margin, 3-4 not very conspicuous small teeth, posterior angles not very prominent, angular: scutellum broad, longer than half the abdomen: coriaceous portion of hemelytra long, flat; membrane short, extending beyond the abdomen which is almost orbicular, broader than the pronotum, its lateral margins extending beyond the hemelytra, flattened:

rostrum reaching second ventral segment, second joint very long, rest nearly equal, last somewhat smaller, robust: venter very convex, ventral furrow short, not conspicuous; feet slender (*Ellenr.*).

160. *CAPPÆA TAPROBANENSIS*, Dallas.

*Pentatoma taprobanensis*, Dallas, List Hem. i, p. 244 (1851); Walker, Cat. Hem. ii, p. 299 (1867).

*Cappæa multilinea*, *Ellenr. Nat. Tijdskr. Ned. Ind.* xxiv, p. 147, f. 17 (1862).

*Cappæa taprobanensis*, Stål, *En. Hem.* v, p. 74 (1876); Distant, A. M. N. H. (5 s.) iii, p. 45 (1879).

♀. Ovate, broad, flat: head rather long, rounded at the apex, black, with the lateral margins and three longitudinal lines testaceous: the black portions thickly and finely punctured, the pale lines impunctate: ocelli minute, yellow: pronotum testaceous, covered with fine black punctures, which leave only narrow lines of the pale colour visible: of the dark patches there are two small ones in the middle of the anterior margin, a larger ocellated spot in each anterior angle, two larger spots occupying the whole middle of the disc, and having a very distinct longitudinal median line, and two rather smaller on each side of these; there is also a narrow line of black punctures within each lateral margin: scutellum thickly punctured with black, especially at the base, with a pale impunctate line running down the middle from base to apex, and a curved line on each side of this running from the base to the middle of the median line, at which point the three lines are united: hemelytra testaceous, clouded with black punctures, with no distinct pale lines; membrane brownish, somewhat opaque, covered with brown spots: margins of the abdomen testaceous, with a large bifid black spot at the junction of each segment, both above and beneath: body beneath testaceous: abdomen smooth and shining, with a few fine punctures on the sides; the stigmata and two spots on each side of each segment, forming two longitudinal rows of spots on each side of the abdomen, black; the space between each pair of black spots is orange: pectus finely and irregularly punctured, with numerous black spots on each side: legs pale testaceous; femora thickly covered with black points; tibiæ covered with fine black points; tarsi nearly black: rostrum long, reaching the base of the third ventral segment; basal joint and the base of the second, testaceous; 2 and 3 joints brownish; fourth black: antennæ with the basal joint, testaceous, spotted with black; 2 and 3 joints brown, (*Dallas*). Long, 11—11½ mill.

Reported from Java, Sumatra, Ceylon, Assam. The Indian Museum has specimens from Ceylon, Malabar, Assam (Sibságar), Conoor (mihi).

## Genus HALYOMORPHA, Mayr.

Verh. Zool.-Bot. Ges. Wien. xiv, p. 911 (1864): Reise Novara, p. 47 (1866): Stål, En. Hem. v, p. 57, 74 (1876).

Body above compressed, beneath convex, head above flat, broad at apex, rounded, lateral margins narrowly reflexed, parallel, a little sinuate: tylus as long as the juga: antennæ 5-jointed, first joint not reaching apex of head, 3-5 joints somewhat of equal length, second joint shorter than third: bucculæ narrow, continued through, anteriorly dilated, subdentiform: rostrum reaching 2 or 3 segments of the abdomen; first joint a little shorter than the bucculæ, second joint scarcely twice as long as the first and shorter than the two apical taken together: eyes large, sessile: ocelli thrice more distant from each other than from the eyes: pronotum transversely somewhat sexangular, anterior angles with a transverse tooth, anterior lateral margins straight, smooth and narrowly reflexed, shoulders a little prominent, rounded: scutellum triangular, posteriorly narrowed: membrane with some somewhat parallel costæ: metastethium compressed: odoriferous aperture with a margined transverse furrow, produced to a distance outwards, gradually evanescent: abdomen beneath not sulcate, convex; margins acute, unarmed: feet simple: tibix broadly sulcate externally; first and third joints of tarsi of equal length (*Mayr*).

## 161. HALYOMORPHA PICUS, Fabricius.

*Cimex picus*, Fabr., Ent. Syst. iv, p. 115 (1794). India.

*Cimex marmoreus*, Fabr., Ent. Syst. Suppt. p. 534 (1798). India.

*Cimex cinnamomeus*, Wolff, Ic. Cim. iii, p. 99, f. 93 (1802). India.

*Edessa picus*, Fabr., Syst. Rhyng., p. 153 (1803).

*Edessa marmorea*, Fabr., Syst. Rhyng., p. 153 (1803).

*Halys timorensis*, Westwood, Hope, Cat. Hem. i, p. 22 (1837): Signoret, Bull. S. E. F. (6 s.) i, p. xli (1881). China, Timor.

*Pentatoma timorensis*, Dallas, List Hem. i, p. 242 (1852): Walker, Cat. Het. ii, p. 299 (1867). Ceylon.

*Pentatoma halys*, Stål, Ofvers. K. V.-A. Förh., p. 182 (1855); l. c., p. 59 (1856): Walker, l. c. ii, p. 300 (1867). China.

*Pentatoma trivialis*, A. Dohrn, Stettin Ent. Zeit. xxi, p. 400 (1860): Walker, l. c., p. 300 (1867). Ceylon.

*Pæcilometis mistus*, Uhler, Proc. Ac. Phil., p. 223 (1860). Japan.

*Halyomorpha timorensis*, Mayr, Reise Nov. Hem., p. 50 (1866). Hong Kong, Shanghai.

*Dalpada remota*, Walker, l. c. i, p. 227 (1867), sec. Distant, Ent. M. M., xvi, p. 201 (1880). Hong Kong.

*Halyomorpha picus*, Stål, Hem. Fabr. i, p. 24 (1868); En. Hem. v, p. 75 (1876); Scott. A. M. N. H. (4 s.) xiv, p. 290 (1874); Distant, l. c. (5 s.), iii, p. 45 (1879); Trans. Ent. Soc., p. 415 (1883).

Antennæ black; third joint with a white ring at the base: head,

pronotum, scutellum, hemelytra greyish or yellow, irrorated with very numerous black dots: beneath flavescent, a lateral line on the pectus, brassy black: femora yellow, punctured black; tibiæ black with a broad white ring at the base (*C. picus*, Fabr.). Body above grey: pronotum anteriorly with two minute yellow dots, posteriorly fuscous: scutellum with two distinct, minute dots at the base: beneath flavescent, a median line and the margins fuscous, and on each abdominal segment on both sides, a small black dot: feet flavescent, punctured fuscous (*C. marmoræus*, Fabr.). Luteous-grey, punctured brassy-black, somewhat variegated: head and pronotum with the sides entire, the latter with four minute luteous dots placed transversely: membrane pale, with six fuscous longitudinal veins, interrupted in the middle: margin of abdomen punctured black and luteous (*H. timorensis*, Westw.). Long, 15—16 mill.

Reported from Timor, China, Japan, Ceylon, Assam, India. A variable and not a very uncommon species in Sikkim and Assam (mihi).

#### 162. HALYOMORPHA SCUTELLATA, Distant.

*Halyomorpha scutellata*, Distant, A. M. N. H. (5 s.) iii, p. 51 (1879).

Brunneous, thickly and strongly punctured: head with frontal and lateral margins black; eyes pitchy; ocelli brown, shining: rostrum black, reaching posterior coxæ: antennæ black; second joint much shorter than the third, fourth joint rather longer than the fifth, both of which are pilose: pronotum with the lateral margins narrowly reflexed, bordered with black, with the extreme edge sanguineous for about two thirds of the length from the apex; base rugulose, a somewhat triangular space enclosed by pale impunctate lines situated on each side of the frontal border behind the eyes; lateral angles prominent: scutellum bright luteous with two dots at the base, two small parallel lines on the disc, and the lateral margin, very narrowly at the base and broadly towards the apex, brunneous; the luteous area has a few deep brown punctures, the other brunneous portion of the scutellum punctured as on other parts of the upper surface: membrane fuscous, with strong longitudinal veins: abdomen above sanguineous, with a marginal row of blueish-black spots, situated conjointly in pairs at the base and the apex of each segment, both above and below: underside of body sanguineous; prostethium with some greenish markings behind the eyes, a large dull blackish patch near the odoriferous apertures, a stigmatal row of rounded blueish-black spots and a large pitchy spot near the apex: legs black; coxæ sanguineous, bases of femora dull reddish (*Distant*). Long, 16; breadth ang. pronot. 9 mill.

Var. *a.* Scutellum without the two brown lines on the disc, marginal and stigmatal spots on the underside of the abdomen coalescing; prostethium with a large black spot behind the eyes in place of greenish markings.

Var. *b.* Specimens from Bombay have the upper surface bluish instead of brownish, have typical scutellar markings, but underside as in var. *a.*

Reported from N. Khasiya hills, 1500-3000 feet; Bombay.

163. HALYOMORPHA MURREA, Distant.

*Halyomorpha murrea*, Dist., Trans. Ent. Soc. p. 344, t. 12 f. 5 (1887).

Body above very pale greenish ochraceous; the corium (except the marginal area), and basal area of the pronotum with a slight purplish tinge: lateral margins of the head, margins of tylus, a small linear spot at the base of the head, and a similar spot on each side before the eyes, black; eyes somewhat purplish; ocelli pale castaneous; antennæ with the basal joint greenish ochraceous, minutely speckled black, 2-3 joints purplish, apical half of third joint black, second joint a little shorter than the third; rostrum just passes the last coxæ; pronotum with the lateral margins and a double row of spots on anterior half, ochraceous; between and around these spots are a number of small and somewhat tessellated black spots; basal half minutely and sparingly darkly punctate: scutellum with four black spots at the base, two median and one near each basal angle, four more obscure and broken black spots across the disc, followed by two similar spots on the basal half, some tessellated and minute black spots at the apex, and a row of minute dark punctures on each lateral margin, from basal third to the apex: corium minutely and sparingly darkly punctate, costal area greenish, thickly and irregularly spotted black, lateral margins near base ochraceous: connexivum ochraceous, with a black linear spot at the base and apex of each marginal segment: membrane extending much beyond the abdomen, pale obscure creamy, minutely and sparingly speckled black, basal two-thirds pale purplish from reflection of abdomen beneath: body beneath and legs pale greenish, a linear spot in front and behind the eyes, a spot near anterior and intermediate coxæ, a spot towards lateral margins of meso- and meta-stethium, a spot at base of the anterior tibiæ, a spot near apices of two last pair femora, a marginal spot at base and apex of apical segments, and the apex of the rostrum, black (*Dist.*), Long, 15; exp. angl. pron., 8 mill.

Reported from Sikkim, a single specimen (mihi).

## Genus TOLUMNIA, Stål.

Ofvers. K. V.-A. Förh. p. 515 (1867): En. Hem. v, p. 57, 75 (1876).

Margins of pronotum anteriorly, and anterior lateral margins, callos or elevated; head distinctly narrowed forwards, rounded at apex, lateral margins somewhat acute, very slightly sinuated behind the middle, tylus somewhat longer than the juga; bucculæ continued through, moderately elevated; ocelli scarcely thrice as distant from each other as from the eyes; rostrum somewhat produced behind the last coxæ, first joint scarcely extending beyond or only equal to the bucculæ, second joint scarcely or but little longer than the third: anterior margin of the pronotum slightly truncate behind the eyes, lateral angles very slightly prominulous, somewhat straight: apical margin of corium very slightly sinuate near the apical angle which is somewhat rounded at the extreme edge: mesostethium distinctly carinate: extremity of angles of abdominal segments acutely prominulous: first tibiæ sometimes dilated (*Stål*).

## 164. TOLUMNIA LATIPES, Dallas.

*Pentatoma latipes*, Dallas, List Hem i, p. 238 (1857): Walker, Cat. Het. ii, p. 298 (1876).

*Dalpada obtusicollis*, Ellenr., Nat. Tijdsskr. Ned. Ind. xxiv, p. 143, f. 10 (1862).

*Tolumnia latipes*, Stål, En. Hem. v, p. 75, (1876); Distant, A. M. N. H. (5 s.) iii, p. 45 (1879).

♂, ♀. Ovate, above dark brown, thickly punctured, irrorated with yellow spots: pronotum with the lateral margins yellowish white: scutellum with a large yellowish white spot in each basal angle, and the apex of the same colour: membrane brownish, semi-transparent: margins of the abdomen banded with black and yellowish-white, the middle of each segment being white: body beneath pale yellow, shining, finely and sparingly punctured: abdomen with a small brown or black spot on the apical segment: pectus with a row of three spots on each side: legs whitish, the apices of the femora the tibiæ and the tarsi, black; the anterior tibiæ are considerably dilated on the outside towards the apex: rostrum reaching the base of the abdomen, whitish, with the tip black: antennæ with the basal joint black; the two following pale brown; 4 and 5 joints black with their bases whitish, (*Dallas*).

Long, ♂,  $8\frac{1}{2}$ —9: ♀,  $10\frac{1}{2}$ —11 mill.

Reported from Sumatra, Siam, Tenasserim, Burma, Assam. The Indian Museum has specimens from Sikkim (mihi), Assam (Naga Hills, Harmatti).

## Genus PALOMENA, Mulsant and Rey.

Pnn. Pent. p. 271, 277 (1866); Stål, En. Hem. v, p. 75 (1876).

Differs from *Peribalus*, Muls., in having the anterior lateral margins of the pronotum neither callous nor smooth: sides of prostethium not, unless very obtusely, elevated: the head is dilated, flat, or somewhat so, towards the apex, lateral margins not, or but very slightly, sinuate; antenniferous tubercles not prominulous beyond the sides of the head.

## 165. PALOMENA SPINOSA, Distant.

*Palomena spinosa*, Distant, Trans. Ent. Soc. p. 149, t, 5, f. 3 (1880).

Above green, thickly, darkly and coarsely punctured: head coarsely and somewhat densely punctured; the juga longer than the tylus and cleft at the apex, with the lateral margins slightly reflexed: antennæ with the first three joints green, fourth (except the base) and whole of fifth, brown; second joint longer than the third, 4 and 5 subequal: pronotum coarsely punctured, somewhat sparingly so on the disc, with the lateral angles produced into broad, obtusely pointed spines, somewhat rounded, and narrowly black at the apex; scutellum thickly punctured, more sparingly so at the apex; corium thickly punctured, especially near the costa, membrane brassy, shining: connexivum green, thickly and darkly punctured, narrowly luteous on the outer margin and at the segmental incisures: body beneath pale, disc of abdomen, coxæ, and bases of femora somewhat luteous; legs green, tarsi brown: stigmata marked with black dots: rostrum luteous, with the apex narrowly black (*Dist.*). Allied to *P. angulosa*, Motsch., from Japan, but distinguished by the much produced pronotal angles.

Long 13—14 mill.; breadth angles pronotum, 9—10 mill.

Reported from Sind, N. India.

## 166. PALOMENA REUTERI, Distant.

*Palomena reuteri*, Distant, Trans. Ent. Soc. p. 122 (1879); Scien. Res. 2nd Yarkand Mission, p. 4, f. 2 (1879).

♂. Green, with head, anterior border of pronotum, basal half of scutellum and membrane, bronzy: head obscurely rugulose, very thickly and strongly punctured with black; tylus slightly shorter than the juga; rostrum luteous, with the tip black: antennæ luteous, apical joint somewhat fuscous, third joint distinctly longer than the second, rather shorter than the fourth, fifth longest: pronotum obscurely rugulose, very thickly and strongly punctured with black, with two slightly waved, lateral, linear, impunctate foveæ situated a little behind

the anterior margin; lateral angles somewhat prominent and rounded: scutellum thickly covered with deep black punctures, slightly rugulose at the base: corium thickly and deeply punctured, with the connexivum luteous, punctured with black: body beneath pale luteous, slightly clouded with greenish: legs greenish, tarsi luteous.

♀. Second joint of antennæ distinctly longer than the third; 2 and 4 subequal: abdomen beneath with some irregular obscure black markings (*Distant*). Long, 11—12; breadth angles of pronotum 6—7 mill.

Reported from Murree (Panjáb).

#### 167. PALOMENA AMPLIFICATA, *Distant*.

*Palomena amplificata*, *Distant*, Trans. Ent. Soc. p. 148, t. 5, f. 2 (1880).

Above green, thickly punctured; head densely and finely punctulate, the lateral margins slightly reflexed, juga longer than the tylus and cleft at the apex; pronotum thickly punctate and somewhat rugulose, the lateral margins amplified and rounded, lateral angles obtusely prominent; scutellum thickly punctured, somewhat rugulose: corium with the punctures somewhat finer and more regular; membrane brassy, shining: body beneath paler, disc of abdomen and the coxæ pale luteous; legs green; tarsi brown; connexivum well produced, green, thickly punctured: antennæ green, 4 and 5 joints brown, the last joint with apical half pitchy; second joint longer than the third; 4 and 5 subequal: rostrum pale luteous, with a median dark line, and apex narrowly pitchy (*Distant*). Long, 13—14; breadth of angles of pronotum 8—9; greatest breadth of abdomen, 8—9 mill.

Reported from Shantung (N. China); Assam (?); recognized by the amplified pronotum and the broad ovate body.

#### 168. PALOMENA VIRIDISSIMA, *Poda von Neuhaus*.

*Cimex viridissimus*, *Poda*, Ins. Mus. Gr. p. 56 (1761).

*Cimex prasinus*, *Fabr.*, Syst. Ent., p. 711 (1775); Spec. Ins. ii, p. 354 (1781); Mant. Ins., ii, p. 292 (1787); Ent. Syst., iv, p. 109 (1794); Syst. Rhyng., p. 166 (1803); *Wolff*, Ic. Cim., p. 52, t. 6, f. 49 (1801).

*Cimex prasinus*, *Fieb.*, Eur. Hem., p. 339 (1861).

*Palomena viridissima*, *Stål*, Hem. Fabr. i, p. 28' (1868); Muls. and Rey, Pun. France, p. 277 (1866); *Distant*, Scien. Res. 2nd Yar. Miss., p. 5 (1879).

Body entirely green, immaculate, last joint of antennæ rufous, fuscous at apex (*C. prasinus*, *Fabr.*). Body ovate, with head, pronotum, hemelytra, scutellum, and feet, green; abdomen above black: antennæ 5-jointed, first joint short, 2 and 3 green, 4 and 5 rufous, last fuscous at apex: eyes small, obscurely fuscous: rostrum 4-jointed, yellow-



greenish, black at apex, as long as half the body: thorax inclined anteriorly, with two small, livid, transverse lines, impressly punctured, margin very thinly ferruginous: scutellum immaculate, subelevated at the base: membrane whitish, with a small fuscous spot at the base at the interior angle: wings white, immaculate: abdomen above black, margin green, spotted fuscous, beneath yellow-greenish: tarsi blackish: first tibiæ with a minute black tooth in the middle (*Wolff*). Varies in size, entire antennæ rufous, beneath green. Long, 14—15 mill.

Stål unites *Cimeæ dissimilis*, Fabr., with this species, but Puton holds them to be distinct. The former has the 3—4 joints of the antennæ subequal, and the anterior lateral margin of the pronotum very slightly arcuate inside, whilst *P. viridissima* has the third joint of the antennæ from one-third to one-fourth shorter than the second, and the anterior lateral margin of the pronotum very slightly arcuate outside.

Reported from Europe, Murree (Panjab).

#### Div. CARPOCORARIA.

En. Hem. v, p. 57 (1876).

a. to e. as in *Tropycorypharia*, (p. 19).

f. Furrow of the odoriferous apertures, short or very short, abruptly abbreviated, not continued in a wrinkle or ridge, second joint of the antennæ longer than the third.

#### Genus CARPOCORIS, Kolenati, Stål.

Mel. Ent. iv, p. 46 (1846): Stål, *Ofvers. K. V.-A., Förh.*, 3, p. 37 (1872).

Stål includes here *Carpocoris*, Muls., *Codophila*, pt. Mulsant, and *Antheminia*, Muls., and arranges the three allied genera thus:—

1—4. Frena not extended beyond the middle of the scutellum.

2—3. Entire anterior lateral margins of the pronotum, or at least anteriorly, reflexed, acutish:—*Carpocoris*.

3—2. Anterior lateral margins of pronotum anteriorly obtuse, not reflexed:—*Codophila*.

4—1. Frena extended beyond the middle of the scutellum:—*Dolycoris* (*q. v.*).

#### 169. CARPOCORIS NIGRICORNIS, Fabr.

*Cimeæ nigricornis*, Fabr., Ent. Syst. iv, p. 94 (1794); Syst. Rhyng, p. 157 (1803): Wolf. Ic. Cim. p. 138, t. 14, f. 132 (1804): Fallen, Hem. Suec. p. 27 (1826).

*Mormidea nigricornis*, Sahlb., Mon. Geoc. Fenn. p. 30 (1848).

*Cimeæ eryngii*, Germar, Reise Dalm. p. 283 (1817): Faun. Ins. Eur. ii, 2, (1817).

*Pentatoma nigricornis*, Hahn, Wanz. Ins. ii, f. 147 (1834.)

*Carpocoris nigricornis*, Kolen., Mel. Ent. iv, p. 40 (1846): Distant, Scien. Res. 2nd Yarkand Miss. p. 5 (1879): Reuter, Ent. Tijds. p. 128 (1880): Duda, Wien, Ent. Zeit. iv, p. 69 (1885).

Head ferruginous or greyish, spines on pronotum always black:

antennæ black; feet pale: pronotum obtusely spinose, somewhat ferruginous (*Fabr.*). Wolff makes the basal joint of the antennæ greyish; head, pronotum, scutellum, hemelytra and feet greyish, impressly punctured; pronotum with four longitudinal lines formed by black points, lateral angles black; margin of abdomen variegated black and greyish; beneath greyish-virescent: tarsi rufescent; first tibiæ with a small tooth. He notes several varieties:—one with head, lateral spines of pronotum and hemelytra purpurascens, pronotum with longitudinal black bands, scutellum virescent, marginal spots on abdomen black with a white pupil; abdomen and pectus greenish; tibiæ rosy, tarsi black at apex. Long  $10\frac{1}{2}$ ; broad,  $6\frac{1}{4}$  mill.

Reported from Kugiár, N. W. Siberia, Astrakhan, N. Africa, Europe.

### Genus DOLYCORIS, Muls. and Rey.

*Carpocoris*, subg. *Dolycoris*, Muls. and Rey, Pun. Pent. p. 238 (1866); *Dolycoris*, Stål, Ofvers. K. V.-A. Forh. xxix (3), p. 38 (1872); En. Hem. v, p. 57, 76 (1876).

Body pilose: connexivum in a great part prominulous beyond the hemelytra: lateral margins of the head not, or but slightly, sinuated: antennæ stoutish: anterior lateral margins of pronotum very distinctly and narrowly reflexed: frena extended beyond the middle of the scutellum.

### 170. DOLYCORIS BACCARUM, Linnæus.

*Cimex baccharum*, Linn., Faun. Suec. ii, 928, (1761); Syst. Nat. i, p. 721 (1767): Scopoli, Ent. Carn. p. 123 (1763): Fallen, Hem. Suec. p. 29 (1826).

*Pentatoma baccharum*, pt., Dallas, List Hem. i, p. 235 (1851): Walker, Cat. Het. ii, p. 283 (1867): Sahlb., Mon. Geoc. Fenn. p. 26 (1848): Saunders, Trans. Ent. Soc. p. 125 (1875).

*Pentatoma pallida*, Dallas, l. c., p. 234 (1851), N. India: Stål, Ofvers., K. V.-A., Förh. p. 497 (1862); Walker, l. c. p. 299 (1867).

*Mormidea nigricornis*, Fieb. (nec. Fabr.) Eur. Hem. p. 335 (1861).

*Carpocoris baccharum*, Muls. and Rey, Pun. France Pent., p. 238 (1866); Stål, En. Hem. v, p. 76 (1876).

*Dolycoris baccharum*, Distant, pt., Res. 2nd Yarkand Miss. p. 5 (1879): J. Sahlb., K. Sv. V.-A., Handl. xvi (4) p. 15 (1879); Reuter, Ent. Tijds. p. 129 (1880); Duda, Wien Ent. Zeit. iv, p. 68 (1885).

Reuter, in 1877 (Ent. Mon. Mag. xiv, p. 11), united *Cimex fuscispinus*, Boheman (K. V.-A., Handl., p. 241, 1849), with *C. baccharum*, Linn., but, in 1880 (Ent. Tijds., p. 129), he describes them separately. Linnæus' description of *Cimex baccharum*, in Faun. Suec., is very curt:—'ovate, greyish; margin of abdomen spotted black,' but, in the Syst. Nat., Linnæus quotes Scopoli's description as synonymous. This runs:—

'Pronotum obtusely spinose: abdomen above black; variegated on the margin with spots of the same colour as the apex of the scutellum, beneath 'e basi mucronem supra thoracem protendens.' The apex of the scutellum, spots on the margin of the abdomen and the feet are of the same colour. In ♂, antennæ unicolorous; marginal dots on abdomen yellowish, beneath without dots; varies, (a) in having hemelytra reddish, fuscous at apex, antennæ black, body beneath yellow; or (b), hemelytra æneous-greenish, immaculate at apex, pronotum obscure, apex of scutellum fulvous, abdomen beneath ferruginous, wings obscure. In ♀, the two last joints of the antennæ are flavescent at the base, sides of pronotum obscure, apex of hemelytra punctured fuscous: pronotum and abdomen beneath punctured, black.' It differs from *D. verbasci* in having the angles of the pronotum produced and pointed. Long, 10—12 mill. Dallas describes his *P. pallida* thus:—♀. 'Allied to *Veterna aberrans*, Germar, more elongate, testaceous, punctured: lateral angles of the pronotum somewhat prominent: rostrum hardly reaching the base of the posterior feet, whitish, extremity of apex black: antennæ black, basal joint whitish; tibiæ and tarsi fulvous.' Long, 14 $\frac{3}{4}$  mill.

Reported from all Europe, N. Asia, N. Africa, Japan, Kashmír, India, Oceania.

#### 171. DOLYCORIS VERBASCI, De Géer.

*Cimex verbasci*, De Géer, Mém. iii, p. 257, t. 14, f. 5 (1773).

*Cimex baccharum*, Fabr., Ent. Syst. iv, p. 117 (1794); Syst. Rhyng. p. 172 (1803); Wolff, Ic. Cim. p. 60, t. 6, f. 57 (1801).

*Pentatoma baccharum*, Lep. & Serv., Enc. Méth. x. p. 57 (1825); Hahn, Wanz. Ins. ii, p. 63, t. 50, f. 152 (1834); ? Douglas and Scott, Brit. Hem. p. 80 (1866).

*Pentatoma confusa*, Westw., Hope, Cat. Hem. i, p. 8 (1837).

*Aelia depressa*, Westw., l. c. p. 32 (1837); Stål, En. Hem. v, p. 126 (1876).

*Pentatoma verbasci*, Dallas, List Hem. i, p. 235 (1851).

*Mormidea baccharum*, Fieb., Eur. Hem. p. 334 (1861).

*Dolycoris baccharum*, pt, Distant, Scien. Res. 2nd Yarkand Miss. p. 5 (1879); Trans. Ent. Soc. p. 415 (1883).

Dallas and Distant with many others unite *D. baccharum* and *D. verbasci*, and make the two the same as the variable form found commonly throughout the entire region from Siberia to the Sind Valley and thence to North Africa. The question whether these forms are to remain separate or are to be united is entirely one for European students to decide.

Oval: pronotum angular, the lateral angles, rounded at the tip, not pointed: head and pronotum above greyish-brown, sometimes with a slight purplish tint: scutellum triangular, ochreous, with apex sea-green; long, and occupying more than half the length of the abdo-

men : coriaceous portion of the hemelytra with a purplish tint, membrane light-brown with a patch of obscure brown on the interior side, near the coriaceous portion: head, pronotum, scutellum, and hemelytra covered with numerous minute concave black points, hardly visible : wings with a black tint ; eyes obscurely brown : body beneath and feet light grey, a little yellowish, with very numerous black points like those above : abdomen above entirely black with the margin spotted black and white or yellowish : antennæ 5-jointed, shorter than the abdomen, black, with white patches at the joints (*De Géer*). Long,  $10\frac{1}{2}$  ; broad,  $6\frac{1}{4}$  mill. Differs from *D. baccarum* in not having the angles of the pronotum produced and pointed, but merely rounded.

Westwood's *Ælia depressa* is thus described :—' Luteous, punctured black : the slight margin of the pronotum pale : sides of scutellum towards the apex, spotted black, apex itself luteous : membrane fuscous, a large internal patch at the base, black : sides of abdomen spotted yellow and black, feet and body beneath luteous, tarsi black.' Long,  $10\frac{1}{2}$  mill.

Reported from Puna (Bombay).

#### 172. DOLYCORIS INDICUS, Stål.

*Dolycoris indicus*, Stål, En. Hem. v. p. 76 (1876).

♀. Very like and closely allied to *D. verbasci*, De Géer, but appears to differ in the narrower form ; head, pronotum, and scutellum less densely punctured ; membrane longer ; anterior lateral margins of pronotum more broadly pallid, sparingly black-punctured at the base (*Stål*). Long,  $9\frac{1}{2}$  ; broad, 5 mill.

Reported from India, Deccan, Darjeeling. Distant has an allied form, *D. formosana*, from Formosa.

#### Genus CODOPHILA, Mulsant, Stål.

pt. Pun. France Pent. p. 237 (1866) ; Stål, Ofvers. K. V.-A. Förh. xxix, 3. p. 38 (1872) ; En. Hem. v, p. 76 (1876).

Differs from *Carpocoris*, Kolenati, Stål, in having the anterior lateral margins of the pronotum anteriorly obtuse, not reflexed.

#### 173. CODOPHILA MACULICOLLIS, Dallas.

*Pentatoma maculicollis*, Dallas, List Hem. i, p. 234 (1851) Stål, Ofvers. K. V.-A., Förh. p. 497 (1862) ; Walker, Cat. Het. ii, p. 299 (1867).

*Pentatoma arabica*, Stål, Ofvers. K. V.-A., Förh. p. 233 (1854).

*Codophila maculicollis*, Stål, En. Hem. v, p. 76 (1876).

♀. Ovate : head pale yellow, rather thickly punctured, with the lateral margins and two longitudinal lines, united in front, black : eyes

pitchy black; ocelli red; pronotum with the lateral angles somewhat prominent; the anterior portion pale yellow, with four black bands, of which the two lateral run from the anterior to the lateral angles, leaving the lateral margins yellow; the two median do not pass the middle of the disc, and correspond with the two black lines of the head; the posterior portion of the pronotum is blackish, and the whole surface is thickly and rather strongly punctured: scutellum with a large triangular patch at the base, and a large patch on each side, broadest towards the apex, greyish, punctured with black, leaving two lines running from the basal angles, and meeting in the middle of the disc, a short longitudinal line uniting these with the apex, and the apex itself, pale yellow: coriaceous part of the hemelytra flesh colour, irregularly punctured with black; membrane dark brown: margins of the abdomen banded with orange and black, the middle of each segment being orange: body beneath testaceous, shining: abdomen with a small spot on each side of the base of each segment within the stigmata, a similar spot in the middle of the posterior margin of the 5 and 6 segments, a small transverse spot on each side of the disc of the third segment, and the stigmata black: pectus with a few black spots: legs brownish, with the tarsi black: rostrum reaching the base of the abdomen, with the two basal joints testaceous, the two apical black: antennæ black, with the basal joint pitchy (*Dallas*). Long,  $15\frac{3}{4}$  mill.

Reported from Arabia, N. India.

#### Div. DIPLOXYARIA.

En. Hem. v, p. 58 (1876).

*a, b, c*, as in *Tropycorypharia* (p. 19).

*d.*—Head transversely convex, rarely somewhat flat, and, if so, the juga are longer than the tylus and contiguous before it, or the second joint of the antennæ is almost thrice longer than the first, or scarcely extending beyond the apex of the head: juga generally longer than the tylus and contiguous before the tylus: frena rarely slightly extended beyond the middle of the scutellum: furrow of the orifices generally short or very short, rarely continued in a long wrinkle or ridge: first joint of the antennæ not reaching the apex of the head: venter sometimes furrowed.

*e.*—Posterior angles of the pronotum not lobed: scutellum not amplified behind the frena: head not cylindrical: rostrum not extended behind the pectus, second joint longer than the third: venter not furrowed.

*f.*—Antennæ alike in both sexes, second joint longer than the first.

## Genus ADRIA, Stål.

En. Hem. v, pp. 58, 78 (1876).

Juga and tylus equal, or somewhat so, in length: bucculæ rather elevated throughout their entire length, posteriorly forming a somewhat right angle: second joint of antennæ about on a level with the apex of the head, not, or only a little, longer than the third, the third joint longer than the first: second joint of rostrum equal, or somewhat so, in length to the two apical taken together, the two apical joints of equal length: prostethium broadly furrowed, margins of furrow elevated, somewhat carinate: costal area of corium very narrow anteriorly and furnished with punctures placed in a simple row, costal margin anteriorly rounded.

## 174. ADRIA PARVULA, Dallas.

*Pentatoma parvula*, Dallas, List Hem. i, p. 246 (1851); Stål, Ofvers. K. V.-A. Förh. p. 497 (1862).

*Adria parvula*, Stål, En. Hem. v, p. 78 (1876); Lethierry, An. Mus. Gen. xviii, p. 649 (1883).

♀. Elongate-ovate, testaceous, punctured fuscous; a small whitish spot on both sides of the scutellum at the base; membrane whitish; a longitudinal band of fuscous dots on each side of the abdomen; rostrum short, not reaching the base of the last pair of feet (*Dallas*). Long, 7—7½ mill.

Reported from India, Burma, Senegal.

## Genus SCYLAX, Distant.

Trans. Ent. Soc. p. 345 (1887).

Head very large, flat and long; the juga very much longer than the tylus, slightly concave, obtusely pointed at the apex, and in ♀ cleft at the apex, but in ♂ apparently united: lateral angles of the pronotum very strongly produced forwards into robust, obtuse spines which, in the typical species, have their apices parallel to the eyes; anterior margin concave for the reception of the head, anterior angles minute and truncate, posterior margin straight, oblique from the basal angles of the scutellum to the lateral angles; scutellum short and broad, not extending much beyond the base of the membrane; the lateral margins obliquely directed inwardly to about the middle and then straight to near the apex which is broadly rounded; corium short not reaching the apex of the scutellum: membrane with prominent reticulated veins: rostrum long, about reaching the last coxæ: antennæ inserted beneath the head in front of the eyes, the second joint barely reaching the apex of the head (*Dist.*).

## 175. SCYLAX PORRECTUS, Distant.

*Scylax porrectus*, Dist., Trans. Ent. Soc. p. 345, t. 12, f. 7 (1887).

Body above ochraceous: head, pronotum, and scutellum somewhat thickly punctate: pronotum with two short transverse and one short median, levigate, longitudinal, linear spots: scutellum with a median, longitudinal, levigate band which has a median row of minute punctures, and a few scattered punctures on each side: costal area of corium very finely and sparingly punctate, the inner area coarsely and somewhat thickly punctate: membrane pale brownish ochraceous: body beneath and legs ochraceous; the body somewhat finely and darkly punctate, and with a median and two sublateral bands formed of blackish punctures: legs speckled brownish: juga divided to near the apex of the tylus: membrane extended to about half the anal appendage: second joint antennæ much shorter than the third: rostrum reaching last coxæ, apex pitchy (*Dist.*). Long, 15 mill.

Reported from India.

## 176. SCYLAX MACRINUS, Distant.

*Scylax macrinus*, Dist., Trans. Ent. Soc. p. 346, t. 12, f. 9 (1887).

Closely allied to the preceding; differs in its smaller size, the juga cleft to a short distance only before the head (united in the ♂): membrane not reaching the apex of the last abdominal segment (*Dist.*). Long, 14—15 mill.

Reported from Sikkim (mihi).

## Genus ÆSCHROCORIS, Dallas.

*Æschrus*, List Hem. i, p. 220 (1851): Stål, En. Hem. v, p. 79 (1876): *Æschrocoris*, Bergroth, Ent. Nach., p. 152 (1887).

The name *Æschrus* was given by Spinola (Gen. d'Ins. Artr., p. 136, 1850) to the African genus subsequently named *Rhinocoris*, by Stål, and therefore Dallas' name cannot stand and should give place to *Æschrocoris* as suggested by Bergroth.

Head elongated, with the sides nearly parallel, the apex nearly square, the juga much longer than the tylus and meeting in front of it: eyes rather small, globose; ocelli small, placed near, but a little behind, the eyes: antennæ about as long as the head and pronotum, five-jointed; basal joint short and stout; second not much longer than the first, about half the length of the third; 4 and 5 joints about equal to the third: rostrum long and slender, reaching the base of the abdomen; basal joint shortest, not passing the base of the head; second longest: 3 and 4 about equal: body short and broad: pronotum with the lateral

angles produced into stout, somewhat cylindrical processes, directed forwards and upwards, with the apex emarginate and deflexed: scutellum reaching beyond the middle of the body; the apex broad with a tubercle in its middle: membrane with irregularly reticulated veins: body beneath very convex; abdomen and sternum unarmed; the lateral margins of the former with a small tubercle at the posterior angle of each segment: legs long, especially the posterior; tarsi of three joints, with the basal joint as long as the apical (*Dallas*).

177. *ÆSCHROCORIS OBSCURUS*, Dallas.

*Æschrus obscurus*, Dallas, List. Hem. i, p. 221, t. 8, f. 4 (1851); Walker, Cat. Het. ii, p. 268 (1867); Stål, En. Hem. v, p. 79 (1876).

♂. Head black, tinted with coppery or violet, somewhat shining, thickly punctured, with two short, longitudinal, parallel ridges on the middle of the vertex, and a similar ridge on the tylus: eyes black: pronotum pale brown, punctured with black and rugose, with an elevated line down the middle; the tips of the lateral processes are black: scutellum of the same colour as the pronotum with a large black pit in each basal angle; apical tubercle black; coriaceous portion of the hemelytra of the same colour and texture; membrane brownish: body beneath black, coarsely punctured rugose, with scattered brown elevations; lateral tubercles of the abdomen brown; pronotal processes black, tinted with coppery: legs brown; femora covered with fine black punctures, with the base, the inside, the apex of the outside, and a ring before the apex, black; tibiæ with the base and a ring about the middle black: rostrum and antennæ brown; the latter becoming darker towards the apex (*Dallas*). Long,  $8\frac{1}{2}$ ; breadth of pronotum,  $8\frac{1}{2}$  mill.

Reported from Java, India.

178. *ÆSCHROCORIS TUBERCULATUS*, Stål.

*Æschrus tuberculatus*, Stål, A. S. E. F. (4 s.) v, p. 169 (1865); En. Hem. v, p. 79 (1876).

♂. Pale fuscous-ferruginous, strongly punctured in patches; head and pronotum anteriorly fuscous-cupreous; venter brassy-black on the disc; femora brassy-black, a median ring on the femora, the tibiæ, and antennæ yellow-testaceous; tibiæ black at the base, ringed fuscous in the middle: pronotum bituberculate on the disc. Close to *Æ. obscurus*, Dallas, differs in the short head, disc of pronotum bituberculate and lateral horns shorter: pronotum furnished with a median longitudinal ridge and others transverse behind the middle; lateral angles produced



in a horn inclining somewhat forwards, emarginate at the apex, furnished anteriorly with a small tubercle in the middle, shorter than the head: scutellum terminated at the apex by a concolorous tubercle, a little elevated (*Stål*). Long,  $7\frac{1}{2}$ ; broad, 5 mill.

Reported from India: taken in Sikkim.

#### Genus *ÆLIOMORPHA*, Stål.

Ofvers. K. V.-A. Förh. p. 313 (1858); Hem. Afric. i, p. 173 (1864); En. Hem. v, p. 58, 79 (1876). Includes *Tetratoma*, Signoret, A. S. E. F. (2 s.) ix, p. 339 (1851).

Body ovate or obovate, beneath moderately convex: head produced, narrowed forwards, rather convex, lateral margins obtuse, tylus and juga equal, or somewhat so, in length, juga acuminate at the apex: bucculæ continued through, moderately elevated: antennæ different in each sex; in ♂, somewhat stout, second joint very short, somewhat annuliform, obsolete; in ♀, slender, second joint elongate, much shorter than the third, basal joint not reaching the apex of the head: rostrum moderate, first joint on a level with the bucculæ posteriorly, second somewhat shorter or just equal to the two apical taken together: lateral margins of pronotum somewhat obtuse: frena reaching or scarcely reaching to the middle of the scutellum, rarely extending beyond the middle: apical angles of the last segment of the abdomen somewhat straight: feet moderate, tibiæ furrowed above or flattish (*Stål*). Signoret's name was previously given to a genus of Coleoptera.

#### 179. *ÆLIOMORPHA LINEATICOLLIS*, Westwood.

*Pentatoma lineatocollis*, Westwood, Hope, Cat. Hem. i, p. 36 (1837).

*Æliomorpha lineaticollis*, Stål, En. Hem. v, p. 80 (1876).

Greyish-luteous, much punctured with fuscous; head and pronotum with a more or less distinct pale longitudinal line; scutellum paler; head with a conical disc, a little fuscous; a broad stripe at the middle of the internal margin of the hemelytra, infuscate; antennæ fuscous; abdomen, beneath, smooth in the middle, punctured on the sides; posterior angles of pronotum hardly prominent (*Westw.*). Long,  $6\frac{1}{4}$  mill.

Reported from Bengal.

#### Div. EYSARCORIARIA.

En. Hem. v, p. 59 (1876).

a. as in *Odiaria* (p. 17).

b.—Costal area of corium anteriorly strongly narrowed and furnished there with punctures generally arranged in a rather regular

single row; costal margin anteriorly obtusish or somewhat so, generally pale, levigate and somewhat callous: juga and tylus of equal length, the juga very rarely a little longer than the tylus, always altogether distant, never acuminate: head generally rather bending forwards, pronotum rather inclined before the middle; anterior lateral margins, at least before the middle, rounded or somewhat so, generally callous and levigate: lateral angles of pronotum usually prominulous: basal angles of the scutellum generally marked by a pale, levigate, callous, often large, spot or streak: body beneath generally rather convex: orifices subauriculately margined or extended in a short furrow, abruptly abbreviated, not continued in a wrinkle or ridge, having the margin elevated: tibiæ somewhat slender, rounded, or above slightly sulcated, or somewhat flattish: second joint of the rostrum reaching the first coxæ or the base of the mesostethium, not, or a little longer, or shorter, than the two apical joints taken together, these equal in length or somewhat so: almost entire second joint of the antennæ extending beyond the apex of the head: body small.

#### Genus STOLLIA, Ellenrieder.

Nat. Tidsskr. Ned. Ind. xxiv, p. 149 (1862); Stål, Ofvers. K. V.-A. Förh. p. 510 (1867): En. Hem. v, p. 59, 81 (1876).

Body short; length of body equal to  $1\frac{1}{2}$  time the breadth of the pronotum; head much inclined; tylus long, juga anteriorly gradually narrowed externally up to the interior apical angle which is somewhat straight or acutish; eyes globulose, small, very prominent; ocelli small: first joint of the antennæ shorter than the head, 2-5 joints almost of equal length, last two more robust: rostrum reaching the second segment of the abdomen: anterior margin of pronotum narrower than the head; lateral margin almost entire, 2-3 small teeth anteriorly being hardly visible; posterior angles broader than the abdomen, more prominent in the ♂, and mucronate or acuminate: pronotum much declined before the line between the posterior angles: scutellum broad, long, covering three-fourths of the abdomen, its posterior angle very broadly rounded: coriaceous part of hemelytra longer than the membrane which has a few veins, sometimes branched: abdomen short, almost orbicular, extending at the sides a little beyond the hemelytra, posteriorly scarcely shorter than them: venter subglobulose, usually shining black, within the callous and levigate lateral margins, finely impressed, margin pale: ventral furrow in the first segment, short but deep: feet weak, sparingly ciliated, punctulate black (*Ellenr.*). The species of this genus appear to be numerous and to require revision.

180. *STOLLIA GUTTIGERA*, Thunberg.

*Cimer guttigerus*, Thunb., Nov. Ins. Spec. ii, p. 32, t. 2, f. 47 (1783).

*Pentatoma nepalensis*, Westw., Hope Cat. Hem. i, p. 36 (1837): Stål, En. Hem. v, p. 126 (1876).

*Pentatoma punctipes*, Westw., l. c. p. 36 (1837): Stål, l. c. p. 126 (1876).

*Eysarcoris guttigerus*, Dallas, List Hem. i, p. 228 (1851); Walker, Cat. Het., ii, p. 275 (1867).

*Eysarcoris nepalensis*, Leth., Ann. Mus. Civ. Gen. xviii, p. 649 (1883).

*Stollia guttigera*, Stål, En. Hem. v, p. 81 (1876): Scott, A. M. N. H. (4 s.) xiv, p. 290 (1874); Distant, l. c. (5 s.), iii, p. 45 (1879): Scott, Trans. Ent. Soc. p. 305 (1880); Distant, l. c., p. 415 (1883).

Obscurely luteous, tinted bronze, punctured black: pronotum broad posteriorly, the posterior angles prominent, obtuse; anteriorly with two small, smooth, black, lunules: scutellum at the base with two large, distant, white spots: pronotum beneath tinted cupreous: abdomen black, margin luteous (*P. nepalensis*, Westw.). Long  $5\frac{1}{4}$  mill. *P. punctipes*, Westw., is described as very like *P. nepalensis*, or, perhaps, only a local variety; a little larger, angles of pronotum less produced and the colour more metallic, Long  $6\frac{1}{4}$  mill. Nearly allied to *S. bovilla*, Dallas, from the Philippines, differs in having the lateral angles of the pronotum less prominent, and the callous wrinkle on the lateral margins finer: ventral limbus yellow.

Reported from Japan, China, Burma, Assam, Nepal: common in Sikkim and Assam (mihi).

181. *STOLLIA FULIGINOSA*, Ellenr.

*Stollia fuliginosa*, Ellenr., Nat. Tidsskr. Ned. Ind. xxiv, p. 150, f. 18 (1862): Walker, Cat. Het. ii, p. 235 (1876): Stål, En. Hem. v, p. 81 (1876).

♂. Ochraceous-brunneous, so closely punctulate black as to appear fuliginous: posterior inter-angular band on pronotum, lateral bands on scutellum, and some scattered spots, more obscure: two small spots, and a transverse waved line on pronotum and spots on lateral angles of the scutellum, luteous: lateral margins of the abdomen extending slightly beyond the hemelytra, luteous, spotted black: membrane opaque, blackish; venter beneath shining black; broad margin, luteous, stigmata black, last tibiæ somewhat curved at the base (*Ellenr.*) Long, 7—8 mill.

Reported from Sumatra, Java, Malacca.

182. *STOLLIA RUGULOSA*, Walker.

*Eysarcoris rugulosus*, Walker, Cat. Het. ii, p. 276 (1867).

Aeneous-lurid, oval, rather roughly punctured; beneath bright æneous, smooth, shining: head elongate; juga and tylus of equal

length; lateral margins slightly reflexed; rostrum tawny, extending to the hind coxæ, apex black: antennæ black, minutely setulose, less than half the length of the body; joints successively increasing in length; first not extending to the front of the head: pronotum with two slight transverse ridges: scutellum with two slight grooves converging from the sides of the fore border to the middle of the disc: legs tawny, short, stout, black-speckled: membrane brown (*Walker*). Body long,  $5\frac{1}{4}$  mill.

Reported from Cachár (Assam): nearly allied to *S. bovilla*, Dallas, and to *S. insularis*, Dallas.

#### 183. STOLLIA DUBIA, Dallas.

*Eysarcoris dubius*, Dallas, List Hem. i, p. 227 (1851): A. Dohrn, Stettin Ent. Zeit., xxi, p. 400 (1860): Walker, Cat. Het. ii, p. 275 (1867).

*Stollia dubia*, Stål, En. Hem. v, p. 82 (1876).

♀. Above greyish, thickly and finely punctured with black: head blackish, tinted with brassy green: pronotum with the lateral margins very slightly indented, the lateral angles somewhat prominent; the anterior margin blackish, tinged with brassy: scutellum more thickly punctured and consequently darker in colour than the pronotum, with a small impunctate spot in each basal angle: membrane brownish, semi-transparent, with the veins darker: abdomen above black, beneath brassy black, very smooth and shining, with the disc impunctate, the sides thickly and finely punctured, the margins testaceous, with a row of black spots on the extreme edge: pectus brownish, very thickly and finely punctured with black: legs testaceous; femora and tibiæ with numerous brown points: rostrum testaceous, with the apex black: antennæ testaceous, with the 2-3 joints about equal (*Dallas*). Long,  $6\frac{1}{2}$ —7 mill.

Reported from Tenasserim. Dohrn notes that a Ceylon variety has the rostrum not only at the apex, but with a median longitudinal line on two last joints, black.

#### 184. STOLLIA DISTACTA, Dallas.

*Eysarcoris distacta*, Dallas, List Hem. i, p. 226 (1851): Walker, Cat. Het. ii, p. 279 (1867).

*Stollia rectipes*, Ellenr., Nat. Tijds. Ned. Ind., xxiv, p. 150, f. 19 (1862): Walker, l. c. p. 279.

*Stollia distacta*, Stål, En. Hem. v, p. 82 (1876).

♀. Above greyish testaceous, rather thickly and finely punctured with brown: head black, slightly brassy; eyes black, ocelli red: anterior lateral margins of pronotum straight, the lateral angles not pro-

minent, anterior portion much paler than the posterior, with a transverse brassy black spot behind each anterior angle: scutellum with a yellow impunctate spot in each basal angle: membrane transparent, nearly colourless, veins slightly tinged brown and the inner basal angle immaculate: disc of abdomen beneath, deep brassy brown or black, the sides thickly and finely punctured, the middle impunctate, the margins broadly testaceous, thickly and finely punctured brown: pectus testaceous, so thickly covered with brown punctures as to appear nearly brown: legs pale testaceous, femora with numerous brown points: rostrum testaceous, apex black: antennæ pale testaceous with the apical joints brownish; second joint distinctly longer than the third (*Dallas*). Long,  $6\frac{1}{4}$  mill.

Reported from Java, Sumatra, Philippines, Calcutta (mihi).

#### Genus EYSARCORIS, Hahn.

Wanz. Ins. ii, p. 66 (1834); Kolen., Melet. Ent. iv, p. 32 (1846) Dallas, List Hem. i, p. 224 (1851): *Eusarcocoris*, Fieber, Eur. Hem. p. 79, 331 (1861): *Pentatoma*, subg., *Eysarcocoris*, Stål, Hem. Afric. i, p. 135 (1864).

Body obovate, very often broad, beneath very convex: head deflexed, rounded at the apex, tylus reaching the apex; bucculæ continued through, rather elevated: antennæ moderate, first joint about on a level with the apex of the head, 2 and 3 joints varying in length: second joint of rostrum as long as, or a little longer than, the two apical joints taken together: pronotum rather declined anteriorly, anterior lateral margins obtuse, slightly callous, entire: scutellum broad posteriorly, somewhat longer than broad at the base; frena not extended to the middle of the scutellum: feet moderate, femora unarmed at the apex; tibiæ above, not, or only obsoletely, furrowed (*Stål*).

#### 185. EYSARCORIS (?) VENTRALIS, Westwood.

*Pentatoma ventralis*, Westw., nec Dallas, Hope, Cat. Hem. i, p. 36 (1837); Stål, En. Hem. v, p. 126 (1876).

*Pentatoma pallicornis*, Westw., l. c. p. 8 (1837).

Pale luteous, very much punctured, black: head and pronotum anteriorly, blackish: scutellum with two distinct, round, whitish spots at the base: body beneath, antennæ and feet, concolorous: abdomen with a large black patch in the middle (*Westw.*). Long  $6\frac{1}{4}$  mill.

Reported from Bengal.

## 186. EYSARCORIS INCONSPICUUS, Herrich Schäffer.

*Pentatoma inconspicuum*, Herr. Schöff. (nec Dallas), Wanz. Ins. vii, p. 93 (1844); ix, p. 155 (1853).

*Eysarcoris misellus*, Stål, Ofvers. K. V.-A. Förh., p. 217 (1853).

*Pentatoma (Eysarcocoris) misella*, Stål, Hem. Afric. i, p. 135 (1864).

*Analocus misellus*, Stål, Ofvers. K. V.-A. Förh. 3, p. 36 (1872).

*Stollia misella*, Stål, En. Hem. v, p. 82 (1876).

*Eysarcoris inconspicuus*, Reuter, Ofvers. Finska Förh. xxv, p. 6 (1883).

Var. *simplex*, Puton, Hém. Het. France ii, p. 55 (1881); B. S. E. F. (6 s.) i, p. ix, (1881).

Var. *mayeti*, Muls., sec. Puton, l. c.

♂, ♀. Somewhat broadly obovate, pale greyish-stramineous, punctured fuscous: head, two anterior spots on pronotum, also a very large median streak running longitudinally, narrowed hindwards, occupying more than one-third of the venter, fuscous-æneous: head very often with a pale, fuscous punctured streak; a minute, smooth, marginal, subcallous, pale spot at the eyes: lateral and anterior margins of pronotum, also small spot on levigate, callous, basal angles of scutellum, pale: very minute marginal spots on venter, black: first joint of rostrum, not, or scarcely, extending beyond the bucculæ, second joint a little longer than the two apical taken together: venter sometimes with an obsolete, lateral, ænescent-fuscous streak: third joint of the antennæ a little shorter than the second (*Stål*). Long  $4\frac{1}{2}$ — $5\frac{2}{3}$ ; broad, 3—4 mill.

Reported from Cape of Good Hope, N. Africa, S. Europe, India, Philippines. Antennæ sometimes fuscous towards the apex.

## 187. EYSARCORIS (?) MEGASPILUS, Walker.

*Eysarcoris megaspilus*, Walker, Cat. Het. ii, p. 276 (1867).

Tawny, shining, convex, short-elliptical, minutely punctured; punctures black: head black with several longitudinal tawny streaks; lobes of equal length: rostrum tawny, extending to the hind coxæ; apex black: antennæ tawny, piceous towards the tips, less than half the length of the body; joints successively increasing in length; first not extending to the front of the head: pronotum black; with a few tawny speckles and with a tawny disc: scutellum with a very large luteous spot on each side at the base, and with a luteous crescent-shaped apical mark, which is notched in the middle: pectus and underside of abdomen with four irregular and interrupted luteous stripes; a luteous ridge between the middle coxæ and the hind coxæ: legs luteous, short, stout; femora with an irregular black band beyond the middle: hemelytra with two

or three blackish patches; membrane pale cinereous (*Walker*). Body long, 4—5 $\frac{1}{4}$  mill.

Reported from N. China, Hong-Kong, Assam (?).

188. *EYSARCORIS* (?) *INSOCIUS*, Walker.

*Eysarcoris insocius*, Walker, Cat. Het. iii, p. 556, (1868).

Dull testaceous, elliptical, thickly and minutely brown punctured: head large, slightly obtuse in front; juga and tylus of equal length: eyes piceous, prominent: rostrum extending to the hind coxæ; apex black: antennæ pale-testaceous; first joint not extending to the front of the head; second a little longer than the third; fourth much longer than the third; fifth partly piceous, longer than the fourth: pronotum with two irregular smooth transverse lines, of which the fore one is much more undulating than the hind one; the latter is between the hind angles, which are prominent and much rounded; sides slightly serrated in front; scutellum with a less thickly punctured stripe extending from the middle to the tip, which is much rounded, a small pale testaceous callus on each side at the base: abdomen beneath with three black stripes; the lateral pair irregular and incomplete; the middle one not extending to the tip, dilated towards the base, where it includes a testaceous spot; tip emarginate: femora with three small black dots near the apex; tibiæ very minutely black-speckled; membrane cinereous; veins few, brown; no transverse veinlets. Var.—Stripes of the abdomen nearly obsolete (*Walker*). Body long, 6 $\frac{1}{2}$ —7 $\frac{1}{2}$  mill.

Reported from India.

Genus *CARBULA*, Stål.

*Pentatoma*, subg. *Carbula*, Stål, Hem. Afric. i, p. 140 (1864); *Carbula*, En. Hem. v, p. 60, 82 (1876).

Body broadly oval or obovate, beneath very convex: head rounded or subtruncated at the apex: the juga and tylus somewhat equal in length, the former obtuse, lateral margins somewhat obtuse, bucculæ moderately elevated, reaching base of the head; antenniferous tubercles partly visible from above: rostrum moderate, the first joint equal to, or extending a little beyond, the bucculæ posteriorly; second joint somewhat equal to, or a little longer, than the apical two taken together: antennæ moderate or somewhat long, first joint not reaching the apex of the head; second joint rarely a little longer than the third: anterior lateral margins of pronotum very often very obtuse; never acute; terminated by a smooth wrinkle or ridge, (which itself is sometimes transversely rugulose), rarely anteriorly crenulated: scutellum triangular,

somewhat short, a little longer than broad at the base; frena extended a little beyond the middle: hemelytra a little narrower than the abdomen; membrane with simple veins: apical angles of the last segment of the abdomen very often obtuse, rarely produced in a small spine: feet moderate, somewhat slender, tibiæ above slightly furrowed (*Stål*).

#### 189. CARBULA BIGUTTATA, Fabricius.

*Cimex 2-guttatus*, Fabr., Ent. Syst., iv, p. 129 (1794).

*Cimex 2-notatus*, Fabr., Syst. Rhyng. p. 165 (1803).

*Carbula biguttata*, Stål, Hem. Fabr. i, p. 25 (1868); En. Hem. v, p. 83 (1876).

♀. Obovate, stramineous: above rather densely, below remotely, distinctly punctured ferruginous fuscous; anterior lateral margins of pronotum flavescent; a moderate, smooth, callous, shining spot on the basal angles, and the extreme apical margin of the scutellum, stramineous: membrane sordid hyaline, veins fuscous: lateral angles of pronotum, basal and apical margins of the segments of the connexivum, extremity of basal and the apical angles of the segments, and a very broad streak on the venter, narrowed hindwards, black: feet very finely and remotely sprinkled with black; 2—3 small black spots near the apex of the posterior femora (*Stål*). Long, 8; broad, 5 mill.

Very closely allied to *C. abdominalis*, Sign. Head flat, juga and tylus equally long, the former subrotundate at the apex, lateral margins parallel before the sinus: 2 and 3 joints of the antennæ equally long: pronotum with the lateral angles, very acute, moderately produced outwards, obsoletely pallescent at the extreme apex, anterior lateral margins very slightly sinuate, slightly reflexed, anteriorly very obsoletely crenulated; apical angles of the sixth abdominal segment, obtuse.

Reported from India.

#### 190. CARBULA (?) OBSCURA, Westwood.

*Pentatoma obscura*, Westw., Hope, Cat. Hem. i, p. 35 (1837).

*Pentatoma bimaculata*, Westw., l. c., p. 8 (1837).

*Carbula ? obscura*, Stål, En. Hem. v, p. 126 (1876).

Fuscous-luteous, punctured black; posterior angles of pronotum prominulous, subacute, black; lateral margin of pronotum anteriorly pallid; scutellum with two distant, white spots at the base: antennæ and feet luteous, punctured fuscous (*Westw.*). Long, 7½ mill.

Reported from India.

#### 191. CARBULA FUSCA, Distant.

*Carbula fusca*, Dist., Trans. Ent. Soc., p. 346 (1887).

Above shining fuscous-brown: head somewhat thickly covered



with bronzy-green punctures; eyes luteous; antennæ brown, the last joint with the apical two-thirds blackish: pronotum with the anterior area and lateral margins punctured bronzy-green, remaining area coarsely punctate, lateral angles prominently and obtusely produced, their apices reddish-brown: scutellum coarsely punctate, sometimes slightly shaded bronzy-green: corium coarsely punctate: membrane pale hyaline: body beneath, rostrum and legs brown, the abdomen paler, with a broad, median, blackish band, on each side of which is a narrower and more irregular band of the same colour, and between these bands are scattered dark punctures: femora punctured or speckled with blackish: head beneath and sternum coarsely and darkly punctate: mesostethium with a large irregular luteous spot on each side: rostrum reaching third abdominal segment: 2-3 joints of antennæ subequal in length, and much shorter than the fourth; 4-5 joints subequal in length, the fifth moderately incrassate (*Dist.*). Long 7-8: exp. angl. pron. 5-6 mill.

Reported from Nepal, Sikkim (mihi), where it is very common.

#### 192. CARBULA SCUTELLATA, Distant.

*Carbula scutellata*, Dist., Trans. Ent. Soc. p. 347 (1887).

Head luteous, covered with coarse black punctures; eyes fuscous; ocelli red; antennæ luteous, infusate at the apex; 4-5 joints subequal in length; rostrum extending just beyond last coxæ: pronotum luteous, coarsely and darkly punctate, the lateral margins levigate, the lateral angles produced into long, acute, black spines: scutellum luteous, sparingly and coarsely darkly punctate, a large levigate spot at each basal angle, apex also broadly impunctate, punctures usually thickest at the lateral margins and sometimes at the base: corium luteous with a purplish tinge, thickly and darkly punctate: membrane pale hyaline: connexivum luteous, with black segmental, marginal spots: body beneath and legs luteous, with a few scattered black punctures on the disc and on the femora, and the margins and apices of the pronotal angles black (*Dist.*). Long, 8; exp. angl. pron.  $5\frac{1}{2}$  mill.

Reported from Bombay, N. Khasiya Hills (Assam).

#### Genus GYENICA, Dallas.

List Hem. i, p. 180 (1851); Walker, Cat. Het. i, p. 217 (1867); Stål, En. Hem. v, p. 83 (1876).

Body elongate-ovate: head elongate, tapering gradually to the apex; tylus reaching the apex; eyes not prominent; ocelli minute, placed close to the eyes; antennæ inserted in front of the eyes, basal joint short, not reaching the apex of the head, 2-3 joints about equal;

rostrum inserted in front of the antenniferous tubercles, reaching the base of the abdomen, basal joint reaching the base of the head, second joint longest, as long as 3-4 together, 3-4 joints about equal: lateral angles of pronotum produced into strong, acute spines, directed forwards and upwards: scutellum triangular, not extending beyond the middle of the abdomen: membrane with longitudinal veins: abdomen with a weak longitudinal furrow, apex produced and pointed (♀), vulvar plates narrow and acute: legs moderate: tarsi 3-jointed, basal joint longest (*Dallas*).

#### 193. GYENICA MARGINELLA, Dallas.

*Gylenica marginella*, Dallas, List Hem. i, p. 181, t. 6, f. 4 (1851); Walker, Cat. Het. i, p. 217 (1867): Stål, En. Hem., v, p. 83 (1876).

Above brown, thickly and finely punctured black, more strongly on the scutellum: head with a median, longitudinal, fulvous line: thorax with a transverse yellow band before the middle, and the lateral spines black: lateral margins of scutellum yellow, impunctate, with a line of coarse, black, punctures close to the margin, apex yellow, finely punctured black: outer margin of corium yellow, coarsely punctured black; membrane transparent: margin of the abdomen fulvous, tinged with green; pectus fulvous, tinged with green and thickly and finely punctured: legs fulvous, apex of each tibiæ and the tarsi, black: rostrum testaceous, apex black: antennæ ferruginous (*Dallas*). Long,  $13\frac{2}{3}$  mill.

Locality unknown: Africa (?).

#### 194. GYENICA AFFINIS, Distant.

*Gylenica affinis*, Dist., Ent. Mon. Mag. xvi, p. 202 (1880).

Above brown, thickly and coarsely punctured: head thickly punctured black, with a median, fulvous longitudinal line, broadest at the base; tylus reaching apex of the head, a little shorter than the jûga; antennæ fuscous, basal joint not reaching apex of the head, second slightly shorter than the third, fourth longest, 5 and 3 subequal: posterior half of pronotum thickly punctured black, anterior portion fulvous, lateral angles produced into strong, acute, black spines, slightly directed forwards: scutellum fulvous, sparingly covered with black punctures, except at the base, where there is a large median, black, coarsely punctured spot: corium concolorous with posterior part of the pronotum, very thickly punctured black; membrane fuscous: body beneath luteous, thickly and finely punctured, slightly tinged with green: legs fulvous: rostrum greenish, apex black. Allied to preceding,

differs in the shorter head, and tylus not extending beyond the jugs; the pronotal spines are smaller and not directed upwards, the scutellum is of another colour (*Dist.*). Long, 10; exp. pron. angl., 6 mill.

Reported from Bombay, Calcutta (mihi).

Genus CRATONOTUS, Distant.

A. M. N. H. (5 s.) iii, p. 50 (1879).

Head broad and elongated; ocular part broadest, with the lateral edges somewhat sinuated about the middle; tylus shorter than the jugs; eyes prominent; ocelli situated rather nearer the eyes than to each other: antennæ longer than the head and pronotum, five jointed; second joint slightly shorter than the third, fourth longest: rostrum robust, just passing the posterior coxæ; second joint longer than the third, apical joint shortest: pronotum twice as wide as long, raised and rounded at the base, deflexed in front, angles obtusely prominent; lateral margins deeply sinuated, with their anterior portion crenulated: scutellum reaching a little beyond the base of membrane, gradually narrowed for two-thirds its length from the base, when it is straightened to apex, which is moderately broad and rounded; width at base about equal to length: membrane with longitudinal veins: abdomen widened above, projecting a little on each side, convex beneath, abdomen and sternum unarmed: legs moderately long, tibiæ sulcated (*Distant*). This genus is near *Durmia*, Stål.

195. CRATONOTUS COLORATUS, Distant.

*Cratonotus coloratus*, Distant, A. M. N. H. (5 s.) iii, p. 50 (1879).

Brown, somewhat shining, thickly punctured with black; head black, thickly punctured; eyes black, with their bases luteous; antennæ luteous; rostrum brownish; pronotum with the basal half rugulose and very coarsely punctured, lateral margins narrowly luteous, pronotal angles pitchy: scutellum transversely rugulose, with a large irregular patch, at base and apex, broadly luteous; membrane pitchy, shining: margins of abdomen above, and body beneath, luteous, the last with a broad green stripe on each side, extending narrowly along on each side of head, widened at anterior coxæ, and extending to about the base of the fifth abdominal segment; two obscure marks on the disc and a sub-apical spot pitchy: legs luteous; apices of femora and tibiæ black; anterior tibiæ punctured with black; tarsi black. Other structural characters as in generic diagnosis above (*Distant*). Long, 19; breadth of angles of pronotum, 11 mill.

Reported from N. Khasiya hills, 1,500—3,000 feet (Assam), Sikkim (mihi).

Tibiæ rounded, without a furrow; see p. 16.

Genus AGONOSCELIS, Spinola.

Ess. p. 327 (1837); Dallas, List Hem. i, p. 179 (1851); Stål, Hem. Afric. i, p. 177 (1864); En. Hem. v, p. 84 (1876).

Includes *Neuroscia*, Am. & Serv., Hist. Nat. Ins. Hém. p. 109 (1843).

Body remotely pilose, oval: head very often somewhat long, gradually narrowed forwards, rounded at apex, entire; jugæ and tylus of equal length: bucculæ continued through, distinctly elevated: rostrum long, or somewhat so, first joint reaching base of the head: anterior lateral margins of pronotum entire, somewhat acute, straight; anterior margin, in the middle at least, somewhat callous: scutellum triangular, rather narrowed at apex, frena extended a little beyond the middle: hemelytra somewhat narrower than the abdomen and much longer: veins of membrane simple: mesostethium slightly carinate: venter sometimes, obsoletely somewhat sulcate: feet moderate; tibiæ cylindrical, not sulcate above (*Stål*).

196. AGONOSCELIS NUBILA, Fabricius.

*Cimex nubilus*, Fabr., Syst. Ent. p. 712 (1775); Spec. Ins. ii, p. 355 (1781); Mant. Ins. ii, p. 293 (1787); Ent. Syst. iv, p. 112 (1794), Cape: Wolff, Ic. Cim. ii, p. 57, t. 6, f. 54 (1801), India.

*Halys nubila*, Fabr., Syst. Rhyng. p. 183 (1803): Stoll, Punaïses, p. 161, t. 40, f. 290? (1788), India.

*Pentatoma grata*, Palis. Beauv., Ins. p. 129, Hém, t. 9, f. 5 (1805).

*Ælia ? nubila*, Hahn, Wanz. Ins. iii, p. 29, t. 82, f. 251 (1835).

*Agonoscelis indica*, Spinola, Ess. p. 329 (1837).

Var. *Ælia crucifera*, Westwood, Hope, Cat. Hem. i, p. 32 (1837). Cape, Java.

Var. *Agonoscelis femoralis*, Walker, Cat. Het. iii, p. 545 (1868). N. India, Banda.

*Neuroscia grata*, Am. and Serv., Hist. Nat. Ins. Hém. p. 109 (1843). St. Domingo?

*Neuroscia sulciventris*, Ellenr., Nat. Tijds. v. Ned. Ind. xxiv, p. 144, f. 11 (1862). Sumatra.

*Agonoscelis nubila*, Dallas, List Hem. i, p. 179 (1851); Uhler, Proc. Ac. Phil. p. 223 (1860), Japan. Walker, l. c. i, p. 217 (1867); Stål, En. Hem. v, p. 85 (1876); Scott, A. M. N. H. (4 s.) xiv, p. 290 (1874); Distant, l. c. (5 s.), iii, p. 45 (1879).

Small, greyish varied with black: antennæ altogether black; head greyish with four black lines: pronotum, greyish, irrorated with black, dorsal line immaculate: scutellum black at the base, with a median line and apex, greyish: hemelytra variegated, a median rufescent patch: wings white with black lines: beneath, glaucous, punctured black, margin of abdomen rufescent (*Fabr.*). *N. grata*, Am. & Serv. (*l. c.*) is thus described: ♂, ♀ yellowish, spotted black; head yellow with four black longitudinal lines above: pronotum yellow, with some reddish tints, punctured black: scutellum yellowish, punctured black, its tip of a light yellow or reddish: corium reddish yellow, with small, black,

irregular, transverse lines; the membrane extending rather beyond the end of the abdomen, white, transparent; veins deep brown: body beneath yellow with two black spots on each side, on each ventral segment: feet yellow, femora with several black dots, tarsi brown: antennæ brown. Long, 10-12 mill.

Reported from the Philippines, Java, Malacca, India, China, Japan. The Indian Museum has specimens from Arakan, Calcutta (mihi) Assam, Mysore, and China. Walker's variety '*femoralis*' appears to be as much entitled to specific rank as many others. It is found with the ordinary form in Sikkim, Assam and Burma, and I have recently had it from the Karen Hills near Tounghoo.

#### Group B. See p. 16.

En. Hem. v, p. 60 (1876).

Includes those genera which have either the second ventral segment produced anteriorly in a spine, or tuberculated; or the venter furnished with a levigate, obtusely round, longitudinal, and sometimes furrowed, ridge; or having the anterior and anterior-lateral margins of the pronotum, or, at least the anterior, distinctly elevated, levigate or callous; or the pronotum anteriorly levigate, or sparingly punctured, and, within the anterior margin, punctured in regular or somewhat regular rows; or the odoriferous apertures are immarginate outwards, or continued in a furrow open at the apex: the entire second joint of the antennæ, or a great part of it, extending beyond the apex of the head.

#### Div. STRACHIARIA, Stål.

Stål, *Ofvers. K. V.-A., Förh.* (3), p. 39 (1872); En. Hem. v, p. 60 (1876).

The odoriferous apertures placed between or near the posterior acetabula, often obsolete, sometimes having the appearance of a small fissure, anterior and posterior margins, sometimes slightly elevated and continued in two parallel or gradually diverging wrinkles or ridges, gradually evanescent, terminating in a furrow, linear, or gradually amplified, open at the apex: evaporative area wanting or obsolete: lateral margins of the head reflexed: base of venter unarmed.

#### Genus AGÆUS, Dallas.

List Hem. B. M. i, p. 185 (1851); Walker, *Cat. Het.* i, p. 229 (1867); Stål, *Ofvers. K. V.-A., Förh.* p. 519 (1867); En. Hem. p. 60, 85 (1876).

Body elongate-ovate: head elongate, longer than broad, the sides

slightly sinuate, nearly parallel, apex pointed: tylus prominulous before the juga which are not, or only very slightly, convergent, anteriorly and posteriorly equally distant, or somewhat so: antennæ inserted a little before the eyes, about half as long as the body, slender, 5-jointed; basal joint short and stout, not reaching nearly the apex of the head; the second joint about twice the length of the first; the third and the fourth nearly equal in length, longer than the second; the fifth a little shorter than the second: rostrum long, slender, reaching behind the last coxæ, inserted rather in front of the middle of the head; the basal joint short, not reaching the base of the head; second longest; third longer than the fourth which is longer than the first: the anterior margin and the anterior-lateral margins of the pronotum elevated or reflexed, smooth, callous: scutellum elongate, much narrowed at the apex; frena extended to a distance beyond the middle of the scutellum: coriaceous portion of the hemelytra longer than the membrane which has nine longitudinal veins: venter slightly furrowed; the furrow from the orifices gradually amplified: feet rather long; basal and apical joints of the tarsi about equal (*Dallas*).

197. *AGÆUS TESSELLATUS*, Dallas.

*Agæus tessellatus*, Dallas, List Hem. i, p. 186, t. 6, f. 6 (1851); Walker, Cat. Het. i, p. 229 (1867).

♀. Above testaceous, thickly and finely punctured with brown: eyes pithy, ocelli red: pronotum with five brassy black spots on each side of the posterior portion of the disc; namely, three large ones near the middle, placed, two on the posterior margin, and one between the apices of these, a small one on the lateral margin near the lateral angle, and one between this and the three large spots: scutellum with the basal portion brassy black, with a narrow median line, the basal angles, the lateral margins, and an oblique angular line on each side testaceous; coriaceous portion of the hemelytra with a broad, brassy black transverse band about the middle, and an indistinct spot of the same colour towards the apex; membrane brown, semitransparent: wings blackish, with the base vermilion: dorsum of the abdomen bright red, shining; margins orange, with a brassy black spot on each suture: abdomen beneath testaceous, very faintly and sparingly punctured, with a row of round, dark brown spots on each side between the stigmata and the median furrow; stigmata black: pectus more or less thickly and finely punctured with brown; pectus impunctate; mesostethium with a slight median ridge: legs testaceous, with a streak on the apex of the femora, a similar streak near the base of the tibiæ, the apex of the tibiæ

and the tarsi, black; rostrum testaceous, with the apex black: antennæ black, with the underside of the basal joint testaceous (*Dallas*). Long, 21—22 mill.

Reported from India, Burma, Assam (mihi).

198. *AGÆUS MIMUS*, Distant.

*Agæus mimus*, Dist., Trans., Ent. Soc. p. 347. t. 12, f. 1 (1887).

Head fuscous; tylus (except apex and lateral margins) ochraceous; eyes greyish; antennæ black, second joint shorter than the third, 3-4 joints subequal in length; head rather thickly and finely punctate, excepting the lateral margins which are levigate: pronotum more coarsely and sparingly punctate, lateral margins levigate and finely crenulate anteriorly, lateral angles obtusely pointed and slightly produced; of a reddish ochraceous colour, with thirteen fuscous spots arranged six at base, of which two almost occupy the lateral angles and the intervening four are more or less triangular, five discal spots, of which the median is longest and intervenes between the two median basal spots and also between two large spots placed near the anterior margin: scutellum coarsely and rather closely punctate, fuscous, with a median longitudinal ochraceous line, and a similar line extending from each basal angle and meeting the median line on the disc: corium finely and sparingly punctate, reddish ochraceous with fuscous punctures and some irregularly shaped spots of the same colour, of which the most prominent are a claval streak, three discal (the lowermost largest), one large and long costal spot at about the middle, and three subapical spots (the median largest): membrane bronzy-brown: abdomen above reddish: head beneath ochraceous, margins of rostral canal, margins of bases of antennæ and a band from the same to the base of the head, fuscous: prostethium fuscous, anterior and posterior margins and a transverse discal line ochraceous; lateral margins and a spot near the coxæ, reddish: meso- and meta-stethium fuscous, their margins and the odoriferous apertures ochraceous, and with reddish spots near the bases of the coxæ: abdomen beneath with a median, longitudinal, furrow, reddish ochraceous, ornamented with a number of large dark fuscous spots: legs fuscous, femora streaked with ochraceous (*Dist.*). Long, 23; exp. angl. pron. 10 mill.

Reported from Assam, Sibságar (mihi).

Genus *EURYDEMA*, Laporte.

*Pentatoma*, subg. *Eurydema*, pt., Lap. Ess. Hém. p. 61 (1832); Herr. Schöff. Nom. Ent. i, p. 37 (1835); *Eurydema*, pt., Am. and Serv. Hist. Nat. Ins. Hém. p. 125 (1843); Kolenati, Melet. Ent. iv, p. 21 (1846): *Strachia*, pt., Dallas, List Hem.

i, p. 257 (1851); Fieb. Eur. Hem. p. 343 (1861); Walker, Cat. Het. i, p. 313 (1867); *Eurydema*, Stål, Ofvers. K. V.-A. Förh. xxix, 3, p. 39 (1872); En. Hem. v, p. 60, 85 (1876).

Stål thus distinguishes between the allied genera:—

1—2. Eyes sessile: anterior and antero-lateral margins of pronotum, elevated, callous:—*Eurydema*, Lap.

2—1. Eyes briefly stylate.

3—4. Pronotum sinuate at the apex, anterior margin callous:—*Stenozygum*, Fieb.

4—3. Pronotum somewhat truncate at the apex; anterior margin not callous:—*Bagrada*, Stål.

#### 199. EURYDEMA FESTIVUM, Linnæus.

*Cimex festivus*, Linn., Syst. Nat. ii, p. 723 (1767).

*Pentatoma picta*, Herr. Schöff. Cont. Panz. Faun. Germ. p. 116 (1835).

*Eurydema pictum*, Herr. Schöff. Nom. Ent. i, p. 55, 91 (1835).

*Strachia picta*, Hahn, Wanz. Ins. iii, p. 14, t. 77, f. 240 (1835); Fieb. Eur. Hem. p. 343 (1861); P. Löw, Wien, Ent. Zeit. ii, p. 57 (1883).

*Cimex fallax*, Scholtz, Prodr., p. 154 (1846).

Var. *albiventris*, Jakov., Bull. Soc. Mosc. li (3) p. 105 (1876).

Var. *cruentatum*, Puton, Hém. Het. France, ii, p. 70 (1880).

*Eurydema festivum*, Distant, Scient. Res. Sec. Yarkand Miss. p. 6 (1879); Reuter, Ent. Tijds. i, p. 130 (1880); Rev. d'Ent. iii, p. 68 (1884); Berlin Ent. Zeit. xxix, p. 40 (1885).

Reuter (l. c.) establishes the fact that *Cimex festivus*, Linn., is not the species of that name as used by later authors, but is *E. pictum*, H. S. hence arises some difficulty in arranging the synonymy. Through the kindness of M. Lethierry, I have received a specimen of *E. festivum*, from Amasia in Asia Minor, which agrees in all respects with Hahn's figure of *S. picta* which is described by him as having 'the antennæ black; head reddish or yellowish, anteriorly with two spots, and from the eyes hindwards, black-green: above punctured; pronotum yellowish, reddish on the border; anteriorly with two transverse spots, and, behind them, a transverse row of four almost quadrate spots, black-green: scutellum yellowish, reddish at the apex, black-green at the base: hemelytra reddish or yellowish, each with a hook-shaped black-green marking, behind which, as also on the outer margin, is a black-green spot: abdomen beneath yellowish or reddish; on the outer margin on each side, a small black-blue point on each incisure: wings black-green with whitish limbus: feet yellowish, ringed and streaked black-green.' Long,  $10\frac{1}{2}$ ; broad,  $5\frac{1}{4}$  mill.

Reported from Europe, Yarkand, Sind valley, and probably Sikkim.



## 200. EURYDEMA DOMINULUM, Scopoli.

*Cimex dominulus*, Scop., Ent. Carn., p. 124 (1763).

*Cimex festivus*, Fabr. Syst. Ent. p. 714 (1775); Spec. Ins. ii, p. 358 (1781); Mant. Ins. ii, p. 295 (1787); Ent. Syst. iv, p. 118 (1794); Syst. Rhyng., p. 172 (1803); Gmelin, ed. Syst. Nat. i (4), p. 2150 (1793); Wolff, Ic. Cim. p. 61, t. 6, f. 58 (1801).

*Strachia festiva*, Hahn, Wanz. Ins. i, p. 181, t. 29, f. 93 (1831); Fieber, Eur. Hem. p. 342, (1861); Saunders, Trans. Ent. Soc., p. 124 (1875); ? L. Duda, Wien Ent. Zeit. iv, p. 70 (1885).

Var. *Eurydema bhesgica*, Kolen. Mel. Ent. iv, p. 28, t. 15, f. 31 (1846).

*Eurydema dauricum*, Motsch., Bull. Soc. Nat. Mosc. (2) p. 502 (1859); Stål, En. Hem. v, p. 86 (1876).

*Eurydema dominulum*, Reuter, Rev. d'Ent. iii, p. 68 (1884); Berlin, Ent. Zeit. xxix, p. 40 (1885).

♂. Head black; margin red; antennæ black, reddish at apex: pronotum red, with six black spots of which four posterior: scutellum red, with a black hemispherical patch at the base: hemelytra red; apex membranous, black; margin whitish, with two black spots at the internal margin, and a black dot at the apex: abdomen red with a black spot above on the apex, beneath on both sides with six ovate black spots: feet black. ♀ of the same colour, but a little larger (*Scopoli*). Long,  $6\frac{1}{2}$  mill. Wolff's description is as follows;—'Head black, lateral margin red, impressly punctured, with a small impressed line, posteriorly bifid, on the apex; orbit of the fuscous eyes rufous: rostrum 4-jointed, black, shorter than half the body: pronotum declined anteriorly, red, shining, impressly punctured, with six black spots, the two anterior large, the four posterior smaller: scutellum red, impressly punctured, longer than half of the abdomen, with a black hemispherical patch at the base, and a small marginal spot on both sides before the apex: hemelytra red, impressly punctured, shining, interior margin, an abbreviated median band close to interior margin, spot at apex, and another in the middle of the exterior margin, black: membrane black, shining, margin broadly white: wings fuliginous, white at apex: abdomen above deep black, shining, margin red, immaculate: beneath rufous, deep black in the middle, very shining; a line of black dots on both sides: pectus deep black, very shining, with all the sutures livid: anus red: feet deep black; first tibiæ with a small tooth before the apex. Varies in size and in having six black ovate spots on each side beneath.' Long, 10 mill.

Reported from Europe, but is probably found in N. India, some of the specimens procured there being very like Wolff's figure but comparison with a long series can alone settle this question.

## 201. EURYDEMA WILKINSI, Distant.

*Eurydema wilkinsi*, (Ochs., in lit.) Dist. Trans. Ent. Soc. p. 123 (1879): Scient. Res. 2nd Yark. Miss. p. 5, f. 4 (1879).

*Strachia conspicua*, Jakov., Bull. Soc. Imp. Nat. Moscou, p. 286 (1881).

Pale luteous, somewhat thickly and coarsely punctured: head with the anterior part of the submarginal, lateral borders, and a large triangular marking at the base; pronotum with two large discal, subquadrate, linear markings, elongated exteriorly; scutellum with the base and two median forked lines, extending therefrom to about the middle, and spots on the lateral margins, a little before the apex; corium with two claval streaks, a linear spot on the middle of the outer margin, a transverse waved band, extending from the base of the membrane for two-thirds across the corium, and a rounded subapical spot, shining green. Abdomen above luteous, apical segment black, connexivum with a row of large green spots; underside of body. pale luteous: abdomen with a marginal row of spots situate on the outer edge of each segmental suture, and a submarginal row of transverse, slightly-waved linear markings, situate on the middle of each segment, greenish-black: sternum with some irregular markings of the same colour: legs pale luteous, streaked with greenish black, and femora obscurely annulated with the same colour near the apex: antennæ black, second joint about as long as 1 and 3 together, 4 somewhat dilated, about as long as 5: rostrum luteous, pitchy at base and apex. In most specimens, the markings on the pronotum are not perfectly subquadrate (*Dist.*). Long, 7 mill.

Reported from Yangi-hissar.

## 202. EURYDEMA ORNATUM, Linnæus.

*Cimex ornatus*, Linn., Faun. Suec. p. 251 (1761); Syst. Nat. ii, p. 723 (1767). Scopoli, Ent. Carn. p. 123 (1763): Wolff. Ic. Cim. p. 15, t. 2, f. 15 (1800).

Var. *Strachia herbacea*, Hahn, Wanz. Ins. iii, p. 13, t. 77, f. 239 (1835): *Eurydema festiva*, var. *herbacea*, Distant, Scien. Res. Sec. Yarkand Miss. p. 6 (1879).

*Pentatoma ornata*, var. *hoffmanseggi*, Gorski, Anal. ad Ent. p. 85 (1852) and var. *falleni*, Gorski, l. c.

*Eurydema ornatum*, var. *ventralis*, Kolen., Mel. Ent. iv, p. 26 (1846).

*Strachia ornata*, Duda, Wien. Ent. Zeit. ii; p. 70 (1884).

*Eurydema ornatum*, Reuter, Rev. d' Ent. iii, p. 68 (1884); Berlin Ent. Zeit. xxix, p. 40 (1885).

Ovate; varied black and red: head and wings black (*Linn.*). Varied black and red: head, antennæ, pronotum beneath, and feet, black: hemelytra with a free spot at the apex of the corium, a black subovate mark on the external margin towards the base; internal margin black and with two black spots, the lower of which is long and ob-

tuse; membrane blackish, margin whitish: two black semibifid spots on the pronotum: abdomen beneath red, in the middle with four transverse spots, on each side with a somewhat double row of black points, of which the one marginal with five somewhat conical points, the other interior, with six somewhat round points, with abrighter pupil in the middle (*Scop.*). Long,  $8\frac{1}{2}$  mill.

Var. *herbacea*, Hahn:—Antennæ and feet black; the shining black-green head narrowly edged red anteriorly: above punctured, red: the anterior and posterior black-green markings on the pronotum united: on the inner margin of the hemelytra, a broad, black green-tinted,  $\perp$ -shaped mark turning outwards which is also produced inwards on to the scutellum, towards the apex, a black spot, and, on the outer margin, another somewhat larger: abdomen beneath red, black in the middle, black with a blue tint, and on each incisure, on each side, a small black-blue spot: wings brown with a greenish tint and whitish limbus. Long,  $7\frac{1}{2}$ — $8\frac{1}{2}$ ; broad, 4— $4\frac{1}{2}$  mill.

Wolff's specimen is thus described:—

Head, antennæ, and rostrum, black; pronotum, scutellum, and hemelytra red, punctured: head punctured, submarginate at the apex, posteriorly with a bifid impressed small line; spot on both sides before the black eyes and the very slender margin, red; rostrum 4-jointed, red at base; antennæ 5-jointed; pronotum with a spot on both sides, posteriorly bifid, black: scutellum with spot at base not reaching margin, and one on both sides before the apex close to the spot on the hemelytra, black; a somewhat elevated small longitudinal line in the middle: hemelytra with a free spot at the apex, another larger at exterior margin towards the base, and a median spot confluent with the slender black limbus, black; membrane black, limbus whitish: margin of abdomen prominulous, red, with four black quadrate spots; beneath yellow-ferruginous with five marginal spots and the same number of elevated points, black: pectus concolorous, with small impressed, curved black lines: anus entire, blackish: feet black, femora at base and tibiæ annulated yellow-ferruginous (*Wolff*). Abdomen beneath sometimes red, with four transverse, black spots: pronotum sometimes with six black spots.

Reported from the Sind Valley.

### 203. EURYDEMA PULCHRUM, Westwood.

*Pentatoma pulchra*, Westw., Hope, Cat. Hem. i, p. 34 (1837). Java.

*Strachia pulchra*, Dallas, List Hem. i, p. 258 (1851); Walker, Cat. Het. iii, p. 332 (1868).

*Eurydema sumatrana*, Ellenr., Nat. Tijds. Ned. Ind. xxiv, p. 152, f. 20 (1862).

*Eurydema pulchra*, Stål, En. Hem. v, p. 86 (1876): Sign., B. S. E. F. (6 s.) i, p. xli (1881). China.

Fulvous: body somewhat depressed; head black, margin pale: spots on hemelytra cyaneous: abdomen beneath with median bands and round lateral spots (*Westw.*). Long,  $8-8\frac{1}{2}$  mill.

Head black with a luteous limbus: pronotum orange red with six black spots, two transverse towards anterior margin, two obliquely ovate towards posterior margin, and two very minute punctiform spots at the posterior angle: scutellum orange red, spotted black, a single, very large, obtusely triangular, spot at the anterior margin, and two marginal rather oblong near the posterior angle: coriaceous portion of the hemelytra black, with a sigma-shaped band in the middle and the external margin, red; membrane black, chalybeous, margin hyaline at the apex: sternum luteous, spotted black at the stigmata: venter luteous, with a transverse band-shaped spot on each segment and two on the stigmata: femora lutescent, black at the apex; tarsi and antennæ, black (*Ellenr.*). Long, 9 mill.

Reported from Java, China, Sikkim where it is not uncommon (mihi).

#### 204. EURYDEMA MULTIPUNCTATA, Distant.

*Eurydema multipunctata*, Dist., Trans. Ent. Soc. p. 348, t. 12, f. 6 (1887).

Body above pale ochraceous, sometimes suffused with purplish above: margins of tylus (angulated externally about the middle) and the base, black: antennæ ochraceous, apex of third and 4-5 joints palely infuscate, fourth joint longest: rostrum ochraceous, tip pitchy, reaching last coxæ; pronotum with twelve black spots, arranged four on anterior margin, remainder on the disc, three in each angular area and two in the middle: scutellum with ten black spots, four at the base, four near middle, and two before the apex: corium with three black spots, arranged somewhat longitudinally: membrane blackish, pale hyaline at apex and margins: body beneath pale ochraceous, head with two black spots at the base, sternum with a double submarginal row of black spots, a transverse black spot on each side of the metastethium, and a double row of black marginal spots on the abdomen (*Dist.*). Long, 8-9 mill.

Reported from Arrah (Bengal), rather rare (mihi).

Genus STENOZYGUM, Fieber.

Eur. Hem. p. 345 (1861); Stål, Ofvers. K. V.-A., Förh. 520 (1867); En. Hem. v, p. 61, 86 (1876). Includes *Nitilia*, subg. *Minodia*, Muls. and Rey, Pun. France Pent. p. 199 (1866).

Body short, oval, hairless, shining, somewhat convex, bright coloured: head not much deflexed, lateral margins rounded, slightly sinuate towards the base; antennæ robust, second joint shorter than the third

and only a little longer than the first; 4-5 joints robust, each one-third longer than the third: basal third of the scutellum not or but slightly elevated: apical angles of the abdominal segments without a spine, not, or but very slightly, prominent: last femora unarmed, not incrassate in ♂.

205. *STENOZYGUM SPECIOSUM*, Dallas.

*Strachia speciosa*, Dallas, List Hem. i, p. 261 (1851); Walker, Cat. Het. ii, p. 326 (1867).

*Stenozygum speciosum*, Stål, En. Hem. v, p. 86 (1879).

♀. Rather elongate, ovate: head, black, impunctate; each of the juga with the inner margin yellow and an orange spot at the base; a large oblong orange yellow spot on the middle of the vertex, and a minute yellow dot on each side between this and the eyes, which are pitchy; ocelli red: pronotum black, divided in the middle by a deep, transverse, strongly punctured furrow; anterior portion smooth, shining, impunctate, with the broad lateral margins, a short line on each side on the anterior margin, and four spots across the disc, just in front of the transverse furrow, yellow; a small raised orange spot near each anterior angle surrounded by a depressed line; posterior portion irregularly punctured, with a broad, median, yellow, longitudinal band, expanded on the posterior margin (and probably continued on the anterior lobe), and a narrower band of the same colour on each side. Scutellum rather elongated, punctured; the base black, with a broad, median, longitudinal yellow line, and an orange spot in each angle; the posterior portion yellow, with a large red patch on the disc, at and behind which, the lateral margins are black; apex impunctate: corium black, punctured, with the disc smooth; with the outer margin broadly but interruptedly pale yellow; the two inner veins pale yellow, an orange spot on the disc before the middle, and a large irregular yellow patch tinged with red in the middle, at the apex; membrane dark brown, shining, somewhat brassy, with the margin hyaline: body beneath tawny, very smooth, shining: abdomen impunctate, with a row of spots on each lateral margin, a similar row on each side within the line of stigmata, and the stigmata themselves, black; the stigmata are seated in a reddish longitudinal line: pectus more or less punctured and spotted with black: femora pale yellow, striped with black, especially towards the apex; tibiae yellow, with the two black lines on the outside; tarsi blackish brown: rostrum pitchy black, with the base yellow: antennæ black, with the second joint much shorter than the third, the basal joint yellow beneath (*Dallas*). Long, 7-8 mill.

Reported from N. India.

## Genus BAGRADA, Stål.

Stettin Ent. Zeit., xxiii, p. 105 (1862); Ofvers. K. V.-A. Förh. xxix, 3, p. 39 (1872); En. Hem. v, p. 61, 88 (1876).

Body subobovate; head triangular; juga somewhat as long as the tylus, converging forwards, not contiguous, however, at the apex: eyes somewhat stylate: ocelli almost thrice as far from each other as from the eyes: second joint of antennæ longer than third: pronotum indistinctly sexangular, posterior angles very obtuse, broadly rounded, anterior margin not, or scarcely, elevated: tibiæ rounded; basal joint of last tarsi shorter than the two apical taken together (*Stål*).

Type *Cimex pictus*, Fabr.

## 206. BAGRADA PICTA, Fabricius.

*Cimex pictus*, Fabr., Syst. Ent. p. 715 (1775); Spec. Ins. ii, p. 359 (1781); Manf. Ins. ii, p. 296 (1787); Ent. Syst. iv, p. 122 (1794); Syst. Rhyng. p. 177 (1803); Wolff Ic. Cim. i, p. 17, t. 2, f. 17 (1800).

*Strachia picta*, Dallas, List Hem. i, p. 259 (1851); Walker, Cat. Het. ii, p. 326 (1867).

*Bagrada picta*, Stål, Stettin Ent. Zeit. xxiii, p. 105 (1862); En. Hem. v, p. 88 (1876); Lethierry, An. Mus. Gen. xviii, p. 743 (1883).

Antennæ black: head black, with lateral line and two very minute points on the vertex, rufescent: pronotum deep black, shining; anterior margin and lateral lines, and a median, palely ferruginous: scutellum deep black, with a longitudinal line and two small spots on each side, pale ferruginous: hemelytra smooth, margin pale, ending in a large ferruginous spot: wings fuscous, immaculate: beneath flavescent, with a lateral line and spots, black: feet pale with black lines (*Fabr.*). Antennæ, eyes and head, black; the latter shining, margined, emarginate at the apex, with a small line on both sides at the margin as far as the eyes, and two dots on the vertex, yellow-ferruginous: circumocular space, yellow: rostrum fuscous, 4-jointed, as long as half the body: pronotum deep black, shining, posteriorly impressly punctured; anterior and lateral margins and a median line, yellow ferruginous, and an anterior spot on each side, yellow: scutellum deep black with a median longitudinal line, and a spot on each side at base and apex, pale ferruginous: hemelytra deep black, impressly punctured, a pale line at the margin confluent with a ferruginous spot on the apex; apex itself black: wings blackish, immaculate: abdomen beneath flavescent, the margins of segments black, a line of black points on each side; pectus spotted rufous: feet pale, varied with small fuscous lines and dots (*Wolff.*). Varies in size, in the pronotum having no yellow spots, in scutellum with two dots, and the abdomen being black with yellow bands. Long, 8; broad, 4 mill.

Reported from N. India, Bengal, Bombay, Baghdad, Abyssinia. The Indian Museum has specimens from Calcutta (mihi), Hardwár (N.-W. Provinces).

#### Genus CIXIA, Stål.

Stettin Ent. Zeit. xxiii, p. 105 (1862); Ofvers. K. V.-A., Förh. p. 520 (1867); Walker, Cat. Het. ii, p. 326 (1867); Stål, En. Hem. v, p. 61, 87 (1876).

Head triangular; juga converging towards the apex, scarcely contiguous at the apex: eyes very briefly stylate: ocelli scarcely or only a little more distant from each other than from the eyes: antennæ long, basal joint extending beyond the apex of the head, second joint shorter than the third: basal joint of rostrum longer than the head: pronotum sex-angular, margins anteriorly and the anterior lateral, elevated: feet unarmed, tibiæ broadly sulcate above: basal joint of the last tarsi as long as the two apical joints taken together (*Stål*).

Type *Cimeæ limbatus*, Fabr.

#### 207. CIXIA LIMBATA, Fabricius.

*Cimeæ limbatus*, Fabr. Syst. Rhynch. p. 176 (1803); Burm. Handb. Ent. ii, (i), p. 367 (1835); Herr. Schöff. Wanz. Ins. iv, p. 91, t. 138, f. 430 (1839).

*Strachia limbata*, Am. and Serv. Hist. Nat. Ins. Hém. p. 127 (1843); Dallas List Hem. i, p. 263 (1851); Walker, Cat. Het. ii, p. 326 (1867).

*Cinxia limbata*, Stål Hem. Fabr. i, p. 30 (1868); En. Hem. v, p. 87 (1876); pupa, Ellenrieder, Nat. Tidsskr. Ned. Ind. xxiv, p. 153, f. 22 (1862).

Above deep black: antennæ deep black: head with two abbreviated lines, rufous: pronotum punctured, with a median cross rufous and entire limbus flavescens: margin of scutellum and a median line, rufous; hemelytra with a rufous median line which is posteriorly arcuate: wings black, whitish at the apex: body variegated (*Fabr.*). Above with antennæ black; two longitudinal lines on the head, margins of pronotum, a longitudinal line through the middle and a transverse line nearer the anterior margin and finer, lateral margins and a median longitudinal line on scutellum, on the hemelytra a broad line from the basal outer margin curved towards the inner angle of the apical margin and thence following the apical margin to the outer angle, two fine lines (one abbreviated) parallel to the inner margin, and two lines between the broad curved line and the external margin, ochreous: abdomen beneath ochreous with four oblong black spots on each side of the disc and a triangular spot at the apex, a spot on each segment towards the margin, three broader spots on each side of the pectus. Long, 13-16 mill.

Reported from Java, Silhat, Burma (mihi). The Indian Museum has specimens from Sumatra, Tavoy, and Harmatti in Assam.

## Genus STRACHIA, Hahn, Stål.

Hahn, pt., Wanz. Ins. i, p. 180 (1831); Dallas, pt., List Hem. i, p. 262 (1851); Walker, Cat. Het. ii, p. 257 (1867); Stål, Stettin Ent. Zeit. xxiii, p. 105 (1862); Ofvers. K. V.-A. Förh. p. 520 (1867); En. Hem. v, p. 61, 87 (1876).

Head triangular; juga somewhat contiguous at the apex, eyes very briefly stylate: ocelli about twice as far from each other as from the eyes: antennæ 5-jointed, long; basal joint scarcely extending beyond the apex of the head, second joint a little shorter than the third: pronotum sexangular, anterior and anterior lateral margins reflexed, the latter sinuate: feet unarmed: femora, in ♂, incrassate; tibiæ above broadly sulcate, last tibiæ, in ♂, slightly curved; basal joint of the last tarsi shorter than the two apical taken together (*Stål*).

Type, *Strachia cruciger*, Hahn.

## 208. STRACHIA CRUCIGERA, Hahn.

*Strachia cruciger*, Hahn, Wanz. i, p. 184, t. 29, f. 95 (1831).

*Strachia flammula*, Ellenr. Nat. Tijds. v, Ned. Ind. xxiv, p. 153, f. 23 (1862).

*Strachia crucigera*, Dallas, List Hem. i, p. 262 (1851); Walker, Cat. Het. ii, p. 332 (1867); Stål, En. Hem. v, p. 87 (1876); Distant, J. A. S. B. xlvi, (2), p. 37 (1879); A. M. N. H. (5 s.) iii, p. 45 (1879).

Above black, punctured, shining: pronotum with a red and yellow cruciform mark; the red, yellow in the middle: sides and apex of the scutellum, black; the coriaceous portion of the hemelytra posteriorly, towards the end, with a yellow transverse band: the abdomen reddish yellow, spotted black on the sides beneath: all the femora black with above a narrow yellow, longitudinal streak.

Hahn describes an Indian specimen thus:—Head black, above with a blueish tinge: antennæ black, outwardly finely pilose: eyes brown-yellow, black in the middle: ocelli small, brown-yellow, shining: rostrum black, shining: pronotum narrowed forwards, with a transverse protuberance through the middle; both the outer corners produced in a sharp point; above, black, shining, with a red cruciform mark which turns into yellow posteriorly: pectus shining, black, with a white spot at each foot and near it a small red spot outwards: scutellum finely punctured, shining, red, yellow in the middle, black on the sides and at the apex: coriaceous portion of the hemelytra black, above on the inner margin, and beneath on the outer margin, a white longish line, then, before the end, a red yellow transverse band; membrane brownish, lighter at the tip, reaching beyond the abdomen which is above yellow-red, shining; each incisure on the outer margin with a narrow black streak: beneath yellow-red, black in the middle, and each segment with a black puncture on the margin: feet and tarsi are glossy black, and each femur is marked above by a narrow yellow longitudinal line.



Var. *a.* Scutellum black with a longitudinal red streak, yellow in the middle, and above, in each corner, a red spot. Long,  $7\frac{1}{2}$ ; broad almost  $4\frac{1}{2}$  mill.

Reported from Java, Sumatra, Tenasserim, Assam (mihi). The Indian Museum has specimens from Tenasserim.

*Species of doubtful position.*

209. *STRACHIA AFFLICTA*, Walker, Cat. Het. ii, p. 332 (1867).

Dark-green, broad, elliptical, shining, thinly and roughly punctured, tawny beneath: head broad, partly tawny along the borders; sides reflexed; juga and tylus of equal length: rostrum tawny, extending to the hind coxæ; antennæ black, slender; and 2 joints tawny; first extending almost to the front of the head; second much shorter than the third, which is tawny at the base: pronotum with slightly reflexed sides; fore angles slightly acute; hind angles much rounded: scutellum long, rounded and rather broad at the tip: abdomen above tawny: legs tawny, rather stout; tibiæ setulose, furrowed: hemelytra with a brownish membrane: wings cinereous (*Walker*). Body long,  $14\frac{1}{2}$ —15 mill.

Reported from India.

210. *STRACHIA INORNATA*, Walker, Cat. Het. ii, p. 331 (1867).

Black, elliptical, smooth, shining, here and there coarsely punctured, testaceous beneath: head with a large testaceous spot on the hind border; sides reflexed; juga and tylus of equal length: rostrum black, extending to the hind coxæ, testaceous at the base: pronotum with a well defined transverse furrow, with a testaceous spot on the fore part of each side, and with a testaceous stripe which is dilated on the fore border and more so on the hind border; angles much rounded: scutellum with a testaceous spot on each side, and with a testaceous stripe: pectus and abdomen beneath with a broad black stripe on each side: legs black, stout; femora towards the base and coxæ testaceous: hemelytra with a testaceous costal dot near the base and with two testaceous spots in the disc; first spot before the middle; second behind the middle, larger than the first; membrane cinereous (*Walker*). Body long,  $7$ — $7\frac{1}{2}$  mill.

Reported from India.

211. *STRACHIA STRANGULATA*, Walker, Cat. Het. ii, p. 344 (1867).

Aeneous-black, elongate-elliptical, shining, thinly and roughly punctured: head smooth; sides slightly reflexed; juga contiguous beyond the tylus: eyes prominent: rostrum black, extending to the

hind coxæ: antennæ black, more than half the length of the body; first joint broad, extending to the front of the head; second as long as the third; fourth longer than the third; fifth shorter than the fourth: pronotum much narrower in front of the transverse furrow, with a pale yellow stripe, which is broadest on the fore border; a nearly round callus on each side in front; sides and fore border pale testaceous, slightly reflexed: scutellum with a pale yellow stripe, which is abbreviated hindward and has a red patch at each side of it at its base, and at its tip: pectus whitish about the coxæ: abdomen beneath with an irregular yellow stripe on each side: legs long; femora slightly incrassated: hemelytra with a white transverse streak, joining the exterior border near the angle of the corium; membrane black, with a whitish pellucid border (*Walker*). Body long, 9—9½ mill.

Reported from Penang: closely allied to *S. bicolor*, Dallas.

212. *STRACHIA LITURIFERA*, Walker, Cat. Het. ii, p. 326 (1867).

Blueish-black, elongate-oval, shining, roughly punctured, pale luteous beneath: head with a red spot on each side in front of the eye; sides pale luteous, slightly reflexed; juga and tylus of equal length; a black patch on each side beneath: rostrum black, pale luteous at the base, extending to the hind coxæ: antennæ black, about half the length of the body; first joint extending nearly to the front; second much longer than the third; fourth as long as the second, shorter than the fifth: pronotum red, with six elongated blueish black spots; of which two are transverse and on the fore border, and the other four are oblique; hind angles rounded: scutellum extending to the angle of the corium; a red stripe extending along half the length from the tip; sides red for half the length from the base: pectus on each side with three red spots, which are irregularly bordered with blackish blue; sides red: abdomen beneath red, and with blackish blue spots along each side; connexivum red, with blackish blue spots: legs black, streaked with pale luteous: hemelytra with two irregular red spots; costa towards the base and exterior border, red; first spot joining the red part of the costa; second joining the red of the exterior border; a whitish costal streak beyond the middle: membrane black, with a whitish pellucid border.

Var.—Thorax with the spots much diminished in size; the red line more prevalent in the hemelytra (*Walker*). Body long, 7—7½ mill.

Reported from N. India.

213. *STRACHIA DESIGNATA*, Walker, Cat. Het. ii, p. 327 (1867).

Black, elongate-oval, shining, roughly and thinly punctured, pale testaceous beneath: head in front with pale reflexed testaceous borders;

juga extending much beyond the tylus; rostrum black, extending to the hind coxæ; antennæ black, about half the length of the body; first joint not extending to the front of the head; second much longer than the third; fourth a little longer than the second: pronotum with a testaceous border, a slender testaceous stripe, and a semicircular testaceous line which rests on the hind border and emits a branch to each side near the fore border: scutellum bordered with testaceous on each side and at the tip, which is narrow; fore part more convex than the hind part, not punctured, but transversely and very finely striated: pectus and abdomen beneath with two stripes of large black spots: abdomen beneath with a middle stripe of transversely elongated black spots: legs black; femora towards the base and coxæ testaceous; posterior tibiæ with a testaceous band: hemelytra with a testaceous stripe which proceeds on the costa from the base, and diverges to the disc and returns to the costa, and there again diverges and joins the exterior border, which is also testaceous; membrane black, with a whitish border (*Walker*). Body long, 8—8½ mill.

Reported from India.

214. *STRACHIA SECURIGERA*, Walker, Cat. Het. ii, p. 334 (1867).

Ochraceous, oval, shining, roughly and thinly punctured, pale yellow beneath: head transversely and finely striated, irregularly black along the hind border; sides slightly reflexed; tylus hardly extending beyond the juga; rostrum black towards the tip, extending rather behind the hind coxæ: antennæ black, slender, full half the length of the body; joints from the first to the fourth successively increasing in length; first luteous, extending to the front of the head; fifth a little shorter than the fourth: pronotum reflexed on each side along the fore border, with two abbreviated black bands; fore band containing a pale yellow callus on each side; hind band slightly interrupted, occasionally thrice interrupted; hind angles rounded: scutellum black, with a luteous transverse, very large, cyathiform mark; tip rather broad, bordered with pale yellow: pectus and underside of abdomen with four stripes of transverse black spots, the latter with a median stripe of large black spots: legs stout; tibiæ towards the tips and tarsi piceous: hemelytra with two black stripes; first stripe subcostal, excavated on the inner side, commencing at one-sixth of the length and extending nearly to the tip, contiguous to the second at its base; second much contracted in the middle, commencing very near the base, not extending beyond the angle of the corium; membrane blackish (*Walker*). Body long, 9—9½ mill.

Reported from Mysol, Burma.

215. *STRACHIA PLATYSPILA*, Walker, Cat. Het. ii, p. 337 (1867).

Grass-green, broad, oval, shining, thinly and roughly punctured: head slightly ochraceous-tinged, transversely and finely striated on each side; three black spots on the hind border, the middle one much larger than the other two; sides slightly reflexed; tylus extending a little beyond the juga: rostrum black, green at the base, extending to the hind coxæ: pronotum with an ochraceous patch on the fore part of the disc, and one on each hind angle; six elongated black spots; two transverse in front, four between the hind angles, which are much rounded: scutellum with two large transverse black spots, on the fore border, and with posterior elongated much larger black spots, which are nearly contiguous; tip rather broad; pectus and under side of abdomen with five stripes of large black spots: legs moderately long and slender; femora with some black dots: hemelytra with three very large black spots; apical half of the corium ochraceous; membrane blackish, with a broad pellucid border (*Walker*). Long,  $9\frac{1}{2}$  mill.

Reported from Penang, Tenasserim.

216. *STRACHIA PARDALIS*, Walker, Cat. Het. ii, p. 330 (1867).

Bright orange-red or luteous, broad, oval, shining, thinly and roughly punctured, pale yellow or white beneath: head transversely and very finely striated, with three black spots, which are connected with the black line along the hind border; an elongated black spot on the tylus, which extends somewhat beyond the juga; sides slightly reflexed: rostrum black towards the tip, extending to the hind coxæ: antennæ piceous, more than half the length of the body; first and second joints bright red; first not extending to the front of the head; third bright red towards the base, nearly twice the length of the second; fourth a little longer than the third and a little shorter than the fifth: pronotum with six elongated black spots, which are partly bordered with pale yellow or wholly bordered with white; first and second spots transverse on the fore border; the other four near the hind border; a black dot on each hind angle, which is rounded; sides slightly reflexed; pale yellow or white in front: scutellum broad and pale yellow or white at the tip; a curved red band, pale yellow on each side where it joins the fore border, sometimes wholly white; a slender red stripe, pale yellow towards the tip or wholly white: pectus with six stripes of quadrate black spots: abdomen above black with pale yellow spots on the connexivum under side with two rows of large black spots on each side, a black dot on the second segment, an abbreviated black band, which is excavated on the hind border on the third segment, and another on the fourth, a large black spot on the fifth, and a transverse smaller one on

the sixth: legs bright red, stout: hemelytra with three large black spots; a lanceolate black streak on the hind border; membrane brown, with a pellucid border (*Walker*). Body long,  $9-9\frac{1}{2}$  mill.

Reported from Bouru, Hong-Kong, Siam, India.

217. *STRACHIA VELATA*, Walker, Cat. Het. ii, p. 329 (1867).

Orange, oval, shining, thinly punctured, pale yellow beneath: head smooth; sides slightly reflexed; juga and tylus of equal length: rostrum pale yellow, extending to the hind coxæ, tip black: antennæ black, a little more than half the length of the body; first joint orange, not extending to the front; second shorter than the third; fourth much longer than the third, as long as the fifth: pronotum with eight elongated cinereous-green spots; two transverse on the fore border; the other six forming a band between the hind angles, which are much rounded: scutellum which is rather broad and extends beyond the angle of the corium, pale yellow towards the tip; four large elongated cinereous-green spots; two transverse on the fore border; two lanceolate: pectus and underside of abdomen with two rows of green dots: legs pale green; tips of the femora ochraceous; tarsi and tips of the tibiæ tawny: hemelytra with a cinereous-green subcostal streak, and with three large cinereous-green spots, the third joining the streak; membrane brown (*Walker*). Body long,  $9\frac{1}{2}$  mill.

Reported from N. India. Like *S. varia*, in structure.

218. *STRACHIA HETEROSPILA*, Walker, Cat. Het., iii, p. 331 (1867).

Ochraceous, oval, broad, stout, shining, coarsely and thinly punctured; beneath pale yellow: head with three black spots on the posterior margin, a black dot in front on the tylus which extends a little beyond the juga; sides slightly reflexed; rostrum black, ochraceous at the base, extending a little beyond the last coxæ; antennæ black, slender, 1-2 joints ochraceous, first not reaching the front of the head, third very much longer than the second, ochraceous at the base: pronotum with four large black spots on the posterior margin, space in front on each side smooth, pale yellow, including a narrow transverse black spot; angles much rounded: the intermediate black spots of the pronotum continued on each side of the base of the scutellum which has also two very broad black streaks converging hindwards, apex broad, rounded; two rows of black spots on each side of the pectus: abdomen beneath with two submarginal rows of black spots: hemelytra with a broad black streak extending along the posterior margin and curved inward at the apex, and a large black costal spot: membrane black, bordered pale cinereous (*Walker*). Long,  $8\frac{1}{2}$  mill.

Reported from Siam.

## Div. HOPLISTODERARIA.

Stål, *En. Hem.* v. p. 61 (1876).

*a.*—Entire orifices margined; or auriculately margined; or, generally, extended in a margined furrow, closed at the apex, or in a continuous ridge: venter generally tuberculated at the base or spinose.

*b.*—Anterior lateral margins of pronotum entire, unarmed, generally distinctly reflexed, or narrowly elevated and callous, rarely obtusely rounded.

*c.*—Mesostethium with a ridge generally slightly, or not so highly, elevated, everywhere equally high: this ridge rarely entirely, or anteriorly strongly, elevated and compressed, and, very rarely, freely produced between the first pair of coxæ, and, if so, then either the tibiæ are sulcated above, or broadly flat and margined, or the venter is furnished at the base with a freely porrect spine, or the ridge itself is deeply sulcated; or the punctures on the head are arranged in longitudinal rows: apical angles of sixth abdominal segment very rarely produced in a large acute tooth; sixth ventral segment, in ♀, obtusely and not so deeply sinuated at the apex.

*d.*—Lateral angles of the pronotum produced in a spine or acuminate process, or sinuated at the apex, anterior lateral margins very obtuse, rounded, convex: pronotum anteriorly levigate, or sparingly punctured; within the sometimes callous anterior margin, furnished with a row of punctures, generally regular: entire bucculæ rather elevated, often higher posteriorly, abruptly elevated and sometimes somewhat lobate posteriorly, there not gradually lower and evanescent: scutellum broad behind the frena which do not extend beyond the middle of the scutellum: venter neither ridged nor furrowed, second segment without a spine or tubercle in the middle; second joint of the rostrum not longer than the two apical joints taken together, generally short: furrow of the orifices elongate, varying in length: scutellum levigate on the basal angles, or marked by a pale, levigate, callous spot: pronotum anteriorly and the head strongly declined, sometimes perpendicularly: feet pale, not sprinkled black, rarely streaked with black: punctures on the head arranged in simple, parallel, longitudinal rows.

## Genus ALCIMUS, Dallas.

*List Hem.* i, p. 218 (1851); Stål, *Ofters.*, K. V.-A., Förh., p. 511 (1867); *En. Hem.* v. p. 61, 88 (1876).

Head short, somewhat triangular, rather broader across the eyes than its length, with the lateral margins strongly indented before the eyes; the tylus passing the juga, making the head rather pointed in

front: eyes prominent, semiglobose, truncated posteriorly in a straight line; ocelli minute, flat, placed close to the eyes: antennæ about as long as the head and pronotum, rather slender, of five joints; basal joint short and stout, not reaching the apex of the head; second joint shorter than the third, about equal to the fifth; third joint longest; fourth longer than the second; antenniferous tubercles very prominent: rostrum reaching the posterior coxæ, inserted about the middle of the head; basal joint reaching the anterior coxæ; second joint longest, as long as the 3 and 4 together; 3 and 4 about equal, nearly as long as the first: body broad, rather flat above; pronotum anteriorly and the head rather perpendicularly inclined; the lateral horns of the pronotum curved upwards and a little hindwards, acute at the apex, with a small tooth on the anterior margin at a short distance from the apex, and with seven furrows, namely, two on the upper surface, three on the lower, one on the anterior and one on the posterior margin: scutellum very long, nearly reaching the apex of the body, not much narrowed towards the apex, and with the lateral margins straight; frena short; mesostethium furrowed: coriaceous portion of the hemelytra with the inner margin very short, not reaching beyond the fourth part of the length of the scutellum; the apical margin, on the contrary, very long, produced along the margin of the scutellum to within about one-fourth of its length from the apex, then suddenly rounded off; membrane with longitudinal veins: base of the abdomen and sternum unarmed: legs moderate; femora tumescent beneath towards the apex; tibiæ above distinctly furrowed; tarsi 3-jointed; second joint shortest; apical joint as long as the first and second together (*Dallas*).

219. *ALCIMUS CORONATUS*, Stål.

*Alcimus coronatus*, Stål, *En. Hem.* v, p. 88 (1876).

♀. Pale flavescent, above obscure and rather densely sprinkled with black punctures which are also cinctured black: lateral horns of pronotum levigate, margined anteriorly by a fine wrinkle or ridge, abbreviated near the apex: head punctulate, with subbasal spot and angulated line beginning at the eyes and produced towards the apex, testaceous: pronotum marked with a smooth anterior band, posteriorly branched, flavescent, punctured within the black anterior margin: scutellum sprinkled yellow, marked at the basal angles with a levigate, flavescent spot: pectus punctured here and there, adorned anteriorly with a smooth, flavescent spot: venter smooth, adorned with a streak which is contracted in the middle of the segments, also with black lateral bands which are punctured: feet streaked with black; antennæ

testaceous, obscure towards the apex (*Stål*). Long, 8; broad,  $5\frac{1}{2}$ ; exp. com. pron., 10 mill.

Reported from the Deccan.

## 220. *ALCIMUS FLAVICORNIS*, Distant.

*Alcimus flavicornis*, Dist., Trans. Ent. Soc. p. 349 (1887).

Head black, with three median lines on anterior half, a linear spot near the base, and a similar spot in front of each eye, yellow; antennæ fuscous-brown, 2-3 joints subequal in length and longest, fourth shorter than the third and longer than the fifth: rostrum dark castaneous, extending beyond the last coxæ: pronotum very dark obscure ochraceous, thickly covered with coarse, dark punctures, anterior fourth black, with five yellow spots, situate one on each lateral margin, and three median angulated spots, two near anterior margin and one between and behind them, apical angles widely produced laterally and upwardly, their apical thirds yellow, extreme apices black: scutellum and corium dark obscure ochraceous, darkly and coarsely punctate, irrorated with levigate yellow markings, and the scutellum with two large, yellow, levigate spots near the basal angles: membrane fuscous, apex paler: head and prostethium beneath as above, with two fused yellow spots on each side of the eyes, the apices of the pronotal angles yellow as above: meso- and meta-stethium and abdomen beneath, ochraceous; the sutures, a row of sublateral streaks and a median longitudinal band to abdomen, blackish: legs dark castaneous; femora more or less streaked yellowish (*Dist.*). Long, 8-9; exp. angl. pron., 10-12 mill.

Reported from Sikkim (mihi).

## Genus HOPLISTODERA, Westwood.

Hope, Cat. Hem. i, p. 18 (1837); Dallas, List Hem. i, p. 194 (1851); Walker, Cat. Het. ii, p. 265 (1867); Stål, Ofvers. K. V.-A. Förh., p. 510 (1867); En. Hem. v, p. 62, 88 (1876).

Body short, stout; usually as long as broad: head smooth, not punctured, unless at the base: pronotum sparingly punctured, inclined anteriorly, levigate, punctured within the lateral margin, spine of the lateral angles stout, acuminate: scutellum broad behind the frena which are short, transversely convex, especially anteriorly, depressed, or somewhat so, at the frena, and furnished with a row of punctures; extending beyond the half of the body and rounded posteriorly: antennæ shorter than half the body, 5-jointed, first joint short, second and third joints equal, longer, the fourth and fifth joints equal, longer and stouter: corium and scutellum of equal length, or somewhat so; membrane with seven longitudinal veins: feet simple; tibiæ rounded.



## 221. HOPLISTODERA VIRESCENS, Dallas.

*Hoplistodera virescens*, Dallas, List, Hem. i, p. 217 (1851); Walker, Cat. Het. ii, p. 265 (1867); Stål, En. Hem. v, p. 89 (1876).

♂. Head orange yellow, brownish towards the vertex, which is sparingly punctured: pronotum very pale yellowish green, rather thickly punctured with brown, with two yellowish brown spots near the anterior margin; the lateral spines not very long, nearly horizontal, acute: scutellum testaceous, the basal portion very sparingly, the apical more closely, punctured with brown; the base with four brown spots: hemelytra pale yellowish green, rather finely and not thickly punctured with brown; membrane transparent: abdomen beneath pale greenish yellow, rather thickly punctured, the punctures brown on each side of the disc, on the middle of the last segment, and on the anal plate: pectus pale yellow, punctured with brown: legs pale yellow, with the apices of the tibiæ and the basal joints of the tarsi brownish: rostrum yellow, with the tip black: antennæ yellow, with the two apical joints fulvous (*Dallas*). Long, 9-10 mill.

Reported from N. India.

## 222. HOPLISTODERA INCISA, Distant.

*Hoplistodera incisa*, Dist., Trans. Ent. Soc. p. 349, t. 12, f. 3 (1887).

Allied to *H. testacea*, Westw. Ochraceous with brownish tints: head finely and sparingly punctate: antennæ ochraceous, becoming darker towards the apex: pronotum sparingly but coarsely punctate, the lateral angles produced into robust, subacute spines, the apices very slightly reflexed hindwards, and with a notched tubercle beneath at about half their length: scutellum with the basal half very sparingly but coarsely punctate, the apical half thickly punctate: corium coarsely and irregularly punctate: membrane pale hyaline: body beneath ochraceous, with a sublateral row of castaneous spots on each side: legs pale luteous; femora annulated brown near the apex: rostrum ochraceous, apex pitchy and extending a little beyond the last coxæ: 2-3 joints antennæ subequal in length, apical joint longest (*Dist.*). Long, 8; exp. angl. pron., 9 mill.

Reported from Mungphu (Sikkim), Assam (mihi).

## Genus BOLACA, Walker.

Cat. Het. ii, p. 251 (1867).

Body elongate-elliptical, rather flat, thickly and minutely punctured: head lanceolate, much shorter than the pronotum; juga extending much beyond the tylus, slightly notched on the outer side, terminating

in two spines: eyes not prominent: rostrum slender, extending to the hind coxæ: antennæ slender, about half the length of the body; joints successively increasing in length: first not extending to the apex of the head: pronotum with a small oblong ringlet on each side in front, connected by a streak with the margin, which is slightly crenulated; anterior angles prominent; hind angles rectangular, slightly prominent: scutellum attenuated towards the tip, extending rather beyond the angle of the corium: ventral segments slightly arched: legs slender, rather long; tarsi three jointed: membrane with five longitudinal veins, of which the subcostal one is forked (*Walker*).

### 223. BOLACA UNICOLOR, Walker.

*Bolaca unicolor*, Walker, Cat. Het. ii, p. 251 (1867).

Ferruginous, hardly pale, but more shining beneath: antennæ piceous towards the tips: membrane cinereous, with ferruginous veins. (*Walker*). Body long,  $15\frac{1}{2}$  mill.

Reported from N. India.

### Div. CATACANTHARIA.

En. Hem. v, p. 62 (1876).

a, b, c. as in Div. *Hoplisteraria*, (p. 66).

d.—Lateral angles of pronotum rarely spinose, or produced in a long process, if so, the basal angles of the scutellum are without a levigate spot; or the venter is spinose, or tuberculated at the base, or furnished with a broad, obtuse, rounded ridge, anteriorly furrowed; or the black punctures on the head are arranged in simple and parallel longitudinal rows: frena, generally, extended behind the middle of the scutellum.

e.—Geniculæ, entire tarsi, or at the apex, generally, moreover, entire feet, or a great part, black: antennæ black, basal joint rarely flavescens: rostrum generally entirely, or almost entirely, black, very rarely with the greatest part, flavescens: entire membrane or the greatest part, black, or brassy black: margins of head, at least partly, usually reflexed: body generally large or moderate, usually yellow, pictured red and black.

### Genus CATACANTHUS, Spinola.

Ess. p. 352 (1837): Am. & Serv. Hist. Nat. Ins. Hém., p. 141 (1843): Dallas, pt., List Hem. i, p. 196 (1851): Walker, pt., Cat. Het. ii, p. 351 (1867); Stål, Hem. Afric. i, p. 188 (1864); En. Hem. v, p. 62, 89 (1876).

Body ovate, beneath moderately convex: head proportionately small, flat, margins slightly elevated; jugs and tylus of equal length;

bucculæ reaching somewhat the base of the head, moderately elevated : antenniferous tubercles almost entirely visible from above, unarmed : eyes globose, sessile : antennæ 5-jointed, first joint extending slightly beyond the apex of the head : rostrum moderate, first joint somewhat on a level with the bucculæ posteriorly, second and third joints about equal : anterior margin of pronotum slightly elevated, anterior lateral margins acute, reflexed or foliaceously dilated : scutellum rather narrowed posteriorly, frena extended beyond the middle : membrane extending much beyond the apex of the abdomen, veins numerous, simple : mesostethium carinate : abdomen broader than the hemelytra, flattened out at the sides ; venter at the base unarmed, or spinose, or tuberculate : feet somewhat long, tibiæ distinctly sulcate above, first pair sometimes slightly dilated externally (*Stål*).

#### 224. CATACANTHUS INCARNATUS, Drury.

*Catacanthus incarnatus*, Dallas, List Hem. i, p. 196, 270 (1851) ; Walker, Cat. Hem., ii, p. 351 (1867) ; Stål, Öfvers. K. V.-A., Förh., p. 632 (1870) ; En. Hem. v, p. 89 (1876) ; Distant, A. M. N. H. (5 s.) iii, p. 45 (1879), and xi, p. 169 (1883) ; J. A. S. B. xlviii (2), p. 37 (1879).

Var. a. *Cimex incarnatus*, Drury, Ill., ii, p. 67, t. 36, f. 5 (1773) ; Thunberg, Nov. Ins. Spec., ii, p. 46 (1783) ; Stoll, Punaíses, p. 14, t. 2, f. 10 (1788).

*Cimex nigripes*, Fabricius, Syst. Ent. p. 710 (1775) ; Spec. Ins. ii, p. 353 (1781) ; Mant. Ins. ii, p. 291 (1787) ; Ent. Syst. iv, p. 106 (1794) ; Wolff, Ic. Cim. i, p. 11, f. 11 (1800).

*Cimex melanopus*, Gmelin, ed., Syst. Nat. i, (4) p. 2149 (1788).

*Edessa nigripes*, Fabr., Syst. Rhyng. p. 149 (1803).

*Pentatoma nigripes*, St. Farg. and Serv., Enc. Méth. x, p. 53 (1825).

*Catacanthus incarnatus*, Am. and Serv. Hist. Nat. Ins. Hém. p. 142 (1843).

Var. b. *Cimex aurantius*, Sulzer, Gesch. Ins. p. 96, t. 10, f. 10 (1776) ; Fabricius, Mant. Ins. ii, p. 290 (1787) ; Ent. Syst. iv, p. 105 (1794) ; Stoll, Punaíses, p. 29, t. 6, f. 39 (1788).

*Edessa aurantia*, Fabr., Syst. Rhyng. p. 149 (1803).

*Cimex aurantius*, Burm. Handb. Ent. ii, (i), p. 365 (1835).

*Pentatoma aurantiacum*, Blanch. Hist. Nat. Ins. iii, 29, Hem. t. 6, f. 4 (1840-41).

*Catacanthus aurantius*, Am. & Serv. Hist. Nat. Ins. Hem. p. 142 (1843).

Var. a. :—Large ; head, black, glabrous ; pronotum sanguineous, apex and margin blackish : scutellum large, rufous, deep black at the base, but the black colour does not reach the sides : hemelytra smooth, black, with a large reniform, sanguineous spot : wings deep black : beneath yellow with a cærulescent spot on the pectus : abdomen at the base and with a spot on each side of each segment, cærulescent : rostrum and feet, black (*C. nigripes*, Fabr.).

Above sanguineous ; head, narrow anterior margin of pronotum, antennæ and feet, shining black, more or less bronzed : two black spots

at the base of the scutellum; one similar spot, oblong and transverse on the disc of each hemelytrum: body beneath yellow with a black bronzed spot on each side of the mesostethium; a narrow band of the same colour at the base of the venter, and a row of five similar spots on each side: the abdominal point reaches only the insertion of the intermediate feet (*C. incarnatus*, Am. & Serv.). Long, 25—30 mill.

Var. *b.*:—Large; head with antennæ deep black; pronotum orange, with the anterior margin deep black: scutellum orange, immaculate: hemelytra orange with a median fuscous spot: wings fuscous: margin of abdomen variegated with orange and black: feet deep black (*C. aurantius*, Fabr.). Long, 25-30 mill.

Var. *c.*:—Scutellum, hemelytra and pectus immaculate. Ceylon.

Reported from Corea, Japan, Java, Sumatra, Borneo, Siam, Malacca, Singapore, Tenasserim, Ceylon, Madras, Bombay, Bengal, Pondicherry, Silhat, Assam. The Indian Museum has specimens from Tenasserim, Assam, Sikkim, Calcutta, Karachi, Malabar. Varies in colour from a sordid yellow, to orange and a bright maroon red, with and without the black spots.

---

## II.—*A General Theorem on the Differential Equations of Trajectories.*

—By ASUTOSH MUKHOPADHYAY, M. A., F. R. A. S., F. R. S. E.

[Received November 17th;—Read December 7th, 1887.]

### CONTENTS.

- §. 1. Introduction.
- §. 2. Statement and demonstration of the theorem.
- §. 3. Application of the theorem to Mainardi's problem.
- §. 4. Other applications of the theorem.
- §. 5. Some applications of Conjugate Functions.

#### §. 1. *Introduction.*

In a paper on "The Differential Equation of a Trajectory," which was read at the last May meeting of the Society, (*Journal*, 1887, Vol. LVI, Part. II, pp. 117—120; *Proceedings*, 1887, p. 151), I pointed out that Mainardi's complicated solution (reproduced by Boole) of the problem of determining the oblique trajectory of a system of confocal ellipses, was equivalent to a pair of remarkably simple equations which admitted of an interesting geometrical interpretation. Believing, as I firmly did, that every simple mathematical result could be established by a correspondingly simple process, I naturally thought it worth while to re-examine the whole question, to see if the very artificial process of

Mainardi, by no means less complicated than his result, could be materially simplified. I was, thus, led to the following very general theorem, which it is my object in the present paper to establish and illustrate, and, which shews that whenever the coordinates of any point on a curve can be expressed by means of a single variable parameter, the coordinates of the corresponding point on the trajectory may be similarly expressed; and, as an immediate corollary to my theorem, I have pointed out the relation which connects it with the theory of Conjugate Functions.\*

§. 2. *Theorem.*

**Theorem.**—If the coordinates of any point on a curve are expressed by means of a variable parameter  $\theta$ , by the two equations

$$\begin{aligned}x &= f_1(\theta, a), \\y &= f_2(\theta, b),\end{aligned}$$

where  $a$  and  $b$  are two arbitrary constants; and, if we seek the oblique trajectory of the system of curves obtained by varying  $a$  and  $b$ , subject to any condition which can be analytically represented by means of a parameter  $\psi$ , as equivalent to the system

$$\begin{aligned}a &= F_1(\psi, h), \\b &= F_2(\psi, h),\end{aligned}$$

where  $h$  is a known constant; the coordinates of the corresponding point on the trajectory are given by the system

$$\begin{aligned}X &= f_1\left\{\theta, F_1(\psi, h)\right\}, \\Y &= f_2\left\{\theta, F_2(\psi, h)\right\},\end{aligned}$$

where  $\psi$  is given as a function of  $\theta$  by the differential equation

$$\frac{d\psi}{d\theta} = \frac{nL}{N - nM}$$

where

$$n = \tan \alpha,$$

$\alpha$  being the angle of intersection of the curve and the trajectory, and

$$\begin{aligned}L &= \left(\frac{df_1}{d\theta}\right)^2 + \left(\frac{df_2}{d\theta}\right)^2 \\M &= \frac{df_1}{d\theta} \frac{df_1}{d\psi} + \frac{df_2}{d\theta} \frac{df_2}{d\psi} \\N &= \frac{df_2}{d\theta} \frac{df_1}{d\psi} - \frac{df_1}{d\theta} \frac{df_2}{d\psi}.\end{aligned}$$

To establish this theorem, let us first fix the ideas by confining our attention to one definite member of the given family of curves as well as to one of the trajectories; then it is clear that the common point of intersection of the curve and the trajectory, may be arbitrarily regarded as a

\* For a full analysis of this paper, see the *Proceedings* for 1887, pp. 250-251.

point, either on the one, or on the other; and, from each point of view, the coordinates satisfy two entirely different equations, though their actual values are the same in both cases; hence, if the coordinates of the point, regarded as a point on the curve, be furnished by the system

$$x = f_1(\theta, a), \quad \dots\dots\dots (1)$$

$$y = f_2(\theta, b), \quad \dots\dots\dots (2)$$

and the trajectory is obtained by varying  $a$  and  $b$  subject to the limitations

$$a = F_1(\psi, h), \quad \dots\dots\dots (3)$$

$$b = F_2(\psi, h), \quad \dots\dots\dots (4)$$

the coordinates of the corresponding point on the trajectory must be obtained by substituting in (1) and (2) the values of  $a$  and  $b$  from (3) and (4), *viz.*, we have

$$X = f_1\left\{\theta, F_1(\psi, h)\right\} \quad \dots\dots\dots (5)$$

$$Y = f_2\left\{\theta, F_2(\psi, h)\right\} \quad \dots\dots\dots (6)$$

In the next place, we have to determine  $\psi$  as a function of  $\theta$ , and this is easily obtained from the condition that the trajectory intersects the curve at a constant angle  $\alpha$ . Now, it is well-known that

$$\frac{dy}{dx} \frac{dY}{dX}$$

are the trigonometrical tangents of the angles which the tangents to the curve and to the trajectory, at their common point of intersection, make with the axis of  $x$ ; hence, if  $n = \tan \alpha$ , we have

$$n = \frac{\frac{dy}{dx} - \frac{dY}{dX}}{1 + \frac{dy}{dx} \frac{dY}{dX}}$$

$$= \frac{\frac{dy}{d\theta} \frac{dX}{d\theta} - \frac{dx}{d\theta} \frac{dY}{d\theta}}{\frac{dx}{d\theta} \frac{dX}{d\theta} + \frac{dy}{d\theta} \frac{dY}{d\theta}} \quad \dots\dots\dots (7)$$

Remembering that in differentiating  $X$  and  $Y$  with respect to  $\theta$ , we must regard  $\theta$  as a function of  $\psi$ , but not so in the case of  $x$  and  $y$ , we have

$$\frac{dx}{d\theta} = \frac{df_1}{d\theta}, \quad \frac{dy}{d\theta} = \frac{df_2}{d\theta}$$

$$\frac{dX}{d\theta} = \frac{df_1}{d\theta} + \frac{df_1}{d\psi} \frac{d\psi}{d\theta},$$

$$\frac{dY}{d\theta} = \frac{df_2}{d\theta} + \frac{df_2}{d\psi} \frac{d\psi}{d\theta},$$

which lead to the values

$$\begin{aligned} & \frac{dy}{d\theta} \frac{dX}{d\theta} - \frac{dx}{d\theta} \frac{dY}{d\theta} \\ &= \frac{d\psi}{d\theta} \left\{ \frac{df_1}{d\psi} \frac{df_2}{d\theta} - \frac{df_1}{d\theta} \frac{df_2}{d\psi} \right\} \\ & \quad \frac{dx}{d\theta} \frac{dX}{d\theta} + \frac{dy}{d\theta} \frac{dY}{d\theta} \\ &= \left( \frac{df_1}{d\theta} \right)^2 + \left( \frac{df_2}{d\theta} \right)^2 + \frac{d\psi}{d\theta} \left\{ \frac{df_1}{d\theta} \frac{df_1}{d\psi} + \frac{df_2}{d\theta} \frac{df_2}{d\psi} \right\}. \end{aligned}$$

Hence, putting

$$L = \left( \frac{df_1}{d\theta} \right)^2 + \left( \frac{df_2}{d\theta} \right)^2, \quad \dots\dots\dots (8)$$

$$M = \frac{df_1}{d\theta} \frac{df_1}{d\psi} + \frac{df_2}{d\theta} \frac{df_2}{d\psi}, \quad \dots\dots\dots (9)$$

$$N = \frac{df_2}{d\theta} \frac{df_1}{d\psi} - \frac{df_1}{d\theta} \frac{df_2}{d\psi}, \quad \dots\dots\dots (10)$$

we have finally, from (7), the equation

$$\frac{d\psi}{d\theta} = \frac{n L}{N - n M}, \quad \dots\dots\dots (11)$$

which is exactly the theorem enunciated above.

It may not be altogether unprofitable to note that the trajectory is determined by two conditions, *viz.*, in the first place, we have to vary the constants in a definite manner; and, in the second place, the trajectory is to intersect the curve at a given angle; the first of these conditions leads to the actual values of the coordinates of any point on the trajectory, furnished by (5) and (6), while the second condition determines the relation between  $\theta$  and  $\psi$  which enter into the values of those coordinates.

§. 3. *Application to Mainardi's Problem.*

**Example I.**—In order to test the power and generality of this theorem, we shall apply it to solve Mainardi's problem of determining the oblique trajectory of a system of confocal ellipses. The primitive ellipse being

$$\frac{x^2}{a^2} + \frac{y^2}{b^2} = 1, \quad \dots\dots\dots (12)$$

we get the confocal system by varying  $a$  and  $b$  subject to the condition

$$a^2 - b^2 = h^2. \quad \dots\dots\dots (13)$$

The coordinates of any point on the ellipse are given by

$$\begin{aligned} x &= a \cos \theta, \\ y &= b \sin \theta, \end{aligned}$$

while the relation between  $a$  and  $b$  given in (13), is equivalent to

$$\begin{aligned} a &= h \cosh \psi, \\ b &= h \sinh \psi, \end{aligned}$$

so that, the coordinates of any point on the trajectory are given by

$$X = h \cos \theta \cosh \psi, \quad \dots\dots\dots (14)$$

$$Y = h \sin \theta \sinh \psi. \quad \dots\dots\dots (15)$$

Again, to determine the relation between  $\theta$  and  $\psi$ , we have

$$\begin{aligned} f_1 &= h \cos \theta \cosh \psi, \\ f_2 &= h \sin \theta \sinh \psi, \end{aligned}$$

which lead to the system

$$\frac{df_1}{d\theta} = -h \sin \theta \cosh \psi,$$

$$\frac{df_2}{d\theta} = h \cos \theta \sinh \psi,$$

$$\frac{df_1}{d\psi} = h \cos \theta \sinh \psi,$$

$$\frac{df_2}{d\psi} = h \sin \theta \cosh \psi,$$

and, these give

$$L = h^2 (\sin^2 \theta \cosh^2 \psi + \cos^2 \theta \sinh^2 \psi),$$

$$M = 0,$$

$$N = h^2 (\sin^2 \theta \cosh^2 \psi + \cos^2 \theta \sinh^2 \psi),$$

so that, the differential equation (11) becomes

$$\frac{d\psi}{d\theta} = n$$

whence,

$$\psi = n (\lambda + \theta),$$

where  $\lambda$  is the constant of integration. Substituting in (14) and (15), we see finally that the coordinates of any point on the oblique trajectory of a system of confocal ellipses, are given by

$$X = h \cos \theta \cosh n (\lambda + \theta),$$

$$Y = h \sin \theta \sinh n (\lambda + \theta),$$

which is exactly the system of equations to which Mainardi's result was reduced in my former paper, and geometrically interpreted there.

§. 4. *Other applications of the Theorem.*

**Example II.**—To find the oblique trajectory of the system of confocal hyperbolas

$$\frac{x^2}{a^2} - \frac{y^2}{b^2} = 1,$$

where

$$a^2 + b^2 = h^2.$$



The coordinates of any point on the hyperbola are given by

$$x = a \cosh \theta,$$

$$y = b \sinh \theta,$$

where

$$a = h \cos \psi,$$

$$b = h \sin \psi,$$

so that the coordinates of any point on the trajectory are given by

$$X = h \cosh \theta \cos \psi,$$

$$Y = h \sinh \theta \sin \psi.$$

To determine  $\psi$  as a function of  $\theta$ , we have

$$f_1 = h \cosh \theta \cos \psi,$$

$$f_2 = h \sinh \theta \sin \psi,$$

whence

$$\frac{df_1}{d\theta} = h \sinh \theta \cos \psi,$$

$$\frac{df_2}{d\theta} = h \cosh \theta \sin \psi,$$

$$\frac{df_1}{d\psi} = -h \cosh \theta \sin \psi,$$

$$\frac{df_2}{d\psi} = h \sinh \theta \cos \psi,$$

and, therefore,

$$L = h^2 \left\{ \sinh^2 \theta \cos^2 \psi + \cosh^2 \theta \sin^2 \psi \right\}$$

$$M = 0$$

$$N = -h^2 \left\{ \sinh^2 \theta \cos^2 \psi + \cosh^2 \theta \sin^2 \psi \right\}$$

The differential equation (11) becomes

$$\frac{d\psi}{d\theta} = -n,$$

so that

$$\psi = n (\lambda - \theta),$$

where, of course,  $\lambda$  is a constant different from the  $\lambda$  in the solution of Mainardi's problem. The coordinates of any point on the oblique trajectory of a system of confocal hyperbolas are, therefore, given by

$$X = h \cosh \theta. \cos n (\lambda - \theta).$$

$$Y = h \sinh \theta. \sin n (\lambda - \theta).$$

If we put

$$\theta = \lambda - \frac{\phi}{n}, \quad \lambda n = -\mu,$$

these equations may be written

$$X = h \cos \phi. \cosh \frac{1}{n} (\mu + \phi),$$

$$Y = -h \sin \phi. \sinh \frac{1}{n} (\mu + \phi),$$

which system is slightly different from what has been obtained above as the solution of Mainardi's problem; but the equations are obviously capable of a geometrical interpretation closely analogous to what is given in my former paper.

If we had to obtain by the ordinary method the oblique trajectory of a system of confocal hyperbolas, we should have to eliminate  $a$  and  $b$  from the equations

$$\frac{x^2}{a^2} - \frac{y^2}{b^2} = 1, \quad a^2 + b^2 = h^2,$$

$$\frac{dy}{dx} = p = -\frac{\frac{x}{a^2} + \frac{ny}{b^2}}{\frac{nx}{a^2} - \frac{y}{b^2}}.$$

The result may be expressed in the form

$$\left\{ (nx - y) + (x - ny) p \right\} \left\{ (x + ny) + (nx + y) p \right\} \\ = h^2 (n + p) (1 + np).$$

But, it is surely no agreeable task to have to find the actual equation of the trajectory by integrating this differential equation.

Assuming the expressions for the coordinates of any point on the oblique trajectory of a system of confocal ellipses, it is easy to write down the expressions for the coordinates of any point on the oblique trajectory of a system of confocal hyperbolas. Consider the point of intersection of an ellipse and its trajectory, and draw through this point the confocal hyperbola; then, since the ellipse and hyperbola cut each other orthogonally, the trajectory, which intersects the ellipse at an angle  $\alpha$ , will intersect the hyperbola at an angle  $\left(\frac{\pi}{2} + \alpha\right)$ , in both cases measuring the angle of intersection in the same sense; the trajectory, therefore, is also the oblique trajectory of the confocal hyperbolas (at an angle  $\frac{\pi}{2} + \alpha$ ), and the coordinates of any point on it, as such, will,

therefore, be obtained by writing for  $n$  ( $= \tan \alpha$ ),  $-\frac{1}{n}$  ( $= \tan \left[\frac{\pi}{2} + \alpha\right]$ )

**Example III.**—To find the oblique trajectory of a system of parabolas which have a common principal axis and which touch each other at their common vertex, and, the equations of which are, accordingly, obtained by varying  $a$  in

$$y^2 = 4ax.$$

The coordinates of any point on the curve are given by

$$x = a \tan^2 \theta,$$

$$y = 2a \tan \theta.$$

As the two constants of the general theorem are here equal, the coordinates of any point on the trajectory are given by

$$\begin{aligned} X &= \psi \tan^2 \theta \\ Y &= 2 \psi \tan \theta. \end{aligned}$$

To determine  $\psi$  as a function of  $\theta$ , we have

$$\begin{aligned} f_1 &= \psi \tan^2 \theta \\ f_2 &= 2 \psi \tan \theta, \end{aligned}$$

which give

$$\begin{aligned} \frac{df_1}{d\theta} &= 2 \psi \tan \theta \sec^2 \theta, \\ \frac{df_2}{d\theta} &= 2 \psi \sec^2 \theta, \\ \frac{df_1}{d\psi} &= \tan^2 \theta \\ \frac{df_2}{d\psi} &= 2 \tan \theta, \end{aligned}$$

so that we have

$$\begin{aligned} L &= 4 \psi^2 \sec^6 \theta \\ M &= 2 \psi \tan \theta \sec^2 \theta (2 + \tan^2 \theta) \\ N &= -2 \psi \tan^2 \theta \sec^2 \theta \end{aligned}$$

and the differential equation for  $\psi$  becomes

$$\frac{d\psi}{d\theta} = - \frac{2n \psi \sec^4 \theta}{\tan \theta (2n + \tan \theta + n \tan^2 \theta)}.$$

This may be written

$$\frac{d\psi}{\psi} = - \frac{2n \sec^4 \theta d\theta}{\tan \theta (2n + \tan \theta + n \tan^2 \theta)},$$

which, by putting  $\tan \theta = z$ , reduces to

$$\frac{d\psi}{\psi} = -2n \frac{(1+z^2) dz}{z (2n+z+nz^2)}$$

or,

$$\frac{d\psi}{\psi} = \frac{3}{2} \frac{dz}{2n+z+nz^2} - \frac{dz}{z} - \frac{1}{2} \frac{(2nz+1) dz}{2n+z+nz^2}.$$

Integrating, we have

$$\begin{aligned} \log \frac{\psi}{\lambda} &= \frac{3}{2} \frac{1}{\sqrt{1-8n^2}} \log \frac{2nz+1-\sqrt{1-8n^2}}{2nz+1+\sqrt{1-8n^2}} \\ &\quad - \log z - \frac{1}{2} \log (2n+z+nz^2), \end{aligned}$$

which gives

$$\psi = \frac{\lambda}{\tan \theta \sqrt{(2n + \tan \theta + n \tan^2 \theta)}} \left\{ \frac{2n \tan \theta + 1 - \sqrt{1-8n^2}}{2n \tan \theta + 1 + \sqrt{1-8n^2}} \right\}^{\frac{3}{2\sqrt{1-8n^2}}}.$$

This holds so long as  $8n^2 < 1$ , or, if  $\alpha$  be the angle of the trajectory

$$\tan \alpha < \frac{1}{2\sqrt{2}}.$$

If  $\tan \alpha$  be greater than this value, the corresponding value of  $\psi$  will be still more complex, but may easily be found. In the particular case where

$$\tan \alpha = \frac{1}{2\sqrt{2}},$$

the differential equation for  $\psi$  reduces to

$$\frac{d\psi}{\psi} = 3\sqrt{2} \frac{dz}{(z+\sqrt{2})^2} - \frac{dz}{z} - \frac{dz}{z+\sqrt{2}}$$

Integrating and substituting for  $z$ , we have

$$\psi \tan \theta (\tan \theta + \sqrt{2}) = e^{\frac{-3\sqrt{2}}{\tan \theta + \sqrt{2}}}.$$

If the orthogonal trajectory be required, the expression for  $\psi$  admits of considerable simplification, for, then we have  $n = \infty$ , and the differential equation for  $\psi$  becomes

$$\frac{d\psi}{\psi} = -\frac{dz}{z} - \frac{1}{2} \frac{z dz}{1 + \frac{1}{2} z^2},$$

which on integration leads to

$$\log \frac{\psi}{\lambda} = -\log z - \frac{1}{2} \log (1 + \frac{1}{2} z^2),$$

or,  $\psi z (1 + \frac{1}{2} z^2)^{\frac{1}{2}} = \lambda$ ,  
which, by putting  $z = \tan \theta$ , reduces to

$$\psi^2 = \frac{2\lambda^2}{\tan^2 \theta (2 + \tan^2 \theta)}.$$

The coordinates, therefore, of any point on the trajectory are given by

$$X^2 = \psi^2 \tan^4 \theta = \frac{2\lambda^2 \tan^2 \theta}{2 + \tan^2 \theta},$$

$$Y^2 = 4\psi^2 \tan^2 \theta = \frac{8\lambda^2}{2 + \tan^2 \theta},$$

which easily shew that the trajectory is the ellipse

$$y^2 + 2x^2 = 4\lambda^2.$$

**Example IV.**—To obtain the oblique trajectory of a pencil of coplanar rays radiating from a point, and whose equation is, therefore, obtained by varying  $a$  in

$$y = ax.$$

*First Method.*

The coordinates of any point on the line are given by

$$y = a\theta,$$

$$x = \theta,$$

so that the coordinates of any point on the trajectory are

$$\begin{aligned} X &= \theta, \\ Y &= \psi\theta, \end{aligned}$$

where, to determine  $\psi$  as a function of  $\theta$ , we have

$$\begin{aligned} f_1 &= \theta, \\ f_2 &= \psi\theta, \end{aligned}$$

which furnish the system

$$\begin{aligned} \frac{df_1}{d\theta} &= 1, \quad \frac{df_2}{d\theta} = \psi, \\ \frac{df_1}{d\psi} &= 0, \quad \frac{df_2}{d\psi} = \theta, \end{aligned}$$

and by virtue of these, we have

$$\begin{aligned} L &= 1 + \psi^2, \\ M &= \theta\psi, \\ N &= -\theta, \end{aligned}$$

whence, the differential equation for  $\psi$  is

$$\frac{d\psi}{d\theta} = \frac{nL}{N - nM} = \frac{n(1 + \psi^2)}{-\theta - n\theta\psi}$$

which gives

$$\frac{1 + n\psi}{1 + \psi^2} d\psi = -n \frac{d\theta}{\theta}.$$

Integrating, we get

$$\tan^{-1} \psi + \frac{n}{2} \log(1 + \psi^2) = -n \log \frac{\theta}{\lambda},$$

which easily reduces to

$$\theta = \frac{\lambda}{\sqrt{1 + \psi^2}} e^{-\frac{1}{n} \tan^{-1} \psi}$$

Hence, finally, the coordinates of any point on the trajectory are given by

$$\begin{aligned} X &= \frac{\lambda}{\sqrt{1 + \psi^2}} e^{-\frac{1}{n} \tan^{-1} \psi} \\ Y &= \frac{\lambda \psi}{\sqrt{1 + \psi^2}} e^{-\frac{1}{n} \tan^{-1} \psi} \end{aligned}$$

It is not difficult to shew that these values lead to a well-known result; for we have

$$\frac{Y}{X} = \psi$$

and

$$(X^2 + Y^2)^{\frac{1}{2}} = \lambda e^{-\frac{1}{n} \tan^{-1} \psi}$$

Transforming to polar coordinates, by putting

$$X = r \cos \phi, \quad Y = r \sin \phi,$$

we have

$$\begin{aligned} \tan \phi &= \psi \\ r &= \lambda e^{-\frac{1}{n} \tan^{-1} \psi}, \end{aligned}$$

whence,

$$r = \lambda e^{-\frac{\phi}{n}},$$

which is the logarithmic spiral.

*Second method.*

We might also have proceeded as follows, *viz.*, putting  $a = \tan \beta$ , the coordinates of any point on the line are given by

$$\begin{aligned} x &= e^\theta \cos \beta, \\ y &= e^\theta \sin \beta. \end{aligned}$$

The coordinates of any point on the trajectory are, therefore, given by

$$\begin{aligned} X &= e^\theta \cos \psi, \\ Y &= e^\theta \sin \psi. \end{aligned}$$

To determine  $\psi$  as a function of  $\theta$ , we have

$$\begin{aligned} f_1 &= e^\theta \cos \psi, \\ f_2 &= e^\theta \sin \psi, \end{aligned}$$

whence, we have the system

$$\begin{aligned} \frac{df_1}{d\theta} &= e^\theta \cos \psi, \\ \frac{df_2}{d\theta} &= e^\theta \sin \psi, \\ \frac{df_1}{d\psi} &= -e^\theta \sin \psi, \\ \frac{df_2}{d\psi} &= e^\theta \cos \psi, \end{aligned}$$

which furnish us with the values

$$L = e^{2\theta}, \quad M = 0, \quad N = e^{-2\theta}.$$

The differential equation for  $\psi$  becomes

$$\frac{d\psi}{d\theta} = -n,$$

whence

$$\psi = n(\lambda - \theta).$$

The coordinates of any point on the trajectory are, consequently, given by

$$\begin{aligned} X &= e^\theta \cos n(\lambda - \theta), \\ Y &= e^\theta \sin n(\lambda - \theta), \end{aligned}$$

and it is not difficult to shew that these values belong to the logarithmic spiral.

**Example V.**—To find the oblique trajectory of a system of circles which touch a given straight line at a given point, and whose equation is, therefore, obtained by varying  $r$  in

$$x^2 + y^2 = 2rx.$$

The coordinates of any point on the circle are given by

$$\begin{aligned} x &= r(1 + \cos \theta), \\ y &= r \sin \theta, \end{aligned}$$

so that, the coordinates of any point on the trajectory are given by

$$\begin{aligned} X &= \psi(1 + \cos \theta), \\ Y &= \psi \sin \theta. \end{aligned}$$

To determine  $\psi$  as a function of  $\theta$ , we have

$$\begin{aligned} f_1 &= \psi(1 + \cos \theta), \\ f_2 &= \psi \sin \theta, \end{aligned}$$

which lead to the system

$$\begin{aligned} \frac{df_1}{d\theta} &= -\psi \sin \theta \\ \frac{df_2}{d\theta} &= \psi \cos \theta \\ \frac{df_1}{d\psi} &= 1 + \cos \theta \\ \frac{df_2}{d\psi} &= \sin \theta, \end{aligned}$$

whence, we have

$$\begin{aligned} L &= \psi^2 \\ M &= -\psi \sin \theta \\ N &= \psi(1 + \cos \theta). \end{aligned}$$

The differential equation for  $\psi$  reduces to

$$\frac{d\psi}{d\theta} = \frac{n\psi}{1 + \cos \theta + n \sin \theta}.$$

Writing  $n = \tan \alpha$ , where  $\alpha$  is the angle of the trajectory, we have

$$\frac{d\psi}{\psi} = \sin \alpha \frac{d(\theta - \alpha)}{\cos \alpha + \cos(\theta - \alpha)}.$$

Integrating, we have at once

$$\log \frac{\psi}{\lambda} = \log \frac{\cos \frac{\alpha}{2} + \sin \frac{\alpha}{2} \tan \frac{\theta - \alpha}{2}}{\cos \frac{\alpha}{2} - \sin \frac{\alpha}{2} \tan \frac{\theta - \alpha}{2}},$$

whence

$$\psi = \lambda \frac{\cos\left(\frac{\theta}{2} - \alpha\right)}{\cos\frac{\theta}{2}}.$$

The equations

$$X = \psi (1 + \cos \theta) = 2 \psi \cos^2 \frac{\theta}{2}$$

$$Y = \psi \sin \theta = 2 \psi \sin \frac{\theta}{2} \cos \frac{\theta}{2}$$

which give the coordinates of any point on the trajectory, therefore, become

$$X = 2\lambda \cos \frac{\theta}{2} \cos\left(\alpha - \frac{\theta}{2}\right)$$

$$Y = 2\lambda \sin \frac{\theta}{2} \cos\left(\alpha - \frac{\theta}{2}\right).$$

Since

$$X^2 + Y^2 = 4\lambda^2 \cos^2\left(\alpha - \frac{\theta}{2}\right)$$

it is easily shewn that the trajectory is the circle

$$x^2 + y^2 = 2\lambda (x \cos \alpha + y \sin \alpha).$$

**Example VI.**—To find the oblique trajectory of a system of parabolas which have a common focus and principal axis, and whose equation is, therefore, obtained by varying  $m$  in

$$y^2 = 4m(x+m).$$

Putting

$$m = a^2,$$

any point on the curve is seen to be given by

$$x = \theta^2 - a^2,$$

$$y = 2a\theta.$$

The coordinates of any point on the trajectory are, therefore, given by

$$X = \theta^2 - \psi^2,$$

$$Y = 2\theta\psi,$$

where  $\psi$  is to be determined as a function of  $\theta$  from the system

$$f_1 = \theta^2 - \psi^2$$

$$f_2 = 2\theta\psi,$$

so that we have

$$\frac{df_1}{d\theta} = 2\theta, \quad \frac{df_2}{d\theta} = 2\psi,$$

$$\frac{df_1}{d\psi} = -2\psi, \quad \frac{df_2}{d\psi} = 2\theta,$$



and these values shew that

$$\begin{aligned} L &= 4 (\theta^2 + \psi^2) \\ M &= 0 \\ N &= -4 (\theta^2 + \psi^2). \end{aligned}$$

The differential equation for  $\psi$ , consequently, becomes

$$\frac{d\psi}{d\theta} = -n$$

whence

$$\psi = n (\lambda - \theta).$$

Hence, finally, the coordinates of any point on the trajectory are given by

$$\begin{aligned} X &= \theta^2 - n^2 (\lambda - \theta)^2. \\ Y &= 2n\theta (\lambda - \theta). \end{aligned}$$

Since  $X$  and  $Y$  are two quadratic functions of the parameter  $\theta$ , it is clear that the trajectory must be a conic; in fact, the actual equation is

$$(1 + n^2)^2 (x^2 + y^2) = \left\{ (n^2 - 1)x + 2ny - 2n^2\lambda^2 \right\}^2,$$

which may be thrown into the form

$$\left\{ 2nx - (n^2 - 1)y \right\}^2 = 4n^2\lambda^2 \left\{ n^2\lambda^2 - (n^2 - 1)x - 2ny \right\},$$

which shews that the trajectory is a parabola, and, if  $n = \tan \alpha$ , the polar equation is

$$\sqrt{r} \cdot \sin \left( a + \frac{\phi}{2} \right) = \lambda \sin a.$$

**Example VII.**—To find the oblique trajectory of the system of curves obtained by varying  $b$  in the equation

$$e^x \sin y = ab.$$

The coordinates of any point on the curve are given by

$$\begin{aligned} x &= \log a \sqrt{\theta^2 + b^2} \\ y &= \tan^{-1} \frac{b}{\theta}. \end{aligned}$$

The coordinates of any point on the trajectory are, therefore, given by

$$\begin{aligned} X &= \log a \sqrt{\theta^2 + \psi^2} \\ Y &= \tan^{-1} \frac{\psi}{\theta}. \end{aligned}$$

To determine  $\psi$  as a function of  $\theta$ , we have

$$\begin{aligned} f_1 &= \log a + \frac{1}{2} \log (\theta^2 + \psi^2), \\ f_2 &= \tan^{-1} \frac{\psi}{\theta}, \end{aligned}$$

which give the values

$$\frac{df_1}{d\theta} = \frac{\theta}{\theta^2 + \psi^2}$$

$$\begin{aligned}\frac{df_2}{d\theta} &= \frac{-\psi}{\theta^2 + \psi^2} \\ \frac{df_1}{d\psi} &= \frac{\psi}{\theta^2 + \psi^2} \\ \frac{df_2}{d\psi} &= \frac{\theta^2}{\theta^2 + \psi^2},\end{aligned}$$

whence

$$L = 1, \quad M = 0, \quad N = -1,$$

and the differential equation for  $\psi$  is

$$\frac{d\psi}{d\theta} = -n,$$

which gives

$$\psi = n(\lambda - \theta).$$

The coordinates of any point on the trajectory are, therefore, given by

$$X = \log a \sqrt{\theta^2 + n^2} (\lambda - \theta)^2$$

$$Y = \tan^{-1} \frac{n(\lambda - \theta)}{\theta}.$$

It can easily be shewn from this system that the actual equation of the trajectory is

$$e^{\alpha} (\sin y + n \cos y) = a\lambda n,$$

or, if  $\alpha$  be the angle of the trajectory, this becomes

$$e^{\alpha} \sin (y + \alpha) = a\lambda \sin \alpha.$$

### §. 5. *Conjugate Functions.*

It will be remarked that in some of the examples given above, the integration of the differential equation for  $\psi$  was materially facilitated whenever we found

$$M = 0, \quad L = \pm N.$$

It is, therefore, a matter of importance to discover under what circumstances this may be expected to happen.

**Theorem.**—The coordinates of any point on a curve being given by

$$x = f_1(\theta, a),$$

$$y = f_2(\theta, b),$$

and, the coordinates of the corresponding point on the trajectory by

$$X = f_1 \left\{ \theta, F_1(\psi, h) \right\},$$

$$Y = f_2 \left\{ \theta, F_2(\psi, h) \right\},$$

if we have

$$\psi = n(\lambda + \theta),$$

and

$$M \equiv \frac{df_1}{d\theta} \frac{df_1}{d\psi} + \frac{df_2}{d\theta} \frac{df_2}{d\psi} = 0,$$

to prove that  $f_1$  and  $f_2$  must be conjugate functions of  $\psi$  and  $\theta$ .

To establish this, we see that the conditions given, *viz.*,

$$\psi = n (\lambda + \theta), M = 0,$$

reduce the differential equation

$$\frac{d\psi}{d\theta} = \frac{n L}{N - n M}$$

to the condition

$$L = N.$$

Now, since  
we have

$$M = 0,$$

$$\frac{\frac{df_1}{d\theta}}{\frac{df_2}{d\theta}} = - \frac{\frac{df_2}{d\psi}}{\frac{df_1}{d\psi}} = \xi, \text{ say.}$$

Substituting in the value for N, we get

$$\begin{aligned} N &\equiv \frac{df_2}{d\theta} \frac{df_1}{d\psi} - \frac{df_1}{d\theta} \frac{df_2}{d\psi} \\ &= (1 + \xi^2) \frac{df_1}{d\psi} \frac{df_2}{d\theta} \\ &= \frac{\frac{df_1}{d\psi}}{\frac{df_2}{d\theta}} L, \end{aligned}$$

and, since  
we must have

$$N = L,$$

$$\frac{df_1}{d\psi} = \frac{df_2}{d\theta}, \dots\dots\dots (16)$$

Therefore

$$\begin{aligned} N &= \left(\frac{df_2}{d\theta}\right)^2 - \frac{df_1}{d\theta} \frac{df_2}{d\psi} \\ L &= \left(\frac{df_1}{d\theta}\right)^2 + \left(\frac{df_2}{d\theta}\right)^2, \end{aligned}$$

whence

$$\frac{df_1}{d\theta} = - \frac{df_2}{d\psi} \dots\dots\dots (17)$$

The two equations marked (16) and (17) make it manifest that  $f_1$  and  $f_2$  must be conjugate functions of  $\psi$  and  $\theta$ .

In Mainardi's problem, which is the first example given above, we have

$$\psi = n (\lambda + \theta), M = 0,$$

so that the quantities

$$h \cos \theta \cosh \psi, \quad h \sin \theta \sinh \psi$$

are conjugate functions of  $\psi$  and  $\theta$ ; hence, we infer from a well-known

property of these functions that the two curves

$$\begin{aligned} \cos x \cosh y &= a \\ \sin x \sinh y &= b \end{aligned}$$

intersect orthogonally at every common point of intersection.

It may similarly be shewn that if we have

$$\psi = n(\lambda - \theta), \quad M = 0,$$

the functions  $f_1$  and  $f_2$  are conjugate with respect to  $\theta$  and  $\psi$ ; for the above investigation remains unaltered, except in that we have

$$L = -N,$$

so that (16) becomes

$$\frac{df_1}{d\psi} = -\frac{df_2}{d\theta}, \quad \dots\dots\dots (18)$$

and we have

$$\begin{aligned} N &= -\left(\frac{df_2}{d\theta}\right)^2 - \frac{df_1}{d\theta} \frac{df_2}{d\psi}, \\ L &= \left(\frac{df_1}{d\theta}\right)^2 + \left(\frac{df_2}{d\theta}\right)^2, \end{aligned}$$

whence

$$\frac{df_1}{d\theta} = \frac{df_2}{d\psi}, \quad \dots\dots\dots (19)$$

and, by virtue of (18) and (19), it is again manifest that  $f_1$  and  $f_2$  are two conjugate functions of  $\theta$  and  $\psi$ . Consequently, as in the second example given above, we have

$$\psi = n(\lambda - \theta), \quad M = 0,$$

the quantities

$$h \cosh \theta \cos \psi, \quad h \sinh \theta \sin \psi$$

are two conjugate functions of  $\theta$  and  $\psi$ , and, the curves

$$\begin{aligned} \cosh x \cos y &= a \\ \sinh x \sin y &= b \end{aligned}$$

are orthogonal trajectories of each other.

Again, it is an elementary principle in the theory of conjugate functions that if  $\phi$  and  $\psi$  are any two conjugate functions of  $x$  and  $y$ ; and if  $\xi, \eta$  are any two other conjugate functions of  $x$  and  $y$ : then, by putting  $\xi$  and  $\eta$  instead of  $x$  and  $y$  in the values of  $\phi$  and  $\psi$ , we get two new conjugate functions of  $x$  and  $y$ . But, we have found above two pairs of such functions, *viz.*,

$$\begin{aligned} \phi &= \sin x \sinh y \} \\ \psi &= \cos x \cosh y \} \\ \xi &= \cosh x \cos y \} \\ \eta &= \sinh x \sin y \}. \end{aligned}$$

Hence we have the two new conjugate functions

$$\begin{aligned} \sin \left\{ \cosh x \cos y \right\} \sinh \left\{ \sinh x \sin y \right\}, \\ \cos \left\{ \cosh x \cos y \right\} \cosh \left\{ \sinh x \sin y \right\}. \end{aligned}$$

We have, therefore, the theorem that the two transcendental curves

$$\begin{aligned} \sin \left\{ \cosh x \cos y \right\} \sinh \left\{ \sinh x \sin y \right\} = a \\ \cos \left\{ \cosh x \cos y \right\} \cosh \left\{ \sinh x \sin y \right\} = b \end{aligned}$$

are orthogonal trajectories of each other. In the same manner, it may be shewn that the quantities which furnish the coordinates of any point on the trajectory in terms of  $\theta$  and  $\psi$ , in the second method of establishing Example IV, as well as in Examples VI and VII, are conjugate functions.

We shall now give some examples in which the properties of conjugate functions will materially simplify the calculation.

**Example VIII.**—Consider the tricircular sextic

$$(x^2 + y^2)(x^2 + y^2 + k^2)^2 = a^2 \left\{ x^2 (x^2 + y^2 - k^2)^2 + y^2 (x^2 + y^2 + k^2)^2 \right\},$$

and suppose that its oblique trajectory is required when  $a$  is made to vary. Writing

$$a^2 = 1 + b^2,$$

the equation may easily be thrown into the form

$$x^2 (x^2 + y^2 + k^2)^2 = a^2 x^2 (x^2 + y^2 - k^2)^2 + b^2 y^2 (x^2 + y^2 + k^2)^2,$$

whence it can be shewn without much difficulty that the coordinates of any point on the sextic curve are given by the system

$$\begin{aligned} \frac{x^2}{k^2} &= \frac{a - \cos \theta}{a + \cos \theta} \cdot \frac{b^2}{b^2 + \sin^2 \theta}, \\ \frac{y^2}{k^2} &= \frac{a - \cos \theta}{a + \cos \theta} \cdot \frac{\sin^2 \theta}{b^2 + \sin^2 \theta}, \end{aligned}$$

and we seek the oblique trajectory, when  $a$  and  $b$  are made to vary subject to the conditions

$$\begin{aligned} a &= \cosh \psi, \\ b &= \sinh \psi. \end{aligned}$$

The coordinates of any point on the trajectory are given by

$$\begin{aligned} \frac{X^2}{k^2} &= \frac{\cosh \psi - \cos \theta}{\cosh \psi + \cos \theta} \cdot \frac{\sinh^2 \psi}{\sinh^2 \psi + \sin^2 \theta} \\ \frac{Y^2}{k^2} &= \frac{\cosh \psi - \cos \theta}{\cosh \psi + \cos \theta} \cdot \frac{\sin^2 \theta}{\sinh^2 \psi + \sin^2 \theta} \end{aligned}$$

To determine  $\psi$  as a function of  $\theta$ , we have

$$X = f_1, \quad Y = f_2,$$

and then by actually calculating the values of

$$\frac{df_1}{d\theta}, \frac{df_2}{d\theta}, \frac{df_1}{d\psi}, \frac{df_2}{d\psi},$$

we can shew that

$$L + N = 0, \quad M = 0,$$

whence the differential equation for  $\psi$  becomes

$$\frac{d\psi}{d\theta} = -n$$

and

$$\psi = n(\lambda - \theta).$$

But, from the theorem we have established at the beginning of this section, we know that the same conclusions may be legitimately drawn without direct calculation, if we can prove  $f_1$  and  $f_2$  to be two conjugate functions, and we proceed to do so. Now we know that if

$$\tan \frac{1}{2}(\theta + \sqrt{-1}\psi) = A + \sqrt{-1}B,$$

the two conjugate functions  $A$  and  $B$  are given by the system

$$\frac{A^2}{B^2} = \frac{\sin^2 \theta}{\sinh^2 \psi}$$

$$A^2 + B^2 = \frac{\cosh \psi - \cos \theta}{\cosh \psi + \cos \theta}$$

whence it follows that

$$A^2 = \frac{\cosh \psi - \cos \theta}{\cosh \psi + \cos \theta} \cdot \frac{\sin^2 \theta}{\sinh^2 \psi + \sin^2 \theta}$$

$$B^2 = \frac{\cosh \psi - \cos \theta}{\cosh \psi + \cos \theta} \cdot \frac{\sinh^2 \psi}{\sinh^2 \psi + \sin^2 \theta}$$

But these are the quantities which when multiplied by  $k^2$  reproduce the squares of what we have called  $f_1$  and  $f_2$  above, which was to be proved. Hence we finally infer that the coordinates of any point on the sextic

$$(x^2 + y^2)(x^2 + y^2 + k^2)^2 = a^2 \left\{ x^2(x^2 + y^2 - k^2)^2 + y^2(x^2 + y^2 + k^2)^2 \right\}$$

may be represented by the equations

$$\frac{x^2}{k^2} = \frac{a - \cos \theta}{a + \cos \theta} \cdot \frac{b^2}{b^2 + \sin^2 \theta}$$

$$\frac{y^2}{k^2} = \frac{a - \cos \theta}{a + \cos \theta} \cdot \frac{\sin^2 \theta}{b^2 + \sin^2 \theta}$$

where

$$a^2 - b^2 = 1,$$

and, accordingly, the coordinates of any point on its oblique trajectory are furnished by the system

$$\frac{X^2}{k^2} = \frac{\cosh n(\lambda - \theta) - \cos \theta}{\cosh n(\lambda - \theta) + \cos \theta} \cdot \frac{\sinh^2 n(\lambda - \theta)}{\sinh^2 n(\lambda - \theta) + \sin^2 \theta}$$

$$\frac{Y^2}{k^2} = \frac{\cosh n(\lambda - \theta) - \cos \theta}{\cosh n(\lambda - \theta) + \cos \theta} \cdot \frac{\sin^2 \theta}{\sinh^2 n(\lambda - \theta) + \sin^2 \theta}$$

**Example IX.**—Take, again, the curve

$$(x^2 + y^2)^2 = \frac{x^2}{a^2} + \frac{y^2}{b^2}$$

and suppose that its oblique trajectory is required, when  $a$  and  $b$  are made to vary subject to the condition

$$a^2 - b^2 = h^2.$$

The coordinates of any point on the curve may be written

$$x = \frac{a \cos \theta}{a^2 \cos^2 \theta + b^2 \sin^2 \theta},$$

$$y = \frac{b \sin \theta}{a^2 \cos^2 \theta + b^2 \sin^2 \theta}$$

and we have also

$$a = h \cosh \psi$$

$$b = h \sinh \psi.$$

The coordinates of any point on the trajectory are, therefore, given by

$$X = \frac{\cos \theta \cosh \psi}{h (\cos^2 \theta \cosh^2 \psi + \sin^2 \theta \sinh^2 \psi)}$$

$$= \frac{2 \cos \theta \cosh \psi}{h (\cosh 2\psi + \cos 2\theta)}$$

$$Y = \frac{\sin \theta \sinh \psi}{h (\cos^2 \theta \cosh^2 \psi + \sin^2 \theta \sinh^2 \psi)}$$

$$= \frac{2 \sin \theta \sinh \psi}{h (\cosh 2\psi + \cos 2\theta)}.$$

To determine  $\psi$  as a function of  $\theta$ , we have

$$f_1 = X, \quad f_2 = Y.$$

But  $f_1$  and  $f_2$  are two conjugate functions; for we know that if we separate the real and imaginary parts of

$$\sec (\alpha + \sqrt{-1} \beta) = A + \sqrt{-1} B,$$

we have

$$A = \frac{2 \cos \alpha \cosh \beta}{\cosh 2\beta + \cos 2\alpha}$$

$$B = \frac{2 \sin \alpha \sinh \beta}{\cosh 2\beta + \cos 2\alpha}.$$

Hence, by the theorem of this section, we have

$$L + N = 0, \quad M = 0,$$

and the differential equation for  $\psi$  becomes

$$\frac{d\psi}{d\theta} = -n$$

whence

$$\psi = n(\lambda - \theta).$$

We see, therefore, finally that the coordinates of any point on the oblique trajectory of the bicircular quartic

$$(x^2 + y^2)^2 = \frac{x^2}{a^2} + \frac{y^2}{b^2},$$

which is obviously the inverse of an ellipse, may be represented by the system

$$\begin{aligned} X &= \frac{2 \cos \theta \cosh n(\lambda - \theta)}{h \left\{ \cosh 2n(\lambda - \theta) + \cos 2\theta \right\}} \\ Y &= \frac{2 \sin \theta \sinh n(\lambda - \theta)}{h \left\{ \cosh 2n(\lambda - \theta) + \cos 2\theta \right\}} \end{aligned}$$

when  $a$  and  $b$  vary subject to the relation

$$h^2 = a^2 - b^2.$$

**Example X.**—Again, if we seek the oblique trajectory of the transcendental curve

$$\tan^2 y = \frac{b^2}{a^2} \frac{a^2 e^{-x} - h^2 e^x}{h^2 e^x - b^2 e^{-x}}$$

when  $a$  and  $b$  vary subject to the condition

$$a^2 - b^2 = h^2,$$

we see that the coordinates of any point on the curve are given by the system

$$2e^{2x} = \frac{a^2 + b^2}{h^2} - \cos 2\theta.$$

$$\cot y = \frac{a}{b} \tan \theta.$$

But as

$$a = h \cosh \psi,$$

$$b = h \sinh \psi,$$

the coordinates of any point on the trajectory are given by

$$X = \frac{1}{2} \log \frac{\cosh 2\psi - \cos 2\theta}{2}$$

$$\cot Y = \coth \psi \tan \theta.$$

To determine  $\psi$  as a function of  $\theta$ , we notice that the quantities

$$f_1 = \frac{1}{2} \log 2 (\cosh 2\psi - \cos 2\theta) - \log 2$$

$$f_2 = \cot^{-1} (\coth \psi \tan \theta)$$

are two conjugate functions, being in fact exactly the two quantities which we obtain in separating the real and imaginary parts of

$$\log \sin (\theta + \sqrt{-1} \psi)$$

Hence, by the theorem of this section, we have

$$L + N = 0, \quad M = 0,$$



and, as before,

$$\psi = n(\lambda - \theta).$$

Therefore, we finally infer that the coordinates of any point on the oblique trajectory of the curve

$$\tan^2 y = \frac{b^2}{a^2} \frac{a^2 e^{-x} - b^2 e^x}{b^2 e^x - b^2 e^{-x}},$$

when  $a$  and  $b$  vary subject to the relation

$$a^2 - b^2 = h^2,$$

are given by the system

$$2e^{2x} = \cosh 2n(\lambda - \theta) - \cos 2\theta.$$

$$\tan y = \tanh n(\lambda - \theta) \cdot \cot \theta.$$

From the theorem established in this section, it is again evident that, if

$$f_1(\theta, \psi), \quad f_2(\theta, \psi)$$

be any two conjugate functions of  $\theta$  and  $\psi$ , and the equation of a curve be obtained by eliminating  $\theta$  from the system

$$x = f_1(\theta, a)$$

$$y = f_2(\theta, b),$$

the equation of the oblique trajectory of this curve when  $a$  is made to vary is obtained by eliminating  $\theta$  from the system

$$X = f_1 \left\{ \theta, n(\lambda - \theta) \right\}$$

$$Y = f_2 \left\{ \theta, n(\lambda - \theta) \right\}.$$

Similarly, if the equation of a curve is obtained by eliminating  $\psi$  from the system

$$x = f_1(a, \psi),$$

$$y = f_2(a, \psi),$$

the equation of the oblique trajectory of this curve when  $a$  is made to vary is obtained by eliminating  $\psi$  from the system

$$X = f_1 \left\{ n(\lambda + \psi), \psi \right\}$$

$$Y = f_2 \left\{ n(\lambda + \psi), \psi \right\}.$$

Again as from the well known formula for expanding

$$f(\theta + \sqrt{-1} \psi)$$

and separating its real and imaginary parts, viz.,

$$f_1 \equiv f(\theta) - \frac{\psi^2}{2} f''(\theta) + \frac{\psi^4}{4} f^{IV} \theta - \&c.,$$

$$f_2 \equiv \psi f'(\theta) - \frac{\psi^3}{3} f'''(\theta) + \&c.,$$

we can determine at pleasure an infinite number of pairs of conjugate functions, it is clear that we may obtain without any difficulty an infinite

number of curves whose oblique trajectories may be determined with ease by the theorems and methods of this paper; but it is needless to multiply instances, as the examples given above will, it is hoped, amply illustrate these observations.

16th November 1887.

*Additional Note on Mainardi's Problem.*

Since the above paper was read, I have been informed by Prof. Booth that Prof. Michael Roberts, in his Lectures on Differential Equations delivered at the University of Dublin, used to solve Mainardi's problem by the help of elliptic coordinates; I have not the opportunity of examining the solution arrived at by Prof. Roberts (as I believe it has never been published), but I give below the results I have obtained by means of the coordinates suggested.

If  $a$  be the semi-axis-major of the primitive conic, and  $h$  half the distance between its foci, its equation is

$$\frac{x^2}{a^2} + \frac{y^2}{a^2 - h^2} = 1,$$

and any member of the confocal family is obtained by varying  $a$ ; so that, if  $\lambda, \mu$  be the elliptic coordinates of any point P on the trajectory, they are determined from the system

$$\frac{x^2}{\lambda^2} + \frac{y^2}{\lambda^2 - h^2} = 1,$$

$$\frac{x^2}{\mu^2} + \frac{y^2}{\mu^2 - h^2} = 1,$$

*viz.*,  $\lambda$  is the semi-axis-major of the ellipse, and  $\mu$  the semi-axis-transverse of the hyperbola through P confocal to the primitive one; hence, solving between these equations, we have

$$x^2 = \frac{\lambda^2 \mu^2}{h^2},$$

$$y^2 = \frac{-(\lambda^2 - h^2)(\mu^2 - h^2)}{h^2}.$$

Taking the logarithmic differential, we see that the element of arc of any curve through P is

$$ds^2 = dx^2 + dy^2 = \frac{\lambda^2 - \mu^2}{\lambda^2 - h^2} d\lambda^2 - \frac{\lambda^2 - \mu^2}{\mu^2 - h^2} d\mu^2.$$

Hence, if  $ds_1, ds_2$  be the elements of arc of the confocal ellipse and hyperbola whose semiaxes are  $\lambda, \mu$ , and which intersect orthogonally at P, we have, for the ellipse regarding  $\lambda$  as constant,

$$ds_1^2 = \frac{\lambda^2 - \mu^2}{h^2 - \mu^2} d\mu^2,$$

and, for the hyperbola regarding  $\mu$  as constant,

$$ds_2^2 = \frac{\lambda^2 - \mu^2}{\lambda^2 - h^2} d\lambda^2.$$

Now, if  $\alpha$  be the angle of the trajectory, *viz.*, the angle at P between the trajectory and the ellipse ( $\lambda$ ), we have clearly

$$\frac{ds_2}{ds_1} = \tan \alpha = n.$$

Hence

$$\frac{\lambda^2 - \mu^2}{\lambda^2 - h^2} d\lambda^2 = n^2 \cdot \frac{\lambda^2 - \mu^2}{h^2 - \mu^2} d\mu^2,$$

or

$$\frac{d\lambda}{\sqrt{\lambda^2 - h^2}} = n \frac{d\mu}{\sqrt{h^2 - \mu^2}}.$$

Integrating, we have

$$\log (\lambda + \sqrt{\lambda^2 - h^2}) = -n \cos^{-1} \frac{\mu}{h} + k,$$

which is, accordingly, the equation of the trajectory in elliptic coordinates. It will be remarked that, though the application of elliptic coordinates removes the difficulties of integration, the result is not obtained in an appreciably simpler form; and, besides, the method is not one of general application, as it requires a knowledge of the elements of arc, as well of the given curve as of its orthogonal trajectory; the methods and theorems of this paper, however, effectually remove these disadvantages.

It may usefully be noted that if we use the inverse hyperbolic functions, the integral of

$$\frac{d\lambda}{\sqrt{\lambda^2 - h^2}} = n \frac{d\mu}{\sqrt{h^2 - \mu^2}}$$

may be written

$$\cosh^{-1} \frac{\lambda}{h} + n \cos^{-1} \frac{\mu}{h} = k,$$

and this at once shews that if we have

$$\lambda = h \cosh \theta,$$

where  $\theta$  is a variable parameter, we must have

$$\mu = h \cos \frac{1}{n} (k - \theta).$$

In this form it is not difficult to identify our solution with Mainardi's result, *viz.*,

$$-2n \tan^{-1} \sqrt{\frac{h^2}{xM} - 1} + \log \frac{1 - \sqrt{1 - \frac{M}{x}}}{1 + \sqrt{1 - \frac{M}{x}}} = C,$$

where M satisfies the quadratic

$$(x^2 + y^2 + h^2) M = x(M^2 + h^2).$$

For since

$$x^2 = \frac{\lambda^2 \mu^2}{h^2}$$

$$y^2 = \frac{-(\lambda^2 - h^2)(\mu^2 - h^2)}{h^2},$$

we have

$$x^2 + y^2 + h^2 = \lambda^2 + \mu^2,$$

whence the quadratic for M becomes

$$M(\lambda^2 + \mu^2) = \frac{\lambda\mu}{h}(M^2 + h^2),$$

which may be written

$$M^2 - h\left(\frac{\lambda}{\mu} + \frac{\mu}{\lambda}\right)M + h^2 = 0,$$

the roots of which are

$$M = \frac{h\mu}{\lambda}, \quad \frac{h\lambda}{\mu}.$$

Taking for the present

$$M = \frac{h\mu}{\lambda},$$

we have

$$Mx = \mu^2,$$

$$\frac{M}{x} = \frac{h^2}{\lambda^2}.$$

The equation of the trajectory, therefore, on substituting these values, becomes

$$-2n \tan^{-1} \sqrt{\frac{h^2}{\mu^2} - 1} + \log \frac{1 - \sqrt{1 - \frac{h^2}{\lambda^2}}}{1 + \sqrt{1 - \frac{h^2}{\lambda^2}}} = C.$$

Putting

$$h = \mu \sec \phi,$$

$$C = 2np,$$

where  $p$  is a new constant, this becomes

$$\frac{1 - \sqrt{1 - \frac{h^2}{\lambda^2}}}{1 + \sqrt{1 - \frac{h^2}{\lambda^2}}} = e^{2n(p+\phi)},$$

or

$$\frac{1}{\sqrt{1 - \frac{h^2}{\lambda^2}}} = \frac{1 + e^{2n(p+\phi)}}{1 - e^{2n(p+\phi)'}}$$

or

$$\frac{h^2}{\lambda^2} = 1 - \left\{ \frac{1 - e^{2n(p+\phi)}}{1 + e^{2n(p+\phi)}} \right\}^2$$

$$= \frac{4e^{2n(p+\phi)}}{\{1 + e^{2n(p+\phi)}\}^2}$$

whence

$$\lambda = h \cdot \frac{1 + e^{2n(p+\phi)}}{2e^{n(p+\phi)}}$$

$$= \frac{h}{2} \{ e^{n(p+\phi)} + e^{-n(p+\phi)} \}$$

$$= h \cosh n(p+\phi).$$

We have, therefore, the system

$$\lambda = h \cosh n(p+\phi)$$

$$\mu = h \cos \phi.$$

If we put

$$n(p+\phi) = \theta,$$

$$\phi = \frac{\theta}{n} - p,$$

this is equivalent to the system obtained above, *viz.*,

$$\lambda = h \cosh \theta$$

$$\mu = h \cos \frac{1}{n} (\theta - pn).$$

If we had used for M the value

$$M = \frac{h\lambda}{\mu},$$

we should have to put

$$Mx = \lambda^2,$$

$$\frac{M}{x} = \frac{h^2}{\mu^2}$$

which shews that  $\lambda, \mu$  would be interchanged in the equation of the trajectory, *viz.*, that would give the system

$$\lambda = h \cos \phi,$$

$$\mu = h \cosh n(p+\phi),$$

and it is important to notice that *this second system does not admit of being derived from the differential equation in elliptic coordinates,*

$$\frac{d\lambda}{\sqrt{\lambda^2 - h^2}} = n \frac{d\mu}{\sqrt{h^2 - \mu^2}}.$$

For the above system is the solution of the differential equation

$$n \frac{d\lambda}{\sqrt{h^2 - \lambda^2}} = \frac{d\mu}{\sqrt{\mu^2 - h^2}}.$$

which is different from the one given above, *viz.*, this leads to the primitive

$$n \cos^{-1} \frac{\lambda}{h} + \cosh^{-1} \frac{\mu}{h} + k = 0,$$

so that, if

$$\lambda = h \cos \phi,$$

we must have

$$\mu = h \cosh n(p + \phi).$$

We see, then, that, because M is given by a quadratic, Mainardi's result is really equivalent to two, *viz.*, we have the two systems

$$\left. \begin{aligned} \lambda &= h \cosh n(p + \phi) \\ \mu &= h \cos \phi \end{aligned} \right\}$$

$$\left. \begin{aligned} \lambda &= h \cos \phi \\ \mu &= h \cosh n(p + \phi) \end{aligned} \right\}$$

and these two systems are the solutions of the two distinct differential equations

$$\frac{d\lambda}{\sqrt{\lambda^2 - h^2}} = n \frac{d\mu}{\sqrt{h^2 - \mu^2}},$$

$$n \frac{d\lambda}{\sqrt{h^2 - \lambda^2}} = \frac{d\mu}{\sqrt{\mu^2 - h^2}}.$$

If, now, we consider for a moment these two differential equations, we see that the first belongs to the trajectory which intersects the confocal ellipses at an angle  $\alpha$  (where  $n = \tan \alpha$ ), while the other belongs to the trajectory which intersects the confocals at an angle  $\left(\frac{\pi}{2} - \alpha\right)$ , since

$$\frac{1}{n} = \tan \left(\frac{\pi}{2} - \alpha\right).$$

But, since the confocal hyperbolas intersect the ellipses orthogonally, it follows at once that the second differential equation belongs to the trajectory which intersects the confocal hyperbolas at an angle  $(\pi - \alpha)$ , in both cases measuring the angle in the same sense; hence, the solution

$$M = \frac{h\mu}{\lambda},$$

which leads to the system

$$\lambda = h \cosh n(p + \phi)$$

$$\mu = h \cos \phi$$

is relevant, while the value

$$M = \frac{h\lambda}{\mu},$$

which furnishes the other system

$$\lambda = h \cos \phi$$

$$\mu = h \cosh n(p + \phi)$$

is irrelevant. We conclude, therefore, that, of the two solutions to which Mainardi's result is really equivalent, only one is relevant; the other being wholly extraneous, as belonging to the oblique trajectory of the orthogonal system of confocal hyperbolas;\* and, it is easy to discriminate which of the two solutions given by the quadratic

$$(x^2 + y^2 + h^2)M = x(M^2 + h^2)$$

leads to the relevant solution; for we have seen that the solution in point is furnished by

$$M = \frac{h\mu}{\lambda};$$

now it is evident geometrically that

$$\lambda > h > \mu,$$

which shews at once that

$$\frac{h\mu}{\lambda} < \frac{h\lambda}{\mu};$$

it follows, therefore, that the smaller of the two roots of the quadratic in M is the proper value. We come to the conclusion, therefore, that in Mainardi's system

$$-2n \tan^{-1} \sqrt{\frac{h^2}{xM} - 1} + \log \frac{1 - \sqrt{1 - \frac{M}{x}}}{1 + \sqrt{1 - \frac{M}{x}}} = C,$$

$$(x^2 + y^2 + h^2) M = x(M^2 + h^2),$$

the smaller root of the quadratic in M gives the oblique trajectory of the system of confocal ellipses, while the greater root furnishes the oblique trajectory of the system of confocal hyperbolas. I am not aware that the real character of the two solutions to which Mainardi's result is equivalent has been before distinguished as above.

Lastly, it is sufficiently obvious that the values of  $\lambda, \mu$  given by either of the above systems may be geometrically represented by a construction closely analogous to what is given in my former paper mentioned at the beginning of this memoir.

10th December 1887.

\* Instances of a single solution resolving itself into two, are by no means rare; for example, in the case of the conic

$$ax^2 + 2hxy + by^2 + 2gx + 2fy + c = 0,$$

this equation is really equivalent to the two

$$by = -(hx + f) + \sqrt{(h^2 - ab)x^2 + 2(hf - bg)x + (f^2 - bc)}$$

$$by = -(hx + f) - \sqrt{(h^2 - ab)x^2 + 2(hf - bg)x + (f^2 - bc)}$$

But the present case is distinguishable from the case of the conic, inasmuch as we have here one of the solutions irrelevant, while, in the case of the conic, both the solutions are relevant, the compound solution being reproduced by multiplying together the resolved solutions.

III.—On Poisson's Integral.

By ASUTOSH MUKHOPADHYAY, M. A., F. R. A. S., F. R. S. E.

[Received January 16th ;—Read February 1st, 1888.]

Contents..

- §. 1. Introduction.
- §. 2. Transformations of the integral.
- §. 3. Symbolic value for  $\pi$ .
- §. 4. Geometric interpretation.

§. 1. Introduction.

The definite integral

$$\int_0^\pi \frac{\sin^{2n} x \, dx}{(1 - 2a \cos x + a^2)^n} \dots\dots\dots (1)$$

has been often discussed by mathematicians; it seems to have been first considered by Poisson in his memoir *Suite du Memoire sur les Integrales Definies* published in the *Journal de l'Ecole Polytechnique* (1815), t. X, Cah. XVII, p. 614. Poisson first attacks the more general integral

$$y = \int_0^\pi \frac{\sin^p x \, dx}{(1 - 2a \cos x + a^2)^n} \dots\dots\dots (2)$$

Differentiating with regard to  $a$ , and integrating by parts, he obtains the differential equation

$$(1 - a^2) \frac{d^2y}{da^2} + \left\{ \frac{p+1}{a} - a(4n+1-p) \right\} \frac{dy}{da} - 2n(2n-p)y = 0,$$

which is satisfied by the value of the definite integral in question. As an integrable case of this equation, Poisson makes the coefficient of  $y$  nugatory, by putting  $p=2n$ ; so that the integral (2) assumes the form (1), while the subsidiary differential equation becomes

$$\frac{d^2y}{da^2} + \frac{2n+1}{a} \frac{dy}{da} = 0,$$

the solution of which is

$$y = c_1 + c_2 a^{-2n}.$$

Poisson next proves that by virtue of the general nature of the integral expression, we must have  $c_2 = 0$ , while, by making  $a = 0$ , it easily follows that

$$c_1 = \int_0^\pi \sin^{2n} x \, dx.$$

Hence, it is finally shewn that

$$\int_0^\pi \frac{\sin^{2n} x \, dx}{(1 - 2a \cos x + a^2)^n} = \int_0^\pi \sin^{2n} x \, dx \dots\dots\dots (3)$$



As the value of the right hand side is well-known, calling  $J$  the value of the definite integral in question, it assumes the compact form

$$J = \frac{\pi}{2^{2n}} \cdot \frac{(2n)!}{\{n!\}^2} \dots\dots\dots (4)$$

This result holds so long as  $a < 1$ ; when  $a > 1$ , we at once infer from (3) that the result in (4) is to be divided by  $a^{2n}$ .

I now propose to obtain a formula of transformation for the more general integral (2); this method has also the advantage of shewing how the indefinite integral itself may be evaluated. Some other integrals which I have arrived at, and which are numbered (6), (7), (9), (10), I have never met with before; they are, I believe, new.

§. 2. *Transformations of the Integral.*

Consider the general indefinite integral

$$I = \int \frac{\sin^p x \, dx}{(1 - 2a \cos x + a^2)^n}$$

By putting

$$P = 1 + a^2, \\ Q = -2a,$$

this reduces to

$$I = \int \frac{\sin^p x \, dx}{(P + Q \cos x)^n}$$

Now

$$\begin{aligned} & \frac{\sin^p x \, dx}{(P + Q \cos x)^n} \\ &= \frac{2^p \left(\sin \frac{x}{2}\right)^p \left(\cos \frac{x}{2}\right)^p dx}{\left(A \cos^2 \frac{x}{2} + B \sin^2 \frac{x}{2}\right)^n}, \quad \left\{ \begin{array}{l} \text{where} \\ A = P + Q = (1 - a)^2 \\ B = P - Q = (1 + a)^2. \end{array} \right. \\ &= \frac{2^p \left(\sin \frac{x}{2}\right)^p \left(\cos \frac{x}{2}\right)^{p-2n} dx}{\left(A + B \tan^2 \frac{x}{2}\right)^n} \\ &= \frac{2^p \left(\tan \frac{x}{2}\right)^p \left(1 + \tan^2 \frac{x}{2}\right)^{n-p} dx}{\left(A + B \tan^2 \frac{x}{2}\right)^n} \end{aligned}$$

Substituting

$$\tan \frac{x}{2} = \sqrt{\frac{A}{B}} \tan \phi,$$

and 
$$\frac{1}{2} \left( 1 + \tan^2 \frac{x}{2} \right) dx = \sqrt{\frac{A}{B}} (1 + \tan^2 \phi) d\phi,$$

in this last expression, and reducing, we get

$$I = \frac{2}{(1 - a^2)^{2n - p - 1}} \int \frac{(\sin 2\phi)^p d\phi}{(1 - 2a \cos 2\phi + a^2)^{1 + p - n}}.$$

Hence, by putting

$$\begin{aligned} -\cos 2\phi &= \cos y = -\cos(\pi - y), \\ 2 \sin 2\phi d\phi &= -\sin y dy, \\ 2d\phi &= -dy, \end{aligned}$$

this easily reduces to

$$I = -\frac{1}{(1 - a^2)^{2n - p - 1}} \int \frac{\sin^p y dy}{(1 - 2a \cos y + a^2)^{1 + p - n}}.$$

We see, therefore, that, by the substitutions given above, the indefinite integral is transformed into another in which the power of the denominator is depressed, provided that

$$n > \frac{1}{2} (p + 1).$$

To obtain the definite integral, we have only to ascertain the new limits; and it is easy to see that, for

$$\begin{aligned} x &= \pi, \\ x &= 0, \end{aligned}$$

we have

$$\begin{aligned} \phi &= \frac{\pi}{2}, \\ \phi &= 0; \end{aligned}$$

and for these values of  $\phi$  we get

$$\begin{aligned} y &= 0, \\ y &= \pi. \end{aligned}$$

Hence, finally, we have the transformation formula

$$\int_0^\pi \frac{\sin^p x dx}{(1 - 2a \cos x + a^2)^n} = \frac{1}{(1 - a^2)^{2n - p - 1}} \int_0^\pi \frac{\sin^p x dx}{(1 - 2a \cos x + a^2)^{1 + p - n}}$$

This result holds if  $a < 1$ ; when  $a > 1$ ,  $(1 - a^2)$  must be replaced by  $(a^2 - 1)$ , as is sufficiently obvious from the above transformation. Poisson characterized the above relation as a "*rapport remarquable*"\*; his demonstration is based on the fundamental differential equation quoted above, and any one who has honestly attempted to master his proof must confess it to be abstruse.

In the particular case when  $p = 2n$ , we get

$$\int_0^\pi \frac{\sin^{2n} x dx}{(1 - 2a \cos x + a^2)^{n+1}} = \frac{1}{1 - a^2} \int_0^\pi \frac{\sin^{2n} x dx}{(1 - 2a \cos x + a^2)^n} \dots \quad (6)$$

\* *Loc. cit.* p. 626.

As the power of the denominator on the right hand side is by one less than that on the sinister, this obviously serves as a formula of reduction, and it at once follows from (4) that

$$\int_0^\pi \frac{\sin^{2n} x \, dx}{(1 - 2a \cos x + a^2)^{n+1}} = \frac{\pi}{2^{2n} (1 - a^2)} \frac{(2n)!}{\{n!\}^2} \dots \quad (7)$$

This formula may be regarded as supplementary to equation (38) in *Bertrand's Calcul.*, t. II, 153. Putting  $n = 0$  in (6), we have the well-known result

$$\int_0^\pi \frac{dx}{1 - 2a \cos x + a^2} = \frac{\pi}{1 - a^2} \dots \dots \dots \quad (8)$$

which might also have been obtained by putting  $n = 0$  in (7)

Again, if we substitute  $n = 0$  in (5), we have

$$\int_0^\pi \frac{\sin^p x \, dx}{(1 - 2a \cos x + a^2)^{p+1}} = \frac{1}{(1 - a^2)^{p+1}} \int_0^\pi \sin^p x \, dx.$$

The value of the right hand side depends on the form of  $p$ . If  $p = 2r$ , we get

$$\int_0^\pi \frac{\sin^{2r} x \, dx}{(1 - 2a \cos x + a^2)^{2r+1}} = \frac{\pi}{2^{2r} (1 - a^2)^{2r+1}} \frac{(2r)!}{\{r!\}^2} \dots \quad (9)$$

If  $p = 2r + 1$ , we get

$$\int_0^\pi \frac{\sin^{2r+1} x \, dx}{(1 - 2a \cos x + a^2)^{2(r+1)}} = \frac{2^{2r+1}}{(1 - a^2)^{2(r+1)}} \frac{\{r!\}^2}{(2r+1)!} \dots \quad (10)$$

§. 3. Symbolic value for  $\pi$ .

We shall now give a symbolic value for  $\pi$ , to which we are easily led by the integral

$$\int_0^\pi \frac{x \sin x \, dx}{1 + \cos^2 x} = \frac{\pi^2}{4}$$

which is also considered by Poisson.\* Poisson has effected the evaluation of this by expanding, and integrating each term separately; the substance of his process is well reproduced by Bertrand (t. II, 150). It is easy to see that this may also be integrated by parts, since

$$\begin{aligned} \int_0^\pi \frac{x \sin x \, dx}{1 + \cos^2 x} &= - \int_0^\pi x \, d \{ \tan^{-1} \cos x \} \\ &= - \{ x \tan^{-1} (\cos x) \}_{x=0}^{x=\pi} + \int_0^\pi \tan^{-1} (\cos x) \, dx = \frac{\pi^2}{4} \end{aligned}$$

\* *Loc. cit.*, p. 623.

Now consider the general integral

$$u = \int_0^\pi \frac{\cos 2nx \, dx}{1 + \cos^2 x},$$

which gives

$$\frac{du}{dn} = -2 \int_0^\pi \frac{x \sin 2nx \, dx}{1 + \cos^2 x}.$$

Hence

$$\left(\frac{du}{dn}\right)_{n=\frac{1}{2}} = -2 \int_0^\pi \frac{x \sin x \, dx}{1 + \cos^2 x} = -\frac{\pi^2}{2}.$$

Again,

$$\frac{1}{1 + \cos^2 x} = 1 - \cos^2 x + \cos^4 x - \&c.$$

Therefore, the  $(r+1)^{\text{th}}$  term of  $u$  may be written in the form

$$(-1)^r \int_0^\pi \cos 2nx \cos^{2r} x \, dx,$$

which at once leads to the symbolic relation

$$\left[\frac{d}{dn} \left\{ \sum_{r=0}^\infty (-1)^r \int_0^\pi \cos 2nx \cos^{2r} x \, dx \right\}\right]_{n=\frac{1}{2}} = -\frac{\pi^2}{2}.$$

§. 4. Geometric Interpretation.

It is interesting to remark that the analytical transformation in Poisson's remarkable relation (5) easily admits of an elegant geometrical interpretation from well-known properties of the ellipse.

Consider the semi-ellipse APA', of which S is a focus, and C the centre; AQA' is the semi-circle described on AA' as diameter; take any point P on the ellipse, join PS, draw PM at right angles to AA', meeting the circle at Q, and join QC. Let the angles

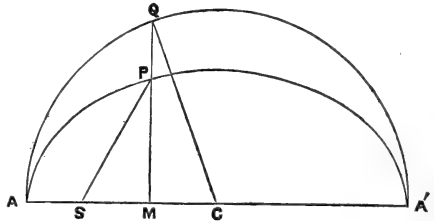

ASP and ACQ be represented by  $\theta$  and  $u$ , respectively; then, as usual in the theory of elliptic motion, we have the famous relation between the true and eccentric anomalies, viz.,

$$\cos \theta = \frac{\cos u - e}{1 - e \cos u}, \dots\dots\dots (11)$$

whence

$$\sin \theta = \sqrt{1 - e^2} \frac{\sin u}{1 - e \cos u}, \dots\dots\dots (12)$$

$$\tan \frac{\theta}{2} = \sqrt{\frac{1+e}{1-e}} \cdot \tan \frac{u}{2}.$$

Taking the logarithmic differential, we have

$$\frac{d\theta}{\sin \theta} = \frac{du}{\sin u} \dots\dots\dots (13)$$

Therefore

$$\left(\frac{\sin u}{\sin \theta}\right)^n d\theta = \left(\frac{\sin u}{\sin \theta}\right)^{n-1} du$$

or 
$$\left(\frac{1-e \cos u}{\sqrt{1-e^2}}\right)^n d\theta = \left(\frac{1-e \cos u}{\sqrt{1-e^2}}\right)^{n-1} du$$

or 
$$\left(\frac{\sqrt{1-e^2}}{1+e \cos \theta}\right)^n d\theta = \left(\frac{1-e \cos u}{\sqrt{1-e^2}}\right)^{n-1} du \dots\dots (14)$$

whence

$$\int \frac{d\theta}{(1+e \cos \theta)^n} = \frac{1}{(1-e^2)^{n-\frac{1}{2}}} \int (1-e \cos u)^{n-1} du.$$

Again, since from (14) we have

$$\frac{d\theta}{(1+e \cos \theta)^n} = \frac{1}{(1-e^2)^{n-\frac{1}{2}}} (1-e \cos u)^{n-1} du,$$

we have from (12),

$$\int \frac{\sin^p \theta d\theta}{(1+e \cos \theta)^n} = \frac{1}{(\sqrt{1-e^2})^{2n-p-1}} \int \frac{\sin^p u du}{(1-e \cos u)^{p-n+1}}$$

which is really equivalent to Poisson's transformation; and it is clear from (12) that for  $\theta = \pi, \theta = 0$ , we have  $u = \pi, u = 0$ . Thus, putting

$$e = \frac{-2a}{1+a^2},$$

$$1-e^2 = \left(\frac{1-a^2}{1+a^2}\right)^2,$$

we have

$$\int_0^\pi \frac{\sin^p \theta d\theta}{(1-2a \cos \theta + a^2)^n} = \frac{1}{(1-a^2)^{2n-p-1}} \int_0^\pi \frac{\sin^p u du}{(1+2a \cos u + a^2)^{p-n+1}}$$

or putting

$$u = \pi - x$$

this may be at once written

$$\int_0^\pi \frac{\sin^p x dx}{(1-2a \cos x + a^2)^n} = \frac{1}{(1-a^2)^{2n-p-1}} \int_0^\pi \frac{\sin^p x dx}{(1-2a \cos x + a^2)^{p-n+1}}$$

as the variable is of no consequence in a definite integral.

Another interesting definite integral may also be obtained from the formulæ given above, viz., we have from (11)

$$e + \cos \theta = \frac{(1 - e^2) \cos u}{1 - e \cos u},$$

whence from (13)

$$\frac{d\theta}{(e + \cos \theta)^n} = \sqrt{1 - e^2} \cdot \frac{(1 - e \cos u)^{n-1}}{(1 - e^2)^n \cos^n u} du.$$

Therefore, putting

$$e = \cos \alpha,$$

we have the relation

$$\int_0^\pi \frac{d\theta}{(\cos \alpha + \cos \theta)^n} = (\operatorname{cosec} \alpha)^{2n-1} \int_0^\pi \frac{(1 - \cos \alpha \cos \theta)^{n-1}}{\cos^n \theta} d\theta. \dots (15)$$

IV.—On the Nature of the Toxic Principle of the Aroidæ—By A. PEDLER, F. C. S. (Lond. & Berl.), Professor of Chemistry, Presidency College, Calcutta, and C. J. H. WARDEN, F. C. S. (Lond. & Berl.), Professor of Chemistry, Medical College, Calcutta.

In the annual report on the Chemical Examiner's Department, Bengal, for 1886, submitted to Government on the 18th February 1887, we gave a brief *resumé* of our investigations on Bish Kachoo, a variety of Arum. We pointed out that the toxic effects of Kachoo were due to purely mechanical causes, and that we were unable to isolate any specific organic poisonous principle from the tubers. In the present communication, we propose giving a detailed account of our investigations, together with an epitome of the most important points connected with the genus Arum.

Watt\* describes the Arums as a genus of herbaceous plants, with tuberous corms often edible, belonging to the natural order of Aroidæ. The genus comprises some twenty species, inhabitants of Europe, the Mediterranean region, and Tropical Asia, and extending from India to Afghánistan.

Botanically, the *leaves* are sagittate or hastate, base of petiole sheathing. *Peduncles* most frequently solitary, short or long. *Spathetube* convolute: *blade* when opened out ovate or ovate-lanceolate: *spadix* sessile, shorter than the *spathe*, appendix naked, frequently stalked and cylindrical, rarely clavate. *Inflorescence* monœcious, *perianth* none. *Female flowers* below forming a cylindrical mass, separated from the

male by a tuft of hair-like neuter flowers, which blend above into the male condition. *Stamens* 3—4: *anthers* sessile, opposite or sub-opposite, obovoid, dehiscing by a slit towards the apex, *connective* more or less prolonged: *pollen* vermiform. *Ovary* oblong-obtuse, 1-locular; *stigma* sessile: *ovules* 6 or many, orthotropous, erect: *funiculus* short: *placenta* parietal 2—3-seriate: *micropyle* superior. *Fruit* an obovoid many-seeded berry.

The following account of the species found in India we have abstracted chiefly from Roxburgh's *Flora Indica*, Watt's *Dictionary of the Economic Products of India*, Dymock's *Vegetable Materia Medica of Western India*, and O'Shaughnessy's *Bengal Dispensatory*.

*A. campanulatum*, Syn. for *Amorphophallus campanalatus*, has a tuberous root, which, when peeled and cut into segments, is sold in Bombay under the name of Madan-mash. The segments are usually threaded upon a string, and are about as large as those of an orange, of a reddish brown colour, shrunken and wrinkled, brittle in dry weather; the surface is mammillated. When soaked in water, they swell up and become very soft and friable, developing a sickly smell. The tubers contain a large quantity of farinaceous matter mixed, according to Baden-Powell, with a poisonous juice which may be extracted by washing or heat. The fresh tubers produce intense itching of the tongue when tasted, and when used as food they are often first boiled with tamarind leaves and paddy husks to remove this irritating property. The dried tubers—Madan-mash—have a mucilaginous taste, and are faintly bitter and acrid. Under cultivation the plant loses much of its acidity. It is largely used as a vegetable, and has a reputation as a remedy for piles. It is also used externally in the form of a poultice for insect bites, and as a stimulating application. In Bengal the tubers are known under the name of *ol*.

*A. lyratum*, Syn. for *Amorphophallus lyratus*.

*A. colocasia*, Syn. for *Colocasia antiquorum*. This variety is known in most parts of India as Kachu. Roxburgh describes two cultivated and three wild varieties of this species; the cultivated being Goori Kachu and Asoo or early Kachu; and the wild, Kalla, or dark-coloured Kachu, found on the edges of ditches and other wet places, Char Kachu, found on dry ground chiefly by road sides, or on dung heaps and among rubbish, and Ban-Kachu in situation and form very like the last mentioned variety. The tubers of the cultivated varieties are used as food. Of the wild varieties the leaves and foot-stalks of the dark coloured Kachu are the parts chiefly eaten by the natives of Bengal; the other wild varieties are rarely eaten in Bengal when better vegetables are procurable.

*A. cucullatum*, Syn. for *Alocasia cucullata*.

*A. fornicatum*, Syn. for *Alocasia fornicata*, known as Bees Kuchoo about Calcutta—used medicinally.

*A. montana*, Syn. for *Alocasia montana*, is, according to Roxburgh, a native of the mountainous forests of the Northern Circars, where its root is said to be employed to poison tigers.

*A. odorum*, Syn. for *Alocasia odora*.

*A. rapiforme*, Syn. for *Alocasia rapiformis*.

*Arum indicum*, Syn. for *Alocasia indica*, known in Bengal as Man-Kuchoo. In Bengal, it is much cultivated about the huts of the natives for its esculent stems and small pendulous bulbs or tubers, these being very generally eaten by people of all ranks in their curries; as a medicine, it is stated to be useful in anasarca, and also in piles and habitual constipation. In using the plant, the tough portions should be rejected, and the stems and root-stalks boiled and the water thrown away, otherwise they are likely to irritate the throat and palate.

*A. curvatum*, Syn. for *Arisæma curvatum*, is stated to have poisonous properties. In Kúlú, the seeds are said to be given with salt for colic in sheep.

*A. cuspidatum*, Syn. for *Arisæma cuspidatum*.

*A. speciosum*, Syn. for *Arisæma speciosum*. In Hazára the root is stated to be poisonous. In Chumba it is applied pounded to snake bites. In Kúlú, where the root is given to sheep for colic, the fruit is said to have deleterious effects on the mouth when eaten by children.

*A. tortuosum*, Syn. for *Arisæma tortuosum*, found in Chumba and also eastward to Nepal. The root of the plant is used to kill the worms which infest cattle in the rains.

*A. divaricatum*, Syn. for *Typhonium divaricatum*.

*A. flagelliforme*, Syn. for *Typhonium cuspidatum*.

*A. gracile*, Syn. for *Typhonium gracile*.

*A. orixense*, Syn. for *Typhonium trilobatum*. The roots when fresh are stated by Roxburgh to be exceedingly acrid, more so than *A. dracunculus* or *maculatum*. The natives apply them in cataplasms to discuss or bring forward scirrhus tumours. They also apply them externally to the bite of venomous snakes, at the same time giving internally a piece about the size of a field bean.

*A. margaretiferum*, Syn. for *Plesmonium margaretiferum*.

*A. sessiliflorum*, Syn. for *Sauromatum sessiliflorum*. The tubers are as large as small potatoes, they are very acrid and poisonous, and are only used externally as a stimulating poultice by natives. The *loth* of Dymock's *Materia Medica*.

*A. silvaticum*, Syn. for *Synantheris silvatica*. According to Dymock



the country people use the crushed seed to cure toothache; it benumbs the nerve; also used as an external application to bruises on account of its benumbing effect. The taste is intensely acrid; after a few seconds it causes a most painful burning of the tongue and lips, which lasts for a long time, causing much salivation and subsequent numbness. A section of the fruit and seed show the following structures from without inwards, 1st, several rows of thick-walled cells having yellowish brown granular contents, 2nd, a parenchyma composed of thin-walled cells having no solid contents except needle-shaped crystals, 3rd, several rows of small cells containing chlorophyll, 4th, a delicate parenchyma, the cells of which are loaded with very small starch granules, mostly round, some truncated.

*A. viviparum*, Syn. for *Remusatia vivipara*.

From the brief *resumé* we have given of the Arums found in India, it will be noticed that a belief in the toxic properties of certain species appears to be pretty generally entertained. In England, *A. maculatum* is the best known species. W. Murrell, M. D.\* gives an interesting account of this variety, from which we abstract the following:—

“This plant,” Dr. Murrell writes, “has several popular names, the best known being “lords and ladies,” “cows and calves,” “the parson in the pulpit,” “wake robin,” and “cuckoo-pint.” In former times it was also known as “aron,” “janus,” “barba aron,” “calve’s foot,” “ramp,” “starch wort,” “cuckow-pintle.” The word arum is probably a corruption of “aron” a word of Egyptian origin. Pliny calls it both *aris* and *aron*.

“The plant, although somewhat rare in Scotland, is common enough all over England, and abounds in moist hedgerows and shady woods, usually flowering in May. The root, washed and dried, forms the *salep* of the older cookery books, and under the name of “Portland sago” was formerly used for adulterating arrowroot.

“It appears to have been highly esteemed by the older writers on medicine: it was used both externally and internally, and was considered invaluable in stimulating digestion and improving the circulation. Culpepper says, “a drachm of the powder of the dried root taken with twice as much sugar in the form of a licking electuary, or the green root, doth wonderfully help those that are pury and short-winded, as also those that have a cough: it breaketh, digesteth, and riddeth away phlegm from the stomach, chest, and lungs; the milk wherein the root hath been boiled is effectual also for the same purpose . . . Taken with sheep’s milk, it healeth the inward ulcers of the bowels: the distilled water thereof is effectual to all the purposes

\* British Med. Journ., May 7th, 1881.

aforesaid. A spoonful taken at a time healeth the itch: and an ounce or more taken at a time for some days together doth help the rupture." It was the active ingredient in the vaunted "Portland Powder," a so-called specific for gout. It is still occasionally sold in Paris as a cosmetic under the name of *Poudre de Cypre*. The London Pharmacopœia of 1788 orders a conserve in the proportion of half a pound of the fresh root to a pound and a half of double refined sugar, beat together in a mortar. The dose is a drachm for adults, and it is a good form for the exhibition of the medicine."

Regarding the employment of *Arum* in modern medical practice, there is a note by Wm. Martindale in the British Medical Journal of June 4th, 1881, which is worth recording. Martindale states, "it having been shown (Pharm. Jour. 1880, p. 849) that the active drug in the nostrum tonga was, in all probability, part of the stem of a species of *Raphidophora*, belonging to the natural order, *Araceæ*, the arum-juice was tried by a medical friend, in a case of obstinate neuralgia which was relieved by tonga; but the latter to the patient was an expensive medicine. The succus in one drachm doses gave similar relief, I was informed; further than this I have not known it tried."

Cases in which toxic symptoms ensued after the ingestion of arum leaves and tubers are found scattered in many works on Medical Jurisprudence, and also in certain medical journals.

In Beck's Medical Jurisprudence, *A. typhillum* and *A. trilobatum* are mentioned as being natives of the United States. Beck remarks that they are all acrid and have produced dangerous effects. Orfila\* gave the fresh roots of *A. maculatum* to dogs, and found that they died at the end of 24 to 36 hours without any other symptoms than dejection: after death the digestive canal was found somewhat inflamed. Marzel† also investigated the physiological action of the fresh root on dogs, and found that it acted as a powerful irritant poison. Bulliard‡ relates the following case of three children who had eaten the leaves of *A. maculatum*. They were seized with horrible convulsions, and with two of them all assistance was unavailing, as they could not be made to swallow anything. One child died at the expiration of twelve days, and the second four days later. The third child was saved with difficulty: its tongue was greatly swelled, and hence deglutition was painful and difficult. Christison§ states, "I have known acute burning pain of the mouth " and throat, pain of the stomach and vomiting, colic, and some diarr-

\* Orfila's Toxicology, vol. ii, p. 83.

† Marzel, B. Med. Gaz. 1881, p. 720.

‡ Histoire des Plantes Vénéneuses de la France.

§ Christison on Poisons, p. 602.

“ hœa occasioned by eating two leaves. The genus possesses the same properties in other climates, the several species being classed among the most potent acrid poisons in their respective regions. The *A. sequinum* of the West Indies is so active, that two drachms of the juice have been known to prove fatal in a few hours. It is not a little remarkable that the acidity of the arum is lost not merely by drying, but likewise by distillation. I have observed that when the roots are distilled with a little water, neither the distilled water nor the residue possesses acidity. Reinsch says, he has eaten powder of arum root, which though not acrid to taste, produced severe burning of the throat not long after it was swallowed.” Guy and Ferrier\* state that “ the root of *A. maculatum* is somewhat heart-shaped, and like all other parts of the plant is highly acrid and irritating. The juice applied to the tongue causes acute darting pain as if it were pierced with sharp needles. The poisonous properties of the plant are wholly dissipated by heat.” Woodman and Tidy† sum up the symptoms of poisoning by *A. maculatum* as follows, “ Great local irritation, swelling of the tongue, convulsions, dilated pupils, insensibility and coma”. Woodman and Tidy also refer to several cases of poisoning by *A. maculatum*, of which we abstract the following. Dr. Russell Stube‡ records a case in which a male æt. 43 took one leaf as a remedy for tape-worm. The symptoms were immediate pain and pricking sensation in the mouth downwards: the tongue became swollen: salivation and vomiting. The patient recovered. Dr. Frayer§ reports a case of a male child æt. 6 who was found in a kind of fit, with spasmodic action of all the muscles of the body, bloody froth at the mouth, pupils dilated, heart’s action very feeble, rigid closure of the jaw. A certain drowsiness succeeded. Recovery ensued. A second case is also reported by Dr. Frayer|| of a male child æt. 8, in which the symptoms were convulsions and widely dilated pupils. Recovery ensued. Dr. Frayer¶ quotes a case of a child æt. 3 who masticated the roots; the symptoms were immediate burning pain in the mouth and lips, torpor in three hours, followed by complete prostration in six hours with delirium and asphyxia, and death in nine hours. Another fatal case is recorded in the *Medical Times and Gazette* for June 6th, 1857, in which death ensued from eating the leaves. Dr. Alliot\*\* gives the following account of a

\* Forensic Medicine

† A Handy Book of Forensic Medicine and Toxicology.

‡ “Lancet” April 13th, 1872.

§ British Med. Journal, Jan. 22nd, 1861.

|| Ibid: June 22nd 1861.

¶ Ibid: June 22nd 1861. Quoted from *Gazette Medica di Porto*.

\*\* British Med. Journal, April 23rd, 1881.

fatal case ; he states that on "Saturday, April 6th, I was called at 6:35 P. M. to attend a girl 4 years old. I attended at 7.15 A. M. and found her dead : the skin mottled all over, *rigor mortis* setting in and the body nearly cold. The history was that she came in from play at 3:30 P. M. on Friday, complaining of being tired. Her mother laid her down and she slept at once, at 5:30 she awoke and took some milk and tea : immediately she vomited some thin milky substance and went to bed, when she slept somewhat restlessly until 10:30 P. M. when she awoke with vomiting and severe purging : this continued with pain until 5 A. M. when she had a slight convulsion, and died at 5:30 A. M. A *post-mortem* examination was made 30 hours after death. *Rigor mortis* had nearly passed off. All the organs were healthy and normal, except that the bases of both lungs were congested. The heart was empty in both ventricles and firmly contracted. The stomach and small intestines were thickly coated with a creamy lining of mucus, with bile : no blood. The stomach further contained half an inch of the fatal leaf : there was also found about as much in one of the stools, and probably more was passed. This with the firmly contracted heart constituted the chief confirmatory evidence of the irritant nature of the poison which caused death."—Chevers,\* quoting from a note by Dr. H. Cleghorn, states, "There are several species of arum requiring examination, of a suspicious, if not of a poisonous nature. On one occasion five Mysore villagers were poisoned by partaking of the acrid rhizomes of an arum, imperfect specimens of which I sent to Dr. Wright for identification, but he could not distinguish the species. If the roots had been boiled, the fatal results would not have occurred, as is well-known, the deleterious property is easily driven off by heat." Dr. Chevers refers to two other cases, one in which a man obtained from a drug dealer a remedy for gonorrhœa, which appeared to have been a root of one of the *Aroidæ* ; fatal results ensued.

In 1886 the Civil Surgeon of Dibrugarh forwarded to the Chemical Examiner, Bengal, some portions of raw Bish Kachu tubers and leaves with the following statement. "A cooly woman administered some of the fried Kachu to another sick cooly on the same garden, but the man experiencing a burning sensation in his mouth instantly spat it out. A pig ate what was so thrown away and died in an hour. A second pig was experimented on with some of the same stuff, and fatal results also supervened." During the course of the same year a second case of poisoning by Kachu was referred to the Chemical Examiner's Department ; in this case slices of Kachu tubers were introduced into a jar containing "goor." The symptoms induced were sufficiently urgent to

\* A Manual of Medical Jurisprudence for India.

necessitate admission of the person into the Medical College Hospital ; the stomach-pump was used as the symptoms were those of irritant poisoning. Recovery ensued.

The European *A. maculatum* has been analyzed by Bucholy and Enz, and the American variety by D. S. Jones. According to the editors of the National Dispensatory, Jones proved the presence of starch, sugar, gum, albumen, resin, fat, and extractives, besides the volatile acrid principle, which is soluble in ether. Enz in 1858 obtained also saponin, "while Bird believes that a volatile alkaloid may be present."

The tubers employed by us in our experiments were kindly supplied by the Civil Surgeon of Dibrugarh, and were of the variety known locally as Bish Kachu and similar to those used in the case which he had referred to the Chemical Examiner. We made over a tuber to Dr. King, F. R. S., Superintendent of the Royal Botanic Gardens, Calcutta, for identification. Dr. King informs us that it is most probably a species of *Alocasia* or *Colocasia*. But the leaves of the species of these genera are so much alike that it is impossible to identify them without flowers.

In our experiments the tubers were first peeled ; during this operation, considerable irritation was experienced about the hands, but there was a complete absence of any irritative action on the olfactory organs or conjunctivæ. This fact appeared to us to point towards the non-volatile nature of the active principle. In a preliminary experiment we tried the effect of an injection of a portion of a tuber into a cat's stomach ; 8 grammes of a peeled and fresh tuber were rubbed down with about 15 c. c. of water and the mixture strained through muslin. The turbid fluid thus obtained was injected into a small healthy cat's stomach at 1.8 P. M. ; at 1.22 P. M. the cat was a little restless, but this soon passed off, and, as far as we were able to ascertain, no ill-effects subsequently ensued as a result of the injection. There was no question about the activity of the sample used in this experiment, because a minute fragment applied to the tip of the tongue caused in a very short time acute lancinating pain, which continued for a considerable period.

In order to obtain an alcoholic extract, the peeled and sliced tubers were strung on wire and exposed to the air to dry. The dried slices were then easily reduced to powder. The powder was packed in a percolator, and exhausted with hot 60 O. P. alcohol. The alcohol having been driven off by the heat of a water-bath, the viscid extract remaining was examined as follows. A portion was mixed with bread and given to a mouse without any effect. A large portion of the extract was treated by Stas's process for the extraction of alkaloids, and the ethereal extract given to a mouse with negative results. In these experiments we observed that, while the fresh tubers caused a marked physiological action when

applied to the mucous membrane of the lips or tongue, the dried tubers were practically inert. The alcoholic extract, as well as the extract obtained by Stas's process, were without the least action on the tongue. We also tried the effect of an extract obtained by cold alcohol, and in which the alcohol had been driven off by spontaneous evaporation, on a mouse without producing any symptoms. This extract was also without physiological action on the tongue. A glycerin and an ethereal extract, prepared by macerating the fresh tubers in the cold with those menstrua, also yielded negative results.

We now tried the effect of distilling the fresh tubers with water. The distillate had no acrid taste: it contained only traces of hydrocyanic acid. The symptoms produced by the introduction of the commoner varieties of arum tubers into the stomach cannot be explained by the presence of hydrocyanic acid. The production of hydrocyanic acid on the distillation of organic vegetable matter with water is by no means rare: ordinary linseed meal indeed yields traces of that acid on distillation with water. It is possible, however, that certain varieties of arum may contain a large amount of prussic acid, as for example the *A. seguinum* of the West Indies, which is stated to furnish a juice, two drachms of which has proved fatal in a few hours.\* The tubers left in the retort after distillation with water were still physiologically active, indicating that the active principle was not dissipated by mere boiling with water. Natives in using arum for culinary purposes frequently add an acid vegetable, or fruit, such as tamarind. We tried the action of certain acids on the fresh tubers, and ascertained that boiling with water acidulated with hydrochloric acid for a very short period rendered the tubers quite inert, when a fragment was applied to the tongue. Dilute nitric acid also acted in a similar manner. The action of acetic acid on the other hand was very much feebler, and the acid had to be stronger in order to produce any decided diminution in activity. So far, our experiments had been in the highest degree unsatisfactory; as far as we were able to judge from the evidence at our disposal, there could be no reason to doubt that the arums as a family did contain a principle capable of inducing toxic symptoms when introduced into the system. Most of the works we had consulted ascribed the poisonous effects to a volatile principle. Our experiments indicated that, while drying the tubers without artificial heat deprived them practically of all activity, exposing them to the temperature of boiling water for at least half an hour at the most only very slightly diminished their activity. As far as we were aware, there was no toxic principle known which exhibited similar reactions with reagents. We again tried the effect of the fresh tubers

\* Woodman and Tidy's "Forensic Medicine."

and leaves (which we also proved to be highly active when applied to the tongue) on a pig, a rabbit, and a guinea-pig, but with negative results. Although we took the precaution to starve these animals before giving them the leaves and tubers, there is a considerable doubt in our minds whether the rabbit and guinea-pig ever ate any of the arum; the pig certainly did eat a small portion of a leaf, but, although it must have been very hungry, it refused a mess of chopped tubers, bran, and sugar. There is thus in these experiments some uncertainty. We were particularly anxious to try the effect of the fresh tubers on a pig, because we had the very circumstantial note from the Civil Surgeon of Dibrugarh, in which it is stated that two pigs had been killed by eating some of the same tubers as those with which we had experimented.

A rough analysis of the ash indicated the presence of a large amount of potassium and magnesium; calcium was also present, but we failed to obtain indications of sodium. The acids consisted of carbonic, phosphoric, and hydrochloric, with traces of sulphuric acid. We also obtained from the dried tubers very marked quantities of potassic nitrate, so that when they had been incinerated they behaved very like tinder, containing salt-petre. The examination of the ash thus failed to afford us any clue to the physiological action of the fresh tubers.

It now occurred to us that possibly the painful effects produced by arum when in contact with the tongue &c. might be due to mechanical causes. A microscopic examination of a section of a tuber revealed the presence of very numerous bundles of needle-shaped crystals; and we also found similar crystals in the leaves and stems. These crystals were seen under the microscope to be insoluble in cold acetic acid, but easily soluble in cold diluted nitric or hydrochloric acid. Caustic potash was without action. A tuber was boiled, and sections made when cold; on microscopic examination crystalline bundles were still visible. The presence of raphides in the cells of plants is well known; even in the arum they have been before observed. Dymock mentions needle-shaped crystals in the parenchyma of the *A. sylvaticum*; and in the nettle tribe stalked crystaloliths have been described suspended in the cells. But, as far as we are aware, the significance of these needle-shaped crystals in the arum has not hitherto been recognized. There appears to us to be no reason to doubt the fact, that the whole of the physiological symptoms caused by arums are due to these needle-shaped crystals of oxalate of lime, and that the symptoms are thus due to purely mechanical causes. Bearing in mind the action of reagents on calcic oxalate, the reason why mere boiling the tubers in water failed to deprive them of their activity is explained by the insolubility of oxalate of lime in water. Again, the action of dilute acetic acid, even at a temperature of 100° C., in slightly

lessening the activity of the tubers is due to the very slight solubility of oxalate of lime in that acid. And, lastly, the complete loss of all physiological action when the tubers were treated with dilute nitric or hydrochloric acid is evidently due to the ready solubility of calcic oxalate in those mineral acids. And these assumptions, as we have already indicated, were fully demonstrated by the microscopic examination of sections of the tubers treated with the reagents we have mentioned. One point, however, remains to be explained. We observed that, on drying, the tubers lost practically the whole of their physiological activity. Clearly there could have been no loss of oxalate of lime on desiccation, and as a matter of fact we found as many crystals on microscopic examination of dried arum as we had found in the fresh tubers. We explain this apparent anomaly in the following simple manner. In the fresh condition of the tubers, the bundles of crystals of oxalate of lime are cone-shaped, more or less, the sharp points covering a wide area, and forming the base, but, in the drying of the tubers, the needles appear to arrange themselves more or less parallel to one another, and the sharp points thus cover a smaller area. And thus, instead of each crystal acting as a separate source of irritation and penetrating the tissues, the bundles act as a whole. It is well-known that finely chopped hair when given with food will cause death by setting up uncontrollable diarrhœa. The hairs covering the legumes of the *Mucuna pruriens* (cowage) are described as straight, quadrangular prismatic, and sharply pointed at the apex, 3 mm. long, and thus easily penetrate the skin, causing intolerable itching, which is greatly increased by washing and rubbing. Cowage, as is well known, has long been used as a vermifuge, under the idea that its prickly setæ, which irritate the skin so severely and are so difficult to detach, wound and injure the worms, and either kill them or promote their expulsion.\* Apparently with a similar object *A. tortuosum* is used to kill worms which infest cattle during the rains. Lastly, we have an example of finely divided mineral matter causing local irritation, in the so-called hill diarrhœa at Dhurmsala, which is apparently produced by the use of water containing very fine scales of mica.†

The usual symptoms produced by arum when administered to the human subject are great local irritation, swelling of the tongue, convulsions, dilated pupils, insensibility, and coma.‡ With these symptoms it might be argued that a mechanical theory for the action of arum would be untenable. It might be conceded that local irritation of the mouth would be produced by arum; but objected that, directly the vegetable entered

\* National Dispensatory.

† Macnamara's 8th Report on Potable Waters in Bengal, Appendix, p. 44.

‡ Woodman and Tidy's Toxicology.



the stomach, it would be acted upon by the gastric juice containing free hydrochloric acid,—and that acid, as is well-known, is a ready solvent for calcic oxalate,—so that, before the vegetable matter containing the needle-shaped crystals could enter the intestine, it would have lost its mechanical irritative properties. In answer to this we would merely remark, that, when mechanical irritation of the stomach is carried beyond certain limits, so as to produce pain, the secretion of the gastric juice, instead of becoming more abundant, diminishes or ceases entirely, and a ropy mucus is poured out instead.\* And it also appears likely to us that the great irritation produced in the mouth would react upon the stomach; for, according to experiments by M. Blondlot, the quantity of the secretion seems to be influenced also by impressions made on the mouth.† We thus fail to see any reason why the arum tissues loaded with needle-shaped crystals should not enter the intestines. Once in the intestines, the mechanical effects of the crystals would be to induce convulsions, dilated pupils, and coma; all of which symptoms are often caused by the mechanical irritation of intestinal worms.

This theory of the mechanical action of the arums, which we advanced in 1886, has since, apparently, been independently adopted by Herr Ståhl, who, at a recent meeting of the Jena Naturalists' Society, read a paper on the significance of those excreta of plants which are known as raphides, and are so often met with in the cells in large quantity. From experiments this investigator inferred that they were a protection to plants against being eaten by animals. Many animals avoid plants with raphides, or eat them reluctantly; and some animals, *e. g.*, snail species, in eating plants that have raphides, select those parts that are without the crystals. Many plants held for poisonous, *e. g.*, *Arum maculatum*, owe their burning taste simply to the very numerous raphides, which, forced out of their cells, enter the tongue and palate. The juice obtained by filtration has quite a mild taste.‡

\* Kirke's Physiology.

† *Ibid.*

‡ "Nature," Dec. 29th, 1887.

---



the stomach, it would be acted upon by the gastric juice containing free hydrochloric acid,—and that acid, as is well-known, is a ready solvent for calcic oxalate,—so that, before the vegetable matter containing the needle-shaped crystals could enter the intestine, it would have lost its mechanical irritative properties. In answer to this we would merely remark, that, when mechanical irritation of the stomach is carried beyond certain limits, so as to produce pain, the secretion of the gastric juice, instead of becoming more abundant, diminishes or ceases entirely, and a ropy mucus is poured out instead.\* And it also appears likely to us that the great irritation produced in the mouth would react upon the stomach; for, according to experiments by M. Blondlot, the quantity of the secretion seems to be influenced also by impressions made on the mouth.† We thus fail to see any reason why the arum tissues loaded with needle-shaped crystals should not enter the intestines. Once in the intestines, the mechanical effects of the crystals would be to induce convulsions, dilated pupils, and coma; all of which symptoms are often caused by the mechanical irritation of intestinal worms.

This theory of the mechanical action of the arums, which we advanced in 1886, has since, apparently, been independently adopted by Herr Stähl, who, at a recent meeting of the Jena Naturalists' Society, read a paper on the significance of those excreta of plants which are known as raphides, and are so often met with in the cells in large quantity. From experiments, this investigator inferred that they were a protection to plants against being eaten by animals. Many animals avoid plants with raphides, or eat them reluctantly; and some animals, *e. g.*, snail species, in eating plants that have raphides, select those parts that are without the crystals. Many plants held for poisonous, *e. g.*, *Arum maculatum*, owe their burning taste simply to the very numerous raphides, which, forced out of their cells, enter the tongue and palate. The juice obtained by filtration has quite a mild taste.‡

\* Kirke's Physiology.

† *Ibid.*

‡ "Nature," Dec. 29th, 1887.

## V.—Notes on Indian RHYNCHOTA; HETEROPTERA, No. 4.

By E. T. ATKINSON, B. A.

[Received December 26th, 1887;—Read January 4th, 1888.]

## DIV. NEZARIA.

En. Hem. v, p. 63 (1876).

a. b. c. as in *Hoplistoderaria* (p. 66).d. as in *Catacantharia* (p. 70).

e. Entire feet, or at least the geniculæ, pale, flavescent or virescent, rarely pictured or sprinkled black: antennæ rarely to a very great part, black: rostrum never entirely black: membrane rarely blackish.

f. Body greenish, very rarely incarnate, above entirely densely, or very densely, punctured; punctures concolorous: membrane colourless: venter without a furrow, second segment spinose or very distinctly tuberculated, tubercle higher than the mesostethium which is not elevated: margins of pronotum neither levigate nor, unless at the very extremity of the lateral margins, very slightly reflexed: tibiæ above flattish or sulcated: dorsum of abdomen greenish, or, in dead specimens, flavescent, very rarely anteriorly black: anterior lateral margins of the pronotum, never, unless very narrowly, and then more broadly beneath than above, black.

## Genus ACROSTERNUM, Fieber.

Eur. Hem., p. 79, 331 (1861): Stål, En. Hem. v, p. 63, 90 (1876).

Broad, oval: head semioval, broadened at the eyes, without a black spot or small line beneath before the eyes at the antenniferous tubercles; frontal callus continued through, anteriorly narrower: eyes robust, ocelli large: jugular plates low, margined, anteriorly scarcely lobulate, as long as the base of the rostrum: pronotum transversely sexangular, flatly convex, margin slightly carinate, straight; corium exarcuate; venter rather densely and distinctly punctured, levigate in the middle.

## 225. ACROSTERNUM GRAMINEUM, Fabricius.

*Cimex gramineus*, Fabr., Mant. Ins. ii, p. 295 (1787); Ent. Syst. iv, p. 120 (1794); Syst. Rhyng, p. 175 (1803).

*Cimex seladonius*, Fabr., Ent. Syst. iv, p. 114 (1794); Syst. Rhyng. p. 170, (1803).

*Acrosternum gramineum*, Stål, Hem. Fabr. i, p. 31 (1868); En. Hem. v, p. 90 (1876).

♂, ♀. Body small, entirely green, immaculate; above a little more obscure, beneath a little paler (*C. gramineus*, Fabr.). Head flavescent, antennæ fuscous at the apex: pronotum virescent, anteriorly flavescent: scutellum flavescent, with a pair of white dots at the apex: hemelytra

virescent with a flavescent streak before the margin: wings white: body virescent (*C. seladonius*, Fabr.). Above yellow-virescent, beneath with antennæ and feet sordid yellow-whitish: second and third joints of antennæ subequal in length: scutellum with a small subcallous whitish spot on both sides, at the apex: extremity of the apical angles of the abdominal segments, black, somewhat acutely prominulous (*Stål*). Very closely allied to *A. incertum*, Sign., differing only in the points noticed. Long, 9; broad, 5 mill.

Reported from India: Utakamand and Calcutta.

#### Genus NEZARA, Am. & Serv.

Hist. Nat. Ins. Hém. p. 143 (1843); Stål, Hem. Afric. i, p. 82, 192 (1864); Ofvers. K. V.-A., Förh., p. 530 (1867); En. Hem. ii, p. 40 (1872); v, p. 63, 91 (1876). Includes *Rhaphigaster*, Dallas, pt. List Hem. B. M. i, p. 274 (1851); Walker, Cat. Het. B. M. ii, p. 356 (1867).

Body oval or obovate: head flat, ovate, rounded at the apex, lateral margins somewhat sinuated, lobe continued through in the middle: first joint of rostrum not extending posteriorly beyond the bucculæ, sometimes somewhat shorter than the bucculæ: first joint of the antennæ barely reaching the apex of the head: anterior lateral margins of the pronotum rarely very slightly reflexed or somewhat callous, anterior margin sinuated between the eyes, behind the eyes on both sides truncated, very rarely slightly callous in the middle: frena continued beyond the middle of the scutellum: mesostethium carinate: venter tuberculate or spinose at the base: head beneath, before the eyes at the antenniferous tubercle, marked by a black spot or small line: tibiæ above very often furrowed.

#### 226. NEZARA VIRIDULA, Linnæus.

*Pentatoma smaragdula*, Leon Dufour, Rech. p. 157 (1833).

*Nezara smaragdula*, Am. & Serv., Hist. Nat. Ins. Hém. p. 144 (1843); Fieber, Eur. Hem. p. 330 (1861).

*Rhaphigaster prasinus*, Dallas, List Hem. i, p. 274 (1851): excl. syn. Linn.

*Pentatoma (Nezara) smaragdula*, Guérin, Sagra Hist. Cuba, Ins. p. 373 (1857).

*Nezara prasina*, Muls. and Rey, Pun. Pent. p. 295 (1866): excl. syn. Linn.

*Nezara viridula*, Stål, Hem. Afric., i, p. 193 (1864); Hem. Fabr. i, p. 31 (1868); En. Hem. ii, p. 41 (1872); v, p. 91 (1876); Mayr, Reise Novara, p. 67 (1866); Dis-tant, A. M. N. H. (5 s.), p. 45 (1879); Biol. Cent. Am. Hem. p. 78 (1880): White, Ent. Mon. Mag. xiv, p. 276 (1879).

Var. *a.*;—*Cimex smaragdulus*, Fabr., Syst. Ent. p. 711 (1775); Spec. Ins. ii, p. 354 (1781); Mant. Ins. ii, p. 292 (1787); Ent. Syst. iv, p. 109 (1794); Syst. Rhyng. p. 167 (1803); Gmelin, ed. Syst. Nat., i (4), p. 2153 (1788); Wolff, Ic. Cim. ii, p. 56, t. 6, f. 53 (1801). Madeira, India.

*Cimex spirans*, Fabr., Ent. Syst. Suppt. p. 533 (1798): Syst. Rhyng. p. 167 (1803). West India Islands.

*Cimex viridissimus*, Wolff, l. c., p. 55, t. 6, f. 52 (1801). India.

*Pentatoma unicolor*, *subsericea*, *leei*, *tripunctigera*, *proxima*, *chinensis*, *chloris*, *chlorocephala*, *propinqua*, and *berylina* Westw., Hope, Cat. Hem. i, p. 38-39 (1837): from Java, India, Cape St. Vincent, Teneriffe, China, Sierra Leone, Brazil, and Puna respectively.

*Rhaphigaster smaragdulus*, Kolen., Mel. Ent. iv, p. 55 (1846).

*Pentatoma plicaticollis*, Lucas, Expl. Algér. Ins., p. 87; Hém., t. 3, f. 9 (1849). N. Africa.

*Rhaphigaster subsericeus*, Dallas, List. Hem. i, p. 275 (1851). N. Bengal.

Var. c. :—*Cimex torquatus*, Fabr., Syst. Ent. p. 711 (1775); Spec. Ins. ii, p. 353 (1781); Mant. Ins. ii, p. 291 (1787); Ent. Syst., iv, p. 108 (1794); Syst. Rhyng., p. 166 (1803); Gmelin, l. c., p. 2150 (1788).

*Pentatoma flavicollis* and *flavicornis*, Pal. Beauv., Ins. Hém., p. 185, t. 11, f. 4 (1805).

*Rhaphigaster torquatus*, Herr. Schöff., Wanz. Ins., iv, p. 100, t. 162, f. 447 (1839).

Var. b. :—*Cimex viridulus*, Linn., Syst. Nat., 10 ed., p. 444 (1758); Mus. Lud. Ulr. p. 172 (1764); Fabr., Syst. Ent. p. 710 (1775); Spec. Ins. ii, p. 354 (1781); Mant. Ins. ii, p. 291 (1787); Ent. Syst. iv, p. 109 (1794); Syst. Rhyng. p. 166 (1803); Gmelin, l. c., p. 2150 (1788).

*Cimex hemichloris*, Germar, Silb. Rev. v, p. 166 (1837).

*Rhaphigaster orbis*, Stål, Ofvers. K. V.-A. Förh., p. 221 (1853).

♂, ♀. Somewhat narrowly obovate; varying in colour; throughout densely punctured; with a very obtuse, broad, levigate, ventral ridge: third joint of the antennæ at the apex, and almost entire 4—5 joints, brunnescent: extremity of anterior lateral margins of the pronotum, also margin of venter, pale stramineous: extremity of apical angles of the segments of the abdomen and a minute spot or small lower line on head before the eyes, black (*Stål*). Long, 12—16; broad, 6—9 mill.

Var. a. :—First joint of antennæ green, fuscous at the apex; second fuscous, green at the base; third entirely fuscous: head rounded, entire, eyes testaceous: margin of pronotum flavescent: scutellum green with three very minute, yellow, basal dots; abdomen greenish, ventral line flavescent: feet virescent (*C. smaragdulus*, Fabr.). Above broadly greenish; scutellum immaculate, a little more obscure at the base: 3—4 joints of antennæ at apex and entire last joint, purple (*Wolff*, l. c.). Westwood's species vary chiefly in the coloration of the antennæ.

Var. b. :—Above green; head and margin of pronotum anteriorly, flavescent or sordid stramineous: antennæ variegated rufous and green (*C. torquatus*, Fabr.). Green: anterior half of head and thorax, three or five spots at the base of the scutellum, and the margin of the abdomen, yellow (*Herr. Schöff.*).

Var. c. :—Above sordid stramineous: two basal spots on the head,

three anterior spots on the pronotum, three anterior spots and apex of scutellum, also spot behind the middle on the hemelytra, virescent.

For the full synonymy of this remarkable cosmopolitan insect, reference may be made to Stål (E. H. ii, p. 41) or Distant (l. c.). It is found throughout North and Central America, and as far south as Cayenne, in all Europe, all Africa including the adjacent islands, Corea, Japan, China, India, the islands of the E. Archipelago, Australia, and New Zealand. The Indian Museum possesses specimens from almost all parts of India.

#### Div. HYLLARIA.

*a. b. c.* as in *Hoplístoderaria* (p. 66).

*d.* as in *Catacantharia* (p. 70).

*e.* as in *Nezaria* (p. 118).

*f.* Body varying in colour, sometimes entirely virescent and adorned with concolorous punctures, if so, the anterior and anterior lateral margins of the pronotum are levigate, elevated or callous, or the head not, unless very remotely and finely, punctured, or the mesostethium elevated and not lower than the basal tubercle of the venter, or the tibiæ obtusely rounded, or the venter furrowed, or the anterior lateral margins of the pronotum black: dorsum of abdomen rarely greenish, even in greenish species, generally croceous, rufescent or black.

*g.* Venter without a furrow: tibiæ above generally margined or furrowed: lateral angles of pronotum produced in a long, acuminate, spiniform process: head without black points arranged in several longitudinal rows.

#### Genus SABÆUS, Stål.

Ofvers. K. V.-A. Förh. p. 513 (1867); p. 632 (1870); En. Hem. v, p. 63, 92 (1876).

Body obovate: head moderately inclined, gradually narrowed forwards, slightly sinuate on each side before the eyes; tylus and juga of equal length; bucculæ continued through, slightly elevated; ocelli rather near the eyes; rostrum extended somewhat behind the last coxæ, first joint on a level with the bucculæ, second joint scarcely longer than the third; first joint of antennæ as long as, or barely extending beyond, the apex of the head, second joint shorter than third: pronotum moderately declined before the middle, anterior margin scarcely elevated, anterior lateral margins obtuse, basal margin straight, basal angles spinosely produced: scutellum moderate, somewhat narrow at the apex, frena extended somewhat beyond the middle of the scutellum: apical angle of corium rounded: mesostethium distinctly carinate; metaste-

thium not elevated: odoriferous apertures continued in a furrow that passes into a ridge: extremity of angles of abdominal segments prominulous; second ventral segment prominulous, in the middle at the base, in an obtuse tubercle: tibiæ rounded, above convex, only towards apex obsolete flattish or subsulcate (*Stål*).

#### 227. *SABÆUS SPINOSUS*, Dallas.

*Rhaphigaster spinosus*, Dallas, List Hem. i, p. 278 (1851).

*Rhaphigaster humeralis*, Dallas, List Hem. i, p. 278 (1851); Walker, Cat. Het. ii, p. 364 (1867).

*Sabæus spinosus*, Stål, Ofvers. K. V.-A. Förh. p. 632 (1870); En. Hem. v, p. 92 (1876).

♀. Above green, very thickly and rather coarsely punctured: pronotum with the lateral angles produced into acute spines: membrane transparent, colourless: margins of the abdomen with a small black point at the posterior angle of each segment: rostrum pale yellowish green, with the apex of the last joint, black: antennæ with the two basal joints, green; the third with the basal half green, the apical half black (*Dallas*). Long  $16\frac{4}{5}$ ; humeral breadth,  $12\frac{1}{2}$  mill.

Reported from Philippines, Assam.

#### Genus *HYLLUS*, Stål.

Ofvers. K. V.-A. Förh. p. 513 (1867); En. Hem. v, p. 63, 92 (1876).

Body broadly obovate: head much inclined, slightly sinuate on both sides before the eyes, thence somewhat narrowed, rounded at apex; tylus scarcely longer than the juga, lateral margins somewhat obtuse; bucculæ continued through, moderately elevated; ocelli near the eyes: rostrum extended somewhat behind the last coxæ, first joint on a level with the bucculæ, second joint longer than the third; first joint of the antennæ not reaching the apex of the head, second joint shorter than the third: pronotum rather declined anteriorly, anterior margin narrowly and distinctly callously elevated, scarcely truncate behind the eyes, anterior lateral margins very obtuse, convex, basal margin very broadly somewhat sinuate, lateral angles spinosely produced: scutellum somewhat short, almost equally broad and long, narrow at the apex, frena extended beyond the middle of the scutellum: extremity of apical angle of the corium rounded: base of venter unarmed, neither spinose, nor tuberculate: mesostethium distinctly carinate: apical angles of the abdominal segments acutely very slightly prominulous: tibiæ furrowed above (*Stål*).



228. *HYLLUS FLORENS*, Walker.

*Mormidea florens*, Walker, Cat. Het. ii, p. 263 (1867).

*Hyllus ceruginosus*, Haglund, Stettin Ent. Zeit. xxix, p. 160 (1868).

*Hyllus florens*, Stål, En. Hem. v, p. 92 (1876).

Deep green, broad, oval, roughly punctured; under side and legs pale: head above ochraceous, bordered with black and sometimes with black sutures between the jugs and the tylus which are of equal length: rostrum extending a little beyond the hind coxæ, tip black: antennæ black, slender, full half the length of the body; first joint green, not extending to the front; third longer than the second, shorter than the fourth; fifth as long as the fourth: pronotum smooth along the fore border; spines black, stout, acute, very long, very slightly ascending: scutellum with a round pale yellow apical spot: abdomen beneath with a pale luteous disc and with black marginal spots: legs slender; tarsi luteous: membrane brown. (*Walker*). Body long,  $8\frac{1}{2}$  mill.

Reported from Sumatra, Malacca, Siam, Burma.

Div. *PLAUTIARIA*.

En. Hem. v, p. 63, 64 (1876).

*a. b. c.* as in *Hoplistoderaria* (p. 66).

*d.* Lateral angles of the pronotum generally not, or rarely very slightly, prominulous, not acuminate, rarely strongly produced and acuminate, if so, the head is furnished with black punctures arranged in parallel longitudinal rows.

*e.* Venter generally tuberculate or spinose at the base, the tubercle touching, or somewhat so, the elevated mesostethium; spine, when present, long and depressed; mesostethium not lower than the basal tubercle of the venter when present: ridge on mesostethium posteriorly sometimes either amplified or thickened hindwards: tibiæ above flat and margined or distinctly furrowed: third joint of the rostrum sometimes longer than the second.

*f.* Head moderate, not, or not so strongly, impressed between the eyes and the ocelli: corium and scutellum rarely somewhat equal in length, and frena rarely shorter by half than the scutellum, if so, the ventral spiracula and the space around them are black: basal tubercle of venter absent, or not extended in a spine.

*g.* Entire body or the greatest part virescent, rarely incarnately virescent: frena extended beyond the middle of the scutellum: the anterior and the anterior lateral margins of the pronotum not, or only slightly, callously elevated: metastethium and basal tubercle of the venter equally highly elevated, the latter touching, or somewhat so, the

metastethium : second and third joints of the rostrum equal, or somewhat so, in length, the third joint never longer than the second : ventral spiracula generally concolorous, very rarely black: tibiæ above narrowly and slightly sulcated, or somewhat so. (*Stål*).

#### Genus PLAUTIA, Stål.

Hem. Afric. i, p. 82, 191 (1864); Ofvers. K. V.-A. Förh. p. 514 (1867); En. Hem. v, p. 64, 92 (1876).

Body broadly obovate: head flat, rounded at the apex, slightly sinuated on both sides before the eyes, tylus about as long as the juga: rostrum produced a little behind the last pair of coxæ, first joint not extending beyond the bucculæ posteriorly, second joint a little shorter than the third: first joint of the antennæ not reaching the apex of the head, second joint never longer than the third: anterior lateral margins of the pronotum entire, not callous, anteriorly entirely callous, levigate, not or barely truncated on both sides behind the eyes: scutellum shortish, frena continued somewhat beyond the middle: mesostethium carinate: venter punctured, basal tubercle very obtuse, somewhat broad, slightly elevated, not somewhat compressed, very obsolete; metastethium less elevated: coriaceous part of the hemelytra beneath (costal limbus generally excepted) sanguineous, or more or less incarnate, above also generally more or less distinctly incarnate: tibiæ sulcated above. (*Stål*).

#### 229. PLAUTIA FIMBRIATA, Fabricius.

*Cimex fimbriatus*, Fabr., Mant. Ins. ii, p. 295 (1787); Ent. Syst. iv, p. 121 (1794); Syst. Rhyng. p. 175 (1803); Herr. Schöff., Wanz. Ins. v, p. 63, t. 164, f. 505 (1839).

*Pentatoma fimbriolatum*, Herr. Schöff., Wanz. Ins. vii, p. 102, f. 768 (1844).

*Pentatoma fimbriata*, Dallas, List Hem. i, p. 251 (1851); Walker, Cat. Het. ii, p. 298 (1867).

*Pentatoma crossota*, Dallas, List l. c. p. 252; Walker, Cat., l. c. p. 300.

*Plautia fimbriata*, Stål, Hem. Afric. i, p. 191 (1864); Hem. Fabr., i, p. 32 (1868); En. Hem. v, p. 92 (1876); Distant, A. M. N. H. (5 s.) iii, p. 45 (1879); Trans. Ent. Soc. p. 415 (1883).

Small: antennæ pale, joints black at the apex: head, pronotum and scutellum green, punctured, immaculate: hemelytra greyish, with a median spot which almost forms a band, fuscous, exterior margin green: wings cinereous, spot at the base fuscous: beneath green with a median line, yellow: anus porrect, emarginate at the apex (*Fabr.*).

♂. ♀. *P. crossota*, Dallas, has head, pronotum and scutellum bright green, rather thickly and finely punctured with brown: eyes black

ocelli red: the head has a very short black line on each side in front of the eyes below the lateral margins: pronotum with a very slender, reddish brown line on the edge of each lateral margin, the lateral margins straight: scutellum with the margin of the apex whitish: coriaceous portion of the hemelytra red, punctured with brown, with the outer margin green, punctured; membrane transparent, with a large brown cloud at the base, in which are two darker brown spots: wings transparent, with the principal vein red: abdomen above crimson, very thickly and finely punctured, with the lateral margins bright green: body beneath green, very thickly and finely punctured, except on the middle of the disc of the abdomen, which is yellowish, very smooth, and punctate; lateral margins of the abdomen with a black point on the apical angle of each segment: legs green; tarsi testaceous; claws black: rostrum pale testaceous, with the tip black; second joint considerably shorter than the third; basal joint green, second pale greenish yellow; third becoming fulvous towards the apex; fourth and fifth fulvous, with the tips brown (*Dallas*). Long, 10—11 mill.

The dorsum of the abdomen varies testaceous, unmarked, or broadly with two black stripes: in a Chinese example it is almost entirely black or subviolaceous-black.

Reported from Java, Eastern Archipelago, Japan, China, Siam Malacca, Silhat, Assam. The Indian Museum has specimens from Java, China, Assam, Sikkim, Calcutta.

#### Genus ZANGIS, Stål.

Ofvers. K. V.-A. Förh. p. 514 (1867); En. Hem. v, p. 64, 93 (1876).

Differs from *Nezara*, in having the body less broadly obovate; hemelytra above and beneath green; membrane entirely colourless; head generally less densely punctured; venter aciculatedly subrugose, not punctured, basal tubercle very distinctly elevated, anteriorly angulated and somewhat compressed, reaching but not higher than the metastethium which is strongly elevated and generally sinuated posteriorly. Differs from *Planitia* in the narrower body, head and scutellum longer and the scutellum narrower at the apex.

#### 230. ZANGIS BERYLLUS, Fabricius.

*Cimex beryllus*, Fabr., Mant. Ins. ii, p. 292 (1787); Ent. Syst. iv, p. 110 (1794); Syst. Rhyng. p. 168 (1803).

*Zangis beryllus*, Stål, Hem. Fabr. i, p. 33 (1868); Stål, En. Hem. v, p. 125 (1876).

♀. Suboval, pale somewhat sordid flavescent, shining, above less

densely punctulate, first and second joints of the antennæ very pale virescent, third fuscous, virescent at the base, fourth and fifth testaceous, yellow-whitish at the base; extreme margin of the head, two longitudinal lines, approached before the middle, posteriorly more distant, parallel, a small line before the ocelli, also a lower line above the antenniferous tubercles, four minute spots on the pronotum at the anterior margin, six placed in a transverse row before the middle, also several behind the middle arranged in an undulating transverse row, four minute basal spots on the scutellum, one marginal on both sides before the middle and several posterior scattered; spots and small transverse lines on the exterior limb of the corium, a small spot on the pro- and mesostethium situate towards the coxæ, patch on the anterior angles of the prostethium, a minute spot almost at the middle of the basal margin of the sides of the mesostethium, lateral marginal puncture on the metastethium, basal and extremity of the apical angles of the ventral segments, narrow subapical and subbasal band on the segments of the connexivum, also apex of rostrum, black: membrane sordid hyaline: anterior lateral margins of pronotum, and exterior margin of corium, anteriorly weakly orange.

Head slightly sinuated before the eyes, somewhat narrowed before the sinus, rounded at the apex, anteocular part shorter than broad at the base; antennæ with the third joint scarcely twice longer than the second: pronotum very remotely punctured before a waved row of black spots, more obscure behind the same row, entire anterior margin narrowly elevated, lowest part of the anterior lateral margins a little reflexed, lateral angles scarcely prominulous: scutellum almost thrice broader at the base than at the apex of the frena: pectus remotely punctured, a large, opaque, lateral spot not punctured: venter very finely punctured, smooth on the disc, second segment at the base convexly elevated in the middle: extremity of the apical angles of the segments somewhat prominulous: tibiæ with a furrow continued through (*Stål*). Long, 15; broad, 8 mill.

Reported from India, Tranquebar.

#### Div. AXIAGASTARIA.

En. Hem. v, p. 64 (1876).

*a. b. c.* as in *Hoplistoderaria* (p. 66).

*d. e. f.* as in *Plautiaria* (p. 123).

*g.* Body flavescent, punctured black: feet sprinkled with black or fuscous: tibiæ above broadly furrowed, or flat and margined: ventral spiracles and the space around them usually black: membrane infusate.

## Genus DIPLOSTIRA, Dallas.

List Hem. i, p. 300 (1851); Walker, Cat. Het. ii, p. 391 (1867); Stål, Ofvers. K. V.-A., Förh, p. 522 (1867); En Hem. v. p. 64, 94 (1876). Includes *Carenoscaptus*, Signoret, A. S. E. F. (2 s.) ix, p. 341 (1851).

Body elongate, broadest across the middle of the pronotum, thence attenuated posteriorly: head large, longer than broad between the eyes, margins very obsoletely sinuate, tylus and juga subequal in length, punctures arranged in longitudinal rows; ocelli moderate, placed very little further from each other than from the eyes: antennæ inserted a little in front of the eyes, about half the length of the body, 5-jointed; basal joint very short, not reaching nearly to the apex of the head; second joint shorter than the third; the third joint shorter than the fourth; the fifth shorter than the fourth, but longer than the third: rostrum stout, reaching the base of the abdomen, inserted in front of the base of the antennæ, basal joint short, not reaching the base of the head, second joint longer, third longest, fourth longer than the first but shorter than the second: pronotum hexagonal, immarginate, lateral margins round: ridge on the meso- and meta-stethium strongly elevated, robust, furnished with a deep furrow, elevated margins of furrow produced anteriorly before the first pair of coxæ, posteriorly behind the last coxæ, lobed; basal tubercle of venter compressed: furrow of the orifices long: scutellum reaching a little beyond the middle of the abdomen with the lateral margins waved, apex very broad and rounded. Coriaceous portion of the hemelytra with the apical margin very oblique; membrane large with numerous longitudinal veins; posterior lateral angles of abdominal segments slightly spinose: abdomen beneath with an obtuse median longitudinal ridge; legs rather stout; tarsi three-jointed; basal joint as long as the two following taken together.

## 231. DIPLOSTIRA VALIDA, Dallas.

*Diplostira valida*, Dallas, List Hem. i, p. 301, t. 10, f. 5 (1851); Walker Cat. Het. ii, p. 391 (1867); Stål, En. Hem. v. p. 94 (1876); Distant, A. M. N. H. (5 s.) iii, p. 45 (1879).

*Carenoscaptus maculipes*, Signoret, A. S. E. F. (2 s.) ix, p. 341 t. 10, f. 10; Walker, l. c. iii, p. 575 (1868). (1851).

♀. Testaceous, shining, more or less punctured with brown: head with the lateral margins black, and with six punctured, blackish brown longitudinal lines, placed two on the tylus and which meet at the middle of the vertex, and two on each of the juga, meeting at the ocelli: pronotum orange testaceous, thickly and coarsely punctured with dark brown; the punctures becoming confluent on the posterior portion of the disc forming a broad blackish brown baud, indistinctly clouded with testace-

ous; the postero-lateral margins are testaceous, coarsely punctured with brown: scutellum orange testaceous; the base impunctate, with the lateral margins strongly punctured with blackish brown, and four punctured blackish brown spots across at the margin of the pronotum; the apex rather finely punctured with brown; the middle occupied by a broad, blackish brown, transverse band, interrupted in the middle: coriaceous portion of the hemelytra with the disc covered with rather coarse, confluent, brown punctures, so that only a few points of the testaceous ground colour appears; outer margin testaceous, with two longitudinal lines of blackish brown punctures; membrane brown, semitransparent: abdomen beneath testaceous, very thickly and finely punctured with brown, and clothed with fine, short, whitish hairs, with the median ridge impunctate, smooth and naked: pectus testaceous, more coarsely, but less closely punctured than the abdomen, naked, shining and somewhat rugose: legs orange red; femora covered with round black points; tibiæ with a black line down each of the ridges of the outer edge; claws black: rostrum and antennæ pale orange-red; the apical joint of the latter palest (*Dallas*).

Long, 25—27 mill. Reported from Silhat, Assam, Sikkim (mihi).

#### Genus AXIAGASTUS, Dallas.

Dallas, List Hem. i, p. 221 (1851): Walker, Cat. Het. ii, p. 268 (1867): Stål, Ofvers. K. V.-A. Förh., p. 511 (1867); En. Hem. v. p. 64, 94 (1876).

Body ovate: head longer than broad between the eyes, rounded at the apex, tylus and juga subequal in length, lateral margins distinctly sinuated; eyes very prominulous, globose: ocelli large, placed close to the eyes: basal joint of the antennæ short and stout, not reaching the apex of the head; second joint more than twice the length of the first, but shorter than the third; rostrum very long, reaching the middle of the third ventral segment, inserted close to the apex of the head; basal joint shortest, reaching the base of the head; second joint longer than the first, shorter than the fourth; third longest: anterior angles of the rostral canal produced downwards into two long, curved tusks, of which the points are turned a little hindwards and inwards: pronotum hexagonal, unarmed, margined anteriorly and on the sides, lateral angles rounded, not produced: scutellum large and long, reaching at least two-thirds the length of the abdomen, with the apex broad and rounded: frena not reaching the middle of the scutellum: coriaceous portion of the hemelytra, much longer than the membrane, reaching nearly to the apex of the scutellum; membrane with longitudinal veins: ridge on the meso- and meta-stethium varying in height and breadth, without a

furrow: legs moderate; tarsi 3-jointed, basal and apical joints about equal (*Dallas*).

### 232. AXIAGASTUS ROSMARUS, Dallas.

*Axiagastus rosmarus*, Dallas, List Hem. i, p. 221, t. 8, f. 5 (1851); Walker, Cat. Het. ii, p. 268 (1867); Stål, En. Hem. v. p. 94 (1876); Distant, A. M. N. H. (5 s.) iii, p. 45 (1879).

♂. Yellow, somewhat shining, rather finely and sparingly punctured with black: head with the margins, a line down each side of the median and two longitudinal lines on the vertex, black: eyes brown; ocelli reddish: pronotum with the lateral margins and four spots placed in a transverse line near the anterior margin, black; posterior margin blackish: scutellum with two small black spots near the middle of the base, a larger one on each lateral margin before the middle, and a large black patch before the apex; hemelytra clouded with brown; membrane brownish, semitransparent: margins of the abdomen banded with black and yellow, the base and apex of each segment being black: abdomen beneath very finely punctured with brown; stigmata black; pectus irregularly punctured with black and brown: legs yellow; femora with large, tibiæ with smaller, black points: rostrum with the extreme tip black: antennæ with the two basal joints yellow, the second with black points; third joint black, with the base yellow (*Dallas*). Long, 16—17 mill. Walker (*l. c.*) notes that the sides of the rostral canal are not spinose in the ♀: the length of the rostrum is variable, antennæ much more than half the length of the body, and the joints to the fourth successively increase in length, 4—5 equal in length; pale luteous spot at apex of the scutellum is very variable in size and shape.

Reported from Siam, Philippines, Assam (mihi).

### Genus ASTYANAX, Stål.

Ofvers K. V.-A. Förh. p. 511 (1867): En. Hem. v. p. 64, 94 (1876).

Body broadly obovate: head much deflexed, slightly narrowed forwards, slightly sinuate on both sides before the eyes, obtusely rounded at the apex; tylus and jugæ equal in length, lateral margins somewhat obtuse; bucculæ rather elevated, continued through; ocelli near the eyes; rostrum extended somewhat behind the last pair of feet, first joint extending beyond the bucculæ; first joint of antennæ not reaching the apex of the head, second joint shorter than the third; pronotum much inclined forwards, anterior margin narrowly callously elevated: scutellum broad, a little longer than broad, somewhat shorter than abdomen, slightly narrowed hindwards behind the frena which occupy

a little more than one-fourth of the length of the scutellum; corium somewhat reaching the apex of the abdomen; apical angle rounded: membrane with longitudinal veins: meso-stethium carinate: furrow of the odoriferous apertures continued in a gradually vanishing wrinkle or ridge: venter rather convex, unarmed at the base (*Stål*).

Type, *Scutellera trimaculata*, St. Farg.

### 233. ASTYANAX TRIMACULATUS, St. Farg. & Serv.

*Scutellera trimaculata*, St. Farg. & Serv. Enc. Méth, x, p. 411 (1825).

*Graphosoma trimaculata*, Germar, Zeitschr. i, p. 54 (1839); Walker, Cat. Het. i, p. 69 (1867).

*Hoplistodera trimaculata*, Dallas, List Hem. i, p. 217 (1851); Walker, l. c., ii, p. 265 (1867).

*Astyanax trimaculata*, Stål, Ofv. K. V.-A. Förh. p. 629 (1870); En. Hem. v, p. 94 (1876).

♂. Pale testaceous, a little greyish; throughout finely punctured brown, the punctures form six longitudinal rows on the head: sides of pronotum spinose: scutellum with three whitish impunctate spots, bordered brown, the apical largest, oval: last four joints of the antennæ long, almost equal: rostrum extending a little beyond the posterior coxæ (*St. Farg.*). Long,  $8\frac{3}{4}$  mill.

Reported from Java, Philippines, Penang, Malacca, Burma.

### Genus CRITHEUS, Stål.

Ofvers. K. V.-A. Forh. p. 517 (1867); En. Hem. v, 64, 94 (1876).

Body oval, depressed: rostrum long, extended almost to the apex of the abdomen, first joint extending somewhat beyond the bucculæ, third somewhat longer than the second; head somewhat narrowed forwards, obtusely rounded at the apex, lateral margins somewhat acute, slightly sinuate behind the middle; juga and tylus of equal length; bucculæ continued through, moderately elevated; ocelli scarcely thrice farther from each other than from the eyes; antennæ somewhat slender, first joint not reaching the apex of the head, second joint shorter than the third: anterior lateral margins of the pronotum, reflexed, straight, anterior margin callous, scarcely truncate behind the eyes, lateral angles scarcely prominulous: scutellum moderate, narrow at the apex, frena extended beyond the middle of the scutellum: veins of membrane, simple: mesostethium carinate: metastethium somewhat elevated, posteriorly emarginate: furrow of the odoriferous apertures passing into a gradually evanescent wrinkle or ridge: abdomen slightly rounded on both sides, venter longitudinally somewhat flat in the middle, the extre-



mity of the angles of the segments somewhat prominulous (*Stål*). Allied to *Aviagastus*, Dallas.

#### 234. CRITHEUS LINEATIFRONS, Stål.

*Critheus lineatifrons*, Stål, Berlin Ent. Zeit. xiii, p. 229 (1869): En. Hem. v, p. 44 (1876).

♂. Oval, pale sordid flavescent, above rather densely dotted black, the dots in patches on the pronotum and scutellum in the form of irregular transverse lines: a smooth longitudinal line on the head and pronotum also two or four small spots arranged in a transverse row before the middle on the pronotum, and a continued line within the anterior margins and the lateral anterior, smooth, this continued line ends within the row of densely accumulated black dots: dorsum of abdomen rufescent, testaceous: head scarcely shorter than the pronotum, transversely, finely, subrugose, marked beneath by black dots accumulated in abbreviated lines: antennæ slender, second joint distinctly longer than the first, third almost more than half longer than the second, fuscous near the apex: pronotum more than twice broader than long; scutellum posteriorly a little less densely punctured, with three small basal spots and the extreme part of the basal margin smooth: hemelytra punctured fuscous-ferruginous, sprinkled with a few small smooth spots; membrane infusate, veined fuscous: pectus sparingly dotted black, the dots accumulated here and there into some small spots: connexivum densely punctured black: venter sparingly punctured ferruginous-fuscous, more sparingly punctured in the middle; incisures, spiracles and transverse line behind the spiracles, black: anal segment in ♂ strongly retuse on the disc, broadly and obtusely sinuate at the apex, sinus itself slightly emarginate in the middle, posterior angles produced in a short lobe which is emarginate at the apex; femora remotely sprinkled ferruginous (*Stål*). Long,  $11\frac{1}{2}$ ; broad, 6 mill.

Reported from Burma.

#### Genus ACESINES, Stål.

En. Hem. v. p. 65, 94 (1876).

Head short, almost equally long and broad between the eyes, broadly rounded at the apex, vaguely punctured, not sinuated in the lateral margins: pronotum vaguely punctured at the very narrowly levigate anterior margin, and at the somewhat acute and narrowly reflexed anterior lateral margins: scutellum moderate, shorter than the corium, posteriorly moderately broad: frena extended beyond the middle of the scutellum: rostrum not extended behind the metastethium, second joint

longer than the third : mesostethial ridge gradually thicker hindwards : metastethium somewhat elevated, sexangular, sinuated at the base ; basal tubercle of venter distinct, angulately prominulous and touching the metastethium : membrane with five veins (*Stål*).

### 235. ACESINES BREVICEPS, Stål.

*Acesines breviceps*, Stål, En. Hem. v, p. 94 (1876).

♀. Oval, somewhat depressed, weakly sordid flavescent, somewhat shining, above and on the pectus rather densely and distinctly punctured black, punctures arranged in lines and groups and leaving small irregular and confluent smooth spots : anterior margin and obsolete longitudinal line on pronotum, also anterior, obtriangular, indeterminate spot on scutellum, less densely punctured or somewhat smoothish : sides of venter remotely sprinkled with fine punctures ; lacerated lateral streak, sixth segment and anal valvules, blackish : dorsum of abdomen, membrane and two apical joints of the antennæ, fuscous : tibiæ minutely sprinkled fuscous. Head about one-third shorter than the pronotum, antecular part transverse, gradually very slightly narrowed forwards beyond the middle, thence at the apex abruptly, broadly and obtusely rounded : first joint of the antennæ scarcely reaching the apex of the head, second joint a little shorter than the third : bucculæ slightly elevated, posteriorly lower : rostrum reaching the base of the venter, first joint on a level with the bucculæ posteriorly, third joint shorter than the second, longer than the fourth : anterior lateral margins of the pronotum straight, acute, very narrowly somewhat laminated and reflexed (*Stål*). Long, 9 ; broad, 6 mill. Reported from India.

### Div. EURYASPARIA.

En. Hem. v, p. 65 (1876).

*a. b. c.* as in *Hoplistoderaria*, (p. 66).

*d. e.* as in *Plautiaria*, (p. 123).

*f.* Head posteriorly, between the eyes and the ocelli, rather strongly, or very distinctly, impressed : corium and scutellum equal in length, or somewhat so : the scutellum broad behind the short frena : anterior lateral margins of the pronotum rounded, levigate, or callous : feet pale, not pictured (*Stål*).

### Genus EURYASPIS, Signoret.

*Euryaspis*, Sign., A. S. E. F. (2 s.), ix, p. 342 (1851); *Euryaspis*, Stål, En. Hem. v, p. 65 (1876).

Scutellum large, occupying more than three-fourths of the abdomen, very broad and rounded : juga and tylus equal in length : rostrum

barely reaching the posterior feet and enclosed at its base : eyes very stout ; ocelli approximate to the eyes : antennæ 5-jointed, the 3—4 joints longest : pronotum very tumid and inclined forwards ; angles rounded : hemelytra longer than the abdomen : sternal ridge ending in a point and flattened between the anterior feet, very broad between the middle and posterior feet, slightly bifurcate in order to receive the ventral point which is very short : abdomen very tumid, ecarinate : feet cylindrical (*Sign.*).

Remarkable for the large scutellum and the rounded tibiæ which are very finely furrowed above.

### 236. EURYASPIS TRANSVERSALIS, Signoret.

*Euryaspis transversalis*, Sign., A. S. E. F. (2 s.) ix, p. 343, t. 10, f. 1, (1851).

*Euryaspis transversalis*, Stål, En. Hem. v, p. 95, (1876).

Yellow, varied with brown and lighter yellow : head small, yellow, with the lateral margins sinuate, the sinuosity black as well as the grooves between the lobes, the space around the ocelli and the posterior margin : pronotum divided in two by a sinuated band of a lighter yellow almost white, proceeding from one to the other of the posterior angles ; the anterior part, yellow, and the posterior, brownish : scutellum with a yellow surface anteriorly, bounded by a circular band of a much lighter yellow and almost white, and, posteriorly, a broad patch of a brownish red, circumscribed yellow, and strongly punctured above on both sides : hemelytra brownish-yellow : membrane transparent with 7—8 veins, hardly bifurcate : body beneath and feet yellow : abdomen with four brown bands : stigmata small and black (*Sign.*). Long, 9 mill.

Reported from Pondicherry.

### Div. MENIDARIA.

En. Hem. v, p. 65, (1876).

*a. b. c.* as in *Ho plistoderaria*, (p. 66).

*d.* Second ventral segment obtusely convex in the middle, or with a porrect spine, rounded or compressed, very rarely obtusely somewhat tuberculate in the middle, if so, the tibiæ are rounded and without a furrow : metastethium not elevated : mesostethial ridge everywhere equal in breadth, or somewhat so : third joint of the rostrum very rarely a little longer than the second.

*e.* Tibiæ above generally sulcated, or flattish and margined, very rarely entirely rounded and without a furrow, if so, the venter has a porrect spine at the base.

*f.* Tibiæ above margined on both sides, or with a broad, very distinct furrow: mesostethial ridge anteriorly not, or barely, strongly elevated, there neither laminated, nor freely produced, nor thickened: ventral spine, when present, short or moderate, rarely extending somewhat beyond the intermediate coxæ: ventral spiracles very rarely black: apical angles of the sixth abdominal segment not produced in a large acute tooth: rostrum extended behind the intermediate coxæ, generally reaching or extending beyond the base of the venter (*Stål*).

#### Genus CRESPHONTES, Stål.

Ofvers. K. V.-A. Förh., p. 514, (1867): En. Hem. v, p. 65, 95, (1876).

Body broadly obovate: head rather inclined, narrowed forwards, very slightly sinuate before the eyes, rounded at the apex; tylus and juga of equal length; antocular part shorter than broad; lateral margins flattened, acute; bucculæ continued through, moderately elevated: ocelli about thrice further from each other than from the eyes; rostrum extended between the last coxæ, first joint as long as the bucculæ, second joint longer than the third; antennæ moderate, first joint scarcely reaching the apex of the head, second joint shorter than the third: pronotum moderately inclined, anterior margin not elevated, scarcely truncate behind the eyes, anterior lateral margins somewhat obtuse, lateral angles obtuse, produced in a broad process: scutellum somewhat broad at the apex, moderately long, frena extended a little beyond the middle of the scutellum: apical margin of corium rounded: mesostethium distinctly carinate: venter, at the base, with a long robust spine: furrow from the odoriferous apertures continued in a long, gradually vanishing, wrinkle or ridge: apical angles of abdominal segments scarcely prominulous (*Stål*).

#### 237. CRESPHONTES NIGRO-MACULATUS, Haglund.

*Cresphontes nigro-maculatus*, Haglund, Stettin Eut. Zeit. xxix, p. 157, (1868): Stål, En. Hem. v, p. 95, (1876).

♂. Subquadrate, posteriorly rounded, pale flavescent or stramineous; head and pronotum, in patches, sides and apex of scutellum densely, punctured black; hemelytra densely punctured rufescent; the lower portion of the hemelytra, dorsum of abdomen, two basal joints of the antennæ, and base of three last joints, connexivum, and feet, more or less, rufescent: three last joints of the antennæ, a somewhat smooth median shining spot on the scutellum, numerous minute spots on pectus and venter, duplicated spots on the connexivum, also some spots on the apices of the femora, black; membrane and wings, fusciscent: basal internal angle of the membrane with an obscure spot.

Head rounded at the apex, tylus continued through; ocelli four times further from each other than from the eyes: antennæ extended, reaching beyond the lateral angles of the pronotum, last three joints equal, twice as long as the second: rostrum hardly reaching the last pair of coxæ: pronotum transverse, almost thrice broader than long; lateral angles roundly produced, posterior margin subsinuate: sides of the scutellum a little sinuate; apex rounded; frena extending somewhat beyond the middle: dorsum of abdomen hardly violascent; beneath densely, but not strongly, punctured; ventral spine narrowed, acute, reaching the middle between the anterior and intermediate coxæ; pleuræ opaque, rufescent: minute black spots on the venter arranged in six rows; longitudinal spots in external rows in middle of the segments near the spiracles; transverse spots in median and internal rows on the basal margin of the segments; the internal rows of spots are wanting on the last two segments, but the last segment has a minute, median, transverse, basal, black spot: tibiæ not distinctly sulcate (*Haglund*). Long.,  $9\frac{1}{2}$ ; broad, hardly 7; exp. hem. 23 mill.

Reported from the Dekhan.

#### Genus ANTESTIA, Stål.

pt. Hem. Afric. i, p. 82, 200, (1864); Ofvers. K. V.-A. Förh., p. 514, (1855); En. Hem. v, p. 66, 95, (1876).

Head more or less deflexed, immarginate; juga and tylus of equal length; first joint of rostrum not extending beyond the bucculæ posteriorly; first joint of antennæ not or scarcely reaching the apex of the head, second joint shorter than the third: anterior and anterior-lateral margins of the pronotum distinctly reflexed or callous, elevated: scutellum broad or somewhat so at the apex: mesostethium not, or but slightly, carinate: venter sometimes distinctly spinose at the base (*Stål*). Certain virescent species of *Antestia* are very like *Zangis* and *Plantia*, but differ in having the second ventral segment in the middle rather convex and not very prominulous, pronotum strongly margined, and the tibiæ above distinctly flat and marginate.

#### 238. ANTESTIA ANCHORA, Thunberg.

*Cimex anchora*, Thunberg, Nov. Ins. Spec. ii, p. 47, t. 2, f. 60, (1783).

*Pentatoma anchora*, Dallas, List Hem. i, p. 254, (1851); Walker, Cat. Het. ii, p. 300 (1867).

*Pentatoma cruciata*, Ellenr., Nat. Tijdskr. Ned. Ind. xxiv, p. 154, (1862).

*Antestia anchora*, Stål, En. Hem. v, p. 96, (1876); Distant, A. M. N. H. (5 s.) iii, p. 45, (1879); J. A. S. B. xlviii (5), p. 37, (1879).

Head pale orange-yellow, with a black, oblong, longitudinal spot between the eyes: pronotum pale orange-yellow on the margins and

anterior half of the median line, rest lutescent-whitish, with six black spots, of which two oblong, transverse, lie along the anterior margin; four, oblong or slightly cuneiform, longitudinal, towards the posterior margin: scutellum lutescent-whitish, the middle pale orange, with two ovate or semicircular black spots at the base, two minute triangular, scarcely visible, at the basal angles, and two large triangular spots towards the apex and whose bases rest on the margins, black: hemelytra pale orange-yellow, with three somewhat rounded black spots arranged triangularly: membrane black, tip pale: beneath, pale virescent with 5—7 rows of black spots, the marginal minute, not continued on the pectus, sometimes indistinct, the second oblong, transverse, the third sometimes confluent with the second and sometimes wanting, the median, on the disc, oblong transverse. In Ellenrieder's example from Sumatra, the two anterior spots on the scutellum are ovate, the posterior triangular, the orange-yellow space between them taking the form of a cross; 1—2 joints of antennæ and the feet, rufous, femora indistinctly annulate, tarsi fuscous-brunneous, beneath sordid lutescent, with, on both sides, a lateral row of black spots and a median row of brunneous spots. Long, 10—11; broad,  $7\frac{1}{2}$  mill.

Reported from Java, Sumatra, Burma, Tenasserim, Sikkim (mihi), China.

### 239. ANTESTIA PULCHRA, Dallas.

*Pentatoma pulchra*, Dallas (nec Westw.), List Hem. i, p. 253, (1851): Walker, Cat. Het., p. 300, (1867): ? Stål, En. Hem. v, p. 128, (1876).

♀. Rounded ovate: head rather large, pale tawny, smooth and impunctate, with the sides narrowly margined: eyes black; ocelli red: pronotum with six black spots which occupy nearly the whole surface, namely, a rather small oblong transverse spot on each side close to the anterior margin, a larger one on each lateral angle, and two large somewhat quadrate spots, covering nearly the whole disc and reaching the posterior margin; the narrow anterior margin, the anterior portion of the lateral margins, a transverse line near the anterior margin, a median longitudinal line, and a longitudinal line on each side running from the transverse line to the posterior margin, are yellow; the median longitudinal line has an orange spot close to the anterior margin, the posterior portion of the disc, with the exception of the median yellow line, is rather strongly, but not very thickly, punctured, with the punctures black on the lateral longitudinal yellow lines, and there is a line of 5—6 fine black punctures on the yellow portions of the lateral margin close to the edge: scutellum yellow, orange towards the base and at the apex, with a narrow transverse black band, interrupted in the middle, at the base, and a large,

somewhat bifid, pitchy black patch occupying nearly the whole of the disc; the basal portion smooth and impunctate, the disc rather strongly punctured, the punctures becoming finer and closer towards the apex, which is very finely and thickly punctured, the lateral margins punctured with black: hemelytra orange, with the inner part of the coriaceous portion yellow, thickly and rather strongly punctured towards the base, more finely towards the apex, with an impunctate space on the disc behind the middle; with a large patch, posteriorly deeply emarginate, on the disc about the middle, and the apical margin pitchy black; membrane dark brown: wings brown, semitransparent, with the apex darker: abdomen above red, very thickly and finely punctured, with the margins yellow; the margins of the second and of the base of the third segments are black. Body beneath pale yellow, smooth, and shining: venter impunctate, with a large black spot on each side of each segment except the last, which has a large square spot of the same colour in the middle; the lateral margins of the second segment are black: pectus with a line of fine blackish punctures within the margins of each segment and with two rows of large black spots on each side, of which the inner row consists of three spots, one in each segment, the outer of four, of which the fourth spot is placed close to the posterior angle of the metastethium: legs orange, with the base of the femora testaceous, and with a more or less distinct brown or blackish ring near the apex of the femora: rostrum brown, with the apex black, and the basal joint pale orange: antennæ black, with the two basal joints orange (*Dallas*). Body long, 11—12 mill.

Reported from India, Burma: the Indian Museum has specimens from Arakan, Sikkim (mihi).

#### 240. ANTESTIA CRUCIATA, Fabricius.

*Cimeæ cruciatus*, Fabr., Syst. Ent., p. 714, (1775); Spec. Ins. ii., p. 358, (1781); Mant. Ins. ii, p. 295, (1787) Ent. Syst. iv., p. 119 (1794); Syst. Rhyng. p. 174 (1803); Wolff, Ic. Cim. ii, p. 62, f. 59, (1801): Herr. Schöff., Wanz. Ins. v, p. 63, t. 164 f. 506, (1839).

*Pentatoma cruciata*, Am. and Serv., Hist. Nat. Ins. Hém. p. 132, (1843): Dallas, List Hem. i, p. 254, (1851); Walker, Cat. Het. ii, p. 300, (1867).

*Antestia cruciata*, Stål, Ofvers. K. V.-A. Förh., p. 630, (1870); En. Hem. v, p. 96, (1876).

This species varies much, sometimes rufescent or croceous, sometimes flavescent or virescent, spots on the upper side larger or smaller, black or olivaceous-virescent, pectus and venter on the anterior angles of the segments marked with a blackish spot or immaculate. Antennæ fuscous: head pale, with two curved black lines, the sides brunneous:

pronotum pale, four spots anteriorly, and posteriorly six spots, black: scutellum black, sides pale at the base, a cruciform patch in the middle and at the apex pale: hemelytra pale, tinted ferruginous, with three black spots: wings fuscous: beneath flavescent, sides spotted black (*Fabr*). The outer spots of the anterior row on the pronotum are sometimes obsolete. Long, 9 mill.

Reported from Java, Burma, Bengal. The Indian Museum has specimens from Calcutta, Sikkim (mihi).

#### 241. ANTESTIA MODIFICATA, Distant.

*Antestia modificata*, Dist., Trans. Ent. Soc. p. 350, t. 12, f. 4, (1887).

Ochraceous, spotted with bluish black, above sparingly punctate: head luteous, margins of tylus and margins of juga in front of the eyes, also two spots at base, bluish-black: eyes brownish: antennæ bluish black: pronotum with eight bluish-black spots, the six largest arranged in two rows on the disc, and a smaller elongate spot in each basal angle: corium with four bluish-black spots, one at the base, one at the apex, and two median: membrane pale hyaline with a large bluish-black subquadrate spot at the base: body beneath pale luteous, sternum spotted with bluish-black, and abdomen with sutural fasciæ and lateral spots of the same colour: legs luteous; femora with a blackish spot near their apices: antennæ with second joint shorter than the third, 4—5 joints longest (*Dist.*). Long, 7 mill.

Reported from Sikkim, where it is rather common (mihi).

#### Genus APINES, Dallas.

List Hem. i, p. 231, (1851); Walker, Cat. Het. ii, p. 283, (1867); Stål, En. Hem. v, p. 97, (1876).

Head deflexed, about as broad as long, rounded at the apex, the tylus as long as the juga: eyes prominent: ocelli distant but not placed very near the eyes: antenniferous tubercles very small, entirely concealed by the lateral margins of the head: antennæ more than half the length of the body, 5-jointed; basal joint short, not reaching the apex of the head; second joint about the length of the first, much shorter than the third; the 3—4 joints about equal; fifth a little longer: rostrum scarcely reaching the posterior coxæ; basal joint reaching the base of the head, second longest, third shorter than the fourth, which is very little shorter than the second: body oblong-ovate, somewhat elongate: pronotum very little broader than long, much broader behind than before: scutellum somewhat triangular, but with the apex rather broad and rounded: corium rather longer than the membrane with its apical



margin oblique and rounded; membrane with longitudinal veins: abdomen and sternum unarmed: legs rather long; tarsi 3-jointed, the basal and apical about equal (*Dallas*).

#### 242. APINES CONCINNA, Dallas.

*Apines concinna*, Dallas, List Hem. i, p. 232, t. 9, f. 2, (1851); Walker, Cat. Het. ii, p. 283, (1867); Stål, En. Hem. v, p. 97, (1876).

♂. Shining black, thickly and finely punctured: pronotum with the lateral margins narrowly edged with white, and with a large somewhat ovate yellow spot on the middle of the disc: scutellum with a large yellow spot in each basal angle, and a large spot of the same colour on the apex; across the disc, close behind the two basal spots, runs an orange yellow line, which forms a kind of anchor, with a short longitudinal line running between the two spots: corium with the basal portion of the outer margin whitish, and with a transverse white band near the apex; membrane blackish: abdomen with the margins of the 3—5 segments white, interrupted with black at the sutures: pectus with a large, triangular white spot in each of the posterior angles: coxæ and base of the femora white; apices of the femora black; anterior tibiæ yellowish white, with a black line down the inside; intermediate tibiæ white, with the base, and a minute line at the apex, black; posterior tibiæ white, with the base and apex black; tarsi black: rostrum black: antennæ black, with the second joint testaceous (*Dallas*). Long,  $6\frac{1}{2}$  mill.

Reported from India, Bombay, Hardwar (mihi).

#### Genus MENIDA, Motsch.

E'tud. x, p. 23, (1861); Stål, En. Hem. v, p. 66, 97, (1876).

Differs from *Antestia*, Stål, in having the second ventral segment with a gradually compressed, porrect spine, almost laminate at the apex, or with a compressed tubercle, prominulous forwards. In *Antestia* there is neither spine nor tubercle.

#### 243. MENIDA SIGNORETHI, Stål.

*Menida Signorethi*, Stål, En. Hem. v. p. 98, (1876).

Very like and closely allied to *M. maculiventris*, Dallas, differs only in having the pronotum at the lateral intramarginal row of dots narrowly smooth, and flavescent, entire anterior margin callous and smooth, not punctured behind the eyes, and head somewhat shorter (*Stål*). Long,  $7\frac{1}{2}$ ; broad, 4 mill.

Reported from India (Africa?).

## 244. MENIDA FLAVO-VARIA, Dallas.

*Rhaphigaster flavo-varius*, Dallas, List. Hem. i, p. 288, (1851).

*Antestia flavo-varia*, Walker, Cat. Het. ii, p. 23, (1867).

*Menida flavo-varia*, Stål, En. Hem. v. p. 98, (1876): Distant, A. M. N. H. (5 s) ii, p. 45, (1879).

Above black, thickly and rather finely punctured: head with a few irregular yellowish points: pronotum with the lateral margins, a spot on the middle of the anterior margin, a corresponding one on the posterior margin, one on each lateral margin, and three or four on the disc, yellow: scutellum with a large cross on the disc, the apex and a spot in each basal angle, yellow: hemelytra with the base of the outer margin, and a spot on the disc, a little behind the middle, yellow; membrane transparent, with an indistinct, brown, transverse band across the middle: abdomen with the margins banded with yellow and black; beneath black, with the sides thickly and finely punctured, the lateral margins banded with yellow and black; basal spine passing the posterior coxæ, brown: legs yellow: rostrum brownish: antennæ pale brown, with the 4-5 joints black (*Dallas*). Long  $7\frac{3}{4}$ —8 mill.

Reported from N. India, Assam, Sikkim (mihi).

## 245. MENIDA FORMOSA, Westwood.

*Pentatoma formosa*, Westwood, Hope, Cat. Hem. i, p. 34, (1837).

*Rhaphigaster spectandus*, Stål, Freg. Eug. Resa Hem., p. 230, (1859).

*Rhaphigaster albidens*, Ellenr., Nat. Tijds. v. Ned. Ind. xxiv, p. 159, (1862).

*Menida formosa*, Stål, En. Hem., v. p. 99, (1876).

Brassy fuscous, varied with whitish; three lines on the head anteriorly, two lines posteriorly, and a dot before the eyes, whitish: pronotum anteriorly with two transverse rings and a waved median line, scutellum with two basal spots and an apical anchor-shaped spot (sometimes connected by a longitudinal median line with the basal spots), pale: two marginal spots on the hemelytra pale; antennæ fuscous, pale at the base; posterior femora and all the tibiæ at the apex, and the tarsi, black (*Westw.*). Long, 6—7 mill.

Very like *M. varipennis*, Westw.: the flavescent lateral lines on the head abbreviated behind the middle; median line forked posteriorly, sometimes interrupted before the fork; band on the pronotum broad, marked and sometimes divided into two by a confused row of black dots; venter flavescent, sides spotted fuscous, median streak sometimes fuscous; yellow marking on the dorsum variable (*Stål*).

Reported from China, Malacca, Sumatra, Burma, Sikkim (mihi).

246. *MENIDA VARIPENNIS*, Westwood.

*Pentatoma varipennis*, Westwood, Hope, Cat. Hem. i, p. 43, (1837).

*Rhaphigaster varipennis*, Dallas, List Hem. i, p. 286, (1851).

*Antestia varipennis*, Walker, Cat. Het. ii, p. 281, (1867).

*Menida varipennis*, Stål, En. Hem. v, p. 93, (1876): Distant, A. M. N. H. (5 s.) iii, p. 45, (1879).

Brassy, thinly punctured, shining: head with three lines (the lateral interrupted), and the orbit of the eyes, anterior and lateral margins of the pronotum and an anterior band interrupted in the middle, scutellum at the base, and an apical moon-shaped spot, whitish: hemelytra fuscous at the base, black in the middle, with a whitish spot before the membrane which is fuscous; antennæ and feet, luteous: posterior angles of the pronotum not prominent (*Westw.*).

Head adorned with a spot at the eyes and with three, parallel, longitudinal lines (the lateral lines interrupted posteriorly), flavescens, shining: beneath black: lateral limbus, two rows of spots and the ventral spine flavescens. Long,  $7\frac{1}{4}$  mill.

Reported from Java, Tenasserim, Sikkim (mihi).

247. *MENIDA DISTINCTA*, Distant.

*Menida distincta*, Distant, Trans. Ent. Soc., p. 122, (1879); Scient. Res, 2nd Yarkand Miss., p. 6, f. 3, (1879).

Luteous, covered with strong greenish-black punctures: head luteous, with the lateral margins and four longitudinal punctured lines greenish-black; these lines are much more distinct on the ante-ocular portion of the head: eyes dull ochreous: antennæ pilose with the second joint shorter than the third, 4—5 joints sub-equal, rather longer than the third; 1—3 joints luteous, apex of the first, and apical half of the third, black; 4—5 joints, black, narrowly luteous at the base: rostrum luteous, apical joints pitchy: pronotum with an anterior submarginal line of greenish-black punctures, and two irregular transverse ocellated punctured marks of the same colour on the anterior portion of the disc: scutellum with a large median sub-basal greenish-black spot, and two small and somewhat indistinct ones of the same colour situated on the lateral margins a little before the apex: membrane transparent, whitish: abdomen above black, connexivum luteous, spotted with black: underside of body and legs luteous, sparingly and distinctly punctured with black: tarsi pitchy (*Distant*). Long, 6 mill.

Reported from Murree, Sind valley.

## 248. MENIDA HISTRIO, Fabricius.

*Cimex histrio*, Fabr., Mant. Ins. ii, p. 296, (1787); Ent. Syst. iv, p. 122, (1794) Syst. Rhyng., p. 178, (1803).

*Rhaphigaster concinnus*, Dallas, List Hem. i, p. 285, (1851); Walker, Cat. Het. ii, p. 281, (1867).

*Antestia histrio*, Stål, Hem. Fabr. i, p. 34, (1868).

*Menida histrio*, Stål, En. Hem. v, p. 98, (1876).

Head deep black; orbit of the eyes and five lines (the two intermediate abbreviated), black; antennæ ferruginous: pronotum rufous with numerous, impressed, fuscous points: anteriorly with two large fuscous spots, punctured rufous: scutellum varied yellow and rufous with three fuscous spots, the posterior marginal: hemelytra fuscous, posteriorly with a rufous patch; wings whitish: beneath deep black with two rows of whitish spots which, however, do not reach the apex: margin of abdomen whitish (*Fabr.*).

Dallas describes his *R. concinnus* thus:—Above testaceous or pale orange, shining, finely, but not very evenly, punctured black: head with the lateral margins, a line within the orbit of each eye, two parallel median longitudinal lines reaching the posterior margin of the head and sometimes an abbreviated line on each of the juga, black: pronotum with a strong, punctured, black line running close to the anterior and antero-lateral margins, and on the anterior portion of the disc, two irregular, transverse, black ocellated marks: scutellum with a lozenge-shaped black spot in the middle near the base and a black spot on each lateral margin near the apex: hemelytra with a broad black apical band which is interrupted in the middle by a broad, oblique, reddish line: the membrane transparent, whitish: margins of the abdomen yellow, thickly punctured, with a black band on each of the sutures: body beneath testaceous, thickly punctured at the sides: with three broad longitudinal bands, one on each side, running from behind the eyes to the apex of the abdomen, having a narrow testaceous margin throughout its entire course, and one down the middle which is sometimes formed of distinct spots on the abdomen: the abdomen is sometimes black, with a large testaceous patch on each side at the base: ventral spine long, reaching the intermediate coxæ, testaceous: legs orange: rostrum pitchy, base testaceous; antennæ pale brown (*Dallas*). ♂, long,  $6\frac{1}{2}$ : ♀, long, 8 mill.

Reported from Tranquebar, China, Calcutta (mili).

## Div. PIEZODORARIA.

En. Hem. v, p, 66, (1876).

a. b. c. as in *Hoplistoderaria*, (p. 66).

d. e. as in *Menidaria*, (p. 133).

f. Tibiæ generally rounded, rarely furnished above with a narrow and obsolete furrow, or flat and immarginate: venter spinose at the base, spine sometimes extended to the head: apical angles of the sixth abdominal segment sometimes produced in a large acute tooth (*Stål*).

## Genus PIEZODORUS, Fieber.

Eur. Hem. p. 78, 329, (1861); Walker, Cat. Het. ii, p. 367, (1867); Stål, En. Hem. v, p. 66, 100 (1876).

Body oblong-obovate, smooth: head short, rounded in front; basal joint of the antennæ shorter than the head, third joint longer than second and as long as the fourth; rostrum extended to between or behind the intermediate coxæ, somewhat slender, first joint not reaching the base of the bucculæ, second joint shorter or about as long as the third which is thickened at the end: anterior margin of the pronotum with a callous elevation, only very narrowly smooth; extreme apex of clavus with a punctiform black or fuscous spot; membrane colourless: basal spine on venter long, mesostethial ridge anteriorly elevated and there incrassate or generally laminate, usually also freely prominulous between the first pair of coxæ; spiracula black; furrow of the odoriferous aperture long, continued in a ridge or wrinkle: apical angle of sixth abdominal segment not produced in a large tooth.

## 249. PIEZODORUS RUBRO-FASCIATUS, Fabricius.

*Cimex rubro-fasciatus*, Fabr., Mant. Ins. ii, p. 293, (1787); Ent. Syst. iv, p. 114, 1794; Syst. Rhyng. p. 170, (1803).

*Cimex hübnéri*, Gmelin, ed., Syst. Nat. i, (4), p. 2151, (1788).

*Cimex flavescens*, Fabr., Ent. Syst. Suppt. p. 534, (1798); Syst. Rhyng. p. 168, (1803).

*Rhaphigaster flavolineatus*, Westwood, Hope, Cat. Hem. i, p. 31, (1837); Dallas, List Hem. i, p. 283, (1851); Walker, Cat. Het. ii, p. 364, (1867).

*Rhaphigaster virescens*, Am. & Serv., Hist. Nat. Ins. Hém. p. 148, (1843).

*Nezara pellucida*, Ellenr., Nat. Tidsskr. Ned. Ind. xxiv, p. 157, f. 26, (1862); Walker, l. c. p. 367, (1867).

*Rhaphigaster oceanicus*, Montr., Ann. Soc. Linn. Lyon. (2 s.) xi, p. 224. (1865).

*Piezodorus rubro-fasciatus*, Stål, Hem. Fabr. i, p. 32, (1868); En. Hem. v, p. 100, (1876); Scott, A. M. N. H. (4 s.) xiv, p. 290, (1874) Distant, Trans. Ent. Soc. p. 415, (1883); Lethierry, Ann. Mus. Gen. xviii, p. 703, (1883).

Above virescent, beneath flavescens: pronotum posteriorly more obscure, furnished with a sanguineous band (*Fabr.*). Above and feet

pale flavescens, immaculate: antennæ rufous, first joint pale at the base: abdomen beneath with a row of black dots (*C. flavescens*, Fabr.). Pale lutescent or albescent, with a sulphur-coloured border, a transverse luteous line between the posterior angles of the pronotum bordered with greyish bands: hemelytra pellucid, membrane hyaline: feet pallescent, tarsi brunneous; 4—5 joints of the antennæ, purpurascens: beneath ochraceous (*N. pellucida*, Ellenr.). Long, 8 mill.

Reported from N. Australia, Java, Sumatra, Philippines, New Caledonia, Ovalau, Tahiti, Assam, Sikkim (mihi), Bengal, Cochin-China, Japan, Zanzibar, Abyssinia.

#### Genus AMBIORIX, Stål.

En. Hem. v, p. 66, 100, (1876).

Apical angles of the sixth abdominal segment produced in a large acute tooth: abdomen gradually narrowed, sides somewhat straight: basal spine of venter extended to the head, gradually compressly acuminate: anterior lateral margins of the pronotum, also the anterior behind the vertex, levigate, the former straight, lateral angles somewhat prominulous, straight, rounded at the apex: frena extended beyond the middle of the scutellum: corium a little longer than the scutellum, apical margin rounded: ventral spiracula black: mesostethium with a fine ridge: tibiæ above narrowly and slightly furrowed: rostrum reaching the last pair of feet, the 2—3 joints somewhat equal in length: membrane colourless (*Stål*).

#### 250. AMBIORIX AENESCENS, Stål.

*Ambiorix aenescens*, Stål, En. Hem. v, p. 100, (1876).

♀. Greyish-flavescens, shining; beneath with the feet verging into ferruginous; above distinctly and densely punctured, black; beneath not so distinctly, and not so densely, punctured fuscous: 2—3 joints of the antennæ, black: head, barely anterior half of pronotum, rounded impunctate basal spot and band near the impunctate flavescens apex of the scutellum, anterior punctures on the costal area of the hemelytra and bands on the connexivum, brassy: the dorsum of the abdomen obscurely violaceous: wings towards the apex and the membrane, infuscate, a colourless apical spot on the membrane: the extreme apical margin of the head, anterior lateral margins and anterior margin of the pronotum (the latter abbreviated on both sides), flavescens, levigate: lateral angles of pronotum slightly prominulous, lateral margins, straight: abdomen in ♀ acutely quadridentate at the apex (*Stål*). Long,  $9\frac{1}{2}$ : broad  $5\frac{1}{2}$  mill.

Reported from N. India.

## Div. BATHYCOELIARIA.

En. Hem. v, p. 67, (1876).

*a. b. c.* as in *Hoplistoderaria*, (p. 66).

*d.* Venter with a furrow, its margins obtusely elevated, cylindrical, smooth: mesostethium distinctly carinate: furrow of the orifices continued in a long wrinkle or ridge.

## Genus JURTINA, Stål.

Ofvers. K. V.-A. Förh. p. 518, (1867); En. Hem. v, p. 67, 101, (1876): includes *Gastraulax*, pt. Herr. Schöff., Wanz. Ins. vii, p. 61, (1844).

Head shorter than the pronotum, gradually narrowed forwards, rounded at the apex, antecular part almost longer than broad, lateral margins somewhat obtuse, posteriorly very slightly sinuate; bucculae continued through, moderately elevated: ocelli about thrice as far from each other as from the eyes; rostrum somewhat reaching the apex of the abdomen, first joint on a level with the bucculae, third joint longest of all; first joint of antennae scarcely reaching apex of head, second joint shorter than third: anterior lateral margins of pronotum straight, somewhat obtuse, anterior margin truncate behind the eyes, lateral angles somewhat prominulous: scutellum moderate, frena extended to apical third of scutellum: veins of membrane simple: mesostethium with a somewhat high ridge: metastethium slightly elevated: furrow from the odoriferous apertures continued in a gradually vanishing wrinkle or ridge: venter deeply furrowed, second segment elevated in the middle, not produced forwards: tibiae obtusely rounded, not furrowed (*Stål*).

## 251. JURTINA INDICA, Dallas.

*Bathycœlia indica*, Dallas, Cat. Hem. i, p. 270, (1851); Walker, Cat. Hct. ii, p. 350, (1867).

*Jurtina indica*, Stål, En. Hem. v, p. 102, (1876).

♂. Above very pale green, very thickly and minutely punctured: head slightly truncated at the apex: pronotum with the lateral margins edged with violet: scutellum with a small round black spot in each basal angle: hemelytra with the outer margin dark green, except towards the base; membrane transparent, colourless: body beneath pale yellow, smooth and shining; abdomen impunctate; pectus finely punctured: legs pale yellow: rostrum pale yellow, with the tip of the last joint black: antennae with the two basal joints and the base of the third pale violet, 3—4 joints pale yellow (*Dallas*). Long, 20 mill.

Reported from N. India.

## Genus ABEONA, Stål.

En. Hem. v, p. 67, 102, (1876).

Head very slightly narrowed before the obtuse lateral sinus, very obtusely and broadly rounded at the apex: anterior lateral margins of pronotum sinuate; obtusely rounded, callous and levigate before the middle, with a reflexed ridge behind the middle, the lateral angles produced, acuminate; costal margin anteriorly straight, callous and rounded, thence slightly amplified: ventral furrow short, extended into the fourth segment: tibiæ rounded with a continued, narrow, distinct furrow.

## 252. ABEONA (?) SERRATA, Distant.

*Abeona serrata*, Dist., Trans. Ent. Soc., p. 350, (1887).

Above ochraceous, thickly, darkly and coarsely punctate: connexivum reddish ochraceous, with black linear spots near bases and apices of segmental sutures: antennæ 4-jointed, 1—2 joints dark ochraceous, 3—4 joints luteous, apical halves blackish; second joint very long, as long as 3—4 joints taken together, 3—4 joints sub-equal: juga much longer than the tylus, but notched in front: lateral margins of the pronotum serrate, lateral angles moderately and broadly produced and obtusely bispinose: a small blackish foveate spot on each basal angle of the scutellum: membrane brownish ochraceous: body beneath with the head, legs, rostrum and sternum ochraceous, the abdomen brownish ochraceous: head with a black linear spot on each side of the base of the antennæ: prostethium with some scattered black punctures: rostrum just passing the intermediate coxæ: tibiæ sulcated above: abdomen obtusely sulcate to about the fourth segment (*Dist.*). Long, 14; exp. angl. pron., 9 mill.

Reported from Bombay.

## 253. ABEONA GLADIATORIA, Stål.

*Abeona gladiatoria*, Stål, En. Hem. v, p. 102, (1876).

♀. A large, remarkable species: very pale sordid flavescent, shining especially beneath, above rather densely, distinctly and equally punctured ferruginous-fuscous, beneath to a very great part impunctate; third joint of the antennæ at the apex, the extreme margin and a small lower line on the head before the eyes, also the acute apex of the apical angles of the ventral segments, black: membrane somewhat colourless, basal angle and an apical spot, fuscous: wings infusate at the apex, dorsum of the abdomen somewhat sanguineous in the middle. Lateral margins of the pronotum callous before the middle, levigate, rounded,



having the lateral part produced in a gradually narrowed process, slender at the apex, and acuminate, turning outwards and slightly forwards: pronotum marked by a black-violaceous line within the smooth part of the lateral margins; anterior margin of lateral process carinately-elevated and black-violaceous, corium punctured violaceous anteriorly within the costal margin; scutellum marked on the basal angles with a small brassy-green spot: pectus near the coxæ with three punctiform black spots; pro- and meta-stethium punctured posteriorly: venter finely aciculate, with a very obtuse, levigate median ridge: connexivum punctured violaceous-fuscous, the extreme margin levigate (*Stål*). ♀, Long, 21; broad, 10; exp. horns of pron. 14, mill.

Reported from India.

#### Div. RHYNCHOCORARIA, *Stål*.

En. Hem. v, p. 67, (1876).

*a. b.* as in *Hoplistoderaria*, (p. 66).

*c.* Mesostethial ridge and metastethium highly elevated, briefly continued, the ridge extended anteriorly in a free lamina produced between and generally to a distance before the first pair of coxæ, anteriorly generally high: basal tubercle of the venter rather strongly elevated, anteriorly angulated, quiescent in the posterior sinus of the metastethium, the apical angles of the sixth abdominal segment generally acute, or produced in a long tooth; sixth ventral segment, in ♀, strongly sinuated in the middle before the anal valvules, the median part of the segment therefore generally shorter than the lateral part: tibiæ obtusely rounded and generally without a furrow, very rarely furnished with a narrow upper furrow: posterior margin of the pronotum generally sinuated.

#### Genus CUSPICONA, Dallas.

List Hem. i, 296, (1851); Walker, Cat. Het. ii, p. 2, (1867): *Stål*, *Ofvers. K. V.-A. Förh.*, p. 521, (1867); p. 637, (1870); En. Hem. v, p. 68, 102, (1876).

Body obovate or oval: head moderate, tylus as long as the juga: ocelli minute, placed near the inner angle of the eyes; rostrum moderate, second joint about as long as or longer than the third; antennæ 5-jointed, about as long as the head and the pronotum taken together, basal joint shortest, not reaching the anterior margin of the head, second joint longer than the third, 4—5 joints nearly equal, as long or longer than the second, sometimes the fourth, sometimes the fifth longest: pronotum not transversely impressed, posterior angles not or but very slightly produced, obtuse: plate of the mesostethial ridge reaching but not produced beyond the anterior margin of the prostethium: tibiæ rounded, only towards the apex flattish or somewhat furrowed; tarsi 3-jointed.

254. *CUSPICONA CURTISPINA*, Stål.

*Hoffmanseggella curtispina*, Stål, Stettin Ent. Zeit., xxix, p. 144, (1861): Walker, Cat. Het. ii, p. 399, (1867).

*Cuspicona curtispina*, Stål, En. Hem. v, p. 103 (1876).

♀. Pale, somewhat sordid flavescent, shining, above distinctly punctured: lateral angles of pronotum produced outwards, somewhat obtuse at the apex, moderately prominulous: apex of the posterior angles of the last ventral segment, rufescent: 2—3 joints of the antennæ of equal length: ventral segments unarmed: rostrum extending hardly beyond the last coxæ (*Stål*). Long, 10; broad,  $5\frac{1}{2}$  mill.

Reported from Java, Burma (?).

255. *CUSPICONA VIRESCENS*, Dallas.

*Cuspicona virescens*, Dallas, List Hem. i, p. 296 (1851); Walker, Cat. Het. ii, p. 379 (1867): Stål, En. Hem. v, p. 103 (1876).

♀. Above pale green, finely and thickly punctured: eyes black: pronotum with the lateral margins yellowish, the lateral spines acute, somewhat turned upwards and a little recurved towards the apex, the extreme tip black: membrane nearly colourless, transparent: body beneath testaceous, the pectus and sides of abdomen rather thickly punctured, sternal ridge rounded in front: legs testaceous, tibiæ becoming brownish towards the apex; tarsi brownish: rostrum testaceous: antennæ ferruginous, basal joint testaceous (*Dallas*). Long,  $10\frac{1}{2}$  mill.

Reported from Java, Burma.

256. *CUSPICONA PLAGIATA*, Walker.

*Cuspicona plagiata*, Walker, Cat. Het. ii, p. 379 (1867).

Testaceous, elongate-oval, minutely punctured, a little paler beneath: head elongate, smooth, transversely and finely striated, bordered with black and with black sutures between the juga and tylus which are of equal length; rostrum extending to the hind coxæ, tip black; antennæ black, slender, about half the length of the body, first joint not extending to the front of the head, second joint very much shorter than the third: pronotum mostly smooth in front, posterior angles forming two long, acute, black-striped, directly diverging spines: pectoral ridge very deep, especially in front of the first coxæ where it is much rounded: abdomen with a very large, purple, apical patch, beneath very slightly ridged, with black spines along each side, the basal spine extending to the last coxæ: legs rather slender: membrane aeneous-brown: wings cinereous, veins black (*Walker*). Long,  $16\frac{3}{4}$  mill.

Reported from N. India.

## 257. CUSPICONA SMARAGDINA, Walker.

*Cuspicona smaragdina*, Walker, Cat. Het. ii, p. 380 (1867).

Deep green, elongate-oval, roughly punctured, luteous and bordered with pale green beneath: head on each side with a luteous streak, which includes a red streak; tylus hardly extending beyond the juga: rostrum green, extending to the second ventral segment; tip black: antennæ black, slender, green towards the base, rather more than half the length of the body; first joint extending nearly to the front of the head; third much longer than the second, much shorter than the fourth; fifth a little shorter than the fourth: pronotum mostly smooth in front; posterior angles forming two long acute spines, which are slightly ascending and inclined forwards; a luteous dot on the hinder base of each spine: pectoral ridge shallow: legs pale green: membrane cinereous (*Walker*). Long,  $14\frac{1}{2}$ —15 mill.

Reported from Burma: the Indian Museum has specimens from Assam.

Add:—*C. antica*, Voll., Versl. Ak. Amst. Naturskun. ii (2), p. 188, (1868), from India.

## GENUS RHYNCHOCORIS, Westwood.

Pt., Hope, Cat. Hem. i, p. 29 (1837):—*Rhynchocoris*, Am. & Serv., Hist. Nat. Ins. Hém. p. 152 (1843); Dallas, List Hem. i, p. 198 (1851); Walker, Cat. Het. ii, p. 392 (1867); Stål, Ofvers. K. V.-A. Förh., p. 521 (1867); p. 637 (1870); En. Hem. v, p. 68, 103 (1876).

Body oblong-ovate, attenuated posteriorly: tylus a little shorter than the juga: rostrum 4-jointed, very long, reaching almost the apex of the abdomen, first joint very small, remaining three nearly equal: antennæ entirely, or to a very great part, black, elongate, very slender, 5-jointed, first joint very short, 2—4 joints gradually increasing in length, fifth as long as the third: pronotum broad, within the entirely somewhat elevated or callous anterior margin, furnished with a simple continued row of punctures; basal margin sinuate, posterior angles distinct, covering basal angles of scutellum, lateral angles much produced: apical angles of the abdominal segments prominulous in a large or somewhat large tooth: scutellum large, triangular, covering almost half of the abdomen, rounded at the apex: membrane with 9 straight longitudinal veins: feet slender: prostethium unarmed: mesostethium much ridged, produced before the prostethium: metastethium somewhat elevated in the middle, posteriorly bifid. Type, *R. humeralis*, Thunb.

## 258. RHYNCHOCORIS HUMERALIS, Thunberg.

*Cimex humeralis*, Thunb., Nov. Ins. Spec. ii, p. 40, t. 2, f. 54 (1783).

*Cimex hamatus*, Fabr., Mant. Ins. ii, p. 286 (1787); Ent. Syst. iv, p. 104 (1794) Stoll, Punaies, p. 80, t. 20, f. 135 and 104, t. 27, f. 186 (1788).

*Edessa hamata*, Fabr., Syst. Rhyng. p. 147 (1803).

*Acanthosoma hamata*, Burm., Handb. Ent. ii (i), p. 359 (1835).

*Rhynchocoris humeralis*, Dallas, List. Hem. i, p. 302 (1851); Walker, Cat. Het. ii, p. 392 (1867); Stål, Hem. Fabr. i, p. 35 (1868); En. Hem. v, p. 104 (1876); Distant, A. M. N. H. (5 s.) iii, p. 45 (1879).

Antennæ black: rostrum as long as the body: the body virescent. (or flavescent), head and anterior part of pronotum more flavescent: pronotum acutely spinose, spine subarcuate hindwards, tip black: sternum porrect, obtuse, compressed: abdomen flavescent with a line of black dots on each side: margin of abdomen serrate, with five acute, small, black teeth: feet flavescent (*C. hamatus*, Fabr.). Altogether olive-green, yellow on the venter; spines of pronotum punctured black; corners of the abdominal segments acute, black. The Assam specimens are brown, and, in some cases, the scutellum is olive-green and also part of the pronotum. Long, 21; breadth of pronotum,  $14\frac{1}{2}$  mill.

Reported from Siam, India, Silhat. The Indian Museum has specimens from Sibsagar (Assam) and Sikkim (mihi), not uncommon.

## 259. RHYNCHOCORIS SERRATUS, Donovan.

*Cimex serratus*, Donovan, Ins. India, Hem., t. 8, f. 2 (1800): Stoll, Punaies, p. 10, t. 1, f. 3 (1788).

*Rhynchocoris serratus*, Am. & Serv., Hist. Nat. Ins. Hém., p. 152, t. 3, f. 2 (1843); Dallas, List. Hem. i, p. 302, (1851); Walker, Cat. Het. ii, p. 392 (1867); Stål, En. Hem. v, p. 104 (1876).

Pronotum with acute spines, testaceous: hemelytra greenish: abdomen serrate (*Don.*).

♀. Olive-green: posterior portion of pronotum and its posterior angles, punctured black, the latter almost entirely black: head above, with two longitudinal lines and one on each side between the base of the antennæ and the eyes, black: membrane hyaline nacreous brown: antennæ black, first joint yellow beneath: feet of the same colour as the body, spotted black (*Am. & Serv.*). Long, 20 mill.

Reported from Malabar, Malacca, Java, Philippines.

## Div. TROPICORARIA.

En. Hem. v, p. 68 (1876).

a. as in *Hoplistoderaria* (p. 66).

b. Entire anterior lateral margins of the pronotum either anteriorly

serrated, denticulated or crenulated, acute or somewhat so: lateral angles of pronotum produced or prominulous: tibiæ above distinctly sulcated or flat and margined.

Genus TROPICORIS, Hahn.

Wanz. Ins. ii, p. 52 (1834): Stål, Ofvers. K. V.-A. Förh., p. 518, (1867); En. Hem. v, p. 69, 105 (1876).

Body elongate-ovate: head gradually narrowed, with the lateral margins anteriorly more or less rounded, entire, not sinuate; juga and tylus about of equal length; antennæ 5-jointed, almost three-fourths the length of the body, the first joint shortest, the second somewhat shorter than the fourth or fifth, the third longest, the fourth as long as the obtusely rounded fifth: rostrum 4-jointed, second joint longest, last shortest; ocelli in a line with the eyes, small: posterior angles of pronotum, acutely produced; anterior margin of lateral process gradually rounded, or forming an angle towards the apex: hemelytra with the costal margin of the corium anteriorly straight, thence slightly rounded, a straight longitudinal vein on the inner margin, and a similar from the same source at the base, close to the outer margin; membrane with a broad limbus and some 5—7 veins: base of venter sometimes unarmed, sometimes tuberculate, and sometimes very briefly spinose.

260. TROPICORIS LÆVIVENTRIS, Stål.

*Tropicoris læviventris*, Stål, En. Hem. v, p. 105 (1876).

♀. Pale flavescent, above distinctly punctured black; punctures on anterior part of pronotum and on anterior part of costal area aenescent: membrane and wings sordid hyaline: dorsum of abdomen weakly croceous: connexivum fusciscent-testaceous, punctured (two apical segments excepted), segments with a pale marginal spot: venter levigate, spiracula black. As to form of pronotum and stature, somewhat like *T. rufipes*, Linn., from which it differs in its larger size, paler colour, finer punctuation on the dorsum, entire juga distant, lateral process of pronotum shorter, more obtuse, not reflexed, and anterior lateral margins very slightly sinuated, scutellum also in the apical part punctured black, in the marking on the dorsum of the abdomen and the connexivum, the venter impunctate, pro- and meta-stethium posteriorly remotely sprinkled with concolorous punctures, not black, corium sprinkled with small, somewhat rounded, impunctate spots: feet not marked: rostrum reaching the base of the venter, second joint somewhat longer than the third: anterior angles of pronotum sub-prominulous outwards in a small tooth: furrow of the orifices longer about by half than the first joint of

the antennæ: head posteriorly with a lateral spot, and in the middle with a larger levigate, somewhat quadrate spot, which has a double row of punctures in the middle (*Stål*). Long, 18; broad, 10 mill.

Reported from India.

#### 261. TROPICORIS PUNCTIPES, Stål.

*Tropicoris punctipes*, Stål, En. Hem. v, p. 106 (1876).

♂. Above lurid and rather densely punctured fuscous; beneath with the antennæ, rostrum and feet pale sordid flavescent, the feet sprinkled fuscous: pectus and venter remotely punctured fuscous; median ridge on the venter broad, very obtusely rounded, levigate: membrane infusate: dorsum of abdomen sanguineous: connexivum punctured, fuscous, externally aenescent-fuscous, segments marked with a sordid flavescent median band: ventral spiracula black. ♂. with the genital segment broadly and rather deeply sinuated at the apex, apical margin prominulous on both sides at the sinus in a small dentiform tubercle, apical angles of the sixth segment of the abdomen somewhat obtuse, not rounded. Stature and punctuation like *T. rufipes*, Linn. from which it differs in the lurid colour of the entire dorsum, apex of scutellum concolorous and punctured, juga distant, anterior angles of pronotum not so much prominulous forwards, lateral process truncated at the apex, or somewhat sinuately truncated, apical angles equal, basal spine of venter somewhat slender, somewhat prominulous before the metastethium, rostrum somewhat shorter, reaching somewhat the apex of the second segment of the venter, also in the form of the genital segment in ♂. Furrow of the orifices short, shorter than the first joint of the antennæ: head posteriorly levigate with a spot at the eyes: second joint of the rostrum distinctly somewhat longer than the third (*Stål*). Long, 11; broad, 7 mill.

Reported from India.

#### Genus AGATHOCLES, Stål.

En. Hem. v, p. 69, 106 (1876).

Head broad, somewhat short, broadly rounded at the apex, lateral margins posteriorly sinuate, parallel before the sinus, rounded at the apex; second joint of rostrum much longer than the third; anterior margin of the lateral process of the pronotum straight up to the apex; entirely densely and distinctly punctured, anterior margin narrowly smooth behind the vertex: venter rather strongly convex. In *Amyntor*, Stål, the head is long, triangular, gradually narrowed, lateral margins anteriorly abruptly sinuate: anterior lateral margins of pronotum posteriorly straight: venter unarmed at the base.

## 262. AGATHOCLES LIMBATUS, Stål.

*Agathocles limbatus*, Stål, En. Hem. v, p. 106 (1879).

♂. Above lurid, rather densely and distinctly punctured black, and sprinkled between the punctures with small pallescent spots or protuberances; beneath black: extremity of the anterior lateral margins of the pronotum, lateral limb of the prostethium and broad limb of the venter, sordid rufescent. ♂. with the sixth ventral segment anteriorly rounded, truncated at the apex, apical angles slightly prominulous, straight. Head posteriorly with a levigate spot at the eyes, margins posteriorly sinuated, parallel before the sinus in the middle, anteriorly rounded: anterior margin of the pronotum very narrowly levigate behind the vertex; behind the eyes broadly truncated; anterior angles with a small tooth turning outwards; anterior lateral margins somewhat straight, somewhat sinuated in the middle, very narrowly reflexed, obsolete and obtusely crenulated before the middle; lateral angles straight, very slightly prominulous: lateral margin of the apex of the scutellum slightly reflexed: pectus remotely and distinctly punctured: abdomen broader than the pronotum, fuscous-violeaceous on the dorsum: venter punctulate, the middle and the rufescent limb levigate: connexivum fuscous: first joint of antennæ black, second lurid, more than twice longer than the first: rostrum reaching the base of the venter, lurid: feet fuscous; coxæ, trochanters, base of femora, and the tarsi, lurid: membrane fuscous: wings sordid hyaline, very slightly infuscate towards the apex (*Stål*). Long, 20: breadth of abd. 12 mill.

Reported from India, Silhat.

## Genus AMYNTOR, Stål.

Ofvers. K. V.-A. Förh. p. 519 (1867): En. Hem. v, p. 69, 107 (1876).

Head acutely triangular, gradually narrowed forwards; juga much longer than the tylus, contiguous before the tylus, a little hiscent and rounded at the extreme apex, lateral margins acute, anteriorly sinuate, prominulous behind the sinus in a somewhat obtuse angle, bucculæ somewhat continued through, moderately elevated; ocelli twice as far from each other as from the eyes; rostrum scarcely reaching the last coxæ, first joint extending a little beyond the bucculæ, second joint longer than the third; antennæ moderate, first joint not reaching the apex of the head, third joint almost twice as long as the second: anterior lateral margins of pronotum hardly sinuate, serrulate, lateral angles acute, rounded at the extreme apex, a little prominulous: costal margin of corium moderately rounded: abdomen rounded on both sides, apical angles of segments very slightly prominulous: venter unarmed at the base:

furrow of the odoriferous apertures not so long, abruptly abbreviated :  
tibiæ broadly sulcate (*Stål*).

263. *AMYNTOR* *OBSCURUS*, Dallas.

*Halys* (*Dichelops*?) *obscurus*, Dallas (nec Westw.), Trans. Ent. Soc. v, p. 188, t. 19, f. 3, a-b, (1849).

*Amyntor obscurus*, Stål, En. Hem. v, p. 107 (1876).

♂, ♀. Body ovate : above brown, obscure, very thickly punctured : pronotum with the lateral angles somewhat prominent, margins pale or yellow : head, pronotum, and scutellum slightly clouded with yellowish : a reddish tint on the hemelytra ; membrane transparent, with a pitchy black spot at the internal basal angle, (this spot is concealed by the tip of the scutellum when the wings are closed) : margins of the abdomen projecting considerably beyond the hemelytra on each side : venter, pectus, legs, rostrum, and antennæ reddish or testaceous brown ; venter smooth, shining, the disc sparingly, the lateral margins very thickly and finely punctured : pectus sparingly punctured, more thickly so at the sides : legs punctured with black ; the tarsi darker : rostrum darker at the tip : antennæ with the two last joints black, except at the base (*Dallas*). Long,  $14\frac{3}{4}$ —16 mill.

Reported from Sikkim.

Genus *COMPASTES*, Stål.

Ofvers. K. V.-A. Förh., p. 519 (1867) ; En. Hem. v, p. 69, 107 (1876).

Head flat, somewhat narrowed forwards, rounded at the apex ; juga longer than the tylus, somewhat hiscent at the apex, lateral margins acute, flattened, posteriorly very slightly sinuate ; bucculæ continued through, moderately elevated ; ocelli a little over twice more distant from each other than from the eyes ; rostrum extending somewhat beyond the last coxæ, first joint extending a little beyond the bucculæ, second joint longer than the third ; antennæ slender, first joint not reaching the apex of the head, second somewhat shorter than the third : lateral margins of pronotum somewhat obtuse, denticulate, lateral angles produced in a stout, broad, truncate, process, obliquely turning forwards, dentate on the margin ; anterior angles acutely prominulous : costal margin of corium anteriorly sinuate, thence much rounded before and at the middle, straight towards the apex : veins of membrane sparingly furcate : furrow from the odoriferous apertures somewhat long : abdomen roundly amplified before the middle, apical angles of segments a little prominulous ; base of venter unarmed : tibiæ broadly sulcate (*Stål*).

Type *Cimex boutanicus*, Dallas.



## 264. COMPASTES BOUTANICUS, Dallas.

*Cimex* ? *boutanicus*, Dallas, Trans. Ent. Soc. v, p. 190, t. 19, f. 4 (1849).

*Compastes boutanicus*, Stål, En. Hem. v, p. 107 (1876).

♀. Body ovate, above brown, obscure, thickly and strongly rugose-ly punctulate : head rather thickly punctured, nearly as broad in front as behind, and with the anterior margin strongly notched ; slightly wrinkled posteriorly : eyes pitchy ; ocelli yellowish : pronotum with the enlarged lateral angles considerably directed forwards, with five teeth at their apex, of which the third and fourth from the front are rounded, the others acute : a strong spine at each anterior angle of the pronotum, immediately behind the eyes, and the antero-lateral margins are strongly serrated : scutellum rather elongated, narrower towards the apex, which is less punctured than the rest of the body and margined with yellowish : hemelytra rather paler than the rest of the surface, thickly and coarsely punctured, and somewhat rugose ; membrane brown : the sides of the abdomen scarcely project beyond the hemelytra : abdomen beneath reddish-brown, smooth, impunctate : pectus paler with numerous scattered black punctures which are larger and closer together on the prostethium : a large dull wrinkled patch on each side of the meta- and meso-stethium : coxæ smooth ; legs yellowish brown, mottled with reddish-brown ; the 2-jointed tarsi are rather paler : antennæ pale yellowish-brown, the basal joint and the others at base and apex, paler : rostrum pale brown with the apex darker and the tip of the basal joint, pitchy black (*Dallas*). Body long, including membrane, 20 mill.

Reported from Sikkim (mihi).

## 265. COMPASTES TRUNCATUS, Distant.

*Compastes truncatus*, Distant, Trans. Ent. Soc. p. 351, t. 12, f. 10 (1887).

Brownish-ochraceous, covered with coarse and darker punctures ; connexivum luteous, with blackish spots at bases and apices of sutures ; membrane brownish, veins darker : 1—3 joints of antennæ brownish, minutely darker at the apices ; second joint longer than the third : pronotum with lateral margins obtusely crenulate, the lateral angles produced into broad and apically truncated spines : body beneath and legs ochraceous, punctured with brownish : rostrum ochreous, apex pitchy, extending to second abdominal segment : ventral spine reaching intermediate coxæ (*Dist.*). Long, 16 ; exp. angl. pron. 10 mill.

Reported from Sikkim (mihi).

## 266. COMPASTES SPINOSUS, Distant.

*Compastes spinosus*, Distant, Trans. Ent. Soc. p. 351, t. 12, f. 11 (1887).

Above brownish, coarsely and darkly punctate : pronotum rugulose,

with a median longitudinal luteous line, the lateral margins with three prominent spines, the lateral angles broadly produced and somewhat obtusely spined posteriorly: membrane pale fuscous: body beneath brownish and darkly punctate: legs ochraceous, mottled and sprinkled brownish; sublateral margins of the sternum bronzy: rostrum ochraceous, apex pitchy, extending beyond the last coxæ (*Dist.*). Long, 17: exp. angl. pron. 8 mill.

Reported from Sikkim.

#### GENUS PRIONOCHILUS, Dallas.

*Rhaphigaster*, subg. *Prionochilus*, Trans. Ent. Soc. v, p. 191 (1849); *Prionochilus*, Stål, Ofv. K. V.-A. Förh., p. 519 (1867); En. Hem. v, p. 69, 107 (1876). Includes *Zelia*, Walker, Cat. Het. ii, p. 406 (1867).

Head flat above, narrowed anteriorly, the juga passing the tylus, and united in front of it; apex of head rounded, with a very slight notch in the middle; eyes rather small, very slightly prominent, touching the anterior margin of the pronotum; ocelli small, situated rather behind the eyes, and nearer to them than to one another; antennæ 5-jointed, about half as long as the body; first joint short, not reaching the anterior margin of the head; the other joints gradually increasing in length towards the apex; 4—5 joints thickest, fourth slightly compressed; rostrum 4-jointed, reaching the base of the ventral spine, the first joint short, as long as the head, inclosed entirely in a groove, which reaches the base of the head; 2—3 joints equal, longer than the first; fourth as long as the first: pronotum declined anteriorly; the anterior margin strongly emarginate, almost in a semicircle, for the reception of the head; the lateral angles very prominent, acute and curved forwards, their points reaching beyond the line of the anterior angles; the anterolateral margins are strongly serrated, and there is a distinct tooth behind each lateral angle: scutellum long, passing the middle of the abdomen, the apex rounded and narrowed; membrane reaching beyond the apex of the abdomen, with eight longitudinal veins, of which the 3—5 from the inner margin spring from a basal cell; the 6—7 are united at the base and the eighth is very short: abdomen extending a little beyond the hemelytra on each side; beneath strongly ridged, with a strong basal spine, which extends forwards as far as the middle of the space between the intermediate and first pairs of legs: vulvar apparatus as in *Rhaphigaster*, &c.: mesostethium with a slight ridge in the middle: legs rather slender, the posterior longest: tibiæ grooved on the outside, and fringed with small stiff hairs, especially towards the apex: tarsi 3-jointed, pilose, basal and terminal joints equal; second very short: claws and pulvilli moderate (*Dallas*).

## 267. PRIONOCHILUS OCTOPUNCTATUS, Dallas.

*Rh. (Prionochilus) 8-punctatus*, Dallas, Trans. Ent. Soc. v, p. 192, t. 19, f. 5 a—c. (1849).

*Prionochilus octopunctatus*, Stål, En. Hem. v, p. 107 (1876); Distant, A. M. N. H. (5 s.) iii, p. 45 (1879).

♀. Ovate, testaceous brown, opaque, beneath paler, above thickly and finely punctured with black: pronotum strongly rugosely-punctate, with four black dots arranged in a transverse line across the disc, from the base of one lateral angle to the other; the marginal serrations yellowish: scutellum less closely punctured than the pronotum, distinctly rugose, with four black dots at the base, placed two close to the posterior margin of the pronotum about the same distance from each other as from the lateral angles of the scutellum, the two behind these, forming with them a small square; on each side of the apex of the scutellum is a small yellow impunctate spot: hemelytra with the punctures arranged somewhat nebularly; a small impunctate spot on the disc, a little behind the middle: membrane transparent with a brownish tinge: ventral spine brown: legs, rostrum and antennæ brownish testaceous; the fourth joint of the antennæ, except its base, the fifth joint entirely, and the apex of the fourth joint of the rostrum, black (*Dallas*). Long, 22; breadth of pronotum,  $12\frac{1}{2}$  mill.

Reported from Sikkim.

## Genus PRIONACA, Dallas.

List. Hem. i, p. 291 (1851); Walker, Cat. Het., ii, p. 375 (1867); Stål, En. Hem. v, p. 69, 107 (1876).

Body short and broad: head nearly as broad as long, rounded and entire in front, juga meeting beyond the tylus; ocelli minute placed near the posterior angles of the eyes and close to the anterior margin of the pronotum: antennæ with the basal joint robust, not reaching the apex of the head; second joint slender, very long, twice the length of the head: rostrum not reaching the posterior coxæ, inserted on a level with the base of the antennæ at some distance from the front of the head; basal joint short, not passing the base of the head; second longest; third longer than the first, a little shorter than the second, fourth shortest: pronotum with the lateral angles produced into strong acute spines, the lateral margins distinctly crenulated: scutellum very little longer than broad, triangular, with the lateral margins waved, the apex rounded: coriaceous portion of the hemelytra much longer than the membrane, with the apical margin rounded; membrane with longitudinal veins: ventral spine not reaching the intermediate coxæ: sternum with a distinct median furrow for the reception of the rostrum (*Dallas*).

## 268. PRIONACA LATA, Dallas.

*Prionaca lata*, Dallas, List. Hem. i, p. 291 (1851); Walker, Cat. Het. ii, p. 375 (1867); Stål, En. Hem. v, p. 107 (1876); Distant, A. M. N. H. (5 s.) iii, p. 45 (1879).

♂. Above yellowish, very thickly punctured with black: pronotum with a large, slightly elevated, impunctate yellow spot on each side near the lateral margins before the middle: corium with a large, impunctate, yellow spot about the middle of the disc; membrane brownish, somewhat opaque, with the inner basal angle dark brown: body beneath fulvous, the pectus brighter than the abdomen which is somewhat opaque, impunctate, with the middle of the 3—5 segments, brown; the lateral margins brownish; the first segment and the ventral spine concolorous with the pectus which is slightly shining, more or less punctured with brown, with the antero-lateral margins and the lateral spines black: legs, rostrum, and the two basal joints of the antennæ fulvous (Dallas). Long, 13 mill.

Reported from Java, Silhat (mihi).

## 269. PRIONACA EXEMPTA, Walker.

*Prionaca exempta*, Walker, Cat. Het. iii, p. 569 (1868); Distant, A. M. N. H. (5 s.) iii, p. 45 (1879).

Testaceous, elliptical, thickly and minutely punctured: head rounded in front; fore part with brown punctures; hind part smooth; juga and tylus of equal length; eyes piceous not prominent; rostrum extending to the last coxæ, apex black; antennæ slender; first joint extending nearly to the front of the head; second much shorter than the third; fourth a little longer than the third: pronotum smooth, except the fore parts on each side where the punctures are brown; lateral angles acute, elongated, shorter than their breadth at the base; scutellum hardly ridged, attenuated towards the tip which is slightly acute: posterior angles of the apical abdominal segment elongated; ventral spine extending to the intermediate coxæ: legs slender: hemelytra with black punctures along the costa; membrane and wings pellucid (Walker). Body, long, 17—19 mill.

Reported from N. India, Sikkim (mihi), rare.

## Genus PLACOSTERNUM, Am. &amp; Serv.

Hist. Nat. Ins. Hém., p. 174 (1843); Dallas, List Hem. i, p. 351 (1851); Walker, Cat. Het. iii, p. 486 (1868); Stål, Ofvers. K. V.-A. Förh, p. 519 (1867); En. Hem. v, p. 69, 107 (1876).

Lateral margins of the head before the middle gradually rounded

and entire; juga not long, longer than the tylus, anteriorly converging; rostrum not extended behind the last pair of feet: first joint shorter than the much elevated bucculæ, second joint shorter, or somewhat so, than the third: ocelli close to the eyes: pronotum broad, lateral margins in part denticulate, posterior angles produced, straightly truncate at the tip: meso-stethial ridge robust, more or less prominulous anteriorly between the first pair of coxæ: meta-stethium elevated, sexangular, posteriorly sinuate, receiving the anteriorly rounded, depressed, basal tubercle of the venter: membrane rather transparent, veins somewhat regular: furrow from the odoriferous aperture produced to a considerable distance with the apical ridge or wrinkle: first joint of tarsi not so short, apical joint of last pair somewhat compressed or tectiform.

#### 270. PLACOSTERNUM TAURUS, Fabricius.

*Cimex taurus*, Fabr., Spec. Ins. ii, p. 344 (1781); Mant. Ins. ii, p. 283 (1787); Ent. Syst. iv, p. 91 (1794); Stoll, Punaises, p. 25, t. 5, f. 34 (1788) ?

*Edessa taurus*, Fabr., Syst. Rhyng. p. 145 (1803).

*Placosternum taurus*, Am. & Serv., Hist. Nat. Ins. Hém. p. 174 (1843); Dallas, List, Hem. i, p. 351 (1851); Herr. Schäff., Wanz. Ins. ix, p. 305, f. 1002 (1853); Walker, Cat. Het. iii, p. 406 (1868); Stål, En. Hem. v, p. 107 (1876); Distant, A. M. N. H. (5 s.) iii, p. 45 (1879).

Body large; above altogether grey, below flavescent, feet punctured black: pronotal processes porrect, thick, compressed, very obtuse (*C. taurus*, Fabr.). *P. taurus*, Am. & Serv., is described as greyish yellow, spotted brown: venter yellowish: two brown rings at the end of the femora, the rest of the feet, also the antennæ, punctured black. Long, 21 mill.

Reported from Java, East. Arch., China, Siam, Singapore, Ceylon, India, Coromandel, Bombay, Silhat, Assam: the Indian Museum has specimens from Sikkim (mili).

#### 271. PLACOSTERNUM CERVUS, Distant.

*Placosternum cervus*, Dist., Trans. Ent. Soc. p. 352 (1887).

Allied to *P. taurus* by the lateral angles of the pronotum being profoundly bisinuated at their apices, but much smaller than that species and having the lateral angles much more developed, being broadly and strongly produced upwards and forwards and deeply notched at each edge of the apex: the lateral angles are not simply crenulate, but shortly spinose (*Dist.*). Long, 19; exp. angl. pron. 17 mill.

Reported from Sadiya (Assam).

## 272. PLACOSTERNUM ALCES, Stål.

*Placosternum alces*, Stål, En. Hem. v, p. 107 (1876).

♀. Very like *P. taurus*; differs in having the lateral process of the pronotum longer, truncate at apex, with the apical angles prominulous in a small tooth: scutellum convex at the base, depressed behind the posteriorly rounded and gradually inclined convex part (*Stål*). Long, 21; broad, 12; exp. horns, 16 mill.

Reported from Ceylon, Calcutta (?).

## 273. PLACOSTERNUM DAMA, Fabricius.

*Cimex dama*, Fabr., Ent. Syst. iv, p. 92 (1794); Wolff, Ic. Cim. i, p. 6, t. 1, f. 6 (1800).

*Edessa dama*, Fabr., Syst. Rhyng., p. 147 (1803).

*Placosternum dama*, Stål, Hem. Fabr. i, p. 34 (1868); En. Hem. v, p. 108 (1876).

♂, ♀. Sordid yellow-whitish, punctulate ferruginous-fuscous: 1—3 joints of antennæ also basal half of fourth joint, sprinkled fuscous-ferruginous, last ferruginous, pallid at the base: membrane grey, veins fuscous: feet sprinkled ferruginous: anterior lateral margins of the pronotum somewhat sinuated, obtusely crenulated, lateral angles obtusely produced, obliquely truncated at the apex and anteriorly sinuate; apical margin of the corium very slightly sinuated outwards. The ♂ has the anal segment deeply subsemicircularly sinuated at the apex, apical angles acute. Close to *P. taurus*, Fabr., but is smaller, lateral angles of pronotum not so long and less deeply produced, more obliquely truncated at the apex and unisinuate, anterior lateral margins somewhat straight before the middle, scarcely rounded, more obsoletely and more obtusely crenulated (*Stål*): Long, 16—19; broad, 10—11 mill.

Reported from India: Dikrang (Assam).

## Genus AMASENUS, Stål.

Trans. Ent. Soc., p. 601 (1863); Ofvers. K. V.-A. Förh., p. 519 (1872); En. Hem. v, p. 69, 108 (1876).

Body oval depressed: juga longer than the tylus, somewhat distant; rostrum reaching base of third ventral segment; antennæ 5-jointed, somewhat short, second joint shorter than the third: lateral margins of pronotum crenulate: scutellum posteriorly produced rather far, sides of produced part parallel: sterna not elevated; posterior feet distant (*Stål*).

## 274. AMASENUS CORTICALIS, Stål.

*Amasenus corticalis*, Stål, Trans. Ent. Soc. (3 s.) i, p. 602 (1863); Walker, Cat. Het. iii, p. 487 (1868); Stål, En. Hem. v, p. 108 (1876).

♀. Greyish-stramineous, remotely punctulate fuscous: large basal patches on pronotum and some scattered, confluent patches on corium

subæneous-black : lateral streak on pro-stethium obscurely æneous : band near the apex of the femora and two bands on the tibiæ, fuscous : head somewhat lobate on both sides before the eyes, slightly sinuate before the lobe, sides thence somewhat parallel, juga very obliquely sinuately truncate towards the apex : lateral angles of pronotum prominent, somewhat sinuately truncate at the apex, anterior lateral margins sinuate in the middle, rounded and crenulated before the sinus : scutellum slightly bigibbous at the base (*Stål*). Long, 24 ; broad, 13 mill.

Reported from Ligor, Malacca, Assam.

*Species of doubtful position.*

275. *Pentatoma bengalensis*, Westwood, Hope, Cat. Hem. i, p. 36 (1837) ; *Stål*, En. Hem. v, p. 126 (1876).

Fulvescent, punctured black ; head with black lines between the eyes ; antennæ fuscous ; anterior part of pronotum with a submarginal line of black dots and other dots arranged on both sides in the shape of an irregular triangle : scutellum with a small levigate space on both sides at the base : apical spot on corium, rufous : membrane hyaline : abdomen beneath with a median line of spots and a submarginal line on both sides, black (*Westw.*). Long, 9—10 mill.

Reported from Bengal.

276. *Pentatoma albo-notata*, Westwood, Hope, Cat. Hem. i, p. 37 (1837) ; *Stål*, En. Hem. v, p. 126 (1876).

Narrower than *P. bengalensis*, *Westw.*, somewhat parallel ; black, punctured : band on the disc of the pronotum abbreviated : spots on the scutellum of an irregular Y-shape, large triangular spot on corium at the apex, coxæ, intermediate tibiæ in the middle, and median band on the abdomen, white : extreme tip of membrane, hyaline (*Westw.*). Long body, 8—9 mill.

Reported from Gambia (*Westw.*) ; Bengal (*Stål*).

277. *Pentatoma unicolor*, Westwood, Hope, Cat. Hem. i, p. 41 (1837) ; *Stål*, En. Hem. v, p. 127 (1876).

Allied to *Pentatoma juniperina*, *Fabr.*, but form of pronotum distinct : sides of pronotum angularly prominent, subacute : above leek-green, somewhat opaque, punctured : membrane fuscous ; body beneath with the feet paler ; antennæ green, two last joints, fuscous (*Westw.*). Long, 12-13 mill.

Reported from Bengal. *Westwood* (p. 38, l. c.) gives this name to a second species from Java which is one with *Nezara viridula*, *Linn.*

278. *Pentatoma indica*, Westwood, Hope, Cat. Hem. i, p. 42 (1837) ; *Stål*, En. Hem. v, p. 127 (1876).

Luteous-fuscous, punctured black, shining, broad : posterior angles

of the pronotum a little prominent, rounded, fulvous at the apex: veins on hemelytra longitudinal: abdomen beneath with a large, longitudinal, median, black spot (*Westw.*). Long, body, 8—9 mill.

Reported from Bengal.

279. *Pentatoma lateralis*, Westwood, Hope, Cat. Hem. i, p. 43 (1837); Stål, En. Hem. v, p. 127 (1876).

Fuscous, sub-opaque, punctured-black; sides of pronotum margined paler, somewhat emarginate in the middle, posterior angles not prominent: membrane pallid, smoky, with five fuscous longitudinal veins: abdomen beneath piceous; margin paler: feet palely luteous (*Westw.*) Long, body, 8—9 mill.

Reported from Bengal.

280. *Pentatoma crassiventre*, Dallas, T. E. S. v, p. 189 (1849); Stål, En. Hem. v, p. 130 (1876).

♀. Body roundish: above olive-testaceous, opaque, thickly and finely punctured with black: head very thickly and rather coarsely punctured: eyes brown: pronotum with the lateral angles considerably produced on each side, but rounded at the apex; emarginate anteriorly for the reception of the head, the posterior margin straight: the anterior portion of the pronotum is more thickly punctured than the posterior, with a faint transverse line on each side near the anterior margin, and a very narrow longitudinal line on the disc, smooth, impunctate: scutellum rather more faintly punctured towards the apex: hemelytra with a small impunctate spot on the disc; the membrane transparent: dorsum of abdomen pitchy black, the margins testaceous, very thickly punctured with black: beneath testaceous, smooth, slightly shining: abdomen convex, punctured with black, the punctures very close together towards the margins, thus forming a broad cloudy line down each side within the line of stigmata; the base of the second segment, and a large spot in the middle of the 5—6 segments, black: pectus and underside of head concolorous with the abdomen: legs pale testaceous, with distinct pitchy punctures; those on the femora much larger than those on the tibiæ; the apices of the latter and the tarsi tinted with ferruginous: antennæ with the two basal joints pale testaceous; rostrum of the same colour, with the apex pitchy black (*Dallas*). Body long, 9; breadth of pronotum,  $6\frac{1}{2}$  mill.

Reported from Sikkim.

281. *Pentatoma fimbriata*, Westw. (nec. Fabr.) Hope, Cat. Hem. i, p. 39 (1837); Stål, En. Hem. v, p. 127 (1876).

Grass-green above and beneath; above, punctured, shining: hemelytra luteous, punctured, varied with brunneous, external margin greenish; large internal patch or streak on the membrane fuscous:



three last joints of the antennæ, black at the apex (*Westw.*). Body, long, 9-10 mill.

Reported from Bengal.

282. *Pentatoma lateralis*, Walker (nec. *Westw.*), Cat. Het. ii, p. 301 (1867).

Tawny, oval, thickly and minutely punctured, pale yellowish beneath; punctures brown: head large; juga and tylus of equal length: rostrum extending to the hind coxæ; tip black: antennæ testaceous, a little less than half the length of the body; first joint not extending to the front of the head; second blackish at the tip, much longer than the third; 3—5 joints pale yellowish, black towards the tips; fourth much longer than the third; fifth longer than the fourth: pronotum with pale yellowish slightly reflexed sides; posterior angles slightly acute and prominent: scutellum attenuated towards the tip, not extending beyond the angle of the corium; tip bordered by a pale yellowish line which is dilated at each end: pectus and abdomen beneath thinly black speckled: abdomen above ochraceous; beneath with an irregular black stripe, which does not extend to the tip: legs slender, pale yellowish; femora and tibiæ black speckled; tibiæ furrowed: hemelytra greenish testaceous, reddish testaceous along the costa; membrane pale cinereous, with nine pale longitudinal veins, of which the fifth is forked near its tip and united with the sixth near the base; wings pellucid (*Walker*). Long,  $11\frac{1}{2}$  mill.

Reported from India, Siam: resembles *Halyomorpha picus*, Fabr., in structure; the eyes and the angles of the pronotum being less prominent.

283. *Pentatoma vicaria*, Walker, Cat. Het. ii, p. 303 (1867).

Grass-green, elongate-oval, thickly and minutely punctured, indistinctly tinged here and there with red, pale yellowish green beneath: head yellow, elongate; hind part green; juga and tylus of equal length: rostrum extending to the last coxæ; tip black: antennæ greenish, less than half the length of the body; joints successively increasing in length; first not extending to the front of the head: pronotum with a broad yellow band along the fore border, the hind border of this band dentate; hind angles obtuse, not prominent: scutellum extending a little beyond the angle of the corium, attenuated towards the tip, with three yellow points at the base: abdomen beneath slightly ridged: legs slender: membrane pellucid (*Walker*). Body, long,  $13\frac{1}{2}$  mill.

Reported from India.

284. *Pentatoma inconcisa*, Walker, Cat. Het. ii, p. 301 (1867).

Tawny, elongate-oval, roughly punctured, beneath testaceous, punctures black: head elongate, tylus and juga of equal length, the former

very thinly punctured, forming a very slight ridge: rostrum extending to the last coxæ, apex black: antennæ black, less than half the length of the body, 3—5 joints successively increasing in length, first testaceous not reaching front of the head, second longer than the third: pronotum with a hardly elevated transverse line near the anterior margin, an indistinct tubercle on each side in front of the line, the posterior angles obtuse but not prominent; scutellum reaching beyond the bend of the corium, narrowed towards the apex which is levigate and luteous; most of the punctures clustered in five patches of which one is on each side of the base, one on the disc, and one on each side beyond the middle: abdomen not emarginate at the apex; connexivum with a black dot at the base of each segment: legs stout, testaceous, thickly setulose, apex of tarsi, black: hemelytra with a few minute, levigate, luteous marks; membrane lurid with six longitudinal veins, of which 1—2 are united near the base (*Walker*). Long,  $10\frac{1}{2}$  mill.

Reported from N. India.

285. *Pentatoma trispila*, Walker, Cat. Het. ii, p. 302 (1867).

Ferruginous, oval, shining, thinly sprinkled pale yellow, rather roughly punctured; beneath pale testaceous: head conical, with two pale testaceous streaks between the eyes; juga and tylus of equal length, the latter testaceous: rostrum extending to the last coxæ, tip black; antennæ testaceous, very slender, more than half the length of the body, joints successively increasing in length, first not reaching the front of the head, apex of third ferruginous, fourth black, with basal fourth part pale yellow, fifth black with basal third yellow: a transverse levigate luteous mark on each side of the pronotum near the anterior margin, sides pale testaceous, posterior angles obtuse not prominent: scutellum extending a little beyond the angle of the corium, a large pale yellow spot on each side at the base, and another at the apex: three black points on each side of the pectus: abdomen above black, with testaceous spots on each side: legs pale testaceous, minutely sprinkled black: apices of the tibiæ and of the joints of the tarsi, brown: membrane lurid (*Walker*). Long,  $10\frac{1}{2}$  mill.

Reported from Siam.

#### Genus ASYLA, Walker.

Cat. Het. ii, p. 403 (1867).

Body elliptical; head large, much rounded in front; sides slightly reflexed: juga as long as the tylus which they partly overlap; rostrum extending nearly to the posterior margin of the second ventral segment: antennæ slender, first joint not extending to the front of the head; second much shorter than the third: pronotum serrated on each

side in front; anterior angles acute; posterior angles dilated, forming two short rectangular horns: scutellum rather small: pectus with a very slight ridge: abdomen somewhat concave above, slightly dentate along each side: legs rather long and slender; tibiæ furrowed; tarsi 3-jointed: membrane with five longitudinal veins, of which the subcostal one is forked (*Walker*). The structure of the head separates it from *Euschistus* and *Galedanta*.

266. *Asyla indicatrix*, Walker, Cat. Het. ii, p. 403 (1867).

Tawny, minutely and rather thinly punctured; punctures blackish; beneath testaceous, ferruginous speckled: rostrum with a black tip: antennæ black: pronotum most thinly punctured in front: scutellum much excavated at each anterior angle: tarsi brown: membrane lurid-cinereous: wings cinereous (*Walker*). Long, 21 mill.

Reported from India.

267. *Mormidea socia*, Walker, Cat. Het. ii, p. 262 (1867).

Dingy yellowish, elongate oval, largely punctured; punctures black; underside and legs pale yellow: head more thickly punctured than the pronotum; jugs and tylus of equal length; rostrum extending to the last coxæ; tip black; antennæ pale yellow, setulose; first joint extending nearly to the front; second longer than the third: pronotum with a transverse callus on each side near the anterior margin and with a smooth slight marginal ridge on each side between the spine and the anterior margin; spines black, stout, acute, slightly projecting forward: scutellum with the disc pale yellow and thinly punctured; three large smooth pale yellow spots, two on the fore angles and one at the tip: pectus, abdomen beneath and femora with a few black points: legs slender, setulose: membrane pellucid (*Walker*). Body, long, 8½ mill.

Reported from India.

268. *Mormidea nigriceps*, Walker, Cat. Het. iii, p. 554 (1868).

Tawny, elliptical, thickly and minutely brown punctured, testaceous beneath: head blackish, somewhat elongated; jugs and tylus of equal length; eyes piceous, prominent; rostrum extending a little beyond the last coxæ, tip black: pronotum with a slight transverse ridge, in front of which it is testaceous and thinly punctured; fore border and a line along the posterior border of the ridge, blackish; the usual transverse calli; posterior angles elongated, acute, a little shorter than their breadth at the base: scutellum smooth and pale yellow at the tip, which is rounded: legs slender; femora and tibiæ slightly brown-speckled: membrane and wings cinereous (*Walker*). Long, 10½ mill.

Reported from India.

269. *Rhaphigaster* (?) *macracanthus*, Dallas, List. Hem. i, p. 289 (1851); Walker, Cat. Het. ii, p. 365 (1867); (?) Stål, En. Hem. v, p. 129 (1876).

♀. Broad and short, somewhat rounded, above brown, somewhat ferruginous, very thickly and finely punctured with black: pronotum with the lateral angles very prominent and obtuse: scutellum very broad at the base: membrane brownish: margins of the abdomen bright reddish orange, with a small black band at the base and apex of each segment near the suture, leaving the suture itself orange: body beneath fulvous, thickly and rather finely punctured; the abdomen somewhat rugose; ventral spine very long, reaching the base of the head, pitchy brown, very smooth and shining: legs fulvous: rostrum testaceous, with the tip black: antennæ with the second joint very short, scarcely more than half the length of the third; the two basal joints testaceous; third joint black, with the base testaceous; 4—5 joints black, with their bases, dull orange or tawny (*Dallas*). Long,  $11\frac{1}{2}$ —12 mill.; breadth of pronotum, 9 mill.

Reported from N. India.

270. *Rhaphigaster apicalis*, Dallas, List. Hem. i, p. 285 (1851); Walker, Cat. Het. ii, p. 281 (1867).

*Antestia* (?) *apicalis*, Stål, En. Hem. v, p. 129 (1876).

♀. Above pale greyish olive: head with six black punctured lines on the anterior portion which unite more or less on the vertex, making that part nearly black, with irregular pale spots: eyes brown; ocelli red: pronotum rather thickly punctured with black, the punctures arranged somewhat in transverse lines, with the anterior portion of the disc blackish, the anterior and lateral margins with a narrow whitish edge: scutellum rather thickly punctured with black, with a small orange spot in each basal angle, a large round black spot in the middle of the base, and a black spot on each lateral margin near the apex: coriaceous portion of the hemelytra rather thickly punctured with black, with the apex and a submarginal spot near the middle, black; membrane transparent, brownish: margins of the abdomen variegated with black and yellow, very thickly punctured: abdomen beneath, greyish-testaceous, with the sides rather thickly and strongly punctured with black; ventral spine long, reaching the intermediate coxæ: pectus testaceous, thickly punctured with black: legs testaceous; femora punctured with black; tarsi with the apical joint brown: rostrum testaceous, with the tip black: antennæ with the three basal joints testaceous; 4 and 5 black, with the base testaceous. (*Dallas*). Long, 9 mill.

Reported from N. India.

271. *Rhaphigaster bisignatus*, Walker, Cat. Het. ii, p. 366 (1867).

Testaceous, elongate-elliptical, thickly and minutely punctured; punctures black: juga and tylus equal in length: eyes rather prominent: rostrum extending nearly to the last coxæ; tip black; antennæ black, nearly half the length of the body, 1—2 joints tawny; first not extending to the front of the head; third a little longer than the second; fourth much longer than the third; fifth not longer than the fourth: pronotum transversely and very slightly impressed in front; a transverse triangular black mark with a testaceous disc on each side in front of the impression: scutellum less thickly punctured than the pronotum; a blackish dot on each side near the tip: abdomen black; connexivum testaceous; under side with two testaceous stripes which do not extend to the tip: ventral spine obtuse, extremely short, not extending to the last coxæ: femora and tibiæ with tawny tips; tibiæ slightly furrowed; tarsi tawny: corium with a brown apical patch, which is bordered on its inner side by an incomplete whitish band, the latter not punctured; membrane lurid: wings pellucid, pale lurid towards the tips (*Walker*). Body, long,  $6\frac{1}{4}$  mill.

Reported from India.

272. *Rhaphigaster patulus*, Walker, Cat. Het. ii, p. 366 (1867).

Pale testaceous, ample, nearly elliptical, thinly punctured: head black-punctured in front; juga and tylus of equal length: rostrum extending to the last coxæ; tip black: antennæ slender, less than half the length of the body; first joint not extending to the front of the head; second much shorter than the third; fourth longer than the third: pronotum black punctured; the punctures more thick in front, excepting a transverse, abbreviated, slightly undulating line; posterior angles prominent, hardly acute: scutellum attenuated towards the tip: pectus not ridged; sides whitish testaceous: abdomen, in the ♂, excavated at the tip; ventral spine extending to the intermediate coxæ: legs slender: hemelytra with black punctures along the costa; membrane and wings pellucid (*Walker*). Long,  $15\frac{1}{2}$ —19 mill.

Reported from N. India.

273. *Rhaphigaster strachoides*, Walker, Cat. Het. ii, p. 365 (1867).

Luteous; oval; thinly and rather finely punctured; punctures black: head black, with five luteous stripes, of which the inner pair are forked in front, and the outer pair are irregular and border the eyes; juga and tylus of equal length: rostrum black towards the tip, extending to the last coxæ: antennæ tawny, less than half the length of the body, joints successively increasing in length; first joint not extending

to the front of the head: pronotum in front with an abbreviated black band, which is dilated on each side, where it contains an interrupted luteous streak; space about the band smooth; hind angles much rounded, not prominent: scutellum with a callus on each angle at the base, and with a black spot on each side near the tip: pectus with three black stripes: abdomen beneath with three stripes of triangular black spots; of these the lateral spots are connected: legs reddish, short, stout: hemelytra with a black spot in the disc of the corium; membrane pellucid (*Walker*). Long,  $5\frac{1}{2}$ —6 mill.

Reported from India.

274. *Rhaphigaster rubriplaga*, Walker, Cat. Het. ii, p. 365 (1867).

Testaceous, nearly oval, thickly punctured, slightly shining: head with a black slender marginal line along each side; juga and tylus of equal length: rostrum extending to the intermediate coxæ: antennæ tawny, less than half the length of the body; joints successively and slightly increasing in length; first not extending to the front of the head: pronotum slightly and transversely impressed on each side in front; a red patch on each side between the posterior angles, which are slightly rounded and not prominent: scutellum with a red spot on each side near the base and with a red band near the tip: abdomen with a black stripe on each side above, and with an incomplete brown stripe on each side beneath; tip truncate; ventral spine extending to the intermediate coxæ: legs rather short and stout: hemelytra with a red spot on the tip of the corium near the costa; membrane and wings pellucid (*Walker*). Long,  $6\frac{1}{2}$ —7 mill.

Reported from India.

275. *Tetrisia bruchoides*, Walker, Cat. Het. i, p. 112 (1867).

Black: body convex, oval, dull, finely scabrous: head transverse, rounded in front, not more than half the breadth of the pronotum; eyes not prominent; rostrum reddish, extending beyond the last coxæ; antennæ rather stout and short: pronotum nearly twice the length of the head, with a transverse furrow in the middle, in front of which the sides are rounded and serrated; a short longitudinal furrow near each side of the hind part: scutellum broader than the pronotum, rounded at the tip, entirely covering the abdomen and the folded hemelytra, of which the membrane is dark brown: abdomen contracted: legs very short and stout (*Walker*). Long,  $5\frac{1}{4}$  mill.

Reported from Singapore. Belongs to sub-family *Plataspina*.

## Sub-fam. ASOPINA, Stål.

En. Hem. i, p. 21 (1870); Ofvers. K. V.-A. Förh., (3), p. 40 (1872); Distant, Biol. Cen. Amer., Hem., p. 26 (1879): *Asopida*, Dallas, List. Hem. i, p. 75 (1851); *Asopida*, Stål, Hem. Afric. i, p. 32, 62 (1864).

(a) to (d) as in sub-fam. *Pentatomina*, (J. A. S. B. Pt. II, p. 192, 1887).

(e) Rostrum long, passing the intermediate coxæ, stouter than in the preceding sub-family, sheath inserted at the labrum which is a little remote from the apex of the tylus: rostral furrow not coarctate anteriorly: first joint of the antennæ generally short and not longer than the longitudinal diameter of the eyes.

## Genus ZICRONA, Am. &amp; Serv.

Hist. Nat. Ins. Hém., p. 86 (1843): Sahlb., Mon. Geoc. Fenn., p. 18 (1848): Dallas, List. Hem. i, p. 108 (1851): Walker, Cat. Het. i, p. 145 (1867): Stål, Ofvers. K. V. A. Förh., p. 499 (1867); En. Hem. i, p. 36 (1870).

Body shining: second joint of the antennæ longer than the third; second joint of rostrum longest, shorter than the two apical taken together; juga not, or scarcely, longer than the tylus: anterior lateral margins of pronotum entire or very obsoletely eroded: frena not extended beyond the middle of the scutellum: second ventral segment not elevated in the middle: feet rather short, tibiæ without a furrow above, convex, at least towards the base, somewhat obtusely rounded, anterior pair not dilated.

## 276. ZICRONA CÆRULEA, Linnæus.

*Cimex cæruleus*, Linn., Syst. Nat., ed. 10, i, p. 445 (1758); l. c, ed. 12, i (2), p. 722 (1767); De Géer, Mém. iii, p. 268 (1773); Fabr., Syst. Ent. p. 716 (1775); Spec. Ins. ii, p. 359 (1781); Mant. Ins. ii, p. 296 (1787); Gmelin, ed. Syst. Nat. i, p. (4), p. 2154 (1788); Wolff, Ic. Cim. i, p. 18, f. 18 (1800).

*Pentatoma cæruleum*, Hahn, Wanz. Ins. ii, p. 65, f. 154 (1834).

*Asopus cæruleus*, Burm., Handb. Ent. ii, (1), p. 378 (1835); Herr. Schäff., Wanz. Ins. vii, p. 112 (1844); Flor, Rhynch. Liv. i, p. 90 (1860).

*Pentatoma concinna*, Westwood, Hope, Cat. Hem. i, p. 39 (1837).

*Pentatoma violacea*, Westwood, l. c. p. 39 (1837).

*Stiretrus cæruleus*, Blanchard, Hist. Nat. Ins. p. 154 (1840).

*Zicrona illustris*, Am. & Serv., Hist. Nat. Ins. Hém. p. 87 (1843); Vollen., Faune Ent. l'Arch. Ind. Neer. iii, p. 15 (1868).

*Zicrona cærulea*, Am. & Serv., Hist. Nat. Ins. Hém. p. 86 (1843); Dallas, List. Hem. i, p. 108 (1851); Fieber, Eur. Hem. p. 346 (1861); Douglas & Scott, Brit. Hem. i, p. 88 (1865); Walker, Cat. Het. i, p. 145 (1867); Stål, En. Hem. i, p. 36 (1870); Scott, A. M. N. H. (4 s.), xiv, p. 289 (1874); Saunders, Trans. Ent. Soc. p. 123 (1875); J. Sahlbohm, K. V.-A. Handl., xvi (4) p. 15 (1879); Distant, Scien. Res. 2nd Yarkand Miss. p. 3 (1879); Trans. Ent. Soc. p. 415 (1883).

“Cærulean-blue, immaculate” is the short description given by the earlier writers. Serville describes this species as having the body, feet, and antennæ metallic greenish-blue shining; body above finely punctured. *Z. illustris*, Am. & Serv., differs only in being metallic blue not greenish-blue, like *Z. cærulea*. The *P. concinna* of Westwood is described as larger than *Z. cærulea*, altogether black with cærulean and purple reflections, antennæ and feet black. The *P. violacea*, Westw., scarcely differs from the preceding, but is altogether more violaceous and somewhat punctured. Others give bright blue or blue-green, shining, punctured: legs and antennæ, black. Dallas and Stål (*l. c. supra*) record fully the synonymy and references to figures. Long 9—10 mill.

Reported from all Europe, N. W. Siberia, Japan, China, Bengal, India, Malacca, Java, Borneo, Bujkoti in Jaunsár Báwar, 7,000 feet (mihi).

#### Genus CECYRINA, Walker.

Cat. Het. i, p. 118 (1867).

Body very elongate-oval, rather flat: head and pronotum rather largely punctured: head not much shorter than the pronotum, a little narrower in front of the eyes, with a slight ridge which emits two short slight forks on each side between the eyes: eyes very prominent: rostrum stout, extending to the last coxæ: antennæ very minutely pubescent, about half the length of the body, first joint stout, second shorter than the third, 4—5 a little broader and longer than the third: scutum slightly rugulose, not longer than broad, the forepart much contracted: scutellum with a slight ridge, narrowed towards the apex, which is rounded: legs rather stout; first femora with a spine beneath the apex; first tibiæ much dilated: the elongate hardly convex body, the shape of the head, and the margined pronotum distinguish this genus from *Cazira* (Walker).

#### 277. CECYRINA PLATYRHINOIDES, Walker.

*Cecyrina platyrhinoides*, Walker, Cat. Het. i, p. 119 (1867).

Tawny, irregularly and more or less speckled with piceous, the latter hue partly predominating: head piceous, with a tawny longitudinal line: rostrum piceous: antennæ reddish; 4—5 joints piceous, fourth with a whitish band near the base: abdomen above very dark red, with tawny spots along each side: membrane cinereous, with two curved brown bands: wings cinereous (Walker). Body, long, 11—12½ mill.

Reported from India.



## Genus BLACHIA, Walker.

Cat. Het. i, p. 117 (1867) : includes *Sesha*, Dist., Trans. Ent. Soc. p. 343 (1887).

Body short-oval, convex, shining : head about half the length and about one-fifth of the breadth of the pronotum ; juga and tylus of equal length ; rostrum moderately stout, extending to the last coxæ ; antennæ slender, very minutely setulose, rather more than half the length of the body, 2—5 joints successively slightly increasing in length : pronotum thinly and finely punctured, nearly twice broader than long, forming an acute angle on each side of the fore border, with an acute diverging spine on each side posteriorly : scutellum slightly contracted posteriorly, hardly extending beyond the corium : legs hardly stout, fore femora with a spine beneath near the apex ; fore tibiæ much dilated.

## 278. BLACHIA DUCALIS, Walker.

*Blachia ducalis*, Walker, Cat. Hem. i, p. 117 (1867).

*Sesha manifesta*, Distant, Trans. Ent. Soc., p. 343, t. 12, f. 2 (1887).

Testaceous : head with a small purple spot on each side of the posterior margin : pronotum with five purple spots, of which two near anterior margin are much smaller than the three in a transverse row near posterior margin : scutellum with a very large purple spot on each side near the base and with a purple spot on each side behind the middle : pectus with three purple patches on each side : abdomen beneath on each side with an inner stripe of three purple spots and an outer stripe of two purple spots : hemelytra with a large purple spot joining the middle of the costa and a smaller apical purple spot ; membrane colourless with two broad brown streaks, one capitate ; wings brown (*Walker*). Body, long,  $10\frac{1}{2}$ —12 mill.

Reported from Siam, Sikkim (mihi).

## Genus CAZIRA, Am. &amp; Serv.

Hist. Nat. Ins. Hém. i, p. 78 (1843) : Dallas, List. Hem. i, p. 82 (1851) ; Walker, Cat. Het. i, p. 117 (1867) : Stâl, Hem. Afric. i, p. 62 (1864) : En. Hem. i, p. 38 (1870).

Body somewhat short, stout : scutellum with vesicular tubercles at the base : venter at the base with a small spine directed forwards and not extending beyond the insertion of the posterior feet : all the femora with a spine beneath towards the apex ; anterior tibiæ much dilated : rest as in *Asopus* (*Am. & Serv.*).

## 279. CAZIRA VERRUCOSA, Westwood.

*Pentatoma verrucosa*, Westwood, Zool. Journ. v, p. 445, t. 22, f. 7 (1835).

*Asopus verrucifer*, Burmeister, Handb. Ent. ii, (i), p. 380 (1835).

*Cazira verrucosa*, Dallas, List. Hem. i, p. 82 (1851), excl. syn. *Linnæi*; Walker, Cat. Het. i, p. 117 (1867) excl. do.: Stål, En. Hem. i, p. 38 (1870); Distant, A. M. N. H. (5 s.) iii, p. 45 (1879).

Rufous-testaceous, variegated with fuscous, punctured, subrotundate; posterior sides of pronotum on both sides unispinose; dorsum with several elevated oblique lines; scutellum at the base with two large, round, rufous tubercles, and two other small lateral tubercles; posteriorly narrowed and produced to the apex of the abdomen, posterior part concave, sides elevated: corium rufous, punctured with black and the apical membrane produced to a distance beyond the abdomen; sides of abdomen visible, serrated: antennæ longer than the pronotum, 2—3 joints equally long, also 4—5 which are a little longer than the two preceding: femora beneath unispinose, first pair stouter; the two first tibiæ dilated, four posterior simple, rufous, with a white ring. (*Westw.*).

Variable in coloration, sometimes fuscous-piceous, sometimes cinnamon-yellow; pronotum with a longitudinal median wrinkle or ridge, a transverse discoidal wrinkle behind the middle, recurved on both sides, anteriorly with two lateral tubercles and behind the tubercles a less distinct obliquely longitudinal wrinkle which is sometimes confluent with the posterior tubercle; apical part of scutellum more or less concave, apex more or less distinctly emarginate (*Stål*). Body with hemelytra long,  $10\frac{1}{2}$ —11 mill.

Reported from Malabar, Dekkan, India, Assam. The Indian Museum has specimens from Sikkim, Sibságar (Assam), and Calcutta (*mihi*).

## 280. CAZIRA INTERNEXA, Walker.

*Cazira internexa*, Walker, Cat. Het. i, p. 118 (1867).

Ochraceous, thick, shining, roughly tuberculate: head about one-fifth the breadth of the pronotum; juga extending somewhat beyond the tylus; rostrum black; antennæ black, 2—4 joints successively increasing in length, fifth a little shorter than the fourth: pronotum with prominent obtuse spines: scutellum with a hump on each side at the base and with two slight longitudinal furrows: legs black, stout; coxæ, first femora at base and last towards the base, luteous; first tibiæ much dilated: membrane black, with a limp spot on the costa before

the middle, and one on the hind border beyond the middle. Distinguished from preceding by the comparatively smooth hinder part of the scutellum (*Walker*). Long,  $9\frac{1}{2}$  mill.

Reported from Cambodia.

### 281. CAZIRA ULCERATA, Herrich-Schäffer.

*Asopus ulceratus*, Herr.-Schäff., Wanz. Ins. iv, p. 103, t. 103, f. 452 (1839) and vii, p. 114 (1844).

*Cazira ulcerata*, Dallas, List. Hem. i, p. 82 (1851); Walker, Cat. Het. i, p. 118 (1867); Stål, En. Hem. i, p. 39 (1870).

Miniaecious: pronotum at the base with raised tubercles, lateral angles produced widely outwards and a little forwards into a spine, of which the lateral margins are sinuate before the apex: scutellum with tubercles at the base: a spot in the middle of the hemelytra, the antennæ, tarsi and apex of last tibiæ, black; the last tibiæ in the middle, white: membrane brownish, with a white spot in the middle of the outer margin: venter spinose at the base: first pair of tibiæ very strongly dilated, the tooth-like inner edge of the tip, black; fore femora with a tooth. Long, 8 mill.

Reported from Hong-Kong, Siam, Calcutta (mihi), Coromandel.

### 282. CAZIRA CHIROPTERA, Herrich-Schäffer.

*Asopus chiropterus*, Herr.-Schäff., Wanz. Ins. v, p. 78, t. 170, f. 523 (1839); vii, p. 113 (1844).

*Cazira verrucosa*, Am. & Serv., Hist. Nat. Ins. Hém., p. 78, t. 3, f. 8 (1843): excl. syn.

*Cazira chiroptera*, Dallas, List. Hem. i, p. 82 (1851); Walker, Cat. Het. i, p. 118 (1867); Vollenhoven, Faun. Ent. Ind. Neerl. iii, p. 4 (1868): Stål, En. Hem. i, p. 39 (1870).

Ferruginous: coarsely punctured: pronotum with a raised smooth median line; lateral angles acutely produced; four black spots, of which one on each side near the lateral angles: base of scutellum with spherical, raised tubercles, a black spot at base and apex: a rounded black spot near the apex of the hemelytra and the apex itself, black; wings fuscous: legs luteous: beneath two spots at the base, and two before the end of the abdomen. Long, 10 mill.

Reported from Java, Sumatra, Borneo, Malacca.

### Genus CANTHECONA, Amyot & Serville.

Hist. Nat. Ins. Hém., p. 81 (1843); Dallas, List. Hem. i, p. 89 (1851); Walker, Cat. Het. i, p. 130 (1867); Stål, Hem. Afric. i, p. 62, 66 (1864); En. Hem. i, p. 41 (1870):—*Cimez*, subg. *Canthecona*, Ofvers. K. V.-A. Förh., p. 49 (1867).

Head somewhat flat; two apical joints of rostrum of equal length, each a little shorter than the second: anterior lateral margins of the

pronotum more or less distinctly crenulated or transversely rugose : frena extended to, or a little beyond, the middle of the scutellum : venter, at the base, furnished with a tubercle or short spine, obtusely conical ; stridulatory spots, in ♂, extended through 4—5 ventral segments, sericeous : first tibiæ not dilated, first femora with a distinct spine.

283. *CANTHECONA BINOTATA*, Distant.

*Canthecona binotata*, Dist. A. M. N. H. (5 s.) iii, p. 47 (1879).

Luteous, thickly punctured with brown : tylus reaching the apex of the head, juga thickly covered with brassy black punctures : eyes prominent, fuscous, luteous at the base : antennæ with 2—3 joints sub-equal, fourth rather longest, 1—2 joints luteous, 3—4 dark fuscous, luteous at the base : rostrum luteous, with the tip reddish : pronotum considerably deflexed from the base towards the head, with a median raised longitudinal line, which is prolonged throughout the whole length of the scutellum ; lateral edges, with an indistinct, obscure, violet, submarginal border, and some other indistinct striæ of the same colour on the disc ; lateral angles produced into short, obtuse, black spines, emarginate and luteous at the tip : scutellum somewhat gibbous at the base, where it is thickly and darkly punctured, the median longitudinal line becoming broad and impunctate towards the apex : corium with a somewhat triangular subcostal blackish spot situated a little beyond the middle : membrane produced considerably beyond the abdomen, black, with the apical half whitish : abdomen above blackish, with a segmental marginal row of alternate sub-quadrangle green and luteous spots : body beneath luteous ; pectus with three violet streaks on each side ; venter with the marginal row of sub-quadrangle green spots as above, a sub-marginal row of narrow, transverse, wavy, dark lines, situate one on each segment, and a large sub-apical blackish spot : legs luteous, pilose ; tibiæ strongly sulcated ; fore tibiæ dilated, their apical halves and bases and the apices of the intermediate and posterior tibiæ, blackish (*Distant.*) Allied to *C. tibialis*, Dist. Long, 15 ; exp. lat. angles of pronotum,  $7\frac{1}{2}$  mill.

Reported from Naga Hills, 2000—6000 feet (Assam) ; Calcutta, Dehra (mihi).

284. *CANTHECONA TIBIALIS*, Distant.

*Canthecona tibialis*, Distant, A. M. N. H. (5 s.) iii, p. 46 (1879).

Head brassy black, very thickly punctured ; tylus reaching the apex of the head, with its base obscurely luteous ; eyes brown : antennæ pilose ; 3—4 joints longest, sub-equal ; apical joint rather shorter than

the second, which is brown, the 3—4 joints blackish with their bases narrowly brown, fifth dark fuscous with basal third luteous: rostrum luteous, tip blackish: pronotum brassy black, very coarsely punctate, and lightly and irregularly rugulose, with a slightly raised median longitudinal line and irregular luteous markings, which indicate faintly four longitudinal striæ, two on each side of the median line; the crenulated portion of the margin and a small spine behind the eyes, luteous; lateral angles produced into short, black, obtuse spines, strongly emarginate at the apex: scutellum with the basal half brassy black, very thickly punctured; apical half paler and more sparingly punctured, with a small median basal spot, a large rounded spot in each basal angle, two small irregular and indistinct markings beneath these, and the apex, broadly luteous: corium luteous, somewhat thickly marked and punctured with black; on the underside, at the apex, is a large reddish spot: membrane fuscous, with two large whitish spots, one on the outer and the other on the inner border: abdomen above shining green, very thickly punctured, with a marginal row of three luteous spots, which appear on the margins of alternate segments above and below: body beneath luteous, pectus thickly punctured with brassy black: abdomen with a median, narrow, longitudinal, impunctate area, from which it is sparingly punctate halfway to the outer border, which is very thickly punctured with brassy black, a large black sub-apical spot: legs luteous, with the apices of the femora, and bases and apices of intermediate and posterior tibiæ, brassy black; fore-tibiæ very widely dilated and strongly punctured black; first tarsi black, rest luteous, with apex black; tibiæ strongly sulcated (*Distant*). Long, 17; exp. lat. ang. pronotum, 9 mill.

Var. *a*. Smaller, with the ground-colour brownish instead of brassy black. Allied to *C. furcellata*, Wolff, from which it differs principally in the shorter and obtuse lateral angles of the pronotum.

Reported from N. Khasiya Hills, 1500—3000 feet; Sikkim (mihi).

### 285. *CANTHECONA FURCELLATA*, Wolff.

*Cimex furcellatus*, Wolff, Ic. Cim. v, p. 182, t. 18, f. 176 (1801).

*Asopus armiger*, Herr.-Schäff., Wanz. Ins. vii, p. 113, 119, f. 711 (1844).

*Canthecona furcellata*, Dallas, Uist. Hem. i, p. 91 (1851); Walker, Cat. Hët. i, p. 130 (1867); Vollenhoven, Faune Ent. l'Arch. Indo-Néer. iii, p. 5 (1868); Stål, En. Hem. i, p. 42 (1870).

Antennæ 5-jointed, yellow-ferruginous, joints fuscous at the apex: head porrect, obtuse, impressly-punctured, variegated fuscous and yellow, with a paler longitudinal line; eyes fuscous: rostrum 4-jointed, ferruginous, fuscous at the apex: pronotum greyish, variegated anteriorly with fuscous, posteriorly with very many impressed fuscous punctures,

with a small anterior longitudinal yellow line; lateral margin serrulate, posteriorly on both sides with a bifid fuscous spine of which the posterior tooth is the shorter: scutellum greyish with numerous impressed fuscous punctures, obscurely at the base with three minute rufous points; a longitudinal line and the apex, paler: hemelytra greyish with impressed fuscous punctures and an obsolete fuscous median line; membrane fuscous with two pale opposite marginal spots before the apex: abdomen above black, margin prominulous, spotted yellow, beneath testaceous, with a row of very minute fuscous spots on both sides, margin somewhat serrate, sternum somewhat porrect anteriorly: pectus testaceous, spotted fuscous: anus obtuse, bidentate: feet testaceous; first femora with a very acute tooth before the apex; tarsi fuscous (*Wolff.*). Long, 15—16 mill.

Reported from India, Bombay, Tenasserim, Berhampur, Arrah (mihi).

#### Genus AUDINETIA, Ellenrieder.

Nat. Tijdschr. Ned. Ind. xxiv, p. 136 (1862): *Cimex* subg. *Audinetia*, Stål, *Ofvers. K. V.-A. Förh.*, p. 496 (1867); *En. Hem.* i, p. 45 (1870).

Head oblong; juga a very little longer than the tylus: second joint of antennæ long, 3—5 joints nearly equal (fourth longer): eyes small, globose, not very prominent: ocelli distinct, close to the pronotum, as far from each other as from the eyes: pronotum declined forwards, convex behind, the anterior margin narrower than the head, sinuated, posterior angles very prominent, transverse, with a bifid spine of which the anterior terminal point is very acute, the posterior somewhat short: hemelytra and abdomen rather elongate, attenuated hindwards: the sides of the abdomen extending a little beyond the hemelytra: membrane albescent, with 7—9 veins, longer than the abdomen: venter from the median line inclined convexly towards the sides; ventral tooth short, not extending beyond the insertion of the last pair of feet: rostrum scarcely reaching the posterior feet, its joints almost equal, but the second long, the last short: femora robust, unarmed; first tibiæ prismatic, unispinose on the lower (inner) side; tarsi robust, first joint long, second very small, hardly visible. Distinguished from *Arma*, Hahn, by the ventral tooth; from *Canthecona*, Am. & Serv., by the first femora being simple, and from others by the spine on the inner side of the first tibiæ (*Ellenr.*). Stål separates it from *Canthecona* by its having the stridulatory spots in ♂ very large, extended through the 3—6 ventral segments: first femora beneath with a small, sometimes very obsolete, tubercle.

## 286. AUDINETIA SPINIDENS, Fabricius.

*Cimex spinidens*, Fabr., Mant. Ins. ii, p. 285 (1787); Ent. Syst. iv, 99 (1794); Gmelin, Syst. Nat. i, (4), p. 2139 (1788); Fabr., Syst. Rhyng., p. 161 (1803).

*Asopus geometricus*, Burm., Handb. Ent. ii, (i), p. 380 (1835).

*Arma geometrica*, Dallas, Trans. Ent. Soc. v, p. 187, t. 19, f. 2 (1849).

*Picromerus spinidens*, Dallas, List Hem. i, p. 95 (1851); Walker, Cat. Het. i, p. 133 (1867).

*Pentatoma aliena*, Westw., Hope, Cat. Hem. i, p. 40 (1837)?

*Audinetia aculeata*, Ellenrieder, Nat. Tijdschr. Ned. Ind., xxiv, p. 137, f. 1, (1862); Walker, l. c., iii, p. 532 (1868).

*Arma spinidens*, Vollenhoven, Faune Ent. l'Arch. Indo-Néer. iii, p. 10 (1868).

*Cimex (Audinetia) spinidens*, Stål, Hem. Fabr. i, p. 16 (1868); En. Hem. i, p. 45 (1870).

*Audinetia spinidens*, Distant, Biol. Cen. Am. Hem. p. 35 (1879); A. M. N. H. (5 s.) iii, p. 45 (1879); Lethierry, An. Mus. Gen. xviii, p. 742 (1883).

Fuscous: spines on pronotum large, acute, with a small acute tooth in the middle posteriorly: apex of scutellum and margin of hemelytra, white; beneath paler: feet pale (*Fabr.*).

♀. Body elongate-ovate, the sides nearly parallel: olive-brown, or brownish-testaceous, very thickly punctured: pronotum with the lateral angles produced into a short, acute, black spine, which is distinctly toothed on its hinder margin; a pale yellowish line runs across the disc of the pronotum from angle to angle: scutellum rather dark at the base, the apex white: hemelytra with the external margin whitish; membrane transparent: abdomen beneath punctured, with an irregular line down the middle, and the stigmata, black: legs, rostrum, and antennæ yellowish brown: the apex of the third joint of the antennæ, and the whole of the fourth, except the base, black: tarsi pitchy (*A. geometrica*, Dallas). Body, long, 14—15 mill.

Reported from Borneo, Java, Sumatra, Assam, Abyssinia, Mexico. The Indian Museum possesses specimens from Calcutta, Harmatti (at the foot of the Daphla hills, Assam), Sikkim (mihi).

## Genus PICROMERUS, Am. &amp; Serv.

Hist. Nat. Ins. Hém., p. 84 (1843); Dallas, List. Hem. i, p. 95 (1851); Walker, Cat. Het. i, p. 132 (1867):—*Cimex* subg. *Cimex*, Stål, Ofvers. K. V.-A. Förh., p. 497 (1867); En. Hem. i, p. 45 (1870).

Body flat: juga not, or scarcely, longer than the tylus, apical interior angle somewhat straight, scarcely acute, not produced inwards: posterior angles of pronotum acutely produced, flattened, dentate on the sides: venter, in ♂, without smooth, silky, stridulatory spots: anterior femora with 1—2 spines towards the tip; anterior tibiæ not dilated.

287. *PICROMERUS OBTUSUS*, Walker.

*Picromerus obtusus*, Walker, Cat. Het. i, p. 133 (1867) : Distant, A. M. N. H. (5 s.) iii. p. 45 (1879).

Lurid brown : oval, rather flat, minutely punctured ; dingy testaceous beneath ; punctures black : rostrum dingy testaceous : antennæ black, piceous towards the base, 4—5 joints whitish towards the base : pronotum crenulate along each side in front ; spines broad, obtuse, hardly forked at the tips : scutellum with a slight ridge which is widely forked towards the fore border : pectus and abdomen beneath with some black patches on each side, stigma of the pectus ochraceous : femora dingy testaceous, black-speckled ; tibiæ tawny, with black tips ; tarsi black : corium lurid, with blackish punctures and with a few small blackish marks : membrane aeneous (*Walker*). Body, long, 11—11½ mill.

Reported from N. India : very common in Sikkim (mihi).

288. *PICROMERUS NIGRIVITTA*, Walker.

*Picromerus nigrivitta*, Walker, Cat. Het. i, p. 133 (1867).

Dingy testaceous, elliptical, rather flat, thickly and minutely black speckled, livid beneath : head with the juga and tylus distinctly marked : rostrum tawny : antennæ black, piceous towards the base ; 4—5 joints pale yellow towards the base : pronotum with a pale tubercle on each side on the disc ; sides straight and serrated from the fore border to the spine, which is aeneous and truncate : scutellum with a slight forked ridge : pectus with ochraceous stigmata : abdomen beneath with a black stripe : legs livid, black-speckled, with a slight aeneous tinge : membrane aeneous (*Walker*). Body, long, 10½ mill.

Reported from Silhat.

289. *PICROMERUS ROBUSTUS*, Distant.

*Picromerus robustus*, Distant, A. M. N. H. (5 s.) iii, p. 48 (1879).

Has somewhat the elongated form of *A. spinidens*, but with the pronotum robust, much deflexed anteriorly, and body narrowed posteriorly : luteous, covered regularly and thickly with coarse brown punctures : tylus and juga equal in length ; eyes large, prominent, obscure fuscous ; rostrum luteous, with the tip pitchy ; antennæ with the 2—3 joints sub-equal, pale luteous, third joint pitchy at apex : pronotum much narrowed in front and widened posteriorly, with an indistinct median, longitudinal line ; a transverse row of four small luteous spots situated a little behind a somewhat obscure transverse ridge ; lateral angles, produced into long, black, pointed spines, toothed



behind, which give them the appearance of being emarginate at the apex: scutellum with a small luteous spot in each basal angle: corium with purplish reflections towards the apex; membrane fuscous with a large whitish spot on the outer and the inner border (size of these spots variable): body beneath luteous, punctured and mottled with brown; intermediate femora testaceous and the tibiæ brownish, with apex and tarsi dark fuscous (*Distant*). ♂, long, 11, exp. lat. angles pron.  $6\frac{1}{2}$  mill.: ♀, long, 14, exp. lat. angles pron. 9 mill.

The ♀ varies in having the luteous spots above much more obscure and the legs luteous.

Reported from Sadiya (Assam), 350 feet.

#### Genus GLYPSUS, Dallas.

List Hem. i, p. 93 (1851); Stål, Hem. Afric. i, p. 62, 63 (1864); En. Hem. i, p. 47 (1870); Walker, Cat. Het. i, p. 132 (1867).

Body ovate: head flattish, jugæ a little longer than the tylus, somewhat contiguous at the apex, bucculæ moderately elevated: antennæ about half as long as the body, the second joint a little longer than the third, the fourth about equal to the second, the fifth shorter than the third: rostrum reaching the posterior coxæ, stout, the two apical joints of equal length, each a little shorter than the second: anterior lateral margins of pronotum crenulate before the middle, the lateral angles strongly spinose: scutellum rather broad, the posterior part narrowed hindwards, rounded at the apex; frena extended a little beyond the middle of the scutellum: sternal ridge broad, depressed, furrowed: venter, in ♂, without stridulatory sericeous spots, second segment armed at the base with a depressed tubercle, slightly prominulous forwards, sinuated at the apex: membrane with nine veins: first femora armed beneath with a spine towards the apex; anterior tibiæ quadrangular, not dilated exteriorly; inner spine rather large: tarsi 3-jointed, second joint very small, basal joint as long as the other two taken together.

#### 290. GLYPSUS FUSCISPINUS, Stål.

*Glypsus fuscispinus*, Stål, En. Hem. i, p. 47 (1870).

♂. Weakly greyish-flavescent, distinctly punctured fuscous-ferruginous; antennæ weakly ferruginous: four very minute spots arranged in a transverse row before the middle, and the lateral angles of the pronotum, also a small impression on the basal angles of the scutellum, black: membrane sordid viaceous, apical spot fuscous. Stature almost of *G. conspicuus*, Westw., but the lateral angles of the pronotum are gradually acuminate, posteriorly near the apex, not, unless very

obsoletely, sinuated. Head scarcely narrowed before the lateral sinuses, distinctly punctured, smooth posteriorly and on the tylus, punctures on the tylus arranged in two rows of groups, and, on the posterior part, densely arranged in six rows of groups; juga with fuscous limbi, furnished in the middle with a somewhat smooth streak: lower side smooth, adorned with a lateral, punctulate, fuscous, streak: second joint of the antennæ shorter than the third: rostrum stout, piceous, first joint weakly sordid flavescent: pronotum rather densely punctured, punctures on the posterior part more obscure, anterior lateral margins slightly sinuate in the middle, obtusely crenulate before the sinus, lateral angles much produced outwards, acute, above obtusely carinate: scutellum and hemelytra densely and distinctly punctured, the scutellum furnished behind the middle with a very obsolete wrinkle or ridge; punctures on pectus and venter in groups; the spot on the pectus inclosing the furrow from the odoriferous orifices, fuscous: the dorsum of the abdomen, black-violaceous, punctulate; segments of the connexivum spotted black on the basal and apical angles, apical angles of the 2—6 ventral segments prominulous in a small tooth; spot on the sixth segment and the aual segment, black: median streak on the venter, smooth: no stridulatory spots: posterior femora obsoletely varied fuscous: furrow on tibiæ obscurely subsanguineous at the bottom (*Stål*). Long, 15; broad, 7; breadth of pronotum, 10 mill.

Reported from India.

#### Genus *PODISUS*, Herrich-Schäffer.

Wanz. Ins. ix, p. 296, 337 (1853); Stål, K. V.-A. Förh., p. 497 (1867); l. c., (3), p. 40 (1872); En. Hem. i, p. 48 (1870); Distant, Biol. Cen. Am. Hem. i, p. 36 (1879):—*Asopus*, Fieb., Eur. Hem. p. 348 (1861).

Stål (En. Hem. l. c.) distributes the species assigned by him to this genus amongst the subgenera—*Troilus*, *Apateticus*, *Apoecilus*, *Podisus*, and *Tylospilus*, of which only *Troilus* appears to occur in India. Subsequently, he raises *Troilus* to a genus with *Asopus luridus*, Fabr., as the type. Venter without stridulatory spots, spinose at the base: first pair of femora unarmed: juga rounded at the apex, distinctly longer than the tylus: bucculæ very slightly elevated, gradually evanescent hindwards: frena extended beyond the middle of the scutellum.

#### 291. *PODISUS LURIDUS*, Fabricius.

*Cimex luridus*, Fabr., Syst. Ent. p. 701 (1775); Spec. Ins. ii, p. 345 (1781); Mant. Ins. ii, p. 283 (1787); Gmelin, ed. Syst. Nat. i (4), p. 2136 (1788); ? Wolf, Ic. Cim. p. 130, t. 13, f. 130 (1804).

*Cimex elector*, Fabr., Ent. Syst. iv, p. 98 (1794); Syst. Rhyng. p. 160 (1803).

*Arma lurida*, Hahn, Wanz. Ins. i, p. 97, t. 15, f. 53 (1831); Dallas, List Hem. i, p. 96 (1851); Walker, Cat. Het. i, p. 134 (1867).

*Pentatoma luridum*, Herr.-Schäff., Nom. Ent. i, p. 56, 92 (1835).

*Asopus luridus*, Burm., Handb. Ent. ii (i), p. 379 (1835); Herr.-Schäff., Wanz. Ins. vii, p. 114 (1844); Gorski, Anal. Ent. p. 117 (1852); Fieber, Eur. Hem., p. 348 (1861); Doug. & Scott, Brit. Hem. i, p. 94, t. 3, f. 6 (1865).

*Pentatoma sublurida*, Westwood, Hope, Cat. Hem. i, p. 41 (1837).

*Arma luridum*, Kolenati, Mel. Ent. iv, p. 40 (1846).

*Asopus (Podisus) luridus*, Flor, Rhynch. Liv. i, p. 95 (1860).

*Podisus (Troilus) luridus*, Stål, Hem. Fabr. i, p. 17 (1868); En. Hem. i, p. 48 (1870).

Var. *angusta*, Reuter, Berlin Ent. Zeit. xxv, p. 156 (1881).

*Podisus luridus*, Mulsant, Pun. France, Pent., p. 347 (1866); Saunders, Trans. Ent. Soc., p. 124 (1875); J. Sahlb., K. V.-A. Handl. xvi (4), p. 15 (1879).

Antennæ black, second joint yellow before the apex: clypeus emarginate: pronotum obtusely spinose, above greyish, beneath flavescens: scutellum greyish, paler at the apex: hemelytra greyish with a median fuscous spot: body fuscous, with a large, distinct, deep-black point before the anus: wings deep black, with a pale marginal spot: feet greyish (*C. elector*, Fabr.). The variety *sublurida*, described by Westwood, has the femora obscure at the apex, antennæ fuscous, apex of fourth joint fulvous, and a large spot before the anus. Long,  $10\frac{1}{2}$  mill. Saunders (l. c.) describes it thus:—'Yellowish-brown, closely punctured with bronzy punctures: head, sides of pronotum, and connexivum, bronzy-green, the latter with red, transverse spots; sides of the pronotum roughly and unevenly denticulate in front, posterior angle much produced: antennæ black, apex of fourth joint widely red: legs pale, spotted black. Long,  $10\frac{1}{2}$  mill.

Reported from nearly all Europe, India.

#### Genus ASOPUS, Burmeister, Stål.

Burmeister, Nova Acta Acad. Leop. xvi, Suppt. p. 292 (1834); Handb. Ent. ii (i), p. 377 (1835); Am. & Serv., Hist. Nat. Ins. Hém. p. 83 (1843); Stål, Hem. Afric. i, p. 63 (1864); En. Hem. i, p. 56 (1862). Includes *Amyotea*, Ellenr., Nat. Tijds. Ned. Ind., xxiv, p. 137 (1862).

Posterior angles of pronotum obtuse, not spinose: ventral spine obtuse, short, hardly reaching insertion of posterior feet: all femora unarmed: tibiæ unarmed, neither foliated nor dilated: last joint of rostrum very short. Differs from *Canthecona* in the unarmed pronotum and femora.

292. *ASOPUS MALABARICUS*, Fabricius.

*Cimex malabaricus*, Fabr., Syst. Ent., p. 718 (1775); Spec. Ins. ii, p. 363 (1781); Mant. Ins. ii, p. 298 (1787).

*Cimex mactans*, Fabr., Spec. Ins. ii, p. 366 (1781); Mant. Ins. ii, p. 301 (1788).

*Lygæus malabaricus*, Fabr., Ent. Syst. iv, p. 151 (1794); Syst. Rhyng., p. 219 (1803).

*Lygæus mactans*, Fabr., Ent. Syst. iv, p. 161 (1794); Syst. Rhyng., p. 227 (1803).

*Cimex oculatus*, Fabr., Ent. Syst. Suppt., p. 535 (1798).

*Lygæus argus*, Fabr., Syst. Rhyng., p. 217 (1803).

*Asopus argus*, Burm., Nova Acta Acad. Leop. xvii, Suppt. p. 293, t. 41, f. 6 (1834).

*Asopus mactans*, Dallas, List Hem. i, p. 107 (1851); Voll., Faun. Ent. l'Arch. Ind. Néerl. iii, p. 12 (1868).

*Asopus dystercoides*, Ellenr., Nat. Tijds. Ned. Ind., xxiv p. 137, f. 2, 3, ♂ (1802); Walker, Cat. Het., i, p. 146 (1867).

*Asopus nigripes*, Ellenr., l. c., p. 138, f. 4, 5, ♀ (1862); Walker, l. c. i p. 146 (1867).

*Asopus malabaricus*, Stål, En. Hem. i, p. 56, 230 (1870).

Head rufescent: antennæ black: pronotum rufous, varied cinereous, with two black spots anteriorly: scutellum large, rufous with two large black spots at the base: wings black: abdomen pale, with large cyaneous spots on both sides (*L. malabaricus*, Fabr.). Head pale rufescent: antennæ black: pronotum black, paler anteriorly, with two black spots: scutellum rufous with two black spots: hemelytra rufous; wings black: beneath flavescent with cyaneous bands (*L. mactans*, Fabr.). Red or red-testaceous: two elliptical transverse spots on the anterior part of the pronotum and two on the anterior angles of the scutellum, membrane, apex of femora, tibiæ, tarsi, antennæ, except the first joint, black: first joint of the antennæ, red: face and rostrum reddish: pectus margined white and red, with rows of black spots; venter margined white and red, banded black, with five bands narrower in the middle: femora rufous: abdomen laterally not extending much beyond the hemelytra, not longer: sometimes two spots on the head (*Ellenr.*). Long, 12—13 mill. I have a specimen of *A. nigripes*, *Ellenr.*, from Bengal.

Reported from India, Sahasram (Bengal), Calcutta (mihi), Java, Borneo, Sumatra, Philippines.

*Species of uncertain position.*

293. *Arma velata*, Walker, Cat. Het. iii, p. 532 (1868).

Ferruginous, nearly elliptical, thickly and minutely punctured; punctures black, dull ochraceous beneath: head mostly blackish above:

eyes rather prominent: antennæ ochraceous; third joint hardly shorter than the second; fourth longer than the third and than the fifth: pronotum with an irregular black band near the fore border; sides indistinctly crenulated; spines black, long, stout, acute: scutellum blackish towards the base, except on each side; tip pale yellow: abdomen beneath with a broad black stripe on the apical segment: legs ochraceous, stout: membrane brown (*Walker*). Long,  $10\frac{1}{2}$  mill.

Reported from India, closely allied to *A. turbida*, Walker, but the spines of the pronotum are longer and more acute.

294. *Arma turbida*, Walker, Cat. Het. i, p. 140 (1867).

Piceous, elliptical, thickly and minutely punctured; black beneath: head less than one-fourth of the breadth of the pronotum; juga and tylus of equal length; antennæ slender: pronotum with a very slight longitudinal ridge; sides crenulated; spines prominent, acutely angular: scutellum with a slight longitudinal ridge towards the apex: abdomen purple, blue at the tip: ventral spine not extending beyond the last coxæ: legs piceous, stout, setulose: membrane cinereous, partly clouded with brown (*Walker*). Long,  $11\frac{1}{2}$  mill.

Locality unknown, India?

Add the following synonymy to that given in these notes:—

J. A. S. B., Pt. II, p. 187, 1886, No. 105, *Eurygaster maurus*, Linn., add:—

*cinerea* and *Schranki*, Goeze; *testudinaria* and *cappata*, Fourer, according to Puton: also.

*Cimex frischii*, Gmelin, Syst. Nat. i (4), p. 2134 (1792).

Var. *E. nigra*, Fieber, Eur. Hem. p. 370 (1861).

Var. *E. signata*, Fieber, l. c.

J. A. S. B., Pt. II, p. 30, 1887, No. 169, *Carpocoris nigricornis*, Fabr., add:—

*Cimex purpureipennis*, De Géer, iii, p. 258 (1773).

*Cimex corneus*, Gmelin, Syst. Nat. i (4), p. 2134 (1792).

P. 42. No. 186:—*Eysarcoris inconspicuus*, Herr.-Schäff., add:—

*Eysarcoris helferi*, Fieber, Eur. Hem. p. 332 (1861).

*Eysarcoris epistomalis*, Muls. and Rey., Pun. France, 177 (1866).

*Pentatoma pusilla*, Costa, Cim. Cent. II, decas 6-10, 24.

*Eysarcoris pseudoaeneus*, Jakow., Hor. Soc. Ent. Ross., vi, p. 117: Bull. Soc. Mosc. 48 (i), p. 238 (1874).

P. 52 No. 199:—*Eurydema festivum*, Linn., transfer:—

Var. *albiventris*, Jak., to *E. dominulum*, Scop., and add:—

Var. *maracandicum*, Oschan, *Strachia id*, Bull. Soc. Mosc. 48 (i), p. 239 (1874).

Var. *decoratum*, Herr.-Schäff, *Pentatoma, id*, Faun. Germ. 116: Walker, Cat. Het. ii, p. 313 (1867).

*Strachia pustulata*, Fieber, Weitenw. Beitr. i, p. 352, t. 2, f. 3', (1836): Walker, l. c.

*Strachia decorata*, Muls. and Rey., Pun. France, Pent. p. 214 (1866).

Var. *mehadiense*, Horvath, Term. füz. v, p. 219 (1881): Rev. d'Ent. vii, p. 187, (1888).

Var. *Christophi*, Jak., Horvath, l. c.

P. 53, No. 200:—*Eurydema dominulum*, Scop., add:—

*Cimex cordiger*, Goeze, Reuter, Rev. Men. d'Ent. iii, p. 68 (1883).

*Eurydema ornatum*, F. Sahlb., Mon. Geoc. Fenn., p. 24 (1848).

*Pentatoma fimbriolata*, Germar, Faun. Ins. 17. For '*bhesgica*,' read '*lhesgica*' in heading.

P. 54, No. 202:—*Eurydema ornatum*, Linn., add:—

Var. *Strachia pectoralis*, Fieber, Eur. Hem., p. 342 (1861).

Var. *Strachia dissimilis*, Fieber, do.

Var. *Eurydema ventralis*, Kolenati, Mel. Ent. iv, 26 (1846).

J. A. S. B., Pt. II, p. 36, 1887, in line 6 from top of page, for '*basal*,' read '*lateral*.'

Do. p. 165, No. 80, in line 5 of description, for '*head*,' read '*body*.'

Do. p. 168, No. 82, in line 10 of description, for '*joining*,' read '*forming*.'

Do. p. 169, line 9 from top, for '*an oblique stria*,' read '*and some oblique striæ*.'

Do. p. 172, No. 86, add to title, '*PATRICIUS*.'

Do. p. 177, line 18 from top of page, for '*within*,' read '*inward of*.'

Do. p. 189, No. 107, in title, for '*CALLIDEA*,' read '*CHRYSOCORIS*.' I have since received a specimen from Assam.









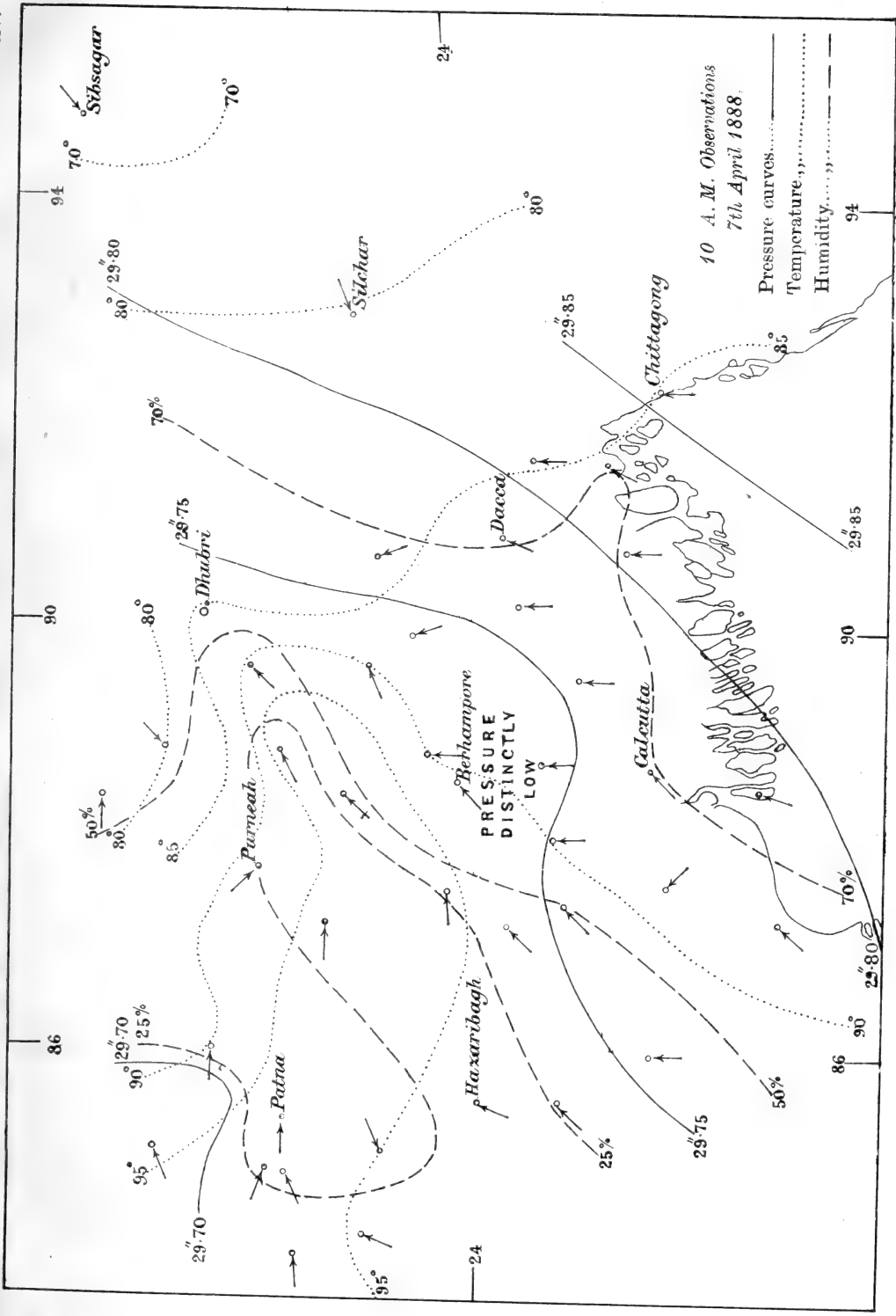

10 A. M. Observations  
7th April 1888.

Pressure curves.....  
Temperature.....  
Humidity.....

PRESSURE  
DISTINCTLY  
LOW



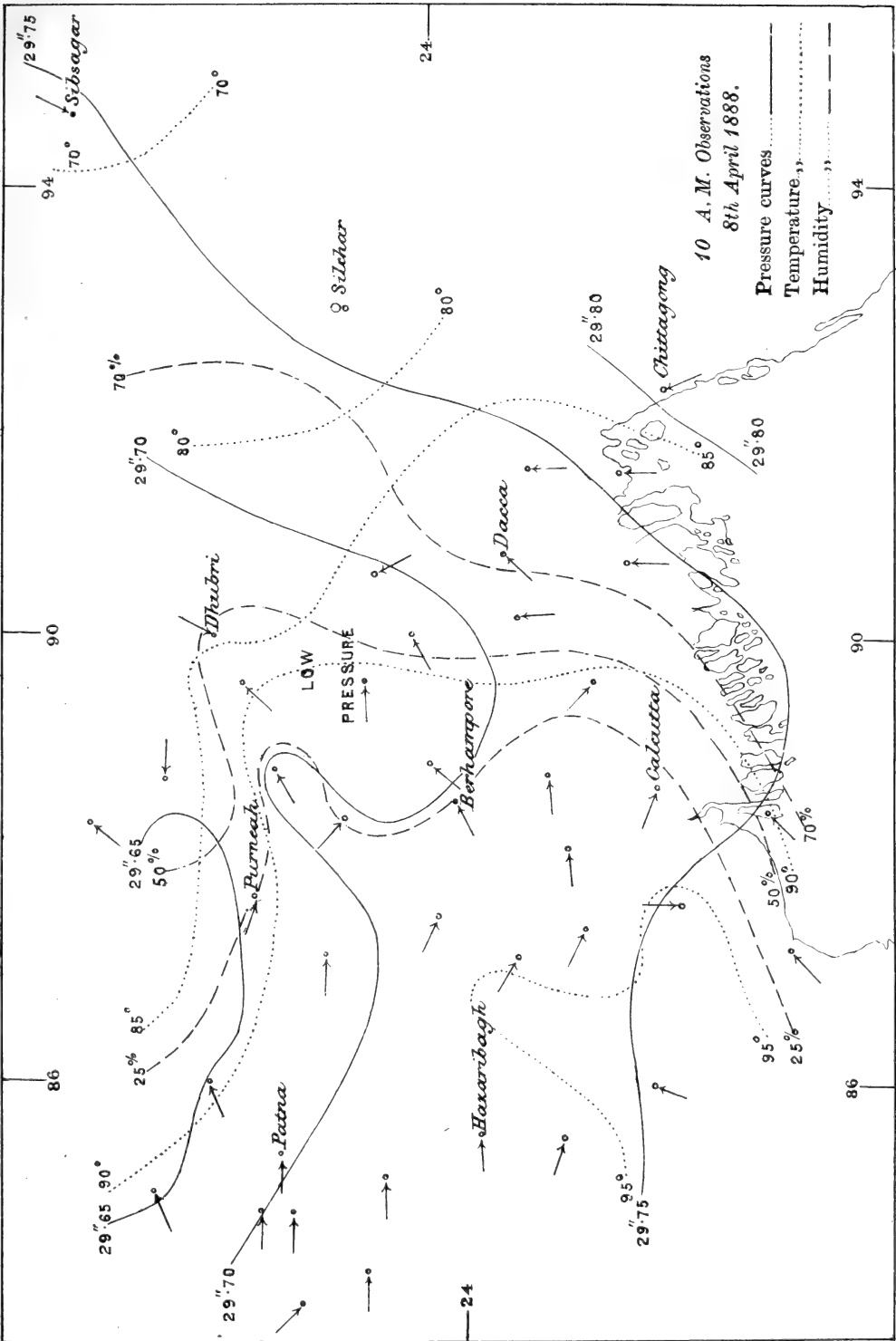
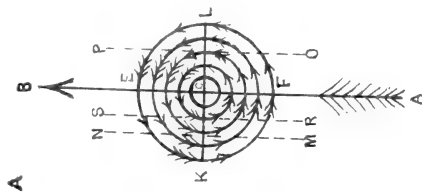
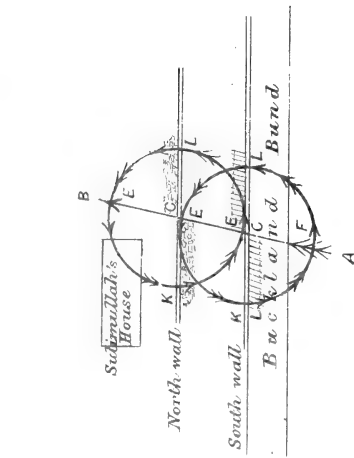



Diagram to represent direction of winds in Tornado



Action of Tornado on Buckland Bund.



Shape of Tornado Cloud.

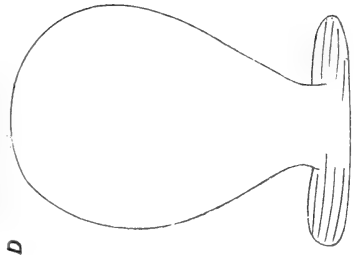

C

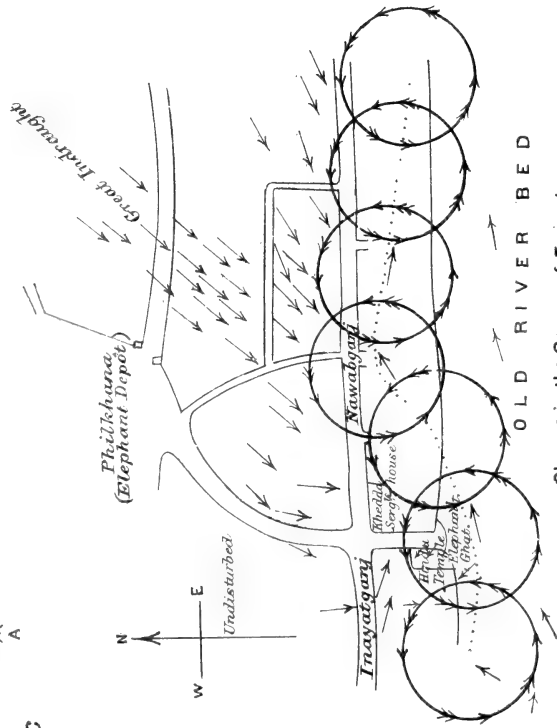

Change in the Course of Tornado.

E

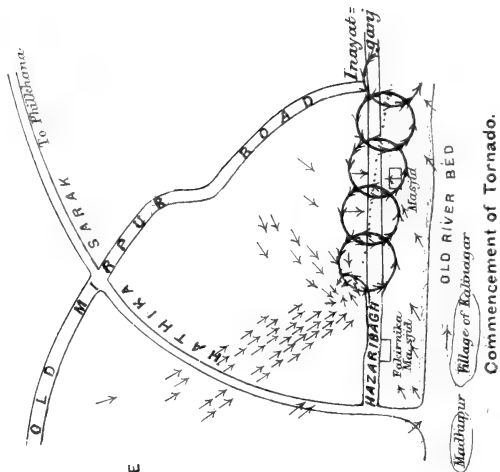

Commencement of Tornado.



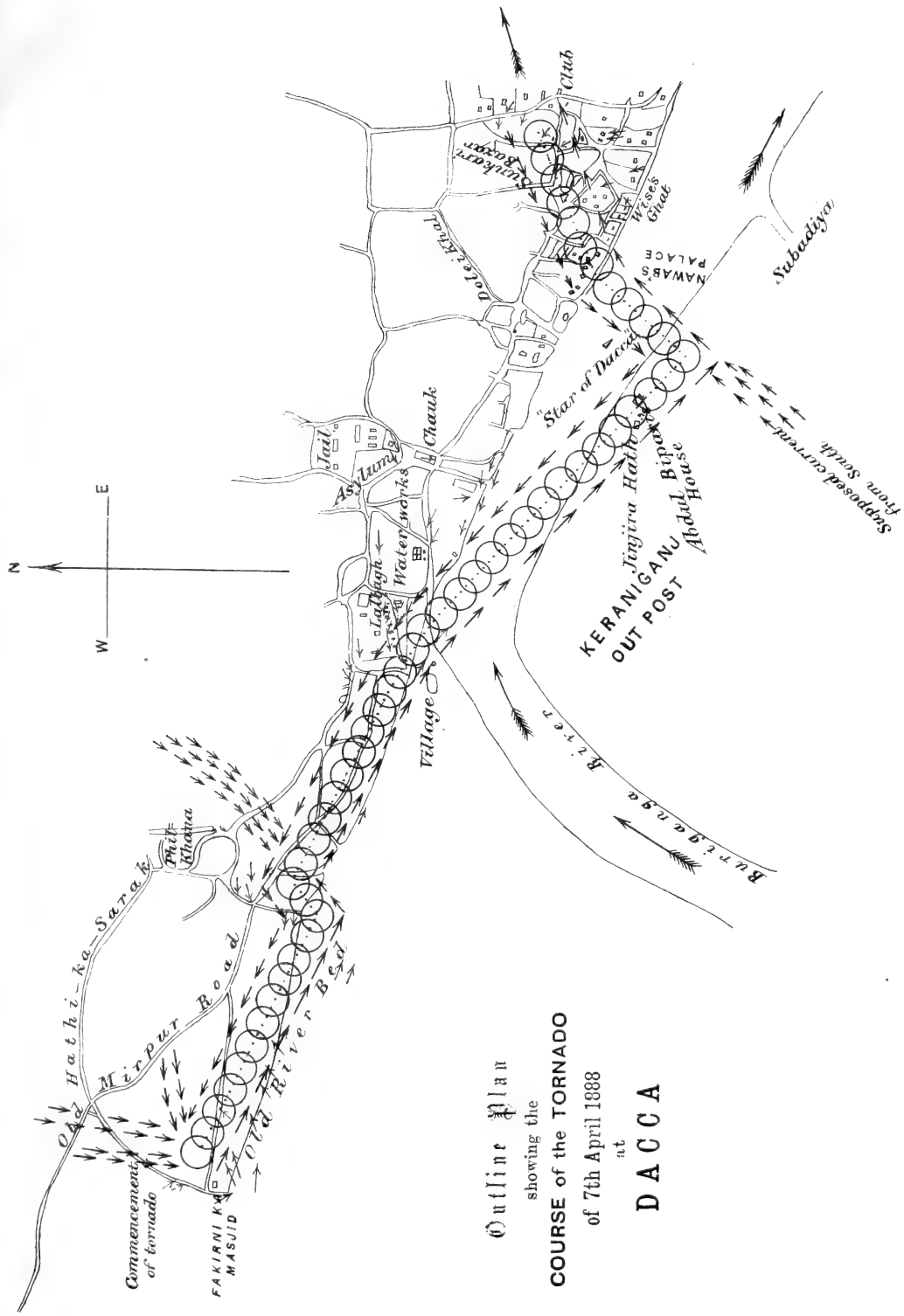

Outline Plan  
 showing the  
**COURSE of the TORNADO**  
 of 7th April 1888  
 at  
**DACCA**





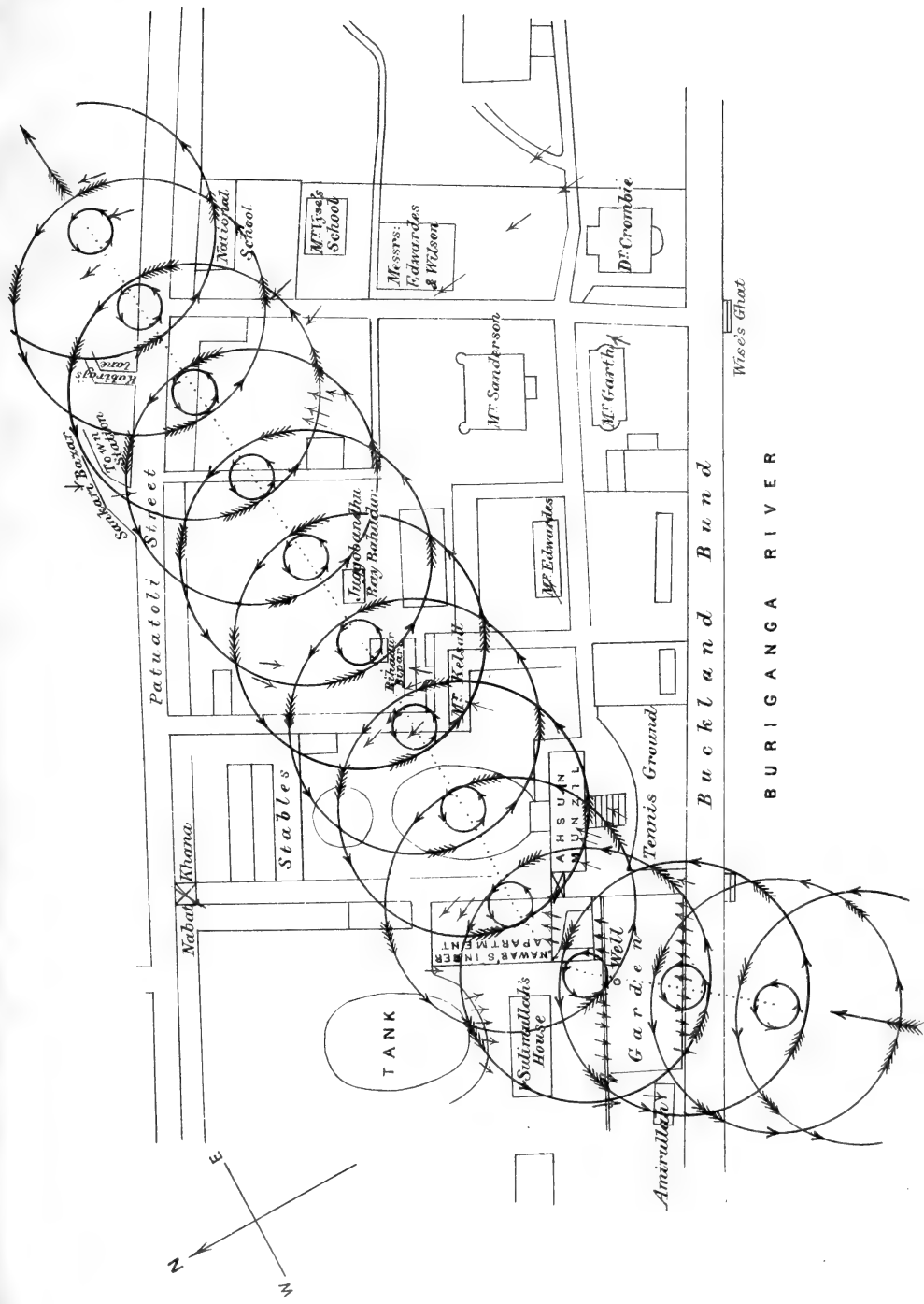

DETAILED PLAN OF THAT PART OF THE TRACK OF TORNADO OF APRIL 7TH WHERE MUCH DAMAGE WAS DONE.



VI.—*On recent Tornadoes in Bengal with special reference to the Tornado at Dacca on April 7th, 1888. In two Parts. Part I. A Description of the Meteorological Conditions in Bengal which accompanied the Formation of the Dacca Tornado.—By ALEX. PEDLER, Offg. Meteorological Reporter to the Government of Bengal. Part II. A full Description of the actual Phenomena of the Dacca Tornado.—By A. CROMBIE, M. D., Civil Surgeon of Dacca.*

(With Plates XXIV.—XXIX.)

[Received and Read May 3rd, 1888.]

PART I.

*Meteorological Conditions accompanying the Dacca Tornado.*

By ALEX. PEDLER.

Amongst the very varied meteorological phenomena which are commonly met with in India or in Bengal, tornadoes are fortunately of rare occurrence. So rare are they in most countries that few people, except those living in the United States, ever have an opportunity of witnessing one. On account of their rarity in India and of the rather loose manner in which such names as cyclones, whirlwinds, dust-storms, and nor'-westers are sometimes applied to classes of storms which have no right to them, it may be well to state that whirlwinds, waterspouts, tornadoes, dust-storms, and even nor'-westers, are all closely connected phenomena, differing from each other in such particulars as dimensions and intensity, or the degree in which the moisture present is condensed and becomes visible, though more or less closely connected in the causes which give them birth. Such storms as these are, however, widely different from true cyclones both in the manner of their formation and in their phenomena. Thus, the largest tornadoes are vastly smaller than the smallest cyclones, so that there is no difficulty in distinguishing between the two classes. The cyclones with which we are familiar in India, and particularly in the Bay of Bengal, are formed over sea areas when the conditions of pressure are very uniform, when the air motion is small over the area where the storm forms, and when the air is of high temperature and nearly saturated with moisture. The formation of a cyclone is apparently only possible when the energy of the storm can be supplied by the rapid inrush of moisture-laden winds in large volumes, and the actual formation of it appears to follow on or to be connected with excessively heavy and torrential rain over a small area. Again, cyclones take time to generate, and they are frequently in existence for days before they attain their maximum strength, and the diameter of the area of hurricane winds is rarely less than 100 miles. Cyclones are also as a rule slow moving storms in

India, averaging perhaps 8 to 10 miles an hour, and they rarely travel faster than about 15 miles an hour, so that consequently a place visited by a cyclone remains under its influence usually for some hours; and, finally, the whole track of a cyclone may be many hundreds of miles in length. Tornadoes or whirlwinds, which, perhaps, from their destructive energy, are alone likely to be confounded with cyclones, are of very different nature. It is true, cyclones and tornadoes are both circular storms, and, in the Northern hemisphere, the rotation of the winds round the centre of these storms is against the hands of a watch; and in this point they agree, but they differ in many others. As the result of the examination of the character of 600 tornadoes in the United States,\* their average size is found to be about 360 yards, the velocity of their progression about 30 miles an hour, the average time consumed by the tornado cloud in passing a given point about six minutes, and the average length of the storm track about 28 miles. Another point in which tornadoes differ completely from cyclones is that tornadoes have a distinct diurnal periodicity, usually occurring from 4 to 6 P. M., and they may occur at any season of the year, while fierce cyclones in the Bay of Bengal are confined to limited periods of the year, and they can have, from the nature of the case, no diurnal periodicity at all. It might, however, be objected that perhaps a tornado might grow to a cyclone, but up to the present time such an action has never been known to occur, and thus it must be admitted that there is a sharp line of demarcation between the two classes of storms.

A tornado, briefly described, is merely a whirlwind of excessive violence, and the tornado cloud usually takes the shape of a funnel, though such descriptions as "cone-shaped," "inverted funnel-shaped," "hour-glass-shaped," &c., sometimes occur. The tornado cloud has generally four movements (1) a motion of translation which is in most cases from the south-west to the north-east at perhaps an average rate of 28 miles an hour, (2) a violent rotating motion, the winds moving against the hands of a watch, (3) a swinging to and fro, so that the path of the storm frequently becomes very irregular, and sometimes (4) a rising and falling motion. With reference to the last movement, tornadoes have been seen by observers to travel actually for some distance through the air with the lower point of the tornado cloud at a considerable distance from the ground and simply to strike the ground from point to point.

The destructive effects of the tornado seem to be vastly more violent than those of cyclones, and the area of destruction is most sharp-

\* Finley, Professional Papers of U. S. Signal Service, Series No. VII., Washington.

ly defined. The effects of tornadoes are in fact almost incredible, and they are due to both lateral and ascensional force. Masonry buildings are almost ground to powder by the lateral force; and, with reference to the uplifting power of tornadoes, it is on record that on June 4th, 1877,\* a tornado passed over Mount Carmel (Illinois) and swept off the spire vane and gilded ball of a church and carried them bodily 15 miles in a north-easterly direction.

PREVIOUS TORNADOES IN BENGAL.—Tornadoes seem to have been rather more frequent in Bengal than appears to be commonly supposed, though, when compared with other regions, such as the United States, their occurrence may be considered very exceptional. In the United States, however, sometimes 10 or 12 tornadoes are known to occur in different districts in a single day, and in the year 1884 no less than 180 tornadoes were recorded by the Meteorological Department in different parts of that country. In Bengal, previous to the year 1870, there appear to be only two or three well authenticated cases of tornadoes on record.† One occurred on the 8th April in the year 1838 in the District of the 24-Pergunnas, and it passed close to Calcutta and was attended with great damage. This storm, which is described by Messrs. Floyd and Patton,‡ was a very violent one and destroyed several villages. Its track is rather difficult to trace, but it appears to have passed near Dum-Dum, through Baliaghata a short distance to the east of Calcutta, and through Sonarpur S. E. of Calcutta on the South-Eastern State Railway. Its course was said to be southerly, a very unusual circumstance. Its track was roughly 16 miles long by  $\frac{1}{4}$  to  $\frac{1}{2}$  a mile broad, and it lasted for 4 hours. The number of persons killed was 215, and the wounded, which were numerous, were sent to the Alipur Hospital. An observer at Dum-Dum says, one of the hail-stones which fell at that place during this storm weighed three and a half pounds. In passing, it may be mentioned that appended to the description of this storm there is a statement of a mass of ice, apparently a conglomeration of hailstones, and measuring 19 feet 10 inches, having fallen in the year 1838 at Nowloor near Dharwar.

Another tornado occurred at Pundooah (Hooghly District) on May 1st, 1865, and is described by Babu Chandra Sekar Chatterjee in the Proceedings of the Asiatic Society of Bengal.§ The diameter of its vortex appears to have been about 200 feet, and its rate of advance in a north-easterly direction about 10 miles an hour. It occurred at

\* Buchan and Balfour Stewart's article on Meteorology in *Encycl. Bri.* 19th. Ed.

† Some of these storms are described in *Blanford's Indian Meteorologist's Vade Mecum.*

‡ *J. A. S. B.*, 1838, p. 422.

§ *P. A. S. B.*, for 1865, p. 124.

6 to 6.30 P. M., and, according to the statements made, its track must have been at least 3 to 4 miles long. It killed 20 persons and did a large amount of damage. The rotation of the winds in the storm was against the hands of a clock.

Major Sherwill\* in 1860 describes several waterspouts (phenomena of similar nature to tornadoes) which he had observed in and near Calcutta previous to this date; and one which occurred on October 7th, 1859, is described by him as having been 1500 feet in height and having inundated half a square mile of country to a depth of six inches.

These, however, are the only clear cases of such storms I can find in Bengal previous to 1860. After this date either these storms have become much more numerous, or, as is more probably the case, owing to the more accurate records kept of such phenomena, our knowledge of their occurrence has become more complete. Thus, Mr. W. G. Willson,† formerly Meteorological Reporter to the Government of Bengal, states there were whirlwinds in April 1871 and September 1872 in the Nadia District, also a rather severe one at Satkhira‡ (24-Pergunnas District) on 25th April, 1872, one at Bhadalia§ (Nadia District) on February 11th, 1874, and another at the same place at 5 P. M. on 16th September 1874.

In the case of the Satkhira storm of April 1872, Mr. Willson considered that it accompanied, or was in some way connected with, the passage of a low pressure area through Bengal at the same time, and he states that the storm moved in the same direction as the trough of low pressure. This storm, however, was very small and only caused three deaths.

The most violent storm of this kind in Bengal on record is described by Mr. Fasson.|| It occurred in the Mymensingh District on March 26th, 1875, and it partially destroyed the villages of Uladah and Chamburi. It seems to have originated over the bed of a large river, instead of, as is usually the case, over hot plains. In this instance, the duration of the whirlwind was 20 minutes, the width of its path 250 yards, and the length of its course from formation to dissipation a little over two miles. Its course was almost exactly from south-west to north-east, and it occurred just after dusk. The whirlwind seems to have been accompanied with a fiery appearance or ruddy glare, and, though it was a storm of great violence, it did comparatively little damage to life and property, as the greater part of its path was over the open country.

The Dacca tornado now described by Dr. Crombie appears to have been very similar in character to that which visited the Mymensingh

\* J. A. S. B. Vol. XXIX, p. 366.

† P. A. S. B. 1875, p. 107.

‡ P. A. S. B. 1872, p. 96.

§ P. A. S. B. 1875, p. 107.

|| P. A. S. B. 1875, p. 104.

District in 1875, as to size, duration, and general direction, but, as its track lay through a populous town instead of the open country, the amount of damage done by it was very large.

METEOROLOGICAL CONDITIONS USUALLY PRECEDING TORNADES.—As will be seen from the preceding description, the number of tornadoes which have occurred in Bengal (and probably in India also), and of which accurate records are obtainable, has been far too small to enable any scientific work to be undertaken as to their causation. In the United States, however, as previously mentioned, tornadoes are frequent, and, under the direction of the War Department, the Signal Service of that country has done most valuable work on these storms. For a full description of the effects of these storms and of the meteorological conditions which precede them, the works of Lieutenant John P. Finley may be consulted.\* But even though Mr. Finley has worked out the records of about 800 tornadoes, he has been unable to lay down more than very general statements as to the meteorological conditions which precede such storms, and, in his last work published in 1885, he states, "The following are some of the conclusions which appear to proceed from a study of the relation of tornado-centres to areas of barometric minimum.

1. That there is a definite portion of an area of low pressure within which the conditions for the development of tornadoes are most favourable, and this is called the dangerous octant.

2. That there is a definite relation between the position of tornado regions and the region of high contrasts in temperature, the former lying to the south and east.

3. That there is a similar definite relation of position of tornado regions and the region of high contrasts in the dew point, the former being, as before, to the south and east.

4. That the position of tornado regions is to the south and east of the region of high contrasts of cool northerly and warm southerly winds, a condition that appears to be dependent upon the preceding, and is of use when observations of temperature and dew point are not accessible.

5. The relation of tornado regions to the movement of upper and lower clouds presents some interesting points for study, but, as yet, no decided results.

6. The study of the relation of tornado regions to the form of barometric depressions appears to show, that tornadoes are more frequent when the major axes of the barometric troughs trend north and south or north-east and south-west, than when they trend east and west."

\* In such papers as Professional Papers of the Signal Service War Department. No. IV. Tornadoes of May 29th and 30th, 1879. No. VI. Report on the character of 600 tornadoes. No. XVI. Tornado Studies for 1884.

In reference to the connection which Mr. Finley appears to find between the passage of barometric minima and the possibility of formation of tornadoes, it will be remarked that Mr. Willson apparently traced a connection between the two same facts in the case of the Satkhira tornado of 1872.

According to the meteorological charts which accompany Mr. Finley's Memoirs, it would appear that the position of the formation of tornadoes is to the south and east of the line taken during the advance of the barometric minimum, and that it occupies the same relative position to the high contrasts of temperature and humidity. Further, it is probable that the track of the tornado bears a definite relation to the position of these same violent contrasts. In all these cases, however, it is not to be assumed that the tornado will be formed in close proximity to barometric minima or to contrasts of temperature and humidity, for the researches in America show that these actions may only exist long distances, perhaps 200 or 300 miles, away. Beyond these rather vague statements, it does not appear safe to go, but it is clear there must be some further cause or causes at work which determine the actual formation of the storm, but of which at the present time we have no knowledge.

Similar actions or contrasts of temperature and humidity brought about by more or less opposing wind systems blowing in neighbouring districts are common in Bengal during the hot weather season. It frequently happens that hot, dry, north-westerly winds may be blowing a short distance inland, while moist, comparatively cool, southerly or south-easterly winds are blowing to the south of them, or along the coast and in the neighbouring districts. Such actions usually, it is believed, produce the nor'westers with which all are familiar, and which are of very frequent occurrence in Bengal from about February to June. The history of some of these storms has been worked out by Mr. Eliot.\* Experience has shown that nor'-westers do not occur either when a steady, hot, and dry westerly or north-westerly current is blowing over Bengal, or even when a steady easterly or south-easterly current heavily laden with moisture is blowing over the Province, as is the case during the rainy season, but it is required that both currents be present in different districts. To state the case roughly and very briefly, it is believed that the actual storm may be formed at the area of interaction by one of two causes. Either the moist wind may be forced upwards above the hot, dry current, when according to well known laws the mass of gas would expand and cool, and at once deposit a part of its moisture in the form of rain. This formation of liquid water from aqueous vapour will immediately set free a large amount of energy, which, perhaps, increases the ascen-

\* Indian Meteorological Memoirs, Vol. I, p. 119.



sional motion ; and this probably forms an important part in the development of the storm and of its well known energy. Or the north-westerly current which is blowing may suddenly overcome the resistance of the southerly current, and cool air from the higher regions of the atmosphere may force its way downwards to the earth's surface and cause similar effects. The formation, however, of these nor'westers appears to necessitate a considerable amount of air motion, and also that the air currents shall be of more or less opposite nature.

This, however, does not exhaust the possibilities of storms in India, and, in many cases, dust-storms, &c. are formed when there are apparently no opposing wind systems at work as previously described. Such storms usually form at considerable distances inland and over highly heated and dry land surfaces, and their formation is probably due to the intense heating effect of the sun's rays on an atmosphere more or less laden with dust and other solid particles. The immediate antecedent cause of the formation of such a storm may perhaps be found in an action which may be best described in the words of Sir George Airy, who states, "The atmosphere is a viscous gas, and it is only on this assumption that cyclonic phenomena and the phenomena of all rotatory storms in the hotter parts of the earth can be explained, and that in such storms there is a mass of hot air which, from the viscosity of its structure, is not able to rise up for a long time until at last it rises up with a burst." It is in fact only by some such action as this that many of the phenomena of hot weather storms in India can be explained. If we admit that, over a considerable tract of land, owing to the heating effect of the sun and the viscosity of the air, there is a decided increase of pressure, which, after accumulating for a time, is suddenly relieved, and that in consequence of this relief of pressure the highly heated air suddenly ascends, then the uprush will, directly the ascensional motion commences, assume a spiral movement, and there will be formed in the northern hemisphere a wind rotation probably against the hands of a watch, similar in fact to that sometimes observed in dust-storms and usually in tornadoes in the northern hemisphere. Though these storms can be understood so far, their enormous energy has not been well accounted for, though many theories and suggestions have been put forward.

Theories such as have just been very briefly and incompletely described are advanced to account for the classes of storms which are frequently met with in India during the hot season of the year, but, from time to time, perhaps once in five or ten years, the conditions which usually are only followed by ordinary nor'westers or dust-storms, but which are more or less violent in their nature, give birth to a whirlwind or tornado of extreme energy and destructive force. In the case of the

Dacca tornado under discussion, an ordinary nor'wester was actually in progress when the tornado suddenly appeared in close proximity to, if not in actual connection with, the storm, but still quite distinct from it, and moving in its own particular path. This would apparently point to the fact that the general conditions which produce nor'westers, or perhaps dust-storms, may with the addition of some cause or causes, possibly almost accidentally present, also generate tornadoes of a violent type. What such additional circumstances or causes are which determine the actual formation of the tornado, it is impossible at present to say, but it is fortunate for India that the combination of circumstances required is rare.

The conditions as to great contrasts of temperature and humidity previously referred to, and the passage of areas of barometric minima may be looked upon as predisposing causes only, but they clearly cannot be classed as proximate causes, for such predisposing conditions obtain very frequently indeed in India, and it is rarely that they are followed by tornadoes.

Tornadoes are also found in America to be formed frequently during still or almost calm weather, and there are accounts of observers having actually seen the formation and growth of a tornado taking place on an almost perfectly calm but sultry day.\* This would perhaps point to some such action as described before in Sir George Airy's words being the possible explanation of their formation; and, if such is the case, any forecast of their probability from any regular or definite series of meteorological conditions would become impracticable, for it is manifestly impossible to say when any sudden uprush of heated air may take place over any large and highly heated area, or at what point such action might occur.

The above statements may perhaps be said to be confessions of an ignorance more or less complete of the subject of tornado formation, but such only are the facts at present known.

#### METEOROLOGICAL CONDITIONS IN BENGAL PREVIOUS TO THE TORNADO.

—The meteorological conditions of the earlier parts of the year do not call for any particular comment. In fact, the phenomena of the formation and existence of a tornado are of such a brief and transitory nature that it would be useless to seek for anything like proximate or even predisposing causes in the meteorology of the previous months of the year; so that an extremely brief record will suffice.

January and February were months of the normal cold weather type in Bengal, and in March the usual rapid increase of temperature

\* H. S. Whitfield, Tornadoes in the Southern States, American Journal of Science, 3rd Series, Vol. II, p. 96 and others.

took place, the mean temperature of the province at the end of March being nearly  $10^{\circ}$  higher than at the commencement. The winds blowing in the various districts were nearly normal in character; dry westerly and north-westerly winds were reported in the west and north-west of the province, moist south-westerly and southerly winds were blowing at the southern stations, and moist south-easterly and easterly winds at the eastern and at some of the northern stations. In consequence of the interaction between these wind systems, a considerable number of local storms or nor'westers occurred, principally about the middle of the month; these ceased about the 18th of March and weather became fine, but again on the 27th, without any particular change in the ordinary conditions, a series of storms set in, very local in character, but some of which were exceedingly fierce. One, if not two, of these storms appear to have been whirlwinds or tornadoes. One of them occurred in the Magura subdivision of the Jessore district, and Mr. F. H. Barrow, C. S., Magistrate of Jessore, describes it as follows:—

“ I have the honor to report that at sunset of 27th March last, a hail-storm blew in the Magura subdivision and devastated the villages Barbhanga, Kukhila, Gobindpore, Nurandia, Ghoranach, Jagdal, and Dakurbhila. It is described as having risen in the shape of a whirlwind from Kalijir bheel about 2 miles to the south-east of Magura and blown right across the south over the villages in the order they are noted. It blew in a cyclonic form, throwing down almost all the huts and uprooting and smashing extensive bamboo topes and fruit trees, it is said by thousands. There was a large tank in village Ghoranach which supplied drinking water to the inhabitants of the neighbouring villages. This tank has been literally filled with falling trees and branches, and the water rendered undrinkable.

“ Four persons died by the fall of trees and huts, and nearly 24 persons, chiefly women, have received hurt.

“ The storm has caused great hardship to the inhabitants of the 7 villages named. They have lost almost everything they had, and have no shed to shelter them.”

The following is a further note by Babu Kali Prasanna Sircar, Subdivisional officer of Magura.

“ The tornado blew towards the south, inclining a little towards the east. It is said that two gusts of wind, one blowing from the east, and the other from the west, met together at Kalijir bheel, about 2 miles south of Magura, and then swept across the country. The area affected is about 7 miles in length and 1 mile in width, and the duration was about 10 minutes. The people say that the tornado blew in the shape

shewn in the sketch.\* It was ushered in by a deep rumbling sound as of a continuous distant thunder and it lasted about 3 minutes."

On the same day, 27th March, an extremely violent storm took place in the Pubna district, which passed over the villages of Barenga, Kalayanpore, and many others. The storm is said to have blown from the north-west and crossed the Brahmaputra and Batabunda over to the district of Dacca. It seems to have lasted, according to the published accounts, about half an hour. Many huts and trees were thrown down and some pucca houses badly injured. More than 20 persons were killed and about 80 severely injured. No details as to this storm have been received from the District Officers by the Meteorological Department, the above facts having appeared in the daily papers, but, so far as can be judged by its destructive violence, etc., this storm also must have been a whirlwind or tornado, though probably not connected with the Magura storm.

From the 27th of March to the 4th April, again, the meteorological conditions of the province call for no particular comment, except that on the 1st there were storms in North Bengal, and on the 4th a few nor'westers were reported in Orissa and West Bengal. From the 4th to the 6th there was an almost complete absence of local storms, and weather appeared fairly settled. The character of the meteorological changes which took place in Bengal from the 5th to the 6th of April is shewn in the following small table:—

*Observations taken at 10 a. m. April 6th, 1888.*

| STATIONS.         | Pressure reduced to 32° and sea level in inches. | Change of pressure since previous day. | Maximum Temperature. | Minimum Temperature. | 10 A. M. Temperature. | Humidity 10 A. M. Sat. = 100. | Wind direction. | Wind velocity in miles per hour. | Cloud proportion. | Rainfall. | State of weather for previous 24 hours. |
|-------------------|--------------------------------------------------|----------------------------------------|----------------------|----------------------|-----------------------|-------------------------------|-----------------|----------------------------------|-------------------|-----------|-----------------------------------------|
| False Point ...   | 29.848                                           | -0.024                                 | 87.4                 | 77.6                 | 85.3                  | 78                            | S.S.W.          | 11                               | 3                 | Nil.      | Fine.                                   |
| Hazaribagh ...    | 29.764                                           | -0.023                                 | 94.5                 | 69.9                 | 91.7                  | 0                             | N.W.            | 12                               | 0                 | Nil.      | Fine.                                   |
| Patna ...         | 29.758                                           | -0.004                                 | 99.7                 | 70.2                 | 94.7                  | 9                             | W.              | 7                                | 0                 | Nil.      | Fine.                                   |
| Sangor Island ... | 29.838                                           | Nil.                                   | 90.2                 | 80.0                 | 85.9                  | 78                            | S.S.W.          | 19                               | 6                 | Nil.      | Fine.                                   |
| Calcutta ..       | 29.831                                           | +0.022                                 | 97.5                 | 75.2                 | 86.4                  | 68                            | S.S.W.          | 4                                | 0                 | Nil.      | Fine.                                   |
| Jessore ...       | 29.838                                           | +0.032                                 | 100.8                | 76.3                 | 90.0                  | 64                            | S.S.W.          | 3                                | 0                 | Nil.      | Fine.                                   |
| Furreedpore ...   | 29.868                                           | +0.005                                 | 88.5                 | 76.9                 | 87.5                  | 65                            | S.              | 5                                | 0                 | Nil.      | Fine.                                   |
| Chittagong ...    | 29.897                                           | +0.032                                 | 88.8                 | 74.3                 | 86.4                  | 68                            | S.S.W.          | 3                                | 3                 | Nil.      | Fine.                                   |
| Dacca ...         | 29.820                                           | +0.012                                 | 94.1                 | 77.0                 | 86.7                  | 70                            | S.W.            | 8                                | 0                 | Nil.      | Fine.                                   |
| Mymensing ...     | 29.823                                           | ...                                    | 90.0                 | 76.1                 | 85.2                  | 63                            | S.E.            | 6                                | 2                 | Nil.      | Fine.                                   |
| Serajgunge ...    | 29.800                                           | +0.021                                 | 99.0                 | 71.7                 | 90.7                  | 44                            | S.S.W.          | 5                                | 0                 | Nil.      | Fine.                                   |
| Dhubri ...        | 29.801                                           | +0.059                                 | 95.6                 | 69.7                 | 84.9                  | 44                            | W.S.W.          | 6                                | 0                 | Nil.      | Fine.                                   |
| Bogra ...         | 29.777                                           | +0.030                                 | 100.3                | 71.8                 | 94.5                  | 21                            | S.W.            | 6                                | 0                 | Nil.      | Fine.                                   |
| Dinagepore ...    | 29.756                                           | +0.020                                 | 99.1                 | 65.7                 | 96.3                  | 11                            | S.W.            | 6                                | 0                 | Nil.      | Sultry.                                 |
| Rampore Beaulah   | 29.790                                           | -0.009                                 | 98.4                 | 66.7                 | 95.6                  | 23                            | S.W.            | 4                                | 0                 | Nil.      | Fine.                                   |
| Berhampore ...    | 29.810                                           | +0.018                                 | 101.2                | 72.3                 | 94.5                  | 18                            | S.S.W.          | 6                                | 0                 | Nil.      | Fine.                                   |

\* The diagram given is very similar to the shape of an apple.

The observations contained in the above table, with those of a good many other stations, are charted on a small map (Pl. XXIV.) on which are drawn the lines of equal pressure reduced to sea-level, which are shewn by continuous lines, the lines of equal humidity in broken lines, and those of equal temperature at 10 A. M. by dotted lines; but in the last case the temperatures are not reduced to their sea-level equivalents, for the majority of stations which are shewn are in the plains of Bengal, and do not therefore differ very much in height above sea-level, and, for the purposes required in this paper, it does not appear that such a correction is necessary. The observations prove clearly that, so far as atmospheric pressure was concerned, the changes were very small, and did not denote that there was any particular disturbance going on in Bengal. On the previous day, the 5th, the observations taken over the whole of India for the India Weather Report had shewn that pressure was falling over part of Orissa and the neighbouring parts of the Central Provinces, while over the whole of Bengal and Behar pressure was rising. On the 6th April, or the day under review, pressure was falling decidedly over Chutia Nagpur and parts of Orissa, while it was still rising over the remainder of the Province, particularly in East and North Bengal. Owing to these changes, a shallow area of comparatively low pressure appears to have formed over parts of West Bengal and Chutia Nagpur, though the lowest pressures in the province were actually recorded in Behar and North Bengal. On this day also, the isothermal lines representing differences of  $5^{\circ}$  are very close to each other, particularly over parts of North Bengal, shewing that there were great contrasts of temperature over limited areas. The broken lines shewing equal degrees of humidity are also very close over East and North Bengal, and, while such stations as Berhampore, Rampore Bauleah, Bogra, Dinagepore, and the area to the west shew generally humidities below 20 per cent., only 50 to 100 miles to the east of this area, humidities of about 70 per cent. were generally reported.

The distribution of the humidity and the wind directions over the Province as laid down in the chart for the day (Pl. XXIV.) shew most clearly that two very distinct wind currents were principally affecting Bengal. There was an exceptionally dry westerly current blowing from the centre of India over Behar, Chutia Nagpur, and West Bengal, and even penetrating as far as North Bengal, for winds were more or less westerly with very low humidity at Bogra, Dinagepore, and Rungpore. At the southern stations, a strong and very moist southerly wind from the Bay of Bengal was blowing, giving, in combination with the westerly winds from Central India, a south-westerly breeze over considerable parts of the centre of the Province, while north-

easterly winds were blowing down the Assam valley, and reached as far as Julpiguri in North Bengal. The limit on this day of the area of the action of the moist southerly winds may be said to be defined by a curved line running through Balasore, Calcutta, Jessore, and Mymensingh; and near this line and to the north and west of it, the contrasts of temperature and humidity were exceptionally large.

The following table gives again some of the principal meteorological observations taken in Bengal on the morning of the 7th April 1888.

*Observations taken at 10 a. m. April 7th, 1888.*

| STATIONS.         | Pressure reduced to 32° and sea-level in inches. | Change of pressure since previous day. | Maximum temperature. | Minimum temperature. | 10 A. M. temperature. | Humidity 10 A.M. Sat. = 100. | Wind direction. | Wind velocity in miles per hour. | Cloud proportion. | Rainfall. | State of weather for previous 24 hours. |
|-------------------|--------------------------------------------------|----------------------------------------|----------------------|----------------------|-----------------------|------------------------------|-----------------|----------------------------------|-------------------|-----------|-----------------------------------------|
| False Point ...   | 29·815                                           | -.033                                  | 86·9                 | 77·6                 | 85·3                  | 74                           | S.S.W.          | 14                               | 0                 |           | Dust Haze.                              |
| Hazaribagh ...    | ·716                                             | -.048                                  | 98·5                 | 72·8                 | 92·2                  | 8                            | S.S.W.          | 9                                | 0                 |           | Fine.                                   |
| Patna ...         | ·711                                             | -.043                                  | 102·9                | 73·2                 | 98·3                  | 16                           | W.              | 5                                | 0                 | ...       | Clear.                                  |
| Saugor Island ... | ·795                                             | -.047                                  | 89·7                 | 80·5                 | 85·9                  | 76                           | S.S.W.          | 22                               | 4                 | ...       | Fine.                                   |
| Calcutta ...      | ·767                                             | -.064                                  | 96·5                 | 77·2                 | 86·9                  | 70                           | S.W.            | 4                                | 2                 | ...       | "                                       |
| Jessore ...       | ·773                                             | -.065                                  | 102·0                | 78·4                 | 89·4                  | 68                           | S.              | 7                                | 0                 | ...       | "                                       |
| Furreedpore ...   | ·858                                             | -.010                                  | 88·5                 | 76·4                 | 88·0                  | 63                           | S.              | 5                                | 0                 | ...       | "                                       |
| Chittagong ...    | ·873                                             | -.024                                  | 87·9                 | 75·5                 | 85·7                  | 65                           | S.              | 7                                | 3                 | ...       | "                                       |
| Dacca ...         | ·779                                             | -.041                                  | 94·5                 | 76·2                 | 86·7                  | 72                           | S.S.W.          | 10                               | 2                 | ...       | "                                       |
| Mymensing ...     | ·780                                             | -.043                                  | 90·3                 | 75·6                 | 84·7                  | 68                           | S.S.E.          | 5                                | 5                 | ...       | "                                       |
| Serajunge ...     | ·741                                             | -.059                                  | 100·0                | 73·7                 | 89·5                  | 59                           | S.S.E.          | 6                                | 0                 | ...       | "                                       |
| Dhubri ...        | ·740                                             | -.061                                  | 96·7                 | 67·8                 | 84·7                  | 59                           | Calm.           | 5                                | 4                 | ...       | Clear.                                  |
| Bogra ...         | ·710                                             | -.067                                  | 101·9                | 74·6                 | 91·5                  | 58                           | W.S.W.          | 6                                | 0                 |           | Hot wind.                               |
| Dinagopore ...    | ·703                                             | -.053                                  | 101·1                | 66·2                 | 99·8                  | 13                           | W.S.W.          | 7                                | 0                 | ...       | Very sultry.                            |
| Rampore Beaulah   | ·740                                             | -.050                                  | 100·4                | 70·7                 | 89·6                  | 64                           | S.              | 5                                | 0                 | ...       | Fine.                                   |
| Berhampore ...    | ·738                                             | -.072                                  | 103·2                | 75·3                 | 90·4                  | 63                           | S.W.            | 7                                | 0                 |           | Foggy.                                  |

On this day, there was again only a slight change in the pressure, and the barometer fell by about 0·03" to 0·07" over the whole province. The most rapid fall of pressure took place at such stations as Calcutta, Kishnagar, Jessore, Berhampore, Serajunge, Bogra, and Dhubri, apparently pointing to the advance of the feeble area of low pressure from Chutia Nagpur and West Bengal towards Central and North Bengal. The area of comparatively low pressure was, however, a feeble one, but it is shewn distinctly in Pl. XXV. by the shape of the isobars for the day, that for 29·75" dipping down rapidly to the south and including a large part of the centre of the Province. There was no particular change of pressure at Dacca or at any of the neighbouring stations

in any way differing from the general atmospheric oscillation which was taking place over Bengal, and no indication of any kind was given of the possible formation of any violent storm over this area. So far then as the pressure indications go, it would appear that the extremely feeble comparatively low pressure area which on the 6th was over Chutia Nagpur and West Bengal was advancing slowly in a north-easterly or easterly direction, and it is certain that the pressure at some of the stations in the centre of the Province, particularly at Kishnagar or between that station and Berhampore, was distinctly low. At Kishnagar indeed the fall of pressure in the 24 hours preceding 10 A. M. of the 7th was 0·074 inch, while at Berhampore it was 0·072 inch.

A glance at Pl. XXV., representing the meteorology of this day, will again shew the very marked contrasts of temperature and humidity which existed over the centre and north of the Province, and particularly in North and Central Bengal, where high temperature with low humidity and low temperature with high humidity existed within a few miles of each other. Thus at 10 A. M. at Dinagepore temperature was 99·8° and humidity was 13 per cent., while at Rungpore, a few miles to the east north-east, temperature was 88·4° and humidity 45 per cent. At Nya Dumka temperature was 97·9° and humidity 13 per cent., and at Berhampore, a few miles to the east, temperature was 90·4° and humidity 63. It will, however, be noticed that this area of great contrasts of temperature and humidity had advanced much further north than it was on the 6th. In fact, when comparing the humidities and wind directions at the various stations on the two days, it is seen that on the 7th the moist southerly wind current had advanced rapidly over Central and part of North Bengal, and had either forced back the dry westerly wind before it, or had pushed its way under it, and thus on this day there is no doubt that the moist current from the Bay of Bengal made its influence felt as far as Berhampore, Rampore Beaulah, Bogra, Maldah, and Rungpore, but that it had failed to reach as far north as Dinagepore. This fluctuation in the area affected by these winds is unusually large and well marked, but, as will be seen subsequently, the observations of the 8th April shewed that this northerly advance of the moist southerly winds was purely temporary, and by the morning of the 8th the moist winds had been completely driven back to their former position. Such large oscillations as these point most unmistakeably to a most disturbed state of the atmosphere, and it will be remembered that, on the evening of this day, the tornado at Dacca happened.

The following table contains some of the principal meteorological observations taken in Bengal on the morning of the 8th April:—

*Observations taken at 10 a. m. April 8th, 1888.*

| STATIONS.           | Pressure reduced to 32° and sea-level in inches. |        | Change of pressure since previous day. | Maximum temperature. | Minimum temperature. | 10 A. M. temperature. |        | Humidity 10 A. M. Sat. = 100. | Wind direction. | Wind velocity in miles per hour. |     | Cloud proportion. | Rainfall. | State of weather for previous 24 hours. |
|---------------------|--------------------------------------------------|--------|----------------------------------------|----------------------|----------------------|-----------------------|--------|-------------------------------|-----------------|----------------------------------|-----|-------------------|-----------|-----------------------------------------|
|                     |                                                  |        |                                        |                      |                      |                       |        |                               |                 |                                  |     |                   |           |                                         |
| False Point ...     | 29·768                                           | — .047 | 86·4                                   | 78·2                 | 86·8                 | 72                    | S.S.W. | 21                            | 0               | ...                              | ... | Dust Haze.        |           |                                         |
| Hazaribagh ...      | ·761                                             | + .045 | 101·3                                  | 70·5                 | 85·6                 | 4                     | W.     | 18                            | 0               | ...                              | ... | Strong wind.      |           |                                         |
| Patna ...           | ·695                                             | — .016 | 104·9                                  | 73·2                 | 90·6                 | 8                     | W.     | 6                             | 0               | ...                              | ... | Clear.            |           |                                         |
| Saugor Island ...   | ·767                                             | — .028 | 89·7                                   | 81·5                 | 85·4                 | 79                    | S.W.   | 27                            | 0               | ...                              | ... | Fine.             |           |                                         |
| Calcutta ...        | ·733                                             | — .034 | 93·5                                   | 72·7                 | 92·4                 | 22                    | W.S.W. | 6                             | 0               | ...                              | ... | "                 |           |                                         |
| Jessore ...         | ·754                                             | — .019 | 99·1                                   | 74·7                 | 92·2                 | 40                    | N.W.   | 4                             | 0               | ...                              | ... | "                 |           |                                         |
| Furreedpore ...     | ·865                                             | + .007 | 88·5                                   | 77·9                 | 87·5                 | 61                    | S.     | 6                             | 0               | ...                              | ... | "                 |           |                                         |
| Chittagong ...      | ·803                                             | — .070 | 87·7                                   | 74·0                 | 83·4                 | 76                    | S.S.E. | 9                             | 0               | ...                              | ... | "                 |           |                                         |
| Dacca ...           | ·714                                             | — .065 | 92·9                                   | 75·2                 | 86·7                 | 75                    | S.W.   | 12                            | 1               | 0·36                             | ... | Tornado.          |           |                                         |
| Mymensing ...       | ·699                                             | — .081 | 90·2                                   | 73·4                 | 86·6                 | 67                    | S.S.E. | 8                             | 3               | ...                              | ... | Fine.             |           |                                         |
| Serajgunge ...      | ·676                                             | — .065 | 101·3                                  | 73·7                 | 89·5                 | 51                    | W.S.W. | 7                             | 0               | ...                              | ... | "                 |           |                                         |
| Dhubri ...          | ·665                                             | — .075 | 99·4                                   | 69·2                 | 84·6                 | 60                    | N.N.E. | 7                             | 1               | ...                              | ... | Clear.            |           |                                         |
| Bogra ...           | ·660                                             | — .050 | 104·3                                  | 73·8                 | 93·1                 | 27                    | W.     | 6                             | 0               | ...                              | ... | High wind.        |           |                                         |
| Dinagepore ...      | ·709                                             | + .006 | 100·6                                  | 69·1                 | 95·8                 | 10                    | W.S.W. | 10                            | 0               | ...                              | ... | Very sultry.      |           |                                         |
| Rampore Beaulah ... | ·680                                             | — .060 | 101·4                                  | 69·7                 | 93·6                 | 27                    | S.W.   | 4                             | 0               | ...                              | ... | Fine.             |           |                                         |
| Berhampore ...      | ·712                                             | — .026 | 104·7                                  | 74·3                 | 93·5                 | 17                    | W.S.W. | 5                             | 0               | ...                              | ... | "                 |           |                                         |

It will be noticed in these observations that there had been a decidedly rapid fall of the barometer at Rampore Beaulah, Mymensing, Serajgunge, Dhubri, and Bogra, while at Saugor Island, Jessore, Calcutta, Berhampore pressure had fallen only slightly. The slight area of comparatively low pressure which was in Central Bengal on the 7th April appears to have again advanced in a north-easterly direction and to have slightly intensified, and on this day a very distinct low pressure area existed in North Bengal, and was represented by such stations as Rungpore, Bogra, Serajgunge, Mymensingh, and Dhubri. The marked contrasts of temperature and humidity still existed over the north and centre of the Province, but scarcely to such an extent as on the 7th, and the lines in Pl. XXV. shewing the increase of temperature by 5° and of humidity by 25 per cent. on this day are still rather close. The most important feature is, however, the change which is seen in the condition of the centre of the province when the humidity and wind directions are considered together, and, as already indicated, the moist southerly wind which had advanced rapidly over the country from the 6th to the 7th had been forced back between the 7th and the 8th with apparently



more than equal rapidity, and in fact the southerly winds had been pushed back much further than they had previously advanced, for on this day their action was confined only to the area to the east of a curved line represented by such stations as Saugor Island, Burrisaul, Fureedpore, Serajunge, and Dhubri. It is therefore clear that there must have been a most unusual and rapid increase in the strength of the dry westerly wind current on the 7th to have overcome the resistance of the strong southerly current in such a complete manner, and the actions of these opposing winds seem to be by far the most important facts in the meteorology of the period, 6th to 8th of April, during which the tornado was formed.

These changes in the areas affected by either the very dry westerly or the very moist southerly current are best shewn by placing in a table the humidities recorded at 10 A. M. at the various stations affected on each day from April 6th to the 9th inclusive.

*Table shewing the Saturation of air with moisture.  
Complete saturation = 100.*

| DISTRICT.             | STATION.                          | April<br>6th,<br>1888. | April<br>7th,<br>1888. | April,<br>8th,<br>1881. | April<br>9th,<br>1888. |
|-----------------------|-----------------------------------|------------------------|------------------------|-------------------------|------------------------|
| Behar ...             | Motihari ...                      | 14                     | 16                     | 6                       | 6                      |
|                       | Arrah ...                         | 13                     | 64                     | 10                      | 11                     |
|                       | Bankipore ...                     | 9                      | 16                     | 8                       | 11                     |
| Chutia Nagpur ...     | Hazaribagh ...                    | 0                      | 8                      | 4                       | 5                      |
|                       | Calcutta ...                      | 68                     | 70                     | 22                      | 13                     |
| South-West Bengal ... | Burdwan ...                       | 45                     | 60                     | 14                      | 10                     |
|                       | Berhampore ...                    | 18                     | 63                     | 17                      | 15                     |
|                       | Jessore ...                       | 64                     | 68                     | 40                      | 50                     |
| East Bengal ...       | Chittagong ...                    | 68                     | 65                     | 76                      | 79                     |
|                       | Burrisaul ...                     | 72                     | 73                     | 73                      | 56                     |
|                       | Fureedpore ...                    | 65                     | 63                     | 61                      | 32                     |
|                       | Dacca ...                         | 70                     | 72                     | 75                      | 50                     |
|                       | Mymensingh ...                    | 63                     | 68                     | 67                      | 18                     |
| North Bengal ...      | Bogra ...                         | 21                     | 58                     | 27                      | 14                     |
|                       | Rampore Beauleah...<br>Maldah ... | 23<br>31               | 64<br>49               | 27<br>26                | 18<br>27               |
|                       | Dinagopore ...                    | 11                     | 13                     | 10                      | 7                      |
|                       | Rungpore ...                      | 16                     | 45                     | 45                      | 21                     |

The figures contained in this table may be more clearly grouped into three districts: first, that to the west and north of the province, second, that to the east and south, and, third, the district in the centre of the province dividing the two. Arranged in this way the figures shewn in the following table are obtained, and it will be seen that over the third of these divisions, or over the area through which the barometric minimum

passed and to the south-east of which the tornado was formed, there were from the 6th to the 8th the most striking and excessive changes in humidity.

| DISTRICT.                                                                                                                                                                                                               | AVERAGE HUMIDITY—SATURATION = 100. |            |            |            |
|-------------------------------------------------------------------------------------------------------------------------------------------------------------------------------------------------------------------------|------------------------------------|------------|------------|------------|
|                                                                                                                                                                                                                         | April 6th.                         | April 7th. | April 8th. | April 9th. |
| A.—Stations in Behar, Chutia Nagpur, and North Bengal acted on by dry wind current ... ..                                                                                                                               | 16                                 | 40         | 18         | 14         |
| B.—Stations in South and South East Bengal ... ..                                                                                                                                                                       | 64                                 | 67         | 54         | 39         |
| C.—Average of Stations, Berhampur, Rampur Beaulah, and Bogra representing an area in a N. E. direction over which apparently the barometric minimum passed and to the south east of which the tornado was formed ... .. | 21                                 | 62         | 24         | 16         |
| Difference between B. & C. ...                                                                                                                                                                                          | 43                                 | 5          | 30         | 23         |

These rapid changes of humidity necessitate equally rapid changes in the air currents affecting the areas, and it is therefore clear that, in Central and North Bengal, or to the north north-west and west of the position in which the tornado was formed, or at all events in which it made itself felt during the period 6th to 8th April,

1. There were rapid changes in the areas affected by two wind currents of almost opposite nature.

2. There were great contrasts of temperature and humidity at neighbouring stations over the same area.

3. There is evidence to shew that there was a shallow area of comparatively low pressure, or a barometric minimum, which passed in a north easterly direction through the centre of the Province from the 6th to the 8th April, or at the time of the formation of the Dacca storm. In other words, the Dacca tornado was formed to the south-east of the track of a feeble low pressure area, and to the south-east of great contrasts of humidity and temperature, as is always found to be the case in America by Mr. Finley and others. But, as before stated, these can only be predisposing causes, and what the immediate cause of the formation of the storm may have been it is impossible to say; and, though it is conceivable that the violent fluctuations of the opposing air currents above referred to may be in some distant way connected with its causation, or with rendering the formation of such a storm extremely probable, yet it is clear we are far from having arrived at its actual cause.

The excellent exhaustive description of the tornado at Dacca which follows this paper is contributed by Dr. A. Crombie, Civil Surgeon of that place. The track of the storm as given by Dr. Crombie shews that the statement of the meteorological observer at Dacca that the storm passed through the compound of that observatory, which was published in the Calcutta Gazette in the Report on the Meteorology of Bengal for the week ending the 13th of April, was incorrect; and it is clear that the storm track was some little distance from the meteorological observatory.

The storm in its destructive effects seems to have been strictly confined to a very sharply defined area, and not to have had even an outer circle of very strong winds, for Mr. E. F. Mondy, Professor of Science, Dacca College, writes:—

“There was nothing of a remarkable nature to indicate its coming. One of the usual not very violent storms was known to be coming, but nothing more. Nor were there any very violent winds outside of its track. I live on the river side and was in my verandah the whole while, not 100 yards from its track on the river side, the river running here about W.  $30^{\circ}$  N., and not a stone's throw from Edward's house (one of those injured though apparently not quite in the track of the storm), which lies N.  $20^{\circ}$  W. from here, but the wind even at this short distance was by no means strong. Yet while I was in the verandah and watched the approach of the storm from the other side of the river, the whole of the tremendous havoc was done just to the N. W. of us.”

The track of the tornado, which is most fully described in Dr. Crombie's paper and is also illustrated by diagrams, appears to have been mainly in an east-south-easterly direction while passing through Dacca, but if Dr. Crombie's surmise is correct that the same tornado afterwards visited the Moonsheegunje District, then its path must have changed to south after rising from the Sankari Bazar. This may undoubtedly have been the case, but there is however nothing impossible in the counter suggestion that the tornado which visited the Moonsheegunje District was a second one. In America, eleven separate tornadoes within a comparatively small area have been known to occur on a single day, and thus it is quite possible that, with the favorable conditions for the formation of such storms which must have obtained in the Dacca District on the 7th of April, two or even more of such storms might have originated. The time at which the storm visited the Moonsheegunje District and the known rate at which the Dacca storm was travelling perhaps favour Dr. Crombie's view.

It is also desirable in connection with the subject of tornadoes in Bengal to place on record an account of another small storm which

visited the Hooghly District on the evening of April 27th. The small town which was visited is close to Serampore, and only about 16 or 17 miles north of Calcutta. The account is written by Mr. F. W. Duke, C. S., Subdivisional officer of Serampore, and the report was submitted to Mr. Toynbee, Magistrate of Hooghly, by whom it was communicated to the Meteorological Department.

The following is Mr. Duke's letter, which is dated April 28th, 1888.

"I have the honor to report that early this morning I was informed by the Police that yesterday evening Bhudressur had been visited by a tornado, and that the Police outpost had been blown down and much damage, accompanied by loss of life, had been done.

"Accompanied by the Assistant Superintendent of Police I proceeded to Bhudressur, and found that a tornado apparently under the form of a whirlwind from right to left had entered the south-eastern part of the town from the river about 8 o'clock yesterday evening. It proceeded north-west by north, and having travelled about  $1\frac{1}{2}$  miles finally left north-east about the northern part of Bhudressur disappearing in the river—as it had come. The breadth of its course was about 200 or 300 yards on land from the shore and the centre and point of greatest violence about the line of the river-bank near the Gunge. It was stated that the tornado was preceded by a booming sound: its total duration is estimated at from 3 to 6 minutes. The violence of the wind must have been inconceivable, many large trees were blown down, and the Grand Trunk Road was completely blocked by them this morning. Many thatched houses, probably some score, were blown down—the tiled part of the town was completely stripped, and the streets were full of fallen tiles. In the town four people were killed by the falling of houses, and many more or less injured. Both the regular outpost and the Police barracks entirely collapsed, all the Police papers and records being buried in the outpost. Most of the constables were in the barracks when they fell in, but all succeeded in struggling out, scratched and bruised it is true, but without broken bones.

"Along the river bank, however, the force of the wind had been most tremendous. In several cases boats of 500 maunds' burden had been picked out of the water and thrown over to the bank. I saw a shattered dinghi which had been blown up on to a tree which had first been partially blown down. Another dinghi had been picked out of the water, blown across 15 or 20 yards of chur, and on to the upper part of a high pucca-ghat. A 500 maund boat had been docked for repairs and the manjhis had built a temporary shelter behind it, the boat was lifted by the storm, turned on end and thrown over the shelter, crushing it to nothing and killing two men in it, the boat itself being crushed out

absolutely flat by the violence of the fall. In another case a large boat was blown up the river-bank, and is now blocking a road within the Gunge. In all as far as I could ascertain, 7 persons had been killed, 3 were missing apparently in the river—nine persons were seriously injured; of these eight were put in a boat and brought to Serampore, and an unascertained number had sustained slight injuries. The material damage I have as yet no means of estimating; when accurate figures are available on mortality, injuries and losses, I will forward them. Temporary accomodation must be provided for the Police. The outpost and barracks are utterly laid waste, and quite beyond repair.”

---

## PART II.

*An account of the Dacca Tornado of the 7th of April, 1888.*

*By DR. A. CROMBIE, Civil Surgeon of Dacca.*

There can be no question that the storm which wrecked a portion of Dacca [on the evening of the 7th of April, 1888, was a tornado or whirlwind. The evidences of its nature are quite conclusive. They consist in observations of the directions in which objects which it encountered have been thrown down or distorted. The objects which give the most unmistakable evidence are walls running at right angles to the track of the tempest, trees, especially plantain trees, the pinnacles of mats and masjids, and kutchahuts; and the experiences of persons who were stationed at or near the vortex as it passed over them.

A tornado is a whirling wind rotating at an enormous speed, and advancing rapidly at the same time, along a more or less straight line. For convenience of description, such a whirlwind may be said to have four radii, an anterior in advance of the vortex, a posterior behind the vortex, and two lateral radii at right angles to the centre line of the track of the storm. All objects situated directly in the centre line of the track will be driven in a direction at right angles to that line, in one direction by the anterior radius, and in the opposite direction by the posterior radius, while objects situated near the sides of the track will be carried or driven forwards on one side, and backwards on the other, in relation to the track of the tempest. One of these lateral radii, that which carries objects in the same direction as that in which the tempest is advancing, may be called the advancing lateral radius, while the opposite which drives objects in the opposite direction may be called the retrograding lateral radius.

In the diagram shown as Fig. A., Pl. XXVII., AB is the line taken by the vortex in its advance, C is the vortex, the circle FLEK represents the whirling of the wind round the vortex C. The arrows indicate

the direction in which it is rotating, CE is the anterior radius, CF the posterior radius; CL is the advancing, and CK the retrograding lateral radius. It is obvious that all objects at E will be blown to the left, all objects standing at F will be blown to the right of the line AB, while all objects at L will be driven forward, and all at K, backwards; it is also obvious that, as the circle moves up the line AB, they will encounter first the force of the wind at E, and be knocked over to the left, and only those which have withstood the wind at E will encounter the wind at F as the tempest advances, and only these will be driven to the right. If the line AB happen to be an unprotected stone wall, it is clear that, as the storm proceeds, the whole of that stone wall will be thrown to the left by the wind at right angles to the anterior radius, none of it will be thrown to the right by the wind at F, because it will probably have previously been demolished by the wind at E. If, however, the wall be placed in the line KL at right angles to the line of progress of the storm, all to the right of the vortex will be thrown down forwards by the advancing lateral radius of the whirlwind, while all to the left will be thrown down backwards by the retrograding lateral radius. This was clearly indicated by the storm of the 7th of April. It struck the Buckland Bund nearly at a right angle about 90 paces above the Nawab's palace. Here there was a garden having a south and a north wall both running parallel to the Bund, and therefore at right angles to the line of the advancing storm. The south wall, next the Bund, was low, but topped by an ornamental cast iron railing, and the north wall was about 10 feet high. To the east of a certain point, the cast iron railing on the south wall was driven into the garden by the wind on the advancing lateral radius CL, while all to the west of the same point was driven on to the Bund by the retrograding wind on the radius CK. The north wall was treated in the same way. All to the east of a certain point, directly opposite the point on the south wall, was driven forwards into the compound of the house being built for Sulimulláh Miya, while all to the west of that point was driven by the retrograding lateral wind backwards into the garden. The corresponding points of these two walls showed precisely where the vortex of the tornado passed over them, and fixed the track of the vortex at this part of its course; and the way in which these two walls fell was alone sufficient, if no other evidence had been forthcoming, to prove that this storm was a tornado, and also that the wind was circling from right to left, as in the diagrams I have drawn. The action of the storm on this part of the Buckland Bund is shown in Fig. B., Pl. XXVII. Unfortunately other evidence was only too plentiful. On the opposite bank, the storm had, before crossing the river, burst through a belt of trees, some 300

yards in breadth in which was concealed a Muhammadan village. All the trees on the east side of the track of the tempest were lying directed towards the river in a northerly direction, all on the west side were directed southwards, inland, away from the river. The former had been broken or uprooted by the advancing lateral radius, the latter by the retrograding lateral radius. In the centre of the track, where they had been exposed to the anterior radius, and afterwards to the posterior radius as well as to the inner lateral radii, nothing but stumps were left; for it is clear that, while all objects outside the lines MN and OP (in Fig. A., Pl. XXVII) will be exposed to only one wind force, an advancing one in the case of OP, or a retrograding one in that of MN, those within those lines will be exposed to three out of the four wind forces in action. Thus, an object situated in the line RS will be first thrown to the left by the wind forces after they have passed the line CE, then subjected to a retrograde force on the line CK, and will afterwards be tossed to the right by the wind forces approaching CF. It was thus that the tornado ground its way through the Nawab's palace and through the masonry houses between his palace and the main street of the town.

For these reasons, when the tornado is passing over masonry buildings, it will appear as if most of the destruction near the centre of the track had been done by a wind blowing from right to left, because the wind forces at right angles to CE, the anterior radius, are the first to come in contact with them. They are immediately thrown down to the left and remain there undisturbed by the subsequent rotatory winds which pass over them. So it is with plantain trees, which do not snap across, but bend and break and lie down flat, retaining their connection with the root by a short stump. But with hard wood trees, and with kutchahuts and furniture, it is different. They are first carried to the left by the wind force near the anterior radius, and afterwards lifted and carried from left to right by the forces on the posterior radius. Thus, it was not uncommon for the roof of A's house to be carried into B's compound, and immediately afterwards B's roof to be lifted and deposited in A's compound. So in the Nawab's house an almirah in one room was carried through a doorway into another room, and from the latter a writing-table was carried through another doorway into the former room. These interchanges only take place near the centre of the track.

The tornado of the 7th of April began its destructive course at the extreme west end of the Municipal limits. Its exact method of commencement will be described further on. Here the houses are built on an old river bank, the bank of the old bed of the Buriganga, which at this season is here a mere khal. This old river bank is continuous in a nearly straight line with the present bed of the Buriganga, which now

approaches the town at the old Muhammadan Fort, the Lalbagh, just above the Water-works, at an obtuse angle to its old course, which was nearly straight from Hazaribagh on the west to Fatula a village 6 miles down the Narainganj road on the south-east. At the extreme west end of Hazaribagh is a mosque, Fakirni-ka-masjid. From this mosque a slightly sinuous road runs as far as the Lalbagh at an average distance of 300 feet from the old river bank. There are houses on both sides of the road, but at first they are chiefly between the road and the river bank. They are nearly all mat huts, the only masonry buildings being mosques: for this part of Dacca is Muhammadan. Afterwards, as the road runs successively through the mohullas called Inayatgunj, Nawabgunj, and Amligolah, pukka houses become more and more numerous, and in Amligolah, which is close to the Lalbagh, the majority of the houses are of this nature, and the inhabitants are mostly Hindu.

The first clear signs of the rotatory nature of the tempest occurred in an orchard to the north-east of Fakirni-ka-masjid, and close to it on the north side of the road referred to. Here there are remains of a clump of plantain trees thrown down and twisted in all directions clearly showing that they were in the vortex itself. Around this clump of plantains there was a fine old plantation chiefly of mangoes and jacks. The branches of all the trees to the north are broken off and thrown to the west, those on the south are thrown to the east, and several of the largest of them are uprooted bodily, and are now lying prone in the same directions, showing that even here the storm was already, in the very beginning of its manifestations, one of great violence. The masjid itself had only a few bricks disturbed, and the lie of the broken trees to the south-west of it was towards the north-east.

From this point to the north-east of Fakirni-ka-masjid, the vortex travelled in a south-easterly direction, crossing the road at an acute angle, and from that point continued its course between the road and the old river bank destroying every kutchahut in this portion of Dacca. All the indications given were as above. Everything to the right of the vortex, that is, on the river bank itself was broken and laid low in a forward direction towards the east. There the advancing lateral radius was at work, while, on the road and to the north of it, all the indications were in an opposite direction, the work of the retrograding lateral radius. Between the river bank and the road, where the winds on the anterior and posterior radii were at work in opposite directions, there was mere confused destruction.

As the whirlwind passed eastwards along Inayatgunj, it gradually edged more and more towards the old bed of the river. This was probably due to the greater resistance offered to the forces on the left of



the line AB (Pl. XXVII., Fig. A.) than to those on the right. This was also the direction in which it originally started, but the continued resistance on the left no doubt helped to force it more and more to the right.

The storm passed well to the right of the pukka house of Babu Kailash Chandra Dás, a Municipal Commissioner, which was not disturbed, and, at the Elephant ghat below the Philkhana, the vortex was actually down in the old bed of the river. The road from the Philkhana to the Elephant ghat here crosses the track of the tornado at a right angle. On the west side of this road, on the old bank of the river, is a small Hindu temple, and there stood a tall Jagarnath Car; along the west side of the road was a brick wall. The brick wall and the Jagarnath Car were thrown down to the west, and the east corners of the temple were torn away, and the bricks thrown to the west into the compound, clearly showing that they had been caught by the retrograding lateral radius, and that the vortex was therefore to the right or south of them as in the diagram, Pl. XXVII., Fig. C. At this point of its course, the Khedda Sergeant's house was beyond the influence of the tornado, and the houses on either side of the road leading from Hazaribagh were undisturbed, but, on a spur of land lying to the south of the old river bed, the branches of trees and the plantains were broken and lying eastwards, as they had been caught by the advancing lateral radius of the whirlwind.

At this point of its course, the tornado bade fair to pass out into the open maidán lying to the south of Nawabgunj, that is to say, in the direction of least resistance, its vortex being already in the old river bed. But it is evident that a great barometric depression had formed to the north of its course. This was no doubt due to the constant sucking action of the wind forces on the retrograding (left) lateral and the posterior radii. It is clear, I think, that there must always be increased barometric pressure to the front of a tornado and on its advancing radius, and a barometric depression outside the retrograding and posterior radii and behind it in its track. However that may be, it is evident that, immediately after passing the Elephant ghat, there was a great barometric depression to the north of the whirlwind, for the vortex suddenly moved to the left (north), and at the same time a great hurricane from the north crashed through the trees, from a point to the east of the Philkhana, and joined in the revel of the tornado, the vortex of which was now near, if not on the main road through Nawabgunj.

The evidences of this great indraught are quite distinct. As you drive from the Lalbagh to the main gate of the Philkhana (Elephant dépôt) by a road which is roughly parallel, but 600 yards to the north of, the path of the tornado, there are all along signs of a high wind which

was directed towards the south and west, but all at once you come upon evidences of a much more violent wind which had no westing in it, one which not only broke the high branches of trees, but uprooted huge peepuls and mangoe trees, and tore its way in a distinct track down south towards the tornado, just after it passed the Elephant ghat. This hurricane from the north of which I write was not more than 60 paces across, and was very local. It was altogether to the east of the Philkhana, where nothing was disturbed. It was curious to see the little low kutchahuts where the mahout's live, standing about, within the Philkhana enclosure, while 200 yards to the east a large solitary gáb tree was overturned, and a huge uprooted peepul tree blocked the road, and there were marks of devastation away everywhere in a track towards the south.

After the occurrence of this indraught from the north, the vortex passed along, or close to, the main road through Nawabgunj eastward. Soon it began to encounter on its left front the pucka houses of Amligolah, and from the resistance they offered to the anterior and retrograding radii, it again began to edge towards the right, passing however between these houses and Ram-Shaha's mât. This mât was taken by the advancing lateral (or right) radius, and two of its pinnacles were thrown down; those on the north-west and south-west corners. They were thrown south-east and east by north respectively. The finials of the two remaining pinnacles were bent south-east and south-east by south, but the terminal finial of the main spire at a height of about 60 feet was bent nearly due east, showing, I think, that the vortex was at this part of its course not perpendicular, but sloping backwards and towards the north-west.

From Ram Shaha's mât, the tornado continued to edge towards the south, till the vortex at last, just before reaching the Lalbagh, passed again on to the maidán. Up to this point the tornado does not seem to have had power to destroy pucka masonry buildings. So far it had only laid low all kutchahuts in its course, broken and uprooted trees, carried away the pinnacles of mosques and temples, and leveled kutchapucka walls. It had only managed to dislodge a few bricks on the most exposed corners of masonry buildings. But as soon as it passed on to the maidán to the south of the Lalbagh, and was so freed of the obstruction offered by these obstacles, it seems to have rapidly accumulated additional force, sufficient before the vortex had passed the east gate of the Lalbagh for its retrograding lateral radius to knock down a portion of three of the police barracks, built high on the south rampart of the old fort, killing one and severely wounding twelve constables by the falling of masonry and beams.

Nearly opposite these three barracks which were destroyed by the retrograding lateral radius, two up-country coolies had been engaged in making a trench, running north and south, about six feet deep at the south end, near the river, but open, from the sloping of the ground, in the direction of the Lalbagh. They were close to the south end of the trench when the tornado came upon them, like a sudden hurricane from the south. They jumped down into the trench and crouched down for shelter, when in an instant, the wind blew with equal violence from the north, and hove a brick up the trench from the direction of the Lalbagh, inflicting a ghastly wound on the head of one of the coolies. From the directions in which the wind blew, the vortex must have passed over this trench, and this fixes its position at this point of its course.

The vortex now passed on to the river. The right or advancing radius did not reach the opposite bank at Haslee, but the left or retrograding radius kept sweeping along the river front as far as the Purana Kuttra. Close to the water-works, the Commissioner's Steamer, the "Linnet", and the police steam-launch, the "Marion," were anchored and made fast to the shore. The "Linnet" was unroofed; the "Marion" carried away from her moorings, a short distance up-stream, and sunk in 42 feet of water. This was obviously the work of the retrograding radius, and the resistance offered to this radius by the river bank and the pukka buildings on it continued to push the vortex more and more to the right, and it finally reached the opposite (south) bank at Jinjira Hath, which was promptly demolished and set on fire.

From Jinjira Hath, there is a road leading south-east to the village of Subadiya about a mile distant. This road was nearly in the direct line of the tornado, as it crossed the river from the south of the Lalbagh, and it followed it, making a track straight in the direction of Subadiya. This road is raised, but passes along a shallow depression or valley, sheltered on the south by high trees, and on the north by the belt of trees on the (south) bank of the Buriganga. Just as it entered on this course, the vortex passed over the new pukka masonry house of Abdul Bipari, and simply ground it to pieces, killing the owner and severely injuring three persons sitting with him at the time. The manner in which it treated this building is conclusive that the forces of the whirlwind had become greatly more intense than they were to the west of the Lalbagh.

From Abdul Bepari's house, the tornado made straight for Subadiya, running at an acute angle inland from the river, and at this moment Dacca lying on the opposite (north) bank of the Buriganga seemed safe, and Subadiya doomed. But before reaching this village it had to cross an open maidán stretching away to the south. Here it appears to have

encountered a strong current of air blowing up this maidán from the south; for no sooner did the tornado enter on this maidán than it abruptly altered its direction, wheeled nearly at a right angle to the left, crashed through the belt of trees between it and the river, and made for the palace of the Nawab on the opposite side.

On the opposite side it struck the Buckland Bund, opposite the private apartments of the Nawab. The exact position of the vortex is determined, as I have already said, by the points of the two walls of the garden intervening between the Bund and the palace, where the railing and wall were thrown down in opposite directions as previously described. A line drawn from these two points shows that the vortex was here directed north-east towards the middle of the western verandah of these private apartments. When the vortex reached that point, the whole of the advancing lateral radius was engaged in unroofing the south verandah of these apartments as well as that of the Ahsanmunzil to the right. The opposition offered by these high buildings to the right or advancing radius retarded this part of the whirl, with the effect that the vortex swung round to the right to the open space behind the Ahsunimunzil, and started off nearly due east in the direction of the Sankar-bazar and the Commissioner's house. As the vortex swung round behind the Ahsunmunzil, it passed over the inner apartments, which were gutted by the retrograding and posterior radii. As the vortex left the open space behind the palace, it had the Nawab's offices close on the right. These were demolished by the advancing lateral radius, while the retrograding radius played with the roof of the stables, and blew the top off the Nabatkhana over the main entrance from Patuatoli.

From the point where it left the Nawab's premises, the vortex worked low among the houses between it and the top of the road leading from the main street to J. P. Wise's house; leaving a track of confused destruction, as if from a prolonged bombardment. It was here that Jagabandhu Ray Bahadur was killed by the falling of his house, yet in the midst of this confusion of demolished houses, levelled walls, and twisted and broken trees, and the remains of kutchahuts, there is standing safe, close behind the Nawab's school-house, which was partly wiped out and wholly wrecked, the residence of one Bahadur Bepari, with its ornamental plaster mouldings, only a little bespattered with mud.

On reaching the main street close to Kabiraj's lane, the anterior radius seems to have become entangled in the narrow lanes and high houses of Sankari bazar, and the vortex to have risen suddenly into the air. The houses in this part of the town are two and three stories high, and only the upper stories are seriously damaged, though all the kutchahuts and many of the low kutchahut walls are thrown down. From

this point the tornado seems to have passed high into the air, making only a final dash downwards at the Municipal Secretary's bath-room and one or two trees in the kachari gardens, the College, and in the Commissioner's compound. The last indications given are those of its anterior radius, and show it as departing in a north-easterly direction. The exact track of the tornado as it passed through Dacca is shewn in Pl. XXVIII., and a more detailed map of that part of its track in which the greatest amount of damage was done is given in Pl. XXIX.

In no part of its course did its breadth exceed 200 paces; where it struck the Buckland Bund it was only 180 paces broad. It travelled altogether over a distance of only  $3\frac{1}{2}$  miles. Its rate of progress is not easy to ascertain. Nawab Ahsanullah tells me that he had been watching the progress of the "Nor'-Wester" all the evening; when, about 7 P. M., a servant came and informed him that there was a very peculiar appearance in the west. He went to the west end of the south verandah of the inner apartments, and there saw what looked like a glowing cloud in the direction of the Lalbagh. He stood looking at it for about three minutes, during which time it seemed to be stationary. He then went inside, where he had not been two minutes before the storm was on the house. Supposing the tornado had reached the Lalbagh when he left the verandah, and that it was three minutes before it reached the Ahsanmanzil, and that the route followed by the tornado was a mile and a half during that interval,—the rate of progress would be one mile in two minutes or 30 miles an hour. The Serang of the "Star of Dacca," who watched it from the time it crossed from the direction of the Lalbagh till it struck the Nawab's palace (the "Star" being anchored within the angle described by the tornado between these points), speaks of its having travelled with great rapidity. On the other hand, Khajeh Amir-ulla, who witnessed its progress over the same distance, estimates the time at 10 or 12 minutes, but admits that it may have been less. I myself saw from the Club verandah a low black cloud passing rapidly over the houses to the west in a north-easterly direction, and I estimate that its progress was not faster than that of a train on the Eastern Bengal State Railway, that is about 20 miles an hour. We have, however, considerable unanimity as to the period occupied by the storm in passing over any given spot: almost every one says it did not occupy more than a minute and a half. Considering the excited state of mind of those over whom it passed, this estimate may I think be safely cut down to one minute. Taking the distance between the extreme front of the anterior radius and the subsidence of the violent gusts which followed in its wake as 300 yards, we arrive at a rate of progress of a mile in  $5\frac{1}{2}$  minutes nearly, or roughly 12 miles an hour.

The force of the wind rotating within the tornado is difficult to estimate. There is no doubt that it was very great. What the wind did when it came upon a pukka house standing at right angles to the course of the tornado, and caught by one of the lateral radii, was not at once to blow down the front wall, but to blow in the doors and windows, and then to lift off the terrace roofing, and blow out the back wall, thus leaving the beams supported only on the top of the front wall. Now there is evidence to show that in such cases the force of the wind blowing through the house, after the back wall had fallen, was sufficient to prevent the unsupported beams from falling for a perceptible time. To this fact Mr. Kelsall and Khajeh Amirulla owe their lives. Mr. Kelsall was in the Nawab's office when the right radius of the tornado caught it and blew the back wall into the street. The unsupported beams remained standing out like flags, long enough after the wall was blown out to enable him to make his escape before they fell. Mr. Kelsall's movements were no doubt very rapid on this occasion, and they were accelerated by the violent wind propelling him in the direction where lay his safety. On the other hand, Khajeh Amirulla was sitting in a small pleasure-house close to the Buckland Bund watching with great interest the roaring cloud bursting on the Bund, the true nature of which he did not understand, when, in a moment, the house was caught by the retrograding radius and demolished. A heavy beam fell on his shoulder; but fell so slowly and gently, owing to the force of the wind underneath it, that it felt like a soft but firm hand pressing him down to the ground. He remained under that beam for three quarters of an hour before he could be dug out. His companion was killed.

The persistency with which eye-witnesses declare that the cloud accompanying the whirlwind glowed cannot be overlooked. The men at Hazaribagh where it began its destructive course were not to be moved from their assertion, that when it first came upon them it glowed with a dull red lurid glare "like a smoky lamp chimney on fire." Khajeh Amirulla, who watched it with much interest, is perfectly clear in his statement that, as it approached him from the opposite bank of the river, it resembled a balloon in shape, and seemed to be lit up with a "reflected light," and that, at the narrow neck, it kept throwing out a body of fire on either side, as in the accompanying sketch, which is a facsimile of his own drawing (Pl. XXVII., Fig. D). The Nawab Ahsanulla and others also speak of its being accompanied with "balls of fire" proceeding at a great speed. On the other hand, nothing is so certain as that no one who was in the course of the tornado presented any appearance of having been burned. The injuries received were all of the nature of contused, lacerated, and punctured wounds, and simple

and compound fractures. In not one instance was there a trace of scorching. Mr. Kelly, the Resident Apothecary of the Mitford Hospital, on whose statement I put much reliance, is equally clear that the cloud, as he saw it, did not glow, and the appearance, as I saw it (but this was probably only the wake of the true tornado), was a low dark unilluminated cloud, throwing out sparks of fire, which were no doubt merely burning embers caught up and carried along by the storm. One of these was undoubtedly of this nature, for it was carried burning into Mr. S. J. Sarkies' verandah, where he crunched it out with the heel of his boot. These were no doubt the "balls of fire" noted by the Nawab and others. The appearance described by Khajeh Amirulla of a body of fire rushing out from below is more difficult to account for. The fires which followed its course in many places do not require the assumption of any fire connected intrinsically with the tornado itself, for the people had just finished cooking their evening meals, and were about to sit down to eat it when the storm burst upon them. The embers from the fires with which they had been cooking were no doubt caught up by the whirlwind and carried along with it, and thatched houses, blown down over these fires, would instantly take fire.

I am told that numbers of large fish were found on the Buckland Bund after the storm, and there is no doubt that they along with much water were caught up by the vortex as it crossed the river. The water thus taken up, circling with the dust of the whirlwind, was worked into a soft mud, and one of the most remarkable phenomena of the storm was the way in which all objects within the influence of the tornado were plastered with a wash of liquid mud. It covers all walls to a depth of nearly one-eighth of an inch, it matted the hair, coated the skin, and was ingrained in the wounds of the injured.

The noise accompanying the progress of the tornado has been variously described. It was compared by the Engineer of the Water Works and by Khajeh Amirulla to the letting off of steam. It was this sound which first attracted the latter's attention, and he put his head out of window to see what steamers were letting off steam at that time of the evening. It was then that he saw the storm breaking on Jinjira half a mile up stream on the other bank. The sound which I heard from the Club verandah in no way resembled the letting off of steam. It was a low sustained rumbling. I think that the discrepancy is capable of reconciliation. What they heard was, besides the noise of the reverberations of the tornado itself, the comparatively shrill sound of the storm crashing through trees and kutchahouses west of the Lalbagh, and on the opposite side of the river. What I heard was the sound of falling masonry, along the track of the storm from the Nawab's palace

to the Sankari bazar. As soon as the storm cloud passed, there was an instant's silence, the stars shone out bright and clear, and then came through the still air the long wail of the injured and houseless.

I have reserved till now the discussion of the origin of this tornado. I do not think it can be dismissed with the remarks that it originated as all tornados do, and as we see them constantly do on a small scale on a hot dusty highway, by the impact of two currents of air flowing in different directions, and which thus after their impact assume a rotatory motion. I do not say that this one did not so originate somewhere, but that there are good grounds for the belief that it did not so originate at Hazaribagh, where its destructive course began. I believe that it was already a whirlwind of great force before it touched ground at that place.

My reasons for this belief, which is at first sight improbable, are to my mind insuperable. They are as follows:—

All day, as usual at this season, a strong south or south-easterly breeze had been blowing. About 5 p. m., the low grumbling of an approaching "nor'-wester" became audible, and a dull slate-blue bank of clouds was seen coming up in the teeth of the wind from the north-west lit up by occasional flashes of lightning. About 6-30 p. m., the nor'-wester was overhead, and a few drops of rain began to fall. In these two currents of air, a south wind blowing hard along the surface, and a high north-west current from the north-west, we have the necessary elements for the birth of a rotatory storm. About this time, Mr. Kelly, the Resident Medical Officer of the Mitford Hospital, was visiting a friend at the Railway lines to the north of the town. Mr. Kelly has spent most of his service in the North West Provinces, and is well acquainted with the appearances of dust storms, and he called the attention of his friend to a dull brown patch low over the mangoe trees to the north, contrasting with the clear slate-blue background of the approaching nor'-wester. This brown patch was travelling rapidly from west to east. He pointed out that this patch exactly resembled a distant dust storm. When it got due north of his point of observation, it seemed to become stationary or rather to be approaching Dacca. From his experience of dust storms he knew it was time to get home. When he reached the Mitford Hospital ten minutes afterwards, he looked for the brown patch, and saw it now to his north-west, *i. e.*, on its way from its former position on the north of the town to the west end of Dacca. About ten minutes afterwards he heard the sound of the tornado on its track from the west of the Lalbagh, and along the opposite bank of the river, and a large tree in the Mitford Hospital compound was blown down.

Here we have the evidence of an intelligent and trustworthy ob-



server noticing a phenomenon with which he was familiar, altogether apart from the other phenomena of the nor'-wester, following a course of its own, and approaching that part of *Dacca* where the tornado first struck.

Next, we have the evidence of the people living at *Hazaribagh*, who are consistent in their assertion that the storm came upon them, with a "lurid glare" from the north, the direction from which Mr. Kelly saw it approaching that part of the town.

Thirdly, we have the appearance presented by the ravages committed by the storm before it settled down as a tornado in the orchard to the north-east of *Fakirmi-ka-masjid*. From these appearances alone, I was driven to the same conclusion before I had heard the evidence of the inhabitants or of Mr. Kelly. To carry the weight they deserve, these appearances must be given in some detail. The position of the first appearance of the tornado is shown in Pl. XXVII, Fig. E.

From the *Elephant Depôt* there is a curvilinear road leading to the old river bank at *Hazaribagh*, for the convenience of watering the elephants. It is known as the *Hathi-ka-sarak*. About half way between the *Philkhana* and *Hazaribagh*, it is crossed by the old *Mirpur* road. From the eastern gate of the *Philkhana* to the point of intersection of these two roads, not a twig or leaf was disturbed by the storm; but after passing the *Mirpur* road on the *Hathi-ka-sarak*, half way between it and the *Hazaribagh ghat*, one comes suddenly upon traces of a violent wind from the north. The first tree which seems to have suffered is a tall *jamun* tree well to the right of the road, the top branch of which has been torn off, and is hanging to the south. There is then an interval of low brushwood, and then a group of mango trees close to the road side. The top branches of all these trees are snapped across and driven to the south. On the opposite side, in a direct line with the *jamun* and the mango trees, all the trees for a distance of fifty paces along the road have their top branches snapped across. There is again an interval of forty paces without a leaf turned on either side of the road, but after that distance, and for another forty or fifty paces, all the top branches are seen to be knocked off the trees; on the right or north side only those quite close to the road, but on the left or *Hazaribagh* side there is a line of destruction towards the south ending about 200 yards away in a chaos of broken and uprooted trees. Continuing to walk along the road, there is no evidence of a storm on the right or left till we reach the old river bed, and just there is a group of tall *jamun* trees overhanging a mat house. One of the top branches of this group of trees has been torn off, and thrown to the south over the mat house, but not a straw of the thatch is disturbed.

Here we have evidence of a violent wind blowing from north to

south about 100 paces broad, and coming downwards at an angle of from five to ten degrees with the surface of the ground ; striking at first only the top branches of tall trees, then the upper branches, and finally snapping across the main branches or uprooting them bodily, when the violence of the wind got lower. To the north and to the east and west of this track nothing had been disturbed. I drove along the old Mirpur road far enough to satisfy myself that beyond the first jamun tree mentioned nothing had been touched.

It is to be noted that there was no evidence of rotation in this wind : everything was carried in one direction, namely, from north to south.

On the old river bed and on the bank there, were, however, evidences of a less violent gale, blowing from west to east and from the south-west to north-east, as indicated by the arrow heads ; and there were signs, to the east of this chaos, of a very violent wind blowing down trees and branches to the west and south-west. To the north-east of Fakirni-kamasjid, was the chaos of broken and uprooted trees, centring round a group of plantain trees twisted and turned in all directions where the vortex had at once established itself.

It is open to any one to say that the vortex originated round those plantain trees, and that the arrow heads in my diagram indicate the directions of the wind as it was sucked into the vortex as it began to rotate, and that the great destruction was caused by the gradual development of power as it continued to rotate.

I oppose this theory with the objections already stated, namely, that an unusual cloud was seen travelling towards this very place, and by the assertions of the people of the place, that the storm did not develop itself there, but burst upon them suddenly from the north, and the extreme violence of the wind at its very first manifestation, before the vortex had begun to move, is opposed to the idea of a gradual development of the whirlwind at this spot.

I hold that the other theory that the tornado was travelling in a higher stratum of air, and descended at a low angle, and struck ground at this spot is compatible with all the observations. It is what the people on the spot say did happen,—it explains the extreme violence of its very first manifestations, and the direction which it immediately took. It may be objected that the total absence of the evidence of rotation in its very first manifestation is opposed to this theory. But it is not really so. If you imagine that as the tornado struck the trees on its way to the ground the vortex was not perpendicular, but sloping towards the north-west, it will be clear that the first part to come in contact with terrestrial objects would be the right or advancing lateral radius. The other three radii would not come into action, on account of the tilting, till the vortex itself was on the ground. The next radius to come into

action would be the posterior, and we have evidence that this was so in the violence of the destruction to the east of the first track from north to south. The anterior radius being tilted most upwards would at first have the feeblest power, and it is the case that the least destruction done was in the river bank straight in front of the violent gale that broke through the trees from the north. If the vortex had gradually formed, one would have expected a more equal distribution of power around it, instead of its being chiefly at first on two sides.

The theory that the tornado already formed was travelling rapidly from north to south before it struck ground, also explains the reason for its starting at once in a south-easterly direction. The resistance of the ground was at first offered solely to one radius, the right or advancing lateral one. The result was equivalent to that of a sudden powerful push to the left, that is, to the east of the direction in which it was previously travelling. The experiment of offering resistance to a humming top at a corresponding point would illustrate the effect of the resistance of the ground to a tornado descending upon it in the way in which I suppose this one did.

The possibility of a tornado travelling in the air may appear doubtful to some, but the probability of its being able to do so, and at great speed, receives confirmation from what I consider to be the progress of this very tornado after it left Dacca. I have said that when the vortex reached the Sankari Bazar it seems to have risen rapidly into the air, for the reason that only the upper stories of the high houses of this part of the town were seriously damaged. It seems after leaving Dacca to have travelled in the air due south for a distance of 20 miles, and to have struck down again in the south of the Munshiganj subdivision of this district, destroying 5 or 6 villages, and causing 60 to 80 deaths. The time it took to travel that distance was not more than 20 minutes to half an hour. It came upon the people in the west suburbs of Dacca just as they were about to sit down to their evening meal, a few minutes after 7 P. M. It reached the neighbourhood of Rajabari in the south of Munshiganj just as they had finished their evening meal, and were preparing for their post-prandial smoke, that is, about 7.30 P. M.

It may be objected that it was not the same tornado which took these villages in Munshiganj, but another and independent one. But the improbability of two different and independent tornadoes, forming and travelling together on one evening in this part of India, where a tornado has never been known before, is, to say the least, very great.

Since writing the above, I have visited the villages referred to in the south of the Munshiganj subdivision. The people say it came from the north-west. It first struck a village called Dohori, then Barakoer, Banuri, Hashail, Silbaran, Majgaon, and Bagbari; a course altogether

of about seven miles. Its track was about east by south, and, like the *Dacca* one, it was about 200 paces broad. The evidences of rotation were equally clear, and the rotation was from right to left, all the trees on the right or advancing radius being blown eastwards, while those on the left or retrograding radius were broken westwards,—at Barakoer there were signs of a great indraught from the north, similar to that which occurred to the east of the *Philkana* at *Dacca*. This indraught passed over the house of *Babu Kali Prasanna Ghosh*, manager of the *Bhowal* estates. The force of the tornado was very great, and the loss of life would have been much greater, if it had not selected a comparatively open track of country for its course. In some of the villages over which it passed, it made a clean sweep of everything, leaving only the raised platforms over which the houses had stood. The people speak of men having been lifted into the air and dashed down on the ground. Twenty-one persons are said to have been killed in this way in the village of *Hashail*.

DACCA,

23rd April, 1888.

The observer at the meteorological observatory at *Dacca* having reported that the Tornado had passed through the compound of the Telegraph Office, and this statement having appeared in the Meteorological Report for the week ending the 13th of April, I subsequently wrote to the officiating Meteorological Reporter as follows:—

“In your short notice which was published last week in the *Gazette*, you surmise that the tornado passed through the telegraph compound, but you will see from these maps that this was not so. The Telegraph Office was well to the right of its track. The trees blown down there were affected by cyclonic blasts which circled round the real tornado, and at some distance from it. You will see that there were several such blasts. One went between *Beighton's* house and my own, breaking down a lot of trees, and carrying away the corner of the house occupied by *Messrs. Edwards and Wilson*. It was such a blast that brought down the wall of the lunatic asylum, which was well away to the north of the tornado, which was at that time crossing the river. I think that the three police barracks at the *Lalbagh* were perhaps affected by a similar blast, only they were much nearer the vortex than the other examples now given. It is otherwise difficult to understand how only those three were affected. Some people even think that the blowing down of the asylum wall is evidence that the vortex was somewhere there. But the damage near the asylum is trivial, and there is no sign of the track either to or from that point, and I am clear that it was not near it, and that my tracing is practically correct. On the opposite side of the river it went rather more inland than I have shown.”

*Supplement to Dr. Crombie's Account of the Tornado of the 7th of April 1888.*

STATEMENT SHOWING THE NATURE OF DAMAGE DONE BY THE TORNADO OF THE 7TH APRIL 1888 IN THE CITY OF  
DACCA AND KIRANIGUNJ STATION.

| STATIONS.   | No. of pucca houses completely demolished. | No. of pucca houses partially demolished. | No. of cutcha bariies completely demolished. | No. of cutcha bariies partially demolished. | No. of boats destroyed. | Estimated value. | No. of persons killed. | No. of persons wounded seriously and treated in Hospital. | No. of persons who died in Hospital up to 16th instant. | No. of wounded persons attended in private houses by Government Doctors. | Total No. of persons wounded including those in Col. 9, 10 and 11. | REMARKS.                                                       |
|-------------|--------------------------------------------|-------------------------------------------|----------------------------------------------|---------------------------------------------|-------------------------|------------------|------------------------|-----------------------------------------------------------|---------------------------------------------------------|--------------------------------------------------------------------------|--------------------------------------------------------------------|----------------------------------------------------------------|
| Town ...    | 5                                          | 93                                        | 114                                          | 61                                          | 25                      | Rs. 588225       | 86                     | 162                                                       | 7                                                       | 248                                                                      | 1200                                                               | (A) I think this is a very fair estimate.                      |
| Lalbagh ... | 4                                          | 54                                        | 2825                                         | ..                                          | 30                      | 63859            | 32                     | 60                                                        | 4                                                       | 248                                                                      | 1200                                                               | (B) Probably 20 more than these were killed.                   |
| Kiranigunj  | ..                                         | 1                                         | 579                                          | ..                                          | 66                      | 26844            | 118                    | 222                                                       | (C) 11                                                  | 248                                                                      | 1200                                                               | (C) Some 5 more are likely to die.                             |
| Total ...   | 9                                          | 148                                       | 3518                                         | 61                                          | 121                     | (A) 678,428      | 118                    | 222                                                       | (C) 11                                                  | 248                                                                      | 1200                                                               | (D) These figures do not include any but fairly severe wounds. |

(Sd.) J. D. CLARK,  
District Superintendent of Police.

VII.—*Natural History Notes from H. M.'s Indian Marine Survey Steamer 'Investigator,' Commander ALFRED CARPENTER, R. N., D. S. O., Commanding. No. 9. Further Notes on the Amphipoda of Indian Waters.—By G. M. GILES, M. B., F. R. C. S., Surgeon-Naturalist to the Marine Survey.*

[Received May 5th, 1887;—Read February 1st, 1888.]

(With Plates VI.—XII.)

How little the Amphipoda of the Bay of Bengal have been hitherto worked may be judged from the fact that every species I have as yet examined appears to be new to science. Indeed, with the single exception of a fresh-water species, *Gammarus fluviatilis*, which I met with in a mountain lake (the Pandar) at an elevation of 11,000 feet in the Hindu-Kush range, and of the doubtful case of *Amphithoe indica*, M.-Edw., described in the present paper, I have yet to find a described Indian form.

The group having been thus hitherto neglected in India, it appears a good plan to set about the description of the species as they come to hand, more especially as, on account of their minuteness and fragility, they are best examined in the living state, a work which can only be carried out on boardship.

On this account the species are described provisionally in the order in which they come to hand, the work of arranging them systematically being left to some future time when sufficient material shall have been collected. I will now proceed to describe the species met with since my last contribution to this Journal.

1. ANONYX AMAURUS, n. sp., Pl. VI., Fig. 1.

This form is interesting on account of its having, as far as I can make out, no traces whatever of eyes. It was trawled at a depth of 1300 fathoms off the Coast of Burmah in Lat.  $16^{\circ} 44' 45''$  N., Long.  $95^{\circ} 34' 30''$  E.; bottom temperature  $36^{\circ}$ . Although this station is over 40 miles from the nearest shore, the bottom appears to consist largely of water-logged drift wood, and other shore material, amongst which was a number of the fruits of a plant which, Dr. King of the Royal Botanical Garden, Calcutta, informs me, are probably those of *Baringtonia racemosa*. The abundant albuminous material of the seed is still comparatively fresh and sound. On breaking open one of these, I found two specimens of our species; and another seed yielded a third specimen. All three are females and the egg-pouches of two contained ova. The animal is, for an amphipod, remarkably broad in proportion to its depth, the pleura being narrow, while the coxal plates are of considerable depth.

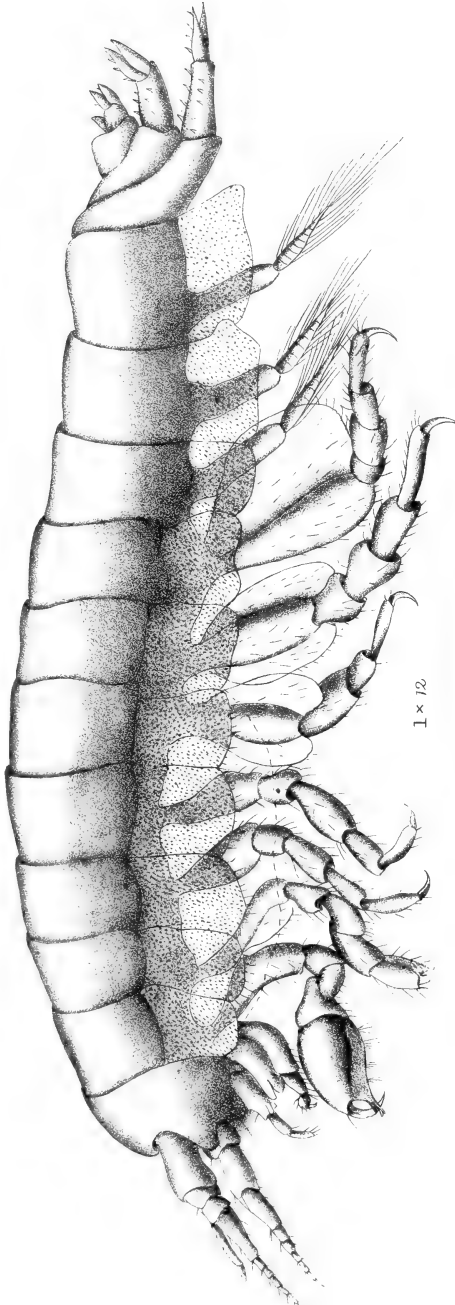

1 x 12

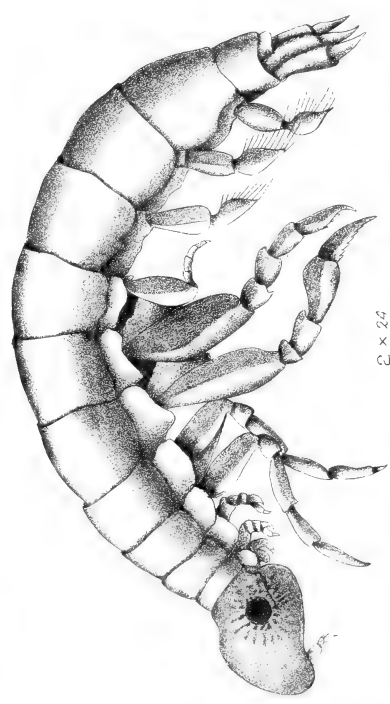

2 x 24

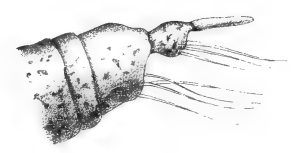

3 x 700



4 x 100

G. M. Gilles del.  
Parker & Goward lith.

West. Newman & Co's Imp.

1. ANONYX AMAURUS.

2. 4. PL. STAMINODICA





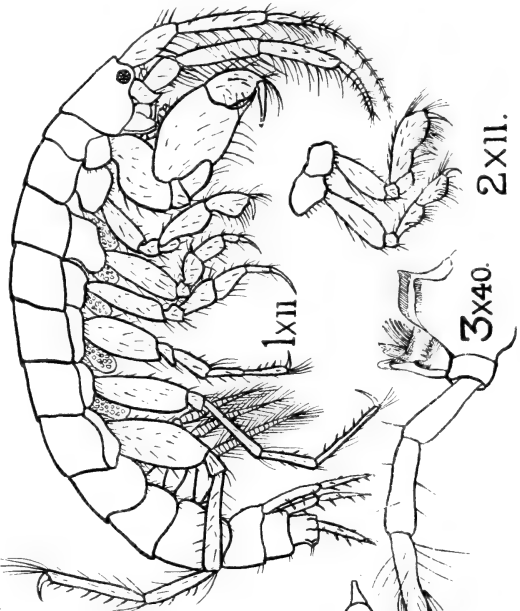
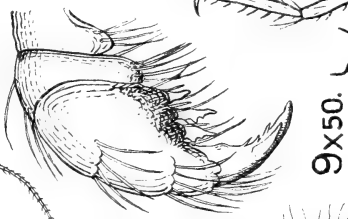
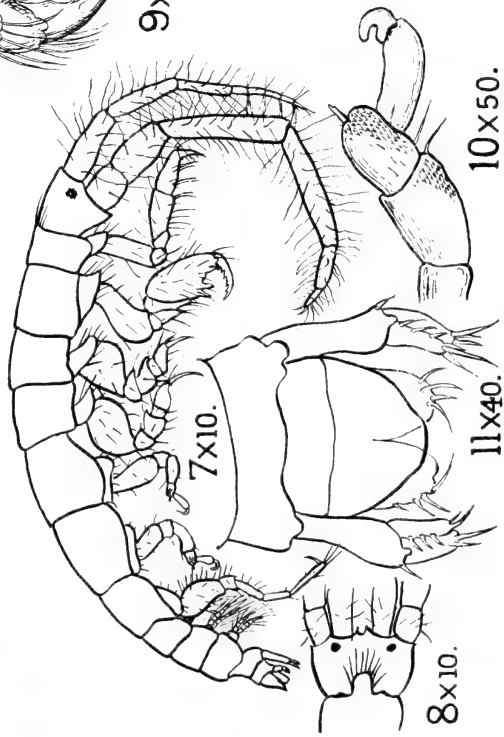
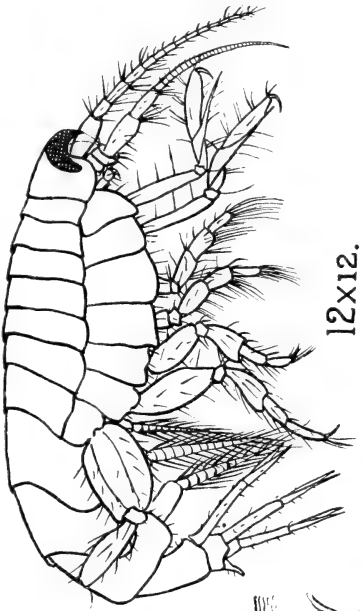
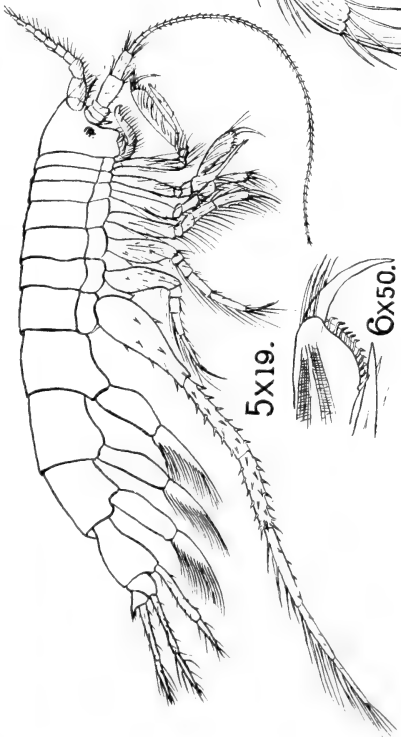



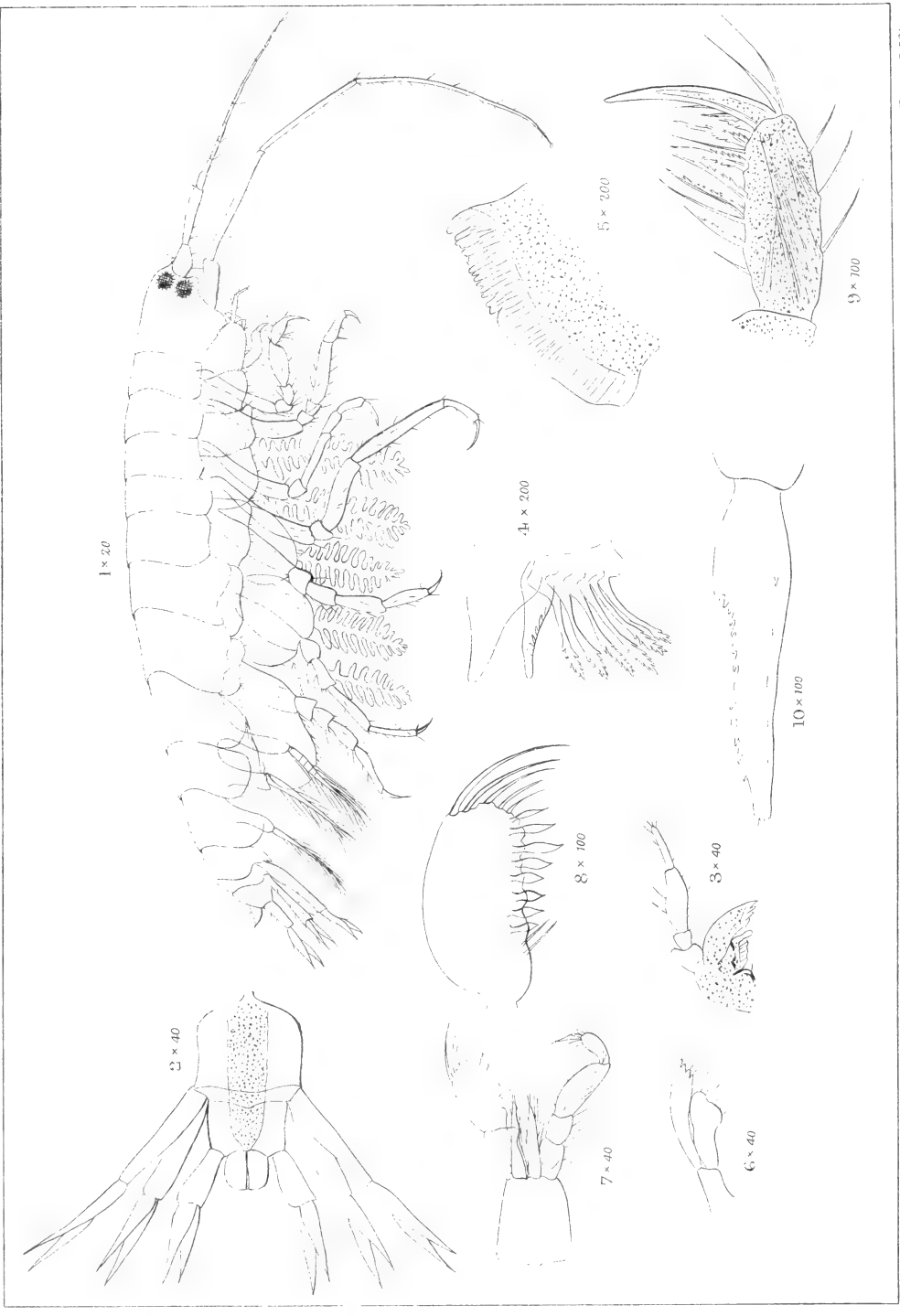



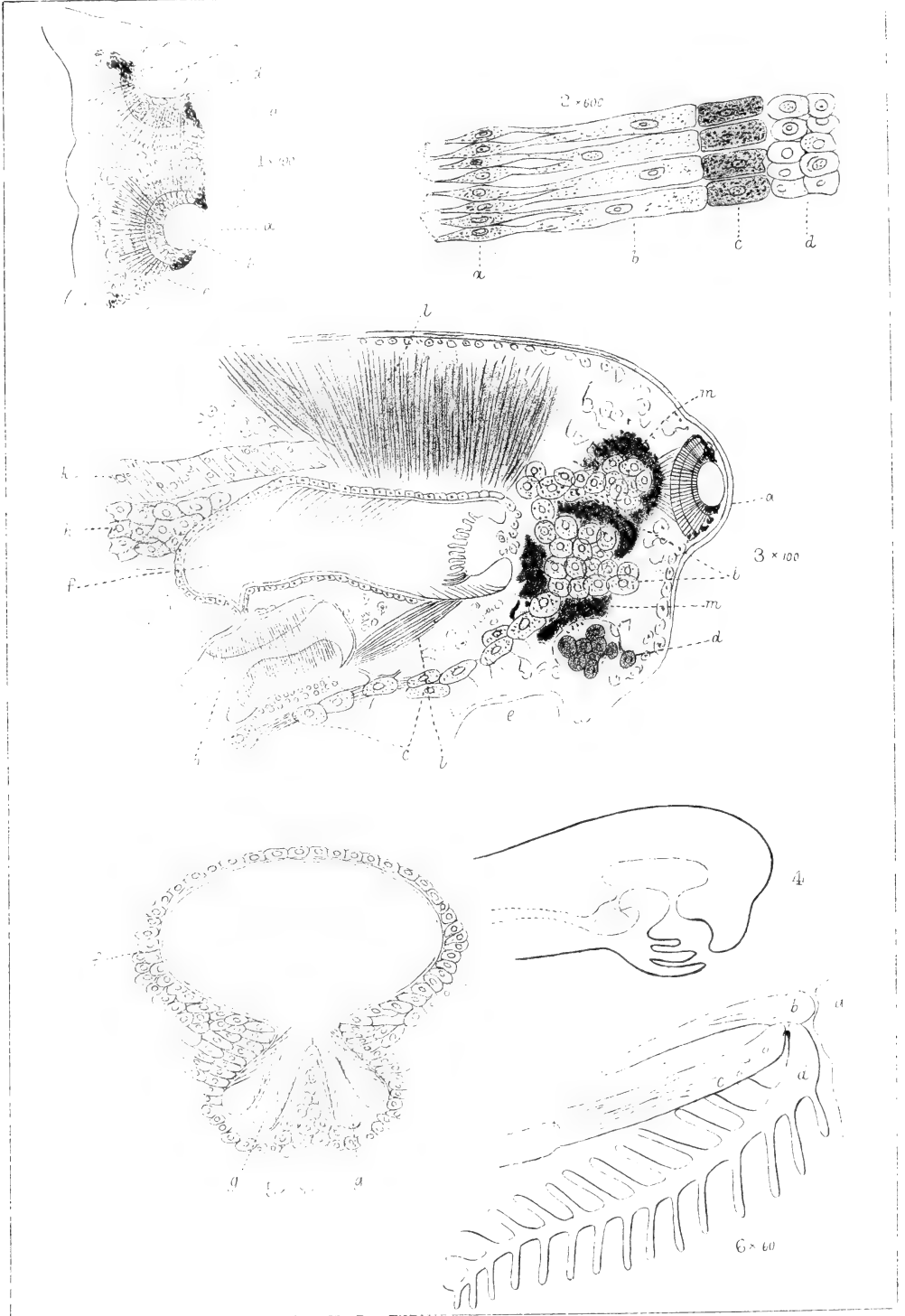



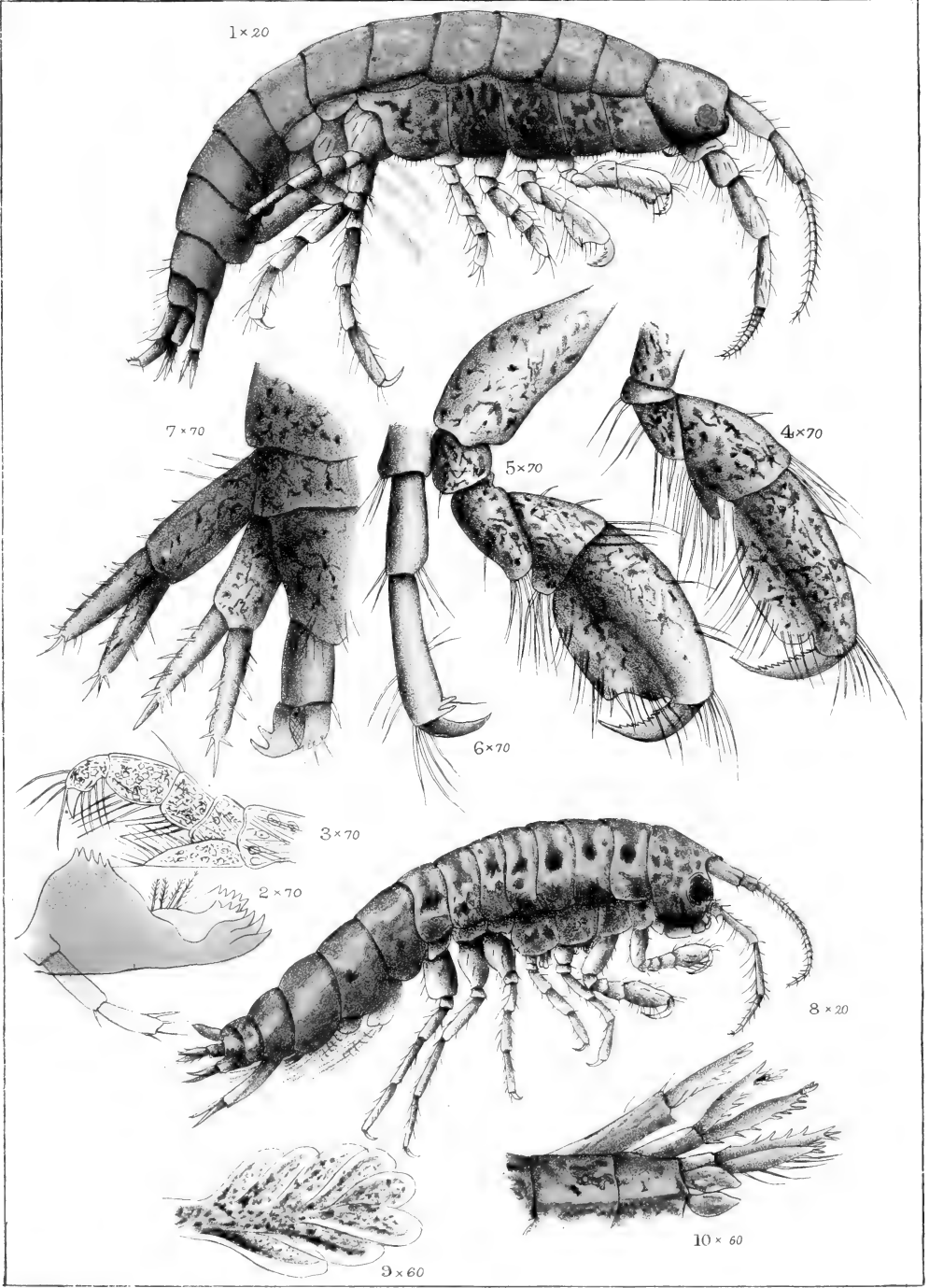

G. M. Giles, del.  
Parker & Coward, lith.

West, Newman & Co. imp.

1-7. AMPHITHOË INDICA. M. EDW.  
8-10. ATYLUS COMES. n. sp.







UROTHOE RUBER.







The legs are short and stout and the mouth-parts exceptionally strong, so as to be eminently suited for digging its way into the hard albumen of the seeds on which it feeds. It might at first sight appear strange that an inhabitant of so great a depth should feed on such exclusively shore products. From the quantity of these seeds and other driftage brought up in the trawl, it is, however, evident that, as long as the tides and currents remain as they now are, the animal can never be at a loss for food. That it is really a bottom organism there can be no doubt, as, apart from its eyeless condition, its limbs are ill-suited for swimming, and the driftage brought up in the trawl was too abundant and of too varied a character to admit of any suspicion of its having been picked up by the trawl on its upward or downward route.

The species can, however, have but a very limited distribution, as situations in which abundant and well-preserved food drifted from the shore is to be found at such a considerable depth must be quite exceptional, and widely separated from each other, as they can only be found in the neighbourhood of great tidal rivers, and where such enter the sea in the neighbourhood of considerable depths.

The animal is of an uniform ivory-white throughout; and the largest specimen is about 12 mm. in length.

The *head* is small and short, rounded in front and broad behind at its junction with the thorax, where the animal very nearly attains its maximum breadth.

The segments of the *thorax* are long and subequal, the middle members of the series, however, slightly exceeding the others in all dimensions.

The first three *abdominal segments* are longer than any of the thoracic and of remarkable depth, the third being the largest. The remaining three segments diminish rapidly in size, and the *telson* is small, conical, and upturned.

The *antennule* is short and stout, its total length being but one-fifth that of the body. It consists of a peduncle of three joints, of which the first is long and cylindrical, and the remaining two, remarkably short, form considerably less than half of the peduncle. The flagellum consists of a long conical basal joint, forming quite half its length, and of five or six short tapering joints of the usual form. The secondary appendage consists of two joints, the first of which, though much thinner and cylindrical, exactly equals the first joint of the primary flagellum in length, while the second joint is small and short.

The *antenna* is subequal to the antennule, but of slighter build. Its peduncle is longer, consisting of three joints of nearly equal length,

which together nearly equal the peduncle of the antennule with the long first joint of its flagellum in length. Its remaining joints if present cannot be distinguished. The flagellum consists of six or seven short joints.

The *gnathites* are remarkably short, the mandibles being especially powerful and provided with a long jointed appendage. The maxillipedes are large and pediform, and are terminated by a globular joint provided with a strong claw.

The second of the *thoracic appendages* is very stoutly built, and is terminated by a powerful subchela, the dactylopodite forming a powerful curved claw, and the propodite having its posterior border prolonged into a stout plate, which is curved downwards to oppose the dactylopodite; this plate is armed with a number of tooth-like spines not shewn in the drawing. The third thoracic appendage, in general form, closely resembles the second, but it is slightly longer, and very much slighter, and differs also in the basipodite being strengthened on its anterior border by a strong flat plate. The fourth and fifth thoracic appendages are somewhat shorter than the two preceding, stoutly made, and of the ordinary ambulatory type. The sixth, seventh, and eighth have their basipodites provided with large strengthening buttress-like plates; all three are stoutly built, but, while the sixth is the shortest, the seventh is the longest of all the appendages. The eighth is intermediate in length, but has its distal five joints shorter even than those of the sixth, its excess of length over the latter being due entirely to the great size of the basipodite, which is nearly twice as long as that of any other appendage; it has no strengthening plates on its anterior border, but this is more than compensated for by the immense size of the posterior buttress.

The first three *abdominal appendages* are of the usual swimming type, but are somewhat small in proportion to the bulk of the animal. The last three appendages are short and stout, and are each provided with a pair of short, subequal, styloid rami; they diminish progressively in length and to a less extent in thickness, the last being rather shorter than its breadth; all three are armed with a series of short stout spines.

The animal differs from any of its congeners enumerated in Spence Bate's Catalogue in the first joint of the flagellum and of the appendage of the antennule being markedly longer than their successors; in being eyeless; and in the exceptional development of the gnathopoda, which are much better formed even than in the closely allied *Opis*, a genus to which, if this character alone were taken into account, the species might be referred. The distinction, however, between *Anonyx* and *Opis*, resting as it does on this character alone, is of very doubtful generic value, and

I have preferred to class the present form under *Anonyx* on account of its more closely resembling in most other points the known species of that genus than it does the hitherto described species of *Opis*.

Since the date of the issue of Spence Bate's Catalogue of the Amphipods of the British Museum (1862), a considerable number of species have been added to *Anonyx* and a few to *Opis*, the descriptions of all of which are not accessible in India. From considerations of locality and depth, it is, however, highly improbable that any of these corresponds to the species now described.

Sars (Archiv Math. Naturv. (Christiania) 1881, p. 437) has described an eyeless species of the genus (*A. typhlops*) from 1710 fathoms in the Arctic seas, but I have not been able to obtain access to the paper. The temperature of the water at such depths as 1300 and 1710 fathoms is pretty constant all over the world, and deep-sea species have, as a rule, a wide distribution, so that it is possible that our forms may be the same. Still it appears extremely unlikely that the present species would be able to obtain suitable food in such regions, so that, provisionally at any rate, I describe it as new in the absence of any evidence to the contrary.

## 2. AMPELISCA LEPTA, n. sp., Pls. VIII. & IX.

This species was dredged in 107 fathoms on the edge of the Swatch-of-no-Ground, at the head of the Bay of Bengal. A very large number of specimens were obtained in the mass of soft mud brought up in the dredge, which, with the exception of a few annelids, contained no other living organisms. The mud contained a quantity of broken lamellibranchs and pteropod shells, but none of these appeared to have been recently inhabited.

The subfamily *Ampeliscades* contains the single genus *Ampelisca*; *Haploops* wanting the character of having two pairs of simple eyes, and so being very doubtfully a member of this subfamily. With the characteristics of *Ampelisca*, as given by Spence Bate (Cat. Amphip. Crustacea, p. 90), the present species entirely agrees, but it differs from the five of the known species figured in that work in the slenderness of the body, and in the great length of the fifth thoracic appendage, and wants also the vinous colouration which appears more or less to characterize many of the species. These points, however, are hardly sufficient to be of generic value.

The animal measures about 6 mm. in length and is of a fine ivory white throughout, with the exception of the rings of dark brown pigment surrounding the eyes.

The *head* is of moderate size, irregularly quadrate; the portion carry-

ing the eyes and antennules projecting forwards much beyond that giving support to the antennæ. In length, it barely equals the first two thoracic segments together.

The two pairs of *eyes* are of fair size and are placed close to each other on the produced upper part of the cephalon, the outer pair being situated a little behind as well as below the inner.

The *thorax* consists of seven distinct segments increasing gradually in length from before backwards, the last being the longest. It forms exactly half of the total length of the animal. The first four coxal plates are deep and vertical, while the last three are narrow and much everted, giving a fictitious appearance of breadth to this portion of the body when seen from above.

The first of the *abdominal segments* is as long as the last thoracic, but the second and third are considerably shorter, while the remaining three are very short, the fifth being not half the width of either the fourth or sixth, and with difficulty distinguishable from the former. The *telson* forms a deeply cleft, semilunar plate, which appears to be movably articulated to the sixth segment.

The *antennæ* and *antennules* are long and slender, but unequal. The *antennules*, much the shorter, equal the first six thoracic segments in length. The peduncle consists of a short spindle-shaped basal joint and two slender distal articulations, of which the first is nearly four times as long as the second, which is with difficulty distinguishable from the flagellum. This latter consists of ten very slender articulations. The *antennæ* are as long as the body less the last four abdominal segments. The peduncle consists of five joints, of which the first two are very short, completely hidden behind the projecting anterior border of the cephalon. The third joint is long and thick and the fourth and fifth very long and slender, so that the flagellum forms much the shorter portion of the organ. This latter is but little longer than that of the antennule and consists of 14 or 15 slender somewhat shorter articulations.

The *gnathites* are rather small and are more adapted for sifting and retaining finely divided material than for biting and cutting. The mouth is guarded in front by a blunt triangular plate, which appears to be immovably connected with the anterior surface of the head. The mandibles are provided with a four-jointed hirsute appendage and with two plates, of which one has a simple cutting edge of no great power, perfectly smooth for its posterior half, but worn in front into a series of irregular dentations. The second plate has a more complex structure. In front it is provided with two stout conical teeth, the more anterior being quite plain and smooth, while the posterior, which is more slender and pointed, has its posterior border minute-



ly dentated. Behind these two teeth comes a plate immovably connected with that bearing them, but placed more to the dorsal aspect of the organ, and bearing six processes or stout hairs of peculiar form. Arising from stout bases they at first become constricted and then expand into a lanceolate terminal plate the borders of which are minutely dentated. It is difficult to determine what may be the function of these peculiar organs, unless it be to finely comminute the mud from which the animal separates the nutritive particles on which it subsists. The first maxillæ present no points of particular interest, consisting of the usual pair of hirsutely edged plates. The second maxillæ are somewhat peculiar, their inner border being armed with a series of peculiarly formed flattened hairs shaped like small lanceolate leaflets. The maxillipeds are four-jointed, pediform, and clawed, and are provided with a pair of elongated flattened inner plates, both these and the main portion of the organ being extremely hirsute.

The second and third *thoracic appendages* are but little modified from the plain ambulatory type, presenting only a tendency to the subchelate plan of construction, the dactylus being long and smooth, and the propodite being but little dilated; the only specialization for grasping being the provision of a series of stout dentate hairs on its posterior border, not unlike those on the mandibles. Both these pairs of appendages are essentially alike, but the third is considerably the longer and is even less specialized than the second, the propodite being barely dilated, and the dactylus, of very moderate strength. The fourth and fifth appendages are quite of the usual ambulatory type, and alike in general plan, but, while the first is the slightest and shortest of all the appendages except the second, the fourth is the longest and stoutest, slightly exceeding the thorax in length. The sixth and seventh are of moderate length, the sixth having its distal articulations exceptionally stout, while those of the seventh are exceptionally slight, both have their basipodites strengthened by anterior and posterior buttress-like plates; the eighth has the basipodite very stout and is strengthened behind only by an extremely broad plate, its breadth being one and a half times its length. The eighth appendage is short and its remaining articulations are in general form like those of the seventh.

The first three *abdominal appendages* are of the usual swimming type, but are more freely furnished with hairs than is usually the case. They diminish regularly in size from before backwards. The last three are biramous and styloid, armed only with a few short spines on their protopodites. The rami are somewhat flattened and have a bold hollow curve on their inner borders beset with minute dentations (Fig. 10.).

The animal differs from *A. gaimardii*, *A. ingens*, *A. belliana*, *A. limicola*, and *A. japonica*, the species figured by Spence Bate (*loc. cit.*), in the great length of the fifth thoracic appendage; from *A. pelagica* in the antennæ being shorter, in its colour being white instead of pale yellow, and in presenting no blotches of red pigment on the cephalon; from *A. macrocephala* in the eyes being larger, and the upper and lower pairs equally distinct, in none of the segments being carinate, in colour, and in size; from *A. tenuicornis*, *A. lævigata*, and *A. carinata* in wanting the posterior dorsal carina.

ANATOMY.—The visual organs of *Ampelisca* are arranged in a manner somewhat exceptional amongst the *Amphipoda*. Being anxious to examine the minute structure of these and to make out whether both pairs of eyes were alike or of different structure, I made several sets of serial sections in the various axes of the animal. From an examination of these, the following points were made out, which, without pretending to be a complete account of the minute anatomy of the animal, it may be well to record.

*Organs of Vision.*—The two pairs of eyes are identical in structure, but quite distinct from each other, and belong to a high type of the simple invertebrate eye. The portion of the chitinous coat of the head which forms the "cornea" is but slightly more convex than the general curve of the part. Imbedded in this is a refractile body of a slightly flattened spherical form, consisting of a delicate sac containing a structureless gelatinous material.

The sac is quite distinct from the cavity in which it is contained, and is capable of dislocation from its hollow bed. In sections where this has happened the contained material may be seen oozing from the shrunken sac, and forming a drop very similar in appearance to the myelin drops that form in the course of a medullated vertebrate nerve. The lens, thus formed, rests on a concave surface formed of the epidermic layer of the head, which here consists of soft rounded cells, granular and easily stained in spirit specimens, but doubtless quite transparent in life. Surrounding the lens, and forming a sort of iris, is a ring of these epithelial cells, deeply impregnated with a deep brown pigment.

Behind this epithelial layer comes the retina. This consists of three distinct layers. Immediately beneath the epithelial layer is a layer of cylindrical bodies, nucleated and deeply pigmented, and continuous with the bases of these (so that each appears to have its continuation in the next layer) is a layer of tapering rods, which divide at their deeper extremity into two or more slender fibres. Between these two layers there is doubtless an organic connection, each cylinder fitting accurately on to its corresponding rod, but that the continuity is

not absolute is evidenced by the existence of a distinct line free from granules at their point of junction, and by the circumstance that rough handling has a tendency to separate the layers at this point. The rods, like the cylinders, are nucleated, the nuclei lying not all in the same plane, but exhibiting a tendency to alternation. These rods contain but few granules and, as already mentioned, divide below into a number of fibres, each of which is continuous with a cell of the third and last layer. This last layer consists of spindle-shaped cells strongly granular and distinctly nucleated. They are prolonged at their superficial extremities into fibres, which are continuous with the branches of the rods of the second layer, and their deep extremities split up into a number of fine fibres, which can, in favourable cases, be made out to inosculate with fibres issuing from the ganglionic mass supplying the eye.

With such refractile arrangements, the outer surface being but little curved, the entire work of refraction must be performed by the lenticular bag of highly refringent fluid, and the rays, passing through the transparent epidermic layer, must be brought to a focus on the deeply pigmented anterior extremities of the front layer of rods of the retina. The lens is probably a modified cuticular structure. It must be acknowledged that so specialized a structure as this is of a higher type than the very ill-developed compound eyes which are commonly met with amongst the *Gammaridae*.

*Nervous System.*—The ventral nerve cord is large and well developed. In the thoracic region, the paired ganglia are placed so close to each other as to nearly blend, the transverse commissures presenting scarce any constriction. In the abdominal region these commissures are somewhat longer. The longitudinal commissures between the second thoracic and the maxillipedal ganglia are longer than usual and diverge outwards, the latter pair being placed fully the width of the œsophagus apart. From these spring the long commissures of the œsophageal collar, which in front join with two long, cord-like chains of cells which lie on each side below the anterior prolongation of the peculiar gizzard to be described below. This ganglionic cord, curving upwards, blends with the main mass of the supra-œsophageal ganglion, which fills up nearly the entire space of the head between the gizzard and its anterior wall. From the periphery of this mass project eight rounded processes, the centres of the two pairs of eyes and of the two pairs of antennæ respectively. Those of the eyes lie almost in contact with the bases of the retinal spindle cells and distinct fibrous connections can be made out between them and the retina. From the long cord-like horns that run back from the main brain mass to the œsophageal commissure, branches may be traced to the gnathites and to the green-gland. Each of the great

ganglion masses, the ventral ganglia included, is surrounded more or less completely by a layer of small round cells that have all the histological characteristics of leucocytes. From an examination of certain figures illustrative of current researches in the group, I am inclined to think that these have been, in some cases, mistaken for nervous elements and described as portions of the ganglion system. They are, however, simple granular rounded cells with small indistinct nuclei, both cell substance and nuclei greedily absorbing all dye stuffs. These cells are quite without tails or other protoplasmic connections, and appear to be packed in the intercellular lymph tissues surrounding the ganglia rather than embedded in any intercellular material. They are certainly mesoblastic and probably are plasmic cells whose function it is to subserve the rapid nutritive changes going on within the ganglionic system.

*Muscular System.*—This, in one species, is but feebly developed, the sections contrasting strongly with those of species of more active habits, such as inhabit the surface. In the head a number of radially placed bands suspend the gizzard, those in the middle line above being the most strongly marked. A strong band runs between the anterior part of the under surface of the gizzard obliquely downwards and backwards to the antero-inferior corner of the "sifting" stomach. The body muscles are especially feeble, the best developed being the great extensors of the segments, which attain a development somewhat superior to the other body muscles. The great obliquely vertical bands which take up so large a share of the segmental space in most crustaceans are scarcely developed at all in the thoracic segments and but feebly so for even the first three abdominal segments, which usually have these muscles of immense size for keeping up the constant vibrations of the three anterior abdominal appendages. Living, however, as this species does, imbedded in tolerably thick mud, it can have but few opportunities for putting this movement in action, the want of a free current through its branchial plates being met in another way. The muscles of the thoracic appendages and of the last three abdominal appendages are correspondingly weak, the greater part of the space within the articulations being taken up with aggregations of plasmic cells like those already described as surrounding the ganglionic centres.

*Digestive System.*—The gnathites, already described, work beneath a vaulted space formed by the sterna of the cephalic and maxillipedal segments. From the middle of this vault a funnel-shaped pharynx leads into a very narrow oesophagus of some length, which opens into a large cavity which appears to function as a gizzard. This cavity is nearly rounded in transverse section, but slightly flattened from above downwards, especially behind, the width of the lumen being about one quarter

the depth of the head and more than a third of its breadth. In length, it considerably exceeds half the length of the head, the œsophagus opening into it rather in front of the middle of its length. It is lined throughout with chitine, and presents sundry toothed plates and hairs which subserve the trituration of food. Of these plates and hairs, the following are the most remarkable: from the anterior wall of the cavity, on either side of the middle line, projects a strong flattened plate somewhat narrowed at its origin from the wall of the cavity and expanded at its border, which latter is armed with a double row of strong teeth, very like those on the triturating plate of the mandible; the upper ranks of these teeth are short, strong, and somewhat lanceolate in form, while the lower ranks are longer, thinner, and of more uniform thickness, and interdigitate with a series of similar long weak teeth placed on a second pair of plates situated on the anterior portion of the ventral wall of the organ (Plate II, fig. 3.). Lastly, the middle part of the dorsal wall of the organ is densely clothed with long thin flexible hairs. From the vicinity of the posterior end of the ventral wall, rather nearer the posterior end of the organ than to the point of entry of the œsophagus, a funnel-shaped depression leads to a very short channel, which admits the food to a second chitin-lined cavity, which I have already alluded to as the "sifting stomach." Seen in transverse section this latter cavity has a cordate outline; a strong chitinous ridge, with a very broad base, projecting upwards into its lumen from its ventral wall, and reaching upwards nearly to the level of the dorsal wall of the organ, thus dividing the greater part of the length of the cavity into two nearly distinct spaces. In front and behind, this ridge sinks down rapidly to the level of the ventral wall of the cavity. Each of the two main spaces into which the viscus is thus cut off is further subdivided by a very delicate chitinous plate which projects upwards and inwards nearly as high as the main median ridge. These plates, the median ridge, and the walls of the viscus are alike clothed with closely set, short, and stiff, but very fine, hairs, so that the entire organ must form a most efficient sieve by which all particles that have not been sufficiently comminuted in the gizzard are kept from entering the mid-gut. The "sifting stomach" opens behind by a constricted channel into the mid-gut. The mid-gut is of considerable dimensions, and is perfectly straight and of nearly uniform diameter throughout, it opens by a narrow anus on the under surface of the sixth abdominal segment close to the telson. In its anterior portion the endothelial coat is two cells in thickness and the mesoblastic layer of perceptible thickness. In the hinder part of the canal, however, the endothelium is reduced to a single row of cells and the meso-

blastic layer is so thin as to be scarcely perceptible. It is a simple rounded channel without foldings or complications of any sort. The large size of the canal is no doubt connected with the bulky nature of the food in proportion to its contained nutriment. In all but one of the specimens cut the intestinal canal was full and its contents simply mud, exactly similar to that clinging to the outside of the animal, which appears to live by swallowing the mud without any particular selection, trusting to the elaborate arrangements of its digestive apparatus to separate and utilize any particles that may possess a nutritive value.

*Glandular System.*—This in our species possesses but a feeble development. Situated below the main mass of the supra-oesophageal ganglion is the green gland, consisting of a mass of somewhat elongated cells enclosed in a distinct capsule. The situation of its duct could not be made out. The liver lies behind the gizzard and immediately underneath the anterior end of the dorsal vessel. It is of small size, and does not completely sheath the mid-gut, being placed almost entirely above and at the sides. Certain glandular cells can also be made out within the basipodites of certain of the thoracic appendages, notably of the fifth, but the position of their ducts could not be discovered with certainty, although I am inclined to think that the opening is in the propodite, near its articulation with the dactylopodite.

*Vascular System.*—The dorsal vessel is a tube of considerable size occupying the greater part of the space between the great extensor muscles of the segments above and the intestinal canal below; and is slightly constricted at the points of junction of segments. Of large size in the thoracic region, it tapers off, in front and behind, and is lost. Beyond the constrictions, already mentioned, no signs of valves could be made out. It appears to open by minute, oblique slits into the general lymph spaces surrounding it. In histological structure it consists of an inner layer of flat, polygonal epithelioid cells, covered by a layer of flattened nucleated fibres disposed in a regular spiral round the tube, the ostioles communicating with the lymph space consisting of interstices between the thus obliquely placed fibres (Pl. II, Fig. 3). The general body cavity is divided into lateral halves by a delicate vertical septum connecting the dorsal vessel with the body wall above and with the intestinal canal below, and each half is further subdivided by a horizontal septum running from pleuron to pleuron above the generative gland tubes to the side of the intestine.

*Organs of Respiration.*—The branchiæ of our species attain an exceptional degree of complexity. There are five pairs, which are attached to the coxopodite of each of the thoracic appendages except the

first and last. Each gill plate consists of a flattened lamina of considerable length, the longest being nearly as long as twice the depth of the body. From each face of this primary lamina, spring secondary laminæ arranged in regular alternation on either side to the number of 20 or 30 on each face. These secondary laminæ are of considerable area, the depth of the largest being quite half the length of an average thoracic segment. Gills of so complicated a structure as this are rare amongst the Amphipoda, and their presence in our species is no doubt connected with its mode of life. Burrowing as it does in thick mud, its anterior abdominal appendages cannot be kept in the usual rapid vibration which in most species maintains a free current of water through the subthoracic hollow. Such a current being unobtainable, the difficulty is met by the great increase of available gill surface secured by the complex branchial structure already described.

*Organs of Reproduction.*—Although a very large number of specimens was obtained, all appear to belong to the female sex, all presenting the same external characteristics, and all the specimens that were dissected having the same form of generative gland. Apparently the animals were not breeding at the time of the haul, as, although the ovaries of most of those sectionized contained young ova, none carried eggs beneath the thorax. The ovaries consist of a simple tube bent on itself and occupying nearly the entire length of the thorax, so that a typical section exhibits four tubes cut across and disposed in a semicircle below the alimentary canal; of these the outer pair appear to be the glandular and the inner, the duct portions of the organs. Such ova as were met with in this latter portion of the tube were enveloped in a voluminous ovoid coating of albuminous material. The flexure of the ovarian tube takes place at the anterior end of the thorax, so that its blind commencement is in the most posterior portion of the region. In one series of sections, the organ presents a suspicious resemblance to a sperm-producing gland, in other respects differing in no way from the usual type, while no ova could be made out in any portion of the series of sections. It may be that this is a male specimen, but, if this be the case, the organs of both sexes closely resemble each other, even to the detail of the double tube bent on itself.

### 3. MICRODEUTOPUS MEGNÆ, n. sp., Pl. VII., Figs. 1—4.

The species described below was taken in the surface net in the turbid water (about 6 fathoms) of the Megna Shoals.

The animal, which is  $4\frac{1}{2}$  mm. long, is of a dirty white colour, and the intestinal canal often shews through the body as a greenish streak.

The *head* is small and somewhat excavated below, the antennæ originating a good deal behind the antennules. There is no rostrum, and the single small black rounded eye is placed on a prominent angle situated between the antennules and antennæ.

The *thorax* forms a little more than half of the entire body length, and is long and slender, the segments (saving the first, which is shorter) being subequal. The coxal plates are small and narrow, the anterior ones being so short as not to overlap in all positions of the animal; that of the third is the deepest, while the last three are extremely narrow.

The *abdomen* is small and, like the thorax, narrow, its first three segments being about the same size and depth as the immediately preceding thoracic segments with their coxæ. The last three segments are small and nearly cylindrical, and the short *telson* is armed above with a pair of peculiar conical protuberances bearing a single strong bristle. The last three segments also have their posterior borders furnished, in the middle line, with a few short stiff hairs.

The *antennules* and *antennæ* are stout, approaching the pediform, especially in the case of the latter. They are subequal in length, the antennules being a little the longer, equalling the length of the thorax less its last segment. The peduncle of the *antennules* forms nearly two-thirds of the entire length of the organs and is very stout. It consists of three joints, of which the first is the stoutest, but is intermediate in length between the two remaining joints, the second joint being much the longest and forming nearly half the peduncle, while the last joint is the shortest and slenderest. All three joints are moderately hirsute, especially along their inferior borders. The appendage of the antennule is uni-articulate, and so small as to be very easily overlooked, indeed, it is of so delicate a character that it will be found to be wanting in a large proportion of specimens. The flagellum proper is very slender and consists of 10 to 14 short articuli armed with extremely short hairs.

The peduncle of the *antennæ* is both absolutely and relatively much longer and stouter than that of the antennules. It is five-jointed, the first two joints being short, but very stout, the last two very long and subequal to each other and to the long middle joint of the peduncle of the antennule, and the third joint about half the length of the two distal pieces. All its joints are moderately hirsute especially on the inferior borders, and the last joint is additionally armed on the sides with a number of stout tooth-like spines. The flagellum is very short, forming not a quarter of the entire length of the organs, and consists of 10 or 12 very short, feebly armed articuli.

The *gnathites* and the digestive apparatus generally present a strong general resemblance to those of *Ampelisca leptæ*, already described. The



mandibles are of even more complex structure, their cutting and triturating plates being alike doubled. Each pair of plates is immovably connected together, the two cutters having simple toothless chisel edges and closely resembling each other in general form, while the triturating plates are very peculiar, the more superficial plate being smaller than the deeper and armed with short, stout, conical teeth, the most anterior being blunt and considerably longer than the rest, and the deeper triturating plates even more complex. Most anteriorly comes a vertically arranged row of three stout, bluntly conical teeth placed, it will be observed, at right angles to the main row of triturating processes. Behind this row comes a peculiar stout tooth with a trenchant bifid apex, and, behind this again, a number of long stout spines of no great strength. The mandibular appendage is of exceptionally great proportional size, being absolutely considerably longer than the pediform ramus of the maxilliped, and may often be made out projecting forwards between the roots of the antennules and antennæ. The palp has four joints, of which the first is very short, while the remaining three are subequal and long. The last joint ends in a dense brush of long thin hairs, but the remainder of the organ is nearly smooth.

The *digestive organs*, as far as they were examined, closely resemble those of *Ampelisca lepta*, the chitinous stomach being subdivided into two cavities, and closely resembling that of *Ampelisca* in the arrangement of its armature. There is the same pair of strongly armed plates at the anterior extremity of the organ, and it is further notable that, as in *Ampelisca*, the spines of these plates resemble in form those on the posterior portion of the triturating mandibular plate; being simple pointed rods, in both cases, in the present species; and lancet-headed spines in both situations in *Ampelisca*. The "sifting" stomach appears to be of identical construction in both species.

The second and third *thoracic appendages*, or *gnathopoda*, present considerable sexual differences. In the male, the 1st gnathopod, though of but medium length, is immensely stout, being nearly as thick as the body of the animal. It is furnished with a well-developed and very powerful double subchela, the dactylus, which is strong and a little varicose, but otherwise unarmed, being opposable to the nearly quadrangular, very short, and hirsute propodite and the latter again to the prolonged postero-inferior angle of the immensely dilated carpopodite. The articulation between this latter and the meropodite is very oblique, being placed much more on the anterior than on the inferior aspect of the articulus. The remaining joints, though very short, present nothing remarkable. The second gnathopod in the male is short, slender, and imperfectly subchelate, the dactylus being barely opposable to the dilated,

but not prolonged, propodite. As in its predecessor, the articulation between the carpus and merus is extremely oblique.

In the female, the *gnathopods* are both much smaller, the first, though larger, being not disproportionately so to the second. The subchelæ of both pairs are single and very rudimentary, that of the first being barely opposible and the grip secured only by a few weak spines on the propodite, while the second pair differ but little from an ordinary ambulatory appendage. The carpo-meropodital articulation of the first is oblique, but in the second gnathopod it is of the ordinary type.

In the young male, the 1st gnathopoda are comparatively small, but can still be distinguished from those of the female by the presence of the distally prolonged spine of the propodite.

The 4th and 5th *thoracic appendages* have rather long and falciform dactylopodites, but are otherwise of the usual ambulatory type; the fifth is the longer of the two, being as long as the last four thoracic segments and subequal to the sixth appendage, while the fourth, which is subequal to the third, is at least one-fifth shorter. The sixth, seventh, and eighth thoracic appendages resemble each other in general form, but increase in dimensions, especially in length, from before backwards, the increase being mainly in the great proportionate length of their distal articuli, the length of their basi- and ischiopodites differing in much smaller proportion, so that, while the sixth does not exceed the fifth in length, the seventh appendage is as long as the entire thorax, and the eighth longer than the seventh by the length of the animal's head. Their basipodites are much compressed, but not distinctly buttressed.

The first three *abdominal appendages* are large and powerful and well armed with hairs, and the last three, short and cylindrical with styloid rami, both protopodites and rami being armed with a number of short stout spines. When extended, they all three reach about the same level and their rami are subequal, the protopodite of the last pair being extremely short.

The animal was found in considerable numbers to all appearance swimming freely in the water; there was, however, abundant drift wood which may have served as its hiding place, and the little creatures when under observation showed a very strong tendency to take advantage of such opportunities of concealment.

It is possible that those taken had been washed from their hold by the strength of the current, which often reaches a speed of  $4\frac{1}{2}$  knots on the Megna Flats. Still, I cannot say that I actually detected a specimen burrowing a shelter for itself in any case that came under my observation.

The posterior appendages are, however, admirably adapted for clinging to any chance protection that might be met with.

The male is provided with five pairs of simple *branchial laminae* attached to each thoracic appendage between the third and seventh inclusive. In the female, the gravid egg pouch renders it difficult to make out the exact number of these laminae, but I am inclined to think that it is the same as in the male.

Our species differs from *M. gryllotalpa* in the much greater proportionate size of the 8th thoracic appendage; from *M. websterii* in the larger size of the seventh appendage and in the body of the latter being much stouter; from *M. anomalus* and *M. tenuis* in the appendage of the superior antenna being uni- instead of multi-articulate; from *M. versiculatus* in the posterior thoracic appendages being longer in that species, and in the peculiar form of the anterior thoracic appendages of *versiculatus*; from *M. longipes* in the antennules and antennae being subequal in our species, while in the former the antennule is much longer than the antenna; from *M. macronyx* in the three posterior segments of the pleon being armed with spines; from *M. grandimanus* in the antennules and antennae being nearly of equal length and in the form of the last pair of abdominal appendages, which in our species have the peduncle much shorter than, instead of subequal to, the rami; from *M. australis*, *M. tenuipes*, and *M. chelifera*, in the flagellum of the antennules being shorter instead of longer than the peduncle; and from *M. mortoni* in this same point (which appears to characterize all the Australian members of the genus), and in the form of the first gnathopod of the male; *M. maculatus* (Thompson, Am. N. 4, (5), IV, p. 33, from Dunedin, New Zealand), agrees with the other Australasian forms in possessing a very long antennule, the appendage of which is multi-articulate, and differs further from our species in the comparative shortness of the 7th thoracic appendage.

#### 4. MONOCULODES MEGAPLEON, n. sp., Pl. VII., Fig. 12.

This species was taken at the surface in the drift net in rather turbid water on the banks off Chittagong.

Only a single (probably male) specimen was obtained, so that I am unable to furnish any details as to its more minute anatomy. The animal is 3.2 mm. long, of a dirty white colour, and the intestinal canal shews through the carapace as a greenish streak.

The *head* is very small, and is produced in front into a peculiar, down-turned hooked rostrum, very minutely serrated along its posterior border. The anterior half of the upper surface, and a portion of the

sides, are occupied by the eyes, which blend in the middle line so as to appear to be a single organ.

The *thorax* is small, forming only a third of the whole body length. The segments increase gradually in length from before backwards, the last being nearly double the length of the first, and are of very moderate depth. The coxal plates, however, are very deep, nearly equalling, as a general rule, the depth of their corresponding segments. The last coxal plate is the only marked exception to this rule, being only half the depth of the corresponding segment and little more than half the depth of that immediately preceding it.

The *abdomen* is very large, forming more than half of the total body length, the first three segments alone exceeding the thorax in length, while the remaining three are as long as the first four thoracic segments. The first three segments are of great depth, while the last three are rather narrow. The *telson* is simple and laminar.

The *antennule* is slightly longer than the thorax. It is moderately hirsute, the distinction between peduncle and flagellum is very ill-marked, the first joint alone of the former markedly exceeding the succeeding articulations in size. The flagellum consists of 10 or 12 short joints.

The *antennæ* are slightly longer, exceeding the antennules by the length of an average thoracic segment. The peduncle forms a good deal less than half its length, is moderately hirsute, and consists of five joints, of which the first three are very short and the last two long and stouter than any part of the peduncle of the antennule. The flagellum is very smooth, its hairs being extremely fine and short, and consists of about forty very short joints, the lines between the component articuli being very indistinct.

With the exception of the maxilliped, which is small, hirsute, and clawed, nothing could be made out of the *gnathites*, which are very small and almost completely hidden by the sides of the head.

The second and third *thoracic appendages* are long and slender, the third being a little the longer and stouter, nearly equalling the combined head and thorax in length. They closely resemble each other and shew well the peculiar form characteristic of the genus in having the postero-inferior angle of the carpopodite prolonged into a spine opposite to the propodite and long enough to meet the dactylopodite. This spine in the second thoracic appendage projects a little behind the propodite, while in the third the propodite slightly exceeds the spine. The fourth and fifth are the shortest of the thoracic appendages; they are subequal and moderately stout, and closely resemble each other, both being very hirsute and termi-

nated by a brush of hairs so dense as to hide their dactylopodites, which, if present, must be very small. The sixth and seventh are stout, and alike in general form, having their meropodites considerably expanded. They are articulated quite to the edge of the coxæ and their basipodites, though strong, are without buttress plates. The seventh is considerably the longer, the sixth being only as long as the head and the first four thoracic segments, while the seventh is as long as the head and thorax save its last segment. The eighth is unfortunately partially wanting on both sides in my one specimen, but is evidently much the largest and longest of the appendages, the basi-, ischio-, and meropodites, which remain, being very considerably larger than those of any other appendage; the basipodite is strengthened by buttress-like plates both in front and behind.

The first three *abdominal appendages* are of the usual type, but are exceptionally powerful. The last three are rather long and thin, the fourth being longest, and the sixth the shortest, the fifth, however, projecting rather beyond the other two, when all three are extended. They are almost without hairs or spines, such as are present being very fine and short, and have their protopodites cylindrical and their rami, of which each has a pair, of styloid form.

Our species differs from *M. carinatus* in wanting the dorsal keels and in both gnathopoda being of typical form; from *M. stimpsonii* in the much larger proportional size of the abdomen; and from *M. demissus* in the last two coxæ being of fair size, certainly not very small, in the eyes being black and not vermilion-coloured, and in the greater size of the abdomen.

#### CONCHOLESTES, gen. nov.

The following species is a most singular one in its habits. It belongs certainly to the subfamily *Corophiides* of the family *Corophiidae*, but I can find no genus, either in Spence Bate's Catalogue of the British Museum Amphipoda, or amongst the numerous new genera that have been established in the family since the date of that publication, that, by any moderate extension, can be made to include so peculiar a species, although it certainly approaches most nearly to *Corophium*.

It was obtained by dredging in 7 fathoms, on a sandy bottom, off the "Seven Pagodas," on the Madras Coast. Amongst the catch were a number of specimens of *Dentalium lacteum*, some living, a few empty, and more containing a small pagurus. On examining the latter, I was surprised to find that two specimens were inhabited by a tubicolous amphipod which had made its home in the shell, lining it with a mix-

ture of silken secretion with fine sandy particles; this inner tube being quite distinct and coherent when separated from the shell by dissolving the latter in dilute hydrochloric acid.

Though quite lively, it was evident that the animal must be quite confined to the bottom, as it was evidently incapable of lifting its heavy house, but crawled about the bottom of the jar by means of its powerful antennæ. Of the two specimens, one was a female, and it is noticeable that the eggs she carried were enclosed in no proper egg-pouch, but were retained under the thorax only by narrow plates fringed with long hairs, which, though of equal morphological value, differ markedly from the usual broad plates.

So far as I am aware, the circumstance of an amphipod making use of a deserted shell as a tube has not been previously observed, and I have based the proposed generic name on this circumstance.

Animal long and slender, with the abdomen composed of six distinct but very small segments; antennule moderately large, flagellate, but without appendage; antennæ very large and pediform inserted barely behind the antennules; 3rd thoracic appendage with a well-developed subchela considerably larger than the weakly subchelæ of 2nd thoracic appendage; 7th and 8th thoracic appendages short, with the carpopodital articulation peculiarly modified, the joint being placed obliquely on the anterior and outer face of the articulus, and the distal end of the carpopodite rounded, and covered with short closely set recurved hooklets; 8th thoracic appendage ambulatory; 4th abdominal appendage biramous, 6th blunt, rounded, without rami, nearly hidden beneath the squamous telson.

##### 5. *CONCHOLESTES DENTALII*, n. sp., Pl. VII, Figs. 7—11.

The *head*, seen laterally, forms a truncated pyramid with the base forwards, the small eye being situated on a small angular process between the antennule and antenna, but no marked recess is formed for the reception of the latter appendage. The carapace projects forwards a little in the middle line between the antennæ in the form of two processes, forming a sort of bifid rostrum.

The *thorax* is very large, being a little more than twice as long as the combined head and abdomen. The length of the segments is somewhat irregular, the first being the shortest, the 2nd, 5th, and 6th subequal and longest, and the remaining segments of intermediate length. The first segment has the additional peculiarity of being prolonged into a sort of rostrum, armed with a tuft of hairs, which overlaps the back of the head. The coxal plates are small,

and quite distinct from each other, the first four forming conical processes directed obliquely forwards and downwards from their corresponding pleura, and the hinder three being longer, but very narrow, plates.

The first three *abdominal segments* are subequal, nearly cylindrical, and are a little shorter than the first thoracic segment; the last three are very diminutive, and the *telson* short, squamous, and semilunar.

The *antennule* is stout, less than half as long as the body. Its peduncle forms three-fourths of the length of the organ, and consists of three joints, subequal in length, but diminishing progressively in stoutness, and the flagellum consists of five stout longish articuli. Both peduncle and flagellum are armed with a large number of long stiff hairs, and the flagellum is, in addition, provided below with a series of flexible flattened hairs quite different from the others. The antenna is pediform and much the largest of all the appendages, being very stout and nearly as long as the entire thorax. Almost the entire length of the organ is formed by the peduncle, the flagellum being represented by a single short, stout joint terminated by a pair of strong claws. The first and last peduncular articuli are subequal and rather short, the second a little longer than these, and the third and fourth subequal and very long, forming together two-thirds of the length of the organ, which is profusely armed with long, stiff hairs.

The *gnathites*, as far as they could be examined, present no points of peculiar interest, the mandibles being of simple form and palpate, and the maxillipeds small and unguiculate.

The first of the *gnathopods* is but feebly subchelate, no palm being developed to the propodite; such grasping power as it may have being furnished by a number of fine serrations on the dactylopodite and some stiffish hairs on the protopodite. The appendage is as long as the peduncle of the superior antennæ; the second gnathopod, though but little longer, is much stouter and has the protopodite much dilated, the palm, though rather oblique, being strongly armed with three formidable teeth, and the dactylopodite being strongly serrated. The dactylopodite also presents the following additional peculiarities: first, it is armed in its anterior border with one or two hairs, a most exceptional circumstance, and, secondly, it is really trifold when seen from above, as, from a point about half way along its length, a powerful secondary tooth projects obliquely on either side; these latter being but little exceeded by the main central tooth either in length or stoutness. As in the 1st gnathopod, the carpo-propodital articulation is rather oblique.

The next two *thoracic appendages* (4th and 5th) are short, being only as long as the two first joints of the peduncles of the anten-

nules. They are mainly remarkable for the stoutness of their articuli and the length and straightness of their dactylopodites. The 6th and 7th thoracic appendages are of very peculiar structure, and have already been shortly described in the generic diagnosis. They are similar in general form, but the 6th is somewhat the larger, its excess of length being gained mainly in the basipodite. Each carpopodite forms a stout cylinder, armed at its point with a short, stout spine, and densely clothed at its apex and outer aspect with short stout recurved hooks. The propodite is articulated a little below the middle of the outer and anterior aspect of the carpopodite, and the dactylopodite forms a small, but much curved hook. The 8th thoracic appendage differs considerably from any of the other appendages, and is more of the normal type. Subequal to the second gnathopod in length, it is the slenderest of all the appendages, the basipodite alone being of any size, and even this considerably tapered distally. All the thoracic appendages are somewhat hirsute.

The first three *abdominal appendages*, though of the usual type, are very small and much broader than long. The fourth is the largest of them all, its peduncle being stout and armed with a few stout spines, and its rami, which are equally stout, about half the length of the peduncle and armed with a number of stiff slightly curved spines. The articulations of the rami of this appendage with its peduncle are strong and of hinge type; and watching the animal while alive, I was impressed with the idea that the organ could be, and probably is, employed by the animal as a forceps for holding on to its house. Of the fifth abdominal appendage I have been unable to obtain a satisfactory view. It is small and its peduncle is very short, though of considerable breadth. The ramus appears to be single and rounded, and has its end beset with recurved hooks, similar to those on the carpopodites of the 6th and 7th thoracic appendages. The last abdominal appendage is short and blunt and has no ramus, its end being armed with a few spines, some of which show a tendency to hooking.

#### 6. AMPHITHOE INDICA, M.-Edw., Pl. X., Figs. 1—7.

This very beautifully ornamented species was obtained in the drift net, in the middle of the Bay of Bengal, on a voyage from Chittagong to Madras. Although so far from land, there was a certain amount of flotsom and jetsom to be met with on the surface, and it was in the interstices of such pieces that the little animal had its home. It builds no regular tube, but constructs an irregular sort of shelter for itself by glueing together tiny morsels of driftage, ekeing out its materials; from the appearance of some of the irregular masses resulting from its



architectural efforts, I am inclined to believe, with pellets of its own excreta, as observed in certain kindred species by F. S. Smith (*Nature*, 1880, p. 595). To this queer home it clings most tenaciously, and I should certainly have overlooked it altogether had not my assistant, in lifting some of the morsels of débris, with the view of cleaning the catch, accidentally demolished a homestead and evicted one of the tenantry; when a closer examination resulted in the discovery of a considerable number of specimens.

The animal is about 5 mm. long, and is very beautifully coloured. The ground colour is a rich deep purple, fading to nearly a burnt-sienna tint towards the dorsal line, the coxal plates being darkest and free from paler markings. The whole of the head and thorax is mottled with patches of the brightest golden yellow, which forms a broad, but somewhat irregular, band along the middle of the back, and is further disposed in irregular patches over the pleura of the somites. The basipodites of the thoracic appendages are of the deepest purple, but on their distal articuli the colour fades to a paler shade of the same tint.

The *head* has an irregularly pentagonal outline, its anterior border being peculiarly vertical and straight, and without any rostrum. It nearly equals in length the first two thoracic segments; its depth is but little less. The eye, which is coloured the brightest scarlet, is of medium size and placed at the antero-inferior angle of the head.

The *thorax* is large, forming five-ninths of the entire body length. Its segments are stout, and as deep as they are long, and do not differ markedly from each other in length, but the 3rd, 4th, 5th, and 6th are subequal, and about  $\frac{1}{3}$  longer than the two first and the last segments. The five anterior coxal plates are deeper than the corresponding segments, and the 5th has the additional peculiarity of being composed of two lobes, of which the anterior is as deep as, or deeper than, the coxæ in front of it, while the posterior lobe is very narrow and corresponds in form and depth to the very small coxæ of the 6th and 7th segments behind it.

The *abdomen* is small, forming but little more than  $\frac{1}{3}$ rd of the entire body length. Its first, second, and fourth segments are subequal in length to the first two thoracic segments, while the third is subequal to a median thoracic, and the last two are very short, the penultimate segment being the shortest of all. In depth, the 1st abdominal segment only equals the last thoracic segment and its coxæ, the 2nd and 3rd are somewhat deeper, and the last three segments very narrow. The *telson* is small, laminar, somewhat upturned, and of a roundedly conical outline. The last three segments are armed with a few hairs along the middle line.

The *antennule* is a little more than a third of the body length, reaching back to nearly the end of the 4th thoracic segment. Its peduncle is moderately stout and forms more than half the length of the organ. Of its three articuli, the first is the longest and stoutest, the second, nearly as large, and the third, very small, is dotted along its inferior border with a number of long fine hairs, but, with the exception of a few short fine hairs, is naked above. The flagellum tapers gradually, and is formed of 13—14 short joints, each of which is distally armed with a few short stiffish hairs.

The *antenna* exactly equals the antennule in length, but is much stouter and subpediform. The peduncle forms  $\frac{3}{4}$ ths of the entire length of the appendage; its first three joints are very stout, but in length together only equal the 4th, which is subequal to the 5th. The proximal segments are pretty liberally clothed with long hairs, and the last with hairs shorter and almost spinous. The flagellum consists of 9—11 very short joints, each of which is armed distally with a circlet of short stiff hairs.

The *gnathites* are rather small and inconspicuous, but the mandible, which is provided with a small appendage, is of remarkable complexity, its triturating portion being subdivided into three distinct, but immovably connected, plates, each armed with dentations of progressively increasing severity. The deepest of these three plates is armed, in addition, with a number of compound sifting hairs.

The maxillæ and maxillipeds are small, but quite of the usual type. The second and third *thoracic appendages* (*gnathopoda*) are small and rather weakly subchelate. The palm of the propodite of the 1st gnathopod is fairly marked, but has its angle round and not produced into an opposible ramus, while that of the 2nd gnathopod has the palm even less pronounced, being retracted and excavated; both have a pair of stout spines near the angle between which the dactylopodite closes. In both, the dactylopodites are feebly serrate, and the carpo-meropodital articulations, oblique. The fourth and fifth thoracic appendages are subequal in length to the gnathopoda; both are somewhat slighter and quite of the usual ambulatory type. The sixth, seventh, and eighth thoracic appendages resemble each other closely in general plan, but differ greatly in length, the sixth being subequal to the appendages in front of it and a little more than  $\frac{1}{4}$ th the body length, while the seventh is fully a third, and the eighth, a sixth, longer than the seventh. All three have the basipodites strengthened by buttress plates, those of the sixth being placed in front as well as behind the cylindrical portion of the articulus, while, in the 7th and 8th, the buttress is placed entirely behind. The basipodites certainly do

“taper” distally (as described by Milne-Edwards, *Nat. Hist. des Crustacés*, vol. iii, p. 31), but not so markedly as to make it a prominent characteristic. All three appendages shew also a peculiarity of the propodites, which are armed at the distal end of their anterior borders with a pair of stout blunt spines including between them a rounded depression, and giving one the impression of their being especially suited to subserve the guiding of a thread. All the thoracic appendages, except the first and last, appear to carry gill plates in both sexes.

The three anterior *abdominal appendages* are large and well developed, but are quite of the usual type. The 4th and 5th abdominal appendages are stout, the peduncle of the 5th being considerably the shorter. Their rami are subequal and styloid and are armed with stout short spines, some of which, near the ends of the rami, shew a tendency to become recurved. The peduncles also are armed with a few similar spines. The last appendage is peculiar. Its peduncle is very short and broad and armed only with a single spine at the end of its inner border. Its rami differ greatly, the inner ramus being very stout and nearly spherical and armed only with a single short spine and a few hairs, while the outer is laminar and quite smooth, and has its inner border developed into a peculiar double hook.

I think it is more than probable that this species is identical with *A. indica*, Milne-Edwards (*loc. cit.*), more especially as my specimens agree in the most prominent peculiarity which the species possesses, namely, the shortness and equality of the antennæ. Milne-Edwards' species was taken on the other side of the peninsula, but, as it is thoroughly pelagic, it is probably found on both sides. His description is, however, so utterly inadequate that it would be impossible to pronounce on the point without seeing the actual specimens. He does not appear to have figured the species, and S. Bates' figure (*Cat. Amph. Crust. British Museum*, pl. xlii, fig. II), which is stated to have been drawn from the type in the Museum of the Jardin des Plantes, is so small and indistinct that it is impossible to draw any certain conclusions from it. As far as they go, figure and description incline me to believe that this is the same species, but in any case a more complete figure and description were a desideratum.

#### 7. *ATYLUS COMES*, n. sp., Pl. X., Figs. 8—10.

The main point of interest connected with the present species is its close superficial resemblance to, and its companionship with, *Amphithoë indica*. Several specimens were taken with the latter species, already described; but it was not until after repeated examinations that I was able to assure myself that the differences were not of a sexual value

only. This was at last negated by the discovery of egg-bearing females belonging to both species.

The colouration of the two species is closely similar (although the *Atylus* has, if anything, a larger share of the bright yellow maculi on a brown purple ground that characterize both species) that I think that there can be little doubt that we have to do with a case of mimicry, in which case there can be little doubt that it is the *Atylus* who gains the advantage, as the *Amphithoë* is much the stouter and stronger species, and possesses the added advantage of being able to construct itself a home which makes pursuit almost futile. Whether or not the *Atylus* avails itself of deserted *Amphithoë* nests, I am unable to say, as the resemblance is so close that, until I had the whole catch under the microscope, I did not suspect that I had to do with more than a single species. I am inclined to think, however, that such must be the case, as all my brightly coloured specimens were certainly turned out of hiding places of sorts, and so think that the probable advantage that is gained by the mimicry is the facility of appropriating empty nests without being discovered as a feeble interloper by the much better armed *Amphithoë*. It seems possible too that such a habit may be more or less a generic characteristic of *Atylus*, as Liljeborg (Oefvers. Vetensk. Akad. Förhandl. p. 8, 1852) had already noticed a curious resemblance between *Amphithoë tenuicornis* and *Atylus compressus*, though there is no note as to their habits.

The species, although a slenderer animal, is about the same length (5 mm.) as *Amphithoë indica*, and has the yellow maculi somewhat larger and more regularly distributed than in that species.

The head is proportionally larger and deeper, being nearly cylindrical and much deeper than long. At its antero-inferior angle is carried a black-pigmented compound eye much longer than the scarlet eye of the *Amphithoë*. The cephalic shield is angulated in the middle line in front, but can hardly be said to be rostrate.

The thorax is small, forming considerably less than half the body length and not much exceeding the abdomen in that respect. It is much compressed, its segments being a good deal deeper than long, and its posterior segments are, if anything, shorter than those in front. The coxal plates are narrow, the anterior four being not more than half the depth of their corresponding segments and the three posterior not much more than a third the depth of the anterior coxæ.

The abdomen is large and deep, its three anterior segments being as long as  $1\frac{1}{2}$  thoracic segments; the fourth segment is also of considerable size, equalling in length an average thoracic segment, and the last two segments are very small. The telson is composed of two, quite

distinct, oval leaflets, regularly articulated to the posterior border of the last segment, and capable of free motion like an appendage. It is possible that this power of thus erecting the telson may serve as a substitute for the uropodal hooks of the associated *Amphithoë*, enabling the animal to hang on to the nest it has appropriated in much the same way that species does by the latter means.

The *antennules* and *antennæ* are subequal and short, being hardly more than a third of the body length, reaching back as far as the back of the third thoracic segment.

The *antennules* have the peduncle considerably shorter than the flagellum, the first joint being long and stout, the second rather more than half the length of the first, and the third joint so small as to be almost indistinguishable from the flagellar articuli, which latter are 14—16 in number, short, and, like the peduncle, but feebly armed with a few fine hairs.

The first joint of the peduncle of the *antennæ* is hidden behind the projecting anterior border of the head and the next two are very short and stout, while the remaining two pieces are long and slender and subequal to each other and to the flagellum, which latter consists of 8—10 short articuli. Both peduncle and flagellum are somewhat more strongly armed than the corresponding parts of the *antennules*.

The *gnathites* are large and strong. The mandibles are simple in construction, the biting plates having a straight, unserrated cutting edge, while the triturating plate consists of a single row of simple blunt teeth arranged in a vertical series with a tuft of compound, sifting bristles behind them. They are provided with a long four-jointed appendage. The first maxilla has the inner lamella strongly toothed and almost mandibuliform, and the second maxilla has the outer ramus but little flattened, and almost palp-shaped.

The *gnathopoda* (2nd and 3rd *thoracic appendages*) are of similar form, with weak subchelæ, the protopodite being simply dilated and not produced into a distinct palm, but the anterior of the two is considerably the smaller, its length only equalling that of the head and first two thoracic segments, while the posterior is longer by the length of an additional thoracic segment. The fourth and fifth thoracic appendages are of the usual ambulatory type, but differ in length, the fourth being subequal to the second gnathopod, while the fifth, the shortest of all the thoracic appendages, is not quite as long as the first gnathopod. The remaining three thoracic appendages closely resemble each other in form, all having, as in the *Amphithoë*, dilated basipodites tapering below, and their remaining articuli long and slender. They differ, however, somewhat in length, the seventh, the longest of all the thoracic

appendages, being as long as the head and first five thoracic segments, while the eighth is a trifle shorter, and the sixth is only subequal to the second gnathopod.

The three anterior *abdominal appendages* are of the usual type and are strong and well developed. The last three appendages are strong, with the inner ramus slightly shorter than the outer, both rami being armed with stoutish spinous hairs. The three pairs of rami are subequal, but the peduncles differ a good deal in size, that of the fifth being only half, and that of the sixth only a quarter, the length of the peduncle of the fourth.

Our species differs from the hitherto described members of the genus as below: from *A. gibbosus*, *A. bispinosus*, *A. swammerdamii*, *A. villosus*, *A. carinatus*, *A. corallinus*, *A. huxleyanus*, *A. spinulicauda*, and *A. compressus*, in having no dorsal carinæ or spines; from *A. crenulatus* and *A. austrinus* in having the antennæ subequal, and not differing considerably in length as in those species; from *A. vulgaris* and *A. capensis* in the antennæ being considerably shorter; and from *A. inermis*, *A. simplex*, and *A. fissicauda* in the last three thoracic appendages not being subequal, but differing a good deal in length.

#### 8. UROTHOE RUBER, n. sp., Pl. XI.

This form was extremely common in the surface net takings on the banks of Chittagong, and was easily distinguished from the other organisms comprised in the catch by its bright brick red colour. Its length is about 3 mm.

Its *head* is small and somewhat olive-shaped; the large eyes being placed rather high up on its lateral aspect.

The *thorax* is of moderate size, forming rather less than half of the body length, excluding the head. It is depressed rather than compressed and its segments increase in size regularly from before backwards. The coxal plates are deep, especially the first four; owing to their extreme transparency it was difficult to make out the posterior ones clearly, but they appeared to be as in the figure, the 5th not being markedly small, as indicated in the generic diagnosis; this, however, is also the case in *U. elegans* (Sp. Bate).

The *abdomen* is large, forming nearly half of the entire body length, its 3rd segment being the largest and alone as long as the head, while the 5th is the shortest of all.

The *antennule* is small, its peduncle is three-jointed and as long as the head, and its basal joint is armed dorsally with a number of plumose compound hairs. The flagellum is very small, 4-jointed, and its appendage even smaller and made up of two very slender articuli.

The *antenna* is much larger than the antennule, its peduncle alone equalling in length the entire organ, while, with its long flagellum, it slightly exceeds the animal in length. The peduncle appears to be 3-jointed from the blending of its first three pieces into one, on which the orifice of the green-gland forms a small tubercle about half along its length. The flagellum is very long, slender, and smooth.

The *gnathites* are small and feebly armed, the mandible, which is provided with a long 3-jointed appendage, armed with a number of long stiff setæ, being provided with a small cutting, and two very small triturating, lamellæ, and the maxillæ and maxillipeds exceptionally small and feeble.

The second and third *thoracic appendages* are small and slender, imperfectly subchelate and extremely hirsute. The 4th and 5th, also very hirsute, are otherwise of the usual ambulatory type, but are even shorter than the gnathopoda. The 6th has a very peculiar form. Its basipodite, short and stout, is expanded below to articulate with the much expanded ischiopodite, half way down which is a row of formidable spines; both it and the meropodite are provided with peculiar lamelliform processes on their posterior borders, from the posterior border of which, and from the inferior border of the process of the latter, spring a number of very long bipennate compound hairs. The inferior border of the propodite is similarly provided, but to a less extent. The lower borders of all the articuli are armed with a row of short stout spines. The 7th is the largest of all the appendages, and, though, in general form, it resembles the ordinary ambulatory appendage, it too is decorated, along the posterior border of the basipodite and meropodite, with long compound hairs of the same character as those on the sixth thoracic appendage. The 8th, somewhat smaller than the 7th, resembles this latter in general form, but is more feebly armed.

The three anterior *abdominal appendages* are large and powerful, and their paddles are armed with compound, plumose hairs, like those of the posterior thoracic appendages, in place of the usual simple cirrhi. The fourth is large and smooth with its rami unequal, the inner being somewhat the smaller. The fifth resembles the fourth, but is considerably smaller. The sixth is the largest of all, and, like the anterior appendages, is armed with long plumose compound hairs. Its protopodite, though short, is very stout, and its large rami are nearly equal, the outer only slightly exceeding the inner in length. The *telson* is squamiform and completely double.

In the female there is a large egg-pouch, which appears to be supplemented by the long fringe of feathery hairs from the posterior thoracic appendages, for in several cases I noticed very advanced ova entangled.

A series of transverse sections shewed the stomach to be very simple and scarcely at all armed. It was also evident that the diet of the animal consists mainly of minute marine algæ and diatoms. The peculiar fin-like form assumed by the sixth abdominal appendage no doubt subserves the almost purely surface existence which the creature appears to lead.

9. *ÆDICERUS PULICIFORMIS*, n. sp., Pl. VII, Figs. 5 & 6, ♀.

Although not in all points agreeing with the definition of *Ædicerus* as restricted in Spence Bate's Catalogue, the present species corresponds sufficiently well to the genus as extended by Kossmann (*Zool. Reis.* ii, p. 130, 1880), who combines under *Oedicerus* the genera *Kroyera*, *Monoculodes*, and *Westwoodilla*, as well as Dana's original *Ædicerus*.

Our species resembles most nearly *Æ. æquimanus*, Kossmann, from the Red Sea (*loc. cit.*). From this, however, it differs in the proportions of the body, the thorax in Kossmann's species being relatively much larger, exceeding considerably in length the first three segments of the abdomen, while the reverse is the case in the species to be presently described.

Female specimen, carrying ova, dredged in Megna shoals, 5 fathoms. Length, about 2 mm. Colour, dirty white.

*Head* quadrate produced into a somewhat acute rostrum, which is fringed below with fine hairs; excluding the rostrum, it is as long as the first three thoracic segments. *Eyes* placed laterally, very small, so that they might well be overlooked.

*Thorax* small, forming less than a third of entire body length, the segments of about uniform depth, but increasing regularly in length from before backwards. Coxal plates small, of almost uniform depth.

*Abdomen* large; the first three segments alone considerably exceeding the thorax in length; fourth segment narrowed in front so as to move freely beneath the much excavated posterior part of the third; fifth and sixth segments very small. *Telson* squamiform, entire.

*All the appendages* are remarkable for their extreme hirsuteness, their distal parts especially being so thickly clothed with long fine hairs that their outline is very difficult to trace.

*Antennules* short, equalling the first five thoracic segments in length; the peduncle forms rather more than a third of their entire length.

*Antennæ* long, peduncle consisting of three short basal, and two longer distal, joints; flagellum slender, multiarticulate, not very hirsute; the entire organ nearly as long as the thorax and abdomen together.

*Maxillipedes* large and pediform. The second of the *thoracic appendages*, as long as the thorax, slender, weakly subchelate, the palm



being ill-developed and the dactylopodite smooth and unarmed. The carpopodite, however, is prolonged into a styliform process opposable to the propodite. Third thoracic appendage closely resembles the second, but has the propodite rather shorter and broader. In both these appendages the inferior border of the propodite is armed with a number of peculiar uncinata hairs. The fourth, fifth, sixth, and seventh thoracic appendages are about the same length as the gnathopoda, the fifth and sixth being slightly the longer, the seventh shorter than the rest, all closely resemble each other and are so thickly covered with hairs that their dactylopodites can only with difficulty be made out among the dense brush springing from the end of the propodite. The eighth differs much from all the preceding thoracic appendages, being very nearly as long as the entire body of the animal. Its three proximal joints are stout and armed with short, sharp spines, while the remaining articulations are filiform and clothed with long thin hairs.

The first three *abdominal appendages* are of the usual type, but are very large, the protopodites being exceptionally long and the rami broad and well armed. The last three pairs are all biramous and styliform.

#### ELSIA, gen. nov.

For the following species I can find no genus into which it will at all well fit. The family *Platyscelidæ*, to which it undoubtedly belongs, has been divided by Professor Claus (Arb. Zool. Inst. Wien. 2, 1879) into two groups, into the second of which—characterized by the body being more or less compressed and extended, by the abdomen being long and not easily flexible on to the ventral aspect of the thorax, and by long and narrow coxal plates,—our species falls without any difficulty. Claus divides this group into three subfamilies, the *Pronoidæ*, *Lycæidæ*, and *Oxycephalidæ*. Of these three, the second corresponds best to the present species, and is thus characterized by Claus, “Body generally shaped as in *Hyperia*: abdomen can be half flexed on thorax: coxal plates of 6 and 7 thoracic appendages triangular; 8th thoracic appendage feeble. In the female the body is more compressed than in the male and the hinder antennæ usually aborted.” Claus enumerates the following genera as belonging to this subfamily, *Thamyris*, *Lycæa*, *Simorhynchus*, *Pseudolycæa*, *Paralycæa*, and *Lycæopsis*. The present species corresponds to none of these, although it approaches most nearly to *Pseudolycæa*. From this, however, it differs in the following points.

- a. The parts near the mouth are *not* “produced into a sort of snout.”
- β. Eyes large, but do not cover the whole extent of head.
- γ. Gnathopoda *not* simple and claw-shaped, but complexly subchelate.

These differences are so considerable that I feel constrained to propose for it a new genus, characterized as below.

*Antennules* short, hidden by the cephalon. *Antennæ* obsolete (in the female). Second and third *thoracic appendages* small, subequal, subchelate, the palm of their forceps formed by the prolonged posterior inferior angle of the carpopodite; sixth and seventh pairs larger than the rest: hindermost pair very small, the basopodite alone well developed, while the distal joints are very small and ill-defined. Fourth and fifth *segments of pleon* fused together.

10. ELSIA INDICA, n. sp., Pl. VI., Figs. 2—4, ♀.

A single specimen (female) was taken in the surface net in Bombay Harbour.

Total length about 4 mm.

*Colour* deep sepia-brown throughout, without spots or blotches.

*Head* ovate, prolonged in front into a sort of proboscis, the lower surface of which is hollowed out; at the back of its lateral faces are the large compound eyes.

*Thorax* much compressed forming nearly half of the entire body length. Coxal plates not markedly differing in depth, the fourth and fifth being somewhat the deepest, while those in front of and behind these gradually diminish. The last three segments are subequal and larger than the rest, the first especially being very narrow.

*Abdomen* broader and less compressed than the thorax and as long as the last four segments of the latter. The first three segments subequal and larger than any of those preceding them. The fourth and fifth blended together, not half as long as the third, and the sixth very small.

The *antennules* are very short, consisting of a peduncle formed of three short, but stout, joints and a rudimentary flagellum consisting of two pieces, of which the first is tumid and pear-shaped, and the second slender and digitiform. The last joint of the peduncle and the first flagellar articulation are furnished with a few short soft hairs.

*Antennæ* obsolete.

The *gnathites* generally, including the maxillipedes, appear small and ill-developed.

The second and third *thoracic appendages* are small and subequal, the hinder being but a trifle the larger, neither approaching the head in length. They closely resemble each other, having a complex unarmed subchela formed by the prolongation of the antero-inferior angle of the carpopodite opposed to the somewhat dilated propodite, and the dactylopodite being small and claw-shaped. The fourth and fifth pair are

subequal, simple, and slender, and as long as the first five thoracic segments; the posterior border of their propodites are weakly denticulated. The sixth and seventh pair closely resemble each other, but the sixth is somewhat the larger, being as long as the entire abdomen. Their basipodites are short and broad and the anterior border of their propodites is markedly denticulated. The eighth is much smaller, and more than half its length is formed by the broad and fairly stout basipodite, the remaining articulations being very small and scarcely definable from each other. In all the thoracic appendages the dactylopodite is extremely minute. Simple *branchial sacs* are attached to the 5th, 6th, and 7th thoracic appendages.

The first three *abdominal appendages* are stout, their protopodites being especially long, while their rami are short and but ill-provided with marginal hairs. The last three pairs are stout with styliiform rami; all three reach to an equal length beyond the posterior extremity of the abdomen.

#### 11. CAPRELLA MADRASANA, n. sp., Pl. XII, Figs. 1 & 2, ♂ ♀.

Three specimens of this form, two males and one female, were taken in the drift net lowered nearly to the bottom in 6—9 fathoms off the "Seven Pagodas" Madras, and afterwards in a similar depth in Palk's Straits.

The animal (with the exception of the eye, which is of a deep purple tint) is of a dirty white colour throughout, and is very small, the males measuring only 3 and the females only 4 mm. in length; and in general outline resembles *C. linearis*, although its nearest ally is probably *C. geometrica*. The body is quite smooth without tubercles or spines, the *head* is rounded and unprovided with any rostrum, and presents a somewhat pear-shaped outline when viewed laterally, being deeper than long.

The first segments of the *thorax* are very long and slender in both sexes, the first being as long as the head and united to it by a visible, but apparently immovable, suture. The second is as long as the head and the first segment together, and the third, fourth, and fifth progressively longer, the last forming  $\frac{2}{3}$ ths of the entire length of the animal. The sixth segment is nearly as long as the second, and the seventh very short.

The rudimentary *abdomen* is represented only by two or three very indistinct rings, and no rudiments of its appendages can be made out with the exception of a short projection armed with a small articulus (or hair?) from the penultimate ringlet.

The *antennule* is more than  $\frac{1}{3}$ rd as long as the body, reaching back as far as the origin of the first pair of branchial sacs. Rather more than half its length is formed by the three-jointed peduncle, whose middle articulus is much the longest, the third joint being very short. It is nearly naked, being armed only with a very few fine, short hairs. The flagellum consists of five joints, of which the first is much the longest, exceeding a good deal, in this respect, the last joint of the peduncle; each joint is armed with a small hair on its distal extremity above, and with a pair of soft flattened hairs below, the first articulus having two additional pairs of such hairs at equal distances along its lower border indicating probably that the flagellum grows from its base by the intercalation of additional articuli, as my second male specimen has this joint longer than in that figured presenting an additional pair of hairs, the last being opposite a very indistinct line of division.

The *antenna* is somewhat shorter than the antennule, being but  $\frac{2}{7}$ ths the total length of the creature; the peduncle is five-jointed, the first two joints being stout, but very short, while the third is but little longer and as slender as the last two articuli, which are very long and subequal and together make up  $\frac{2}{3}$ rds of the entire length of the organ. The flagellum consists of two stout articuli, and, like the peduncle, is armed, more especially along its inferior border, with strong simple hairs.

The *gnathites* appear to be of normal form, the mandibles being provided with a large palp, and the maxillipeds, small, but of pediform outline and clawed.

The second *thoracic appendage* is small and takes its origin from the anterior border of the segment, close to the maxillipeds. It is only as long as the third thoracic segment and is but feebly subchelate, the propodite being but little dilated. It has, however, some amount of grasping power, as the posterior border of the propodite is armed with a ridge divided into peculiar square-topped teeth, and the dactylopodite is provided with a number of stout tubercular spines. The third thoracic appendage is the longest and largest of the appendages, and, though no true palm is developed, is more strongly subchelate than its predecessor; the propodite being much dilated and armed with a peculiar downwardly directed tooth about its middle, and further provided, at the proximal end of the same margin, beyond the reach of the opposition of the dactylopodite, with a strong tubercle armed with a stout spine exactly like those on the propodites of the posterior thoracic appendages by which the animal fixes itself. The third and fourth thoracic segments have no appendages except a pair of simple laminar gill-sacs. The sixth pair of appendages is very weak, but little

longer than the segment from which it springs, and quite of the usual ambulatory type. The seventh and eighth pairs are large and powerful and are used by the animal to anchor itself to any suitable object; they resemble each other closely in general form, but the eighth is much the larger, the seventh being only as long as the 1st and 3rd thoracic segments, while the eighth is as long as the 2nd, 3rd, and 4th thoracic segments together. Each has the basipodite rather stout and the meropodite and carpopodite of very moderate size, the main part of the length of these appendages being formed by the propodite and dactylopodite, which are of great size and strength; the dactylopodite being stout and falciform, and the propodite being provided at its proximal extremity with a tubercle and spine like that already described as similarly situated on the 3rd thoracic appendage. By means of the grasp obtained between this and the point of the dactylopodite, the animal is able to attach itself to such comparatively smooth surfaces as the interior of a leaden ring which formed the walls of the cell in which it was confined.

The female differs from the male in the following points:—

1st. She is larger and proportionately stouter.

2nd. She is provided with an egg-pouch attached to the 3rd and 4th thoracic segments. This is large and deep; the laminae of the 3rd segment being directed downwards and backwards, and their posterior border overlapped by those springing from the 4th segment. During life these laminae are kept in constant motion so as to produce a continuous current of water round the contained ova.

3rd. No trace of the abdomen or its appendages can be made out.

Observing the living animal, I was much struck with the activity of its circulation, which is much more active than in any other amphipod that has come under my notice, the lymph current flowing as rapidly as in the highest crabs.

## 12. *CAPRELLA PALKII*, n. sp., Pl. XII, Fig. 3.

This species closely resembles the preceding, so much so that, a single immature female only having been obtained, I am in some doubt as to whether or not it is a distinct species or merely a stage of *C. madrasana*. On the whole, however, I am inclined to think that it is specifically distinct.

The specimen was dredged in 7 fathoms in the mouth of Palk's Straits, and was clinging to some Sargassum weed. The differences between the two species are as follows:—

1st. The 1st thoracic segment is proportionally shorter.

2nd. The 3rd and 4th thoracic segments are each armed with two

stout, forwardly directed, dorsal spines, one situated about the middle of the segment, and the other at its hinder edge.

3rd. There is more difference between the antennæ, the superior pair being proportionally larger.

4th. The 2nd thoracic appendage has its propodite better developed.

5th. The 3rd thoracic appendage is somewhat smaller.

#### EXPLANATION OF THE PLATES.

##### PLATE VI.

Fig. 1. *Anonyx amaurus*,  $\times 12$ . The dotted line beneath the body shows the outline of the brood-pouch. The coxal plates are represented as semitransparent, in order to shew the form of the parts beneath; they are in point of fact, however, quite opaque. Fig. 2. *Elsia indica*,  $\text{♀}$ ,  $\times 24$ . Fig. 3. Antennule,  $\times 100$ . Fig. 4. One of the gnathopods,  $\times 100$ .

##### PLATE VII.

Fig. 1. *Microdeutopus megnæ*,  $\text{♂}$ ,  $\times 11$ . Fig. 2. Gnathopoda of female,  $\times 11$ . Fig. 3. Mandible and its appendage,  $\times 40$ . Fig. 4. Pediform ramus of the maxilliped, to shew its relative proportions to the mandibular palp,  $\times 40$ . Fig. 5. *Edicerus pulcificiformis*,  $\times 19$ . Fig. 6. Terminal joints of gnathopoda,  $\times 50$ . Fig. 7. *Concholestes dentatii*,  $\times 10$ . Fig. 8. Head, seen from above,  $\times 10$ . Fig. 9. Subchela of 2nd gnathopod,  $\times 50$ . Fig. 10. Distal joints of 6th thoracic appendage,  $\times 50$ . Fig. 11. Last three abdominal segments,  $\times 40$ . Fig. 12. *Monoculodes megapleon*,  $\times 12$ .

##### PLATE VIII.

Fig. 1. *Ampelisca leptæ*,  $\times 20$ . Fig. 2. Last three abdominal segments and appendages,  $\times 40$ . Fig. 3. The mandible and its appendages,  $\times 40$ . Fig. 4. Sifting plate of mandible,  $\times 200$ . Fig. 5. Cutting plate of mandible,  $\times 200$ . Fig. 6. 1st maxilla,  $\times 40$ . Fig. 7. 2nd maxilla and maxilliped,  $\times 40$ . Fig. 8. One of the rami of 2nd maxilla,  $\times 100$ . Fig. 9. Imperfect subchela of 2nd thoracic appendage,  $\times 100$ . Fig. 10. Ramus of one of posterior abdominal appendages,  $\times 100$ .

##### PLATE IX.

Fig. 1. Transverse section of head ( $\times 100$ ) of *A. leptæ* at the level of the upper pair of eyes; (a) chitinous coat of animal, (b) lens, (c) lens of the other side dislocated and shrunken with contained fluid oozing out, (d) epithelial layer of dermis deeply pigmented to form a sort of iris, (e) retina. Fig. 2. A portion of retina of preceding,  $\times 600$ ; (a) deepest layer of spindle-shaped bodies, (b) middle layer of nucleated rods divided below into fibres inosculating with ends of the preceding layer, (c) deeply pigmented rods external to middle layer, (d) epithelial layer of dermis. Fig. 3. Vertical longitudinal section of head of *A. leptæ*  $\times 100$ , cut a little to one side of the middle line in the plane of the inner pair of eyes; (a) inner eye, (b) cerebral nervous mass (the upper

of the two dotted lines from (b) points to the centre of the inner eye, the lower to that of the inferior antenna; between them is seen a smaller projection, that of the external eye), (c) anterior portion of œsophageal nervous collar, (d) the green-gland, (e) the cavity of the mouth, (f) cavity of the gizzard, (g) sifting stomach, (h) the liver, (k) anterior part of dorsal vessel, (m. m.) masses of plasmic cells surrounding the nervous centres, (z. z.) muscles of the gizzard. Fig. 4. Diagrammatic median section of *A. lepta* to shew arrangement of the parts of the intestinal canal. The thick line shews the external integument, the thin, the fore-gut, the dotted line the mid-gut. Fig. 5. Transverse section head of *A. lepta*, at the level of the passage between the gizzard and the "sifting stomach;" (f) gizzard, (g) sifting stomach,  $\times 180$ . Fig. 6. Semi-diagrammatic transverse section of the basal portions of a thoracic appendage,  $\times 60$ ; (a) pleuron of segment, (b) coxa, (c) basipodite, (d) gill-plate.

Plate X.

Fig. 1. *Amphithoë indica*, M.-Edw.,  $\times 20$ . Fig. 2. Mandible,  $\times 70$ . Fig. 3. Maxilliped,  $\times 70$ . Fig. 4. 1st Gnathopod  $\times 70$ . Fig. 5. 2nd ditto,  $\times 70$ . Fig. 6. Distal joints, 5th and 6th thoracic appendages,  $\times 70$ . Fig. 7. Last three abdominal segments and appendages,  $\times 70$ . Fig. 8. *Atylus comes*,  $\times 20$ . The specimen figured was somewhat smaller than that of *Amphithoë indica*, but the difference is an individual not a specific character. Fig. 9. Last three abdominal appendages,  $\times 60$ . Fig. 10. One of the compound branchial plates,  $\times 60$ .

PLATE XI.

Fig. 1. *Urothoë rubra*,  $\times 30$ . Fig. 2. Flagellum and appendages of antennule,  $\times 200$ . Fig. 3. Mandible,  $\times 100$ . Fig. 4. 6th thoracic appendage,  $\times 100$ . Fig. 5. Last three abdominal segments,  $\times 100$ . Fig. 6. Transverse section through animal in hinder thoracic region; (a) coxa, (b) gill-laminæ, (c) nerve-ganglion, (dd) ovarian tubes, (e) intestine, (f) heart, (g) digestive glands - "liver."

PLATE XII.

Fig. 1. *Caprella madrasana*, ♂,  $\times 36$ . Fig. 2. *Caprella madrasana*, ♀,  $\times 36$ . Fig. 3. *Caprella palkvi*,  $\times 36$ .



## VII.—On Eupetaurus, a new form of Flying Squirrel from Kashmir.

By OLDFIELD THOMAS, British Museum (Natural History).

[Received August 8th ;—Read Sept. 5th, 1888.]

(With Plates XXII and XXIII.)

As long ago as 1877, Mr. W. T. Blanford received, among a set of mammals obtained by Mr. L. Mandelli, the skin of a large flying squirrel belonging evidently to a new form, but in such a bad condition that no scientific description of it could be given, and the skin has therefore remained unnamed until the present time. Precisely the same thing has happened in the case of a skin obviously of the same animal purchased by Mr. R. Lydekker about 1879 from some skin-dealers in Srinagar, Kashmir, and said to be from the Astor district. Both these specimens have now been presented by their respective owners to the national collection. Mr. Lydekker's specimen is a most magnificent example, so far as its size and the character of its fur are concerned, but again, being without a skull, and showing a certain superficial resemblance to what the common Indian Flying squirrel, *Pteromys oral*, Tickell, might be if occurring in a cold climate, no zoologist has dared to describe it.

Finally, before speaking of the specimen that has settled what this fine squirrel really is, a reference may be made to two flying squirrels in the Leyden Museum described by Dr. Anderson\*, one said to be from Kashmir and the other probably from Thibet, which, judging only from his descriptions, may be not improbably a melanoid and a normal, but imperfect, example respectively of this most interesting addition to the known fauna of India.

At last in 1887, Mr. G. M. Giles, of the Indian Marine Survey, when on the Kafristán-Chitral Mission under Colonel Lockhart, C. B., had brought to him at Gilgit a living example of the present form, which had been taken at an altitude of about 6000 feet. This specimen on its death was skinned, and, fortunately, its skull brought home for comparison, and by the kindness of Prof. Wood-Mason and Mr. Giles I have been entrusted with it for description.

It is by the skull alone, first brought home by Mr. Giles, that we are enabled to make out its true position, as no one, from an inspection of the skin, would have suspected that the animal was anything but a fine and very long-furred species of *Pteromys*. The skull, however, shows that this is not the case, and that the species must be relegated to a new genus, representing a highly specialized hypsodont form quite unapproached, so far as its dental characters are concerned, by any member of the family *Sciuridæ*.

\* Zool. Yunn. Exp. Mamm. pp. 284 and 286, 1878.



Of the three specimens before me I propose to call the two received from Mr. Lydekker and Mr. Giles together the co-types, the description of the external characters and the coloured plate being founded on the former, as the largest and finest specimen of all, while the latter has furnished the particulars for the description and figures of the skull and teeth.

EUPETAURUS, gen. nov.

Externally as in *Pteromys*, except that the claws do not possess the exceeding sharpness characteristic of all previously known floating mammals.\*

Skull distinguished from that of *Pteromys* by its longer, trumpet-shaped muzzle, more marked supraorbital notches, longer anterior palatine foramina, and shorter bony palate.

Teeth strikingly contrasted with those of any of the other *Sciuridæ* by being hypsodont instead of brachyodont, while their essential pattern remains unchanged. Thus, while the crown of each tooth is enormously lengthened vertically, the grooves ordinarily present on the grinding surface of the molars of *Pteromys* are reproduced as deep vertical infoldings of the enamel, which, when seen in the natural section produced by wear, give the teeth very much the general appearance of those of many of the *Hystricomorpha*. Owing to the worn state of the teeth in the single skull available, it is impossible to say how many extra superficial grooves there may have been, but of the deeper notches there are two on the outer and one on the inner side of each cheek-tooth† above, and two on each side of each tooth below, the anterior internal notch, however, in the posterior teeth almost worn out of sight. The teeth also, apart from their hypsodont structure, are distinguishable by their very large proportional size, by being set more obliquely than is the case in other squirrels, and by presenting, in cross-section, a sharp postero-internal angle, markedly different from the evenly convex internal border of the teeth of *Pteromys*. The implantation of the large upper premolar is also peculiar, in that of the three distinct roots it has in the allied forms the antero-external and the internal have coalesced into a single broad flat root running along the whole of the long antero-internal border of the tooth.

\* Whether Flying Phalangers, Flying Squirrels, or Galeopithecii, this sharpness of the claws is obviously an adaptive character of the highest utility to an animal in the habit of taking long flying leaps from tree to tree and yet without the Bat's or Bird's power of saving itself from a more or less serious fall in case it fails to secure its hold on the tree towards which it is leaping.

† Excepting of course the small cylindrical penultimate premolar.

## EUPETAURUS CINEREUS,\* n. sp. (Plate XXII).

Size equalling or exceeding that of the largest species of *Pteromys*. Fur extremely long, soft, and silky. General colour uniform grizzled greyish brown, the hairs of the back slaty grey for about an inch or an inch and a half, then the tips of the shorter woolly hairs are a dull pale grey, while those of the longer straighter hairs are ornamented with a white subterminal, and a black terminal band. Ears pointed, hairy, their backs black or brown, their internal surfaces grey. Upper surface of parachute darker brown. Hands and feet brown or black; palms and soles thickly hairy, except on the surface of the pads; the former with three distal pads at the bases of the fingers and two large proximal pads, the latter with four distal pads, and a single internal, proximal pad. Whole of under surface pale brownish grey, the hairs slate-coloured basally and dirty white terminally. Tail long, cylindrical, exceedingly bushy, more like that of a fox than that of a squirrel, the hairs averaging nearly 3 inches in length; its colour similar to that of the body, but rather darker terminally. In Mr. Lydekker's specimen there is a small tuft of white hairs at the extreme tip.

Skull as described above, and as shown in detail in the figures (Pl. XXIII). Special attention may, however, be drawn to its comparatively light and slender build, to the long muzzle, the slender frontal processes of the premaxillæ, the deeply concave forehead, long palatine foramina, large expanded bullæ, and to the very peculiar shape of the lower jaw, in which the coronoid process does not rise so high as the condyle, while the latter is bent up away from the angle to an unusually great extent. The incisors are yellow in front, but little darker above than below.

## Dimensions:—

|                   | Mr. Lydekker's specimen. | Mr. Giles's specimen. |
|-------------------|--------------------------|-----------------------|
| Head and body ... | 610 mm. (= 24 in.)       | 515 mm.               |
| Tail ...          | 380 "                    | 480 "                 |
| Hind-foot ...     | (c.) 87 "                | 85 "                  |
| Ear ...           | 28 "                     | 29 "                  |

Skull. Basal length, (c) 68 millim.; greatest breadth, 46; nasals, length, 28; greatest breadth 14.5, least breadth 6.5; interorbital breadth 20; intertemporal breadth 15.5; post-orbital processes, tip to tip, 34;

\* I had originally wished to connect with this animal the name of Mr. Giles, to whose care in bringing a skull as well as a skin we owe the possibility of appreciating its natural position, and to whom therefore mammalogists have every reason to be grateful. Since, however, further investigations have shewn that he was not the original discoverer of the species, an honour that Mr. Mandelli or Mr. Lydekker might equally claim, I consider it better to give it a name altogether impersonal in its nature.

palate, length 41, breadth including posterior premolars 20·8, least breadth inside the same teeth 6·7; diastema, length, 16·8; anterior palatine foramen (c) 8·5; length of molar series, from front of last premolar to back of last molar, 19·3. Lower jaw, length (bone only) 54·5, (to incisor tip) 59, height, from condyle to below angle, 34·6.

The discovery of such a fine new mammal as the present in so comparatively well-known a region as Kashmir, is very remarkable, and especially as *Eupetaurus* is found in Gilgit, a place whose fauna Dr. John Scully, both as collector and describer,\* has so thoroughly and ably investigated.

It was under the skilled supervision of Prof. Wood-Mason that Behari Lal Das executed the beautiful drawing of its skull now reproduced to form Plate XXIII.

A further interest, however, attaches to *Eupetaurus* from its being the only member of the *Sciuridæ* in which the character of hypsodontism† has been developed, although, among the whole group of *Sciuro-morpha*, *Castor* and *Anomalurus* have hypsodont teeth, while *Haplodon* has the still further advance of possessing permanently rootless molars. Throughout mammals hypsodontism has been developed independently over and over again, as for example in *Elephas* as compared to the brachyodont *Mastodon*; in *Equus* as compared to *Anchitherium*, in *Neotoma* as compared to *Cricetus*, and, best known of all, in the *Bovidæ* as compared to the *Cervidæ*.

The superiority of high-crowned over low-crowned teeth is obvious, especially to animals living on food that has a strong grinding action on the teeth due either to natural silex contained in it, or to sand and dirt mixed with it. In all cases it is probable that the jaws have a more or less horizontal chewing action in hypsodont, as compared to a vertical "chumping" action in brachyodont animals.

Finally it should be noticed that hypsodontism represents of course only the first step towards the development of entirely rootless teeth, a development that has again often independently taken place, but which must in every case have been by way of hypsodontism, the complete series of steps being evidently as follows. First and least specialized then is the short-crowned long-rooted tooth (as in ordinary brachyodont animals); secondly, the high-crowned short-rooted tooth (as in the hypso-

\* Cf. "On the Mammals of Gilgit, p. 35, 1881, p. 197, and "On some Mammals from the North-West frontier of Kashmir," Ann. Mag. N. H. (5) VIII, p. 95, 1881. I understand that Dr. Scully himself recognised Mr. Giles's Flying Squirrel as new.

† A concise description of hypsodontism has been given by Flower, Encycl. Brit. (9) Art. *Mammalia*, XV, p. 471, 1883.

dont forms) ; thirdly, the tooth so high-crowned that its roots are only formed at a late period of life as in *Evotomys* and others ; and finally the highly specialized growing tooth that never develops roots at all.

In connection with the dental evolution of this interesting animal, it would be advisable for naturalists and sportsmen in Kashmir to notice what its food is, as compared with that of the other squirrels. Judged from its blunt claws, it probably frequents rocks and precipices rather than trees, and it is therefore possible that its ordinary food may consist of lichens, mosses, and other rock-loving plants, which, by being mixed with sand and particles of rock, would necessitate the development of such long lasting molars as it is remarkable for possessing.

Additional specimens of *Eupetaurus* would be most valuable for scientific examination, especially if of different ages, and I may be permitted to express the hope that some of the many British sportsmen who annually visit Kashmir will help to enrich either the Indian Museum in Calcutta or the National Museum at home with examples of this, the latest addition to the Mammal-fauna of our Indian Empire.

---

IX.—*Notes on Indian Chiroptera.*—By W. T. BLANFORD, F. R. S.

[Received April 25th ;—Read June 6th, 1888.]

In the course of last year, whilst preparing an account of the bats of India and its dependencies for a general work on Indian Mammalia, I found that, in a few instances, scraps of information are now available, in addition to the mass of facts brought together by my friend Mr. G. E. Dobson in his standard works on the order Chiroptera. In a very few cases I am obliged to differ from his nomenclature, the most important of these being the use of the generic term *Hipposiderus* instead of *Phylorhina*, and of *Xantharpyia* instead of *Cynonycteris*. The reasons for these changes I have explained at length in a paper published in the Proceedings of the Zoological Society for 1887, pp. 636, 637. Some points that I had noted have, I find, been already fully investigated by my friend Mr. J. Scully in his paper on the Chiroptera of Nepal, published in the Society's Journal for last year (Pt. II, p. 233). As some time may still elapse before my work on Mammals will be published, a short note may be useful. I have endeavoured to identify all the species noticed by Hodgson, Blyth, Kelaart, and Jerdon, a few of which, owing doubtless to the difficulty and occasionally impossibility of determining them satisfactorily, have been left unnoticed by Dobson, and,

although I have not always been successful, I do not think there are now many forms left unnoticed.

#### RHINOLOPHUS AFFINIS.

Besides the synonyms quoted by Dobson, the *R. rouxi* of Jerdon\* and, in part, of Blyth must be referred to this species. The latter indeed was practically identified in Dobson's Catalogue of specimens in the Indian Museum, printed at the end of his Monograph of Asiatic Chiroptera. But Blyth, in his Catalogue of Mammalia, included his *R. lepidus* under *R. rouxi*, and I believe *R. lepidus* to be *R. minor*, with which it agrees in description and measurements. I shall have some further remarks to make on this when I come to *R. minor*.

Besides the *R. rubidus* and *R. cinerascens* of Kelaart (Prod. Faun. Zeyl. p. 13) referred by Dobson to *R. affinis*, there appears no reason why the *R. rammanika* of Kelaart (ib. p. 14) should not be assigned to the same species. Blyth in his catalogue placed *R. rammanika*, with, however, a mark of doubt, under his *R. rouxi*.

In both the Monograph of Asiatic Chiroptera and the British Museum Catalogue of Chiroptera a *Rhinolophus fulvidus*, Kelaart, is mentioned, and, in the first named work, the measurements of the type are given. I cannot discover any species of this name described by Kelaart, and, from Blyth's mention of *R. fulvidus* in J. A. S. B. XX, p. 182, it is probable that this term was a mistake or MS. name for *R. rubidus*. The new and unnamed species referred to in the next page (183) by Blyth was clearly that subsequently described by Kelaart as *R. rammanika*.

#### RHINOLOPHUS PETERSI.

This horse-shoe bat was originally described by Dobson from a specimen of unknown locality (J. A. S. B. XLI, Pt. II, p. 337). The species was subsequently obtained by Hutton at Masuri (P. Z. S. 1872, p. 700). Recently another specimen has been captured by Mr. Davison at Coonor, Nilgiri Hills, Madras Presidency, and sent to the British Museum, where it was identified by Mr. Thomas.

#### RHINOLOPHUS MINOR.

Mr. Scully, in his excellent account of the Chiroptera of Nepal, has identified *Rhinolophus subbadius* of Hodgson and Blyth with *R. minor*. So far as Blyth is concerned, this is precisely the same conclusion as that to which I had arrived independently, and, as Blyth's description was taken from a supposed typical specimen sent by Hodgson, it would

\* Dobson classed *R. rouxi* of Temminck as a synonym of *R. affinis* and both Blyth and Jerdon took the name from Temminck.

naturally be supposed that there could be no question about the identification of Hodgson's type also. Yet, strange to say, Hodgson's *R. subbadius* belonged, not only to a different species, but to a distinct genus. A comparison of the description and measurements by Hodgson quoted by Blyth together with his own (J. A. S. B. XIII, p. 486) would alone cause suspicion. No true *Rhinolophus* can be said to have the "nasal appendage quadrate," and it would be remarkable if Blyth's measurement of the tail should be only  $\frac{5}{8}$  inch when Hodgson found it to be  $1\frac{1}{4}$  inches. In fact, Hodgson's *R. subbadius* was *Hipposideros bicolor* or perhaps *H. amboinensis*. It was referred to *Hipposiderus* by Hodgson himself in 1847 (J. A. S. B. XVI, p. 896) and by Gray in the 1846 British Museum Catalogue of Hodgson's collections (p. 3), and that this reference is correct is shewn by Hodgson's drawings. Evidently, in this case, Hodgson had one specimen drawn and sent another, which proved to belong to a distinct form, to the Asiatic Society's Museum in Calcutta.

But this is not all that has to be told about *R. minor*. Blyth at the same time that he described *R. subbadius* gave an account of another allied form which he called *R. lepidus*. The principal difference between the two was the form of the posterior nose-leaf, the sides of which were but slightly emarginate towards the tip in *R. subbadius*, but "so considerably emarginated" in *R. lepidus* that the tip appeared "as a narrow terminal prolongation, one-sixteenth of an inch in length."

In one of the brief notes, often full of suggestion, that Blyth was in the habit of attaching to his zoological reports, and which, for want of a complete index, are so often forgotten, both *R. subbadius* and *R. lepidus* were shewn (J. A. S. B. XXI, p. 347) to be varieties of *R. minor*, Horsfield, differing only in colour. Again in the same volume, p. 361, *R. subbadius* was identified with *R. minor*. But before his Catalogue of Mammalia was written, Blyth had either forgotten his previous remarks or changed his opinions, for in that work, whilst *R. lepidus* was assigned to *R. rouxi* (*R. affinis*), *R. subbadius* was left as a distinct species (l. c. pp. 24, 25). Curiously enough, although under *R. rouxi* in that catalogue there is a reference to "*R. minor* (?) apud nos, J. A. S. XXI, 486," the page is incorrect.

In 1872 (J. A. S. B. XLI, Pt. II, p. 337), Dobson described a horse-shoe bat as *R. garioensis*. This species, which was kept distinct in both the Monograph and Catalogue, was shewn in them to differ from *R. minor* only in having the margins of the posterior nose-leaf straight instead of concave, in short it was *R. subbadius* of Blyth with the posterior nose-leaf slightly more triangular. Finally, in 1880 (Report Brit. Assoc. p. 175), Dobson united *R. garioensis* and *R. minor*, thus arriving at the same conclusion as Blyth had reached 28 years before.

## RHINOLOPHUS TRAGATUS.

This Himalayan bat was identified by Dobson (P. A. S. B. 1872, p. 208) with the European *R. ferrum-equinum*, and unquestionably the two are very closely similar. The identification has ever since been generally accepted, and, in Dobson's great works on the Chiroptera, *R. tragatus* is quoted as a synonym of *R. ferrum-equinum*.

There is, however, a distinction not often to be made out in skins, but easy of recognition in examples preserved in spirit, that suffices, I think, to justify the separation of the two forms. In *R. tragatus*, as observed long ago by Blyth (J. A. S. B. XXII, p. 409), the lower lip is traversed by three vertical grooves, as in *R. affinis*, *R. minor*, *R. macrotis*, and many other species, whilst in true *R. ferrum-equinum* there is but a single groove, as in *R. hipposiderus*, *R. pearsoni*, etc. The nose-leaf as a rule in *R. tragatus* is considerably broader than in *R. ferrum-equinum*, but there is some variation.

All the Himalayan specimens that I have been able to examine, including examples from Darjiling, Nepal, and Masuri, have three grooves. The specimens in the British Museum obtained by Mr. Scully in Gilgit agree, however, entirely with the Palæarctic form, *R. ferrum-equinum*, and have but a single mental groove.

## HIPPOSIDERUS DIADEMA.

The locality Odeypore given by Dobson for this bat in the Monograph of Asiatic Chiroptera, p. 200, and repeated in Anderson's Catalogue of Mammalia in the Indian Museum, Calcutta, p. 115, is not Odeypore or Udaipur in Rájputána, but, I believe, a small state lying north-west of Sambalpur. The locality given for my own specimens "Pullundur, Central Provinces" is S. E. of Nágpur and not far from Bhandára. These localities are of some importance, being the only two in the Peninsula of India, so far as I can learn, whence this bat has been recorded, though it was obtained in abundance by Kelaart at Kandy in Ceylon, and has a wide distribution from the Himalayas to Timor and the Philippines.

## HIPPOSIDERUS BICOLOR.

From the remarks made under *Rhinolophus minor*, it is evident that Mr Hodgson must have obtained one of the forms referred to this species in the Nepal Valley, I think from the figure, *H. amboinensis*. I am disposed to agree with Mr. Scully and to class *H. amboinensis* as a distinct species from *H. bicolor* (*H. fulvus*).

## CÆLOPS FRITHI.

This species, originally described by Blyth from a Sundarban

specimen, and subsequently recorded by Dobson from Java and Laos (Siam), has recently been discovered by Col. Kinloch near Darjiling.

#### MEGADERMA SPASMA.

Blyth 36 years ago (J. A. S. B. XXI, p. 346) noticed the occurrence of this bat in Ceylon. In his Catalogue, p. 23, note, he observed that the specimens had disappeared from the Society's Museum. I well remember his lamenting the loss of several bats, the bottles having been stolen for sale and their valuable contents thrown away. The species does not appear to have been again observed east of the Bay of Bengal, and Dobson, very naturally, in his Catalogue of Chiroptera, p. 158, considers the occurrence of this species in Ceylon doubtful.

In some MS. notes which Mr. F. W. Bourdillon kindly placed at my disposal, a bat obtained from a hollow tree, at an elevation of 2700 feet above the sea near Mynall, in Travancore, was described. It was clearly a species of *Megaderma*, and the size (length  $2\frac{3}{4}$  inches, forearm 2) and nose-leaf agreed much better with *M. spasma* than with *M. lyra*. There are some specimens of *M. spasma* in the British Museum labelled as from Ceylon, but their history is unknown. They have the forearm 2.1 to 2.2 inches in length. On the whole, I think it probable that *M. spasma* does inhabit Ceylon and Southern India.

#### NYCTOPHILUS GEOFFROYI.

This bat, which is identified by Dobson with *N. timoriensis* of Geoffroy, is an inhabitant of the Australian region, being found in Australia, Tasmania, and some of the Pacific islands. It is, however, included amongst the mammals of India (p. 48) by Jerdon, who says, "This bat, which has been found in Europe and Australia, was sent from Mussoorie by Hutton." Hutton, however (P. Z. S. 1872, p. 704), denied all knowledge of the species, and Mr. R. A. Sterndale, in his Natural History of the Mammalia of India, although he copies the description quoted by Jerdon, very naively remarks that he can find no trace of the bat in Dobson's Monograph. It is, I think, evident that Jerdon took the name and locality from Blyth's Catalogue, and that in this there has been a mistake in printing. At the end of the text in p. 36 there is printed: "Genus *Nyctophilus*, Leach, Hab. Australia. A. Specimen presented by the Sydney Institution (1845)." On the top of the next page comes:—"116, *N. Geoffroyi*, Leach, Syn. *Barbastellus pacificus*, Gray. Hab. Europe, Himalaya. A. B. Specimens in spirit, Masuri, Capt. H. Hutton (1844)." Now in all other genera in this catalogue, the name of the genus is followed by the name of the species, not by the habitat, and it is, I think, clear that "116. *N. geoffroyi*, Leach, Syn. *Barbastellus pacificus*, Gray." ought to come immediately below "Genus *Nyctophilus*, Leach" and be-



fore "Hab. Australia." This view is confirmed by the fact that a single specimen of *N. geoffroyi*, not two, presented in 1845 by the Sydney Institution, was found by Dobson in the Indian Museum (containing the specimens of which Blyth's Catalogue was a list) and recorded by him in the Catalogue of specimens printed as an Appendix to his Monograph of Asiatic Chiroptera, p. 220. The Hab. Europe, Himalaya, and record of two specimens from Masuri presented by Captain Hutton in 1844 must have referred to some other bats, and, as 116 A. in the same Catalogue of Dobson is identified with *Synotus darjelinensis*, whilst in Anderson's Catalogue 116 A. and B. are both referred to that species, it is, I think, manifest that the reference belongs to the species preceding *Nyctophilus*, namely, to *Barbastellus communis*, with which, until Dobson pointed out the difference, *Synotus darjelinensis* was supposed to be identical.

#### VESPERUGO NASUTUS.

The locality of this bat is given as Shikarpur, Sind. The specimen was obtained, I believe, so far as my memory serves, in the Shikarpur collectorate, not near the town, but across the Indus, a short distance east of Rori.

#### VESPERUGO IMBRICATUS.

There is, in the British Museum, a skin of this species sent by Blyth and labelled Calcutta. The specimen is in all probability Indian.

#### VESPERUGO MORDAX.

Dobson, in his "Report on Accessions to our Knowledge of the Chiroptera during the years 1878—1880," published in the Report of the British Association, 1880, p. 184, shews why the eastern form of *V. maurus* (or rather perhaps *V. savii*) should be distinguished under the name of *V. mordax*, Peters (M B. Akad. Berlin, 1866, p. 402).

In the British Museum collection there is a skin of this species labelled *V. maderaspatanus*, Elliot. This is probably the *Scotophilus maderaspatanus* of Gray's "List of the Specimens of Mammalia in the Collection of the British Museum," 1843, p. 29, a species that, like many others in the same list, has never, to the best of my belief, been described. The name is in all probability wrongly attributed to Elliot.

#### VESPERUGO CEYLONICUS.

Dobson, in his Catalogue, p. 222, describes a species of bat as *V. indicus* from two Mangalore specimens, and records the existence of a third specimen, labelled Madras (but very probably from the Malabar coast), in the British Museum collection. He also calls attention to the fact that *Scotophilus ceylonicus*, Kelaart, "may be identical, as the de-

scription and most of the measurements correspond closely; but the outer upper incisors are described as having two or three cusps, and the length of the tibia is given as 0·7 inch," instead of 0·55. The type too had been lost.

Now in *V. indicus*, as in *V. noctula*, "the outer incisor is hollowed out to receive the extremity of the lower canine when the jaw is closed," so that this incisor may very well be described as having two or three cusps. But Kelaart's expression is more characteristic. He says, "Upper incisors 2 pairs both indistinctly bilobed? or certainly the lateral ones are trifid." Now the inner upper incisor is bifid and in all probability the precise form of the outer upper incisor varies, according as it is worn away by the point of the lower canine. Certainly, in some skulls of *V. noctula*, 'trifid' would correctly express the form of the tooth. I think, therefore, that there should be no hesitation in recognizing Kelaart's name for the species.

#### VESPERUGO ABRAMUS.

Blyth in 1852 (J. A. S. B. XXI, p. 360) received several bats from Masuri, sent by Captain T. Hutton. Amongst the species supposed to be identified was the pipistrelle, which Blyth, then and subsequently, called *Myotis pipistrellus* (though the genus *Myotis* of Gray, I believe, was confined to species of *Vespertilio*\*). In 1853 (J. A. S. B. XXII, p. 581), Blyth pointed out that the supposed pipistrelle from Masuri differed from the true pipistrelle of Europe in colour and in the small size of the foot, which, with its claws, scarcely exceeded  $\frac{3}{16}$  in.; and he proposed for this form the name *M. parvipes*, a name that is retained by Jerdon in his work on the Mammals of India, p. 43, but which is not, so far as I am aware, mentioned by Dobson. The type was lost.

Years afterwards Captain Hutton, in his paper on Himalayan bats, described a *Vesperugo micropus* (P. Z. S. 1872, p. 708). This was subsequently identified by Dobson, I believe from examination of the type, with *V. abramus*. I cannot but suspect that Blyth's *Myotis parvipes* was the same.

At the same time, the dimensions of the foot, as given by Blyth, agree more nearly with those of the true pipistrelle, and the only reason for not identifying *M. parvipes* with *V. pipistrellus* is that this species has not been recognized amongst Hutton's collections, nor is it known to occur in the Himalayas east of Kashmir, where it was obtained by Stoliczka (Yarkand Mission Mamm. p. 11). It is also possible that

\* The genus was proposed in 1842 (A. M. N. H. X, p. 258). The examples quoted were *V. murinus*, *V. bechsteini*, and *V. nattereri*, all belonging to the second section of the genus in Dobson's Catalogue.

*Myotis parvipes* may have been a true *Vespertilio*. It is to be regretted that so imperfect a description was given.

I had expected to be obliged to restore the name of *coromandelicus* by which this bat was so long and so widely known in India, but, so far as I can ascertain, no Latin name was given by F. Cuvier, who merely called a small bat, but doubtless this species, *Vespertilion de Coromandel*. (Nouv. Ann. du Muséum d' Histoire Naturelle I, p. 21).

#### VESPERUGO PIPISTRELLUS.

In the Society's Journal for 1857 (Vol. XX, p. 159, note), Mr. Blyth identified a spirit-specimen sent by Mr. Hodgson of *Vespertilio pallidiventris* with the pipistrelle, after comparing the former with British specimens of the latter. In Blyth's Catalogue, however, although the locality "Himalaya?" is assigned to the pipistrelle, there is no mention of *Vespertilio pallidiventris*, and the figure of the latter in Hodgson's MS. drawings is very unlike the pipistrelle. Scully is doubtless right in his identification of *V. pallidiventris* with *V. nepalensis*. I have examined Hodgson's drawings, and the only reason for doubt in the shortness of the tragus in the figure.

#### VESPERUGO KUHLI.

I think *Pipistrellus lepidus*, Blyth (J. A. S. B. XIV, p. 340), from Kandahar, must be identical with *Vesperugo leucotis*, Dobson, now considered by the last named writer a variety of *V. kuhli*. The description agrees, and the species is common in Sind, Baluchistan, and Southern Persia, consequently it is very likely to be the common small bat of Kandahar.

#### SCOTOPHILUS KUHLI.

I think it is a matter for serious regret that the late Dr. Peters, when he had ascertained, by an examination of Leach's type of *Scotophilus*, what the genus really was, did not at once propose a new generic term. Leach in 1822 (Trans. Linn. Soc. XIII, p. 71) described a new genus and species of bat under the name of *Scotophilus kuhli*. The name *Scotophilus* was apparently left in oblivion until Dr. Gray in 1838 (Mag. Zool. Bot. II, p. 497) applied it to a very miscellaneous assemblage of bats, comprising the *Vespertilio temmincki* of Horsfield and the *Scotophilus kuhli* of Leach (re-named *S. leachi*) together with a large number of species of *Vesperugo*. It is only fair to say that Leach's account of the dentition in the young *Scotophilus* agreed in some respects with that of *Vesperugo*, but not with that of the type represented by *Vespertilio temmincki* of Horsfield.

However Gray's paper led to a wide use of the term in an erroneous sense, and, when, therefore, Peters, in 1866, examined Leach's original type and found it to be an immature example of the form then generally known as *Nycticejus temmincki*, with milk teeth, it is unfortunate that the name *Scotophilus* was not abandoned, as it might well have been, for Leach's description was erroneous and misleading.

Dobson has recapitulated the facts above mentioned (P. Z. S. 1875, p. 368), and I believe he was precisely of the same opinion as myself, but rather than propose a new name he accepted *Scotophilus*. But this has led to another difficulty. The specific name *temmincki*, applied by Horsfield to one of the commonest, most widely spread, and best known of oriental bats, could scarcely be dropped without inconvenience, so the common yellow bat stands in Dobson's works as *Scotophilus temminckii*. If, however, the examination of the type is sufficient for the identification of the genus, the species may be determined in the same manner. This Dobson acknowledges, but gets over the difficulty by leaving the question of the adult form to which the young type belongs open.

Now it is true that in many genera of bats it would be very difficult, perhaps impossible, to identify the young, but the present is not one of those instances. There are but two other species that have the same peculiar and unmistakable tragus as *S. temminckii*, viz., *S. borbonicus* and *S. gigas* both African. In both of these the upper incisors have a very differently formed cingulum. By cutting down slightly on the gum the permanent incisors have been examined in Leach's type by Mr. Oldfield Thomas, and shewn, as was anticipated, to be those of *S. temmincki*. It was of course much more probable that Leach's specimen should belong to this very common Indian and Malay form than to a comparatively rare African species. If, therefore, we are guided by type specimens, the specific name *kuhli* has priority over *temmincki*, and we must abandon a well known specific name for an unknown one. The only alternative is to discard the genus *Scotophilus*, and this is now scarcely practicable. The species must therefore stand in future as *Scotophilus kuhli*.

#### SCOTOPHILUS ORNATUS.

*Nycticejus nivicolus*, Hodgson (A. M. N. H. 1855, XVI, p. 44), proves by a comparison of his MS. drawings with specimens of *Scotophilus ornatus* (Blyth) to be that species. Blyth's name has priority.

*S. ornatus*, according to Jerdon, is found at low elevations in warm Himalayan valleys, whilst the name of *Nycticejus nivicolus* indicates a very different habitat. But Hodgson only knew that the bat named by him came from the interior of the Sikkim Himalaya, near snow, and it

may have been obtained from a deep valley at no great elevation above the sea.

HARPYIOCEPHALUS LEUCOGASTER.

There is in the British Museum a skin of this species procured by Hodgson near Darjiling.

VESPERTILIO HASSELTII.

A specimen from Burma, the exact locality not recorded, is in the British Museum.

VESPERTILIO LONGIPES.

There can, I think, be very little, if any, doubt that this small bat described by Dobson in 1872 from the caves of Bhima Devi, Kashmir, is the same form as was named by Blyth *Myotis theobaldi* in 1855 (J. A. S. B. XXIV, p. 363). Blyth's types were obtained by Mr. Theobald from limestone caves near Matar Nag, N. of Islamabad (J. A. S. B. XXII, p. 581), and were at first referred by Blyth to *Myotis pallidiventris*, Hodgson, but subsequently distinguished. The types were afterwards lost. The measurements, the large feet, and the habitat render it nearly certain that the two forms are identical, but it is impossible to adopt Blyth's name without clearer evidence, for his description is insufficient, and he declares the species to be extremely close to the pipistrelle, which *V. longipes* is not.

VESPERTILIO MEGALOPUS.

The collection containing the type of this bat was supposed to be from the Gaboon, West Africa. The known species in the collection, however, prove to be from Kashmir, and there is every probability that *V. megalopus* is from the same country.

MYOTIS BERDMOREI, Blyth.

This was a name given by Blyth in his Catalogue, p. 35, to three specimens of a bat in spirit received from Major Berdmore in 1859. The description of the species appeared in the Society's Journal for that year (J. A. S. B. XXVIII, p. 293). The specimens were in all probability obtained at or near Shivé Gyeng on the Sittoung (or Sitang) River, Burma. The types appear to have been subsequently lost, as they are not mentioned in Dobson's Catalogue at the end of his monograph of Asiatic Chiroptera, or in Anderson's Catalogue.

In this case I am unable to suggest what the species can have been. It was said to resemble the pipistrelle in size and structure, but the fore-

arm was  $1\frac{1}{2}$  in. long, considerably more than in *Vesperugo pipistrellus*. The species might have been founded on large individuals of *V. abramus*, but, as specimens of that form were recorded as being received at the same time and referred to a distinct genus and species (*Scotophilus coromandelianus*), this is scarcely probable. It is far more likely that *Myotis berdmorei* was a true *Vespertilio*, and it may have been *V. montivagus* of Dobson or some other ally of *V. mystacinus*. But for the fact that the species was referred to *Myotis*, a genus composed of forms with the foot only in part free from the wing membrane, I should be inclined to suspect that *M. berdmorei* was identical with true *Vespertilio adversus* of Horsfield (not of Temminck). The description and measurements agree very well, and it is highly probable that this wide-ranging species occurs in Burma. Moreover, as has just been shewn, there is every reason to suspect that another form referred by Blyth to *Myotis* (*M. theobaldi*) belongs to *Vespertilio* of the same section as *V. adversus*.

#### VESPERTILIO DOBSONI.

I trust that the types of this species will be carefully re-compared with *V. formosus*. Judged from Anderson's description Cat. Mam. Indian Museum, p. 143, *V. dobsoni* may very possibly be merely a large variety. The difference is not nearly so great as in the case of *Scotophilus kuhli* (*S. temminckii*) and *S. heathi*, which are connected by intermediate forms.

#### KERIVOULA HARDWICKII.

There is in the British Museum a specimen of this species obtained by Mr. Theobald in the Punjab, and another from Ceylon.

#### KERIVOULA PAPILLOSA.

This bat was included by Jerdon amongst the mammals of India, but Dobson gives only Java as a locality. A specimen was sent from Calcutta by Mr. Pearson and is now in the British Museum. Tomes has also recorded a specimen from Ceylon. Neither locality is thoroughly authenticated, but for the present the species may, I think, be retained in the Indian list.

#### MINIOPTERIS SCHREIBERSI.

Dobson has shewn that *Vespertilio fuliginosa* of Hodgson is this species, consequently *Scotophilus fuliginosus*, Jerdon, Mammals, p. 36, should be the same, and Jerdon professes to copy Hodgson's description. But the characters given are very different and must apply to some other bat.

In conclusion, it may be useful to give the correct names, or, where the species have not been determined with certainty, the approximate identifications, of the bats enumerated in Jerdon's Mammals. I know from experience how impossible it is to identify the species from the descriptions, and any one who consults Sterndale's Mammalia of India will see what a source of confusion Jerdon's names have proved. The numbers are Jerdon's. In the few cases in which Dobson's specific names differ from mine I have quoted both.

## BATS IN JERDON'S MAMMALS.

| <i>Jerdon's Name.</i>                | <i>Corrected Name.</i>                                                            |
|--------------------------------------|-----------------------------------------------------------------------------------|
| No. 12. <i>Pteropus edwardsi</i>     | <i>P. medius.</i>                                                                 |
| No. 13. <i>P. leschenaultii</i>      | <i>Xantharpyia amplexicaudata</i> ( <i>Cynonycteris amplexicaudata</i> , Dobson). |
| No. 14. <i>Cynopterus marginatus</i> | <i>C. marginatus.</i>                                                             |
| No. 15. <i>Megaderma lyra</i>        | <i>M. lyra.</i>                                                                   |
| No. 16. <i>M. spectrum</i>           | <i>M. lyra.</i>                                                                   |
| No. 17. <i>Rhinolophus perniger</i>  | <i>R. luctus.</i>                                                                 |
| No. 18. <i>R. mitratus</i>           | <i>R. mitratus.</i>                                                               |
| No. 19. <i>R. tragatus</i>           | <i>R. tragatus.</i> ( <i>R. ferrum-equinum</i> , Dobson).                         |
| No. 20. <i>R. pearsoni</i>           | <i>R. pearsoni.</i>                                                               |
| No. 21. <i>R. affinis</i>            | <i>R. affinis.</i>                                                                |
| No. 22. <i>R. rouxi</i>              | <i>R. affinis.</i>                                                                |
| No. 23. <i>R. macrotis</i>           | <i>R. macrotis.</i>                                                               |
| No. 24. <i>R. subbadius</i>          | <i>R. minor.</i>                                                                  |
| No. 25. <i>Hipposideros armiger</i>  | <i>Hipposiderus armiger</i> ( <i>Phyllorhina armigera</i> , Dobson).              |
| No. 26. <i>H. speoris</i>            | <i>H. speoris.</i>                                                                |
| No. 27. <i>H. murinus</i>            | <i>H. bicolor.</i>                                                                |
| No. 28. <i>H. cinereus</i>           | <i>H. bicolor.</i>                                                                |
| No. 22. <i>Cælops frithii</i>        | <i>Cælops frithii.</i>                                                            |
| No. 30. <i>Rhinopoma hardwickii</i>  | <i>Rhinopoma microphyllum.</i>                                                    |
| No. 31. <i>Taphozous longimanus</i>  | <i>Taphozous longimanus.</i>                                                      |
| No. 32. <i>T. melanopogon</i>        | <i>T. melanopogon.</i>                                                            |
| No. 33. <i>T. saccolaimus</i>        | <i>T. saccolæmus.</i>                                                             |
| No. 34. <i>Nyctinomus plicatus</i>   | <i>Nyctinomus plicatus.</i>                                                       |
| No. 35. <i>Scotophilus serotinus</i> | <i>Vesperugo serotinus.</i>                                                       |
| No. 36. <i>S. leisleri</i>           | <i>V. leisleri.</i>                                                               |
| No. 37. <i>S. pachyomus</i>          | <i>V. serotinus.</i>                                                              |

| Jerdon's Nams.                         | Corrected Name.                                                                     |
|----------------------------------------|-------------------------------------------------------------------------------------|
| No. 38. <i>S. coromandelianus</i>      | <i>V. abramus</i> .                                                                 |
| No. 39. <i>S. lobatus</i>              | <i>V. kuhli</i> .                                                                   |
| No. 40. <i>S. fuliginosus</i>          | ? <i>Miniopterus schreibersi</i> .                                                  |
| No. 41. <i>Noctulinia noctula</i>      | <i>Vesperugo noctula</i> .                                                          |
| No. 42. <i>Nycticejus heathii</i>      | <i>Scotophilus kuhli</i> ( <i>S. temmincki</i> ,<br>Dobson).                        |
| No. 43. <i>N. luteus</i>               | <i>S. kuhli</i> .                                                                   |
| No. 44. <i>N. temmincki</i>            | <i>S. kuhli</i> .                                                                   |
| No. 45. <i>N. castaneus</i>            | <i>S. kuhli</i> .                                                                   |
| No. 46. <i>N. atratus</i>              | <i>Vesperugo atratus</i> .                                                          |
| No. 47. <i>N. canus</i>                | <i>V. kuhli</i> .                                                                   |
| No. 48. <i>N. ornatus</i>              | <i>Scotophilus ornatus</i> .                                                        |
| No. 49. <i>N. nivicolus</i>            | <i>S. ornatus</i> .                                                                 |
| No. 50. <i>Lasiurus pearsoni</i>       | <i>Harpyiocephalus harpyia</i> .                                                    |
| No. 51. <i>Murina swillus</i>          | <i>H. cyclotis</i> .                                                                |
| No. 52. <i>M. formosa</i>              | <i>Vespertilio formosus</i> .                                                       |
| No. 53. <i>Kerivoula picta</i>         | <i>Kerivoula picta</i> .                                                            |
| No. 54. <i>K. pallida</i>              | <i>Vespertilio formosus</i> .                                                       |
| No. 55. <i>K. papillosa</i>            | <i>Kerivoula papillosa</i> .                                                        |
| No. 56. <i>Vespertilio caliginosus</i> | <i>V. muricola</i> .                                                                |
| No. 57. <i>V. siligorensis</i>         | <i>V. mystacinus</i> .                                                              |
| No. 58. <i>V. darjilingensis</i>       | ? <i>V. mystacinus</i> .                                                            |
| No. 59. <i>V. blythii</i>              | <i>V. murinus</i> .                                                                 |
| No. 60. <i>V. adversus</i>             | <i>V. caliginosus</i> .                                                             |
| No. 61. <i>Myotis murinus</i>          | <i>V. murinus</i> .                                                                 |
| No. 62. <i>M. theobaldi</i>            | ? <i>V. longipes</i> .                                                              |
| No. 63. <i>M. parvipes</i>             | doubtful, probably <i>Vesperugo abra-</i><br><i>mus</i> or <i>V. pipistrellus</i> . |
| No. 64. <i>Plecotus auritus</i>        | <i>Plecotus auritus</i> .                                                           |
| No. 65. <i>Barbastellus communis</i>   | <i>Synotis darjilingensis</i> .                                                     |
| No. 66. <i>Nyctophilus geoffroyi</i>   | <i>Nyctophilus timoriensis</i> (not Indian,<br>included by mistake).                |







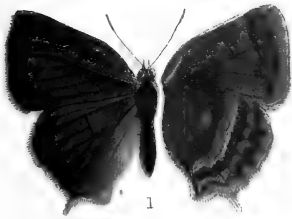

1



6

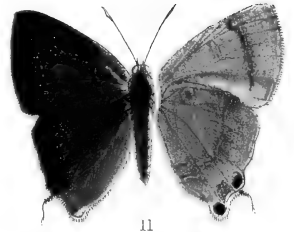

11

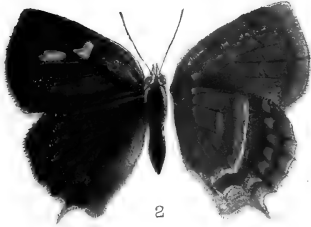

2

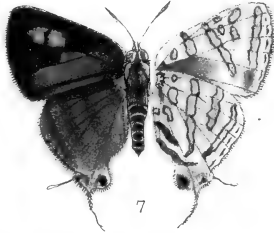

7

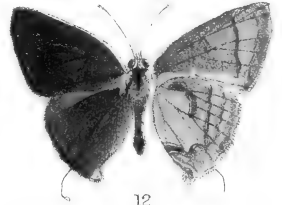

12

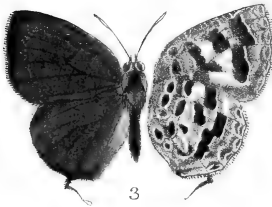

3

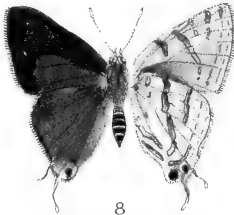

8

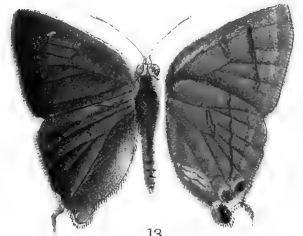

13

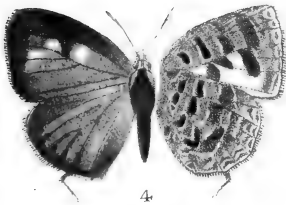

4



9



14

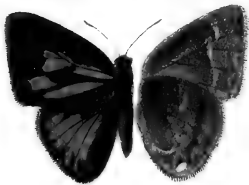

5

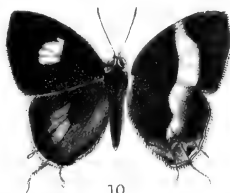

10



15

E. L. Dóe, del.

Parker & Coward chr. lith.



#### NOTICE.

Foreign Societies who favour the Asiatic Society of Bengal with their publications are informed that they may be sent either to the address of the Society at Calcutta, or to the Agents of the Society in London, Messrs. Trübner & Co., 57 and 59, Ludgate Hill, London.

#### AVIS.

Des Sociétés Etrangères qui honorent la Société Asiatique de Bengale de ses publications, sont priées de les envoyer ou directement à l'adresse de la Société, 57, Park Street, Calcutta, ou aux Agents de la Société à Londres, Messrs. Trübner et Cie, 57 and 59, Ludgate Hill.

#### ANZEIGE.

Ansländische Gesellschaften welche die Asiatische Gesellschaft von Bengalen mit ihren Publicationen beehren, sind hierdurch ersucht dieselben entweder direct an die Adresse der Gesellschaft, 57, Park Street, Calcutta, oder an deren Agenten in London, Messrs. Trübner & Co., 57 and 59, Ludgate Hill, senden zu wollen.



X.—*On new or little-known Butterflies from the Indian Region.*

By LIONEL DE NICÉVILLE, F. E. S., C. M. Z. S.

[Received May 14th;—Read June 6th, 1888.]

(With Plates XIII. and XIV.)

Family NYMPHALIDÆ.

Subfamily SATYRINÆ.

## I. MYCALESIS MALSARIDA, Butler.

*M. malsarida*, Butler, Cat. Diurn. Lep. B. M., *Satyridæ*, p. 134, n. 27, pl. iii, fig. 14 (1868); id., Marshall and de Nicéville, *Butt. of Ind.*, vol. i, p. 127, n. 105 (1883); *Kabanda malsarida*, Moore, *Trans. Ent. Soc. Lond.* 1889, p. 168; *Mycalesis khasiana*, Moore, *Proc. Zool. Soc. Lond.* 1874, p. 566; id., Marshall and de Nicéville, l. c., n. 106; *Kabanda khasiana*, Moore, *Trans. Ent. Soc. Lond.* 1880, p. 168.

Through the kindness of the Rev. Walter A. Hamilton, I have recently received from Sylhet twelve males and two females of this species, all captured within a short period of one another. As regards the upperside they show no variation. The species is a remarkable one, in that it is the only Indian *Mycalesis* that has no ocelli whatever above. The undersides, however, of these fourteen specimens (which Mr. Hamilton selected for me from a very considerable number purposely to show these variations) exhibit a perfect gradation from a specimen with a single ocellus only (and that most minute, in the first median interspace of the hindwing, all the other ocelli being reduced to minute dots) to another with the ocelli as large as shewn in Mr. Butler's figure. In addition to this ocellular variation, we have, concomitantly, quite as great a diversity in the ground-colour. In the form with the obsolete ocelli, the basal two-thirds of the wings are ochreous-brown, and the outer third, with the abdominal margin of the hindwing, is purplish-grey. In the form with all the ocelli large and perfect, we have the whole of the ground-colour much darker, the discal purple line much more prominent, the purplish grey border of the other form entirely absent, and the series of ocelli surrounded by a purple line. Every gradation is before me between these two extremes.

When this species was treated of in "The Butterflies of India," the authors had not seen *M. khasiana*; had they had access to a single typical specimen, they would not have questioned its specific distinctness from *M. malsarida*. There is no doubt, however, that these two species are as much one as are *Melanitis leda* and *M. ismene* or *Mycalesis blasius* and *M. perseus*. These extraordinary variations are no doubt entirely caused by the state of the atmosphere at the moment probably when the larva is turning to a pupa and all its tissues are soft. With regard to many of the Indian *Satyrinæ*, they are divided into two strongly-

marked well-defined groups, which I have designated dry- and wet-season forms respectively. These forms *prevail* during their respective seasons, but are by no means strictly confined to them. For instance, it is a common occurrence in India to have what is called a "break in the rains," when for many successive days one has weather somewhat similar to that obtaining in the dry-season. Any larvæ turning to pupæ during a "break" would almost certainly, though they would emerge perhaps a week afterwards in a deluge of rain, be of the dry-season form. Similarly, during the dry-season, dry-season forms prevail, but, should a rainy day or two come, pupæ formed during the wet interval would probably produce the wet-season form of butterfly. Again, as it takes butterflies some little time to lay their eggs (after having completed this operation they die immediately), it must frequently happen that the two forms overlap: a dry-season female not having laid her eggs during the dry season would do so at the beginning of the rains, and, though caught in the rainy season, would still be a dry-season butterfly, its worn appearance, if nothing else, proclaiming the fact; and *vice versâ* with a wet-season butterfly not having completed her laying during the rains and caught in the dry-season. So it is with *M. malsarida*. Mr. Hamilton obtained a very long series of it in the spring below Shillong in Sylhet: the greater portion were, as they should have been, of the dry-season form, but a few were of the other extreme, and these he picked out, together with intergrade specimens between the two extremes, and sent to me. The prevailing form of this species is therefore *M. khasiana* in the dry-season and true *M. malsarida* in the wet-season, and the occasional appearance of the one form or the other out of its proper season will not upset the main fact of the occurrence of two distinct well-marked forms corresponding to the seasons, the dry and the wet, into which the Indian climate may be primarily divided.

Mr. Moore's subgenus *Kabanda* contains therefore a single species only, so far as is at present known, and adds one more to the groups of *Mycalesis* in which seasonal dimorphism occurs, as given by Mr. W. Doherty in vol. lv, pt. ii, of this Journal, p. 106.

*M. malsarida* may be considered to be a rare species, as it appears to be strictly confined to Assam, though it is probably common enough in the spots where it is found at all.

#### Subfamily NYMPHALINÆ.

##### 2. ZOPHOESSA RAMADEVA, de Nicéville, Pl. XIII, Fig. 3, ♂.

*Z. ramadeva*, de Nicéville, P. A. S. B. 1887, p. 147.

I take this opportunity to figure this very pretty and distinct species. It lacks (as also does *Z. andersoni*, Atkinson) the glandular



patch of differently-formed scales on the upperside of the hindwing near the base of the costa which is one of the characters of Mr. Doherty's sub-genus *Charma*,\* of which *Zophoessa baladeva*, Moore, is the type. The name "*Charma*" is very close to *Charmus*, but has a different origin, being that of a valley in Kumaon, I believe.

### 3. BYBLIA ILITHYIA, Drury.

*Papilio ilithyia*, Drury, Ill. Ex. Ins., vol. ii, p. 29, pl. xvii, figs. 1, 2, female (1773); *Hypanis simplex*, Butler, Proc. Zool. Soc. Lond. 1883, p. 146, n. 7, pl. xxiv, fig. 8, ? female.

In "The Butterflies of India," vol. ii, p. 15, I admitted *B. simplex*, Butler, as a species distinct from *B. ilithyia*, Drury, though I had not seen a specimen, on the strength of Colonel Swinhoe's assurances that it is a good species and his having recorded it from Poona, Mhow, Depalpore, and Assirghur. He recorded *H. polinice*, Cramer (which is a synonym of *B. ilithyia*, Drury), also from Poona and Mhow, and identifies one of my specimens from Depalpore as *B. ilithyia*, so that the two species occur together in three out of the four localities from which *B. simplex* has been recorded.

Not being able to identify *B. simplex*, I sent my entire collection of specimens of this genus to Colonel Swinhoe, who has kindly separated them into the two species, *B. ilithyia* and *B. simplex*. Of the latter species he identifies five specimens, one from Bombay, two from Poona, one from Sirur, and one from the Central Provinces. I find that these five specimens show as much variation as do those in my long series of *B. ilithyia*, and I cannot trace one single character running through these five examples by which I can distinguish them from *B. ilithyia*, and I do not know how Colonel Swinhoe identified them. The points of difference between the two species that I gave in the key to the genus in my book are quite incorrect, having been taken solely from Mr. Butler's figure of *B. simplex*, with which the specimens Colonel Swinhoe identifies as such do not at all agree. Mr. Butler's description of *B. simplex* is of little use to students in India, as he compares it to *B. cora*, Feisthamel, an African species, which Mr. Trimen in his "South-African Butterflies," vol. i, p. 264, gives as a synonym of *B. ilithyia*. In conclusion, I think that there is only one species of *Byblia* in India, which stands as *ilithyia*, unless of course Colonel Swinhoe should have incorrectly identified my specimens of *B. simplex*, in which case all his recorded localities for that species would probably also be wrong, but this is a very unlikely contingency.

\* J. A. S. B., vol. lv, pt. ii, p. 117 (1886).

## 4. NEPTIS NANA, n. sp., Pl. XIII, Fig. 1, ♂.

HABITAT: Bhutan.

EXPANSE: ♂, 2.5 inches.

DESCRIPTION: MALE. UPPERSIDE, *both wings* distinguished from *N. narayana*, Moore,\* by having all the markings bright ochreous instead of "pure white," as described and figured by Mr. Moore for that species, or just very faintly tinged with palest ochreous, as in the specimens I have seen. *Hindwing* with the submarginal band narrower. UNDERSIDE, *both wings* with the ground-colour and pale violet markings of a deeper and richer shade of colour. *Hindwing* with the submarginal band as above narrower, the pale violet band between it and the discal band broader and better-defined, and the marginal pale violet line nearer the margin.

There are three male specimens of *N. nana* in the collections of Messrs. Otto Möller and A. V. Knyvett taken in April and June by their native collectors in Bhutan. The rich ochreous coloration of the markings of the upperside will at once distinguish *N. nana* from *N. narayana*. The range of the latter species has been considerably extended by Colonel A. M. Lang, R. E., taking it at Naini Tal rarely at from 5,500 to 6,500 feet elevation in the middle of May. *N. nana* is also allied to "*Limenitis*" *antonia*, Oberthür,† from Moupin, from which it may be known, on the upperside of the forewing, by the discal streak being shorter, and the lower portion of the discal macular band (in *N. antonia* formed of four spots at regular intervals divided only by the veins, in *N. nana* apparently of two spots only, with a considerable space of the ground between them, the upper spot nearly a circle, the lower an elongated streak) differently shaped. On the hindwing the submarginal yellow band in *N. nana* is narrower. It is also more distantly allied to "*Limenitis*" *arandia*, Oberthür,‡ described without exact locality as from China, but the extreme tenuity of the yellow markings on the upperside of both wings in that species will at once distinguish it from *N. nana*; the markings of the underside are similar in character, but those on the hindwing are much blurred, and the ground-colour is pale yellow almost throughout. *N. nana* is also allied to *N. thisbe*, Ménétrié,§ a species that has no yellow submarginal band on the upperside of the hindwing, and occurs in Amurland.

\* P. Z. S. 1858, p. 6, n. 8, pl. xlix, fig. 3, *male*.† *E'tudes d'Ent.*, vol. ii, p. 22, n. 11, pl. iv, fig. 3 (1876).‡ *E'tudes d'Ent.*, vol. ii, p. 23, n. 12, pl. iv, figs. 4a, 4b (1876).§ Figured in Schrenck's *Reisen*, vol. ii, p. 26, n. 56, pl. ii, fig. 9 (1859).

5. *ATHYMA RUFULA*, de Nicéville.

*A. rufula*, de Nicéville, Butt. of India, vol. ii, p. 181, n. 474 (1886).

HABITAT: South Andaman Isles.

EXPANSE: ♂, 2.6 inches.

DESCRIPTION: MALE. UPPERSIDE, *both wings* black. *Forewing* with a prominent oval white spot at the end of the discoidal cell, and an indistinct broken basal narrow white streak; three subapical oval white spots divided by the discoidal nervules, the upper the smallest, the lower rather larger, the middle spot the largest; an oblique discal series of three white spots, the upper in the first median interspace large and oval touching its bounding nervules, the one below in the submedian interspace quadrate, filling the interspace, slightly constricted at each side, the lowest spot below the submedian nervure elongated; an indistinct pale rufous marginal and submarginal macular band, the latter ending anteriorly in a prominent bright rufous spot as in *A. cama*, Moore. *Hindwing* with the first subcostal nervule and that portion of the costal nervure between the bases of its branches pure white; a broad discal white band from the submedian nervure to the first subcostal nervule, with a small oval spot in the costal interspace in continuation; a narrow pale marginal band, and a broader more distinct submarginal band. UNDERSIDE, *both wings* dull ochreous more or less marked with black between the veins. *Forewing* with the bluish-white discoidal streak formed of four equal portions; a bluish-white spot near the base of the submedian interspace bearing a prominent wedge-shaped black spot; otherwise marked much as on the upperside. *Hindwing* with a curved subcostal white streak, and a discal series of decreasing black spots between the veins from the first median nervule to the costa; the abdominal margin broadly bluish; otherwise marked much as on the upperside.

I have at last received a male of this species from Mr. R. Wimberley; the first female was caught as far back as 1872, and is now in the Indian Museum, Calcutta. The male is nearest to that sex of *A. cama*, but may at once be known on the upperside by the cell-streak and spot being white, not rufous; the white subapical spots and discal band are also differently formed; in the hindwing the discal white band ending in a small well-separated oval spot in *A. rufula* is also a distinguishing feature. The colour of the ground on the underside is a good deal different too, and the streak in the cell of the forewing of *A. rufula* being divided, while it is entire in *A. cama*, will readily distinguish between these species.

## 6. EUTHALIA ADIMA, Moore.

*Adolias adima*, Moore, Horsfield and Moore, Cat. Lep. Mus. E. I. C., vol. i, p. 194, n. 392 (1857); *Euthalia adima*, de Nicéville, Butt. of India, vol. ii, p. 210, n. 505 (1886).

When I wrote about this species in "The Butterflies of India," I had seen no specimen of it, but, thanks to Mr. Walter A. Hamilton, I have received a considerable series of males and five females, all taken below Shillong in Assam. They shew great variation in the only character which distinguishes the species from *E. appiades*, Ménétriés, *viz.*,—the entire absence or more or less prominence of the blue band on the outer margin of the hindwing on the upperside in the male. In some specimens there is not the smallest speckle of blue, in others there are just a few blue scales at the anal angle, in others a considerable pair of patches in each interspace, till the other extreme is reached in which there is an almost continuous band, as in *E. appiades*, divided only by the veins and internervular folds. The female is indistinguishable from the common form of that sex of *E. appiades*. I was wrong in the "Butterflies of India" in saying that *E. adima* "is apparently nearest allied to *E. jahnvi*, Moore:" superficially a typical male of *E. adima* is nearer to *E. jahnvi* than it is to *E. appiades*, the former having no blue coloration on the upperside, but, as will be seen from the above remarks, *E. adima* is a very variable species in the male, and one extreme of the variability approaches very near indeed to *E. appiades*, and the females of the two are indistinguishable. Mr. Hamilton tells me that *E. appiades* does not occur at the spot where he finds *E. adima*; the latter may therefore be treated as a local race of *E. appiades* till the series of gradations between the two species is found to be quite complete; at present there is a considerable gap between my most blue *E. adima* and *E. appiades*, though that specimen is really much nearer to *E. appiades* than it is to typical *E. adima*. The true *E. appiades* occurs almost all over Assam and is a very common species. It is a little strange that it should be replaced at the foot of the Shillong hills by so variable a local race.

## Family LYCÆNIDÆ.

## 7. ZEPHYRUS DOHERTI, n. sp., Pl. XIV, Figs. 1, ♂, 2, ♀.

HABITAT: Western Himalayas.

EXPANSE: ♂ ♀, 1·5 to 1·7 inches.

DESCRIPTION: "MALE. UPPERSIDE, *both wings* black. *Forewing* with the black area confined to the costa narrowly, the outer margin broadly and increasingly to the anal angle, and the inner margin narrowly; the rest of the surface extremely dark iridescent green varying to iridescent purple according to the play of the light, crossed by the black

veins. *Hindwing* with some streaks of the same colour between the veins on the disc; anal lobe and tail (the latter tipped with white) obscure reddish. **UNDERSIDE**, *both wings* reddish-brown, sometimes ochreous-brown; the discoidal cells closed by a narrow red band outwardly defined with black. *Forewing* with a waved discal red band, its outer edge irregular, and defined by a fine black, then a silvery line, extending from the costa to the first median nervule; a submarginal increasing macular dark fascia, the apical half of the outer margin reddish. *Hindwing* with a broader discal red band than in the forewing prominently outwardly defined with a silvery line, a submarginal lunular red band, which is bent upwards at the anal angle and continued some distance along the abdominal margin, where it is inwardly defined (as are also the two lunules next to it on both sides) with a fine silvery line; a series of red lunules on the margin; *tail* red. *Cilia* cinereous throughout. **FEMALE**. **UPPERSIDE**, *both wings* black. *Forewing* with an irregular orange spot placed outwardly against the disco-cellular nervules, and another similar spot placed below and beyond it in the second median interspace, sometimes extending diffusedly into the interspace below; the discoidal cell and a patch in the middle of the submedian interspace rich purple (never green) in some lights; this colour sometimes entirely absent. *Hindwing* unmarked. **UNDERSIDE**, *both wings* as in the male.

May at once be distinguished from *Z. icana*, Moore, by the discal band of both wings on the underside being narrower and outwardly defined with a bright silvery line. The two lunular marginal bands on the underside of the hindwing are in *Z. dohertii* also more prominent and deep vermilion throughout: in *Z. icana* they are more orange and that colour is confined to the anal angle. The discal band on the hindwing below is always distant from the disco-cellular band: in *Z. icana* the two are run into each other, owing to the much greater breadth of the band.

I possess numerous specimens, including four females, of *Z. dohertii* taken by Mr. P. W. Mackinnon at Tehri Gurhwal, near Masuri, 8,500 feet, in June; I also took four males on the Jalauri Pass, at about 9,000 feet, Kulu, in July. As Mr. W. Doherty first pointed out the distinctness of this species,\* I have much pleasure in naming it after him.

8. ACESINA ABERRANS, n. sp., Pl. XIV, Figs. 3, ♂, 4, ♀.

**HABITAT**: Upper Tenasserim.

**EXPANSE**: ♂, 1.45; ♀, 1.50 inches.

**DESCRIPTION**: **MALE**. **UPPERSIDE**, *both wings* shining bluish-purple, with a very narrow outer black margin. *Hindwing* with some marginal

\* J. A. S. B., vol. lv, pt. 2, p. 131 (1886).

narrow black streaks on either side of the tail divided from the cilia by a white thread; *tail* black tipped with white. **UNDERSIDE**, *both wings* coloured and marked almost exactly like *A. paraganesa*, mihi. *Forewing* with the discal macular band much broken in the middle, the lower portion below the third median nervule being shifted backwards considerably, so that the outer anterior angle of the uppermost spot of the lower portion touches the inner posterior angle of the spot above it; in *A. paraganesa* this band is straight and unbroken. *Hindwing* with a few metallic green scales towards the anal angle which are not present in *A. paraganesa*. **FEMALE**. **UPPERSIDE**, *forewing* with the costa, apex, and outer margin all broadly black, the base and disc of the wing to the inner margin pale blue; a whitish spot at the end of the discoidal cell, one beyond in the lower discoidal interspace, and two smaller ones below divided by the second median nervule. *Hindwing* with the costa broadly, the outer margin less broadly and decreasingly black, the veins black, widening out towards the margin, the rest of the wing pale blue; a fine anteciliary white line on either side of the tail. **UNDERSIDE**, *both wings* marked as in the male, but the metallic green scales on the *hindwing* wanting.

A larger species than *A. paraganesa*, the male conspicuously different, as the blue coloration extends over the entire surface except the extreme margin, while in *A. paraganesa* it is confined to a patch on the disc and base; the opposite sexes in *A. paraganesa* are also nearly alike, while in *A. aberrans* they are widely different. This is only the second species of the genus. The male was taken by Captain C. T. Bingham in the Meplay Valley on the 6th January, 1882, the female was also obtained by him at Donat in January.

#### 9. ZARONA JASODA, n. sp., Pl. XIV, Fig. 5, ♂.

**HABITAT**: Pegu Hills, Burma.

**EXPANSE**: ♂, 1·4 inches.

**DESCRIPTION**: **MALE**. **UPPERSIDE**, *both wings* black. *Forewing* with a streak on either side of the median nervure, a small patch filling the base of the second median and a larger one filling the base of first median interspace, a lengthened streak in the interno-median area and placed obliquely above it, a large somewhat quadrate patch in the submedian interspace, all brilliant shining ultramarine-blue inclining to brilliant emerald-green in some lights. *Hindwing* with the posterior two-thirds of the surface also blue crossed by the black veins, the outer margin narrowly black, and with somewhat diffused black spots placed upon and near the termination of the median nervules, two conjoined spots in continuation of these latter in the submedian interspace; costal and abdominal

margins pale fuscous. **UNDERSIDE**, *both wings* deep glossy purplish-brown. *Forewing* with a discal macular irregular fascia, and with a double series of indistinct marginal lunules; inner margin pale. *Hindwing* with a very irregular discal macular fascia, outwardly slightly defined with whitish; marginal lunules much as in the forewing, some indistinct plumbeous irrorations towards the anal angle.

Nearest to "*Poritia*" *pharyge*, Hewitson, from Perak and Borneo, from which it may at once be distinguished by the absence of the three subapical and six marginal blue spots and the broad streak in the internomedian area on the upperside of the forewing, and the much greater extent of blue coloration on the upperside of the hindwing; the markings of the underside also are very different.

Described from a single specimen in the collection of Captain C. T. Bingham, who captured it in December, 1887.

10. *APHNEUS RUKMA*, n. sp., Pl. XIV, Fig. 6, ♂.

**HABITAT**: Sikkim.

**EXPANSE**: ♂, 1.3 inches.

**DESCRIPTION**: **MALE**. **UPPERSIDE**, *forewing* black, the base and lower discal area slightly iridescent deep blue of the exact shade and extent of *A. nipalicus*, Moore;\* a small ferruginous spot near the base of the second discoidal interspace. *Hindwing* with the costal margin broadly, outer margin narrowly black, abdominal margin pale fuscous, the rest of the wing iridescent deep blue; anal angle ferruginous, bearing two black spots sparsely marked with metallic silvery scales; *tails* black, tipped with white. **UNDERSIDE**, *forewing* pale chrome-yellow, the inner margin below the median nervure fuscous, beyond and below the first median nervule whitish; a very short black streak from the base of the wing touching the costal nervure posteriorly; a small oval spot beyond in the discoidal cell; another crossing the cell from the base of the first median nervule to the costa; an oblique discal band from the middle of the costa towards the anal angle; a figure of eight beyond, parallel to the discal band and touching the costa; two oblong spots beyond touching in the middle, not reaching the discal band, but forming with it a disconnected Y-shaped figure; a submarginal catenulated band, ending posteriorly in two black spots in the submedian interspace; all these spots and bands of a darker chrome-yellow than the ground, broadly outwardly defined with black; a marginal fine black line more or less broken up into spots. *Hindwing* pale chrome-yellow; the spots and bands arranged as usual, coloured as in the forewing, the discal and submarginal bands where they are recurved to the abdominal margin marked with

\* J. A. S. B., vol. liii, pt. 2, p. 27 (1884).

metallic silvery lines; the anal lobe marked much as on the upperside, but the ferruginous colour more inclined to orange.

The type is unique in the collection of Mr. Otto Möller. The species is nearly allied to *A. nipalicus*, Moore, which also occurs in Sikkim, and from which the male does not differ on the upperside, but may be known on the underside by having none of the spots and bands of the forewing traversed by a silvery line.

11. *APHNÆUS RUKMINI*, n. sp., Pl. XIV, Fig. 8, ♂.

HABITAT: Sikkim.

EXPANSE: ♂, 1·35, and 1·60 inches.

DESCRIPTION: MALE. UPPERSIDE, *forewing* as in *A. rukma*, but lacks the ferruginous spot. *Hindwing* as in *A. rukma*, but the anal lobe dull ochreous instead of ferruginous. UNDERSIDE, *both wings* pale reddish-ochreous or stone-colour. *Forewing* with the inner margin paler, the usual blackish patch towards the base of the inner margin; all the markings much reduced and attenuated; the short streak at the base of the cell and ring-spot beyond entirely absent in one specimen, but present in the other; the other bands and spots sparsely marked with silvery as in *A. nipalicus*, Moore. *Hindwing* also with all the bands highly attenuated and marked with a silvery line; a very small ferruginous-orange spot only on the anal lobe.

The species is known to me by two male specimens in the collection of Mr. Otto Möller, one of which was taken on 8th May, 1888. Except in size, they are nearly exactly alike.

12. *APHNÆUS SANI*, n. sp., Pl. XIV, Fig. 7, ♀.

HABITAT: Sikkim, Bhutan.

EXPANSE: ♂ ♀, 1·5 inches.

DESCRIPTION: MALE. UPPERSIDE, *both wings* exactly as in *A. rukma*, but the ferruginous spot beyond the discoidal cell rather larger. UNDERSIDE, *both wings* differ from that species in the ground-colour being pale cinnamon-red instead of pale chrome-yellow, all the bands and spots the same, but, instead of being filled in with dark chrome-yellow, they are cinnamon-red. FEMALE. UPPERSIDE, *forewing* black with an oval suffused ferruginous patch on the disc marked in the middle by a black spot; the lower discal and basal areas metallic plumbeous-silvery. *Hindwing* dull fuscous, sparsely sprinkled with plumbeous scales. UNDERSIDE, *forewing* very pale chrome-yellow; the figure of eight and two spots beyond much smaller and quite divided. *Hindwing*, ground-colour dull pale cinnamon, marked as in the male.

This species is known to me by three male specimens almost exactly



alike in the collection of Mr. Otto Möller, one of which was taken in Sikkim on 11th July, 1884, another is without date, and the third was taken in Bhutan in April, 1887, also a single female in the collection of Mr. G. C. Dudgeon taken on 6th May, 1887, also in Sikkim.

Whether *A. nipalicus*, *A. rukma*, *A. rukmini*, and *A. sani* are four distinct or one protean species must remain undecided for the present. The ground-colour of *A. nipalicus* and *A. rukma* is the same on the underside, viz. yellow, but the former has the bands and spots marked with a silvery line, while the latter has not. The colour of *A. rukmini* is dull Indian-red or stone-colour, bands marked with a silvery line; of *A. sani* cinnamon-red, with no silvery line. By these characters, as far as my specimens go, the various species can be readily distinguished.

13. HORAGA RANA, n. sp., Pl. XIV, Fig. 10, ♂.

HABITAT: South Andaman Island.

EXPANSE: ♂, 1.15 to 1.25; ♀, 1.20 to 1.35 inches.

DESCRIPTION: MALE. UPPERSIDE, both wings differ from *H. albimacula*, Wood-Mason and de Nicéville, in the violet-blue coloration being replaced by pure cærulean blue. Forewing in having the oval white discal patch smaller, bounded by the lower discoidal and first median nervules, in one specimen only extending very slightly into the submedian interspace, divided into three portions by the black crossing nervules; in one specimen there is a considerable patch of pure cærulean blue scales on the basal half of the wing below the median nervure, which patch is obsolete in another specimen and entirely absent in a third. UNDERSIDE, forewing differs in having the median white band extending conspicuously almost to the costa and pure white throughout, the anterior portion of it not washed with fuscous as in *H. albimacula*. Hindwing with the median white fascia on the average twice as broad; this, however, is a variable feature in both species. FEMALE much larger than the male in three out of four specimens. UPPERSIDE, forewing with the discal white patch twice as large, extending from the subcostal almost to the submedian nervure, and proportionally broad; a few pale grey-blue scales placed below the median nervure towards the base in two specimens. Hindwing with some scattered pale grey-blue scales on the disc. UNDERSIDE, both wings bright fulvous. Forewing with the discal white patch almost touching the costa, its anterior portion narrow and outwardly slightly hooked; the ground-colour beyond the white patch increasingly to the costa fuscous; inner angle and margin pale. Hindwing with the outwardly-diffused discal band outwardly bordered by a pale fuscous fascia, widest at the costa and obsolete at the third median nervule. Otherwise as in *H. albimacula*.

Described from two males and three females collected by the late Mr. A. R. de Roepstorff, and now in the Indian Museum, Calcutta, and another pair taken by Mr. R. Wimberley in my own collection.

I have taken this opportunity to figure a male of *H. albimacula*, (Pl. XIV, Fig. 9), which is the only other species of the genus occurring in the Andaman Islands, and is not furnished with the "male-mark" present in *H. rana* and all Indian species except *H. viola*, Moore.

14. RAPALA TARA, n. sp., Pl. XIV, Fig. 11, ♂.

HABITAT: Sylhet, Naini-tal.

EXPANSE: ♂, 1.6; ♀, 1.65 inches.

DESCRIPTION: MALE. UPPERSIDE, *both wings* black glossed with rich deep purple-blue in some lights, somewhat as in *R. sphinx*, Fabricius (a common species in Sylhet and Burma, and figured by Hewitson as *Deudoria varuna*), but not of so brilliant or rich a shade. *Forewing* with a prominent round discal velvety black sexual patch on the middle of the disc extending slightly into the discoidal cell and traversed by the bases of the two lower median nervules. *Cilia* black, on the hindwing white from the second median nervule to the anal angle. *Hindwing* with the anal lobe marked with a small ochreous spot. UNDERSIDE, *both wings* greenish-ochreous. *Forewing* with two short brownish lines at the end of the cell; a regularly-curved narrow brown discal band from the costa to the submedian nervure. *Hindwing* with the disco-cellular lines as in the forewing, the discal band also, but outwardly very irregular, finely defined with white; a similar short oblique band on the middle of the abdominal margin; a round black spot on the margin in the first median interspace faintly crowned with ochreous; the anal lobe black, the space beyond sprinkled with black and white; fine anteciliary black and white lines becoming obsolete anteriorly; *tail* long, black, tipped with white. FEMALE. UPPERSIDE, *both wings* dull purple, entirely lacking the rich deep purple gloss present in the male. UNDERSIDE, *both wings* bright ochreous, the markings as in the male.

Described from several examples of both sexes obtained in Sylhet by the native collectors of the Rev. Walter A. Hamilton, also from two females taken by Colonel A. M. Lang, R. E., one at Naini-tal, 5,000 feet, on 29th September, the other at Nalaina, near Naini-tal, 4,200 feet, on 22nd September, 1887. The blue coloration of the upperside of the male is different from that of any species known to me; the "male-mark" is also more prominent than in any other species of the genus and different in character; it is present in *R. orseis*, Hewitson, but is quite different, and is altogether absent in *R. sphinx*, Fabricius.

15. *RAPALA ROSACEA*, n. sp., Pl. XIV, Fig. 12, ♂.

HABITAT: Sikkim.

EXPANSE: ♂, 1.16 to 1.56; ♀, 1.40 to 1.52 inches.

DESCRIPTION: "MALE. UPPERSIDE, *both wings* fuscous. *Forewing* glossed with shining deep steel-purple from the base to beyond the middle. *Hindwing* with all but the costa, outer margin narrowly, and abdominal margin broadly, glossed with shining deep steel-purple. UNDERSIDE, *both wings* vinous-red, in some specimens the red colour somewhat obsolescent. *Forewing* with two short dark lines at the end of the cell, a discal very even slightly curved narrow dark band from the costa to the submedian fold, a submarginal obscure fascia. *Hindwing* with the disco-cellular and discal markings as in the forewing, but the latter at its posterior end assuming a W-shaped figure, the whole band outwardly narrowly defined with white, at its posterior end also inwardly defined with white, the anal lobe marked with red in the middle, a red spot on the margin beyond the base of the tail, between which the wing is irrorated with grey scales, a narrow red line running up from the anal lobe to the abdominal margin below the discal line. *Cilia* reddish-brown throughout. *Tail* black, tipped with white. FEMALE coloured and marked exactly like the male, but of course lacking the male secondary sexual characters.

Mr. Otto Möller possesses five males and six females of this distinct species all taken in Sikkim in March. The reddish-vinous coloration of the underside at once distinguishes it from all the species of the genus known to me.

16. *RAPALA BUXARIA*, n. sp., Pl. XIV, Fig. 13, ♂.

HABITAT: Bhutan.

EXPANSE: ♂, 1.62 inches.

DESCRIPTION: MALE. UPPERSIDE, *both wings* dark brown overlaid with a deep steel-blue gloss, in certain lights the whole surface shows a resplendent cærulean coloration of much the same shade as in *Rapala schistacea*, Moore, though of far greater extent. *Hindwing*, the anal lobe with an oval patch of deep vermilion scales, the abdominal margin pale brown and very hairy, *tail* black tipped with white. UNDERSIDE, *both wings* of a pale ochreous-brown colour. *Forewing* with a pair of fine brown lines closing the discoidal cell; a very straight oblique discal line from the costa to the middle of the submedian interspace, made up of two equal portions, inwardly of a pale brown portion, outwardly of a dark brown portion; a very indistinct submarginal fascia. *Hindwing* with a pair of very fine brown lines closing the discoidal cell;

a very straight discal line as in the forewing from the costa to the first median nervule, from thence to abdominal margin forming a W-shaped figure; a submarginal fascia as in the forewing; anal lobe black crowned with whitish, inwardly marked with an orange line; a round black spot crowned with ochreous on the margin in the first median interspace, the wing-surface between it and the anal lobe sprinkled with black and white scales, a fine black marginal thread. *Cilia* reddish-brown throughout. *Body* concolorous with the wings above, pale yellow below. *Head* with the frontal tuft and *palpi* pale yellow.

Apparently nearest to *Rapala nissa*, Kollar, with which it closely agrees in the coloration and markings of the underside, though the discal line on the underside is straighter and more even than is usually the case in that species. It differs, however, from *R. nissa* on the upperside in having the rich iridescent blue reflections, which are only seen in certain lights, and are entirely absent in *R. nissa*.

Described from a single specimen taken in Bhutan in April, in the collection of Mr. A. V. Knyvett.

17. *TAJURIA ISTROIDEA*, de Nicéville, Pl. XIV, Fig. 14, ♂.

*T. istroidea*, de Nicéville, Proc. Zool. Soc. Lond., 1887, p. 458, pl. xl, fig. 3, female.

HABITAT: Sikkim.

EXPANSE: ♂, 1·4 inches.

DESCRIPTION: MALE. Differs from the description of "*Remelana*" *yajna*, Doherty,\* on the UPPERSIDE of the *hindwing* in the glittering azure patch being of greater extent, occupying the anterior half of the discoidal cell, instead of extending into it slightly, and reaching to the costa and to the apex of the wing. On the UNDERSIDE the apex of the *forewing* is concolorous with the rest of the wing, not darker as in *R. yajna*, the discal line is outwardly curved, of a deeper rufous than the ground-colour, outwardly defined by a fine white line, instead of being chiefly white, slender, and sinuous, and without any trace of an outer black bounding line; the *hindwing* has the abdominal margin concolorous with the rest of the wing, not partly white as in *R. yajna*.

Described from a single specimen taken in Sikkim on 2nd December, 1887, in Mr. Otto Möller's collection. The underside agrees exactly in colour and markings with the female, except that the ground-colour is rather darker.

\* J. A. S. B., vol. 1v, pt. 2, p. 128, n. 140 (1886).

18. *TAJURIA DONATANA*, n. sp., Pl. XIV, Fig. 15, ♂.

HABITAT: Upper Tenasserim.

EXPANSE: ♂, 1.35 inches.

DESCRIPTION: MALE. UPPERSIDE, *both wings* deep purplish-black. *Forewing* with the basal and lower discal areas rich deep iridescent blue, the colour extending slightly into the discoidal cell from the base of the first median nervule to the base of the wing. *Hindwing* with an elongated discal patch of rich iridescent blue of a lighter and brighter shade than in the forewing; the abdominal margin anteriorly pale fuscous and fringed with white, anal lobe white marked by a round black spot, bearing a few metallic silvery scales; *cilia* from the anal angle to the second median nervule white, thence to the apex of the forewing black. UNDERSIDE, *forewing* rich chrome-yellow, unmarked, the inner margin broadly pale fuscous. *Hindwing* rich chrome-yellow; the anal area sprinkled with black and white scales; the anal lobe intensely black, with an intensely black small round spot on the margin in the first median interspace; the black and white anal area bounded anteriorly by an irregular iridescent greenish silvery line, above which is an irregular W-shaped white figure finely defined with black; a fine black anteciliary line from the anal angle to the discoidal nervule. *Tails* black tipped with white, the outer rather the shorter.

A smaller species than the "*Myrina*" *orsolina* of Hewitson,\* from Celebes and Macassar; differing in the shape of the blue patch on the upperside of the forewing, which in that species is deeply indented at the base of the first median nervule; also by the absence on the underside of both wings of the very pale broken linear brown band described, but not shown in the figure, as occurring in *M. orsolina*, and in other details.

I have described *T. donatana* from a single example taken by Captain C. T. Bingham in the Donat range, Upper Tenasserim, in April.

## Family PAPILIONIDÆ.

## Subfamily PAPILIONINÆ.

19. *PAPILIO NOBLEI*, n. sp., Pl. XIII, Fig. 2, ♂.

HABITAT: Karen Hills, Burma.

EXPANSE: ♂, 4 inches.

DESCRIPTION: MALE. UPPERSIDE, *both wings* black. *Forewing* with four longitudinal streaks of scattered ochreous scales in the discoidal cell. *Cilia* black. *Hindwing* with a large cream-coloured tripartite sub-apical patch from the discoidal nervule to the costal nervure much as in

\* Ill. Diurn. Lep., p. 38, n. 39, pl. xvii, figs. 56, 58, *male*; 57, *female* (1865).

*P. helenus*, Linnæus; a semi-circular red mark enclosing a round portion of the ground-colour at the anal angle; *cilia* black, but with a spot of white in the costal, discoidal, and median interspaces. **UNDERSIDE**, *both wings* blackish-brown. *Forewing* with the streaks in the discoidal cell as above, but more prominent, some scattered ochreous scales on the disc, and a short pale streak on the margin on each internervular fold. *Hindwing* with the cream-coloured patch as above, a submarginal series of pale yellow lunules from the costa to the third median nervule, each lunule marked in the middle by ochreous; an ochreous lunule in the first median interspace, and an almost complete ferruginous-ochreous ring-spot at the anal angle, above which is an elongated patch of whitish scales; there are a few scattered blue scales on the disc from the submedian nervure to the discoidal nervule. *Cilia* black, but marked with a white spot in the middle of each interspace.

Nearest to *P. helenus*, from which it may be readily distinguished by its smaller size, narrower wings, and the single red lunule on the upperside of the hindwing only; on the underside by the short internervular streaks on the margin of the forewing, by the large subapical cream-coloured patch of the hindwing being entire, not divided as in *P. helenus* into three well-separated spots by the black veins, by the submarginal lunules being pale ochreous-yellow instead of red, by there being no lunule in the second median interspace, a single lunule in the first median interspace (in *P. helenus* there are two), and in the scattered blue scales on the disc, and the patch of whitish scales in the submedian interspace placed against the submedian nervure. It is altogether a narrower insect than *P. helenus*, and does not agree in shape with any species known to me, though it is perhaps in that respect nearest to *P. demolion*, Cramer, to which group, on further consideration while this paper is passing through the press, I have come to the conclusion that it belongs, in which opinion Mr. Wood-Mason, to whom I have submitted the specimens, concurs.

Two male specimens of *P. noblei* exactly alike have been obtained one in February and one in March in the Karen Hills by the native collector attached to the Phayre Museum, Rangoon. I have named the species after Mr. B. Noble, the Curator of that Museum, who has generously presented one of the specimens to me, besides many other rarities from the Burma region.

#### Family HESPERIIDÆ.

20. HESPERIA (?) CEPHALOIDES, n. sp., Pl. XIII, Fig. 4, ♂.

HABITAT: Karen Hills, Burma.

EXPANSE: ♂, 1·6 inches.

DESCRIPTION: MALE. **UPPERSIDE**, *both wings* dark purplish-brown;

*cilia* alternately black and white. *Forewing* with a large somewhat square spot at the end of the cell, a little larger rhomboidal one below it in the first median interspace, and a much smaller square one at the middle of the second median interspace, three small conjoined round subapical dots, of which the upper one is the largest, the middle one the smallest, all translucent white; an opaque dot touching the submedian nervure in the middle of the submedian interspace. *Hindwing* with three translucent white spots forming an equilateral triangle, of which the two at the base are the largest and equal, and the apical one is a mere dot. **UNDERSIDE**, *forewing* with a broad costal streak occupying the upper half of the discoidal cell and reaching to just beyond the middle of the wing, and an apical patch, bright chrome-yellow, between which streak and patch the ground-colour is castaneous, the rest of the wings black; the translucent white spots as on the upperside, but with two additional small black spots between the lowest of the subapical series and the spot in the second median interspace. *Hindwing* with the basal half of the wing chrome-yellow, the outer half castaneous; a small round castaneous spot near the base of the wing, the three discal translucent spots as on the upperside, but with two additional opaque round spots, one near the costa at the inner edge of the castaneous portion of the wing, the other in the middle of the submedian interspace, all five spots surrounded by a fine black line; there are traces of a series of blackish spots between the veins near the margin. *Head, thorax, and abdomen* black above, beneath, *legs, and palpi* chrome-yellow.

Very near to, but quite distinct from, *Hesperia cephalo*, Hewitson,\* a fairly common Sikkim species, from which it differs in its larger size, and in the following particulars:—the subapical series of spots on the forewing has the middle spot the smallest and the upper one the largest, while in *H. cephalo* the series is an increasing one; in *H. cephalo* the spot below these is in the lower discoidal interspace, in *H. cephaloides* it is in the second median interspace; on the hindwing, in *H. cephaloides* there are three small spots, in *H. cephalo* there are two only, both large, the outer one very large; on the underside in *H. cephalo* the costal yellow streak extends uninterruptedly from the base to the apex, in *H. cephaloides* it is interrupted by a large castaneous patch; in *H. cephalo* the hindwing is entirely yellow, in *H. cephaloides* the basal half only is yellow, the outer half being castaneous; the spots too are very different and in greater number and occupy different positions.

I am indebted to Mr. B. Noble, the Curator of the Phayre Museum, Rangoon, for the opportunity of describing this interesting species, of which he has obtained two specimens. They were captured

\* Ent. Month. Mag. vol. xiii, p. 152 (1876).

by the native collector attached to that institution in the Karen Hills in April, 1887.

21. PLESIONEURA LAXMI, n. sp., Pl. XIII, Fig. 5, ♂.

HABITAT: Upper Tenasserim.

EXPANSE: ♂, 1·8 inches.

DESCRIPTION: MALE. UPPERSIDE, *both wings* olive-greenish. *Forewing* with a very large quadrate spot filling the outer end of the discoidal cell and extending somewhat narrowly to the costa; a small quadrate spot near the base of the second median interspace; another quadrate spot below it fully four times as large, in the middle of the first median interspace; two dots placed obliquely in the submedian interspace, the upper one placed below the lower outer angle of the large spot in the interspace above; three subapical well-separated dots in a curved series, the upper one twice as large as the other two taken together—all these spots lustrous translucent white; an indistinct dark macular band, and two small black dots placed one above the other obliquely near the base of the submedian interspace. *Hindwing* rather paler than the forewing; a subcostal black spot placed near the base of the wing, two parallel discal black macular bands. UNDERSIDE, *both wings* ochreous-brown. *Forewing* marked as above, *Hindwing* with the bands broken up into spots and arranged thus:—a largish black spot in the discoidal cell, almost completely surrounded by a series of spots beginning with a moderate-sized one near the base of the subcostal interspace, a very large round one near its middle, then about eight small spots curving round to the base of the wing. *Cilia* brownish throughout. *Antennæ* ochreous-brown above, the hook black above, ochreous below. *Body and head* more or less concolorous with the wings above and below.

I possess a single specimen taken by Captain C. T. Bingham in March in the Thoungyeen Forests, Burma. It is nearest to *P. agni*, mihi,\* but the ground-colour of the upperside is entirely different, as are also many of the markings.

22. PLESIONEURA BASIFLAVA, n. sp., Pl. XIII, Fig. 7, ♂.

HABITAT: Travancore.

EXPANSE: ♂, 1·8 inches.

DESCRIPTION: MALE. UPPERSIDE, *both wings* dark glossy brown, with a slight vinous tinge. *Cilia* paler brown. *Forewing* with a pyramidal spot at the end of the cell, and a large somewhat rounded one below it in the first median interspace, both semi-transparent lustrous white. *Hindwing* unmarked. UNDERSIDE, *both wings* rather paler than above.

\* J. A. S. B., vol. lii, pt. 2, p. 87, n. 32, pl. x, fig. 4, female (1883).



*Forewing* marked as on the upperside. *Hindwing* with the basal third of the wing rich chrome-yellow. *Head* and *body* above concolorous with the wings, *palpi* and *thorax* below grey, *abdomen* cinereous.

I am indebted to Mr. Harold S. Ferguson for a single specimen of this remarkable species, which as far as I know has no near ally. He informs me that it was captured by a Mr. Atholl MacGregor, probably in March or April, 1880, at Pirmaad, and that Mr. MacGregor, who is now in England, possesses only one other specimen.

23. HIDARI BHAWANI, n. sp., Pl. XIII, Fig. 6, ♂.

HABITAT: Arracan Coast, Burma.

EXPANSE: ♂, 2·2 inches.

DESCRIPTION: MALE. UPPERSIDE, *both wings* ochreous-brown. *Forewing* with four lustrous semi-transparent pale yellow spots, one just beyond the middle of the cell much constricted in the middle, an oval one in the upper discoidal interspace, a squarish one near the middle of the second median interspace, and the last near the middle of the first median interspace, lunular; a small opaque spot in the submedian interspace touching the middle of the submedian nervure. *Hindwing* unmarked, but densely woolly towards the base. UNDERSIDE, *forewing* brown, the costa and the apex broadly pale ochreous more or less striated with fine brown lines; the four semi-transparent spots as above, but with two minute ones above the subapical spot divided by the fourth subcostal nervule; the spot in the submedian interspace larger and diffused. *Hindwing* pale ochreous, but with a dark brown streak parallel and near to the costa from the base to the outer margin, and the abdominal margin widely brown, the ochreous portion of the wing coarsely striated with brown. *Head* and *thorax* above clothed with long pale ochreous hairs, but with a line of dark brown hairs running down the middle; *abdomen* dark brown above; *palpi*, *thorax*, and *abdomen* pale ochreous beneath; *antennae* with the shaft pale ochreous above dark brown beneath, club pale ochreous anteriorly, fuscous posteriorly.

Described from a single specimen in Captain C. T. Bingham's collection taken by him in February, 1886. It cannot be mistaken for the other three species of the genus, *H. irava*, Moore, *H. sybirta*, Hewitson, or *H. staudingeri*, Distant, all of which occur in the Malay Peninsula.

24. COLADENIA HAMILTONII, n. sp., Pl. XIII, Fig. 8, ♂.

HABITAT: Sylhet.

EXPANSE: ♂, 1·6 inches.

DESCRIPTION: MALE. UPPERSIDE, *forewing* olive-greenish fuscous,

with two very irregular broad discal black fasciæ joined in the middle; three most minute transparent subapical dots, the uppermost the largest, placed at the outer edge of the anterior portion of the outer black fascia, a very minute similar spot in the second median interspace, a very attenuated spot across the middle of the first median interspace, both placed on the outer black fascia; the inner margin somewhat broadly irrorated with greyish scales; a submarginal indistinct broad blackish fascia. *Hindwing*, ground-colour much as in the forewing, but the outer third of the wing irrorated with gray scales; a recurved black macular decreasing band from the costa near the apex of the wing to the second median nervule; the disco-cellular nervules defined by a pale line. **UNDERSIDE**, *both wings* vinous-fuscous. *Forewing* with the transparent spots as above. *Hindwing* with the disc irrorated with whitish; the macular black band much as above; an anteciliary whitish line. *Cilia* fuscous.

The Rev. Walter A. Hamilton, after whom I have much pleasure in naming it, obtained a single specimen in Sylhet in the spring. It is quite unlike any species known to me, and I place it in the genus *Coladenia* only because it agrees in outline with *C. tissa*, Moore.

25. PARNARA UMA, n. sp., Pl. XIII, Fig. 9, ♀

**HABITAT**: Karen Hills, Burma.

**EXPANSE**: ♀, 2·0 inches.

**DESCRIPTION**: **FEMALE**. **UPPERSIDE**, *both wings* rich dark glossy brown, the base clothed with somewhat long greenish-ochreous setæ. *Cilia* ochreous-brown. *Forewing* with a spot in the discoidal cell divided in the middle by a fold of the wing, its upper portion lengthened, inwardly sharply pointed; three increasing conjoined subapical spots, the posterior one nearly twice as large as the other two taken together; a quadrate spot near the middle of the second median interspace, a larger one in the first median interspace placed exactly midway between the spot in the second median interspace and the lower portion of the cell spot, its outer edge highly excavated, its inner edge correspondingly rounded—all these spots shining translucent ochreous. **UNDERSIDE**, *both wings* brown strongly washed with vinous. *Forewing* with the spots as above but white instead of ochreous, the spot in the cell entire. *Hindwing* with a lengthened subcostal broad streak posteriorly bounded by the subcostal nervule and second subcostal nervule; a discal recurved transverse series of six quadrate spots, of which the two below the posterior end of the subcostal streak are the smallest, a similar but somewhat suffused spot near the base of the wing—the streak and spots all pure silvery. *Head* and *body* concolorous with the wings above,

*palpi* and *sternum* pale ochreous beneath, rest of body and legs concolorous with wings beneath.

A single specimen was obtained in April, 1887, in the Karen Hills by the native collector attached to the Phayre Museum, Rangoon, and I am indebted to Mr. B. Noble for the opportunity of describing it. It is a remarkable species with no near Indian ally, but appears to belong to the same group as the "*Hesperia*" *ornata* of Felder,\* from Buitenzorg, Java, a species which has the spots of the forewing on the underside smaller, and a double series of spots on the hindwing, as shewn in the figure.

## EXPLANATION OF THE PLATES.

## PLATE XIII.

- Fig. 1. *Neptis nana*, n. sp., ♂, p. 276.  
 ,, 2. *Papilio noblei*, n. sp., ♂, , p. 287.  
 ,, 3. *Zophoessa ramadeva*, de Nicéville, ♂, p. 274.  
 ,, 4. *Hesperia?* *cephaloides*, n. sp. ♂, p. 288.  
 ,, 5. *Plesioneura laxmi*, n. sp., ♂, p. 290.  
 ,, 6. *Hidari bhawani*, n. sp., ♂, p. 291.  
 ,, 7. *Plesioneura basistava*, n. sp., ♂, p. 290.  
 ,, 8. *Coladenia hamiltonii*, n. sp., ♂, p. 291.  
 ,, 9. *Parnara uma*, n. sp., ♀, d. 292.

## PLATE XIV.

- Fig. 1. *Zephyrus dohertii*, n. sp., ♂, p. 278.  
 ,, 2. ,, ,, n. sp., ♀, p. 279.  
 ,, 3. *Acesina aberrans*, n. sp., ♂, p. 279.  
 ,, 4. ,, ,, n. sp., ♀, p. 280.  
 ,, 5. *Zarona jasoda*, n. sp., ♂, p. 280.  
 ,, 6. *Aphnæns rukma*, n. sp., ♂, p. 281.  
 ,, 7. ,, *sani*, n. sp., ♀, p. 282.  
 ,, 8. ,, *rukmini*, n. sp., ♂, p. 282.  
 ,, 9. *Horaga albimacula*, Wood-Mason & de Nicéville, ♂.  
 ,, 10. ,, *rana*, n. sp., ♂, p. 283.  
 ,, 11. *Rapala tara*, n. sp., ♂, p. 284.  
 ,, 12. ,, *rosacea*, n. sp., ♂, p. 285.  
 ,, 13. ,, *buxaria*, n. sp., ♂, p. 285.  
 ,, 14. *Tajuria istroidea*, de Nicéville, ♂, p. 286.  
 ,, 15. ,, *donatana*, n. sp., ♂, p. 287.

\* Reise Novara, Lep., vol. iii, p. 515, n. 900, pl. lxxii, fig. 6, *male* (1866).

XI.—*A List of the Ferns of Simla in the N. W. Himalaya between Levels of 4,500 and 10,500 Feet.*—By H. F. BLANFORD, F. R. S.

[Received May 12th ;—Read June 6th, 1888.]

(With Plates XVI.—XXI.)

In the course of my summer residence at Simla during the last ten, and more particularly the last five, years, I have availed myself of such opportunities as have offered to collect and examine the materials for a list of the local ferns. The limits of my field of work have necessarily been determined by considerations of ready accessibility, and do not extend much below 4,500 feet on the one hand, nor above 10,500 feet on the other. I have, indeed, sometimes visited lower slopes and valleys both in the neighbourhood of Simla and in Chamba and the Jumna valley, but my examination of these lower levels has been too imperfect to admit of my attempting anything like so complete a list of their fern flora as for the range of elevations between the limits above specified. To the ferns occurring between 4,500 and 10,500 feet, therefore, this list is restricted.

In lateral extension, it takes cognizance of that portion of the Simla ridge which extends from the south-western limits of the station to the further side of Hatu, a distance by the Great Tibet Road of about 52 miles, but beyond the immediate neighbourhood of Simla my examination of the hill slopes has been restricted to levels above 8,000 feet.

As is well known, Simla stands on that ridge of the Himalaya which divides the drainage of the Sutlej from that of the Tonse and Jumna, the former a tributary of the Indus, the latter, of the Ganges, and is therefore a part of the main watershed of India. The outer hills, between Simla and the plains, are for the most part bare of forest, and the absence of shade and the dryness of the air which blows up from the plains during many months of the year are eminently unfavourable to plants so fond of coolness and moisture as the majority of the fern tribe. East of Simla, in the direction of the mountains, forests were at one time dense and vigorous, but for a distance of thirty miles most of those on the Simla ridge have now been either destroyed and cleared, or so far wasted and denuded of all their larger timber that, save where protected of late years, they present little more than stretches of brushwood and small coppice. A few remnants, however, still exist at Mashobra and Mahalu; and the northern faces and summits of Kumalhari and Hatu are still covered with magnificent forests, which afford rich ground for fern collectors and, indeed, botanists generally.

In the glens and valleys below Simla, destruction has been equally at work; and there can be little doubt that, 20 or 30 years ago, the fern



Chas. Fitch lith.

West, Newman & Co Imp.

ASPENIUM (DIPLAZIUM) TORRENTIUM. C.B. Clarke.









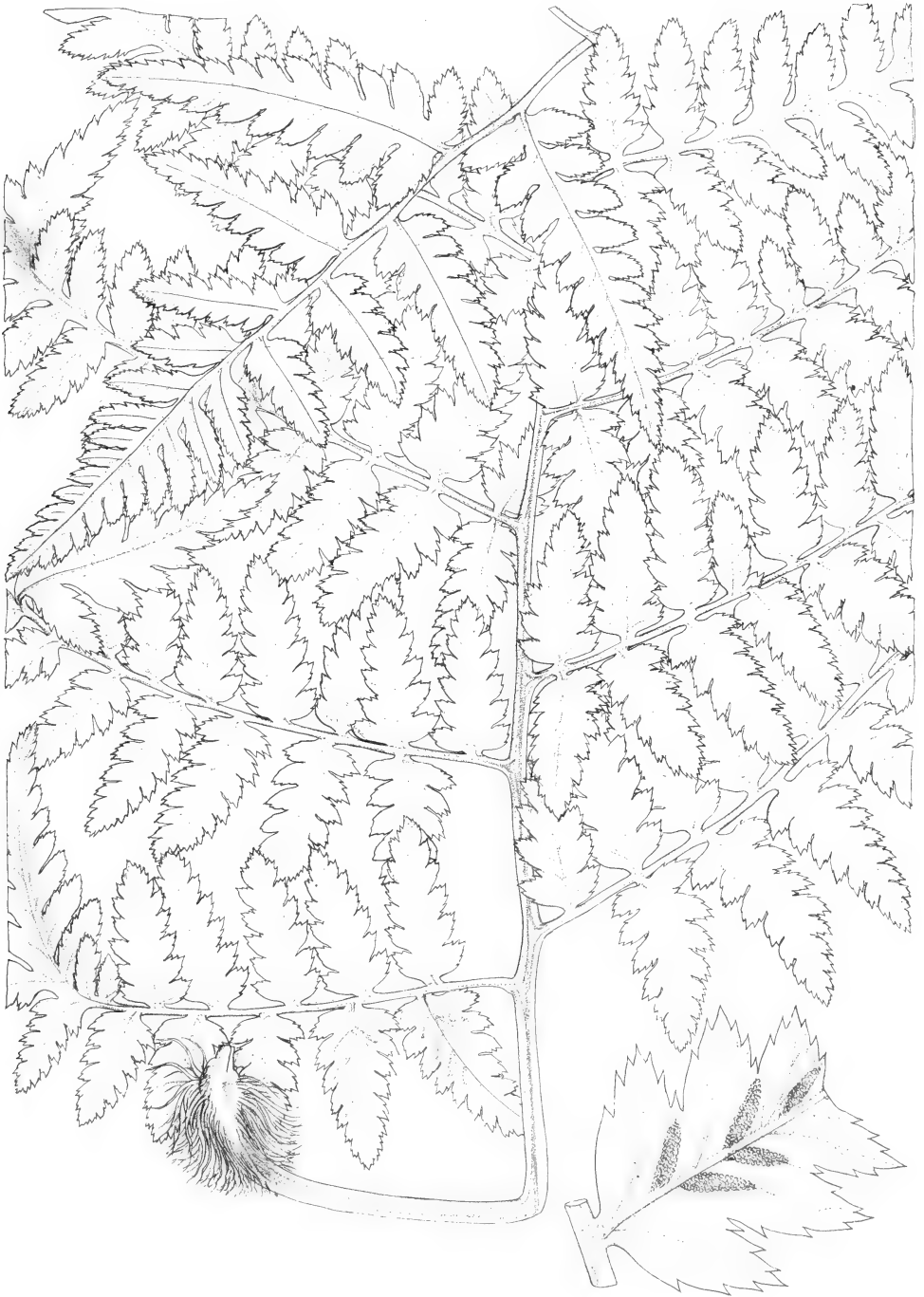

Cha. Fitch. del.

West, Newman & Co. imp.

ASPENIUM (DIPLAZIUM) LATIFOLIUM D. Don. var. FRONDOSA. Wall. sp.



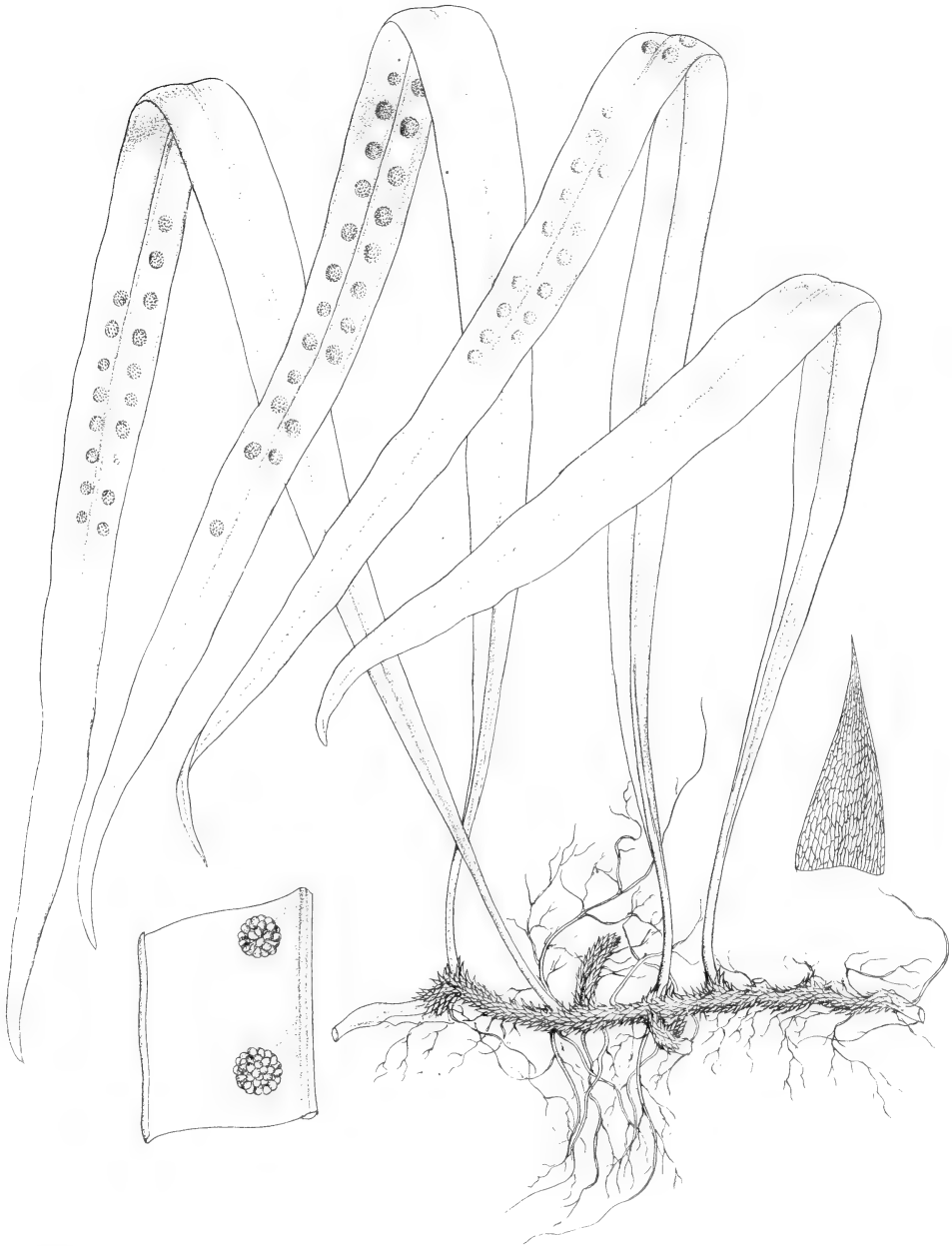

Cha. Fitch, lith.

West, Newman & Co imp.

POLYPODIUM (PHYMATODES) LINEARE. *Thunb*

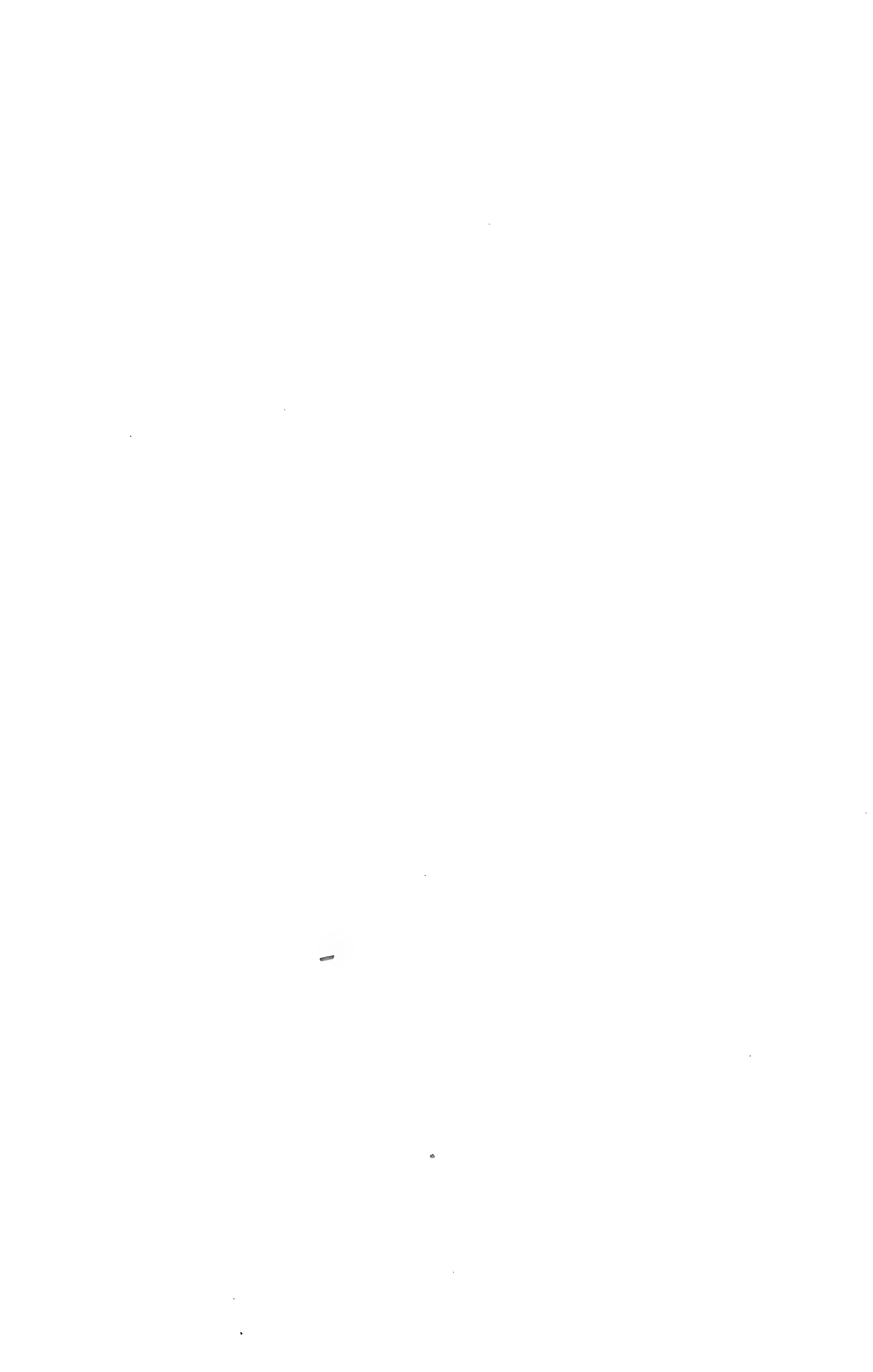

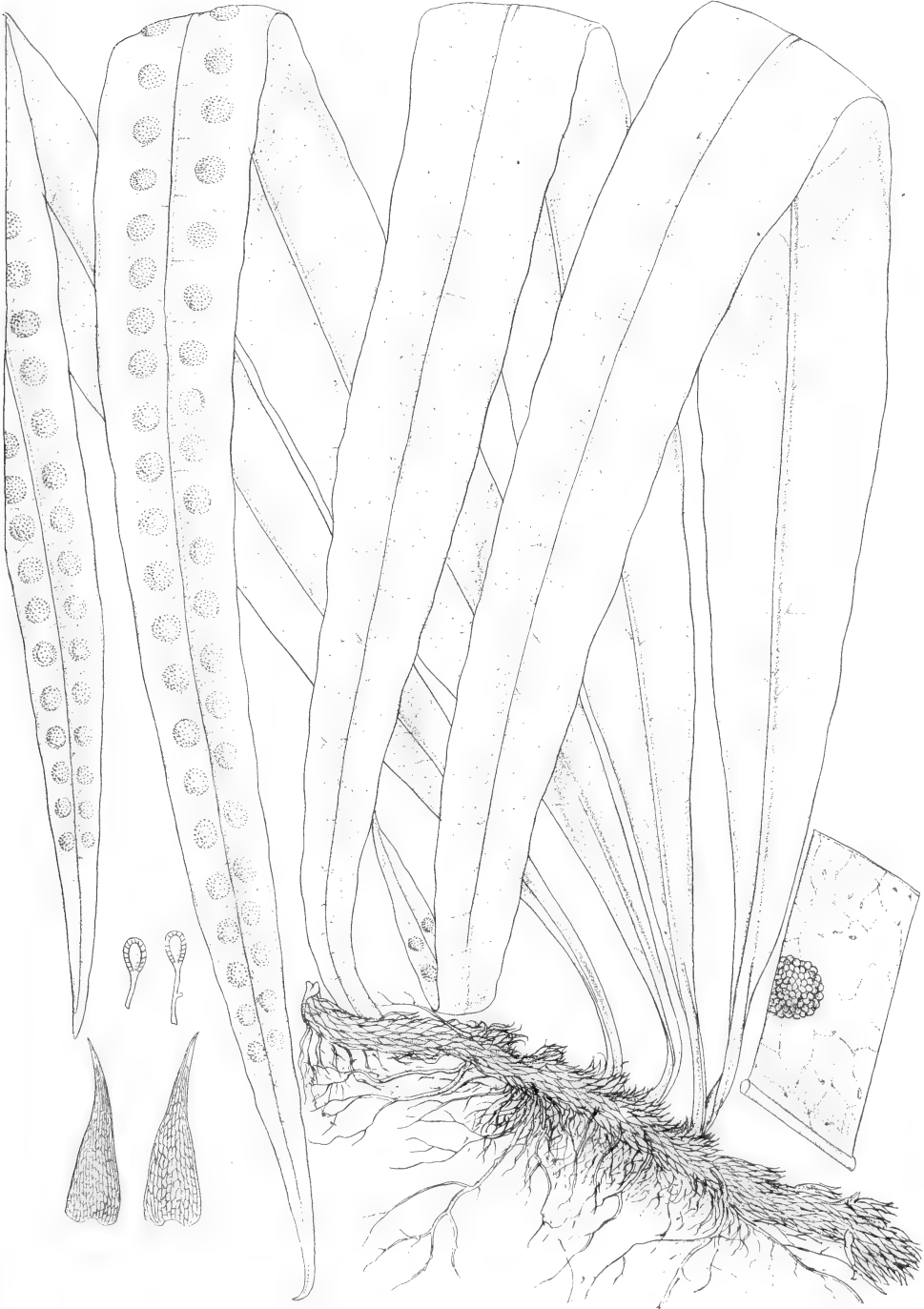

Chas. Fitch, lith.

West, Newman & Co. imp.

POLYPODIUM (PHYMATODES) SIMPLEX Swartz.



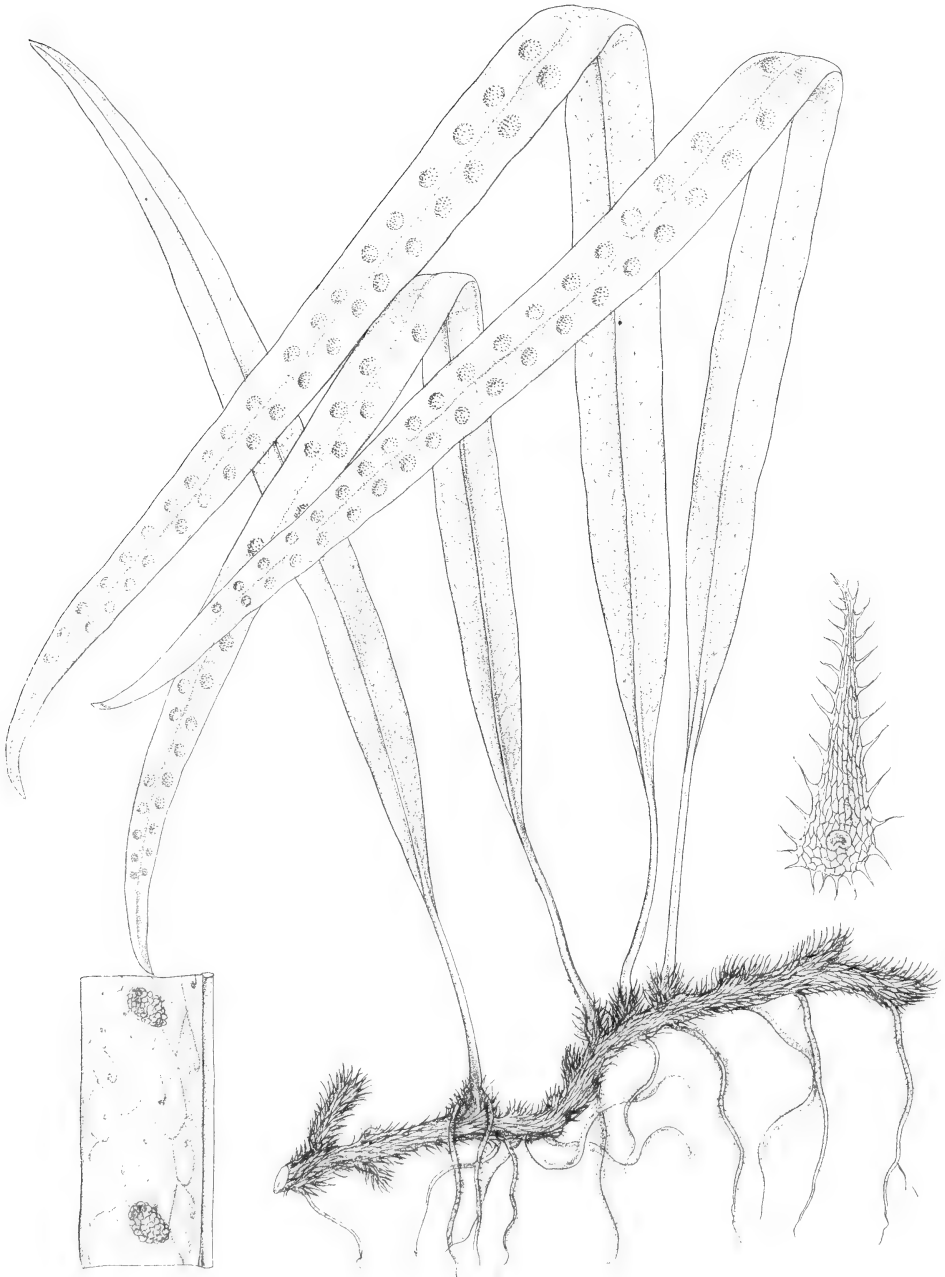

Cha<sup>s</sup> Fitch lith.

West, Newman & Co<sup>s</sup> imp.





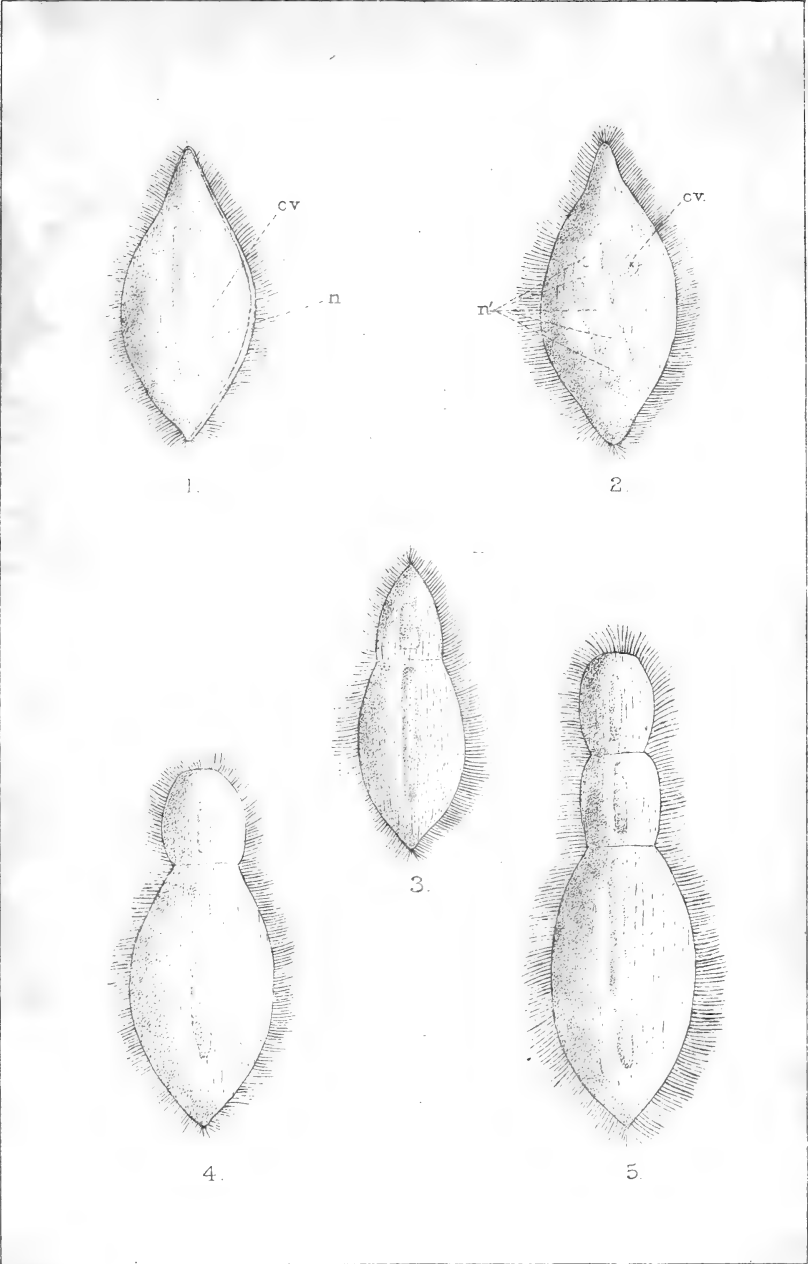

H.H.A. del.

A.T.Miller, Govt. School of Art, Calcutta. Lith.

ANOPLOPHERA ÆELOSOMATIS, n.sp.



flora of this neighbourhood was far richer in individuals and, to some extent probably, in species than it now is. In 1877 and 1882, in the course of a very superficial search, I obtained two or three species which I have since hunted for in vain; and, in a list of ferns collected between 1875 and 1877, drawn up by one who appears to have been a careful and competent collector, and published anonymously in the latter year, twenty-two other species and varieties are enumerated which I have not met with. Some few of these are doubtless from either lower or higher levels than those here adopted as limits, and one or two may be erroneous determinations, but it is very likely that several have since been extirpated.

The 1877 list enumerates 86 species and varieties; my own, not less than 101, and it therefore includes 37 which are not in the former; but 20 of these were not then described, or at all events had not been identified as Indian ferns, and some of them may possibly have been included under other and erroneous names. And five of my own list I consider as doubtfully distinct. It contains, therefore, but 12 distinct forms, well known as Indian in 1877, which escaped the former collector.

The names in the 1877 list which do not appear in mine, omitting those which have been changed, or which I have rejected, are the following :—

- Trichomanes auriculatum.*
- Cystopteris fragilis* (a high level form).
- Cheilanthes rufa* (a low level fern).
- Pteris longipinnula.*
- Asplenium heterocarpum.*
- A. tenuifolium.*
- A. Hohenackerianum.*
- A. oxyphyllum.*
- Nephrodium gracilescens.*
- N. thelypteris.*
- N. cochleatum* (a low level fern).
- N. Brunonianum* (a high level fern).
- N. barbigerum* (ditto).
- N. sparsum.*
- N. setigerum* (a low level fern).
- Polypodium appendiculatum.*
- P. punctatum.*
- P. adnascens* (possibly *P. fissum*).
- P. hiemiontideum.*
- P. propinquum* (perhaps *P. rivale*).
- P. juglandifolium.*
- Gymnogramme tolla.*

Of these, *T. auriculatum*, *Pt. longipinnula*, *Asp. heterocarpum*, *A. tenuifolium*, *Neph. gracilescens*, *N. setigerum*, *Pol. appendiculatum*, and *P. hiemiontideum* are not known from the N.W. Himalaya, and *Aspl. Hohenackerianum* not from Northern India, and some at least probably rest on erroneous identifications. *Cyst. fragilis*, *Cheil. rufa*, *Neph. cochleatum*, *N. Brunonianum*, and *N. barbigerum* are quoted either from higher or lower levels than those of my list. The others may either have disappeared of late years, or, if still existing in the neighbourhood of Simla, they have escaped my notice.

In the nomenclature of my list, I have generally followed Mr. Clarke's review of the ferns of Northern India, read before the Linnæan Society in June, 1879, and published in their Transactions; and I am indebted to Mr. Clarke and Dr. King for the identification of some forms, especially the *Diplaziums*, three of which I give on Mr. Clarke's authority. I should myself have considered these as mere forms of *Asp. polypodioides*, or perhaps rather *Aspl. umbrosum*. In a few cases, I have ventured to depart from Mr. Clarke's views, dividing specifically forms which he has associated, and associating others which he has, although with doubt, enumerated under different specific names. The following are the principal instances:—

*Adiantum Edgeworthii* is recognized as specifically distinct from *A. caudatum*. Col. Beddome has suggested the separation, and I fully concur with him.

Two varieties of *Cheilanthes farinosa* are separated from the type and so named. And *Cheilanthes Dalhousiæ*, as well as *Cheilanthes albomarginata*, are recognized as good distinct species. I have collected both largely and find them to be constant forms with no tendency to graduate into *Ch. farinosa*.

Wallich's *Asplenium (Athy.) tenuifrons* is separated from *A. nigripes*, the habit, elevation, range, and character of the habitat of the two being quite distinct.

Mr. Clarke's *Aspl. filix femina*, var. *polyspora* has since been recognized as identical with A. Brongniart's *Athy. Schimperii*, to which I have therefore referred it.

Wallich's *Athy. pectinatum*, which Mr. Clarke treats also as a variety of *A. filix femina*, is also separated. It has a creeping root-stock and in other characters is sufficiently distinct and characteristic.

Mr. Clarke's *Neph. filix mas*, var. *normalis* passes by such indefinite gradations into the form which he identifies with *N. rigidum* that it is impossible to separate them. This appears to have been more than surmised by Mr. Clarke himself.

The Simla fern which has been referred to *Neph. canum*, J. Smith,

is inseparable from *N. prolixum*, as also Mr. Clarke suspected; I learn from Mr. Baker that the original habitat of the type is unknown, and the Simla ferns do not correspond with it very closely. *N. canum* is therefore omitted from my list.

Lastly, I follow Col. Beddome in separating *Polypodium simplex* from *Pol. lineare*. The former is a thin-fronded, eminently perishable fern which shrivels up and disappears with the first breath of the dry northerly wind. The latter is a thick coriaceous fern which simply rolls up its fronds at the end of the rains and waits till the damp air and rain of the following monsoon once more unrolls them and restores their torpid vitality. *P. clathratum*, Clarke, is a third allied, but quite distinct, species very abundant in Simla.

There are a few other changes that, as the result of my own experience in the field, I should be inclined to make, but I have refrained in deference to Mr. Clarke's wider knowledge.

It is much to be desired that botanists should agree to some general rule to regulate specific distinction in dealing with forms so variable and yet presenting so few marked characters as ferns. At present, the practice of different describers is by no means uniform, and that which each follows is generally to be gathered only by inference from the results of his work. The rule which I have formulated for my own guidance is that, when two sets of forms which can readily be distinguished apart occupy the same or contiguous areas (if as far as is known they are not linked by intermediate forms either in these areas or in the interval between them), they should be recognized as distinct species, and such distinction would not be invalidated by the existence of a form possessing intermediate characters in some far distant region. On such grounds I base the separation of *Cheilanthes Dalhousiæ* from *Cheilanthes farinosa*, and *Adiantum Edgeworthii* from *A. caudatum*.

I attach much importance too to marked differences of habit such as have been noticed above in the case of *Polypodium lineare* and *P. simplex* (in this case, however, the two forms have a different venation also). And especially when these are accompanied with equally marked differences in the characters of the habitat and the range of elevation of the contrasted forms. Thus *Asplenium tenuifrons* differs from *A. nigripes*, not only in the manner of its growth, and the form and texture of the frond, but it is restricted to levels below 7,000 feet and the immediate neighbourhood of streams; whereas *A. nigripes* grows on well shaded hill slopes, only at elevations above 8,000 feet. In all these cases no intermediate forms are met with.

The following is a numerical generic summary of the species and varieties enumerated in this list.

|                     | Species. | Varieties. |
|---------------------|----------|------------|
| <i>Woodsia</i>      | 1        |            |
| <i>Dicksonia</i>    | 1        |            |
| <i>Trichomanes</i>  | 1        |            |
| <i>Davallia</i>     | 3        | 1          |
| <i>Adiantum</i>     | 6        |            |
| <i>Cheilanthes</i>  | 4        | 2          |
| <i>Onychium</i>     | 1        | 1          |
| <i>Cryptogramme</i> | 1        |            |
| <i>Pteris</i>       | 5        |            |
| <i>Woodwardia</i>   | 1        |            |
| <i>Asplenium</i>    | 21       | 3          |
| <i>Aspidium</i>     | 6        | 2          |
| <i>Nephrodium</i>   | 7        | 4          |
| <i>Oleandra</i>     | 1        |            |
| <i>Polypodium</i>   | 18       |            |
| <i>Notholaena</i>   | 1        |            |
| <i>Gymnogramme</i>  | 4        |            |
| <i>Osmunda</i>      | 2        |            |
| <i>Ophioglossum</i> | 1        |            |
| <i>Botrychium</i>   | 3        |            |
| Total               | 88       | 13         |

*List of Ferns collected in the Neighbourhood of Simla between the Levels of 4,500 and 10,500 Feet.*

1. *WOODSIA ELONGATA*, Hook.

Common on Kumalhari and Hatu, above 9000 ft. At Baghi, at the eastern extremity of Hatu, it occurs as low as 8,500 ft.

2. *DICKSONIA SCABRA*, Wall.

Rare. Found only at 5,800 and 6,000 feet below Simla.

3. *TRICHOMANES BIPUNCTATUM*, Poir.

Not common. My highest is 6,500 feet. Also on damp rocks and trees below Simla at 5,500 and 5,800 ft.

4. *DAVALLIA (LEUCOSTEGIA) IMMERSA*, Wall.

Very rare. Mentioned in the 1877 list. The only specimen I have seen is a barren frond found by Col. Collett at 5,800 ft.

5. *DAVALLIA (LEUCOSTEGIA) PULCHRA*, Don. sp.

The typical form, distinguished by its red rachis, obtuse segments and ovate scales of the rhizome is abundant on trees on Kumalhari and Hatu above 8,500 ft., but does not occur lower.

6. *DAVALLIA PULCHRA*, var. *pseudocystopteris*, Kunze sp.

Very abundant on trees at Simla between 5,500 and 8,000 ft. It is to be met with only in the rains, and blanches and shrivels up with the first northerly winds, about the beginning of September, except in damp ravines, where it lasts a few weeks later.

7. *DAVALLIA (STENOLOMA) CHINENSIS*, Swartz.

Rare. In two ravines below Chota Simla at about 5,000 ft. Clarke quotes it from Kumaon; but it is rare at Mussoorie.

8. *ADIANTUM LUNULATUM*, Burm.

At 4,500 ft. in the Sainal valley below Simla, but at no higher elevation. It ranges over the plains of India in damp places.

9. *ADIANTUM CAUDATUM*, L.

Common in damp situations by streams from 5,000 ft. downwards. Abundant in the Doons and Sivaliks.

10. *ADIANTUM EDGORTHII*, Hook.

Found in situations similar to the preceding, but at higher levels. It is not common, but I have gathered it in several ravines below Simla up to 6,000 ft.

11. *ADIANTUM CAPILLUS VENERIS*, L.

Common on damp rocks by streams below 6,000 ft. In the arid climate of Beluchistan, it grows in the subterranean water-courses (termed *karezes*) used for irrigation.

12. *ADIANTUM VENUSTUM*, L.

One of the commonest and most abundant ferns of Simla, covering banks and sloping ground in shady places, and ranging from 4,500 ft. up to the top of Hatu at 10,500 ft.

It varies much in cutting, being either 2- or 4-pinnate. Also in the shape and size of the ultimate pinnules, which vary from narrowly

cuneate to rhomboidal and transversely elliptical, being broader than deep. Both series of forms occur throughout the range. The sori are generally orbicular reniform with a deeply notched margin; but sometimes oblong with a straight margin.

### 13. ADIANTUM PEDATUM, L.

Rare. I have found it only on the north face of Hatu, at elevations of 8,500 and 10,000 ft. This last is nearly 1,000 ft. higher than Clarke's and Beddome's highest assigned range.

### 14. CHEILANTHES SUBVILLOSA, Hook.

Chiefly above 8,000 ft. But I have found stragglers as low as 7,300 ft. on Jako. It is common in the neighbourhood of Matiana and Nagkanda, on the bank by the roadside.

### 15. CHEILANTHES DALHOUSIÆ, Hook.

Quite distinct from *C. farinosa*, and subject to little variation. Its range is from 7,800 ft. to the highest visited (10,500 ft.). Fine specimens are to be found on Jako, though not common. It is more abundant on Kumalhari and Hatu.

It appears to be restricted to the Himalaya, and is most abundant in the N. W. Himalaya. In Sikkim it appears to be rare, but Sir J. Hooker gathered it at 10,000 ft. on Lacheely, and Mr. Levinge found it growing plentifully on Sinchal close to Darjiling at 8,000 ft. He agrees with me as to its specific value. The following is a description of its distinctive characters.

Stipes 2 to 4 ins. long, shorter than the frond, naked or with a few lax spreading scales near the base. Fronds 6 to 9 inches long, 2 to 4 inches broad, acute lanceolate, without white powder at any stage of growth. Lower two pairs of pinnæ subequal. Segments narrow. Lines of sori interrupted at the sinus. Involucres even, crenate or toothed on the margin, hardly lacerate.

### 16. CHEILANTHES ALBO-MARGINATA, C. B. Clarke.

Very abundant in and around Simla, covering the roadside banks and old stone retaining walls. Range from 4,800 ft. (my lowest) up to 8,500 ft., above which it is replaced by *Ch. Dalhousiæ*. Like that species it appears to be restricted to the Himalaya and chiefly to the N. W. Himalaya, though I learn from Mr. Levinge that his native collector brought him a specimen from the interior of Sikkim. A *Cheilanthes* which occurs on the Khasi hills, also Mount Abu and the Nilgiris, and



has been referred to this species, is that which I describe below as *Ch. farinosa*, var. *anceps*. The following is a description of *C. albo-marginata*, which is well represented in the figure Plate 52 of Mr. Clarke's Review, except that the scaliness of the costæ and veins is not fully shown.

Stipes 4 to 10 ins. long, generally shorter than the frond, bearing throughout dark linear lanceolate scales with pale translucent margins. Similar scales extend to the primary and secondary rhachises and costæ. Fronds up to 11 inches long, acute deltoid, under surface naked or in the young state, and in the small fronds that persist through the dry season, thinly coated with yellowish white powder. Lowest pair of pinnæ generally the longest. Segments oblong. Lines of sori scarcely interrupted at the sinus. Margins of involucre highly lacerate.

It is always readily distinguishable from other allied forms by the presence of scales on the veins and costæ, and by the highly lacerate involucre.

#### 17. CHEILANTHES FARINOSA, Kaulf, var. *typica*.

This is very abundant in the Sivaliks and Doons and in the deeper valleys of the outer Himalaya up to 4,000 ft. In the neighbourhood of Simla, it may be found as high as 5,000 ft., above which I have not met with it. The following characters distinguish it from other allied forms.

Stipes up to 12 ins. long, generally longer than the frond, deep red brown, naked or with a few linear scales, near the base only. Frond deltoidly lanceolate, acute to acuminate, up to 8 ins. long and 5 ins. broad, always thickly coated beneath with white powder. Lowest pair of pinnæ always the longest. Segments narrow. Sori continuous round the sinus. Margins of involucre entire, uneven or toothed, not lacerate.

This form ranges all over India. I have collected it at Pachmari at 3,000 ft., and I have specimens from the Khasi hills at 3,000 and 5,000 ft., and from the Nilgiris up to 6,000 ft.

#### 18. CHEILANTHES FARINOSA, var. *anceps*\* nov.

This has been frequently confounded with *Ch. albomarginata*. It appears to have as wide a range in India as the typical variety. In the North-West Himalaya, it has a well defined, but restricted, range of elevation, viz., from 3,500 to 6,000 ft., and is common below Simla between 4,500 and 5,000 ft. Its characters are as follow :—

\* This was described as *C. anceps* in a paper entitled, 'The silver Ferns of Simla and their Allies, read before the Simla Natural History Society, June 25th, 1886.

Stipes thick up to 8 ins. long, little longer or shorter than the frond, dark chestnut to almost black, bearing, generally throughout, dark linear lanceolate scales, with pale margins, which often extend to the principal rachis, but not beyond. Frond lanceolate to oblong lanceolate. Under surface always thickly coated with white powder. Lowest two or more pairs of pinnæ subequal, rather distant. Involucres narrow, with toothed or lacerate margins.

Readily distinguished from the typical form by the shortness of the lowest pair of pinnæ, and the greater extension of the scales. In large well grown fronds, the lower three or four pairs of pinnæ are nearly equal, and the form of the frond approaches that of *Ch. subvillosa*. Specimens collected by Mr. Clarke in the Khasi hills present the same characters as those of the N.-W. Himalaya. I have specimens also from Mt. Abu, collected by Dr. King, and from the Nilgiris at 4,000 ft. and 6,000 ft., collected by Mr. Gamble.

#### 19. CHEILANTHES FARINOSA, var. *grisea*\* nov.

This is an alpine form which I have met with only between Nágkanda and Bághi at 8,300 to 8,500 ft. Mr. Gamble has collected it on Sinchal near Darjiling at 8,000 ft.

Stipes slender, 2 to 6 ins. long, light brown, naked or bearing a few thin brown and translucent lanceolate scales (not white margined) near the base. Fronds dimorphous. One form narrow lanceolate 4 to 5 ins. long,  $1\frac{1}{2}$  to 2 ins. broad, thin papyraceous. Lower 3 or 4 pairs of pinnæ sub-equal distant. Under surface thickly coated, upper surface sprinkled with white powder. Segments narrow oblong. The other form ovate lanceolate. Pinnæ close, triangular. Lower two pairs equal. Both forms fertile. Involucres as in typical variety.

These last five forms of *Cheilanthes* form a natural group, probably descended from the same parent form. *C. Dalhousiæ* and *C. albomarginata* are sufficiently distinct to be regarded as species. The two last enumerated approach the typical form more nearly and may conveniently be treated as varieties. With respect to the dimorphism of var. *grisea*, it would appear that the typical variety sometimes shows a similar tendency, as Mr. Clarke has communicated to me specimens from Shillong which he has noted as var. *subdimorpha*.

#### 20. ONYCHIUM JAPONICUM, Kunze.

The type form is very rare at Simla. It has been found near Mas-

\* Originally described as *Cheil. grisea*, nob.

hobra at about 6,000 ft. I have gathered it also in the Ravi valley near Chamba, a hundred miles further to the north-west.

21. *ONYCHIUM JAPONICUM*, var. *multisecta*, F. Henderson.

This is one of the commonest Simla ferns, growing abundantly, on the ground, both in forest and on the open hill side. It has a creeping root-stock. Its range at Simla is from 6,000 to 9,000 ft.

22. *CRYPTOGRAMME CRISPA*, R. Br.

On rocks by the roadside between Nágkanda and Bághi at about 8,300 ft.

23. *PTERIS CRETICA*, L.

Very abundant in certain parts of Simla, especially on the Sutlej side of the spur, between 5,500 and 6,500 ft. It disappears above 8,000 ft.

24. *PTERIS LONGIFOLIA*, L.

This is a fern of the plains, abundant in and about Calcutta. I have found it below Simla at 4,800 ft., but this is above its ordinary range.

25. *PTERIS QUADRI-AURITA*, Retz.

Tolerably common in damp sheltered places up to 8,600 ft., which is a higher range than that given by Clarke and Beddome (7,000 ft.). The Simla form is pretty constant. It has 14 or 15 pairs of sub-opposite pinnae; either the lowest only, or the lowest 3 or 4 pairs bipartite.

26. *PTERIS EXCELSA*, Gaud.

Very rare. Apparently restricted to well shaded spots by the margin of streams. I have collected it in two places at 5,500 and 5,800 ft., but I have not met with it during the last four years, the original sites having been devastated by wood-cutters and cattle, or exhausted by collectors.

27. *PTERIS (PIESIA) AQUILINA*, L.

This world-wide fern occurs down to 5,500 ft. below Simla, and it ranges up to between 9,000 and 10,000 ft. Very common at 8,000 ft. along the Great Tibet Road.

28. *WOODWARDIA RADICANS*, Smith.

Common on steep, well shaded banks, close to streams, below 5,500 ft.

29. *ASPENIUM ENSIFORME*, Wall.

Very rare. I have not met with it myself, but it is mentioned in the anonymous 1877 list, and was found last year by the late Col. Crookshank near Bāghi at about 6,000 ft.

30. *ASPENIUM ALTERNANS*, Wall.

Very common on rocks and stony banks from my lowest levels (4,500 ft.) up to about 8,000 ft. The largest fronds I have seen do not exceed 9 ins. in length, whereas I have specimens from Sikkim, where Clarke says it is rare, fully one foot long.

31. *ASPENIUM TRICHOMANES*, L.

Also a very common fern. Found in situations similar to the preceding from 5,000 up to 9,000 ft.

32. *ASPENIUM LONGIFOLIUM*, Don.

Found growing on rocks, by streams, in well shaded ravines below 6,000 ft. Clarke and Beddome give the range at 6,000 to 8,000 ft., but I have never met with it above 6,000 ft. It is nowhere a common fern.

33. *ASPENIUM UNILATERALE*, Lamk., var. *udum*, Atkinson.

I know of only one locality near Simla for this fern, viz., below the Chadwick falls at 5,800 ft. The normal form does not occur at Simla.

34. *ASPENIUM LACINIATUM*, Don., var. *depauperata*, Clarke.

Not common. Found in the same localities as *A. longifolium* and in similar situations. Mr. Clarke describes this variety as having small fronds, and Col. Beddome thinks it is only a starved form. In general, the fronds are small, not exceeding 6 or 7 inches, including the stipe. But I have specimens, differing in no respect from these except in size, which are over 12 inches in length, equal to the average of the planicaule variety.

35. *ASPENIUM FONTANUM*, Bernh., var. *exiguum*, Bedd.

Rare in the neighbourhood of Simla. I have found it on rocks at 6,800 ft. and 7,500 ft.

36. *ASPLENIUM VARIANS*, Hook. and Grev.

Not uncommon, but nowhere abundant. Ranges from 4,800 ft. up to 10,500, at which elevation it was gathered by Dr. Watt on the top of Hatu.

37. *ASPLENIUM (ATHYRIUM) ATKINSONI*, Clarke, var. *Andersoni*.

Abundant in certain places on Hatu and Kumalhari at elevations of 8,500 ft. and upwards. Grows on the ground under trees, not in thick shade.

38. *ASPLENIUM (ATHYRIUM) THELYPTEROIDES*, Michx.

Abundant about Nágkanda 18,500—9,500 ft, covering the hill-side in the forest with circular tufts of fronds from 2 to 3 ft. in length.

39. *ASPLENIUM (ATHYRIUM) MACROCARPUM*, Hook.

Very rare. I have never met with it myself. But it was collected last year by a Simla resident a little below the Simla bazar, I believe, about 7,000 ft. or rather lower.

40. *ASPLENIUM (ATHYRIUM) MACROCARPUM*, var. *Atkinsoni*, Hkr. & Bkr.

Also very rare. I have found it only at the Chadwick falls at 5,820 ft., and not at all during the last two or three years.

41. *ASPLENIUM (ATHYRIUM) SCHIMPERI*, A. Br.

*A. filix fœmina*, var. *polyspora*, Clarke.

This species, hitherto known as such only from Africa, is identical with the fern described by Mr. Clarke under the above synonym, as identified with his type in the Kew herbarium. It is one of the commonest and most abundant of the Simla ferns in the rains. It covers the ground beneath the oak trees on Jako and Mashobra hill, and the more open glades of the Elysium spur, and it ranges from the bottom of the Jaru-ka-nál ravine (5,500 ft.) to the top of Hatu (10,500 ft.). It occurs also at Mussoorie, but I have seen no specimens from any place further east. Mr. Clarke gives its range as from Kumaon to Chumba.

Except in the width of the fronds, which vary from lanceolate to deltoid lanceolate, the characters are very constant. Large specimens from Nágkanda are 2-pinnate. It is readily distinguishable from other *Athyria* by the creeping root-stock, combined with large horse-shoe shaped sori, and by the basal portion of the stipe being of a deep purple

colour, with brown lanceolate scales. Also by the greatly reduced pair of basal pinnæ.

42. *ASPLENIUM (ATHYRIUM) NIGRIPES*, Mett.

The typical form of this fern is common on the partially shaded banks and hill sides, on the northern face of Kumalhari and Hatu, at elevations between 8,000 and 9,500 ft., but not nearer Simla. There are rarely more than 2 or 3 fronds on the rhizome, and they are firm in texture and, in general, nearly as broad as long.

43. *ASPLENIUM (ATHYRIUM) TENUIFRONS*, Wall.

Mr. Clarke regards this as merely a form of *A. nigripes*. In this view I cannot agree with him; differing as it does so greatly in habit and habitat, while neither exhibits a great range of variation. It is restricted to well shaded ravines, growing in the beds of streams at elevations below 7,000 ft. The fronds, numbering 4 or 5 or more, form a circular tuft on the short erect rhizome. They vary in form from ovate lanceolate to acute lanceolate, and the width of my broadest specimen is less than half the length of the frond; in the narrowest it is less than one-fourth. The texture is thin and the upper surfaces of the partial rachises and costæ bear long glandular filaments. The colour of the frond in the fresh state is bright green, forming a beautiful contrast with the delicate pink tint of the rhachis and stipe. It is no doubt near *A. Clarkei*, and apparently grows in similar situations, but the fronds are broader and never root at the ends.

44. *ASPLENIUM (ATHYRIUM) FILIX FEMINA*, Bernh., var. *dentigera*, Clarke.

Abundant on the northern face of Hatu and Kumalhari between 8,500 and 10,000 ft. The fronds grow in a circular tuft from an erect rhizome, attaining a length of 2 or 3 feet.

45. *A. FILIX FEMINA*, var. *retusa*, Decne., subvar. *elongata*, Clarke.

I name this form from Mr. Clarke's type in the Kew herbarium. Many of the sheets so marked by him are from the neighbourhood of Simla. This fern is abundant on Kumalhari above Matiana up to 10,000 ft. Also on the roadside between Theog and Martiana at 8,000 ft., growing chiefly in rock crevices. The stipes are densely tufted on a decumbent root-stock; the fronds generally drooping. In mode of growth, and indeed in most of its characters, it differs so greatly from the preceding that it should, I think, be distinguished as a species.

46. *ASPLENIUM* (*ATHYRIUM*) *PECTINATUM*, Wall.

Not uncommon in damp ravines below 6,000 ft. It has, as a rule, a creeping root-stock, but the stipes are sometimes, though rarely, tufted. The partial rhachises and costæ bear glandular filaments like *A. tenuifrons*. It ranges down to at least 4,500 ft., generally growing near streams, and I have found it as high as 6,000 ft., or 1,000 ft. higher than Clarke's highest assigned range.

47. *ASPLENIUM* (*DIPLAZIUM*) *JAPONICUM*, Thunb.

Rare. I have found it only at the Chadwick falls at 5,800 ft.

48. *ASPLENIUM* (*DIPLAZIUM*) *TORRENTIUM*, Clarke.

## Plate XVI.

I give this on Mr. Clarke's authority, who identified my specimens with the remark that "they are *A. torrentium* exactly as we have it in Sikkim." For my own part, I had regarded it as merely a simple form of the next following species, growing in exactly the same situations. It is rare, as I have met with it twice only at elevations of 4,500 ft. and 5,800 ft.

49. *ASPLENIUM* (*DIPLAZIUM*) *POLYPODIOIDES*, Mett.

Among boulders in the beds of streams below 6,000 ft., a *Diplazium* with large bipinnate fronds is common in all the valleys around Simla. The caudex is not erect but decumbent with tufted stipes. My impression is, and always has been, that, despite some variation in the form of the segments and the length of the sori, they are all of one species. But Mr. Clarke, whose much wider experience gives him an authority to which I cannot pretend, has examined my collections with the result that, in addition to *A. torrentium* and *A. polypodioides*, *ferè typica*, he identifies the two following.

50. *ASPLENIUM* (*DIPLAZIUM*) *LATIFOLIUM*, Don. var. *polymorpha*, Wall. sp.

## Plate XVII.

From three localities varying from 4,500 ft. to 6,000 ft.

51. *ASPLENIUM* *LATIFOLIUM*, var. *frondosa*, Wall. sp.

## Plate XVIII.

From two localities at 4,500 ft. and 5,500 ft. respectively.

52. *ASPIDIUM* (*DIPLAZIUM*) *MULTICAUDATUM* ? Wall.

This identification is open to some doubt. The only specimens I have were collected in 1877 and 1882, at elevations of 4,500 ft. and 5,000 ft., and are without rhizomes. Both Dr. King and Mr. Clarke are of opinion that they are probably this species, and it certainly occurs no farther off than at Mussoorie. I include it therefore provisionally in my list.

53. *ASPIDIUM* (*POLYSTICHUM*) *AURICULATUM*, L., var. *cæspitosa*, Wall.

Very rare within my limits of elevation and area, though Mr. Clarke gives its range as from 4,000 to 8,000 ft. I have found it but once at 4,800 ft.

54. *ASPIDIUM* (*POLYSTICHUM*) *ILICIFOLIUM*, Don.

I am very sceptical as to the claim of this fern to specific rank. It appears to me to be an alpine form of *A. aculeatum*, which grows on rocks, and graduates into var. *rufo-barbata*. I believe Mr. Clarke and Col. Beddome hold the same view. Very characteristic specimens of the simply pinnate form occur on the rocks about Nágkanda between 8,000 and 9,000 ft., and small specimens may occasionally be found at Mahasu and Mashobra at about the same lower level. The bipinnate form, which forms the first step of the passage into *A. aculeatum*, is common at the same elevation.

55. *ASPIDIUM* (*POLYSTICHUM*) *THOMSONI*, Hook.

This is rather a rare fern. Col. Collett has collected it as low as 7,500 ft., and I have met with it myself at two or three localities from 8,000 to 10,000 ft.

56. *ASPIDIUM* (*POLYSTICHUM*) *ACULEATUM*, Swartz.

Common; ranging from the lowest to the highest level visited (4,500 to 10,500 ft.). The low level forms differ from the higher in having the stipe and rachis clothed with dark hair-like scales, without pales; whereas those above 8,000 ft. have thin pale linear scales sparsely intermingled with dark brown pales.

57. *ASPIDIUM* (*POLYSTICHUM*) *ACULEATUM*, var. *lobata*, Hook.

At all levels, but not common.

58. *ASPIDIUM ACULEATUM*, var. *rufo-barbata*, Wall.

From 5,000 to 9,500 ft. Common from 6,000 to 8,000 ft.



59. *ASPIDIUM* (*POLYSTICHUM*) *PRESCOTTIANUM*, Wall.

Abundant on Hatu, growing in dense masses on the hill side between 9,500 and 10,500 ft.; associated with *A. filix femina*, var. *dentigera*; *N. filix mas*, var. *fibrillosa*; *Osmunda Claytoniana*, &c.

60. *ASPIDIUM* (*CYTOMIUM*) *FALCATUM*, Swartz, var. *caryotideum*, Wall.

Very rare. The one or two known localities are rocky ravines between 5,000 and 6,500 ft.

61. *NEPHRODIUM* (*LASTREA*) *PROLIXUM*, Baker.

Common in ravines below 6,000 ft. I include herewith the forms from Simla that have been referred to *N. canum*, the type of which is a specimen of unknown origin, grown at Kew and having submarginal sori.

62. *NEPHRODIUM* (*LASTREA*) *FILIX MAS*, Richd., var. *normalis*, Clarke.

One of the commonest ferns in and about Simla, in partially shaded spots, at all elevations above 5,000 ft. Above 8,000 ft., the stipe and rachis become more scaly, the pinnules more acute and deeply cut, the frond being sub-tripinnate. These are the forms referred by Mr. Clarke to *N. rigidum*, but there is a complete passage from the simpler to the more compound forms. All have the under surface of a pale bluish tint, which distinguishes them from var. *marginata* at lower levels.

63. *NEPHRODIUM FILIX MAS*, var. *patentissima*, Wall. sp.

Only the small form mentioned in Mr. Clarke's review occurs in the neighbourhood of Simla, and this only at elevations above 8,000 ft. It is not uncommon about Nágkanda and on Hatu, and seems to pass into var. *fibrillosa*, to which, as pointed out by Col. Beddome, it is nearly allied.

64. *NEPHRODIUM FILIX MAS*, var. *fibrillosa*, Clarke.

Very abundant on Kumalhari and Hatu above 8,500 ft., ranging up to 10,500 at least.

65. *NEPHRODIUM FILIX MAS*, var. *Schimperiana*, Hochst, sp.

Rare below 7,000 ft., but very common, and in places abundant, between that and 9,000 ft. on Jako, Mashobra, and Mahasu hills, and along the Tibet Road about Matiana and Nágkanda, in situations similar to those of var. *normalis*. It attains a large size, fronds of 2 and 3 ft. being

not rare. I cannot agree with Col. Beddome in regarding this as passing into var. *marginata*. On the contrary, I should be inclined to regard it as specifically distinct from all varieties of *N. filix mas*.

66. *NEPHRODIUM FILIX MAS*, var. *marginata*, Wall.

Clarke gives the range of this fern as from 6,000 to 9,000 ft. At Simla, according to my experience, 6,000 ft. is the higher, not the lower limit, and all the bipinnate forms allied to *N. filix mas* that I have collected at higher elevations are those above referred to under var. *normalis*. The fern here referred to appears to be identical with the *N. elongatum* from Southern India. I have collected it in several valleys below Simla between 5,000 and 6,000 ft., and below Mussoorie and Dalhousie at about 5,000 ft., or rather lower. It is generally found in wooded ravines in the immediate neighbourhood of streams. It does not seem to me to be very near any variety of *N. filix mas*. It differs from the compound forms of var. *normalis* by its more herbaceous texture and darker colour, never having the pale bluish tint of the under surface so characteristic of that and other varieties of *N. filix mas*.

In the dry state, when much of its characteristic habit is lost, it bears some resemblance to the high level ferns referred by Mr. Clarke to *N. remotum*, but I cannot admit any close affinity. There is an interval of 2,500 ft. between the upper limit of the present form and the lower limit of *N. remotum*. Although some specimens of the two resemble each other in shape, in general, those of var. *marginata* are broader and less oblong. Their texture is thicker and their cutting though similar in character is coarser and larger. *N. marginata* never bears the black scales which are abundant on the stipe and rhachis of *N. remotum*. The veins are more prominent and the sori less close to the midrib. Although these characters, thus stated in detail, are doubtless critical, taken all together they constitute a difference of habit which, in conjunction with the difference of range, seems to me to indicate specific distinction.

67. *NEPHRODIUM (LASTREA) REMOTUM*, Clarke.

I adopt Mr. Clarke's name for this fern, without implying acquiescence in the view that it is identical with the European prototype. The fern here referred to is common about Nágkanda at elevations between 8,300 ft. and 9,500 ft., but does not occur nearer Simla. It is a thin-textured fern, some of the characters of which have been noticed under the preceding.

68. *NEPHRODIUM (LASTREA) CRENATUM*, C. B. Clarke.

Clarke and Beddome assign to this species a range from 2,000 up to 7,000 ft. in the Himalaya. It is nowhere common within the limits here adopted. I have met with it as high as 7,500 ft.; otherwise only at the lowest levels visited. It is, however, common lower down on the hills between 3,000 and 4,000 ft. as in the Jumna valley, and below Chakrata, always growing in rock crevices.

69. *NEPHRODIUM (LASTREA) BORYANUM*, Hk. and Bk.

Not uncommon in well shaded ravines below 6,000 ft.

70. *NEPHRODIUM PARASITICUM*, L.

Not met with above 5,000 ft.; but common in the deep valleys at 4,500 ft. and below. It is a glabrous form, producing fronds up to 3 ft. long.

71. *NEPHRODIUM PENNIGERUM*, Hook., var. *multilineata*, Clarke.

Mr. Clarke does not include the N.-W. Himalaya in the range of this species. It occurs, however, together with the preceding at the lowest levels visited below Simla, and I have it also from Mussoorie collected by Mr. C. W. Hope, and from below Chakrata.

72. *OLEANDRA WALLICHII*, Presl.

Not common, but locally abundant, growing on perpendicular rock faces between 5,500 and 6,000 ft.

73. *POLYPODIUM (PHEGOPTERIS) ERUBESCENS*, Wall.

On steep shady banks by streams at the bottom of some of the deep valleys below Simla, where it is pretty common. My highest elevation is about 5,500 ft.

74. *POLYPODIUM (PHEGOPTERIS) AURICULATUM*, Wall.

Very rare in the neighbourhood of Simla. I have met with it but once, *viz.*, in 1882 in the Sámal valley at 4,500 ft.

75. *POLYPODIUM (PHEGOPTERIS) DISTANS*, Don.

Common in ravines, down to my lowest level, and up to nearly 10,000 ft. At the former limit the fronds are small and narrow, with short, distant pinnae and the root stock decumbent, hardly creeping.

Above 7,500 ft. the fronds grow to 3 and 4 feet in length broadly lanceolate and with close-set pinnæ 2 inches broad; the pinnæ cut down square to a winged rhachis; segments deeply pinnatifid. Some specimens of these latter have a creeping rhizome.

76. *POLYPODIUM (PHEGOPTERIS) DRYOPTERIS*, L.

I have not met with this myself, but Dr. Watt collected it at Bâghi at 9,000 ft.

77. *POLYPODIUM (GONIOPTERIS) MULTILINEATUM*, Wall.

Not uncommon in the Glen and some other wooded ravines below 6,000 ft. The pinnæ are narrow. It ranges nearly 1,000 ft. higher than Mr. Clarke's assigned upper limit (5,000 ft.).

78. *POLYPODIUM (GONIOPHLEBIUM) AMÆNUM*, Wall.

Common in damp shady places on rocks and rocky banks, generally near streams; at all levels between 5,500 and 8,500 ft.

79. *POLYPODIUM (GONIOPHLEBIUM) LACHNOPUS*, Wall.

Not very common. Found on trees and rocks in shady ravines below 6,000 ft.

80. *POLYPODIUM (GONIOPHLEBIUM) MICRORHIZOMA*, C. B. Clarke.

Very common in the rains on rocks and trees from 5,500 ft. up to 8,500 ft., which is about the limit of its range in the neighbourhood of Simla.

81. *POLYPODIUM (NIPHOBOLUS) FISSUM*, Hk. and Bk.

Rare and found only at levels below 5,500 ft.

82. *POLYPODIUM (DRYNARIA) RIVALE*, Nutt.

Locally abundant on the oaks on Jako at about 7,800 ft. Also on similar trees between Theog and Matiana at about 8,000 ft. Not common.

83. *POLYPODIUM (PHYMATODES) LINEARE*, Thunb.

Plate XIX.

This is a fern of comparatively the lower levels. It is common in the Glen at about 6,000 ft., and I have found stragglers up to about

6,500 ft., but not higher. The fronds are thick and coriaceous, and in dry weather roll up from the margins, and so remain for weeks or months; unrolling again, like *Niphobolus*, on the return of wet weather.

84. *POLYPODIUM (PHYMATODES) SIMPLEX*, Swartz.

Plate XX.

Very abundant on trees during the rains. The lowest limit of its range is rather above than below 6,000 ft., and I have gathered it up to 8,500 ft., but it is rare above 8,000 ft. The fronds last only as long as the rains, and they blanch, shrivel, and disappear in September. Their texture is thin, the venation distinct, and they are often crimped at the edges. The rhizome is thicker than that of *P. lineare*, but the scales that clothe it, and those that cover the young sori, are similar to those of *P. lineare*. In the living state the two species are very different.

85. *POLYPODIUM (PHYMATODES) CLATHRATUM*, C. B. Clarke.

Plate XXI.

Quite distinct from both the preceding, though often growing with *P. simplex*. Its lower limit is about 7,000 ft., but it is abundant on the trees on the north side of Jako, a little above that level, and ranges up to at least 10,000 ft. on Kumalhari and Hatu. Like *P. simplex*, it is found only in the rains, and in texture and mode of growth much resembles that species. But it is readily distinguishable by its narrow linear fronds, the character of the venation, and the clathrate scales of the rhizome and the sori. The sori are small, frequently oblong, of a bright orange colour, and sometimes confluent. The scales of the sori disappear at an early stage. The stipes are generally shorter and the fronds longer and more linear than in the specimen figured by Mr. Clarke. It is very common at Simla, and Mr. Duthie has collected it in Kumaon.

86. *POLYPODIUM (PHYMATODES) MEMBRANACEUM*, Don.

Occurring only in the immediate neighbourhood of streams in deep shady ravines up to about 5,000 ft. Not common.

87. *POLYPODIUM (PHYMATODES) HASTATUM*, Thunb.

Very rare. In fact, I know of only one locality for it, near Simla, a rock at 6,200 ft. in the neighbourhood of a waterfall.

## 88. POLYPODIUM (PHYMATODES) STEWARTH, C. B. Clarke.

This is equally rare, and has been found at only one place near Simla, on rocks at an elevation of about 7,400 ft.

## 89. POLYPODIUM (PHYMATODES) MALACODON, Hook.

Occurs only on Kumalhari and Hatu, near the summits of these hills, *viz.*, above 10,000 ft., but locally plentiful, growing on rocks.

## 90. POLYPODIUM (PHYMATODES) EBENIPES, Hook.

Also found only on Kumalhari and Hatu, but down to lower levels. It occurs on rocks between Nágkanda and Bággi between 8,000 and 8,500 ft., and also on the top of Hatu, associated with the preceding species.

## 91. NOTHOLCENA MARANTÆ, R. Br.

A high level fern and not common. I have gathered it as low as 8,300 ft., and it grows on the top of Hatu at 10,500 ft.

92. GYMNOGRAMME (LEPTOGRAMME) AURITA, Hk., var. *Levingii*, Clarke.

Abundant in some places at 8,000 ft. and upwards, in damp shady places, especially marshy spots, in the forest. In my opinion it should rank as a species distinct from *G. aurita*.

## 93. GYMNOGRAMME (SYNGRAMME) VESTITA, Hook.

The well known mouse-ear fern. Very common on rocks and on overhanging stony banks. Ranging from 6,000 up to 9,000 ft.

## 94. GYMNOGRAMME (SYNGRAMME) FRAXINEA, Bedd.

Common locally at all elevations from 5,000 up to 10,000 ft. growing on the ground in forest. Below 6,000 ft. it is bipinnate only as regards the lowest pair of pinnæ, and the pinnules are broad and large. Those from higher elevations have several pairs of pinnæ again pinnate and the pinnules are smaller and narrower. It is often 3-pinnate.

## 95. GYMNOGRAMME (SELLIGNEA) INVOLUTA, Hook.

Not common at Simla, and only found below 6,000 ft. on rocks in shady places by streams.

## 96. OSMUNDA CLAYTONIANA, L.

Only on Hatu at about 10,000 ft. or higher. It unrolls its fertile

fronds in June, and in September fertile fronds may be hunted for in vain.

97. *OSMUNDA REGALIS*, L.

Very rare, and now nearly extirpated by assiduous collectors. Below 6,000 ft.

98. *OPHIOGLOSSUM VULGATUM*, L.

Rare. Found by Dr. Watt on Hatu between 8,000 and 9,000 ft. in July 1885. It has been found also at Mussoorie.

99. *BOTRYCHIUM LUNARIA*, Swartz.

Equally rare. Found with the preceding by the same botanist and also on the slopes of Kumalhari near Nágkanda.

100. *BOTRYCHIUM DAUCIFOLIUM*, Wall.

Rare. I have found it only on one hill within the limits of Simla, where it occurs, in glades in the forest, at an elevation a little below 7,000 ft.

101. *BOTRYCHIUM VIRGINIANUM*, L., var. *lanuginosa*, Wall.

Rare, though less so than the preceding. I have gathered it at several places round Simla at elevations between 5,000 ft. and 6,800 ft.

---

XII.—*On the Differential Equation of all Parabolas.*

By ASUTOSH MUKHOPADHYAY, M. A., F. R. A. S., F. R. S. E.

[Received May 18th;—Read June 6th, 1888.]

CONTENTS.

- § 1. Introduction.\*
- § 2. Transon's Theory of Aberrancy.
- § 3. Geometric Interpretation.
- § 4. Miscellaneous Theorems.

§ 1. *Introduction.*

It is my object in the present paper to give the geometrical interpretation of the differential equation of all parabolas, as promised at the end of my remarks on Monge's Differential Equation to all Conics.† I have already incidentally pointed out‡ the easiest method of deriving the differential equation of all parabolas from the integral equation of the curve, *viz.*, the parabola being given by

$$ax^2 + 2hxy + by^2 + 2gx + 2fy + c = 0,$$

where  $h^2 = ab,$

we have, by solving for  $y,$

$$by = -(hx + f) \pm \left\{ 2(hf - bg)x + (f^2 - bc) \right\}^{\frac{1}{2}},$$

which may be written

$$y = Px + Q \pm \sqrt{Rx + S},$$

and this being on both sides operated upon by  $\left(\frac{d}{dx}\right)^2,$  leads to

$$\frac{d^2y}{dx^2} = \mp \frac{1}{4} \frac{R^2}{(Rx + S)^{\frac{3}{2}}},$$

whence

$$\left(\frac{d^2y}{dx^2}\right)^{-\frac{2}{3}} = lx + m,$$

so that

$$\left(\frac{d}{dx}\right)^2 \left(\frac{d^2y}{dx^2}\right)^{-\frac{2}{3}} = 0,$$

which is equivalent to the developed form

$$3 \frac{d^2y}{dx^2} \frac{d^4y}{dx^4} - 5 \left(\frac{d^3y}{dx^3}\right)^2 = 0,$$

and this is the differential equation to be geometrically interpreted. It

\* For a full analysis of this paper, see P. A. S. B. 1888, pp. 156-157.

† P. A. S. B. 1888, p. 86, footnote.

‡ J. A. S. B. 1887, vol. lvi, part ii, p. 136; P. A. S. B. 1887, pp. 185-186.



seems not wholly unnecessary to point out that what we are required to do is simply the discovery of a property of the parabola, leading to a geometrical quantity which, while adequately represented by the above differential expression, vanishes at every point of every parabola. As the interpretation I propose to give, follows directly from the properties of the osculating conic of any curve, I will begin with a brief account of Transon's Theory of Aberrancy as expounded in his original memoir.\*

§ 2. *Transon's Theory of Aberrancy.*

Consider the conic of closest contact at any point P of a given curve; if NP be the normal to the conic at P, and O its centre, the line OP is called the axis of aberrancy, the point O the centre of aberrancy, and the angle NOP the angle of aberrancy, viz, this is the angle which measures the deviation of the curve from the circular form. Again, from the closely analogous case of the circle of curvature, we may borrow a very useful term and call the length OP, which joins P with the centre of aberrancy, the *radius of aberrancy*; and the reciprocal of this radius may conveniently be termed the *index of aberrancy*.† Similarly, the locus of the centre of aberrancy as P travels along the given curve, may not be inappropriately termed the *aberrancy curve*. Before proceeding to obtain analytical expressions for these geometrical quantities in connection with the osculating conic, we shall first prove the following lemma :

If  $\delta$  be the angle between the central diameter and the normal at any point of a conic,  $\rho$  the radius of curvature,  $\rho'$  the radius of curvature at the corresponding point of the evolute, we have

$$\tan \delta = \frac{1}{3} \frac{\rho'}{\rho}.$$

Let C be the centre of the conic, and P the given point on the perimeter;  $p$  the perpendicular from the centre on the tangent at P;  $r$  the central radius vector CP;  $n$  the normal PN as limited by the axis major;  $\omega$  the angle which the normal PN makes with the axis major, and  $\delta$  the angle CPN. Then, we have the well-known relations

$$\begin{aligned} p &= r \cos \delta \\ r^2 &= a^2 \cos^2 \omega + b^2 \sin^2 \omega = a^2 (1 - e^2 \sin^2 \omega) \end{aligned}$$

\* *Recherches sur la Courbure des Lignes et des Surfaces, Journal de Mathematiques, (Lionville) 1er Ser., t. VI (1841), pp. 191-208.* For a very short notice of the subject by Prof. Cayley, see Salmon's *Higher Plane Curves*, p. 368 (Ed. 1879).

† In the case of the circle of curvature, the very expressive phrase "index of curvature," which is the reciprocal of the radius of curvature, has been now abridged into the single short term "curvature;" but whether anything has been gained by the change is doubtful,

$$n = \frac{b^2}{a} \frac{1}{\sqrt{1 - e^2 \sin^2 \omega}}$$

Hence

$$r = \frac{p}{\cos \delta} = \frac{a \sqrt{1 - e^2 \sin^2 \omega}}{\cos \delta},$$

and

$$\frac{\sin(\omega - \delta)}{\sin \omega} = \frac{n}{r} = \frac{b^2 \cos \delta}{a^2 (1 - e^2 \sin^2 \omega)},$$

whence

$$\tan \delta = \frac{e^2 \sin \omega \cos \omega}{1 - e^2 \sin^2 \omega}.$$

Now, it is well-known that the element of arc of the ellipse is given by

$$ds = \frac{b^2}{a} \frac{d\omega}{(1 - e^2 \sin^2 \omega)^{\frac{3}{2}}},$$

whence

$$\rho = \frac{ds}{d\omega} = \frac{b^2}{a} \frac{1}{(1 - e^2 \sin^2 \omega)^{\frac{3}{2}}},$$

$$\rho' = \frac{d\rho}{d\omega} = \frac{3b^2}{a} \frac{e^2 \sin \omega \cos \omega}{(1 - e^2 \sin^2 \omega)^{\frac{5}{2}}},$$

which give

$$\frac{\rho'}{\rho} = \frac{3e^2 \sin \omega \cos \omega}{1 - e^2 \sin^2 \omega}.$$

Hence, finally,

$$\tan \delta = \frac{1}{3} \frac{\rho'}{\rho},$$

and thus the formula is seen to be true for a central conic. To establish the property for a parabola, we notice that the centre being now at infinity, the angle at any point P between the normal and the central radius vector is the angle between the normal and the diameter, which is equal to the angle which the normal makes with the principal axis; hence, we have

$$\delta = \omega.$$

But the intrinsic equation of the parabola is well-known to be given by

$$\frac{ds}{d\omega} = \frac{2a}{\cos^3 \omega},$$

where  $4a$  is the latus-rectum. Hence,

$$\rho = \frac{2a}{\cos^3 \omega}$$

$$\rho' = \frac{d\rho}{d\omega} = \frac{6a \sin \omega}{\cos^4 \omega},$$

so that

$$\frac{\rho'}{\rho} = 3 \tan \omega,$$

which gives the required formula

$$\tan \delta = \frac{1}{3} \frac{\rho'}{\rho}.$$

The above formula in the case of a central conic follows also from the properties of conjugate diameters, *viz.*, if  $r_1$  be the semi-diameter conjugate to  $r$ , we have

$$\begin{aligned} r^2 + r_1^2 &= a^2 + b^2 \\ pr_1 &= ab \\ \rho &= \frac{r_1^3}{ab}. \end{aligned}$$

Hence

$$rdr + r_1 dr_1 = 0$$

and

$$\begin{aligned} \frac{d\rho}{ds} &= \frac{3r_1^2}{ab} \frac{dr_1}{ds} = -\frac{3r_1}{ab} \frac{rdr}{ds} \\ &= -\frac{3r}{p} \frac{dr}{ds} = 3 \tan \delta, \end{aligned}$$

since

$$\frac{dr}{ds} = -\sin \delta, \quad \frac{p}{r} = \cos \delta.$$

Therefore

$$\tan \delta = \frac{1}{3} \frac{d\rho}{ds} = \frac{1}{3} \frac{\rho'}{\rho},$$

as before.

We now proceed to express the elements of the osculating conic in terms of the differential co-efficients. For this purpose, we remark that

$$\rho = \frac{\left\{ 1 + \left( \frac{dy}{dx} \right)^2 \right\}^{\frac{3}{2}}}{\frac{d^2y}{dx^2}} = \frac{\left( \frac{ds}{dx} \right)^3}{\frac{d^2y}{dx^2}}$$

reduces the equation

$$\rho = \frac{ds}{d\omega} = \frac{ds}{dx} \frac{dx}{d\omega}$$

to

$$\frac{d\omega}{dx} = \frac{\frac{d^2y}{dx^2}}{\left( \frac{ds}{dx} \right)^2} = \frac{\frac{d^2y}{dx^2}}{1 + \left( \frac{dy}{dx} \right)^2},$$

and we have also

$$\frac{d\rho}{dx} = \frac{\left\{ 1 + \left( \frac{dx}{dy} \right)^2 \right\}^{\frac{1}{2}}}{\left( \frac{d^2y}{dx^2} \right)^2} \left\{ 3 \frac{dy}{dx} \left( \frac{d^2y}{dx^2} \right)^2 - \left[ 1 + \left( \frac{dy}{dx} \right)^2 \right] \frac{d^3y}{dx^3} \right\}.$$

Hence, we get

$$\begin{aligned} \tan \delta &= \frac{1}{3} \frac{\rho'}{\rho} = \frac{1}{3\rho} \frac{d\rho}{d\omega} \\ &= \frac{1}{3\rho} \frac{\frac{d\rho}{dx}}{\frac{d\omega}{dx}} \\ &= \frac{dy}{dx} - \frac{\left\{ 1 + \left( \frac{dy}{dx} \right)^2 \right\} \frac{d^3y}{dx^3}}{3 \left( \frac{d^2y}{dx^2} \right)^2}. \end{aligned}$$

Using  $p, q, r$  to denote the first, second and third differential co-efficients of  $y$  with respect to  $x$ , we have the formula for the angle of aberrancy in the now familiar form

$$\tan \delta = p - \frac{(1 + p^2) r}{3q^2}.$$

It is easy to verify this formula when the equation of the conic is given in form

$$\frac{x^2}{a^2} + \frac{y^2}{b^2} = 1,$$

for the coordinates of any point being  $a \cos \phi, b \sin \phi$ , the equation of the central radius vector is

$$ay \cos \phi = bx \sin \phi,$$

and the normal is

$$\frac{ax}{\cos \phi} - \frac{by}{\sin \phi} = a^2 - b^2,$$

so that the angle between these two lines is given by

$$\tan \delta = \frac{a^2 - b^2}{ab} \sin \phi \cos \phi.$$

Again, from the equation of the curve we have

$$\begin{aligned} p &= -\frac{b}{a} \frac{x}{\sqrt{a^2 - x^2}} = -\frac{b}{a} \cot \phi. \\ q &= -\frac{ab}{(a^2 - x^2)^{\frac{3}{2}}} = -\frac{b}{a^2 \sin^3 \phi} \\ r &= -\frac{3abx}{(a^2 - x^2)^{\frac{5}{2}}} = -\frac{3b \cos \phi}{a^3 \sin^5 \phi}, \end{aligned}$$

which give

$$\begin{aligned} \frac{r}{3q^2} &= \frac{a \sin \phi \cos \phi}{b}, \\ 1+p^2 &= \frac{a^2 \sin^2 \phi + b^2 \cos^2 \phi}{a^2 \sin^2 \phi} \\ p - \frac{(1+p^2)r}{3q^2} &= \frac{a^2 - b^2}{ab} \sin \phi \cos \phi \end{aligned}$$

so that

$$\tan \delta = p - \frac{(1+p^2)r}{3q^2},$$

which is the formula to be verified.

Next, to calculate the radius of aberrancy  $R$ , let  $d\omega$  the angle between two consecutive normals, and  $d\psi$  the angle between two consecutive axes of aberrancy; then, we have clearly

$$d\omega = d\psi + d\delta.$$

Again, consider the triangle formed by two consecutive radii of aberrancy and the element of arc of the given curve; then, we have

$$\frac{R}{\sin \left( \frac{\pi}{2} - \delta \right)} = \frac{ds}{d\psi}.$$

And, similarly, from the triangle formed by two consecutive normals and the element of arc of the given curve, we get

$$ds = \rho d\omega,$$

whence

$$R = \rho \cos \delta \cdot \frac{d\omega}{d\psi}.$$

But from the equation

$$\tan \delta = \frac{1}{3\rho} \frac{d\rho}{d\omega},$$

we have

$$\sec^2 \delta \cdot \frac{d\delta}{d\omega} = \frac{1}{3} \cdot \frac{\rho \frac{d^2\rho}{d\omega^2} - \left( \frac{d\rho}{d\omega} \right)^2}{\rho^2},$$

or substituting for  $\delta$ , we get

$$\frac{d\delta}{d\omega} = 3 \cdot \frac{\rho \frac{d^2\rho}{d\omega^2} - \left( \frac{d\rho}{d\omega} \right)^2}{9\rho^2 + \left( \frac{d\rho}{d\omega} \right)^2}.$$

Hence

$$\frac{d\psi}{d\omega} = 1 - \frac{d\delta}{d\omega}$$

$$= \frac{9\rho^2 + 4 \left( \frac{d\rho}{d\omega} \right)^2 - 3\rho \frac{d^2\rho}{d\omega^2}}{9\rho^2 + \left( \frac{d\rho}{d\omega} \right)^2}.$$

Therefore, from

$$R = \rho \cos \delta \cdot \frac{d\omega}{d\psi},$$

we have easily the relation

$$R = \frac{3\rho^2 \left\{ 9\rho^2 + \left( \frac{d\rho}{d\omega} \right)^2 \right\}^{\frac{1}{2}}}{9\rho^2 + 4 \left( \frac{d\rho}{d\omega} \right)^2 - 3\rho \frac{d^2\rho}{d\omega^2}}$$

We can now, without much difficulty, change the variables, and thus obtain an expression for  $R$  in terms of  $x$  and  $y$ . Thus, as we have already seen

$$\begin{aligned} \rho &= \frac{(1 + p^2)^{\frac{3}{2}}}{q} \\ \frac{d\rho}{dx} &= \frac{(1 + p^2)^{\frac{1}{2}}}{q^2} \left\{ 3pq^2 - r(1 + p^2) \right\} \\ \frac{d\omega}{dx} &= \frac{q}{1 + p^2}, \end{aligned}$$

whence

$$\frac{d\rho}{d\omega} = \frac{(1 + p^2)^{\frac{3}{2}}}{q^3} \left\{ 3pq^2 - r(1 + p^2) \right\}.$$

Hence, we have

$$\frac{d^2\rho}{dx^2} = \frac{(1 + p^2)^{\frac{1}{2}}}{q^4} \left\{ (1 + p^2) \left[ q^2 (3q^2 - 5pr) + (1 + p^2) (3r^2 - qs) \right] \right. \\ \left. + 3pq^2 \left[ 3pq^2 - r(1 + p^2) \right] \right\}$$

and

$$\begin{aligned} \frac{d^2\rho}{d\omega^2} &= \frac{d}{d\omega} \left( \frac{d\rho}{d\omega} \right) = \frac{dx}{d\omega} \frac{d}{dx} \left( \frac{d\rho}{d\omega} \right) \\ &= \frac{(1 + p^2)^{\frac{3}{2}}}{q^5} \left\{ (1 + p^2) \left[ 3q^4 - 8pq^2r + (1 + p^2) (3r^2 - qs) \right] + 9p^2q^4 \right\}. \end{aligned}$$

Hence, by actual calculation, we find that

$$\begin{aligned} 9\rho^2 + \left( \frac{d\rho}{d\omega} \right)^2 &= \frac{(1 + p^2)^4}{q^6} \left\{ r^2 (1 + p^2) - 6pq^2r + 9q^4 \right\} \\ 9\rho^2 + 4 \left( \frac{d\rho}{d\omega} \right)^2 - 3\rho \frac{d^2\rho}{d\omega^2} &= \frac{(1 + p^2)^5}{q^6} (3qs - 5r^2). \end{aligned}$$

Therefore, finally, we get

$$R^3 = \frac{9q^2 \left\{ r^2 + (rp - 3q^2)^2 \right\}}{(3qs - 5r^2)^2}.$$

Hence, it is evident that if I be the index of aberrancy, that is to say, the reciprocal of the radius of aberrancy, we have

$$I = \frac{3qs - 5r^2}{3q \left\{ r^2 + (rp - 3q^2)^2 \right\}^{\frac{1}{2}}}.$$

It is hardly necessary to point out that, as these formulæ hold when the origin is anywhere, they are true when the origin is taken to be the given point on the curve whose osculating conic we are considering.

If we take the tangent and normal at the given point as the axes of  $x$  and  $y$  respectively, we may easily obtain expressions for the coordinates of the centre of aberrancy, *viz.*, we have

$$X = R \sin \delta, \quad Y = R \cos \delta,$$

and from the relation

$$\tan \delta = p - \frac{(1 + p^2)r}{3q^2},$$

we get

$$\sin \delta = \frac{3pq^2 - r(1 + p^2)}{\sqrt{1 + p^2} \left\{ r^2 + (rp - 3q^2)^2 \right\}^{\frac{1}{2}}}$$

$$\cos \delta = \frac{3q^2}{\sqrt{1 + p^2} \left\{ r^2 + (rp - 3q^2)^2 \right\}^{\frac{1}{2}}}.$$

Hence, the coordinate axes being the tangent and normal at any point of a given curve, the values of the coordinates of the centre of aberrancy at that point are given by

$$X = \frac{3q \left\{ 3pq^2 - r(1 + p^2) \right\}}{\sqrt{1 + p^2} (3qs - 5r^2)}$$

$$Y = \frac{9q^3}{\sqrt{1 + p^2} (3qs - 5r^2)}.$$

If the coordinate axes, instead of being the tangent and normal at the given point, are such that the axis of  $x$  makes an angle  $\theta$  with the tangent, we have

$$\tan \theta = -\frac{dy}{dx} = -p,$$

$$\sin \theta = \frac{-p}{\sqrt{1 + p^2}}, \quad \cos \theta = \frac{1}{\sqrt{1 + p^2}},$$

and the new coordinates of the centre of aberrancy are given by the two expressions

$$\begin{aligned} X \cos \theta + Y \sin \theta &= \frac{-3qr}{3qs - 5r^2} \\ -X \sin \theta + Y \cos \theta &= \frac{-3q(pr - 3q^2)}{3qs - 5r^2}. \end{aligned}$$

We, therefore, finally infer that if a curve be referred to rectangular axes drawn through any origin, the co-ordinates  $(\alpha, \beta)$  of the centre of aberrancy at any given point  $(x, y)$  of the curve, are given in the most general form by the system

$$\begin{aligned} \alpha &= x - \frac{3qr}{3qs - 5r^2} \\ \beta &= y - \frac{3q(pr - 3q^2)}{3qs - 5r^2} * . \end{aligned}$$

The equation of the axis of aberrancy, in its most general form, may now be at once written down, *viz.*,  $x, y$  being the coordinates of the point on the curve through which the axis of aberrancy passes, and  $X, Y$ , the current coordinates, we have for the required equation

$$\frac{X - x}{Y - y} = \frac{x - \alpha}{y - \beta} = \frac{r}{pr - 3q^2}.$$

It may usefully be noted that the values of  $\alpha, \beta$  obtained above, lead to some interesting results, *viz.*, we have

$$\begin{aligned} \frac{d\alpha}{dx} &= \frac{r(9q^2t - 45qrs + 40r^3)}{(3qs - 5r^2)^2}, \\ \frac{d\beta}{dx} &= \frac{(pr - 3q^2)(9q^2t - 45qrs + 40r^3)}{(3qs - 5r^2)^2}, \end{aligned}$$

so that we may put

$$\begin{aligned} \frac{d\alpha}{dx} &= \lambda T, \\ \frac{d\beta}{dx} &= \mu T, \end{aligned}$$

where

$$\begin{aligned} \lambda &= \frac{r}{(3qs - 5r^2)^2}, \mu = \frac{pr - 3q^2}{(3qs - 5r^2)^2}, \\ T &\equiv 9q^2t - 45qrs + 40r^3, \end{aligned}$$

so that

$$T = 0$$

is Monge's differential equation to all conics.† It is clear from these two expressions that if the given curve is a conic, we have

\* Cf. Dublin Examination Papers, 1876, p. 152, Ques. 6, by Prof. M. Roberts.

† Cf. Dublin Examination Papers, 1880, p. 361, Ques. 5, by Prof. M. Roberts.



$$T = 0,$$

which shews that  $\alpha$  and  $\beta$  are both independent of  $x$ , as is, indeed, geometrically evident, since the osculating conic of a given conic being the curve itself, the centre of aberrancy is a fixed point, *viz.*, the centre of the given conic. Similarly, if

$$\lambda = \infty, \mu = \infty,$$

we must have

$$3qs - 5r^2 = 0,$$

which shews that the given curve is a parabola, and, then the centre of aberrancy has its coordinates infinite, *viz.*, the centre of aberrancy is the centre of the parabola which is, of course, at infinity. We may also easily find the values of

$$\frac{d\alpha}{dy}, \frac{d\beta}{dy},$$

*viz.*, we have

$$\frac{d\alpha}{dy} = \frac{d\alpha}{dx} \frac{dx}{dy} = \frac{1}{p} \frac{d\alpha}{dx} = \lambda_1 T,$$

$$\frac{d\beta}{dy} = \frac{d\beta}{dx} \frac{dx}{dy} = \frac{1}{p} \frac{d\beta}{dx} = \mu_1 T,$$

where

$$\lambda_1 = \frac{\lambda}{p} = \frac{r}{p(3qs - 5r^2)^2},$$

$$\mu_1 = \frac{\mu}{p} = \frac{pr - 3q^2}{p(3qs - 5r^2)^2},$$

and, these results shew that when, as before,

$$T = 0,$$

the centre of aberrancy is independent of  $y$ , and, when

$$\lambda_1 = \infty, \mu_1 = \infty,$$

it is at infinity.

The directions of the principal axes of the osculating conic are also easily determined, for the conic being

$$ax^2 + 2hxy + by^2 + 2gx + 2fy + c = 0,$$

if  $\theta$  be the angle of inclination of the axis major to the axis of  $x$ , we have

$$\tan 2\theta = \frac{2h}{a - b}.$$

But, I have elsewhere\* calculated the values of the constants on the right hand side in terms of the differential co-efficients, *viz.*, we have

$$\frac{h}{b} = c_3, \quad \frac{a}{b} = c_3^2 - \frac{c_1}{c_2^2},$$

where

\* P. A. S. B. 1888, pp. 82—83.

$$c_1 = -\frac{U}{9q^{\frac{2}{3}}}, \quad c_2 = \frac{V}{9q^{\frac{1}{3}}},$$

$$c_3 = \frac{W}{V},$$

$$U = 3qs - 5r^2, \quad V = 3qs - 4r^2,$$

$$W = 3q^2r - pV.$$

$$T_0 = 9q^4 - 6pq^2r + (p^2 + 1)V$$

Hence, substituting, we get

$$\begin{aligned} \tan 2\theta &= \frac{2c_2^2 c_3}{c_2^2 c_3^2 - c_1 - c_2^2} \\ &= \frac{2VW}{W^2 + 9q^4U - V^2} \\ &= \frac{2(3q^2r - pV)}{9q^4 - 6pq^2r + (p^2 - 1)V} * \\ &= \frac{2W}{T_0 - 2V}. \end{aligned}$$

The lengths of the axes of the conic of closest contact may also be easily calculated, *viz.*, the conic being

$$ax^2 + 2hxy + by^2 + 2gx + 2fy + c = 0,$$

and  $\sigma$  the length of either axis, we have the well-known equation

$$\sigma^4 + \frac{\Delta(a+b)}{(h^2-ab)^2} \sigma^2 - \frac{\Delta^2}{(h^2-ab)^3} = 0$$

where  $\Delta$  is the discriminant. Now I have already† shewn that

$$\Delta = \frac{(h^2-ab)^{\frac{3}{2}}}{c_1^{\frac{3}{2}}}.$$

Therefore, we have

$$\begin{aligned} \frac{\Delta(a+b)}{(h^2-ab)^2} &= \frac{a+b}{c_1^{\frac{3}{2}}(h^2-ab)^{\frac{1}{2}}} = \frac{\frac{a}{b} + 1}{c_1^{\frac{3}{2}} \left( \frac{h^2}{b^2} - \frac{a}{b} \right)^{\frac{1}{2}}} \\ &= \frac{c_3^2 - \frac{c_1}{c_2^2} + 1}{c_1^{\frac{3}{2}} \sqrt{\frac{c_1}{c_2^2}}} = \frac{c_2^2(1+c_3^2) - c_1}{c_2 c_1^{\frac{3}{2}}} \\ &= \frac{9q^2 T_0}{U^2} \cdot \ddagger \end{aligned}$$

Similarly

\* Cf. Dublin Examination Papers, 1876, p. 152, Ques. 5, by Prof. M. Roberts.

† P. A. S. B. 1888, p. 80.

‡ P. A. S. B. 1888, p. 83.

$$\frac{\Delta^2}{(h^2 - ab)^3} = \frac{1}{c_1^3} = - \frac{729q^8}{U^3}.$$

Therefore, the equation for the lengths of the axes reduces to

$$\sigma^4 + \frac{9q^2 T_0}{U^2} \sigma^2 + \frac{729q^8}{U^3} = 0$$

where  $T_0 = 0$  is the differential equation of all equilateral hyperbolas, and  $U = 0$  of all parabolas.

If the roots of this equation be  $\sigma_1^2, \sigma_2^2$ , the area of the conic is

$$\pi \sigma_1 \sigma_2 = \frac{27\pi q^4}{U^{\frac{3}{2}}},$$

a result I have obtained before.\*

We may similarly consider the osculating parabola and the osculating equilateral hyperbola at any point  $(x, y)$  of a given curve. Thus, if

$$ax^2 + 2hxy + by^2 + 2gx + 2fy + c = 0$$

where

$$h^2 = ab$$

be the osculating parabola, and  $m$  its principal parameter, we can easily calculate  $m$  in terms of the differential coefficients from the formula

$$\frac{m}{2} = \frac{f\sqrt{-a} - g\sqrt{b}}{(a + b)^{\frac{3}{2}}}.$$

For, solving for  $y$ , we have

$$y = Px + Q + \sqrt{2Hx + B}$$

where

$$P = -\frac{h}{b}, \quad Q = -\frac{f}{b}$$

$$H = \frac{hf - bg}{b^2}, \quad B = \frac{f^2 - bc}{b^2}.$$

Hence, as usual,

$$p = P + \frac{H}{(2Hx + B)^{\frac{1}{2}}}$$

$$q = \frac{-H^2}{(2Hx + B)^{\frac{3}{2}}}$$

$$r = \frac{3H^3}{(2Hx + B)^{\frac{5}{2}}},$$

so that

$$pr - 3q^2 = \frac{3PH^3}{(2Hx + B)^{\frac{5}{2}}},$$

and

\* P. A. S. B. 1888, p. 84.

$$r^2 + (pr - 3q^2)^2 = \frac{9H^6(1 + P^2)}{(2Hx + B)^5},$$

whence

$$\frac{q^5}{\{r^2 + (pr - 3q^2)^2\}^{\frac{3}{2}}} = \frac{-H}{27(1 + P^2)^{\frac{3}{2}}}.$$

But since

$$H = \frac{hf - bg}{b^2} = \frac{f\sqrt{a} - g\sqrt{b}}{b^{\frac{3}{2}}}$$

$$P = -\frac{h}{b} = -\frac{\sqrt{a}}{\sqrt{b}}$$

we have from

$$\frac{m}{2} = \frac{f\sqrt{a} - g\sqrt{b}}{(a + b)^{\frac{3}{2}}},$$

the relation

$$m = \frac{-2H}{(1 + P^2)^{\frac{3}{2}}}$$

and, therefore

$$m = \frac{54q^5}{\{r^2 + (pr - 3q^2)^2\}^{\frac{3}{2}}}$$

which is accordingly the formula sought.

Again, let us investigate the coordinates of the centre of an equilateral hyperbola osculating a curve at a given point. In the first place, we know that in an equilateral hyperbola the projection of the radius of curvature at any point on the central radius vector, is equal to that radius vector; for, if  $R$  be the radius vector,  $\delta$  the angle between the normal and the radius vector,  $\rho$  the radius of curvature, and  $a$  the semi-axis-transverse, we can easily show that

$$\rho = -\frac{R^3}{a^2}, \quad \cos \delta = \frac{a^2}{R^2},$$

whence

$$R = -\rho \cos \delta.$$

Hence, if an equilateral hyperbola osculates a curve at a given point, in the first instance take the tangent and normal at that point as the axes of  $x$  and  $y$  respectively; then, expressions for the coordinates of the centre are easily obtained, *viz.*,

$$X = R \sin \delta, \quad Y = R \cos \delta,$$

where  $R$  is the distance of the centre from the origin, and  $\delta$  the angle between the central radius vector and normal, so that

$$\frac{R}{\cos \delta} = -\rho = \frac{(1+p^2)^{\frac{3}{2}}}{q}.$$

But the equilateral hyperbola being a conic, we have from the preceding investigation

$$\tan \delta = p - \frac{(1+p^2)r}{3q^2},$$

whence

$$\sin \delta = \frac{3pq^2 - r(1+p^2)}{\sqrt{1+p^2} \left\{ r^2 + (rp - 3q^2)^2 \right\}^{\frac{1}{2}}}$$

$$\cos \delta = \frac{3q^2}{\sqrt{1+p^2} \left\{ r^2 + (rp - 3q^2)^2 \right\}^{\frac{1}{2}}}.$$

Therefore we see that the distance of the centre of the osculating equilateral hyperbola from the given point (which is the origin) is furnished by

$$R = \frac{-3q(1+p^2)}{\left\{ r^2 + (rp - 3q^2)^2 \right\}^{\frac{1}{2}}}.$$

Hence, the coordinate axes being the tangent and normal at any point of a given curve, the values of the coordinates of the centre of the osculating equilateral hyperbola at that point are given by

$$X = \frac{3q\sqrt{1+p^2} \left\{ r(1+p^2) - 3pq^2 \right\}}{r^2 + (rp - 3q^2)^2}$$

$$Y = \frac{3pqr\sqrt{1+p^2}}{r^2 + (rp - 3q^2)^2}.$$

If the coordinate axes, instead of being the tangent and normal at the given point, are such that the axis of  $x$  makes the angle  $\theta$  with the tangent, we have

$$\tan \theta = -\frac{dy}{dx} = -p$$

$$\sin \theta \frac{-p}{\sqrt{1+p^2}}, \quad \cos \theta = \frac{1}{\sqrt{1+p^2}},$$

and the new coordinates of the centre of the osculating equilateral hyperbola are given by the two expressions

$$X \cos \theta + Y \sin \theta = \frac{3qr(1+p^2)}{r^2 + (rp - 3q^2)^2}$$

$$-X \sin \theta + Y \cos \theta = \frac{3q(1+p^2)(pr - 3q^2)}{r^2 + (rp - 3q^2)^2}.$$

We, therefore, finally infer that if a curve be referred to rectangular

axes drawn through any origin, the coordinates  $(\xi, \eta)$  of the centre of the osculating equilateral hyperbola at any given point  $(x, y)$  of the curve, are given in the most general form by the system

$$\xi = x + \frac{3qr(1+p^2)}{r^2 + (rp - 3q^2)^2}$$

$$\eta = y + \frac{3q(1+p^2)(pr - 3q^2)^2}{r^2 + (rp - 3q^2)^2}.$$

The equation of the line joining the centre of the osculating equilateral hyperbola with the given point on the curve is at once written down in its most general form, *viz.*,  $x, y$  being the coordinates of the point and  $X, Y$  the current coordinates, we have for the required equation

$$\frac{X - x}{Y - y} = \frac{x - \xi}{y - \eta} = \frac{r}{pr - 3q^2},$$

which shews that the centre of the osculating equilateral hyperbola is on the axis of aberrancy, as is also geometrically evident. From the above values of  $\xi, \eta$ , it can be shown after some reductions that

$$\frac{d\xi}{dx} = \lambda_0 T_0, \quad \frac{d\eta}{dx} = \mu_0 T_0$$

where

$$\lambda_0 = \frac{9q^4 - r^2(1+p^2)}{\left\{ r^2 + (rp - 3q^2)^2 \right\}^{\frac{1}{2}}},$$

$$\mu_0 = \frac{r(1+p^2)(6q^2 - pr) - 9pq^4}{\left\{ r^2 + (rp - 3q^2)^2 \right\}^2},$$

$$T_0 = 9q^4 - 6pq^2r + (1+p^2)(3qs - 4r^2),$$

so that  $T_0 = 0$  is the differential equation of all equilateral hyperbolas.

### § 3. Geometric Interpretation.

It is now extremely easy to give the true geometric interpretation of the differential equation of all parabolas; for we have shewn above that the index of aberrancy is given by the formula

$$I = \frac{3qs - 5r^2}{3q \left\{ r^2 + (rp - 3q^2)^2 \right\}^{\frac{1}{2}}},$$

and the differential equation of all parabolas is

$$3qs - 5r^2 = 0.$$

Hence, we conclude that the required geometric interpretation is the property that *the index of aberrancy vanishes at every point of every parabola.*

§ 4. *Miscellaneous Theorems.*

The differential expression

$$3qs - 5r^2,$$

the vanishing of which we find to be the differential equation of all parabolas, may appropriately be taken to represent the species of the conic of closest contact at any point of a given curve. For, from the equation

$$ax^2 + 2hxy + by^2 + 2gx + 2fy + c = 0,$$

we have

$$y = Px + Q \pm \sqrt{Ax^2 + 2Hx + B},$$

where

$$P = -\frac{h}{b}, \quad Q = -\frac{f}{b},$$

$$A = \frac{h^2 - ab}{b^2}, \quad H = \frac{hf - bg}{b^2}, \quad B = \frac{f^2 - bc}{b^2},$$

whence we have, as usual

$$\frac{d^2y}{dx^2} = q = \pm \frac{AB - H^2}{(Ax^2 + 2Hx + B)^{\frac{3}{2}}},$$

$$r = \mp \frac{3(AB - H^2)(Ax + H)}{(Ax^2 + 2Hx + B)^{\frac{5}{2}}},$$

$$s = \pm \frac{3(AB - H^2) \left\{ 4(Ax + H)^2 - (AB - H^2) \right\}}{(Ax^2 + 2Hx + B)^{\frac{7}{2}}};$$

Therefore, by actual calculation, we get

$$5r^2 - 3qs = \frac{9A(AB - H^2)^2}{(Ax^2 + 2Hx + B)^4},$$

so that it is clear that the differential expression

$$5r^2 - 3qs$$

is of the same sign as

$$A \text{ and } h^2 - ab.$$

Hence, we have the theorem that at any point of a curve, the conic of five-pointic-contact is an ellipse, hyperbola, or parabola, according as

$$5 \left( \frac{d^3y}{dx^3} \right)^2 - 3 \frac{d^2y}{dx^2} \frac{d^4y}{dx^4}$$

is negative, positive, or zero.\*

Since we have proved that the radius of aberrancy is given by the formula

\* See Dublin Examination Papers, 1875, p. 279, Ques. 4, by Prof. M. Roberts.

$$R = \frac{3\rho^2 \left\{ 9\rho^2 + \left( \frac{d\rho}{d\omega} \right)^2 \right\}}{9\rho^2 + 4 \left( \frac{d\rho}{d\omega} \right)^2 - 9\rho \frac{d^2\rho}{d\omega^2}},$$

and as, moreover, in every parabola, the reciprocal of  $R$  vanishes, the differential equation of all parabolas in terms of  $\rho$  and  $\omega$  is

$$3\rho \frac{d^2\rho}{d\omega^2} - 4 \left( \frac{d\rho}{d\omega} \right)^2 - 9\rho^2 = 0.*$$

To integrate this, put

$$\rho = e^{\int u d\omega},$$

whence

$$3 \frac{du}{d\omega} = u^2 + 9,$$

or,

$$d\omega = \frac{3du}{u^2 + 9},$$

which gives

$$u = 3 \tan (\omega + k),$$

so that

$$\begin{aligned} \int u d\omega &= 3 \int \tan (\omega + k) d\omega \\ &= 3 \log m \sec (\omega + k), \end{aligned}$$

and

$$\rho = e^{\int u d\omega} = m^3 \sec^3 (\omega + k),$$

which, therefore, is the relation between  $\rho$  and  $\omega$  in every parabola, leading at once to the intrinsic equation

$$s = m^3 \int \sec^3 (\omega + k) d\omega,$$

and, if the origin be suitably chosen, we may put  $k = 0$ , so that we have the well-known result

$$s = m^3 \int \frac{d\omega}{\cos^3 \omega}.$$

14th May, 1888.

\* See also P. A. S. B. 1888, p. 84, footnote.



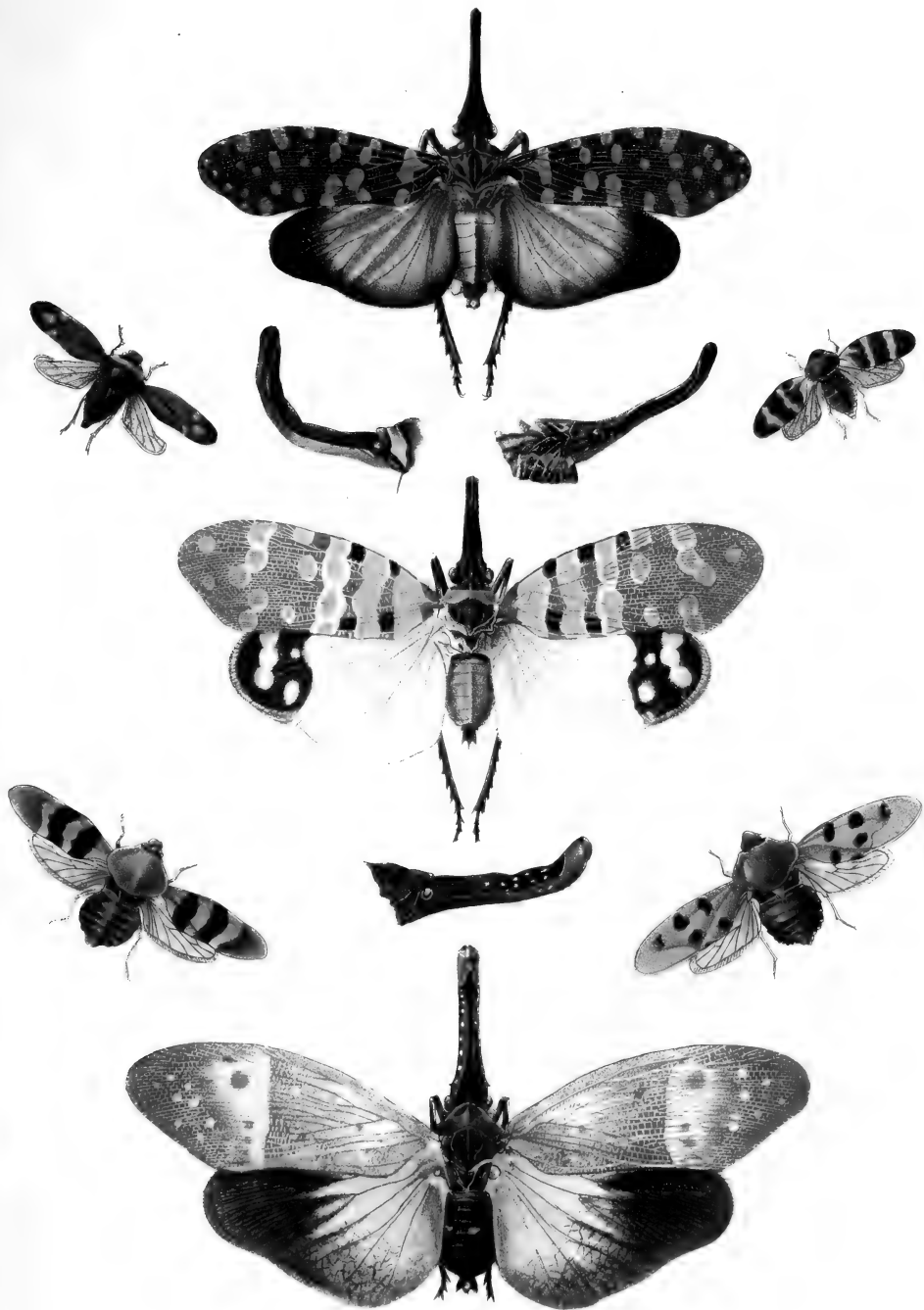

E.L.Dés del.  
Farker & Coward chr. lith

West, Newman & Co imp.



XIII.—*New or little known Indian Rhynchota.*—By E. T. ATKINSON, B.A.

[Received May 15th, 1888;—Read June 6th, 1888.]

(With Plate XV.)

COSMOSCARTA NIGROFASCIATA, n. sp., Pl. XV, lower left hand figure.

Orange yellow: two broad transverse bands on each tegmen, the one before, the other in the middle, black; apex of tegmina finely reticulated blackish: pectus (except the lateral margins), and fine margin of the base of the segments of the abdomen above and beneath, black: feet yellow-ochreous: wings fuscous hyaline. Long, 15: exp. teg. 39 mill.

Hab. Mungphu (Sikkim). Through some misconception the figures in Plate XV. have not been numbered.

COSMOSCARTA TAPROBANENSIS, n. sp.

Above black: face, broad median longitudinal band on vertex, a regularly undulating transverse line across the middle of the pronotum, antero-lateral margins of the pronotum, basal third of each tegmen, and a transverse line at base of apical third which is slightly interrupted towards the posterior margin, also the scutellum and the genitalia in ♀, red: the red basal third of the tegmina contains two oblique irregular bands, the basal formed by three black spots of which the largest is at the costal margin, and the second comprising 3-4 irregular black spots, of which the largest is at the posterior margin: abdomen above reddish, a broad black transverse band at the base, interrupted by the scutellum, which has a small round black dot in the middle of the disc; apical half of abdomen fuscous: beneath and feet, red; pectus and a row of spots on each side of the ventral segments, black. Long, 9: exp. teg. 21 mill

Hab. Pundaloya (Ceylon): from Mr. E. E. Green.

COSMOSCARTA UNDATA, Walker.

J. A. S. B. pt. ii, p. 10 (1885).

Var. *tripunctata* n., Pl. XV, upper left hand figure.

— *affinis* n.

The ordinary forms of this species have the markings on the tegmina broadly suffused with reddish-testaceous, and vary chiefly in the depth of the croceous band on the thorax, and in having the apical band on the tegmina continuous or formed of three spots. I have since received two specimens which I regard as varieties of this species, though at first sight appearing to be distinct.

*a* :—Var. *affinis*, in which the rufous-testaceous bands at the base and in the middle are reduced to narrow lines, and the apical band to three somewhat distant spots arranged in a triangle. Long, 11 : exp teg. 30 mill.

*b* :—Var. *tripunctata*, mihi, in which the basal and median bands on the tegmina are entirely absent and the three apical spots are small and semi-oval and arranged triangularly : base of wings not rufescent. Long, 12 : exp. teg. 30 mill.

Hab. Var. *a*, Dibrugarh (Assam) ; Var. *b*, Dam-Dim (Bhután Duárs).

COSMOSCARTA OCTOPUNCTATA, Am. & Serv.

Pl. XV, lower right hand figure.

*Cercopis octopunctata*, Hist. Nat. Ins. Hém., p. 559, t. 10, f. 6 (1843) : Walker List Hom., iii, p. 656 (1851).

*Cercopis dorsalis*, Walker ( *n. b. l.* ), J. Linn. S. Zool. x, p. 283 (1867).

*Cosmoscarta octopunctata*, Butler, Cist. Ent. i, p. 262 (1874).

A very distinct species : orange-yellow : five black spots on each tegmen of which two before, and two behind, the middle, the fifth on the posterior margin about the middle, and which, when the tegmina are closed, becomes confluent with the similar spot on the other tegmen, so as to make both appear one : there is sometimes another black spot before the reticulated part on the costal margin : pectus, except the lateral margins, and base of the segments of the abdomen above and beneath, black : antero-lateral borders of the pronotum much amplified and flattened out at the margin. Long, 17 : exp. teg. 42 mill.

Hitherto only known from Java and Sumatra, now found at Mungphu in Sikkim. A second example has the thorax more amplified, shining, and only eight black spots on the tegmina.

COSMOSCARTA GREENI, n. sp.

Head and eyes deep black, the head yellow-pilose : ocelli yellowish with red reflections : pronotum sordid orange-yellow, pilose, with two small impressions near the anterior margin, darker ; metanotum black, margined ochreous : tegmina black, basal fourth of the posterior margin, basal third of the costal margin and therefrom a transverse band proceeding somewhat obliquely towards the posterior streak and almost meeting it, also three spots arranged in a triangle in the apical third, and of which the cordiform apical is largest, red : wings semihyaline, basal third reddish orange, rest fuscous : abdomen above black, with a narrow transverse basal band, reddish-ochreous : pectus, venter and feet black ;

venter with a reddish-ochreous band towards the base; last tibiæ sometimes sordid yellow. Long 10: exp. teg. 26 mill.

Hab. Pundaloya (Ceylon): Mr. E. E. Green. Allied to *C. undata*, Walker, from which it differs in coloration and the smaller size.

COSMOSCARTA NIGRA, n. sp.

Body and feet deep black; abdomen and venter deep metallic bluish-black, shining: tegmina brownish-black; wings fuscous. Long, 12: exp. teg. 34 mill.

Hab. Sikkim.

COSMOSCARTA LURIDA, n. sp.

Head, pronotum, pectus and feet, also band along basal two-thirds of costal margin of tegmina, lurid: abdomen above and beneath black, with a bronzy tinge: tegmina (except the costal limbus), luteous: wings fuscous-hyaline. Long, 15: exp. teg. 36 mill.

Hab. Singapore.

COSMOSCARTA SIKKIMENSIS, n. sp.

Frons and feet fuscous: vertex and thorax black, densely yellow pilose, the latter with a band along the anterior margin, narrow anterior lateral limbus and posteriorly, sordid fuscous: tegmina black, a short basal streak briefly produced along costal and posterior margins, a transverse band at the base and apex of the middle third, and the apical limbus indistinctly, red: wings fuscous-hyaline, red at the base and for a short distance along the anterior margin: abdomen purplish-black, shining, with a deep castaneous, narrow, basal, transverse streak, Long, 14: exp. teg. 33 mill.

Hab. Sikkim.

COSMOSCARTA MINOR, n. sp.

Head and thorax metallic bluish-black, shining, the latter finely impressly punctured: base and apex of abdomen reddish, a broad transverse median band, brownish-black: tegmina blackish with a basal streak giving off a short sub-costal branch and two transverse bands, one at the base and the other at the apex of the middle third, red: wings fuscous-hyaline: feet brown; posterior coxæ and femora often more or less croceous or reddish. A small species, allied to the *C. decisa*, Walker, group. Long, 7 exp. teg. 21 mill.

Hab. Sikkim: Dam Dim (Bhután Duárs).

COSMOSCARTA DECISA, Walker (Pl. XV : upper right hand figure).

A local variety of this species, described in Journal Pt. II, p. 9 (1885), is figured here from Dam Dim in the Bhután Duárs.

CALLITETTIX AFFINIS, n. sp.

Black with a greenish tinge: head beneath, scutellum, anal segment of abdomen above and beneath, tegmina and feet, testaceous-red: apex of tegmina with a narrow black limbus: wings fuscous-hyaline: abdomen above and beneath (except the red anal segment), and the pectus, black. Long, 9: exp. teg. 23 mill. Differs from *C. producta*, Stål, in the colour of the abdomen and scutellum and its larger size.

Hab. Pundaloya (Ceylon): Mr. E. E. Green. *C. melanochra*, Stål, has been procured in Sikkim.

Genus MACHÆROTA, Burm.

J. A. S. B. pt. II, p. 23 (1885); p. 196 (1886).

I have already noticed four species of this genus, a fifth (*M. pugionata*, Stål) has been described from N. Australia, and a sixth (*M. guttigera*) by Professor Westwood from Ceylon (Trans. Ent. Soc., p. 329, 1886). I have had one specimen from Nagpur, but too much mutilated for description, also several specimens of the larvæ from Sikkim, and of the curious tubular home formed by these insects in the larval state, I have procured several specimens on the common jujube (*Zizyphus*) in Calcutta. These tubes are serpuliform and resemble the letter J without the transverse bar at the top; the foot, too, is curved over to embrace the twig on which they rest, and the length varies from half to two-thirds of an inch.

Professor Westwood's paper contains an interesting account of the formation of this tube by Mr. S. Green of Colombo, the substance of which I reproduce here. Mr. Green writes:—The larva resides in a tube which is fixed on a twig or leaf-stalk of the Suriya tulip-tree (*Adansonia digitata*) on the end of the branches, and appears to be commenced and finished by the insect whilst in the larval state. The newly hatched larva is a little tiny creature of an orange colour in the midst of a spot of froth in which it moves about and, in this state, commences to form the tube. When the foundations have once been laid, the larva, in a horizontal position, encloses, with a wall, a space sufficient to contain itself in a perpendicular position, with its head downwards. It is then seen continually working its anus against and round about the inside of the tube near its orifice, at intervals, both day and night; the anus discharges a clear water-like fluid which falls drop by drop from the tube. The

insect has a life of some weeks in the larval state and never shows itself outside the tube until it is ready to assume the perfect state. Then the pupa comes out tail first, and takes up a position on the top of the tube (transversely like the letter T) and in the middle of the bubbles. In about ten minutes it completely extricates itself from its old skin and the curved horn on its thorax seems to uncurl.

The ♂ appears to be considerably smaller and of a darker colour.

The full sized larva-tubes are about half an inch long and about a line in diameter. They are about the thickness of writing-paper, of a dirty whitish colour, with the surface finely transversely wrinkled. The basal portion is dilated and curved so as partially to clasp the twig on which it is fixed. In this manner the bottom of the tube is closed and, as the insect resides in it with the head downwards, Mr. Westwood remarks: "I do not understand how it can obtain nourishment from the plant through its delicate rostrum, unless it occasionally emerges from its abode which, of course, is stationary." The immature insect differs from the imago in the usual manner, having the wings only visible in a rudimental condition in the pupa state, in which the only appearance of the large curved dorsal horn is seen in a very small dorsal protuberance in the middle of the hind part of the thorax.

Mr. Westwood observes that the water expelled by these insects is of the same nature as the 'cuckoo-spit' of the English *Aphrophora spumaria*, being the fluid excrement of the larva, consisting of the juices of the plant on which it subsisted, and which, being discharged, with very little alteration in its nature, drop by drop, from the anus of the insect, forms an accumulated moistened mass which keeps the body of the insect in a moist condition until it is ready to assume the perfect state. The insect does no injury to the tree or to the branch on which it feeds.

Mr. F. Ratte (in Proc. Linn. Soc. N. S. Wales, ix, p. 1164, 1885) describes the occurrence of similar larva-cases in Australia. He shows that these cases contain three-fourths of carbonate of lime, some being helicoidal and others conical, resembling some fossil and recent *Serpulae*. The conical are usually found on *Eucalyptus*, the opening turned upwards and the larva being placed in it with the head downwards. In the helicoidal shells, the insect lies horizontally for the greatest part of its larval life. In both instances, it follows that the larva presents its tail to the opening, instead of its head. It introduces its rostrum through a longitudinal slit into the bark of the stem on which the case is fixed [but in the cases before me I have not been able to discover the slit] and emits at intervals from its anus a drop of clear water at the entrance of the shell.

Specimens of the Ceylon and Indian tubes are deposited in the Indian Museum.

*THAMNOTETIX NIGRO-PICTA*, Stål, Ofvers. K. V. A. Förh. p. 740 (1870).

♀. Yellow-virescent, smooth, shining: with the face, anterior sub-impressed, transverse line on the vertex, anterior margin of the pronotum, scutellary and commissural margins of the clavus, a spot before the middle extended to the claval suture and there acutely produced hindwards, and third apical part of corium, pectus, abdomen, greatest part of the femora, anterior tibiæ and the tarsi, black: the last tibiæ at the source of the spines spotted black: ventral incisures flavescens. Closely allied to *T. bipunctata*, Fabr. (J. A. S. B. Pt. II, p. 111, 1885), differs in having the head shorter, more obtuse, anteriorly obtusely rounded, and in the marking. Head as broad as the thorax, but somewhat shorter; vertex a little longer in the middle than at the eyes, hardly twice as broad as the eyes, anteriorly within the margin transversely sub-impressed. Long, 5; broad,  $1\frac{1}{2}$  mill.

This species was described by Stål from the Philippines. It has since been procured from Borneo, Sumatra, Ceylon (mihi) and various parts of India (mihi) and will easily be recognised as one of the small green insects that suddenly appear towards the end of the rains (September usually) in Calcutta. During the few days that they occur they may be found at night in considerable heaps beneath the lamps in the public streets, and they disappear as abruptly as they come. *T. bipunctata*, Fabr., appears at the same time. M. Lethierry of Lille has been good enough to identify this species for me.

*FULGORA CONNECTENS*, Atkinson (Pl. XV; middle figure and head to left.)

This beautiful species has already been described by me (J. Pt. II, p. 130, 1885), and I am now enabled to give a figure drawn by Babu B. L. Das. (Type in Indian Museum.)

*FULGORA AMPECTENS*, Atkinson (Pl. XV; lower middle figure and head.)

This species has also been described (l. c. p. 133) and the figure has been drawn by the same artist. (Type in Indian Museum.)

*FULGORA ANDAMANENSIS*, Distant. (Pl. XV: upper middle figure and head to left).

This species has been described (l. c. p. 135) and the present figure represents the interesting variety from the Nicobar islands referred to in the description already given (l. c. p. 136). There is little doubt that in this genus, the shape and size of the cephalic process must, in many cases, be looked to for specific characters rather than the markings on



the tegmina, and for this reason a side view of the cephalic process in these three species is given. (Variety in Indian Museum.)

J. A. S. B. Pt. II, p. 200, 1885:—*Pyrops nobilis* Westw., includes *Pyrops servillei*, Spinola (A. S. E. F. viii, p. 237, t. 2, f. 1, 1839) from Java. I have seen a specimen of the former from Malacca which differs in no respect from Spinola's description and figure, except perhaps in the lighter colour of the thorax and cephalic process, and this difference may be due to the action of preservatives. *P. javanensis*, Dist. has also been procured from Singapore.

POLYDICTYA AFFINIS, n. sp.

Frons, vertex and thorax, dark tawny: abdomen above sanguineous, apical half above and beneath more ochreous and with blackish patches; a white irised black dot on each side of the anterior segments: tegmina bluish-virescent from the base nearly to the middle, the bluish colour more distinctly seen beneath; brownish towards the apex, veins brown; wings vermilion at the base, thence semihyaline, veins brown: venter and feet dark tawny; first tibiæ darker; last tibiæ 4-spinose: tegmina nearly equally broad throughout, scarcely amplified towards the apex. Long, 19: exp. teg., 58 mill.

Hab. Sikkim.

MESSENA SINUATA, n. sp.

Frons tawny, levigate, shining, with a blackish limbus at the vertex marked by two rows of very minute yellow-brown dots: vertex and pro- and meso-notum darker, with several irregular, minute, black dots: metanotum and the abdomen above and mesostethium sanguineous, apex of abdomen and the genitalia covered with a white flocculent substance: tegmina with a broad reddish patch reaching the posterior margin for two-thirds the length from the base, and the costal margin for one-third, marked by numerous, irregular, transverse black streaks, and bounded, towards the apex, by a nebulous interrupted band of brown marks, between which and the apex is a broadish transverse patch and some small spots, brown and black; apical part semi-hyaline closely reticulated, veins brown: wings white, semi-hyaline, with a fuscous patch along the anterior margin becoming broader and darker from the base to about two-thirds the length where it abruptly ceases; also three large black spots towards the apex and between them and the apical margin some minute black dots: first femora (except the apex internally) and the intermediate pair of feet, tawny: first femora at the apex internally and last pair of feet dark brown, first tibiæ thickly spotted dark

brown: venter with transverse bands and marginal row of spots, black.

Frons very broad, broader than the pronotum which is about as long as the vertex: head prominulous before the eyes which are spinose beneath: tegmina slightly sinuate on the costal margin behind the middle, apical margin anteriorly broadly rounded, posteriorly subquadrate, posterior margin somewhat straight: first femora gradually amplified from base to apex; first tibiæ dilated throughout, last tibiæ 6-spinose. Long, 15: exp. teg., 46 mill.

Hab. Trivandrum (S. India): Mr. H. Ferguson; May.

MESSENA BURMANICA, n. sp.

Frons, vertex and thorax dark reddish-tawny: eyes darker, spinose beneath; antennæ truncate with a rather long filiform process at the apex: abdomen above sordid ochreous, basal third darker: tegmina with the basal fourth tawny, varied virescent and with a quadrate, black spot on the disc, apical three-fourths whitish, veins tawny, an irregular black patch near the commissure, and an irregular row of somewhat quadrate black spots and dots close to the apical margin of which the largest is on the posterior margin: wings with three large, oblong, transverse black spots towards the apex: abdomen beneath reddish tawny, the margin tinted orange: first femora and intermediate pair of feet, blackish-brown. Closely allied to *M. pulverosa*, Hope, differs in the markings on the tegmina which are also not so broad, and in the colour of the abdomen. Long with anal appendages, 17; exp. teg., 50 mill.

Hab. Palone (Burma): Captain Bingham (August).

CERYNIA VIRIDULA, n. sp.

Head and thorax above light green, in faded specimens, sordid yellow: tegmina light green; wings milky-white, immaculate: apical half of antennæ, eyes, two small lines on tegmina, one oblique in the middle towards the posterior margin, the other smaller, straight, at the beginning of the apical fourth and nearer the anterior margin, also a very narrow apical limbus reaching also to one-third of the posterior margin, deep black: abdomen covered with a white flocculent substance: feet greenish-yellow, tarsi black. Body long, 17: exp. teg. 49 mill.

Hab. Puna (Bombay): type in Indian Museum.

The type of the Genus *Cerynia* (J. Pt. II, p. 64, 1885) is *Flata albata*, Stål, already described (J. l. c. p. 73) and of which I have recently procured specimens of the white and pale green varieties from Malacca. In the first line of the description of that species for 'within,' read

'with.' In the description of *Phromnia* (J. l. c., p. 64) for 'thorax concealed' in line 2, read 'concealed by thorax.' The chief points of difference between the two genera are that in *Cerynia*, the first joint of the antennæ is scarcely shorter than the second and the membrane of the costa is narrowed at the base; whilst in *Phromnia*, the second joint of the antennæ is twice, or scarcely twice, as long as the first and the costal membrane is equally broad throughout. These are apparently small differences on which to found genera, but the result seems natural and the genera at present may be allowed to stand separate.

J. A. S. B. Pt. II, p. 52 (1885):—*Ricania obscura*, Fabr., is the type of Stål's genus *Mindura* (l. c. p. 62) of which I have seen a specimen, locality unknown.

CENESTRA AFFINIS, n. sp.

Body subsordid yellow: frons highly carinate on the sides, with a black line running parallel to each of the lateral ridges; eyes black: antennæ black, second joint longer than the first: pronotum with two median longitudinal black lines; mesonotum anteriorly with a lateral sagittate mark and two longitudinal lines on the anterior portion of the disc, black, its posterior margin with four small cuneate black spots: abdomen spotted and streaked black: femora more or less sordid yellow, tibiæ and tarsi black, tegmina rounded at the apex, bluish-brown, spotted and clouded with white farinose matter above, beneath brown with a slight bluish tinge; the very narrow costal limbus to two-thirds the length, and thence broadening into a band which turns inwards to nearly the disc, sordid whitish; this band is barely traceable above through the farinose covering: wings ample, semihyaline fuscous, veins of a deeper colour. In *C. circulata*, Guérin, the tegmina are yellow-whitish with black bands; in *C. matutina*, Walker, they are of a rosy colour, and in *C. aurora*, Guérin, they are sub-orange and the wings are white. Long, body 9-10; with teg. closed, 16; exp. teg., 35 mill.

Hab. Singapore.

BRACHYPLATYS CAROLINÆ, n. sp.

Brassy-black, shining: antennæ ochraceous, finely pilose, apical halves of last three joints more or less blackish-brown: anterior half of eyes yellowish-white, posterior part with a roseate tinge: head above with six yellow spots arranged in a semicircle: very fine anterior and lateral (anteriorly double) margins of pronotum, also lateral and posterior margins of scutellum, reddish yellow: pectus and venter, black, the latter with a yellow band along the margin and proceeding therefrom

to the disc on each side, eleven long yellow rays, an irregular large blackish-brown spot at the junction of the anterior part of the base of each ray with the marginal yellow band and partly on both, also a small round black dot on each alternate ray, towards the base: legs ochraceous-yellow, thickly and finely spotted brown, especially the femora: one of the largest species of this genus hitherto recorded. Long, 10: greatest breadth of abdomen, 8 mill.

Hab. Mungphu (Sikkim): 3,800 feet.

BRACHYPLATYS NIGER, n. sp.

Above and beneath shining black: femora and tibiæ with a brownish tinge, posterior tarsi sordid ochraceous: eyes bright light yellow: parts about the rostrum in repose sordid yellow. Long, 8: broad, 6 mill.

Hab. Malacca.

COPTOSOMA BRUNNEA, n. sp.

Deep castaneous-brown, shining: juga, spot in middle of frons, anterior margin of the pronotum (interrupted in the middle), lateral margins of the same (inclosing anteriorly a longitudinal deep-brown streak), lateral and posterior margins of the scutellum, genitalia for the most part, ventral limbus and feet, subsordid yellow-ochraceous: tylus, two transverse streaks before the transverse impression on pronotum, lateral angles slightly, also two spots towards the base of the scutellum more deeply reddish: ocelli bright red: eyes deep brown: pectus and venter darker: anterior margin of pronotum slightly reflexed. Long,  $3\frac{1}{4}$  mill.

Hab. Pundaloya (Ceylon): Mr. E. E. Green.

COPTOSOMA MINIMA, n. sp.

Brassy-black, shining: juga, lateral margins of pronotum (inclosing anteriorly a longitudinal brown streak), lateral and posterior margins of scutellum, two small round spots on each side towards the anterior margin of the pronotum, and a spot on each posterior lateral angle, also a larger transverse spot at each side of the base of the scutellum, and the legs, yellow: venter brassy-black, margin of each segment with an oblong longitudinal yellow patch inclosing in the middle a longitudinal brown streak: one of the smallest species of this genus recorded. Long,  $1\frac{1}{2}$  mill.

Hab. Pundaloya (Ceylon): Mr. E. E. Green.

## COPTOSOMA NAZIRÆ, n. sp.

Above and beneath, brassy-black, shining : juga, lateral margins of the pronotum (inclosing anteriorly a black longitudinal streak), lateral and posterior margins of scutellum, also a spot on each side towards the base, ventral limbus, and the legs, yellowish : eyes castaneous. Long, 3 mill.

Hab. Nazira (Assam); Mungphu (Sikkim); Mr. R. Pantling.

## CHRYSOCORIS SIMPLEX, n. sp.

Light metallic-green, shining, turning into purplish after death; traces of the light colour remaining on the tylus, posterior part of pronotum and posterior part of the scutellum, but varying much : a small transverse, oval, elevated space on each side of the pronotum towards the anterior margin; anterior and antero-lateral margins slightly sinuate, extreme edge very slightly reflexed; posterior lateral angles very slightly obtusely prominulous; posterior margin almost straightly truncate : scutellum with three small round black spots on each side, sometimes obsolete : rostrum and antennæ brownish black; coxæ yellowish; femora and tibiæ metallic-green varied with purplish; tarsi brownish-black, ochraceous pilose : pectus golden-green with red reflections, turning to purplish : venter yellow, a larger subconical basal patch and another similar at the apex, black; two rows of lateral black spots, one submarginal, formed of round spots, the other inwards, formed of triangular spots, between the rows a band, and the extreme margin and apex, metallic-green turning into purplish : sometimes the basal and apical black patches on the venter are so approached that the discal yellow is reduced to a small transverse band. Long, 11-13 mill.

Hab. Kotagiri (Nilgiris) : April : Mr. Henderson.

## CHRYSOCORIS NILGIRIENSIS, n. sp.

When alive, above and pectus bright greenish-golden with red reflections which turns into deep purplish after death : antennæ and rostrum black; eyes deep brown : head golden with a median longitudinal line chalybeous-green : pronotum with eleven black spots, three small, transverse, sub-quadrate, close to the anterior margin; three rounded, arranged triangularly towards each lateral angle, and two elongate, linear, in the middle of the posterior portion of the disc : scutellum with eight spots, of which one median longitudinal near the base, three ovate transverse on each side, and one rounded subapical : pectus entirely golden and metallic green with scattered red reflections : disc of venter pale yellow, shining; extreme margin purplish-red, bordered in-

wardly by a broad golden greenish band which has a round black spot in the middle of each segment next the external purplish-red margin, and, inwardly, a triangular black patch, the base of which rests on the base of each segment; these spots often coalesce to form an oblong black transverse patch with metallic-green reflections: base and apex of the venter with a black patch; anus golden: femora cinnabar, apices and tibiæ externally metallic-blue, shining; tarsi black. Very close to *C. marginellus*, Westwd., but longer, stouter, and varying in markings beneath. Long, 16 mill.

Hab. Conoor (April).

COMPASTES MINOR, n. sp.

Above ochraceous, very closely impressly punctured brownish-black, somewhat closer on the lateral angles of the pronotum: beneath lighter ochraceous very sparingly punctured brown on the venter: juga longer than the tylus, not approached in front thereof: antennæ black, last joint pilose, with basal half ochraceous, apical half brown: rostrum ochraceous, last joint brown, reaching the last coxæ: pronotum moderately declined forwards, with two oval, transverse, outlined reddish-brown marks towards the anterior margin; lateral angles produced, somewhat obtusely rounded at the apex: membrane brown, transparent; legs ochraceous, femora streaked or spotted brown, granulated; tibiæ finely spinose. Long, 12: breadth angles pron., 6 mill.

Hab. Chakráta (Jaunsár-Báwar, N. W. Provinces).

SASTRAGALA AFFINIS, n. sp.

*Sastragala uniguttata* Am. & Serv. (nec. Don.) Hist. Nat. Ins. Hém., p. 155 1843)?

Amyot & Serville's description does not agree with Donovan's figure and appears to me to belong to the following species received from Madras. 'Yellowish greenish-testaceous, punctured coarsely and densely above: lateral angles of pronotum produced in short subacute spines black, and the line between them more or less black: scutellum black, with a broad ovate transverse reddish ochraceous spot in the middle: apex of corium with a black linear C-shaped spot, open towards the external margin; membrane transparent, nearly the colour of the hemelytra: disc and apex of the abdomen black, reddish towards the sides and on the genitalia; the lateral limbus pale greenish-testaceous: beneath paler yellow-greenish with a reddish tinge on the disc of the basal half of the venter: feet pale greenish-yellow: antennæ dull ochreous-testaceous. Long  $8\frac{1}{4}$ ; exp. ang. pron. 4 mill.

Hab. Utakamand, Kotagiri (7000 feet): April: Mr. Henderson.

MONONYX INDICUS, n. sp.

Ochraceous-brunneous: head and pronotum irregularly tuberculate; lateral margins of the pronotum much roundly dilated, the dilated part semitransparent: scutellum subconvex, with a tubercle at each basal angle and at the apex: hemelytra with a few darker streaks here and there, and some semiacute small spinous tubercles on the coriaceous part; membrane concolorous: connexivum with the posterior margin of each segment, black: coxæ and femora yellow-testaceous; tibiæ and tarsi dark brown inclined to black. Long, 10; abd. broad, 7 mill.

Hab. Sikkim: rather common.



XIV.—*The Butterflies of the Nilgiri District, South India.*—By G. F. HAMPSON, B. A., *Coll. Exon. Oxon.* Communicated by THE SUPERINTENDENT OF THE INDIAN MUSEUM.

[Received Sept. 10th ;—Read Nov. 7th, 1888.]

The Nilgiris form the south-western extremity of the Eastern Gháts, which branch off from the Western Gháts north of the Palghát Gap, the only gap in the great range of mountains which run parallel with the west coast of India from Cape Comorin to Bombay. Zoologically, the Nilgiri District forms the north-eastern extremity of the Ceylonese subdivision of the Oriental region—the sub-region extending northward along the Western Gháts to Bombay—, and its fauna and flora is essentially of a Ceylonese type, largely mingled with the wide-spread forms of the plains of India.

The district is a wedge-shaped triangle with a base of about twenty-five miles resting on Malabar, its apex, forty miles off, pointing north-east towards Madras.

On the west, the Malabar boundary runs along the slopes of the Nilgiris at an elevation of three to six thousand feet; on the other sides, the district takes in a narrow strip of the plains from three to ten miles wide, bounded on the north by the Moyar River, on the other side of which lies Mysore and the Wynád, and on the south by the Bowani River, beyond which is the Coimbatore district. These rivers join at the north-eastern apex of the Nilgiris to flow later on into the Cauvery.

For zoological purposes the district falls naturally into four divisions :—

(1.) The plateau, with a general elevation of six thousand feet, though the rounded hills and peaks run up much higher, some to nearly nine thousand feet. Innumerable valleys, each with its swamp and stream, cut up the surface of the plateau. The land is clothed with short grass, and in every position sheltered from the wind are patches of forest from one to several hundred acres in extent. The fauna and flora of this division has a large remnant of Palæarctic genera and species, though the forms have mostly become sufficiently differentiated to form distinct species.

(2.) The slopes of the hills, clothed with forest and long lemongrass, and ranging in elevation from 1000 ft. to 6000 ft. on the southern slopes, and from 3000 ft.—the elevation of the Mysore plateau—to 6,500 ft. on the northern slopes. To this division most of the peculiar forms belong, and it is by far the richest in species.

(3.) The strips of cultivated land at the base of the hills, with an



elevation of 1000 ft. on the southern side and 3000 ft. on the northern, and a fauna similar to that of the plains of India.

(4.) The tract of low-country forest within the north-western boundary, with a fauna like that of the jungles of the Wynád and Mysore, which lie just beyond.

Compared with most parts of Peninsular India, the district is very rich in butterflies, especially the slopes of the hills from two to five thousand feet in elevation. The following list will be found to be nearly complete, and I do not expect that more than about twenty species will be added to it.

The only regular flights of butterflies are those before the two monsoons, one from west to east at the end of May and beginning of June before the south-west monsoon, and one from east to west at the end of September and beginning of October before the north-east monsoon.

Most of the species have four broods, two in the dry-season and two in the wet-season; but some species have only the two wet-season broods, as Mr. Doherty has observed in other parts of India. Seasonal dimorphism is rather difficult to study on the Nilgiris, owing to the fact that the western and north-western slopes get heavy rain during the south-west monsoon and hardly any during the north-east; while the eastern and south-eastern slopes have their wet season during the north-east monsoon and get little of the south-west; and, consequently, the wet- and dry-season broods are some three months later in appearing on the southern and eastern slopes than on the western and northern, and the two forms get much mingled in the intermediate districts, which partially get both monsoons.

### Family NYMPHALIDÆ.

#### Subfamily EUPLÆINÆ, Moore.

##### Group *Limnaina*, Moore.

1. *HESTIA MALABARICA*, Moore.

3000—4000 ft. Found only on the western slopes, the species being confined to the region of heavy rainfall.

2. *TIRUMALA LIMNIACE*, Cramer.

3. *TIRUMALA SEPTENTRIONIS*, Butler.

4. *LIMNAS CHRYSIPPUS*, Linnæus.

I have no specimen intermediate between *L. chrysippus* and *L. alcipoides*, Moore.

5. *SALATURA GENUTIA*, Cramer.

6. *PARANTICA AGLEA*, Cramer.

7. *CADUGA NILGIRIENSIS*, Moore.

Common throughout the district.

Group *Euploëina*, Moore.

## 8. PADEMMA KOLLARI, Felder.

Two males at 3,500 ft. elevation on the northern slopes, and three pairs at 500 ft. on the western slopes.

## 9. CRASTIA CORE, Cramer.

## 10. NARMADA COREOIDES, Moore.

Found with *C. core* and not uncommon in spring and autumn at all elevations.

## Subfamily SATYRINÆ.

## 11. MYCALESIS (VIRAPA) ANAXIAS, Hewitson.

3000—5000 ft. In heavy forest; not common.

## 12. MYCALESIS (ORSOTRIËNA) MANDATA, Moore.

Form *mandosa*, Butler.

3000 ft. Common in the jungles at the northern base of the hills and throughout the Wynád and Mysore forests. The wet-season form *mandata* is found from June to September, when its place is taken by the dry-season form *mandosa*.

## 13. MYCALESIS (CALYSISME) PERSEUS, Fabricius.

Form *blasius*, Fabricius.

„ *subfasciata*, Moore.

The wet-season form *blasius* on the Nilgiris has the ocellus on the upperside of the forewing as large as in *M. mineus*.

## 14. MYCALESIS (CALYSISME) MINEUS, Linnæus.

Form *justina*, Cramer.

„ *indistans*, Moore.

„ *visala*, Moore.

## 15. MYCALESIS (TELINGA) ADOLPHEI, Guérin.

5000—6000 ft. Confined to forest on the edges of the plateau. This species has only the two wet-season broods in May and August. The allied species, *M. oculus*, Marshall, is found on the Anaymalai hills south of the Palghát Gap.

## 16. MYCALESIS (NISSANGA) JUNONIA, Butler.

2000—3000 ft. Confined to the southern and western slopes, where it is common in heavy forest.

## 17. LETHE EUROPA, Fabricius.

3000—5000 ft. Rather rare.

## 18. LETHE TODARA, Moore.

3000—5000 ft. Common in the low-country jungles and on the slopes of the hills. A slight geographical variety of *L. drypetis*, Hewitson, the male of which species is slightly darker, the female with the white

band on the upperside of the forewing rather narrower than in *L. todara*.

19. *LETHE NEELGHERRIENSIS*, Guérin.

2000—7000 ft. Common throughout the district.

20. *YPHIMA BALDUS*, Fabricius.

Form *marshallii*, Butler.

21. *YPHIMA STRIATA*, n. sp.

HABITAT: southern slopes of the Nilgiris, 2000—4000 ft.

EXPANSE: 1·5 inches.

*Wet-season form.*

DESCRIPTION: MALE. UPPERSIDE, *both wings* uniform dark brown. *Forewing* with a distinct bipupilled black ocellus outlined with yellowish-brown. *Hindwing* with two ocelli faintly pupilled and with yellow iris, situated between the median nervules. UNDERSIDE, *both wings* white with numerous distinct brown striæ. *Forewing* with one bipupilled ocellus larger and brighter than on the upperside; crossed by two brown fasciæ, one submarginal, one discal, nearly meeting at the hinder angle. *Hindwing* with a double ocellus on a short brown fascia near the apex, and three linearly disposed towards the anal angle, the one nearest it bipupilled, these three ocelli situated on a brown fascia, and all the ocelli large and distinct; a fascia crossing the wing beyond the cell from the costa to the inner margin, and a less distinct one near the base of the wing. FEMALE; only differs in being rather larger and paler than the male. MALE; with no trace of the patch of dense scales on the upperside of the forewing.

*Dry-season form.*

MALE. UPPERSIDE, *forewing* with a slight patch of dense scales on the median nervure; with a very small and indistinct ocellus. UNDERSIDE, *both wings* with the fasciæ indistinct and the striæ smaller and denser. *Hindwing*, with the ocelli much smaller than in the wet-season form, the double ocellus near the apex separated into two ocelli, the upper one minute, and the bipupilled ocellus near the anal angle forming a double ocellus. FEMALE. UPPERSIDE, *forewing* differs from the male in having a large and distinct black bipupilled ocellus with yellow iris. UNDERSIDE, *both wings* with the fasciæ more prominent, but not as much so as in the wet-season form.

The wet-season form occurs commonly at about 3000 ft. on the southern slopes of the Nilgiris in August, and the dry-season form in December and January.

On August 25th of this year—one in which there has been hardly any rain on that side of the hills—I took at 5000 ft. a single male with no

trace of the patch of dense scales on the forewing, which also had no trace of an ocellus: the underside darker—the colour of *Y. mahratta*, Moore —, the fasciæ of both wings indistinct as in the dry-season form, the ocelli on the underside of the hindwing even smaller and more separated.

The disposition of the ocelli and general appearance of the two forms is the same, as also that of the single male above described, and I believe them to constitute one species, which I suspect to be the one mentioned as *Y. singala* from Kumaon and *Y. thora* from Ganjam by Mr. Doherty, J. A. S. B., 1886, Vol. LV, Part II, No. II, p. 120. The species is allied to, but quite distinct from, *Y. singala* and *Y. thora*, which I suspect are two forms of one species.

22. *YPTHIMA MAHRATTA*, Moore.

3500 ft. The northern slopes, rare.

23. *YPTHIMA HUEBNERI*, Kirby.

3000—4000 ft. The northern slopes, common.

24. *YPTHIMA CEYLONICA*, Hewitson.

2000—4000 ft. The southern slopes, where it takes the place of *Y. huebneri* of the northern slopes.

25. *YPTHIMA CHENUI*, Guérin.

5000—8000 ft. Common on rocky hill sides. It has four broods with scarcely any difference in the ocellation. Also found of larger size on the Anaymalai Hills south of the Palghát Gap flying with *Y. ypthimoides*.

26. *YPTHIMA TABELLA*, Marshall.

Common at the north-west corner of the Nilgiris on the Wynád boundary.

27. *ZIPETES SAITIS*, Hewitson.

2000—3000 ft. Not uncommon on the western slopes. A brood emerges at the end of September.

28. *MELANITIS ASWA*, Moore.

Form *tambra*, Moore.

3000—4000 ft. Common on the lower slopes flying round trees at dusk. The former with the nearly straight outer margin to the forewing is the wet-season form appearing in June, the latter with the falcated forewing taking its place in December. The wet-season form varies much in the prominence of the ocelli of the underside; the dry-season form sometimes has the upperside immaculate, sometimes with one or more white subapical spots on the forewing.

29. *MELANITIS BELA*, Moore.

One specimen from the southern slopes is the only Nilgiri record of this species.

## 30. MELANITES LEDA, Linnæus.

Form *ismene*, Cramer.

On the Nilgiris the specimens of the wet-season form, *M. leda*, mostly have the fulvous markings of *M. ismene*, the dry-season form, on the upperside.

## 31. MELANITIS ACULEATA, n. sp.

HABITAT: Nilgiris N. slopes and Mysore forests, 3000 ft.

EXPANSE: 3·1 inches.

*Dry-season form.*

DESCRIPTION: MALE. UPPERSIDE, *both wings* uniform dark brown. *Forewing* with the outer margin very strongly falcated; a large black spot between the second and third median nervules, in the interspace above it another black spot with an indistinct whitish one on its outer edge, between this uppermost black spot and the costa a dusky ferruginous patch. *Hindwing* with three sharp-pointed angulations on the outer margin, two small white spots between the median nervules, and one between the upper median and lower discoidal nervules. UNDERSIDE, *both wings* ferruginous-brown, suffused with grey and ochreous near the base and costa of forewing and in some specimens mottled with black patches. *Forewing* with a brown fascia outside the cell from the costa to near the hinder angle. *Hindwing* with a fascia outside the cell from the costa to the abdominal margin; some specimens with a series of small white submarginal spots varying in number. FEMALE. Rather smaller than the male. UPPERSIDE, *forewing* with two white subapical spots. UNDERSIDE, *both wings* more variegated and the ocellation more distinct.

*Wet-season form.*

Differs only in having the outer margin of the forewing nearly straight and the ferruginous subapical patch more obscure.

This species is the South Indian representative of *M. ziteneus*, being slightly smaller than that species and with the subapical ferruginous patch obscure. Described from six males and one female of the dry-season brood and two males of the wet-season brood.

## Subfamily ELYMNIINÆ.

## 32. ELYMNIA CAUDATA, Butler.

1000 ft. Bamboo jungle at the foot of the southern and western slopes, rare.

## Subfamily MORPHINÆ.

## 33. DISCOPHORA LEPIDA, Moore.

One female seen on the western slopes in October, 1888, at 300 ft.

## Subfamily ACRÆINÆ.

34. TELCHINIA VIOLÆ, Fabricius.

## Subfamily NYMPHALINÆ.

35. ERGOLIS MERIONE, Cramer.  
 36. ERGOLIS TAPROBANA, Westwood.  
 37. ERGOLIS ARIADNE, Linnæus.  
 38. BYBLIA ILITHYIA, Drury.  
 1000—3000 ft. Near tanks on the plains.  
 39. EURIPUS CONSIMILIS, Westwood.

One specimen seen at the flower of *Lantana* at the north-western corner of the Nilgiris, October, 1888.

40. CUPHA ERYMANTHIS, Drury.  
 3000—6000 ft. Common.

LARVA, pale apple-green with branching black spines. PUPA, pale apple-green with three pairs of red and black frontal processes, and red and black frontal streaks.

41. ATELLA PHALANTA, Drury.  
 42. CETHOSIA MAHRATTA, Moore.

300—3500 ft. Common on the western slopes and a rare straggler throughout the rest of the district.

43. CYNTHIA SALOMA, Swinhoe.

Both sexes common on the western slopes, rare throughout the rest of the district.

44. ROHANA CAMIBA, Moore.

3000—6000 ft. The female very rare, the male not common.

45. PRECIS IPHITA, Cramer.  
 46. JUNONIA ALMANA, Linnæus.

Form *asterie*, Linnæus.

47. JUNONIA ATLITES, Linnæus.  
 48. JUNONIA LEMONIAS, Linnæus.  
 49. JUNONIA HIERTA, Fabricius.  
 50. JUNONIA ORITHYIA, Linnæus.  
 51. NEPTIS HORDONIA, Stoll.

Form *plagiosa*, Moore.

On the lower slopes the former is the wet-season form, the latter the dry-season, on the plateau *N. plagiosa* occurs throughout the year.

52. NEPTIS VIRAJA, Moore.

One specimen taken on the western slopes in October 1888, at 500 ft.

## 53. NEPTIS VARMONA, Moore.

Form *swinhoei*, Butler,,, *eurymene*, Butler.

*N. eurymene* is the dry-season form, *N. varmona*, the wet-season, and *N. swinhoei*, a variety of the former. Another small form is found on the plateau exactly like *N. astola* from the N.-W. Himalayas, except that the ground-colour of the underside is pale yellow.

## 54. NEPTIS KAMARUPA, Moore.

3000—4000 ft. A quite distinct species, larger and with the ground-colour of the underside a much brighter orange.

## 55. NEPTIS KALLAURA, Moore.

3000—4000 ft. Rare.

## 56. NEPTIS NANDINA, Moore.

3000—4000 ft. The width of the white bands on the underside in these two species varies much and, though *N. nandina* is larger, I doubt if they are distinct.

57. NEPTIS OPHIANA, Moore, var. *nilgirica*, Moore, n.

DESCRIPTION: "Allied to the Sikkimese *N. ophiana*, wings shorter. UPPERSIDE, both wings with similarly disposed white markings. Forewing with the discal series of spots much larger, the lower spot of the middle pair being quadrate in shape (not obliquely triangular as in *N. ophiana*) there are also two large spots in the lower pair instead of one only as in *N. ophiana*. Hindwing with the medial band and discal spots broader. UNDERSIDE, both wings bright red with broad markings as above, and intervening outer narrow fasciæ. EXPANSE: 2.37 inches."

Mr. F. Moore gives the above description as of a new species, and it appears to be constant in this district, except that the colour of the underside varies, and the narrow outer fasciæ of the hindwing are often absent, but, as Mr. de Nicéville points out ("Butterflies of India," Vol. II, p. 105) that in other localities the distinguishing characters are inconstant, it is better it should rank as a variety. 3000—5000 ft. Not uncommon.

## 58. NEPTIS JUMBAH, Moore.

3000—5000 ft. Common.

## 59. CIRRHOCYROA RELATA, de Nicéville.

## 60. CIRRHOCYROA THAIS, Fabricius.

## 61. CIRRHOCYROA SWINHOEI, Butler.

3000—6000 ft. Commoner on the southern than the northern slopes. I do not believe in the distinctness of the above three forms; a similar variety of *C. swinhoei* with the inner edge of the discal band of forewing on underside not constricted at lower discoidal and first median nervules occurs, and intermediate specimens are found.

62. *HYPOLIMNAS BOLINA*, Linnæus.

63. *HYPOLIMNAS MISIPPUS*, Linnæus.

Three forms of the female occur "mimicking" *L. chrysippus*, *L. alcippus*, and *L. dorippus*.

64. *ARGYNNIS NIPHE*, Linnæus.

Confined to the plateau, where it is very common; much smaller in size than North Indian specimens.

65. *PARTHENOS VIRENS*, Moore.

Common on the western slopes and occurs throughout the district as a rare straggler.

66. *MODUZA PROCRI*s, Cramer.

3000—4000 ft. Rare.

67. *ATHYMA PERIUS*, Linnæus.

3000—7000 ft.

68. *ATHYMA MAHESA*, Moore.

3000—4000 ft. Rare. The dry-season form is larger than Sikkim specimens of *mahesa*—not *ranga*—and has the markings similar, while the wet-season form is smaller and has the markings on the upperside reduced to the discal band on both wings, and on the forewing three indistinct spots from the subcostal nerve and one in the cell.

69. *ATHYMA SELENOPHORA*, Kollar.

3000—5000 ft. Very rare. I have only taken three males and three females. Compared with Sikkim specimens the male has the upper spot of the discal band, on the forewing, smaller and rounder, the next spot of the same size, then the rest of the band on both wings narrower.

70. *ATHYMA INARINA*, Butler.

3000 ft. Two males which have the fulvous band on the upper-side obsolescent, also one female on the western slopes.

71. *SYMPHÆDRA NAIS*, Forster.

1000—3000 ft. In bamboo jungle.

72. *EUTHALIA EVELINA*, Stoll.

1000—4000 ft. Rare and difficult to catch.

73. *EUTHALIA LEPIDEA*, Butler.

2000—6000 ft. Rare.

74. *EUTHALIA GARUDA*, Moore.

1000—3000 ft. Rare.

75. *EUTHALIA LUBENTINA*, Cramer.

3000—4000 ft. Rare.

76. *PYRAMEIS CARDUI*, Linnæus.

Confined to the plateau.

77. *PYRAMEIS INDICA*, Herbst.

Confined to the plateau.



## 78. VANESSA CANACE, Linnæus.

3000—7000 ft.

LARVA, orange and white in alternate segments, numerous black spots on the orange segments, black streaks on the white, seven white branching black-tipped spines on each orange segment. PUPA, variegated reddish-brown with frontal gold and silver spots, head produced and bifid.

Differs from the description of the early stages of *V. haronica*.

## 79. CYRESTIS THYODAMAS, Boisduval.

Throughout the district. The yellow form does not occur.

## 80. KALLIMA WARDI, Moore.

2000—4000 ft. Rare on the northern, not uncommon on the southern slopes. Comes freely to sugar. The prominence of the discal spots varies much; rather larger and paler than specimens from Canara.

## 81. CHARAXES ATHAMAS, Drury.

Form *samatha*, Moore.

3000—4000 ft. Common.

## 82. CHARAXES FABIVS, Fabricius.

3000—4000 ft. Rare.

## 83. CHARAXES IMNA, Butler.

3000—4000 ft. Rare. The male has the basal fulvous area much brighter than *C. psaphon*, the female is larger than the female of that species = *C. serendiba*, and has the apex of the forewing much more produced, the shape of the white band and the black line defining its inner margin varies much, and on the forewing the band sometimes extends within the black line.

## Family LEMONIIDÆ.

## Subfamily LIBYTHÆINÆ.

## 84. LIBYTHEA MYRRHA, Godart.

Form *rama*, Moore.

3000—7000 ft. The width of the markings varies much, some specimens being typical *L. myrrha*, some intermediate, and some *L. rama*.

## 85. LIBYTHEA LEPITA, Moore.

3000—4000 ft. Rare. All the markings are small, and the discoidal streak, on the forewing, and two spots beyond it are well separated, and the underside is more variegated compared to Kumaon specimens.

## Subfamily NEMEOBIINÆ.

## 86. ABISARA SUFFUSA, Moore.

3000—5000 ft. Fairly common.

## Family LYCÆNIDÆ.

## 87. SPALGIS EPIUS, Westwood.

2000—4000 ft. Commoner on the southern slopes than the northern.

## 88. NEOPITHECOPS ZALMORA, Butler.

3000—4000 ft. The size of the white markings varies much in the several broods, but usually the dry-season form has much more white on the upperside than the wet-season form, and the black markings of the underside are smaller and fewer.

## 89. MEGISBA THWAITESI, Moore.

2000—4000 ft. The acuteness of the forewing and the size of the white discal patch vary slightly.

## 90. CURETIS THETYS, Drury.

1000—3000 ft. Confined to the southern and western slopes and very rare. The outer margin of the hindwing much rounded. Both the orange and white forms of the female occur.

## 91. CYANIRIS PUSPA, Horsfield.

Form *lavendularis*, Moore.

„ *lilacea*, var. n.

DESCRIPTION: MALE. UPPERSIDE, *both wings* with no white on the disc. FEMALE. UPPERSIDE, *both wings* with the whole white discal area suffused with blue more especially towards the base. UNDERSIDE, *both wings* as in the typical *C. puspa*. The seasonal broods do not differ. HABITAT: Nilgiris southern slopes and Nellyampathy Hills, Cochin.

2000—4000 ft. The *puspa* form is smaller than Himalayan specimens. The *lavendularis* form agrees with Ceylon specimens.

## 92. CYANIRIS ALBIDISCA, Moore.

3000—7000 ft. Common.

## 93. CYANIRIS LIMBATUS, Moore.

3000—7000 ft. Male very common; female rare, the whole disc suffused with blue.

## 94. CYANIRIS AKASA, Horsfield.

6000—8000 ft. Confined to the plateau, where it is very common.

## 95. CHILADES LAIUS, Cramer.

1000—3000 ft. Found in cultivation at the base of the hills in the cold weather.

## 96. CHILADES VARUNANA, Moore.

One pair taken on the western slopes in October 1888, at 300 ft.

## 97. ZIZERA PUTLI, Kollar.

1000—3000 ft. Found in cultivation at the base of the hills.

## 98. ZIZERA PYGMÆA, Snellin.

1000—7000 ft.



J. Smut del et lith

*Eupetaurus cinereus.*

PLATE XXII. — SQUIRRELS.

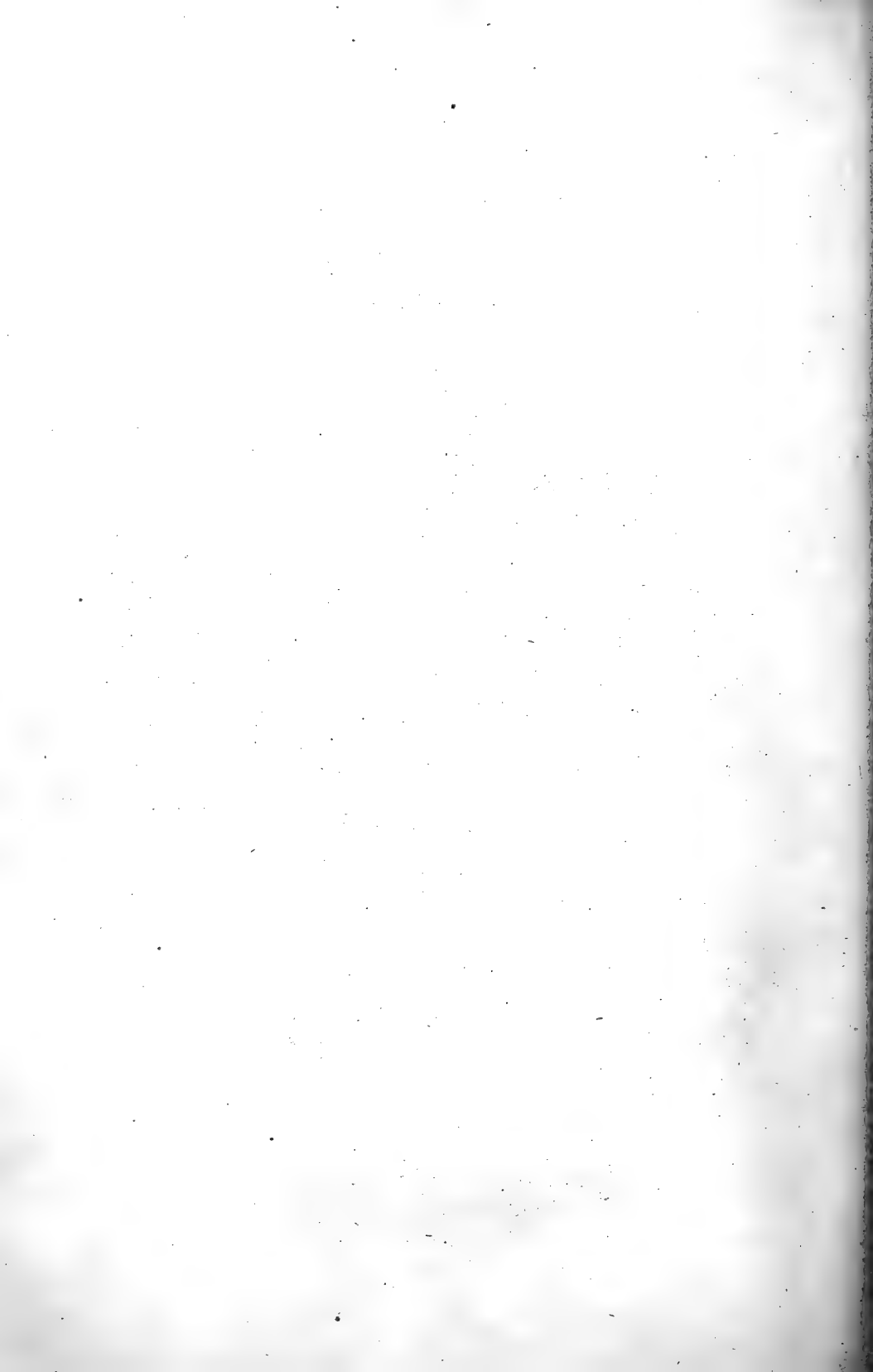

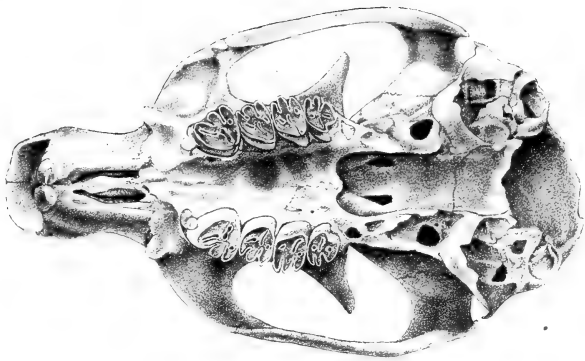
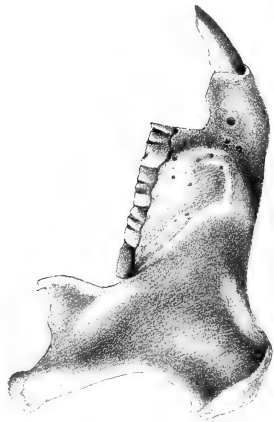
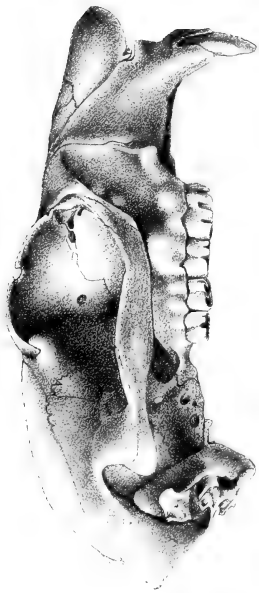
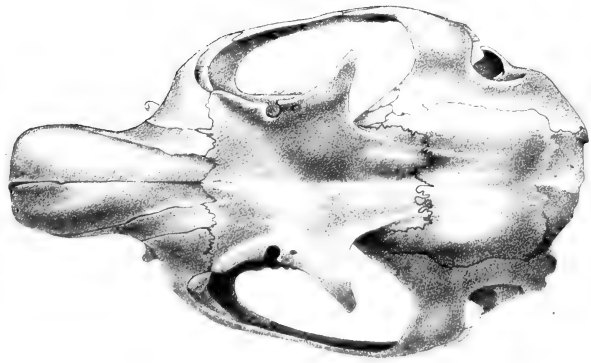

Behari Lal Das, del.

*Eupetaurus cinereus.*

Minutem. Pres. Libr.

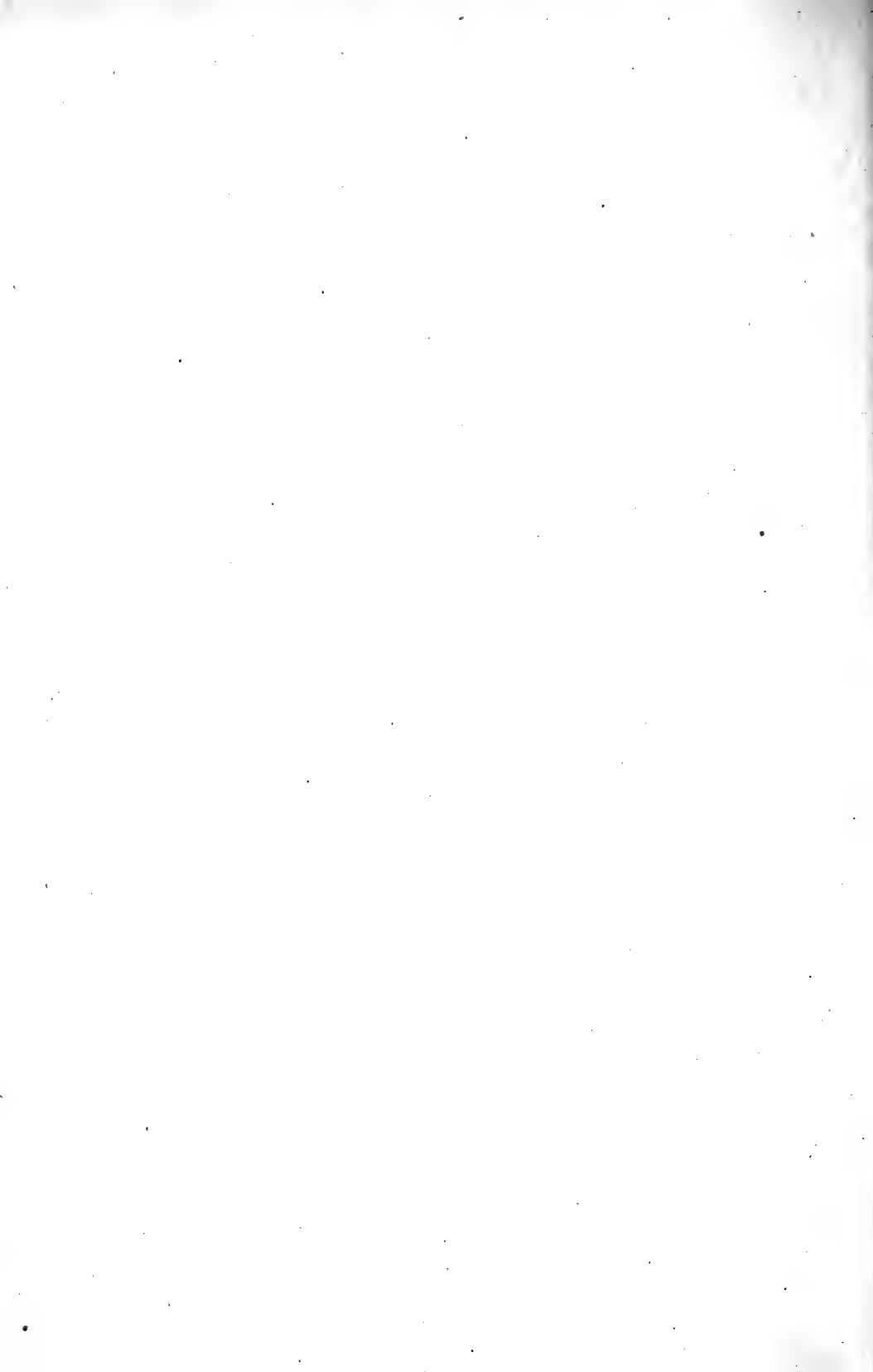

## 99. ZIZERA INDICA, Murray.

1000—7000 ft.

The black spots of the band on the underside of the forewing larger than in *Z. sangra*.

## 100. ZIZERA OSSA, Swinhoe.

1000—7000 ft. Much paler than *Z. maha*. Male with the dusky outer margin narrower. Female of the same colour—not dark as in *Z. maha*—the apex of the forewing broadly dusky.

## 101. AZANUS UBALDUS, Cramer.

1000—7000 ft. Rather rare.

## 102. AZANUS CRAMERI, Moore.

1000—3000 ft. Rare.

## 103. TARUCUS PLINIUS, Fabricius.

1000—7000 ft.

## 104. TARUCUS NARA, Kollar.

Form *callinara*, Butler.

1000—3000 ft. Specimens differ much in size; the spots of the underside are sometimes well separated, sometimes conjoined.

## 105. CASTALIUS DECIDEA, Hewitson.

Form *interruptus*, Moore.,, *hamatus*, Moore.

2000—5000 ft. *C. decidea* is the wet-season form, *C. interruptus*, the dry-season form, and *C. hamatus*, which occurs on the southern and western slopes, the dry-season form in regions of heavy rain-fall.

## 106. CASTALIUS ROSIMON, Fabricius.

1000—7000 ft.

## 107. CASTALIUS ETHION, Doubleday and Hewitson.

2000—4000 ft. In the female the blue markings of the male are replaced by black.

## 108. CASTALIUS ANANDA, de Nicéville.

Common at the foot of the Nellyampathy Hills, Cochin, in November, 1882. In September, 1882, I took about a dozen males and one female at 5000 feet on the northern slopes of the Nilgiris. They were confined to a few square yards and evidently belonged to one brood. I have never seen the species since.

## 109. EVERES PARRHASIUS, Fabricius.

1000—4000 ft.

## 110. JAMIDES BOCHUS, Cramer.

1000—7000 ft.

## 111. LYCÆNESTHES LYCÆNINA, Felder.

2000—4000 ft.

## 112. NACADUBA PROMINENS, Moore.

2000—6000 ft.

113. *NACADUBA MACROPHALMA*, Felder.

2000—6000 ft. The male of the wet-season brood is paler in colour than that of the dry-season brood, and has the areas between the discal bands on both wings of a dusky black colour. The dusky patches vary in extent and disposition.

114. *NACADUBA VIOLA*, Moore.

3000—4000 ft. April and May.

115. *NACADUBA ARDATES*, Moore.

1000—4000 ft. The tailed and tailless forms occur in both sexes throughout the year, and I believe them to be distinct species.

116. *NACADUBA DANA*, de Nicéville.

2000—4000 ft. Common.

117. *NACADUBA HAMPSONI*, de Nicéville.

2000—4000 ft. Male fairly common, female unknown. The wet-season form has dusky markings on the underside similar to those of *N. macrophthalma*, but more variable in extent.

118. *CATOCHRYSOPS STRABO*, Fabricius.119. *CATOCHRYSOPS CNEJUS*, Fabricius.

Form *patala*, Kollar.

„ *hapalina*, Butler.

120. *POLYOMMATUS BÆTICUS*, Linnæus.121. *LAMPIDES ÆLIANUS*, Fabricius.

Form *alexis*, Stoll.

1000—4000 ft. The former the wet-season, the latter the dry-season form.

122. *LAMPIDES ELPIS*, Godart.

1000—4000 ft.

123. *TALICADA NYSEUS*, Guérin.

2000—8000 ft. Very common.

124. *CATAPECILMA ELEGANS*, Druce.

2000—4000 ft. Fairly common.

125. *HORAGA ONYX*, Hewitson.126. *HORAGA VIOLA*, Moore.

2000—4000 ft. I have taken some thirty specimens of *Horaga*, and all the dark ones (*H. viola*) are males, and all the blue ones (*H. onyx*) females, and I believe the two forms are male and female of one species, but as in Sikkim and the Himalayas both *H. onyx* and *H. viola* have the sexes alike,—*H. onyx* male with secondary sexual characters on the forewing—the Nilgiri form would be a distinct species, but proof is wanting.

127. *SITHON INDRA*, Moore.

2000—5000 ft. Very rare.



128. RATHINDA AMOR, Fabricius.  
2000—4000 ft. Rare.
129. IRAOTA TIMOLEON, Stoll.  
1000—3000 ft. The species, as usual, appears under two forms.
130. DEUDORIX EPIJARBAS, Moore.  
2000—7000 ft.
131. VADEBRA ? LANKANA, Moore.  
2000—3000 ft. Seven males and one female on the southern slopes in April of this year. The generic name should be changed as the genus of *Euplexine* has priority.
132. ZESIUS CHRYSOMALLUS, Hübner.  
2000 ft. A single female in April of this year.
133. BASPA MELAMPUS, Cramer.  
2000—7000 ft. Rare.
134. VIRACHOLA ISOCRATES, Fabricius.  
2000—4000 ft. Much paler than North Indian specimens.
135. VIRACHOLA PERSE, Hewitson.  
2000—4000 ft. Some males have a patch of fulvous on the fore-wing, others not.
136. RAPALA LAZULINA, Moore.  
2000—4000 ft. Common.
137. RAPALA SCHISTACEA, Moore.  
2000—4000 ft. Common.
138. RAPALA DISTORTA, de Nicéville.  
3000 ft. One female in August of this year on the southern slopes, and eight females on the western slopes, 1000—2500 ft., in September, 1888. Differs from the description and figure of *R. distorta* in having the blue area on the upperside of both wings more restricted, and on the underside the white lines more regular and split up into well-defined lunules.
139. SPINDASIS VULCANUS, Fabricius.
140. SPINDASIS TRIFURCATA, Moore.  
2000—4000 ft. Not common.
141. SPINDASIS ELIMA, Moore.  
2000—4000 ft. Not uncommon.
142. SPINDASIS CONCANA, Moore.  
2000—4000 ft. Rather rare.
143. SPINDASIS LAZULARIA, Moore.  
3000—4000 ft. Rare.
144. SPINDASIS ABNORMIS, Moore.  
6000 ft. A male in Mr. Moore's collection taken by Mr. A. Lindsay, and a female in mine taken by Major-General Evezard, both at

Coonoor, are the only known specimens of this rare and distinct species. As Mr. de Nicéville will describe the female in "The Butterflies of India," Vol. III, it is unnecessary to do so here.

145. PRATAPA CLEOBIS, Godart.

3000—6000 ft. Rare. Nilgiri specimens have the discal band on the underside not bounded outwardly by a white line, and the markings at the anal angle obsolescent compared with North Indian specimens.

146. TAJURIA LONGINUS, Fabricius.

2000—4000 ft. Rare.

147. TAJURIA MELASTIGMA, de Nicéville.

2000—3000 ft. I have taken two males and two females, and on several occasions found wings on the ground. There is also a male in Mr. A. Lindsay's collection. Mr. de Nicéville will describe the female in "The Butterflies of India" Vol. III.

148. CHERITRA JAFFRA, Butler.

About fifteen specimens taken in September, 1888, on the western slopes.

149. HYPOLYCÆNA NILGIRICA, Moore.

1000 ft. Described from a single male taken by Mr. A. Lindsay, which is the only Nilgiri record of the species, though it has since been taken in Ceylon.

150. HYPOLYCÆNA ETOLUS, Fabricius.

Three females taken on the western slopes in September, 1888, at 2,500 ft.

151. LOXURA ATYMNUS, Cramer.

1000—4000 ft.

152. LOXURA SURYA, Moore.

About ten specimens taken on the western slopes in September, 1888, at 300—3000 ft.

153. BINDAHARA SUGRIVA, Horsfield.

2000—4000 ft. Fifteen males and one female this year, before which I had not seen the species. The wet-season form is larger and has the underside darker and yellower than the dry-season form.

154. SURENDRA TODARA, Moore.

2000—4000 ft. Common

155. AMBLYPODIA NARADOIDES, Moore.

Form *darana*, Moore.

2000—4000 ft. Fairly common on the southern slopes, rare on the northern. The variety of the female without any blue on the upperside (*A. darana*) is rare.

156. SATADRA CANARICA, Moore.

3500 ft. A single female March, 1887, on the northern slopes.

At least two species of *Nilasera* occur, which I have seen on one or

two occasions, but been unable to capture ; one of the *N. centaurus* group, the other with the variegated underside of the *N. amantes* group.

### Family PAPILIONIDÆ.

#### Subfamily PIERINÆ.

157. *LEPTOSIA XIPHIA*, Fabricius.  
1000—7000 ft.

158. *TERIAS HECABE*, Linnæus.  
Form *hecabeoides*, Ménétriés.

„ *æsiopæ*, Ménétriés.

„ *purrea*, Moore.

„ *excavata*, Moore.

„ *silhetana*, Wallace.

„ *uniformis*, Moore.

„ *swinhoei*, Butler.

*T. silhetana*, *uniformis*, and *swinhoei* possibly form one distinct species. The forms *hecabeoides* and *æsiopæ* were described from the West Indies, and it seems scarcely probable they are Indian.

159. *TERIAS LYBYTHEA*, Fabricius.

Form *drona*, Horsfield.

„ *rubella*, Wallace.

„ *venata*, Moore.

„ *rama*, Moore.

*T. venata* and *rama* probably form a distinct species.

160. *TERIAS LÆTA*, Boisduval.

161. *CATOPSILIA CATILLA*, Cramer.

162. *CATOPSILIA CROCALE*, Cramer.

These two species are doubtfully distinct, and there are several intermediate named forms.

163. *CATOPSILIA GNOMA*, Fabricius.

Form *ilea*, Fabricius.

164. *CATOPSILIA PYRANTHE*, Fabricius.

These two species again are doubtfully distinct. *C. ilea* is intermediate.

165. *IXIAS PYRENE*, Linnæus.

166. *IXIAS PYRENASSA*, Wallace.

Form *dharmsalæ*, Butler.

The former is the wet-season brood, the latter the dry-season form.

167. *IXIAS MERIDIONALIS*, Swinhoe.

Form *anubala*, Swinhoe.

The former is the dry-season form, the latter the wet-season form.

168. *IXIAS AGNIVERNA*, Moore.  
 169. *HEBOMOIA GLAUCIPPE*, Linnæus.  
 170. *CALLOSUNE EUCHARIS*, Fabricius.

Form *pseudevanthe*, Butler.

The former is the dry-season form, the latter the wet-season form.

171. *CALLOSUNE ETRIDA*, Boisduval.  
 Form *pernotatus*, Butler.  
 „ *purus*, Butler.  
 „ *bimbura*, Butler.

*C. bimbura* is the cold weather form.

172. *CALLOSUNE DANÆ*, Fabricius.  
 173. *IDMAIS AMATA*, Fabricius.

1000—3000 ft. Common.

174. *IDMAIS TRIPUNCTA*, Butler.

1000 ft. At the base of the southern slopes. The genera *Callosune* and *Idmais* frequent the plains at the base of the Nilgiris and only appear on the plateau as stragglers.

175. *COLIAS NILAGIRIENSIS*, Felder.  
 Confined to the plateau.

176. *HYPOSCRTIA NARENDRA*, Moore.  
 2000—4000 ft.

177. *CATOPHAGA WARDI*, Moore.  
 178. *CATOPHAGA PAULINA*, Cramer.  
 179. *CATOPHAGA NEOMBO*, Boisduval.  
 180. *CATOPHAGA GALENA*, Felder.  
 181. *CATOPHAGA LANKAPURA*, Moore.

2000—7000 ft. *C. wardi* is the most distinct of the above five forms.

182. *APPIAS VACANS*, Moore.

1000—3000 ft. Rare. A slight, but apparently constant variety of *A. hippoides*, differing from it in having dark markings at the base of the hindwing on the underside.

183. *APPIAS LIBYTHEA*, Fabricius.  
 1000—3000 ft. Rare.

184. *GANORIS GLICIRIA*, Cramer.

Confined to the plateau. Nilgiri specimens are darker than Himalayan ones, especially on the underside of the hindwing.

185. *HUPHINA PHRYNE*, Fabricius.  
 Form *cassida*, Fabricius.

The former is the wet-season, the latter the dry-season form.

186. *HUPHINA ZEUXIPPE*, Cramer.

A quite distinct species with sharper apex to the forewing, and more powerful flight.

## 187. HUPHINA REMBA, Moore.

Common on the western slopes, a rare straggler throughout the rest of the district.

## 188. BELENOIS MESENTINA, Cramer.

Form *auriginea*, Butler.

„ *lordaca*, Walker.

1000—8000 ft. *B. auriginea* is the wet-season, *B. lordaca* the dry-season form, and *B. mesentina* the wet-season form from dry localities and high elevations; it is found on the plateau.

189. *Nepheronia fraterna*, Moore.

Form *ceylonica*, Felder.

1000—3000 ft. The former is the dry-season, the latter the wet-season form.

## 190. NEPHERONIA PINGASA, Moore.

1000 ft. The western slopes and Malabar. A form from regions of heavy rain-fall.

## 191. NEPHERONIA GÆA, Felder.

1000—3000 ft. The Indian form of the Burmese *N. valeria*.

## 192. DELIAS EUCHARIS, Drury.

1000—7000 ft.

## Subfamily PAPILIONINÆ.

## 193. PAPILIO (ORNITHOPTERA) MINOS, Cramer.

3000—7000 ft.

## 194. PAPILIO (CHILASA) DISSIMILIS, Linnæus.

1000—4000 ft. Rare.

## 195. PAPILIO (CHILASA) CLYTIA, Linnæus.

1000—4000 ft. Rare.

## 196. PAPILIO (CHILASA) DRAVIDARUM, Wood-Mason.

Common in the western slopes, rare on the northern.

## 197. PAPILIO (MENELAIDES) PANDIANA, Moore.

Confined to the western slopes, 1000—3000 ft., where it is common.

## 198. PAPILIO (MENELAIDES) HECTOR, Linnæus.

1000—7000 ft.

## 199. PAPILIO (MENELAIDES) ARISTOLOCHIÆ, Fabricius.

1000—7000 ft.

## 200. PAPILIO (ORPHEIDES) ERITHONIUS, Cramer.

1000—7000 ft.

## 201. PAPILIO (LAERTIAS) PAMMON, Linnæus.

1000—7000 ft. The three forms of the female occur.

## 202. PAPILIO (CHARUS) DAKSHA, n. sp.

*Papilio daksha*, Moore, MS.

"Allied to *C. helenus*. Differs in its more triangular form of forewing. Hindwing with the three white (very pale yellow) patches, as seen on the upperside, much wider in both sexes, the upper portion being twice the width of that in *C. helenus*, and the lower portion extends to, and slightly crosses, the discocellular. On the underside, the grey-speckled fascia on the forewing is narrower, and crosses the discal area midway between the end of the cell and exterior margin; the white patches on the hindwing are of the same width as seen from above, and form a complete continuous band, cut evenly by the slender black veins (not disconnected as they are in *C. helenus*); the submarginal and anal red lunules are similarly disposed, but in both sexes there are two small lunules between the subanal and the white patch."

"Expanse ♂ 5, ♀  $5\frac{1}{2}$  inches."

"This species is to *P. helenus* what *P. tamilana* is to *P. paris*."

1000—7000 ft. Common. Larva like that of *P. helenus* as figured by Horsfield and Moore, feeds on orange, and has the power of protruding two pink horns from the head with a delicious scent; it will always do this if taken up by a pair of scissors as by the beak of a bird.

203. PAPILIO (HARIMALA) CRINO, Fabricius.

1000—3000 ft.

204. PAPILIO (HARIMALA) BUDDHA, Westwood.

Confined to the western slopes, where it is not uncommon.

205. PAPILIO (ACHILLIDES) TAMILANA, Moore.

3000—7000 ft. From April to June. Not uncommon.

206. PAPILIO (ILIADES) POLYMNESTOR, Cramer.

2000—7000 ft.

207. PAPILIO (PATHYSA) NOMIUS, Esper.

1000 ft. One specimen.

208. PAPILIO (DALCHINIA) TEREDON, Felder.

2000—7000 ft.

209. PAPILIO (DALCHINIA) THERMODUSA, Swinhoe.

3500 ft. The northern slopes, two specimens February, 1886, and February, 1888.

210. PAPILIO (ZETIDES) DOSON, Felder.

1000—6000 ft. Rather rare.

211. PAPILIO (ZETIDES) AGAMEMNON, Linnæus.

1000—7000 ft.

212. PAPILIO LIOMEDON, Moore.

The western slopes, 2500 ft. Two specimens, September, 1888.

#### Family HESPERIIDÆ.

213. BADAMIA EXCLAMATIONIS, Fabricius.

3000—7000 ft. The two wet-season broods only.

214. *CHOASPES BENJAMINI*, Guérin.  
Confined to the plateau. The two wet-season broods only.
215. *CHOASPES GOMATA*, Moore.  
6000 ft. One male at tea blossom, October, 1887.
216. *ISMENE HELIRIUS*, Cramer.  
3000—6000 ft. Common at tea blossom. The two wet-season broods only, July and October.
217. *PARATA CHROMUS*, Cramer.  
3000—6000 ft.
218. *PARATA ALEXIS*, Fabricius.  
3000—7000 ft.
219. *BIBARIS SENA*, Moore.  
3000—6000 ft. Rare.
220. *BARACUS SUBDITUS*, Moore.  
2000—4000 ft. Common on both northern and southern slopes. Four broods.
221. *BARACUS SEPTENTRIONIS*, Wood-Mason & de Nicéville.  
2000—4000 ft. The southern slopes only. Common and has four broods.
222. *ASTICTOPTERUS STELLIFER*, Butler.  
2000—4000 ft.
223. *ASTICTOPTERUS SUBFASCIATUS*, Moore.  
About forty specimens taken in September, 1888, on the western slopes, at 500—3000 ft.
224. *MATAPA ARIA*, Moore.  
2000—6000 ft. Rare.
225. *GANGARA THYRSIS*, Fabricius.  
2000—6000 ft. Rare.
226. *PARNARA KUMARA*, Moore.  
2000—6000 ft. Common.
227. *PARNARA TOONA*, Moore.  
Three specimens taken in September, 1888, on the western slopes.
228. *PARNARA NAROOA*, Moore.  
2000—4000 ft. Not uncommon.
229. *PARNARA BEVANI*, Moore.  
2000—4000 ft.
230. *PARNARA BADA*, Moore.  
1000—4000 ft.
231. *SUASTUS GREMIUS*, Fabricius.  
1000—6000 ft. Not common.
232. *SUASTUS ADITUS*, Moore.  
2500 ft. Twenty-five specimens taken in September, 1888, on the

western slopes. Differs from Andaman specimens in the spots of the forewing being smaller, the underside of the hindwing being suffused on the disc with purple.

233. *SUASTUS SUBGRISEUS*, Moore.

3500 ft. Northern slopes, one specimen.

234. *CHAPRA MATHIAS*, Fabricius.

2000—6000 ft.

235. *CHAPRA AGNA*, Moore.

2000—4000 ft.

236. *CHAPRA PROMINENS*, Moore.

2000—4000 ft.

237. *TELICOTA BAMBUSE*, Moore.

2000—6000 ft.

238. *PADRAONA DARA*, Kollar.

2000—4000 ft. Underside greenish.

239. *PADRAONA PSEUDOMÆSA*, Moore.

2000—4000 ft. Underside ochreous.

240. *PADRAONA MÆSOIDES*, Butler.

2000—4000 ft. Markings on underside of hindwing defined with black.

241. *PADRAONA GOLA*, Moore.

2000—4000 ft.

Another form of *Padraona* occurs with the fulvous markings occupying the greater part of the upperside of the forewing. I do not know if it has been described. It is nearest to *P. gola*.

242. *CUPITHA PURREA*, Moore.

2000—4000 ft. Rare.

243. *AMPITTIA MARO*, Fabricius.

1000—3000 ft. Not common.

244. *TARACTOCERA CORAMAS*, Hewitson.

Confined to the plateau, where it swarms on grass-land from June to November.

245. *TARACTOCERA MÆVIUS*, Fabricius.

3000 ft. The northern slopes, four specimens, July, 1888.

246. *THANAOS INDISTINCTA*, Moore.

3000. The forest below the northern slopes, from July to November.

247. *HALPE BETURIA*, Hewitson.

2000—4000 ft. Rare.

248. *HALPE CEYLONICA*, Moore.

2000—4000 ft. Common.

249. *HALPE SITALA*, de Nicéville.

3000—5000 ft. Not common.



250. HALPE HONOREI, de Nicéville.  
300—4000 ft.

251. HALPE CERATA, Hewitson.

About thirty specimens taken on the western slopes in September, 1888.

252. ISOTEINON VINDHIANA, Moore.

253. ISOTEINON NILGIRIANA, Moore.

254. ISOTEINON MODESTA, Moore.

*I. vindhiana* is, I think, the dry-season form of *I. nilgiriana*, and *I. modesta*, described from a single specimen taken by Mr. A. Lindsay, a variety.

2000—4000 ft. *I. nilgiriana* and *I. vindhiana* common. *I. modesta* I have never taken.

255. GOMALIA ALBOFASCIATA, Moore.

1000—3000 ft. Found in cultivation on the plains, rare.

256. PYRGUS GALBA, Fabricius.

1000—8000 ft.

257. HYAROTIS ATRATUS, Fabricius.

2000—4000 ft. Not uncommon on the southern slopes, rare on the northern.

258. TAGIADES ATTICUS, Fabricius.

2000—5000 ft.

259. TAGIADES OBSCURUS, Mabille.

2000—5000 ft. Not common.

260. PLESIONEURA LEUCOCERA, Kollar.

2000—5000 ft. Common.

261. PLESIONEURA FUSCA, n. sp.

HABITAT: Nilgiris and Shevaroy Hills.

EXPANSE: 1·7 inches.

DESCRIPTION. Differs from *P. spilothyus* in having the cilia of the hindwing alternately black and white as in *P. leucocera*; the costal bifid spot of the discal series, on the forewing, white, not ochreous; the underside mottled with obscure grey; the latter half of the antennæ, in the male, white. The two lower spots of the subapical series, on the forewing, are often wanting, also the lowest spot of the discal series. Very near to *P. nigricans*, de Nicéville.

2000—4000 ft. Not uncommon.

262. PLESIONEURA SPILOTHYRUS, Felder.

2500 ft. The western slopes, two specimens, September, 1888.

263. PLESIONEURA AMBAREESA, Moore.

2000—6000 ft. Not uncommon on the southern slopes, rare on the northern.

## 264. PLESIONEURA ALYSOS, Moore.

3600 ft. One specimen on the northern slopes.

## 265. PLESIONEURA RESTRICTA, Moore.

2000—4000 ft. Rare.

## 266. PLESIONEURA BASIFLAVA, de Nicéville.

About twenty specimens taken in September, 1888, on the western slopes, at 2000—3000 ft.

## 267. UDASPES FOLUS, Cramer.

1000—7000 ft. Not common.

## 268. COLADENIA DAN, Fabricius.

2000—4000 ft.

## 269. COLADENIA TISSA, Moore.

2000—4000 ft. Fairly common, a geographical race of *C. indrani*.

## 270. ABARATHA RANSONNETII, Felder.

Form *taylori*, de Nicéville.

The latter is the dry-season form; specimens occur with the ground-colour of every shade between pale chestnut and nearly black.

## 271. ABARATHA AGAMA, Moore.

3000 ft. One specimen taken by Mr. Alfred Lindsay on the southern slopes.

## 272. TAFENA THWAITESI, Moore,

2000—4000 ft. Not uncommon.

## 273. ANTIGONUS ANGULATA, Felder.

2000—4000 ft. Not uncommon. Probably this is the species recorded from the Nilgiris as *A. potiphera* in Kirby's Synonymic Catalogue.

## 274. SARANGESA DSAHARA, Moore.

1000—3000 ft. The western slopes, not common.

## 275. SARANGESA ALBICILIA, Moore.

2500 ft. The western slopes, two specimens, September, 1888.

It differs from Ceylon specimens in being dusky instead of white on the underside of the hindwing.



XV.—*The Psychrometer and the Condensing Hygrometer.*—By S. A. HILL, B. Sc., *Meteorological Reporter to the Government of the North-Western Provinces and Oudh.*

[Received August 23rd ;—Read November 7th, 1888.]

In continuation of his classical researches into the thermal properties of aqueous vapour, Regnault turned his attention to the subject of hygrometry, and a translation of his paper on this subject will be found in *Taylor's Scientific Memoirs*, Vol. IV. The original paper in the *Comptes Rendus* is, I believe, not accessible in India, or at all events, in Allahabad. As the outcome of his researches he gave to the world a perfected form of the chemical or absorption hygrometer, a new and improved variety of condensing hygrometer, and an improved formula for reducing the readings of the psychrometer, or combination of dry and wet-bulb thermometers used as an instrument for determining the degree of moisture of the air.

The chemical hygrometer remains much as Regnault left it, but various other forms of condensing or dew point instruments have since been invented, though they are not much, if at all, known, in this country. The best of these are two invented by Alluard and Crova, Regnault's countrymen, and both of them are constructed on the same principle as his, *viz.*, that of cooling down a polished metallic vessel, by the evaporation of ether or some other volatile liquid inside it, until dew begins to be deposited on the surface, and noting the temperature at which this effect occurs by means of a thermometer immersed in the liquid. The chief difficulty in the use of Regnault's form of this instrument is that the small silver capsule (now generally replaced by an electro-plated one of thin brass) in which the ether is evaporated is difficult to maintain in as high a state of polish as is desirable, owing not only to its liability to be scratched, but to the tendency of the silver to become tarnished by accidental overflows of the ether. The consequence of a loss of polish from any cause is that dew is not observed until the temperature has fallen somewhat below the proper dew point. In Alluard's instrument, this difficulty is supposed to be got over by substituting for the silver surface one of gilt brass, which is much less liable to tarnish, and in Crova's instrument, by making the silver vessel in the form of a hollow cylinder with a horizontal axis, on the inner surface of which cylinder dew is observed by looking through it parallel to the axis. Even with Regnault's original instrument the difficulty is not a serious one, if care be taken to have the vessel properly burnished to start with, to repolish it with fine rouge immediately before each series of obser-

vations, and to place behind it a dark coloured screen when it is in use. For the purpose of the second series of observations, given below, the vessel belonging to one of Regnault's instruments, made about 15 years ago by Casella, was freshly electro-plated, burnished, and polished by my own hands.

An objection to the use of all condensing hygrometers which at first sight appears a serious one has been put forward in *Symons' Monthly Meteorological Magazine* for June 1885 by Mr. R. Strachan, who says, "A condensing hygrometer, whether Daniell's, Regnault's, Dines's, or Alluard's, has the thermometer's bulb immersed in a cooling medium and one surface of the dew plate is also in contact with the cooling medium, but the surface upon which the dew is formed is cooled by conduction, and is exposed to the air, which may be many degrees, 50 or 60, or more, warmer. In these circumstances when dew appears the thermometer must be colder than the outside of the plate. When the dew disappears the thermometer cannot have received the same addition of heat as the outer surface of the plate." Had there been any real weight in this objection, it would have doubtless been anticipated by Regnault, who, however, merely says that the surface on which the dew is deposited has the same temperature as the liquid, because the metal is very thin and is in immediate contact with the liquid, which must have sensibly the same temperature throughout, since it is constantly stirred by the bubbles of air. A little calculation will prove that, though the outside of the vessel is no doubt warmer than the inside, as Mr. Strachan suggests, the difference is so small as to be of no consequence whatever.

Suppose the vessel to be made of copper and to be  $\frac{1}{50}$  of an inch thick. It is usually made of brass coated with silver, the combination having probably about half the conducting power of copper, and being therefore equivalent to one of copper twice as thick. Now at page 216 of Professor Tait's book on *Heat* are given several experimental values for the thermal conductivity of copper, ranging from 4.11 to 2.04, on the pound, foot, and second system of units, the mean of all the values being 3.3. This is the number of thermal units which would be transmitted per second through a square foot of a plate one foot thick, if the two surfaces were kept at temperatures differing by  $1^{\circ}$ . Through a superficial area of 1 square foot and a thickness of  $\frac{1}{50}$  inch the flow of heat would be  $3.3 \times 12 \times 50 = 1980$  units per second. Under the assumption made about the metal actually employed, the heat transmitted would be half this or 990 units per second. Now suppose this heat is brought to the plate by air blowing at the rate of 20 miles per hour,—a somewhat extreme assumption, at any rate in India. In one

second  $\frac{20 \times 5280}{3600} = 29.33$  cubic feet will come in contact with the given surface. Under ordinary circumstances the mass of a cubic foot of air is about 0.08 lb., and its specific heat is 0.2375; therefore the total thermal capacity of the air which impinges on the square foot in one second is  $29.33 \times 0.08 \times .2375 = 0.55$ . Let this air be cooled from 105.2° F. to 30.7° F. This is the extreme case presented by the observations below, and is a much greater difference of temperature than any contemplated by Mr. Strachan. The air which reaches the plate every second will yield only  $(105.2 - 30.7) \times 0.55 = 40.975$  thermal units. Supposing this heat to be all taken up and transmitted by the plate, it can only produce a difference of temperature between the two sides equal to  $\frac{40.975}{990} = 0.0414^\circ$  F, or only about  $\frac{1}{25}$  of a degree.

Now, when experimenting in the open air, it is found impossible to determine the dew point with a degree of precision more minute than one or two tenths of a degree, however delicate the apparatus may be, as the dew point is constantly varying; hence a source of error which can never under any circumstances actually occurring affect the observations to the extent of more than  $\frac{1}{25}$  of a degree may be safely neglected.

An important practical difficulty in the use of any form of condensing hygrometer in very dry, hot weather, and one which renders the use of Daniell's instrument impossible under such circumstances, is that, without artificial cooling by some other means, it is almost impossible, by blowing or aspiration, to make ether evaporate rapidly enough to cool the liquid and the vessel which contains it down to the dew point, and maintain them at or near that temperature for an appreciable length of time. A more volatile liquid, like bisulphide of carbon, would probably do better, but apart from the objection to the use of this liquid on account of its evil smell, it cannot be used, because its fumes instantly tarnish the brightly polished silver surface. In the Allahabad observations 1 and 2 of the second series, tabulated below, this difficulty was got over by passing the current of air from the mouth through a small flask packed round with crushed ice in a covered beaker, which was placed about 18 inches from the hygrometer and on the leeward side of it. The breath before bubbling through the ether was thus cooled down almost to the dew point of the external air, and its excess of moisture was removed by condensation in the flask. Such a method of attaining the desired result would have been inadmissible in a place altogether devoid of ventilation, but no objection to it can arise when the instruments are directly exposed to our April hot winds.

In all the observations printed in Table I., the thermometer readings

have been corrected for scale error, as determined by comparison in water with a Kew standard. For the second series, these errors were re-determined, and the standard thermometer verified at the freezing point, at the beginning of April. The dew point thermometer is one of Casella's with a cylindrical bulb and a long scale which may be read off with ease to the tenth of a degree from a distance of three or four feet. The dry and wet bulb instruments are by Hicks. They have spherical bulbs about  $\frac{1}{3}$  of an inch in diameter and they have been very carefully graduated, their corrections to the standard at the present time being as follows :—

|                                      |                                      |
|--------------------------------------|--------------------------------------|
| No. 7 (Dry)                          | No. 8 (Wet)                          |
| Below $85^{\circ}$ , — $0.7^{\circ}$ | Below $57^{\circ}$ , — $0.7^{\circ}$ |
| Above $85^{\circ}$ , — $0.8^{\circ}$ | Above $57^{\circ}$ , — $0.8^{\circ}$ |

The condensing hygrometer is much more sensitive, or responds much more readily, to variations in the dew point than does the wet bulb thermometer. This may be partly the effect of its thermometer having a large cylindrical bulb and a capillary tube. Thus, when both instruments were exposed to a hot wind on the afternoon of the 7th April at Allahabad, the following fluctuations of the dew point were observed in a period of less than three minutes :  $36.9^{\circ}$ ,  $35.9^{\circ}$ ,  $33.7^{\circ}$ ,  $34.5^{\circ}$ ,  $30.7^{\circ}$ ,  $34.4^{\circ}$ . During this time the dry thermometer varied from  $104.2^{\circ}$  to  $105.2^{\circ}$  and back again to  $104.3^{\circ}$ , whilst the wet bulb stood constant at  $66.7^{\circ}$ .

Every dew point observation in the table, except No. 4 of Series II, represents the mean of at least four separate observations, made alternately at the moments of appearance and disappearance of dew. Every entry under dry bulb and wet bulb temperatures is the mean of two observations made immediately before and directly after the corresponding dew point observations, and the time to which they are referred is approximately the mean time of the whole set of observations.

Except in the Allahabad observations, in which I was assisted by Pandit Soti Raghubans Lal, a student in the M. A. class of the Muir College, all the observations have been made by myself. The second series has been expressly designed to determine if possible the influence of various degrees of ventilation upon the indications of the psychrometer.

TABLE I.—*Hygrometric Observations.*

| Series Number. | Locality.     | Place of Observation. | Date.    | Hour. | CORRECTED READINGS. |           |            | Barometer. | Ventilation.                   |
|----------------|---------------|-----------------------|----------|-------|---------------------|-----------|------------|------------|--------------------------------|
|                |               |                       |          |       | Dry Bulb.           | Wet Bulb. | Dew Point. |            |                                |
|                |               |                       |          |       |                     |           |            |            |                                |
| I (1881).      | 1 Naini Tal.  | Verandah.             | May 1    | 10—30 | 73·3                | 56·0      | 41·5       | 23·70      | Light breeze.                  |
|                | 2 Ranikhet.   | Obsy. shed.           | " 4      | 11    | 70·5                | 51·8      | 26·2       | 24·10      | Calm.                          |
|                | 3 Badri Nath  | Open hillside.        | " 17     | 15—40 | 59·2                | 49·7      | 41·8       | 20·59      | Fresh breeze.                  |
|                | 4 Do.         | Do.                   | " 18     | 13    | 58·5                | 46·1      | 35·8       | 20·61      | Strong wind.                   |
|                | 5 Dobri.      | Do.                   | " 29     | 11    | 68·5                | 58·6      | 51·4       | 22·45      | Calm.                          |
| II (1888).     | 1 Allahabad.  | Laboratory.           | April 17 | 11—15 | 92·4                | 67·2      | 38·0       | 29·40''    | Slight, from punkha over-head. |
|                | 2 Do.         | Do.                   | " 12     | 12    | 92·2                | 67·2      | 39·2       | 29·38      | Do.                            |
|                | 3 Do.         | College Corridor      | " 13     | 13    | 104·5               | 66·7      | 35·3       | 29·35      | Hot wind.                      |
|                | 4 Do.         | Do.                   | " 13—15  | 13—15 | 105·2               | 66·7      | 30·7       | 29·35      | Strong hot gust.               |
|                | 5 Mussoorie.  | Verandah              | April 26 | 15—15 | 69·9                | 54·2      | 30·2       | 23·56      | Calm.                          |
|                | 6 Do.         | Do.                   | " 15—30  | 15—30 | 71·3                | 54·0      | 26·7       | 23·55      | Do.                            |
|                | 7 Do.         | Do.                   | " 15—45  | 15—45 | 71·4                | 49·5      | 19·9       | 23·55      | Artificial ventilation.        |
|                | 8 Do.         | Do.                   | May 1    | 14—45 | 59·8                | 53·9      | 48·0       | 23·50      | Calm.                          |
|                | 9 Do.         | Do.                   | " 15—10  | 15—10 | 60·3                | 52·1      | 45·7       | 23·50      | Artificial vent.               |
|                | 10 Do.        | Do.                   | " 15—20  | 15—20 | 60·1                | 53·2      | 45·1       | 23·50      | Very light air.                |
|                | 11 Chakrata.  | In Doorway.           | " 14     | 13    | 75·2                | 57·7      | 38·7       | 23·39      | Calm.                          |
|                | 12 Deoban.    | Open forest.          | " 15     | 10    | 64·3                | 48·3      | 32·3       | 21·49      | Breeze.                        |
|                | 13 Do.        | Do.                   | " 10—20  | 10—20 | 65·4                | 48·6      | 32·2       | 21·49      | Do.                            |
|                | 14 Lakvár.    | In Doorway.           | " 17     | 12    | 85·1                | 65·0      | 44·5       | 25·81      | Calm.                          |
|                | 15 Do.        | Do.                   | " 12—30  | 12—30 | 86·8                | 62·1      | 43·6       | 25·80      | Artificial vent.               |
|                | 16 Dehra.     | Verandah              | June 14  | 13—30 | 93·9                | 71·2      | 54·6       | 27·52      | Light air.                     |
|                | 17 Do.        | Do.                   | " 13—45  | 13—45 | 94·3                | 69·7      | 52·3       | 27·52      | Do.                            |
|                | 18 Mussoorie. | Do.                   | July 2   | 17—15 | 69·3                | 61·2      | 53·8       | 23·50      | Calm.                          |
|                | 19 Do.        | Do.                   | " 17—30  | 17—30 | 69·3                | 59·6      | 52·6       | 23·51      | Artificial vent.               |
|                | 20 Do.        | Do.                   | " 17—40  | 17—40 | 69·3                | 60·7      | 52·7       | 23·51      | Calm.                          |
|                | 21 Allahabad. | Laboratory.           | July 28  | 12—50 | 80·1                | 77·3      | 75·8       | 29·15      | Slight from punkha.            |
|                | 22 Do.        | Corridor.             | " 13—30  | 13—30 | 79·4                | 77·6      | 76·9       | 29·13      | Breeze.                        |

In Regnault's memoir, above referred to, what is known as the convection theory of the psychrometer, first worked out by August, is given. It assumes that there is a current of air, either vertical or horizontal, that the air arrives in the vicinity of the wet thermometer with the temperature indicated by the dry one, and goes away with the temperature of the wet one, and that whilst in contact with the wet bulb it

becomes completely saturated with moisture. These assumptions lead to the formula,

$$f = f' - \frac{s}{L} (t - t') h, \text{ in which the symbols have the following meanings:—}$$

ings:—

$f$  = pressure of water vapour actually present in the air ;

$f'$  = pressure of saturated vapour at the temperature  $t'$  ;

$t$  = temperature of air ;

$t'$  = temperature of wet bulb ;

$h$  = height of the barometer ;

$s$  = specific heat of air under the actual conditions ;

$d$  = density of vapour compared to the actual air if the pressures and temperatures were equal ;

$L$  = Latent heat of evaporation at the temperature  $t'$ .

Dr. Apjohn, about the same time as August, arrived at a formula identical in form with August's, but differing in the value assigned to the factor  $\frac{s}{Ld}$ . Clerk Maxwell afterwards constructed a more elaborate

formula, in which the effects of radiation and diffusion were taken into account, but which, by neglecting small quantities of the second order, reduces into a form similar to that here given.

To enable us to deduce with precision the hygrometric condition of the air from the readings of the dry and wet bulb thermometers, it is therefore only necessary to determine exactly the value of the constant  $A$  of the formula  $f = f' - A (t - t') h$ . With the best values of  $s$ ,  $d$ , and  $L$  known in 1845, the value of  $A$ , when the thermometers are centigrade, becomes  $\frac{0.429}{610 - t'}$ , a formula giving for ordinary temperatures results

differing very little from those computed by Apjohn's formula, in which a constant value of the latent heat of evaporation is assumed. To verify this formula (which, with the true values of the three quantities entering into the factor  $A$ , as afterwards determined, should have 0.38 in the numerator instead of 0.429), Regnault instituted a long and very careful series of comparisons between the indications of a psychrometer placed outside his laboratory window and the results obtained by means of a chemical hygrometer through which air from the space between the two thermometers was drawn. The degrees of humidity calculated from the psychrometric observations by means of the formula were found to be in almost every case too high; but, when the degree of humidity was above 40 per cent., the psychrometer was found to give results in close accordance with the truth when the numerator of  $A$  was



altered from 0.429 to 0.48, though, for lower degrees of humidity, this alteration made the air appear too dry. The same was found to be the case with a series of observations made in the Pyrenees by M. Izaru at a mean atmospheric pressure of 700 millimetres, the standard observations for comparison being those of a condensing hygrometer.

In Regnault's class-room, with the doors and windows closed and no sensible circulation of air, it was found that, by using the same formula, the humidity deduced was much too high, or that the factor A must for still air be considerably increased.

Since 1845, many observers have attempted to verify or improve upon Regnault's results—amongst them Mr. H. F. Blanford, F. R. S., who, in 1876, published, in the *Journal* of this Society (Part II, VII), an account of observations made in various parts of India with a view to determine which formula of reduction was best suited to the conditions obtaining in this country. Mr. Blanford's general conclusion was that the dew point computed by August's formula, with Regnault's constants, from observations of the psychrometer made under an open shed, comes very near to that observed with a condensing hygrometer, even when the dew point is more than 40° below the temperature of the air. Both Apjohn's formula and Glaisher's factors give too high a result. This conclusion is verified by the observations now published, of which the first series has already appeared in the *Indian Meteorological Memoirs*, Vol. I. In Table II. the absolute and relative humidities as given by the dew point instrument and deduced from the psychrometric observations by August's formula are compared, and it will be seen that, whereas in still air, whether in the interior of a room or in a verandah without a thorough draught, the deduced humidities are invariably too high, the formula gives results agreeing closely with the truth whenever there is fair ventilation.

In very strong winds the formula gives results slightly too low, for in such conditions the assumptions underlying the theory are more or less completely verified and the theoretical value of  $\frac{s}{d}$  should be used instead of the modified value adopted by Regnault.

TABLE II.—*Deduced Results.*

| Series.    | Number. | From Dew Point. |                    | By August's Formula.<br>$f=f' - \frac{.48(t-t')h}{1130-t'}$ |                    | Difference computed—observed. |                    | $A = \frac{f'-f}{\frac{s}{5}(t-t')h}$ |
|------------|---------|-----------------|--------------------|-------------------------------------------------------------|--------------------|-------------------------------|--------------------|---------------------------------------|
|            |         | Vapour tension. | Relative Humidity. | Vapour tension.                                             | Relative Humidity. | Vapour tension.               | Relative Humidity. |                                       |
| I (1881).  | 1       | ·2669           | 32                 | ·2669                                                       | 32                 | +·0040                        | 0                  | ·00083                                |
|            | 2       | ·1411           | 19                 | ·1859                                                       | 25                 | +·0448                        | + 6                | ·00098                                |
|            | 3       | ·2659           | 53                 | ·2709                                                       | 53                 | +·0050                        | 0                  | ·00084                                |
|            | 4       | ·2109           | 43                 | ·1996                                                       | 41                 | -·0113                        | - 2                | ·00072                                |
|            | 5       | ·3808           | 55                 | ·3935                                                       | 56                 | +·0127                        | + 1                | ·00092                                |
| II (1888). | 1       | ·2298           | 15                 | ·3330                                                       | 22                 | +·1032                        | + 7                | ·00106                                |
|            | 2       | ·2406           | 16                 | ·3359                                                       | 22                 | +·0953                        | + 6                | ·00105                                |
|            | 3       | ·2068           | 9                  | ·1555                                                       | 7                  | -·0513                        | - 2                | ·00073                                |
|            | 4       | ·1716           | 8                  | ·1462                                                       | 6                  | -·0254                        | - 2                | ·00077                                |
|            | 5       | ·1679           | 23                 | ·2567                                                       | 35                 | +·0888                        | +12                | ·00124                                |
|            | 6       | ·1442           | 19                 | ·2370                                                       | 31                 | +·0928                        | +12                | ·00121                                |
|            | 7       | ·1071           | 14                 | ·1260                                                       | 16                 | +·0189                        | + 2                | ·00087                                |
|            | 8       | ·3359           | 65                 | ·3553                                                       | 69                 | +·0194                        | + 4                | ·00105                                |
|            | 9       | ·3083           | 59                 | ·3049                                                       | 58                 | -·0034                        | - 1                | ·00077                                |
|            | 10      | ·3015           | 58                 | ·3344                                                       | 64                 | +·0329                        | + 6                | ·00117                                |
|            | 11      | ·2361           | 27                 | ·2952                                                       | 34                 | +·0591                        | + 7                | ·00107                                |
|            | 12      | ·1837           | 30                 | ·1871                                                       | 31                 | +·0034                        | + 1                | ·00082                                |
|            | 13      | ·1830           | 29                 | ·1832                                                       | 29                 | +·0002                        | 0                  | ·00082                                |
|            | 14      | ·2946           | 24                 | ·3850                                                       | 32                 | +·0904                        | + 8                | ·00112                                |
|            | 15      | ·2846           | 22                 | ·2728                                                       | 21                 | -·0118                        | - 1                | ·00077                                |
|            | 16      | ·4280           | 26                 | ·4822                                                       | 30                 | +·0542                        | + 4                | ·00097                                |
|            | 17      | ·3936           | 24                 | ·4208                                                       | 26                 | +·0272                        | + 2                | ·00089                                |
|            | 18      | ·4156           | 58                 | ·4863                                                       | 68                 | +·0707                        | +10                | ·00119                                |
|            | 19      | ·3979           | 56                 | ·4096                                                       | 57                 | +·0117                        | + 1                | ·00090                                |
|            | 20      | ·3993           | 56                 | ·4415                                                       | 62                 | +·0422                        | + 6                | ·00118                                |
|            | 21      | ·8931           | 87                 | ·9013                                                       | 88                 | +·0082                        | + 1                | ·00100                                |
|            | 22      | ·9261           | 92                 | ·9240                                                       | 92                 | -·0021                        | 0                  | ·00075                                |

If we neglect the variations of L, which are not great for the range of temperature with which we have to deal in Indian meteorology, the mean value of A, in the formula adopted, for centigrade degrees and ordinary temperatures is about ·00080; or, if we include these variations, A ranges from ·00077 to ·00082. The theoretical value when  $\frac{s}{d} = 0.38$  is ·00063. With these may be compared some other results by the same and other observers:—

|                                 |        |
|---------------------------------|--------|
| Apjohn, .....                   | ·00063 |
| Regnault, in still air .....    | ·00128 |
| Do. in open air with wind ..... | ·00074 |

|                                          |        |
|------------------------------------------|--------|
| Sworykin, with fair ventilation .....    | ·00072 |
| Doyère, with sling thermometers .....    | ·00069 |
| Blanford, under thermometer sheds .....  | ·00083 |
| Angot.....                               | ·00085 |
| Chistoni .....                           | ·00085 |
| Hazen, with artificial ventilation ..... | ·00068 |

In the last column of Table II. the value of this factor derived from each set of observations is given. The extreme values shown in that column, ·00124 and ·00072, are almost identical with those found by Regnault. The mean for the 11 sets of observations with good ventilation is ·00078, for the 9 with bad ventilation, ·00111, and for the 7 with slight but insufficient ventilation, ·00101. The fact that substantially the same values have been found for *A*, under similar conditions as regards ventilation, on the two days of observation at Allahabad, the first day being excessively hot and dry and the last a steamy day in the rains, points to the conclusion that to whatever extent this factor may be dependent on ventilation, it is almost if not quite independent of the degree of humidity. When August's formula is used indiscriminately for all conditions of wind movement, as is now done by the Indian Meteorological Department, the effect must be to exaggerate considerably the variations of humidity both in the diurnal and the annual period. Observations made during the nights of the cold season, or on calm days in the rains, give too high a degree of humidity, whilst those made during the prevalence of the hot winds in April and May yield results somewhat too low.

The observations now published, if not so numerous or so accurate as those furnished by some other observers, are in two senses more extensive than any I have yet seen ; for they not only include observations showing a greater difference between the air temperature and the dew-point than is often observed in any other country, but some of them have been made near sea-level and others at various heights up to nearly 11,000 feet. They thus enable us to determine whether the barometric pressure should be taken into account in reducing psychrometric observations, as the theory indicates, or whether in accordance with Glaisher's assumption, recently revived and advocated by Professor H. A. Hazen,\* the variations of pressure have no influence on the indications of the wet bulb thermometer. Selecting only the observations with good ventilation, we may tabulate the results as follows:—

\* *American Journal of Science*, vol. xxx, Dec., 1885.

| Series. | No. | Barometer. | Factor A. |
|---------|-----|------------|-----------|
| I.      | 3   | 20.59 in.  | .00084    |
| „       | 4   | 20.61 „    | .00072    |
| II.     | 12  | 21.49 „    | .00082    |
| „       | 13  | 21.49 „    | .00080    |
| „       | 9   | 23.50 „    | .00077    |
| „       | 19  | 23.51 „    | .00090    |
| „       | 7   | 23.55 „    | .00087    |
| „       | 15  | 25.80 „    | .00077    |
| „       | 22  | 29.13 „    | .00075    |
| „       | 3   | 29.35 „    | .00073    |
| „       | 4   | 29.35 „    | .00077    |

The mean barometric pressure for the first six sets of observations is 21.86 inches and the mean value of  $A$  is .00081. For the other five the mean pressure is 27.44 inches and the mean value of the factor is .00078.

The other observations also indicate a substantial agreement in the mean results, as will be seen from the following figures, though the value of  $A$  in their case increases slightly as pressure decreases owing to the preponderating influence of the relatively too numerous observations made in still air at Mussoorie.

| Series.             | No. | Barometer. | Factor A. |
|---------------------|-----|------------|-----------|
| I.                  | 5   | 22.45 in.  | .00092    |
| II.                 | 11  | 23.39 „    | .00107    |
| „                   | 8   | 23.50 „    | .00105    |
| „                   | 10  | 23.50 „    | .00117    |
| „                   | 18  | 23.50 „    | .00119    |
| „                   | 20  | 23.51 „    | .00118    |
| „                   | 6   | 23.55 „    | .00121    |
| „                   | 5   | 23.56 „    | .00124    |
| I.                  | 1   | 23.70 „    | .00083    |
| „                   | 2   | 24.10 „    | .00098    |
| II.                 | 14  | 25.81 „    | .00112    |
| „                   | 16  | 27.52 „    | .00997    |
| „                   | 17  | 27.52 „    | .00089    |
| „                   | 21  | 29.15 „    | .00100    |
| „                   | 2   | 29.38 „    | .00105    |
| „                   | 1   | 29.40 „    | .00106    |
| Mean of first eight |     | 23.37 in.  | .00113    |
| Mean of last eight  |     | 27.07 „    | .00099    |

If, without reference to ventilation, we combine all the observations

in which the pressure was above 24.89 inches, the average value of all the pressure observations, we find the mean value of *A* to be .00091, and all the remaining observations give a mean of .00097.

From these figures it is abundantly evident that it is not the combined factor *Ah* of the second term of the formula which is constant, as Hazen supposes, and as was tacitly assumed by Glaisher in constructing his table of empirical factors, but only *A* that is so; and, wherever the pressures are considerably less than at sea level, Glaisher's factors, or any table constructed on the assumption that variations of pressure are of no account, must lead to erroneous results.

The factor *A* is thus nearly if not quite independent of pressure, but varies with the amount of ventilation up to a certain moderate velocity of wind, after which it appears to remain constant, except perhaps when the humidity is very low, as during the hot winds. With a view to testing Regnault's opinion that the formula adapted for ordinary open air conditions gives too low results when the air is very dry, we may tabulate the values of *A*, given in Table II., according to the relative humidities deduced from the temperature of the air and the dew point. This is here done, the observations being divided into two sets by the limit of 40 per cent. humidity, supposed by Regnault to be that below which his formula was inapplicable.

| Series.                                       | No. | Relative Humidity. | <i>A</i> . | Series.                                        | No. | Relative Humidity. | <i>A</i> . |
|-----------------------------------------------|-----|--------------------|------------|------------------------------------------------|-----|--------------------|------------|
| II.                                           | 4   | 8%                 | .00077     | I                                              | 4   | 43%                | .00072     |
| "                                             | 3   | 9                  | .00073     | "                                              | 3   | 53                 | .00084     |
| "                                             | 7   | 14                 | .00087     | "                                              | 5   | 55                 | .00092     |
| "                                             | 1   | 15                 | .00106     | II                                             | 19  | 56                 | .00090     |
| "                                             | 2   | 16                 | .00105     | "                                              | 20  | 56                 | .00118     |
| I.                                            | 2   | 19                 | .00098     | "                                              | 10  | 58                 | .00117     |
| II.                                           | 6   | 19                 | .00121     | "                                              | 18  | 58                 | .00119     |
| "                                             | 15  | 22                 | .00077     | "                                              | 9   | 59                 | .00077     |
| "                                             | 5   | 23                 | .00124     | "                                              | 8   | 65                 | .00105     |
| "                                             | 14  | 24                 | .00112     | "                                              | 21  | 87                 | .00100     |
| "                                             | 17  | 24                 | .00089     | "                                              | 22  | 92                 | .00075     |
| "                                             | 16  | 26                 | .00097     |                                                |     |                    |            |
| "                                             | 11  | 27                 | .00107     |                                                |     |                    |            |
| "                                             | 13  | 29                 | .00080     |                                                |     |                    |            |
| "                                             | 12  | 30                 | .00082     |                                                |     |                    |            |
| I.                                            | 1   | 32                 | .00083     |                                                |     |                    |            |
| Mean for observation with R.<br>H. below 40 % |     |                    | } .00095   | Mean for observations with R.<br>H. above 40 % |     |                    | } .00095   |

The large and small values of *A* are not distributed in this table according to any regular law, and the means of the two columns are as nearly as possible identical. It seems probable therefore that, when

Regnault got too low results by using his finally adopted formula in dry states of the atmosphere, this was rather the effect of a high wind than of the mere dryness of the air.

The first practical conclusion to be drawn from the discussion of these observations is that Regnault's modification of August's psychrometric formula is not likely to be improved upon, since it takes into account all the more important variables upon which the indications of the instrument depend, except the uncertain one of wind movement, and its constants have been correctly adapted to suit the condition of a moderate breeze in the open air. The second is that, if we want the dry and wet bulb thermometers to indicate the humidity correctly at times when there is no wind, we should make arrangements to ventilate them artificially at the moment of observation. This is not regularly done at any of our Indian observatories.



XVI.—*Anoplophrya æolosomatis*, a new Ciliate Infusorian parasitic in the Alimentary Canal of *Æolosoma chlorostictum*, W.-M., MSS.—  
By HENRY H. ANDERSON, B. A. Communicated by THE MICROSCOPICAL SOCIETY OF CALCUTTA.

[Received 1st January;—Read November 7th, 1888.\*]

(With Plate I.)

A wine-glass full of weeds and water from a neighbouring tank had been standing on my table for some days, when, one evening, having no fresh material, I began to re-examine the contents of the glass. It was swarming with a species of *Æolosoma*, first discovered by Mr. J. Wood-Mason, Superintendent of the Indian Museum, and named by him *Æolosoma chlorostictum*. One of these worms having been accidentally crushed by the pressure of the coverslip, among the contents of its alimentary canal were seen some Holotrichous Ciliate Infusoria belonging to the genus *Anoplophrya* of the family *Opalinidae*. Almost every one of the *Æolosoma* taken from the wine-glass during the next week contained specimens of the *Anoplophrya*, which is, I believe, a new species, and to which I would give the name *Anoplophrya æolosomatis*. It differs from all the members of this genus described by Kent, except *Anoplophrya mytili*, in possessing a single contractile vesicle, and its shape and the form of its endoplast distinguish it from that species; these characteristics distinguish it too from the forms discovered since the publication of Kent's manual by Leidy, Balbiani, and Foulke, as far as I can judge from the accounts of the discoveries of these writers that I have been able to get at.

In shape it is oval, tapering to a point at both ends, the tapering portion being considerably produced posteriorly. It is from  $\frac{1}{300}$  to  $\frac{1}{400}$ th of an inch in length; the compound forms are, however, considerably larger; the longest seen and measured, consisting of the parent form and two segments, was  $\frac{1}{110}$ th of an inch long. The breadth is barely half the length and the thickness from one eighth to one tenth. The endoplast is axial, band-shaped, extending nearly the whole length of the body, in most specimens straight, though in a few somewhat curved or S-shaped. It is very plain in specimens that are drying, not so clear, but still easily observable, in living specimens watched in the alimentary canal of living *Æolosoma*. It is coarsely granulated, and, in one specimen observed, five large and highly refractive, though not

\* Having been previously read before the Microscopical Society of Calcutta on December 5th, 1887.

crystalline, particles of different sizes were seen in it. In most cases, as the body lost its vitality, the granular portion of the endoplast contracted and became surrounded by a clear space. The surface of the infusorian is densely ciliated and finely striated in a longitudinal direction. The contractile vesicle was observed with great difficulty; in many specimens examined in the body of their host it could not be seen at all; in some, however, it was faintly seen, and in some very clearly; in no case was more than one observed, though numerous individuals passed under careful examination; it is situated centrally above the endoplast.

When watched in the alimentary canal of the *Æolosoma*, the *Anoplophrya* were usually stationary, with cilia in constant vibration. When by the crushing of the worm they were forced out, they swam vigorously forward for a short distance and then, in almost every case, reversed their motion, usually getting back again close to the point they had started from; but they seemed at once to lose the power of motion, though their cilia kept vibrating for a long time. Specimens which had got right away into clear water soon became quiescent and lost their shape; those which were surrounded by the contents of the alimentary canal kept their power of motion for a long time, in one case for over half an hour.

The multiplication by transverse fission is interesting as resembling the process that takes place in *Anoplophrya nodulata*. A number of different specimens in different stages of division were seen and drawn. The first form showed a constriction of the posterior extremity, about the last quarter of the endoplast being divided off. Judging from the various specimens in intermediate stages observed, this constriction gradually increases till the part which is being divided off is about twice as broad in its broadest part as it is at the point where it is attached to the parent form. In numerous cases a second constriction and appearance of fission anterior to the first was seen, the segments remaining attached. It was noticeable that the individuals in process of division were far larger than those not being divided and also that the segments were very much smaller than the parent form. The segments were approximately equal to one another, though in all cases the middle one, that is to say, the one divided off latest, was somewhat larger than the hinder one. The hinder segment was in one case observed to break off from the others and commence an independent existence.

Though for some time I was unable to find any of these *Anoplophrya* in *Æolosoma* taken from the same glass as those were in which I had found them swarming weeks before, I noticed numerous very small ciliated bodies, which were in some cases in very vigorous motion.



These were, however, so small that, even with the aid of a  $\frac{1}{10}$ " immersion objective, I was unable to distinguish their structure. Possibly, they were the result of sporular reproduction and were simply immature forms of this *Anoplophrya*. After an interval of some weeks from the time of the first disappearance of the parasite, I again found a few small specimens, but the accidental overturn of the wine-glass by a servant put an end to the investigation.

EXPLANATION OF PLATE I.

Fig. 1. *Anoplophrya æolosomatis*, n. sp.,  $\times 400$ ; n., endoplast or nucleus, c. v., contractile vesicle.

Fig. 2. A specimen showing refractive particles ( $n'$ ) in the endoplast and an unusually conspicuous contractile vesicle,  $\times 400$ .

Fig. 3. A specimen which had commenced to divide,  $\times 300$ .

Fig. 4. Another in which the fission had proceeded still further,  $\times 300$ .

Fig. 5. A third divided into a chain of three segments,  $\times 300$ .

The three last figures having all been drawn from specimens mounted in water exhibit no trace of a contractile vesicle.

---

XVII.—*On certain Features in the Geological Structure of the Myelat District of the Southern Shan States in Upper Burmah as affecting the Drainage of the Country.*—By BRIGADIER-GENERAL H. COLLETT, C. B. Communicated by DR. D. D. CUNNINGHAM.

[Received August 18th ;—Read Nov. 17th, 1888.]

There are some curious features in the geological structure as affecting the systems of drainage of the Myelat district of the Southern Shan States in Upper Burmah which appear to me to be novel and worthy of attention.

The general geological formation in this part of the great Shan plateau may be described as water-worn limestone with occasional interposed sheets and boulders of conglomerate underlying a sedimentary deposit of finely divided red clay, which varies in thickness from a thin superficial covering up to three or four hundred feet according to the amount of denudation it has undergone. This mantle of red clay at one time certainly overspread the whole country, probably at a nearly uniform level, for patches of it, like raised beaches, are seen clinging to sheltered hollows in the black limestone ridges which rise through it in long parallel folds, remnants which no doubt mark the ancient level of the red clay as deposited in the quiet depths of an ocean or large lake. The underlying limestone wherever exposed to view is seen to have been worn into rounded hollows and projecting bosses apparently by the action of water at a time when it was exposed to sub-aerial denudation, and it is, like limestone in other parts of the world, full of clefts, crevices, and caverns which communicate with each other to form subterranean channels into which a great part of the superficial drainage of the country disappears.

To such an extent is this the case in the Myelat that, though the district is traversed by distinct ranges of hills, the valleys lying between them have not as a rule been excavated by water-courses in the ordinary sense of the word, nor do they drain into rivers, but into holes in the ground, and thus we have the strange spectacle repeatedly presented to us of large basin-like depressions, and even narrow valleys, ending in a *cul de sac* and possessing no apparent outlet for the discharge of their drainage.

These depressions (which vary in size from a punch-bowl of a few feet in diameter to areas covering, as I roughly estimate, three or four square miles, and occasionally not less than two hundred feet in depth) are of an altogether different character from the "swallow holes" or "sinks" common in districts of calcareous rocks in

Scotland and elsewhere, and which are due to percolating water dissolving the limestone and forming superficial holes into which the overlying peat or soil gradually sinks.\* The same general principle governs of course both cases; but in Scotland there is only a thin covering of peaty soil overlying the limestone, whereas in the Shan hills we have a considerable thickness of fine red clay. It thus happens that in the first case we get only a few shallow holes, whereas in the latter vast masses of clay have been in the course of ages carried into the bowels of the earth, resulting in the excavation of extensive depressions, the entire drainage of which is carried away by subterranean channels.

The progress of the excavation of these depressions can be seen in every stage. The conditions of the phenomena, it must be remembered, are a thick covering of fine clay resting on a flooring of weather-worn limestone. The limestone abounds in holes and cracks, into one of which, at any given spot, the rain-water, percolating from above through the red clay, finds its way. This carries with it some of the clay from just above the hole, and a commencement has been made. Next rainy season more water finds its way by the same route and more of the sub-soil is subtracted. In a few months or years, the overlying clay becomes largely undermined and sinks down, and we get either a small crater, if the stratum of clay be not more than a few feet thick, or, if the clay be thicker, a broad circular depression in which rain-water will collect to carry on the process. Now, a similar process will be simultaneously going on at other points more or less adjacent to that we have been considering, and, in the course of time, the several craters or depressions thus formed will meet and coalesce. The water as it escapes through the underlying rock will enlarge its channels of exit by dissolving the limestone: more of the overlying red clay will year by year be removed: the area drained and the volume of water escaping will gradually augment: the ridges separating the contiguous centres of action will gradually disappear, and it is not difficult to understand how in the course of ages, that is, since the surface of the red clay became upraised into dry land, we shall in this manner at last find large areas of depression draining into underground channels.

These areas may even at the present time be seen in every stage of formation. There is the small crater-like opening 30 or 40 feet across which opened out last year, perhaps in the middle of some poor man's field, with its broken precipitous sides and ragged edges: there is the wide gently sloping valley extending over several hundred acres,

\* See Prof. A. Geikie, "The Scenery of Scotland viewed in connection with its Physical Geology," 2nd edition, p. 36.

and terminating at its lowest point in a cluster of exposed limestone rocks half hidden in a rank growth of grass and bushes: there is the round punch-bowl-like hollow from 100 to 500 feet across with often the gaping mouths of its drainage exit plainly discernible at the bottom: and in the more hilly districts there is the deep trench-like valley, closed at both ends, and once filled up to the brim with red clay of which hardly a trace now remains, and at its lowest point the exposed black limestone rocks through the interstices of which the entire superincumbent mass of clay must, during a long series of years, have been carried away by the water.

It seems most astonishing, and, at first sight, almost impossible, that the vast masses of red clay which, we can plainly see, have been eroded from the surface of the country can have been carried into the bowels of the earth instead of, as one is accustomed to see, into rivers and seas: but there is no escaping from the conclusion which I have endeavoured to explain. The evidence is absolutely undeniable, and the fact is universally accepted by the people of the country, who when asked what becomes of the drainage of one of these large basin-like depressions, always at once reply that "of course, it goes into the ground," as if it was quite the normal state of affairs that it should do so.

As a natural consequence, the Myelat district is remarkable for the absence of rivers. In the part which I know best,—comprising the sub-districts of Pwehla, Nankon, Kyon, Nangon, Thamakan, and Pinmi, and embracing an area of more than 250 square miles,—the map\* shows but one small stream, which is really nothing more than a ditch (the Baungdaw Chaung falling into the Inle Lake at Imlèywa), to carry off the drainage of a country in which the annual rainfall probably exceeds fifty inches.

I am not aware whether the facts I have endeavoured to describe are unusual, or whether similar instances of the products of denudation disappearing under ground are known in other countries; but I cannot remember having read of such a case.

MEIKTILA, UPPER BURMAH.

25th July, 1888.

\* Sheet No. 5, S. W., South Eastern Trans-frontier Map, Survey of India. Calcutta, May, 1888. (Unpublished proof.)

---

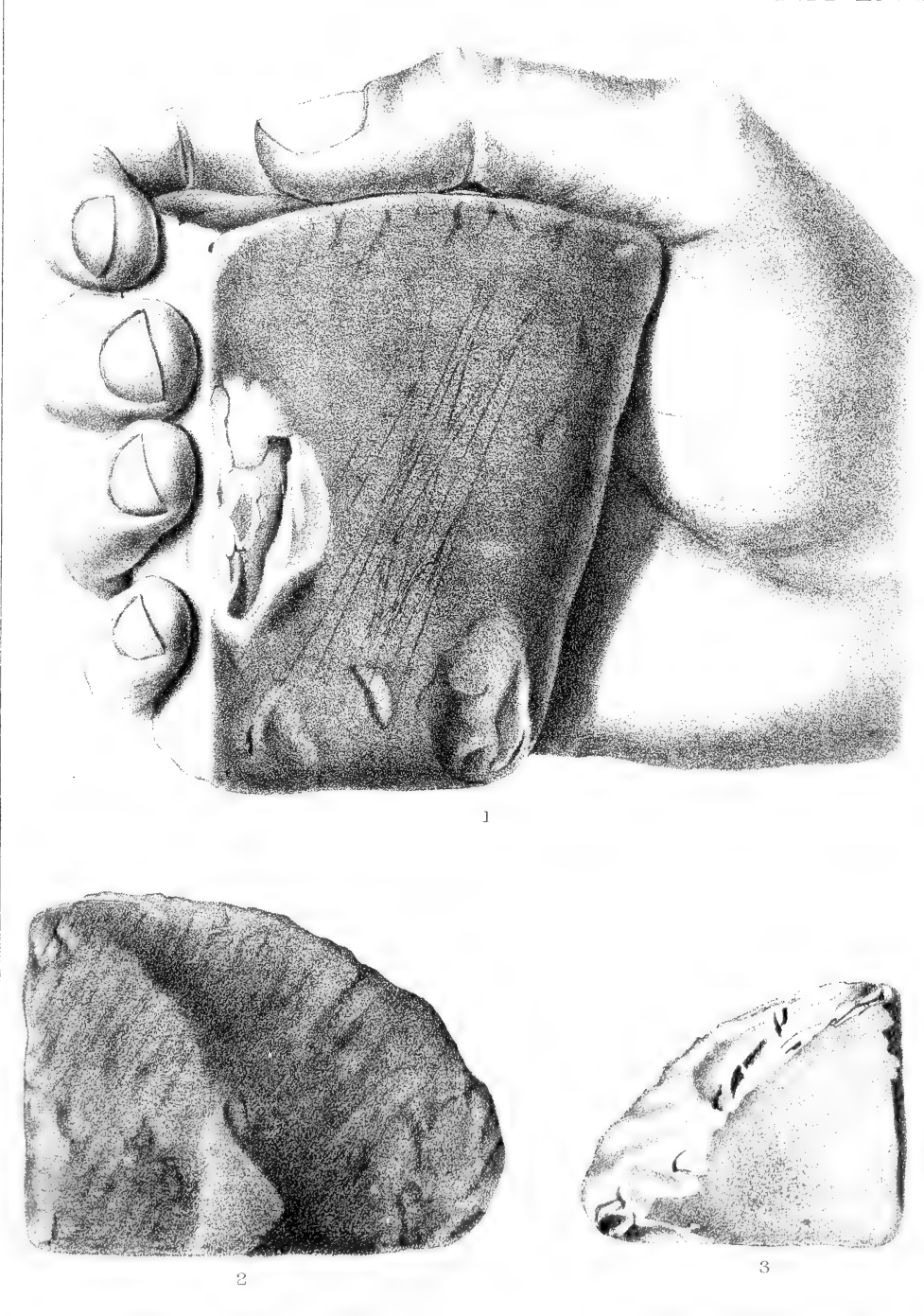

1

2

3



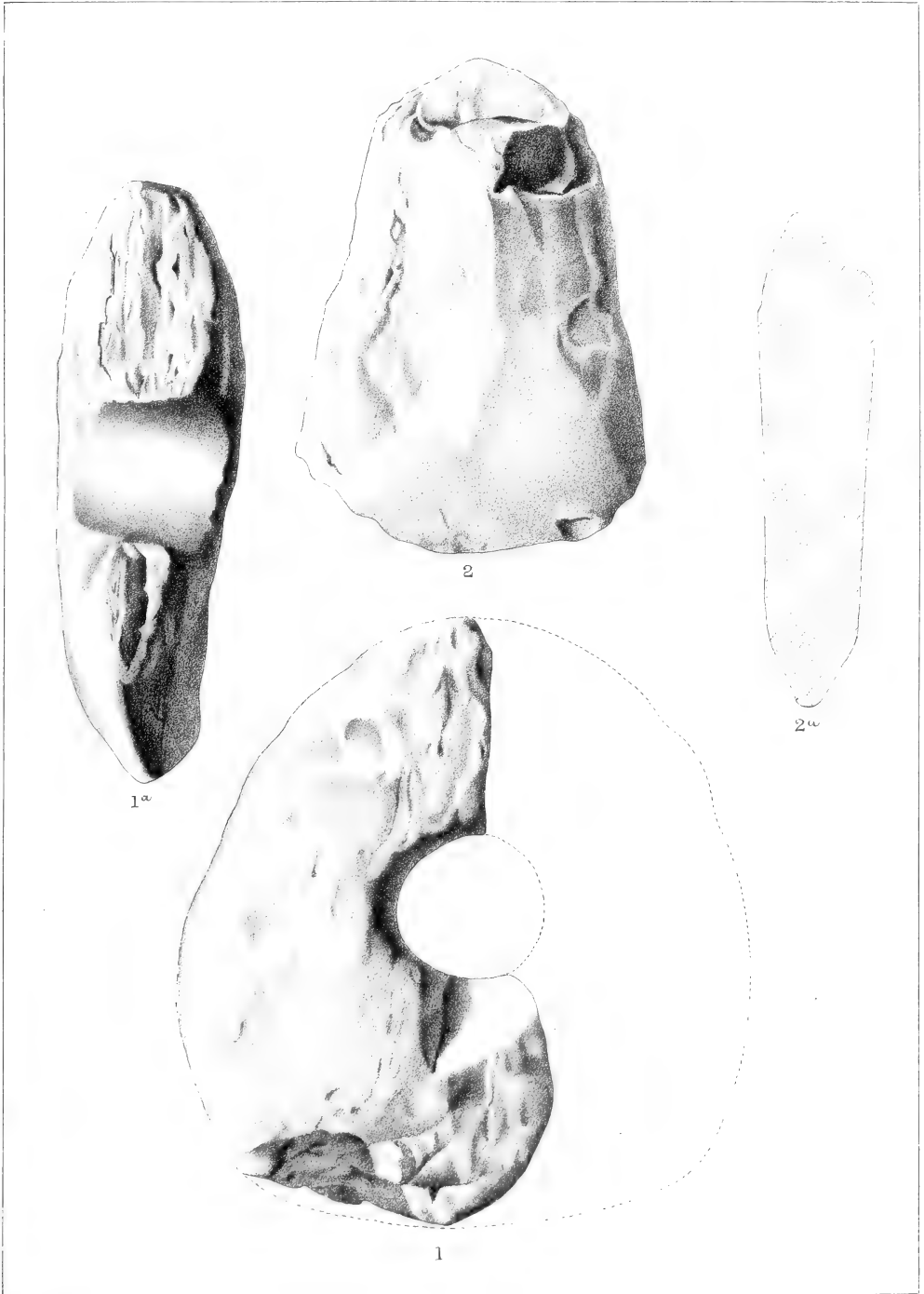

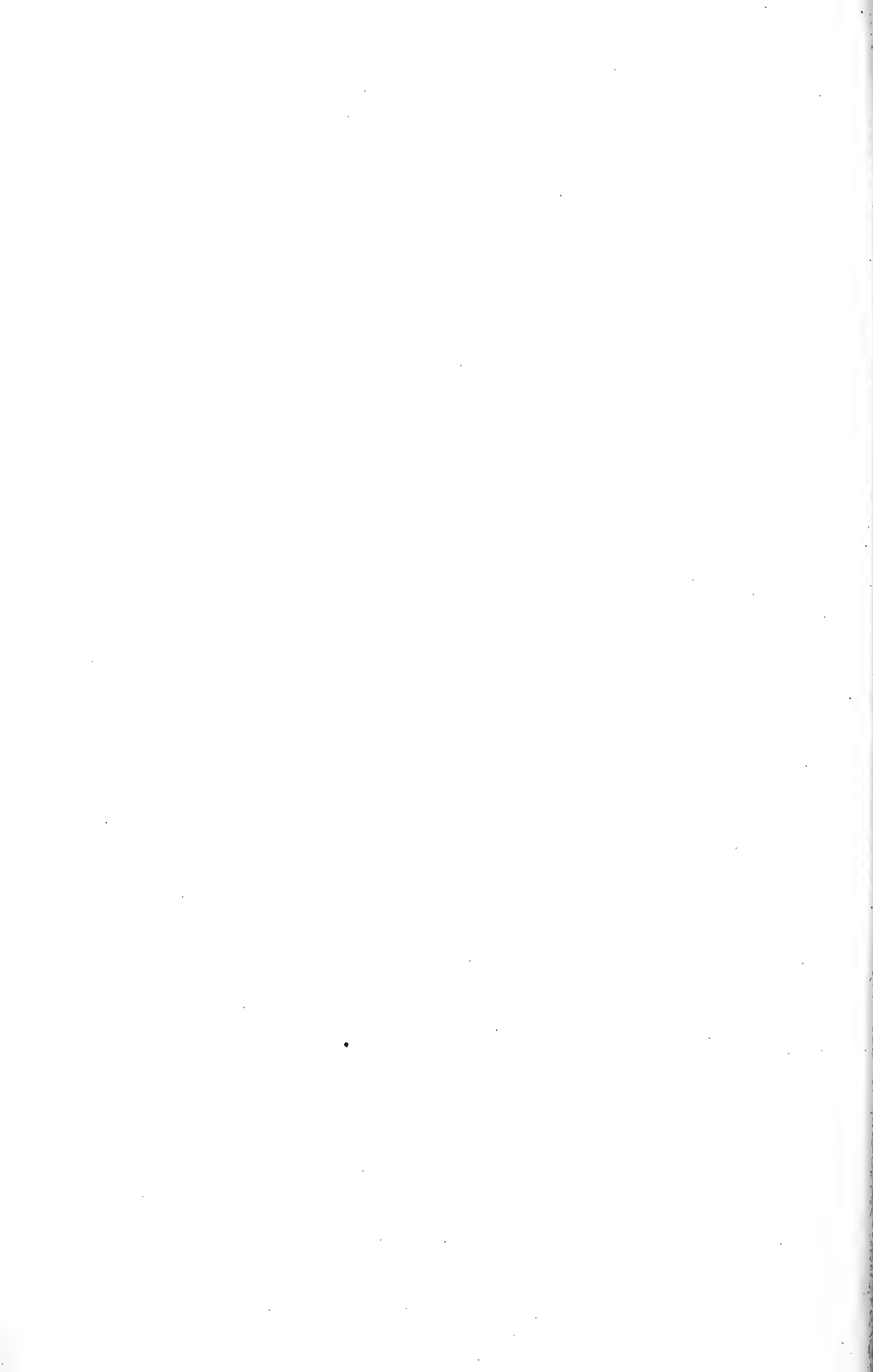





2



1



6



7

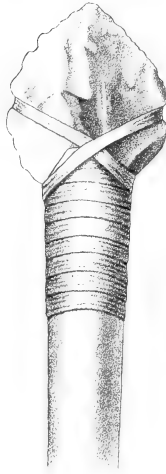

5<sup>a</sup>

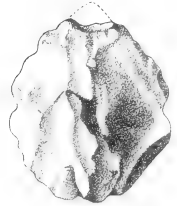

5

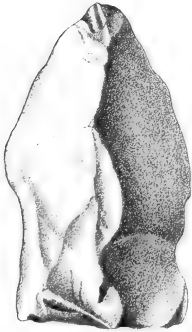

3

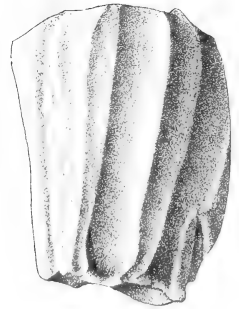

9



10



4



8

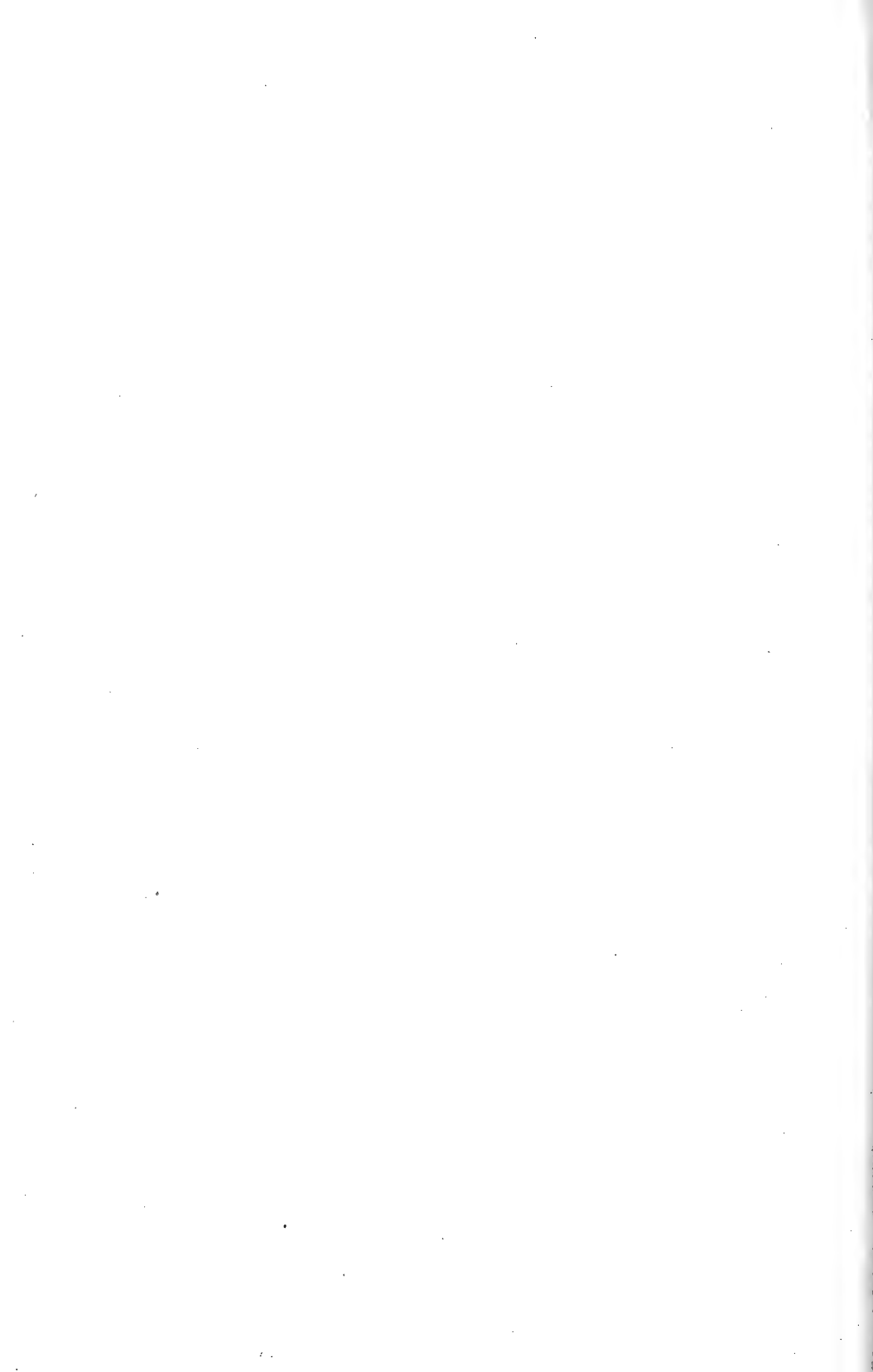

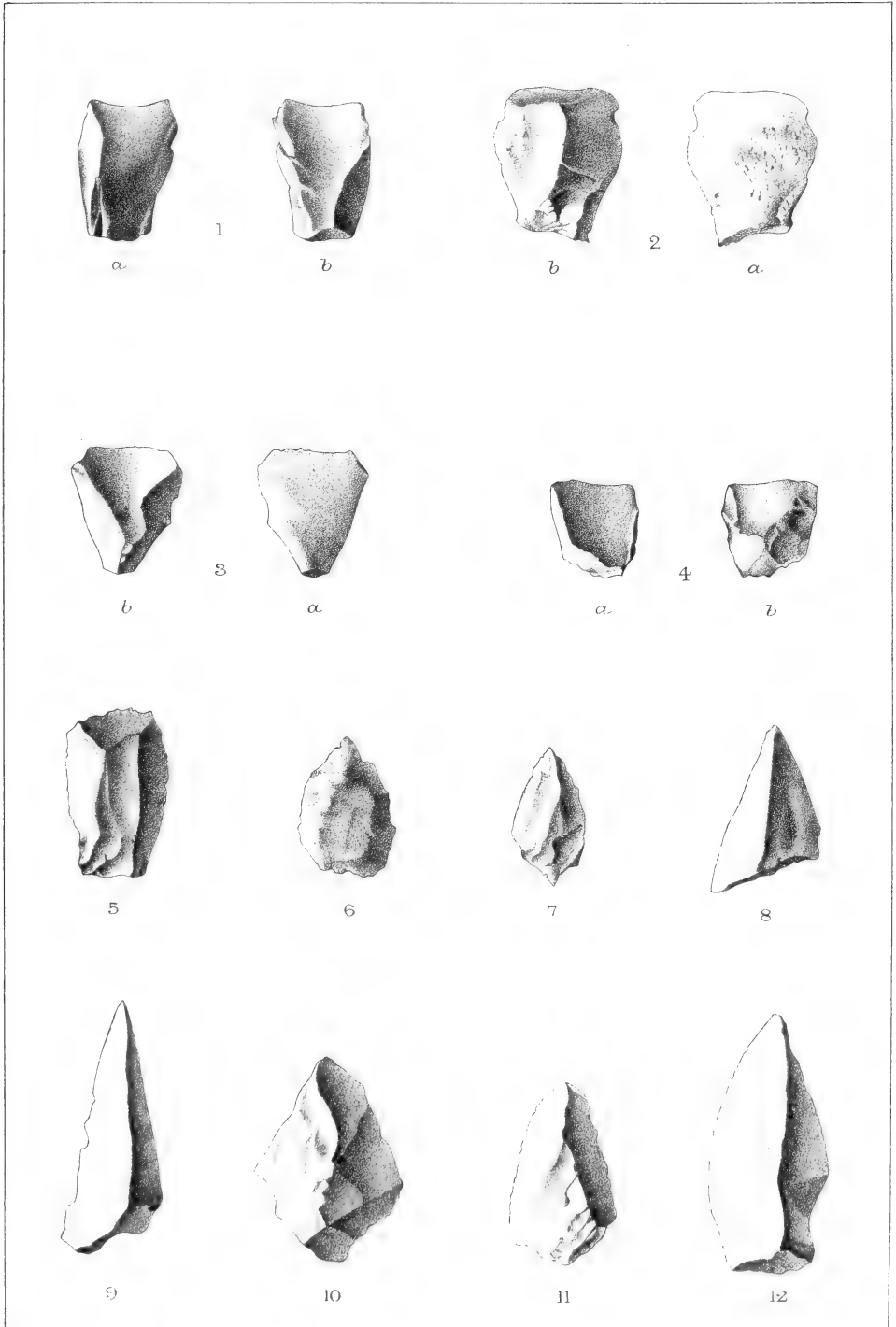



XVIII.—*Notes on some Objects from a Neolithic Settlement recently discovered by MR. W. H. P. DRIVER at Ranchi in the Chota-Nagpore District.*—By J. WOOD-MASON, *Superintendent of the Indian Museum, and Professor of Comparative Anatomy in the Medical College of Bengal, Calcutta.*

[Received and Read January 4th, 1888.]

(With Plates II—V.)

At a recent meeting of this Society some ancient stone beads were exhibited by the Philological Secretary on behalf of Mr. W. H. P. Driver, who had found them at Ranchi in the Chota-Nagpore District. With these beads were associated one or two pieces of chert and some quartz crystals which had evidently been artificially chipped and flaked. The presence of these worked pieces of stone amongst the beads suggesting the suspicion that a settlement of neolithic people similar in character to those of Jubalpur in the Central Provinces had been hit upon, I, with the goodwill of the Philological Secretary, placed myself in communication his correspondent, who has been kind enough to send me all the larger of the objects described below and, at my special request, a considerable quantity of fragments of different kinds of stone gathered without selection from the same site. Amongst the latter I have had the good fortune to find a number of arrow-heads belonging to two distinct forms of the same simple type.

#### OBJECTS DISCOVERED BY MR. DRIVER.

Pl. II. represents a curious implement of olive-green grey unctuous clayey stone which readily absorbs moisture from the hand and gives an ashy-grey streak when grazed, however lightly, by a harder substance such as chert. It tapers from 20 c. in girth at the butt to 13 c. at the functional end, which is worn as smooth as a piece of lithographic slate that has been prepared for the engraver, exhibiting only some very fine scratches chiefly in one direction. It has three sides, two of which are fairly smooth and flat, and at right angles to one another, while the third is rough and convex. All three sides have been 'dressed' by some tool, which in the case of the rough convex side seems to have been pointed. The marks of the 'dressing' are ashy grey of a somewhat darker tint than the fresh streak of the stone. If, as seems probable, the rough convex side has been so fashioned as to fit the hollow palm of the hand (as in Fig. 1), the instrument is a right-handed one, and must have been worked to and fro the body of the operator, in the direction, that is to say, indicated by the scratches on the surface

of its smaller end. A second specimen in Mr. Driver's collection differs only in being a little shorter.

|                                               |     | Millems. |
|-----------------------------------------------|-----|----------|
| Height from butt to functional end, ...       | ... | 84       |
| Width of larger flat side at butt, ...        | ... | 65       |
| "                    " at functional end, ... | ... | 36       |
| "            smaller flat side at butt, ...   | ... | 48       |
| "                    " at functional end, ... | ... | 32       |

From the nature of the unmistakable signs of wear it exhibits at the smaller end, as from that of its composition, I infer that this implement was used as a polisher, though this may not have been its original use, for it is possible that it may once have been one of the 'legs' of a two-legged instrument similar to one of unknown origin and use preserved in the Indian Museum, in which case the two examples of it, being of the same side, must necessarily be parts of two similar instruments.

A triangular wedge-shaped piece of dark purple flinty jasper bears evident signs of long use as a polisher or graver or both possibly. It is worn to a smooth, polished, and slightly convex surface on one of its two large faces, the other large face and its three sides presenting the natural surface of the parent rock from which it was chipped; it is smoothly and extensively rounded off and polished by use at the junction of its two largest sides, along the lower edge of which the polishing extends, widening on the one side towards the thin end of the wedge, and forming on the other a very narrow triangular facet meeting the principal polished surface at an obtuse angle, by which the circumferential grooves with which some of the stone beads\* occurring in the same spot are ornamented may well have been engraved. The instrument is capable of imparting a high polish to a dull facet of a quartz crystal or to a carnelian bead, and it is an excellent touchstone, as I have proved by experiment.

|                                                                        |        | Millems. |
|------------------------------------------------------------------------|--------|----------|
| Length, from the angle at thicker end to middle of<br>thinner end, ... | ... .. | 60       |

\* These beads are doubtless of much later age than the celt, the ringstone, and the arrow-heads described below. That they, like the prehistoric objects, were made on the spot where they have been found seems satisfactorily proved by the association with them of bits of stone of different kinds (chalcedony, carnelian, onyx, sardonyx, rock-crystal, etc.) dressed roughly into shape all ready to be ground into beads, of roughly ground and imperfectly polished, but unbored, beads, of beads perfectly polished and partially bored, in fact, of beads in all stages of manufacture. They belong clearly to several different periods, some being quite rude (? prehistoric), and others quite artistic both in shape and ornamentation, and thus indicating that their manufacturers had attained to a much higher grade of civilization.

|                                                       |    |
|-------------------------------------------------------|----|
| Breadth, between the divergent ends of the two sides, | 76 |
| Thickness at angle, ... ..                            | 78 |

I do not consider that either of the foregoing objects is of any great antiquity. They may both indeed be comparatively modern.

The most interesting of Mr. Driver's own finds is the perforated stone figured in Pl. III, Figs. 1, 1a. Unfortunately, little more than one half of the object has been preserved, but from what remains restoration is easy. The instrument is made out of a bit of actinolite schist. It is all but as broad as long, and oval in shape, with one end much broader than the other, which is a much larger segment of a much smaller circle; it has, in fact, much the outline if an irregular echinoid of the genus *Echinodiscus*. It was apparently slightly and equally convex in every direction on both its faces, and rounded at the sides and ends, the broader one of which latter appears to have seen hard service. It has a parallel-sided shaft-hole almost in the middle, and in the margin of this hole on one side a broad notch has been cut cleanly and obliquely across the fissile planes of the stone and may possibly have been intended to receive a pin for securing it firmly to a wooden shaft.

|                                               |          |
|-----------------------------------------------|----------|
|                                               | Millems. |
| Greatest length (taken from the restoration), | ... 87   |
| „ breadth, „ „ ...                            | ... 83   |
| Diameter of shaft-hole, ... ..                | ... 19   |
| Greatest thickness near shaft-hole, ...       | ... 26   |

The next object to be noticed is a thin and flattish celt (Pl. III, Figs. 2, 2a.) probably of black trap. It never appears to have been polished all over, but only to have had the principal inequalities of its surfaces smoothed off and its edge ground. Its sides, which were possibly once narrowly rounded, are now in a much battered and flaky condition; the butt has been much chipped since the rough polishing was done; and the cutting edge, which is unequally sloped on the two sides, is much broken and blunted by rough usage; all these lesions are probably of the same date, for they are all weathered to identically the same dark greenish grey colour; but a large chip at one end of one face of the cutting edge is darker, that is to say, is less weathered, and hence probably of later date, than the rest, but even it presents a strong contrast in colour to the recent chip at the opposite end of the same face by which the unaltered black rock has been exposed.

|                                                   |          |
|---------------------------------------------------|----------|
|                                                   | Millems. |
| Length, from the middle of the butt to the middle |          |
| of the cutting end, ... ..                        | 71       |
| Breadth across the butt end, ... ..               | 32       |
| „ „ cutting end, ... ..                           | 51       |
| Greatest thickness, ... ..                        | 16.5     |

OBJECTS DISCOVERED BY THE WRITER AMONGST THE CHIPS AND  
FLAKES SENT DOWN BY MR. DRIVER.

Pl. IV, Fig. 10, represents a small instrument of doubtful purpose, which is interesting on account of the evident signs of having been used it exhibits at its smaller and rounded extremity, which is much abraded, the abrasion readily catching the eye from its grey colour. It is an outside flake of black chert which has apparently been reduced by flaking to the desired shape after being struck off from the parent lump. It measures, length 34, breadth 10, thickness 4·2 millesms. This instrument will again be referred to later on.

I now pass on to the consideration of the most interesting and important of the objects from the Neolithic settlement at Ranchi, namely, the arrow-heads I have found in relatively considerable abundance amongst the mass of cores, flakes, and unworked material collected for manufacture which had been gathered and forwarded to me by Mr. Driver, who, since the nature of these objects was demonstrated to him by me, has been fortunate to find two fine specimens, one of rock crystal and the other of chert.

With the single exception of the acutely-pointed tanged and barbed specimen reported from India by Mr. John Evans, F. R. S.,\* on the authority of Prof. Buckman, no *worked* stone arrow-heads appear to have previously been recorded from India. For, though my friend Professor Valentine Ball, F. R. S., in his paper on the Forms and Geographical Distribution of Ancient Stone Implements in India,† states with the greatest confidence that certain flakes of chert, agate, etc., which he exhibited at the reading of his paper, “were undoubtedly used as lancets, knives, arrow-heads, etc.,” yet he does not appear to have been acquainted with a single specimen the nature of which as an arrow-head was so clear and so indisputable as to justify its being entered as such in the list of localities in India where stone implements have been discovered which is appended to his paper. Mr. R. B. Foote, another authority on this interesting subject, in a paper recently read before this Society, speaking apparently for India generally, makes the following remarks, “A remarkable fact with reference to the varieties of weapons and tools made by the Neolithic people of South India is the absence hitherto of any traces of their having manufactured stone arrow-heads, such as are frequently found in other countries occupied by tribes who had attained to a very similar grade of civilization. It is hard to imagine that the Neolithic people of the Deccan were unacquainted with the

\* *Ancient Stone Implements of Great Britain*, p. 361.

† *P. R. I. A.* 1879, ser. 2, vol. p. i, 388 et seqq.



use of the bow prior to the first introduction of iron. That they used brass after becoming acquainted with iron is clearly proved by the discovery of unquestionable iron arrow-heads in the Pátpád cache and in many prehistoric graves in the South. With an abundance of stone, such as agate, chalcedony, lydian stone, jasper, and chert, fit for making arrow-heads, it is certainly most remarkable that no true worked arrow-heads have yet been found, and it is most desirable that all prehistoric explorers in India should pay special attention to this point. I have found some few flakes of chert and jasper that might have been used to tip an arrow, but I have found and seen none that were obviously prepared for that purpose."

Of the objects which have been determined by me to be arrow-heads no less than six, four of one and two of the other of the two distinct forms represented in the collection from Ranchi, are without doubt of this nature, for in addition to having the appropriate shape, in addition to being of such a form that they might have been used to tip an arrow, they have been obviously prepared for that purpose, having been artificially worked either near the butt or at the sides into notches for the reception of cords for securing them to their shaft.

The specimen represented in Fig. 1 of Pl. IV, a very sharp and perfect one of chalcedony, has the butt-end roughly notched. It is much weathered white and clings strongly to the tongue when touched thereby.

That represented in Fig. 2, of black chert, has the butt worked by chipping and abrasion into very evident lateral notches; its point has been broken off at a joint in the stone. The working at the butt is less weathered than the stem, or rather the stem is only slightly weathered and the worked butt looks almost quite fresh, and glossy.

Fig. 3 represents a coarse and heavy specimen of chert deeply weathered to a dirty pale clay brown from black probably; it is blunted either by use or exposure, at the tip; it has been roughly worked at the sides towards the base into notches, and when mounted on its shaft must have been covered for nearly half its length from the butt by the cords and resin or gum by which it was no doubt bound to its shaft, to which it must have lent a rather clumsy appearance.

Fig. 4, of black non-weathered chert, is widest at the butt and therefore was well adapted for secure fixture to the shaft without the aid of any notches.

Fig. 5 is a particularly interesting specimen, because it without any doubt presents us with a most characteristic example of a contrivance for attachment which is, or until lately was, still in vogue amongst modern savages for their arrow and lance-heads, and of which numerous

beautiful examples have come down to us from prehistoric times in Europe. I allude to the notches which are placed opposite to one another one on each side between the barbs and the stem in one form of arrow-head, and of which two pairs are present in some European flint spear-heads of Neolithic age. The specimen from Ranchi which exhibits this interesting peculiarity is a broad leaf-shaped arrow-head of white quartz. It bears on each side at rather less than half way along its length from the butt a rounded indentation, by the aid of which doubtless it was attached to its shaft much after the manner depicted in the accompanying adaptation of Fig. 104 of Nilsson's 'Stone Age' representing a stone arrow-head from California mounted on its shaft.

Fig. 6 represents a chert arrow-head found by Mr. Driver. This specimen—the original colour of which cannot be ascertained, because it is weathered to a dirty clay grey—has no notches, but on the contrary has the base semicircularly rounded, like typical British leaf-shaped arrow-heads\* of Neolithic age.

Fig. 7 is a rock-crystal arrow-head found by Mr. Driver. It is worked into a slight notch on each side of its thick tang-like base.

Figs. 8, 9, and 12 of Pl. V represent three simple trihedral arrow-heads—all of black chert—of which Fig. 8 is slightly weathered, 11, scarcely at all weathered, presents a large notch on the right side, and 12, weathered to the colour of fuller's-earth, a projection on the left side. All three are so shaped as readily to have been secured to their shafts by cords and gum without the aid of special notches.

Fig. 10 represents an octahedral arrow-head roughly but skilfully hewn out of rock crystal.

Fig. 6 is a not very successful representation of a pretty little leaf-shaped specimen in milky quartz, and Fig. 7 another of similar form in reddish chert.

Fig. 11, similar in form to that represented in Fig. 6 of Pl. IV, is of pale brown-coloured chalcedony weathered white so as to be adherent to the tongue like the subject of Fig. 1 of Pl. IV.

The most interesting and remarkable of all the objects I have picked out of the material so kindly gathered for me by Mr. Driver are unquestionably those represented in the first five figures of Pl. V. Four of them are, there can, I think, be no doubt, chisel-edged arrow-heads similar to those which have been found in Egyptian tombs†—in several cases still secured by bitumen to the shaft,—and on Neolithic sites in different parts of Europe,‡ including even the British Isles.

\* Evans, *op. cit.* 333, figs. 281—4.

† Evans, *op. cit.* p. 329, fig. 272.

‡ Evans, *op. cit.* p. 352, 353, fig. 342, and Espy, p. 365, fig. 344.

Fig. 1, Pl. V is of black chert with the original brown crust remaining on one side and on the butt end; its hollow cutting edge and its angles are extremely sharp.

Fig. 4 is a pretty little specimen in green chert.

Fig. 3 of slightly translucent black chert, with the original grey-crusted surface of the parent stone remaining on the triangular facet which slopes to the cutting edge, has its angles obliquely and symmetrically cut off.

Of the four specimens which are here figured and described as arrows of the chisel-edged type, Fig. 2 is the most interesting from the presence of lateral notches for the reception of ligaments rendering it, to say the least, in the highest degree probable that the specimen is a veritable arrow-head of the chisel-edged type and enabling one to feel more sure that the nature of the three specimens that possess no notches has been correctly interpreted. It is of opaque reddish yellow chalcedony weathered white and become strongly adherent to the tongue by long exposure to the action of water containing carbonic anhydride in solution, by which a soluble constituent of the stone has been removed from the surface and a chalky substance greedy of moisture left behind.\* In this case both the notches have been made from the same side, but in the cases of Figs. 2 and 5 of Pl. IV, from opposite sides, of the stone, opposite faces of the arrow in the latter and the same face in the former sloping to the bottom of the notches; this difference is, as I find by experiment, explained by the worker having turned the stone over for the purpose of making the second notch in the latter, but not in the former. I have also found that similar notches can readily be made by pressing such a flake as that represented in Fig. 10 of Pl. IV with a grating movement hard upon another of the same substance, and that the active flake becomes similarly abraded grey in the process.

In the four preceding figures (*a.*) refers to the inner or core face, and (*b.*) to the outer or worked face of the arrow-head.

Fig. 5, of very fine grained and compact pale grey vitreous quartzite, has been worked at the base in a manner similar to Fig. 2 of Pl. IV, and is, I am inclined to think, an arrow-head of the same type which has become a chisel-edged one by the accidental loss of its point at a joint in the stone.

A form of worked flake which is, I think, of too frequent occurrence to be accidental merits a brief notice. It may be described as a broad and short crescent-like sharp wedge from 21 to 35 millesms. in

\* The ( $\alpha$ ) and the ( $\beta$ ) silica of Berzelius, the one white and insoluble, the other transparent horny and soluble in water. Evans, *op. cit.* p. 450.

breadth by 7 to 11 in length only, with a straight cutting edge and a finely chipped arched blunt 'back.' It occurs in chert, chalcedony, and quartz. It is possible that it may be a short and broad form of the chisel-edged type intended to be attached to its shaft by means of some resinous substance only, and that it may be the stone prototype of the iron-headed arrow of similar shape which is referred to by Mr. Evans on p. 353 of his book on the ancient stone implements of Great Britain.

That all the arrow-heads were made on the spot where they have been found seems to be satisfactorily proved by flakes, cores, and raw materials for manufacture occurring in profusion with them.

The form and relations of the cores, flakes, and arrow-heads suggest the view that the last-named were first sketched out, so to speak, by flaking on the nuclei, then struck off, and finally notched or otherwise worked.

The chert core represented in Fig. 8 of Pl. IV partially illustrates this. Fig. 9 is a chert core from which some of the thin band-shaped flakes that are so abundant at Ranchi have been struck. Cores of quartz crystals and rock crystal also occur.

I class all the worked specimens as notched rather than as 'tanged' arrow-heads, because there has been no attempt to adapt the flakes for insertion in a cleft of the shaft by reducing their original thickness at the butt, and because there is always a more or less distinct 'neck' between the butt-end and the blade; though I do not insist that none of them were let to some extent into the shaft.

All the arrows (except 7 and 10 of Pls. IV and V) are flakes and they present two faces, a flat or inner or core face, with a more or less evident bulb of percussion, and a flaked outer face. They may be called flake-arrows. The simplest of them closely resemble the obsidian flake arrow-heads of modern savages.

The following are the measurements of the arrows-heads and cores:—

|         |                                | Pl. IV.       |                   |   |  |
|---------|--------------------------------|---------------|-------------------|---|--|
| Fig. 1. | Length, 38,                    | breadth 16,   | thickness 8·5 mm. |   |  |
| 2.      | Length, tip<br>restored, 26    |               |                   |   |  |
|         | without tip 20·4,              | breadth 12·2, | thickness 4       | „ |  |
| 3.      | Length, 43,                    | breadth 24·5, | thickness 10·8    | „ |  |
| 4.      | Length, 21·4,                  | breadth 16,   | thickness 7·7     | „ |  |
| 5.      | Length, tip<br>restored, 26·3  |               |                   |   |  |
|         | without tip 23·6,              | breadth 21·5, | thickness 6·8     | „ |  |
| 6.      | Length, tip<br>restored, 28·0, |               |                   |   |  |
|         | without tip 26·7,              | breadth 15·0, | thickness 5·7     | „ |  |

7. Length 29·5, breadth 15·6, thickness 8·4 mm.
8. Length 20·4, breadth 14·9, thickness 18·5 „
9. Length 37, breadth 27, thickness 17·8 „
10. Length 34, breadth 10, thickness 4·2 „

## Pl. V.

- Fig. 1. Length 19·8, breadth 12·8, thickness 6·3 „
2. Length 21·7, breadth 18, thickness 6·6 „
  3. Length 17·8, breadth 15·5, thickness 5 „
  4. Length 13·3, breadth 12·8, thickness 5·8 „
  5. Length 23·7, breadth 14·7, thickness 4·9 „
  6. Length 19·4, breadth 13·2, thickness 3·7 „
  7. Length 17·5, breadth 10·1, thickness 3·8 „
  8. Length 23·0, breadth 14·5, thickness 6·7 „
  9. Length 35·5, breadth 15·0, thickness 14·4 „
  10. Length 23·7, breadth 21, thickness 14 „
  11. Length 25·3, breadth 15 1, thickness 8 „
  12. Length 35·6, breadth 16·6, thickness 10·5 „

As in Neolithic settlements elsewhere, there occur in abundance at Ranchi, in the soil with the implements, not only unworked quartz crystals, quartz of various kinds, chert, jasper, and other stones, suitable for the manufacture of tools and weapons, and evidently collected for that purpose, as has already been stated, but also lumps of red earthy hæmatite,\* some of which have not been used, but some on the other hand have been rubbed down to a smooth surface on a flat stone or scraped in the production of the red pigment which all savages from the very earliest prehistoric times to the present day have delighted in. On the subject of this red pigment Mr. Evans† writes: “There can be little doubt of this red pigment having been in use for what was considered a personal decoration by the Neolithic occupants of Great Britain. But this use of red paint dates back to a far earlier period, for pieces of hæmatite with the surface scraped, apparently by means of flint flakes, have been found in the French and Belgian caves of the Reindeer Period, so that this red pigment appears to have been in all ages a favourite with savage man. The practice of interring war-paint with the dead is still observed amongst the North American Indians:—

The paints that warriors love to use  
Place here within his hand,  
That he may shine with ruddy hues  
Amidst the spirit land.”

\* It has been recorded from the Neolithic Settlements of South India, by R. B. Foote, J. A. S. B. 1886, vol. lvi, pt. ii, p. 271.

† Op. cit., p. 238.

The savages of the Andaman Islands still use a red pigment for decorative purposes, as also do the Bhutea women to be seen in Darjeeling.

Worked flints and other stones of similar palæolithic simplicity, but from their mode of occurrence no doubt also neolithic, have been discovered in the Solomon Islands (Long. 154° to 163° E., Lat. 5° to 11° S.) by Mr. H. B. Guppy,\* who states that they “are commonly found in the soil when it is disturbed for purposes of cultivation and are frequently exposed after heavy rain.”

P. S.—Since the above notes were written, several more boxes of relics, including some fine polished celts, of which I hope shortly to present an account, have been received from Mr. Driver.

\* *The Solomon Islands and their Natives*, London, 1889, pp. 77—78.

---

# I N D E X. †

Names of New Genera and Species have an asterisk (\*) prefixed.

- 
- |                                                                                                                                                                                                                                                                                                                                                                                                                                                                                                                                                                                                                                                                                                                                                                                                                                                                                                                                                                                                                                                                                                                                                                                                                                                                                                                                                                                                                                                                         |                                                                                                                                                                                                                                                                                                                                                                                                                                                                                                                                                                                                                                                                                                                                                                                                                                                                                                                                                                                                                                                                                                                                                                                                                                                                                                                                                                                                                                                                                         |
|-------------------------------------------------------------------------------------------------------------------------------------------------------------------------------------------------------------------------------------------------------------------------------------------------------------------------------------------------------------------------------------------------------------------------------------------------------------------------------------------------------------------------------------------------------------------------------------------------------------------------------------------------------------------------------------------------------------------------------------------------------------------------------------------------------------------------------------------------------------------------------------------------------------------------------------------------------------------------------------------------------------------------------------------------------------------------------------------------------------------------------------------------------------------------------------------------------------------------------------------------------------------------------------------------------------------------------------------------------------------------------------------------------------------------------------------------------------------------|-----------------------------------------------------------------------------------------------------------------------------------------------------------------------------------------------------------------------------------------------------------------------------------------------------------------------------------------------------------------------------------------------------------------------------------------------------------------------------------------------------------------------------------------------------------------------------------------------------------------------------------------------------------------------------------------------------------------------------------------------------------------------------------------------------------------------------------------------------------------------------------------------------------------------------------------------------------------------------------------------------------------------------------------------------------------------------------------------------------------------------------------------------------------------------------------------------------------------------------------------------------------------------------------------------------------------------------------------------------------------------------------------------------------------------------------------------------------------------------------|
| <p>Abaratha agama, 368<br/>         „ ransonnetii, 368<br/>         „ taylori, 368<br/>         Abisara suffusa, 355<br/>         *Acesina aberrans, 279, 280, 293<br/>         „ paraganesa, 280<br/>         Achillides tamilana, 364<br/>         Acraënaë, 352<br/>         Adansonia digitata, 336<br/>         Adiantum, 298<br/>         „ capillus Veneris, 299<br/>         „ caudatum, 296, 297, 299<br/>         „ Edgeworthii, 296, 297, 299<br/>         „ lunulatum, 299<br/>         „ pedatum, 300<br/>         „ venustum, 299<br/>         Adolias adima, 278<br/>         Æolosoma, 381, 382<br/>         „ chlorostictum, 381<br/>         Alocasia, 113<br/>         „ cucullata, 107<br/>         „ fornicata, 108<br/>         „ indica, 108<br/>         „ montana, 108<br/>         „ odora, 108<br/>         „ rapiformis, 108<br/>         Amblypodia darana, 360<br/>         „ naradoides, 360<br/>         Amorphophallus campanalatus, 107<br/>         „ lyratus, 107<br/>         Ampelisca, 223, 226, 233<br/>         „ belliana, 226<br/>         „ carinata, 226<br/>         „ gaimardii, 226<br/>         „ ingens, 226<br/>         „ japonica, 226<br/>         „ lævigata, 226<br/>         * „ lepta, 223, 232, 233, 254, 255<br/>         „ limicola, 226<br/>         „ macrocephala, 226<br/>         „ pelagica, 226<br/>         „ tenuicornis, 226<br/>         Ampeliscades, 223<br/>         Amphipoda, 220, 226</p> | <p>Amphithoë, 244, 245<br/>         „ indica, 220, 240, 243, 244,<br/>         255<br/>         „ tenuicornis, 244<br/>         Ampittia maro, 366<br/>         Anchitherium, 259<br/>         Anomalurus, 259<br/>         Anonyx, 222, 223<br/>         * „ amaurus, 220, 254<br/>         „ typhlops, 223<br/>         Anoplophrya, 381, 382, 383<br/>         * „ æolosomatis, 381, 383<br/>         „ mytili, 381<br/>         „ nodulata, 382<br/>         Antigonus angulata, 368<br/>         „ potiphera, 368<br/>         Aphnæus nipalicus, 281, 282, 283<br/>         * „ rukma, 281, 282, 283, 293<br/>         * „ rukmini, 282, 283, 293<br/>         * „ sani, 282, 283, 293<br/>         Aphrophora spumaria, 337<br/>         Appias hippoides, 362<br/>         „ libythea, 362<br/>         „ vacans, 362<br/>         Araceæ, 110<br/>         Argynnis niphe, 354<br/>         Arisæma curvatum, 108<br/>         „ cuspidatum, 108<br/>         „ speciosum, 108<br/>         „ tortuosum, 108<br/>         Aroideæ, 106, 112<br/>         Arum, 106, 109, 110, 111, 112, 114, 115,<br/>         116, 117<br/>         „ campanulatum, 107<br/>         „ colocasia, 107<br/>         „ cucullatum, 107<br/>         „ curvatum, 108<br/>         „ cuspidatum, 108<br/>         „ divaricatum, 108<br/>         „ dracunculus, 108<br/>         „ flagelliforme, 108<br/>         „ fornicatum, 108<br/>         „ gracile, 108<br/>         „ indicum, 108</p> |
|-------------------------------------------------------------------------------------------------------------------------------------------------------------------------------------------------------------------------------------------------------------------------------------------------------------------------------------------------------------------------------------------------------------------------------------------------------------------------------------------------------------------------------------------------------------------------------------------------------------------------------------------------------------------------------------------------------------------------------------------------------------------------------------------------------------------------------------------------------------------------------------------------------------------------------------------------------------------------------------------------------------------------------------------------------------------------------------------------------------------------------------------------------------------------------------------------------------------------------------------------------------------------------------------------------------------------------------------------------------------------------------------------------------------------------------------------------------------------|-----------------------------------------------------------------------------------------------------------------------------------------------------------------------------------------------------------------------------------------------------------------------------------------------------------------------------------------------------------------------------------------------------------------------------------------------------------------------------------------------------------------------------------------------------------------------------------------------------------------------------------------------------------------------------------------------------------------------------------------------------------------------------------------------------------------------------------------------------------------------------------------------------------------------------------------------------------------------------------------------------------------------------------------------------------------------------------------------------------------------------------------------------------------------------------------------------------------------------------------------------------------------------------------------------------------------------------------------------------------------------------------------------------------------------------------------------------------------------------------|

† A complete Index to the articles on *Rhynchota* published in this volume will be issued with the last of the series in a subsequent volume.

- Arum lyratum*, 107  
 „ *maculatum*, 108, 109, 110, 111, 113, 117  
 „ *margaretiferum*, 108  
 „ *montana*, 108  
 „ *odorum*, 108  
 „ *orixense*, 108  
 „ *rapiforme*, 108  
 „ *seguinum*, 111, 114  
 „ *sessiliflorum*, 108  
 „ *silvaticum*, 108  
 „ *speciosum*, 108  
 „ *sylvaticum*, 115  
 „ *tortuosum*, 108, 116  
 „ *trilobatum*, 110  
 „ *typhillum*, 110  
 „ *viviparum*, 109  
*Aspidium*, 298  
 „ *aculeatum*, 308  
 „ „ *var. rufo-barbata*, 308  
 „ *filix fœmina, var. dentigera*, 309  
 „ (*Cyrtomium*) *falcatum, var. caryotideum*, 309  
 „ (*Polystichum*) *aculeatum*, 308  
 „ „ „ *var. lobata*, 308  
 „ „ *auriculatum, var. cœspitosa*, 308  
 „ „ *ilicifolium*, 308  
 „ „ *Prescottianum*, 309  
 „ „ *Thomsoni*, 308  
*Asplenium*, 298  
 „ *alternans*, 304  
 „ *ensifforme*, 304  
 „ *filix fœmina, var. dentigera*, 306  
 „ „ „ „ *polyspora*, 296, 305  
 „ „ „ „ *retusa*, subvar. *elongata*, 306  
 „ *fontanum, var. exiguum*, 304  
 „ *heterocarpum*, 295, 296  
 „ *Hohenackerianum*, 295, 296  
 „ *laciniatum, var. depauperata*, 304  
 „ *latifolium, var. frondosa*, 307  
 „ *longifolium*, 304  
 „ *nigripes*, 296, 297  
 „ *oxyphyllum*, 295  
 „ *polypodioides*, 296  
 „ „ *fere typica*, 307  
 „ *tenuifolium*, 295, 296  
 „ *tenuifrons*, 297, 307  
 „ *torrentium*, 307  
 „ *trichomanes*, 304  
 „ *umbrosum*, 296  
 „ *unilaterale var. udum*, 304  
*Asplenium varians*, 305  
 „ (*Athyrium*) *Atkinsoni, var. Andersoni*, 305  
 „ „ *Clarkei*, 306  
 „ „ *filix fœmina, var. dentigera*, 306  
 „ „ *macrocarpum*, 305  
 „ „ „ *var. Atkinsoni*, 305  
 „ „ *nigripes*, 306  
 „ „ *pectinatum*, 307  
 „ „ *Schimperi*, 305  
 „ „ *tenuifrons*, 296, 306  
 „ „ *Thelypteroides*, 305  
 „ (*Diplazium*) *Japonicum*, 307  
 „ „ *latifolium, var. polymorpha*, 307  
 „ „ *multicaudatum*, 308  
 „ „ *polypodioides*, 307  
 „ „ *torrentium*, 307  
*Astictopterus stellifer*, 365  
 „ *subfasciatus*, 365  
*Atella phalanta*, 352  
*Athya cama*, 277  
 „ *inarina*, 354  
 „ *mahesa*, 354  
 „ *perius*, 354  
 „ *ranga*, 354  
 „ *rufula*, 277  
 „ *selenophora*, 354  
*Athyria*, 305  
*Athyrium Atkinsoni, var. Andersoni*, 305  
 „ *Clarkei*, 306  
 „ *filix fœmina*, 296  
 „ „ „ *var. dentigera*, 306  
 „ „ „ „ *polyspora*, 305  
 „ *macrocarpum*, 305  
 „ „ *var. Atkinsoni*, 305  
 „ *nigripes*, 306  
 „ *pectinatum*, 296, 307  
 „ *Schimperi*, 296, 305  
 „ *tenuifrons*, 296, 306  
 „ *Thelypteroides*, 305  
*Atylus*, 244  
 „ *austrinus*, 246  
 „ *bispinosus*, 246  
 „ *capensis*, 246  
 „ *carinatus*, 246  
 \* „ *comes*, 243, 255  
 „ *compressus*, 244, 246  
 „ *corallinus*, 246  
 „ *crenulatus*, 246  
 „ *fissicauda*, 246  
 „ *gibbosus*, 246  
 „ *huxleyanus*, 246  
 „ *inermis*, 246



- Atylus simplex*, 246  
 „ *spinulicauda*, 246  
 „ *swammerdamii*, 246  
 „ *villosus*, 246  
 „ *vulgaris*, 246  
*Azanus crameri*, 357  
 „ *ubaldus*, 357  
*Badamia exclamationis*, 364  
*Baracus septentrionis*, 365  
 „ *subditus*, 365  
*Barbastellus communis*, 265, 272  
 „ *pacificus*, 264  
*Baringtonia racemosa*, 220  
*Baspa melampus*, 359  
*Belenois auriginea*, 363  
 „ *lordaca*, 363  
 „ *mesentina*, 363  
*Bibaris sena*, 365  
*Bindahara sugriva*, 360  
*Botrychium*, 298  
 „ *daucifolium*, 315  
 „ *lunaria*, 315  
 „ *Virginianum*, var. *lanu-*  
     *ginosa*, 315  
 Bovidæ, 259  
 \**Brachyplatys carolinæ*, 341  
 \* „ *niger*, 342  
*Byblia*, 275  
 „ *cora*, 275  
 „ *ilithya*, 275, 352  
 „ *simplex*, 275  
*Caduga nilgiriensis*, 347  
*Cælops frithii*, 271  
 \**Callitettix affinis*, 336  
 „ *melanochra*, 336  
 „ *producta*, 336  
*Callosune*, 362  
 „ *bimbura*, 362  
 „ *danæ*, 362  
 „ *etrida*, 362  
 „ *eucharis*, 362  
 „ *pernotatus*, 362  
 „ *pseudevanthe*, 362  
 „ *purus*, 362  
*Calysisme*  
 „ *blasius*, 348  
 „ *indistans*, 348  
 „ *justina*, 348  
 „ *mineus*, 348  
 „ *perseus*, 348  
 „ *subfasciata*, 348  
 „ *visala*, 348  
*Caprella geometrica*, 251  
 „ *linearis*, 251  
 \* „ *madrasana*, 251, 253, 255  
 \* „ *palkii*, 253, 255  
*Castalius ananda*, 357  
 „ *decidea*, 357  
 „ *ethion*, 357  
 „ *hamatus*, 357  
 „ *interruptus*, 357  
 „ *rosimon*, 357  
*Castor*, 259  
*Catapocilma elegans*, 358  
*Catochrysops cnejus*, 358  
 „ *hapalina*, 358  
 „ *patala*, 358  
 „ *strabo*, 358  
*Catophaga galena*, 362  
 „ *lankapura*, 362  
 „ *neombo*, 362  
 „ *paulina*, 362  
 „ *wardi*, 362  
*Catopsilia catilla*, 361  
 „ *crocale*, 361  
 „ *gnoma*, 361  
 „ *ilea*, 361  
 „ *pyranthe*, 361  
 \**Cenestra affinis*, 341  
 „ *aurora*, 341  
 „ *circulata*, 341  
 „ *matutina*, 341  
*Cercopis dorsalis*, 334  
 „ *octopunctata*, 334  
*Cervidæ*, 259  
*Cerynia*, 340, 341  
 \* „ *viridula*, 340  
*Cethosia mahratta*, 352  
*Chapra agna*, 366  
 „ *mathias*, 366  
 „ *prominens*, 366  
*Charaxes athamas*, 355  
 „ *fabius*, 355  
 „ *inna*, 355  
 „ *psaphon*, 355  
 „ *samatha*, 355  
 „ *serendiba*, 355  
*Charma*, 275  
*Charmus*, 275  
 \**Charus daksha*, 363  
 „ *helenus*, 364  
*Cheilanthes*, 298, 300, 302  
 „ *albomarginata*, 296, 300,  
     301, 302  
 „ *anceps*, 301  
 „ *Dalhousiæ*, 296, 297, 300,  
     302  
 „ *farinosa*, 296, 297, 300  
 \* „ „ var. *anceps*, 301  
 \* „ „ „ *grisea*, 302  
 „ „ „ *subdimorpha*,  
     302  
 „ „ „ *typica*, 301  
 „ „ *grisea*, 302  
 „ *rufa*, 295, 296  
 „ *subvillosa*, 300, 302  
*Cheritra jaffra*, 360  
*Chilades laius*, 356  
 „ *varunana*, 356  
*Chilasa clytia*, 363  
 „ *dissimilis*, 363  
 „ *dravidarum*, 363  
*Choaspes benjamini*, 365

- Chaospes gomata*, 365  
*Chrysocoris marginellus*, 344  
 \* " *nilgiriensis*, 343  
 \* " *simplex*, 343  
*Cirrhochroa relata*, 353  
 " *swinhoei*, 353  
 " *thais*, 353  
*Cœlops frithii*, 263, 271  
*Coladenia*, 292  
 " *dan*, 368  
 \* " *hamiltonii*, 291, 293  
 " *indrani*, 368  
 " *tissa*, 292, 368  
*Colias nilagiriensis*, 362  
*Colocasia*, 113  
 " *antiquorum*, 107  
 \* *Compastes minor*, 344  
 \* *Concholestes*, 237  
 " *dentalii*, 238, 254  
 \* *Coptosoma brunnea*, 342  
 \* " *minima*, 342  
 \* " *naziræ*, 343  
*Corophiidae*, 237  
*Corophiides*, 237  
*Corophium*, 237  
*Cosmoscarta decisa*, 335, 336  
 \* " *greeni*, 334  
 \* " *lurida*, 335  
 \* " *minor*, 335  
 \* " *nigra*, 335  
 \* " *nigrofasciata*, 333  
 " *octopunctata*, 334  
 \* " *sikkimensis*, 335  
 \* " *taprobanensis*, 333  
 " *undata*, 333, 335  
 \* " " *var. affinis*, 333, 334  
 \* " " *tripunctata*, 333, 334  
*Crastia core*, 348  
*Cricetus*, 259  
*Cryptogramme*, 298  
 " *crispa*, 303  
*Cupha erymanthis*, 352  
*Cupitha purrea*, 366  
*Curetis thetys*, 356  
*Cyaniris akasa*, 356  
 " *albidisca*, 356  
 " *lavendularis*, 356  
 \* " *lilacea*, *var.* 356  
 " *limbatus*, 356  
 " *puspa*, 356  
*Cynonycteris*, 260  
 " *amplexicaudata*, 271  
*Cynopterus marginatus*, 271  
*Cynthia saloma*, 352  
*Cyrestis thyodamas*, 355  
*Cyrtotium falcatum*, *var.* *caryotideum*, 309  
*Cystopteris fragilis*, 295, 296  
*Dalchinia teredon*, 364  
 " *thermodusa*, 364  
*Davallia*, 298  
 " *pulchra* *var.* *pseudocystopteris*, 299  
 " (*Leucostegia*) *immersa*, 298  
 " " *pulchra*, 299  
 " (*Stenoloma*) *chinensis*, 299  
*Delias eucharis*, 363  
*Dentalium lacteum*, 237  
*Deudorix epijarbas*, 359  
 " *varuna*, 284  
*Dicksonia*, 298  
 " *scabra*, 298  
*Diplazium*, 296, 307  
 " *Japonicum*, 307  
 " *latifolium* *var.* *polymorpha*, 307  
 " *multicaudatum*, 308  
 " *polypodioides*, 307  
 " *torrentium*, 307  
*Discophora lepida*, 351  
*Drynaria rivale*, 312  
*Echinodiscus*, 389  
*Elephas*, 259  
 \* *Elsia*, 249  
 " *indica*, 250, 254  
*Elymnias caudata*, 351  
*Elymniinae*, 351  
*Equus*, 259  
*Ergolis ariadne*, 352  
 " *merione*, 352  
 " *taprobana*, 352  
*Eucalyptus*, 337  
 \* *Eupetaurus*, 256, 257, 259, 260  
 " *cinereus*, 258  
*Euploeina*, 348  
*Euploeinae*, 347, 348, 359  
*Euripus consimilis*, 352  
*Enthalia adima*, 278  
 " *appiades*, 278  
 " *evelina*, 354  
 " *garuda*, 354  
 " *jahnu*, 278  
 " *lepidea*, 354  
 " *lubentina*, 354  
*Everes parrhasius*, 357  
*Evotomys*, 260  
*Flata albata*, 340  
*Fulgora amplectens*, 338  
 " *andamanensis*, 338  
 " *connectens*, 338  
*Galeopitheci*, 257  
*Gammaridae*, 227  
*Gammarus fluviatilis*, 220  
*Gangara thyrasis*, 365  
*Ganoris gliciria*, 362  
*Gomalia albofasciata*, 367  
*Goniophlebium amœnum*, 312  
 " *lachnopus*, 312  
 " *microrhizoma*, 312  
*Goniopteris multilineatum*, 312  
*Gymnogramme*, 298

- Gymnogramme aurita, 314  
     "    tolla, 295  
     "    (Leptogramme) aurita,  
         var. Levingii, 314  
     "    (Selligneae) involuta, 314  
     "    (Syngramme) fraxinea,  
         314  
     "    "    vestita,  
         314  
 Halpe beturia, 366  
     "    cerata, 367  
     "    ceylonica, 366  
     "    honorei, 367  
     "    sitala, 366  
 Haplodon, 259  
 Haploops, 223  
 Harimala buddha, 364  
     "    crino, 364  
 Harpyiocephalus cyclotis, 272  
     "    harpyia, 272  
     "    leucogaster, 269  
 Hebomoia glaucippe, 362  
 Hesperia cephala, 289  
 \*    "    cephaloides, 288, 289, 293  
     "    ornata, 293  
 Hesperiidæ, 288, 364  
 Hestia malabarica, 347  
 \*Hidari bhawani, 291, 293  
     "    irava, 291  
     "    staudingeri, 291  
     "    sybirta, 291  
 Hipposideros amboinensis, 262, 263  
     "    armiger, 271  
     "    bicolor, 262  
     "    cinereus, 271  
     "    murinus, 271  
     "    speoris, 271  
 Hipposiderus, 260, 262  
     "    amboinensis, 262, 263  
     "    armiger, 271  
     "    bicolor, 263, 271  
     "    diadema, 263  
     "    fulvus, 263  
     "    speoris, 271  
 Horaga, 358  
     "    albicaccula, 283, 284, 293  
     "    onyx, 358  
 \*    "    rana, 283, 284, 293  
     "    viola, 284, 358  
 Huphina cassida, 362  
     "    phryne, 362  
     "    remba, 363  
     "    zeuxippe, 362  
 Hyarotis atratus, 367  
 Hypanis polinice, 275  
     "    simplex, 275  
 Hyperia, 249  
 Hypolimnas bolina, 354  
     "    misippus, 354  
 Hypolycaena etolus, 360  
     "    nilgirica, 360  
 Hyposcritia narendra, 362  
 Hystricomorpha, 257  
 Idmais, 362  
     "    amata, 362  
     "    tripuncta, 362  
 Iliades polymnestor, 364  
 Iraota timoleon, 359  
 Ismene helirius, 365  
 Isoteinon modesta, 367  
     "    nilgiriana, 367  
     "    vindhiana, 367  
 Ixias agniverua, 362  
     "    anubala, 361  
     "    dharmsalæ, 361  
     "    meridionalis, 361  
     "    pyrenassa, 361  
     "    pyrene, 361  
 Jamides bochus, 357  
 Junonia almana, 352  
     "    asterie, 352  
     "    atlites, 352  
     "    hierta, 352  
     "    lemonias, 352  
     "    orithyia, 352  
 Kabanda, 274  
     "    khasiana, 273  
     "    malsarida, 273  
 Kallima wardi, 355  
 Kerivoula hardwickii, 270  
     "    pallida, 272  
     "    papillosa, 270, 272  
     "    picta, 272  
 Kroyera, 248  
 Laertias pammon, 363  
 Lampides ælianus, 358  
     "    alexis, 358  
     "    elpis, 358  
 Lantana, 352  
 Lasiurus pearsoni, 272  
 Lastrea Boryanum, 311  
     "    crenatum, 311  
     "    filiæ mas, var. marginata, 309  
     "    "    "    normalis, 309  
     "    prolixum, 309  
     "    remotum, 310  
 Lemoniidæ, 355  
 Leptogramme aurita, var. Levingii, 314  
 Leptosia xiphia, 361  
 Lethe drypetis, 348  
     "    europa, 348  
     "    neelgherriensis, 349  
     "    todara, 348, 349  
 Leucostegia immersa, 298  
     "    pulchra, 299  
 Libythæinæ, 355  
 Libythea lepita, 355  
     "    myrrha, 355  
     "    rana, 355  
 Limenitis antonia, 276  
     "    armandia, 276  
 Limnaina, 347

*Limnas alcippoides*, 347  
 „ *alcippus*, 354  
 „ *chrysippus*, 347, 354  
 „ *dorippus*, 354  
*Loxura atynnus*, 360  
 „ *surya*, 360  
*Lycæa*, 249  
*Lycæidæ*, 249  
*Lycænesthes lycænina*, 357  
*Lycænidæ*, 278, 356  
*Lycæopsis*, 249  
*Machærota*, 336  
 „ *guttigera*, 336  
 „ *pugionata*, 336  
*Mastodon*, 259  
*Matapa aria*, 365  
*Megaderma*, 264  
 „ *lyra*, 264, 271  
 „ *spasma*, 264  
 „ *spectrum*, 271  
*Megisba thwaitesi*, 356  
 \**Melanitis aculeata*, 351  
 „ *aswa*, 350  
 „ *bela*, 350  
 „ *ismene*, 273, 351  
 „ *leda*, 273, 351  
 „ *tambra*, 350  
 „ *ziteneus*, 351  
*Menelaides aristolochiæ*, 363  
 „ *hector*, 363  
 „ *pandiana*, 363  
 \**Messena burmanica*, 340  
 „ *pulverosa*, 340  
 \* „ *sinuata*, 339  
*Microdeutopus anomalus*, 235  
 „ *australis*, 235  
 „ *chelifer*, 235  
 „ *grandimanus*, 235  
 „ *gryllotalpa*, 235  
 „ *longipes*, 235  
 „ *macronyx*, 235  
 „ *maculatus*, 235  
 \* „ *megnæ*, 231, 254  
 „ *mortoni*, 235  
 „ *tenuipes*, 235  
 „ *tenuis*, 235  
 „ *versiculatus*, 235  
 „ *websterii*, 235  
*Mindura*, 341  
*Miniopteris schreibersi*, 270, 272  
*Moduza procris*, 354  
*Monoculodes*, 248  
 „ *carinatus*, 237  
 „ *demissus*, 237  
 \* „ *megapleon*, 235, 254  
 „ *stimpsonii*, 237  
 \**Mononyx indicus*, 345  
*Morphinæ*, 351  
*Mucuna pruriens*, 116  
*Murina formosa*, 272  
 „ *suillus*, 272

*Mycalesis*, 273, 274  
 „ *blasius*, 273, 348  
 „ *indistans*, 348  
 „ *justina*, 348  
 „ *khasiana*, 273, 274  
 „ *malsarida*, 273, 274  
 „ *mandata*, 348  
 „ *mandosa*, 348  
 „ *mineus*, 348  
 „ *oculus*, 348  
 „ *persens*, 273  
 „ *subfasciata*, 348  
 „ *visala*, 348  
 „ (*Calysisme*) *blasius*, 348  
 „ „ *indistans*, 348  
 „ „ *justina*, 348  
 „ „ *mineus*, 348  
 „ „ *persens*, 348  
 „ „ *subfasciata*, 348  
 „ „ *visala*, 348  
 „ (*Nissanga*) *junonia*, 348  
 „ (*Orsotriæna*) *mandata*, 348  
 „ „ *mandosa*, 348  
 „ (*Telinga*) *adolphei*, 348  
 „ (*Virapa*) *anaxias*, 348  
*Myotis*, 266, 270  
 „ *berdmorei*, 269, 270  
 „ *murinus*, 272  
 „ *pallidiventris*, 269  
 „ *parvipes*, 266, 267, 272  
 „ *pipistrellus*, 266  
 „ *theobaldi*, 269, 270, 272  
*Myrina orsolina*, 287  
*Nacaduba ardates*, 358  
 „ *dana*, 358  
 „ *hampsoni*, 358  
 „ *macrophthalma*, 358  
 „ *prominens*, 357  
 „ *viola*, 358  
*Narmada coresoides*, 348  
*Nemeobiinæ*, 355  
*Neopithecopis zalmora*, 356  
*Neotoma*, 259  
*Nepheronia ceylonica*, 363  
 „ *fraterna*, 363  
 „ *gæa*, 363  
 „ *pingasa*, 363  
 „ *valeria*, 363  
*Neprodium*, 298  
 „ *barbigerum*, 295, 296  
 „ *Brunonianum*, 295, 296  
 „ *canum*, 296, 297, 309  
 „ *cochleatum*, 295, 296  
 „ *elongatum*, 310  
 „ *filix mas*, 310  
 „ „ „ *var. fibrillosa*, 309  
 „ „ „ *marginata*, 310  
 „ „ „ *normalis*, 296,  
 309, 310  
 „ „ „ *patentissima*,  
 309

- Nephradium filix mas* var. *Schimperi-*  
*ana*, 309  
 „ *gracilescens*, 295, 296  
 „ *marginata*, 310  
 „ *parasiticum*, 311  
 „ *pennigerum*, var. *multi-*  
*lineata*, 311  
 „ *prolixum*, 297  
 „ *remotum*, 310  
 „ *rigidum*, 296, 309  
 „ „ var. *marginata*,  
 309  
 „ *setigerum*, 295, 296  
 „ *sparsum*, 295  
 „ *thelypteris*, 295  
 „ (*Lastrea*) *Boryanum*, 311  
 „ „ *crenatum*, 311  
 „ „ *filix mas*, var.  
*marginata*, 309  
 „ „ *filix mas*, var.  
*normalis*, 309  
 „ „ *prolixum*, 309  
 „ „ *remotum*, 310  
*Neptis antonia*, 276  
 „ *astola*, 353  
 „ *eurymene*, 353  
 „ *hordonia*, 352  
 „ *jumbah*, 353  
 „ *kallaura*, 353  
 „ *kamarupa*, 353  
 \* „ *nana*, 276, 293  
 „ *nandina*, 353  
 „ *narayana*, 276  
 „ *ophiana*, 353  
 \* „ „ var. *nilgirica*, 353  
 „ *plagiosa*, 352  
 „ *swinhoei*, 353  
 „ *thisbe*, 276  
 „ *varmona*, 353  
 „ *viraja*, 352  
*Nilasera*, 360  
 „ *amantes*, 361  
 „ *centaurus*, 361  
*Niphobolus*, 313  
 „ *fissum*, 312  
*Nissanga junonia*, 348  
*Noctulinia noctula*, 272  
*Notholœna*, 298  
 „ *marantæ*, 314  
*Nyctejus atratus*, 272  
 „ *canus*, 272  
 „ *castaneus*, 272  
 „ *heathii*, 272  
 „ *luteus*, 272  
 „ *nicivulus*, 268, 272  
 „ *ornatus*, 272  
 „ *temmincki*, 268, 272  
*Nyctinomus plicatus*, 271  
*Nyctophilus*, 264, 265  
 „ *geoffroyi*, 264, 265, 272  
 „ *timoriensis*, 264, 272  
*Nymphalidæ*, 273, 347  
*Nymphalinæ*, 274, 352  
*Cedicerus*, 248  
 „ *æquimanus*, 248  
 \* „ *puliciformis*, 248, 254  
*Oleandra*, 298  
 „ *Wallichii*, 311  
*Onychium*, 298  
 „ *Japonicum*, 302  
 „ „ var. *multisecta*,  
 303  
*Opalinidæ*, 381  
*Ophioglossum*, 298  
 „ *vulgatum*, 315  
*Opis*, 222, 223  
*Ornithoptera minos*, 363  
*Orpheides erithonius*, 363  
*Orsotriœna mandata*, 348  
 „ *mandosa*, 348  
*Osmunda*, 298  
 „ *Claytoniana*, 309, 314  
 „ *regalis*, 315  
*Oxycephalidæ*, 249  
*Pademna kollari*, 348  
*Padraona*, 366  
 „ *dara*, 366  
 „ *gola*, 366  
 „ *mæsoides*, 366  
 „ *pseudomæsa*, 366  
 \* *Papilio daksa*, 363  
 „ *demolion*, 288  
 „ *helenus*, 288, 364  
 „ *ilithyia*, 275  
 „ *liomedon*, 364  
 \* „ *noblei*, 287, 288, 293  
 „ *paris*, 364  
 „ *tamilana*, 364  
 „ (*Achillides*) *tamilana*, 364  
 \* „ (*Charus*) *daksha*, 363  
 „ (*Chilasa*) *clytia*, 363  
 „ „ *dissimilis*, 363  
 „ „ *dravidarum*, 363  
 „ (*Dalchinia*) *teredon*, 364  
 „ „ *thermodusa*, 364  
 „ (*Harimala*) *buddha*, 364  
 „ „ *crino*, 364  
 „ (*Iliades*) *polymnestor*, 364  
 „ (*Laertias*) *pammon*, 363  
 „ (*Menelaides*) *aristolochiæ*, 363  
 „ „ *hector*, 363  
 „ „ *pandiana*, 363  
 „ (*Ornithoptera*) *minos*, 363  
 „ (*Orpheides*) *erithonius*, 363  
 „ (*Pathysa*) *nomius*, 364  
 „ (*Zetides*) *agamemnon*, 364  
 „ „ *doson*, 364  
*Papilionidæ*, 287, 361  
*Papilioninæ*, 287, 363  
*Paralycœa*, 249  
*Parantica aglea*, 347  
*Parata alexis*, 365

- Parata chromus*, 365  
*Parnara bada*, 365  
 „ *bevani*, 365  
 „ *kumara*, 365  
 „ *narooa*, 365  
 „ *toona*, 365  
 \* „ *uma*, 292, 293  
*Parthenos virens*, 354  
*Pathysa nomius*, 364  
*Phegopteris auriculatum*, 311  
 „ *distans*, 311  
 „ *dryopteris*, 312  
 „ *erubescens*, 311  
*Phromnia*, 341  
*Phyllorhina*, 260  
 „ *arnigera*, 271  
*Phymatodes clathratum*, 313  
 „ *ebenipes*, 314  
 „ *hastatum*, 313  
 „ *lineare*, 312, 313  
 „ *malacodon*, 314  
 „ *membranaceum*, 313  
 „ *simplex*, 313  
 „ *Stewartii*, 314  
*Pierinae*, 361  
*Piesia aquilina*, 303  
*Pipistrellus lepidus*, 267  
*Platyscelidæ*, 249  
*Plecotus auritus*, 272  
*Plesioneura agni*, 290  
 „ *alysos*, 368  
 „ *ambareesa*, 367  
 \* „ *basiflava*, 290, 293, 368  
 \* „ *fusca*, 367  
 \* „ *laxmi*, 290, 293  
 „ *leucocera*, 367  
 „ *nigricans*, 367  
 „ *restricta*, 368  
 „ *spilothyrus*, 367  
*Plesmonium margaretiferum*, 108  
 \* *Polydictya affinis*, 339  
*Polyommatus bœticus*, 358  
*Polypodium*, 298  
 „ *adnascens*, 295  
 „ *appendiculatum*, 295, 296  
 „ *clathratum*, 297  
 „ *fissum*, 295  
 „ *hiemiontideum*, 295, 296  
 „ *juglandifolium*, 295  
 „ *lineare*, 297, 313  
 „ *propinquum*, 295  
 „ *punctatum*, 295  
 „ *rivale*, 295  
 „ *simplex*, 297  
 „ ( *Drynaria* ) *rivale*, 312 [312  
 ( *Goniophlebium* ) *amœnum*,  
 „ „ *lachnopus*, 312  
 „ „ *microrhizoma*,  
 312  
 „ ( *Goniopteris* ) *multilinea-*  
*tum*, 312  
*Polypodium* ( *Niphobolus* ) *fissum*, 312  
 „ ( *Phegopteris* ) *auriculatum*,  
 311  
 „ „ *distans*, 311  
 „ „ *dryopteris*, 312  
 „ „ *erubescens*, 311  
 „ ( *Phymatodes* ) *clathratum*,  
 313  
 „ „ *ebenipes*, 314  
 „ „ *hastatum*, 313  
 „ „ *lineare*, 312  
 „ „ *malacodon*, 314  
 „ „ *membranaceum*,  
 313  
 „ „ *simplex*, 313  
 „ „ *Stewartii*, 314  
*Polystichum aculeatum*, 308  
 „ „ *var. lobata*, 308  
 „ *auriculatum*, *var. cæspi-*  
*tosa*, 308  
 „ *ilicifolium*, 308  
 „ *Prescottianum*, 309  
 „ *Thomsoni*, 308  
*Poritia pharyge*, 281  
*Pratapa cleobis*, 360  
*Precis iphita*, 352  
*Pronoideæ*, 249  
*Pseudolycæa*, 249  
*Pteris*, 298  
 „ *Cretica*, 303  
 „ *excelsa*, 303  
 „ *longifolia*, 303  
 „ *longipinnula*, 295, 296  
 „ *quadri-anrita*, 303  
 „ ( *Piesia* ) *aquilina*, 303  
*Pteromys*, 256, 257, 258  
 „ *oral*, 256  
*Pteropus edwardsi*, 271  
 „ *leschenaultii*, 271  
 „ *medius*, 271  
*Pyrameis cardui*, 354  
 „ *indica*, 354  
*Pyrgus galba*, 367  
*Pyrops javanensis*, 339  
 „ *nobilis*, 339  
 „ *servillei*, 339  
 \* *Rapala buxaria*, 285, 293  
 „ *distorta*, 359  
 „ *lazulina*, 359  
 „ *nissa*, 286  
 „ *orseis*, 284  
 \* „ *rosacea*, 285, 293  
 „ *schistacea*, 285, 359  
 „ *sphinx*, 284  
 \* „ *tara*, 284, 293  
*Raphidophora*, 110  
*Rathinda amor*, 359  
*Remelana yajna*, 286  
*Remusatia vivipara*, 109  
*Rhinolophus*, 262  
 „ *affinis*, 261, 262, 263, 271

- Rhinolophus cinerascens*, 261  
 „ *ferrum-equinum*, 263, 271  
 „ *fulvidus*, 261  
 „ *garoensis*, 262  
 „ *hipposiderus*, 263  
 „ *lepidus*, 261, 262  
 „ *luctus*, 271  
 „ *macrotis*, 263, 271  
 „ *minor*, 261, 262, 263, 271  
 „ *mitratus*, 271  
 „ *pearsoni*, 263, 271  
 „ *perniger*, 271  
 „ *petersi*, 261  
 „ *rammanika*, 261  
 „ *rouxi*, 261, 262, 271  
 „ *rubidus*, 261  
 „ *subbadius*, 261, 262, 271  
 „ *tragatus*, 263, 271  
*Rhinopoma hardwickii*, 271  
 „ *microphyllum*, 271  
*Ricania obscura*, 341  
*Rohana camiba*, 352  
*Salatura genutia*, 347  
*Sarangesa albicilla*, 368  
 „ *dasahara*, 368  
 \**Sastragala affinis*, 344  
 „ *uniguttata*, 344  
*Satadra canarica*, 360  
*Satyridæ*, 273  
*Satyrinæ*, 273, 348  
*Sauromatum sessiliflorum*, 108  
*Scinridæ*, 256, 257, 259  
*Sciuromorpha*, 259  
*Scotophilus*, 267, 268  
 „ *borbonicus*, 268  
 „ *ceylonicus*, 265  
 „ *coromandelianus*, 270, 272  
 „ *fuliginosus*, 270, 272  
 „ *gigas*, 268  
 „ *heathi*, 270  
 „ *kuhli*, 267, 268, 270, 272  
 „ *leachi*, 267  
 „ *leisleri*, 271  
 „ *lobatus*, 272  
 „ *maderaspatanus*, 265  
 „ *ornatus*, 268, 272  
 „ *pachyomus*, 271  
 „ *serotinus*, 271  
 „ *temmincki*, 268, 270, 272  
*Sellignea involuta*, 314  
*Serpulæ*, 337  
*Simorhynchus*, 249  
*Sithon indra*, 358  
*Spalgis epius*, 356  
*Spindasis abnormis*, 359  
 „ *concana*, 359  
 „ *elima*, 359  
 „ *lazularia*, 359  
 „ *trifurcata*, 359  
 „ *vulcanus*, 359  
*Stenoloma chinensis*, 299  
*Suastus aditus*, 365  
 „ *gremius*, 365  
 „ *subgriseus*, 366  
*Surendra todara*, 360  
*Symphædra nais*, 354  
*Synantheris silvatica*, 108  
*Syngamme fraxinea*, 314  
 „ *vestita*, 314  
*Synotus darjelinensis*, 265, 272  
 „ *darjelingensis*, 272  
*Tagiades atticus*, 367  
 „ *obscurus*, 367  
 \**Tajuria donatana*, 287, 293  
 „ *istroidea*, 286, 293  
 „ *longinus*, 360  
 „ *melastigma*, 360  
*Talicada nysæus*, 358  
*Tapena thwaitesi*, 368  
*Taphozous longimanus*, 271  
 „ *melanopogon*, 271  
 „ *saccolæmus*, 271  
 „ *saccolaimus*, 271  
*Taractroceræ coramas*, 366  
 „ *mævius*, 366  
*Tarucus callinara*, 357  
 „ *nara*, 357  
 „ *plinius*, 357  
*Telchinia violæ*, 352  
*Telicota bambusæ*, 366  
*Telinga adolpheï*, 348  
*Terias æsiopæ*, 361  
 „ *drona*, 361  
 „ *excavata*, 361  
 „ *hecabe*, 361  
 „ *hecabeoides*, 361  
 „ *læta*, 361  
 „ *lybthea*, 361  
 „ *purrea*, 361  
 „ *rama*, 361  
 „ *rubella*, 361  
 „ *silhetana*, 361  
 „ *swinhoei*, 361  
 „ *uniformis*, 361  
 „ *venata*, 361  
*Thamnotettix bipunctata*, 338  
 „ *nigro-picta*, 338  
*Thamyris*, 249  
*Thanaos indistincta*, 366  
*Tirumala limniacæ*, 347  
 „ *septentrionis*, 347  
*Trichomanes*, 298  
 „ *auriculatum*, 295, 296  
 „ *bipunctatum*, 298  
*Typhonium cuspidatum*, 108  
 „ *divaricatum*, 108  
 „ *gracile*, 108  
 „ *trilobatum*, 108  
*Udaspes folus*, 368  
*Urothoë elegans*, 246  
 \* „ *ruber*, 246  
 „ *rubra*, 255

- Vadebra lankana*, 359  
*Vanessa canace*, 355  
   *haronica*, 355  
*Vespertilio*, 266, 267, 270  
   *adversus*, 270, 272  
   *blythii*, 272  
   *caliginosus*, 272  
   *coromandelicus*, 267  
   *darjilingensis*, 272  
   *dobsoni*, 270  
   *formosus*, 270, 272  
   *fuliginosa*, 270  
   *hasselti*, 269  
   *longipes*, 269, 272  
   *megalopus*, 269  
   *montivagus*, 270  
   *muricola*, 272  
   *murinus*, 272  
   *mystacinus*, 270, 272  
   *nepalensis*, 267  
   *pallidiventris*, 267  
   *siligorensis*, 272  
   *temmincki*, 267, 268  
*Vespertilion de Coromandel*, 267  
*Vesperugo*, 267  
   *abramus*, 266, 270, 272  
   *atratus*, 272  
   *bechsteini*, 266  
   *ceylonicus*, 265  
   *imbricatus*, 265  
   *indicus*, 265, 266  
   *kuhli*, 267, 272  
   *leisleri*, 271  
   *leucotis*, 267  
   *maderaspatanus*, 265  
   *maurus*, 265  
   *micropus*, 266  
   *mordax*, 265  
   *murinus*, 266  
   *nasutus*, 265  
   *nattereri*, 266  
   *nepalensis*, 267  
   *noctula*, 266, 272  
   *Vesperugo pallidiventris*, 267  
   *pipistrellus*, 266, 267, 270, 272  
   *savii*, 265  
   *serotius*, 271  
*Virachola isocrates*, 359  
   *perse*, 359  
*Virapa anaxias*, 348  
*Westwoodilla*, 248  
*Woodsia*, 298  
   *elongata*, 298  
*Woodwardia*, 298  
   *radicans*, 304  
*Xantharpyia*, 260  
   *amplexicaudata*, 271  
*Ypthima baldus*, 349  
   *ceylonica*, 350  
   *chenui*, 350  
   *huebneri*, 350  
   *mahratta*, 350  
   *marshallii*, 349  
   *singala*, 350  
   *striata*, 349  
   *tabella*, 350  
   *thora*, 350  
   *ypthimoides*, 350  
*\*Zarona jasoda*, 280, 293  
*\*Zephyrus dohertii*, 278, 279, 293  
   *icana*, 279  
*Zesius chrysomallus*, 359  
*Zetides agamemnon*, 364  
   *doson*, 364  
*Zipetes saitis*, 350  
*Zizera indica*, 357  
   *maha*, 357  
   *ossa*, 357  
   *putli*, 356  
   *pygmæa*, 356  
   *sangra*, 357  
*Zizyphus*, 336  
*Zophoessa andersoni*, 274  
   *baladeva*, 275  
   *ramadeva*, 274, 293



NEW SERIES.

VOL. LVII.

CCLXXXII.

# JOURNAL

OF THE

## ASIATIC SOCIETY OF BENGAL.

Vol. LVII, Part II, No. I.—1888.

EDITED BY

THE NATURAL HISTORY SECRETARY.

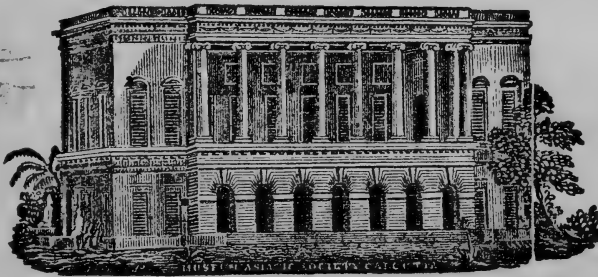

“The bounds of its investigation will be the geographical limits of Asia: and within these limits its inquiries will be extended to whatever is performed by man or produced by nature.”—SIR WILLIAM JONES.

\*\*\* *Communications should be sent under cover to the Secretaries, Asiat. Soc., to whom all orders for the work are to be addressed in India; or, in London, care of Messrs. Trübner and Co., 57 & 59, Ludgate Hill.*

CALCUTTA:

PRINTED BY G. H. ROUSE, AT THE BAPTIST MISSION PRESS,  
AND PUBLISHED BY THE  
ASIATIC SOCIETY, 57, PARK STREET.

1888.

Price (exclusive of postage) to Subscribers, Re. 1.—To Non-Subscribers R 1-8  
Price in England, 2 Shillings and sixpence

Issued June 8th, 1888.

## CONTENTS.

---

|                                                                                                                                                                                                                                                                   | <i>Page</i> |
|-------------------------------------------------------------------------------------------------------------------------------------------------------------------------------------------------------------------------------------------------------------------|-------------|
| I.— <i>Notes on Indian RHYNCHOTA ; HETEROPTERA, No. 3.—By E. T. ATKINSON, B. A.</i> ... ..                                                                                                                                                                        | 1           |
| II.— <i>A General Theorem on the Differential Equations of Trajectories.—By ASUTOSH MUKHOPADHYAY, M. A., F. R. A. S., F. R. S. E.</i> ... ..                                                                                                                      | 72          |
| III.— <i>On Poisson's Integral.—By ASUTOSH MUKHOPADHYAY, M. A., F. R. A. S., F. R. S. E. (With a Woodcut)</i> ... ..                                                                                                                                              | 100         |
| IV.— <i>On the Nature of the Toxic Principle of the Aroideæ.—By A. PEDLER, F. C. S. (Lond. &amp; Berl.), Professor of Chemistry, Presidency College, and C. J. H. WARDEN, F. C. S. (Lond. &amp; Berl.), Professor of Chemistry, Medical College, Calcutta</i> ... | 106         |

---

# CONTENTS

OF THE NATURAL HISTORY PART (PT. II.) OF THE

## JOURNAL OF THE ASIATIC SOCIETY OF BENGAL FOR 1887.

---

No. 1, (issued July 23rd, 1887). *On the Influence of Indian Forests on the Rainfall.*—By HENRY F. BLANFORD, F. R. S., Meteorological Reporter to the Government of India. *On the changes observed in the Density of the Surface Sea-water, coincident with, and due to Aerial Disturbances, and consequent Alteration of Baric Pressure over adjacent sea Areas; and on the Usefulness of a more exact measurement of the Specific Gravity of Sea-water: more especially with Reference to the Waters near and about the Hooghly River Pilot Station.*—By SAMUEL R. ELSON. *Notes on Indian Rhynchota: Heteroptera, No. 1.*—By E. T. ATKINSON, B. A., PRESIDENT. *A second series of New Species of Ficus from New Guinea.*—By GEORGE KING, M. B., LL. D., F. L. S., Superintendent of the Royal Botanic Garden, Calcutta. *On some New Species of Ficus from Sumatra.*—By GEORGE KING, M. B., LL. D., F. L. S., Superintendent, Botanic Garden, Calcutta. *On the Mammals and Birds collected by CAPTAIN C. E. YATE, C. S. I., of the Afghan Boundary Commission.*—By J. SCULLY. *On the Species of Loranthus indigenous to Perak.*—By GEORGE KING, M. B., LL. D., F. L. S., Superintendent of the Royal Botanic Garden, Calcutta. *Étude sur les Arachnides de l'Asie méridionale faisant partie des collections de l'Indian Museum (Calcutta).* Par M. E. SIMON, de Paris.—Communicated by THE SUPERINTENDENT OF THE INDIAN MUSEUM. *On the Differential Equation of a Trajectory.*—By ASUTOSH MUKHOPADHYAY, M. A., F. R. A. S., F. R. S. E. Communicated by THE HON'BLE MAHENDRALAL SIRKAR, M. D., C. I. E. (With a Woodcut.)

No. 2, (issued November 2nd, 1887). *On the Effects produced by small Quantities of Bismuth on the Ductility of Silver.*—By SURGEON-MAJOR J. SCULLY, Assay Master, Calcutta. *On Monge's Differential Equation to all Conics.*—By ASUTOSH MUKHOPADHYAY, M. A., F. R. A. S., F. R. S. E. Communicated by THE HON'BLE MAHENDRALAL SIRKAR, M. D., C. I. E. *Notes on Indian Rhynchota: Heteroptera, No. 2.*—By E. T. ATKINSON, B. A., PRESIDENT. *Natural History Notes from H. M.'s Indian Marine Survey Steamer "Investigator,"* Commander ALFRED CARPENTER R. N., Commanding. No. 4. *Description of a new species of Crustacea belonging to the Brachyurous family Raninidæ.*—By J. WOOD-MASON, Esq., Superintendent of the Indian Museum, and Professor of Comparative

*Anatomy and Zoology in the Medical College of Bengal, Calcutta.* (With Pl. I.) *Natural History Notes from H. M.'s Indian Marine Survey Steamer "Investigator,"* Commander ALFRED CARPENTER, R. N., Commanding. No. 5. *On some Nodular Stones obtained by trawling off Colombo in 675 Fathoms of Water.*—By E. J. JONES, A. R. S. M., Geological Survey of India. (With Pl. II.) *Natural History Notes from H. M.'s Indian Marine Survey Steamer "Investigator,"* Commander ALFRED CARPENTER, R. N., Commanding. No. 6. *On six new Amphipods from the Bay of Bengal.*—By G. M. GILES, M. B., F. R. C. S., Surgeon-Naturalist to the Marine Survey. (With Pls. III.—VIII.) *Natural History Notes from H. M.'s Indian Marine Survey Steamer "Investigator,"* Commander ALFRED CARPENTER, R. N., Commanding. No. 7. *The Mean Temperature of the Deep Waters of the Bay of Bengal.* By Commander CARPENTER, R. N., D. S. O., F. R. Met. Soc., F. Z. S. Communicated by THE SUPERINTENDENT OF THE INDIAN MUSEUM. (With Pl. X.)

No. 3, (issued January 30th, 1888). *On the Chiroptera of Nepal.*—By J. SCULLY. *Notes on some recent Neolithic and Palæolithic Finds in South India.*—By R. BRUCE FOOTE, F. G. S., Superintendent of the Geological Survey of India, Fellow of the University of Madras.—Communicated by THE SUPERINTENDENT OF THE INDIAN MUSEUM. (With a Map. Pl. XI.) *Étude sur les Arachnides de l'Asie méridionale faisant partie des collections de l'Indian Museum (Calcutta).*—Par M. E. SIMON, de Paris. Communicated by THE SUPERINTENDENT OF THE INDIAN MUSEUM. *A Memoir on Plane Analytic Geometry.*—By ASUTOSH MUKHOPADHYAY, M. A., F. R. A. S., F. R. S. E., Communicated by THE HON'BLE MAHENDRALAL SIRCAR, M. D., C. I. E. (With three Woodcuts.)

No. 4, (issued March 18th, 1888.) *A Descriptive List of the Uredinæ occurring in the Neighbourhood of Simla (Western Himalaya).*—By A. BARCLAY, M. B., Bengal Medical Service (With Pls. XII.—XV.) *Natural History Notes from H. M.'s Indian Marine Survey Steamer "Investigator,"* Commander ALFRED CARPENTER, R. N., Commanding. No. 8. *Description of a new species of the Brachyurous Genus Lyreidus from the Depths of the Andaman Sea.*—By J. WOOD-MASON, ESQ., Superintendent of the Indian Museum, and Professor of Comparative Anatomy and Zoology in the Medical College of Bengal, Calcutta. Title-page, Index, &c., to the Volume.

---

NEW SERIES.

VOL. LVII.

CCLXXXIV.

JOURNAL  
OF THE  
ASIATIC SOCIETY OF BENGAL.  
Vol. LVII, Part II, No. II.—1888.

EDITED BY  
THE NATURAL HISTORY SECRETARY.

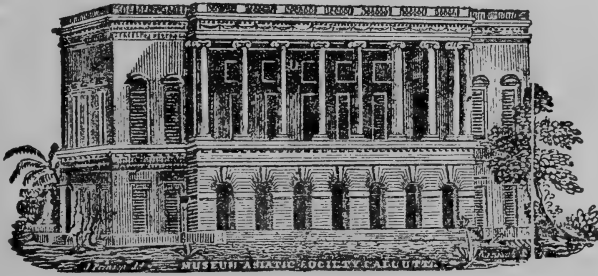

“The bounds of its investigation will be the geographical limits of Asia: and within these limits its inquiries will be extended to whatever is performed by man or produced by nature.”—SIR WILLIAM JONES.

\*\* *Communications should be sent under cover to the Secretaries, Asiat. Soc., to whom all orders for the work are to be addressed in India; or, in London, care of Messrs. Trübner and Co., 57 & 59, Ludgate Hill.*

CALCUTTA:

PRINTED BY G. H. ROUSE, AT THE BAPTIST MISSION PRESS,  
AND PUBLISHED BY THE  
ASIATIC SOCIETY, 57, PARK STREET.

1888.

Price (exclusive of postage) to Subscribers, Re. 1.—To Non-Subscribers Rs. 1-8

Price in England, 2 Shillings and sixpence

Issued July 19th, 1888.

## CONTENTS.

---

|                                                                                                                                                                                                                                                                                                                                                                                                                                                                                        | <i>Page</i> |
|----------------------------------------------------------------------------------------------------------------------------------------------------------------------------------------------------------------------------------------------------------------------------------------------------------------------------------------------------------------------------------------------------------------------------------------------------------------------------------------|-------------|
| V.— <i>Notes on Indian RHYNCHOTA ; HETEROPTERA, No. 5.—By E. T. ATKINSON, B. A.</i> ... ..                                                                                                                                                                                                                                                                                                                                                                                             | 118         |
| VI.— <i>On recent Tornadoes in Bengal with special reference to the Tornado at Dacca on April 7th, 1888. In two Parts. Part I. A Description of the Meteorological Conditions in Bengal which accompanied the Formation of the Dacca Tornado.—By ALEX. PEDLER, Offg. Meteorological Reporter to the Government of Bengal. Part II. A full Description of the actual Phenomena of the Dacca Tornado.—By A. CROMBIE, M. D., Civil Surgeon of Dacca. (With Plates XXIV.—XXIX.)</i> ... .. | 184         |

---

# CONTENTS

OF THE NATURAL HISTORY PART (PT. II.) OF THE

## JOURNAL OF THE ASIATIC SOCIETY OF BENGAL FOR 1887.

---

No. 1, (issued July 23rd, 1887). *On the Influence of Indian Forests on the Rainfall.*—By HENRY F. BLANFORD, F. R. S., Meteorological Reporter to the Government of India. *On the changes observed in the Density of the Surface Sea-water, coincident with, and due to Aerial Disturbances, and consequent Alteration of Baric Pressure over adjacent sea Areas; and on the Usefulness of a more exact measurement of the Specific Gravity of Sea-water: more especially with Reference to the Waters near and about the Hooghly River Pilot Station.*—By SAMUEL R. ELSON. *Notes on Indian Rhynchota: Heteroptera, No. 1.*—By E. T. ATKINSON, B. A., PRESIDENT. *A second series of New Species of Ficus from New Guinea.*—By GEORGE KING, M. B., LL. D., F. L. S., Superintendent of the Royal Botanic Garden, Calcutta. *On some New Species of Ficus from Sumatra.*—By GEORGE KING, M. B., LL. D., F. L. S., Superintendent, Botanic Garden, Calcutta. *On the Mammals and Birds collected by CAPTAIN C. E. YATE, C. S. I., of the Afghan Boundary Commission.*—By J. SCULLY. *On the Species of Loranthus indigenous to Perak.*—By GEORGE KING, M. B., LL. D., F. L. S., Superintendent of the Royal Botanic Garden, Calcutta. *Étude sur les Arachnides de l'Asie méridionale faisant partie des collections de l'Indian Museum (Calcutta).* Par M. E. SIMON, de Paris.—Communicated by THE SUPERINTENDENT OF THE INDIAN MUSEUM. *On the Differential Equation of a Trajectory.*—By ASUTOSH MUKHOPADHYAY, M. A., F. R. A. S., F. R. S. E. Communicated by THE HON'BLE MAHENDRALAL SIRKAR, M. D., C. I. E. (With a Woodcut.)

No. 2, (issued November 2nd, 1887). *On the Effects produced by small Quantities of Bismuth on the Ductility of Silver.*—By SURGEON-MAJOR J. SCULLY, Assay Master, Calcutta. *On Monge's Differential Equation to all Conics.*—By ASUTOSH MUKHOPADHYAY, M. A., F. R. A. S., F. R. S. E. Communicated by THE HON'BLE MAHENDRALAL SIRKAR, M. D., C. I. E. *Notes on Indian Rhynchota: Heteroptera, No. 2.*—By E. T. ATKINSON, B. A., PRESIDENT. *Natural History Notes from H. M.'s Indian Marine Survey Steamer "Investigator," Commander ALFRED CARPENTER R. N., Commanding. No. 4. Description of a new species of Crustacea belonging to the Brachyurous family Raninidæ.*—By J. WOOD-MASON, Esq., Superintendent of the Indian Museum, and Professor of Comparative

*Anatomy and Zoology in the Medical College of Bengal, Calcutta.* (With Pl. I.) *Natural History Notes from H. M.'s Indian Marine Survey Steamer "Investigator,"* Commander ALFRED CARPENTER, R. N., Commanding. No. 5. *On some Nodular Stones obtained by trawling off Colombo in 675 Fathoms of Water.*—By E. J. JONES, A. R. S. M., Geological Survey of India. (With Pl. II.) *Natural History Notes from H. M.'s Indian Marine Survey Steamer "Investigator,"* Commander ALFRED CARPENTER, R. N., Commanding. No. 6. *On six new Amphipods from the Bay of Bengal.*—By G. M. GILES, M. B., F. R. C. S., Surgeon-Naturalist to the Marine Survey. (With Pls. III.—VIII.) *Natural History Notes from H. M.'s Indian Marine Survey Steamer "Investigator,"* Commander ALFRED CARPENTER, R. N., Commanding. No. 7. *The Mean Temperature of the Deep Waters of the Bay of Bengal.* By Commander CARPENTER, R. N., D. S. O., F. R. Met. Soc., F. Z. S. Communicated by THE SUPERINTENDENT OF THE INDIAN MUSEUM. (With Pl. X.)

No. 3, (issued January 30th, 1888.) *On the Chiroptera of Nepal.*—By J. SCULLY. *Notes on some recent Neolithic and Palæolithic Finds in South India.*—By R. BRUCE FOOTE, F. G. S., Superintendent of the Geological Survey of India, Fellow of the University of Madras.—Communicated by THE SUPERINTENDENT OF THE INDIAN MUSEUM. (With a Map. Pl. XI.) *E'tude sur les Arachnides de l'Asie méridionale faisant partie des collections de l'Indian Museum (Calcutta).*—Par M. E. SIMON, de Paris. Communicated by THE SUPERINTENDENT OF THE INDIAN MUSEUM. *A Memoir on Plane Analytic Geometry.*—By ASUTOSH MUKHOPADHYAY, M. A., F. R. A. S., F. R. S. E., Communicated by THE HON'BLE MAHENDRALAL SIRCAR, M. D., C. I. E. (With three Woodcuts.)

No. 4, (issued March 18th, 1888.) *A Descriptive List of the Uredineæ occurring in the Neighbourhood of Simla (Western Himalaya).*—By A. BARCLAY, M. B., Bengal Medical Service (With Pls. XII.—XV.) *Natural History Notes from H. M.'s Indian Marine Survey Steamer "Investigator,"* Commander ALFRED CARPENTER, R. N., Commanding. No. 8. *Description of a new species of the Brachyurous Genus Lyreidus from the Depths of the Andaman Sea.*—By J. WOOD-MASON, ESQ., Superintendent of the Indian Museum, and Professor of Comparative Anatomy and Zoology in the Medical College of Bengal, Calcutta.

---



NEW SERIES.

VOL. LVII.

CCLXXXVI.

JOURNAL  
OF THE  
ASIATIC SOCIETY OF BENGAL.

Vol. LVII, Part II, No. III.—1888.

EDITED BY

THE NATURAL HISTORY SECRETARY.

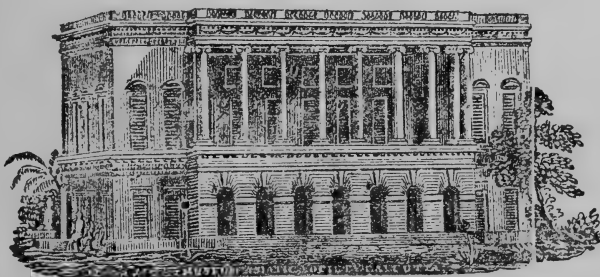

“The bounds of its investigation will be the geographical limits of Asia: and within these limits its inquiries will be extended to whatever is performed by man or produced by nature.”—SIR WILLIAM JONES.

\*\* *Communications should be sent under cover to the Secretaries, Asiat. Soc., to whom all orders for the work are to be addressed in India; or, in London, care of Messrs. Trübner and Co., 57 & 59, Ludgate Hill.*

CALCUTTA:

PRINTED BY G. H. ROUSE, AT THE BAPTIST MISSION PRESS,  
AND PUBLISHED BY THE  
ASIATIC SOCIETY, 57, PARK STREET.

1888.

Price (exclusive of postage) to Subscribers, Re. 1.—To Non-Subscribers Rs. 1-8  
Price in England, 2 Shillings and sixpence

Issued October 10th, 1888.

## CONTENTS.

---

|                                                                                                                                                                                                                                                                                                                         | <i>Page</i> |
|-------------------------------------------------------------------------------------------------------------------------------------------------------------------------------------------------------------------------------------------------------------------------------------------------------------------------|-------------|
| VII.— <i>Natural History Notes from H. M.'s Indian Marine Survey Steamer 'Investigator' Commander ALFRED CARPENTER, R. N., D. S. O., Commanding. No. 9. Further Notes on the Amphipoda of Indian Waters.—By G. M. GILES, M. B., F. R. C. S., Surgeon-Naturalist to the Marine Survey (With Plates VI.—XII.),</i> ... .. | 220         |
| VIII.— <i>On Eupetaurus, a new form of Flying Squirrel from Kashmir.—By OLDFIELD THOMAS, British Museum (Natural History). Communicated by THE NATURAL HISTORY SECRETARY. (With Plates XXII. &amp; XXIII.),</i> ... ..                                                                                                  | 256         |
| IX.— <i>Notes on Indian Chiroptera.—By W. T. BLANFORD, F. R. S.</i>                                                                                                                                                                                                                                                     | 260         |

---

# CONTENTS

OF THE NATURAL HISTORY PART (PT. II.) OF THE

## JOURNAL OF THE ASIATIC SOCIETY OF BENGAL FOR 1887.

---

No. 1, (issued July 23rd, 1887). *On the Influence of Indian Forests on the Rainfall.*—By HENRY F. BLANFORD, F. R. S., *Meteorological Reporter to the Government of India.* *On the changes observed in the Density of the Surface Sea-water, coincident with, and due to Aerial Disturbances, and consequent Alteration of Baric Pressure over adjacent sea Areas; and on the Usefulness of a more exact measurement of the Specific Gravity of Sea-water: more especially with Reference to the Waters near and about the Hooghly River Pilot Station.*—By SAMUEL R. ELSON. *Notes on Indian Rhynchota: Heteroptera, No. 1.*—By E. T. ATKINSON, B. A., PRESIDENT. *A second series of New Species of Ficus from New Guinea.*—By GEORGE KING, M. B., LL. D., F. L. S., *Superintendent of the Royal Botanic Garden, Calcutta.* *On some New Species of Ficus from Sumatra.*—By GEORGE KING, M. B., LL. D., F. L. S., *Superintendent, Botanic Garden, Calcutta.* *On the Mammals and Birds collected by CAPTAIN C. E. YATE, C. S. I., of the Afghan Boundary Commission.*—By J. SCULLY. *On the Species of Loranthus indigenous to Perak.*—By GEORGE KING, M. B., LL. D., F. L. S., *Superintendent of the Royal Botanic Garden, Calcutta.* *Étude sur les Arachnides de l'Asie méridionale faisant partie des collections de l'Indian Museum (Calcutta).* Par M. E. SIMON, de Paris.—Communicated by THE SUPERINTENDENT OF THE INDIAN MUSEUM. *On the Differential Equation of a Trajectory.*—By ASUTOSH MUKHOPADHYAY, M. A., F. R. A. S., F. R. S. E. Communicated by THE HON'BLE MAHENDRALAL SIRKAR, M. D., C. I. E. (With a Woodcut.)

No. 2, (issued November 2nd, 1887). *On the Effects produced by small Quantities of Bismuth on the Ductility of Silver.*—By SURGEON-MAJOR J. SCULLY, *Assay Master, Calcutta.* *On Monge's Differential Equation to all Conics.*—By ASUTOSH MUKHOPADHYAY, M. A., F. R. A. S., F. R. S. E. Communicated by THE HON'BLE MAHENDRALAL SIRKAR, M. D., C. I. E. *Notes on Indian Rhynchota: Heteroptera, No. 2.*—By E. T. ATKINSON, B. A., PRESIDENT. *Natural History Notes from H. M.'s Indian Marine Survey Steamer "Investigator,"* Commander ALFRED CARPENTER R. N., *Commanding.* No. 4. *Description of a new species of Crustacea belonging to the Brachyurous family Raninidæ.*—By J. WOOD-MASON, ESQ., *Superintendent of the Indian Museum, and Professor of Comparative*

*Anatomy and Zoology in the Medical College of Bengal, Calcutta.* (With Pl. I.) *Natural History Notes from H. M.'s Indian Marine Survey Steamer "Investigator,"* Commander ALFRED CARPENTER, R. N., Commanding. No. 5. *On some Nodular Stones obtained by trawling off Colombo in 675 Fathoms of Water.*—By E. J. JONES, A. R. S. M., *Geological Survey of India.* (With Pl. II.) *Natural History Notes from H. M.'s Indian Marine Survey Steamer "Investigator,"* Commander ALFRED CARPENTER, R. N., Commanding. No. 6. *On six new Amphipods from the Bay of Bengal.*—By G. M. GILES, M. B., F. R. C. S., *Surgeon-Naturalist to the Marine Survey.* (With Pls. III.—VIII.) *Natural History Notes from H. M.'s Indian Marine Survey Steamer "Investigator,"* Commander ALFRED CARPENTER, R. N., Commanding. No. 7. *The Mean Temperature of the Deep Waters of the Bay of Bengal.* By Commander CARPENTER, R. N., D. S. O., F. R. Met. Soc., F. Z. S. *Communicated by THE SUPERINTENDENT OF THE INDIAN MUSEUM.* (With Pl. X.)

No. 3, (issued January 30th, 1888.) *On the Chiroptera of Nepal.*—By J. SCULLY. *Notes on some recent Neolithic and Palæolithic Finds in South India.*—By R. BRUCE FOOTE, F. G. S., *Superintendent of the Geological Survey of India, Fellow of the University of Madras.*—*Communicated by THE SUPERINTENDENT OF THE INDIAN MUSEUM.* (With a Map. Pl. XI.) *E'tude sur les Arachnides de l'Asie méridionale faisant partie des collections de l'Indian Museum (Calcutta).*—Par M. E. SIMON, de Paris. *Communicated by THE SUPERINTENDENT OF THE INDIAN MUSEUM.* *A Memoir on Plane Analytic Geometry.*—By ASUTOSH MUKHOPADHYAY, M. A., F. R. A. S., F. R. S. E., *Communicated by THE HON'BLE MAHENDRALAL SIRCAR, M. D., C. I. E.* (With three Woodcuts.)

No. 4, (issued March 18th, 1888.) *A Descriptive List of the Uredineæ occurring in the Neighbourhood of Simla (Western Himalaya).*—By A. BARCLAY, M. B., *Bengal Medical Service* (With Pls. XII.—XV.) *Natural History Notes from H. M.'s Indian Marine Survey Steamer "Investigator,"* Commander ALFRED CARPENTER, R. N., Commanding. No. 8. *Description of a new species of the Brachyurous Genus Lyreidus from the Depths of the Andaman Sea.*—By J. WOOD-MASON, ESQ., *Superintendent of the Indian Museum, and Professor of Comparative Anatomy and Zoology in the Medical College of Bengal, Calcutta.*

---

NEW SERIES.

VOL. LVII.

CCLXXXVII.

# JOURNAL

OF THE

## ASIATIC SOCIETY OF BENGAL.

Vol. LVII, Part II, No. IV.—1888.

EDITED BY

THE NATURAL HISTORY SECRETARY.

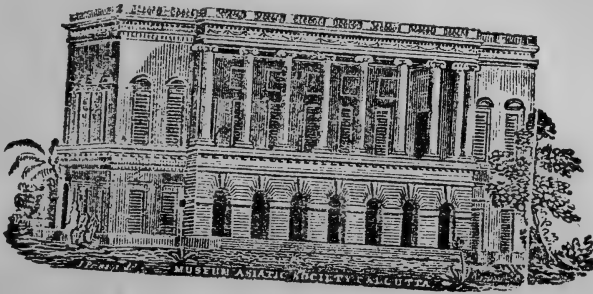

“The bounds of its investigation will be the geographical limits of Asia: and within these limits its inquiries will be extended to whatever is performed by man or produced by nature.”—SIR WILLIAM JONES.

\*\* *Communications should be sent under cover to the Secretaries, Asiat. Soc., to whom all orders for the work are to be addressed in India; or, in London, care of Messrs. Trübner and Co., 57 & 59, Ludgate Hill.*

CALCUTTA:

PRINTED BY G. H. ROUSE, AT THE BAPTIST MISSION PRESS,  
AND PUBLISHED BY THE  
ASIATIC SOCIETY, 57, PARK STREET.

1889.

Price (exclusive of postage) to Subscribers, Re. 1.—To Non-Subscribers, Re. 1-8  
Price in England, 2 Shillings and sixpence.

Issued March 23rd, 1889.

## CONTENTS.

---

|                                                                                                                                                                                                                                                                                                                                             |     |
|---------------------------------------------------------------------------------------------------------------------------------------------------------------------------------------------------------------------------------------------------------------------------------------------------------------------------------------------|-----|
| <p>X.—<i>On new or little-known Butterflies from the Indian Region.</i>—By<br/>LIONEL DE NICEVILLE, F. E. S., C. M. Z. S. (With Pls. XIII.<br/>&amp; XIV.) .....</p>                                                                                                                                                                        | 273 |
| <p>XI.—<i>A List of the Ferns of Simla in the N. W. Himalaya between<br/>Levels of 4,500 and 10,500 Feet.</i>—By H. F. BLANFORD, F. R. S.<br/>(With Pls. XVI.—XXI.) .....</p>                                                                                                                                                               | 249 |
| <p>XII.—<i>On the Differential Equation of all Parabolas.</i>—By ASUTOSH<br/>MUKHOPADHYAY, M. A., F. R. A. S., F. R. S. E. ....</p>                                                                                                                                                                                                         | 316 |
| <p>XIII.—<i>New or little-known Indian Rhynchota.</i>—By E. T. ATKIN-<br/>SON, B. A. (With Pl. XV.) .....</p>                                                                                                                                                                                                                               | 333 |
| <p>XIV.—<i>The Butterflies of the Nilgiri District, South India.</i>—By<br/>G. F. HAMPSON, B. A., Coll. Exon., Oxon. Communicated by<br/>THE SUPERINTENDENT OF THE INDIAN MUSEUM .....</p>                                                                                                                                                  | 346 |
| <p>XV.—<i>The Psychrometer and the Condensing Hygrometer.</i>—By S. A.<br/>HILL, B. SC., Meteorological Reporter to the Government of the<br/>North-Western Provinces and Oudh .....</p>                                                                                                                                                    | 369 |
| <p>XVI.—<i>Anoplophrya æolosomatis, a new Ciliate Infusorian parasitic<br/>in the Alimentary Canal of Æolosoma chlorostictum W.-M.,<br/>MSS.</i>—By HENRY H. ANDERSON, B. A. Communicated by THE<br/>MICROSCOPICAL SOCIETY OF CALCUTTA (With Pl. I.) .....</p>                                                                              | 381 |
| <p>XVII.—<i>On certain Features in the Geological Structure of the Mye-<br/>lat District of the Southern Shan States in Upper Burmah as<br/>affecting the Drainage of the Country.</i>—By BRIGADIER-GENERAL<br/>H. COLLETT, C. B. Communicated by DR. D. D. CUNNINGHAM, .....</p>                                                           | 384 |
| <p>XVIII.—<i>Notes on some Objects from a Neolithic Settlement recently<br/>discovered by MR. W. H. P. DRIVER, at Ranchi in the Chota<br/>Nagpore District.</i>—By J. WOOD-MASON, Superintendent of the<br/>Indian Museum, and Professor of Comparative Anatomy in the<br/>Medical College of Bengal, Calcutta (With Pls. II.—V.) .....</p> | 387 |

---

# CONTENTS

OF THE NATURAL HISTORY PART (PT. II.) OF THE

## JOURNAL OF THE ASIATIC SOCIETY OF BENGAL FOR 1887.

No. 1, (issued July 23rd, 1887). *On the Influence of Indian Forests on the Rainfall.*—By HENRY F. BLANFORD, F. R. S., Meteorological Reporter to the Government of India. *On the changes observed in the Density of the Surface Sea-water, coincident with, and due to Aerial Disturbances, and consequent Alteration of Baric Pressure over adjacent sea Areas; and on the Usefulness of a more exact measurement of the Specific Gravity of Sea-water: more especially with Reference to the Waters near and about the Hooghly River Pilot Station.*—By SAMUEL R. ELSON. *Notes on Indian Rhynchota: Heteroptera, No. 1.*—By E. T. ATKINSON, B. A., PRESIDENT. *A second series of New Species of Ficus from New Guinea.*—By GEORGE KING, M. B., LL. D., F. L. S., Superintendent of the Royal Botanic Garden, Calcutta. *On some New Species of Ficus from Sumatra.*—By GEORGE KING, M. B., LL. D., F. L. S., Superintendent, Botanic Garden, Calcutta. *On the Mammals and Birds collected by CAPTAIN C. E. YATE, C. S. I., of the Afghan Boundary Commission.*—By J. SCULLY. *On the Species of Loranthus indigenous to Perak.*—By GEORGE KING, M. B., LL. D., F. L. S., Superintendent of the Royal Botanic Garden, Calcutta. *Étude sur les Arachnides de l'Asie méridionale faisant partie des collections de l'Indian Museum (Calcutta).* Par M. E. SIMON, de Paris.—Communicated by THE SUPERINTENDENT OF THE INDIAN MUSEUM. *On the Differential Equation of a Trajectory.*—By ASUTOSH MUKHOPADHYAY, M. A., F. R. A. S., F. R. S. E. Communicated by THE HON'BLE MAHENDRALAL SIRKAR, M. D., C. I. E. (With a Woodcut.)

No. 2, (issued November 2nd, 1887). *On the Effects produced by small Quantities of Bismuth on the Ductility of Silver.*—By SURGEON-MAJOR J. SCULLY, Assay Master, Calcutta. *On Monge's Differential Equation to all Conics.*—By ASUTOSH MUKHOPADHYAY, M. A., F. R. A. S., F. R. S. E. Communicated by THE HON'BLE MAHENDRALAL SIRKAR, M. D., C. I. E. *Notes on Indian Rhynchota: Heteroptera, No. 2.*—By E. T. ATKINSON, B. A., PRESIDENT. *Natural History Notes from H. M.'s Indian Marine Survey Steamer "Investigator,"* Commander ALFRED CARPENTER R. N., Commanding. No. 4. *Description of a new species of Crustacea belonging to the Brachyurous family Raninidæ.*—By J. WOOD-MASON, Esq., Superintendent of the Indian Museum, and Professor of Comparative Anatomy and Zoology in the Medical College of Bengal, Calcutta. (With Pl. I.) *Natural History Notes from H. M.'s Indian Marine Survey*

Steamer "Investigator," Commander ALFRED CARPENTER, R. N., Commanding. No. 5. *On some Nodular Stones obtained by trawling off Colombo in 675 Fathoms of Water.*—By E. J. JONES, A. R. S. M., Geological Survey of India. (With Pl. II.) *Natural History Notes from H. M.'s Indian Marine Survey Steamer "Investigator,"* Commander ALFRED CARPENTER, R. N., Commanding. No. 6. *On six new Amphipods from the Bay of Bengal.*—By G. M. GILES, M. B., F. R. C. S., Surgeon-Naturalist to the Marine Survey. (With Pls. III.—VIII.) *Natural History Notes from H. M.'s Indian Marine Survey Steamer 'Investigator,'* Commander ALFRED CARPENTER, R. N., Commanding. No. 7. *The Mean Temperature of the Deep Waters of the Bay of Bengal.* By Commander CARPENTER, R. N., D. S. O., F. R. Met. Soc., F. Z. S. Communicated by THE SUPERINTENDENT OF THE INDIAN MUSEUM. (With Pl. X.)

No. 3, (issued January 30th, 1888). *On the Chiroptera of Nepal.*—By J. SCULLY. *Notes on some recent Neolithic and Palæolithic Finds in South India.*—By R. BRUCE FOOTE, F. G. S., Superintendent of the Geological Survey of India, Fellow of the University of Madras.—Communicated by THE SUPERINTENDENT OF THE INDIAN MUSEUM. (With a Map, Pl. XI.) *Étude sur les Arachnides de l'Asie méridionale faisant partie des collections de l'Indian Museum (Calcutta).*—Par M. E. SIMON, de Paris. Communicated by THE SUPERINTENDENT OF THE INDIAN MUSEUM. *A Memoir on Plane Analytic Geometry.*—By ASUTOSH MUKHOPADHYAY, M. A., F. R. A. S., F. R. S. E., Communicated by THE HON'BLE MAHENDRALAL SIRCAR, M. D., C. I. E. (With three Woodcuts.)

No. 4, (issued March 18th, 1888.) *A Descriptive List of the Uredines occurring in the Neighbourhood of Simla (Western Himalaya).*—By A. BARCLAY, M. B., Bengal Medical Service (With Pls. XII.—XV.) *Natural History Notes from H. M.'s Indian Marine Survey Steamer 'Investigator,'* Commander ALFRED CARPENTER, R. N., Commanding. No. 8. *Description of a new species of the Brachyurous Genus Lyreidus from the Depths of the Andaman Sea.*—By J. WOOD-MASON, Esq., Superintendent of the Indian Museum, and Professor of Comparative Anatomy and Zoology in the Medical College of Bengal, Calcutta.

---



NEW SERIES.

VOL. LVII.

CCC.

# JOURNAL

OF THE

## ASIATIC SOCIETY OF BENGAL.

Vol. LVII, Part II, No. V.—1888.

EDITED BY

J. WOOD-MASON, ESQ.

VICE-PRESIDENT.

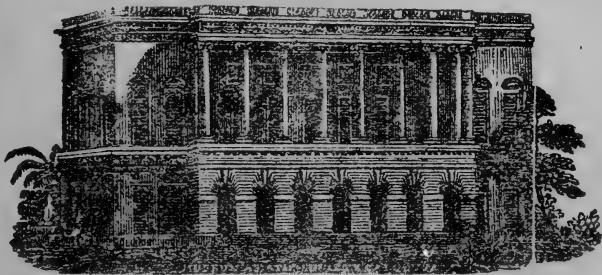

"The bounds of its investigation will be the geographical limits of Asia: and within these limits its inquiries will be extended to whatever is performed by man or produced by nature."—SIR WILLIAM JONES.

\* \* \* *Communications should be sent under cover to the Secretaries, Asiat. Soc., to whom all orders for the work are to be addressed in India; or, in London, care of Messrs. Trübner and Co., 57 & 59, Ludgate Hill.*

CALCUTTA:

PRINTED AT THE BAPTIST MISSION PRESS,

AND PUBLISHED BY THE

ASIATIC SOCIETY, 57, PARK STREET.

1890.

Issued 31st May, 1890.

## CONTENTS.

---

Title-page, Index, etc. to Vol. LVII, Pt. II, 1888.

---

# CONTENTS

OF THE NATURAL HISTORY PART (PT. II.) OF THE

## JOURNAL OF THE ASIATIC SOCIETY OF BENGAL FOR 1887.

No. 1, (issued July 23rd, 1887). *On the Influence of Indian Forests on the Rainfall.*—By HENRY F. BLANFORD, F. R. S., Meteorological Reporter to the Government of India. *On the changes observed in the Density of the Surface Sea-water, coincident with, and due to Aerial Disturbances, and consequent Alteration of Baric Pressure over adjacent sea Areas; and on the Usefulness of a more exact measurement of the Specific Gravity of Sea-water: more especially with Reference to the Waters near and about the Hooghly River Pilot Station.*—By SAMUEL R. ELSON. *Notes on Indian Rhynchota: Heteroptera, No. 1.*—By E. T. ATKINSON, B. A., PRESIDENT. *A second series of New Species of Ficus from New Guinea.*—By GEORGE KING, M. B., LL. D., F. L. S., Superintendent of the Royal Botanic Garden, Calcutta. *On some New Species of Ficus from Sumatra.*—By GEORGE KING, M. B., LL. D., F. L. S., Superintendent, Botanic Garden, Calcutta. *On the Mammals and Birds collected by CAPTAIN C. E. YATE, C. S. I., of the Afghan Boundary Commission.*—By J. SCULLY. *On the Species of Loranthus indigenous to Perak.*—By GEORGE KING, M. B., LL. D., F. L. S., Superintendent of the Royal Botanic Garden, Calcutta. *E'tude sur les Arachnides de l'Asie méridionale faisant partie des collections de l'Indian Museum (Calcutta).* Par M. E. SIMON, de Paris.—Communicated by THE SUPERINTENDENT OF THE INDIAN MUSEUM. *On the Differential Equation of a Trajectory*—By ASUTOSH MUKHOPADHYAY, M. A., F. R. A. S., F. R. S. E. Communicated by THE HON'BLE MAHENDRALAL SIRKAR, M. D., C. I. E. (With a Woodcut.)

No. 2, (issued November 2nd, 1887). *On the Effects produced by small Quantities of Bismuth on the Ductility of Silver.*—By SURGEON-MAJOR J. SCULLY, Assay Master, Calcutta. *On Monge's Differential Equation to all Conics.*—By ASUTOSH MUKHOPADHYAY, M. A., F. R. A. S., F. R. S. E. Communicated by THE HON'BLE MAHENDRALAL SIRKAR, M. D., C. I. E. *Notes on Indian Rhynchota: Heteroptera, No 2.*—By E. T. ATKINSON, B. A., PRESIDENT. *Natural History Notes from H. M.'s Indian Marine Survey Steamer "Investigator,"* Commander ALFRED CARPENTER, R. N., Commanding. No. 4. *Description of a new species of Crustacea belonging to the Brachyurous family Raninidæ.*—By J. WOOD-MASON, ESQ., Superintendent of the Indian Museum, and Professor of Comparative Anatomy and Zoology in the Medical College of Bengal, Calcutta. (With Pl. I.) *Natural History Notes from H. M.'s Indian Marine Survey*

Steamer "Investigator," Commandar ALFRED CARPENTER, R. N., Commanding. No. 5. *On some Nodular Stones obtained by trawling off Colombo in 675 Fathoms of Water.*—By E. J. JONES, A. R. S. M., Geological Survey of India. (With Pl. II.) *Natural History Notes from H. M.'s Indian Marine Survey Steamer "Investigator," Commandar ALFRED CARPENTER, R. N., Commanding. No. 6. On six new Amphipods from the Bay of Bengal.*—By G. M. GILES, M. B., F. R. C. S., Surgeon-Naturalist to the Marine Survey. (With Pls. III.—VIII.) *Natural History Notes from H. M.'s Indian Marine Survey Steamer 'Investigator,' Commander ALFRED CARPENTER, R. N., Commanding. No. 7. The Mean Temperature of the Deep Waters of the Bay of Bengal.* By Commander CARPENTER, R. N., D. S. O., F. R. Met. Soc. F. Z. S. Communicated by THE SUPERINTENDENT OF THE INDIAN MUSEUM. (With Pl. X.)

No. 3, (issued January 30th, 1888.) *On the Chiroptera of Nepal.*—By J. SCULLY. *Notes on some recent Neolithic and Palaeolithic Finds in South India.*—By R. BRUCE FOOTE, F. G. S. Superintendent of the Geological Survey of India, Fellow of the University of Madras.—Communicated by THE SUPERINTENDENT OF THE INDIAN MUSEUM. (With a Map. Pl. XI.) *Étude sur les Arachnides de l'Asie méridionale faisant partie des collections de l'Indian Museum (Calcutta).*—Par M. E. SIMON, de Paris. Communicated by THE SUPERINTENDENT OF THE INDIAN MUSEUM. *A Memoir on Plane Analytic Geometry.*—By ASUTOSH MUKHOPADHYAY, M. A., F. R. A. S., F. R. S. E., Communicated by THE HON'BLE MAHENDRALAL SIRKAR, M. D., C. I. E. (With three Woodcuts.)

No. 4, (issued March 18th, 1888.) *A Descriptive List of the Uredineæ occurring in the Neighbourhood of Simla (Western Himalaya).*—By A. BARCLAY, M. B., Bengal Medical Service (With Pls. XII.—XV.) *Natural History Notes from H. M.'s Indian Marine Survey Steamer 'Investigator,' Commander ALFRED CARPENTER, R. N., Commanding. No. 8. Description of a new species of the Brachyurous Genus Lyreidus from the Depths of the Andaman Sea.*—By J. WOOD-MASON, ESQ., Superintendent of the Indian Museum, and Professor of Comparative Anatomy and Zoology in the Medical College of Bengal, Calcutta.

---





Col.

CALIF ACAD OF SCIENCES LIBRARY



3 1853 10006 4638





journalofasi571888unse

journalofasi571888unse



10

z0042

Journal of the Asiatic Society of Ben  
vol.57(1888)

California Academy of Sciences Lib  
California Academy of Sciences Lib



journalofasi571888unse

journalofasi571888unse

Friday, April 22, 2011 11:44:26

