

[Blank rectangular box]



LIBRARY OF
THE NEW YORK BOTANICAL GARDEN

1945

Gift - R. Hagelstein

EST. 1892

R. W. GIBSON, INC.

2.1

2.23

2.4

JOURNAL

OF THE

New-York

Microscopical Society.

Vol. IV.

LIBRARY
NEW YORK
BOTANICAL
GARDEN



NEW-YORK:
PUBLISHED FOR THE SOCIETY,
QUARTERLY.

INDEX TO VOLUME IV.

Actinia, Living,	171	Color, Change of, in Chameleon,	154
Address, Inaugural, of the President,	106	— —, in cuttle-fish,	155
Air-bubbles, Removing, from a balsam mount,	154	— —, in frog,	155
Antelope, Prong-horn, Sections of hair of,	167	Comma bacillus, reputed cause of Cholera,	18
Annual Reception, The,	155	Committee on Annual Reception,	92
ASHBY, GEORGE E., Insects in Gum Copal,	176	—, on Nominations,	92
Bacillus, Comma, reputed cause of Cholera,	18	—, on death of Joseph Zentmayer,	165, 174
BATES, WILLIAM H., Cholera Asiatica,	12	Conch, Radula of the,	1
BEECHER, CHARLES E., Method of preparing radulae,	7	Cover-glass, Continuous centering of,	159
Beetle, "Brush and Comb" of the, <i>Harpalus Pennsylvanicus</i> ,	169	COX, CHARLES F., Inaugural Address,	106
—, The, <i>Zopherus Mexicanus</i> , cutting metal,	145	—, Phosphorescence of marine organisms,	123
Bibliography of the Foraminifera, Supplement I. to the,	33	—, Photographs by Dr. Van Heurck,	123
Bitter-sweet, fungus on,	80	—, Thread-cells of certain cœlenterate animals,	131
Black cross of the Sugar Pine,	158	—, Inorganic forms resembling diatoms,	167
Bone, Sections of, of Finback Whale,	163	Cuttle-fish, Change of color in,	155
BRIGGS, D. H., Beautiful Micro-polariscope Objects,	115	Current-slide, Holman's,	167
BRITTON, N. L., Seed-coats of <i>Habenaria Hookeri</i> ,	165	DAMON, WILLIAM E., Living Actinia,	171
Brooklyn Institute, Microscopical Section of,	175	<i>Dermestes</i> , Vitality of larva of,	170
—, Microscopical Society, Extract from Proceedings of, "Brush and Comb" of the beetle, <i>Harpalus Pennsylvanicus</i> ,	96	DEVÖE, F. W., The Beetle, <i>Zopherus Mexicanus</i> , cutting metal,	145
Bubbles, Air, Removing from a balsam mount,	154	Diamonds, Meteorite containing,	162
Cabinet : see Donations,	80	Diatoms, Correction of article on,	32
<i>Celastrus scandens</i> , fungus on,	80	—, Inorganic forms resembling,	167
Centering, Continuous, of a cover-glass,	159	Discomedusæ,	164
Chameleon, Skin of the,	154, 158	Donations to Cabinet and Library :—	
Cholera, Asiatica,	12	By J. L. ZABRISKIE,	88, 93, 158, 162, 167
—, Comma bacillus, reputed cause of,	18	— GEORGE F. KUNZ,	88, 170
—, Neurosis of,	15	— CHARLES E. BEECHER,	93
<i>Cicada</i> , Mouth-parts of,	81	— MISS MARY A. BOOTH,	120
Coal, Woody structure in,	158	— G. S. WOOLMAN,	120
Cœlenterate animals, Thread-cells of,	131	— A. M. CUNNINGHAM,	120
		— D. H. BRIGGS,	125
		— JAMES WALKER,	152
		— N. L. BRITTON,	165
		— W. ALFRED McCORN,	175

DEDLEY, P. H., Comma bacillus, reputed cause of Cholera,	18	Ichnemon-fly parasitic on Hawk-moth,	84
—, Notes on <i>Lentinus lepidus</i> , and <i>Trametes pini</i> ,	118	Inaugural Address of the President,	106
—, Report on Fossiliferous test-plates,	81	Inorganic forms resembling diatoms,	167
—, Rock-sections from Panama,	124	Insects in Gum Copal,	176
—, Woody fibre of Termite's nest,	150	Journal of Morphology,	98
—, — structure in coal,	158	JUNOR, K. F., Change of color in cuttle-fish,	155
ECCLES, ROBERT G., Thallophytes in medicinal solutions,	19	—, Structure and habits of <i>Echinus</i> ,	162
Election of Officers,	125	—, The microscopical characteristics of the Echinodermata,	175
Essex County Mic. Soc. of New Jersey, Extract from Proceedings of,	97	—, Invitation by, to a lecture,	175
<i>Endendrium ramosum</i> ,	153	KUNZ, GEORGE F., Meteorite containing diamonds,	162
Fern, The, <i>Trichomanes lucens</i> ,	154	—, Invitations to excursions of N. Y. Mineralogical Club,	177
Finback Whale, Sections of bone of,	163	—, Monazite sand,	177
Foraminifera, Supplement I. to the Bibliography of,	33	Larva of <i>Dermestes</i> , Vitality of,	170
Forms, Inorganic, resembling diatoms,	167	Larvæ of the Stag-beetle eating railroad ties,	147
Frog, Change of color in,	155	LEGGETT, F. W., Mouth-parts of <i>Cicada</i> ,	81
Fungus, <i>Phyllactinia guttata</i> ,	80	—, Ichnemon-fly, parasitic on Hawk-moth,	84
—, <i>Phragmidium mucronatum</i> ,	85	—, Vitality of larva of <i>Dermestes</i> ,	170
—, <i>Lentinus lepidus</i> ,	118	<i>Lentinus lepidus</i> ,	118
—, <i>Trametes pini</i> ,	118	Library : See Donations.	
Gasteropoda, Method of preparing radulae of,	7	LOCKWOOD, SAMUEL, Correction of article on diatoms,	32
Graphic Granite,	126	—, Pathology of Pollen in <i>Aestivis</i> ,	99
GROVE, E. B., Striated muscle-fibre of <i>Harpalus caliginosus</i> ,	28	—, Larvæ of the Stag-beetle eating railroad ties,	147
—, The Fern, <i>Trichomanes lucens</i> ,	154	Lord's Prayer, "Webb" writing of,	159
Gum Copal, Insects in,	176	Marine organisms, Phosphorescence of,	123
Hair of horse, Sections of,	161	Medical Microscopical Society of Brooklyn, Extract from Proceedings of,	97
—, of Prong-horn Antelope, Sections of,	167	Medusæ,	164
<i>Harpalus caliginosus</i> , striated muscle-fibre of,	28	Metal, The beetle <i>Zopherus Mexicanus</i> cutting,	145
— <i>Penusylvanicus</i> , "Brush and Comb" of,	169	Meteorite containing diamonds	162
HELM, STEPHEN, Habitat of <i>Volvox</i> ,	176	<i>Microgaster</i> , Ichnemon-fly, parasitic on Hawk-moth,	84
HENSOLDT, H., Microscopic investigation of rocks,	139	Micro-polariscope objects, Beautiful,	115
—, Demonstration of preparing rock-sections,	166	Microscopical investigation of rocks,	139
HOLMAN, D. S., Current-slide,	167	Microtome, August Becker Sledge,	165
Horse, Sections of hair of,	161	Mineralogical Club, N. Y., Invitation by,	177
HYATT, J. D., Skin of the Chameleon,	154, 158	Monazite sand,	177
—, Habitat of <i>Volvox</i> ,	176		
Hydromedusæ,	153		

Mounting, air-bubbles removed	154	RIEDERER, LUDWIG, Hydromedusa,.....	153
—, Continuous centering of cover,.....	159	—, Sense-organs in palpus of <i>Pieris oleracea</i> ,.....	161
Muscle-fibre, Striated, of <i>Harpalus caliginosus</i> ,.....	28	—, Change of color in frog, ..	155
Neurosis of Cholera,.....	15	—, The Medusa,.....	164
New York Evening Sun, Thanks to,.....	177	—, August Becker Sledge-microtome,.....	165
Officers, Election of,.....	125	Rock-sections from Panama,..	124
Palpus of <i>Pieris oleracea</i> , Sense-organs in,.....	161	Rocks, Microscopical investigation of,.....	139
Pathology of Pollen in <i>Æstivis</i> . ..	99	Rose brand, <i>Phragmidium mucronatum</i> ,.....	85
Pegmatite,.....	126	San Francisco Microscopical Society, Extract from Proceedings of,.....	95
Petrology, A plea for,.....	139	Sea-anemones,.....	171
Phosphorescence of marine organisms,.....	123	Sections of wood of <i>Pinus Lambertiana</i> ,.....	158
Photographs by Dr. Van Heurck,.....	123	—, of hair of the horse,....	161
<i>Phyllactinia guttata</i> ,.....	80	—, of bone of Finback Whale	163
<i>Pieris oleracea</i> , Sense-organs in palpus of,.....	161	—, Rock, from Panama,....	124
<i>Pinus Lambertiana</i> ,.....	158	Sense-organs in palpus of <i>Pieris oleracea</i>	161
Polariscope, Beautiful Micro-objects,.....	115	SCHÖNEY, L., Neurosis of Cholera,.....	15
Pollen in <i>Æstivis</i> ,.....	99	SCHULTZ, CHARLES S., "Webb" writing of the Lord's Prayer, ..	159
Polypomedusa,.....	164	Skin of the chameleon,....	154, 158
President, Inaugural Address of,.....	106	Slide, Holman's current-.....	167
PROCEEDINGS:—		Stag-beetle, The larvæ of the, eating railroad ties,.....	147
Meeting of Oct. 7th, 1887, ..	86	Striated muscle-fibre of <i>Harpalus caliginosus</i> ,.....	28
21st,.....	87	Sugar Pine, Black cross of the, ..	158
Nov. 4th,.....	90	<i>Sun</i> , The N. Y. Evening, Reports by,.....	177
18th,.....	92	<i>Sycotypus canaliculatus</i> , Radula of,.....	1
Dec. 3d,.....	118	Termite's nest, Woody fibre of, ..	150
16th,.....	122	Test-plates, Report on Fasoldt. ..	81
Jan. 6th, 1888, ..	122	Thallophytes in medicinal solutions,.....	19
20th,.....	127	Thread-cells of coelenterate animals,.....	131
Feb. 3d,.....	150	Trachymedusa,.....	164
17th,.....	152	<i>Trametes pini</i> ,.....	118
Mar. 2nd,.....	157	<i>Tubularia larynx</i> ,.....	153
16th,.....	160	VAN HEURCK, DR. HENRI, Photographs by,.....	123
Apr. 6th,.....	162	Vitality of larva of <i>Dermestes</i> , ..	170
20th,.....	166	<i>Volvox</i> , Habitat of,.....	176
May 4th,.....	168	WALEs, WILLIAM, Eulogy on Joseph Zentmayer,.....	165
18th,.....	174	"Webb" writing of the Lord's Prayer,.....	159
June 1st,.....	175	Whale, Finback, Sections of bone of,.....	163
15th,.....	176	WOODWARD, ANTHONY, Supplement I, to Bibliography of the Foraminifera,.....	33
Prong-horn Antelope, sections of hair of,.....	167		
Publications received, 128, 170, ..	180		
Radula of the Conch,.....	1		
Radulae, Method of preparing, ..	7		
Railroad ties, Larvæ of the Stag-beetle eating,.....	147		
Reception, The Annual,.....	155		
Report on Fasoldt test-plates, ..	81		
—, of the Treasurer,.....	123		
—, on death of Joseph Zentmayer,.....	174		

Woody fibre of Termite's nest,	150	ZABRISKIE, J. L., Sections of	
— structure in coal.....	158	bone of Finback Whale,....	163
Writing, "Webb," of the		—, — of hair of Prong-	
Lord's Prayer.....	159	horn Antelope.....	167
ZABRISKIE, J. L. Radula of the		—, "Brush and Comb" of	
Conch.....	4	the beetle, <i>Harpalus Penn-</i>	
—, The fungus <i>Phyllactinia</i>		<i>sylvanicus</i>	169
<i>guttata</i>	80	Zentmayer, Joseph. Announce-	
—, — <i>Phragmidium mu-</i>		ment of death of.....	165
<i>cronatum</i>	85	—, Committee respecting	
—, Black cross of the Sugar		death of,	165
Pine.....	158	—, Report of committee on	
—, Continuous centering of		death of,.....	174
a cover-glass.....	159	<i>Zopherus Mexicanus</i> . The	
—, Sections of hair of the		beetle, cutting metal.....	145
horse.....	161		

JOURNAL
OF THE
NEW-YORK MICROSCOPICAL SOCIETY.

VOL.-I. JANUARY, 1885. No. 1.

ELECTRICAL ILLUMINATION IN MICROSCOPY:
EXPERIMENTS AND VIEWS OF DRS. HENRI
VAN HEURCK AND THEODOR STEIN.

BY E. A. SCHULTZE.

(*Read November 7th, 1884.*)

This subject has for some time had the attention of scientific men both in this country and in Europe. Among the first to note the advantages of the electric light in microscopical research, figures Dr. Henri Van Heurck, of Antwerp, a student who ranks as high in Belgium as does Mr. Edison in the United States. His investigation began, about ten years ago, with a trial of the effects of a Galvanic battery on platinum, but the trial yielded no satisfactory results. He was the first to employ the Swan lamp for microscopical illumination, the experiment being made at the Paris Exposition. Shortly afterward, in November, 1881, with a view to greater progress in this work, Mr. Swan endeavored to manufacture the smallest possible lamps; and in the following January he constructed one which required only seven volts, or the power of four Bunsen elements, and sent it to Dr. Van Heurck. The latter carefully tested its usefulness, and he published the results in the Proceedings of the Belgian Society of Microscopists. In March, 1882, a committee of that Society visited him for the purpose of witnessing his methods and measuring their success. Before the end of that year he published in the Bulletin of the Society an extended article on the adaptability of electrical illumination to the microscope, in which he gives a theoretical explanation of the superiority of the electric light over all others, and much useful information, besides, regarding its practical working. He found that for the resolution of diatoms, as well as for all other work requiring objectives of high power, the light furnished by his electric lamp,

when fed by a suitable battery, was better by far than any he had previously employed; also that an electro-motive force of six or seven volts amply suffices for all uses.

The views of Dr. Van Heurck are ably seconded by Dr. Theodor Stein, of Frankfort-on-the-Main, in an article contributed by him to the "Zeitschrift für Wissenschaftliche Mikroskopie," Vol. I., No. 2 (1884). I have made a digest of such parts as are material to my purpose, as follows.

'The electric light,' says Dr. Stein, 'has been in use many years for showing microscopic objects by projection upon a screen with the use of the magic lantern. With constant improvement in the manufacture of objectives, the discernment of fine structure was possible even by this method. But the excellence of the performance found its limit at a power of eighty diameters, a higher amplification seriously impairing definition.

'At the Electrical Exhibition in Munich, in 1882, trial was made of the advantage of electrical illumination in working with the compound microscope. The light furnished was found to be sufficient for the finest observation with objectives of the highest power, and to be free from the well-known disadvantages of other kinds of artificial light;—the yellow ray and the heat ray. All possible preparations were examined, such as muscle, nerve, epithelia, bone, skin, bacteria, diatoms, &c. Especially surprising was the faultless picture of the red blood-corpuscles, to the correct showing of which a yellow light is particularly inimical. In the region of blue and violet, the spectrum of the light from an incandescence lamp is incomparably more intense than that of light from any other artificial source. In these observations light of different intensities was used, ranging between sixteen and sixty candle-power, and was received by the sub-stage mirror and was reflected thence upon the object.

'These experiments suggested to me, in the winter of 1882, the idea of setting aside the mirror, and placing the incandescence lamp beneath the stage for the direct illumination of the object. As no lamp small enough for the purpose was in existence, I requested Mr. C. H. F. Müller, of Hamburg, to make me some according to certain specifications which I gave him. At this time appeared in the Journal of the Royal Microscopical Society¹ an article by C. H. Stearn, who, at a meeting of the

¹Cf. Journ. R. Micros. Soc., Ser. II., Vol. III., 1883, Pt. 1, p. 29.

Society held January 10th, had exhibited a microscope furnished with electrical illumination. I again conferred with Mr. Müller; and I now have lamps, manufactured by him, which suit my purpose. Illustrated at *A*, Fig. 1, is a small lamp; at *C*, a larger one.² Each consists of a glass globe, at the exact centre of which is a horse-shoe carbon supported by two platinum wires. The wires terminate outside the globe, in the eyes *f* and *e*. The neck of the lamp *A* is forced into the spiral spring *B*, and connection is made with the hooks *f*¹ and *e*¹. The spring presses the lamp upward and thus brings about an intimate contact of the eyes *f* and *e* with the hooks *f*¹ and *e*¹. These hooks

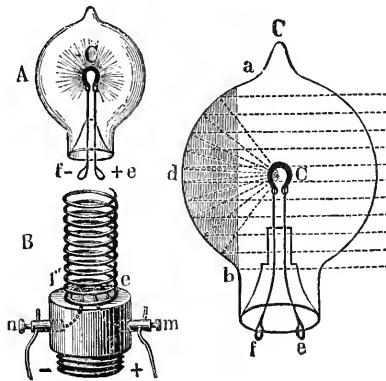

1.

communicate with two conducting wires *m* and *n*, which are let into a hard-rubber screw. The screw itself is attached to the extremity of a jointed arm articulating with the microscope as shown in Fig. 2. To bring a lamp of the smaller size to a brilliant white heat, a current from two Bunsen or Grove elements 20 cm. high, is sufficient. The lamp *C*, Fig. 1, having a larger carbon, will require three elements. Should a stronger light in any direction be required, a part of the globe, as seen at *d*, Fig. 1, may be silvered on the outside so as to act as a reflector. For lamps to be used with low-power objectives, opal glass is preferable to common glass, as the light through it is less fatiguing to the eye.

² All the cuts illustrating this article are copied from the "Zeitschrift für Wissenschaftliche Mikroskopie."

'In Fig. 2 we see a small lamp (*e*) and a larger lamp (*a*) attached to an upright microscope. The foot (*S*) of the instrument is screwed to a wooden box (*C D*). For facile movement in every direction, both lamps are supported by arms furnished with ball-and-socket joints.

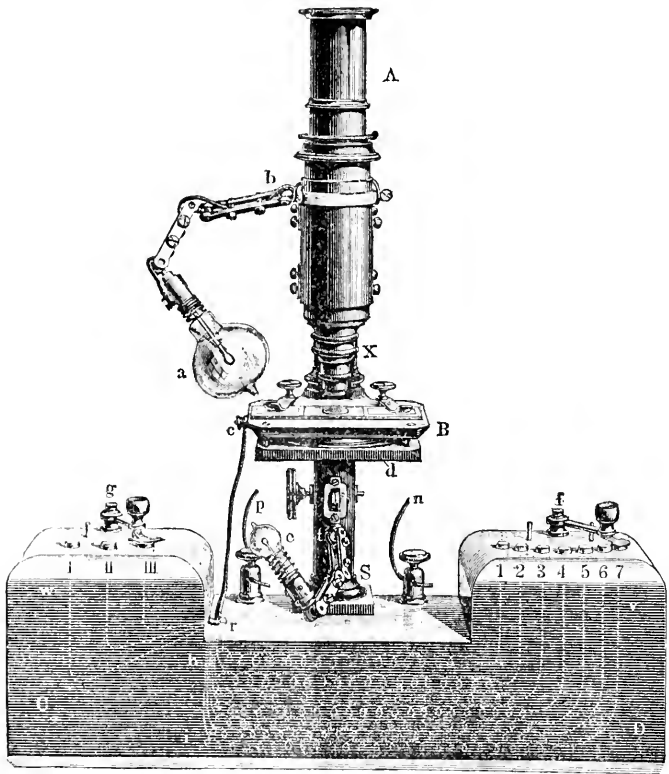

2.

'The wires from the battery are fastened to the instrument by the binding-screws *p* and *n*. From the screw at *n* a concealed wire goes direct to the foot (*S*) of the stand, and beyond this point the microscope itself serves as a conductor communicating with the lamps *a* and *e*. The return wires are well insulated. That from the lamp *a* runs along the jointed arm *b*, then down the back of the stand and along the side of the stage to the support *c*, and thence into the box through the aperture *r*. That

from the sub-stage lamp runs along the jointed arm *t*, then behind the stand and by the side of the stage to *c*, and thence it accompanies the first wire. Besides these there is a third wire, also insulated, and passing downward, which is attached to the stage. Between *c* and *r* the three are bound together in one bundle. The communication between the binding-screw at *p* and the lower end of one or other of the three wires entering the box at the orifice *r*, takes place through an important subsidiary apparatus, the rheostat, and is regulated by means of the switches *g* and *f*. The switch *f* and the spiral German-silver wires, *v i h*, constitute the rheostat, by means of which the electric current can be strengthened or weakened at pleasure. The wires have different diameters, and thus oppose to the current

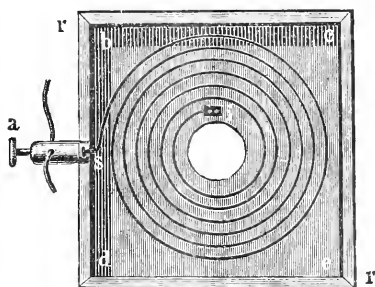

3.

different degrees of resistance. If a small battery of two elements be used, the rheostat is superfluous. But if a powerful battery be employed, the current will, unless subdued, be too strong for the lamps and will destroy them.

‘The operator begins work by sliding the switch *g* to the proper point. He will move it to the knob I if he wish to use the upper lamp, to the knob II if the lower, and to the knob III if he desire the current to traverse the stage (*B*) alone. Next, to adjust the current to the size of the lamp, the power of the objective, and the character of the object under investigation, he will first place the switch *f* on knob 1, and then will cautiously slide it to knobs 2, 3, 4, etc., until the required degree of illumination is obtained.’

Dr. Stein next gives the construction of what he would call an “Electrically-heated Stage.” Between the two plates of the

stage is placed a platinum spiral (see Fig. 3), which may be heated by the electric current so as to raise the temperature of an object under examination. The degree of the heat is easily controlled by the rheostat, and it may be measured by means of a spiral bimetallic thermometer. In the illustration (see Fig. 4), *r* and *S* are ribbons of iron and brass, soldered together. The inner end, *a*, is screwed to the stage close to its opening, *m*. The free end, *b*, acts upon an index, *d*, which is pivoted at *x*, and whose point traverses the graduated arc *f g*.

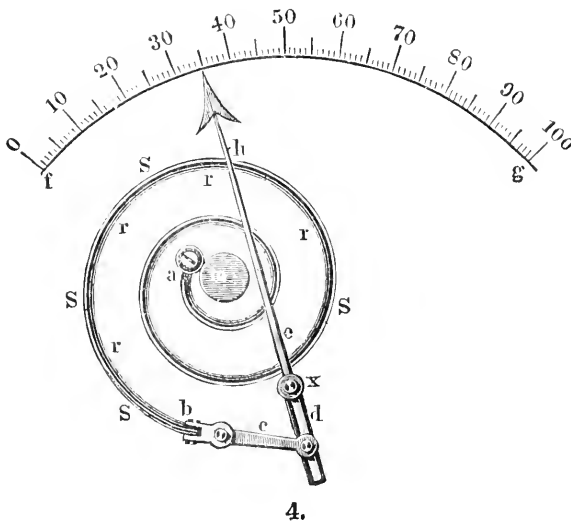

4.

The rest of the article treats, in a full and interesting manner, of the application of electrical illumination to photomicrography, and describes a form of stand especially adapted to that department of microscopical work. The details cannot be given here. One or two facts, however, I must note,—the microscope has a vertical position instead of the usual horizontal one, and the illumination necessary for taking a most excellent photograph of *Pleurosigma augulatum* costs an electro-motive power of only five volts.

Dr. Stein concludes his article with an expression of confident belief that the microscopist who has once employed the electric light for his researches, will thenceforward use no other.

CRITICISMS ON J. KRUTTSCHNITT'S PAPERS¹
AND PREPARATIONS² RELATING
TO POLLEN-TUBES.

BY N. L. BRITTON.

(*Read November 21st, 1884.*)

When a theory having no well-ascertained facts on which to base its arguments is persistently forced on the scientific community, it becomes the duty of some one to refute the ideas thus advanced and, if possible, prevent their further circulation, to the end that those who are less well-provided with opportunities for study may not be deceived into forming erroneous conclusions, or into doubting abundantly proved theories. As the Special Committee on Phanerogamic Botany for this Society, I have thought it my office to assume such task.

It has been sought by Mr. J. Kruttschnitt to show that during the process of fertilization of the ovules in Phanerogamic plants, the pollen-tubes which extend from pollen-grains resting on or attached to stigmatic surfaces, do not enter the ovules in the manner described in all recent treatises on Vegetable Physiology, but that the protoplasmic contents (fovillæ) of the grains reach the embryo-sac in some other way; and he suggests³ that "the pollen-tubes discharge their contents amongst the papillæ of the stigma, * * * * thus carrying down the substance of the pollen only; * * * * the ovule is fertilized by absorbing the contents of the pollen-grain."

The mounts which Mr. Kruttschnitt has made and distributed consist of vertical and horizontal sections through ovaries, and longitudinal sections through stigmas and styles. This method of examination is not as satisfactory as that of picking the ovary open with a needle at the critical time. What is to be gained from horizontal ovarian sections is not apparent. The distribution of hundreds of such slides will have no effect on the opinion of the well-informed student. It is not stating the case too severely to say that his preparations indicate nothing whatever in proof of his theory; whatever evidence they bring is purely negative, and therefore unsatisfactory. His ideas are, indeed,

¹Am. Month. Micros. Journ., June, 1882; Sept., 1883.

²Am. Postal Micros. Club, special box No. 4, issued Oct. 16, 1884, and previously distributed slides.

³Am. Month. Micros. Journ., 1883, p. 166.

but the revival of an ancient supposition ; and this fact suggests that a series of extracts from the works of investigators of acknowledged ability, which shall illustrate the growth of the accepted theory from its birth, will materially aid my effort to show that Mr. Kruttschnitt's position is untenable.

Until the observations of Amici (1823), pollen-tubes remained undiscovered, though the influence of pollen in seed production had long been recognized. "It was at first thought that the grains of pollen simply open on the stigma, and that the granules which they contain, being absorbed by the stigma, go to form the embryo, or concur in its formation."⁴ Amici noticed the tubes proceeding from the pollen of *Portulaca oleracea*, and that they are formed by the protrusion of the intine through the extine.⁵ A few years later Adolphe Brongniart examined the pollen of numerous species of plants and observed the tubes ; he succeeded in following them only into the style, where he believed they terminated and discharged their contents.⁶ At about the same period, Amici and, independently, Ehrenberg made observations indicating similar results. In 1831 Robert Brown presented to the Linnæan Society of London his memoir on "The Organs and Mode of Fecundation in the Orchideæ and Asclepiadæ ;"⁷ at that time he had traced the pollen-tubes to the placenta, and possibly in one instance to the ovule.

In a subsequent communication to the Linnæan Society, "Additional Observations on the Mode of Fecundation in Orchideæ,"⁸ speaking of pollen-tubes, he says :

"In *Orchis Morio* I have repeatedly and very clearly observed them scattered in every part of the surface of the placenta, and in not a few cases have been able to trace them into the aperture of the ovulum, to which they adhere with considerable firmness ;" and in a foot-note he adds, "Since these additional observations were read, I have found in several other Orchideæ, especially *Habenaria viridis* and *Ophrys apifera*, tubes scattered over the surface of the placenta, and not unfrequently inserted in like manner into the apertures of the ovula. * * * * At what period they reach the foramen of the testa, whether before or

⁴Figuier, "The Vegetable World," p. 179.

⁵Atti della Società Italiana, Vol. XIX., p. 251, and Ann. Sci. Nat., Vol. II., p. 66.

⁶Ann. Sci. Nat., Vol. XII., p. 31.

⁷Trans. Linn. Soc., Vol. XVI., pp. 685-715.

⁸Read June 5th, 1832 ; see "Miscellaneous Botanical Works of Robert Brown," published for the Ray Society, London, 1866, p. 540.

after the first faint appearance of the nucleus, I have not yet been able to determine."

[Brown believed that the tubes proceeding from the pollen, which he calls *mucoous cords*, do not themselves enter the ovules, but that they generate other tubes, the immediate agents of impregnation; and he states that the latter are "remarkably and irregularly flexuose, apparently from the numerous obstacles they have to overcome after leaving the cords and beginning to mix with the ovula."]

In a still later paper, "Supplementary Observations," London, 1833,⁹ he describes his further examination of *Asclepias purpurascens*. "On the 12th of the present month (July) I succeeded in tracing the pollen-tubes in that species not only over the whole ovuliferous surface of the placenta, but also going off to the ovula, to a definite point of each of which a single tube was found in many cases attached."

In 1835 Corda published his "Beiträge zur Lehre von der Befruchtung der Pflanze."¹⁰ He was probably the first to announce the observation of the entrance of pollen-tubes into the micropyles of ovules in the Gymnospermæ, and he followed them to the embryo-sac in the Coniferæ. He says (I quote from Dr. Gray's translation), "By a careful examination of the cavity of the ovule in the fruit of *Pinus* with a lens, or even by a close inspection with the unassisted eye, grains of pollen may be seen reposing in its orifice. If we lay open the cavity in the scale by taking off the covering, removing at the same time the primine of the ovule which is originally adherent to the scale, we observe the pollen-tubes, which have reached from the pollen to the endostome of the secundine."

About the year 1837, Schleiden advanced the theory that the embryo is formed in the ovule at the time of impregnation by the contents of the extremity of the pollen-tube, and does not exist before the introduction of the tube. He says,¹¹ "At the flowering period, the pollen falls upon the stigma, and then commences the development of the reproductive cells. Each grain extends itself into a long filament, * * * * and in this form

⁹Loc. cit., pp. 549, 550.

¹⁰Acta Acad. Leopold Carol. Nat. Cur., Vol. XVII.; translated, and prefaced by remarks on the history of the subject, by Dr. Asa Gray, in Am. Journ. Sci., Vol. XXXI. (1st Series), p. 308.

¹¹"Die Pflanze"; translated by Arthur Henfrey, under the title, "The Plant; a Biography," London, 1848, p. 71, Pl. III. figs. 6-9.

penetrates to the cavity of the germen, to enter one of the seed-buds (ovules) and, finally, into the embryo-sac. The extremity which has passed in, now becomes filled with cells, and these develop forthwith into a perfect, though as yet simple and minute plantule, the so-called embryo or germ." Schleiden figures the process in *Viola tricolor*. It is needless to say that this idea has long since been proved erroneous. At the present time all are agreed that the only office of the pollen-tube is to bring to the incipient embryo (archegonia, corpuscula) the substance of fertilization.

Figuier remarks,¹² "This tube, as M. Brongniart has shown, elongates itself by a most remarkable vegetative process, insinuating itself into the interstices of the cellular tissue, which has been designated from this cause the conducting tissue, and that doubtless by which it is nourished. Occupying the centre of the style, this tube traverses its whole length, entering into the ovary, and is there brought in contact with the ovules, penetrating by their micropyllic perforations." He gives figures of the ovules of *Polygonum* and *Viola tricolor* with the pollen-tubes attached, and other figures showing the results of Tulasne's observations which proved the falsity of Schleiden's theory of the origin of the embryo in the extremity of the pollen-tube.

Le Maout and Decaisne, in "Traité Général de Botanique," give the following account of the process of impregnation of the ovule, and illustrate it with a figure of (*Eurothera longiflora*). I quote from Mrs. Hooker's English translation.¹³ "Thereupon (after reaching the stigma), the pollen swells, through the action of endosmose, the inner membrane ruptures the outer at one of the points which touch the stigma; the pollen-tube lengthens, traverses the interstices of the stigmatic cells, and reaches the conducting tissue which fills the canal of the style, and which is charged, like the stigma, with a thick fluid. Still lengthening, the pollen-tube finally enters the cavity of the ovary, traverses the conducting tissue which lines the placentæ, and at last reaches the ovule, when it enters the micropyle and comes in contact with the cell of the nucleus (embryonic sac), its tip resting on the membrane of the sac, and partly adhering to it. Soon after this contact of the pollen-tube, one, or oftener two vesicles (em-

¹² "The Vegetable World," pp. 181 *et seq.*

¹³Pp. 156 and 157; fig. 750.

bryonic vesicles) usually appear within the embryonic sac, below the tip of the pollen-tube. These vesicles elongate ; the upper and thinner end adhering to the membrane of the sac. While one of the two shrinks and disappears, the other develops, and fills more or less completely with its free end the cavity of the embryonic sac. * * * * All physiologists concur in the above."

Le Maout and Decaisne describe also the fertilization of *Santalum*, and give illustrations of it.¹⁴ "The fertilization of the ovule in Santalaceæ, presents a quite exceptional phenomenon, which deserves to be mentioned. The ovary is unilocular, and the free central placenta bears several suspended ovules ; each is a *naked* nucleus. At the period of fertilization the nucleus bursts at the lower part, the embryonic sac emerges by this opening and ascends along the whole length of the outer surface of the nucleus, to meet the pollen-tube a little below the top of the nucleus. The latter soon withers, and the embryonic sac, which alone grows, forms the integument of the seed."

H. Marshall Ward, in an elaborate paper "On the Embryo-sac and Development of *Gymnadenia conopsea*,"¹⁵ says of its impregnation, "The pollen-tube, after a sinuous course from the placenta, has made a sharp bend ere plunging into the micropyle, and has then spread its broad apex over the 'Gehülfinnen,'¹⁶ apparently penetrating between the sac and the integument ; but the difficulty of following so delicate an outline as it presents is no ordinary one. * * * * If no pollen-tube enters the micropyle, the whole ovule turns brown, shrivels, and the contents of the sac become ill-defined, and decay."

In Griffith and Henfrey's Micrographic Dictionary, last edition, there is a figure of the embryo-sac and supporting cells of *Orchis Morio*, after the contact of the pollen-tube. The two are shown in contact (pl. 47, fig. 5).

In Gymnosperms, after the pollen-tubes have extended for a short distance into the ovule, their growth temporarily ceases, or progresses very slowly ; they enter on a period of rest. "This continues in the annual-seeded Coniferæ a few weeks, in the biennial-seeded about a year. For example, the pollen-tubes reach the corpuscula of *Taxus baccata* at the end of May of the

¹⁴Loc. cit., p. 157 ; figs. 751, 752, 753.

¹⁵Quart. Journ. Micros. Sci., Vol. XX. (New Series), p. 1, pls I., II., III.

¹⁶Germinal vesicles. *Literally*, female consorts.

first year, of *Pinus sylvestris* at the beginning of June of the second year."¹⁷

The length of the pollen-tube in angiospermous plants is dependent on the length of the style. The time required for the pollen-tubes to reach the ovules after starting from the grains, is, however, very different in different plants, and is in no way related to the stylar elongation. "In *Crocus vernus* the pollen-tube travels the distance (10 mm.) from the stigma to the micropyle in from one to three days, in *Arum maculatum* (2 to 3 mm.) in five days. The short style of many Orchids is penetrated by the pollen-tube only after the lapse of several weeks or months."¹⁸ The same statement is made by Hofmeister.

Dr. Asa Gray states the known facts in the process of fertilization of the ovule, in the following language:—¹⁹

"In many kinds of pollen, the grains, when immersed in water, soon distend to bursting, discharging the contents. In others, and in most fresh pollen, when placed in ordinarily aerated water, at least when this is slightly thickened by syrup or the like, and submitted to a congenial temperature, a projection of the inner coat through the outer appears at some one point, and by a kind of germination grows into a slender tube, which may even attain two or three hundred times the diameter of the grain; and the richer protoplasmic contents tend to accumulate at the farther and somewhat enlarging extremity of this pollen-tube. * * * * Commonly the pollen remains unaltered until it is placed upon the stigma. The more or less viscid moisture of this incites a similar growth, and also doubtless nourishes it; and the protruding tube at once penetrates the stigma, and by gliding between its loose cells buries itself in the tissue of the style, descending thence to the interior of the ovary and at length to the ovules. Fertilization is accomplished by the action of this pollen-tube upon the ovule, and upon a special formation within it."

M. Detmer has examined the structures which facilitate the passage of the pollen-tube into the ovule, in a great many species of plants.²⁰ He states that in *Welwitschia* (a peculiar Gymno-

¹⁷Detmer, "Lehrbuch der Pflanzenphysiologie," p. 354.

¹⁸Loc. cit., p. 358.

¹⁹"The Botanical Text Book," Part I., pp. 258-259, 1880.

²⁰Jenaische Zeitschr. Naturwiss. XIV., 530; and Abstract in Journ. Roy. Microsc. Soc., Series 2, Vol. 1., p. 262. See also observations of M. G. Capus, in Ann. Sci. Nat. (Bot.), VII., p. 209; and abstract in Journ. Roy. Microsc. Soc., 1879, p. 910.

sperm from South Africa) the corpuscula develop into long tubes within the nucellus, meeting the pollen-tubes.

The editor of the "Journal of the Royal Microscopical Society" thus sums up the results of Detmer's observations: "The growing pollen-tubes receive their formative materials from the mucilaginous and amyloid substances secreted by secreting organs on the stigma, and in the stylar canal and interior of the ovary. These secreting organs are more or less papillose. * * * * Besides providing nutrition for the pollen-tubes, these papillose structures furnish also a conducting tissue to guide the pollen-tube * * * * to the micropyles of the ovules. * * * * Seeing that this tissue reaches up to the very micropyle itself, and that it only can supply the pollen-tube with the nutriment it requires, it follows that the entrance of the pollen-tube into the ovule is purely a mechanical phenomenon and does not depend on any mysterious relationships between the pollen-tube and the embryo-sac."

The most elaborate investigations on the whole subject of vegetable impregnation are those of E. Strasburger. Indeed, they are given in such minuteness of detail that I cannot hope in an article of this kind to present even an abstract of them; and I will merely name, in a foot-note, some of the publications in which they are to be found.²¹ An examination of the results reached by this distinguished physiologist cannot fail to convince the reader of the truth of the statement that pollen-tubes enter the ovules and deposit part of their contents.

Hofmeister also has contributed largely to the literature of these phenomena.

Bessey thus describes the impregnation of the ovule in *Gymnospermæ*,²² and he illustrates it with diagrams of the fertilized ovule in *Pinus Larico* after Strasburger, and of *Juniperus communis* after Hofmeister:—

"Fertilization is effected by means of the pollen, which comes in contact with the apex of the ovule. * * * * When the ovule has reached the proper stage the micropyle is filled with a fluid, which, drying, carries the adherent pollen grains into contact with the apex of the ovule body, where they germinate and form pollen-tubes; the latter penetrate the soft tissue of the

²¹"Ueber Zellbildung und Zelltheilung," Jena, 1875; "Die Befruchtung bei den Coniferen," Jena, 1872; "Ueber Befruchtung und Zelltheilung," Jena, 1877.

²²"Botany for High Schools and Colleges," 1880, p. 403.

ovule and eventually reach the corpuscula. * * * *
 The union of the protoplasm of the pollen-tube with that of the germ-cell appears to take place by diffusion through the wall of the former, as no openings in it have been discovered." He refers to the fecundation of Angiospermæ in the following language,²³ illustrating the process by a figure of the fertilized ovule of *Viola tricolor* taken from Sachs :—

"Fertilization takes place as follows : The pollen grain, resting upon the moist surface of the stigma, absorbs moisture and germinates, sending out a tube which penetrates the soft tissues of the stigma and style, finally reaching the cavity of the ovary, where it enters the micropyle of an ovule."

Dr. William B. Carpenter's treatment of this subject is clear and concise. "The tracing downwards of the pollen-tubes through the tissue of the style may be accomplished by sections (which, however, will seldom follow one tube continuously for any great part of its length), or, in some instances, by careful dissection with needles. Plants of the *Orchis* tribe are the most favorable subjects for this kind of investigation ; which is best carried on by artificially applying the pollen to the stigma of several flowers, and then examining one or more of the styles daily. 'If the style of the flower of an *Epipactis* (says Schacht), to which the pollen has been applied about eight days previously, be examined in the manner above mentioned, the observer will be surprised at the extraordinary number of pollen-tubes, and he will easily be able to trace them in large strings, even as far as the ovules. *Viola tricolor* and *Ribes nigrum* and *rubrum* are also good plants for the purpose ; in the case of the former plant, withered flowers may be taken, and branched pollen-tubes will not unfrequently be met with.' The entrance of the pollen-tube into the micropyle may be most easily observed in Orchideous plants, and in *Euphrasia* ; it being only necessary to tear open with a needle the ovary of a flower which is just withering, and to detach from the placenta the ovules, almost every one of which will be found to have a pollen-tube sticking in its micropyle."²⁴

The artificial branching of pollen-tubes has been well illustrated and described by S. Reisseck.²⁵

²³Loc. cit., p. 422.

²⁴"The Microscope and its Revelations," 6th Edition, 1881, pp. 464, 465.

²⁵Acta Acad. Leopold Carol. Nat. Cur., XXI., Pt. 2, pls. XXXIV., XXXV.

Sachs describes the fertilization of the *Coniferæ* as follows, giving illustrations of *Taxus Canadensis* and *Juniperus communis*, both taken from Hofmeister :—²⁶

“The pollen-grains having reached the apex of the nucellus put out their tubes at first only for a short distance into its tissue ; their growth is then for a time suspended. After the archegonia are completely developed, the pollen-tubes begin to grow again into the endosperm in order to reach them.²⁷ * * * *
Whilst the pollen-tubes penetrate through the loose portion of the tissue of the nucellus, their width gradually increases at their lower end, their wall becoming at the same time thicker ; until at length they meet the wall of the embryo-sac which has now become soft, break through it, penetrate into the funnel of the endosperm, and attach themselves firmly to the cells of the neck of the archegonia.”

The process in Angiospermæ is thus described, and a figure of the fertilized ovule of *Viola tricolor* given in explanation:—²⁸

“The pollen-grains which germinate on the stigma send out their tubes through the channel of the style where there is one, or more usually through the loose conducting tissue in its interior, down to the cavity of the ovary. Frequently both in erect basilar and in pendulous anatropous ovules the micropyle lies so close to the base of the style that the descending pollen-tubes can enter it at once ; but more often the pollen-tubes have to undergo further growth after their entrance into the cavity of the ovary before they reach the micropyles of the ovules ; and they are then guided in the right direction by various contrivances.²⁹ * * * * Since every ovule requires one pollen-tube for its fertilization, the number of tubes which enter the ovary depends, speaking generally, on the number of ovules contained in it ; the number of pollen-tubes is, however, usually larger than that of the ovules ; where these latter are very numerous, the number of pollen-tubes is also very large, as in Orchideæ, where they may be detected in the ovary even by the naked eye as a shiny white silky bundle.”

²⁶“Text Book of Botany,” Edited by Sidney H. Vines, Oxford, 1882, pp. 523, 524.

²⁷Compare Detmer, loc. cit. “In *Salisburia adiantifolia* (Ginkgo), fertilization does not take place till October, when the fruit is ripe and has already fallen off. The embryo is developed within the seed during the winter months” (See Strasburger “Die Coniferen und Gnetaceen,” 1872, p. 291).

²⁸Loc. cit., pp. 582, 583.

²⁹Compare Detmer, “Jenaische Zeitschr. Naturwiss.” XIV., p. 530.

The Botanical Atlas⁸⁰ contains a large colored drawing of the ovule of *Narcissus poeticus* undergoing fertilization. The process in *Viola tricolor* is also illustrated in the same publication.

In Wood's Class-book of Botany may be found a figure⁸¹ illustrating the fertilization of *Polygonum Pennsylvanicum*.

In the light of the mass of evidence which we have brought forward in support of the accepted theory of fertilization (and it is by no means a complete index to the literature of the subject), any further remarks are almost superfluous. I will merely add that a few years ago I was fortunate enough to examine the ovary of *Cypripedium acaule* at a favorable time, and there observed the pollen-tubes filling the style like a skein of silk and many of them connected with the ovules. The observation was made in the field, by merely tearing open the ovary, and the specimen was inadvertently lost. But even if I had not had the aid of ocular evidence, I would hesitate to adopt a theory which, like that of Mr. Kruttschnitt, is a deduction from negative considerations alone. The fact of failure on the part of one, or, indeed, of several persons, to discover a pollen-tube in contact with the embryo-sac of an ovule, can, it seems to me, have no weight, when viewed in connection with the fact that so many able investigators have often and undeniably seen such contact.

⁸⁰By D. McAlpine, Pt. I, Phanerogamia, New York, 1883.

⁸¹Fig. 607.

PROCEEDINGS OF THE SOCIETY.

MEETING OF OCTOBER 3D, 1884.

The President, Mr. C. Van Brunt, in the chair.

Twenty-two persons present.

The Corresponding Secretary read two letters,—one from the Managers of the American Exhibition to be held at London next year, inviting the Society's coöperation; the other from the Smithsonian Institution, asking for portraits of prominent scientific men.

The following objects were exhibited:—

Mineral Wool : by G. F. KUNZ.

Furnace Slag : by G. F. KUNZ.

Oxalurate of Ammonia (Arborescent Crystals) : by EDWARD G. DAY.

A Möller Slide illustrating thirty-six species of *Pleurosigma* : by W. G. DE WITT.

Pond-life, from Staten Island : by E. A. SCHULTZE.

Pond-life, from New Jersey : by A. D. BALEN.

1. *Melicerta ringens*.

2. *Plumatella repens*.

Mr. Balen said that he had expected to exhibit *Stephanoceros Eichornii*. He had a few days before collected some from a pond in which he had sought for it several years without success.

Mr. Day, who exhibited the slide of Arborescent Crystals of the Oxalurate of Ammonia, spoke of the uncertainties of success attending efforts to produce in all cases a definite form of crystal.

Mr. Day showed a hair-worm of a length of twenty-one and a half inches, which he had taken from a grasshopper that was not more than one and a half inches long.

Mr. E. B. Grove said that he had discovered in the large gray grasshopper the same parasite that Mr. Day had found, but of a less length in proportion to the size of the host.

Mr. Day stated that he had received from Mr. P. L. Hatch a letter informing him of his finding tape-worms in hen's eggs.

MEETING OF OCTOBER 17TH, 1884.

The President, Mr. C. Van Brunt, in the chair.

Thirty-seven persons present.

Mr. John A. Chambers was elected an Active Member of the Society.

Dr. Antonio de Gordon y Acosta, of the University of Havana, Cuba, was elected an Associate Member.

The following objects were exhibited :—

Fronde of Fern, stained, showing Sporangia and Spores : by EDWARD G. DAY.

Group of Insect Eggs : by M. M. LEBRUN.

Elytron of *Carabus* : by E. A. SCHULTZE.

Elytron of *Necrophorus mortuorum* : by E. A. SCHULTZE.

Skin of Dogfish : by WALTER H. MEAD.

Crystallized Natrolite, from Weehawken Tunnel : by G. F. KUNZ.

Clathrocystis : by A. D. BALEN.

Organisms from Croton Water : by A. D. BALEN.

Multiple Images formed by the Eye of the Cockroach (*Blatta orientalis*) : by J. D. HYATT.

Dr. Britton called attention to Dr. Waller's Report to the City Board of Health, presented about five years ago, in which Croton-water organisms are described.

Mr. Hyatt stated that he had lately experimented with the eyes of a variety of insects with the view of ascertaining their comparative excellence for showing multiple images under the microscope, and that he had found the eyes of the mosquito and the cockroach to be the fittest for this purpose.

 MEETING OF NOVEMBER 7TH, 1884.

The President, Mr. C. Van Brunt, in the chair.

Forty-five persons present.

Mr. Henry M. Dickinson was elected an Active Member of the Society.

The following objects were exhibited :—

Stellate Hairs on leaf of Mallow : by WALTER H. MEAD.

Eye of Insect, showing Hexagonal Form of Facets : by EDWARD G. DAY.

Section of Eye of *Limulus* : by J. D. HYATT.

Parasite found on a Mosquito : by J. D. HYATT.

Section of Spore Coal : by M. M. LE BRUN.

Pond-life : by A. D. BALEN.

1. *Volvox minor*.

2. *Actinosphærium Eichornii*.

Of Spore Coal, Dr. Britton said : " I have here specimens of Huron shale from Ohio, in which the bodies supposed to be spores from the Lycopods of that period are well shown. These bodies are small, black, globular, of uniform size, and without discernible structure ; and they occur in enormous quantity throughout the deposit. An interesting article on this subject, from the pen of Prof Orton, was published in the Proceedings of the Montreal meeting (1882) of the American Association for the Advancement of Science."

Mr. E. A. Schultze, in an article printed elsewhere in this Number of the JOURNAL, set before the Society the efforts which have been made in Europe to employ successfully the electric light in microscopical work. For researches requiring the use of high-power objectives, it had been found superior to all other kinds of artificial illumination. Dr. Theodor Stein had devised a rheostat which brings the electric current under easy and perfect control, thus securing safety to the lamp and constancy to the intensity of the light.

Dr. F. Y. Clark said : " In my experiments in the use of electrical illumination, I have found the chief obstacle to success to consist in the difficulty of getting a suitable battery. I have, however, finally procured one which works admirably. It is the Haid Electric Battery, a recent invention, and was made by the Excelsior Manufacturing Co., of this city. It has three elements, and it runs from one to three hours. It is portable—it can be carried in one's pocket, and it is easily managed. In my experience the electric light is far the best for the examination of objects, be they transparent or opaque ; and it does not weary my eyes."

Mr. P. H. Dudley : " I have tried to use the Galvanic current for illumination in photomicrography, but have found its action too inconstant. You may not always, by the eye, notice the

fluctuations in the intensity of the light, but in photography you will remark them quickly. The light from a kerosene lamp works better."

The President: "I have found that an incandescence lamp, to work well, must have the carbon near the top of the globe; and that this part of the globe must be flat, so that it may be brought near to the object, and may not produce diffraction rings; and that the bottom should be non-reflecting, since reflected light, mingling with the direct rays, occasions indistinctness. White light is certainly better than yellow light; and I believe that if a good rheostat can be had, by which the strength of the current may be so regulated that the carbon can be brought to a white heat and kept there without endangering either the carbon or the globe, electrical illumination will come into use for microscopical purposes everywhere, particularly in delicate work. The rheostat made by Dr. Stein, which is described in Mr. Schultze's communication, seems complete."

MEETING OF NOVEMBER 21ST, 1884.

The President, Mr. C. Van Brunt, in the chair.

Seventy-five persons present.

Dr. N. L. Britton, as Committee on Phanerogamic Botany, brought forward the subject of the fertilization of the ovule. His views were in full accord with the current theory, which teaches that the elastic inner coat of the pollen-grain, extending itself in the form of a slender closed sac called the pollen-tube, and carrying within itself at its extremity the fovillæ of the pollen-grain, descends into the loose tissue of the stigma and the style, and thence into the interior of the ovary; and that this tube eventually enters the micropyle of an ovule, rests its point on the embryo-sac, and in some way not fully explained, communicates its contents to the germinal vesicle and fertilizes it. His object was to combat, in the interest of science, the views of Mr. J. Kruttschnitt, of New Orleans, who denies that the pollen-tube itself penetrates to the embryo-sac, and suggests that its contents are discharged among the tissues of the style and that they pass thence to the ovary and the ovules. Dr. Britton fortified his position by ample quotation from eminent authorities, and

he illustrated his subject with drawings projected upon the screen by the magic lantern, and with a mounted section of *Monotropa uniflora* showing the pollen-tube in contact with the embryo-sac—a slide furnished for the occasion by Mr. Joseph Schrenk.¹

The President approved Dr. Britton's criticisms, and invited discussion.

Mr. Schrenk said: "It has been stated by Strasburger that the protoplasm of the pollen-tube always occupies the end of the tube; and the truth of this statement is upheld by the longitudinal section of *Monotropa uniflora* which I have the pleasure of exhibiting under the microscope this evening. But, besides this feature, we can observe on this slide an interesting mechanical contrivance by which the contents of the pollen-tube are confined to the terminal part of the organ. Close behind the body of protoplasm a sort of partition, thick and shiny in appearance, is formed, and, as the growth of the pollen-tube advances, other partitions are built up. For this we can conceive no other function than to keep the protoplasm from travelling back. This peculiarity of structure certainly supports the theory that the protoplasm of the pollen advances within the pollen-tube itself and nowhere else."

Mr. J. D. Hyatt said: "Prof. Alphonso Wood told me in detail his researches in this department of vegetable physiology. The cut in his book, representing the pollen-tube of *Polygonum Pennsylvanicum*, to which Dr. Britton has alluded, was drawn from his own observation."

MEETING OF DECEMBER 5TH, 1884.

The President, Mr. C. Van Brunt, in the chair.

Forty-five persons present.

Mr. Charles F. Lemcke, Mr. Anthony Woodward, and Mr. M. H. Eisner were elected Active Members of the Society.

The following objects were exhibited:—

Pulex irritans, made transparent by hydrogen peroxide : by J. D. HYATT.

Pleurosigma angulatum, shown by the electric light : by G. S. WOOLMAN.

¹Dr. Britton's article is given elsewhere in this Number of the JOURNAL. See p. 7.

Parasite of *Chenalopez .Egypticus* (prepared by Prof. Simonson, of Zurich) : by E. A. SCHULTZE.

Heteromeyenia repens, showing the Statospheres : by A. D. BALEN.

Cocconeis on *Anacharis* : by A. D. BALEN.

Stentor cœruleus : by A. D. BALEN.

Aspergillus glaucus on Cheese : by B. BRAMAN.

HYDROGEN PEROXIDE AS A BLEACHING AGENT.

Mr. Hyatt said: "Knowing that hydrogen peroxide possesses the property of discharging the color from organic bodies without injuring their tissue, I determined to make trial of this agent in preparing insects for examination. The result is highly gratifying. The flea which is on the stage of one of the microscopes, was bleached in this way. The heart and all the other internal organs are clearly shown. Each is perfect, and each is in its proper place. The exhibition of the respiratory system is particularly fine. In the process of decoloration by liquor potassæ, these delicate structures are either partly or quite destroyed."

ELECTRICAL ILLUMINATION.

Mr. Woolman: "The incandescence lamp which I have brought for exhibition, is the Swan lamp. The arc is very small and is, I think, well adapted for the resolution of fine lines, like those of the *Pleurosigma angulatum*. The lamp is suspended from the end of a jointed arm attached to an independent support, and is under the complete control of the operator. The electricity is generated by a Grenet battery of two cells, each containing a zinc and a pair of carbons."

The President requested a free expression of views on the subject of the electric light.

Mr. C. F. Cox: "The inquiry into the advantages of electrical illumination in microscopy is becoming a prominent one, and the impression will naturally arise that this kind of illumination is destined to supersede all others. Two things claim attention and discussion,—the lamp and the light. In the form of the lamp there is room for great variety, and on the merits of each variety opinions may differ. But the chief question is, What is the quality of the light itself, and for what uses is it fittest? Its quality places it between lamp light and direct sunlight, but

nearer to the latter than to the former. Now, as direct sunlight is not suitable for opaque objects, since by diffraction it confuses their structure by creating deceptive appearances, so the electric light is, in my opinion, objectionable in the ratio of the nearness of its intensity to that of direct sunlight. For the study of opaque objects under low-power objectives, I find lamp light to be the best, its character as a more diffused light fitting it for the coarser kinds of work, such as the exhibition of elytra. In the examination of such transparent objects as require high-power objectives, the electric light is undoubtedly the more effective. The point which I wish to make is, that no single kind of artificial light has sufficient versatility for the best performance of every one of the many and diverse varieties of work to which the microscope is applied."

Dr. F. Y. Clark : "At first I doubted the serviceableness of the electric light in microscopy. But when by means of it I found myself able to distinguish good, velvety gold foil from poor foil, then I began to prize it. In poor foil are minute holes and fractures, from which the good foil is free. These are detected by the electric light, while the light from an oil lamp does not disclose them."

Mr. P. H. Dudley : "As the result of eight months' trial of the electric light in photomicrography, I found that success demands the employment of a short, thick carbon filament, and the heating of the filament to a degree of incandescence that is scarcely below the destructive point. If the heat go a degree or two higher, the lamp is destroyed. I used the bichromate battery, of eight cells, with double plates, seven inches by eight, in each cell. Apart from considerations of expense, and the extreme difficulty of securing an even current of the requisite strength, the electric light is the best for photography. These drawbacks, however, led me to abandon its use."

The President : "The work of applying the electric light to the microscope is yet in its infancy. What form of lamp is best for general use has not, perhaps, been determined. Probably several forms will be required, to suit different purposes. Only by the skill and industry of many men can the problem be solved. The electric light is of pure and excellent quality. But, in practice, the height to which its brilliancy can be carried, is limited. For I have found that as soon as the light has reached perfect

whiteness, or has acquired a bluish tint, the heat destroys the lamp. The inconvenience arising from the rapid exhaustion of the strength of the electric current, may be partly obviated by the use of a storage battery. I have seen this device employed with marked success."

BACILLUS LEPRÆ AND BACILLUS TUBERCULOSIS.

Mr. E. A. Schultze read a translation which he had made, of an article recently contributed by Dr. P. Baumgarten to the "Zeitschrift für Wissenschaftliche Mikroskopie," on "Methods for Determining the Difference between *Bacillus lepræ* and *B. tuberculosis*." Its purpose was to show that these bacilli, though nearly identical in form, may be correctly and easily distinguished from each other by coloration; and it describes four processes of staining, three of which are given below.

First Process:

1. Pour five or six drops of saturated alcoholic solution of fuchsine into a small watch-glass containing distilled water.
2. Float on the dye for six or seven minutes several dry cover-glasses laden with fresh bacilli.
3. Decolor for fifteen seconds in absolute alcohol mixed with nitric acid in the proportion of ten parts to one.
4. Put into distilled water in order to remove the acid.
5. Moisten with aqueous solution of methylene-blue, and examine at once with a $\frac{1}{13}$ th- or $\frac{1}{18}$ th-inch homogeneous-immersion lens; and the *Bacilli lepræ* will show themselves as well-defined red rods, while the *B. tuberculosis* will present no color whatever.

Second Process:

1. Place for not more than fifteen minutes the bacilli-bearing material into the fuchsine solution above described.
2. Decolor for thirty seconds in the mixture of alcohol and nitric acid.
3. Wash in distilled water.
4. Dehydrate in absolute alcohol three or four minutes.
5. Put into oil of bergamot, and examine with homogeneous-immersion objective. The *Bacilli lepræ* will be easily recognized as shining red rods on a blue ground, while nothing will be seen of the *B. tuberculosis*.

Third Process:

1. Place the bacilli-bearing sections for two or three minutes

into Ehrlich's solution of fuchsine, which is composed of eleven parts of saturated alcoholic solution of fuchsine and one hundred parts of aniline-water.

2. Decolor for thirty or sixty seconds in the nitro-alcoholic mixture.

3. Dip the sections for two or three minutes in aqueous solution of methylene-blue.

4. Dehydrate in absolute alcohol three or four minutes.

5. Transfer to oil of bergamot, and examine with homogeneous-immersion lens. The lepra-bacilli will be seen colored red, while the tubercle bacilli will not be marked at all.

THE CHOLERA BACILLUS.

L. Schöney, M. D., said: "The study of pathogenic bacteria is one of great importance. The views of Dr. Koch, a pioneer in this work, and one of the keenest of investigators, have met with much opposition, and this opposition has sharply assailed his latest promulgated discovery of a micro-organism specific of Asiatic cholera,—the comma-bacillus. Dr. Lewis stated that this form is found in the saliva of perfectly healthy persons, and Drs. Finkler and Prior asserted its existence in cases of cholera nostras; but Dr. Koch has shown that these gentlemen did not make the requisite pure culture. The curved bacilli in saliva and of cholera nostras are longer, more slender, and less blunt at the ends, and, more important still, do not grow in an alkaline peptone gelatine. Only the bacillus of Asiatic cholera develops in that. The crucial test recently made in the Berlin Hygienic Laboratory, of inoculating with the cholera bacillus, was repeatedly successful."

Dr. Britton: "The researches of the Rev. W. H. Dallinger on the 'Least and Lowest Living Things'¹ are of great interest as demonstrating that, however similar to one another these forms may appear, their difference will certainly be detected through a study of their life-history."

MEETING OF DECEMBER 19TH, 1884.

The President, Mr. C. Van Brunt, in the chair.

Twenty-eight persons present.

¹See "Nature," Oct. 23d, and Oct. 30th, 1884.

Mr. P. H. Dudley and Mr. C. W. McAllister were elected Active Members of the Society.

The following objects were exhibited:—

Radial longitudinal section of Tamarack (*Larix Americana*), showing medullary rays and starch grains : by P. H. DUDLEY.

Fibro-cells of *Pleurothallis ruscifolia* : by M. M. LE BRUN.

Transverse section of Mandrake : by J. L. WALL.

Ecidium ranunculacearum : by WALTER H. MEAD.

The "Electric Spark," prepared by Mr. E. G. Day : by H. M. DICKINSON.

A New Microscope Stand, furnished by Mr. Green, successor to Mr. Tolles : by J. WARNOCK.

An Improved Portable Microscope, made by Mr. Zentmayer : by C. S. SHULTZ.

Mr. Dickinson said: "The 'Electric Spark' which I am to exhibit, is made by the passing of electricity through a tiny Geissler tube. The tube is mounted in a deep cell, and is viewed through the microscope."

Mr. Shultz : "Wishing a microscope which should embody, so far as is possible, the excellent qualities of the Army Hospital, the Histological, and the Portable Stands of Mr. Zentmayer, I procured of that maker the instrument which you see in my hand. Besides other desirable features, it has a rotating stage, a mirror of good size, and a large optical body."

Mr. William Wales (in answer to an inquiry) : "The advantage of a large over a small tube is connected mainly with the use of the A eye-piece, because that eye-piece, having a larger field-lens, can have a larger diaphragm and thus command an ampler field. Liking to make the parts of a microscope to harmonize with one another and with the size of the whole instrument, manufacturers naturally attach a small tube to a small stand."

The microscope which was exhibited by Mr. Warnock is, practically, a Tolles stand. Mr. Tolles was the author of all the drawings and specifications, and some of the castings were made before his death. The instrument was finished under the direction of Mr. Charles X. Dalton, who was Mr. Tolles's worker in brass.

Mr. Shultz urged the Society to devise some plan for the mutual exchange of mounted objects and other microscopical material.

The President appointed Mr. Wall, Mr. Shultz, and Mr. Mead a Committee of Nomination to prepare a list of names of Members to be recommended by them for election as officers for the ensuing year, and the Committee were instructed to present their report at the next regular meeting of the Society.

THE MEDULLARY RAYS OF THE TAMARACK.

Mr. P. H. Dudley said: "My 'section' of the wood of the Tamarack was made while the wood was green. Disturbance of the cell-contents,—starch, resin, etc.,—by boiling, was thus avoided. The tree was felled on the 27th of November, and it had fourteen annular rings, eight of which were duramen. I have examined the ligneous tissue of thirty species of Coniferæ, and have observed in the medullary rays of the Tamarack a great variety of interesting features, some of which distinguish this from the other species, with the partial exception of the White Spruce.

"A tangential section exhibits most of the medullary rays in single plates. When the plates number two or more, they usually inclose a large canal, and then the section of the bundle is lenticular in contour.

"In the radial longitudinal section, small lenticular cavities of the peculiar kind which marks all conifers in their tangential section, are exhibited in abundance in the one or two series of cells at each of the two margins of a medullary plate. The septum separating the divisions of a double-convex cavity is strongly thickened at its centre. Some of the cavities are plano-convex, having no counterpart on the other side of the cell wall. The walls of the cells that lie between the two marginal tracts, show lenticular cavities rarely, and then, except occasionally in the central row or rows, in only a half-developed state. Instead, they exhibit pits of the shape of wells and of funnels, extending to the boundary lamella but never through it. Neither these pits nor the lenticular cavities are evenly distributed, being at some points scattered, at others clustered.

"The ends of the cells are almost universally oblique to the sides, and their section is oftener curved than straight.

"The openings communicating between the marginal ray-cells and the vertical cells next to which they lie, are generally circular in form, and centrally perforated, like the bordered pits seen in the vertical cells, but much smaller than those. Of the rest

of the openings, some are oblong, some elliptical; and the axes of these fissures, following the striations of the walls of the upright cells, are parallel to one another.

“In the marginal cells of a medullary plate, I have discovered no starch grains, but in the intermediate rows of cells they abound, especially in the alburnum. Their quantity gradually decreases in the duramen, and in the pith they are almost wanting. The grains are ovoid, and have but two-thirds the size of those in rice.”

MISCELLANEA.

That Man is certainly the happiest, who is able to find out the greatest Number of reasonable and useful Amusements, easily attainable and within his Power: and, if so, he that is delighted with the Works of Nature, and makes them his Study, must undoubtedly be happy; since every Animal, Flower, Fruit, or Insect, nay, almost every Particle of Matter, affords him an Entertainment. Such a Man never can feel his Time hang heavy on his Hands, or be weary of himself, for want of knowing how to employ his Thoughts: each Garden or Field is to him a Cabinet of Curiosities, every one of which he longs to examine fully; and he considers the whole Universe as a Magazine of Wonders, which infinite Ages are scarce sufficient to contemplate and admire enough.—*Henry Baker, in “The Microscope Made Easy,” published at London in 1742.*

—‘If fresh green leaves be immersed in boiling water and afterwards in alcohol, their chlorophyll is extracted without rupture of the cells, and the leaves become blanched. Placed then in a strong alcoholic solution of iodine, the decolored leaf will be stained a buff-yellow if no starch be present, and blue-black if much be present; and there will be intermediate shades of color corresponding to intermediate amounts of starch.

‘The formation of starch is dependent on light. The starch formed in the leaf during the day, may disappear completely during the night. It disappears in the form of soluble glucoses which travel through the vascular bundles to the growing parts of the plant. Though this process takes place chiefly in the night, it goes on slowly by day also, but is then masked by the much more energetic production of starch.’—*Prof. J. Sachs.**

**Cf. Jour. Roy. Mic. Soc., IV. (1884), p. 589; also Sci.-Gossip, 1884, p. 273.*

—More microscopy can be learned and more knowledge acquired by ten hours' devotion to the original investigation of anatomical structure or of physiological phenomena, than by a hundred hours of surrender to the amusement of trying or to the pride of parading one's lenses by examining mounted test-objects only. The glory of a lens, like that of a man, is work.

—In looking for cyclosis in plant-cells, care must be taken to distinguish protoplasmic action from the oscillatory movement called "Brownian," and from the motions of bacterial organisms. By the practised eye these phenomena are easily discriminated. The caution is given for the benefit of the inexperienced observer.

—THE MINUTENESS OF SPORULES.—Bacteria increase by repeated self-division. But sometimes the multiplication is effected by the production of sporules. The sporules of the micro-organisms which develop in an aqueous solution of sulphocyanide of potassium, and of sundry other chemicals, are so small that they will pass freely through a dozen or more thicknesses of the finest filter-paper. The smallest sporules known are, probably, those of *Bacterium termo*. A lens of the finest quality, magnifying five thousand diameters, failed to disclose them to the keen and watchful eye of Dr. Dallinger. Their immense numbers gave them the aspect of a homogeneous, glairy, clouded fluid. But this experienced observer knew that they must presently, through increase of size by growth, become visible in their individuality; and at the end of nearly two hours they began to display themselves throughout the field with the 'suddenness and beauty of the apparition of the stars at night-fall.'

INDEX TO ARTICLES OF INTEREST TO MICROSCOPISTS
WHICH HAVE RECENTLY APPEARED IN OTHER
JOURNALS.

- Æcidium bellidis*, DC., On the Life History of : C. B. FLOWRIGHT.
Jour. Linn. Soc. (Bot.), XX. (1884), pp. 511-12.
Air, External, of Washington; An examination of : J. H. KIDDER.
Jour. of Micr., III. (1884), pp. 182-5 (2 figs.).
Alcoholgährungspilze, Neue Untersuchungen über : EMIL CHR. HANSEN.
Ber. Deutsch. Bot. Gesell., II. (1884), Nov. 5th.

Ammonium Molybdate, The Action of, on the Tissues of Plants: THOMAS SPEARMAN RALPH.

Jour. of Micr., III. (1884), pp. 155-62.

Antheridia. See Floridæ.

Aperture and Working Distance: E. GUNDLACH.

The Microscope, IV. (1884), pp. 246-8.

Aulacomnion palustre, Schwagr., Note on the Gemmæ of: F. O. BOWER.

Jour. Linn. Soc. (Bot.), XX. (1884), pp. 465-7 (4 figs.).

Bacteria, Preparing and Mounting: T. J. BURRILL. (Am. Soc. of Microscopists.)

Micr. News, IV. (1884), pp. 199-203.

Brain and Spinal Cord, The Microscopical Investigation of: W. T. COUNCILMAN, M. D.

Am. Mon. Micr. Jour., V. (1884), pp. 201-3.

Chinese Ink in Microscopy, The Use of: M. LEO ERRERA.

Am. Mon. Micr. Jour., V. (1884), pp. 208-10.

Cockroach, The Nervous System of the: L. C. MIALL and ALFRED DENNY.

Sci.-Gossip, 1884, pp. 244-52 (13 figs.).

Crustacea, The Study of the Larval Forms of the: EDWARD LOVETT.

Jour. of Micr., III. (1884), pp. 175-78

Diatoms, Researches on the Structure of the Cell-walls of (continued): Dr. J. H. FLÖGEL.

Jour. Roy. Micr. Soc., IV. (1884), pp. 665-96 (53 figs.).

Diatomaceæ, The Collection and Preparation of: ALFRED W. GRIFFIN.

Jour. of Micr., III (1884), pp. 138-46.

Diatomaceæ from the Island of Socotra, On Some: F. KITTON.

Jour. Linn. Soc. (Bot.), XX. (1884), pp. 511-15 (1 pl.).

Drawing-Prisms: J. ANTHONY, M. D.

Jour. Roy. Micr. Soc., IV. (1884) pp. 697-703 (2 figs.).

Drawings, Multiplying: C. M. VORCE.

Am. Mon. Micr. Jour., V. (1884), pp. 207-8.

Epidermis der Blütenblätter, Untersuchungen über die: G. H. HILLER.

Jahrb. für wissensch. Bot., XV. (1884), pp. 411-51 (2 pls.).

Floridæ, and some Newly-Found Antheridia, Notes on: T. H. BUFFAM.

Jour. Quek. Micr. Club, I. (1884), pp. 337-44 (16 figs.).

Foraminifera, The Preparation and Mounting of: F. M. HAMLIN, M. D. (Am. Soc. of Microscopists).

Micr. News, IV. (1884), 196-9.

Forms of Life, Lowest and Smallest, as revealed by the Modern Microscope. Some of the principal passages of the lecture delivered by the Rev. Dr. W. H. Dallinger, at the Montreal meeting of the British Association.

Jour. Roy. Micr. Soc., IV. (1884), pp. 721-5.

From the *Times*, Sept. 2d, 1884.

Gabbard and Galloper Sands, Parasitic Vegetable Organisms in Calcareous Particles of: J. G. WALLER.

Jour. Quek. Micr. Club, I. (1884), pp. 345-59 (40 figs.).

- Haustoria of some N. A. Parasitic Phanerogams, Notes on the: JOSEPH SCHRENK.
Bull. Torrey Bot. Club, XI. (1884), pp. 109-14 (13 figs.).
- Hydrozoa and Medusæ: J. B. JEAFFRESON.
Jour. of Micr., III. (1884), pp. 178-82 (4 figs.).
- Imbedding Apparatus.
Am. Nat., XVIII. (1884), pp. 1289-90 (1 fig.). From Zool. Anz.
- Infusoria from Bristol, Some New: J. G. GRENFELL.
Jour. of Micr., III. (1884), pp. 133-8 (9 figs.).
- Infusorian of the Family Vorticellidæ, An Unusual: D. S. KELLICOTT.
The Microscope, IV. (1884), pp. 248-53 (2 figs.).
- Least and Lowest of Living Things, Researches on the Origin and Life Histories of the: REV. W. H. DALLINGER.
Nature, XXX. (1884), pp. 620 & 645.
- Magnifying Power: E. GUNDLACH.
Am. Mon. Micr. Jour., V. (1884), pp. 205-6.
- Medusæ. See Hydrozoa.
- Microbe du Cholera, La Vitalité du: MM. NICATI and RIETSCH.
Revue Scientif., XXXIV. (1884), pp. 658-60.
- Microbes dans les Maladies, L'Action des: J. HÉRICOURT.
Revue Scientif., XXXIV. (1884), pp. 619-25.
- Microscope of Large Field; Note by M. A. Gravis, translated from "Bull. Soc. Belge de Micr."
Am. Mon. Micr. Jour., V. (1884), pp. 211-12.
- Microscope, How to Work with the: E. M. NELSON.
Jour. Quek. Micr. Club, I. (1884), pp. 375-9.
- Microscope Lamps, New; illustrated.
Am. Mon. Micr. Jour., V. (1884), pp. 203-5.
- Mounting, Concluding Remarks on; under heading Microscopical Technic.
Am. Mon. Micr. Jour., V. (1884), pp. 210-11.
- Nostoc*: M. C. COOKE.
Jour. Quek. Micr. Club, I. (1884), pp. 362-3.
- Objectives, Choosing.
Am. Mon. Micr. Jour., V. (1884), p. 214
- Palæontology, The Microscope in: MALCOLM POIGNAUD.
Jour. of Micr., III. (1884), pp. 163-70 (3 figs.).
- Peronosporæ, On the: GEORGE NORMAN.
Jour. of Micr., III. (1884), pp. 186-9 (Pt. 1).
- Sori of Fern, *Marattia alata*, under heading Graphic Microscopy: E. T. D.
Sci.-Gossip, 1884, pp. 241-2 (1 pl.).
- Sphæria pocula*, Schweinitz, The Structure and Affinity of: M. C. COOKE.
Jour. Linn. Soc. (Bot.), XX. (1884), pp. 508-11 (1 pl.).
- Sponge Skeleton, The, as a means of Identifying Genera and Species: J. G. WALLER.
Jour. Quek. Micr. Club, I. (1884), pp. 365-71.
- Struthiopteris Germanica* und *Pteris aquilina*, Anatomie der Vegetationsorgane von: P. TERLETZKI.
Jahrb. für wissensch. Bot., XV. (1884), pp. 452-501 (2 pl.).

Tubifex, Some Further Researches on: A. HAMMOND.

Jour. of Micr., III. (1884), pp 147-55 (13 figs.).

Turn Table, Griffith's New; illustrated.

Am. Mon. Micr. Jour., V. (1884), p. 207.

White Zinc for Mounting: C. E. HANAMAN.

Am. Mon. Micr. Jour., V. (1884), p. 220.

Working Distance. See "Aperture."

JOURNAL
OF THE
NEW-YORK MICROSCOPICAL SOCIETY.

VOL. I. FEBRUARY, 1885. No. 2.

COMPOUND EYES AND MULTIPLE IMAGES.

BY J. D. HYATT.

(Presented January 2d, 1885.)

My microscopical recreations the past summer were directed mainly upon the structure of the compound eyes of insects, not so much for a definite scientific purpose, as with the practical object of discovering what insects have eyes that are the most serviceable for showing multiple images under the microscope. The results thus far obtained are far from exhaustive; yet I have fallen upon some curious features in the structure of these organs, which may possess the interest of novelty to an audience not composed exclusively of entomologists.

These compound eyes, consisting externally of a great number of lenses, sometimes exceeding twenty thousand, set in a framework of convex or, often, hemispherical form, have a range of vision, or "angular aperture," very much larger than could be commanded by a simple eye of the same convexity. For, while the simple eye could form correct images of those objects only which are situated within the range of rays passing through its optical axis, the minute lenses composing the compound eye may, many of them, receive light from a horizon as low down as the base of the entire set, if not lower.

In some species of Neuroptera the head is nearly cylindrical, and is placed with its axis transverse to the axis of the insect's body. As the eyes, constituting, of course, the extremities of the cylinder, have a diameter exceeding that of their support, and are, besides, hyperhemispherical, they give to the head the appearance of a dumbbell. Were one of these insects placed at the centre of a hollow sphere, it could, undoubtedly, see at the same moment every point of the sphere's interior surface.

The *Gyrinus*, or Water-beetle, which may be seen sporting on the surface of still water in summer, has the unusual number of

four compound eyes. Besides the usual pair on the upper and frontal part of the head, set in the under side of the head is another pair, looking directly downward and completely submerged—"water-immersion" eyes. The utility of this arrangement is readily seen. Its anatomy I have not myself examined; but I have somewhere heard or read that the two eyes on each side, though separated externally, are, in a measure, connected internally. The *Gyrinus* is the only example of this peculiar structure that has come under my observation.

To those who admire color, a microscopical observation of the eyes of living insects, especially those of the order Diptera, and of the night-flying Lepidoptera, will be fruitful of delight. For the eyes of these insects display an endless variety of colors which vie in brilliancy with the most lustrous of the "bright jewels of the mine." After the death of the insect, however, the color soon disappears.

In mounting compound eyes for the purpose of showing multiple images, the first step, after carefully washing the interior of the cornea, is to press the cornea flat, so that all the lenses may lie as nearly as possible in the same plane. But as this operation necessarily occasions either a breaking or a folding of the cornea, I cut out, with a small punch made for the purpose, a circular disk not larger than can be pressed flat without disturbing the facets. In punching out these disks, a single cutting gives two circular pieces, showing that the cornea is double; and in the eyes of *Cicada*, a single cutting gives three separate disks, showing a triple set of lenses in the cornea. Each set constitutes, without doubt, an achromatic combination.

In some of the Diptera, particularly of the genus *Tabanus*, or Horse-fly, the lenses of the upper and anterior part of the eye are much larger than those situated below a median line. A disk cut from one of these eyes in such a way as to include a number of the upper, or larger facets, and also some of the lower, is represented in the accompanying diagram. It will be observed that the larger facets have, at least, twice the diameter of the smaller, or four times their superficial area. A still more remarkable feature, however, is the difference in focus between the larger lenses and the smaller. For upon placing this part of the eye upon the stage of the microscope, and adjusting the focus for multiple images, I found that the larger lenses form

pictures at a plane considerably above the focal plane of the smaller ones. From this fact it would appear that these insects are furnished with eyes of two varieties, corresponding to our long-sight and short-sight spectacles; in other words, telescopic and microscopical eyes, the telescopic looking upward and forward, and the microscopical downward. The economy of such

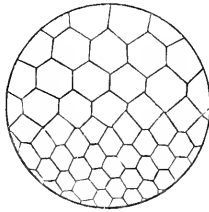

an optical structure in a parasitic insect which seeks its prey at a distance, is so obvious that I need not stop to explain it.

For showing multiple images, the most perfect eyes that I have yet found are those of *Blatta orientalis*, or the Cockroach. As the eyes of this insect are quite brittle, only a small part of the cornea can be pressed flat in one piece. Yet a piece large enough to fill the field commanded by a half-inch objective and a *B* ocular can be cut out with the punch. The many advantages which it possesses, more than counterbalance its lack of superficial extent. For the lenses are very transparent, and comparatively large, and, being set in a moderately hard framework, do not separate so as to destroy the achromatic combination. Nor do the lenses which make up each combination slip upon one another when subjected to slight pressure, as do the lenses in the eyes of most other insects except the Coleoptera. When the lenses do thus slip upon one another, each separate eye shows two or three imperfect images instead of a single good one. The chief advantage, however, which the eyes of the Cockroach possess over all others is that they may be mounted in glycerine and thus kept perfectly transparent without losing their properties as lenses.

The usual method of exhibiting the multiple images is to place the mounted cornea of the compound eye upon the stage, and focus the microscope so much above it as to show a clear circle of light in each facet. Then, if any small object be placed be-

tween the stage and the mirror, its image will be exhibited by every lens. Also if a small letter, figure, or picture, in black, with a clear, white background, be placed one or two inches below the stage, and a strong light be condensed upon it, it will be seen with tolerable distinctness. Such objects are, however, much more sharply defined if first cut out, and then pasted upon a thin cover-glass, which may be mounted on the substage. In this situation the object is illumined by light reflected from the mirror. The effect will be still better if a slip of ground glass be interposed between the object and the mirror, so as to shut off the image of the lamp, if lamplight be employed, or of distant objects, if daylight be used. The eye of a mosquito will show two or three hundred pictures of a person, in silhouette, with great distinctness, provided you have a window so situated as to allow light from the sky or from a white cloud to pass unobstructed to the mirror. The person must stand at a distance of five or six feet from the microscope, and with the profile of his face in clear relief against the sky. The plane mirror must, of course, be used.

I have recently been much interested in examining the structure of the eye of *Limulus*, or the Horse-shoe Crab, which, though compound, is quite different, in some particulars, from that of insects. The exterior of this eye is perfectly smooth, and consists of a transparent horny coat of considerable thickness. The concave interior surface is studded with lenses varying in form from plano-convex, near the centre, to conical and paraboloid, toward and at the periphery. These lenses are so placed that their optical axes converge to a common point situated in a plane a little below the base of the whole eye. This point, without doubt, is occupied by the retina, or the extremity of the optic nerve. Good multiple images will be made by this eye if a small disk cut from the central part be used, the eye being flattest at that point and the lenses least conical. From any other part of the eye it would be extremely difficult to cut a disk that would not, in consequence of the oblique position of the lenses, greatly distort the images.

Multiple images may be formed under the microscope in many other ways than by the use of compound eyes. The minute plano-convex bodies of water produced by breathing on a slide, will display good images of any small object supported above

the mirror. In like manner, images will be made by other transparent bodies, or by the transparent parts of any structure, which are of lenticular or globular form.

Concave lenses, as well as convex, will give images, but with this difference,—the images will be found below the plane of the foci of the lenses, and will be inverted; whereas, images produced by convex lenses are formed erect and, as before stated, at a plane above such focus. It follows that air-bubbles in water will yield inverted images, the water immediately surrounding them acting as a biconcave lens.

These facts may possibly be of some service in determining the character of minute bodies or structures, such, for example, as human blood corpuscles, all of which show erect images—a proof that they are nucleated or, at least, lenticular at the centre. The head of the pin-shaped sponge-spicule, and the nuclei in certain diatoms, produce inverted images.

HETEROMEYENIA RYDERI.

BY PROF. SAMUEL LOCKWOOD, PH.D.

(Read January 16th, 1885.)

While summering in 1883 at Twin Mountain, N. H., Mr. F. W. Devoe and myself did some object-hunting for the microscope. On pulling up some submerged sticks from a still pond in a field, we observed that they were encrusted with certain green, moss-like prominences, which proved to be specimens of a fresh-water sponge. The species has been determined by Mr. Edward Potts to be *Heteromeyenia Ryderi*. Mr. Devoe has prepared an interesting mount of the sponge, on which, at this gentleman's request, a few remarks are herewith offered.

By reason of the green color, the amateur, on first seeing a specimen of *Spongilla*, is invariably deluded into the belief that he has found a peculiar species of confervoid alga. The color is owing to the abundance of chlorophyll in the sarcode of the sponge. This sarcode, or pseudo-flesh, is composed largely of undifferentiated, that is, structureless, protoplasm; the rest, consisting of the differentiated protoplasm, is composed of flagellate cells not unlike ciliated monads.

It may be remarked that the Spongida, or Porifera, are divided

into three great groups, according to the substance which makes up the skeleton. If the skeleton is composed of keratose, that is, of horny matter, as in the sponge of commerce, the group is known as the Keratosa. If the skeleton consists of lime, the group is known as the Calcareae, or Calcispongia; and if the skeleton is made of silica, the group is called Silicea. To the last group belongs the fresh-water sponge, in which the skeleton is made up of very fine spicules of silica. Knowing this fact, the amateur needs not to be deceived by the green aspect of his specimen, when it is found fresh and occupying its native habitat; for, instead of the simple gelatinous feel of the conferva, our little *Spongilla*, when taken between the fingers, imparts a crinkly feeling due to the presence of these spicules of silica.

The sponge was long regarded a vegetable; and in Japan, I am told, the term for sponge literally means "sea-cotton." Biologists to-day agree in assigning the Spongida to the animal kingdom. Indeed, if one of the flagellate cells, or "separate sarcoids," with some protoplasm adhering, be carefully detached from a colony, it will move about with its vibrating cilium, and, like an *Amœba*, will project the adhering protoplasm into many pseudopodia, or false locomotive organs, of never ceasing change as to form and number.

When first studied abroad, the fresh-water sponge was put into a genus, *Spongilla*, containing two species, *S. lacustris*, and *S. fluviatilis*. Afterwards the genus *Meyenia* was erected, into which *S. fluviatilis* was placed; and, later, the other species became known as *S. lacustroides*. It is an interesting fact, that these two European species have American representatives.

The specimen of *Heteromeyenia Ryderi* mounted by Mr. Devoc, will prove highly interesting, if attention be directed to the following objects, easily observed upon the slide.

1. The skeleton spicules. These are of pure silica, and very translucent, but do not polarize well. They are slightly arcuate, or bow-shaped, in form, and are exquisitely sharp at both ends. Indeed, in respect of sharpness, no cambric needle is comparable with them. Shown under high powers, these tiny bows are not uniformly smooth, but are occasionally studded with very minute spurs.

The economy of this studding of the spicules with these pointed spurs is, I think, plain, and is really beautiful. They help

the spicules to felt together and thus sustain in position, the simple structure of living jelly, with its system of aqueducts for the distribution of the alimentary supply, and also with its system of oscula, or sewer outlets of the effete water. These are sometimes called the dermal or flesh spicules, because their office is to bind together the sarcode of the colony.

2. The next notable objects are the yellow spheres scattered among the skeleton spicules. Formerly they were known as gemmules, but now they are oftener called statospheres, and statoblasts. These are the reproductive bodies. They are sometimes called the winter eggs—a significant, though not scientifically accurate term. They may be compared to capsules filled with very fine seeds, since they are stored with reproductive germs, of which each has several hundreds. These pretty golden spheres are produced at the close of summer, shortly before the death of the colony—for the sarcode perishes at the approach of the cold season. The sporules, or germs, of the statosphere survive the winter, and with the first warm weather they leave their spherical nest by a hole at one side of the sphere.

3. Here and there in the mount may be noted one or more yellowish granules. They are sporules which have been liberated in the breaking down of the statosphere by the nitric acid used in preparing the mount. I think it owing to the acid that these sporules are seen as granular, or not homogeneous bodies. It may be added here that these germs thus set free in spring, either start new colonies by attaching themselves to submerged sticks or stones, or, as is frequently the case, they settle upon the little heap of skeleton spicules of the extinct colony, and so actually rehabilitate and enlarge the defunct establishment.

4. These statospheres, or winter eggs, are held entangled in the felted mass of the skeleton spicules in the same way that the bur of a burdock is held in place when put in the hair of a boy by some mischievous playmate. Each bristly hair of the bur is hooked. So it is with the exterior of these globular bodies. To keep them in place in the felted skeleton, the surface of each statoblast is studded with tiny spicules, each one of which is bi-rotulate, or two-wheeled; that is, it has an axle connecting the two wheels and consolidated with them, like the bobbin, or spool, on which thread is wound. This shaft connecting the two little wheels is so held in the shell, or outer coat, of the statosphere,

that one wheel of the bobbin is inside of the shell, like the rivet-head in a boiler, and the other wheel is outside of the shell, and projects a little in order to be entangled in the felting of the skeleton spicules of the body mass of the sponge. I have likened these little spicules on the statoblast to a bobbin, or spool. Their technical name, though in English, is somewhat formidable, since they are known as the "short birotulate statosphere spicules."

5. This brings us to another point of interest. Interspersed somewhat sparingly among these short birotulate spicules, which are practically innumerable, is another double-headed spicule, of about twice the length of those just described, and differing from them greatly in the character of the two ends. Technically it is termed birotulate. This word, however, is not so accurately descriptive of these, as it is of the bobbin-shaped spicules. These long statosphere spicules deserve to be called double-grapnels; for each end is, not a wheel, but a series or circle of hooks. In this way extraordinary holding power is afforded, to secure the statoblast during its winter stay in the skeleton of the colony.

Generally the shaft, or axle, of the short bobbin-like spicule is smooth, though it is sometimes a little spurred. But in the larger, or grapnel spicule, the spurring of the shaft is so frequent and so pronounced, as to excite curiosity regarding its function. I hardly dare attempt an interpretation, farther than to suggest that this arrangement gives to the shaft a steadier hold in the shell of the statosphere.

PROCEEDINGS.

MEETING OF JANUARY 2D, 1885.

The President, Mr. C. Van Brunt, in the chair.

Thirty-four persons present.

Mr. Edward A. Caswell was elected an Active Member of the Society.

The Special Committee appointed at the meeting of December 19th, to nominate a list of officers for the ensuing year, presented their report.

The following objects were exhibited :—

Bacilli from *Pneumo-enteritis* : by W. H. BATES, M. D.

Stephanodiscus Niagaræ, mounted in balsam of Tolu : by EDWARD G. DAY.

Pond-life : by A. D. BALEN.

Surirella (seventy-four forms ; mounted by Möller) : by E. A. SCHULTZE.

An Electric Lamp : by R. W. ST. CLAIR, M. D.

MICRO-ORGANISMS OF PNEUMO-ENTERITIS (SWINE PLAGUE).

Dr. Bates said: "The specimens of bacilli which I have brought for exhibition, were derived from swine at Flatbush, L. I. There is some controversy as to the character of the micro-organisms which are specific of *Pneumo-enteritis*. Some observers consider them to be micrococci, while Dr. Klein places them with the bacilli. My specimens evidently belong to the latter class. They are identical with those figured by Dr. Klein in his writings on this subject."

STEPHANODISCUS NIAGARÆ.

Mr. Edward G. Day : "*Stephanodiscus Niagaræ*, a diatom of great beauty, occurs abundantly in the river Niagara and in Lake Erie. My specimens were obtained in Cleveland, which gets its supply of water from the lake. They are easily procured by tying over a faucet a linen-cambric handkerchief, and letting the water drip through it several hours.

"On account of the high refractive index of balsam of Tolu, diatoms mounted in it show brighter, and exhibit their structure more clearly, than when Canada balsam is used. The work of

mounting, however, has to be finished at once, otherwise the balsam is likely to crystallize under the edge of the cover-glass. This medium is best prepared for use by dissolving it in chloroform, and carefully filtering the solution. The method of mounting with it is similar to that with ordinary balsam. When the work is done, the chloroform is expelled by one or two days' exposure to gentle heat."

The President said that his own observation accorded with the statement of Mr. Day regarding the tendency to crystallization ; that he had himself seen slides of diatoms which, though prepared by an experienced hand, had become impaired through the crystallization of the mounting medium.

MULTIPLE IMAGES.

Mr. J. D. Hyatt gave his observations on the formation of multiple images by compound eyes. They are printed in full on pages 33-37.

A NEW ELECTRIC LAMP.

The incandescence lamp which was among the objects exhibited, was described, and its quality and working illustrated, by R. W. St. Clair, M. D. "The battery," said he, "has six cells, for one filling of which about five ounces of fluid are required. The arc in the lamp is a vein of the beech leaf, carbonized. Its life is long. I have one which has been in use more than a year. The light is readily governed by making connection with more or fewer of the cells. It has been tested in photomicrography with satisfactory results."

The President remarked that the electric light exhibited by Dr. St. Clair is the best for brilliancy that has yet been brought before the Society.

Mr. E. A. Schultze stated that Dr. Van Heurck is employing electrical illumination in photographing diatoms, and that his work, which can but be of great interest and value, will soon be given to the world.

MICRO-ORGANISMS OF PNEUMO-ENTERITIS.

Mr. R. Hitchcock, of Washington, was present, and the President invited him to favor the Society with any observations which he was pleased to make. He responded : "I brought with

me two preparations, both excellent, which I thought would interest you. One is of the *Bacillus tuberculosis*, the other is of micrococcus. As has been stated by Dr. Bates this evening, observers differ in opinion as to the relation between bacterial organisms and *Pneumo-enteritis*, or swine-plague. Dr. Klein has decided in favor of the bacillus, and has maintained his position a long time; but I think that the evidence is decidedly against him. Recently, Dr. Salmon has demonstrated the presence of micrococcus in swine-plague; and a few days ago I received a note from Dr. Sternberg, informing me that he had himself just obtained a pure culture of the micrococcus of this disease, while previously he had seen only the bacillus. The credit of the discovery of micrococci he freely accords to Dr. Salmon. The study of micrococcus is perplexing, because of the invariable presence of bacilli in the material examined, and because of the greater ease of finding them than of finding micrococci."

ELECTION OF OFFICERS.

The President announced the closing of the polls, and the following was declared to be the result of the balloting:—

For President, CORNELIUS VAN BRUNT.

For Vice-President, C. F. COX.

For Recording Secretary, A. D. BALEN.

For Corresponding Secretary, EDWARD G. DAY.

For Treasurer, M. M. LE BRUN.

For Librarian and Curator, W. G. DE WITT.

For Auditors; { EDWARD C. BOGERT,
FREDERICK W. DEVOE,
WILLIAM R. MITCHELL.

MEETING OF JANUARY 16TH.—THE ANNUAL MEETING

The President, Mr. C. Van Brunt, in the chair.

Thirty-six persons present.

The second regular session of the Society in January is the Annual Meeting. At this meeting the officers present their Reports.

REPORT OF THE PRESIDENT, ON THE STATE OF THE SOCIETY.

"My Report," said the President, "will be brief. The Society

is to be congratulated, both on account of the attendance during the past year, and on account of the character and amount of the work done. The roll of Active Membership now embraces fifty-five persons—an increase of nine. The number of Honorary Members is eight; of Associate, twenty-two. The total membership is, therefore, eighty-five. The attendance has averaged twenty members and sixteen visitors. Including the Paper which is to be read this evening, the record of Papers presented will be as follows:—

1. Feb. 15th.—The Wine-Fly (*Drosophila ampelophila*). By PROF. SAMUEL LOCKWOOD, PH.D.
2. Mar. 7th.—A Plan for the Exchange of Object-slides and other Microscopical Material, among the Members of the Society. By C. S. SHULTZ.
3. Mar. 21st.—The Microscope One Hundred Years Ago. By B. BRAMAN.
4. Apr. 18th.—Embryology of the Batrachia, with Illustrations from the Axolotl. By H. J. RICE.
5. May 2d.—The Gold-sands of California. By C. H. DENISON.
6. May 16th.—Textile Fibres. By T. M. LETSON.
7. June 6th.—Notice of a New Fungus, *Appendicularia entomophila*, Peck, parasitic on the Fly *Drosophila nigricornis*, Loew. By the Rev. J. L. ZABRISKIE.
8. June 20th.—The Photomicrography of Woods. By P. H. DUDLEY.
9. Nov. 7th.—Electrical Illumination in Microscopy. By E. A. SCHULTZE.
10. Nov. 21st.—Criticisms on Mr. J. Kruttschnitt's Papers and Preparations Relating to Pollen-tubes. By N. L. BRITTON, PH. D.
11. Dec. 5th.—Methods for Determining the Difference between *Bacillus Lepræ* and *B. tuberculosis*. Translated from the German, by E. A. SCHULTZE.
12. Jan. 2d.—Compound Eyes and Multiple Images. By J. D. HYATT.
13. Jan. 16th.—*Heteromycenia Ryderi*. By PROF. SAMUEL LOCKWOOD, PH.D.

“These Papers, mainly unsolicited, have added much to the scientific value of our sessions. The meetings have, besides,

had a pleasantly social character. I can express no better wish in behalf of the Society than that the delightful features of our year just past, may continue through the coming year."

SUMMARY OF THE REPORT OF THE TREASURER,
MR. M. M. LE BRUN.

Balance, Jan. 18th, 1884,	-	-	-	\$	31.94	
Receipts, to Jan. 16th, 1885,	-	-	-		<u>310.00</u>	\$341.94
Disbursements, to Jan. 16th, 1885,						<u>316.00</u>
Balance, Jan. 16th, 1885,	-	-	-			\$25.94

OBJECTS EXHIBITED.

The objects exhibited were,

1. Fresh-water Sponge: by F. W. DEVOE.
2. Sponge Spicules: by J. D. HYATT.
3. Spiracles of House-Fly: by A. G. LEONARD.
4. Tongue of Fly, with Pseudo-tracheæ flattened: by F. W.

LEGGETT.

5. *Buthus Carolinianus*, showing Ocelli: by B. BRAMAN.
6. Stomach of Carolina Locust: by HORACE W. CALEF.
7. Brain of Rat, injected (mounted by Cole, of London): by

EDWARD G. DAY.

8. *Acer campestre*, transverse section, double-stained: by J.

L WALL.

9. *Taxus brevifolia*, tangential section: by J. L. ZABRISKIE.

10. Leaf of *Leucophyllum Texauum*, showing Ramose Hairs: by E. A. SCHULTZE.

11. Leaf of *Magnolia grandiflora*, showing Hairs: by W. G. DE WITT.

12. *Polyporus sanguineus*, a Fungus: By W. G. DE WITT.

FRESH-WATER SPONGE.

The specimen of fresh-water sponge (*Heteromeycnia Ryderi*) exhibited by Mr. Devoe, was obtained from a pond at Twin Mountain, N. H., in the summer of 1883. Dr. Samuel Lockwood, the companion of the exhibitor in that excursion, prepared a written description of this object, embracing also observations on the life-history of this genus of sponge, and presented it to the Society. It was read before the Society by Mr. Hyatt, and it is published in full in this Number of the JOURNAL.

DIMENSIONS OF SPICULES OF *HETEROMEYENIA RYDERI*.

Mr. Hyatt had measured the spicules of *Heteromeyenia Ryderi*, and he gave the result, as follows:—

Largest pointed spicules: average length, $\frac{1}{100}$ th of an inch.

Grappling-hook spicules: average length, $\frac{1}{1000}$ ths of an inch.

Short birotulate spicules: length, from $\frac{1}{10000}$ th to $\frac{1}{1000}$ ths of an inch.

Wheels of short birotulate spicules: average diameter, $\frac{1}{10000}$ ths of an inch.

OBSERVATIONS ON FRESH-WATER SPONGE.

Mr. Hyatt said that fresh-water sponge—but not of the species exhibited by Mr. Devoe—abounds in the Bronx River, attaching itself to sunken brush-wood; also, that it occurs in great quantity in the Erie Canal.

The President: “There is a vigorous growth of sponge on the filter-beds through which passes the water-supply of Poughkeepsie; and, at one time, the decay of the gelatinous substance of the sponge imparted to the water an unsavory taste.”

Mr. Devoe (in response to, an inquiry): “My specimen was mounted dry, after maceration in dilute nitric acid. By such maceration some of the spicules are, it is true, disengaged from the stator; but, when caution is exercised, enough spicules are left to show with how great beauty they are distributed over the surface of the sphere. For the discovery of the full beauty of an individual spicule, a high-power lens is necessary.”

Dr. Bates: “I have been informed by Mr. Henry Mills, of Buffalo, that for a permanent mount of fresh-water sponge, carbolic acid is the best medium.”

Mr. Balen: “This sponge will keep indefinitely when once dried. The animal matter decays; the rest remains. The general shape of the sponge is preserved, and the spicules are left undisturbed.”

TAXUS BREVIFOLIA.

Mr. Zabriskie: “*Taxus brevifolia* is a remarkably dense and durable wood. My section of it shows the spiral fibres of the wood-cells in great abundance.”

LEUCOPHYLLUM TEXANUM.

Mr. Schultze: “The hairs on the leaf of *Leucophyllum Texanum*

are curiously and beautifully branched, and are a very pleasing opaque object for the microscope. They are densely crowded, and some of them have as many as twenty ramifications. I am indebted for my specimen to Dr. Britton."

Dr. Britton: "*Leucophyllum* is a genus of low, branching, shrubby plants indigenous to Mexico and the southwestern part of the United States. Three species are known. They bear axillary, showy, violet-purple flowers. *L. Texanum*, Benth., grows to a height of from two to eight feet, and has silvery-white, obovate, nearly sessile leaves, half an inch in length. The specimen is from San Diego, Texas."

EGGS OF LIMULUS POLYPHEMUS.

Dr. Julien: "I have the pleasure of presenting to the Society some specimens of eggs of *Limulus Polyphemus*, the gift of Prof. W. B. Dwight, of Poughkeepsie; also, some infusorial earth, collected near Vancouver Barracks, Washington Territory, by Dr. Timothy E. Wilcox, U. S. A."

Prof. Dwight sent, with his gift, a letter conveying the following information: 'These eggs of *Limulus Polyphemus* are nearly mature. They were found last summer, buried two or three inches in the sand, at a locality three miles south of Cottage City, Martha's Vineyard. It was difficult to separate them from the sand without injuring them, so delicate is the outer membrane. For their preservation, I know of no better medium than dilute alcohol.'

The membrane alluded to is transparent, and the young *Limulus* is seen quite clearly. The eggs are spherical, and their diameter is three-twentieths of an inch, very nearly.

A copy of "Desmids of the United States," a gift from its author, the Rev. Francis Wolle, was added to the Library.

INDEX TO ARTICLES OF INTEREST TO MICROSCOPISTS
WHICH HAVE RECENTLY APPEARED IN OTHER
JOURNALS.

- Amœba, The, and the Cell : C. H. STOWELL.
The Microscope, IV. (1884), pp. 265-71 (6 figs.).
- Angular Aperture Question, Robert B. Tolles and the : Annual Address of the President, JACOB D. COX.
Proc. Am. Soc. Mic., 1884, pp. 5-39 (4 figs.).
- Aphides, Embryology of (EMANUEL WITLACZIL, *Zeitschr. für Wiss. Zool.*): G. MACLOSIE.
Am. Nat., XIX. (1885), pp. 172-6 (3 figs.).
- Bacteria, Staining, for Microphotographic Purposes : EDGAR THURSTON.
Eng. Mech., XL. (1884), pp. 335-6.
- Bacteria, Chromogene.
Am. Mon. Mic. Jour., V. (1884), pp. 224-6.
- Blastopore in the Newt (*Triton cristatus*), On the fate of the : ALICE JOHNSON.
Quar. Jour. Mic. Sci., XXIV. (1884), pp. 659-72 (17 figs.).
- Blood, Morphology of Rheumatic : E. CUTTER.
Proc. Am. Soc. Mic., 1884, pp. 194-8 (11 figs.).
- Camera Lucida, Schröder's.
Am. Mon. Mic. Jour., V. (1884), p. 221.
- "Chicken Gapes," The Parasite in : DR. WALKER.
The Microscope, IV. (1884), pp. 271-2.
- Cholera Bacillus, The.—Koch's reply to his critics.
Science, IV. (1884), pp. 554-5.
- Choano-Flagellata, S. K., New Members of the Order. See Infusorial Order.
- Cholera Microbe, The.
Am. Mon. Mic. Jour., V. (1884), p. 238.
- Circulation, The Extra-Vascular : J. REDDING.
Proc. Am. Soc. Mic., 1884, pp. 81-90.
- Comma Bacterium, Dr. Koch and the : E. RAY LANKESTER.
Nature, XXXI. (1884), pp. 168-71 (6 figs.).
- Copepod of the Clam, On a parasitic : R. RAMSAY WRIGHT.
Am. Nat., XIX. (1885), pp. 118-24 (10 figs.).
- Culture-tubes for Micro-Organisms.
Am. Mon. Mic. Jour., VI. (1885), pp. 1-2 (2 figs.).
- Diatoms—*Eupodiscus*, Researches on the Structure of the Cell-walls of : J. H. L. FLÖGEL.
Jour. Roy. Mic. Soc., IV. (1884), pp. 851-2 (1 fig.).
- Diatom Valves, The Structure of the : R. P. H. DURKEE.
Proc. Am. Soc. Mic., 1884, pp. 105-9 (3 figs.).
- Diatom Valves, Broken, On some Photographs of, taken by Lamplight : J. D. COX.
Jour. Roy. Mic. Soc., IV. (1884), pp. 853-8.
- Diatomaceæ, Mounting the.
The Microscope, IV. (1884), p. 280.
- Difflugia globulosa*, Duj., Copulation of : CARL F. JICKEL.
Am. Mon. Mic. Jour., VI. (1885), pp. 15-16.

Eggs of Mottled Umber Moth (*Hybernia defoliaria*); under heading Graphic Microscopy: E. T. D.

Sci.-Gossip, 1884, p. 265 (colored plate).

Elektrischen Glüh-und-Bogen-Licht, Ueber einige Versuche mit: MAX FLESCHE.

Zeitschr. für Wiss. Mik., I. (1884), pp. 561-3.

Embryology, Outlines of (1. Introduction).

The Microscope, V. (1885), pp. 15-20 (5 figs.).

Endomemions-Objective: LEOPOLD DIPPEL.

Zeitschr. für Wiss. Mik., I. (1884), pp. 485-90 (2 figs.).

Erineum anomalum (Mite Gall), found on the Black Walnut, A Botanical Study of the: LILLIE J. MARTIN. (A. A. A. S., Phila., 1884.)

Am. Nat., XIX. (1885), pp. 136-40 (10 figs.).

Eupodiscus. See Diatoms.

Eyes of Some Invertebrata: JUSTUS CANIÈRE.

Quar. Jour. Mic. Sci., XXIV. (1884), pp. 673-81 (4 figs.).

Eylais extendens (?) (The Red Water-Mite); under heading Graphic Microscopy: E. T. D.

Sci.-Gossip, 1885, pp. 1-2 (colored plate).

Färberei zur Mikroskopischen Zwecken: HANS GIERKE.

Zeitschr. für Wiss. Mik., I. (1884), pp. 497-557.

Fauna, Minute, of Fairmount Reservoir, On the: E. POTTS.

Proc. Acad. Nat. Sci., Phila., 1884, p. 217.

Fungi Found in Sewage-Effluents: A. W. BENNETT.

Proc. Am. Soc. Mic., 1884, pp. 90-92 (1 fig.).

Fungus (*Milowia nivea*), Description and Life-History of a New: G. MASSEE.

Jour. Roy. Mic. Soc., IV. (1884), pp. 841-5 (9 figs.).

Germ Theory of Disease.

Eng. Mech., XL. (1884), pp. 313-14.

Graphiology, Microscopic: J. E. WYTHE.

Quek. Jour., II. (1884), pp. 86-90.

Hair: Microscopically Examined and Medico-Legally Considered: WILLIAM J. LEWIS.

Proc. Am. Soc. Mic., 1884, pp. 50-70 (22 figs.).

Halisarca lobularis, The Development of: W. J. SOLLAS.

Quar. Jour. Mic. Sci., XXIV. (1884), pp. 603-21.

Handwriting, Microscopical Examination of; under heading Examination of Agreement, etc.: GEO. E. FELL.

Proc. Am. Soc. Mic., 1884, pp. 47-58 (Ill.).

Honey-Glands in Pitchered Insectivorous Plants, On the Distribution of: J. M. MACFARLANE.

Nature, XXXI. (1884), pp. 171-2.

Hybernia defoliaria. See Eggs of Mottled Umber Moth.

Infusoria, Observations on, with Descriptions of New Species: D. S. KELLICOTT.

Proc. Am. Soc. Mic., 1884, pp. 110-25 (11 figs.).

Infusoria, Rotatoria, etc.; Notes: D. S. KELLICOTT.

Proc. Am. Soc. Mic., 1884, pp. 126-30.

Infusoria from Fresh Water, Some apparently undescribed: ALFRED C. STOKES.

Am. Nat., XIX. (1885), pp. 18-27 (8 figs.).

Infusoria, Fresh-Water, Notices of New: ALFRED C. STOKES.

Am. Mon. Mic. Jour., V. (1884), pp. 226-30 (10 figs.).

- Infusorial Order Choano-Flagellata, S. K., New Members of the : ALFRED C. STOKES.
Am. Mon. Mic. Jour., VI. (1885), pp. 5-12 (7 figs.).
- Infusorial Life, Indestructible : JABEZ HOGG.
Eng. Mech., XL. (1885), p. 406, and p. 430.
- Infusorial Teratology, A Little : ALFRED C. STOKES.
The Microscope, V. (1885), pp. 7-11 (10 figs.).
- Live-Cell for Observation with the Microscope, Description of a Convenient Form of : G. M. GILES.
Sci.-Gossip, 1885, pp. 7-9 (2 figs.).
- Meteorites, Microscopic. *Am. Mon. Mic. Jour.*, VI. (1885), pp. 16-17.
- Micro-Organisms, Culture-tubes for. See Culture-tubes.
- Microbes et leur rôle pathogénique, Les : H. DE VARIGNY.
Revue Scientif., XXV. (1885), pp. 38-49.
- Micrometer, Report of Committee on Standard ; Abstract of.
Proc. Am. Soc. Mic., 1884, pp. 220-7.
- Microtome, Caldwell's Automatic.
Quar. Jour. Mic. Sci., XXIV. (1884), pp. 648-54 (6 figs.).
Am. Nat., XIX. (1885), pp. 215-19 (6 figs.).
- Microtome, An Inexpensive. *Sci.-Gossip*, 1885, pp. 7-9 (2 figs.).
- Microscope for Class-room Demonstration, The : W. G. THOMPSON.
Science, IV. (1884), pp. 540-1 (1 fig.).
- Microscope-Objectives and Lenses, The Magnifying Power of : W. H. BULLOCH.
Proc. Am. Soc. Mic., 1884, pp. 183-5.
- Microscope-Objectives, The Universal Screw for : E. BAUSCH.
Proc. Am. Soc. Mic., 1884, pp. 153-9.
- Milovtia nivea*. See Fungus.
- Mite Gall. See *Erincum anomalum*.
- Mounting Medium, A New : H. L. SMITH.
Proc. Am. Soc. Mic., 1884, pp. 186-90.
- Mounting Specimens, A few Hints on Hardening, Imbedding, Cutting, Staining, and : G. DUFFIELD.
Proc. Am. Soc. Mic., 1884, pp. 209-11.
- Muscinées, Recherches sur l'Archégone et le développement du Fruit des : M. F. HY.
Revue Scientif., XXXIV. (1884), pp. 692-5.
- Newt (*Triton cristatus*). See Blastopore, and Primitive Streak.
- Objectives, An Improvement in : E. GUNDLACH.
Proc. Am. Soc. Mic., 1884, pp. 148-52.
- Objectives, Testing, Considerations in : E. BAUSCH.
The Microscope, V. (1885), pp. 1-5.
- Oculars, Report of the Committee on.
Proc. Am. Soc. Mic., 1884, pp. 228-33 (1 fig.).
- Ovules, On the Fecundation of, in Angiosperms : JOHN KRUTTSCHNITT.
Proc. Am. Soc. Mic., 1884, pp. 93-98.
- Peltidea aphthosa* (L.) Ach., Thallusbildung an den Apothecien von : M. FÜNFSTÜCK.
Ber. der Deutsch. Bot. Gesellsch., II. (1884), pp. 447-52 (4 figs.).

- Photography with High Powers by Lamplight; Illustrating Structure of Diatoms: JACOB D. COX.
Proc. Am. Soc. Mic., 1884, pp. 99-104 (9 figs.).
- Photographic Methods: C. M. VORCE.
Am. Mon. Mic. Jour, VI. (1885), pp. 13-14.
- Phryganids, The Development of: WILLIAM PATTEN.
Quar. Jour. Mic. Sci., XXIV. (1884), pp. 549-602 (78 figs.).
- Physostegia Virginiana*, The Fertilization of: AUG. F. FOERSTE.
Am. Nat., XIX. (1885), pp. 168-9 (3 figs.).
- Pollens, Original Method of Staining and Mounting: J. T. BROWNELL.
Proc. Am. Soc. Mic., 1884, pp. 212-13.
- Polycystina, Cleaning and Mounting.
The Microscope, IV. (1884), pp. 280-2.
- Primitive Streak in the Newt (*Triton cristatus*), The Presence of a. See Blastopore.
- Pteris aquilina*, Anatomie der Vegetationsorgane von: P. TERLETZKI.
Jahrb. für Wiss. Bot., XV. (1884), pp. 452-501 (2 pl.).
- Puccinia*, A New British: W. B. GROVE.
Sci.-Gossip, 1885, pp. 9-10 (3 figs.).
- Rhabdopleura*, A Contribution to the Knowledge of: E. RAY LANKESTER.
Quar. Jour. Mic. Sci., XXIV. (1884), pp. 622-47 (38 figs.).
- Scales of Butterflies, Note on the Structure of: ROYSTON PIGOTT.
Eng. Mech., XL. (1884), p. 215.
- Schlittenmikrotom, Neue Construction des Objecthalters am: HERMANN HENKING.
Zeitschr. für Wiss. Mik., I. (1884), pp. 491-6 (2 figs.).
- Section-cutter, On a New Form of: W. A. ROGERS.
Proc. Am. Soc. Mic., 1884, pp. 191-3.
- Sections, Serial: S. H. GAGE.
Proc. Am. Soc. Mic., 1884, pp. 202-8 (3 figs.).
- Silver, The Deposition of, on Glass and other Non-Metallic Surfaces: FRANK L. JAMES.
Proc. Am. Soc. Mic., 1884, pp. 71-80.
- Sphæriaceæ imperfectæ cognitæ: M. C. COOKE.
Grevillea, XIII. (1884), pp. 37-8.
- Spines of Echinoidea, Notes on the Structural Characters of the: F. JEFFREY BELL.
Jour. Roy. Mic. Soc., IV. (1884), pp. 846-50 (6 figs.).
- Spongidaë, Thoughts on the: HENRY MILLS.
Proc. Am. Soc. Mic., 1884, pp. 131-47 (3 figs.).
- Tolles, Robert B., and the Angular Aperture Question. See Angular Aperture Question.
- Tolles, Robert B., Memoir of: GEO. E. BLACKHAM.
Proc. Am. Soc. Mic., 1884, pp. 41-46.
- Vaucheria*, The Life-History of: A. H. BRECKENFELD.
Am. Mon. Mic. Jour., VI. (1885), pp. 2-6 (4 figs.).
- Water-Mite, Red. See *Eylais extendens* (?)

MISCELLANEA.

EARLIEST OBSERVATION OF MULTIPLE IMAGES.—The earliest observer of the phenomenon of microscopic multiple images, was Leeuwenhoek (1632–1723), the Father of Scientific Microscopy. He used the cornea of the eye of the Dragon-fly. ‘When I removed,’ said he, ‘the tunica cornea a little from the focus of the microscope, and placed a lighted candle at a small distance in front, I saw some hundreds of wonderfully minute inverted images of the flame of the candle, and these so distinctly that I could discover the motion or trembling in each of them. Directing my view through the same tunica cornea to the steeple of our new church, I saw the representation of a great number of minute steeples, inverted, and they seemed no larger than the point of a needle seen by the naked eye.’

The compound microscope, of course, by inverting these inversions, shows the images erect. Leeuwenhoek's observations and discoveries were all made with the simple microscope.

EYES OF *TABANUS*.—Every microscopist has noted the geometrical symmetry of the beaded lines formed by the corneules of the compound eyes of insects. To this law of graceful arrangement the eyes of *Tabanus* furnish no exception, notwithstanding the division of the cornea into two distinct regions by the line of demarcation which undulates across it. In the specimen which, examined in its natural state, by reflected light, guides this description, the facets below the common boundary of the two districts have about one-half the diameter of those above it. The observer would naturally expect to see twice as many vertical, or nearly vertical, rows below as above; to find the upper rows in line with only alternate lower ones; and to discover the rest of the lower ones intercalated between their more honored fellows.¹ Owing, however, to obliqueness of direction, the rows of the smaller facets appear of the same number with those of the larger, and continuous with them. This appearance is purchased at the cost of a considerable bending of the beaded lines from their direct course, where they cross the boundary; still, the deflection does not, either mathematically or to the eye, destroy the general symmetry.

¹Such intercalations do, indeed, occur; but only sparingly. In the specimen examined, only three have been observed.

JOURNAL
OF THE
NEW-YORK MICROSCOPICAL SOCIETY.

VOL. I.

MARCH, 1885.

No. 3.

ADDRESS OF THE PRESIDENT, MR. CORNELIUS
VAN BRUNT, DELIVERED AT THE ANNUAL
RECEPTION, FEBRUARY 6TH, 1885.

The members of the New-York Microscopical Society have invited their friends to be present this evening, not for the purpose of listening to an address, but that they may see the interesting and beautiful objects for exhibition under the microscope.

Every branch of microscopical research is so full of interest that no justice can be done in any one direction in an address of this character. I will, therefore, confine my remarks to the improvements made in the microscope itself, and to those subjects of research that are now receiving the most attention.

In regard to the instrument : many improvements have been made in the stand, in methods of swinging the understage and mirror, and in adapting the binocular ;—and many of the most recent stands are models of beauty and good workmanship. But, as a whole, the advance has not been as marked in this direction, as in the making of lenses for high magnifying power. A few years since, the only lenses employed were what are termed dry lenses ; that is, an objective brought down close to the object under examination, by means of the rack and pinion, and used without any intervening medium but the air, as an ordinary hand-lens is used.

With the higher powers, especially, the passage of the rays of light obliquely from the object, through the glass cover, then through the air, and into the lens of the objective, produces a distortion,—as a tea-spoon is apparently distorted by immersion in a glass of water,—the ray being bent by passing from a substance of one refractive index to that of another.

The first improvement was the use of water as the medium between the glass-cover of the object, and the glass of the objective, instead of air. This arrangement produced a lens of

better definition ; and many new forms were seen, and many other forms were better seen than ever before.

Yet a still further advance was made, when a medium homogeneous with the glass, was used, or of the same refractive and dispersive index as glass, instead of water ; and the lenses that give the best definition and show minute objects the clearest are those called "homogeneous-immersion objectives." These lenses, however, with the highest powers in use, are not at all suited to a public exhibition—every motion being magnified as well as the object ; and the delicate adjustments necessary to keep this object in focus, preclude the use of such lenses, except in a very quiet place.

It is often asked, "What are the limits of the powers of a microscope? Have they been reached by opticians?" From our present standpoint, with the known difficulty of grinding small lenses, also with the difficulty of using them satisfactorily, it would not seem possible to go much further in this direction. But we know too little of the forces in this universe, usable by man, to form a correct judgment.

The delicacy of the human ear was not conceived of, until the telephone demonstrated that the ear can hear and appreciate vibrations inappreciable by the most delicate instrument ; and that acoustic vibrations can be transformed into electrical, and back again, until there is, virtually, no limit to the use of the ear but the imperfection of insulation.

In a letter published a few days since, Mr. Thomas A. Edison states that there could be no difficulty in talking over a wire stretched to the moon, and that over the treeless and dry plains of the West, it is as easy to hear one thousand miles as a few miles in a crowded city.

In the same way, the delicacy of the human eye is not yet appreciated. Prof. Rood, some years since, by a very ingenious mechanical method,—described in the "American Journal of Science,"—demonstrated that the eye is capable of seeing with a flash of light lasting the fifty-millionth part of a second.

We have, so far, only used the refractive powers of translucent substances—as glass—to see minute things ; but the future may give us, by other means, a method of seeing—as we now have a method of hearing—ininitely preferable to the one in present use.

A little reflection in regard to the space in which we live, will show us how ignorant we are of the surroundings of our existence; and how inconceivable are the facts—those things that we know to be facts—around us. We cannot conceive of any atom so small that it cannot be divided, or of any extension of space so great that it has no bounds; and it is between these infinities that we live, and are trying to push each way into the unknown;—by the telescope and mathematics into the vast distances outside of this globe, and by the microscope among the minute forms of life, toward the constitution of matter.

Of the constitution of matter, we learn only indirectly. We are all familiar with the molecular and atomic theory. Although it is a theory, something like it must be true; for there is a subdivision that will, if continued, separate all compound substances into their original elements, the atoms of which are smaller than the molecules—such as water into hydrogen and oxygen. Beyond this, it is quite as much a mystery as the outside confines of space.

One thing is evident,—the constitution of matter appears to be adapted to beings of about our size. Many inconveniences would attend a man one-sixteenth of an inch high; every drop of water would be a mountain, and no existence, such as we now have, would be possible. An expansion, instead of reduction, would be equally undesirable, as a moment's thought must show. Still, microscopically, we are far away from either molecules or atoms; for, according to Sir William Thomson's researches on thin films, a molecule of water must bear the same ratio to a drop the size of a pea, as an orange to a globe the size of the earth.

The question is often asked, "How much will the best microscope magnify?" Now, it is not a question of magnifying, at all. It is, "How much can we see when we do magnify?" The commonest lens of one-inch focus, can make a picture of an object—either on a screen or to be viewed by an eye-piece—of two or three thousand diameters; but the whole picture will be so imperfect and obscure, that no detail can be seen; and the eye can see much better when the magnifying power is only sixty or seventy diameters.

So, in regard to the best homogeneous-immersion lenses, the limit of clear vision is five or six thousand diameters. Therefore, the possibility of seeing a molecule by a lens that would

require two hundred and fifty million diameters, is rather remote.

In regard to the objects shown by the microscope here this evening: the magnifying powers range from twenty, to five or six hundred diameters; the *Bacillus* may require a lens magnifying about one thousand diameters.

So much for the microscope as an instrument of research; and although, as before remarked, if we ever see a molecule, it will be by some other method than refraction, we do have before us, shown by the microscope as it now exists, a world of life and beauty, unseen by the unassisted eye. The objects to be seen this evening are from many different fields of research, and it will not be out of place to refer to them, although a short description is appended to each form, in the list of objects distributed. We have eight microscopes showing entomological objects,—insects and parts of insects,—all of which are interesting. The use of the lenses of the compound eye of the beetle (No. 3), and of the mosquito (No. 16), for the purpose of showing multiple images, is worth attention from those who have never seen this curious experiment. The bouquet of butterfly-scales is a very artistic arrangement of minute forms. The *Tingis hyalina* (No. 32) is a very black and objectionable insect in a very nice dress. We have nineteen microscopes devoted to botanical specimens; sections, pollen, diatoms, desmids,—all worth looking at,—four of which are living forms; and two of these (Nos. 39 and 44) show the curious movements of the protoplasm in the cells of living plants. Seven microscopes are devoted to minerals, among which the crystallization of gold in fern-like shapes is one of the most beautiful; three to polarization of salts; two to living infusoria; one to embryology; two to electric light; two to *Bacilli*; the rest to different subjects, among which I would particularly refer to the ciliary action upon the gills of an oyster (No. 10). After looking through this microscope, anyone can be fully aware of the immense amount of vitality that is taken into the stomach with every raw oyster.

Although some of the subjects of research are not of immediate practical value, many of them are, and from further investigation much can be expected.

Much time and effort have been devoted to the first forms of life. As the theory of evolution derives the higher forms from the lower, and as examples of intermediate stages are present

with us, it has been thought that creation is going on all the time, and that it can be shown that forms of life are developed in water, without any previous life for their origin. This, however, is not shown to be true. Indeed, the results of all the experiments so far, show that no life with which we are acquainted, is brought into existence without a previously existing germ, that may be invisible.

One of the first forms of life is "protoplasm." It is the "living portion" of the plant, that which is sensitive, which moves, and which appropriates the food; and in it lies the principle that makes the plant grow.

This is always in constant motion, under the proper conditions of heat and moisture, and is shown under Microscopes Nos. 39 and 44.

There are but few characteristics which distinguish between vegetable and animal protoplasm. Everything, animal and vegetable, begins in a "speck of jelly;" and this jelly-speck in its simplest animal form, the *Amœba*, is found everywhere in water, and has been seen by every microscopist.

Grant Allen, in a recent publication, describes it as follows: "In these minute and very simple animals there is absolutely no division of labor between part and part; every bit of the jelly-like mass is alike head and foot and mouth and stomach. The jelly-speck has no permanent limbs, but it keeps putting forth vague arms and legs every now and then from one side or the other; and with these temporary and ever-dissolving members it crawls along merrily through its tiny drop of stagnant water. If two of the legs or arms happen to knock up casually against one another, they coalesce at once, just like two drops of water on a window-pane, or two strings of treacle slowly spreading along the surface of a plate. When the jelly-speck meets any edible thing—a bit of dead plant, a wee creature like itself, a microscopic egg—it proceeds to fold its own substance slimily around it, making, as it were, a temporary mouth for the purpose of swallowing it, and a temporary stomach for the purpose of quietly digesting and assimilating it afterward. Thus what at one moment is a foot, may at the next moment become a mouth, and at the moment after that again a rudimentary stomach. The animal has no skin and no body, no outside and no inside, no distinction of parts or members, no individuality, no identity.

Roll it up into one with another of its kind, and it couldn't tell you itself a minute afterward which of the two it had really been a minute before."

I will also refer to another subject that has received much attention. Many years since, peculiar forms of life had been found with decomposing animal and vegetable matter. Many forms are described by Ehrenberg, as *Vibrio*, *Bacterium*, etc. They are now named *Micrococcus*, *Bacterium*, *Bacillus*, *Vibrio*, *Spirillum*, and they are simple granules, duplicate cells, rods and spiral filaments, nearly all possessing the power of motion, usually by flagella,—or vibrating hairs,—and can be seen satisfactorily only by the best lenses. It remained for Professor Tyndall to show that no decomposition can take place without this life; and that solutions of materials that are ready for decomposition will not be changed if placed in an atmosphere of perfectly pure air. Further investigation has shown that characteristic forms of minute life accompany disease; and we have not only *Bacillus tuberculosis* of Consumption (No. 34), and Cholera Bacillus (No. 35), but a host of other Bacilli.

The question that interests us is, Do these forms produce disease, or do they only accompany the disease as their product? Every house-wife knows quite as well as Prof. Tyndall, that perishable substances can be kept in a jar for a long time without change, by hermetically sealing the jar at the temperature of boiling water. But the workers with the microscope have found the reason why: and that is, that these forms of Bacilli and Bacteria that always accompany decomposition, are necessary to it; that they are mostly destroyed by heat at the temperature of boiling water; and that the germs of these forms are everywhere present in ordinary air, and no decomposition takes place if such air be excluded after the destruction of these forms. Very naturally it is inferred that the Bacteria produce the decomposition, and also that the Bacilli of Cholera, Tuberculosis, etc., produce these diseases.

These are yet open questions. Much of the life-history of these forms has been learned, many experiments have been made, and the literature of the subject is becoming large. Although inoculation with some forms has produced disease, there is a great diversity of opinion in regard to this matter; and many more experiments are needed to decide this momentous question.

The objects shown here this evening do not exactly represent the work of the Society. That is shown by the papers read during the year, and by the discussions at our regular meetings.

This Society is organized for the purpose of increasing our knowledge on every subject in the investigation of which a microscope can be used. Our knowledge is limited. We have, as individuals, and collectively, obtained but a glimpse of this great universe ; and in that part of the universe revealed by the microscope, we have nearly everything yet to learn.

Slowly, year after year, the microscope has improved. Year after year, a little has been added to the general stock of knowledge, each acquisition only showing us how vast is the unknown yet to become known. We have, however, the beginning. In each direction a little has been accomplished, and it is for combined effort and work that our Society has been formed. I am proud of the work that has been done during the past year. Many new facts have been learned ; many interesting discussions about known facts have taken place, and many papers have been read that are worthy of preservation. Also excellent exhibitions of objects under the microscope have been given at every meeting. In short, our Society has been a "success" in every way, and we would desire our friends to enjoy it with us.

In the pursuit of Microscopy there is a keen enjoyment—an enjoyment, of which the ignorant can form no conception—an enjoyment that goes through life to the end.

THE LIFE OF AN OYSTER.

BY PROF. SAMUEL LOCKWOOD, PH.D.

(Delivered February 20th, 1885.)

LADIES AND GENTLEMEN :

The time was when it was enough to say of a living thing, that it lived. You remember the Fool's question in King Lear,—

“Canst tell how an oyster makes his shell?”

This was simply a proverb of old. Here was a little creature, a mere clot of animate jelly, capable of building for itself a house of stone. How it did it, who could tell? No one. The Fool's question was a puzzle to the wisest. Indeed, then, and long after, it was hardly safe to seem to know too much. To-day, however, the question may be put, not only how does the oyster make its shell, but also how does the egg make the oyster? Science, now, can describe the building of the house, and can narrate the life-history of the builder and occupant.

Two years ago I lectured in this place on the oyster. I desire that my address to-night shall be wholly distinct from that one. Yet, as my lecture-notes are always very brief, it is easy to forget what was said so long ago; hence I shall trust to your charity, should I unwittingly at some point repeat myself. I recollect that the longest part of that lecture was devoted to the physiology of the oyster—that the three vegetal systems were discussed at length; namely, the nutritive, or food system; the circulatory, or blood system; and the respiratory, or breathing system. The nerve system was also considered in detail. Now, my desire when coming here was to make no reference to any of these four sets of functions. But I have been requested to dwell a little upon the nutritive, or digestive group of functions; and this I am glad to do, because it will enable me to speak of an organ, the use of which was not known at the date of my former lecture.

You will remember that I had some large carefully drawn diagrams. The fear of repeating myself induced me not to bring them; hence you will please follow my rude illustrations on the blackboard. I will now with the crayon outline an oyster shell. This is the right valve, the [one from which the

mollusk is eaten when taken on the half-shell. This large spot which I make is the adductor muscle, with which the creature pulls together its shells. It is the part which is cut through with the knife when the caterer opens the bivalve. Well to the left of this I draw four plates, or leaves, so lying on one another as to show their outer edges, which give the appearance of a frill. This series of plates constitutes the gills, or breathing apparatus. Now, here we find the inner edges of these four plates to be, so to speak, soldered together, making the base of the gills; and along this base, in rows, is a series of holes. The plates are really composed of an infinite series of microscopic tubes, each tube being like a tiny flute with holes on the side. The water enters between the plates, and as the surface of the tiny tubes is covered with cilia, or fleshy hairs, these keep up a lashing by which the water is driven through the gill-tubes, and the air contained in the water is deprived of its oxygen; after which the disaërated fluid passes out at the holes in the bases of the gills. The coarse cilia, or beard, on the edges of the mantle, or thin film which enwraps the oyster, by their action make an eddy at the opened valves, into which the water rushes, bringing in the food. The outer surface of the gills is covered with the minute cilia, all helping to drive the inflowing current upward. Here at the uppermost end of the oyster, near the hinge, are four little plates, not lying upon one another, as the gill-plates do, but standing together, as it were. These are the labia, or lips of the oyster; for, in fact, the creature's mouth is simply the orifice between these two pairs of lips. When the food-laden water reaches this spot, the lips begin a sorting process, by which that which is fit for food is allowed to enter, and the unfit is rejected. The oral aperture is almost immediately over the stomach, the passage being too short to be properly called a gullet, or œsophagus. Yet the word is convenient. Thus the stomach receives the food immediately. The dark gray mass in which this organ is imbedded, is the liver. The oyster's stomach is, literally, inside of its liver. Let us now note the course of the intestinal tract. Beginning at the lower end of the stomach, or where in our own structure would be the pylorus, the intestine runs to a point considerably beyond the middle of the adductor muscle, between that and the gill bases. Here it doubles upon itself. Then, returning, it passes

through the liver to a point near the oral cavity, or mouth, which it sweeps nearly over; and, winding round the liver on its other side, and then going beneath that organ, it passes beyond to the other side of the adductor muscle, in front of which the vent rests in an open space which we will call the cloaca. Here it voids its indigesta, which are immediately committed to the sea.

The liver, as you know, is bitter, a quality which the Roman epicures prized highly. But we must dwell here a minute longer, to describe the remarkable services which this large organ renders to the stomach of the oyster.

But, first, a word as to the oyster's food. A part is composed of infusoria, often called animalcules, little creatures invisible to our unaided eyes. These are easily digested. This is probably true also of the sporules of algæ, and even the unicellular algæ themselves. It is not true, however, of a large part of the oyster's food, such as the minute copepods, tiny crustaceans with limy shells; and the swarms of diatoms, very minute plants with siliceous shields, which even resist the action of nitric acid. An oyster's stomach is of itself a helpless affair. It has no triturating surface, or secretors of solvent acid. But it draws all it needs, from the liver. In the walls of the stomach are openings continuous into small tubes in the renal mass. Here are the bile secretions, and those of the pancreas; also the salivary glands, and the gastric follicles. We see, therefore, why the stomach is placed inside the liver,—that organ is really the laboratory of the necessary dissolvents of the oyster's food.

Now it may be that one important ingredient which is contained most richly in gastric juice, is supplied but feebly, if at all, from this renal source. You who like tripe hardly need be told that it is not strong food, but is of easy digestion, because of the pepsin it contains, derived from the gastric follicles of the bovine stomach. The action of pepsin is probably that of a ferment, while that of the other substances mentioned may be chemical and mechanical. Lately the microscope has given a hint in this direction, and a hint to the scientist is sometimes a Godsend leading to a discovery. Here you see a little organ, like a tiny white thread of vermicelli. It lies almost parallel to the intestines, and one end of it penetrates into the stomach, at its lower end. This is called the crystal-

line style, or rod ; and a notable fact is that under the microscope it does not reveal the slightest cell structure, as a tiny morsel taken from the oyster anywhere else certainly would. What I mean is that the substance of this style is homogeneous, as if it were made of simple gelatine. Now for the hint to which I have alluded. The part, or end, which is inside the stomach, like the end of a stick of candy in the baby's mouth, is abraded, or melted away in part. The surprising fact, then, is the almost perfect certainty that this organ supplies pepsin to the oyster's stomach—a conclusion which has only been reached within a few days past, from the study of this organ in other mollusks.

But you observed the extraordinary length of the intestine—nearly three times that of the oyster's body. Now, as the food is lashed along by the numberless cilia inside the intestine through its entire length, and as the nourishing juices are taken through the walls by osmosis, you see that this arrangement subjects the entire food-supply to a thorough absorption. But the length is not all the wisdom in this digestive scheme. The intestine is not a simple cylinder. A cross section shows a convolute inner wall ; it is as if a small cylinder were soldered by one side along the inside of the large cylinder along its whole length, thus increasing immensely the absorbing surface.

You may think it wonderful that the oyster should grow so fast upon such minute food. I have lately been compelled to study this matter up. Some months ago a live sea-horse was brought to me. Her scientific name is *Hippocampus heptagonus*, but we named her Hippie. It has been a joy to me to have kept her in good condition so long. But it has required some management. The fisherman who brought it was asked how it should be fed. "Oh," said he, "it is n't a fish, and so don't feed, but lives on suction." He spake wiser than he knew, as this singular fish does live entirely on microscopic life. I will tell you my secret—how I managed the matter. I gave her an aquarium to herself, and kept two large jars for breeding animalcules ; that is, infusoria, &c. But these invisible things need nitrogen, and an aquarium should be absolutely clean. The problem seemed to be, how to have it clean and dirty at the same time. Now, if you drop into your aquarium a bit of fresh beef, and let it be until, like the peddler's fish, it has become a

little mellow, it will generate nitrogen, and that will quicken the breeding of infusoria. When, by microscopical examination, I find that this food-supply is getting low, I transfer Hippie to one of the large jars ; and, if that gives out, I place her in the other jar. By this time the larder at home is resupplied, and the little creature is restored to her proper place.

So far we have got along without much technical discourse. As I must note the leading kinds, or species, of oysters, we must resort to a few scientific names. In the extreme South there is a long narrow oyster called the strap oyster, and, by the negroes, coon-heel. In southern New Jersey, in the mouth of the Delaware, on the crowded beds, the oysters, for want of room, will grow standing on their heads ; hence they elongate. These are known as stickups. But these and some other forms are but variations of our common oyster along the entire eastern coast-line, and are all one species known as *Ostrea Virginiana*. Europe has three species. The one common to England and France, and some other places on the Continent, is *O. edulis*. On reaching Italy we find the little oyster known as *O. plicatula*. You have heard of that greediest Roman of them all, that imperial gourmand Vitellius, who ate a thousand oysters at a sitting, and who, after having the royal fauces tickled with a feather by a slave, would disburden his stomach, then fill it afresh. Perhaps the transaction was possible with the little *Plicatula*. But what about such specimens as the *Virginiana*, which Mr. Thackeray was invited to grapple with in Fulton Market ? Three individuals filled his plate. Said an English lady to whom he was relating his experience : " Why, Mr. Thackeray, what were your feelings ? " " Well, I felt, in attacking but one of them, that it was like trying to swallow a baby." A thousand " Virginias " would have been trying to the vitals of Vitellius. The fourth oyster to be mentioned is the one whose original home seems to be the Tagus, in Portugal. This species is *Ostrea angulata*. It is said to be the one whose shells were used in the ostracism, or vote of banishment, in ancient Greece.

The four species mentioned are all that have any place in commerce. The oyster native to France, Northern Europe, and England, is the *O. edulis*. This species, and the Italian, *O. plicatula*, are hermaphrodite, or bisexual, while the Portuguese, *O. angulata*, and the American, *O. Virginiana*, are unisexual.

In these species, as among the fishes, there is a true spawning of eggs by the female, and a fecundating of them in the water which has been fertilized by the presence of the male. But with *O. edulis*, and *O. plicatula*, there is no spawning of eggs at all. The eggs are retained between the lobes of the animal, and there hatched, and when emitted into the water, are already well advanced, each having a pair of perfectly formed shells.

The English oyster, *O. edulis*, is capable of producing a million and a half of spawn in a season. But it is shown to a demonstration that our American bivalve, *O. Virginiana*, can produce in one season, that is, in the r-less months, from twenty, to twenty and a half millions of spawn. But these are simply eggs, and do not get the start of the spawn which is emitted already hatched. However, I do think that there is some relation between our American push, and our physical environment. It is a characteristic of the country. An insect ordinarily well-behaved on the other side of the ocean, so multiplies, if it but immigrate here, as to become a pest and a defiance.

How does the oyster make his shell? At a recent meeting of the American Association for the Advancement of Science, a paper was read asserting that the extreme age of an oyster is twenty years. Now I had previously, in an article in the Popular Science Monthly, demonstrated that an oyster might be in fair edible condition at the age of thirty years. Here are the shells of one of the oysters on the characters of which the statement was based. This double shell is thirty years old, and the enclosed mollusk was large, and in fair condition. But of this specimen, more anon. In building its shell the oyster starts with the hinge end, at the spot known to conchologists as the *umbo*. A small plate, or single scale, now represents each valve, and that is the first season's growth. The next season a new growth, or plate, shoots out from underneath the first one, just as shingles do. The oystermen call these laps, or plates, "shoots," and they claim that the number of shoots indicates the years of the oyster. They certainly do contain a record of the seasons, showing the slow-growing and the fast-growing seasons. But there is often great difficulty in clearly differentiating these shoots. The record is often obliterated in places by the growth of parasites, which build their shells or tubes upon the oyster. I have likened these shoots to shingles. Now, at the gable of a

house these shingles may be seen edgewise. So on the side of an oyster-shell is a series of lines. This is the edgewise view of the shoots, or season-growths. Another factor is this purple spot, or scar, in the interior of the shell. It is the place of attachment of the adductor muscle. Its first place of attachment was close up to the hinge. Had it stayed there until the shell had become adult, how difficult would be the task of pulling the valves together! the leverage to be overcome would be so great; for we must bear in mind the fact that at the hinge end the valves are held by this black ligament, which is, in life, elastic, swelling when the shell opens, and being compressed when the animal draws the valves together. So, with every year's growth, or elongation of the shell, the mollusk moves the place of attachment of the muscle onward, that is, an advance farther from the hinge. As it does so, it covers up with white nacre all the scars that are back of the one in actual use as the point of attachment of the muscle. This you can prove by eating off with nitric acid this covering, and thus exposing the whole life-series of scars, or attachments.

I have likened the oyster's shoots, or season-growths, to the shingles on a roof. To make the similitude complete, it would be necessary for the bottom shingle on the roof to underlie the whole series, and reach even to the roof-tree, or ridge-pole. Then the second shingle from the gutter must in like manner underlie all the rest of the series; so of the third; and so on with the rest. In this way lie the shoots, or laps, of the oyster's shell. The last one deposited underlies them all, and every one terminates at the channel in the bill—so that this groove in the bill contains a series of transverse lines, each one marking a season, or year. Thus we get really four factors for the solution of the question, "How old is the oyster?" all of which are the outcome of the method or way of making the shell.

Now for the story of the shell in my hand. This, with another, was given me by an intelligent oyster-raiser at Keyport, N. J., with the question, "How old are they?" My answer was: "About thirty years." Said he: "You have hit it. In 1855 I planted a bed of oysters on a clean sandy bottom. But they did not do well. Oysters want, at least, a little mud. The next year we took them up for the market; but they were poor. So we dredged the bed, and did not plant there again. This year

I thought we would examine that bottom, and, to my surprise, we took up these two oysters, which evidently were left of that planting thirty years ago. I opened them, and they proved to be of fair quality." Does not this agreement between the naturalist and the oysterman deserve to be called a demonstration?

How does the oyster begin life? I shall now speak only of the American oyster, whose earliest babyhood is so different from that of the English mollusk—since theirs is emitted in an advanced stage of development, while ours is emitted simply as an egg. In the r-less months, our oyster-beds are, many of them, marked by the appearance of little clouds of a milky hue. These proceed from the female oyster, which snaps its shell, and thus emits its spawn into the water. The male, in like way, emits the fecundating milt; but, to the eye, this is invisible. The eggs, sinking to the bottom, fall in with some of the milt in the water, and the spermatozoa at once attach themselves to them. As seen under the microscope, the tiny egg becomes like a bur; that is, as if it were beset on the surface with cilia. In a word, it is fecundated, and with this addition of life it mounts up from its bed and floats away. In two or three hours the egg is hatched, and the development of the little creature begins. At first, it is a little triangular thing. It now begins to swim actively. But how does it do it? From what we might call the base of the angle which outlines the little thing, you see a pad projecting. Really it is a brush of cilia, every individual of which is lashing its way with the force of a projectile. In a very few hours a spot appears on each side of the apex of the triangle. Each spot is the beginning of a shell, or valve; and the fact of its beginning where it does, at what we have already called the umbo, has caused Dr. John Ryder to name this the umbo stage of the oyster's life. Nature in her work with an egg seems to delight in developing toward a side. In this way she starts a fish, a reptile, a bird, and a mammal. But our "midget" oyster is perfectly symmetrical—each valve, or side, is the exact counterpart of the other.

This roving life of the embryo oyster exposes it to infinite perils. It is certain that of the twenty or thirty millions of eggs emitted, not more than an average of two or three individuals will attain a size fit for the market. If all were to survive, such

would be the growth of oyster-beds that coastwise navigation must cease. But the waste is simply enormous—so many are the enemies and so various the perils of the infant mollusk. To devise wise methods of artificial culture is now the great problem on which the scientific men of the U. S. Fish Commission are at work. That done, we may hope for some arrest of this stupendous waste.

I suppose our young oyster to have stopped his roving life. He has made an attachment, wise or unwise. And strange attachments he does sometimes form. I have in my collection quite a display of eccentric, if not discreditable ostrean alliances. I have one oyster which is hugging desperately a ring-bolt, another devotedly attached to a decanter, and, again, no less than half a dozen ardently attached to a whiskey bottle. Whatever may be the object chosen,—and anything will do that serves as an anchorage,—the mollusk, if not disturbed, stays there for the rest of its natural life.

Let us suppose our little oyster now attached to its object. It is yet the merest atomy of life—a microscopic object—and, it is likely, not much over a day old. But in that atom, and during that time, how rapidly the life forces have worked! The little thing now puts all its powers at house building. First, it lays the foundation by placing itself on its left side, in order that the hollow, or dish-shaped valve, may be cemented to its anchorage. There is now a secreting and exuding of a horny substance, of a mucilaginous consistency, which is called concholine. This is laid down on the rock, or other support, in a meshy form, just like a tiny wad of the finest conceivable lace. Into these meshes percolates the carbonate of lime held in solution by the sea water. In this way is the foundation laid. Next, there is a spreading out of the shells on asymmetrical lines—for the valves are becoming unequal and dissimilar. But during this foundation work, what about food-getting? Perhaps we shall see.

One of the first serious studies of my young days, in Zoology, was the question, What becomes of the tadpole's tail? I carried a tadpole into froghood. He had ceased to be a gill-breather, and, having lungs, must emerge from the water, and come to the air. Nor could he any longer live on carrion and putrid plants. He must now hunt the living insects. Such a change is hardly less than a shock. I observed that my frog kept still, but bear-

ing his tail behind him, which, of course, was the proper place, if he must carry it at all. Now it was just this "at all" which perplexed me. The books said that the tadpole's tail is lost by atrophy—that is, that it dries off. Nonsense! Nature does not entail such a waste of the raw material. I watched the frog day by day, and discovered that the caudal annex was being absorbed. It was getting shorter, but the shortening was going on at the thick, or proximal end. Now, so it was—every particle of that appendage was taken in. This done, the animal had to forage for subsistence. And similarly is it with our baby oyster while laying the foundation, and shaping its house. That prominent organ, the swimming pad, is getting absorbed—for it is now its food-supply. It is now developing internally, for as yet there is but little more than the beginning of things. The intestine is simply a short, straight organ, and is not yet convolute. But the liver is very large; in fact, it quite preponderates.

And what of *Ostrea's* life? Who are her friends? There is a pretty red branching sponge, which often grows upon the oyster, *Microciona prolifera*. Formerly it was very common. It is less so now. This sponge often serves the oyster well, in buoying the bivalve up when sinking in the mud. It is also in its way a grove in which the infusoria breed, and so supply food to the mollusk. The oyster, too, has a gay "commensal." I like this pretty old word of Chaucer, meaning one who dines at our table, and is welcome there. Of course, all this precludes the idea of a parasite. This gay little commensal is a red and white crab hardly larger than a pea. It lives literally in the oyster, ensconced between the folds of the mantle—but it does not live upon its host. Between them both there seems to be a good understanding. It is the female *Pinnotheres ostreum*. Experienced oystermen have told me that it is rarely found except with oysters in good condition. The curious fact is that it is only the female *Pinnotheres* that lives in the oyster. The male is often seen floating on the surface of the water, with a pretty white anchor on his jacket, the gay little sailor that he is. His general hue is brown. He has a harder shell than the female, whose shell is thin and transparent. The truth is that, though twice as large as the male, she is very tender, and her coddling life as a commensal, is a necessity. The red sponge I have mentioned is called by the oystermen "red-beard." There is another

object that delights to grow upon the oyster, which they call "gray-beard," and sometimes "gray-moss." It is one of the Bryozoa. The one that I have often found is *Sertularia argentea*, an exquisite creature ; for, though looking like a delicate silvery alga, it is not a plant at all, but a finely branching Zoophyte, or community of exquisite living animal florets. This serves the oyster well, in much the same way as does the red sponge.

But our oyster has many enemies. The boring yellow sponge, *Cliona sulphurea*, eats very minute holes into the shell, so numerous, and so winding, as in some instances to cause the shell to fall in pieces. These minute holes, under the microscope, show gouges at their edges, as if they had been cut with chisels, like post holes. But the process is as yet a mystery. The great winkles, *Sycotypus canaliculatus* and *Fulgur carica*, with their file-tongues will rasp off the nib end of the oyster shell, then introduce the sucking siphon, and so consume the mollusk at their leisure. The little drill, *Urosalpinx cinerea*, is a severe pest. This shell and the two just mentioned are spiral univalves. The drill is a small shell rarely measuring three-fourths of an inch in length, and its lingual ribbon, or file-tongue with its armature of several rows of sharp teeth, is microscopic. I have watched it at work, and I think that the little burglar bores a hole through the oyster's house by crooking its tongue, as I do my finger, letting the knuckle represent the bend, or crook of the file-tongue, in which case the teeth would stand out like a brush ; which brush twisted around and back again, in a three-quarter or perhaps entire circle, would represent the action of a drill. The hole is always perfectly symmetrical, and generally is counter-sunk at the place of starting. The hole completed, the tiny siphon tube of the mollusk is introduced, and the soft parts of the oyster are taken up. Sometimes the drum, *Pogonias chromis*, inflicts severe damage on an oyster-bed. This singular fish has in the upper part of its throat very large, and solid, pharyngeal bones, which are covered with closely set hard round pavement-teeth, not unlike the cobble-stones of old. With its front teeth it picks up an oyster, and it crushes it with the pharyngeal teeth, and then swallows it. This fearful creature gets its name from a booming noise which it is able to make. One year a school of drums entered Raritan Bay, and destroyed many thousands of dollars' worth of oysters in a single night. Except-

ing man himself, the worst enemy of the oyster is the five-finger, or sea-star, *Asterias arenicola*. A sea-star is an object with five rays, and is of the consistence of soft leather. If we turn it over we observe a canal along each ray, or finger, through its entire length. On each side of this canal is a row of ambulacra, or little feet, each with a sucking disc at its extremity. At the centre, or base, of the rays is the oral cavity, in which is the stomach sack, which is capable of being everted and protruded. It is a blind sack, but its walls will, by osmosis, take up food. With these five rays, and their thousands of little suckers, it will grasp an oyster ; and, waiting until the mollusk opens, be it never so little, it will thrust in its everted stomach, and suck out the oyster's life. I have not demonstrated the point, but my belief is that the sea-star has some urticating power, and even paralyzes its victim. To the oyster-raiser, the star is often a calamity. Many thousands of bushels are sometimes taken by it in a season from the beds. Other enemies there are, but time is wanted to speak of them.

I must say a word on the pearl. Though not the pearl oyster, our mollusk is a pearl maker. Nacre, or mother of pearl, constitutes, to a greater or less extent, the shells of all oysters. But the isolated individual pearl, that which is accounted a gem, and the worthy decoration of a bride, is always an enforced product. It is made upon occasion of inconvenience, suffering, or disease. It was a pretty coincidence this morning, that, having just finished thinking out the brief for this address, I looked into Shakespeare, and alighted on that expression of Touchstone : " Rich honesty dwells like a miser in a poor-house, as your pearl in your foul oyster." It is surely interesting that this wisdom of the poet, drawn from the proverbial lore of the people, finds its verification in science. The pearl is the outcome of suffering. It is elaborated in distress. So delicate, so mild, so exquisite. It is already perfect—the one only gem that does not ask the lapidary's skill. And how many a precious thought, having passed through the alembic of suffering, has crystallized into a living form, a thought-pearl of purity, ethereal and immaculate !

And now, my friends, if our discourse has enabled us to know better one of God's lowly little creatures, we have done well, since it will help us to love the creator more.

PROCEEDINGS.

MEETING OF FEBRUARY 6TH, 1885.—THE ANNUAL RECEPTION.

The first meeting of the Society in February is the Annual Reception. At this meeting the regular order of business is suspended, the President whose term of office has expired, delivers an Address, the newly elected officers assume their duties, and an exhibition of microscopic objects is given for the entertainment of the Society's guests.

On the evening of February 6th, 1885, the Society gave its seventh Annual Reception. For the accommodation and gratification of its guests, the auditorium, with side-room, of Lyric Hall, at No. 723 Sixth Avenue, and the services of Mr. C. W. Stub and his orchestra, had been engaged for this occasion. The President, in his Address, reviewed briefly the recent improvements in the construction of microscope-stands and objectives, and presented some thoughts on the capabilities of the instrument and on certain parts of its field of work. The Address is published in full in this number of the JOURNAL.

At the close of the Address, the doors of the side-room were thrown open. In this room had been arranged sixteen round tables, and on each were three microscopes with their objects. The list of objects, with their linear magnification and the names of their respective exhibitors, is given below.

1. *LIQUID-CAVITY IN A RUBY.* × 50.
Exhibited by G. F. KUNZ.
2. *MICROSCOPIC CRYSTALS OF GARNET.* × 25.
Exhibited by G. F. KUNZ.
3. *MULTIPLE IMAGES OF THE WORDS, THE SUN, FORMED BY EYE OF BEETLE.* × 400.
Exhibited by F. W. LEGGETT.
4. *RADIAL LONGITUDINAL SECTION OF TAMARACK (Larix Americana), SHOWING MEDULLARY RAYS.* × 550.
Exhibited by P. H. DUDLEY.
5. *THE CUCKOO-BEE (Chrysis); MOUNTED ENTIRE, IN GLYCERINE* × 20.
Exhibited by the REV. J. L. ZABRISKIE.
6. *FLOWER OF CLAYTONIA VIRGINICA.* × 25. ;
Exhibited by F. COLLINGWOOD.

7. *THUIDIUM; A MOSS: SHOWN BY POLARIZED LIGHT.*
 × 50.
Exhibited by W. G. DE WITT.
8. *FOOT OF SPIDER.* × 75.
Exhibited by W. G. DE WITT.
9. *POLLEN OF PERIWINKLE (Vinca rosea).* × 250.
Exhibited by E. A. SCHULTZE.
10. *CILIARY MOTION IN THE OYSTER.* × 65.
Exhibited by F. W. DEVOE.
11. *BRANCHIAL CIRCULATION IN EMBRYONIC AXO-
 LOTL.* × 20.
Exhibited by F. W. DEVOE.
12. *TRANSVERSE SECTION OF STEM OF PEPPER-
 PLANT.* × 30.
Exhibited by E. C. BOGERT.
13. *INFUSORIA, FROM INFUSION OF HAY.* × 400.
Exhibited by F. Y. CLARK, M. D.
14. *GOLD AND TIN FOIL: SHOWN BY ELECTRIC
 LIGHT.* × 25.
Exhibited by F. Y. CLARK, M. D.
15. *ARRANGED DIATOMS.* × 40.
Exhibited by F. B. GREEN.
16. *MULTIPLE IMAGES OF A ROTATING*  *, FORMED
 BY EYE OF MOSQUITO.* × 800.
Exhibited by J. D. HYATT.
17. *TRANSVERSE SECTION OF STEM OF SERJANIA, A
 SOUTH AMERICAN VINE.* × 50.
Exhibited by C. F. COX.
18. *TRANSVERSE SECTION OF INFANT'S TONGUE.* × 90.
Exhibited by HORACE W. CALEF.
19. *ELECTRICAL RAIN—ELECTRIC SPARKS FROM AN
 INDUCTION COIL.* × 70.
Exhibited by EDWARD G. DAY.
20. *HEAD OF TIGER-BEETLE.* × 30.
Exhibited by EDWARD G. DAY.
21. *SECTIONS OF HUMAN HAIR, SHOWING THE PIG-
 MENT IN THE CELLS.* × 1,200.
Exhibited by M. M. LE BRUN.

22. *ARBORESCENT CRYSTALS OF OXALURATE OF AMMONIA.* × 70.
Exhibited by C. W. McALLISTER.
23. *BOUQUET OF BUTTERFLY-SCALES.* × 30.
Exhibited by C. W. McALLISTER.
24. *JAWS AND TONGUE OF WASP.* × 30.
Exhibited by M. H. EISNER.
25. *ARACHNOIDISCUS EHRENBERGII, IN SITU ON ALGA.* × 50.
Exhibited by W. WALES.
26. *ISTHMA NERVOSA, IN SITU ON ALGA.* × 50.
Exhibited by W. WALES.
27. *MICRASTERIAS AMERICANA; A DESMID.* × 175.
Exhibited by A. D. BALEN.
28. *FERN-LEAF GOLD CRYSTALS.* × 30.
Exhibited by G. S. WOOLMAN.
29. *CRYSTALS OF KINATE OF QUINIA, SHOWN BY POLARIZED LIGHT.* × 50.
Exhibited by G. S. WOOLMAN.
30. *PARAMECIUM BURSARIA; A CILIATED INFUSORIAN.* × 125.
Exhibited by A. D. BALEN.
31. *SECTION OF TWIN PEARL.* × 30.
Exhibited by H. M. DICKINSON.
32. *TINGIS HYALINA; AN INSECT OF THE ORDER HEMIPTERA.* × 20.
Exhibited by H. M. DICKINSON.
33. *STELLATE HAIRS ON LEAF OF BUCKTHORN.* × 50.
Exhibited by M. M. LE BRUN.
34. *BACILLUS TUBERCULOSIS.* × 1,050.
Exhibited by L. SCHÖNEY, M. D.
35. *COMMA-BACILLUS OF CHOLERA.* × 450.
Exhibited by L. SCHÖNEY, M. D.
36. *RUBY COPPER, FROM CORNWALL, ENGLAND.* × 30.
Exhibited by W. H. BATES, M. D.
37. *ARRANGED DIATOMS.* × 50.
Exhibited by C. VAN BRUNT.

38. *POLYCYSTINA*. × 30.
Exhibited by C. VAN BRUNT.
39. *CYCLOSIS IN NITELLA*. × 100.
Exhibited by W. R. MITCHELL.
40. *VERTICAL SECTION OF CONVOLUTION OF HUMAN CEREBELLUM*. × 30.
Exhibited by S. A. BRIGGS.
41. *SECTION OF DERBYSHIRE COAL, SHOWING CONIFEROUS STRUCTURE*. × 55.
Exhibited by S. A. BRIGGS.
42. *CRYSTALS OF SALICINE: SHOWN BY POLARIZED LIGHT*. × 25.
Exhibited by GEN. WAGER SWAYNE.
43. *SPIROGYRA*. × 50.
Exhibited by WALTER H. MEAD.
44. *CYCLOSIS IN ANACHARIS*. × 450.
Exhibited by WALTER H. MEAD.
45. *GOLD SAND, FROM CALIFORNIA*. × 45.
Exhibited by J. WARNOCK.
46. *POLLEN OF MORNING GLORY (Ipomœa purpurea)*. × 55.
Exhibited by J. L. WALL.
47. *CIRCULATION OF BLOOD IN THE FROG*. × 50.
Exhibited by J. L. WALL.
48. *PERISTOME OF THE MOSS BARTRAMIA POMIFORMIS*. × 37.
Exhibited by B. BRAMAN.

MEETING OF FEBRUARY 20TH, 1885.

The President, Mr. C. Van Brunt, in the chair.

Sixty-seven persons present.

Prof. Samuel Lockwood, Ph.D., addressed the Society, at their request, on the Life of the Oyster.

At the close of the Address, the President stated that the members of the Society, with their friends, had been cordially invited to meet Prof. Lockwood socially, immediately after the adjournment, at the residence of Mr. Devoe.

Prof. Lockwood's Address is published in full in this number of the JOURNAL.

PUBLICATIONS RECEIVED.

“Easy Experiments” ; pp. 40. By A. R. Horne, M. D.

Journal of the Cincinnati Society of Natural History : Vol. VII., No. 4 (January, 1885) ; pp. 67.

Proceedings of the American Society of Microscopists : Seventh Annual Meeting, Rochester, N. Y., 1884 ; pp. 300.

Johns Hopkins University, Baltimore, Md. Studies from the Biological Laboratory : Vol. III., No. 2 (December, 1884) ; pp. 72. Circulars : Vol. IV., No. 36 (January, 1885) ; pp. 10.

Preliminary List of Parasitic Fungi of Wisconsin ; pp. 40. By William Trelease. 1884.

American Exhibition, London, 1886. Three Pamphlets from John Robinson Whitley, Director-General and Executive Commissioner.

Drugs and Medicines of North America : Vol. I., No. 3 (October, 1884) ; pp. 32.

Electrician and Electrical Engineer : Vol. IV., No. 38 (February, 1885) ; pp. 44.

Bulletin of the Brooklyn Entomological Society : Vol. VII., No. 10 (February, 1885) ; pp. 12.

The American Monthly Microscopical Journal : Vol. VI., No. 1 (January, 1885) ; pp. 20. No. 2 (February, 1885) ; pp. 20.

Anthony's Photographic Bulletin : Vol. XVI., No. 1 (January 10th, 1885) ; pp. 32. No. 3 (February 14th, 1885) ; pp. 32.

School of Mines Quarterly : Vol. VI., No. 2 (January, 1885) ; pp. 96.

The Microscope : Vol. V., No. 1 (January, 1885) ; pp. 24. No. 2 (February, 1885) ; pp. 24.

Ottawa Field-Naturalists' Club : Transactions No. 5, Vol. II., No. 1 (1883-1884) ; pp. 152.

The West-American Scientist : Vol. I., No. 3 (February, 1885) ; pp. 7.

Bulletin of the Torrey Botanical Club : Vol. XII., No. 1 (January, 1885) ; pp. 12.

INDEX TO ARTICLES OF INTEREST TO MICROSCOPISTS
WHICH HAVE RECENTLY APPEARED IN OTHER
JOURNALS.

Algæ, Fresh-Water : FRANCIS WOLLE.

Bul. Torrey Bot. Club, XII. (1885), pp. 1-6 (37 figs.).

Angiopteris evecta. See *Osmunda*.

Archerina Boltoni, nov. gen. et sp., a Chlorophyllogenous Protozoon, allied to
Vampyrella, Cienk : E. RAY LANKESTER.

Quar. Jour. Mic. Sci., XXV. (1885), pp. 61-73 (26 figs.).

Blastopore, Mesoderm, and Metameric Segmentation : W. H. CALDWELL.

Quar. Jour. Mic. Sci., XXV. (1885), pp. 15-28 (19 figs.).

Botys hyalinalis, On the Embryology of : J. A. OSBORNE.

Sci.-Gossip, 1885, pp. 32-6 (10 figs.).

Chitin, On the Occurrence of, as a Constituent of the Cartilages of *Limulus*
and *Sepia* : W. D. HALLIBURTON.

Quar. Jour. Mic. Sci., XXV. (1885), pp. 173-81.

Chitonidæ, On the Presence of Eyes in the Shells of Certain, and on the
Structure of these Organs : H. N. MOSELY.

Quar. Jour. Mic. Sci., XXV. (1885), pp. 37-60 (30 figs.).

Cholera Bacillus, The : J. M. ADAMS.

The Microscope, V. (1885), pp. 38-40.

Christianite, Crystals of ; under heading Pacific Ocean.

Ency. Brit., 9th Ed., XVIII. (1885), p. 125 (1 fig.).

Comma Bacillus, The, of Koch : GEORGE M. STERNBERG, Surgeon U. S.
Army.

Science, V. (1885), pp. 109-11 (2 figs.).

Diatom ooze ; under heading Pacific Ocean.

Ency. Brit., 9th Ed., XVIII. (1885), p. 123 (1 fig.).

Diatomaceous Forms, Some New, from the " Saugschiefer " of Dubravica : F.
KITTON.

Sci.-Gossip, 1885, pp. 36-7 (3 figs.).

Diatomaceæ, On the Collection and Preparation of the : ALFRED W. GRIFFIN.

Jour. of Mic., III. (1884), pp. 229-36.

Doassansia occulta (H. Hoffm.) Corun. See Fungus.

Embryology, Outlines of (Second paper).

The Microscope, V. (1885), pp. 25-31 (2 figs.).

Eyes in the Shells of Certain Chitonidæ, On the Presence of, and on the Struc-
ture of these Organs. See Chitonidæ.

Fibrin, The Origin of the, Formed in the Coagulation of Blood : WILLIAM H.
HOWELL.

Studies, Biol. Lab., Johns Hopkins Univ., III. (1884), pp. 63-71.

Flustra foliacea, Its Inhabitants and Guests ; under heading A Piece of
Hornwrack : ARTHUR S. PENNINGTON.

Jour. of Mic., IV. (1885), pp. 6-12 (10 figs.).

Fungi, How Live in Winter : BYRON D. HALSTED.

Pop. Sci. Mon., XXVI. (1885), pp. 611-20 (12 figs.).

Fungus, Notes on a, Parasitic on Species of *Potamogeton* : W. G. FARLOW.

Trans. Ottawa Field-Nat. Club, II. (1884), pp. 127-9.

Globigerina ooze ; under heading Pacific Ocean.

Ency. Brit., 9th Ed., XVIII. (1885), p. 123 (2 figs.).

Heterœcismal Uredines, British, On the Life-History of Certain (The Ranuncul *Æcidia* and *Puccinia Schœleriana*): CHARLES B. PLOWRIGHT.

Quar. Jour. Mic. Sci., XXV. (1885), pp. 151-72.

Hydrastis Canadensis; Microscopical Structure : LOUISA REED STOWELL.

Drugs and Med. of N. A., I (1884), pp. 85-6 (4 figs.).

Hypoblast, On the Origin of the, in Pelagic Teleostean Ova : GEORGE BROOK.

Quar. Jour. Mic. Sci., XXV. (1885), pp. 29-36 (7 figs.).

Kupffer's Vesicle, The Significance of, with Remarks on other Questions of Vertebrate Morphology : J. T. CUNNINGHAM.

Quar. Jour. Mic. Sci., XXV. (1885), pp. 1-14 (9 figs.).

Limulus, On the Occurrence of Chitin as a Constituent of the Cartilages of. See Chitin.

Mesoderm. See Blastopore.

Metameric Segmentation. See Blastopore.

Microscope, The, and how to Use it : V. A. LATHAM.

Jour. of Mic., IV. (1885), pp. 22-34.

Microtome, A Freezing.

Sci.-Gossip, 1885, pp. 37-8 (2 figs.).

Morphology, Vertebrate. See Kupffer's Vesicle.

Onoclea, A Third Coat in the Spores of the Genus : DOUGLASS H. CAMPBELL.

Bul. Torrey Bot. Club, XII. (1885), pp. 8-9 (5 figs.).

Osmunda and *Todea*, On the Apex of the Root in : F. O. BOWER.

Quar. Jour. Mic. Sci., XXV. (1885), pp. 75-103 (35 figs.).

Ovum, E. Van Beneden's Researches on the Maturation and Fecundation of the : J. T. CUNNINGHAM.

Quar. Jour. Mic. Sci., XXV. (1885), pp. 107-35 (23 figs.).

Parasitism.

Ency. Brit., 9th Ed., XVIII. (1885), pp. 258-71 (4 figs.).

Pathology.

Ency. Brit., 9th Ed., XVIII. (1885), pp. 361-407 (56 figs.).

Pelvic Fins, On the Translocation Forwards of the Rudiments of the, in the Embryos of Physoclist Fishes : JOHN A. RYDER.

Am. Nat., XIX. (1885), pp. 315-17.

Peronosporæ, On the : GEORGE NORMAN.

Jour. of Mic., III. (1884), pp. 197-214 (49 figs.).

Photomicrography at the Health Exhibition (Brit. Jour. Phot.).

Am. Mon. Mic. Jour., VI. (1885), pp. 28-32.

Protoplasm.

Nature, XXXI. (1885), pp. 290-2.

Protozoon, Chlorophyllogenous. See *Archevina Boltoni*.

Pteropod ooze ; under heading Pacific Ocean.

Ency. Brit., 9th Ed., XVIII. (1885), p. 123.

Puccinia Schœleriana. See Heterœcismal Uredines.

Pulex. Under heading Suctoria.

Trans. Ottawa Field-Nat. Club, II. (1884), pp. 86-90.

Radiolarian ooze ; under heading Pacific Ocean.

Ency. Brit., 9th Ed., XVIII. (1885), p. 123 (1 fig.).

Ranunculi *Æcidia*. See Heterœcismal Uredines.

Reproductive Organs, Typical, The Comparative Morphology of, in the Vegetable Kingdom (No. 1, Conjugation).

Cole's Studies in Mic. Sci., February, 1885, pp. 1-4 (colored plate).

Rocks, The Microscopical Study of : JOHN ERNEST ADY.

Ill. Sci. Mon., III. (1885), pp. 1-4.

Senecio vulgaris : R. H. MOORE.

Jour. of Mic., III. (1884), pp. 237-47 (8 figs.).

Sepia, On the Occurrence of Chitin as a Constituent of the Cartilages of. See Chitin.

Spirorbis borealis, On the Larval Forms of : J. WALTER FEWKES.

Am. Nat., XIX. (1885), pp. 247-57 (16 figs.).

Suprarenal Bodies, On the, of Vertebrata : W. F. R. WELDON.

Quar. Jour. Mic. Sci., XXV. (1885), pp. 137-50 (19 figs.).

Teleosteans, The Development of. See Kupffer's Vesicle.

Teleostean Ova, Pelagic. See Hypoblast.

Todea barbara. See *Osmunda*.

Toe of Mouse, Injected ; under heading Graphic Microscopy : E. D. T.

Sci.-Gossip, 1885, p. 25 (colored plate).

Tunicata, On the Evolution of the Blood-vessels of the Test of the : W. A. HERDMAN.

Nature, XXXI. (1885), pp. 247-9 (5 figs.).

Vegetable Fibres, The Study of.

Am. Mon. Mic. Jour., VI. (1885), pp. 22-5.

Vorticella, A New : ALFRED C. STOKES.

The Microscope, V. (1885), pp. 34-6 (1 fig.).

Yeast, The Organisms in : HENRY C. A. VINE.

Jour. of Mic., III. (1884), pp. 214-28 (12 figs.).

Yellow Fever, The Microbe of—Preventive Inoculation : MM. D. FREIRE and REBOURGEON.

Am. Mon. Mic. Jour., VI. (1885), pp. 21-2.

MISCELLANEA.

ROYAL MICROSCOPICAL SOCIETY, Annual Meeting, February 11th, 1885: Extracts from Report in *English Mechanic*.—Dr. Maddox exhibited some specimens of Dr. Miguel's improved nutritive lichenised paper for the registration and cultivation of atmospheric and other bacteria, and gave the following particulars of the method used to color the organisms after incubation. The sterilised nutritive paper charged with the lichen jelly is, after use, placed in the incubator for the cultivation of the microbes. It is afterwards put into a saturated solution of alum for five minutes, then washed, and placed in a bath of sulphate of indigo (two grammes to one litre of water) for thirty seconds, again washed, and put into a bath of permanganate of potash (two grammes to 1,000 of water), for thirty to sixty seconds. The paper, now of a rose color, is washed, and immersed for half a minute in a three *per cent.* solution of oxalic acid, by which the paper becomes bleached, while the organisms are shown of a very distinctly blue color.

In the Report of the Council was included the following item: The Council have voted five pounds five shillings to the memorial now being raised in America to the late R. B. Tolles, one of the earliest to appreciate, not merely the theoretical, but the practical, bearing of the immersion system in allowing of the increase of the aperture of an objective beyond that of a dry objective of 180 degrees, which it was so long supposed to be impossible to exceed.

The President addressed the Society on the subject of the life-history of a sceptic organism hitherto unrecorded. The following is an abstract:—

Commencing with a review of the position of bacteria and monads in biology, Dr. Dallinger went on to remark that whoever had studied the same field of septic bacteria for a week or a fortnight without change of conditions would know the strange complexity of relations that are seen to arise, and until this complexity of relations in common forms was understood assured progress was impossible. How the bacteria are inter-related, how far they are mutable and under what conditions, and whether functional changes are as readily, or more readily, induced than morphological changes visibly perceptible, were questions of the

highest moment awaiting solution. The forms which give rise to specific diseases were now being vigorously and almost exclusively studied, to the detriment of investigation into forms not connected with disease, from which, however, they must have arisen at some past time. The discovery alleged to have been made by Hans Büchner in 1880, of the convertibility of the bacillus of the terrible disease anthrax, or splenic fever of cattle, into the innocuous *Bacillus subtilis* which it outwardly resembles, and the converse, appears so startling to even a Darwinian, that there must be error somewhere; for if the law of actual variation, with all that is involved in survival of the fittest, could be so readily brought into complete operation, and yield so pronounced a result, where would be the stability of the organic world? There could be no permanence in anything living. Dr. Dallinger agreed with Dr. Klein in considering Büchner's so-called results utterly improbable. It was of the utmost importance, however, to discover the true relations between such organisms, and the effect of changed conditions. Whether the changes produced by Pasteur in his attenuated virus were true biological changes, or a mere physical and accompanying chemical attenuation consequent on enfeebled nutrition or extended dilution of some element of the virus, and consequently not involving permanent change, was still unsettled; but Dr. Dallinger inclined to the latter view. The new organism referred to above first came under notice about four years ago in an exhausted maceration of cod-fish which had decomposed in a broth extracted from the boiling of rabbits, long kept at a temperature of 90° to 95° Fahr. By a complex and ingenious arrangement, not only was the drop of fluid under examination, but also the vapor surrounding it, kept at a necessary constant temperature not varying more than one-tenth of a degree Fahrenheit, and thus its form and movements were fully ascertained. The sub-oval body, lens-shaped, destitute of internal organs, measured about the $\frac{1}{10000}$ in. in length, by the $\frac{1}{15000}$ in. in breadth; but it had no fewer than six long thread-like flagella, or motile organs, like whip-lashes, each three times as long as the body. One very remarkable mode of locomotion resulting was comparable only to wave-like leaps, reminding the observer of the movements of a shoal of porpoises. The organism was never attached, but by a free darting down upon and away from minute particles

of decomposing matter, by large numbers, the matter was in half an hour visibly reduced in size. "No sight accessible to the human eye," said Dr. Dallinger, "can be more fascinating or more beautiful than this. A field of 50 or even 100 may be observed with ease pursuing their untiring work. It is the more entrancing that it is apparently rhythmic, not like the measured march of a regiment, but the rhythmic movement of a peal of bells." The analysis of this movement and its results was most difficult because of the incessant change of position of the organisms. The mode of ordinary multiplication by fission also presented features of great interest, owing to the problem of the formation of the new and numerous flagella. For a long period it was found impossible to observe any sexual form of multiplication; but unwearied diligence at last succeeded after three years' work. A kind of fusion of two individuals occurred, one of the individuals gradually contracting its flagella, losing its characteristic shape, and becoming ultimately absorbed in the other, which all the while, strange to say, continued swimming with full vigor. After complete union had taken place, the movement was much slower, and the body broke up rapidly into very minute portions, in the course of from four to five hours, the motion of the whole organism being still active. Then, as it swam, it was seen to be dropping from it a stream of granules, the spores, and these being continuously watched, were seen to grow up into the likeness of the parent form, and shortly after to multiply by the old process of fission. Thus, should drying of the fluid take place, a multitudinous supply of the minutest germs, able to resist high temperatures, would become disseminated in the atmosphere, each capable of reproducing the whole series of changes.

Dr. Carpenter, C. B., said that the pleasing duty had been assigned to him of moving a vote of thanks to their excellent and highly esteemed President for the very admirable and interesting address to which they had just listened. He began, as they were aware, by giving them a summary of the doctrines of Abiogenesis and Biogenesis; but there was one omission in his remarks, due, no doubt, to his modesty, but which ought not to be omitted, and that was that there was no class of facts which had contributed so much to the settlement of some of these important questions as the researches which their President himself had

made. They would, no doubt, remember that the great supporter of Abiogenesis, Dr. Bastian, relied upon the appearance of organisms in flasks which had been exposed to high temperatures ; but Dr. Dallinger had shown that though the organisms might be destroyed, the spores could still exist under these conditions. He quite agreed that the two sides of the question—pathogenic and morphological—should be studied separately, and that the observations in the latter case should be carried out in the way adopted by the President by isolating and keeping the object continuously under observation until its whole life-history had been ascertained ; but the pathogenic aspect was also of great importance, and must be worked out with similar care. Dr. Roberts, of Manchester, who was not only a very careful observer, but also a man of very large experience in diseases, wrote a paper some time ago entirely on Darwinian lines, and he there took some very striking examples, such as the production of the bitter almond from the sweet almond, the one being perfectly wholesome, but the other containing a powerful poison. He had himself always maintained that in the study of species it was necessary to study the intermediate forms as well as the complete forms, and had carried this out with great advantage in the case of the orbitolites thirty years ago. Just so he believed the study of the intermediate forms of disease to be necessary. A short time ago he wrote a paper bearing on this subject in the *Nineteenth Century*, and since then he had received a great number of letters in which many instances had been adduced showing that there had been intermediate stages of disease. He desired most heartily to congratulate the Society and also the President upon the admirable and successful work which he had described to them, and upon the completeness of the life-history which he had been able to give them as the results of work, moreover, which extended over a period of four years. As was well known, he (Dr. Carpenter) had always spoken strongly of the value of thorough and continuous work on one subject. There was a great deal of good microscopical power running to waste, for the simple reason that the owners of the instruments gave themselves up to a kind of dilettante study, instead of concentrating their attention. Their President had shown them what was the value of close continuous work, and no better encouragement could be given to the younger members of the So-

ciety than was afforded by such an excellent example. He had, therefore, great pleasure in moving that the best thanks of the Society be given to the President for his admirable address.

JOURNAL
OF THE
NEW-YORK MICROSCOPICAL SOCIETY.

VOL. I.

APRIL, 1885.

No. 4.

THE CELL-STRUCTURE OF PINUS STROBUS.

BY P. H. DUDLEY, C. E.

(Read March 6th, 1885.)

Pinus Strobus, or White Pine, is one of our most valuable coniferous trees. Its wood from different localities presents variations in structure, hardness, density, and strength; and, as observers are not fully agreed as to all of its features, any description of its structure can only be considered as a contribution to the mass of facts yet to be collected to give us the information desired.

Under the microscope, transverse sections and radial longitudinal sections from the duramen usually show two classes of tracheïdes, one of thin and the other of thick walls. Tracheïdes of the former class occupy the inner portion of the annular ring, and contain a part of the resin canals: those of the latter class are in the outer portion of the ring. The cells of the outer three to five rows are more flattened than the others; and their tangential surfaces contain the lenticular cavities, which are smaller than those of the thin-walled cells; and the openings in their domes seem oblong. Openings of the same description in the thin-walled tracheïdes are round or elliptical.

On the periphery of the annular ring are found the occasional cells, which, when young, contain starch.

Recent examinations of the conifers show a greater differentiation of the tissues than was formerly supposed to exist. The larger the proportion of the thick-walled to the thin-walled tracheïdes, the greater, within certain limits, is the density, hardness, and strength of the wood. I have here two pieces of selected clear lumber, the best the market affords, and you will be surprised to see the difference in their appearance. In one block,—marked *A*,—the annular rings number eighteen or nineteen per inch, each of which has from thirty-five to forty rows of

tracheïdes, chiefly quadrangular. The maximum size of the thin-walled cells ranges from seventy-three by sixty-six micromillimetres, to ninety by eighty-three ; and the thickness of the walls ranges from two and one-half to three and one-half micromillimetres. The maximum dimensions of the thick-walled cells are from fifty-three by forty micromillimetres, to fifty-six by forty-three, and the thickness of the wall ranges from six to eight micromillimetres. There is, moreover, a regular increase in the thickness of the walls, from the interior to within four or five rows of the exterior part of the ring. The thick-walled tracheïdes form but a small portion of the ring, the resin canals are not numerous, and the wood is soft, light, clear, easily worked, and is desirable for pattern making.

In the second block,—marked *B*,—the annular rings number seven or eight per inch, and each ring contains from sixty-five to seventy rows of hexagonal tracheïdes of about the same size with those of block *A*. But the thick-walled tracheïdes form a larger portion of the ring than in block *A* ; the resin canals are more numerous ; and the wood is harder, heavier, streaked, and more difficult to work.

I have another block,—marked *C*,—which is a specimen of the merchantable lumber grown in the vicinity of New York. Its wood differs from that of blocks *A* and *B* in having a sharp line of demarcation between the thin-walled and the thick-walled tracheïdes, the latter being nearly solid,—resembling *Pinus australis*,—the wood very hard, heavy, knotty, difficult to work, and liable to warp badly. The rings of *Pinus australis* have about equal shares of the two classes of tracheïdes, and the difference in strength between the two classes is great.

I brought another piece of wood, sculptured into a model representing, on a scale of five hundred diameters, the general construction of a thin-walled tracheïde. The outer lamella between adjacent cells is supposed to be removed. In transverse section these cells appear as quadrangular, pentagonal, or hexagonal : my model shows the hexagonal form. One side is carved so as to represent the general appearance of a tracheïde in a radial section. The rounded places, which show the domes in the cell-wall and their canals connecting with the lumen, are more numerous at the ends than at the central portion of the tracheïde. The construction of the bordered pits which these domes form

is very interesting, and I hope to make it plain by some models. The statement in the text-books, that, when the pits are forming, they have at first a septum which in a short time breaks away and leaves a free communication, needs modification. Here are two blocks, models, marked *D* and *E*, representing, on a scale of four thousand diameters, tangential sections respectively of the thin-walled and the thick-walled tracheïdes. In the latter, especially those which are nearly closed, the septum, generally thickened centrally, will be found intact, as shown by block *E*. In the thin walls, the septum will be found lying against the dome, and is sometimes very difficult to distinguish; and, often, it is removed in cutting the specimen.

The cells of the medullary system are uniseriate,—except those which enclose a resin canal,—and are of two classes, marginal and central. The former have, by some, been called tracheïdes; but in American species they do not merit that classification. Small lenticular cavities with septum are visible. The communications between these cells and the upright tracheïdes are delicate and interesting. For we see round portions of the wall projecting inward, forming little domes with central opening and projecting orifice; then, under each dome, a septum; then funnel-shaped openings extending to the lumen. All these appear in transverse section as delicate, lenticular cavities.

The central cells of the medullary system are quite different. Their walls are more or less irregular, their ends curved, their openings large; and in transverse section these walls apparently project into the lumen of the upright tracheïdes, the limiting lamella only not being perforated. This is not the case with all the conifers.

Our tracheïde model illustrates yet other points. You see these transverse indentations, and these openings. The former show the position of the central rays of the medullary tract. Sometimes there are only two rays, sometimes four, eight, or nine: no regularity in the number has been found. The openings show the form of the communications into the lumen. The small openings at each side of the large central openings, belong to the marginal rays of the medullary tract. The ends of the tracheïde are rounded, pointed, and, when directly in contact with the medullary tract, sometimes straight.

In the tangential section, the sides of the tracheïde are some-

what undulating, and, as the overlapping of each row of adjacent cells occurs chiefly in the plane of a radial section, the ends of a tracheide taper gradually towards a point.

The upright resin canals connect with those of the medullary tract.

LIMITATION OF THE VISUAL FIELD OF THE WORKER HONEY-BEE'S OCELLI.

BY THE REV. J. L. ZABRISKIE.

(*Read March 6th, 1885.*)

The Honey-bee is a remarkably hairy insect. On the head the hairs are dense, and of various lengths; and they cover every part, even the compound eyes and the mandibles. The antennæ, however, are apparently smooth, having only microscopic hairs; and a path through the long hairs, from each ocellus, or simple eye, directly outward,—to be described more fully presently,—is practically smooth.

The ocelli are so situated that when the bee is at rest and the face vertical, they are directly on the top of the head, arranged as an equilateral triangle, and one ocellus is directed to the front, one to the right side, and one to the left.

Long, branching hairs on the crown of the head stand thick like a miniature forest, so that an ocellus is scarcely discernible except from a particular point of view; and then the observer remarks an opening through the hairs,—a cleared pathway, as it were, in such forest,—and notes that the ocellus, looking like a glittering globe half immersed in the substance of the head, lies at the inner end of the path. The opening connected with the front ocellus expands forward from it like a funnel, with an angle of about fifteen degrees. The side ocelli have paths more narrow, but opening more vertically; so that the two together command a field which, though hedged in anteriorly and posteriorly, embraces, in a plane transverse, of course, to the axis of the insect's body, an arc of nearly one hundred and eighty degrees.

These paths through the hairs appear to me to be indications that the ocelli are intended for distant vision, although the opinion that near vision is their function is held by eminent opticians.

The ocelli are nearly hemispherical, and the diameter of each is about fifteen times that of a facet of the compound eye. Such a form of lens would, I will concede, indicate for these organs a short focus, and, hence, a fitness for near vision.

But if the ocelli are intended for near objects, it is difficult to understand why they are surrounded by a growth of hair so dense as to permit unobstructed vision only in a very narrow field, and why they are so placed on the top of the head as to be debarred from seeing any objects in the neighborhood of the mandibles and the proboscis, the ability to see which objects would appear to be very necessary in the constant and delicate labors of the worker Honey-bee among the flowers.

A CATERPILLAR FUNGUS FROM NEW ZEALAND, AND SOME RELATED SPECIES OF THE UNITED STATES.

BY THE REV. J. L. ZABRISKIE.

(*Read March 20th, 1885.*)

Of the objects which I have the pleasure of exhibiting this evening, the main one is a larva, probably of some large moth, infested with a fungus of peculiar growth. It was loaned to me for the present occasion by its owner, the Rev. Dr. Baldwin, formerly a missionary at Foo Chow, China, but now pastor of the M. E. Church at Nyack, N. Y. It was presented to him as a curiosity by a scientific friend, who had received it from the chorister of the cathedral at Auckland, New Zealand. The larva is nearly two and one-half inches long. It has become changed to a hard, woody mass, the effect of the drying up of the mycelium of the fungus. Of the fungus itself there were originally two long processes, issuing from the top and back of the head of the larva, where it articulates with the first segment of the trunk (See Fig. 1). Unfortunately, one of these processes is gone; but the other is here, although broken. These are the stems of the inflorescence, intended to bear the fruit, or spores, in an enlarging mass at the summit. From the stem which is here present, the fruiting head has been lost. The part which remains is hard, dry, and brittle, and has been curled in its growth. It is also, at one point, abruptly and irregularly enlarged. If straightened, it would measure about three and one-

half inches in length. These stems are reported as sometimes growing much longer.

I do not know the species of this specimen, there being no head or spores to determine it. But there can be no reasonable doubt that it belongs to the genus *Torrubia*, of which the older genus *Cordyceps* is now held to be a synonym; and it is, probably, either *Torrubia Sinclairii* or *Torrubia Robertsii*, both which species are reported as found in New Zealand.

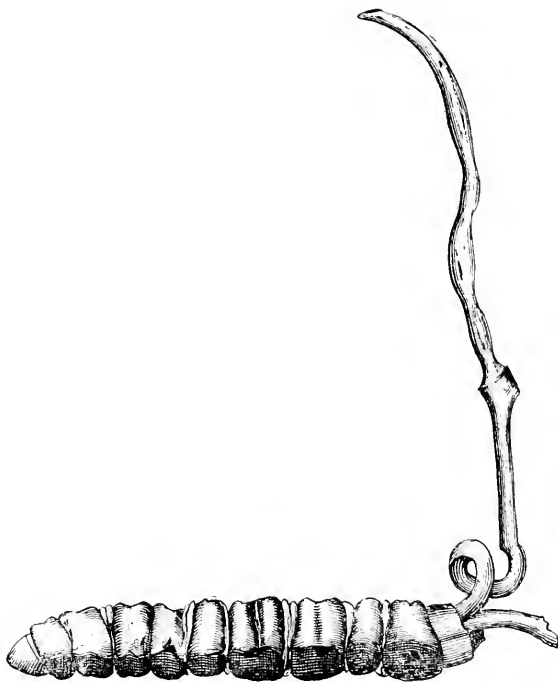

Fig. 1.—New-Zealand Caterpillar Fungus (original).

The classification given in Cooke's "Hand-Book of the British Fungi," places the genus *Torrubia* in the second division, or Sporidiifera,—the fungi which have the spores in asci, or sacs,—and in the sixth, or last family, the Ascomycetes, or genuine sac-bearers. It is entered as the first genus of the Sphæriacei, of which *Sphaeria*, or the simple sphere with sacs, is the type. The fruit of the genus *Torrubia* is compound, consisting of a

number of perithecia combined in a globular or elongated head. It will be observed that this specimen stands among the highest orders of the fungi.

Two dozen or more species of *Torrubia* have been described as found in different countries. These fungi are the friends of man, because they assist him in the contest with injurious insects. Of the several species which, fortunately, occur in our own country, perhaps one of the most common and most widely distributed is the *Torrubia Ravenelii*, Berk. It is described by Prof. C. V. Riley in the "American Entomologist," Vol. III. (Old Series), 1880. It infests the "White Grub," which is the large, fleshy, brown-headed larva of the *Lachnosterna fusca*, or June-beetle—a larva well-known to farmers and gardeners for its destructive habits. It feeds principally on the



Fig. 2.—White-Grub Fungus (after Riley).

roots of plants, especially of young corn, of various grasses, and of the strawberry. The *Torrubia Ravenelii*, when developed in this larva, fills its body; and it sends out, invariably from the lower side of the head, near the base of the mandibles, two, sometimes four, fruiting stems, to a length of five or more inches. The infested larva is under ground, and the fruiting stems grow upward out of the soil and into the air. The length depends, probably, on the quantity of aliment

which is at the command of the fungus. In the second and third illustrations, after Riley, which accompany this article, the fruiting stems are abortive (See Figs. 2 and 3). But the next illustration, after Berkeley, exhibits the stems in fruit (See Fig. 4). The stem becomes flexuous, and is surmounted by an elongated conical head. The head is dotted with a multitude of black protruding perithecia, which contain the spore-sacs. Each sac yields many spores. The illustration includes a representation of one of the spores as it appears when highly magnified—very long and slender, and many-jointed. When fully ripe, the spore breaks up at the joints. Each segment is capable of reproducing the fungus.

Another species native to this country, and frequently met with, is the *Torrubia militaris*. It infests those pupæ of moths which are concealed just beneath the surface of the ground. The

fruiting stem issues usually from the head, but sometimes from the articulations, of the pupa, and it rises in the air to perfect its fruit (See Fig. 5). Commonly there is only one stem from one pupa, but occasionally several are found. The stem, together with its head, is from one to two inches long, and its color is orange-red. The entire surface of the head is thickly studded with the conical immersed perithecia, which contain the sacs and spores. Fig. 5 shows a few of these perithecia *in situ*, magnified seventy diameters, but less crowded relatively than in the object itself. The same figure shows one of the spore-cases from these perithecia. These cases are unusually long and slender, and are filled with the long, thread-like spores, two of which are here figured. The spores are nearly as long as the cases which contain them, and are divided by a multitude of transverse septa into minute joints.

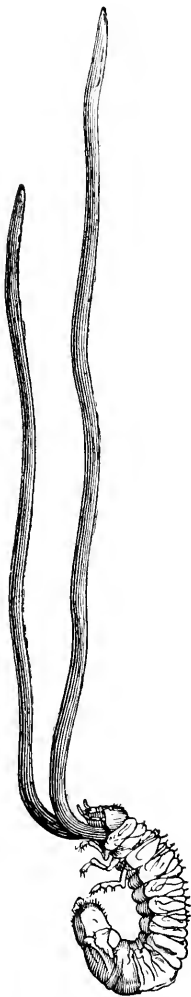

Fig. 3.—White-Grub Fungus (after Riley).

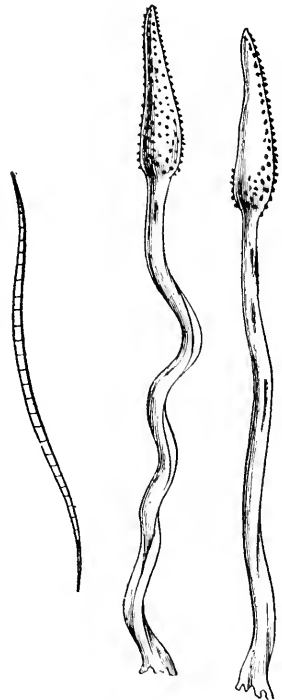

Fig. 4.—Fructification of White-Grub Fungus (after Berkeley.)

Your attention is called to one more native species, the *Torrubia clavulata*, Schw., represented in Fig. 6. It infests the

coccus, or scale-insect, of the Black Ash. This coccus is of the genus *Lecanium*. The male is a two-winged creature, which passes through its sportive life in a very short period. But the noticeable member of the family, on account of her endurance, and her attachment to her home, is the female. When very young, she fastens herself to some suitable spot on the ash twig, thrusts her beak into the bark, and lives on the sap of the plant. She now begins to be covered with a shell. This enlarges and hardens into a nearly hemispherical mass firmly attached to the

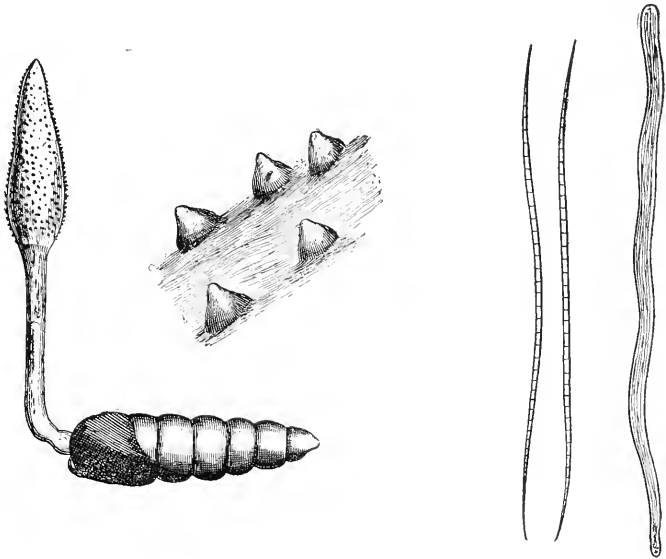

Fig. 5.—Pupa Fungus (original).

twig and about a quarter of an inch in diameter. Here the insect lives and dies, without ever moving from her selected station. She is frequently affected with the fungus last mentioned,—the *Torrubia clavulata*,—which, as autumn approaches, bursts through various parts of the rounded shell in little fruiting stems about one-tenth of an inch in length. I have collected this fungus on Haight's Island,—an island in the Hudson River, about fifteen miles below Albany,—where it appears to be quite frequent. Sometimes the fruiting stems number from fifteen to nineteen on one insect. Usually the stems are simple, slender,

and curved ; and the head, which is about one-quarter or one-sixth the length of the stem, is black, broadly elliptical, and crowded with the comparatively large, rounded perithecia, thus presenting the appearance of a miniature mulberry. On one specimen the stems were nearly all branched—an unusual occurrence. A stem of this description (shown in Fig. 6) had originally three branches, only one of which is now entire. In this species of *Torrubia*, the spore-cases and the spores are quite slender ; still, their forms are much less slender, and the joints much less numerous, than in the other species.

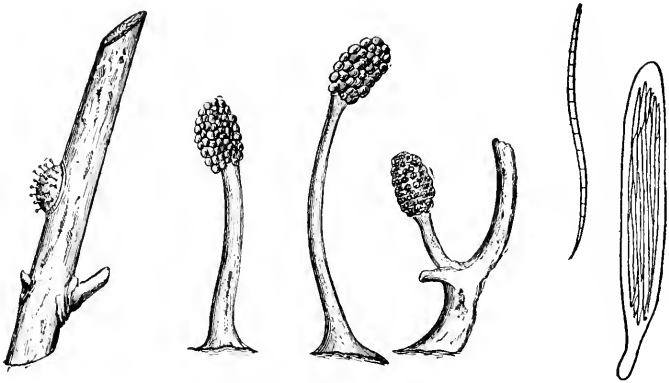

Fig. 6.—Scale-Insect Fungus (original).

Prof. Riley says that Mr. Walsh, in an article published in the "Practical Entomologist" (Vol. II., p. 116) on the fungus which attacks the White Grub, was the first to suggest in this country the practical use of fungi in the farmer's war against insects ; and he further says, that "however little faith he may have in the use of beer-mash or yeast as a general insecticide, as recommended by Dr. Hagen, he is fully convinced that great good may be accomplished in destroying insects injurious to vegetation, by the study and propagation of those particular fungi that are severally known to attack particular species." We may yet live to see the day when the fungi will be used by man as one of the prominent means of exterminating our insect pests.

CHILOMONAS PARAMÆCIUM.

BY SARA GWENDOLEN FOULKE.

(Received March 25th, 1885.)

Since its discovery by Ehrenberg, this form has been carefully studied by Bütschli, Stein, and Kent, the two latter giving the first entirely accurate diagnosis of its character.

According to Kent, *Chilomonas* is classified as follows: Order, Flagellata-Eustomata; Family, Chilomonadidæ; Genus, Chilomonas.

Fig. 1 represents the form so accurately that no detailed description is necessary.

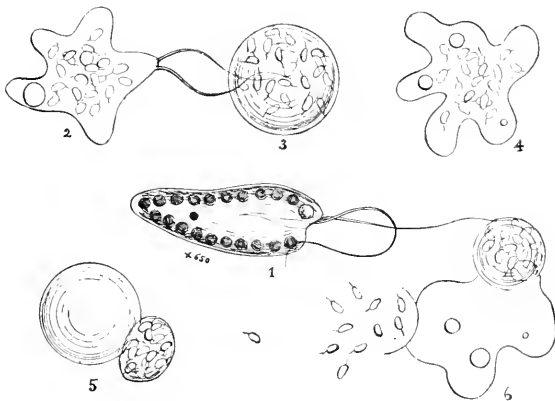

Bütschli states that this animalcule, when isolated for observation, quickly loses its normal contour and becomes spherical, finally disintegrating.

While I was investigating a drop of water teeming with *Chilomonas*, a minute flagellate amœboid form (Fig. 2) entered the field, and after swimming uncertainly about for some moments, settled to the bottom of the live-box, where it moved in amœboid fashion, the two flagella becoming merged in the pseudopodia-like processes. The presence of about twenty small highly refractive bodies, suspected to be germs, was noticed. Soon the mass became so diffused as to form a mere film, and presently disintegrated, setting free these bodies, which swam away. Several similar individuals were found, some of which, on be-

coming quiescent, took a globular shape, retaining both flagella to the last. This sphere then grew larger and its wall thinner until, like a bubble, it burst, liberating the germs, which were always present, and very active (Fig. 3). So many of these forms were now found, while the number of the adult forms of *Chilomonas* at the same time diminished, that the identity of the two was suspected; and the suspicion was verified almost immediately by my witnessing the transformation throughout.

An individual would begin to spin round, gradually losing contour, while the refractive "corpuscles" ranged near the cell-wall left their places and moved actively about, showing, as did also the increased transparency of the cell, incipient liquefaction of the endoplasm. An amœboid character was now assumed until, finally, one or the other of the two phases above noted was entered upon. When the final shape was that of Fig. 4, the freeing of the germs was effected in various ways. Sometimes, as stated, the film became generally disintegrated. In other cases, one large external vesicle was formed, leaving only a very small portion of protoplasm enclosing the germs, and from this the germs energetically freed themselves after the bursting of the vesicle (Fig. 5). In still others, a small vesicle formed about the germs and, moving to the cell-wall, extruded itself, and burst, liberating the germs directly into the water, after which, the remainder of the animalcule disintegrated (Fig. 6).

In from four to five days each of these germs developed into an adult *Chilomonas*, having the characteristic form at an early stage of growth. The "corpuscles," or, correctly, the germs, appeared in these at maturity.

The habit of breaking up, as recorded by Bütschli, probably coincides with the above phenomena, and, although that author does not describe the liberation of germs, I believe this habit to exist principally for that purpose, as the young, or recently matured, *Chilomonas* was not affected by confinement. This, then, seems to be the first time that the true character of the ornamental belt of so-called corpuscles has been indicated.

The transition to the globular and the amœboid phases afforded strong corroboration of the opinions of Stein and Kent, as opposed to that of Bütschli, regarding the point of growth of the flagella,—showing them to be inserted close together.

TRACHELIUS OVUM.

BY SARA GWENDOLEN FOULKE.

(Received March 25th, 1885.)

In first describing this Infusorian, Ehrenberg attributed to it the possession of a much ramified œsophageal canal, but his view, later upheld by Claparède and Lachmann, has been strongly opposed by W. Saville Kent, who claims that the so-called alimentary canal is merely the granular protoplasm highly vacuolate. My own observations had coincided with those of Mr. Kent, and, recently, strong confirmation of his opinion was obtained from the following phenomena:—

I had taken from a *Chara* bog numbers of *Trachelii*. Their unusually large size—one-fortieth of an inch—afforded special advantages for observation. In color, the specimens were a transparent creamy yellow. When first removed to the live-box, they uniformly showed the ventral side to be flattened and deeply indented longitudinally, so that a transverse section would be kidney-shaped. After a confinement of some minutes, they became globose in contour, and thus they remained during captivity; but when they were set free, the indentation soon reappeared. In one specimen, the granular reticulation, at first finely shown, seemed to become less profusely ramified, and a current of the protoplasm towards the central mass was noticed. This flow continued until all the smaller branches were massed at a sub-central point, leaving the rest of the body apparently hollow. One pseudopodium-like process was now sent to a more posterior point in the periphery, and the flow was resumed, this time outwards, until the protoplasm was collected into a nodule attached to the cell-wall, along which a small portion flowed, afterwards remaining motionless. No nucleus could be detected in this specimen, though present in all others examined.

The above condition remained unchanged for nearly an hour, when, wishing to test the apparent hollowness of the cell, I removed from the live-box all but a small portion of the water, and pressed the *Trachelius* with a blunt knife-blade. Complete collapse ensued, and the animal now resembled a twisted rag.

It seemed, however, nowise injured by the operation, as, after about six hours passed at the edge of the water, it resumed its globose shape, and free motion about the live-box again began.

An accident prevented further investigation, but, from the diffused condition of the nucleus, incipient reproductive phenomena were suspected.

In this connection I should like to draw attention to a form described by me in a communication to the Academy of Natural Sciences of Philadelphia, March 4th, 1884, under the name of *Trachelius Leidyi*. The distinction then made with regard to shape having been rendered invalid by the observations above noted, color, and the more profuse vacuolation of the periphery, alone remain, and, regarding these as insufficient differences, I have decided to withdraw the species.

PROCEEDINGS.

MEETING OF MARCH 6TH, 1885.

The President, Mr. C. Van Brunt, in the chair.

Thirty-eight persons present.

John Butler, M. D., Mr. Lucius Pitkin, Mr. Henry L. Brevoort, and Mr. Max Levy, were elected Active Members of the Society.

OBJECTS EXHIBITED.

1. Sections of *Pinus Strobus* : by P. H. DUDLEY.
2. Head of the worker Honey-bee : by J. L. ZARRISKIE.
3. Fossil leaf of *Hausmannia* : by N. L. BRITTON.
4. Transverse section of leaf of *Pinus pungens* : by H. W.

CALEF.

5. *Stauroncis phœnicenteron* : by E. A. SCHULTZE.
6. Embryonic Spiders; mounted in glycerine : by F. W.

DEVOE.

7. Cholera Bacilli : by W. H. BATES, M. D.
8. Spores of Cholera Bacillus : by L. SCHÖNEY, M. D.
9. *Synapta*, from Bermuda : by W. G. DE WITT.

THE CELL-STRUCTURE OF PINUS STROBUS.

Mr. Dudley exhibited microscopic sections of *Pinus Strobus*, or White Pine, and hand-specimens of three varieties of the wood as determined by differences of fineness and hardness. He described the cell-structure; and he illustrated his description by photographs, and by three large wooden models which represented severally a tracheide, a lenticular cavity of the thin-

walled tracheides, and a similar cavity of the thick-walled tracheides. His observations form the opening article in this Number of the JOURNAL. Discussion added the following matter:—

Mr. Dudley: "The wood of a tree growing in an exposed situation, has the firmer grain: its fibres are less easily separated by flexure. I believe my specimens, notwithstanding their differences, to belong to one species only."

Dr. Britton: "Only one species of White Pine is found east of the Mississippi, and no marked varieties of it are known to botanists. The fact of its producing wood of different grain under different conditions, has a parallel in the behavior of the *Liriodendron tulipifera*, or Tulip-tree, the wood of which is sometimes nearly white, sometimes quite yellow; and to woodmen the tree is known accordingly as White Tulip Poplar or Yellow Tulip Poplar. There is reason for referring this difference to diversity of soil."

LIMITATION OF THE VISUAL FIELD OF THE WORKER HONEY-BEE'S OCELLI.

Mr. Zabriskie exhibited the head of the worker Honey-bee for the purpose of directing attention to a peculiar disposition of the abundant hairs surrounding the ocelli, these hairs admitting the light through narrow openings which greatly circumscribe the ocelli's visual field. He thought this arrangement to indicate that the ocelli are intended for distant vision. At the conclusion of his observations,—which are given in full elsewhere in this Number of the JOURNAL,—Mr. Zabriskie added: "Besides the worker Honey-bee, I have brought for exhibition the drone and the queen of the same species, and the queen-cells; the queen of *Bombus Virginicus*, one of our native Humble-bees; the *Melissodes binotata*, male and female; the *Melissodes pruinosa*, both sexes; the beautiful *Anthophora dispar*, male and female, of Tunis, Africa; and the celebrated little stingless bee of Abyssinia, the *Trigona Beccarii*, which lives in immense colonies, and stores large quantities of honey. The *Anthophora dispar* has a very long proboscis. The possession of such a proboscis by our own bees, would add millions of dollars annually to the wealth of the United States."

FOSSIL LEAF OF HAUSMANNIA.

Dr. Britton : " My specimens of fossil leaf were taken from the lower cretaceous clays of Middlesex Co., N. J. As these clays are extremely fine and plastic, fossil leaves are remarkably well preserved in them as thin membranaceous sheets of carbonized vegetable tissue, which, when recently collected, show very perfectly all the details of venation. At the suggestion of Prof. Newberry, I have detached and examined a fragment of one of these carbonaceous films, and I find the parenchymatous cell-structure and the stomata plainly discernible. The examination was made on *Hausmannia*, a genus the botanical affinities of which are somewhat uncertain. I may add, that specimens of lignite from the same strata show their woody cell-structure quite clearly, and that those which were examined proved to be coniferous."

CHOLERA BACILLI.

Dr. Bates : " I have two slides. One, prepared by Dr. Koch, shows a pure culture of cholera bacilli. The other, a double slide, is from Paris : one mount contains a pure culture of cholera bacilli ; the other, secretions taken from a patient who had died of cholera. The two forms correspond exactly."

SYNAPTA.

Mr. De Witt : " My object, a species of *Synapta*, from Bermuda, is mounted entire. The most noticeable parts are the branched tentacles surrounding the mouth, and the perforated calcareous plates and anchor-shaped spines. The common impression that the spines are locomotive organs is not supported by my observation of the habits of this animal. They serve, instead, for defense, and for attachment to the sea-weed on which the creature is found. The organs of motion are the tentacles."

Mr. Bogert presented to the Society some dried specimens of *Gyrinus natator*.

MEETING OF MARCH 20TH, 1885.

The President, Mr. C. Van Brunt, in the chair.

Twenty-four persons present.

The President appointed the Committees for the current Society-year, as follows :—

I. THE STANDING COMMITTEES.

1. On Admissions ; C. S. Shultz, J. Warnock, W. Wales, J. D. Hyatt, J. L. Zabriskie.
2. On Publications ; B. Braman, J. L. Wall, W. H. Mead.

II. THE SPECIAL COMMITTEES.

1. On Entomology, J. D. Hyatt.
2. On Improvements in Microscopes and Microscopical Apparatus, W. Wales.
3. On Medical Science, L. Schöney, M. D.
4. On Mineralogy, A. A. Julien.
5. On Cryptogamic Botany, J. L. Zabriskie.
6. On Phanerogamic Botany, N. L. Britton.
7. On Adulterations, W. H. Bates, M. D.

OBJECTS EXHIBITED.

1. Caterpillar Fungus, from New Zealand : by J. L. ZABRISKIE.
2. Scale-Insect Fungus (*Torrubia clavulata*) : by J. L. ZABRISKIE.
3. Photograph of *Amphipleura pellucida* ; taken by Dr. Van Heurck : by WALTER H. MEAD.
4. Diatoms ; mounted in Prof. H. L. Smith's newest medium : by C. VAN BRUNT.
5. Photographs of Diatoms ; taken by C. Febiger : by C. VAN BRUNT.
6. *Closterium acerosum* : by A. D. BALEN.
7. Eye of *Limulus*, upper surface : by WALTER H. MEAD.
8. Eye of *Limulus*, under surface : by WALTER H. MEAD.
9. Path of Electric Spark ; prepared by Prof. G. M. Hopkins : by C. W. McALLISTER.
10. Ovoid Concretions on the shell of a hen's egg : by M. M. LE BRUN.

NEW-ZEALAND CATERPILLAR FUNGUS ; AND SCALE-INSECT FUNGUS.

Mr. Zabriskie exhibited, described, and illustrated a fungus, of the genus *Torrubia*, which had pervaded the larva of a large lepidopter, and had developed two fruiting stems ; also, a fun-

gus, the *Torrubia clavulata*, which had destroyed a coccus, of the genus *Lecanium*, and had sent up through the shell of its host several stems of inflorescence. He described and illustrated, besides, two other species of *Torrubia* which are parasitic on injurious insects; and he touched the topic of the service which such fungi might, if their life-history were better known, be made to perform as insecticides. His observations are given in full elsewhere in this Number of the JOURNAL.

PHOTOGRAPH OF AMPHIPLEURA PELLUCIDA.

Mr. Mead: "The photograph of *Amphipleura pellucida* which I have here, was loaned to me for this exhibition by Mr. R. Hitchcock. It shows the dots. It was taken by Dr. Henri Van Heurck, with the use of incandescent light, vertical illuminator, and a $\frac{1}{8}$ th-inch Zeiss homogeneous-immersion objective."

The President: "This photograph shows both sets of lines clearly. It was taken, I have been informed, from a silvered frustule."

DIATOMS MOUNTED IN PROF. SMITH'S NEWEST MEDIUM.

President Van Brunt: "Prof. H. L. Smith, as you all know, has made a series of experiments in order to discover the best material for mounting diatoms. He at length found a medium which brought out the markings of diatoms very distinctly, but it did not last well—it would soon cloud or crystallize. As the result of further trial, he now has a medium which, he says, does not crystallize. It is glycerine holding a salt in solution, and has a refractive index of 1.8. I have here a dozen or more slides of diatoms mounted in this material. The markings show quite as well as in any other medium of high refractive index. I do not, however, think that a medium of high index is suitable for any but the most minute and delicate diatoms—diatoms which are not easily seen under the ordinary conditions. The large forms, when mounted in this medium, appear quite dark, and almost opaque."

PHOTOGRAPHS OF DIATOMS.

President Van Brunt: "I have brought for exhibition a number of photographs of diatoms that were mounted in Prof. Smith's new medium. They were taken by Mr. Febiger, of Wilmington, Del., to whom, for this purpose, I sent my own box of slides.

He uses for this kind of work a Spencer $\frac{1}{8}$ th-inch lens. He sent these pictures without expressing an opinion as to the value of the medium. It is important to get a mounting material which will give a good photograph. Balsam has been objected to. The new medium, consisting, as it does, of a salt dissolved in glycerine, has an advantage, since its refractive index can be easily varied by varying the proportion of the ingredients. It has also a disadvantage. It is not dense enough—especially when, through dilution, the index is not higher than 1.5 or 1.7—to hold the diatoms in place: they slide about in all directions, and a photograph of them cannot well be taken. And even when this medium is viscous enough to hold the frustules, the heat of the lamp soon causes them to move. Will Mr. Dudley state his views on this subject?"

Mr. Dudley: "My experience in photographing diatoms mounted in the new medium, accords with the statement given by the President; and I have found, in addition, that the slightest particles of dirt, present in the medium, gradually move toward the larger diatoms, and thus mar the picture."

OBSERVATIONS ON RESOLUTION OF AMPHIPLEURA PELLUCIDA.

Mr. Wales: "When, about twenty-five years ago, diatoms began to be studied as test-objects, the lenses, which were then of very low aperture, disclosed in *Pleurosigma angulatum* only one system of lines. Afterwards, lenses of higher angular aperture revealed, besides the intersecting lines; and, still later, further increase of resolving power made known the beads, or bosses. This, therefore, is the order: first, the systems of lines; afterwards, the bosses. This law applies to all diatoms that have been fully resolved. It must hold true, as well, of *Amphipleura pellucida*. If, therefore, a lens is incapable of showing the two systems of lines in this diatom, I feel sure that it will not show the beads; and I am constrained to think that those persons who believe themselves to have seen the beads, with such a lens, have confounded illusive images with real ones. I have myself, as yet, seen, by transmitted light, only one set of the lines. The new medium of Prof. Smith will, perhaps, enable us to resolve both sets. The photograph made by Dr. Van Heurck shows them; but that was taken with a vertical illuminator."

CLOSTERIUM ACEROSUM.

Mr. Balen exhibited cyclosis in *Closterium acerosum*, using for the purpose a $\frac{1}{2}$ th-inch objective.

PATH OF ELECTRIC SPARK.

Mr. McAllister exhibited, under a power of sixty diameters, a slide which showed the course taken by an electric spark in traversing a thin film of soot adherent to the glass. Its path is an irregular net-work of mixed sinuose and zigzag lines. This object is prepared in the following way:—

A slide, after being smoked over a small gas-jet, is placed centrally between the terminals of an induction coil, and at right angles to their direction. The terminals are held about three-eighths of an inch apart. A strong current is required.

The President: "A curious effect is produced by passing repeated charges of electricity from a Holtz machine through two plates of glass, between and in contact with which is a sheet of brass foil. The foil is driven into the glass, and it is retained there permanently."

OVOID CONCRETIONS ON SHELL OF HEN'S EGG.

Mr. Le Brun showed, under a magnification of twenty-five diameters, a compact group, in a single layer, of a hundred or more ovoid calcareous bodies *in situ* on the exterior surface of a piece of the shell of a hen's egg. These bodies are solid, they adhere but slightly to their support and to one another, and their long diameter seldom exceeds one-fortieth of an inch.

The table of dimensions of the spicules of *Heteromeyenia Ryderi* which was prepared by Mr. Hyatt and was published in the February Number of the JOURNAL, page 46, contains a typographical error. Corrected, the table will read as follows:—

DIMENSIONS OF SPICULES OF HETEROMEYENIA RYDERI.

Largest pointed spicules: average length, $\frac{1}{100}$ th of an inch.

Grappling-hook spicules: average length, $\frac{2}{1000}$ ths of an inch.

Short birotulate spicules: length, from $\frac{1}{1000}$ th to $\frac{1.5}{1000}$ ths of an inch.

Wheels of short birotulate spicules: average diameter, $\frac{8}{10000}$ ths of an inch.

PUBLICATIONS RECEIVED.

Anthony's Photographic Bulletin : Vol. XVI., No. 4 (February 28th, 1885); pp. 32. No. 5 (March 14th, 1885); pp. 32. No. 6 (March 28th, 1885); pp. 32.

The Microscope : Vol. IV. (January to December, 1884). Presented by E. C. Bogert.

Proceedings of the Canadian Institute, Toronto : New Ser., Vol. II., Fasciculus No. 3 (October, 1884); pp. 210. Third Ser., Vol. III., Fascic. No. 1 (March, 1885); pp. 78.

Transactions of the Massachusetts Horticultural Society : 1883, Parts I. and II.; pp. 343. Schedule of Prizes for the year 1885; pp. 36.

Journal of the Royal Microscopical Society : Ser. II., Vol. V., Part I (February, 1885); pp. 176.

The Newport Natural History Society. Constitution and By Laws : 1884; pp. 15.

Bulletin of the Brooklyn Entomological Society : Vol. VII, Nos. 11 and 12 (March and April, 1885); pp. 19.

The Electrician and Electrical Engineer : Vol. IV., No. 39 (March, 1885); pp. 36.

The Journal of the Quekett Microscopical Club : Ser. II., Vol. II., No. 11 (March, 1885); pp. 34.

Drugs and Medicines of North America: Vol. I., No. 5 (March, 1885); pp. 32.

The Microscope : Vol. V., No. 3 (March, 1885); pp. 24.

The American Monthly Microscopical Journal : Vol. VI., No. 3 (March, 1885); pp. 20.

The Botanical Gazette : Vol. X., No. 1 (January, 1885); pp. 16. No. 2 (February, 1885); pp. 16. No. 3 (March, 1885); pp. 16.

Johns Hopkins University Circulars : Vol. IV., Nos. 37 and 38 (March, 1885); pp. 32.

The Microscopical Bulletin and Optician's Circular : Vol. II., No. 1 (February, 1885); pp. 8.

The Indiana Pharmacist : Vol. III., No. 11 (March 15th, 1885); pp. 19.

Manitoba Historical and Scientific Society, Winnipeg, Manitoba, Canada. Transactions : Nos. 12, 13, 14, 15, 17, 18 (1884-5); pp. 73.

Bulletin of the Torrey Botanical Club : Vol. XII., Nos. 2 and 3 (February and March, 1885); pp. 20.

The Journal of Microscopy and Natural Science : Vol. IV., Part 13 (January, 1885); pp. 64.

The American Museum of Natural History, Central Park, New York. Annual Report of the Trustees; Constitution; By-Laws; and List of Members for the year 1884-5; pp. 39.

The Midland Naturalist : Vol. VIII., No. 85 (January, 1885); pp. 32. No. 86 (February, 1885); pp. 28. No. 87 (March, 1885); pp. 28.

Bridgeport Scientific Society. Science and the Supernatural; pp. 31. By Prof. A. J. DuBois.

Proceedings of the Natural History Society of Glasgow : Vol. V., Part 2 (1881-2); pp. 100.

INDEX TO ARTICLES OF INTEREST TO MICROSCOPISTS
WHICH HAVE RECENTLY APPEARED IN OTHER
JOURNALS.

- Algae of Minnesota supposed to be poisonous. Some : J. C. ARTHUR.
Bul. Minn. Acad. Nat. Sci., II. (1882), Appendix, pp. 1-12.
- Amiurus*, On the Nervous System and Sense-Organs of : R. RAMSAY WRIGHT.
Proc. Canadian Inst., II. (1884), pp. 352-86 (Illus.).
- Amöben, Studien über : AUGUST GRUBER.
Zeitschr. für Wiss. Zool, XLI., Pt. 2 (1884), pp. 186-225 (50 figs.).
- Amphipleura*, Beading of, and Photomicrography : R. HITCHCOCK.
Am. Mon. Mic. Jour., VI. (1885), pp. 42-5.
- Anthesis, On the Mechanism of, in the Ericaceæ : H. H. RUSBY.
Bul. Torrey Bot. Club, XII. (1885), pp. 16-20 (13 figs.).
- Ascidian (*Leptoclinum*), On the Larva of an, found at the Land's End : A. D. MICHAEL.
Jour. Quek. Mic. Club, II. (1885), pp. 111-14 (4 figs.).
- Bacteria. On, and the Methods of Staining them : E. THURSTON.
Jour. Quek. Mic. Club, II. (1885), pp. 121-4.
- Bacteria, Culture Media for.
Am. Mon. Mic. Jour., VI. (1885), pp. 55-7.
- Bees and Wasps. The Apparatus for Differentiating the Sexes in. An Anatomical Investigation into the Structure of the Receptaculum Seminis and adjacent parts : FRANK R. CHESHIRE.
Jour. Roy. Mic. Soc., V. (1885), pp. 1-15 (8 figs.).
- Cell, Organic. Structure and Division of the : CHARLES MORRIS.
Pop. Sci. Mon., XXVI. (1885), pp. 810-19.
- Cerianthus solitarius*, Notes on a Slide showing Ten Sections of the Oral disc and Tentacles of : ARTHUR PENNINGTON.
Jour. Quek. Mic. Club, II. (1885), pp. 109-10.
- Chryso-myxa*. See *Gymnosporangium*.
- Cotylédons et de l'Albumen, Recherches sur l'Anatomie Comparée des : J. GODFRIN.
Ann. des Sci. Nat. (Bot.), XIX. (1885), pp. 5-158 (81 figs.).
- Crucifères, Ordre d'apparition des premiers vaisseaux dans les feuilles de (Troisième partie) : A. TRÉCUL.
Comptes Rendus, C. (1885), pp. 413-18.
- Cyanca*, On the British Species of, and the Reproduction of *Mytilus edulis*, L.: PROF. MCINTOSH.
Ann. and Mag. Nat. His., XV. (1885), pp. 148-52.
- Cyclosis, Pseudo : SAMUEL LOCKWOOD.
Am. Mon. Mic. Jour., VI. (1885), pp. 46-7.
- Ericaceæ. See Anthesis.
- Fibres, Tissues, Etc. Method of Analysis of (M. VÉTILLART, *Etudes sur les Fibres*): Translated by RUFUS W. DEERING.
Am. Mon. Mic. Jour., VI. (1885), pp. 47-52.
- Fungi, Notices of, in Greek and Latin Authors : WILLIAM HOUGHTON.
Ann. and Mag. Nat. His., XV. (1885), pp. 22-49.

Geology, The Microscope in.

Science, V. (1885), pp. 190-1.

Gymnosporangium and *Chrysomyxa* of the United States, Notes on some species of : W. G. FARLOW.

Proc. Am. Acad. Arts and Sci., 1885, pp. 311-23.

Idioblasten bei einigen Cruciferen, Ueber Eiweissstoffe führende : E. HEINREICHER.

Ber. der Deutsch. Bot. Gesellsch., II. (1884), pp. 463-7 (18 figs.).

Insects, The Retina of : SYDNEY J. HICKSON.

Nature, XXXI. (1885), pp. 341-2.

Insectes, Etudes sur la tête et la bouche des larves d' : A. BARTHÉLEMY.

Comptes Rendus, C. (1885), pp. 121-4.

Leptoclinium. See Ascidian.

Limnanthemum lacunosum, Griseb., Notes on : JOSEPH SCHRENK.

Bul. Torrey Bot. Club, XII. (1885), pp. 13-16 (10 figs.).

Microbes bienfaisants, Les : PAUL LOYE.

Revue Scientif., XXXV. (1885), pp. 214-16.

Microbes, Sur la vitalité des germes de : E. DUCLAUX.

Comptes Rendus, C. (1885), pp. 184-6.

Microbe du Choléra, La Vitalité du : MM. NICATI et RIETSCH.

Revue Scientif., XXXV. (1885), pp. 277-8.

Microtome, Bulloch's Combination.

Am. Mon. Mic. Jour., VI. (1885), pp. 45-6 (1 fig.).

Mounting Specimens, A few Hints on Hardening, Imbedding, Cutting, Staining and : GEORGE DUFFIELD.

The Microscope, V. (1885), pp. 53-5.

Mytilus edulis. See *Cyanea*.

Newt, Life-History of the : ENGLETHWAITE.

Eng. Mech., XL (1885), p. 567.

Robert's Ruling Machine, The Original, Description of (Roy. Mic. Soc.) : J. MAYALL, JR.

Eng. Mech., XLI. (1885), p. 52.

Orbitolites, On the Structure of : W. B. CARPENTER.

Jour. Quek. Mic. Club, II. (1885), pp. 91-103 (22 figs.).

Organisms, Living, Scarcity of, in the Air at High Altitudes (*Geneva Arch. des Sci.*, for Nov.)

Science, V. (1885), p. 235.

Photomicrography—How to Photograph Microscopic Objects : J. H. JENNINGS. (Photographic News.)

Anthony's Photo. Bul., XVI. (1885), pp. 126-7 ; 145-6.

Photomicrography, Staining Tissues for : GEORGE A. PIERSOL.

Am. Mon. Mic. Jour., VI. (1885), pp. 41-2.

Plantes Aquatiques, la Structure de la Tige des, Recherches sur : J. COSTANTIN.

Ann. des Sci. Nat. (Bot.), XIX. (1884), pp. 287-331 (30 figs.).

Pollens, Original Method of Staining and Mounting : J. T. BROWNELL.

The Microscope, V. (1885), pp. 55-7.

Pollinies chez les Orchidées, Note sur les Mouvements des : E. PAQUE.

Comptes-rendus Soc. Roy. de Bot., de Belgique,

XXIV., Pt. 12 (1885), pp. 6-9.

- Polysiphonia elongata* : under heading Graphic Microscopy : E. T. D.
Sci.-Gossip, 1885, pp. 49-50 (colored plate).
- Polyzoa, Marine, Contributions towards a General History of the (Continued) :
 THOMAS HINCKS.
Ann. and Mag. Nat. His., XV. (1885), pp. 244-57 (22 figs.).
- Protoplasm, The Continuity of the, in Plant Tissue : WALTER GARDINER.
Nature, XXXI. (1885), pp. 390-1.
- Red Sea, The color of the : DR. STONHAM.
Sci.-Gossip, 1885, p. 52 (3 figs.).
- Renonculacées, Recherches sur la Structure des : PAUL MARIE.
Ann. des Sci. Nat. (Bot.), XX. (1884), pp. 5-180 (80 figs.).
- Rocks, The Microscopical Study of (II.) : JOHN ERNEST ADY.
Ill. Sci. Mon., III. (1885), pp. 67-70.
- Rotifer vulgaris*, On the Reproduction and Development of (OTTO ZACHARIAS,
Zeitschrift für Wissenschaftliche Zoologie : Translated by W. S. DALLAS.
Ann. and Mag. Nat. Hist., XV. (1885), pp. 125-43 (3 figs.).
- Saccharomyces*, On the Occurrence of Variations in the Development of a :
 G. F. DOWDESWELL.
Jour. Roy. Mic. Soc., V. (1885), pp. 16-18.
- Spinnen, Das Gehör- und Geruchsorgan der : FRIEDR. DAHL.
Archiv. für Mik. Anat., XXIV., Pt. I (1884), pp. 1-10 (8 figs.).
- Sponges, Fresh-water, Observations on some : FRANZ VEJDOVSKY.
Ann. and Mag. Nat. His., XV. (1885), pp. 13-18.
- Spongida, Mode of Circulation in the : H. J. CARTER.
Ann. and Mag. Nat. His., XV. (1885), pp. 117-22 (2 figs.).
- Spongilla fluviatilis*. See Spongille.
- Spongilla sibirica*. See Sponges.
- Spongillæ, On the Development of the : A. GÖTTE.
Ann. and Mag. Nat. His., XV. (1885), pp. 73-5.
- Synchytria*, The, of the United States : W. G. FARLOW.
Bot. Gazette, X. (1885), pp. 11 (12 figs.).
- Tissues, Method of Analysis of. See Fibres.
- Tyroglyphidae*, Notes on the Life-Histories of some of the little-known : A. D.
 MICHAEL.
Jour. Roy. Mic. Soc., V. (1885), pp. 19-32 (17 figs.).
- Uromyces*, Descriptions of Iowa : J. C. ARTHUR.
Bul. Minn. Acad. Nat. Sci., II. (1882), Appendix, pp. 13-37.
- Vaucheria*, Formation of Oospores in.
Cole's Studies in Mic. Sci., III. (1885), pp. 5-8 (colored plate).
- Wasserleitung im Laubmoosstämmchen, Ueber : G. HABERLAUDT.
Ber. der Deutsch. Bot. Gesellsch., II. (1884), pp. 467-71.
- Wasps. See Bees.
- Zygnemaceæ, On Sexuality in the : F. BATES.
Jour. Quek. Mic. Club, II. (1885), pp. 104-8.

MISCELLANEA.

THE WORKING SESSION OF THE AMERICAN SOCIETY OF MICROSCOPISTS.—In the course of years of practice, every thoughtful microscopist discovers methods of manipulation, ways of observation, and principles of interpretation, which differ in some respects from such as have, through books and journals, become familiar to all. A meeting at which these discoveries can be made known, their value tested, and their benefit appropriated, can but tend to promote the science of microscopy and thus assure with greater certainty the correctness of the results attained in all departments of microscopical research. The American Society of Microscopists did wisely in organizing a meeting of this character. The Working Session, both at Chicago and at Rochester, proved an exceedingly useful feature of the Annual Meeting. Mr. C. M. Vorce, to whom the direction of the Working Session of the convention to be held at Cleveland next August, has been assigned, has prepared an excellent schedule of work. His task is onerous, commensurately with its importance, and his success must depend, not less on his own acknowledged zeal and ability, than on the prompt and cordial coöperation of experienced microscopists. Every Microscopical Society in the land ought to be represented in this work.

THE ALGO-FUNGAL-LICHEN HYPOTHESIS.—Hypothesis helps investigation, provided it be not followed blindly. Some hypotheses are so romantic, they affect so strongly the fancy of their propounder and his followers, as to warp observation and occasion erroneous deductions. Partly of this character, it seems probable, is Schwendener's theory of the morphology and physiology of lichens. At a recent meeting of the New-York Microscopical Society, Dr. Britton invited attention to the Rev. J. M. Crombie's criticism of this theory in Vol. xxI., No. 135, of the *Journal of the Linnean Society (Botany)*. Schwendener's theory is, 'that the lichen is not a distinct plant, but a colony consisting of hundreds and thousands of individuals, of which, however, only one acts as master, while the others, in perpetual captivity, provide nourishment for themselves and their master; that this master is a fungus of the order Ascomycetes, and that its slaves'—the organisms upon which it is parasitic—'are green

algals, which it has caught hold of and forced into its service.' Mr. Crombie gives a series of observations which, he believes, subvert this hypothesis; for they show that the lichen-hyphæ differ essentially from fungal mycelia both in character and in conduct, and that the lichen-gonidia are equally dissimilar to true algals. He thinks the doctrine of the autonomy, or individuality, of the lichen, fully established.

THE MICROSCOPE IN THE SCHOOL-ROOM.—No person who has not made the trial, can form an adequate conception of the mental quickening occasioned by an exhibition of selected microscopic objects to classes in the school-room. The scales on the butterfly's wing, the hexagonal facets of the compound insect-eye, the transformation, as it were, of seemingly shapeless grains of sand into structures of exquisite beauty, the cyclosis of protoplasm in plant-cells, and the movement of blood-corpuscles in the foot of the frog,—reaching the mind through the eye, make and leave an impression, give an understanding, which books and diagrams are powerless to produce. The microscope, frequently and intelligently used, makes nature pellucid. There ought to be an excellent one under skilful manipulation in every school.

SEPTIC ORGANISMS.—Commenting on the phenomena of self-multiplication exhibited in the life-history of these organisms, Dr. Dallinger says (Journ. Roy. Micr. Soc., Apr., 1885, p. 194):

“The mystery of all this simplicity of vital movement is deep; and although we can observe and in accurate manner record the process, its *modus operandi* is far beyond our present grasp.

“One thing is certain,—on this rapid power of self-multiplication depends the entire utility of these organisms, and in this function of self-division it would appear that they have reached the highest point of vital development. Lowly they are—we know of nothing living that is lowlier—but in the processes of vital evolution, amongst the lowly and simple as amongst the highly organized and most complex, we find the perfection of concurrent adaptation.

“One other feature in these minute organisms claims a note. They are subject to no caprice; after twelve years of close observation I am convinced that the vital processes are as orderly, rigid and immutable as in the most complex organisms. Their

life-cycles are as clearly definable as those of a crustacean or a bird. No vital phenomenon not to be found amongst higher and larger organisms, is discoverable here. Only the methods of specific mutation resulting from the secular processes enunciated in the Darwinian law are in operation."

THE WORKING SESSION OF THE AMERICAN SOCIETY OF MICROSCOPISTS.—The Executive Committee of the American Society of Microscopists having appointed me Director of the Working Session of the Society for the meeting to be held at Cleveland, Ohio, next August, I have prepared the following scheme of work for that occasion. The general theory of the plan is to illustrate methods of research in the main, leaving the details, which are merely matters of mechanical execution, to be treated as subsidiary matters, since the available limits of the Working Session are insufficient to cover the whole ground at any one meeting.

SCHEME OF DEMONSTRATIONS.

1. The use of the Micro-Spectroscope, and its applications to original research.
2. The use of the Polariscope in original investigations.
3. Photomicrography, and its applications as an aid to research.
4. The use of the Camera Lucida ; various styles and methods.
5. Micrometry ; illustration of different methods.
6. Cultivating bacteria ; exposition of different methods.
7. Injecting vessels and tissues ; exposition of different methods.
8. Staining tissues, etc., in mass. Simple and compound stainings.
9. Staining sections. Simple and compound stainings.
10. Section cutting—soft tissues. Use of various microtomes.
11. Section cutting—hard substances. Methods of cutting and grinding.
12. Section cutting. Serial sections.
13. Use of the Dissecting Microscope. Methods and apparatus.
14. Practical demonstration of the relation of aperture to power in microscope objectives.

15. Methods of manipulation, decantation, desiccation, isolation, etc.
16. Methods of measuring aperture, power, focal length, etc.
17. Methods of illumination for special purposes, special objects, etc.
18. Uses of the Mechanical Finger. Application to research, etc.
19. Electrical and thermal applications in research. Hot Stages, etc.
20. Uses of Live-Boxes, Growing-Cells, Compressoriums, Troughs, and special apparatus for investigations of special objects, etc.
21. Special methods of treatment or examination of special subjects of investigation, such as blood, pus, urine, etc.
22. Staining and mounting bacteria, micrococci, etc., for examination.
23. Special methods of cell-making, cementing, cover-cutting, etc.
24. Special methods of mounting, labelling, finishing, packing, storing, or registering slides. Finder Records, etc., etc.

It is expected that one or more workers will illustrate each of the above subjects. Many of the most efficient members of the Society have already promised their co-operation. Suggestions relating to the work in any respect are invited, and all who are willing to aid in illustrating any of the above, or other subjects not enumerated, are cordially requested to inform me as soon as possible what part of the work they will undertake, and communicate such information as may be needed in preparing for the suitable presentation of their exhibits.

164 Lake Street,

Cleveland, Ohio.

C. M. VORCE.

CORRIGENDUM.—For the words, “A New Microscope Stand, furnished by Mr. Green, successor to Mr. Tolles,” in the January Number of the JOURNAL, page 26, substitute the words, A New Microscope Stand, made by Mr. Dalton, of Boston.

JOURNAL
OF THE
NEW-YORK MICROSCOPICAL SOCIETY.

VOL. I.

MAY, 1885.

No. 5.

THE PROPER CARE AND USE OF MICROSCOPE
LENSES.

BY WILLIAM WALES.

(Given April 3d, 1885.)

However good the lenses of an instrument may be, they will not do their best work except when properly cared for and properly used. Yet I have met with reputable microscopists who do not in practice appreciate this obvious truth.

Let me show you how a lens is cleaned. My implements are four,—an old, soft, silk handkerchief, a small stick of soft wood, a phial of alcohol, and a watch-maker's glass of two powers.

I have here an eye-piece. I will first examine it with the magnifying glass, by reflected light, to learn its condition. If it be found to need cleaning, alcohol is to be applied with the handkerchief. This liquid must not be allowed to touch the lacquer; but the cell which holds the lens will not be harmed by it, since that has been burned black with acid. If, after the cleaning, fibres from the cloth be found adhering to the lens, they may be blown off by a quick breath.

I have brought an objective which was sent to me to be cleaned. I will attach it to an instrument, and will place under it a slide of familiar diatoms. Now view the object through the lens. It looks so obscure that you will all exclaim, "Well, this is a very poor objective;" whereas, it is of excellent quality, as you shall presently see. In it are eight pieces of glass. The back combination is composed of two crowns and the flint; the middle, of a double-concave flint and a double-convex crown; the front, of two crowns, with a flint between them. It has, probably, not been cleaned for twenty years. Suppose your watch to have been thus neglected! I will now clean this objective. I begin the work by unscrewing the cells. I then moisten a part of the handkerchief with alcohol, and, with the help, if needed,

of the stick of wood in searching the corners, carefully clean each combination, and I then screw each cell back accurately to its place.—The work is now finished, and I will attach the objective again to the microscope, and will again ask you to view the slide of diatoms through it.—The dimness is now, you perceive, all gone. Indeed, you can hardly believe it the same objective; and you have ocular proof that cleanliness is essential to the best performance of a lens, and are witnessing an instance of the dependence of important results on attention to little things.

Several years ago, while I was getting ready to visit England, the owner of a Powell and Lealand objective wished me to take the lens to its makers for correction or exchange. "It is a poor lens," he said. I could not credit his statement, for I knew the work of the Messrs. Powell and Lealand to be faultless. I called on those gentlemen. We examined the objective together, and discovered on one of the combinations a film of some substance which could not be removed except with alcohol. In five minutes the lens was clean and in perfect order; and to this day the owner refuses to believe that the lens which I brought back to him is the same with that which I took abroad.

Never trust the cleaning of your objectives to the brass-worker, or to any person who does not know how carefully a lens ought to be handled. The brass-worker will polish the outside of the objective, but will get the lenses out of centre. To my great disgust, I once found a brass-worker subjecting one of my $\frac{1}{16}$ ths-inch lenses to that treatment. I asked, "What are you doing with that objective?" "Putting it in order, at the request of its owner," he said: "he wants to sell it." Taking the lens, I cleaned it for him without charge.

A camel's-hair brush can neither completely nor safely remove the film of dust with which the exposed surface of the back combination of an objective is sometimes found to be coated. It will make a series of rings on the surface of the lens, and it may, if grit be present, scratch the glass. Nor should the handkerchief, either wet or dry, be introduced into the tube of any but a low-power objective. The cells must first be unscrewed from their mountings, and then the cleaning can be done properly. But, let me add,—

An objective ought never to be taken apart by any one but its maker. He has the lathe upon which it was made; and he

alone, when the parts have been separated, can replace them in their original adjustment to the optical centre. Any other person will be likely to screw in the cells either too tightly or not tightly enough, and will thus throw the combinations out of their necessary delicate relation to one another. Besides, unless skill and care be exercised in screwing the parts together, the front and the middle combinations will sometimes be brought in contact, and the flint glass, which is very thin at the centre, will be broken. The screw-thread of the cells is very delicate. Yet some persons, after failing to catch it, apply force enough to break it. Such carelessness passes comprehension.

A large-angle oil-immersion lens gets out of order easily. If you find the definition of such objective to have lost its sharpness, you may know that the front lens is out of centre. It has come in contact with the slide. A very slight pressure is sufficient to work the mischief. This susceptibility to injury is unavoidable, as every optician will tell you. It is incident to the requirements of high-angle construction.

A few days ago an objective was sent to me with the request that the front lens should be reset. It had in some way been forced out of its place. I reset it as well as I could. But that objective, even if it had been repaired by its makers, the Messrs. Powell and Lealand, can never be what it was before the injury. The only way of repairing it was by inserting a ring of cement which, projecting slightly through the shoulder, necessarily cut down the angle. A heavy shoulder means, of course, a low angular aperture.

A novel method of using an immersion lens came under my notice recently. A water-immersion objective had been ordered. It was made and sent, but it did not give satisfaction. I inquired by letter, "In what way do you proceed to work with it?" "I fill it with distilled water, and then screw it to the instrument," was the reply.

An objective is sometimes almost ruined through sheer carelessness. I made a costly lens for a New-York optician. He tossed it several times in his hand, and finally dropped it upon the floor. "Oh," he said, "that will not harm it!" I looked at it, and found the front combination tilted at an angle of about forty-five degrees. This act of carelessness cost that optician twenty-five dollars.

I have here the back setting of a $1\frac{1}{2}$ -inch lens which was made by me several years ago. The purchaser of the lens had screwed it so tightly to his microscope that he could not, with his hand, unscrew it. So he used a pair of heavy gas-fitter's pliers, and succeeded in pulling the tube of the fine adjustment out of the body of the instrument. This rude handling damaged the microscope to the amount of forty-five dollars.

Quite recently the owner of an instrument which cost three hundred and fifty dollars told me that he had a wonderfully clever son. "Why," he exclaimed, "he has, with a screw-driver, taken the microscope all apart! He is unable, however, to put it together again." This outrage illustrates the incapacity of some people, old, as well as young, to appreciate the products of fine workmanship.

I do not favor the nose-piece. If you must have one, choose one that is of good design and thoroughly well made. Lenses, especially those of high power, ought not to be tested with the use of this accessory.

A superior lens, worked by an illustrious microscopist, becomes its maker's best advertisement. But when it falls into the hands of a careless or incompetent person, and is not carefully used or regularly and properly cleaned, to hold the maker responsible for its consequent unsatisfactory performance is to do him great wrong.

SPONGES.

BY PROF. HENRY J. RICE, SC. D.

(Given April 17th, 1885.)

To the morphologist few forms of life present more interesting objects of study than do the various members of the family of sponges, since in their life-history are found typified certain changes or conditions through which, modified to a greater or less extent, almost all other animals have to pass in attaining maturity.

The general aspect of the sponge, and its habit of attachment to some support, caused it for a long time to be considered a vegetable. But when the distinction between animal and vegetable life had become better understood, and the sponge itself had been carefully studied, both as to its manner of growth and

its structure, it became evident that this organism belongs to the animal kingdom. Its exact position in that kingdom has not been fully determined ; but, without stopping at present to consider its Protozoan or Metazoan relationships, we may describe it as we know it,—either as a community of animals, or as a communal animal—one from many, or many from one.

Sponges are found mostly in tropical or warm seas where the water is moderately shallow, although certain forms occur in fresh water in temperate regions. They vary exceedingly in color, shape, and size, yet they can be placed for the most part in a few subdivisions. The classification is not, however, either fixed or entirely satisfactory as it now exists ; still, for all present purposes, a division may be made into the groups, or families, of the Myxospongiæ, Calcispongiæ, Fibrospongiæ, and Clionidæ. This classification is based on the absence or presence of spicules in the body-walls of the sponge, and on the composition of these spicules. In the Myxospongiæ the walls consist of sarcode, or protoplasm, alone. In the Calcispongiæ the tissue is strengthened by calcareous spicules, and in the Clionidæ the spicules are siliceous. In the Fibrospongiæ the framework of the body is of a fibrous nature, being made up of a substance called keratose. To this group are assigned the beautiful and delicate glass-sponges, although their framework is of siliceous.

How do sponges grow? and what is the first stage of their life-history? The marine sponges begin life either from the egg or by budding. The fresh-water sponge, besides the development from the egg, may start from a minute seed-like body, or statosphere, which is formed in autumn in the walls of the sponge, and from which a germ, the true statoblast, emerges in spring to develop into the adult form. Owing to the spicules with which they are adorned, some of the statospheres are very beautiful. The classification of this family is largely based on the shape of these spicules.

The sponge of commerce is the keratose skeleton of certain members of the group Fibrospongiæ, all the living substance having been eliminated. We shall better see the difference between the sponge in this condition and the sponge in its natural state, if we first learn how the animal lives. In gazing down into the water in regions where sponges abound, the observer will descry, fastened to rocks and other supports, certain velvety

plant-like objects which resemble bunches of compact sea-weed more than anything else. It would be difficult for the un-instructed to recognize them as sponges: yet such they are. If we take one of the simplest of these, we find that it is shaped somewhat like a vase. By its base it was attached to its anchorage. At the upper end is an opening, the osculum, leading into a central cavity, the ventriculus. The wall is (usually) of two layers. The inner consists of cells provided with long cilia, the outer with cells furnished with spicules. The wall may be continuous, or it may be perforated with one or more pores through which water passes from without into the ventriculus. If the wall be thick, the pores will be many, and will represent as many canals leading to the central cavity. When these pores are so numerous as to lie close together, the ciliated cells are no longer observed on the wall of the main cavity, but will be found lining the canals. These cells, when sufficiently magnified, are seen to have a body-portion to which is attached the cilium, while around the base of the cilium and extending out from the body of the cell is a hyaline collar which gives to the whole a bottle-shaped appearance. The cell-body usually contains a nucleus, a nucleolus, and a contractile vacuole. These cells are the feeding organs of the sponge; and the cilia, by their motion, cause currents in the water and thus procure for the cells their food. Such food-particles as cannot be absorbed and appropriated are sent on with the general current into the ventriculus, from which they are expelled at the osculum.

The resemblance of these flagellate collared cells to monads, combined with the supposition that the sponge consists exclusively of communities of such cells, has caused this animal to be ranked as a Protozoön. But the study of the egg and its development leads me to a different view. The investigator will notice in the wall of the sponge, not only flagellate collar-bearing cells, such as have been described, but also, behind these, other cells of various kinds which are unciliated, and are sometimes seen grouped in small clusters. Some of these inter-tissue cells, situated just beneath the lining of a canal-wall, assume special functions; and by self-division each original cell becomes transformed into a little group of cells, some of which are large and some small. The smaller are ciliated and the larger not. The segmentation continues until an embryo is formed in which

the large cells are upon one side, or the basal half, and the small cells occupy the other portion. The cell thus transformed is then passed out of the body-wall of the sponge into the canal, and is carried by the current of water which it there encounters, into the central cavity of the sponge, and thence through the osculum into the waters without. It is there moved about by its cilia and by the sea-currents until, striking some hard object, it anchors itself by its basal extremity. But, meanwhile, changes have been going on within the egg itself. The two kinds of cells have separated so as to produce a central or segmentation cavity, with the cells arranged as a shell or coating around the cavity—and the little animal forms what is known as a morula. A collarette of cells is then formed around the centre of the embryo, and by the multiplication of these and the other cells the segmentation cavity becomes nearly or quite obliterated. At the same time the ciliated cells of the outside of the embryo grow upward all around it, and soon a gastrula is the result—or a bottle-shaped animal with a central cavity which is lined with ciliated cells and is in communication, by many pores, with the waters without ; that is, we have a newly-formed sponge.

The flagellate cells with which we observe the interior of our newly-formed sponge to be lined—whence come they ? They are simply the exoderm cells of the original egg transformed into monads. Now, a monad is a Protozoön, since its growth does not involve change in cell-structure. But the development of the sponge does involve a process of differentiation, and hence this animal ought, I think, to be ranked as a Metazoön.

I have spoken of the sponge as a community of animals. How is that community formed ? Returning to our sponge, and watching it carefully, as before, we find one or more buds forming on the outside. These do not begin as growths upon the exterior, but as eversions of the wall itself, which appear, at first, as indentations in the inner surface. Presently an opening is formed at the apex of the bud. This becomes an osculum, resembling that of the parent and performing the same function. These buds start early, and grow with the growth of the parent, and each bud becomes a centre from which other buds shall spring, from each of which proceed yet other ramifications. Since the original parent form, with the oldest buds or branches, grows a little higher than the others, we shall have, as the result of the

successive buddings, a colony of a shape more or less globular. In other words, the sponge takes on the figure with which we are familiar, with pores throughout the mass, and exhibiting at or near the centre the osculum of the original sponge. Sometimes two large oscula are seen, corresponding to two growths, one of which branched off early from its companion. The ventriculi, old and young, of the entire colony, are in free communication with one another. In general it may be said that the water goes in on all sides and goes out on all sides, but tends to pass out by different openings from those by which it came in.

The foregoing description presents the sponge simply as a porous mass of sarcode cells. In other examples spicules are found attached to the outside wall in numbers so great as to invest it completely. These may assume every variety of shape and size, and are often of great beauty. Some are needle-like; others have the form of a three-pointed star; still others are crescent-shaped, with a long spur projecting from the middle of the convex side. These all interlock in such manner as to form a strong and complete net-work in the outer tissue of the sponge. Only occasionally do they extend through all the tissues.

But in this form the sponge is of no practical service. To be useful, it must be free from spicules and must have a framework of keratose. Where, then, and how is the keratose deposited? Some sponges have a layer of cells between the inner and the outer layers; in other words, mesoderm, as well as endoderm and exoderm cells. The keratose is generally formed as a mass of fibres interlacing in all directions through the mesoderm layer, and sometimes also embracing and thus firmly uniting the inner and the outer layers. The result of this growth in a sponge of this kind is that every canal in the whole sponge becomes inclosed in a tube of keratose, so that the keratose of the entire communal animal constitutes a framework of the same general form with the animal itself. Now, should you pluck a living sponge, of this variety, from its anchorage, you would find it feeling soft and slimy in your hand. The slimy substance is simply the sarcode of the exoderm cells, which envelops the whole sponge. The inner walls have also their layer of living cells. But the dealer in sponges wishes them rid of their sarcode. Accordingly, when the sponges are gathered from the

sea-bottom they are taken to the shore and placed where the water can get access to them and wash away the protoplasmic matter. They are still further cleansed by the use of chloride of lime, by exposure to the sun, and by washing in water, until nothing but the keratose is left. They are then dried and packed and sent to the market. The closeness of the packing greatly changes their appearance; but, when freed from compression and soaked in water, they regain nearly their original size and shape. It is to the ease with which it absorbs and, under pressure, gives up, water, that the fibrous sponge owes its usefulness; and this property depends on the flexibility and elasticity of the keratose fibres, as well as on the abundance of the canals which ramify among them.

In the quality of the keratose, sponges differ according to their habitat. Those occurring in United States waters are coarse. The finest grow along the coasts of Syria and Greece. These are detached from their beds with great care by the hands of divers who go down from vessels specially designed for this work. Among them is the famous Turkish cup-sponge, which is highly valued on account of the silk-like fineness and softness of its fibres. Its form gives it its name. A large specimen is costly. Indeed, in former times it brought almost its weight in gold. Sponges with coarse keratose fibre are less expensive, and are collected with less care. Of medium quality and cost is the "woolly sponge," so called from its resemblance to sheep's wool. It is soft, tough, and, for ordinary uses, good.

The ordinary keratose sponges are not beautiful; they are simply useful. The converse is true of the form called the glass-sponge. This occurs sometimes in very deep waters. In most cases its framework consists entirely of long and delicate glass-like spicules. One species, called Venus's Flower-basket, is shaped like a cornucopia, and grows sometimes to a length of twelve or more inches. Its fibres are so interlaced with one another as to form octagonal openings and present a sieve-like aspect. Of other forms of glass-sponge, some are globular, some oval. An abundance of fine intersecting fibres gives to these also a beautiful lace-like appearance. From the base proceeds a bundle of long glass-like threads by which the sponge is anchored to the sea-bottom.

The so-called boring-sponge, the enemy of the oyster, belongs

to the group Clionidæ. Fastening itself to the shell of the oyster, this sponge eats into it, tunnels it, and sometimes pierces even the inner nacreous layer. The peculiar construction of the shell facilitates this work. The shell is made up of a succession of calcareous plates, which are more or less discontinuous, and are of increasing size as they recede from the umbo. These layers are hard, and strongly resist the saw. Between them is a soft packing, consisting of prismatic calcareous material, which cuts as easily as cheese. When, therefore, the sponge has bored through a hard plate of the shell, it spreads its branches readily through the soft material beneath. It is obvious that, especially where the packing between the hard layers has been rendered continuous because of a want of continuity in those layers, the work of destruction must be rapid, and that the shell will soon become disintegrated. I have seen oyster-shells which had become so thoroughly perforated by the boring-sponge that the two valves, when pried open by the knife, fell in pieces, leaving only two small plates where the adductor muscle was attached.

PROCEEDINGS.

MEETING OF APRIL 3D, 1885.

The President, Mr. C. Van Brunt, in the chair.

Thirty-three persons present.

OBJECTS EXHIBITED.

1. Fourteen Photographs of Diatoms ; taken in 1876, by J. J. Woodward, Asst. Surg., U. S. A. : by A. WOODWARD.
2. Eighty-eight Diatoms, arranged in three rows ; mounted by Mr. Peticolas : by C. S. SHULTZ.
3. Fifteen Diatoms, arranged in a star-shaped group : by C. S. SHULTZ.
4. Diatoms from Puget Sound : by C. S. SHULTZ.
5. Diatoms from Ajaccio, Corsica : by C. S. SHULTZ.
6. Five Slides of miscellaneous Diatoms : by C. S. SHULTZ.
7. *Conochilus volvox*, and *Volvox globator* : by A. D. BALEN.
8. Iridescent shell of Baculite ; from Dakota : by G. F. KUNZ.
9. Ruby Copper, from Cornwall, England : by G. F. KUNZ.

DR. WOODWARD'S PHOTOGRAPHS OF DIATOMS.

President Van Brunt attributed the excellence of Dr. Woodward's photomicrographs to the use of the wet-plate process and of sunlight.

Mr. Dudley said that the dry-plate process, although it has been greatly improved since its introduction, and is destined to further improvement, will probably never render the fine lines of diatoms with the precision of the wet-plate process.

DIATOMS FASTENED BY HEAT.

President Van Brunt: "Prof. Hamilton Smith has recently sent me an excellent slide of diatoms mounted in his newest medium and exempt from the mobility which drew forth criticism at the meeting of March 20th. The diatoms were fixed to the cover-glass by means of heat. When diatoms are fastened by this method, only so much heat should be applied as is found to be really necessary. Least heat is required when the diatoms are taken from a solution of alkali."

THE PROPER CARE AND USE OF MICROSCOPE LENSES.

Mr. Balen: "For cleaning the lenses of my microscope, I use an old silk handkerchief which has been cleansed from grease and from soap, and has been made soft, after drying, by being rubbed inside another handkerchief. The upper lens of the eye-piece I protect from dust by keeping over it a small circular piece of blue glass. It hence needs not that frequent cleaning which, if care be not used, endangers polish."

Mr. Wales, after expressing approval of Mr. Balen's method of cleaning lenses, described and illustrated his own. He gave also hints and cautions on the proper care and use of lenses, and sketched some curious instances of their maltreatment. His observations constitute the opening article in this Number of the JOURNAL.

MEETING OF APRIL 17TH, 1885.

The President, Mr. C. Van Brunt, in the chair.

Fifty-six persons present.

OBSERVATIONS ON SPONGES.

H. J. Rice, Sc. D., who was present as a guest, gave an Address, by invitation, on the subject of sponges. He treated

mainly the life-history of the sponge of commerce, describing its development both from the egg and from the bud. He concluded his Address with a notice of *Cliona*, or the boring-sponge, and of the harm done by it to the oyster. He gave it as his opinion that the embryology of sponges ranks them with the Metazoa. His observations form the second article in this Number of the JOURNAL.

Discussion elicited the following matter :—

Mr. J. D. Hyatt: "The boring-sponge attacks shells and limestones. It sends out into them roots, or arms, which, through ramification, become smaller and smaller, like the mycelium of a fungus. The borings in even very hard marble reach sometimes a depth of more than two inches, and at their extremities they are microscopic.

"I have discovered no evidence that the health of the oyster is impaired by the boring of the sponge. The sponge does not feed upon the oyster. It has been observed in aquaria to attach itself quite as readily to a vacant as to an occupied shell. When its arms have penetrated to the inner surface of the shell of a living oyster, the mantle of the mollusk, becoming irritated by their presence, checks and, I think, stops the intruders by depositing at once an extraordinary quantity of nacre at the points of intrusion. You see as a result small elevations at those points. The shell may, at the same time, have become so far honey-combed in other directions that it can be easily crushed by the hand."

Prof. Rice: "The sponge does not, it is true, seek the oyster; yet the oyster is liable to perish in consequence of the disintegration of its shell by the borings of the sponge. This liability occurs in those cases in which the borings have weakened the innermost plate to such a degree that the part to which the adductor muscle is attached gives way under the traction of the muscle. The valves are then forced open by the tension of the ligament, and the oyster is left defenceless against its enemies.

"I have seen shells in which the borings seemed to penetrate, not only the nacreous lining proper, but also layer after layer of material which the oyster had deposited for the obvious purpose of protecting itself against the encroachments of the sponge."

A FILTER WASH-BOTTLE.

Mr. C. E. Hanaman, of Troy, presented to the Society a filter wash-bottle of his own invention and of easy construction. "It is especially adapted," said the donor, "for the use of histologists. The bottle is of the common kind, with a mouth an inch or more in diameter. The cork is fitted with the tube of a thistle-top funnel, besides the usual delivery and air-supply tubes. The mouth of the funnel is furnished with a cork. To the end of the delivery tube is attached by an air-tight joint a short piece of larger tubing filled with filter-cotton. This is corked at its lower end, and into the cork passes a small tube terminating in a jet. Over this jet, when the apparatus is not in use, may be placed a small phial. This wash-bottle protects alcoholic solutions of staining agents from evaporation."

THE AMERICAN SOCIETY OF MICROSCOPISTS.

Mr. Hyatt : "I hope that as many members as possible of our Society will make an effort to attend the Annual Meeting of the American Society of Microscopists which is to be held this summer at Cleveland. Among the members of that Society are many of the most distinguished microscopists in the United States. The meetings are always valuable scientifically and pleasant socially."

PUBLICATIONS RECEIVED.

Brooklyn Entomological Society. *Entomologica Americana* : Vol. I., No. 1 (April, 1885) ; pp. 20.

The Electrician and Electrical Engineer : Vol. IV., No. 40 (April, 1885) ; pp. 40.

Journal of the Cincinnati Society of Natural History : Vol. VIII., No. 1 (April, 1885) ; pp. 72.

First Annual Report on the Injurious and Other Insects of the State of New York ; pp 3-44. By J. A. Lintner, State Entomologist ; Albany, 1882.

Proceedings of the American Academy of Arts and Sciences : New Ser., Vol. XI., Whole Ser., Vol. XIX., Pt. I. (May, 1883, to December, 1883) ; pp. 230. Pt. II. (May, 1883, to May, 1884) ; pp. 358.

Bulletin de la Société Royale de Botanique de Belgique : Tome Vingt-Troisième (1884) ; pp. 568.

Anthony's Photographic Bulletin : Vol. XVI., No. 7 (April 11th, 1885) ; pp. 32. No. 8 (April 25th, 1885) ; pp. 32.

The American Monthly Microscopical Journal : Vol. VI., No. 4 (April, 1885) ; pp. 20.

Elephant Pipes in the Museum of the Academy of Natural Sciences, Davenport, Iowa ; pp. 38. By Charles E. Putnam.

The Midland Naturalist : Vol. VIII., No. 88 (April, 1885) ; pp. 28.

Proceedings of the Natural Science Association of Staten Island : October, 1884, to April 11th, 1885 ; pp. 6.

The West-American Scientist : Vol. I., No. 5 (April, 1885) ; pp. 7.

The Journal of Microscopy and Natural Science : Vol. IV., Pt. 13 (January, 1885) ; pp. 64. Part 14 (April, 1885) ; pp. 70.

Proceedings of the Colorado Scientific Society : Vol. I., 1883 and 1884 ; pp. 28+144.

Die Natur, Halle, Prussia : New Series, Vol. I., No. 14 (April 4th, 1885) ; pp. 8.

The Microscope : Vol. V., No. 4 (April, 1885) ; pp. 24.

Nuovo Giornale Botanico Italiano : Vol. XVII., No. 1 (January 22d, 1885) ; pp. 48.

The Botanical Gazette : Vol. X., No. 4 (April, 1885) ; pp. 18.

The School of Mines Quarterly : Vol. VI., No. 3 (March, 1885) ; pp. 96.

Journal of the Royal Microscopical Society : Ser. II., Vol. V., Pt. 2 (April, 1885) ; pp. 208.

Bulletin of the Natural History Society of New Brunswick, Canada : No. 4 (1885) ; pp. 116.

The Microscopical Bulletin and Optician's Circular : Vol. II., No. 2 (April, 1885) ; pp. 8.

INDEX TO ARTICLES OF INTEREST TO MICROSCOPISTS
WHICH HAVE RECENTLY APPEARED IN OTHER
JOURNALS.

Alga (*Edogonium crassiusculum*), Filiform, Life-History of a (To be continued): M. C. COOKE.

Mid. Nat., VIII. (1885), pp. 74-6, and 89-94 (4 figs.).

Algæ of Fresh Water, Provisional Key to Classification of (To be continued): R. HITCHCOCK.

Am. Mon. Mic. Jour., VI. (1885), pp. 68-74.

Anatomical and Histological Methods, Some: O. P. HAY.

Am. Nat., XIX. (1885), pp. 526-9 (1 fig.).

Animal Metamorphosis (Pt. I.): J. B. JEAFFRESON.

Jour. of Mic., IV. (1885), pp. 84-96 (13 figs.).

Bacilles courbes ou bacilles-virgules (*Komma-bacillus*), Sur la nature indifférente des, et sur la présence de leurs germes dans l'atmosphère: J. HERICOURT.

Comptes Rendus, C (1885), pp. 1027-9.

Bacterium lactis. See Lactic Ferment.

Batrachospermum moniliforme. See Cystocarps.

Chironomus prasinus (Pt. I.): A. HAMMOND.

Jour. of Mic., IV. (1885), pp. 65-74 (30 figs.).

Cystocarps, Formation of, in *Batrachospermum*.

Cole's Studies in Mic. Sci., April, 1885, pp. 9-12 (colored plate).

Dianella cærulea. See Petalody of the Ovules.

Dioön edule, Lindl., Descrizione Anatomica dell' Infiorescenza e del Fiore Femmineo del: G. CUGINI.

Nuov. Giorn. Bot. Ital., XVI. (1885), pp. 29-43 (28 figs.).

Eggs of Vapourer Moth (*Orgyia antiqua*); under heading Graphic Microscopy: E. T. D.

Sci.-Gossip, 1885, pp. 73-4 (colored plate).

Embryology, Outlines of (Third paper).

The Microscope, V. (1885), pp. 81-5 (8 figs.).

Histological and Anatomical Methods. See Anatomical and Histological Methods.

Homogeneous-Immersion Objectives: A. Y. MOORE.

The Microscope, V. (1885), pp. 73-5.

Immersion Illuminator, On a Cata-dioptic: J. WARE STEPHENSON.

Jour. Roy. Mic. Soc., V. (1885), pp. 207-11 (1 fig.).

Infusoria, Some New: ALFRED C. STOKES.

Am. Nat., XIX. (1885), pp. 433-43 (10 figs.).

Intracellular Digestion, Abstract from an Article on, by Dr Elias Metschnikoff: H. G. BEYER.

Am. Mon. Mic. Jour., VI. (1885), pp. 61-5.

Lactic Ferment (*Bacterium lactis*), On Some unusual Forms of: R. L. MADDOX.

Jour. Roy. Mic. Soc., V. (1885), pp. 205-6 (1 fig.).

Lantern Microscope, The. See Microscope.

- Leech, Medicinal, The Physiology of the : JOHN B. HAYCRAFT.
Mid. Nat., VIII. (1885), pp. 98-100.
- Microscope, The, and How to Use it (Pt. II.—On Mounting Microscopic Objects) : V. A. LATHAM.
Jour. of Mic., IV. (1885), pp. 96-104 (1 fig.).
- Microscope, The Lantern : LEWIS WRIGHT.
Jour. Roy. Mic. Soc., V. (1885), pp. 196-204 (3 figs.).
- Microbes, La Culture des, et l'Analyse biologique de l' Air et de l' Eau par les procédés les plus pratiques : HERMANN FOL.
La Nature, XIII. (1885), pp. 227-30, and 298-302 (10 figs.).
- Molecular Motion ; under heading Pleasant Hours with the Microscope : HENRY J. SLACK.
Knowledge, VII. (1885), 318-9.
- Mounting Microscopic Objects. See Microscope, The, and How to Use it.
- Noyau Cellulaire, Nouvelles Recherches sur le, et les Phénomènes de la Division communs aux Végétaux et aux Animaux : M. LÉON GUIGNARD.
Ann. des Sci. Nat., XX. (1885), pp. 310-72 (84 figs.).
- Edogonium crassiusculum*. See Alga.
- Orgyia antiqua*. See Eggs of Vapourer Moth.
- Petalody of the Ovules and other Changes in a Double-Flowered form of *Dianella cærulea*, On. MAXWELL T. MASTERS.
Nature, XXXI. (1885), pp. 487-8.
- Phanèrogams, Recherches sur le Péricycle ou Couche Périphérique du Cylindre Central chez les : M. LOUIS MOROT.
Ann. des Sci. Nat., XX. (1885), pp. 217-309 (50 figs.).
- Pond-Life : WILLIAM EVANS HOYLE.
Jour. of Mic., IV. (1885), pp. 105-13 (26 figs.).
- President's Address, The (Royal Microscopical Society) : W. H. DALLINGER.
Jour. Roy. Mic. Soc., V. (1885), pp. 177-195 (42 figs.).
- Rocks, The Microscopical Study of : JOHN ERNEST ADY.
Ill. Sci. Mon., III. (1885), pp. 99-103. (4 figs.).
- Staining Tissues in Microscopy (To be continued) (HANS GIERKE, *Zeitschr. für Wiss. Mic.*) : Translated by W. H. SEAMAN.
Am. Mon. Mic. Jour., VI. (1885), pp. 65-8.
- Tradescantia Virginica*, la Division des Noyaux dans le, Note sur : E. BERNI-MOULIN.
Bul. Soc. Roy. Bot., Belg., XXIII. (1884), pp. 7-14 (17 figs.).





oi

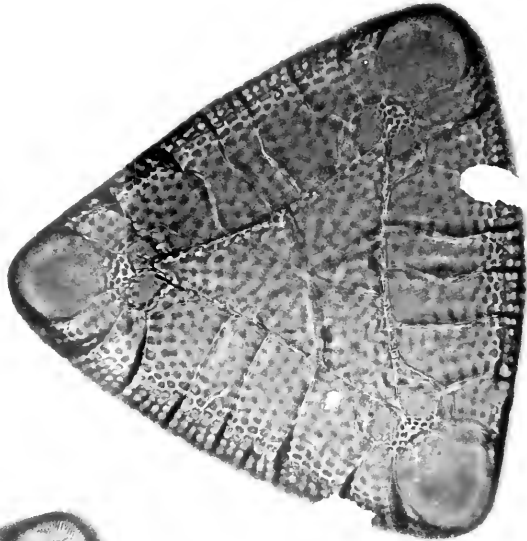
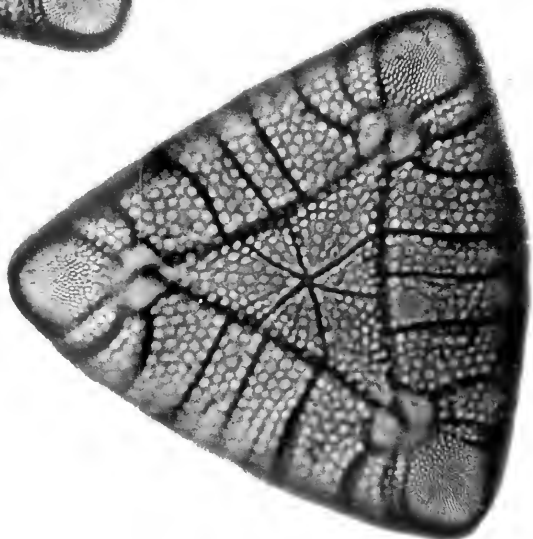

3

TRICERAT. M. DAVYANUM, Grev.

1.

JOURNAL
OF THE
NEW-YORK MICROSCOPICAL SOCIETY.

VOL. I.

JUNE, 1885.

No. 6.

THE SEALED FLASKS OF CRYSTAL.

BY ALEXIS A. JULIEN, PH. D.

(Read May 15th, 1885.)

To the loot of Pekin the art-lovers of the world owed their first thorough knowledge of the curious images, balls, vases and flasks carved, often grotesquely, in the very hardest materials—jade, agate, and rock-crystal—by the skilful artificers of China and Japan. Such an object drew its interest, not only to the beauty of its form, but also to the lustre, transparency and imperishability of its material, and, often, to its priceless value, as representing an entire lifetime of patient labor.

But nature has gone even farther, having produced, in the so-called fluid-cavities of the harder minerals, flasks and vases still more minutely and deftly worked and of vastly greater antiquity, filled, besides, with strange liquids and gases, and then hermetically sealed forever with the very material of the flask itself. A kind of romantic and even artistic interest has been manifested by mineralogists and microscopists toward these delicate inclosures, and much careful study has been bestowed upon them. It is not the purpose of this paper, however, to review the literature of the subject, nor even to describe these fluid-cavities in detail, but simply to present such suggestions in regard to the collection and preparation of specimens, the choice of objectives and accessory apparatus, and the common method of examination, as may smooth the path for the study of these cavities by the general microscopist who may not have made microscopic lithology a specialty.

Contrary to the general belief, the material which contains these cavities is not rare. All the harder crystallized minerals have them, and the conditions for their easy examination are presented everywhere in our common gems,¹—the diamond, ruby,

¹Isaac Lea: Proc. Acad. Nat. Sci. Phila., 1869, Feb. and May; and 1876, May.—H. C. Sorby and P. J. Butler: Proc. Roy. Soc., London, 1869, XVII., p. 291.

sapphire, emerald, aquamarine, tourmaline, fluorite, chrysoberyl, and, above all, the topaz² and the amethyst. Many a microscopist is unaware of the beautiful inclosures which are to be found in the jewels in the possession of his own family, and which can generally be examined even without removing the gems from their setting, the jewels being merely held in the stage-forceps under a low-power objective. To prevent interference by reflection from the many facets, a temporary mount may be made by cementing to the gem a thin cover-glass with a drop of thickened but cold balsam. After examination, the balsam can be removed by immersion a short time in benzine or spirits of turpentine. Many lapidaries and dealers are aware that the flaws which occur in gems and greatly decrease their value consist largely of inclosures;—sometimes minute inclosed crystals of other minerals; sometimes cavities filled with some gas and beautifully faceted with the crystalline form belonging to the material of the gem; sometimes cavities of a great variety of forms, filled partly or wholly with a liquid in the form of a bubble of gas, and having, perhaps, other small crystals of other gems or cubes of salt clinging to the walls. These inclosures soon come when, as a matter of scientific interest, a lapidary possesses a gem will pride themselves on their specimens when it contains rather than on their absence—at least, so far as the flaws represent either included crystals or fluid-cavities.

I shall invite your attention this evening to the subject of the fluid-cavities in quartz, or rock-crystal, putting aside altogether those contained in other minerals.

The first point claiming consideration is the selection and preparation of material. The material is plentiful in which these cavities occur in forms of great variety and with fluid contents of an exceedingly interesting character. The number of localities at which such specimens have been found has increased largely within the last few years, and it is probable that in a short time any investigator of this subject will know where to look for suitable material without leaving the place in which he resides. It can be procured in abundance on the island of New York from several sources; viz., the quartz-grains in the common

²Sir David Brewster. See, for ref., J. D. Dana's "System of Mineralogy," articles Brewsterite and Cryptolite; also Phil. Mag., 1847, (3), XXXI., p. 497; 1853, (4), V., p. 235; etc.—R. Th. Simmler: Pogg. Ann., 1858, CV., p. 460.—H. Vogelsang and H. Geissler: Pogg. Ann., 1863, CXXXVII., p. 56.—Alexis A. Julien: Jour. Am. Chem. Soc., III.

rocks of the island; the fibrolitic gneiss³ near High Bridge, and indeed all the other forms of gneiss, schists, and granite; the smoky quartz which occurs in the granite veins; the quartz-grains in many of the coarser granites and sandstones which are imported into the city, in great variety, as building stones; and even many of the quartz-grains in the sand of our seashore, as at Coney Island. The smoky form of quartz is almost always a vein quartz, of very common occurrence on our island, and familiarly known to all our collectors of local minerals. Especially on the west side of the city, all the way up from Sixtieth-street to the upper end of the island, very nearly, wherever excavations are going on for opening streets or for the foundations of buildings, the granite-veins, carrying this form of quartz, are conspicuous.

The matrix of the quartz has been deposited by heated solutions in fissures of the gneiss, often producing an alteration of the gneiss in its neighborhood. One form of the deposit is the smoke-colored variety of quartz, which is filled with minute fluid-cavities. Its color is not necessarily due to the presence of cavities: it has been attributed to a bituminous substance disseminated through it. Dr. Lea, of Philadelphia, has stated⁴ that the fluid-cavities "are in smoky quartz much rarer" than in transparent rock-crystal—evidently referring to the larger cavities visible to the eye. However, the minute cavities are invariably present in vast abundance through smoky quartz.

Interesting localities elsewhere, at which quartz of this variety, containing fluid-cavities of remarkably large size, is to be found, are Branchville, Conn.,⁵ Chester, Penn., and White Plains, N. C. The Branchville material has been already very fully described. In the material from Chester—which was sent to me by Mr. T. D. Rand, of Philadelphia—the cavities are occupied by brine, holding cubes of salt and occasional hexagonal crystals of another mineral, and by liquid carbon dioxide and its gas. The quartz from White Plains—which locality has been described by Mr. W. E. Hidden⁶—has yielded the largest and most remarkable cavities, holding carbon dioxide, on record. Thin sections of

³A. A. Julián: "On the Fissure-Inclusions in the Fibrolitic Gneiss of New Rochelle, N. Y." *Am. Quar. Mic. Jour.*, Jan., 1879, pp. 3-15.

⁴"Further Notes on 'Inclusions' in Gems, etc." *Proc. Acad. Nat. Sci. Phila.*, 1876, p. 6.

⁵G. W. Hawes: *Am. Jour. Sci.*, 1881, XXI., p. 203.—A. W. Wright: *Idem*, p. 209.

⁶Note on "Fluid-bearing Quartz Crystals." *Am. Jour. Sci. and Arts*, (3), 1883, XXV., p. 393.

the smoky quartz from all these localities are on exhibition here to-night.

But in addition to these natural sources of material, there are artificial substances, represented also by slides on exhibition, which may well illustrate many of the conditions that have affected the origin and development of fluid-cavities in natural crystals. Examples of these are exhibited in crystals of common salt, colored reddish or yellowish by potassium dichromate. The readiest mode of their preparation is the following.⁷ A solution of potassium dichromate is taken, just strong enough to appear red to the eye. This is saturated with common salt in fine powder, and the mixture is freed from the excess of salt and from impurities by filtration. The solution is allowed to crystallize very slowly in a flask, loosely covered by paper, in a warm place. The hopper-shaped crystals of salt are not produced under these conditions on the surface, but little cubes are deposited over the bottom. These do not fall down in the ordinary transparent form of crystals of common salt, but are clouded, and colored yellowish to reddish. On examination of the slides under the microscope, it will be seen that the cause of the cloudiness is the saturation of each salt-crystal with thousands of fluid-cavities that are partly filled with liquid, partly with a gas, the liquid being a solution of potassium dichromate caught up during the crystallization of the salt, and being red or yellow according to its strength, and often containing still more minute crystals of the same red salt. These clouded crystals are not mounted in the original colored solution, but simply in a colorless saturated solution of common salt, or in castor oil, or in Canada balsam, inclosed in a wax cell. We have in the simultaneous formation of these artificial crystals, their cavities, and their inclusions, conditions and results closely corresponding in a general way to those which have occurred in nature in the formation of crystals with fluid-cavities.

In preparing for microscopical study the common material from this island, two easy methods may be employed. One is the grinding of thin sections. This method has been fully described, in the English language, in the well-known works of Rutley and Beale.⁸ A single suggestion may be added to

⁷H. C. Sorby: *Quar. Jour. Geol. Soc.*, 1858, XIV., pp. 4-6.

⁸F. Rutley: "On the Study of Rocks," p. 59.—L. S. Beale: "How to Work with the Microscope," Fifth Edition, p. 212.

Sorby's description, given in the latter work, in which he calls special attention to the necessity of avoiding the use of polishing powder. For grinding a thin section of a compact mineral, polishing powder is appropriate, because there are no cavities which will absorb it. It is not necessary, therefore, to use a cover-glass upon a thin section of smoky quartz : it is preferable to polish the upper surface. In the preparation of thin sections of a granular mineral or of a true rock, however, polishing powder must not be used, since the scales of mica and the cleavage planes and other crevices, which occur in a rock section, would be likely to become filled with the powder, and the usefulness of the section would thereby be destroyed. Nor should such thin section be of too great thinness, lest the larger cavities be emptied. For the proper examination of these, a thickness of one millimetre, or even much more, will not be too great, so long as the cavities of the size desired are preserved and their position is sufficiently near the upper surface to be within the focal distance of the objective employed.

Another and simpler method of preparation is applicable to many compact specimens of the mineral ; viz., chipping off thin flakes by a quick sharp blow of a small hammer, and mounting them in thickened balsam under a cover-glass, or in ordinary balsam or damar in a cell. Unfortunately, in many cases, especially where the liquid contents consist largely of liquid carbon dioxide, and a condition of extreme tension prevails, the material is apt to be so extremely brittle that the least jar causes it to crumble into angular fragments, unsuitable for mounting, and with the largest and most interesting cavities emptied. Such a material will also decrepitate when heated, sometimes with very great violence, flying into powder and projecting the particles out of the test-tube or vessel. Special precaution must be taken, in mounting either a flake or a thin section of so fragile a material, lest it be fractured by heat. The thin section may be cemented upon the slide by a film of balsam, previously thickened by heating ; and, immediately after pressing down the section, the manipulator may quickly cool the whole mount by blowing upon it, or by resting it upon a cold metal plate.

Thin sections which contain very minute cavities, and which may therefore need examination under high-power objectives, should, of course, be mounted under the thinnest covers. If an

examination of the "critical point" of the contained liquid is to be made, by the method and with the immersion-apparatus to be described presently, it will be of advantage to mount them on slides of the thinnest material and shorter than those generally used by lithologists (45 mm. x 26 mm.), in order to diminish the diameter of the tank and the volume of the water employed in that apparatus. It will be well to mark such slides with a diamond point in place of using a paper label.

The selection of objectives for the study of these sections is not difficult. Although high powers are necessary to reveal some of the phenomena connected with the fluid-cavities, very low powers will answer for most purposes. Ordinarily, a power magnifying four hundred diameters is the most useful. Lenses ranging from a one-fifth to a one-eighth have been the most useful to me. Yet there are times when a power as low as that of a half-inch objective can be used, even for the study of the minute cavities in which there are moving bubbles. Of course, the very highest powers are often desirable in examining other cavities, with the limitation already expressed, that the cavity must be so near the surface as to be within the focal distance of the objective.

Transmitted light is, of course, requisite for the study of these cavities, but reflected light or that produced by dark ground illumination is sometimes the most ready means for their first discovery in running over a thin section of rock containing grains of quartz. Most cavities contain more or less gas, and this causes them to reflect the light like drops of molten silver and to catch the eye far more quickly, often, than if they had been first examined in the ordinary way.

The thorough examination of the more minute cavities will often require a command of all the resources to be found in the substage condenser, the use of the diaphragms, and the position of the mirror, for modifying the intensity and obliquity of transmitted light. The variety of forms and of refractive appearances presented in the fluid contents of the cavities, the effects of the irregular shapes and projections of the cavities and of the reflection of light from their walls, and the curious images produced by the irregular distribution and aggregation of other cavities in different focal planes, often cause perplexing phenomena, which are likely to mislead the judgment.

The chemical nature of the liquids and gases which occupy the cavities can be readily detected by chemical means. For example, the carbon dioxide, to the presence of which in the cavities of some specimens allusion has already been made, can be identified by simply crushing a fragment of the quartz in a mortar, under baryta-water, or by examining the gas with a spectroscopæ after expelling it by heat from a flask into a Geissler tube. A few simple microscopical accessories may be also employed for the same purpose. The expansion of this gas by a slight increase of temperature above 20° C. is so great that advantage can be taken of its peculiar sensitiveness in this respect for its identification, on this minute scale, by very simple means. The simplest of all is a piece of rubber tubing, about one foot in length and one-eighth of an inch in bore. If the peculiar limpidness and delicate outline of the liquid in a fluid-cavity should lead the observer to suspect it to be liquid carbon dioxide, he has but to put this tube to his mouth and blow a gentle stream of warm air for a minute or two upon the slide, from either above or below the stage. The simple warmth of his breath (about 32° C.) will be sufficient to convert the liquid carbon dioxide into a gas and thus to render its identification at once complete; for that temperature allows at least one degree to spare in reaching the point in the pure substance (31° C.) at which this change of state takes place. If there happens to be a gas-bubble of large size in relation to the layer of liquid in the cavity, the increase of temperature tends at the same time to expand the gas, and to cause the liquid to evaporate into the inner space. These two actions usually so counteract each other that hardly any change is visible. At other times an appearance of boiling is produced. But when the temperature of 29° to 31° C. is reached, in an instant the liquid layer disappears and nothing is visible within the cavity except the blurred outlines of its walls. The precise temperature at which liquid carbon dioxide thus passes entirely into the gaseous form within the cavity, is termed its "critical point." This is a condition affecting all liquids, that is, all condensed gases;—at a certain fixed temperature—which varies with the gas—the liquid flies into the gaseous state when heated in an inclosed cavity the walls of which are strong enough to resist the enormous pressure so resulting. When the slide has cooled back to the

critical point (about 31° C.), the inclusion suddenly resumes the visible form it possessed before, or sometimes assumes the form of two or three bubbles, or even occasionally of a cluster or of a shower of bubbles. If the original gas-bubble happens to be much smaller in volume than that of the inclosing liquid, and the slide is warmed gently in the same way, the bubble will be seen to dilate steadily, often rapidly, with a similar sudden disappearance of the liquid layer near the critical point. In all such experiments the observer must be on his guard as to the temperature of the atmosphere and of the mineral section at the beginning of the observation. In a warmly heated room, during the winter, and on a warm day, during the summer, the critical point may have been already passed and these transformations have become completed. In these circumstances no indications of the presence of carbon dioxide will be visible at the first observation unless care has been taken to keep the slide under examination cool, *i. e.*, below 30° C., which may be done by previously dipping it in cool water. The temperature of the air at midsummer in this city (30° to 33° C.) is often sufficient alone to bring the liquid up to its critical point, under the eye of the observer.

In most mineral sections the fluid contents of the cavities consist of water or some saline solution, which would usually remain but little affected in form or appearance during an experiment like that just described. Occasionally, however, the bubbles in a water-cavity are excited into lively motion and repelled into the farthest side of the cavity by the sudden application of heat. In place of a rubber tube, the application of a warm wire, glass rod, or of the burning end of a cigar, a little below the slide, may be substituted to produce the same effects—or even the direct application of the warm end of one's finger to the bottom of the slide for a few minutes.

It may be here remarked that the violent explosion of granite when exposed to high temperature, as during the great fire in the business districts of Boston, may be attributed largely to the known abundance of liquid-cavities in the quartz-grains of that rock. This is represented by the slides, on exhibition, of thin sections of the coarse Quincy granite, and of the similar hornblendic granite from the Egyptian Obelisk now in our Central Park. In both these rocks, the quartz contains many large

cavities holding water, and sometimes gaseous carbon dioxide, its liquid, or all three, in the same thin section.

For the exact determination of the temperature of expansion of the liquid in these cavities, many instruments have been devised, all belonging to the class called warming-stages. In these, recourse is had sometimes to the use of a current of heated air or of heated water, or to the conduction of heat by a metal plate. Most of these are extremely inaccurate, often complex, and untrustworthy, and it may be owing to this cause that Brewster obtained, for the critical temperature of the liquids in quartz, results of the very wide range between 20° and 51° C. As only the specialist in lithological investigation will ordinarily have recourse to such apparatus, it will be sufficient for the purpose of this paper to refer simply to a review of the subject, already published,⁹ and to the description therein contained of a simple immersion-apparatus which I have devised. Brewster, Sorby, and Hartley had used the same principle, while they employed the method which is indicated in the following language: "To determine the critical point of the new fluid, immersing the slide in water of known temperature, removing, wiping it hastily, placing it on the microscope stage, and instantly examining it, seemed preferable to any other mode of operating."¹⁰ I obtained, however, with greater convenience, far more accurate results by means of an apparatus permitting the slide to remain under observation, immersed in a layer of water on the stage of the microscope, and continuously warmed by a current of air from the breath of the observer, or, if necessary, by the conduction of heat to the bottom of the vessel from a small flame at the side of the stage. By this means an accurate determination of the actual temperature at which a fluid inclusion expands into a gaseous state may be obtained in a few minutes to the one-twentieth of a degree, centigrade.

The simplest form of this apparatus, which is inexpensive and can be fitted up by any microscopist, consists of three parts, as follows:—

1. A shallow glass tank, such as may be cut off the bottom of a chemical beaker, of sufficient diameter for the slide to lie within it, just immersed in a thin layer of water, but separated

⁹Jour. Am. Chem. Soc., Vol. III.; Am. Mon. Mic. Jour., 1884, pp. 189-90; Proc. Am. Assoc. Adv. Sci., 1884.

¹⁰Hartley: Jour. Chem. Soc., London, 1876, p. 139.

from the bottom by two little blocks of rubber or glass. This tank is placed upon the stage of the microscope.

2. A chemical thermometer of sufficient delicacy, with a short bulb, or with a long bulb bent at a right angle. This is inserted in the tank, as nearly upright as possible, and the depth of the water is made just enough to cover the bulb. The length of the scale should be such as to bring the degrees between 27° and 32° near the level of the observer's eye when it is at the eyepiece, to facilitate immediate observation without the delay caused by moving the head.

3. A piece of small rubber tubing, tied to the body of the stand, with the upper end inserted in the observer's mouth, and with the lower end, which terminates in a short piece of glass tubing drawn to a fine aperture, lying in the water on the bottom of the tank.

An immersion objective may be employed, or, if the cavity be large, any objective of lower power may be used, with its front immersed in the water. After the cavity has been brought into sharp focus, a steady but gentle stream of air is blown through the tube, the immersion of the objective preventing interference from the waves on the surface of the agitated water. The cavity is continuously observed, as the bath and the immersed thin section are gradually warmed by the current of the observer's breath, and when the critical point is reached and the liquid contents of the cavity suddenly disappear, a quick observation of the thermometer is made.

Again, as the bath cools,—which process may, in hot weather, be hastened by adding carefully a few drops of cool water, with continual agitation by the air current,—the original bubble may be observed to leap back into view, and a second observation of the thermometer is taken as a check to the first.

If a higher temperature be required for other uses of this apparatus, an oil or other liquid may be substituted for the water in the bath, and it may be heated by conduction, from a taper or lamp burning by the side of the stage, through a stiff slip of copper introduced beneath the glass tank. A small hole, for observation, through this copper slip, should be placed immediately over the centre of the aperture of the stage. The apparatus may be further protected from radiation of heat, and more uniform results ensured, by inclosing the tank in a ring of

pasteboard or sheet cork, and by inserting plates of cork between the copper plate and the stage.

The general size, form, and contents of the fluid-cavities have been very fully described by numerous observers, and, in the absence of illustrations, they need be only briefly referred to in this paper.

The size of the cavities varies greatly. Sometimes they are visible to the eye, rendering the sections of quartz cloudy. In others, when they are held up to the light, one can see the individual cavities. Other thin sections swarm with the most minute forms visible within the reach of our highest magnifying powers, and probably far beyond. In the quartz-grains of most quartzose rocks,—*e. g.*, granite, gneiss, schists, and sandstones,—the smaller-sized cavities are very common, though invisible to the eye. Those which are large enough to be visible to the eye may be sought in some quartz crystals, in smoky quartz, and in Brazilian topaz; but they are somewhat rare as yet, even in specimens of these minerals. About a quarter of a century ago all the mineralogical cabinets contained crystals of quartz from Little Falls, N. Y., in which were little cavities containing water and bitumen—the latter often floating on the surface within the bubble. Perhaps the largest liquid-cavity known is that inclosed in the famous specimen of calcite once in the collection of the late Prof. Chilton, a chemist, of this city. This cavity contains nearly two gills of liquid. The specimen is said to be now in the collection of Mr. C. Bement, of Philadelphia.

The shapes of the cavities are almost infinite in variety, generally rounded, often full of projections, and frequently displaying crystalline outlines. These have been called negative crystals, since they are simply cavities possessing planes, angles, and general crystalline forms, corresponding to those of the crystal in which they are included.

The numbers of these cavities in smoky quartz are beyond all statement, and often diminish its specific gravity by several hundredths. In a Cornish granite the fluid-cavities of the quartz were found on an average not more than $\frac{1}{1,000}$ th of an inch apart, equivalent to a proportion of a thousand millions in a cubic inch of quartz. As this mineral occurs in enormous quantity throughout our rocks, a vast amount of liquid gas must be thus locked up under our feet. In the smoky quartz of

Branchville, Mr. Wright found about seven-hundredths of one *per cent.* of liquid. In the quartz of the Cornish granites the cavities sometimes make up at least five *per cent.* of its volume, and the water in them, on an average, about one *per cent.* of its volume, or four-tenths of one *per cent.* of its weight. As the quartz-grains in a granite or in gneiss rarely amount to less than fifty *per cent.* of the whole rock, it is probable that the liquid contents of such a granite commonly reach as much as one-fifth of one *per cent.*: *i. e.*, about four pounds of liquid to a ton of the rock.

The contents of these cavities are, in general, air or nitrogen or some other gas, such as carbon dioxide; but nitrogen seems to predominate. In studying a section, one will often be surprised to observe the wide variation in the character of the different cavities in close approximation. Some are completely filled with liquid, some half filled, some empty,—that is, occupied merely by gas. The most common inclusion in the cavities consists of a liquid, usually transparent and colorless, which may be either water or brine. By brine I mean a solution more or less strong of some salt, often supersaturated. One or more crystals of the salt are often seen adhering to the walls. On gently heating a thin section containing an inclusion of this kind, the crystal sometimes disappears, and, on cooling, it reappears, occasionally in the form of several crystals. These crystals consist mostly of potassium chloride, sodium chloride, and calcium sulphate, or gypsum. They are generally attached firmly to the sides, or wedged in some narrow corner. Some have been found loose, so that, on revolving the section, the crystal was seen to tumble around the cavity; but this occurrence is very rare. It is of interest to note, that in not a single case has the “Brownian Movement” been observed to affect the crystals or other solid particles occurring in a fluid-cavity.

The occurrence of carbon dioxide in these cavities has been already mentioned. Its liquid form has a specific gravity of only 0.6, water being taken as unity. This may be easily recognized,¹¹ when it nearly fills a cavity, by the peculiar limpidness of the liquid and its freedom from color, by the delicacy of the outlines of the gas-bubble floating within it, and by the phenom-

¹¹See the excellent papers by W. N. Hartley, *Jour. Chem. Soc.*, London, 1876, pp. 137-43; and 1877, pp. 237-50.

ena of dilatation produced by a gentle heat. Other cavities contain two liquids,—the heavier saline solution next the wall and enveloping the salt-crystals, and the lighter carbon dioxide within. In this case three outlines are usually exhibited in each cavity,—that of the cavity itself on the outside, then the limiting line between the layers of saline solution and carbon dioxide, and, within, the circular outline of the gas-bubble. In some cavities the volume of the gas-bubble is very large in proportion to the amount of liquid carbon dioxide. On heating, there ensues, in this case, a rapid evaporation of the liquid into the inner space. Thilorier has stated, in the record of his laboratory experiments on tubes partly filled with this volatile liquid, that when half full, such a tube acted as a retrograde thermometer, the increase of temperature being marked by a diminution of the volume of the liquid on account of its vaporization ; but, when two-thirds full, it served as a normal thermometer of great sensitiveness, the volume of the liquid expanding with the rise of temperature. So, in these cavities with large bubbles, the amount of liquid carbon dioxide present is so small that, at the temperature then prevailing, it is reduced to so thin a layer as to be insufficient to wet any longer the inner surface of the saline layer. Then the saline solution lies as usual next the wall, with a huge gas-bubble immediately in contact ; but within the latter lies the limpid liquid carbon dioxide gathered into a ball, the liquid and gas having interchanged positions. All these varieties of condition may be distinguished after a little study, especially by noting the depth of the dark rim or shadow of the outline of the lighter liquid next the denser, or of the gas-bubble next either liquid—the depth of the shadow being in each case proportionate to the difference in density of the two fluids.

In some cases the bubble adheres firmly to the wall or corner of a cavity and cannot be dislodged. Commonly it runs freely around the wall of the cavity, as the thin section is rotated upon the stage, always, of course, adhering to the uppermost side of the cavity as in a natural spirit-level. Thus it might be fancied that any sagacious gnome, having lost his way in the subterranean recesses, might determine his reckoning, as to up and down, by the position of the bubbles of the liquid-cavities in the rocky walls surrounding him.

An interesting feature of the smallest cavities, usually less than

$\frac{1}{1,000}$ th of an inch, often $\frac{1}{50,000}$ th of an inch in diameter, is the so-called spontaneous motion with which the inclosed bubbles are affected. Some may be seen under a high power (a $\frac{1}{16}$ th-inch or $\frac{1}{10}$ th-inch objective) vibrating gently, others rolling to and fro, and others dashing from side to side in restless motion. This motion may be very rarely seen even in cavities visible under a $\frac{3}{8}$ ds-inch objective, or a magnifying power of about sixty-five diameters. Its cause has been connected pretty certainly with unequal thermal conditions on the sides of the cavities, producing alternations of evaporation and condensation within the space of the bubbles. Their motion thus serves as an index of the delicate balance which must prevail throughout the fluid, under pressure of its own vapor, within the cavity. Occasionally, bubbles in motion have been seen to stop, even permanently; others have begun their motion under the eyes of the observer, and continued it as long as they remained under examination. I am not aware that this spontaneous motion of the bubbles has yet been observed in the fluid-cavities of artificial crystals.

A curious phenomenon has been occasionally noticed by the experimenter while heating the fluids in a cavity of rock-crystal. At a certain temperature, in one case as high as 150° C., the gas-bubble becomes more dense than the liquid and sinks to the bottom of the cavity. "The cause of this motion appears to be that the bubbles consist of a gas so highly compressed that it is nearly of the same density as water at the ordinary temperature. On heating, the water expands, thus still further condensing the gas in the cavity, which then becomes heavier than the liquid, and consequently sinks in it."¹²

In closing, I may refer briefly to a few practical applications of the facts which have been discovered in reference to fluid-cavities. As in the sedimentary rocks fossils are necessarily relied upon for the determination of their life-history, so especially in the crystalline rocks have these fluid-cavities served a most useful purpose for determining the genetic history—the conditions which obtained during their formation or alteration. So exact is that statement that geologists have ascertained, within perhaps one thousand feet, the exact depth at which certain rocks were formed in England, and the exact pressure to which others in Scotland were subjected (represented in the

¹²W. N. Hartley : Jour. Chem. Soc., London, 1877, pp. 237-50.

Scotch granites imported into this city as building stones), during the folding up of the strata into mountains. The heat produced in the course of this tremendous compression of the rocks has left its record in the resulting crystalline condition of these rocks and in the fluid-cavities which they contain.

An investigation of great interest was prosecuted by Messrs. H. C. Sorby¹³ and J. C. Ward,¹⁴ of England, to ascertain the conditions of temperature and pressure which have prevailed during the formation of certain Scotch and Cornish rocks, especially granites and elvans, in which such partly filled cavities occur. It was established by them that the bubble floating upon the liquid represented the vapor-filled vacuity left by the contraction, by cooling, of the liquid which must have originally filled the heated cavity. The determination of the temperature (89° – 356° C.) at which the liquid could be artificially compelled to resume its original condition and volume at the time of the genesis of the crystalline rock, and of the relative change in its volume, gave a measure of the depth below the surface at which this temperature prevails, and of the superincumbent pressure necessary to produce the required tension in the cavities. By reasonings of this kind, it was estimated that the Scotch granites were consolidated under pressures varying from sixty-nine thousand to seventy-eight thousand feet of rock at a temperature between 200° and 360° C. (a dull red). These cavities may be looked upon as offering a like record of past thermal experiences to that which we now obtain by means of maximum thermometers and pyrometers. For such investigations it was necessary to select peculiarly symmetrical long cavities of tubular or cylindrical form, the volume of which could be measured approximately, and that of the liquid they contained. Such tubular cavities are particularly common along certain planes in the white Brazilian topaz, and are often connected irregularly in pairs or even in groups of parallel tubes. In one case, a pair so connected, in a U-shaped figure, contained bubbles and portions of liquid (carbon dioxide) so delicately balanced in the opposite arms, that the whole arrangement could be made artificially to act very much like a differential thermometer.

We owe to Geo. W. Hawes the detection in one instance, in

¹³Quar. Jour. Geol. Soc., 1858, XIV., pp. 453-500; and Min. Mag., 1877, I., p. 41.

¹⁴Quar. Jour. Geol. Soc., 1875, XXXI., p. 568; and 1876, XXXII., p. 1.

New Hampshire,¹⁵ of the apparent conditions by which the carbon dioxide was actually formed in the cavities of the granite at that locality, *i. e.*, by expulsion from a limestone in contact with silicic acid. This was the same effect as that which we now see in the effervescence of carbon dioxide produced when any free acid is dropped upon calcium carbonate.

The general investigation of the fluid-cavities is by no means exhausted, and it may lie within the reach of members of this Society to gather new facts which may throw great light upon the conditions of metamorphism to which the rocks and minerals inclosing such cavities were subjected.

¹⁵Geol. of N. H., Vol. III., Pt. IV., p. 307.

TRICERATIUM DAVYANUM.

BY P. H. DUDLEY, C. E.

(Read May 15th, 1885.)

The following description of *Triceratium Davyanum*, Grev.,¹ was published by Dr. R. K. Greville in the "Quarterly Journal of Microscopical Science" in 1862 (See Vol. II., New Series, p. 232; and Pl. X., Fig. 4): "Valve with slightly convex sides, rounded angles, and large punctate pseudo-nodules; border and the central triangular space largely cellulate, the former divided into compartments by transverse lines. Distance between the angles, .0068 in. to .0080 in. There can be no question that, for beauty and interest, this magnificent species stands at the very head of the genus, distinguished, as it is, for many fine forms. The only two examples as yet known were both discovered by my acute and indefatigable friend, Mr. Johnson."

I have taken, in different focal planes, some photographs of side-views of the specimen of *Triceratium Davyanum* mounted by Mr. Febiger which was exhibited by our President at the meeting of May 1st. These will enable us to some degree to understand its sculpture without resorting to the expedient of making sections of a diatom which is so rare and so highly prized. They are direct reproductions, in printer's ink, of the negatives, and exhibit exactly the relation of all the parts as given by the microscope. They will be seen to furnish several important features not shown in Dr. Greville's engraving. They were taken with a lens of high power and high angle (N. A., 1.13), a homogeneous-immersion $\frac{1}{10}$ th, my object being to limit the penetration so as not to show the entire convexity in one view, and so as to afford, besides, a basis of measurement. The magnification is four hundred and eight, linear.

In photograph No. 1 is shown the general appearance of the specimen when the markings in the pseudo-nodules, at the angles of the diatom, are in focus, the rim of those nodules rising apparently $\frac{1}{10,000}$ th of an inch above the markings. In this

¹ "I have great pleasure," said Dr. Greville, "in dedicating this rare species to Dr. Davy, who collected and brought home the material in which it was discovered." The material was from the Barbadoes deposit.

view the secondary triangle, with its small, central nodule, is below the focal plane, and no areolation is seen bordering any part of the two blank spaces, resembling openings, which lie between the base of each pseudo-nodule and an apex of the secondary triangle.

In photograph No. 2 the focus is run in $\frac{2}{10,000}$ ths of an inch below its position in No. 1. The central nodule is here distinct, and the longitudinal division of its radiating lines can also be seen. The general areolation seems less deep, the convexity is also reduced, and areolation becomes apparent below the base of each pseudo-nodule.

For photograph No. 3 the focus was run in $\frac{1}{10,000}$ ths of an inch from No. 2, or $\frac{6}{10,000}$ ths of an inch from No. 1. The apices of the secondary triangle, which Dr. Greville represents as plain are here seen to be areolated. The outer border of the diatom is not quite distinct, some convexity still existing. The depth of the entire convexity would seem to be less than $\frac{1}{1,000}$ th of an inch. With the focus lowered about $\frac{2}{10,000}$ ths of an inch further, the convexity disappeared, but no indication of a row of cells like that shown in Dr. Greville's illustration could be seen.

FORAMINIFERA FROM BERMUDA.

BY A. WOODWARD.

(Presented May 15th, 1885.)

In two gatherings of Foraminifera, one made by Mr. W. G. DeWitt in 1884, the other by Mr. J. F. Kemp in 1885, at six different localities in the Bermuda Islands, I have found forms representing eighty-nine species, belonging to thirty-seven genera. My list of these, given below, does not claim to be a complete catalogue of Bermuda Foraminifera. To such catalogue access to material from other localities and from greater depths would be necessary.

The Hinsen's Island gathering furnishes, it will be seen, the largest number of species. The forms are very perfect, and many of them, such as *Biloculina*, *Spiroloculina*, and *Miliolina*, are quite common. Hamilton Harbor yields fewer species, but the specimens, especially of *Orbiculina adunca* and *Orbitolites complanata*, are well preserved. The forms from the shell-sand of Shelly Bay, north shore, are not abundant, but are perfect and beautiful. Those from Somerset Island and Paget Beach are few, badly worn, and difficult to identify.

H. B. Brady, in his Report on the Foraminifera collected in the Challenger expedition, speaks of the wide variation of form embraced within the specific limits of *Paneroplis pertusus*, from the compressed planospiral shell of about three convolutions, to the thin outspread shell of the species *planatus*. These gradational forms are, I found, quite fully represented in this Bermuda material.

Explanation of abbreviations :

H. I.—Hinsen's Island, low tide.

H. H.—Hamilton Harbor, five fathoms.

S. B.—Shelly Bay.

Sh. B.—Shelly Bay, north shore.

S. I.—Somerset Island, shore sand.

P. B.—Paget Beach.

×—Habitat.

W. and J.—Walker and Jacob.

F. and M.—Fichtel and Moll.

J. and P.—Jones and Parker.

P. and J.—Parker and Jones.

	H. I.	H. II.	S. B.	Sh. B.	S. I.	P. B.
<i>Biloculina</i> , d'Orbigny.						
“ <i>ringens</i> , Lamarck, sp.	×	×	×	×		
“ <i>elongata</i> , d'Orbigny.	×	×		×		
“ <i>tubulosa</i> , Costa.				×		
<i>Spiroloculina</i> , d'Orbigny.						
“ <i>acutimargo</i> , Brady.	×	×				
“ <i>antillarum</i> , d'Orbigny.	×					
“ <i>crenata</i> , Karrer.	×	×				
“ <i>excavata</i> , d'Orbigny.		×				
“ <i>grata</i> , Terquem.	×	×				
“ <i>limbata</i> , d'Orbigny.	×					
“ <i>robusta</i> , Brady.	×		×			
“ <i>tenuis</i> , Czjzek, sp.	×	×				
<i>Miliolina</i> , Williamson.						
“ <i>bicornis</i> , W. and J., sp.	×	×	×	×		
“ <i>cultrata</i> , Brady.				×		
“ <i>agglutinans</i> , d'Orbigny, sp.			×			
“ <i>alveoliniformis</i> , Brady.		×	×	×		
“ <i>oblonga</i> , Montagu, sp.				×		
“ <i>Parkeri</i> , Brady.	×		×			
“ <i>pulchella</i> , d'Orbigny, sp.	×	×	×	×		
“ <i>Linnæana</i> , d'Orbigny, sp.			×	×		
“ <i>reticulata</i> , d'Orbigny, sp.	×	×	×	×		
“ <i>seminulum</i> , Linné, sp.	×	×	×	×	×	×
“ <i>tricarinata</i> , d'Orbigny, sp.	×	×			×	
“ <i>gracilis</i> , d'Orbigny, sp.				×		
“ <i>valvularis</i> , Reuss, sp.				×		
<i>Nubecularia</i> , Defrance.						
“ <i>lucifuga</i> , Defrance.		×				
<i>Articulina</i> , d'Orbigny.						
“ <i>lineata</i> , Brady.	×	×		×		
“ <i>sagra</i> , d'Orbigny.	×			×		
“ <i>sulcata</i> , Reuss.	×		×	×		
<i>Vertebralina</i> , d'Orbigny.						
“ <i>striata</i> , d'Orbigny.	×	×		×		
<i>Planispirina</i> , Seguenza.						
“ <i>cclata</i> , Costa, sp.	×	×		×		

	H.	I.	H.	H.	S. B.	Sh. B.	S. I.	P. B.
<i>Planispirina exigua</i> , Brady.	×	×						
“ <i>communis</i> , Seguenza.	×				×		×	
<i>Cornuspira</i> , Schultz.								
“ <i>foliacea</i> , Philippi, sp.	×	×				×		
“ <i>involutens</i> , Reuss.	×					×	×	
<i>Peneroplis</i> , Montfort.								
“ <i>pertusus</i> , Forsk., sp.	×	×	×	×	×	×	×	×
“ “ var. <i>LEVIGATUS</i> , Karrer.	×	×				×		
“ “ var. <i>CARINATUS</i> , d’Orbigny.	×	×				×		
“ “ var. <i>CYLINDRA-</i> <i>CEUS</i> , Lam., sp.					×	×		
“ “ var. <i>ARIETINUS</i> , Batsch, sp.							×	
“ “ var. <i>PLANATUS</i> , F. and M., sp.							×	
<i>Orbiculina</i> , Lamarck.								
“ <i>adunca</i> , F. and M., sp.	×	×	×	×	×	×	×	×
<i>Orbitolites</i> , Lamarck.								
“ <i>complanata</i> , Lamarck.	×	×	×	×	×	×	×	×
“ <i>duplex</i> , Carpenter (<i>macro-</i> <i>pora</i> , Ehrenberg, sp.?)	×							
“ <i>marginalis</i> , Lamarck, sp.	×	×				×		
<i>Alveolinina</i> , d’Orbigny.								
“ <i>melo</i> , F. and M., sp.	×					×		
<i>Haplostiche</i> , Reuss.								
“ <i>Soldanii</i> , J. and P., sp.	×	×						
<i>Textularia</i> , DeFrance.								
“ <i>Barrettii</i> , J. and P.	×							
“ <i>gramen</i> , d’Orbigny.			×					
“ <i>luculenta</i> , Brady.	×	×						
“ <i>trochus</i> , d’Orbigny.	×	×						
<i>Bigenerina</i> , d’Orbigny.								
“ <i>robusta</i> (sp.?), Brady.			×	×				
<i>Trochammina</i> , P. and J.								
“ <i>trullissata</i> , Brady.	×							
<i>Chrysalidina</i> , d’Orbigny.								
“ <i>dimorpha</i> , Brady.			×					

	H. I.	H. H.	S. B.	Sh. B.	S. I.	P. B.
<i>Valvulina</i> , d'Orbigny.						
“ <i>conica</i> , P. and J.	×			×		
<i>Clavulina</i> , d'Orbigny.						
“ <i>communis</i> , d'Orbigny.	×		×	×		
“ <i>cylindrica</i> , Hantken.	×	×	×			
“ <i>Parisiensis</i> , d'Orbigny.	×	×	×	×		
“ <i>angularis</i> , d'Orbigny.				×		×
<i>Belivina</i> , d'Orbigny.						
“ <i>dilatata</i> , Reuss.	×					
<i>Nodosaria</i> , Lamarek.						
“ <i>comata</i> , Batsch, sp.	×					
“ (<i>Dentilina</i>) <i>intercellularis</i> , Brady.	×					
“ <i>mucronata</i> , Neugeboren, sp.	×			×		
“ <i>radicula</i> , Linné, sp.	×					
“ <i>hispida</i> , d'Orbigny.				×		
<i>Fronicularia</i> , DeFrance.						
“ <i>alata</i> , d'Orbigny.		×				×
“ <i>inequalis</i> , Costa.	×					
<i>Vaginulina</i> , d'Orbigny.						
“ <i>linearis</i> , Montagu, sp.	×					
<i>Cristellaria</i> , Lamarek.						
“ <i>compressa</i> , d'Orbigny.	×	×		×		
“ <i>Schloenbachi</i> , Reuss.	×			×		
“ <i>cultrata</i> , Montfort, sp.				×		
<i>Uvigerina</i> , d'Orbigny.						
“ <i>angulosa</i> , Williamson.		×				
“ <i>porrecta</i> , Brady.		×		×		
<i>Sagrina</i> (d'Orbigny), P. and J.						
“ <i>raphanus</i> , P. and J.	×			×		
<i>Globigerina</i> , d'Orbigny.						
“ <i>bulloides</i> , d'Orbigny.	×			×		
<i>Orbulina</i> , d'Orbigny.						
“ <i>universa</i> , d'Orbigny.	×		×	×		
<i>Patellina</i> , Williamson.						
“ <i>corrugata</i> , Williamson.			×			
<i>Cymbalopora</i> , Hagenow.						
“ (<i>Tretomphalus</i>) <i>bulloides</i> , d'Orbigny.	×					

H. I. II. H. S. B. Sh. B. S. I. P. B.

<i>Discorbina</i> , P. and J.							
“ <i>rosacea</i> , d’Orbigny.	×	×	×				
“ <i>turbo</i> , d’Orbigny, sp.	×						
<i>Truucatulina</i> , d’Orbigny.							
“ <i>reticulata</i> , Czjzek, sp.	×						
“ <i>variabilis</i> , d’Orbigny, sp.							×
<i>Anomalina</i> , d’Orbigny.							
“ <i>foveolata</i> , Brady.			×	×			
<i>Carpenteria</i> , Gray.							
“ <i>monticularis</i> , Carter.	×						
“ <i>protiformis</i> , Goës.	×						
<i>Pulvinulina</i> , P. and J.							
“ <i>auricula</i> , F. and M., sp.							×
<i>Nonionina</i> , d’Orbigny.							
“ <i>depressula</i> , W. and J., sp.	×			×			
“ <i>umblicata</i> , Montagu, sp.			×				
<i>Amphistegina</i> , d’Orbigny.							
“ <i>Lessonii</i> , d’Orbigny.	×	×	×	×	×	×	×
<i>Operculina</i> , d’Orbigny.							
“ <i>ammonoides</i> (sp.), Gronovius, sp.							×

A NEW SYMBIOTIC INFUSORIAN.

BY DR. ALFRED C. STOKES.

(Received May 23d, 1885.)

The following animalcule, from a little *Sphagnum*' swamp in this locality, is but one among many infusorial forms that crowd the waters, most of which are undescribed, and new to science. This especial one is presented here because of its unusual interest as furnishing an apparent example of so-called symbiosis. The chlorophyll corpuscles within the ectoplasm are so numerous that they are in contact, thus forming an almost continuous subcuticular layer. According to Brandt's doctrine of animal and vegetable commensalism, or double parasitism, these chlorophyll corpuscles, which are, I presume, subspherical, are not mere collections of pigmentary matter, but true unicellular algae

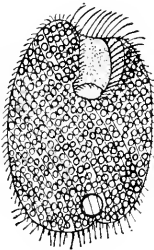

Fig. 1.



Fig. 2.

living a parasitic life so far as their position and their absorption of the excreted products of the host are concerned, and at the same time compelling that host to play the *role* of parasite in appropriating the products elaborated by the plants. The theory—the discovery, as its supporters call it—is a beautiful one, but one which, in the opinion of the writer, is hardly tenable when applied to the Infusoria, where it is claimed to be particularly applicable.

In the present example the subcuticular symbiotic algæ form, as stated, an almost continuous sheet of vivid-green corpuscles, as a rule completely obscuring the internal structure of the In-

fusorian. The endoplasm, however, is colorless and, when forced out by pressure, or when set free by diffluence after the creature's death, is seen to enclose numerous angular and colorless plates mingled with many smaller granules of similar character, the largest being perhaps two or three times the size of the presumably symbiotic algæ. These endoplasmic plates (Fig. 2) are flat, irregular, structureless, and somewhat refringent; they are probably amylaceous. If, therefore, we may judge from the form, position, and arrangement of the chlorophyll corpuscles, they would seem to present an excellent example of symbiosis. But the statement is made that "The animals (Phytozoa, as they may be termed) renounce their independent life and allow themselves to be entirely supported by their parasites, when once the green or yellow algæ have entered their tissues and have multiplied there sufficiently. They absorb no more solid organic substances, although they are perfectly able to do so, but are entirely comparable, from the morphological point of view, to animals devoid of chlorophyll. This life of algæ in common with animals is one of the strangest things which can be conceived. Morphologically it is the algæ which are the parasites, but physiologically the animals."¹ So far as some, at least, of the Infusoria are concerned, the truth of this statement seems doubtful. The species which I have named *Leucophys emarginata* is a case in point. The enclosed chlorophyll corpuscles, the symbiotic algæ, if they are such, could hardly be more abundant, unless the entire sarcode should be filled with them. They certainly appear to be sufficiently multiplied, yet the Infusorian is voracious. It gorges itself with diatoms. Small Infusoria are eagerly accepted, and, in one instance, I have witnessed the capture of a full-sized *Paramecium aurelia*, Müll., which, although visible to the naked eye, was powerless to resist the current that swept it down the peristome-field and through the capacious oral aperture. The excrementitious matter forms a correspondingly large mass of empty diatom frustules, fragmentary remains and granules, surrounded by a colorless protoplasmic envelope.

The assertion that the green coloring matter of all these lower forms is symbiotic, it is equally difficult to accept. In several Infusoria the coloration is diffused, and not collected into gran-

1. Jour. Roy. Mic. Soc., II. (1882), pp. 343-4.

ules, discs or spherules. A Vorticella described by the writer under the name of *V. smaragdina* is so tinted, the ectoplasm, and apparently the endoplasm as well, being translucent and homogeneous.

The following is the description of the Infusorian referred to. It is shown in Fig. 1, under an amplification of about one hundred and sixty-five diameters.

Leucophrys emarginata, sp. nov. (Figs. 1 and 2).

Body pouch-shaped, depressed, about one and one-half times as long as broad, soft and flexible but persistent in form, the extremities subequal in width, the dorsal surface convex, the ventral flattened; the posterior extremity obliquely rounded, conspicuously emarginate at the left-hand side of the median line, the anterior obliquely truncate, deeply concave, the angles rounded, the right-hand border considerably prolonged beyond the frontal margin, the left-hand body-margin slightly flattened, the right-hand one convex; cuticular surface obliquely striate, minutely roughened; cuticular cilia fine, arranged in oblique longitudinal rows, those of the posterior extremity supplemented by numerous, longer, less rapidly vibrating hairs; peristome-field wide, deep, confined to the anterior third of the ventral surface, broadest anteriorly, the apical extremity rounded and curved toward the right-hand side, the dextral border straight, occasionally somewhat concave, overarching the deeply and laterally excavated peristome-field; oral aperture capacious, broadly ovate; endoplasm crowded with green, apparently disciform, chlorophyll corpuscles arranged somewhat regularly in oblique longitudinal lines; contractile vesicle single, spherical, postero-terminal, on the left-hand side of the median line; nucleus long, band-like, convolute, placed in the anterior body-half; anal aperture large, in close proximity to the contractile vesicle. Length of body $\frac{1}{150}$ th of an inch. Habitat: marsh water, with *Sphagnum*.

The longer supplementary hairs clothing the posterior extremity and restricted to it, are from two to three times longer than those of the general surface. They appear to originate from the posterior striations, as do the shorter ones, and to have a less rapid and more independent movement.

TRENTON, N. J.

PROCEEDINGS.

MEETING OF MAY 1ST, 1885.

The President, Mr. C. Van Brunt, in the chair.

Twenty-five persons present.

Mr. J. C. Lathrop was elected an Active Member of the Society.

OBJECTS EXHIBITED.

1. *Triceratium Davyanum*, Greville, a rare and beautiful diatom, from Barbadoes deposit; mounted by Mr. C. Febiger: by C. VAN BRUNT.
2. *Navicula Sillimanorum*, from Crane Pond, Mass.; mounted by Mr. J. A. Bagley: by WALTER H. MEAD.
3. *Plumatella*: by A. D. BALEN.
4. *Closterium*, and *Nostoc*: by W. G. DE WITT.
5. Triungulin larva of the Narrow-necked Oil-beetle (*Meloe angusticollis*, Say), a parasite of *Anthophora*: by J. L. ZABRISKIE.
6. Zentmayer's Abbe Condenser: by C. S. SHULTZ.
7. Dynamo-Electric Machines, for use in microscopical illumination: by G. F. KUNZ.

TRIUNGULIN LARVA OF MELOE ANGUSTICOLLIS.

The Rev. J. L. Zabriskie: "The Oil-beetle (*Meloe angusticollis*, Say) takes its name from its habit of emitting an oily fluid from the joints of its legs. The insect is of a dark-blue color, has very short wing-covers, and a large, soft abdomen. It is remarkable for passing through seven stages of transformation; viz., the egg, the triungulin, or first larva, the second larva, the false pupa, the third larva, the pupa, the imago. The first larva is called triungulin because each foot looks as if it had three claws. What seems the middle claw is an enormously developed foot-pad. In form this larva resembles a louse. The three thoracic segments are nearly equal in size, flattened, transversely oblong, and in the back of the middle segment, near the median line, is the first pair of spiracles. The tip of the abdomen is furnished with two pairs of setæ, of which the inner is much longer than the outer. I captured my specimen on one of our native bees of the genus *Andrena*.

“The habits of *Meloe* have been fully described by Prof. C. V. Riley (See “American Naturalist,” 1878, p. 216). He says, in effect : ‘This insect lays more than three thousand eggs, depositing them in the ground. The triungulin larvæ are very active. Soon after hatching, they climb certain flowering plants and attach themselves to bees and flies which visit the flowers. All, however, are destined to perish excepting the few fortunate ones that are carried to the nest of the *Anthophora*, a honey-storing bee which tunnels for itself a habitation in the ground. The triungulin devours the egg of the bee. Moulting, and passing into the second and less active larval state, the insect feeds on the honey garnered by the bee.’”

Mr. Zabriskie exhibited also the imago, male and female, of *Meloe angusticollis*, and the Blister-beetles *Cantharis vesicatoria* and *Lytta marginata*, which are closely related to *Meloe*.

DYNAMO-ELECTRIC MACHINES.

Mr. G. F. Kunz exhibited two small dynamo-electric machines, one of which was operated by the foot, the other by the hand. They were loaned for the occasion by the Excelsior Electric Apparatus Company, of New York. Mr. Kunz said : “With the aid of a small gas engine or a small water motor, a dynamo-electric machine will produce a brighter and steadier light than can be obtained from a battery, and will produce it at less cost. For microscopical illumination it can be used with great advantage, especially in photography.”

ZENTMAYER'S ABBE CONDENSER.

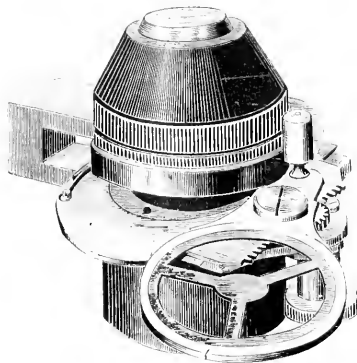

Mr. C. S. Shultz exhibited and described the Zentmayer Abbe

Condenser. It can be readily adapted to the substage of any microscope. The mounting is simple and light. The diaphragm-plate is easily manipulated.

MEETING OF MAY 15TH, 1885.

The President, Mr. C. Van Brunt, in the chair.

Thirty-seven persons present.

OBJECTS EXHIBITED.

1. Syenite from the Obelisk, Central Park ; shown by polarized light : by A. WOODWARD.

2. Foraminifera from Raine Island—one hundred and fifty forms, representing one hundred species, gathered from a depth of one hundred and fifty-five fathoms; prepared by Mr. Joseph Wright, of Belfast, Ireland : by A. WOODWARD.

3. Crystals containing cavities with Inclusions : by A. A. JULIEN. Among these were,—

(1) Topaz, granyte, and smoky quartz, showing cavities containing liquid carbonic acid gas and a bubble of the gas.

(2) Crystal of topaz, showing cavity containing brine with crystals of sodium chloride.

(3) Quartz with large cavity containing a movable globule of water.

(4) Artificially prepared crystals of sodium chloride clouded by cavities filled with solution of potassium dichromate.

4. Photographs, in different planes, of *Triceratium Davyanum* : by P. H. DUDLEY.

INCLUSIONS IN CRYSTAL.

Dr. A. A. Julien read a Paper entitled "The Sealed Flasks of Crystal." He treated particularly the inclusions found in smoky quartz. His Paper constitutes the first article in this Number of the JOURNAL.

PHOTOGRAPHS OF TRICERATIUM DAVYANUM.

Mr. P. H. Dudley exhibited and described three photographs of *Triceratium Davyanum* which, by representing the diatom as it appears when viewed in as many different focal planes, elucidate, in part, its sculpture. His description forms the second article in this Number of the JOURNAL.

FORAMINIFERA FROM BERMUDA.

Mr. A. Woodward stated that he had examined a large number of specimens of recent Foraminifera collected at Bermuda, and had fully identified among them nearly ninety species, representing thirty-seven genera. A list of these will be found in another part of this Number of the JOURNAL.

PROF. HAMILTON L. SMITH'S NEW MOUNTING MEDIUM.

President Van Brunt: "My remarks at the meetings of March 20th and April 3d respecting Prof. H. L. Smith's new medium for mounting were incomplete, and might create an impression that I consider this medium a failure. I wish to correct this impression by repeating what I then said, and by giving more fully the facts in regard to this discovery of Prof. Smith.

"The new medium is, as I stated, glycerine holding in solution a salt, or salts, giving a refractive index of about 1.8. By applying heat and expelling the water the index is raised still higher, and the medium is hardened to such a degree that diatoms or other forms do not move easily in it, even when free to move. I have slides in which the forms, mounted in this material thus hardened, cannot be made to move either by pressure or under the ordinary heat used in photography. Should the refractive index of the medium be reduced, for purposes of photography, by dilution with glycerine, large forms, such as *Coscinodiscus* and the larger *Naviculæ*, would be liable to move, especially if exposed to heat.

"It is not, however, necessary that any forms should be free to move in this medium. Diatoms may be fastened to the cover-glass by heat. I possess a slide of selected forms which were fastened to the cover in that way. It was prepared by Dr. Clapp, of Indiana. Fresh forms, from which the endochrome is burned out in this process, are found to adhere to the glass very strongly.

"Of other ways, of which there are many, of fixing objects to the cover-glass, I will give one which has been used very successfully in glycerine mounts,—the albumen method. Mix filtered or strained albumen and glycerine, in equal parts, and with a needle apply a thin film of the mixture to a surface of the cover-glass. On this film place the object. If, now, the albumen be coagulated by a gentle heat, it will hold the object

so fast that it can be mounted in glycerine and will always keep its place. The albumen is transparent except when too much is used.

“For mounting objects which require a high refractive index, I consider Prof. Smith’s new medium preferable to any other yet found. Even when diluted to a fluid consistency, it will not evaporate, and is easily confined by white-zinc cement. Whether it is permanent or not, time only can determine. Prof. Smith does not give his formula, and his reason for not doing so is that ‘he does not wish to be premature in putting before the world another material that may prove a failure.’ In the April Number of the “Journal of the Royal Microscopical Society” he is, I notice, taken to task for keeping secret the composition of his deep-yellow medium (2.4 refractive index). My impression is that he did give to his friends the formula of this preparation. I have known Prof. Smith many years, and I am sure that, if he should make an important discovery of this kind, he would not retain it as a trade secret.”

PUBLICATIONS RECEIVED.

The Electrician and Electrical Engineer: Vol. IV., No. 41 (May, 1885) pp. 4c.

Entomologica Americana: Vol. I., No. 2 (May, 1885); pp. 20.

Journal of Mycology: Vol. I., No. 1 (January, 1885); pp. 16. No. 2 (February, 1885); pp. 16. No. 3 (March, 1885); pp. 16. No. 4 (April, 1885); pp. 12. No. 5 (May, 1885); pp. 12.

Johns Hopkins University Circulars: Vol. IV., No. 39 (May, 1885); pp. 12.

Anthony's Photographic Bulletin: Vol. XVI., No. 9 (May 9th, 1885); pp. 32. No. 10 (May 23d, 1885); pp. 32.

The American Monthly Microscopical Journal: Vol. VI., No. 5 (May, 1885); pp. 20.

The Microscope: Vol. V., No. 5 (May, 1885); pp. 24.

West-American Scientist: Vol. I., No. 6 (May, 1885); pp. 6.

The Midland Naturalist: Vol. VIII., No. 89 (May, 1885); pp. 28.

The Botanical Gazette: Vol. X., No. 5 (May, 1885); pp. 16.

Transactions of the Massachusetts Horticultural Society: 1884, Pt. I.; pp. 181.

Bulletin of the Torrey Botanical Club: Vol. XII., No. 4 (April, 1885); pp. 12.

Proceedings of the Natural Science Association of Staten Island: May 9th, 1885; p. 1.

INDEX TO ARTICLES OF INTEREST TO MICROSCOPISTS
WHICH HAVE RECENTLY APPEARED IN OTHER
JOURNALS.

Amphipoda, The Urinary Organs of the: W. BALDWIN SPENCER.

Quar. Jour. Mic. Sci., XXV. (1885), pp. 183-91 (5 figs.).
Apothecium, Structure of the, in *Solorina*.

Cole's Studies in Mic. Sci., III. (1885), pp. 13-6 (colored plate).
Athyrium Filix-femina. See Lady-Fern.

Athyrium Filix-femina, var. *clarissima*, Further Notes on a singular Mode of
Reproduction in: CHARLES T. DRUERY.

Jour. Linn. Soc. Lond. (Bot.), XXI. (1885), pp. 358-60 (2 figs.).
Bacteria, Koch's Method of Isolating and Cultivating, as used in the Laboratory of the Bureau of Animal Industry, Dept. Agriculture: DRS. D. E. SALMON and THEOBALD SMITH.

Am. Mon. Mic. Jour., VI. (1885), pp. 81-4.
Bacteria, Mounting. See Staining, Microscopical.

Cercospora, Enumeration of the North American, with Descriptions of the
Species: J. B. ELLIS and BENJAMIN M. EVERHART.

Jour. of Mycology, I. (1885), pp. 17-24; 33-40; 49-56; 61-67.
Choanoflagellata. See Sponges.

- Collodion, The Uses of : C. O. WHITMAN.
Am. Nat., XIX. (1885), pp. 626-8.
- Echinus, Transverse Section of Spine of; under heading Graphic Microscopy : E. T. D.
Sci.-Ges., 1885, pp. 97-98 (colored plate).
- Embryology, Outlines of (Fourth paper). Metamerism Segmentation.
The Microscope, V. (1885), pp. 107-12 (4 figs.).
- Ferns, On Apospory in (with special reference to Mr. Charles T. Druery's Observations). F. O. BOWER.
Jour. Linn. Soc. Lond. (Bot.), XXI. (1885), pp. 360-8 (4 diags., 12 figs.).
- Gill-book of *Limulus*. See *Scorpio*.
- Halicryptus*. See *Priapulus*.
- Heteræcious Uredines, Remarks on the Reproduction of the : CHARLES B. PLOWRIGHT.
Jour. Linn. Soc. Lond. (Bot.), XXI. (1885), pp. 368-70.
- Insects, The Eye and Optic Tract of : SYDNEY J. HICKSON.
Quar. Jour. Mic. Sci., XXV. (1885), pp. 215-51 (35 figs.).
- Lady-Fern (*Athyrium Filix-femina*), Observations on a singular Mode of Development in the : CHARLES T. DRUERY.
Jour. Linn. Soc. Lond. (Bot.), XXI. (1885), pp. 354-7.
- Lantern Transparencies : C. M. VORCE.
Am. Mon. Mic. Jour., VI. (1885), pp. 84-5.
- Limulus*, Gill book of. See *Scorpio*.
- Liquidambar Styraciflua*, or American Storax, the Gum of, as a Mounting Medium : A. B. AUBERT.
Am. Mon. Mic. Jour., VI. (1885), pp. 86-7.
- Loxosoma*, On the Structure and Development of : SIDNEY F. HARMER.
Quar. Jour. Mic. Sci., XXV. (1885), pp. 261-337 (62 figs.).
- Lung-book of *Scorpio*. See *Scorpio*.
- Microspectroscope, The : A. V. MOORE.
The Microscope, V. (1885), pp. 101-0 (15 figs.).
- Priapulus* and *Halicryptus*, On the Skin and Nervous System of : ROBERT SCHARFF.
Quar. Jour. Mic. Sci., XXV. (1885), pp. 193-213 (12 figs.).
- Ramularia obovata*, Fckl. : J. B. ELLIS and BENJAMIN M. EVERHART.
Jour. of Mycology, I. (1885), pp. 69-70.
- Rocks, The Microscopical Study of : JOHN ERNEST ADY.
Ill. Sci. Mon., III. (1885), pp. 131-3 (2 figs.).
- Scorpio*, A New Hypothesis as to the Relationship of the Lung-book of, to the Gill-book of *Limulus* : E. RAY LANKESTER.
Quar. Jour. Mic. Sci., XXV. (1885), pp. 339-42.
- Scutigera coleoptrata* (one of the Myriapoda), On a Peculiar Sense Organ in : F. G. HEATHCOTE.
Quar. Jour. Mic. Sci., XXV. (1885), pp. 253-60 (9 figs.).
- Section Cutting, Notes on : E. L. MARK.
Am. Nat., XIX. (1885), pp. 628-31.
- Segmentation, Metamerism. See Embryology, Outlines of.
- Solorina crocea*. See Apothecium.
- Sponges, On the Relationship of the, to the Choanoflagellata : FRANZ EILHARD SCHULZE.
Ann. and Mag. Nat. His., IV. (1885), pp. 365-77.
- Staining, Microscopical—Mounting Bacteria : F. GRANT.
Eng. Mech., XLI. (1885), pp. 212-4.
- Staining Tissues in Microscopy (II.) (HANS GIERKE, *Zeitschr. für Wiss. Mic.*): Translated by W. H. SEAMAN.
Am. Mon. Mic. Jour., VI. (1885), pp. 89-91.
- Storax, American. See *Liquidambar Styraciflua*.
- Vorticella*, A Key to the : ALFRED C. STOKES.
The Microscope, V. (1885), pp. 97-101 (8 figs.).

MISCELLANEA.

THE AMERICAN SOCIETY OF MICROSCOPISTS.—Prof. H. L. Smith, President of the American Society of Microscopists, announces that the Eighth Annual Meeting of the Society will be held at Cleveland, O., beginning on Tuesday, August 18th, 1885, and lasting four days. He urges members to bring to the meeting the choice products of the past year's investigations. He requests that titles and abstracts of papers be sent as soon as practicable to the Secretary, Prof. D. S. Kellicott, Ph.D., 119 Fourteenth-street, Buffalo, N. Y., and that all persons who intend to be present, or to join the Society, inform him or the local committee at Cleveland of their intention. "The value of the organization," continues Prof. Smith, "has been established, and we are full of hopeful expectation that all the working microscopists of the country will join its membership and make it the centre of active microscopical investigation and the means of mutual stimulus to better and higher scientific work.* * The arrangements made by the local committees are such as to ensure most agreeable and interesting sessions, with the most ample facilities for those who present papers to illustrate them by projection apparatus and otherwise.* * Each year shows more plainly the importance of having the papers which may be read, so prepared that they may be left with the Secretary at the close of the meeting, and that the publication of the Proceedings shall not be delayed by revisions of manuscript or for the preparation of drawings.* * The session for illustration of practical work in preparing and mounting objects, which proved so fascinating and useful a feature of the Chicago and Rochester meetings, will be still more varied and instructive than before. Mr. C. M. Vorce, Cleveland, has charge of the preparations for the working session."

LEUCOPHRYS EMARGINATA.—Dr. Alfred C. Stokes's illustrated article descriptive of a new species of infusorian which he names *Leucophrys emarginata* furnishes an example of careful observation. A feature of great interest in the article is the discussion of the bearing of the structure and habits of this infusorian on Brandt's doctrine of reciprocal parasitism. The author's views on this point are clearly presented, and they appear just.

AMPHIPLEURA PELLUCIDA AND THE DIFFRACTION THEORY.
—The photographs of this diatom recently made by Dr. Van Heurck have given rise to some discussion, and some of those who do not admit the reality of the beaded appearance shown by the photographs, claim to rest their view on the Abbe diffraction theory.

This shows that some misconception exists as to the application of the theory, which does not establish, as supposed, that all appearances of minute structure with high powers are wholly illusory and do not correspond to any physical structure. On the contrary, the images shown by the microscope are all, in fact, caused by real structural peculiarities of the object observed. Thus in the case of the "beads" of *A. pellucida*, the existence of such an image proves that the diatom has not merely a periodic differentiation of structure in one direction, but that such differentiation exists in two directions which cross at right angles.

What the diffraction theory shows is that the *real* form and structure of the beads cannot be determined by the mere inspection through the microscope of their images. The microscope leaves wholly undecided the question whether they are elevations, or depressions, or simple centres of thickening in the substance of the valve, resulting, it may be, from the intersection of two siliceous layers, the densities of which vary periodically.—*Jour. Roy. Mic. Soc.*, 1885, p. 529.

"OMNIS NUCLEUS E NUCLEO."—It is nuclein that fertilizes. Sperm-cell may unite with germ-cell, but there is no further development unless the nuclei of the two cells combine. The nucleus is regarded as a more highly organized substance than protoplasm, and as representing a special centre of force in the cell.—DR. O. HERTWIG. See *Jour. Roy. Mic. Soc.*, 1885, pp. 421-423.

ARTIFICIAL DIVISION OF INFUSORIA.—Prof. M. Nussbaum and, independently, Dr. A. Gruber have obtained some interesting results as to the regeneration of unicellular organisms. The former divided an *Oxytricha* into halves either longitudinally or transversely and found that the two halves soon became normal animals, and that the complete organisms thus formed developed again by spontaneous division. If the artificial division be into unequal parts, these parts grow again, except those which are

without a nucleus; so that a nucleus seems to be essential to the retention of the regenerative power of a cell.

Dr. Gruber experimented in a similar manner upon *Stentor coeruleus*. He observed that when this infusorian was divided transversely through the centre, the posterior section in twelve hours developed a new peristome-area with the large cilia and the oral spiral. The part containing the mouth also added a new posterior portion. A longitudinal division through the peristome was followed by the same regenerative process, two complete peristomes being again formed.—See *Jour. Roy. Mic. Soc.*, 1885, p. 472.

CHOICE OF OBJECTIVES AND OCULARS.—Though objectives of very high power are occasionally made, even $\frac{1}{1000}$ -inch focus being announced, the larger and more conservative portion of microscopists evidently incline, as they always have done, toward a much more moderate limit. It is probably quite safe to say that objectives anywhere from $\frac{1}{4}$ th to $\frac{1}{12}$ th-inch, if not lower, can now be obtained which will show, as well as has ever been done, anything that has yet been seen by the microscope.

The question as to the choice of moderate or extreme apertures for objectives is still open, and somewhat evenly disputed. Dr. Carpenter and a large following of conservative judges still hold to the former view—not doubting the value of large aperture, but believing that it should accompany higher powers, and that to a 1-inch, for instance, should not be assigned the aperture and work of a $\frac{1}{4}$ th, nor to a $\frac{1}{16}$ ths that of a $\frac{1}{4}$ th; and this view is corroborated by the mathematical computations of the relation of aperture to power by Prof. Abbe (*J. R. M. S.*, 1883, p. 790). On the other hand, a large number of experienced persons prefer large angles even for biological work, some claiming that the highest attainable angles are the best for all uses and powers.

In the combining of oculars with objectives, it is still undecided whether it is preferable to secure a sufficient variety of powers by means of a large number of objectives, or by the high and low eye-piecing of a few. Dr. Carpenter prefers the 2-inch, and would use even the 1-inch for exceptional purposes. Prof. Abbe selects $\frac{3}{8}$ ds-inch ($\times 15$) as the highest really useful ocular.—R. H. WARD, M. D. *Appleton's Annual Cyclopaedia for 1884*: Article, *Microscopy*.

JOURNAL
OF THE
NEW-YORK MICROSCOPICAL SOCIETY.

VOL. I.

JULY, 1885.

No. 7.

ON CERTAIN SO-CALLED PRODIGIES.

BY C. F. COX.

(Read June 5th, 1885.)

The "American Monthly Microscopical Journal" published, in February last, a newspaper clipping giving the dates of various reputed "colored rains." That list, the work of an anonymous compiler, is manifestly only a fragment of what might be made by a diligent searcher of chronicles and histories; for mysterious natural phenomena have always been objects of more or less superstitious attention and have been prominent subjects of written record from the earliest historical times.

To the student and philosopher of to-day the annals of the so-called prodigies of earlier ages have a certain interest and value, because they furnish landmarks in the progress of accurate observation and give us clues to that credulous state of the human mind which seems to have necessarily preceded the foundation of inductive reasoning. Besides this, however, the mere historian of scientific discovery will find in these ancient records what we must believe to be truthful statements of facts mingled with distorted and erroneous interpretations and many unintentional misstatements of what were thought to be facts; and he may, not altogether unprofitably, exercise his ingenuity in and apply his later knowledge to the separation of the true from the false, and the elucidation of that which has seemed obscure.

In this view of the matter, I have thought that I might venture to enlarge the list of such old-time prodigies as would naturally interest persons accustomed to the use of the microscope; by which I mean such marvels and wonders as would not now seem to be extraordinary or prodigious, because of the light which microscopical investigation would be able to throw upon them.

I find myself speaking of these prodigies as if they were occurrences peculiar to ancient times, while the fact is that neither the

occurrences themselves, nor the superstitious and ignorant conditions of mind which attributed to them supernatural origins and saw in them miraculous portents, have been entirely wanting in any generation,—not even our own. Indeed, since I have become interested in this subject, I have taken to cutting from the newspapers of the day, and pasting into the back of one of my very old chronicles of prodigies and monsters, all accounts I have happened upon of wonders in nature approaching in character to those recorded in the musty volume thus turned to scrap-book purposes ; and already I have constructed a striking and startling parallelism both in matter and in spirit.

But not only has there existed a sort of fetichism and a crude worship of natural phenomena in every age of the world, but there has persisted in every race and people something of the taint imparted to the first of mankind by the father of lies, so that when it comes to merely reporting the bare facts of any case which is somewhat obscure or uncommon in character, ordinary human testimony is hardly to be trusted ; for mysticism and imagination are found to have taken the place of sober sense and scientific scrutiny. We all know how difficult it is now-a-days to obtain from intelligent spectators, of general truthfulness, absolutely veracious accounts of so-called spirit manifestations or even of the confessed tricks of clever conjurers. What wonder, then, if the people of centuries ago mixed fiction with fact when attempting to record their impressions of the awe-inspiring operations of the elements ?

As the world whirls on and the sum of human knowledge increases, there is more and more appropriateness in the words of Plutarch,—“ As geographers thrust into the extremities of their maps those countries that are unknown to them, remarking at the same time that all beyond is hills of sand and haunts of wild beasts, frozen seas, marshes and mountains that are inaccessible to human courage or industry ; so, in comparing the lives of illustrious men, when I have passed through those periods of time which may be described with probability, and where history may find firm footing in facts, I may say of the remoter ages, that all beyond is full of prodigy and fiction, the region of poets and fabulists, wrapt in clouds, and unworthy of belief.”¹

In ancient Rome every phenomenon of a character to inspire

¹Life of Theseus. Langhorn's translation.

awe or alarm was looked upon as a miracle of important meaning, designed by the gods as a warning of coming events or as a penalty for some past sin of omission or commission. Accordingly the national religion provided means both for ascertaining the portents of prodigies and for satisfying their supposed requirements. The senate took official notice of thunder-storms, freshets, inundations, earthquakes, eclipses, comets, meteors, hail-storms, and unusual showers of every kind, of the flights of birds, the movements of wild beasts, the actions of domestic animals, of the births of monsters and deformities, both brute and human, and even of various palpably fictitious events founded in mere rumor; and matters so trifling and insignificant that they seem to us simply ridiculous,—as, for example, the varying appetites and dispositions of certain sacred chickens,—were made subjects of solicitous observation and of grave consideration. Upon information of the occurrence of any prodigy in any part of the empire, the Sibylline Books, or Books of the Fates, were solemnly consulted by the priestly officers having the charge of them, and, in accordance with their interpretations and directions, such supplications and sacrifices were decreed as seemed necessary to appease the gods and to expiate supposed faults or to secure desired favors.

In such a state of society not only were prodigies likely to occur, but, as Livy the historian remarks (Bk XXI., Ch. LXII.),² “as is not unusual when people’s minds have once taken a turn towards superstition, many were reported and credulously admitted”—which perhaps had no basis in fact. In another place (Bk. XXIV., Ch. X.) Livy says, “Numerous prodigies were reported to have happened this year [Y. R. 538 : B. C. 214], and the more these were credited by simple and superstitious people, the more such stories multiplied.” And in one instance he confidently asserts that “several deceptions of the eyes and ears were credited as facts” (Bk. XXIV., Ch. XLIV.). Still later he remarks that there “arose abundance of superstitious notions, and the minds of the people became disposed both to believe and to propagate accounts of prodigies, of which a great number were reported” (Bk. XXIX., Ch. XIV.).

At last, however, he seems to have felt it incumbent on him to declare a kind of neutrality in what we may believe to have

²Baker’s translation.

been a controversy going on in his day, something like the conflict between science and theology supposed to have been waged at later periods : for he says : “ I am well aware that, through the same disregard of religion which has led men into the present prevailing opinion, of the gods never giving portents of any future events, no prodigies are now either reported to government or recorded in histories. But, for my part, while I am writing the transactions of ancient times, my sentiments, I know not how, become antique, and I feel a kind of religious awe which compels me to consider that events which the men of those days, renowned for wisdom, judged deserving of the attention of the state and of public expiation, must certainly be worthy of a place in my history ” (Bk. XLIII., Ch. XIII.).

Somewhat in the same strain of half skepticism and half apology is the passage in Plutarch's *Life of Coriolanus*, which says : “ Indeed, we will not deny that images may have sweated, may have been covered with tears, and emitted drops like blood. For wood and stone often contract a scurf and mouldiness that produces moisture; and they not only exhibit many different colours themselves, but receive variety of tinctures from the ambient air : at the same time there is no reason why the Deity may not make use of these signs to announce things to come. It is also very possible that a sound like that of a sigh or a groan may proceed from a statue, by the rupture or violent separation of some of the interior parts; but that an articulate voice and expression so clear, so full and perfect, should fall from a thing inanimate, is out of all the bounds of possibility; for neither the soul of man, nor even God himself, can utter vocal sounds, and pronounce words, without an organized body and parts fitted for utterance. Wherever, then, history asserts such things, and bears us down with the testimony of many credible witnesses, we must conclude that some impression not unlike that of sense influenced the imagination and produced the belief of a real sensation; as in sleep we seem to hear what we hear not, and to see what we do not see.”

Notwithstanding this rather just canon of criticism, Plutarch does not refuse to repeat, and apparently to endorse, those accounts of prodigies which had come down to him in histories and other writings, particularly the stories derived from Livy. Thus, besides many other such marvels, he men-

tions, in his Life of Romulus, that it rained blood in Rome ; in the Life of Camillus, that images have often sweated; in the Life of Timoleon, that the face of an image dropped with sweat; in the Life of Marcellus, that the river which runs through the Picene was seen flowing with blood; in his Life of Alexander, that the statue of Orpheus in Libethra, which was of cypress wood, was in a profuse sweat for several days; in the Life of Antony, that Antony's statue in Alba was covered with sweat for many days, which returned though it was frequently wiped off; and, in his Life of Brutus, that the arm of one of the officers sweated oil of roses, which would not cease though they often wiped it off.

To these statements of Plutarch I may appropriately append his further explanation of his philosophical position, given in these words: "Many such accounts we have from our ancients, and not a few persons of our own time have given us wonderful relations, not unworthy of notice. But to give entire credit to them, or altogether to disbelieve them, is equally dangerous, on account of human weakness. We keep not always within the bounds of reason, nor are masters of our minds; sometimes we fall into vain superstition, and sometimes into an impious neglect of all religion. It is best to be cautious, and to avoid extremes." ³

Keeping this admonition of Plutarch's in mind, we may profitably explore the ancient chronicles for matters both curious and interesting.

It appears to me that the Romans were the most superstitious of the civilized nations of antiquity, and that Livy has given more prominence and attached more importance to prodigies than any other author professing merely historical writing. In his History of Rome I find that he records *showers of earth* as occurring six times,—B.C. 295, 194, 192, 190, 172, and 167. He also mentions a *shower of chalk* as happening in the year 214 B.C. From him we learn that, in B.C. 217, the statue of Mars on the Appian Road, and the images of the wolves, *sweated*; that, in 206 B.C., a profuse sweat flowed from the Altar of Neptune, in the Flaminian circus; that, in B.C. 181, the image of Juno Sospita, at Lanuvium, *shed tears*; and that, in the year 169 B.C., the image of Apollo, in the citadel at

³Life of Camillus.

Cumæ, shed tears during three days and three nights. A *shower of milk* is said by him to have fallen in Sinuessa in B.C. 209; and he reports that a *stream of milk* flowed in the river at Ariminum, in the year 194 B.C. Marvellous appearances of blood, in one form or another, are subjects of frequent record. Thus, in 217 B. C., two shields, in Sardinia, are said to have *sweated blood*; in the same year, in Antium, and again in B.C. 206, in the same place, reapers discovered the ears of corn to be bloody as they gathered them. In the year 217 B. C., at Cære, streams of water were mixed with blood, and the Fountain of Hercules was tinged with bloody spots; in 214 a stagnating piece of water, caused by the overflowing of the River Mincius, in Mantua, appeared as of blood; in 213 the river flowed in streams of blood at Amiternum; in 209 water flowed in a bloody stream at Alba; and in 207 a stream of blood flowed in at one of the gates of Minturna. *Showers of blood* are reported as having occurred: in B.C. 214, in the cattle-market, in the Istrian street, in Rome; in 194, in the Forum, Comitium, and Capitol; in 183, for two days, in the area of Vulcan's temple; in 181, in the courts of the temples of Vulcan and Concord; in 172, during three successive days, in Saturnia; and in B.C. 169, at Rome, in the middle of the day. And in 167 B.C., we are told, Marcus Valerius, a Roman citizen, in Calatia, reported that blood had flowed from his hearth during three days and two nights.

I find in Livy but one reference to a *shower of flesh*. It is said to have occurred in the year of the City 293, or B.C. 459, and is recorded in these words: "Among other prodigies, a shower of flesh fell, which, as was reported, was in a great measure intercepted in its fall by a vast number of birds flying about the place, and what escaped them lay scattered on the ground for several days, without any degree of putrefaction, or being even changed in smell. The books were consulted by the duumviri presiding over sacred rites, and it was predicted that dangers impended from a concourse of foreigners; that an attack was to be made on the higher parts of the city, and lives lost in consequence;" &c., &c.

Pliny, in his Natural History, refers to this same prodigy in the following passage: "We finde recorded in monuments that it rained milke and bloud, when M. Acilius and C. Porcius were

Consuls. And many times else besides it rained flesh, as namely whiles L. Volumnius and Serv. Sulpitius were Consuls; and look what of it the fowles of the aire caught not up nor carried away, it never putrified" (Bk. II., Ch. LVI).⁴

Other than this, Pliny's records of prodigies are meagre and vague, being confined to a reported shower of so-called iron, a fall of wool, and a rain of "tyles and bricks." In the quotation made from him above, as well as in that from Livy, it will be found to be of importance to note the connection between the shower of flesh and the presence of a flock of birds, this being one of the instances in which ancient records of prodigies carry with them their own probable explanation.

The shower of flesh referred to by Livy and Pliny is mentioned also in a rare and curious illustrated Chronicle of Prodigies and Monsters compiled by Conrad Wolffhart (or Lycosthenes), and published in Latin at Basle in 1557, in which is incorporated all that is known of a work "*De Prodigijs*," by Julius Obsequens, a Roman writer in the time of Augustus. In this chronicle of Wolffhart's (of a copy of which I am the fortunate owner) occur also the only other records of descents of flesh known to me, except the somewhat notorious "Kentucky meat-shower" of 1875. The first of those other cases is said to have occurred in Liguria in 1456, A. D., and the last in France in 1552. As this would have been in Wolffhart's own life-time we should naturally expect from him some particulars, but he furnishes only the bald statement, "*in Francia sanguine & carne pluit.*"

Wolffhart's Chronicle is a rich mine of astonishing things, from which I shall endeavor to summarize briefly his accounts of the matters in which we are specially interested, after eliminating those which he quotes from Livy and which we have already considered. Like other writers upon prodigies, he records showers of earth (in the years 163, 160, and 131, B.C.), a shower of chalk (B.C. 96), a fall of stones and shells (B.C. 89), a rain of mud (B.C. 100), and one of ashes (A.D. 744). He also describes many wonderful meteoric showers and numerous miraculous falls of manna and other edible substances, which might perhaps fairly engage our attention if the limit of our time would permit. His references to showers of milk are remark-

⁴Philemon Holland's translation.

ably numerous. These he records as having taken place in the years B.C. 272, 265, 263, 160, 127, 122, 116, 114, twice in 106, in two different places in 104, also at two places in 102, in 93 and in 90. In the year 122 B.C. a fall of oil and milk together is said to have occurred. He tells us also that in B.C. 131 streams of milk flowed into a cistern in Rome; that in the year 102 B.C. streams of milk sprang up gushing from the earth; and that in the year 41 B.C. the ditches ran with milk.

With other chroniclers, Wolffhart mentions the sweating of images and other like objects, and also informs us of statues that dripped with blood. Thus, a stone effigy of Antony, in Alba, emitted much blood in the year 41 B.C., and blood trickled from the big toe of a statue of Jupiter in the same place, the year before. In the year 131 B.C., he says, a new shield was spotted with blood; but he does not tell us whether the blood was supposed to have fallen upon it or to have exuded from it. In B.C. 204 the grain in the fields of Tarra-cina was found to be spotted with blood. Blood dropped from bread, or appeared upon it, in the years B.C. 332 and 89, and A.D. 583 and 1163. In A.D. 1093 bread that had been baked under ashes was stained as if with blood; and in 1550 it is said that when some soldiers were cutting bread with a knife drops of blood trickled from it and the whole interior was discovered to be full of it.

Blood is reported to have flowed or trickled from the earth in the years B.C. 263, 208, 163, 144, 140, 94, 92, 91, and 40, and in A.D. 782 and 940. On one of these occasions it is said to have clotted, on another to have flowed in a torrent, and once to have continued running for several days.

Blood is said to have flowed from, or to have bubbled up in, natural springs in B.C. 272 and in A.D. 1549, 1550, and 1555. These latter events having occurred in what were modern times to Wolffhart, are given with more than his usual particularity. That of 1550 is referred to a meadow in Saxony, and it is said of the blood which bubbled up that if a little were taken in the hand it turned a light yellow. The occurrences of 1555 are located at Vinaria and are set down to specific dates, as, for example, June 6th and the two days following; also June 12th and 13th.

Artificial fountains are also reputed to have flowed with

blood, or to have had their waters mixed with it, the wonder lasting on one of these occasions for twenty-five days. The years in which these things are supposed to have happened are B.C. 340, 263, and 133, and A.D. 570, 935, 1002, 1010, 1163, and 1555.

Streams of water are said to have been changed into or tinged with blood in B.C. 459, 332, 234, 221, and 90. The River Danube is reported to have emitted a bloody torrent in A.D. 1349, which would seem to have been at a sufficiently late time to warrant our expecting some sort of careful observation of the phenomenon, whatever it really was.

We are told that in B.C. 205 and in A.D. 1552 a lake and a pond flowed with blood; that in A.D. 53, for several days, the ocean on the coast of Britain rolled up blood; and that in the time of the Emperor Nero (A.D. 66) the sea on the shores of Italy had the appearance of blood, while impressions of human forms were left on the sands.

Finally, Wolffhart makes mention of showers of blood which occurred in B.C. 178, 163, 131, 125, 104, 102, 100, 43, 35, and 28, and in A.D. 48, 541, 570, 782, 1114, 1120, 1163, 1165, 1274, 1337, 1349, 1456, 1531, 1539, 1542, 1553, 1555, and 1556. Some others he describes with more detail. For instance, in B.C. 214 there was a fall of stones with much blood. In B.C. 110 it rained milk and blood together. In A.D. 541 real blood dropped from the clouds upon men's clothes. In A.D. 864 there was a fall of bloody snow. In A.D. 874 it rained blood for three days and three nights, at Brixia, Italy. In 1147 and 1555 there were descents of great numbers of butterflies sprinkled with blood, and as if it rained blood with them. In 1551 a bloody wisp was seen in the sky accompanied with a shower of blood, at Lisbon; and in A.D. 570, and again in 1104, a fierce battle was seen to rage in the heavens, from which blood fell to the earth.

It is natural enough that in early times accounts of prodigious and marvellous occurrences should have been published principally for the entertainment and edification of the simple-minded and ignorant *vulgus*. Hence there have been printed at various times numerous catch-penny chapbooks, composed of compilations of awe-inspiring annals and traditions. One of the most prolific authors of this class of pseudo-historical litera-

ture was one Robert Burton, a resident of London, who, towards the close of the seventeenth century, produced nearly a dozen of what his publisher, with excusable partiality, called "very useful, pleasant and necessary books," to be sold at a shilling each. One of these works is entitled "The Surprising Miracles of Nature and Art," &c. ; and another, "Admirable Curiosities, Rarities, and Wonders in England, Scotland and Ireland," &c. As the author himself states, the events of which he treats are given "as they are recorded by the most authentic and credible historians of former and latter ages," and I therefore think we may take their accounts as at least indicating the common belief as to the frequent occurrence of certain prodigies down to the beginning of the eighteenth century. In quoting from Burton I shall endeavor to omit those matters which have been already referred to in quotations from more ancient authors, though this is not always an easy point to determine, owing to the general carelessness and uncertainty as to dates in early writers and the varying systems of chronology employed by them.

In common with other chroniclers, Burton records cases of miraculous sweating and weeping of crosses, images, etc., which are not worth repetition here. We may also for the present pass over the reports of the descent of corn and other articles of food from the sky. The wonders which particularly interest us are the following: In A.D. 50, "in and about the coasts of England, for certain days, the sea seemed as blood;" and in A.D. 63 "the ocean seemed to be blood." In A.D. 81 it rained blood in Germany. In 323 a fountain ran with oil in Italy. In 434 it rained blood in Savoy. In 529 it rained blood for four days together in Piedmont. In A.D. 570, "at York, in England, the fountains ran blood; likewise blood fell from the clouds in Lombardy." In 639 it rained blood in Naples. In 688 it rained blood for seven days "throughout all Britain," and in the same year milk, cheese, and butter were reported to have been turned into blood. In 735 it rained oil in Spain. In 778 it rained blood, as well as earth and ashes, in Rome. In 808 it rained blood in Holland. In 1022 it rained milk in Rome, and a fountain of water in Lorraine was turned into blood. In 1100 a well in Finchamsted, Berkshire, England, "boiled up with streams of blood and continued so fifteen days together, and

the waters discoloured all others where they came." In 1198, and again in 1378, it rained blood in England. In 1399 in a little town in Bedfordshire "it rained blood, the red drops whereof appeared in sheets hung out to dry." In 1618 and again in December, 1619, the water which runs through the city of Sixto, in Hungary, was turned into blood, and the ice therein was also blood-red. In the same year the water in a ditch in Vienna appeared like blood "for the space of eight days." In 1620, in Poland, it rained blood so abundantly that "the drops fell very fast from the tops of the houses." In 1622, in Darmstadt, trees were found the leaves of which dropped blood. On the 16th of July, 1622, in Wittenburg, it rained blood on the hands and clothes of the laboring men and likewise upon trees, stones, etc. In 1623 a well in Bohemia was for some days turned into blood; and in the same year, in Tursin, "the table, chairs and walls of the parlour of a citizen's house all sweated blood so that it began to run along the room," while in the towns of Mayenfield and Maylantz the sickles and the hands of the laborers, as they were mowing in the fields, were seen to be bloody. In 1624 it rained blood at Weinsham, in Bohemia, and at Friburg, in Silesia. In May, 1631, the water was turned into blood at Hall, in Lower Saxony; "and about the middle of this month this town was taken by Tilly * * and whilst his army lay in the town one of his chief officers saw blood prodigiously dropping from the house wherein he lay." In 1632, in Franestein (near Dresden), a woman who had bought some bread and carried it home was surprised, when she came to cut it, to see blood issue from it. In 1633, at Dobenshutz, in Althenburg, "blood sprang out of a fish-pond with such a filthy savour that if it were touched they could not wash off the stink in two or three days." In 1634 it rained blood and brimstone at Berlin. In November, 1635, in Holstein, "it rained thick blood whose drops being used as ink represented true natural blood in writing." In Isenach, in 1637, the conduit, situated in the market-place, "instead of water suddenly poured out blood, and so continued for two hours." At Weimar, in 1637, the water was turned to blood. In 1640 "a pond in Cambridge became red as blood, the water whereof being taken up in basons remained still of the same colour," and at Bencastle, in Northum-

berland, England, it rained blood, which "covered the church and churchyard." In May, 1646, it rained brimstone at Wittenburg. And, finally, in June, 1653, "a black cloud was seen over the town of Pool, in Dorsetshire, and soon after dissolved into a shower of blood which fell warm upon men's hands, and some green leaves with those drops upon them were sent to London and seen by many."

In the third chapter of the Rev. Dr. Hugh Macmillan's very charming little book entitled "First Forms of Vegetation," you will find accounts of many such prodigies as those to which I have just called your attention, and some of them are much more extraordinary than any which I have cited. His scientific explanations, too, are no less interesting than his merely historical quotations, and you will oblige me if you will supplement this paper with a perusal of his fascinating pages. I have not, I think, mentioned a single case which is also to be found in his book.

As it is no part of my purpose to make a complete catalogue of reputed prodigies, I shall not further enlarge my list. I have already given items extending over nearly twenty-five hundred years of history, which are sufficient to show that reports of miraculous operations in nature were so frequent and so nearly universal as to warrant our believing that they were, in general, founded in facts to which merely false interpretations were given. I do not mean to say that every single instance that has been recorded will fall under this generalization, for many may easily have been, and some probably were, pure inventions; and, as Livy says, "the more these were credited by simple and superstitious people, the more such stories multiplied." But each class of prodigies may be regarded as representing, or, rather, misrepresenting, a class of actually observed phenomena, and we may properly and profitably inquire what those phenomena were. Let us do this as briefly as possible.

1. The *Sweating and Weeping of Images, Altars, etc.*, may be disposed of without much delay, for it is almost impossible to conceive of any cause for this appearance except the commonly observed phenomenon of the condensation of watery moisture upon any relatively cold surface.

2. The *Bleeding of Statues, Shields, etc.*, may, I think, be explained, in some cases, by the sudden appearance of mere

rust; though it is difficult to believe that at any historical time the process of oxidation was not well known even to the most unlearned. Still, we can imagine circumstances under which so simple and ordinary an occurrence might have been magnified into a sanguinary portent. The more reasonable explanation in most instances, however, would be the growth upon the object of a red lichen or alga, as, for example, *Hæmatococcus sanguineus*, or *Palmella cruenta*. The latter is known also, in popular language, as Gory Dew, which, as Dr. Carpenter says ("The Microscope and its Revelations," Sixth Edition, p. 292), "is common on damp walls and in shady places, sometimes extending itself over a considerable area as a tough gelatinous mass, of the color and general appearance of coagulated blood."

3. *Showers of Earth, Chalk, Ashes, etc.*, need no accounting for, in most cases, except upon the theory that, when not simply fictitious, they were probably what they were called; for the drifting of sands from distant deserts or plains and the wafting of ashes from far-off volcanoes have always been common and well-understood occurrences. So-called rains of brimstone, however, may have been composed of pollen-grains or spores, or other vegetable products, resembling sulphur in color. Such a fall of pine pollen, which happened in Yokohama, Japan, in April, 1871, is described in "Science Gossip" for 1871, page 189.

4. *Showers of Oil* were probably never showers at all. The reports concerning them may have been occasioned by the discovery upon the earth or upon stones or plants, of greasy spots such as are produced by certain insects and some worms, or they may have arisen from the appearance upon pools of water left by rain of those iridescent films which, we now know, are caused by a variety of substances, including diatoms, iron-bearing earths, and, of course, fat or oil itself. Another cause of this appearance might be one of the gelatinous protophytes,—a *Nostoc*, for example, or a member of the order Palmellaceæ. Describing the beaded filaments of which the Nostochaceæ consist, Dr. Carpenter says (p. 297): "The masses of jelly in which they are imbedded are sometimes globular or nearly so, and sometimes extend in more or less regular branches; they frequently attain a very considerable size; and as they occasionally present themselves quite suddenly (especially in the latter part

of autumn, on damp garden-walks), they have received the name of 'fallen stars.' They are not always so suddenly produced, however, as they appear to be; for they shrink up into mere films in dry weather, and expand again with the first shower." And of *Palmoglyca macrococca*, which usually spreads itself as a green slime on damp stones, walls, etc., he remarks (p. 277): "It is curious to observe that during this conjugating process a production of oil-particles takes place in the cells; these at first are small and distant, but gradually become larger, and approximate more closely to each other, and at last coalesce so as to form oil-drops of various sizes, the green granular matter disappearing; and the color of the conjugated body changes, with the advance of this process, from green to a light yellowish-brown."

5. *The flowing of Oil* in brooks, fountains, etc., is probably the popular way of describing, under other conditions, the same iridescence to which I have already referred, and which needs no further consideration here.

6. *Showers of Wool, etc.*, are well elucidated by an account quoted in White's "Natural History of Selborne" (Letter XCVII.), of a sudden overspreading of the branches of a grapevine "with large lumps of a white fibrous substance resembling spiders' webs, or rather raw cotton. It was of a very clammy quality, sticking fast to everything that touched it, and capable of being spun into long threads. * * * It remained all the summer, still increasing, and loaded the woody and bearing branches to a vast degree." It turned out to be a product of the *Coccus*.

7. *Showers of Milk*, like other reported showers, were probably merely so-called. The appearance of milk-white spots upon foliage might easily give rise to the belief that drops had fallen from the sky, when, in fact, no actual descent had been observed. Such milk-like spots may have been produced by many causes, but the cause which most readily suggests itself to a microscopist is some form of the fungus called "white rust," which frequently appears upon the leaves of cabbage, cauliflower, shepherd's-purse, etc., as patches resembling splashes of white-wash or spatters of milk.

8. *The Flowing of Milk* from the earth, in streams, etc., might be in most cases the superstitious interpretation of so sim-

ple a fact as the mixture of calcareous earth with ordinary running water, particularly after severe storms, at which times the ignorant mind would be in a state of easy impressibility and credulity. I suppose, too, that under favorable conditions some of the lower forms of both vegetable and animal life might multiply so enormously as to give a milky hue to considerable bodies of water, as they do constantly under our own observation in a smaller way.

9. *The Spotting of Bread, Grain, Leaves, Stones, etc., with Blood*, is a phenomenon easily accounted for by a very slight knowledge of the various forms and habits of the red and orange-yellow fungi. The bloody mould of bread has always been comparatively common, but the exact character of the organism producing it has never yet been clearly determined. Ehrenberg describes it as an animalcule, under the name of *Monas prodigiosa*. It has since been transferred to the algæ, with the title of *Palmella prodigiosa*: but there is still some doubt as to whether it should not be considered more properly a fungus. At any rate, it is to be found described in all the text-books. The gory staining of grain is attributable to what is known as "red rust," or "corn-rust" (*Trichobasis*), which in certain seasons is very plentiful on all kinds of grasses. The Rev. M. J. Berkeley speaks of a wheat-field in which not a single leaf was free from this fungus, "insomuch that a person walking through the wheat was completely painted with the spores, of a fine rust-red;" and of course the spores would readily color the hands of laborers gathering the grain. The spotting of leaves of shrubs and trees is an occurrence within the experience of probably everyone of us, and simply to mention *Ecidium*, *Puccinia*, and *Uredo* is to suggest the explanation of numerous old-time marvels.

10. *The Flowing of Blood* in the ocean, rivers, springs, etc., is to be accounted for in some instances by the presence, in unusual quantities, of red algæ seen through the distorted eyesight of awe-stricken ignoramuses or pictured through the perverted imaginations of prejudiced *literati*. Thus the Sargasso Sea became to the ancient mind a stream of blood and the abode of death. It is said that certain infusoria occasionally become so abundant in the ocean as to give it a livid hue, and a rather fanciful origin has thus been invented for the

name of the Red Sea, though a much more reasonable one is found in the theory just mentioned with reference to the prevalence of red sea-weed. As to the appearance of blood in bodies of fresh water, we need to seek no further for a basis of fact than the well-known and well-understood circumstances connected with the characters and life-histories of some of the protophytes; for example, the common *Protococcus pluvialis*, which, though usually green, is sometimes red, and which multiplies at times with most amazing rapidity. With regard to this remarkable organism I cannot do better than to quote Dr. Carpenter again, who says of it (p. 281): "Rapid evaporation of the water in which the 'motile' forms may be contained, kills them at once; but a more gradual loss, such as takes place in deep glasses, causes them merely to pass into the 'still' form; and in this condition—especially when they have assumed a red hue—they may be completely dried up, and may remain in a state of dormant vitality for many years. It is in this state that they are wafted about in atmospheric currents, and that, being brought down by rain into pools, cisterns, etc., they may present themselves where none had been previously known to exist; and there, under favorable circumstances, they may undergo a very rapid multiplication, and may maintain themselves until the water is dried up, or some other change occurs which is incompatible with the continuance of their vital activity. They then very commonly become red throughout, the red coloring substance extending itself from the centre towards the circumference, and assuming an appearance like that of oil-drops; and these red cells, acquiring thick cell-walls and a mucous envelope, float in flocculent aggregations on the surface of the water."

11. *Showers of Blood* are in great part accounted for in what has just been said; but there is one class of these sanguinary prodigies which is referable to a very curious phenomenon that takes place in the insect-world. You will find an account of several such wonderful occurrences in "Science Gossip" for 1871, page 45. One of the cases there mentioned happened in July, 1608, when "a supposed shower of blood fell for several miles around the suburbs of Aix-la-Chapelle. The cause of this was discovered by M. de Peiresc to depend upon the exudation of large drops of a blood-colored

liquid on the transformation of large chrysalides into the butterfly state. The drops produced red stains on the walls of the small villages in the neighborhood, on stones in the highways, and in the fields. The number of butterflies flying about, too, was prodigious." The writer of this account says: "On one occasion twenty-eight chrysalides of *Vanessa Antiopa*, or Camberwell Beauty, which I had preserved in a small room, attached to projecting bodies, underwent transformation on a single day in July. The walls and floor were so bespattered with bright crimson-colored fluid, resembling blood, as to give the appearance of a regular shower of the fluid." Figuiet, in his "Insect World," describes the same phenomenon at some length, and quotes (p. 188) Réaumur as saying of the large Tortoise-shell butterfly: "Thousands change into pupæ towards the end of May or the beginning of June. Before their transformation they leave the trees, often fastening themselves to walls; and, making their way into country houses, they suspend themselves to the frames of doors, etc. If the butterflies which come out of them towards the end of June or the beginning of July were all to fly together, there would be enough of them to form little clouds or swarms, and consequently there would be enough to cover the stones in certain localities with spots of a blood-red color, and to make those who only seek to terrify themselves and to see prodigies in everything, believe that during the night it had rained blood."

12. "*The Red Snow*," says Dr. Carpenter, "which sometimes colors extensive tracts in Arctic or Alpine regions, penetrating even to the depth of several feet, and vegetating actively at a temperature which reduces most plants to a state of torpor, is generally considered to be a species of *Protococcus*; but as its cells are connected by a tolerably firm gelatinous investment, it would rather seem to be a *Palmella*."

13. *Showers of Flesh* are well exemplified by the so-called "meat-shower" which occurred in Kentucky in 1875, as most of us well remember. At the time, it caused almost as much ignorant wonder and gave rise to nearly as many nonsensical notions as it would have done hundreds of years ago. The first attempts at accounting for the marvel attributed it to a mysterious fall of *Nostoc*, but careful microscopical examina-

tions by Dr. A. Mead Edwards, Dr. J. W. S. Arnold, and others, subsequently demonstrated that the substance which fell was lung-tissue, cartilage, and muscular fibre; so that the shower was of veritable meat. Still later it was made out that the tissue was that of a horse, and when finally the miraculous rain came to be connected with the appearance of a flock of buzzards, the whole secret was out; for it is a habit of those unsavory birds to gorge themselves with carrion to the point of bursting and then to vomit, as they fly, what they are unable to retain.

Thus easily was a modern prodigy disposed of; and quite as rationally, we now see, might we dispose of all ancient prodigies which were not mendacious fabrications, if only we could catechise witnesses and apply scientific methods to the examination of such facts as were found to remain.

APPENDIX.

It may be of interest to the curious to know how some of these prodigious events were explained by the pseudo-science of the seventeenth century, and so I append some extracts from a work entitled "*Speculum Mundi, or a Glasse Representing the Face of the World; shewing both that it did begin, and must also end; the manner how, and time when, being largely examined. Whereunto is joyned an Hexameron, or a serious discourse of the causes, continuance, and qualities of things in Nature; occasioned as matter pertinent to the work done in the six dayes of the World's creation.*" "By John Swan, M^r of Arts, late Student of Trinitie Colledge, Camb.—A.D. 1643."

"And now it followeth that I divide all sorts of rain into two kinds: First, such as are ordinary; secondly, such as be extraordinary.

"I call those ordinary when nothing but water falleth. And I call those extraordinary which others call prodigious rains: as when worms, frogs, fish, wheat, milk, flesh, bloud, wool, stones, iron, earth, &c., fall from the clouds. Plinie makes mention of many such prodigies as these, in the 56 chapter of his second book; setting down the times when they happened.

"Concerning all which, next under God (the causer of the causes causing them) these or the like reasons may be urged to shew how it is possible they should be procured, and upon what causes they naturally depend.

“1. And first for the raining of worms; it may be thought that the putrefaction of some dead carcasses or other hath been drawn up into the aire as fumes and vapours are, where it breedeth such worms as use to breed out of the like matter here below.

“2. The like may be said of frogs, when the vapour is exhaled out of marish grounds at such times as they engender.

“3. So also of fishes; excepting that (as is supposed) the force of winds may suddenly sweep away little frey out of ponds upon montanous places; and so also little young frogs, with many the like things, may be taken up. Some write of a whole calf falling from the clouds; and have been thereupon perswaded that it is possible, of Vapours and Exhalations, with the power of heavenly bodies concurring, a calf may be made in the aire. But this is idle. It was therefore (as others write) taken up in some storm of whirlwind, and so let fall again.

“4. As for wheat and other grain, it hath been observed that their raining down hath often come in case of extremitie, to the great preservation and refreshment of the distressed: in which regard it may be supposed that it was an immediate work of God, wrought without the rule of nature: so that were all the wits in the world prest into one, yet were they all too weak to shew a true cause of such a prodigie. * * * To speak therefore as I think, I will not boldly affirm how this was caused, but onely touch at the possibilitie of it; namely, that it might be effected like unto other strange rains, first drawn from the earth into the aire, and then sent down again. * * * He that hath seen (saith one) an egg-shell full of dew drawn up by the sunne into the aire, in a May morning, will not think it incredible that wheat and other grain should be drawn up in much hotter countreys then ours is, much rather the meal or flower which is lighter.

“5. By the like reason also it sometimes raineth milk: for when the *intensissimus solis calor*, the vehement heat of the sunne, shall either draw milk from the udders of cattell, and shall mix it with the other parts of the cloud; or shall so throughly trie, purifie, digest or concoct the vapour, that it may look something white, then will the drops look as if it rained milk.

“6. As for the raining of flesh, it is supposed to be after this

manner, namely through the drawing up of blood from places where much blood hath been shed, which being clotted together seemeth as if it were flesh.

“7. And so also it may rain blood; namely when it is not clotted together, but thinner, &c. * * * But, say some, there is often great store of blood spilt and yet no prodigie appeareth. To which is answered, that it is not the ordinarie exhaling virtue which resteth in the starres and Planets that can draw up such bloody vapours, although much blood be spilt; but then onely when there is a more unusual concurrence of causes: for sometimes they are disposed to one thing, sometimes to another. And for the working of any strange thing, it must be when there is a strange kind of combination amongst them. * * * And unto this also adde, that there may be drops like unto blood, and yet no blood drawn up; and this may be, either when the sunne draweth vapours out of putrified watery places, in which (as I have often seen) in a drought resteth much slimie and red-coloured corrupted water; or else when the Sunnes immensive heat doth so boyl the water in the cloud, that * * * it looketh red when it falleth.—The like cause I gave before unto the water of a white colour; but know that it must then be of another qualitie, the matter of the vapour I mean; for there are some kinds of waters, as is well known, which being boyled turn to white salt, &c.—And as for a red colour, the ordinarie rain sheweth that it is possible; for we see that ordinary rain-water looketh alwayes more brown then spring or river-water, being as if a more powerfull operation would turn it into red.

“8. The raining of wooll, or hair, is when a certain mossinesse like wooll, such as is upon quinces, willows, and other young fruits and trees, is drawn up by the Sunne among Vapours and Exhalations, which being clotted together falleth down like locks of wooll, or hair.

“9. Concerning stones, they proceed from earthly matter gathered into the clouds, as before was shewed concerning the Thunder-stone, &c. * * *

“10. Iron may also drop out of the clouds, when the generall matter of all metalls, which is quicksilver and brimstone, with the speciall matter of mixtion making iron, are all drawn up together and there concocted into metall. * * *

“ 11. And as for earth, chalk, dirt, and the like, it is drawn up in thin dust at the first with the vapour : Or else, by force of some wind blowing from caverns, or holes of the ground, it is carried up ; and being conglomerated, or as it were glued together, falleth down again.

“ 12. But beside all these, there have sometimes been red drops, which falling upon men’s garments have made a stain like unto a crosse. Such drops as these fell upon the clothes of the Jews, when in the dayes of the Apostate Julian they went about to restore their citie and temple. * * * But this surely was a thing altogether miraculous. For their red crosses came not alone, but were accompanied with other prodigies : * * * This was both the prodigie, and the issue of it : of which, being so plainly miraculous, I know not what to say.

“ But I find that other times have in a manner afforded the like. Wherefore (although I speak nothing atall of these at this time thus miraculous) concerning them some reasons may be given.

“ And not to go farre, Magirus, in the Comment upon his Physicks, telleth us that in Suevia, a Province in Germanie, in the yeare of our Lord 1534, the aire distilled certain red drops, which falling upon linen garments, made such an impression or stain as was like unto a crosse.⁵ Which impression (as he alledgeth out of Cardan his sixteenth book *De subtilitate*) might be procured thus ; viz., because a certain kind of extraordinarie dry dust sticked to those garments ; which, by the piercing or through-washing drops falling upon it, was so miraculously divided into parts, that there seemed a figure as of a cross. Or thus, because the woven threads in themselves had such a form. Or else, (which is most probable) because the humour in the middle part lay on high, whereas the sides were but thin and fashioned according to the dashing of the drop. For when a drop falleth upon anything with a kind of force, we see that most of the humour resteth in the midst, whilest certain sparkling raies are dashed about the sides. And thus he thinketh it

⁵Wolffhart, in his Chronicle, mentions instances of little crosses appearing upon clothing, etc., as follows:—

In the time of Julian the Apostate, about A.D. 367 or 8;—spoken of as rain or dew.

In the fifth year of the Emperor Constantine, A.D. 746;—referred to as being like oil.

A.D. 784, and A.D. 969, without any particulars.

A.D. 1503, in Germany, when they are said to have appeared on bread.

might be then, in the fall of those staining drops ; which why they stain, hath relation to that which I said before concerning the raining of bloud.

“I will therefore now conclude ; adding in the last place, that the devil, by God’s permission, both often hath and also doth produce many such prodigies as these that I have spoken of, with sundry other like unto them, especially amongst the Heathen, Pagan, and superstitious nations.”

PROCEEDINGS.

MEETING OF JUNE 5TH, 1885.

The President, Mr. C. Van Brunt, in the chair.

Twenty-eight persons present.

Mr. R. I. Fearon was elected an Active Member of the Society.

OBJECTS EXHIBITED.

1. Photographs of Diatoms, taken by Dr. Henri Van Heurck: by THE SOCIETY.

2. *Cylindrospermum*: by A. D. BALEN.

3. Annular and spiral deposit from root of *Opuntia vulgaris*: by WALTER H. MEAD.

4. Section of human scalp; prepared by Mr. Arthur C. Cole, London: by EDWARD G. DAY.

5. *Vaucheria*, showing oögonia and antheridia; prepared by Mr. Arthur C. Cole: by J. L. WALL.

6. Transverse section of stem of Fleur de Lis: by B. BRAMAN.

7. *Mesocarpus* in conjugation; prepared by Mr. Arthur C. Cole: by B. BRAMAN.

8. Chapman's Mould for making microscopical cells: by E. B. GROVE.

DR. VAN HEURCK'S PHOTOGRAPHS OF DIATOMS.

President Van Brunt: "I have the pleasure of announcing that Dr. Henri Van Heurck has presented to this Society a copy of his 'Synopsis des Diatomées de Belgique,' together with a series of photographs taken by him with the incandescent electric light. Both the Synopsis and the photographs are here."

By vote of the Society, under motion made by Mr. C. S. Shultz and seconded by Mr. C. F. Cox, the Corresponding Secretary was instructed to convey to Dr. Van Heurck the Society's high sense of his generosity and of the great value of his gift. "Such an expression," said Mr. Cox, "is eminently fitting. Dr. Van Heurck holds a leading position among Euro-

pean investigators, and he has studied the Diatomaceæ with special care and distinguished success; and it is interesting to note that the results of his studies confirm the results of researches made in the same field in our own country. If we examine these photographs of Dr. Van Heurck, we shall find that they have a larger intention than to show the particular appearance of any one diatom; they bear upon the general question of the structure of the diatom shell."

CHAPMAN'S MOULD FOR MICROSCOPICAL CELLS.

The Chapman Mould, which was exhibited by Mr. E. B. Grove, is a convenient implement for making cells out of such plastic material as shel-lac, sealing-wax, or paraffine. It consists of a cylindrical core, and a removable collar concentric with it—both of brass. A rounded or bevelled shoulder inside the collar shapes the top of the cell, and a small shoulder on the core moulds a countersink suitable for the reception of the cover-glass. As a single mould is intended for but one size and one depth of cell, several are necessary to an outfit.

HARD-RUBBER CELLS.

Mr. C. F. Cox: "Excellent cells for mounting opaque objects may be made from hard-rubber tubes. A few years ago I ordered of a manufacturing company of this city a number of such tubes of the length of about one foot and of the exact sizes necessary, when made into rings, to take one-half-inch, five-eighths-inch, and three-fourths-inch cover-glasses. By means of a turning-lathe the tubes may be easily and evenly cut into cells of any desired depth. My tubing cost only a few dollars, but I have from it a supply of cells sufficient, probably, to last my lifetime."

ADDRESS ON CERTAIN SO-CALLED PRODIGIES.

Mr. C. F. Cox addressed the Society on the subject of the prodigies, so-called, of ancient and mediæval times, and showed the indebtedness of science to the microscope for an explanation of many of them. The Address is published in full in this Number of the JOURNAL.

Mr. J. D. Hyatt said: "In a place where I once passed the summer a phenomenon occurred which created much excitement. The surface of a considerable body of water that had

collected in a low piece of ground near a cemetery, suddenly became covered with *Euglena sanguinea*, which gave the water the exact appearance of a pool of fresh blood. Some of the people were greatly alarmed, and they inquired of me the cause of the phenomenon. I explained it to them as clearly as I could; yet they still believe and would testify that this pool, situated so near the *cemetery, was for many days that summer reddened with blood."

MEETING OF JUNE 19TH, 1885.

The President, Mr. C. Van Brunt, in the chair.

Forty-five persons present.

Ivin Sickels, M. D., was elected an Active Member of the Society.

On motion of Mr. Mead it was voted that, when the Society adjourns, it shall adjourn to meet on the first Friday of October next.

It is the Society's custom to give to its last meeting prior to adjournment for the summer a partly social character. To this end it makes at this meeting a larger and more miscellaneous exhibition of objects than at its other regular meetings.

OBJECTS EXHIBITED.

1. *Lacinularia socialis* : by A. D. BALEN.
2. *Closterium lunula* : by A. D. BALEN.
3. *Peridinium spiniferum* : by C. S. SHULTZ.
4. Circulation of blood in foot of Frog : by J. L. WALL.
5. Cyclosis in *Vallisneria* : by WALTER H. MEAD.
6. Cyclosis in *Anacharis* : by JAMES WARNOCK.
7. Cyclosis in *Nitella* : by JAMES WARNOCK.
8. Micrococci from normal human saliva, showing chain-like arrangement of cells, and illustrating reproduction by fission in one direction : by LUCIUS PITKIN.
9. *Sarcina ventriculi*, showing cells in square clusters, and illustrating duplicative subdivision in directions at right angles to each other : by LUCIUS PITKIN.
10. *Cimex lectularius*, showing tracheæ and spiracles; bleached in hydrogen peroxide : by F. W. LEGGETT.
11. Spiracles in skin of *Dytiscus* : by EDWARD G. DAY.

12. Arranged butterfly scales : by C. W. McALLISTER.
13. Foraminifera from Bermuda : by W. G. DEWITT.
14. Leaf of *Onosmodium Carolinianum*, showing curious pubescence : by J. D. HYATT.
15. Palate of *Patella vulgata* (Limpet), showing teeth : by J. D. HYATT.
16. *Syndendrium diadema* : mounted by Möller : by M. M. LE BRUN.
17. *Papyrus*, transverse and longitudinal sections, from the Nile : by H. W. CALEF.
18. *Echinus* spine, transverse section, by dark-ground illumination with Zentmayer's Abbe Condenser : by C. S. SHULTZ.
19. Sunstone—oligoclase spangled throughout with minute scales of gold-colored mica—from the Greeley farm, Chappaqua, N. Y. : by G. F. KUNZ.
20. Artificial Sunstone, or Venetian Goldstone—glass spangled with brass filings : by G. F. KUNZ.
21. "File" of Katydid : by B. BRAMAN.
22. Spores of *Equisetum* : by B. BRAMAN.
23. A Portable Cabinet, accommodating one hundred slides ; designed by Prof. Hamilton L. Smith : by EDWARD G. DAY.

NOTE ON PERIDINIUM AND ASTERIONELLA.

Mr. C. S. Shultz : "I have observed for several years that when the water-supply of New York or of other cities is pervaded with the gelatinous substance which gives it a fishy taste, neither *Peridinium* nor *Asterionella* abounds in it. The abundant occurrence of these forms accompanies and indicates a purer condition of the water."

HINTS ON MICROSCOPICAL MOUNTING.

At the President's request, Mr. E. G. Day gave some hints of his methods of microscopical mounting, as follows :—

"Wax cells may be readily made by using a pair of dividers about two and one-half inches long, furnished with a thumb-screw and having fine steel points. You may with this instrument cut from sheet wax a ring of any diameter, and by laying ring upon ring you can build a cell of any depth. The wall of such a cell may be punctured with a fine needle so as to allow

the escape of moisture. The cell is best fastened to the slide with liquid marine glue, or with a solution of white shel-lac in methylated spirit, put on the slide with a brush.

“Much has been said against the use of white-zinc cement. When this preparation is of superior quality, like that furnished by Mr. Walmsley, and is properly treated, I find it an excellent material for shallow cells. Either white shel-lac dissolved in methylated spirit, or a certain preparation called ceramic glazing, will, if applied with a brush to the white-zinc ring, effectually protect the mounting medium.

“The formation of fungus-growths on the under-side of the cover-glass can always be prevented by the application of the smallest possible quantity of carbolic acid before the cell is closed.

“The best way, I think, of cleaning cover-glasses is to immerse them for five or six minutes in nitric acid and stir them about with a glass rod. The acid is then decanted, and the covers, after being thoroughly washed with water, are placed in alcohol in a wide-mouthed bottle, and are ready for use.”

ADJOURNMENT TO OCTOBER SECOND.

The President: “The next meeting of the Society, which will take place October 2d, will have a somewhat social character, like the meeting of this evening. It is hoped that the members will bring to us at that time many interesting and valuable results of their summer observations and experiences.”

VACATION.—With the publication of this, the July Number, the JOURNAL enters upon a three months' vacation. It takes this occasion to thank other scientific Journals for their expressions of good will, and it wishes them a summer of unusually agreeable work.

PUBLICATIONS RECEIVED.

National Druggist : Vol. VI., No. 22 (May 29th, 1885); pp. 15. No. 23 (June 5th); pp. 12. No. 24 (June 12th); pp. 14. No. 25 (June 19th); pp. 14. No. 26 (June 26th); pp. 11. Vol. VII., No. 1 (July 3d); pp. 14. No. 2 (July 10th); pp. 10. No. 3 (July 17th); pp. 10.

Brooklyn Entomological Society. Entomologica Americana : Vol. I., No. 3 (June, 1885); pp. 20. No. 4 (July); pp. 20.

The Electrician and Electrical Engineer : Vol. IV., No. 42 (June, 1885); pp. 40. No. 43 (July); pp. 40.

Comptes-Rendus des Séances de la Société Royale de Botanique de Belgique: May 3d, 1885; pp. 8.

Journal of Mycology : Vol. I., No. 6 (June, 1885); pp. 12. No. 7 (July); pp. 12.

The Botanical Gazette : Vol. X., No. 6 (June, 1885); pp. 16. No. 7 (July); pp. 15.

Description of *Carcharodon carcharis* : pp. 8. By W. G. Stevenson, M.D.

The Canadian Science Monthly : Vol. III., No. 1 (January, 1885); pp. 16. No. 2 (February); pp. 16. No. 3 (March); pp. 16. Nos. 4 and 5 (April and May); pp. 24.

Anthony's Photographic Bulletin : Vol. XVI., No. 11 (June 13th, 1885); pp. 32. No. 12 (June 27th); pp. 32. No. 13 (July 11th); pp. 32.

The American Monthly Microscopical Journal : Vol. V., No. 6 (June, 1885); pp. 20. No. 7 (July); pp. 20.

The Midland Naturalist : Vol. VIII., No. 90 (June, 1885); pp. 32.

The West-American Scientist : Vol. I., No. 7 (June, 1885); pp. 8.

The Microscopical Bulletin and Science News : Vol. II., No. 3 (June, 1885); pp. 8.

Bulletin de l'Académie d'Hippone : No. 9 (1870); pp. 84. No. 10 (1871); pp. 96. No. 11 (Essai d'un Catalogue Minéralogique Algérien, 1873); pp. 210. No. 12 (1876); pp. 169. No. 14 (1879); pp. 112+34. No. 15 (1880); pp. 449+34. No. 16 (1881); pp. 167+34. No. 17 (1882); pp. 13+107+74. No. 19 (1884); pp. 192+135. Supplément, pp. 28. No. 20 (1884); Fasc. 1, pp. 36; Fasc. 2, pp. 47; Fasc. 3, pp. 41. Status Organiques de l'Académie d'Hippone, 1863; pp. 16.

The School of Mines Quarterly : Vol. VI., No. 4 (May, 1885); pp. 96.

North Staffordshire Naturalist's Field Club. Annual Report, 1884; pp. 140.

The Naturalist in Florida: Vol. I., No. 5 (May, 1885); pp. 6.

The Microscope : Vol. V., No. 6 (June, 1885); pp. 24. No. 7 (July, 1885); pp. 24.

Bulletin of the Torrey Botanical Club : Vol. XII., No. 5 (May, 1885); pp. 12.

The Journal of the Microscopical Society of Victoria : Vol. I., No. 1 (August, 1879); pp. 32. Nos. 2 and 3 (May, 1880); pp. 46. No. 4 (April, 1882); pp. 32. Vol. II., No. 1 (April, 1882); pp. 48.

Proceedings of the Newport Natural History Society, 1883-4; pp. 43. 1884-5; pp. 100.

Proceedings of the Natural Science Association of Staten Island: June 13th, 1885; 1 page.

Journal of the Royal Microscopical Society: Ser. II., Vol. V., Pt. 3. (June, 1885); pp. 196.

Proceedings of the Natural History Society of Glasgow: Vol. IV., Pt. 1. (1878-9); pp. 113+39+35. Pt. 2. (1879-80); pp. 4+331+7. Vol. V., Pt. 1. (1880-1); pp. 4+153. Pt. 3. (1882-3); pp. 71+7. Vol. I., New Ser., Pt. 1. (1883-4); pp. 71+7.

Johns Hopkins University, Baltimore, Md. Studies from the Biological Laboratory: Vol. III., No. 3 (June, 1885); pp. 72. Circulars: Vol. IV, No. 40 (July, 1885); pp. 24.

Königl. böhmischen Gesellschaft der Wissenschaften, Prag. Abhandlungen der mathematisch-naturwissenschaftlichen Classe, VI. Folge, 12. Band (1883-4); pp. 693. Jahresbericht, 2. Juli, 1884; pp. 59. Sitzungsberichte, 1884; pp. 29+144+437.

Monatsblätter des Wissenschaftlichen Club in Wien: Vol. V. (1883-4); pp. 126+72. Vol. VI., Nos. 1-9 (1884-5); pp. 116.

Transactions of the Massachusetts Horticultural Society: 1884; Pt. 2.; pp. 165+2.

Journal of Microscopy and Natural Science: Vol. IV., Pt. 15. (July, 1885); pp. 80.

Festschrift (1883) der 56. Versammlung Deutscher Naturforscher und Ärzte gewidmet von der Naturforschenden Gesellschaft zu Freiburg i. B.; pp. 176.

Berichte über die Verhandlungen der Naturforschenden Gesellschaft zu Freiburg i. B.: Band VIII., Heft I. (1882); pp. 127. Heft II. (1884); pp. 160.

Annual Reports of the Trustees of the Peabody Academy of Science, Salem, Mass.: 1874 to 1884; pp. 137.

Department of the Interior, U. S. Geological Survey, J. W. Powell, Director. Mineral Products of the United States: Calendar years 1882, 1883, and 1884.

Nuovo Giornale Botanico Italiano: Vol. XVII., No. 3 (July 1st, 1885); pp. 128.

INDEX TO ARTICLES OF INTEREST TO MICROSCOPISTS
WHICH HAVE RECENTLY APPEARED IN OTHER
JOURNALS.

- Algae of Fresh Water, Provisional Key to Classification of (II. III.): R. HITCHCOCK.
Am. Mon. Mic. Jour., VI. (1885), pp. 103-14, 129-30.
- Amaranthus caudatus*. See Seeds of Love-lies-bleeding.
- Animal Metamorphosis (Pt. 2): J. B. JEAFFRESON.
Jour. of Mic., IV. (1885), pp. 174-86 (27 figs.).
- Ant, White, Tasmanian. See Parasites, Infusorial.
- Balanoglossus Kowalevskii*, The Later Stages in the Development of, with a Suggestion as to the Affinities of the Enteropneusta: WILLIAM BATESON.
Quar. Jour. Mic. Sci., Supplement, 1885, pp. 81-122 (63 figs.).
- Balanus sulcatus*. See Barnacle.
- Barnacle (*Balanus sulcatus*), Section of Shell of; under heading Graphic Microscopy: E. T. DRAPER.
Sci.-Gossip, 1885, pp. 145-6 (colored plate).
- Blood, The Microscopical Discrimination of: C. M. VORCE.
Am. Mon. Mic. Jour., VI. (1885), pp. 127-9.
- Chara*, The Sexual Reproductive Organs of.
Cole's Studies in Mic. Sci., III. (1885), pp. 17-20 (8 figs.).
- Chironomus prasinus* (Pt. 2.): A. HAMMOND.
Jour. of Mic., IV. (1885), pp. 165-74.
- Cholera Bacillus, The: HORATIO R. BIGELOW.
Science, V. (1885), pp. 454-5 (3 figs.).
- Coal Seams, Carboniferous, On the Structure and Origin of: EDWARD WETHERED.
Jour. Roy. Mic. Soc., V. (1885), pp. 406-20 (31 figs.).
- Cystopus*, or White Rust: GEORGE NORMAN.
Jour. of Mic., IV. (1885), pp. 135-50 (29 figs.).
- Diatom Shell, Structure of the. Siliceous Films too thin to show a broken edge: JACOB D. COX.
Jour. Roy. Mic. Soc., V. (1885), pp. 398-405.
- Diatoms in the Stomachs of Shell-Fish and Crustacea: E. S. COURROUX.
Jour. of Mic., IV. (1885), pp. 196-8.
- Echinoderm Morphology, Notes on, No. IX. On the Vascular System of the Urchins: P. HERBERT CARPENTER.
Quar. Jour. Mic. Sci., Supplement, 1885, pp. 139-55.
- Enteropneusta. See *Balanoglossus Kowalevskii*.
- Fishes, Marine, On the Spawning of certain: PROF. M'INTOSH.
Ann. and Mag. Nat. Hist., XV. (1885), pp. 429-37 (7 figs.).
- Hépatiques, Sur l'origine des spores et des élatères chez les: LECLERC DU SABLON.
Comptes Rendus, C. (1885), pp. 1391-3.

- Hydrozoa, On Some Deep-sea and Shallow-water : JOHN J. QUELCH.
Ann. and Mag. Nat. His., XVI. (1885), pp. 1-20 (10 figs.).
- Infusoria, Some New, from American Fresh Waters : ALFRED C. STOKES.
Ann. and Mag. Nat. His., XV. (1885), pp. 437-49 (17 figs.).
- Infusoria, Fresh-water, Notices of New : ALFRED C. STOKES.
Am. Mon. Mic. Jour., VI. (1885), pp. 121-7 (10 figs.).
- Limulus polyphemus*, On the Embryology of (III.) : A. S. PACKARD.
Am. Nat., XIX. (1885), pp. 722-7 (5 figs.).
- Methods of Work (II.) : ALBERT E. JENKINS.
The Microscope, V. (1885), pp. 126-31.
- Meyenia fluviatilis*. See Sponge, Fresh-Water.
- Microbes, The Cultivation of (Abstract) (HERMANN FOL, *La Nature*).
Science, V (1885), pp. 500-4 (10 figs.).
- Microscope, The, and How to Use it (Pt. III.—On Mounting Microscopic Objects—Continued) : V. A. LATHAM.
Jour. of Mic., IV. (1885), pp. 186-96.
- Microscope, The, in Medicine : C. H. STOWELL.
The Microscope, V. (1885), pp. 121-6.
- Mineral and Rock Sections, Observations on the Preparation of, for the Microscope (Abridged) : JOHN ERNEST ADY.
Eng. Mech., XLI. (1885), pp. 342-3 (2 figs.).
- Mounting Microscopic Objects. See Microscope, The, and How to Use it.
- Mounting Beetles and other Insects without Pressure : ROBERT GILLS.
Jour. of Mic., IV. (1885), pp. 151-4.
- Motella mustela*, L., On some Points in the Development of : GEORGE BROOK.
Jour. Linn. Soc. Lond. (Zool.), XVIII. (1885), pp. 298-307 (14 figs.).
- Myxomycetes, The—Their Collection and Preservation : GEO. A. REX.
Bot. Gazette, X. (1885), pp. 290-3.
- Nemertea, The Circulatory and Nephridial Apparatus of the : A. C. OUDEMANS.
Quar. Jour. Mic. Sci., Supplement (1885), pp. 1-80 (75 figs.).
- Nobert's Ruling Machine : JOHN MAYALL, JR.
Knowledge, VII. (1885), pp. 433, 452-3, 504-5, 523-4.
- Nucleolus, Ueber den : E. ZACHARIAS.
Bot. Zeitung, XLIII. (1885), pp. 258-265.
- Opercularia constricta*, n. sp. : D. S. KELLICOTT.
Am. Mon. Mic. Jour., VI. (1885), p. 121 (1 fig.).
- Oribatidæ, New British : A. D. MICHAEL.
Jour. Roy. Mic. Soc., V. (1885), pp. 385-97 (11 figs.).
- Parasites, Infusorial, Notes on the, of the Tasmanian White Ant : W. SAVILLE KENT.
Ann. and Mag. Nat. His., XV. (1885), pp. 450-3.
- Photomicrography, Theory and Practice of : W. N. MILLER.
Anthony's Photo. Bul., XVI. (1885), pp. 307-14.
- Photomicrography--How to Photograph Microscopic Objects : J. H. JENNINGS (Photographic News).
Anthony's Photo. Bul., XVI. (1885), pp. 343-4.
- Photomicrography by Lamplight : W. H. WALMSLEY.
Photo. Times, XV. (1885), pp. 274-7 and 289.

Polyzoa : E. RAY LANKESTER.

Ency. Brit., 9th Ed., XIX. (1885), pp. 429-41 (25 figs.).

Protoplasts, On the Intercellular Relations of (IV.) (Continued from VII. (1884), p. 126) : WILLIAM HILLHOUSE.

Mid. Nat., VIII. (1885), pp. 145-8.

Protozoa : E. RAY LANKESTER.

Ency. Brit., 9th Ed., XIX. (1885), pp. 830-66 (26 figs.).

Protoplasm : PATRICK GEDDES.

Ency. Brit., 9th Ed., XIX. (1885), pp. 828-30.

Protoplasma chez les végétaux, Sur la canalisation des cellules et la continuité du : L. OLIVIER.

Comptes Rendus, C. (1885), pp. 1168-71.

Rana temporaria, Some Notes on the Early Development of : W. BALDWIN SPENCER.

Quar. Jour. Mic. Soc., Supplement, 1885, pp. 123-37 (25 figs.).

Ramularia, North American Species of : J. B. ELLIS and BENJ. M. EVERHART.

Jour. of Mycology, I. (1885), pp. 73-83.

Rock Sections, Preparation of, for the Microscope. See Mineral and Rock Sections.

Rocks, The Microscopical Study of : JOHN ERNEST ADY.

Ill. Sci. Mon., III. (1885), pp. 163-6.

Seeds of Love-lies-bleeding (*Amaranthus caudatus*) ; under heading Graphic Microscopy : E. T. DRAPER.

Sci.-Gossip (1885), pp. 121-2 (colored plate).

Spirogyra, Notes on the Conjugation of : J. N. ROSE.

Bot. Gazette, X. (1885), pp. 304-6.

Sponge, Fresh-Water, *Meyenia fluviatilis*, On a Variety of the : H. J. CARTER.

Ann. and Mag. Nat. His., XV. (1885), pp. 453-6.

Staining Tissues in Microscopy (HANS GIERKE, *Zeitschr. für Wiss. Mic.*) : Translated by W. H. SEAMAN.

Am. Mon. Mic. Jour., VI. (1885), pp. 106-7, 131-3.

Tea, The Microscopical Examination of.

Am. Mon. Mic. Jour., VI. (1885), pp. 101-2 (2 figs.).

Urchins, On the Vascular System of the. See Echinoderm Morphology.

White Rust. See *Cystopus*.

Wolfia microscopica : F. HEGELMEIER,

Bot. Zeitung, XLIII. (1885), pp. 242-9.

JOURNAL
OF THE
NEW-YORK MICROSCOPICAL SOCIETY.

VOL. I. NOVEMBER, 1885. No. 8.

PROCEEDINGS.

MEETING OF OCTOBER 2D, 1885.

The President, Mr. C. Van Brunt, in the chair.

Thirty-five persons present.

OBJECTS EXHIBITED.

1. *Volvox globator* : by A. D. BALEN.
2. *Hyalotheca* : by W. G. DE WITT.
3. Robber-Fly, showing tracheæ ; bleached in hydrogen peroxide : by EDWARD G. DAY.
4. Arranged Diatoms—*Triceratium*, *Actinocyclus*, *Heliopelta*, etc.; by dark-ground illumination : by C. S. SHULTZ.
5. Diatoms from Lake Geneva—*Odontidium hiemale*, *Diatoma grande*, *Surirella Helvetica* : by E. A. SCHULTZE.
6. Diatoms—a fresh-water fossil deposit ; by reflected light : by C. VAN BRUNT.
7. Seeds of *Orthocarpus purpurascens* : by G. S. WOOLMAN.
8. Silicified Wood from Arizona ; transverse and radial sections : by M. M. LE BRUN.
9. Barbed Awns of Achenia of *Bidens frondosa*, *B. bipinnata*, and *B. chrysanthemoides* : by J. L. ZABRISKIE.
10. Rutile in Ceylonese Moonstone : by GEO. F. KUNZ.
11. So-Called Mummies' Eyes, from Peru : by GEO. F. KUNZ.
12. A Microphotograph : by F. W. DEVOE.

DIATOMS FROM LAKE GENEVA.

Mr. E. A. Schultze : "I collected my specimens of Lake Geneva diatoms at the base of the Castle of Chillon. Diatoms exist there in great abundance and purity, adhering to the rock. The upper part of the lake is rich in these forms, and the species occurring there are different from those inhabiting the waters of the lower part near the city of Geneva. Besides diatoms I

found numerous desmids, among them the *Micrasterias denticulata*; also interesting infusorians, such as *Stephanoceros Eichhornii*.

“The intense blueness of the waters of this lake has attracted much scientific inquiry. Prof. Tyndall attributes it to the presence of mineral particles, probably glacier dust brought into the lake by rivers, and of so extreme minuteness as not to settle even when the water is allowed to stand a long time. Water taken from a depth of twenty-five or more feet I found to be almost cloudy when examined under the microscope, so heavily charged was it with this dust.”

SILICIFIED WOOD FROM ARIZONA.

Mr. M. M. Le Brun: “My specimens of silicified wood exhibit the structure of the wood very perfectly in both transverse and radial section. The lenticular markings characteristic of the Coniferæ are preserved with special distinctness.

“I have brought two photographs of the locality which furnished this material. Of the many petrified tree-trunks shown in them, one is deserving of particular mention on account of its length and its situation. It is not less than one hundred and fifty feet long, and it spans a wide cañon which has been formed since the tree fell.”

Mr. Geo. F. Kunz: “On account of the great beauty and variety of its coloring, this silicified, or agatized wood is beginning to be used in jewelry. It is worthy to take the place of Scotch agate and of blood-stone. With proper facilities for transportation fully one thousand tons of the material would become of commercial value for mosaic-work, table-tops, and other ornamental purposes.”

BARBED AWNS OF ACHENIA OF BIDENS.

The Rev. J. L. Zabriskie: “Whoever brushes against a plant of the genus *Bidens* at its maturity has occasion to notice the facility with which the seeds detach themselves from it and cling to the clothing. Under the microscope each of the awns crowning these achenia is seen to be furnished with, commonly, three ranks of retrorse barbs which differ somewhat in character in the different species. The barbs on the four awns of *B. bipinnata*, or Spanish Needles, are remarkable for length and slenderness and for the acuteness of the angle which they make

to the axis of the awn. The barbs on the several awns of *B. chrysanthemoides*, or the Larger Bur Marigold, are shorter, and their angles less acute, and on one or more of the awns they are ranged in two ranks instead of the usual three.

“It is an interesting fact that, while the barbs are very sharp, the tips of the awns themselves are blunt, being hooded by the bases of two or three barbs. They were obviously not intended for penetration. The character, position, and direction of the barbs fit the achenia for adhesion to the wool and fur of passing animals, and thus secure for the plant a wider dispersion.”

RUTILE IN CEYLONESE MOONSTONE.

Mr. Geo. F. Kunz : “Rutile is a common inclusion in moonstone, and its presence usually lessens the value of the gem.”

SO-CALLED MUMMIES' EYES.

Mr. Geo. F. Kunz : “My specimens of eyes taken from the mummies of Peru were loaned to me for this exhibition by the

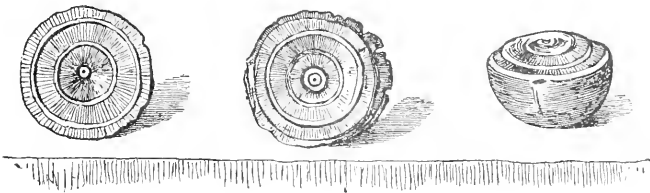

Messrs. Tiffany and Co. They are in fact the crystalline lenses of the eyes of *Loligo gigas*,—the Great Cuttle-fish of the Peruvian coast,—which, divided hemispherically, the embalmer substituted for the perishable and lustreless natural eye in order to give to the faces of the dead a more life-like appearance. These lenses possess a structure like that of the pearl, an aggregation of concentric layers. From lapse of time they have acquired a color varying from a light amber yellow to a rich amber brown. It is the opinion of some persons that a poisonous substance, such as arsenic, was used in the preparation of these lenses. This opinion, I am constrained to say, rests on inadequate grounds.”

The diameters of the specimens exhibited by Mr. Kunz ranged between eight mm. and nineteen mm. The accompanying drawings represent three of the larger ones in their natural size.

Mr. H. B. Chamberlin, secretary of the Denver Microscopical Society, was present at this meeting. Responding to a request of the President, he described briefly and gracefully the membership, the meetings, and the work of his Society. The Society was organized two years ago, and it has now forty-five members.

MEETING OF OCTOBER 16TH, 1885.

The President, Mr. C. Van Brunt, in the chair.

Twenty-seven persons present.

Prof. Alfred M. Mayer, of the Stevens Institute of Technology, was elected an Active Member of the Society.

OBJECTS EXHIBITED.

1. Section of Carboniferous Limestone from Peoria, Ill., containing *Fusulina cylindrica* : by A. WOODWARD.
2. Head of House-Fly, transparent : by F. W. DEVOE.
3. *Pectinatella magnifica* : by A. D. BALEN.
4. Diatoms from Tampa Bay, Florida,—*Eupodiscus*, *Coscinodiscus*, *Triceratium*, *Auliscus*, *Actinoptychus*, *Navicula* : collected by the Officers of the Coast-Survey : by E. A. SCHULTZE.
5. Cross-Fertilizing Apparatus of *Lobelia syphilitica*, L. : by J. L. ZABRISKIE.
6. Meteoric Iron from Gloriëta Mountain, New Mexico : by GEO. F. KUNZ.
7. Seeds of *Alyssum maritimum* : by B. BRAMAN.

FUSULINA CYLINDRICA.

Mr. A. Woodward : "The foraminifer *Fusulina cylindrica* is found in abundance in the carboniferous limestone of Kansas, Nebraska, Missouri, and Illinois. For purposes of examination, the stone may be easily cut into thin sections, or perfect specimens of *Fusulina* may be picked out of it with little difficulty. This form assumes various shapes. Its surface between the septal furrows is generally smooth. The furrows themselves are rough, moderately distinct, and a little curved toward the extremities. The transverse section exhibited under the microscope shows the structure and number of the volutions, which

are closely coiled, the spaces between rarely exceeding twice the thickness of the shell walls. In the adult the septa between the chambers number from thirty to forty in the outer turn of the shell."

PECTINATELLA MAGNIFICA.

Mr. A. D. Balen : "*Pectinatella magnifica* is an interesting object for the microscope when the colony is small. Often the colonies are too large to be placed in any receptacle that can be conveniently put under the instrument, having sometimes a diameter of seven or more inches ; and they are not so easily kept alive as is a small one. To cut off a part is to peril the life of the whole. This species of Polyzoön is always found attached to some support. Its statoblasts are lenticular, and have anchor-shaped hooks radiating from their margin."

CROSS-FERTILIZING APPARATUS OF LOBELIA SYPHILITICA.

The Rev. J. L. Zabriskie : "The flower of *Lobelia* furnishes an interesting example of the possession of ingenious apparatus designed for securing cross-fertilization. In no one, perhaps, of the thirteen species found native in the northern part of the United States, is this contrivance exhibited more plainly than in the species *siphilitica*. The five filaments are separate, but the anthers are united into a capacious tube which is bent to one side and, at the maturity of the stamens, is filled with a mass of loose pollen-grains. The aperture of the tube is bearded on the lower side with white bristles. The stigma is fringed with stiff hairs which, radiating in all directions, occupy the whole diameter of the space inclosed by the anthers. At the first opening of the flower the stigma is found at the inner end of the anther-tube. Then the style, elongating by growth, urges the stigma upward, and pushes the pollen before it to the brush of bristles which, attached, as we have seen, to the lower side of the aperture, appears well adapted to transfer the pollen to the back of an insect passing into the flower.

"Another fact deserves notice. When an insect large enough to press against this apparatus and bend it upward enters the flower, the filaments, flexed by the pressure, retract the anther-tube, while the style, which remains rigid, causes the stigma to act in this case also like the plunger of a force-pump.

“Though the stigma, when the flower is young, is immersed in the pollen-mass, it is unable to appropriate that pollen. For its two lobes are pressed together like a pair of closed lips, giving the appearance of a serpent's head. But as the flower fades, the pistil increases in length, and finally the stigma projects through the aperture of the anther-tube, and then the lips open widely, exposing the stigmatic surface to be acted on by the pollen brought from another flower.

“The specimen exhibited is a longitudinal section through the anther-tube, showing the inclosed pollen-mass, the bearded aperture, and the stigma, with its collar of bristles, at the inner end of the tube. There is exhibited also the anther-tube of a mature flower, with the stigma protruding and widely opened.

“This subject was clearly explained and illustrated in “The American Naturalist” for 1879, by Prof. J. E. Todd, and also, in another article, by Prof. William Trelease.”

WHITE ROSIN AS A MOUNTING MEDIUM.

Mr. William Wales : “Some time ago it occurred to me that white rosin might prove a good medium for mounting microscopic objects. It is easily soluble in alcohol, it melts readily, it cools quickly, and it is more transparent than balsam. I have found it a better material than balsam for cementing lenses, and I deem this a good test. At my desire, Mr. Henry L. Brevoort has given it a trial as a mounting medium. He has just communicated to me the result in writing.”

Mr. Wales then read Mr. Brevoort's communication. Its main points are here given, in substance. ‘The results of my experiments in mounting with white rosin are very satisfactory. My method is the following : On the centre of a clean glass slide laid on the heating table, I put a small piece of rosin of the purest quality. Heat is gently applied until the rosin becomes as liquid as it can be made without burning it. To remove air-bubbles, with a pointed glass rod I add to the liquefied rosin, and stir in with it, a half-drop of turpentine. A moment or two after the object to be mounted has been placed in the medium and the cover-glass has been dropped upon it, the slide must be removed from the hot table and a spring clip applied. In five minutes the mount will be ready for finishing and labelling. I have studied such objects as hairs and fur-fibres for three or four

years, and I find rosin preferable to balsam as a medium for mounting them.'

ILLUMINATION BY AID OF AIR-BUBBLES.

'For very delicate structures, such as fur-fibres,' continues Mr. Brevoort, 'I often purposely permit air-bubbles in the mounting material, or introduce them into it. The chances are that some of the fibres will pass through some of the air-bubbles, and when they do this in the proper position, the fibres will be found to be illuminated by the reflection of light from the upper part of the concave surface of the bubble, and the surface of the fibres may be studied with a $\frac{1}{4}$ -inch immersion lens as readily as with a 1-inch. This method of illuminating I find of great service with the highest powers. I have used it with balsam and glycerine. With the latter it works exceedingly well. The air-bubbles may best be introduced by means of a stylographic pen-filler.'

PUBLICATIONS RECEIVED.

Proceedings of the American Academy of Arts and Sciences: New Ser., Vol. XII., Whole Ser., Vol. XX. (May, 1884, to May, 1885); pp. 558.

Transactions of the Connecticut Academy of Arts and Sciences: Vol. VI., Pt. 2 (1885); pp. 517.

The Microscope: Vol. V., No. 8 (August, 1885); pp. 24. No. 9 (September); pp. 24. No. 10 (October); pp. 24.

The American Monthly Microscopical Journal: Vol. VI., No. 8 (August, 1885); pp. 20. No. 9 (September); pp. 20. No. 10 (October); pp. 20.

The Botanical Gazette: Vol. X., No. 8 (August, 1885); pp. 16. Nos. 9 and 10 (September and October); pp. 46.

The Journal of Mycology: Vol. I., No. 8 (August, 1885); pp. 12. No. 9 (September); pp. 12. No. 10 (October); pp. 12.

The West-American Scientist: Vol. I., No. 8 (July and August, 1885); pp. 8. No. 9 (September); pp. 8.

Brooklyn Entomological Society. Entomologica Americana: Vol. I., No. 5 (August, 1885); pp. 20. No. 6 (September); pp. 20. No. 7 (October); pp. 20.

The Natural History Society of Montreal, Canada. The Canadian Record of Science: Vol. I., No. 3 (1885); pp. 64.

The Journal of the Cincinnati Society of Natural History: Vol. VIII., No. 2 (July, 1885); pp. 84. No. 3 (October); pp. 56.

Proceedings of the Canadian Institute, Toronto: Third Ser., Vol. III., Fascic. No. 2 (July, 1885); pp. 6+101.

Drugs and Medicines of North America: Vol. I., No. 6 (June, 1885); pp. 31.

The Canadian Science Monthly : Vol. III., No. 6 (June, 1885) ; pp. 16. No. 7 (July, 1885) ; pp. 16.

Anthony's Photographic Bulletin : Vol. XVI., No. 14 (July 25th, 1885) ; pp. 32. No. 15 (August 8th) ; pp. 32. No. 16 (August 22d) ; pp. 32. No. 17 (September 12th) ; pp. 32. No. 18 (September 26th) ; pp. 32. No. 19 (October 10th) ; pp. 32. No. 20 (October 24th) ; pp. 32.

The Midland Naturalist : Vol. VIII., No. 91 (July, 1885) ; pp. 32. No. 92 (August) ; pp. 32. No. 94 (October) ; pp. 28.

Bulletin of the Torrey Botanical Club : Vol. XII., No. 6 (June, 1885) ; pp. 12. No. 7 (July) ; pp. 12. No. 8 (August) ; pp. 16.

Les Météorites Tombées en Belgique et les Météorites en Général (1885) ; pp. 39. By W. Prinz.

The Electrician and Electrical Engineer : Vol. IV., No. 44 (August, 1885) ; pp. 40. No. 45 (September, 1885) ; pp. 40.

National Druggist : Vol. VII., No. 4 (July 24th, 1885) ; pp. 10. No. 5 (July 31st) ; pp. 12. No. 6 (August 7th) ; pp. 12. No. 7 (August 14th) ; pp. 12. No. 8 (August 21st) ; pp. 12. No. 9 (August 28th) ; pp. 12. No. 10 (September 4th) ; pp. 10. No. 11 (September 11th) ; pp. 16. No. 12 (September 18th) ; pp. 10. No. 13 (September 25th) ; pp. 14. No. 14 (October 2d) ; pp. 14. No. 15 (October 9th) ; pp. 14. No. 16 (October 16th) ; pp. 12. No. 17 (October 23d) ; pp. 12.

Cambridge Entomological Club. Psyche : Vol. IV., Nos. 129-31 (January-March, 1885) ; pp. 30.

Bulletin de la Société Royale de Botanique de Belgique : Tome Vingt-Quatrième (1885) ; pp. 232.

Bulletin of the Washburn Laboratory of Natural History : Vol. I., No. 1 (September, 1884) ; pp. 28. No. 2 (January, 1885) ; pp. 56. No. 3 (March and April, 1885) ; pp. 28.

"Trichina Spiralis and Trichinosis;" pp. 46 By Thomas B. Redding, A. M.

Johns Hopkins University, Baltimore, Md. Circulars : Vol. IV., No. 41 (July, 1885) ; pp. 16. No. 42 (September) ; pp. 10. Studies from the Biological Laboratory : Vol. III., No. 4 (September) ; pp. 24.

A Revision of the North American Species of the Genus Scleria ; pp. 10. By N. L. Britton, Ph. D.

Bulletin of the Minnesota Academy of Natural Sciences : Vol. II., No. 5 (June, 1885) ; pp. 81.

Journal of the Royal Microscopical Society : Ser. II., Vol. V., Pt. 4 (August, 1885) ; pp. 176.

Proceedings of the Philosophical Society of West Chester, Pennsylvania : 1881-85 ; pp. 20.

The Naturalist's World : Vol. II., No. 21 (September, 1885) ; pp. 20. No. 22 (October) ; pp. 20.

Bulletin de la Société Impériale des Naturalistes de Moscou : 1884 ; pp. 217.

Transactions of the Massachusetts Horticultural Society : 1885, Pt. I. ; pp. 219.

Bulletin de l'Académie d'Hippone : No. 20 (1884) ; Fasc. 4, pp. 46.

Penzance Natural History and Antiquarian Society. Report and Transactions : 1884-85 ; pp. 110.

Monatsblätter des Wissenschaftlichen Club in Wien : Vol. VI., No. 10 (July 15th, 1885) ; pp. 12. No 11 (August 15th) ; pp. 8. No. 12 (September 15th) ; pp. 14. Ausserordentliche Beilage : No. 6 ; pp. 10. No. 7 ; pp. 13.

Bulletin de la Société d' Études Scientifiques d' Angers : Fourth Year (1884) ; pp. 420.

The Microscopical Bulletin and Science News : Vol. II., No. 4 (August, 1885) ; pp. 8. No. 5 (October) ; pp. 8.

INDEX TO ARTICLES OF INTEREST TO MICROSCOPISTS
WHICH HAVE RECENTLY APPEARED IN OTHER
JOURNALS.

Algæ of Fresh Water, Provisional Key to Classification of (IV.) : R. HITCHCOCK.

Am. Mon. Mic. Jour., VI. (1885), pp. 170-4.

Ambulacra, On the Anatomy of the, of the Recent Diadematidæ.

Jour. Linn. Soc. London (Zool.), XIX. pp. 95-114 (11 figs.).

Amaba," Critical Notes on Dr. Augustus Gruber's "Contribution to the Knowledge of the : Surg Maj WALLICH.

Ann. and Mag. Nat. His., XVI. (1885), pp. 215-27.

Amaba, The Pseudocyclosis in : G. C. WALLICH.

Am. Mon. Mic. Jour., VI. (1885). pp. 190-3.

Animals, The Coverings of (To be continued) : W. B. KESTEVEN.

Ill. Sci. Mon., III. (1885), pp. 202-7 (4 figs.).

Antennæ of the Honey-Bee, Notes on the : T. J. BRIANT.

Jour. Linn. Soc. London, (Zool.), XIX. (1885), pp. 84-8 (6 figs.).

Antheridia, The Structure of, in *Polytrichum*.

Cole's Studies in Mic. Sci., III. (1885), pp. 25-8 (10 figs.).

Archegonium, Structure of, in *Marchantia*.

Cole's Studies in Mic. Sci., III. (1885), pp. 21-4 (8 figs.).

Aulophorus vagus, On the Anatomy and Histology of : JACOB REIGHARD.

Proc. Am. Acad. Arts and Sci., XX. (1885), pp. 88-106 (31 figs.).

Avicularian Mandible, On the use of the, in the determination of the Chilostomatous Bryozoa : ARTHUR WM. WATERS.

Jour. Roy. Mic. Soc., V. (1885). pp. 774-9 (44 figs.)

Bacillus (*B. alvei*), a new, The Pathogenic History and History under Cultivation of, the Cause of a Disease of the Hive Bee hitherto known as Foul Brood : FRANK R. CHESHIRE and W. WATSON CHEYNE.

Jour. Roy. Mic. Soc., V. (1885), pp. 581-601 (15 figs.).

Bacillus, Curved or "Comma," Experiments on Feeding some Insects with the, and also with another Bacillus (*B. subtilis*?) : R. L. MADDOX.

Jour. Roy. Mic. Soc., V. (1885), pp. 602-7.

Bacteria and the Cell Theory.

The Lancet, II. (1885), pp. 348-50.

Blood Corpuscles, Measurement of: MARSHALL D. EWELL (*Chicago Legal News*).

Am. Mon. Mic. Jour., VI. (1885), pp. 150-1.

Campanula Americana, L., The Process of Fertilization in: CHARLES R. BARNES. (*A. A. A. Science*.)

Bot. Gazette, X. (1885), pp. 349-54 (16 figs.).

Coptis trifolia, The Microscopic Structure of: LOUISA REED STOWELL.

The Microscope, V. (1885), pp. 169-76 (11 figs.).

Crystals, Rosanoff's, in the Endosperm-Cells of *Manihot Glaziovii*, Müll. Arg.: SPENCER LE M. MOORE.

Jour. Linn. Soc. London (Bot.), XXI. (1885), pp. 621-4 (8 figs.).

Cyclas cornea, Lam (*Sphaerium cornutum*, L.), Die Entwicklung von: H. E. ZIEGLER.

Zeitschr. für Wiss. Zool., XLI. (1885), pp. 525-69 (38 figs.).

Diadematidæ. See Ambulacra.

Diatoms of the Gulf: J. D. COX.

Am. Mon. Mic. Jour., VI. (1885), pp. 145-7.

Embryonic Tissues, A Means of Differentiating: C. O. WHITMAN.

Am. Nat., XIX. (1885), pp. 1134-7.

Eye, An Imperfection of the, and Test Objects for the Microscope: LUCIEN HOWE.

The Microscope, V. (1885), pp. 226-8.

Fish Eggs, Pelagic, On the Development of some: ALEXANDER AGASSIZ and C. O. WHITMAN.

Proc. Am. Acad. Arts and Sci., XX. (1885), pp. 23-75 (6 figs.).

Floscularia, On Four New Species of the Genus, and Five other New Species of Rotifera: C. T. HUDSON.

Jour. Roy. Mic. Soc., V. (1885), pp. 698-14 (9 figs.).

Foraminifera, Group of; under heading Graphic Microscopy: E. T. DRAPER.

Sci.-Gossip, 1885, pp. 193-4 (colored plate).

Glass, On Erosion of the Surface of, when exposed to the Joint Action of Carbonate of Lime and Colloids: WILLIAM M. ORD.

Jour. Roy. Mic. Soc., V. (1885), pp. 761-8.

Glaosporium, The North American Species of: J. B. ELLIS and B. M. EVERHART.

Jour. of Mycology, I. (1885), pp. 109-19.

Grylotalpa, Die Embryologie der: A. KOROTNEFF.

Zeitschr. für Wiss. Zool., XLI. (1885), pp. 570-604 (85 figs.).

Gymnosporangium and *Chrysomya* of the United States, Notes on some Species of: W. G. FARLOW.

Proc. Am. Acad. Arts and Sci., XX. (1885) pp. 311-323.

Human Lungs, Nerves in the, Some observations on the Distribution and Termination of: EDWIN F. BECKWITH.

The Microscope, V. (1885), pp. 145-52 (3 figs.).

Histological Methods, Some : C. S. MINOT.

Am. Nat., XIX. (1885), pp. 828-30. (1 fig.), pp. 916-17 (1 fig.).

Infusoria, Fresh-water, Notices of New (IV.) : ALFRED C. STOKES.

Am. Mon. Mic. Jour., VI. (1885), pp. 183-90 (14 figs.).

Iris des Menschen und der Wirbelthiere, Untersuchungen über den Bau der : J. KOGANEI.

Archiv. für Mik. Anat., XXV. (1885), pp. 1-48 (6 figs.).

Laticiferous Vessels, On the Occurrence of Articulated, in *Hevea* : D. H. SCOTT.

Jour. Linn. Soc. London (Bot.), XXI (1885), pp. 566-73.

Leech, The External Morphology of the : C. O. WHITMAN.

Proc. Am. Acad. Arts and Sci., XX. (1885), pp. 76-87 (5 figs.).

Macrotoma plumbea, Ueber. Beiträge zur Anatomie der Poduriden : A. SOMMER.

Zeitschr. für Wiss. Zool., XLI., (1885), pp. 683-718 (42 figs.).

Marchantia polymorpha. See Archegonium.

Microbe, On a Septic, from a high altitude ; the Niesen *Bacillus* : G. F. DOWDESWELL.

Jour. Roy. Mic. Soc., V. (1885), pp. 769-73.

Micrometers, Standard, Prof. Rogers' Ruling Machine and Method of Ruling : MARSHALL D. EWELL.

The Microscope, V. (1885), pp. 221-6.

Microscope, The, and How to Use it (Pt. IV.—Practical Histology) : V. A. LATHAM.

Jour. of Mic., IV (1885), pp. 231-45.

Micro-Fungi, New British : G. MASSEE.

Jour. Roy. Mic. Soc., V. (1885), pp. 757-60 (19 figs.).

Muds, Marine, Cleaning : GEO. H. TAYLOR.

Am. Mon. Mic. Jour., VI. (1885), pp. 147-9.

Objective and its Focal Length, A Practical Method of finding the Optical Centre of an : W. F. DURAND.

Am. Mon. Mic. Jour., VI. (1885), pp. 141-5.

Pennatulida. Microscopic Sections and the Mode of Automatic Section-Cutting and Mounting : W. P. MARSHALL.

Mid. Nat., VIII. (1885), pp. 191-3.

Phanicurus, On : M. H. de LACAZE-DUTHIERS (Translated from 'Comptes Rendus').

Ann. and Mag. Nat. His., XVI. (1885), pp. 157-62.

Photomicrographs, How to Make (To be continued) : W. H. WALMSLEY.

The Microscope, V. (1885), pp. 217-21.

Photomicrography, The Actinic and Visual Focus in, with High Powers : JACOB D. COX.

Am. Mon. Mic. Jour., IV. (1885), pp. 193-5.

Photomicrography, Optical Arrangements for, and Remarks on Magnification : ROMYN HITCHCOCK.

Am. Mon. Mic. Jour., VI. (1885), pp. 168-70.

Polytrichum commune. See Antheridia.

Pond-Life (II) : WILLIAM EVANS HOYLE.

Jour. of Mic., IV. (1885), pp. 245-51.

Prothallia of Ferns, The Development of the : DOUGLAS H. CAMPBELL.

Bot. Gazette, X. (1885), pp. 355-60 (10 figs.).

Protoplasm, Observations on the Continuity of : SPENCER LE M. MOORE.

Jour. Linn. Soc. London (Bot.), XXI. (1885), pp. 595-621 (62 figs.).

Rocks, The Microscopical Study of : JOHN ERNEST ADY.

Ill. Sci. Mon., III. (1885), pp. 198-202, 227-9 (1 fig.), 259-62 (1 fig.).

Rotifera See *Floscularia*.

Samenkörper, Beiträge zur Entwicklungsgeschichte der : GUSTAV VON WEDERSPERG.

Archiv für Anat. Mik., XXV. (1885), pp. 113-36 (38 figs.)

Scolopendrium vulgare, Sorus of.

Cole's Studies in Mic. Sci., III. (1885), pp. 29-32 (colored plate).

Selaginella, Cone of.

Cole's Studies in Mic. Sci., III. (1885), pp. 33-6 (colored plate).

Self-Fertilization, On the Contrivances for ensuring, in some Tropical Orchids :

HENRY O. FORBES.

Jour. Linn. Soc. London (Bot.), XXI. (1885), pp. 538-50 (14 figs.).

Sphaerium cornutum, L. See *Cyclus cornea*, Lam.

Sponge, Freshwater, *Meyenia fluviatilis*, auctt., from Florida, On a Variety of the : H. J. CARTER.

Ann. and Mag. Nat. His., XVI. (1885), pp. 179-81.

Staining Tissues in Microscopy (HANS GIERKE, *Zeitschr. für Wiss. Mic.*) :

Translated by W. H. SEAMAN.

Am Mon. Mic Jour. VI (1885), pp. 152-6.

Star-Fish, Small Brittle ; under heading Graphic Microscopy : E. T. DRAPER.,

Sci-Gossip, 1885, pp. 169-70 (colored plate)

Tooth of Ant-Eater, Transparent Section of ; under heading Graphic Microscopy : E. T. DRAPER

Sci-Gossip, 1885, pp. 217-18 (colored plate).

Urtica dioica, L., les organes végétatifs de l', Recherches anatomiques sur :

A. GRAVIS.

Mem. Acad. Roy. Belg., XLVII. (1884), pp. 1-256 (23 pls.).

Vaccination anticholérique, La : H. DE VARIGNY.

Revue Scientif., XXXV. (1885), pp. 783-7

Vorticella limnetis (species nova) : ALFRED C. STOKES.

The Microscope, V. (1885), pp. 145-6 (1 fig.).

Zoogloecae, Observations on Several, and Related Forms : WILLIAM TRELEASE.

Studies Biol. Lab., Johns Hopkins Univ., III. (1885), pp. 193-216 (17 figs.).

MISCELLANEA.

MICROSCOPE, MICROSCOPIC, MICROSCOPICAL.—The practice of even the most scholarly microscopists is not quite uniform in the employment of the words microscope (used adjectively), microscopic, and microscopical. Is it not desirable to make an effort to bring about uniformity? The usage which best commends itself to us is in accord with the following directions:—

1. Apply “microscope” (the adjective) to the component or essential parts of the microscope. *E. g.*: microscope stand, microscope stage, microscope objective.

2. Restrict “microscopic” to objects or features too minute to be seen or appreciated by the naked eye.

3. Reserve “microscopical” for uses to which the term “microscopic,” as above restricted, would be inappropriate. *E. g.*: Microscopical Society; microscopical accessories; microscopical science, works, observations, researches, themes, purposes, uses; microscopical examination.

As an epithet to the word “examination,” microscopical is certainly preferable to microscopic, since the idea intended to be conveyed is of an action performed with the aid of the microscope, rather than of one too minute to be visible to the naked eye.

Among professional men an organized society of microscopists is now generally, if not universally, denominated a Microscopical Society. “Microscopic Society” is sometimes heard, and, unfortunately, it sometimes gets into print. Its use ought to be actively discountenanced.

MECHANICAL SELF-DIVISION OF STENTOR.—A *Stentor* was recently observed by the writer to divide itself into two nearly equal parts by what appeared to be a mechanical process. By a vibrating gyratory movement¹ frequently repeated for two hours, the anterior part was, as it were, twisted off the posterior. The oral segment migrated to the border of the cage, and retained its vitality eight hours. The other segment developed a new oral spiral at its torn extremity, and became at the end of about ten hours a complete individual.

¹Like the motion of the balance-wheel of a watch

CHALCEDONY PARK, the name given to the area of one thousand or more acres in which occur the jasperized or agatized trees of which mention was made in the meeting of October 2d, is situated a few miles from Corriza, a station on the Atlantic and Pacific Railroad. The trunks are partly buried in beds of lava and sandstone, and large wheel-like fragments lie scattered about. The substitution of siliceous fibre for woody fibre must have been effected through the agency of siliceous waters.

Under a good microscope—a binocular is best—a piece of coniferous wood, illumined from above, will often be semitransparent to a depth of the aggregate thickness of three or four plates of cells. It thus, with its several ranks of lenticular markings, becomes a more beautiful object than when, in thin section, it is viewed by transmitted light. We have had opportunity to examine the silicified wood from Chalcedony Park only as an opaque object. Some of the specimens exhibited with great distinctness the structure just described, but of a beauty far more striking, owing to the crystalline character of the material and the exceeding richness of the coloring.

COCAINE HYDROCHLORATE FOR MOUNTING ANIMALCULA.—The action of the reagents in general use for killing animalcula for mounting disturbs the natural appearance and position of such delicate structures as the tentacles of Hydroids and Bryozoa. Prof. J. Richard has successfully employed in these cases the anæsthetic power of cocaine hydrochlorate. Several of the animalcules are placed in a watch-glass with five cubic centimetres of water. When they are fully expanded a $\frac{1}{2}$ per cent. solution of cocaine hydrochlorate is added drop by drop until it forms a fifth part of the entire fluid. Half a cubic centimetre of the anæsthetic is then added, and the animals become completely fixed. Ten minutes afterward they are quite dead, and can be mounted in the ordinary way.—See *Jour. Roy. Mic. Soc.*, 1885, p. 893.

PROFESSIONAL MICROSCOPY.—So long as mind is associated with matter, uses its energies, or is obstructed by its limitations, will the knowledge of the laws of physical life interest man nearly, and aid him to his goal. Indeed, biological investigation is, if we mistake not, the most absorbing of present purely scientific pursuits. The nature of the force called life may con-

tinue an enigma; its law of work, however, may yet become fully known, and this fulness of knowledge may better incalculably man's estate.

But biology owes its existence to the microscope, and to that instrument must it look for its progress and its triumphs. And what, in its present state, is this instrument, with its immediate accessories, and all its various kinds of subsidiary apparatus? and what the scope and quality of intelligence, of knowledge, of training of eye and hand, embraced in its mastery? To this question, the story, however simply told, of the work performed by Dr. Koch in his studies of bacterial life, or by Drs. Dallinger and Drysdale in their researches on the origin and life-histories of the "least and lowest of living things," would be a grand and sufficient reply.

There is, then, a science of microscopy. Its mastery is peculiarly difficult, requiring rare sagacity and dexterity, and a lifetime of devotion, and its study has become a profession. This fact is not known to all, it having grown too fast for any but a watchful eye to keep pace with it. "There is no science of microscopy—the microscope is only an instrument," was said in our hearing a few days ago. A gun is but an instrument; yet is there not a science of gunnery? and its acquisition is an indispensable part of the professional soldier's education. The importance of a special and systematic course of instruction in microscopy is gaining recognition in some of our best institutions of learning.

MICROMETRY AND BLOOD-CORPUSCLES.—No microscope is complete unless equipped with ample and accurate means of micrometric measurement, and no man who does not fully understand the use of those means is entitled to be called a professional microscopist. He who possesses this accomplishment has facilities for adding valuable material to the stock of human knowledge. The careful measurements made by Dr. Ewell, of Chicago, of the diameters of human blood-corpuscles may yet prove of inestimable service in some cases of medical and criminal jurisprudence. Where the issue of life and death is involved, Dr. Ewell declares it reckless, if not criminal, to express an opinion upon a measurement of fewer than one hundred corpuscles.

THE CLEVELAND CONVENTION.—The sessions of the American Society of Microscopists at its Eighth Annual Meeting were fruitful of instruction, stimulus, and delight. The Addresses, the Papers, the illustrations of work and of methods at the Working Session, and the Soirée, at which fully fifteen hundred persons viewed the fine selection of objects on exhibition under more than one hundred and fifty microscopes, must have made upon even the casual observer an ineffaceable impression of the precision with which scientific research is now conducted. The excellence of the Report of its Proceedings, great as it will be found to be, will be incompetent to work out in the mind of one not present at the Convention the more subtle and enduring education which would have sprung from attendance in person.

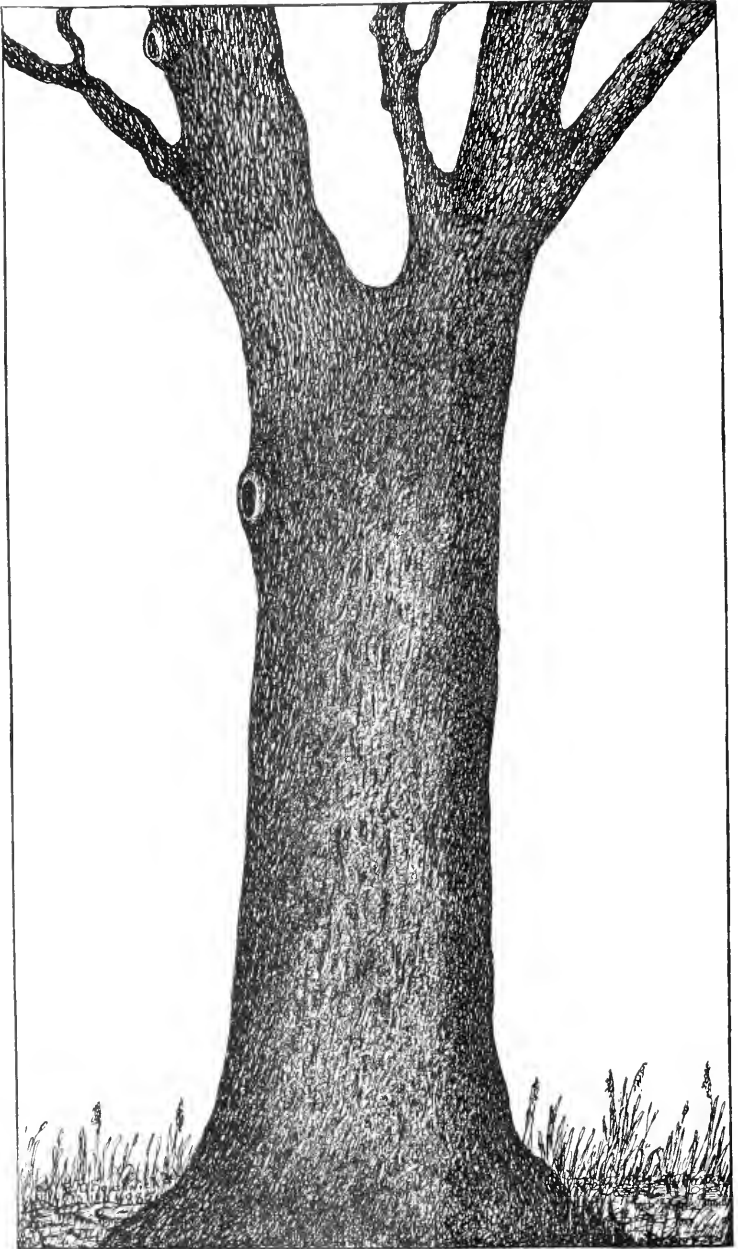

PROTOCOCCUS VIRIDIS IN SITU ON ELM.

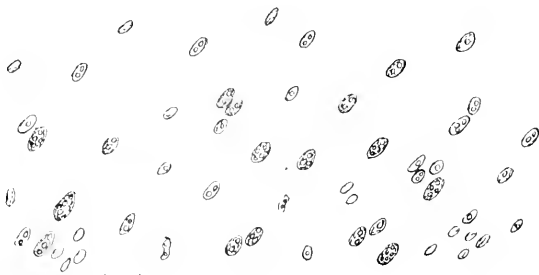

Motile Form as first seen $\times 500$.



Motile Form after six days $\times 500$.

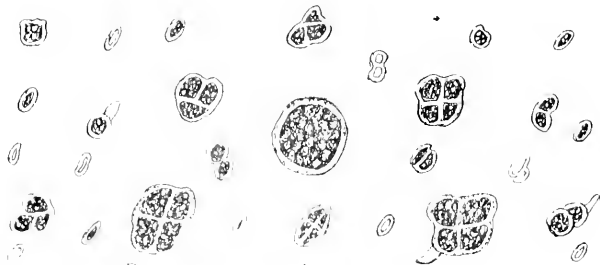

Protococcus viridis $\times 500$.



JOURNAL

OF THE

New-York

Microscopical Society.

Vol. II.



NEW-YORK :
PUBLISHED FOR THE SOCIETY.

JOURNAL
OF THE
NEW-YORK MICROSCOPICAL SOCIETY.

VOL. II. JANUARY, 1886. No. 1.

PROTOCOCCUS VIRIDIS.

BY E. B. SOUTHWICK.

(Read Dec. 18th, 1885.)

The microscopic plant to which your attention is called this evening is classed among the Protophyta, the sub-kingdom containing certain imperfectly known genera which are in all probability but degraded forms of Algæ, such as the families *Rivulariæ*, *Oscillariæ*, *Nostochinæ*, *Palmelleæ*, and *Volvocinæ*.

They are gelatinous organisms found on damp stones, trunks of trees, and the earth, in fresh water either cold or thermal, rarely in the sea, and are composed either of globules or of simple or branched filaments continuous or chambered, and nearly always enveloped in mucilage.

Protococcus, the genus under consideration this evening, includes various unicellular *Palmellaceæ*. They increase by division into two or four parts, which separate, but are connected by a semi-gelatinous layer. Sometimes its cells give rise to four ciliated zoöspores of two sizes, the larger of which settle down and develop a cellulose coat, while of the farther development of the smaller, nothing is known. The famous Red Snow of the *Arctic* regions and the *Alps*, which is also found on stones in fresh-water streams, belongs to this *genus*, and is known as *Protococcus nivalis*.

Protococcus viridis grows on the trunks of trees, on stones, on patches of mortar, and apparently in most places sufficiently moist and shaded to induce its growth.

As observed in Central Park, New York city, it is chiefly on the northern and the northwestern exposures, being most abundant on many trees near the ground. On those favorable for the retention of moisture and sufficiently shaded, the *Protococcus* is

apparently as luxuriant fifteen feet above, as at the base. Different species of trees seem to be more or less favorable to its growth, and often the shade of a limb protects it from the rays of the sun and the beating rain. On the European Beech (*Fagus sylvatica*) it is abundant at the base of the tree only; at the height of two feet, little is found. The bark, being of a hard, close texture, does not favor its growth. On the Red Maple (*Acer rubrum*) it does not seem to be abundant. The bark, although rather soft, is not hygroscopic, and therefore does not favor its development. On the American Elm (*Ulmus Americana*) the growth is most luxuriant, extending to a great height, the soft spongy bark being favorable to it. On the Scotch Pine (*Pinus sylvestris*) the growth is apparently very feeble, and under the microscope the cells were seen to be scarce and in small detached clusters of from four to six. The outside of this bark is of a corky nature and apparently not hygroscopic. The color is very dark, with patches of a whitish substance, which under the microscope was found to be covered with a minute lichen thallus of extreme delicacy and beauty, having a concave surface and finely fringed edges; with this growth but few *Protococci* were found, the thallus of this minute lichen contesting with them the right of occupancy. On the Norway Spruce (*Abies excelsa*) the growth seems to be most luxuriant on the branches and upper portions of the tree, the lower part of the trunk being too dry.

In many specimens examined the gelatinous substance seemed to be of sufficient consistency to hold the smaller particles of quartz and foreign matter; in many cases the uplifting mass of growth was seen to carry upon it a great number of these particles. On the Tulip Tree (*Liriodendron tulipifera*) the growth was the most luxuriant of any examined and the foreign matter was less abundant, probably because the rapid growth standing out in large projecting clusters had covered it. On the Catalpa (*Catalpa bignonioides*) the plant had apparently been vigorous, yet when examined under the microscope it was found to be of a dark green, and not of that bright yellow green so characteristic of vigorous growth.

On the European Larch (*Larix Europæa*), the growth was not vigorous on the trunk, while on the branches and upper portions

of the stem it appeared stronger, showing that on the bark of the younger wood it found a more congenial habitat. Under the microscope the masses were quite flat, and among them were observed quantities of a white, granular matter. On the Hibiscus (*Hibiscus Syriacus*) the growth was of the finest character, and hyphæ were observed in a budding process, having from two to six branching cells; below the hyphæ were the large masses of *Protococcus* cells which had been produced by fission, mostly in twos and fours, standing out in projecting clusters. In this specimen and in many others examined, several brownish buds, probably of another species of *Protococcus*, were found, showing growth by gemmation as well as by fission, and with abundant hyphæ.

On the White Birch (*Betula alba*) the growth is chiefly confined to those broken portions of the bark which present a rough surface for the retention of moisture and the collecting of foreign matter. Under the microscope the growth was seen to be scanty, yet the hyphæ-bearing cells were abundant. On the Hemlock (*Tsuga Canadensis*) it was very abundant and of a bright yellow green, and the gelatinous mass was so strong that when placed under the cover glass of a slide in water they were with difficulty separated. On the Deciduous Cypress (*Taxodium distichum*) the plant was more vigorous than on any other coniferous tree, the soft spongy bark being well adapted for its growth. On the west side of the Park walls, along Fifth and Eighth avenues, the growth is so abundant that the coping and three tiers of Nova Scotia sand-stone have a bright green color. The next tier, of North River blue-stone, has very little upon it, and on the basal course of Gneiss none is apparent, yet on the mortar it is abundant. On the Terrace north of the Mall, the Nova Scotia sand-stone on the northern and the western exposures is covered with a rich growth, and no doubt this is one of the causes of the disintegration of the stone. The *Protococcus* holding moisture, and the expansion by freezing breaking down the small particles of stone. On the south side of the transverse road the growth is abundant, while on the north side but little is seen.

In treating the trees in the Central and other Parks of New York with polysolve, a preparation used for the destruction of

insects, the *Protococcus* was apparently killed. But during the month of August, about a week after the trees had been cleaned, a rain-storm set in, which lasted nearly three days. The growth on the trees that had been cleaned was apparently as vigorous as on those that had not, giving the impression that the polysolve had either not killed the *Protococcus*, or that a new growth had rapidly been formed from the germs in the air.

The following is a list of 100 trees which are prominently affected with *Protococcus viridis* in Central Park.

Magnolia glauca, Linn.

acuminata, Linn.

cordata, Michx.

macrophylla, Michx.

Umbrella, Lam.

conspicua, Salisb.

On the Magnolias the growth is only near the ground and not abundant.

Liriodendron tulipifera, Linn.—Luxuriant, and of a bright yellow green color.

Tilia Americana, Linn.

Europæa, Linn.

heterophylla, Vent.

alba, Waldst and Kit.

Not abundant, and chiefly at the base.

Ptelea trifoliata, Linn.—Abundant and luxuriant.

Ilex Dahoon, Walter.

opaca, Ait.

Not abundant, and near the base.

Euonymus atropurpureus, Jacq.

Europæus, Linn.

Abundant on both trunk and branches.

Rhamnus catharticus, Linn.—Little if any was observed upon this tree; the bark does not seem to be a suitable habitat.

Esculus Hippocastanum, Linn,

flava, Ait.

Californica, Nutt.

Neither abundant nor vigorous.

Acer Pennsylvanicum, Linn.

spicatum, Lam.

circinatum, Pursh.

saccharinum, Wang.

dasycarpum, Ehrht.

rubrum, Linn.

plantanoides, Linn.

pseudo-platanus, Linn.

On *Acer rubrum* and *Acer dasycarpum* the growth does not seem to be as vigorous as on the remaining species.

Negundo aceroides, Mœnch.—Abundant and vigorous.

Robinia Pseudacacia, Linn.

viscosa, Vent.

Quite abundant, but apparently not vigorous.

Gymnocladus Canadensis, Lam.—Very little was observed on this tree.

Gleditschia triacanthos, Linn.—Not abundant, and in small detached masses.

Cercis Canadensis, Linn.—A very small quantity at the base only.

Prunus serotina, Ehrht.—Abundant at the base only, the bark apparently too hard for its growth.

Pyrus Americana, D. C.—Abundant and vigorous.

Cratægus Crus-galli, Linn.

coccinea, Linn.

Oxyacantha, Linn.

tomentosa, Linn.

Growth not abundant, and weak.

Amelanchier Canadensis, Torr. and Gray.—Abundant and vigorous.

Hamelis Virginica, Linn.—Very little was found on this tree.

Cornus Florida, Linn.—This tree does not seem adapted to its vigorous growth, as very little was found, and then at the base only.

Nyssa sylvatica, Marshall.—Not abundant, and only near the base.

Diospyros Virginiana, Linn.—Not abundant, and at the base of the tree only.

Halesia tetraptera, Linn.—Growth very abundant and vigorous at the base; where the trees were leaning, the growth extended well up on the trunk.

Fraxinus Americana, Linn.

pubescens, Lam.

viridis, Michx. f.

excelsior, Linn.

On the ashes the *Protococcus* finds a suitable habitat, as it is abundant and vigorous.

Catalpa bignonioides, Walt.—Abundant.

Paulownia imperialis, Sieb.—Abundant near the base.

Sassafras officinale, Nees.—Not abundant nor vigorous.

Ulmus Americana, Nutt.

fulva, Michx.

racemosa, Thos.

campestris, Linn.

Montana, Bauh.

Growth vigorous and in great abundance.

Celtis occidentalis, Linn.—Very little found.

Morus rubra, Linn.

alba, Linn.

Very little found.

Maclura aurantiaca, Nutt.—Not abundant.

Platanus occidentalis, Linn.

orientalis, Linn.

On patches of the bark from which the outer portion had fallen off last year.

Juglans nigra, Linn.

cinerea, Linn.

On these the growth is neither abundant nor vigorous, and on many none could be found.

Carya alba, Nutt.

porcina, Nutt.

amara, Nutt.

In a group of several of these trees the *Protococcus* was found on *C. porcina* only, and on that but sparingly.

Quercus alba, Linn.

macrocarpa, Michx.

bicolor, Willd.

Prinus, Linn.
obtusifolia, Michx.
rubra, Linn.
coccinea, Wang.
tinctoria, Willd.
palustris, Du Roi,
cerris, Linn.
pedunculata, Willd.
sessiliflora, Sal.

On the White Oaks the growth was apparently not as vigorous as on the Black and the Red Oaks, and on none of them was it abundant or vigorous.

Castanea vesca, Gærten.

Americana, A. De Cond.

Not abundant nor vigorous.

Ostrya Virginica, Willd.—Very little was found on this tree, and that near the base.

Betula papyrifera, Marsh.

alba, Linn,

alba, var. *populifolia*, Spach.

The growth was confined to the broken patches of bark, or to places where the outside had been taken off.

Betula lutea, Michx. f.

nigra, Linn.

lenta, Linn.

Not abundant nor vigorous.

Alnus serrulata, Willd.

incana, Willd.

glutinosa, Gærten.

Very little was observed on these trees, and at the base only.

Salix alba, Linn.

Babylonica.

Very little, and at the base only.

Populus grandidentata, Michx.

monilifera, Ait.

balsamifera, Linn.

Not abundant.

Thuja occidentalis, Linn.—Abundant near the base of the tree.

Juniperus Virginiana, Linn.—None was observed on this tree.

Taxodium distichum, Richard.—Abundant and luxuriant, chiefly at the base of the tree.

Sequoia gigantea, Decaisne.—None observed on this tree.

Pinus strobus, Linn.

sylvestris, Linn.

Very little was found on *P. sylvestris*, but on *P. strobus* the growth at the base of the tree was quite abundant; on scars where the limbs had been severed, the pitch that had exuded was being gradually grown over with *Protococcus*.

Pinus mughus, Jacq.—The trunk and branches of this small pine were completely covered with a vigorous growth.

NOTES ON PROTOCOCCUS VIRIDIS.

BY P. H. DUDLEY.

(Read December 18th, 1885.)

We have just heard the little plant under consideration classed among the lowest orders of vegetation. Huxley goes further, and says, "*Protococcus* and *Torula* (yeast plant) are the representatives of the two great contrasting types of the beginning of plant life." Though each is of but simple cell structure, their physiological functions are directly opposite. The first builds up from simple to complex protein compounds; the latter reduces complex compounds to simple ones, obtaining its protein matters from higher organisms.

Protococcus in sunlight decomposes carbon di-oxide, utilizes the carbon in its structure, and sets part of the oxygen free, as do the higher plants. *Torula*, on the other hand, absorbs oxygen and throws off carbon di-oxide. *Protococcus viridis* is filled with chloro-plastids, their absence in *Torula* enables us to distinguish between them at a glance.

All the complex plants have cells of the same physiological features as either *Protococcus* or *Torula*, which fact divides them into two groups, first, those like the *Protococcus*, which give the beautiful verdure to the landscape, while the fungi represent the latter.

As humble as our plant may seem from its classification, modern science is still unable to solve its mysteries; it is one of the great manufacturing chemists, among plants, converting crude materials into combinations which, upon decay, may be taken up by higher vegetation. Spread out upon trees and rocks, its gelatinous substance is ready to catch and imbed the floating dust and inorganic matter brought to it by the wind, some of which will be converted and used. The air also brings great carboys of carbon di-oxide and exchanges them for oxygen. Fumes of sulphuric, sulphurous, nitric and nitrous acids, and also ammonia come to be combined; the rain brings chlorides and other chemicals to be utilized. Each of the individual

cells of the *P. viridis*, only measuring from two to ten micro-millimetres in diameter, can do more in its small laboratory than our chemists with all the room and appointments that science has suggested—it builds its own cellulose walls from inorganic matter. Chemists are hardly agreed upon the composition of cellulose and the protein compounds, and, if they were, they could not introduce the life principle to produce them. In looking at the cells under a microscope we must be content with little more than an exterior view, only dimly seeing, through the translucent walls, the wonders within. With the best objectives skilful opticians have placed in our hands, which I would say in passing are among the triumphs of science and art, we cannot find the door of this wonderful laboratory to enter and see, much less to understand, the contents of the crucibles, retorts, the stock of reagents and minerals used. We cannot see the prisms and lenses which divide the rays of light to act upon the chlorophyll, inducing chemical affinity, so as to produce compounds of starch, sugar, or cellulose, as the case may be. No exhibit will be given of the mechanism transforming light into electricity, polarizing the atoms, or arranging them into different forms according to the number present. We can only wonder whether the salts of potassium, calcium, magnesium and sodium are of first importance in the compounds produced, or are bullion for the mints of the higher plants. Calling to our aid the various chemical reagents, we are almost equally baffled.

Placing under the microscope *Protococcus*, on stone, or on a piece of bark, with a power of fifty, we see budded club-shaped masses, standing out in relief, with some imbedded sand and a few branches of hyphæ. If we remove some to a glass slide, add a drop of water, and gently tap the cover glass to separate some of the buds, and then view with a power of 200, cells of various sizes are seen, some round, others subdividing into twos, threes, fours, &c. The subdivisions into twos or fours are not as elliptical as those shown of *P. vulgaris* and *P. pluvialis*, but with rounder ends, as shown by Kützing. The cellulose wall is plainly seen enclosing the greenish protoplasm, with a few darker spots of green. Some of the cellulose sacs will be seen to be empty and clear. By increasing the power to 500, the greenish spots become larger, but generally indistinct, though this is not the case

in all slides. Specimens from different trees show different details. Our specimens were collected in November and December to date, which must be considered.

In all probability the full cycle of development of *P. viridis* in its habitat, cannot be determined without observations extending through the different months of a year, at least. Mr. Southwick reports some trees as covered quickly during storms, after he had cleaned them. Whether his solutions failed to destroy all the germs, or they were supplied from other sources, is being investigated. November 23d a heavy N. E. storm began in this vicinity, $1\frac{18}{100}$ inches of water fell in 24 hours, about $\frac{1}{40}$ of the usual yearly rain fall. On the 24th the rain-fall was $\frac{16}{100}$ of an inch. On the 23d the mean temperature was 35° , max. 38° , miles traveled by the wind, 324. The next day the mean temperature was 38.3° , max. 39° , miles traveled by the wind, 379, according to Dr. Draper's meteorological records in Central Park. On some trees the *P. viridis* seemed to be brighter, more on the north-west side, than before the storm; but no new patches were found, therefore fresh isolated growths did not occur during this storm, and trees which had been just cleaned were exempt, and on the deciduous trees, the water coursing down the bark had removed it, leaving either side green.

In *P. vulgaris* and *P. pluvialis*, resting and motile forms are shown, besides those of subdivision; in *P. viridis* we looked through a great number of specimens for the motile forms, and only found them in specimens collected during the last two or three days. I had examined many which were dry when frozen, and found only a few, but on taking some from a brick which was hygroscopic, the plant being wet when frozen, I found an abundance of motile forms.

The cellulose sac, which surrounds the protoplasm, was burst, and the latter escaped, assuming an oblong or elliptical form, but not with one end double pointed as figured in *P. vulgaris* and *P. pluvialis*. The statement that these motile forms have two long cilia, so far has not been verified by our investigations. The chloro-plastids seen in the motile forms are round, some having two, and others four or five, giving the appearance of nuclei. Freezing several times does not destroy the motile form, the delicate sac being flexible and elastic. On the shady side of

rocks, stone, brickwork and mortar which are porous or hygroscopic, the *Protococcus* grows in greater or less abundance, and in walking through the cross-streets of the city, one cannot fail to notice it on the basement steps and railings on the south side of the street, in contrast to its absence on the north. By helping to retain moisture, great aid is given to the disintegration of the rocks and stone work, especially by the dissolving power and then the freezing of the absorbed water. Under some of the flakes which came off from the obelisk, I found an abundance of one and two cells of the genus *Protococcus*, the germs of which must have passed through the small exterior cracks and crevices with the rain water: these had only two divisions instead of four as found in *P. viridis*. Several other cells and spores were found, some of which had been probably imported. If the cells of *Protococcus* formed and subdivided under the flakes, then the growth of chloro-plastids took place in translucent light. They were light yellow green, which became blue green upon wetting, and exposure to sunlight. On the duramen of soft woods, after sufficient exposure to soften the fibres, forming lint, *P. viridis* will grow readily. Its appearance on white cedar trees is usually the first evidence of their softening. The effect of reagents upon the cells is very interesting: concentrated ammonia swells them out nicely for examination—many of the specimens here are mounted in that medium. Caustic potash is more severe, and changes the green color. Alcohol contracts the protoplasmic contents. Hydrochloric acid changes the green cells to more of a yellow, and shows the cellulose wall plainly. Iodine solution colors them brown, showing the chloro-plastids, and the contents in the hypha. The indications of starch grains are too much obscured by the iodine to be traced, without special treatment. Sulphuric acid added to iodine, colors the cell walls blue in most cases, showing that it is cellulose. In fresh growing specimens the surrounding gelatinous matter will be colored blue, showing that it is at first cellulose, but later undergoes mucilaginous transformation so as to be no longer recognized as cellulose. I have here some alcoholic extracts of the chlorophyll; cold alcohol does not extract the color quickly, and must be boiled for two or three minutes—add benzine to the product, gently shaking it, let it stand a moment—the benzine has dissolved the dark blue green

and rises to the top of the alcohol extract, which is now of a light yellow green color.

Krauss calls the former xanthophyll, and the latter kyanophyll, and held with others that the two represent chlorophyll, and both are components of the same green substance.

According to the investigations of Pringsheim and Weisner it appears that the kyanophyll of Krauss, is relatively pure chlorophyll, but the xanthophyll of Krauss consists of yellow modifications of chlorophyll whose relations to crude chlorophyll are not fully established. They considered that xanthophyll is a mixture of three yellows, namely, etiolin, xanthophyll and anthoxanthin. Etiolin is the coloring matter which is formed by etiolated growths breathing in the darkness.

A NEW HIGH-REFRACTIVE MOUNTING MEDIUM.

BY PROF. H. L. SMITH.

(Read Dec. 18th, 1885.)

Since the publication of the formula for a new mounting medium composed of stannous chloride and glycerine jelly,¹ I have made what appears to be a very great improvement, by substituting bromide of antimony for the stannous chloride, and boro-glyceride for the glycerine jelly. The boro-glyceride has been prepared for me by Mr. C. F. Booth (Tarrant & Co., Manufacturing Chemists, N. Y. City), and was first brought to my notice by this gentleman. I use a 50 *per cent.* solution of this, and it appears, so far, to answer admirably as a substitute for the gelatine, and it possesses the advantage of making a much more solid mount. Antimony bromide is somewhat more expensive than stannous chloride, but it works very kindly in making mounts; the compound can be readily made by any one, and as only a moderate heat is required it can be made in the bottle in which the medium is to be kept. As the moisture of the air will affect this medium, it will be better to prepare it, or at least to keep it, in glass-stoppered bottles. Rubber corks, or indeed the ordinary corks, do not appear to be much affected by it, still a suitable glass-stoppered bottle is to be preferred.

¹American Monthly Microscopical Journal, Vol. VI., No. 9, Sept., 1885.

When it is properly prepared, and care is used not to over-heat, the medium will be of a deep amber color, and will make mounts which are almost absolutely colorless. The refractive power is considerably more than can be obtained with the stannous chloride medium. As the boro-glyceride alone becomes hard upon heating and evaporating the excess of gelatine, we can, if for some objects a medium of lower refractive index is desired, make the compound to have whatever refractive power may be necessary up to fully 1.8, or, it may be, more. The specimen which I send herewith for inspection by the Society, was made in the stock bottle without any attempt at the purification or filtering of the solution. The medium is used in the same manner as balsam, and, if properly made, will have the consistency of thick balsam; a small dip is taken out on a glass rod and applied to a warmed slide, and on this the cover is placed, the diatoms having been previously dried and burned upon it. The whole is now heated and boiled, as in making a balsam mount. The boiling is prolonged somewhat more perhaps than in making a balsam mount, but the medium works very kindly, and the cover will settle down and the bubbles all disappear on cooling; if not, the heat can be again applied and the few remaining bubbles coaxed out, and now, if the boiling has been sufficiently prolonged, the cover will be found as securely fixed when the slide is quite cold, as it would have been if Canada balsam treated in the same way had been used. As the material remains soft with comparatively little heat, the slide must be entirely cooled before proceeding to clean off the excess of the medium, if there be any. As the medium is quite soluble in water (which, however, turns it white), the excess can be easily and quickly removed by using a little roll of moistened tissue paper; and without any fear of disturbing the mount, the slide and all around the cover must be wiped quite dry, and, to insure this, perhaps a slight reheating will be best. If, however, reheating is indulged in, the slide must be allowed to cool before applying the finishing ring.

I have been using a cement made of gold size and litharge, which dries rapidly, and appears to make an excellent, tough, and hard finishing ring. I prefer, however, the wax ring, punched out from the ordinary sheet wax as prepared for artificial

flowers. One of these rings can be picked up from the flat table, by placing the slide upon it with the cover of the mount down, so as to insure the cover being central with the ring, and using very slight pressure, for otherwise the wax would adhere to the table. When the ring has been picked up in the right position, the heat of a small flame is cautiously applied under the slide, until the ring softens, and settles down first on one side, and then, following round under the ring cautiously, until the wax is just melted, but not so as to run, which would spoil the symmetry and beauty of it; if an air bubble is entangled, it may be touched while the wax is still melted, with a hot pin point, or point of forceps warmed. As soon as the ring has been all melted the slide can be put on the table, to let the wax harden, and as soon as the slide is thoroughly cooled, the wax ring and cover can be rubbed vigorously, and the ring polished. These rings will bear any amount of rubbing, and do not need any subsequent applications of varnish, though there would be no objection to the use of them, either for ornament or for a still more efficient protection of the mount. I have recently made some mounts, sealing them in another manner, which appears to answer well; rings are punched out of paper about the thickness of the cover, and with a central opening of the same size as the cover. After making the mount and cleaning it, one of these rings is placed on the slide, having the cover just coming through the opening, flush with the surface. Then a bit of paraffine is placed on one side and melted; of course, it flows in and under and saturates the ring, and runs in between the inner margin of the ring and the cover; the whole is now cooled, and rubbed vigorously, thus removing the excess of the paraffine. These mounts appear to keep well.

Formula—2 fluid-drams boro-glyceride, 50 *per cent.* solution, 1 $\frac{1}{3}$ oz. antimony bromide.

Warm the boro-glyceride solution, and add the antimony bromide in small portions, heating until all is thoroughly dissolved; the heat must be applied carefully to avoid browning, but must be sufficient to dissolve thoroughly the bromide; on cooling, the mixture will be nearly solid, and will measure somewhat more than one fluid-ounce. In conclusion, I may say, that while the boro-glyceride appears to answer so admirably for

antimony bromide, I do not find it quite equal to the gelatine for stannous chloride. It will not permit so much to be dissolved, and does not act as kindly. As the result of all my experiments, I am disposed to give the preference to the antimony and boro-glyceride.

To make a handsome mount, it is quite important that all excess of the medium outside the cover should be removed, as the antimony will discolor more or less the wax ring, or any cement now known to me.

PROCEEDINGS.

MEETING OF DECEMBER 4TH, 1885.

The President, Mr. C. Van Brunt, in the chair.

Thirty-five persons present.

OBJECTS EXHIBITED.

1. Diamond-Beetle : by M. H. EISNER.
2. Silicified Coniferous Wood from Arizona : by C. S. SHULTZ.
3. Transverse section of the peduncle of *Nymphaea odorata*, showing intercellular hairs : by BENJAMIN BRAMAN.
4. Section of injected human brain : by WM. G. DE WITT.
5. Silicified wood from the Yellowstone National Park : by WM. G. DE WITT.
6. *Mesocarpus* in conjugation ; mounted by A. C. Cole, of London : by A. D. BALEN.
7. Fibrous Malachite from the Copper Queen Mine, Arizona : by M. M. LE BRUN.
8. Silicified wood from Arizona, showing the mycelium of a Fungus : by M. M. LE BRUN.
9. Silicified wood from Arizona : by L. SCHÖNEY, M. D.
10. Pollen of *Strelitzia Regine*, mounted in glycerine : by N. L. BRITTON.
11. Section of "Tiger's Eye" from Arizona : by C. S. SHULTZ.

ELECTRICAL ILLUMINATION FOR THE MICROSCOPE.

Mr. E. A. Schultze remarked on his recent experiments on the production and use of the incandescent electric light. He

had tried many forms of batteries for the production of the current, but had found them all unsatisfactory, as the best of them required cleansing, and renewal of chemicals, after running for about three hours. He then attempted the use of a small steam engine fed by illuminating gas, to drive a dynamo. He abandoned this method after ascertaining that no engine of moderate size would give sufficient rapidity to the generator, and that the vibrations imparted to the floors precluded the use of high-power lenses: it was objectionable for other reasons also. He then procured a small gas engine, which was placed in an adjoining room. This gave sufficient rotary velocity to the dynamo to produce a light of between two and three candle-power, and was eminently successful. The engine required no attention, and the noise was barely perceptible. The light is attached to the microscope-stand by a double ball and socket joint, and can thus be placed in any position. It possesses great resolving power, and the advantages of direct illumination over reflected light from the mirror are very pronounced. Mr. Schultze preferred the Swan lamp over all others, there being no projecting point on top, due to closing the bulb after exhaustion.

Mr. De Witt suggested the advantage of using the electric light in the study of minute organisms with the apparatus employed by Messrs. Drysdale and Dallinger, and described in Kent's *Infusoria*, plate LI. They were obliged to tilt the microscope to a horizontal position to obtain the required illumination; this difficulty would be avoided by the use of the Swan lamp.

An agent of the Gibson Storage Battery Co. exhibited a battery of two storage cells, producing a light of one candle-power, which would run continuously for two and three-quarters hours. The cells might be charged from the arc-light or incandescence lamp currents, or from gravity or other cells.

POLLEN OF STRELITZIA.

Referring to the slide exhibited, Dr. N. L. Britton described the pollen as nearly globular and very large. It is mentioned in Edgeworth's "Pollen", p. 17, where its size is given as $\frac{5}{1000}$ of an inch, which is about 100 μ . The grains are filled with granular protoplasm, readily seen with a two-inch objective. Their color is white.

MEETING OF DECEMBER 18TH, 1885.

The President, Mr. C. Van Brunt, in the chair.

Thirty-one persons present.

OBJECTS EXHIBITED.

1. *Protococcus viridis* from Central Park, N. Y., and its vicinity : by E. B. SOUTHWICK and P. H. DUDLEY.
2. *Eozoon Canadense* from Petite Nation, Canada: by A. WOODWARD.
3. Silicified Wood from Fredericksburg, Va.: by A. WOODWARD.
4. Surface of *Amphibius imperialis*, a beetle, from South America : by M. H. EISNER.
5. Embryo of Chick, after 48 hours' incubation ; mounted by Prof. H. L. Smith : by F. H. LEGGETT.

PROFESSOR H. L. SMITH'S NEW HIGH-REFRACTIVE MOUNTING MEDIUM.

President Van Brunt : " Prof. H. L. Smith has devoted much time to this subject, and the number of substances he has examined is very great. He has given the formulæ of many compounds of a high refractive index—a sulphur compound—an arsenical compound—stannous-chloride and glycerine. Also stannous-chloride and glycerine gelatine, and others, the most of which have not stood the test of time.

" How far this new compound will answer the purpose time only can determine, although the probabilities of permanence are in its favor.

" The stannous-chloride and glycerine compound is permanent unless too much of the salt has been dissolved in the glycerine. In such a case it is apt to crystallise on the slide after mounting. If too little is used in an effort to mount forms in a medium of lower refractive index, the material is too fluid, and the forms move. The addition of gelatine is objectionable for several reasons.

" This new medium, is entirely different from the others in having a new material, boro-glyceride, for the base. This is in its glacial condition and quite hard. Prof. Smith uses it with one-half pure glycerine ; that he calls a 50 *per cent.* solution. Mr. Booth states that it is simply a solution of 92 parts of glyceride and 62 parts of boracic acid, nearly

an-hydrous, mixed at a temperature of 300° F., and that it is not a chemical combination but a mechanical mixture, and is readily separated into its original materials.

“This medium is unchangeable when protected from the air, but when exposed to it, rapidly absorbs moisture. It is a solid at ordinary temperatures, is an antiseptic, dissolves readily in absolute alcohol, and would seem to be a far better medium than glycerine gelatine for mounting, without the addition of bromide of antimony; and I think that Mr. Booth should be thanked for suggesting so valuable an addition to the list of mounting mediums.

“Antimony bromide, which is rather an uncommon salt, gives the high refractive index to this base. This salt is readily decomposed. Water is not a solvent, but separates the antimony, precipitating it in the form of a white powder.

“This salt is soluble in the 50 *per cent.* solution of boro-glyceride and in the proportions given. It does not crystallize on the slide after mounting, but when more of the salt is used it forms a most beautiful polariscope object. These crystals do not form immediately, and, if found on a slide, they can be made to disappear by a slight heat.

“But with this base and this salt a compound can be made of any refractive index, from that of the boro-glyceride to that of the solution given by Prof. Smith, which he states upon the bottle to be 1.8. Each of these solutions becomes hard upon cooling.

“Prof. Smith has used this medium for several months, and there is no reason why it should not be as permanent as the stannous-chloride in glycerine.”

THE LATE DR. WM. B. CARPENTER.

The Committee appointed to draft resolutions relative to the death of Dr. William B. Carpenter, reported the following:—

To the New-York Microscopical Society:

Your committee respectfully submit, for your adoption, the following expression of sentiment in view of the death of Dr. William B. Carpenter:—

1. The New-York Microscopical Society feel that through this sad event the microscope has lost one of its greatest masters,

and microscopical science one of its brightest ornaments. For sagaciousness in the interpretation of the disclosures of this instrument, and for conversance with the whole vast field of its explorations, they look upon Dr. Carpenter as without a superior, and almost without a peer.

2. The members of this Society gratefully acknowledge their individual indebtedness to Dr. Carpenter for the guidance, stimulus, and instruction furnished by his great work, "The Microscope and its Revelations." They revere, besides, his genial personal qualities, which, while he was their guest one evening in the fall of 1882, bound him to them in the bonds of a delightful and enduring remembrance.

New York, Dec. 18th, 1885.

B. BRAMAN,
J. L. ZABRISKIE,
JNO. L. WALL,
Committee.

PUBLICATIONS RECEIVED.

Monatsblätter des Wissenschaftlichen Club in Wien : Vol. VII., No 2 (November 15th, 1885); pp. 10.

Brooklyn Entomological Society. Entomologica Americana : Vol. I., No. 9 (December, 1885); pp. 20.

National Druggist : Vol. VII., No. 23 (December 4th, 1885); pp. 12. No. 24 (December 11th); pp. 14. No. 25 (December 18th); pp. 14. No. 26 (December 25th); pp. 10.

The Electrician and Electrical Engineer : Vol. IV., No. 48 (December, 1885); pp. 40.

Tidings from Nature : Vol. II., No. 3 (December, 1885); pp. 16.

Anthony's Photographic Bulletin : Vol. XVI., No. 23 (December 12th, 1885); pp. 32. No. 24 (December 26th); pp. 32.

American Monthly Microscopical Journal : Vol. VI., No. 12 (December, 1885); pp. 20.

The Hoosier Naturalist : Vol. I., No. 5 (December, 1885); pp. 15.

Bulletin de la Société Belge de Microscopie : Vol. XII., No. 1 (October 26th, 1885); pp. 27.

The Physicians' Visiting List for 1886. P. Blakiston, Son & Co., Philadelphia.

The Microscope : Vol. V., No. 12 (December, 1885); pp. 20.

Museum of Comparative Zoölogy at Harvard College. Twenty-fifth Annual Report of the Curator : 1884-85; pp. 36.

Journal of Mycology : Vol. I., No. 12 (December, 1885); pp. 20.

The West-American Scientist : Vol. I., No. 11 (November, 1885); pp. 6.

The Botanical Gazette : Vol. X., No. 12 (December, 1885); pp. 36.

Journal of the Royal Microscopical Society : Ser. II., Vol. V., Pt. 6 (December, 1885); pp. 191.

The Midland Naturalist : Vol. VIII., No. 69 (December, 1885); pp. 22.

The Microscopical Bulletin and Science News : Vol. II., No. 6 (December, 1885); pp. 8.

Comptes-Rendus des Seances de la Société Royale de Botanique de Belgique : November 14th, 1885; pp. 23.

Journal and Proceedings of the Royal Society of New South Wales, for 1884 : Vol. XVIII., pp. 224.

Bulletin de l'Académie d' Hippone : No. 21 (1885), Fasc. 1, pp. 80.

Bulletin of the Torrey Botanical Club : Vol. XII., No. 11 (November, 1885); pp. 12.

INDEX TO ARTICLES OF INTEREST TO MICROSCOPISTS
WHICH HAVE RECENTLY APPEARED IN OTHER
JOURNALS.

- Algæ, Kansas, Second Contribution to the Knowledge of : FRANCIS WOLLE.
Bull. Washburn College Lab. Nat. Hist., I. (1885), pp. 62-4.
- Amplifying Power of a Lens or Lens System, Remarks on Prof. Abbe's Note
on the Proper Definition of the : E. GILTAY.
Jour. Roy. Mic. Soc., V. (1885), pp. 960-7.
- Bacillus, Further Experiments on Feeding Insects with the Curved or
"Comma" : R. L. MADDOX.
Jour. Roy. Mic. Soc., V. (1885), pp. 941-52.
- Bacillus, On the Cholera "Comma" : G. F. DOWDESWELL.
Jour. Roy. Mic. Soc., V. (1885), pp. 953-8.
- Bacterienforschung, Einige Kritische Bemerkungen zu Dr. Hueppe's Buch :
E. CHR. HANSEN.
Zeitschr. für Wiss. Mik., II. (1885), pp. 355-8.
- Binocular Prisms, Improved form of Stephenson's : C. D. AHRENS.
Jour. Roy. Mic. Soc., V. (1885), p. 959 (2 figs.).
- Callionymus lyra*, L., On the Ova of : PROF. M'INTOSH.
Ann. and Mag. Nat. Hist., XVI. (1885), pp. 480-2 (4 figs.).
- Ceratium hirundinella* (O. F. Müller), Note on, its Variability and Mode of Re-
production : HENRY BLANC.
Ann. and Mag. Nat. Hist., XVI. (1885), pp. 444-53 (9 figs.).
- Coniferen*, Die Markstrahlen der : A. KLEEBURG.
Bot. Zeit., XLIII. (1885), pp. 674-729 (7 figs.).
- Condensor, Reichert's : I. MÖLLER.
Zeitschr. für Wiss. Mik., II. (1885), pp. 339-40.
- Crystals in the Endosperm-Cells of *Manihot Glaziovii*, Müll., Arg., On Rosa-
noff's : SPENCER LE MARCHANT MOORE.
Jour. Linn. Soc. London (Bot.), XXI. (1885), pp. 621-4 (8 figs.).
- Deckglasskitt, Ueber den besten : L. HEIDENREICH.
Zeitschr. für Wiss. Mik., II. (1885), pp. 333-8.
- Desmids, On Some New and Rare : W. BARWELL TURNER.
Jour. Roy. Mic. Soc., V. (1885), pp. 933-40 (27 figs.).
- Diatomaceen-Material, Das Reinigen und Präpariren von : E. DEBES.
Zeitschr. für Wiss. Mik., II. (1885) pp. 411-19.
- Disease of Strawberry Leaves, The Spot (*Ramularia Tulasnei*, Sacc.) : WM.
TRELEASE.
2d Ann. Rep. (1885), *Wis. Agric. Exper. Station*, pp. 47-58.
- Doppelfärbung mit Hämatoxyloxyon, Notiz zu Watney's : M. FLESCH.
Zeitschr. für Wiss. Mik., II. (1885), p. 353.

- Doppelfärbung mit Indigo und Carmin, zur Anwendung der Merkel'schen : M. FLESCH.
Zeitschr. für Wiss. Mik., II. (1885), pp. 349-52.
- Eggs of Parasite of Vulture : E. T. DRAPER.
Sci.-Gossip, 1885, p. 265 (colored plate).
- Fishes, The Pelagic Stages of Young : A. AGASSIZ and C. O. WHITMAN.
Mem. Mus. Compar. Zoöl., XIV. (1885), pp. 1-56 (149 figs.).
- Fistulipora*, M'Coy, On the Genus : H. ALLEYNE NICHOLSON.
Ann. and Mag. Nat. His., XVI. (1885), pp. 496-517 (39 figs.).
- Fungi, Kansas Parasitic, A Partial List of the : W. A. KELLERMAN.
Bull. Washburn College Lab. Nat. Hist., I. (1885), pp. 72-81.
- Fungi, Lower, of Kansas, A Contribution to the Knowledge of the : F. W. CRAGIN.
Bull. Washburn College Lab. Nat. Hist., I. (1885), pp. 67-72.
- Gastrosteus spinachia*, On the Nest and Development of : EDWARD E. PRINCE.
Ann. and Mag. Nat. His., XVI. (1885), pp. 487-96 (6 figs.).
- Intercellurgänge, Ueber die Auskleidung der : H. SCHENCK.
Ber. Deutsch. Bot. Gesellsch., III. (1885), pp. 217-25 (7 figs.).
- Jungermanniæ*, Observations of the Oil Bodies of the : JOHN RATTRAY.
Trans. and Proc. Bot. Soc., Edinburgh, XVI. (1885), pp. 123-8.
- Keimung, Beiträge zur Morphologie und Biologie der : GEORG KLEBS.
Untersuch. Botan. Inst. Tübingen, I. (1885), pp. 536-635 (24 figs.).
- Lactiferous Vessels in *Hevea*, On the Occurrence of : DUKINFELD H. SCOTT.
Jour. Linn. Soc. (Bot.), XXI. (1885), pp. 560-6 (4 figs.).
- Microscopical Advances—Ancient and Modern,—II. : G. W. ROYSTON-PIGOTT.
Eng. Mech., XLII. (1885), pp. 291-2.
- Mikrometerschraube, Ueber die Leistungsfähigkeit der : J. OST.
Zeitschr. für Wiss. Mik., II. (1885), pp. 295-300.
- Mikroskopischen Technik, Mittheilungen zur : A. BRASS.
Zeitschr. für Wiss. Mik., II. (1885), pp. 300-8 (3 figs.).
- Mikroskopie, Beiträge zur pharmakognostischen : E. VINASSA.
Zeitschr. für Wiss. Mik., II. (1885), pp. 309-25 (4 figs.).
- Mosses of the Genus *Fissidens*, Notes on the European and North American Species of : WILLIAM MITTEN.
Jour. Linn. Soc. London (Bot.), XXI. (1885), pp. 550-60.
- Objecttisch, C. Reichert's neuer beweglichen : E. FLEISCHL.
Zeitschr. für Wiss. Mik., II. (1885), pp. 289-95 (2 figs.).
- Objecthalter mit Kugelgelenk : I. H. LIST.
Zeitschr. für Wiss. Mik., II. (1885), pp. 341-2 (2 figs.).
- Pear Blight and its Cause : J. C. ARTHUR.
Am. Nat., XIX. (1885), pp. 1177-85.
- Pinus sylvestris*, Observations sur les canaux à résine du : DR. BAUDISAGE.
Bull. Trimestriel Soc. Bot. de Lyon, 188 , pp. 37-8.
- Podophyllum Emodi*, On the Germination of : ALEX. DICKSON.
Trans. and Proc. Bot. Soc. Edinburgh, XVI. (1885), pp. 129-30 (1 fig.).
- Proteinkörper in den Zweigen von *Epiphyllum*, Ueber merkwürdig geformte : HANS MOLISCH.
Ber. Deutsch. Bot. Gesellsch., III. (1885), pp. 195-202 (6 figs.).

Protoplasmic Continuity in the *Fucales* : THOMAS HICK.

Jour. Bot., XXIII. (1885), pp. 354-7.

Puccinia Malvaccarum, Ueber das Verschwinden gewisser Insecten infolge der Einwanderung der : F. LUDWIG.

Hedwigia, XXIV. (1885), pp. 219-20.

Protoplasm, Observations on the Continuity of : SPENCER LE MARCHANT MOORE.

Jour. Linn. Soc. London (Bot.), XXI. (1885), pp. 595-620 (62 figs.).

Resolution in the Microscope, On the Limits of : FRANK CRISP.

Jour. Roy. Mic. Soc., V. (1885), pp. 968-73.

Rhizopods of North America," Critical Observations on Prof. Leidy's "Fresh-water, and Classification of the Rhizopods in general: Surg.-Maj. WALLICH.

Ann. and Mag. Nat. His., XVI. (1885), pp. 453-73.

Rocks of Nova Scotia and Cape Breton, Notes of a Polariscopic and Microscopic Examination of Crystalline : D. HONEYMAN.

Proc. and Trans. Nova Scotian Inst. Nat. Sci., VI. (1883-4), pp. 121-130.

Ruscus androgynus, On the Occurrence of Foliage Leaves in, with Some Structural and Morphological Observations : ALEX. DICKSON.

Trans. and Proc. Bot. Soc. Edinburgh, XVI. (1885), pp. 130-47 (9 figs.).

Saprolegnia ferax, Notes on the Inoculation of Fishes with. (Extracted from 22d, 23d and 24th Annual Reports of the Inspector of Fisheries of England and Wales.)

Jour. Bot., XXIII. (1885), pp. 302-8

Siebröhren in der unverletzten Pflanze. Ueber den Inhalt der : A. FISCHER.

Ber. Deutsch. Bot. Gesellsch., III. (1885), pp. 230-9 (12 figs.).

Spermatozoiden, Die Entwicklung der : D. BIONDI.

Archiv für Mic. Anat., XXV. (1885), pp. 594-620 (18 figs.).

Spermatologische Beiträge : V. LA VALLETTE ST. GEORGE.

Archiv für Mic. Anat., XXV. (1885), pp. 581-93 (34 figs.).

Spermatogenese bei den Pulmonaten, Ueber die : GUSTAV PLATNER.

Archiv für Mic. Anat., XXV. (1885), pp. 564-81 (29 figs.).

Sponges, Notes on Nova Scotia, Fresh-Water : A. H. MCKAY.

Proc. and Trans. Nova Scotian Inst. Nat. Sci., VI. (1883-4), pp. 145-8.

Staurocephalus (*Staurocephalus Siberti*), On a New British : PROF M'INTOSH.

Ann. and Mag. Nat. His., XVI. (1885), pp. 482-4 (4 figs.).

Tauchmicrotom von grosser Leistungsfähigkeit, Ueber ein vereinfachtes : H. E. HILDEBRAND.

Zeitschr. für Wiss. Mik., II. (1885), pp. 343-5 (1 fig.).

Tauchmikrotom, besonders für grosse Schnitte, Ein Neues : C. WEIGERT.

Zeitschr. für Wiss. Mik., II. (1885), pp. 326-33 (2 figs.).

Unterguss, Ueber einen neuen : D. BORN and C. WIEGER.

Zeitschr. für Wiss. Mik., II. (1885), pp. 346-8.

Victorella pavida, The, of Saville Kent : E. C. BOWSFIELD.

Ann. and Mag. Nat. His., XVI. (1885), pp. 401-7 (3 figs.).

JOURNAL
OF THE
NEW-YORK MICROSCOPICAL SOCIETY.

VOL. II. FEBRUARY, 1886. No. 2.

THE BEST COVER-GLASS CEMENT.

BY DR. L. HEYDENREICH, OF ST. PETERSBURG.¹

(Read Dec. 18th, 1885.)

The best cover-glass cement should be :—

1st. Absolutely hermetic, and should not, under any circumstances, require renewal every year. Two or three coats of the cement, applied at short intervals after an object is mounted, should permanently secure and preserve the object.

2d. It should be as hard as glass, or, if possible, harder.

3d. It should not crack nor become detached, and should be so solidly adherent as to be less likely to break than the glass to which it is attached ; and

4th. It should be insoluble in water or glycerine, or in any liquid used as an immersion medium with objectives.

Notwithstanding the large number of cover-glass cements already known and in use, I think another should be sought for, one which shall conform to the foregoing requirements. That all do not so conform is evident when we hear of the damage caused by the use of cements which fail in effectually preserving microscopical preparations, some of which preparations are of considerable value. As an instance of such damage, I mention the case of the fine collection of nerve-tissues belonging to Jakubowitsch.

We have commercial varnishes which are very hard and durable. Some of them, used in the finishing of carriages, are found, after the lapse of a year, to be in the same condition as when first applied. The varnish used on tin pans in Albumen-factories remains unchanged for a year, although subjected daily, for many hours, to a temperature of 100° R. These and similar

¹Translated by E. A. Schultze, from *Zeitschrift für Wissenschaftliche Mikroskopie*, Vol. II., pt. 3.

varnishes are made of resins, copal, or amber. Of all resins, amber and some kinds of copal are the hardest. Copal-varnish is both hard and elastic ; amber-varnish is harder than copal, but not so elastic, and is, consequently, more brittle : hence, for a cover-glass cement, a mixture composed of both should be used. Only the best and clearest kinds of amber (the opaque pieces contain various kinds of minerals), and only the hardest kind of copal (that is, the East-India or Zanzibar copal), should be selected for cover-glass cements. Zanzibar copal is taken from the earth in flat, disk-shaped pieces, varying in dimensions from the size of a pea to the size of the human hand ; is colorless, yellow, or of a dark red-brown color, and transparent ; the surface, rough. Bombay copal comes in larger pieces, is of a yellowish-red color, has, when broken, a smooth, glassy surface, and is but very slightly inferior in quality to the copal of Zanzibar. Sierra-Leone copal comes in small, ball-shaped pieces, about one inch in diameter, or in pieces resembling drops in shape. All the other kinds are softer than those just described.

The best solvent for resin, and the one which possesses the most adhesive quality, is linseed-oil varnish, made of pure, old, linseed oil. Neither alcohol, ether, chloroform, nor any other quickly evaporating menstruum should be used. In order to hasten desiccation of the resin, and to obtain for the cement the proper consistency, an ethereal oil which, upon drying, will leave a surface perfectly even, should be added to the mixture ; and oil of lavender, either alone, or mixed with linseed-oil varnish, is suitable for these purposes.

The resins being thus dissolved in linseed-oil varnish until the solution attains the consistency of syrup, oil of lavender should be added until the mixture becomes thin enough to use in mounting microscopical objects—and the cement is finished.

The property of adhering to glass is increased in the cement by adding to it a small quantity of cinnabar ; but such addition causes it to dry less rapidly. In a week from the time of using it the cement becomes dry, and so firm that the finger-nail will make but a slight impression on it. For months it remains in this condition. At the expiration of a year, it is very hard and has a glassy surface.

So much for the component parts. The preparation of this cement being somewhat difficult, it would perhaps be advanta-

geous to buy the varnishes ready made, and then proceed as follows :—

Taking equal parts of the best, clearest, and hardest amber-varnish and copal-varnish, mix them and heat until all the turpentine has disappeared. This will require a temperature of 100° to 150° R. As soon as all the turpentine has evaporated, remove the dish from the flame, allow it to cool somewhat, and then add oil of lavender to the liquid in the proportion of $\frac{1}{2}$ to 1; mix well, and allow the entire mass to cool thoroughly. The process is terminated by adding from 20% to 40% of artificial cinnabar (eosin with cinnabar), which should be very carefully and thoroughly rubbed in. The best method for rubbing in the cinnabar is that employed in the preparation of fine oil-paints. Should the cement when finished be too thick for use, as much oil of lavender as will give the required fluidity may be added. The component parts and their proportions would then be as follows :—

Amber, - - - -	25 parts
Copal, - - - -	25 “
Linseed-oil varnish, - -	50 “
Oil of lavender, - - -	50-60 “
Artificial cinnabar, - -	40-60 “

Dr. Heydenreich continues his article by describing the manner in which the cement should be applied, but as his method is the same as that employed in the use of Canada balsam and other cover-glass cements, and, consequently, familiar to all microscopists, I have not thought it necessary to make a note of it. I will, however, state that he advises, in order to secure a perfect mount, that a second ring be made after the first or second week from the time of mounting; and a third, after the first or second month; each additional ring to be slightly wider than the preceding one.

A SIMPLE AND INEXPENSIVE FORM OF BLACK-GROUND ILLUMINATOR.

BY PROF. ALFRED M. MAYER, OF THE STEVENS INSTITUTE OF TECHNOLOGY.

(*Read Jan. 15th, 1886.*)

This is a simple and inexpensive form of black-ground illuminator, devised for the study of aquatic life with low-power objectives of angular apertures up to 50° or 60° . For this purpose it works admirably, showing aquatic organisms as brilliant objects on a black ground, so that they are instantly detected among the more opaque particles of ooze in which they are generally found; thus saving much time in such studies.

The illuminator shows these objects in their true colors; for the pencil of illuminating rays, when properly adjusted, is sensibly colorless. The interior structure of rhizopods, infusoria, rotifers, worms, &c., is brought out in a manner which is very striking.

An angular aperture far exceeding that of the objective is not, in my opinion, desirable. This opinion is based on experiments with other dark-ground illuminators which give these large angles to the emergent pencil. With these we do not see so well the interior structure of translucent bodies—probably by reason of the interior reflections produced on rays falling at angles of too great incidence (when referred to the axis of the lens) on the boundaries of those portions of the organism which have different refractive indices. It is my opinion that, if the rays enter the objective at the smallest angle required for a black-ground, the interior structure of these bodies is shown in the best manner. Objects exhibited by this illuminator show no glow around their borders. A glow is often seen when other illuminators are used, and interferes much with good definition of the margins of objects.

The light which was used in my illuminator is obtained by placing a hollow lens, of the diameter of about five inches, between the flame of a student's-lamp and the plane mirror of the microscope. The flame of the lamp is diaphragmed down to a

square opening which embraces the brightest part of the flame. The hollow lens contains a dilute solution of ammonio-sulphate of copper, prepared as follows: The lens is nearly filled with distilled water, and then a strong solution of the ammonio-sulphate of copper is added till a turquoise color is obtained. The solution is now cloudy from a partial precipitation of the hydrated oxide of copper. Ammonia is now added until the precipitate is just redissolved and the solution is free from any tint of green. The depth of color of the fluid in the lens has to be adjusted by trial, so that the blue of the lens shall just balance the orange of the flame. Then a soft, white light appears in the field. This intense whiteness, like alabaster, is very apparent in the dry mounts of shells of *Diffugiæ*, and frustules of *Arachnoidisci*, exhibited before the Society.

The plane mirrors, as generally made, of nearly all microscopes, except those of the grand-models, are too small in the front-and-rear diameter to illuminate the lower lens of dark-ground illuminators. I obviate this defect by cutting an ellipse out of a piece of plane mirror, and attaching this to the frame of any plane mirror by means of four small pieces of cork cemented to the back of the elliptical mirror. These pieces of cork fit outside of the circular brass frame of the ordinary plane mirror. The ellipse of the plane mirror has a minor axis a little larger than the diameter of the lower lens of the illuminator. The major axis is so long that when the mirror is inclined as much as it will ever need to be, to the axis of the microscope, the whole of the surface of the lower lens of the illuminator is covered by reflected light. The shorter axis of the elliptical mirror which I use is $1\frac{3}{4}$ inches, the longer axis is $2\frac{1}{2}$ inches.

The optical combination forming this illuminator is as follows:—

There are three plano-convex lenses in contact with one another. These may be designated *A*, *B*, and *C*, in their order from below upward.

A is a plano-convex lens with its plane side facing the mirror. The radius of its curvature is $2\frac{1}{4}$ inches. Its thickness through its axis is $\frac{17}{1000}$ ths of an inch. *B* is a plano-convex, with its convex side down. Its radius is 1 inch. Its thickness is $\frac{4}{1000}$ ths of an inch. *C* is a plano-convex, of the same radius and thickness as *B*. Its convex side is down.

On *B* is cemented a stop, formed of a piece of paper blackened with lamp-black in shellac. The diameter of the central stop is $\frac{7}{100}$ ths of an inch. The width of the annular opening around the stop is $\frac{1}{10}$ th of an inch.

Each of the lenses in the experimental form of the illuminator exhibited has a diameter of $1\frac{1}{2}$ inches. It is evident that this diameter may be lessened in the lenses *B* and *C*, so that the combination when mounted will have the form of the frustum of a cone. With this form, the combination could enter the aperture in the majority of microscope stages, and its upper lens be brought even in contact with the under side of a slide.

The mean angle of the emergent rays at the upper lens, *C*, is $69\frac{1}{2}^{\circ}$.

The mean diameter of the annular opening of the stop is calculated in reference to the curvatures of the lenses, so that the central rays issuing from this stop fall normally on the convex surface of the lens *C*, and thus traverse it without refraction. This also tends to correct the chromatic dispersion of the pencil of rays emerging from *B*, whose boundaries of red and blue fall in directions inclined towards the normal of the lens *C*, on opposite sides of this normal.

This combination is not patented, and is at the service of all opticians and microscopists.

VITALITY OF THE LARVÆ OF THE NUT-WEEVIL.

BY F. W. LEGGETT.

(Read Jan. 15th, 1886.)

In preparing spiracles for mounting, I have made considerable use of those furnished by the nut-weevil (*Balaninus nucum*), a plentiful supply of which I found, much to the disgust of my family, in some hickory nuts on our table. It is not appetizing, I must acknowledge, to find one of these grubs ensconced within a morsel of fruit which you are about to convey to your mouth, and very few people are educated up to the point of gazing with enjoyment on its white, squirming body; yet its whole life-history is interesting—a fact too well known to need repetition. I knew that, shut up within its air-tight hickory-house, its consumption of air must be infinitesimal, but I was not prepared to

discover that it could live on air "bottled for private use," or upon that separated from liquids during days of complete immersion therein. In the course of dissecting a dozen, perhaps, of the larvæ, I found that, although apparently dead, they were not so in fact. They were cleverly performing the part of feigning death, or were indulging in a siesta, following a hearty meal of hickory-nut stolen from the tyrant, man. Exposure to the air for a short time revived them.

Desiring to bleach a larva without destroying any of its softer parts, I placed one in a six-inch test-tube, filled to within one-half inch of its capacity, with peroxide of hydrogen, and here follows the result, as copied from memoranda made by me at the time: Put larva in test-tube at 7 P. M., Jan. 7th. Took it out at 5 P. M., Jan. 8th. Cut off a part of the side of the larva and mounted the piece cut off. At 7, the same evening, the creature was very lively. Placed it on a slide and looked at it through the microscope. The creature continued very lively the whole evening, although the moisture from the wounded part dried, and fastened the larva firmly to the slide. Jan. 9th, 7:45 A. M., the creature was still alive, although the posterior end near the wound continued to be hard and dry. On Jan. 10th, at 2 P. M., I placed another larva of the nut-weevil in the same test-tube with the same peroxide of hydrogen. Like the former one, it immediately sank to the bottom, where it remained until Jan. 14th, at 7 P. M., when I removed it to a glass cup and laid it on its side. Into this cup I poured about twenty drops of water. On Jan. 15th, at 8.30 A. M., I found the creature expanding and contracting itself. Thinking that this motion might be an optical delusion on my part, I showed it to two members of my family. Both saw the movement distinctly, and further, when I touched the creature with a needle, saw it raise its head in an unmistakably living manner. On Jan. 16th this larva was living and active. One specimen I mounted in Deane's mixture, taking it for that purpose directly from the test-tube where it had been immersed in the peroxide of hydrogen, thus giving it no chance to recover from its swoon by exposure to the air, if, like its fellows, it had swooned under the effects of immersion. For aught I know to the contrary, it may be alive on the slide at this moment.

PROCEEDINGS.

MEETING OF JANUARY 1ST, 1886.

The President, Mr. C. Van Brunt, in the chair.

Seventeen persons present.

The report of the committee appointed at the last meeting to nominate officers for the year 1886, was accepted and adopted, and the committee was discharged.

The hour for opening the polls for the annual election of officers having arrived, the President appointed Mr. Shultz, Mr. Warnock, and Mr. Wales, tellers to receive and count the ballots, and declared the polls open.

Mr. De Witt called the attention of the members to certain provisions in the Constitution and By-laws, suggested alterations, and, on motion, a committee was appointed to consider the advisability of amending and revising the same, with power to recommend such changes as they might deem proper; which committee consisted of Mr. De Witt, Mr. Mead, and Mr. Wall.

ELECTION OF OFFICERS.

The President announced the closing of the polls, and the following was declared to be the result of the balloting:—

For President, J. L. ZABRISKIE.

For Vice-President, P. H. DUDLEY.

For Recording Secretary, M. M. LE BRUN.

For Corresponding Secretary, B. BRAMAN.

For Treasurer, C. S. SHULTZ.

For Librarian, W. G. DE WITT.

For Auditors, { E. C. BOGERT,
F. W. DEVOE,
W. R. MITCHELL.

MEETING OF JANUARY 15TH.—THE ANNUAL MEETING.

The President, Mr. C. Van Brunt, in the chair.

Twenty-eight persons present.

REPORT OF THE PRESIDENT, MR. C. VAN BRUNT, ON
THE STATE OF THE SOCIETY.

The President said : “ While I acknowledge that the gain in membership during the past year, and the satisfactory condition of our treasury, indicate continued prosperity for the society, I cannot help saying that, in my opinion, a more important indication of such prosperity is the unmistakably growing interest of the members in our proceedings, as shown by their full attendance, by their frequent contributions of valuable information to the Society, and by the readiness of so many of them to discuss whatever questions come before it.

“ Something like this I said to you at the Annual Meeting of 1885, but I am pleased to add, that I have greater justification for the remarks now, than I had then.

“ One feature of our gatherings I have observed, and with satisfaction,—the social element which pervades them, caused mainly by the presence of so many visitors of the gentler sex, members of our families, or our friends. I think that this feature adds to the attractiveness of our meetings ; indeed, I think the attendance of visitors of both sexes should be encouraged.

“ From the Minutes, I have prepared a concise statement of the more important subjects which have occupied our time at the meetings of the past year, which statement is as follows :—

1. Feb. 20th.—The Life of an Oyster. By PROF. SAMUEL LOCKWOOD, Ph.D.
2. Mar. 6th.—Cell-structure of *Pinus Strobus*. By P. H. DUDLEY.
3. Visual Field of Worker Honey-Bee's Ocelli. By the Rev. J. L. ZABRISKIE.
4. Mar. 20th.—A Caterpillar Fungus from New Zealand, and Some Related Species of the United States ; illustrated. By the Rev. J. L. ZABRISKIE.
- 5 Apr. 3d.—The Proper Care and Use of Microscope Objectives. By WILLIAM WALES.

6. Apr. 17th.—Sponges. By H. J. RICE.
7. May 1st.—Exhibition and Description of two small Dynamo-Electrical Machines used for Microscopical Illumination. By G. F. KUNZ.
8. May 15th.—“The Sealed Flasks of Crystal” (Inclusions in crystals). By A. A. JULIEN.
9. June 5th.—On Certain So-Called Prodigies. By C. F. Cox. Chapman’s Mould for Making Microscopical Cells. By E. B. GROVE.
10. Nov. 6th.—A Minute Phosphorescent Organism from the Surf on the Coast of New Jersey. By A. A. JULIEN.
11. Dec. 4th.—Electric Light for Use with the Microscope. By E. A. SCHULTZE.
12. Dec. 18th.—*Protococcus viridis*; with Illustrations. By P. H. DUDLEY and E. B. SOUTHWICK.
A New Mounting Medium, by H. L. Smith. Read by the President, C. VAN BRUNT.

“A wide publicity has of late been given to our proceedings, through the agency of the Journal of our Society, which will, I think, ultimately result in much benefit to us.

“The average attendance during the past year was : members 20, visitors 15.”

SUMMARY OF THE REPORT OF THE TREASURER,
MR. M. M. LE BRUN.

Balance, Jan. 16th, 1885,	-	-	-	\$ 25.94	
Receipts, to Jan. 16th, 1886,	-	-	-	<u>312.50</u>	\$338.44
Disbursements, to Jan. 16th, 1886,	-	-	-		<u>215.75</u>
Balance, Jan. 16th, 1886,	-	-	-		\$122.69

SUMMARY OF THE REPORT OF THE LIBRARIAN,
MR. W. G. DE WITT.

Publications received during the year ending Jan. 16th, 1886,—	-	-	-		
Foreign,	-	-	-	90	
Domestic,	-	-	-	<u>230</u>	
Total,	-	-	-		320

the pages of which aggregated over 25,000.

OBJECTS EXHIBITED.

1. Diatoms mounted in Prof. H. L. Smith's new Medium : by C. VAN BRUNT.
2. Sections of Echinus Spines (*Diadema setacea*) : by J. D. HYATT.
3. Dichroism of certain New-York Micras : by J. D. HYATT.
4. Section of Lava from Nevada : by J. D. HYATT.
5. Amber, enclosing various Diptera : by WM. G. DE WITT.
6. Achenia of *Cyperus flavescens*, L., and *C. diandrus*, Torr. : by N. L. BRITTON.
7. *Sarcoptes scabiei* (Itch Mite), male and female : by C. S. SHULTZ.
8. Mycelium, Pileus, and Spores of *Lentinus lepideus*, Fries : by P. H. DUDLEY.

THE ITCH MITE.

Mr. Chas. S. Shultz exhibited a slide containing specimens of one of the Acari, *Sarcoptes scabiei* (Itch Mite), the cause of Scabies or "Itch," a parasitic disease of the human skin, and said:—

"This slide contains a mature male and female, an undeveloped young mite, and an egg. Few only of the younger people in this country have seen cases of Itch, or the mite which causes the disease, although not many years ago the Itch was quite common here. At present, it is prevalent among the peasantry of Central Europe, especially in portions of the Austrian provinces of Hungary, Bohemia, &c., where the people saturate their underclothing and mittens with grease to protect themselves from the cold, and retain these garments unchanged upon their persons for months. On the warmer parts of the body, especially the arm pits, bends of the elbows, and between the roots of the fingers, the female mite, which is the chief cause of the disease, burrows into the flesh, there depositing her eggs, and, while awaiting their hatching, cuts into the flesh, causing irritating pustules to form upon its surface. When the eggs are hatched, the young Acari rapidly develop, and leave the breeding place, the females starting new burrows or galleries, the males hiding quietly under the cuticle, causing no irritation. The male mite is but one-half the size of the female. The mature *Sarcoptes* has eight legs. The young begin with six only, but develop the other two after commencing their burrowing. 'The four anterior legs

are provided with sucking disks, and with bristles armed at their extremities with minute claws; but the posterior feet have no sucking disks. The mouth has a double upper and lower lip, between which play the jaws armed with teeth, moving over each other like the blades of scissors, and resembling the claws of a lobster.' Centuries ago, Scabies or Itch was ascribed to a parasite, but not until the modern microscope was used in the study of such subjects, could a sight be obtained of the creature itself and its wonderful structure."

ACHENIA OF *CYPERUS FLAVESCENS*, L., AND *C. DIANDRUS*, TORREY.

Dr. N. L. Britton called attention to the difference in surface markings of the achenia of these two sedges. In *C. flavescens* the superficial cells on the achenia are oblong, about four times as long as broad. In *C. diandrus*, and in our other native species of the subgenus *Pycneus*, these are quadrate, and much larger than in *C. flavescens*, which may thus be distinguished from the others. Mr. C. B. Clarke, in a monograph on the Indian species of *Cyperus* (*Jour. Linn. Soc. (Botany)*, XXI.), has used these features to advantage in classifying the species. Dr. Britton's investigations confirm Mr. Clarke's diagnosis in this respect.

FUNGI WHICH CAUSE DECAY IN TIMBER.

P. H. Dudley: "The fungus *Lentinus lepideus*, Fr., an Agaric, is the one I have found to be very destructive to railway sleepers, bridge-timbers, and planks, made of yellow, or Georgia pine (*Pinus palustris*, Mill.). It has a whitish, delicate mycelium, its hyphæ being 1 to 1.5μ in diameter, and when attacking the wood at its ends, is able, in many cases, to separate the annual rings. It secretes fluids possessing acid reactions, readily softens the thin-walled tracheides, causing their decomposition, and produces an abundance of crystals of the form of oxalate, and sometimes of phosphate, of lime. In some cases, carbonate of lime has also been found. The mycelium once started, secretes enough moisture for its own nourishment and development, and rapidly multiplies. Decomposition of the wood, the so-called 'dry-rot,'—which, contrary to the general opinion, never takes place in the absence of moisture—as rapidly ensues, unless the moisture be dried by external agencies. In railway sleepers, as soon as the thin-walled tracheides are softened by the action

of this fungus, larvæ, from $\frac{1}{16}$ th to $\frac{1}{8}$ th of an inch long, perforate and consume them, leaving the thick-walled, harder cells in the condition of a series of shells, rendering the sleeper useless in less time than would the action of the fungus alone. When the fungus attacks the sleeper on its sides or bottom, the mycelium spreads over it in a beautiful arborescent manner, and requires a longer time to penetrate the wood than when the attack is made at the end of the sleeper. As the *Lentinus lepideus* fruits under very favorable conditions only, it is rarely found on railway sleepers. It can be identified by certain characteristics which it possesses. Associated with it, are found in great abundance various species of *Schizomycetes*, many of them occupying cells adjacent to those containing the mycelium of the *Lentinus lepideus*. The fruit spores of the last named are white, abundant, $3.5\mu \times 8\mu$ in size, curved, one end apiculate. The annual loss to consumers of yellow pine, caused by this fungus, amounts to hundreds of thousands of dollars."

PUBLICATIONS RECEIVED.

The Naturalist's World : Vol. II., No. 24 (December, 1885) ; pp. 16. Vol. III., No. 25 (January, 1886) ; pp. 20.

Johns Hopkins University. Circulars : Vol. V., No. 45 (December, 1885) ; pp. 12.

National Druggist : Vol. VIII., No. 1 (January 1st, 1886) ; pp. 16. No. 2 (January 8th) ; pp. 16. No. 3 (January 15th) ; pp. 16. No. 4 (January 22d) ; pp. 16.

Brooklyn Entomological Society. Entomologica Americana : Vol. I., No. 10 (January, 1886) ; pp. 20.

Indiana Medical Journal : Vol. IV., No. 6 (December, 1885) ; pp. 24.

Monatsblätter des Wissenschaftlichen Club in Wien : Vol. VII., No. 3 (December 15th, 1885) ; pp. 10. No. 4 (January 15th, 1886) ; pp. 12. Ausserordenliche Beilage : No. 1 ; pp. 41.

Transactions of the New-York Academy of Sciences : Vol. III. (1883-4) ; pp. 168. Vol. V., No. 1 (October, 1885) ; pp. 24. No. 2 (November) ; pp. 48.

Proceedings of the Natural Science Association, of Staten Island : December 12th, 1885 ; p. 1. Extra, No. 4 ; p. 1. January 9th, 1886 ; pp. 2.

The Correspondence University Journal : Vol. III., No. 3 (January, 1886) ; pp. 16.

The Electrician and Electrical Engineer : Vol. V., No. 49 (January, 1886) ; pp. 40.

Anthony's Photographic Bulletin : Vol. XVII., No. 1 (January 9th, 1886) ; pp. 32. No. 2 (January 23d) ; pp. 32.

The Journal of the Cincinnati Society of Natural History : Vol. III., No. 4 (January, 1886) ; pp. 58.

The Journal of Mycology : Vol. II., No. 1 (January, 1886) ; pp. 12.

The Microscope : Vol. VI., No. 1 (January, 1886) ; pp. 24.

Drugs and Medicines of North America : Vol. I., No. 8 (December, 1885) ; pp. 32.

Bulletin of the United States National Museum, No. 23, 1885 ; pp. 59+278. From Isaac Lea, LL. D.

The Journal of Microscopy and Natural Science : Vol. V., Pt. 17 (January, 1886) ; pp. 68.

Massachusetts Horticultural Society : Schedule of Prizes offered for the year 1886 ; pp. 40.

The American Monthly Microscopical Journal : Vol. VII., No. 1 (January, 1886) ; pp. 20.

Vick's Illustrated Monthly Magazine, and Floral Guide : January, 1886 ; pp. 32+128.

The Botanical Gazette : Vol. XI., No. 1 (January, 1886) ; pp. 24.

Bulletin of the Torrey Botanical Club : Vol. XII., No. 12 (December, 1885) ; pp. 12.

Bulletin de la Société Belge de Microscopie : Vol. XII., No. 2 (November 30th, 1885) ; pp. 7.

INDEX TO ARTICLES OF INTEREST TO MICROSCOPISTS
WHICH HAVE RECENTLY APPEARED IN OTHER
JOURNALS.

Algæ, Fresh-Water : FRANCIS WOLLE.

Bul. Torr. Bot. Club, XII. (1885), pp. 125-9 (15 figs.).

Antheridien und Spermatozoiden der heterosporen Lycopodiaceen : WL.
BELAJEFF.

Bot. Zeitung, XLIII. (1885), pp. 794-819 (60 figs.).

Astigmatism and its Relation to the Use of Optical Instruments : ERNST GUND-
LACH.

The Microscope, VI. (1886), pp. 1-4.

Blood, Human, A Study of : C. H. STOWELL.

The Microscope, V. (1885), pp. 265-9 (3 figs.).

Boro-Glyceride. See Mounting Medium.

Cimicifuga racemosa, Microscopical Structure of : LOUISA REED STOWELL.

Drugs and Med. of N. A., I. (1885), pp. 258-62 (7 figs.).

Cotton Fibre, Notes on the (To be continued) : WALTER HENSHALL.

Sci.-Gossip, 1886, pp. 9-10 (1 fig.).

Dropping Tube, An Efficient : D. S. KELLICOTT.

Am. Mon. Mic. Jour., VII. (1886), pp. 4-5.

Entomophthora, Larval, A New : J. C. ARTHUR.

Bot. Gaz., XI. (1886), pp. 14-7 (11 figs.).

Equiseteumsporen, Einfluss der Beleuchtungsrichtung auf die Theilung der :
E. STAHL.

Ber. Deutsch. Bot. Gesellsch., III. (1885), pp. 334-40 (2 figs.).

Methods of Study. See Staining.

Microscopical Advances—Ancient and Modern.—III., IV. : G. W. ROYSTON-
PIGOTT.

Eng. Mech., XLII. (1885), pp. 331-2 (13 figs.); pp. 417-8 (6 figs.).

Microscopical Drawing, Accessories for : G. S. S.

Sci.-Gossip, 1886, p. 8.

Mounting Medium (Boro-Glyceride), A New, of High-Refractive Index : H.
L. SMITH.

Am. Mon. Mic. Jour., VII. (1886), pp. 3-4.

Object-Glasses, Magnifying Power of ; under heading Micro. O. G.'s : FRED.
H. EVANS.

Eng. Mech., XLII. (1886), p. 361.

Photomicrographs, How to Make (II.) : W. H. WALMSLEY.

The Microscope, V. (1885), pp. 271-4.

Photomicrography (III.) : R. HITCHCOCK.

Am. Mon. Mic. Jour., VII. (1886), pp. 5-10 (5 figs.).

Pollen-Spores of *Tradescantia Virginica* : JOHN M. COULTER and J. N. ROSE.

Bot. Gaz., XI. (1886), pp. 10-4 (17 figs.).

Protoplasma von *Drosera rotundifolia*, Ueber die Aggregation im : HUGO DE
VRIES.

Bot. Zeitung, XLIV. (1886), pp. 1-11 (25 figs.).

Schizoneurina, or Cotton Bugs ; under heading Pleasant Hours with a Microscope : HENRY J. SLACK.

Knowledge, IX. (1886), pp. 75-6 (5 figs.).

Sexual Organs of Reproduction in Angiosperms, Structure of the (No. 1.—Anther of *Lilium*).

Cole's Studies in Mic. Sci., III. (1885), pp. 41-4 (colored plate).

Sponges, New Fresh-Water, from Nova Scotia and Newfoundland : A. H. MACKAY.

Canadian Record Sci., II. (1886), pp. 19-22 (6 figs.).

Staining ; under heading Methods of Study (IV.) : ALBERT E. JENKINS.

The Microscope, VI. (1886), pp. 5-11.

Staining Tissues in Microscopy (HANS GIERKE, *Zeitschr. für Wiss. Mic.*) (VII.) : Translated by W. H. SEAMAN.

Am. Mon. Mic. Jour., VII. (1886), pp. 13-5.

Stannous-Chloride Medium, Directions for Using the, in Mounting Diatomaceæ : H. L. SMITH.

Mic. Bul., II. (1886), p. 46.

Tradescantia Virginica. See Pollen-Spores.

Vacuolen, Plasmolytische Studien über die Wand der : HUGO DE VRIES.

Jahrb. Wiss. Bot., XVI. (1885), pp. 465-598 (43 figs.).

Veränderungen welche in den Perianthkreisen der Blüten während der Entwicklung der Frucht vor sich gehen, Ueber anatomische : CARL REICHE.

Jahrb. Wiss. Bot., XVI. (1885), pp. 638-86 (19 figs.).

Wandverdickungen in den Samenoberhautzellen einiger Cruciferen, Bau und Entwicklungsgeschichte der : MAX ABRAHAM.

Jahrb. Wiss. Bot., XVI. (1885), pp. 599-637 (61 figs.).

Zygomorphie der Blüten, Ueber die Ursachen der : H. VÖCHTING.

Ber. Deutsch. Bot. Gesellsch., III. (1885), pp. 341-5.

JOURNAL OF THE NEW-YORK MICROSCOPICAL SOCIETY.

INDEX TO VOL. I. (1885.)

Achenia of <i>Bidens</i> , Barbed Awns of,.....	198	Cockroach, Eyes of, for Multiple Images,.....	18, 35
Address of the President,.....	53	Compound Eyes and Multiple Images,.....	33
Algo-Fungal-Lichen Hypothesis, The,.....	109	Condenser, Zentmayer's Abbe,.....	156
American Society of Microscopists,.....	109, 111, 125, 162, 212	Coniferæ, Various, Lenticular Markings of, Compared,.....	218
<i>Amphipleura pellucida</i> , Photograph of,.....	102	Convention, The Cleveland,.....	212
—, Observations on Resolution of,.....	103	COX, C. F., On Certain So-Called Prodigies,.....	165
— and the Diffraction Theory,.....	163	Cross-Fertilizing Apparatus of <i>Lobelia syphilitica</i> ,.....	201
Animalcula, Cocaine Hydrochlorate for Mounting,.....	210	Crystals, Feather, of Uric Acid from a Caterpillar,.....	217
Annual Reception, The,.....	72	Diatoms, Photographs of,.....	123
<i>Asterionella</i> and <i>Peridinium</i> , Note on,.....	190	—, Fastening, by Heat,.....	123
<i>Bacillus Lepreæ</i> and <i>B. tuberculosis</i> ,.....	24	—, Dr. Van Heurck's Photographs of,.....	187
Baker, Henry, Extract from his "Microscope Made Easy,".....	28	— from Lake Geneva,.....	197
<i>Bidens</i> , Barbed Awns of Achenia of,.....	198	Diffraction Theory, <i>Amphipleura pellucida</i> and the,.....	163
<i>Blatta orientalis</i> , Eyes of, for Multiple Images,.....	35	DUDLEY, P. H., Cell-Structure of <i>Pinus Strobus</i> ,.....	85
Bleaching Agent, Hydrogen Peroxide as a,.....	22	—, Identification of Arizona Fossil Wood,.....	230
Blood, Showers of,.....	180	—, Medullary Rays of Tamarack,.....	27
—, Spotting of Bread with,.....	179	—, <i>Triceratium Davyanum</i> ,.....	145
Blood-Corpuscles, Micrometry and,.....	211	Dynamo-Electric Machines for Microscopical Illumination,.....	156
BRITTON, N. L., Criticisms on Mr. J. Kruttschnitt's Papers and Preparations Relating to Pollen-Tubes,.....	7	Eggs of <i>Limulus Polyphemus</i> ,.....	47
Caterpillar Fungus from New Zealand, and some Related Species of the United States,.....	89	—, Hens', Ovoid Concretions on Shells of,.....	104
Cell-Structure of <i>Pinus Strobus</i> ,.....	85	Election of Officers,.....	43
Cells, The Chapman Mould for,.....	188	Electric Spark, Path of,.....	104
—, Hard-rubber,.....	188	Electrical Illumination in Microscopy,.....	1, 19, 22
—, Wax,.....	190	<i>Euglena sanguinea</i> , Note on,.....	188, 189
—, White-zinc,.....	191	Exhibition of Objects at Annual Reception,.....	72
Chalcedony Park,.....	210	Eyes of <i>Blatta orientalis</i> ,.....	35
Chapman Mould for Cells,.....	188	— <i>Gyrinus</i> ,.....	33
<i>Chilomonas paramecium</i> ,.....	95	— <i>Limulus</i> ,.....	36
Cholera Bacillus,.....	25	— Neuroptera,.....	33
Cleveland Convention, The,.....	212	— <i>Tabanus</i> ,.....	34, 52
Cocaine Hydrochlorate for Mounting Animalcula,.....	210	—, Mummies', So-Called,.....	199
		Flesh, Showers of,.....	181
		Fluid-Cavities in Quartz. See "Sealed Flasks of Crystal,".....	129
		Foraminifera, Bermuda,.....	147

Fossil Leaf of <i>Hausmannia</i> , . . .	100	<i>Leucophrys emarginata</i> ,	153
Fossil Wood, Arizona, Description of,	195, 210	<i>Limulus Polyphemus</i> , Eggs of, . . .	47
— — —, Identification of,	220	<i>Lobelia siphilitica</i> , Cross-Fertilizing Apparatus of,	201
— — —, Lenticular Markings in,	220	LOCKWOOD, SAMUEL, <i>Heteromeyenia Ryderi</i> (a Fresh-Water Sponge),	37
FOULKE, SARA GWENDOLEN, <i>Chilomonas paramucium</i> ,	95	—, The Life of an Oyster,	60
—, <i>Trachelius ovum</i> ,	97	—, Feather Crystals of Uric Acid from a Caterpillar,	217
Fresh-Water Sponge, Observations on,	46	Medullary Rays of Tamarack, . . .	27
Fungus (<i>Torrubia</i>), Caterpillar, from New Zealand,	89, 90	<i>Meloë angusticollis</i> , Triungulin Larva of,	155
—, <i>Torrubia Rovenelii</i> ,	91	Micrometry and Blood-Corpuscles,	211
—, — <i>militaris</i> ,	91	Micro-Organisms of <i>Pneumococci</i> (Swine Plague),	41, 42
—, — <i>clavulata</i> ,	92	Microscope, The, in the School-Room,	110
— Growths on Cover-Glass, How Prevented,	191	—, Microscopic, Microscopical,	209
<i>Fusulina cylindrica</i> ,	200	— Lenses, The Proper Care and Use of,	113
Geneva, Lake, Blueness of Waters of, How Caused,	198	— —, Care of,	123
Hairs, Branched, of <i>Leucophyllum Texanum</i> ,	46	— —, The Best, Only,	224
Hanamau Filter Wash-Bottle, . . .	125	Microscopic Objects, Exhibition of,	72
<i>Hausmannia</i> , Fossil Leaf of,	100	Microscopy, Professional,	210
<i>Heteromeyenia Ryderi</i> (a Fresh-Water Sponge),	37	MISCELLANEA :—	
— — —, Dimensions of Spicules of,	104	The Study of Nature a Source of Happiness,	28
HYATT, J. D., Compound Eyes and Multiple Images,	33	Starch in Leaves,	28
Hydrogen Peroxide as a Bleaching Agent,	22	The Minuteness of Sporules, . . .	29
Identification of Arizona Fossil Wood,	220	Earliest Observation of Multiple Images,	52
Illumination by Aid of Air-Bubbles,	203	Eyes of <i>Tabanus</i> ,	52
—, Electrical, in Microscopy,	1, 19, 22	Royal Microscopical Society, Annual Meeting, 1885,	80
—, Microscopical, Dynamo-Electric Machines for,	156	The Working Session of the American Society of Microscopists,	109, 111
Index to Articles of Interest to Microscopists, 29, 48, 77, 106, 127, 160, 194, 205, 222		The Algo-Fungal-Lichen Hypothesis,	169
Infusoria, Artificial Division of, . . .	163	The Microscope in the School-Room,	110
Infusorian, A New Symbiotic,	152	Septic Organisms,	110
JULIEN, ALEXIS A., The Sealed Flasks of Crystal,	129	The American Society of Microscopists,	162
—, A Phosphorescent Organism from the Surf at Ocean Beach, N. J.,	214	<i>Leucophrys emarginata</i> , Note on,	162
<i>Lacinularia socialis</i> , Note on,	218	<i>Amphipleura pellucida</i> and the Diffraction Theory,	163
Lenticular Markings in Arizona Fossil Wood, See "Identification of Arizona Fossil Wood," and "Chalcedony Park,"	220, 210	"Omnis Nucleus e Nucleo,"	163
— — — of Various Coniferae Compared,	218	Artificial Division of Infusoria,	163
<i>Leucophyllum Texanum</i> , Branched Hairs of,	46	Choice of Objectives and Oculars,	164
		Microscope, Microscopic, Microscopical,	209
		Mechanical Self-Division of <i>Stentor</i> ,	209

Chalcedony Park,.....	210	Phosphorescence Correlated with Nerve-Force,.....	216
Cocaine Hydrochlorate for Mounting Animalcula,...	210	Phosphorescent Organism, A, from the Surf at Ocean Beach, N. J.,.....	214
Professional Microscopy,...	210	Photograph of <i>Amphipleura pellucida</i> ,.....	102
Micrometry and Blood-Corpuscles,	211	<i>Pinus Strobus</i> , Cell-Structure of,.....	85
The Cleveland Convention,...	212	— —, Observations on,...	99
The Best Lenses Only,.....	224	<i>Pithophora Kewensis</i> , Note on,	218
Seeds of <i>Orthocarpus purpurascens</i> ,.....	224	<i>Pneumo-enteritis</i> (Swine Plague), Micro-Organisms of,	41, 42
Completion of Vol. I.,.....	224	Pollen-Tubes, Criticisms on Mr. J. Kruttschnitt's Papers and Preparations Relating to,...	7
Mosquito, Eyes of, for Multiple Images,	18, 36	— —, Discussion,.....	20, 21
Mounting Animalcula, Cocaine Hydrochlorate for,...	210	President, Report of the, on the State of the Society,.....	43
— Medium, Observations on Prof. H. L. Smith's New-est,.....	102, 158	President's Address,.....	53
— —, Silicate of Soda as a,...	213	PROCEEDINGS:—	
— —, White Rosin as a,....	202	Meeting of Oct. 3d, 1884,....	17
—, Albumen Method of,.....	158	17th,.....	18
—, Microscopical, Hints on,..	190	Nov. 7th,.....	18
Multiple Images, Compound Eyes and,.....	33	21st,.....	20
— —, Earliest Observation of,.....	52	Dec. 5th,.....	21
— —, Method of Exhibiting,.....	35	19th,.....	25
Mummies' Eyes, So-Called,...	199	Jany. 2d, 1885,...	41
Nucleus.—“Omnis Nucleus e Nucleo,”...	163	16th,.....	43
Objectives and Oculars, Choice of,.....	164	Feb. 6th,.....	72
Objects, Exhibition of, at Annual Reception,.....	72	20th,.....	75
Ocelli, Worker Honey-Bee's, Visual Field of,.....	88	Mar. 6th,.....	98
Oculars, Objectives and, Choice of,.....	164	20th,.....	100
Officers, Election of,.....	43	Apr. 3d,.....	122
Organism, A Phosphorescent, from the Surf at Ocean Beach, N. J.,.....	214	17th,.....	123
Organisms, Septic,.....	110	May 1st,.....	155
—, Micro-, of <i>Pneumo-enteritis</i> ,.....	41, 42	15th,.....	157
<i>Orthocarpus purpurascens</i> , Seeds of,.....	224	June 5th,.....	187
Oyster, The Life of an,.....	60	19th,.....	189
—, Embryology of the,.....	67	Oct. 3d,.....	197
—, Enemies of the,.....	70	16th,.....	200
—, Food of the,.....	62	Nov. 6th,.....	213
—, Friends of the,.....	69	20th,.....	217
—, Shell of the, How Made,...	65, 66	Prodigies, So-Called, On Certain,.....	165
—, Species of the,.....	64	Publications Received,.....	76,
<i>Pectinatella magnifica</i> , Note on,	201	105, 126, 160, 192, 203, 221	
<i>Peridinium</i> and <i>Asterionella</i> , Note on,.....	190	Reception, The Annual,.....	72
Phosphorescence Connected with Oxidation,.....	215	Report of the President on the State of the Society,.....	43
		— Treasurer,.....	45
		RICE, HENRY J., Sponges,.....	116
		Rosin, White, as a Mounting Medium,.....	202
		Royal Microscopical Society, Annual Meeting, 1885,.....	80
		School-Room, The Microscope in the,.....	110
		SCHULTZE, E. A., Electrical Illumination in Microscopy,...	1

SCHULTZE, E. A., <i>Bacillus Lepre</i> and <i>B. tuberculosis</i> ,.....	24	<i>Trachelius ovum</i> ,.....	97
Sealed Flasks of Crystal,.....	129	Treasurer, Report of the,.....	45
Septic Organisms,.....	110	<i>Triceratium Davyanum</i> ,.....	145
Silicate of Soda as a Mounting Medium,.....	213	Uric Acid from a Caterpillar, Feather Crystals of,.....	217
Silicified Wood from Arizona,.....	198, 210, 220	Vacation,.....	191
Smith's, Prof. H. L., Newest Mounting Medium, Observations on,.....	102, 158	VAN BRUNT, C., The President's Address,.....	53
Spicules of <i>Heteromeyenia Ryderi</i> , Description of,.....	38, 39, 40	—, Prof. H. L. Smith's New Mounting Medium,....	158
— — —, Dimensions of,.....	104	Visual Field of Worker Honey-Bee's Ocelli,.....	88
Sponge, Fresh-Water (<i>Heteromeyenia Ryderi</i>),.....	37	WALES, WILLIAM, The Proper Care and Use of Microscope Lenses,.....	113
— — —, Observations on,.....	46	Wash-Bottle, Filter, The Hanaman,	125
Sponges,	116	WOODWARD, A., Bermuda Foraminifera.....	147
— : Boring Sponge,.....	121, 124	Working Session, The, of the American Society of Microscopists,	109, 111
—, Embryology of,....	118, 119	ZABRISKIE, J. L., Caterpillar Fungus from New Zealand, and some Related Species of the United States,.....	89
— : Glass Sponge,.....	121	—, Lenticular Markings of Various Coniferæ Compared,....	218
Spore Coal, Note on.....	19	—, Triungulin Larva of <i>Meloe angusticollis</i> ,.....	155
Sporules, The Minuteness of,....	29	—, Visual Field of Worker Honey-Bee's Ocelli,.....	88
Starch in Leaves,.....	28	Zentmayer's Abbe Condenser, .	156
<i>Stentor</i> , Mechanical Self-Division of,.....	209		
<i>Stephanodiscus Niagare</i> ,.....	41		
STOKES, ALFRED C., A New Symbiotic Infusorian,.....	152		
Swine Plague (<i>Pneumo-enteritis</i>), Micro-Organisms of,.....	41, 42		
<i>Synapta</i> , Note on,	100		
<i>Tabanus</i> , Eyes of,.....	34, 52		
Tamarack, Medullary Rays of, ..	27		

JOURNAL
OF THE
NEW-YORK MICROSCOPICAL SOCIETY.

VOL. II.

MARCH, 1886.

No. 3.

THE MICROBES OF PANARY FERMENTATION.¹

The question of panification is one of such importance that it might at first sight be supposed that it would have been one of the first to be solved by contemporary science. Such, however, has not at all been the case, for in recent years the most contradictory opinions upon the chemistry of bread have been emitted by distinguished scientists. In order to ascertain what phenomena accompany panary fermentation, let us rapidly pass in review the various categories of bread. In the first place, we have unleavened bread, the use of which is pretty much restricted to the ceremonies of various religions. At first sight, it would seem that we had nothing to do here with any ferment, but, as a matter of fact, there is no such thing as unleavened bread, and, supposing that such a thing really existed, we should here again have some very complex phenomena to submit to scientific analysis.

In bread with leaven, we see an action analogous to that of brewer's yeast upon an infusion of malt—to that of the substances commonly known as “mother of wine” and “mother of vinegar.” What is the nature of leaven, and what does it do in dough? In order to answer these questions, it will perhaps be easier to reason by analogy. The ferment contained in leaven is comparable to brewer's yeast, which is a microscopic plant—a *Saccharomyces*—that possesses the remarkable property of converting the sugar of must into alcohol and carbonic acid. Brewer's yeast and mother of wine, then, modify the composition of saccharine must and determine its yield of alcohol. But it is not yeasts only that act upon organic liquids, for in mother of vinegar we have narrow cells, of varying length,

¹Condensed from a paper by Emile Laurent, in the *Bulletin de la Société Royale de Botanique de Belgique*.

called bacteria. The existence of these organisms in leaven and dough had been pointed out several times without any one ever dreaming of according them any very important role ; but such was not the case with quite a small form found in leaven by Mr. Engel, who had no hesitation in attributing to it the phenomenon of panary fermentation. This was in 1872. At this epoch there was very little talk of the chemical action produced by bacteria, and a somewhat peculiar circumstance was adduced in favor of yeasts. It appears that for many centuries it has been customary in some places to add a little brewer's yeast to dough, and, at present, bread made in this manner is extensively eaten in those countries where beer is the principal beverage. What role must be attributed to brewer's yeast in the preparation of bread? Have we here an alcoholic ferment as in the brewer's mash-tub? This is a very delicate question, and one which would require an excursion into the domains of chemistry for an answer.

Let us now pass to something that is more directly connected with the subject of this paper.

Bacillus panificans.—Let us make some dough with any sample of flour whatever, and expose it for a few hours to a temperature of 35°. With an amplification of from 400 to 500 diameters, the microscope will show us the presence of starch and gluten, and, here and there, of small, slender rods, which are six times their width in length, and which are movable in the water in which the preparation was made. We have before us a bacterium of the type *Bacillus*. In order to facilitate the distinction of the micro-organisms in dough, it is well to employ a drop of a solution of iodine, or to color the bacilli by means of an aqueous solution of methyl violet or of fuchsine.

These bacilli are met with in leaven and dough of very diverse origin, and no sample of either has been examined which does not contain them. Some persons, while admitting that these organisms are dispersed over the entire earth, may nevertheless deny their specific unity ; but Dr. Koch's studies have fortunately furnished us with a sufficiently sure means of characterizing any species of bacterium. For this purpose, a bit of dough is intimately mixed with a little water freed from germs by the Chamberland filter, or by repeated boiling. A drop of the liquid is added to a tube of gelatinized and peptonized

bouillon, and the contents are then carefully poured upon a strip of glass, or upon a flattish watch-crystal that has been sterilized at a high temperature. At the end of the second day, or beginning of the third, there will appear upon the layer of gelatine some whitish spots, which, when examined under the microscope, will be found to be bacilli. Each rod has produced offshoots, and its progeny occupies a particular space that forms what is called a "colony." Every colony of the same species has an aspect that is peculiar to it, and, if several species be found in flour, we shall see several sorts of colonies. But there is one form of colony that predominates in a truly astonishing proportion. By its perfectly circular form, by its color, and by its mode of development in cultures upon gelatine, it may be recognized in a mixture of the bacteria of putrefaction. The rods of this species are found in bread after it has been baked, and more than 500,000 of them have been seen in a gramme of leavened bread—say 250,000,000 to the pound. These figures may cause those to shudder who have a horror of microbes; yet these bacilli are not only harmless, but are even powerful aids to us in the digestion of food.

Let us examine their mode of life in dough. We already know that, under the action of water and soluble ferments, there is an increase of the peptones and sugars in the dough. The germs of the *Bacillus* disseminated in flour soon multiply upon contact with water and soluble aliments. This species, moreover, has the property of depriving dough of a portion of its gluten, and of reducing the latter to soluble substances. In return, it improves the quality of bread. It lives and breathes, and consequently produces carbonic acid, which forms cavities in consequence of the elasticity of the gluten. It is due to this action that bread is rendered lighter and more agreeable to eat. Aside from this important function, the bread-bacillus brings about quite complicated actions in the dough. It will suffice to mention the production of acetic, butyric and lactic acids, which give bread a very pronounced acidity. There is no longer any possible doubt of it—the bacillus under consideration is the bacterium of panary fermentation, and so the name *Bacillus panificans* has been proposed for it.

And now as to the physiology of the organism: It is easily cultivated in Koch's nutritive gelatine, acid or slightly alka-

line. In acid gelatine it produces carbonic acid, but in alkaline no bubbles are formed, because a combination with the base occurs. It begins to develop at a temperature of about 6° , and the development continues up to 45° . At first, we observe some very short rods, but later on, after the liquid has become impoverished, we find elongated bacilli only. When the temperature is sufficient, these form a superficial veil wherein we often find very long filaments. The spores make their appearance at the centre of each articulation soon afterwards, and quickly drop off. They are easily distinguished in a preparation, since they are not colored by aniline. These spores are killed only at a temperature of 100° , prolonged for at least ten minutes. The sporeless rods, also, withstand very high temperatures, and it is certain that they survive at a depth of more than 7 or 8 millimetres in the bread, after the latter has been baked.

When we eat a little bread, then, we swallow myriads of living bacilli. These are not destroyed in the human stomach, but, on the contrary, find in the alimentary canal an abundance of albuminoid and starchy substances for their nourishment. Owing to their being adapted to both acid and alkaline media, and to their property of living with or without air, they must contribute towards digestion in man's alimentary canal.

It is this same species of bacillus that, with a few others, works in night-soil, and renders organic residua fit for the nourishment of the plants of our fields and gardens.

A few words as to bread made with yeast: As a matter of fact, there is no bread free from bacteria, since germs always exist in the flour used. For the same reason, we never have any bread made exclusively with yeast. In Belgian bread, fermentation is induced by *Saccharomyces cerevisie*. The phenomenon is the same as with the bacillus, save that it proceeds much more rapidly. Thus, it takes six or seven hours to prepare bread with leaven, while with yeast we in two hours obtain a dough that is fit for baking. Nevertheless, we may ask whether this substitution of the *Saccharomyces* for the *Bacillus* can be done without danger, and whether the one is just as well adapted as the other for panary fermentation. Aside from the phenomenon of disengagement of carbonic acid, common to all living beings, we have to consider the physiological action

of the *Saccharomyces* as compared with that of the *Bacillus*. The actions are different, as we may easily see by comparing the taste of bread made with yeast with that of bread made with leaven. Such difference is doubtless caused by products of fermentation of variable nature and number.

It is now possible to give a brief resumé of the principal phenomena that occur during the preparation of bread. Through kneading, the dough acquires a homogeneous composition in every part. Upon contact with water and the soluble ferments derived from the triturated cells, a portion of the starch and albuminoids becomes more easily assimilable for living beings. The organic ferments, *Saccharomyces* or *Bacillus*, mixed with the dough during kneading, feed on the substances that have become soluble, and produce carbonic acid gas. This latter accumulates in the cavities of the gluten, and thus, through the intervention of these organisms, the bread acquires lightness and savor. Baking finishes these modifications by altering the structure of the starch grains that have remained intact, and by increasing the size of the cavities through the expansion of the gas by heat. So the size of the loaf greatly increases in the oven. The external surface of the dough undergoes completer transformations than the central part does, in consequence of the higher temperature to which it is submitted. The starch is converted into dextrine, especially if there be a little steam in the oven, or the surface of the loaf be moistened with water; and thus results the beautiful, golden varnish so much liked by consumers.

This study of *Bacillus panificans* will permit us to explain the cause of

Ropiness in Bread.—During the warmest months, from June to September, it often happens that bread prepared in country houses undergoes transformations of a peculiar nature. Two or three days after being baked, it emits a putrid odor, and, when eaten, has a saccharine and not unpleasant taste. In a short time, the odor becomes stronger, and recalls that of albuminoid substances in a state of decomposition, and a finger inserted in the loaf shows the interior to be of a ropy consistency. This state of the bread is caused by the *Bacillus panificans*, when there is lack of sufficient acidity. The trouble may be prevented by the addition of a sufficient quantity of some organic acid to the dough.

PROCEEDINGS.

MEETING OF FEBRUARY 5TH, 1886.

The President, Mr. C. Van Brunt, in the chair.

Thirty-four persons present.

The President spoke as follows :—

“ This meeting, being the first after the Annual Meeting, is known, under our By-laws, as the Annual Reception. As it is incumbent on the newly elected officers to assume their duties at the Annual Reception, I take pleasure in resigning the chair to Mr. Zabriskie, our President for 1886.”

Mr. Zabriskie, on taking the chair, said :—

“ I thank you, gentlemen of the Society, for the honor you have done me in selecting me to preside over your deliberations. I am less confident of my ability to discharge the duties appertaining to the office of President in a manner which shall prove satisfactory to you, than I am of my desire to do so.

“ I would like to be of use to you, I would like to learn much from you ; and while I cannot but acknowledge that you exhibit considerable interest in the work and welfare of the Society, I would like, if I could do so, to say something which will not only keep that interest alive, but will stimulate it to increased activity.

“ The reflection that the field covered by the labors of such a Society as ours is so very large that no one has time, or means, or ability to work in every part of it, is encouragement for even modest efforts in microscopical investigation. In the verification of phenomena observed by other persons, facts unnoticed before are often met with, sometimes unimportant, sometimes significant, sometimes completely altering the conclusions of our predecessors.

“ Such reflections are incentives to the microscopical worker of every class and rank ; and if, induced by a desire to see, to learn, to know, even the least experienced undertake research, how well provided he is with help ! In no part of the world of

science has the explorer trustier maps and charts for his guidance than in the wonderfully fascinating portion, entrance to which must be made through the microscope.

“If there be persons who only pursue their studies under the stimulus of possible gain or good to themselves or to their fellows, surely, microscopical work offers to even such opportunities innumerable, embracing, as it does, almost every conceivable subject of a physical nature which can possibly interest man—from the etiology of disease to the constituents of the spheres.

“Let us, then, continue our investigations with additional energy. Let us bring their results here. In the hope that our meetings during the year upon which we now enter will be signalized by interesting and valuable work, I assume the trusts which you have imposed upon me.”

The following objects were exhibited :—

1. Globules of Copper ejected from a Siberian Volcano : by H. W. CALEF.
2. *Polyporus pinicola*, Fx., showing reactions of Phosphoric Acid : by P. H. DUDLEY.
3. Arranged Diatoms (one hundred and three species from the Pernambuco deposit); mounted by C. H. Kain, Camden, N. J.: by E. A. SCHULTZE.
4. Jasperized Wood from Arizona, showing fibrous structure : by L. SCHÖNEY.
5. *Rubus occidentalis* ; transverse section, shown by polarized light : by W. G. DE WITT.
6. Shell of *Diffugia corona* ; shown by polarized light: by W. G. DE WITT.
7. Crystals of Potassium Carbonate, shown by polarized light: by B. BRAMAN.
8. *Volvox globator* : by A. D. BALEN.

GEOLOGICAL PERIOD OF THE JASPERIZED WOOD FROM ARIZONA.

Dr. L. Schöney said : “I obtained my specimen of jasperized wood from the Jasperized Wood Company. It was mounted in Canada balsam by Mr. Lowden, of Poughkeepsie. The specimen shows, in its transparent spots, the characteristic markings of *Araucaria*—most probably of the species *Cunninghami*—with the dots in alternate rows. This group of trees is represented

in the Jurassic period (the Wealden epoch), on the upper horizon of it, or in the lower Triassic. The living representatives at the present time are confined to the southern hemisphere, to Brazil, Chili, but especially to Australia, and Norfolk-Island. *Araucarias* are found in the Carboniferous strata, closely allied to the specimen present, but, as with it are found other fossils, including sharks' teeth, which indicate a period later than the Carboniferous, the horizon of our specimen is more probably Jurassic or Triassic. Additional characteristic fossils of the place from which this specimen was taken must be found and determined, to settle the question definitely."

VOLVOX GLOBATOR KEPT ALIVE FOR THREE MONTHS.

Mr. A. D. Balen: "I have brought some specimens of *Volvox globator* which are interesting from the fact that they were taken from a bottle which has contained living organisms like these for three months, dating back from to-night, February 5th. During the last ten years I have made numerous attempts to keep these plants alive, but, except in the present instance, have found that they usually die out in about two or three weeks. Running through the southern portion of Plainfield is Cedar brook, a part of which, between Park and Prospect Avenues, passes through low ground, swampy in wet seasons, but sometimes quite dry. About half way between the avenues, there are several depressions which form little ponds. From these I have for several years taken plants and animals for microscopical examination, among them *Volvox*, which at times was very abundant. On November 5th, 1885, from the contents of each of three of those ponds I filled a four ounce quinine bottle. I took the bottles home, and on examination found a large quantity of *Volvox* in one, but only a small quantity in the others. All were in the ordinary sterile condition. After a few days none were visible in two of the bottles, but in the remaining bottle they had increased in number. This increase continued until a fire was made in the stove in my room, January 13th, 1886, when the *Volvox* lost color and began to disappear, owing, I thought, to the effects of coal-gas from the stove. I moved this third bottle to a window further from the stove than it had been placed, and, on the 17th, filled it with water from a well to replace what had evaporated. From that time the plants again in-

creased in number, but decreased, I think, in size. The bottle has hung constantly in front of a window where the sun shone in during a part of the day."

MEETING OF FEBRUARY 19TH, 1886.

The President, Mr. J. L. Zabriskie, in the chair.

Twenty-seven persons present.

The following objects were exhibited :—

1. Crystals of Vanadinite : by M. M. LE BRUN.
2. Young Poduras, found on gills of Toad-Stool : by W. G. DE WITT.
3. Fresh Crystals of Platino-Cyanide of Magnesium : by C. VAN BRUNT.
4. Seeds of *Anagallis arvensis*, in situ in pyxis : by B. BRAMAN.
5. *Ribes nigrum* ; transverse section of stem, double stained : by WALTER H. MEAD.

Mr. P. H. Dudley exhibited a Thoma Microtome, and described the method of using the same.

Mr. H. L. Brevoort exhibited a compound microscope and accessories made by Dolland, of London, which had been in the possession of Mr. Brevoort's family since 1795.

The President exhibited a smaller microscope of simpler construction, also by Dolland, and as old as that shown by Mr. Brevoort.

Mr. W. G. De Witt said that the scales shown by him were from a young podura. They were found, he said, near Savannah, Georgia, on the gills of a toad-stool, in the month of April. He suggested that search for poduras be made in this vicinity during the months of May and June, which, in this latitude, correspond in temperature with April in Savannah.

Mr. Arthur G. Leonard was elected an active member.

PUBLICATIONS RECEIVED.

National Druggist : Vol. VIII., No. 5 (January 29th, 1886); pp. 16. No. 6 (February 5th); pp. 16. No. 7 (February 12th); pp. 12. No. 8 (February 19th); pp. 16.

The Electrician and Electrical Engineer : Vol. V., No. 50 (February, 1886); pp. 40.

Indiana Medical Journal : Vol. IV., No. 7 (January, 1886); pp. 22.

Transactions of the New-York Academy of Sciences : Vol. V., No. 3 (December, 1885); pp. 38.

The School of Mines Quarterly : Vol. VII., No. 2 (January, 1886); pp. 96.

Brooklyn Entomological Society. Entomologica Americana : Vol. I., No. 11 (February, 1886); pp. 20.

The Naturalist's World : Vol. III., No. 26 (February, 1886); pp. 20.

The Canadian Science Monthly : Vol. III., Nos. 10 and 11 (October and November, 1885); pp. 24.

Anthony's Photographic Bulletin : Vol. XVII., No. 3 (February 13th, 1886); pp. 32.

The American Monthly Microscopical Journal : Vol. VII., No. 2 (February, 1886); pp. 20.

The Microscope : Vol. VI., No. 2 (February, 1886); pp. 24.

Nuovo Giornale Botanico Italiano : Vol. XVIII., No. 1 (January, 1886); pp. 64.

Bulletin of the Torrey Botanical Club : Vol. XIII., No. 1 (January, 1886); pp. 16.

The Correspondence University Journal : Vol. III., No. 4 (February, 1886); pp. 12.

Bulletin de la Société Royale de Botanique de Belgique : Tome Vingt-Quatrième, Fasc. 2 (1885); pp. 130. Comptes-Rendus des Séances; pp. 224. Tome Vingt-Cinquième, Deuxième Partie (1886); pp. 33.

Berichte über die Verhandlungen der Naturforschenden Gesellschaft zu Freiburg i B.: Band VIII., Heft I. (1885); pp. 47.

American Naturalist for December, January, and February. Reprints of Articles on Microscopy; pp. 15.

Drugs and Medicines of North America : Vol. I., No. 9 (March, 1886); pp. 32.

The Botanical Gazette : Vol. XI., No. 2 (February, 1886); pp. 24.

Journal of the Trenton Natural History Society : Vol. I., No. 1 (January, 1886); pp. 22.

Bulletin of the Torrey Botanical Club : Vol. XIII., No. 2 (February, 1886); pp. 16.

INDEX TO ARTICLES OF INTEREST TO MICROSCOPISTS
WHICH HAVE RECENTLY APPEARED IN OTHER
JOURNALS.

- Algae of Fresh Water, Provisional Key to Classification of (VI.): R. HITCHCOCK.
Am. Mon. Mic. Jour., VII. (1886), pp. 30-1.
- Algenformen, Mittheilen ueber einige: ROBERT WOLLNY.
Hedwigia, XXV. (1886), pp. 1-5 (7 figs.).
- Algæ, Fresh-Water (I.): GEORGE NORMAN.
Jour. of Mic., V. (1886), pp. 33-6.
- Anurida maritima*, Guerin, The Development of: JOHN A. RYDER.
Am. Nat., XX. (1886), pp. 299-302 (10 figs.).
- Antheridium in Ferns, On the Development of: DOUGLASS H. CAMPBELL.
Bull. Torrey Bot. Club, XIII. (1886), pp. 48-51 (7 figs.).
- Astigmatism Practically Considered in Microscopical Work: JAMES K. STOCKWELL.
The Microscope, VI. (1886), pp. 29-32.
- Astasia ocellata*, l', et l' *Euglena viridis*, Recherches biologiques sur: W. KHAWKINE.
Ann. des Sci. Nat., XIX. (1885), pp. 1-48 (7 figs.).
- Botrychium ternatum*, On the Development of the Root in: DOUGLASS N. CAMPBELL.
Bot. Gazette, XI. (1886), pp. 48-53 (10 figs.).
- Cicadas*, On the Sound-Producing Apparatus of the: C. LLOYD MORGAN.
Nature, XXXIII. (1886), pp. 368-9 (2 figs.).
- Cotton Fibre, Notes on the (II.): WALTER HENSHALL.
Sci.-Gossip, 1886, pp. 37-9 (1 fig.).
- Epithelium, How to Examine: C. H. STOWELL.
The Microscope, VI. (1886), pp. 25-8 (6 figs.).
- Epiphytism among *Algæ*, On Some New Cases of: WILLIAM CRAIG.
Trans. and Proc. Bot. Soc. Edinburgh, XVI. (1886), pp. 209-19.
- Euglena viridis*. See *Astasia ocellata*.
- Fungi Inducing Decay in Timber: P. H. DUDLEY.
Trans. N. Y. Acad. Sci., V. (1886), pp. 110-118.
- Fungus, A Nettle: W. B. GROVE.
Sci.-Gossip, 1886, pp. 35-7 (4 figs.).
- Hepaticarum species novum vel minus cognitæ: F. STEPHANI.
Hedwigia, XXV. (1886), pp. 5-9 (20 figs.).
- Histologie der Haut der *Reptilien*, Beiträge zur: W. LWOFF.
Bull. Soc. Imper. Nat. Moscow, LX. (1884), pp. 313-337 (9 figs.).
- Hypocreaceæ*, Synopsis of the North American (To be continued): J. B. ELLIS and B. M. EVERHART.
Jour. Mycol., II. (1886), pp. 28-31.
- Infusoria from American Fresh Waters, Some New: ALFRED C. STOKES.
Ann. and Mag. Nat. His., XVII. (1886), pp. 98-112 (21 figs.).

Infusoria, Temporary Encystment among : J. G. GRENFELL.

Sci.-Gossip, 1886, pp. 31-3 (7 figs.).

Lonicere, Di alcune anomalie riscontrate negli organi fiorali delle : F. CAVARA.

Nuovo Giorn. Bot. Ital., XVIII. (1886), pp. 52-9 (53 figs.).

Malattia del Frumento, una nuova, Alcune osservazioni sopra : FAUSTO MORINI.

Nuovo Giorn. Bot. Ital., XVIII. (1886), pp. 32-43.

Microbes de la Fermentation alcoolique de Lait : EM. BOURQUELOT.

Revue Scientif., XXXVII. (1886), pp. 172-7.

Micrometers, The Relative Merits of Filar and Ordinary Glass Eye-Piece : M. D. EWELL.

The Microscope, VI. (1885), pp. 32-40.

Microscopical Advances—Ancient and Modern (V.): DR. ROYSTON PIGOTT.

Eng. Mech., XLII. (1886), pp. 483-4.

Microscope, The, and How to Use it (Pt. V.—Double-Staining, etc.): V. A. LATHAM.

Jour. of Mic., V. (1886), pp. 36-43.

Mildews of Indiana : J. N. ROSE.

Bot. Gazette, XI. (1886), pp. 60-3.

Moss, A British, New to Science : G. A. HOLT.

Jour. Bot., XXIV. (1886), p. 65 (7 figs.).

Mouth Organs, The, and other Characteristics of the British Geodephaga : ROBERT GILLS.

Jour. of Mic., V. (1886), pp. 10-24 (32 figs.).

Mounting Mediums with High-Refractive Indices : W. H. SEAMAN.

Am. Mon. Mic. Jour., VII. (1886), pp. 21-4.

Phyllopod Crustacea, Metamorphosis and Morphology of certain : C. L. HERRICK.

Bull. Scientif. Lab. Denison University, I. (1885), pp. 16-24 (35 figs.).

PASTEUR, La Laboratoire de.

Revue Scientif., XXXVII. (1886), pp. 370-1.

Peziza, Notes on : J. B. ELLIS.

Jour. Mycol., II. (1886), pp. 44-7.

Phyllostictas of North America : GEORGE MARTIN.

Jour. Mycol., II. (1886), pp. 12-26.

Physiological Functions of Plant Tissues, Haberlandt's Views on the : G. F. SCOTT ELLIOT.

Trans. and Proc. Bot. Soc., Edinburgh, XVI. (1886), pp. 261-9.

Rhizosolenia alata, Auxosporenbildung von : FRANZ SCHÜTT.

Ber. Deutsch. Bot. Gesellsch., IV. (1886), pp. 8-14.

Rotifers of America (Pt. 1), with Descriptions of a New Genus and several New Species : C. L. HERRICK.

Bull. Scientif. Lab. Denison University, I. (1885), pp. 43-62 (21 figs.).

Rotifers, Final Notes on the So-Called Desiccation of : HENRY DAVIS.

Jour. Quek. Mic. Club, II. (1886), pp. 231-3.

Sexual Organs of Reproduction in Angiosperms, Structure of the (No. 2.—Ovary of *Lilium*).

Cole's Studies in Mic. Sci., III. (1886), pp. 45-8 (colored plate).

JOURNAL
OF THE
NEW-YORK MICROSCOPICAL SOCIETY.

VOL. II.

APRIL, 1886.

No. 4.

PHILOPTERUS CORVI.

BY PROF. SAMUEL LOCKWOOD, PH.D.

(Read March 19th, 1886.)

According to Dr. Packard, the great order Hemiptera, the defective-winged insects, takes in the *Cicada*, the *Notonecta*, or Water-Boatman, the *Aphide*, or leaf-vermin, and many other insects, including certain degenerate species which are entirely wingless, closing with the most degraded forms of the whole order,—the parasites which infest animals and which are known as lice proper. These vermin are embraced in two distinct families, one bearing the name of Pediculina, the other, Mallophaga. The former are genuine blood-suckers, being specially fitted for that business, having a sharp-edged tubular snout which can be thrust into the skin of the host and through which blood can thus be withdrawn. They have no jaws. They infest man and beast, and, strange to say, different species may infest the same animal, each species confining itself to its own especial part of the body. It is even claimed that the lice found on different races of men are specifically different.

The Mallophaga infest birds and mammals; in other words, the feather-clad and the hair-clad animals. Even the porpoise of the sea is not permitted to be free from them. They devour the feathers and hairs upon which they dwell, and hence the great difference between their mouth-parts and those of the blood-suckers. The Mallophaga are masticators. They possess jaws by means of which they comminute their tough pabulum, namely, feathers and hairs, which consist almost entirely of keratose, or horn. They are numerous in species although the number of genera is comparatively small.

There used to be a doggerel proverb among sporting men,—
“The feathers and the hair
Make many a man swear.”

It is well that verbal utterance is denied to the beasts and the birds. If it were not, surely the miseries inflicted on them by man and the Mallophaga would evoke maledictions enough to raise one's hair.

Of the several genera of these pests of the bird is one named *Philopterus*, a word which seems to mean a lover of the flying-race. Evidently, it must be by way of irony that this tormenting creature is set down as a lover of the birds! This parasite, the *Philopterus*, more accurately described, is a lover of feathers; and, like the expert house-wife, it recognizes and prefers “live feathers;” for immediately after the death of its host the *Philopterus* deserts its feathery home, both bed and board.

On the 30th day of January last, a crow just shot was brought to my house. It was infested with vermin, of which the slide exhibited this evening contains two specimens. They differ very much in size. The larger one I set down as *Philopterus Corvi*. I am not sure that the smaller one is of the same species. Besides that of size it has other differences, notably the curious development of hair on each side of its head, which is lacking in the larger one. A pedicelled egg behind the abdomen indicates that it is of the female sex; but, then, bearded ladies are not often found outside of “Dime Museums.” The discrepancy of size is very marked, and generally, when this is so pronounced between two mature individual insects of the same species, the one of the lesser proportions is the male. However, one meets problems like this constantly, and in the pursuit of entomology the perplexed student is often compelled to admit, “It beats the boys!”

PROCEEDINGS.

ANNUAL RECEPTION OF 1886.

The Eighth Annual Reception of the Society was held at Lyric Hall on the evening of March 5th, 1886.

In several important features this reception differed from those which had preceded it. There was no address by the President, the annual address by that officer having been delivered at a previous meeting of the Society; hence, the entire evening was given up to the examination, by the guests, of the microscopic objects shown, and to the usual social interchanges which so markedly characterize these receptions. From the numerous objects offered for exhibition by the members, fifty-two only were selected by the managers. These occupied twelve substantial tables which were placed in the Auditorium. The great size of this room permitted the one thousand guests present to move about with comfort and to study at their convenience the objects shown by the thirty-three members who were exhibitors. The contiguous hall, in which were the musicians, contained ample seating room for such persons as from time to time left the tables, to be nearer the music, to rest, or to converse more at ease than they could in the exhibition hall.

The objects shown were as follows:—

1. *GREEN SAPPHIRE WITH CUNEIFORM INCLUSIONS.*
Exhibited by G. F. KUNZ.
2. *GEM GRAVEL, FROM CEYLON.*
Exhibited by G. F. KUNZ.
3. *SCALES OF THE SEA-ROBIN.*
Exhibited by W. H. BATES, M. D.
4. *ROTIFER VULGARIS.*
Exhibited by W. R. MITCHELL.
5. *TONGUE OF DOG.*
Exhibited by EDWARD G. DAY.
6. *CLAW OF MOSQUITO.*
Exhibited by EDWARD G. DAY.
7. *RECENT FRESH-WATER DIATOMS.*
Exhibited by C. VAN BRUNT.

8. *A MICROSCOPIC ENGRAVING.*
Exhibited by C. VAN BRUNT.
9. *SPINNERET, OR SPINNING ORGAN OF THE SPIDER.*
Exhibited by C. VAN BRUNT.
10. *CRYSTALS OF HORSFORD'S ACID PHOSPHATES:*
SHOWN BY POLARIZED LIGHT.
Exhibited by C. VAN BRUNT.
11. *CILIA OF THE OYSTER.*
Exhibited by F. W. DEVOE.
12. *YOUNG SALMON (just hatched).*
Exhibited by F. W. DEVOE.
13. *HUMAN BLOOD,*
Exhibited by F. W. DEVOE.
14. *FERN-LEAF GOLD CRYSTALS.*
Exhibited by G. S. WOOLMAN.
15. *PLATINO-CYANIDE OF MAGNESIUM.*
Exhibited by G. S. WOOLMAN.
16. *SEEDS OF ORTHOCARPUS PURPURASCENS.*
Exhibited by G. S. WOOLMAN.
17. *CRYSTALS OF STEEL IN A STEEL CASTING.*
Exhibited by P. H. DUDLEY.
18. *ETCHED SURFACE OF A STEEL CASTING.*
Exhibited by P. H. DUDLEY.
19. *DIAMOND-BEETLE.*
Exhibited by M. H. EISNER.
20. *EMBRYO CHICK (fourth day).*
Exhibited by M. H. EISNER.
21. *SPIRACLES.*
Exhibited by F. W. LEGGETT.
22. *CRYSTALS OF CINNABAR.*
Exhibited by J. A. CHAMBERS.
23. *VOLCANIC GLASS, FROM DAKOTA.*
Exhibited by E. B. GROVE.
24. *BACILLUS TUBERCULOSIS.*
Exhibited by L. SCHÖNEY, M. D.
25. *ARRANGED DIATOMS.*
Exhibited by WILLIAM WALES.
26. *MANGE INSECT (Dermatodectes (Sarcoptes) equi) FROM A HORSE.*
Exhibited by WILLIAM WALES.
27. *FOSSIL WOOD FROM ARIZONA, TRANSVERSE SECTION.*
Exhibited by M. M. LE BRUN.

28. *FOSSIL WOOD FROM ARIZONA, LONGITUDINAL RADIAL SECTION.*
Exhibited by M. M. LE BRUN.
29. *POLYCYSTINA.*
Exhibited by BENJAMIN BRAMAN.
30. *CIRCULATION OF BLOOD IN THE FROG.*
Exhibited by J. L. WALL.
31. *LACINULARIA SOCIALIS.*
Exhibited by W. E. DAMON.
32. *CIRCULATION OF BLOOD IN THE TAIL OF A FISH.*
Exhibited by WALTER H. MEAD.
33. *ARRANGED GROUP—DIATOMS, SYNAPTA, AND CHIRO-
DOTA.*
Exhibited by C. S. SHULTZ.
34. *EGGS OF PARASITE.*
Exhibited by C. S. SHULTZ.
- 35 and 36. *POND-LIFE.*
Exhibited by A. D. BALEN.
37. *MULTIPLE IMAGES FORMED BY EYE OF COCKROACH.*
Exhibited by J. D. HYATT.
38. *TROMBIDIUM, OR RED MITE.*
Exhibited by the Rev. WM. HUCKEL.
39. *SECTION OF A FRAGMENT FROM THE OBELISK.*
Exhibited by A. WOODWARD.
40. *DIATOMS.*
Exhibited by E. A. SCHULTZE.
41. *SPICULES OF GORCONIA.*
Exhibited by W. G. DEWITT.
42. *TRICHINA SPIRALIS IN HUMAN MUSCLE.*
Exhibited by W. G. DEWITT.
43. *IRIDESCENT COPPER PYRITES.*
Exhibited by LUCIUS PITKIN.
44. *DIATOMS.*
Exhibited by LUCIUS PITKIN.
45. *SECTIONS OF PINE-NEEDLES.*
Exhibited by H. W. CALEF.
46. *HEAD OF CRANE-FLY.*
Exhibited by F. COLLINGWOOD.
47. *YOUNG CATERPILLARS.*
Exhibited by E. B. SOUTHWICK.
48. *JAWS OF LARVA OF APPLE-TREE BORER (*Sepeda can-
dida*, Fabr.).*
Exhibited by E. B. SOUTHWICK.

49. *A PIGEON-POST FILM.*
Exhibited by the REV. J. L. ZABRISKIE.
50. *SECTION OF FELTED WOOLEN GOODS.*
Exhibited by H. L. BREVOORT.
51. *INSECT SCALES.*
Exhibited by C. W. McALLISTER.
52. *ARRANGED DIATOMS.*
Exhibited by C. W. McALLISTER.

MEETING OF MARCH 19TH, 1886.

The President, Mr. J. L. Zabriskie, in the chair.

Twenty-five persons present.

OBJECTS EXHIBITED.

1. Graphite Scale from No. 1 Cast Iron: by P. H. DUDLEY.
2. No. 2 Cast Iron, showing fine and coarse structure: by P. H. DUDLEY.
3. No. 3 Cast Iron, showing fine and coarse structure: by P. H. DUDLEY.
4. Vertical section of human Scalp; mounted by S. G. Shanks, M.D.: by A. G. LEONARD.
5. Crow-Lice (*Philoaterus Corvi*): by F. W. DEVOE.
6. Eggs of *Chrysopa oculata*, Say, *in situ* on their long silken stalks: by E. B. SOUTHWICK.
7. Hymenopterous Insect of the genus *Torymus*, parasitic on the gall (*Rhodites bicolor*) on the Swamp Rose (*Rosa Carolina*, L.): by J. L. ZABRISKIE.
8. An Ant and one of its "cows" (*aphides*): by E. B. SOUTHWICK.
9. Jaws of Larva of Nut-Weevil: by F. W. LEGGETT.

STRUCTURE OF CAST IRON.

Mr. P. H. Dudley said: "I have under the microscope a scale from No. 1 cast iron.

"Among the several grades of cast iron are those known as No. 1, No. 2, No. 3, and No. 4; special names being given to other grades, as white, mottled, etc. The coarsest parts of cast iron in large castings are found in the centre of the castings, the apparent crystals being much larger there than in any other part. No. 1 cast iron contains graphite, that is, it contains

about five *per cent.* of carbon, of which more than one-half is graphitic carbon. Before the metal congeals, this seems to partly crystallize, forming minute laminae, which become the weak places in the larger pieces of cast iron.

“I have scales from railroad iron which are nearly one-eighth of an inch in thickness. When this iron breaks, the fracture does not pass through the solid portions, but follows the planes of these scales. A piece of No. 1 cast iron, three feet long and three inches by four inches thick, will break if these scales are in the metal. In No. 2 cast iron these scales are smaller. I have found in it one small fragment only, which perhaps consists of a single minute lamina, and was discovered lying between what appeared to be crystals.

“The scale under the first microscope is from No. 1 iron, and consists probably of four or five layers, although it is not more than $\frac{1}{3000}$ th of an inch thick. Under the second microscope is a specimen of No. 2 iron, and under the third microscope is a specimen of No. 3 iron. In the No. 2 and No. 3 the outer portions of the specimens are of fine texture, but the central parts are almost as coarse as in No. 1, which is evidence of weakness of structure.

“These laminae limit the size of castings. In the manufacture of ordnance the limit where size precludes strength is soon reached. Very large guns are in fact sometimes weaker than small ones.

“The graphite scale (under the first microscope) resembles very closely the graphite which comes from Ticonderoga. The piece of cast iron No. 2 (under the second microscope), although apparently finer than specimen No. 3 (under the third microscope), displays what appear to be crystals, also a layer-like structure, the plates of which extend in various directions. Between these plates cavities exist which make the iron comparatively porous.”

CONCERNING STEEL RAILS,

Mr. Dudley, in answer to a question, remarked: “In steel the percentage of graphite is very small. Bessemer steel contains about $\frac{1}{10}$ ths of one *per cent.* of carbon, of which a small proportion is sometimes graphitic carbon. Steel is not absolutely amorphous. Its crystals are, at present, supposed to be surrounded by carbide of iron. It is considered that, the softer

the steel, the more rapidly it wears and the more likely it is to break. It does not wear smooth, it drops out in patches; the small laminae become loosened and the large scales fall off. Steel for rails is not made now as it was when steel rails were introduced. Then, the rails were made of ingots of steel ten or twelve inches square and of sufficient length to make one rail only. Now, the ingot is from fifteen to sixteen inches square and long enough to make three rails. The rails now made contain, as shown by analysis, practically the same percentage of carbon as those first made, yet they are much softer than those, because the granulations of the metal are coarser, the large size of the ingots being answerable for that. These granulations are bounded by a delicate layer of what is probably carbide of iron, and they become loosened very easily. This explains why the axles of car-wheels are liable to fracture. The fracture follows along the planes—even in wrought iron—of these apparent crystals (granulations). At the present time, the life of a steel rail is about one-half as long as when steel rails were first made. The wear of a rail is as follows: The rail rests upon ties. Dust, containing particles of grit, accumulates between the ties and the rail, and cuts and grinds away the metal under the motion of the rail produced by the passage of railway trains over the track. No means exist of securing the rails from the movements caused by trains in motion. The under side of a rail will thus be worn away one-eighth of an inch while the upper side is worn away one-quarter of an inch. A few years ago rails were enlarged at the top and lessened at the bottom, in consequence of the belief that they would wear better if so shaped; but the result was, they wore out so rapidly at the base that their use became dangerous before the upper side was worn out: hence, the present shaped rail, which is large at the top as well as at the bottom."

EGGS OF THE CHRYSOPA OCVLATA.

Mr. E. B. Southwick: "The position of the eggs is the peculiar feature of the object I have brought. They are the eggs of the lace-wing fly and are situated on silken stalks half an inch in length. The fly deposits its eggs in masses among swarms of plant-lice upon which the larvæ feed. The eggs are placed on these stalks in order that they shall be out of the

reach of danger. The stalks are alike in size, and the material of which they are composed resembles in appearance the product of the silk-worm. I have not been able to find in books any satisfactory explanation of this egg-depositing process."

Mr. Beutenmüller : "It would seem that at present no one knows how these stalks are produced."

The President : "I have always supposed that the stalks were composed of a substance similar to the glutinous matter employed by insects sometimes for covering the egg mass. The stalks must be strong, for they support their burdens of eggs through rains and winds and all the vicissitudes of the weather. I have seen as many as twenty eggs in a cluster."

Mr. Braman : "I have found them attached to a culm of grass, seven or eight of them in a row, nearly one-quarter of an inch apart."

A PARASITE ON THE GALL OF THE SWAMP-ROSE.

The President said : "I have brought for exhibition a parasite found on the gall of the swamp-rose—a hymenopterous insect of the genus *Torymus*. Its species I do not know. There are a great many species which have not yet been determined. I submitted this parasite to Prof. Riley, of Washington, for identification. He has not yet determined its species. Six at least of these parasites were taken by me from this one gall. The gall (*Rhodites bicolor*, Harris) is very beautiful in its young and fresh state. It is as large as the fruit of the wild gooseberry, being about half an inch in diameter, and has spines one-third of an inch long projecting in every direction from its surface. When young and before its maturity it is very often cream-colored, shading into a vermilion. After maturity it changes to a dark-brown color.

"The parasite is remarkable for its long, stout ovipositor and for the extreme beauty of its colors."

The President exhibited and described a wooden case, designed by himself, the purpose of which was to hold in a small compass, without pressure, a considerable number of such plant specimens as would be injured if confined in the ordinary collection cases where they would be subjected to pressure.

Mr. William E. Damon was elected an Active Member of the Society.

BOOK NOTICES.

SECOND ANNUAL REPORT OF THE INJURIOUS AND OTHER INSECTS OF THE STATE OF NEW YORK. By J. A. LINTNER, State Entomologist. Albany: Weed, Parsons and Company. 1885. Pp. 265.

This Second Report, lately issued, is admirable in form and exceedingly valuable in material. The continuous dealing with economic entomology throughout its pages amply verifies the author's statement in the Introduction, that it has been prepared with special reference to the benefit of the agricultural community. Its full descriptions of many injurious insects, their transformations and modes of attack, coupled with directions for the application of tried remedies, must be eminently interesting and valuable to any farmer who will heed them.

Besides other admirable characteristics which might be mentioned, this Second Report, fulfilling the hopes excited by its voluminous predecessor, is especially valuable, both to the professional and the amateur entomologist, on account of its republication of contributions to this department by Dr. Asa Fitch, its full record of synonymy and bibliography, and its complete table of contents, and its general and plant indexes—the two latter occupying about twenty pages.

NOTES ON HISTOLOGICAL METHODS, including a brief consideration of the methods of Pathological and Vegetable Histology, and the application of the Microscope to Jurisprudence. For the use of Laboratory Students in the Anatomical Department of Cornell University. By SIMON H. GAGE, Assistant Professor of Physiology, and Lecturer on Microscopical Technology. Pp. 56. Ithaca, N. Y.: Andrus & Church.

"The object of histological methods is to assist the investigator in obtaining a complete knowledge of the tissues. Complete knowledge of any tissue comprises, in the writer's opinion, an understanding of: (1) The gross anatomy. (2) The form, nature and relations of the structural elements. (3) The blood-vessels. (4) The lymph-vessels. (5) The nerve-supply,—the relation of the terminal filaments of the nerves to the structural elements. (6) The histogenesis or development. (7) The function or physiology of the tissue.

“At the present day, however, not a single tissue is known in all the detail indicated above.”—*Extract from Prefatory Note.*

TOPICS.—(1) The Microscope and its Parts. (2) Learning to use a Microscope. (3) Slides and Covers; Interpretation of Appearances. (4) Magnification, Micrometry and Drawing. (5) The Study of living tissues. (6) Isolation and preservation of the structural elements. (7) Hardening tissues. (8) Section cutting and mounting. (9) Serial sections. (10) Fine injections. (11) Methods of pathological histology. (12) Methods of vegetable histology. (13) The Microscope in Jurisprudence. (14) Reagents and their preparation. (15) Bibliography.

HOW TO PHOTOGRAPH MICROSCOPIC OBJECTS. A Manual for the Practical Microscopist. By I. H. JENNINGS. New York: E. & H. T. Anthony & Co. Pp. 32. (Illustrated.)

“The following pages are presented to the practical microscopist as one of the best collections of useful information on photo-micrography that has appeared for many years. The author's standing amongst English scientific workers is a sufficient guarantee for the thoroughness of the methods and processes described, and we feel that American laborers in the same field will find them an invaluable aid in this interesting department of applied photography.”—*Publisher's Notice.*

Lesson I.—Microscopical Apparatus. II.—Photographic Apparatus. III.—Illuminating Apparatus. IV.—Exposing the Plate. V.—Development. VI.—Defects in the Negative. VII.—Printing. VIII.—Preparing Objects for Photography. IX.—Preparing Entomological Slides. X.—Preparing Vegetable Tissues for Photography. XI.—Preparing Sections of Hard Substances for Photography. XII.—Preparing Crystallizations for Photo-micrography.

PUBLICATIONS RECEIVED.

National Druggist : Vol. VIII., No. 9 (February 26th, 1886); pp. 16. No. 10 (March 5th); pp. 12. No. 11 (March 12th); pp. 12. No. 12 (March 19th); pp. 12. No. 13 (March 26th); pp. 12.

Anthony's Photographic Bulletin : Vol. XVII., No. 4 (February 27th, 1886); pp. 32. No. 5 (March 13th); pp. 32. No. 6 (March 27th); pp. 32.

The Electrician and Electrical Engineer : Vol. V., No. 51 (March, 1886); pp. 40.

Indiana Medical Journal : Vol. IV., No. 8 (February, 1886); pp. 22. No. 9 (March); pp. 22.

Proceedings of the American Academy of Arts and Sciences : New Ser., Vol. XIII., Whole Ser., Vol. XXI., Pt. 1. (May to October, 1885); pp. 247.

Second Report of the Injurious and Other Insects of the State of New York (1885); pp. 262. By J. A. Lintner.

The West-American Scientist . Vol. II., No. 1 (January, 1886); pp. 10. No. 13 (February); pp. 5. No. 14 (March); pp. 5.

Proceedings of the Canadian Institute, Toronto : Third Ser., Vol. III., Fascic. No. 3 (February, 1886); pp. 45.

Proceedings of the Natural Science Association of Staten Island : February 13th, 1886; p. 1.

Journal of the Royal Microscopical Society : Ser. II., Vol. V., Pt. 6a (December, 1885); pp. 45 + 57. Vol. VI., Pt. 1 (February, 1886); pp. 192.

Bulletin of the Washburn College Laboratory of Natural History : Vol. I., No. 4 (October, 1885); pp. 36.

The Naturalist's World : Vol. III., No. 27 (March, 1886); pp. 20.

Bulletin of the Torrey Botanical Club : Vol. XIII. No. 2 (March, 1886); pp. 16.

Bulletin of the California Academy of Sciences : No. 4 (January, 1886); pp. 213.

The Correspondence University Journal : Vol. III., No. 5 (March 15th, 1886); pp. 12.

Notes on Histological Methods ; pp. 56. By Simon H. Gage.

Journal of Mycology : Vol. II., No. 3 (March, 1886); pp. 12.

The American Monthly Microscopical Journal : Vol. VII., No. 3 (March, 1886); pp. 20.

The Botanical Gazette : Vol. XI., No. 3 (March, 1886); pp. 24.

Jahrbücher des Nassauischen Vereins für Naturkunde : Jahrgang 38 (1885); pp. 181.

The Microscope : Vol. VI., No. 3 (March, 1886); pp. 24.

The Microscopical Bulletin and Science News : Vol. III., No. 1 (February, 1886); pp. 8.

Comptes-Rendus des Séances de la Société Royale de Botanique de Belgique: February 13th, 1886; pp. 14.

Ottawa Field-Naturalists' Club : Transactions No. 6, Vol. II., No. 2 (1884-1885); pp. 132.

INDEX TO ARTICLES OF INTEREST TO MICROSCOPISTS
WHICH HAVE RECENTLY APPEARED IN OTHER
JOURNALS.

Algæ, Fresh-Water, (including *Chlorophyllaceous Protophyta*) of the English Lake District ; with descriptions of twelve new species : ALFRED W. BENNETT.

Jour. Roy. Mic. Soc., VI. (1886), pp. 1-15 (33 figs.).

Algæ of Fresh Water, Provisional Key to Classification of : R. HITCHCOCK.

Am. Mon. Mic. Jour., VII (1886), pp. 50-2.

Astigmatism and its Relation to the Use of Optical Instruments further considered : E. GUNDLACH.

The Microscope, VI. (1886), pp. 63-5.

Bacteria, The Cultivation of, and the Cholera Bacillus : LESTER CURTIS.

Proc. Am. Soc. Mic., 1885, pp. 142-50.

Bacteria, On the Cultivation of : EDGAR M. CROOKSHANK.

Jour. Roy. Mic. Soc., VI. (1886), pp. 25-31 (6 figs.).

Botrychium ternatum, The Development of the Root in : DOUGLAS H. CAMPBELL.

Bot. Gaz., XI. (1886), pp. 49-53 (10 figs.).

Butter and Fats. To Distinguish one Fat from another by Means of the Microscope : THOMAS TAYLOR.

Proc. Am. Soc. Mic., 1885, pp. 128-38.

Cartilage, Studies of the Development of the, in the Embryo of the Chick and Man : M. L. HOLBROOK.

Proc. Am. Soc. Mic., 1885, pp. 76-82 (2 figs.).

Central *v.* Oblique Light : EDWARD M. NELSON.

Eng. Mech., XLII. (1886), pp. 527-8 (5 figs.).

Chick Embryos, On the Preparation of, for Microscopical Examination : W. P. MANTON.

Proc. Am. Soc. Mic., 1885, pp. 66-70.

Diamond, in Ruling Lines upon Glass, Explanatory Notes on a Series of Slides presented to the Society, Illustrating the Action of a : W. A. ROGERS.

Jour. Roy. Mic. Soc., VI. (1886), pp. 16-21.

Diatom Hoops, Some. The Question of their Mode of Growth (*Aulacodiscus Kittoni*) : JACOB D. COX.

Proc. Am. Soc. Mic., 1885, pp. 33-7 (2 fig.).

Dried Beef, Poisonous : H. J. DETMERS.

Proc. Am. Soc. Mic., 1885, pp. 54-9 (1 fig.).

Floscule, A New : D. S. KELLICOTT.

Proc. Am. Soc. Mic., 1885, pp. 48-50.

Focus, The Actinic and Visual, in Photo-Micrography : JACOB D. COX.

Proc. Am. Soc. Mic., 1885, pp. 29-32 (2 figs.).

Infusoria, Fresh-Water, Observations on some : D. S. KELLICOTT.

Proc. Am. Soc. Mic., 1885, pp. 38-47.

Infusoria, Fresh-Water, Stray Notes on : D. S. KELLICOTT.

The Microscope, VI. (1886), pp. 53-8 (4 figs.).

Microscopical Advances—Ancient and Modern (VI.): DR. ROYSTON PIGOTT.

Eng. Mech., XLIII. (1886), pp. 45-6.

Micro-Organisms, On the appearances which some present under different conditions, as exemplified in the Microbe of Chicken Cholera : G. F. DOWDESWELL.

Jour. Roy. Mic. Soc., VI. (1886), pp. 32-6 (6 figs.).

Mounting Media of High-Refractive Index : HAMILTON L. SMITH.

Proc. Am. Soc. Mic., 1885, pp. 86-90 (1 fig.).

Muscle, First Development of, in the Embryo of the Chick and Man : M. L. HOLBROOK.

Proc. Am. Soc. Mic., 1885, pp. 71-5 (1 fig.)

Peridinium and other Infusoria, Notes on : ALFRED C. STOKES.

Jour. Trenton Nat. His. Soc., I. (1886), pp. 18-22.

Photo-Micrographs, How to Make (III) : W. H. WALMSLEY.

The Microscope, VI. (1886), pp. 49-53 (2 figs.).

Photo-Micrography (IV.) : R. HITCHCOCK.

Am. Mon. Mic. Jour., VII. (1885), pp. 48-50 (1 fig.)

Pollen-Tubes Again : J. KRUTTSCHNITT.

Proc. Am. Soc. Mic., 1885, pp. 62-5 (5 figs.).

Pumice-Stone and other Vesicular Rocks, On the Preparation of Sections of : H. J. JOHNSTON-LAVIS.

Jour. Roy. Mic. Soc., VI. (1886), pp. 22-4.

Resolution, On "Central" Light in : J. W. STEPHENSON.

Jour. Roy. Mic. Soc., VI. (1886), pp. 37-9 (4 figs.).

Rocks, The Microscopical Study of : J. S. DILLER.

Am. Mon. Mic. Jour., VII. (1885), pp. 41-2.

Rowland Gratings, Determination of the Absolute Length of Eight, at 62 Fahr. : W. A. ROEBERS.

Proc. Am. Soc. Mic., 1885, pp. 151-98 (3 figs.).

Sexual Organs of Reproduction in Angiosperms, Structure of the (No. 2.—Ovary of *Lilium*).

Cole's Studies in Mic. Sci., III. (1886), pp. 45-8 (colored plate).

Schimmelpilze, Intramolekulare Athmung und Gährthätigkeit der : N. W. DIKONOW.

Ber. Deutsch. Bot. Gesellsch., IV. (1886), pp. 2-7.

Spheropsidea, British (Continued) : M. C. COOKE.

Grevillea, XIV. (1886), pp. 101-8.

Staining Tissues in Microscopy (HANS GIERKE, *Zeitschr. für Wiss. Mic.*) (VIII., IX.) : Translated by W. H. SEAMAN.

Am. Mon. Mic. Jour., VII. (1886), pp. 31-5 ; 53-4.

Testa of Several Leguminous Seeds, Structure of the : L. H. PAMMEL.

Bull. Torrey Bot. Club, XIII. (1886), pp. 16-24 (21 figs.).

Zahnplatten der Gattung *Limnea*, Studien ueber die : W. DRYBOWSKI.

Bull. Soc. Imper. Nat. Moscou, LX. (1884), pp. 256-62 (8 figs.).

MISCELLANEA.

CARTILAGE.—An excellent source for hyaline cartilage is an end of one of the long bones of *Necturus*. The larynx of the cat also furnishes good material. Sections may be made free-hand of the fresh material as follows: Remove most of the soft parts covering the cartilage, wrap it in newspaper or other strong paper, and grasp it by the thumb and index of the left hand so that it projects slightly above the nail of the thumb and index. Wet the cartilage well with salt solution, and wet the razor or section knife with the same. Grasp the razor firmly, rest the blade on the nail of the thumb or index; move the razor forward across the tissue with a drawing cut, making each section with a single sweep of the knife. Make several sections, and transfer them to a dish of picric acid solution. They should be left in this half a day or more. They may then be washed with water and mounted in glycerin or glycerin jelly. If it is desired, the sections may be stained with alum carmine after soaking in water till the picric acid is removed. Stained sections may be mounted in balsam, but glycerin or glycerin jelly is preferable. As it is sometimes impossible or undesirable to make sections of fresh cartilage, the cartilage in small pieces may be kept in the picric acid for a few days, and then in 75 to 80 per cent. alcohol, until one is ready to make the sections. In that case the sections are transferred to water or 35 per cent. alcohol as they are cut, and the razor and tissue are wet with the 35 per cent. alcohol, with salt solution or with water. The sections must not be allowed to dry in any case. It is difficult for the inexperienced to make free-hand sections of sufficient thinness and evenness, hence the cartilage may be cut in the microtome as follows: Fill the well of the microtome nearly full of melted imbedding mass; dry one end of the cartilage with filter paper, and insert it into the melted mass so that the other end of the cartilage is about on a level with the top of the microtome. To prevent drying, place a small mass of absorbent cotton, wet with salt solution, over the exposed end of the cartilage. Cool the imbedding mass as soon as possible by the use of snow, ice or cold water. Wet the razor with salt solution and make the sections as rapidly as possible, using a drawing cut as in free-hand sections.—*Notes on Histological Methods*, by *Simon H. Gage*.

THE MICROSCOPE IN JURISPRUDENCE. — While an *entire* human body may be distinguished as such with certainty, histological knowledge is not, in my opinion, sufficiently advanced at the present day to enable one to say *that any microscopic structure is absolutely characteristic of and peculiar to a human being.*

While it is true that no one can say that a given microscopic structure is part of a human being, and not of any other animal, he might say with certainty, that it could not be from some animals in which the given structure is known to be very different. The histological or microscopical expert, in my opinion then, cannot give positive evidence with regard to the exact source of any microscopic structure. The *most* he can do is to say what it may be, and what it cannot be. Even this, unsatisfactory as it may seem, requires a profound knowledge of human and comparative histology, and of the changes that may be produced in the various structures by drying and dampness, by chemical and mechanical means. There is also often required a thorough knowledge of optics, and great manipulative skill. He, who, in the name of Science, allows himself through ignorance or design to become an advocate and not an expounder of the whole truth, so far as it is known, has been well characterized by Woodward as possibly more dangerous to society than the criminals he is called upon to convict; and the lawyer who through ignorance or design allows truth and justice to be so betrayed, is no better.—*Extract from Notes on Histological Methods, by Simon H. Gage.*

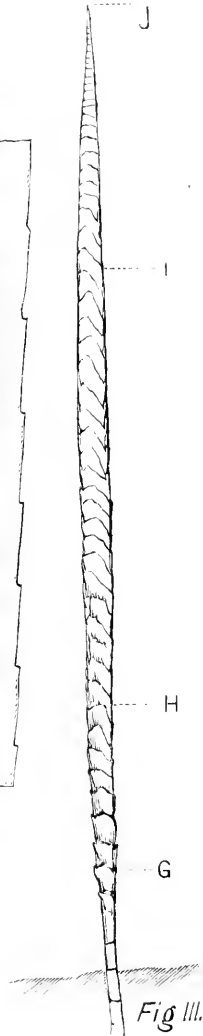
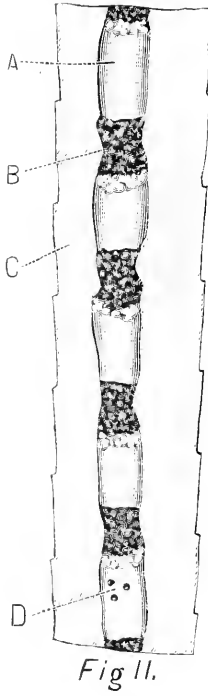
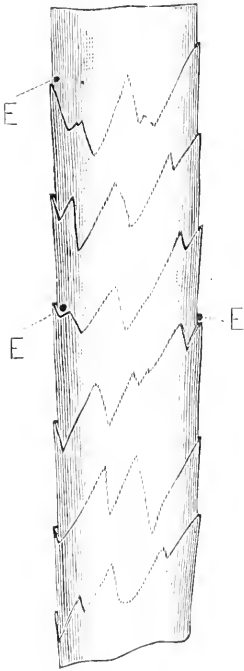

FUR FIBRES.

JOURNAL
OF THE
NEW-YORK MICROSCOPICAL SOCIETY.

VOL. II.

MAY, 1886.

No. 5.

FUR FIBRES.

BY H. L. BREVOORT.

(Presented April 2d, 1886.)

Plate III.

The structure of fur fibres differs from that of the hair fibre except in the interior portion. The fur fibre of the common rabbit is shown in plate III. Fig. 1 shows the exterior scales of the fibre. The interior appears somewhat as shown in Fig. II. The portion at *A* is an air cell. At *B* is a mass of pigment cells, which is the only material in these isolated portions, and gives color to the fur fibres. These pigment cells are almost all of a light brownish yellow color. In the darker furs they occur more frequently and the masses are larger and more compact. By treatment with glycerine they can be separated and then they drop into the air spaces. This formation is continued almost from the point of the fibre, which is of the shape shown in the upper part of Fig. III., to near the base. The air spaces interspersed with pigment cells are found from *G* to *J* (Fig. III.), but nothing can be seen, even with the most powerful objectives I have used, in the portion of the fibre below the point marked *G*; and so in the skin itself the root of the fibre is perfectly transparent.

I have found by long observation that the pigment cells gradually come out under the scales upon the exterior of the fibre, and then, when they meet the oxygen of the air, they appear to break up and supply to the fibre the water-repellent material on the outside. I have seen them pass to the surface, though the walls of the passage through which they moved were invisible; and I would suggest that that is probably the way in which all fibres with a scaly structure, such as human hair, are

supplied with grease, or whatever the oily material may be with which the outside surfaces are furnished, namely, by the exudation of pigment granules from under the scales to the exterior of the fibre.

You see, also, why fur is such an excellent non-conductor. It contains an enormous quantity of air cells, in which the air is closely imprisoned, and these, when once warmed by the heat of the animal's body, will keep him warm for a long time. The walls of these cells are of such a character that glycerine will not penetrate them until they have been soaked in it for about two weeks.

Certain animals, as we all know, grow white in winter and dark again in summer, while others, particularly those that live in the South, such as the marsh-hare, grow black in the winter but become lighter again in the summer. This seeming contradiction I think can be explained. So far as I have been able to discover by experiments on a few rabbits, the pigment cells on the approach of cold weather are discharged, to a great extent, or new fur fibres devoid of pigment are developed; at any rate, the air cells are enlarged. This change enables the animal to resist dry cold. In the summer, when the animal is called upon to resist moisture, the amount of pigment is increased, while the air cells decrease, since at that season more water-repellent material is needed on the surface. And you will notice, also, that in most animals the back is darker than the stomach. This is because the cold of the ground has to be resisted when the animal lies down, while the back has to resist moisture. On the other hand, the swamp-hare of the South turns darker in winter, I suppose, because, under the conditions of its existence, it requires more water-repellent material.

The Arctic Fox turns almost pure white in winter because it has to resist dry cold, and in summer, when it has to resist less cold than moisture, it is not so white. This explanation, however, is simply a theory which opens an interesting field of inquiry, but which would take a long time to prove, and I should be glad if anybody would take the matter up.

I have observed under the pigment cells a series of colorless cells, but what function they perform in the fibre, I have not ascertained. They are present in almost all of the fibres.

In a fibre freshly taken from the animal, pigment cells that

have worked out under the scales to the exterior, can, under a one-sixteenth or one-twentieth inch objective, be seen like little dots, as shown at *E*, Figs. I. and II. I have seen a pigment cell about half way out, which, in a few days, under my observation, worked its way entirely out.

I believe that the trail left by certain animals is caused by the rubbing off of some of these pigment cells, which I think contain some material which dogs can smell. Animals which leave the strongest trail always have dark hairs on the feet. The deer probably discharges some form of pigment cell from his hoof.

EXPLANATION OF PLATE III.

Fig. I., Exterior view : *E*, Pigment cells on exterior of fibre from the Common Rabbit.

Fig. II., Interior view : *A*, Air cell ; *B*, Compacted pigment cells ; *C*, Wall of fibre ; *D*, Loosened pigment cells.

Fig. III., Whole fibre: *G*, No scales ; *H*, Prominent scales ; *I*, Scales as in Fig I.; *J*, Scales gradually lessening toward point of fibre.

SPIRAL FIBRE OF THE BANANA STALK.

BY THE REV. J. L. ZABRISKIE.

(*Read April 2d, 1886.*)

The spiral fibres of the large stalk which supports the fruit-bunch of the Banana are remarkable for their abundance, large size, and beauty. If a prism be cut longitudinally from the inner substance of the stalk, one-quarter of an inch square and of any convenient length, and slight transverse incisions, all in the same plane, be made on the four sides, on slight bendings in various directions, the cells and vessels which have not been cut will break, and the portions of the prism on either side of the incisions may be gently separated, drawing out the spiral fibres in great abundance. These fibres tear away from their respective vessels in ribbons which vary greatly in fineness, as may be easily detected by the unaided eye. The appearance of ribbons is caused by parallel strands of the fibres, from three to thirteen in number, coming away together from their vessels, and adhering, until they are drawn for a considerable length. Many of them may be drawn out at least two inches before they break. In order to observe the beauty of the large ribbons, it

is advisable to draw them out not more than half an inch, or their strands will be more or less separated, and will resemble in appearance straightened threads.

A thin longitudinal slice of the stalk shows that the spiral vessels, even when lying in immediate contact, vary greatly in size, from $\frac{1}{10000}$ th to $\frac{5}{10000}$ ths of an inch in diameter; and the fibres themselves vary correspondingly, the largest being about $\frac{1}{5000}$ th of an inch in diameter.

One of the distinguishing beauties of the larger ribbons is occasioned by the fact that their fibres are crossed nearly at right angles by another set of apparent fibres of extreme fineness; this second set divides the surface of the ribbon into minute spaces, which are nearly squares or parallelograms, according to the distance between the cross lines, and gives the appearance of lattice work constructed of resplendent glass rods.

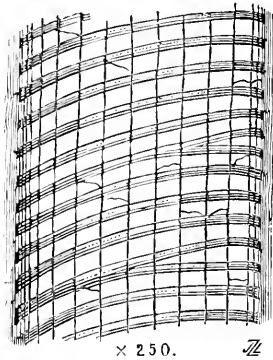

Spiral fibre of the Banana stalk.—A portion of a large spiral vessel.

The longitudinal slice shows that the second sets of fine fibres run longitudinally through the entire length of the large spiral vessels. They do not appear to occur in the smallest vessels, but are most numerous in the largest vessels, where a half longitudinal section will show as many as ten, and they gradually decrease in number in the respective vessels of decreasing size, until finally only two or three can be faintly discerned. These sets of fine longitudinal lines, crossing nearly at right angles the larger spiral fibres, appear to be the outlines of delicate, lengthened, nearly rectangular cells; and these cells appear either to

form the walls of the spiral ducts or to have a peculiarly intimate relation to these walls. These fibres of the Banana polarize well.

OBSERVATIONS ON THE STRUCTURE OF CASTANEA VULGARIS.

BY P. H. DUDLEY, C.E.

(Read April 2d, 1886.)

The tissues of *Castanea vulgaris*, var. AMERICANA, A.DC., our chestnut, consist of vessels or ducts, tracheides, parenchyma, and libriform and septate fibres, which are so combined as to present a very complex structure in the fibro-vascular bundle or annual ring. The large vessels form during the first part of the season's growth, and are confined to from one-sixth to one-third of the ring, making two, three, or four quite definite, concentric rows.

In transverse sections, each vessel or duct is oval, the major axis being radial to the tree. In size they have large limits of variation in different trees. I find the major axis to range from 200 to 500 μ , and the minor axis from 180 to 410 μ .

These large vessels or ducts are jointed in lengths of from one to two diameters. After the third or fourth year they are filled with tissue which has been designated as Tyloses, and the impression has been conveyed that it is merely accidental. This view I do not accept. In the duramen these vessels or ducts, in this wood, are never empty or open, but are filled with tissue which at one period contained protoplasm.

Surrounding these large vessels or ducts are cells of little more than parenchyma, though they are lignified according to the indications given by either of the reagents Phloroglucin or Indol. These cells, which Sanio might call intermediate fibres, have septa, and in autumn and winter contain starch. The thin places in their walls are elliptical in some instances, and in others, round. The thin places in the walls of the vessels correspond to those of the adjacent tissues except those of the medullary rays, a modification in each taking place, and instead of being elliptical horizontally, they are often so vertically, and in many cases they are triangular in form. In the ring not occupied

by the large vessels or ducts, many smaller ones are interspersed, not in concentric rows, but inclined from a radial direction to the centre of the tree; they gradually decrease in size to the outer portion of the ring. Surrounding these smaller ducts are tissues which may be classed as tracheides, being quite long and having an abundance of circular thin places in their walls.

Interspersed all through the bundle or ring are cells, possibly cambiform cells, with thin walls, which, in the alburnum, during the autumn and winter, contain starch grains. In this part of the wood, during the same season, the medullary rays also contain starch. The transverse walls in these cells are frequent, every three or four diameters in length containing a division. Another class of cells of much greater length, but little larger in size, are constricted at the transverse cell-wall, giving the appearance of slightly rounded ends. These do not differ much in appearance from the vertical cells in the *Sequoias*, which contain coloring matter. I tested them for tannin and they indicated its presence, but other cells also did the same.

The libriform cells in this wood have comparatively thin walls, and a large lumen. The quadrangular fibres surrounding the large vessels measure from 25 to 30 μ in diameter, while the lumen measures from 19 to 25 μ . The libriform fibres near the central and outer portion of the ring measure from 19 to 25 μ in diameter, the lumen measuring from 10 to 15 μ in diameter. Nearly solid fibres are not found in this wood as in *Carya alba*, a closely allied tree.

In the tangential section, the medullary rays are found in single and in double rows; the former predominating. From one to thirty cells form the single vertical bundles—and in the others often only one or two cells are doubled. This wood splits easily. From the microscopical examination of this wood, one would class it as one of medium softness, which is found to be true by other tests. Its specific gravity ranges from .4 to .5 of one *per cent.*; a cubic foot of dry wood weighing from 26 to 32 lbs. In contact with the ground it is very durable, and when used for railway ties does not decay before the fibres are destroyed under the rails.

The large vessels it contains give veneers cut from the second-growth wood a beautiful appearance, and it is much used for interior finishing.

HIGH-REFRACTIVE MEDIA.

BY PROF. H. L. SMITH.

(Read April 2d, 1886.)

The results of experiments made subsequently to the discovery of the boro-glyceride and antimony-bromide medium, described in a preceding paper,¹ are of importance, and demand a brief notice. The antimony compound works very pleasantly, and still appears to be the best when high-refractive power is required; but unless all excess is completely removed from outside the cover, it stains the protecting ring. The litharge and gold-size ring and the zinc-white ring are merely darkened; but the black asphalt ring is softened. Thoroughly cleaning off the excess around the cover remedies this difficulty.

The chief improvement I would make in the formula given, I now think, is the substituting of stannous chloride for antimony bromide, and of arsenious acid for boracic acid.

I find that a compound of stannous chloride, arsenious acid and glycerine is so very slightly deliquescent, that the mounts may be left for weeks without cleaning off the excess, and that very little if any softening of the material ensues. The mounts are easily cleaned, as the cover is very firmly attached.

The medium is not so liable to turn when heat is applied, as when boro-glyceride or gelatine and glycerine is used; the latter, indeed, for that reason, is quite objectionable. The refractive power of the mixture is not quite so high as when antimony bromide is employed; but the refractive power is quite high enough for anything except the most hyaline tests; and as a little excess of material outside the cover does not discolor the ring, and does not seem to alter by quite long standing without a ring, I now prefer this compound.

This medium is prepared as follows: Weigh out six parts of stannous chloride, and two to two and one-fourth parts of pure arsenious acid. Melt the stannous chloride in a test tube and boil it for a little while; add while hot an amount of glycerine equal to the bulk of the melted stannous chloride, not more; heat and shake until it forms a perfectly clear solution. Add now, little by little, the arsenious acid, constantly shaking and heating

¹See this Journal, *ante*, p. 13,

until all is dissolved. This mixture when cold should be very viscid.

In making a preparation with this medium, at first, on heating, a great number of small bubbles may appear under the cover. A little more heating enlarges these to steam-bubbles, then, by allowing the slide to cool a little, the cover will settle down, and most of the bubbles will disappear; but if any are still present, another application of the heat of a small flame under the slide at the edge of the cover, where the bubbles are most abundant, will remove them. Towards the completion of the preparation, the slide may be inverted, if necessary, and the small flame allowed to play directly on the edge of the cover; thus, careful treatment will dispose of all bubbles. When cold, the excess is easily removed with a moistened roll of tissue paper, and, finally, after the cleaning, the slide should be warmed just sufficiently to expel any moisture that may have found its way under the cover. If, after the ring is applied and the preparation otherwise completed, any metallic stain should show on the cover or slide, it can be removed with a roll of tissue paper moistened with hydrochloric acid.

The arsenious acid also makes an excellent compound with the antimony bromide; and the highest-refractive-power white medium that I have yet seen is made as follows: Melt antimony bromide and add to it while hot half its bulk of glycerine; in this put arsenious acid, little by little, shaking and heating at the same time, until by its solution the bulk is increased three-fourths of one part, so that the final mixture will be: antimony bromide 2 parts, glycerine 1 part, arsenious acid $\frac{3}{4}$ part, all in bulk. This compound is solid, or very nearly so, when cold, and will require slight warming to take out a drop on the dipping-rod. It does not soften much, if at all, on exposure, and its refractive index is well on towards 2. The mounts made with this material are very satisfactory.

Finally, I think that the yellow medium, the compound of "realgar" and bromide of arsenic, can be made permanent and easy to use by the addition of a small excess of sulphur. The realgar is broken up and dissolved, by the aid of heat, in the bromide of arsenic. The solution is evaporated until, when cold, it becomes so viscid as to flow with difficulty; enough sulphur is now added to increase its bulk about one-sixth (I

have not been able to determine the exact proportions yet), and thoroughly dissolved ; it becomes now somewhat more limpid, and is used as one would use balsam. It requires a very high heat to boil, so the slide must be heated cautiously ; but there is no difficulty in boiling, and this should be continued for a little while, when the cover will settle down entirely free from bubbles, and, if the user is careful not to slide it, may be gently pressed down. When cold, the deep color will disappear and the cover will be very firmly fixed. To use this medium, the best polished slides must be obtained, as all the pits and scratches of ordinary slides show up very disagreeably. The covers also must be well cleaned. I have preparations which were made with this material more than three months ago, that show no symptoms of change.

Too much sulphur, however, will, in time, crystallize. I cannot now state what proportions can be safely used, but the amount named above, thus far appears within limits.

NOTICE OF A NEW LOCALITY FOR HAPLOPHRAGMIUM CASSIS, A RARE FORAMINIFER.

BY A. WOODWARD.

(Read April 16th, 1886.)

While spending my vacation during the summer of 1884 on Peak's Island, situated in Portland Harbor, Maine, I dredged for microscopical objects in the channel between Peak's and Great Hog Islands.

The depth of water was from about four to thirteen fathoms at low tide.

I made several very successful hauls, bringing up many species of Gasterpods, Lamellibranchs, Crustaceans, etc. ; also much mud of a bluish gray color, some of which I washed carefully through a fine-meshed cloth until the water ran perfectly clear. Upon examining the residue with a pocket lens, I found, to my surprise, the very rare arenaceous foraminifer, *Haplophragmium cassis*, in great abundance, associated with the following forms, which are common on our coast; viz.,

Biloculina ringens, Lamarck, sp.

Nonionina depressula, Walker and Jacob, sp.

Polystomella striatopunctata, F. and M.

Previously to this find, the distribution list comprised only three localities; namely,

Gaspe Bay, mouth of the river St. Lawrence, 16 fathoms (Dawson).

Lively Harbor, Disco, Greenland, 5 to 20 fathoms (Norman).

Deva Bay, Spitzbergen, 7 fathoms (Robertson).

I now add the fourth :

Portland Harbor, Peak's and Great Hog Islands, 4 to 13 fathoms (Woodward).

These foraminifera are about one-eighteenth of an inch in length ; the chambers are composed of grains of sand strongly cemented together. The walls, however, are thin and brittle, and it is almost impossible to select them from the sand in which they are found without breaking, except by taking them up with a bristle.

PROCEEDINGS.

MEETING OF APRIL 21, 1886.

The President, the Rev. J. L. Zabriskie, in the chair.

Thirty-two persons present.

OBJECTS EXHIBITED.

1. Sections of *Castanea vulgaris*, VAR. AMERICANA, A. DC. : by P. H. DUDLEY.

2. *Streptococcus Vaccinæ*, Animal : by W. H. BATES, M. D.

3. *Streptococcus Vaccinæ*, Humanized : by W. H. BATES, M. D.

4. Spiral Fibre of Banana Stalk : by J. L. ZABRISKIE.

5. Ouvarovite (Chrome Garnet) from Oxford, Canada : by G. F. KUNZ.

6. Native Iron from Ovifak, Greenland : by G. F. KUNZ.

STRUCTURE OF CASTANEA VULGARIS.

Mr. Dudley read a paper on the structure of *Castanea vulgaris*, which constitutes the third article in this Number of the JOURNAL.

In response to inquiries, Mr. Dudley further stated, that the large ducts described by him extended through what would represent one year's growth, and are continuous from year to year ;

but they divide, and, after three or four years, are filled with tissue, and there is probably little or no circulation in them; that he had without difficulty traced them through a twelve-foot board. This was the longest he had observed.

He had observed tyloses in a great many other species, and, besides, in all the oaks and locusts. It was some time before he had noticed this tissue in cutting sections. The knife not being sharp enough, tore the tissue out. It remains in the old wood of the oak, and is about the last thing to decay. The Society would remember that in a photomicrograph exhibited by him some time ago, it was shown that the mycelium of a fungus had destroyed the greater portion of the fibres, but this tissue remained intact.

The President said that he had found that these cells, in various species of the oak, would resist severe treatment. They are not always found in the duct when the section is cut. He had used a sharp knife, but the tissue would frequently come away in cutting the section, even when the greatest care was used.

FUR FIBRE.

Mr. Brevoort gave to the Society the result of some observations made by him in studying the subject of fur fibres, which will be found in the first article in this Number of the JOURNAL.

STREPTOCOCCUS VACCINÆ.

Dr. W. H. Bates exhibited two slides showing *Streptococcus Vaccinæ*, Animal, and Human, and said: "The first occurs in minute, oval cells, either single, double, or in chains. The specimens exhibited show all these conditions. The humanized is the same after it has passed through the body. These organisms are found at the point of vaccination, both in man and in the lower animals, after inoculation."

SPIRAL FIBRE OF BANANA STALK.

The President exhibited a slide showing spiral fibre of the Banana stalk, and read a paper describing the structure of the fibres, which is published in this Number of the JOURNAL.

PLAGIOGRAMMA VALIDUM.

Mr. Schultze exhibited a photomicrograph of a newly

discovered diatom, obtained from material from Barbadoes, and which had been named *Plagiogramma validum* by Prof. H. L. Smith.

HIGH-REFRACTIVE MEDIA.

Prof. H. L. Smith's paper on "High-Refractive Media" was read by Mr. Van Brunt (*Supra*, page 75).

Mr. Van Brunt: "Professor Smith's experiments have been very extensive, and the formulæ given by him are the result of a vast deal of labor, and he should be thanked for his experiments. I have obtained some curious results in repeating these experiments of Prof. Smith, which I would like to present at a future meeting.

"Prof. Smith has been trying to discover a medium in which diatoms may be mounted so as to show their structure under the most favorable conditions, and I think he will eventually succeed."

The Corresponding Secretary announced that the Society had been invited by the Torrey Botanical Club to attend a lecture to be delivered by Prof. W. G. Farlow, of Cambridge, Mass., before the Club, on the 9th instant, at Columbia College, on the subject of "Fungous Diseases of Plants."

On motion, the Corresponding Secretary was instructed to convey the thanks of the Society to the Torrey Botanical Club for the invitation.

Mr H. L. Brevoort was appointed a special committee on Textile Fibres.

MEETING OF APRIL 16TH, 1886.

The President, the Rev. J. L. Zabriskie, in the chair.

Thirty-one persons present.

OBJECTS EXHIBITED.

1. *Haplophragmium cassis*, Parker's Sp., from Portland Harbor, Maine: by A. WOODWARD.
2. Scalariform Ducts in the Tree-Fern *Dicksonia antarctica*: by C. S. SHULTZ.
3. Section of Cat's Tongue: by C. S. SHULTZ.
4. *Bacillus tuberculosis*: by W. H. BATES, M. D.
5. Photomicrograph of *Bacillus tuberculosis*: by W. H. BATES, M. D.

6. Rutile Crystals, from Burke Co., North Carolina : by G. F. KUNZ.

7. Scalariform Cells of the wood of the Sweet-Gum tree (*Liquidambar Styraciflua*, L.) : by J. L. ZABRISKIE.

8. *Bacterium lactis*, Lister : by P. H. DUDLEY.

HAPLOPHRAGMIUM CASSIS.

Mr. Woodward's note "On a new locality for *Haplophragmium cassis*" was read.

COTTON FIBRE.

Mr. Brevoort exhibited some photomicrographs of cotton fibre obtained from a friend who was connected with a large Cotton Manufacturing Company, and explained the method employed by the company in the microscopical examination of cotton fibre, which is as follows:—

As the cotton is received, samples are taken from each bale and photographed, and from the appearance of the photomicrograph and an examination of the cotton it is determined which bales shall be mixed in manufacturing.

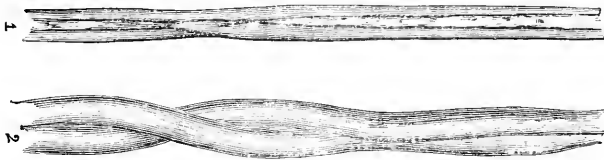

The spirality of the fibre is first looked for. The cotton with spiral fibre will twist together much more readily than the cotton whose fibre is comparatively flat and straight. In manufacturing, the spiral fibre makes less waste and a more even thread. A fibre with good thick edges will give strength to the yarn, while the oil deposits present in fibre make the yarn smoother and more elastic. The evenness in diameter causes the fibre to draw more evenly, and makes a smooth round thread. Fibres with spirality, good thick edges, well filled with oil, and even in diameter, will make good cloth with little waste, while round, straight fibres will make weak yarn with a large amount of waste.

LIQUIDAMBER STYRACIFLUA.

The President exhibited a longitudinal, radial section of the wood of the Sweet-Gum tree (*Liquidambar Styraciflua*), and, in

explanation of the exhibit, described in what directions cuttings of the wood had been made to furnish the sections shown. He also described the scalariform cells and their structure.

Mr. Pellew was appointed a special committee on Bacteriology.

PUBLICATIONS RECEIVED.

The Journal of the Quekett Microscopical Club : Ser. II , Vol. II., No. 13 (October, 1885) ; pp. 213. No. 14 (February, 1886) ; pp. 34.

Brooklyn Entomological Society. Entomologica Americana : Vol. II., No. 1 (April, 1886) ; pp. 20.

The American Museum of Natural History, Central Park, New-York City. Annual Report of the Trustees for the year 1885-6 ; pp. 52

Bulletin de l'Académie d' Hippone : No. 21 (1885), Fasc. 1 ; pp. 67.

Bulletin de la Société Impériale des Naturalistes de Moscou : Vol. LX., Pt. 2 (1884) ; pp. 206. Vol. LXI., No. 1 (1885) ; pp. 264.

Johns Hopkins University, Baltimore, Md. Studies from the Biological Laboratory : Vol. III., No. 5 (March, 1886) ; pp. 49.

Bulletin of the Torrey Botanical Club : Vol. XIII., No. 4 (April, 1886) ; pp. 20.

The Naturalist's World : Vol. III., No. 28 (April, 1886) ; pp. 20.

The Journal of Microscopy and Natural Science : Vol. V., Pt. 18 (April, 1886) ; pp. 64.

The Electrician and Electrical Engineer : Vol. V., No. 52 (April, 1886) ; pp. 40.

The Hosier Naturalist : Vol. I., No. 6 (January, 1886) ; pp. 18. No. 8 (March) ; pp. 12.

The Aurora. Iowa State Agricultural College : Vol. XIV., No. 1 (March, 1886) ; pp. 19.

Anthony's Photographic Bulletin : Vol. XVII., No. 7 (April 10th, 1886) ; pp. 32. No. 8 (April 24th) ; pp. 32.

The Journal of the Cincinnati Society of Natural History : Vol. IX., No. 1 (April, 1886) ; pp. 64.

Proceedings of the Natural Science Association of Staten Island : March 13th, 1886 ; p. 1. April 10th ; p. 1.

National Druggist : Vol. VIII., No. 14 (April 2d, 1886) ; pp. 16. No. 15 (April 9th) ; pp. 12. No. 16 (April 16th) ; pp. 12. No. 17 (April 28th) ; pp. 12.

The Journal of Mycology : Vol. II., No. 4 (April, 1886) ; pp. 12.

The American Monthly Microscopical Journal : Vol. VII., No. 4 (April, 1886) ; pp. 20.

The Botanical Gazette : Vol. XI., No. 4 (April, 1886) ; pp. 32.

The Correspondence University Journal : Vol. III., No. 6 (April 17th, 1886) ; pp. 12.

Nottingham Naturalists' Society. Thirty-Second Annual Report (1884), with Transactions ; pp. 40.

- How to Photograph Microscopic Objects ; pp. 32. By I. H. Jennings.
 The West-American Scientist : Vol. II., No. 15 ; pp. 5.
 The Microscope : Vol. VI., No. 4 (April, 1886) ; pp. 24.
 The School of Mines Quarterly : Vol. VII., No. 3 (April, 1886) ; pp. 104.
 The Historical and Scientific Society of Manitoba. Transactions Nos. 19,
 20, 21 (1885-6) ; pp. 29. Annual Report of the : Vol. VII., No. 6
 Monatsblätter des Wissenschaftlichen Club in Wien : Vol. VII., No. 6
 (March 15th, 1886) ; pp. 12. Ausserordentliche Beilage : No. 3 ; pp. 11.
 Comptes-Rendus des Séances de la Société Royale de Botanique de Belgique:
 December 6th, 1885 ; pp. 53.
 Dreizehnter Bericht des Naturhistorischen Vereins in Passau : 1883-5 ; pp. 98.
 Achtundzwanzigster Bericht des Naturhistorischen Vereins in Augsburg :
 1885 ; pp. 31 + 168.

INDEX TO ARTICLES OF INTEREST TO MICROSCOPISTS
 WHICH HAVE RECENTLY APPEARED IN OTHER
 JOURNALS.

- Algæ, Fresh-Water (Part II.): GEORGE NORMAN.
Jour. of Mic., V. (1886), pp. 92-102 (30 figs.).
 Antheridium in Ferns, The Development of the : DOUGLAS H. CAMPBELL.
Bul. Tor. Bot. Club, XIII. (1886), pp. 49-52 (9 figs.).
 Astigmatism and the Microscope : W. J. MARTIN.
The Microscope, VI. (1886), pp. 79-80.
Catenicella ventricosa : TUFFEN WEST.
Jour. of Mic., V. (1886), p. 113 (2 figs.).
 Cell Nucleus, Researches on the. See President's Address, The (Royal Micro-
 scopical Society).
 Cholera and Commas, Official Refutation of Dr. Koch's Theory of.
Quar. Jour. Mic. Sci., XXVI. (1886), pp. 303-16.
 Diatoms, The Mounting of (E. DEBES, *Hedwigia*) : Translated by F. DIENELT.
Am. Mon. Mic. Jour., VII. (1886), pp. 65-7.
 Diatoms, Method of Cleaning : GEO. H. TAYLOR.
Mic. Bul., III. (1886), pp. 14-5.
 Diatomic Marvels. See Microscopical Advances.
 Earthworms, Studies on : WILLIAM B. BENHAM.
Quar. Jour. Mic. Sci., XXVI. (1886), pp. 213-301 (42 figs.).
 Euchlanis, Notes on the Genus : See Rotifers, A group of.
 Fungus, A Sycamore : W. B. GROVE.
Sci.-Gos., 1886, pp. 76-8 (6 figs.)
 Hydrophobia, Note on the Microscopical Appearances in the nervous centres,
 after death from : W. B. KESTEVEN.
Jour. of Mic., V. (1886), pp. 103-4 (3 figs.).
Lingula (Glottidia) pyramidata, Stm. (Dall), A Study of the Structure of : H.
 G. BEYER.
Studies Biol. Lab., Johns Hopkins Univ., III. (1886), pp. 227-65 (21 figs.).

Marine Collecting with the surface-net, On : G. W. M. GILES.

Sci.-Gos., 1886, pp. 79-80 (2 figs.).

Microscope, The, and How to Use it (Pt. VI.—Double Staining, Cont.) : V. A. LATHAM.

Jour. of Mic., V. (1886), pp. 105-11.

Microscopical Advances (VII.) (Diatomic Marvels) : DR. ROYSTON-PIGOTT.

Eng. Mech., XLIII. (1886), pp. 115-6 (2 figs.).

Microtome, The Thoma-Jung, An Alcoholic Drip for: W. T. SEDGWICK.

Am. Nat., XX. (1886), pp. 488-90 (3 figs.).

Mounting Several Groups of Objects Under one Cover, A Method of : S. G. SHANKS.

Am. Mon. Mic. Jour., VII. (1886), pp. 64-5.

Mole (*Talpa Europæa*), The Development of the, The Ovarian Ovum, and Segmentation of the Ovum : WALTER HEAPE.

Quar. Jour. Mic. Sci., XXVI. (1886), pp. 157-74 (21 figs.).

Objectives, The New.

Jour. Roy. Mic. Soc., VI. (1886), pp. 316-21.

Peripatus, The Development of the Cape Species of : ADAM SEDGWICK.

Quar. Jour. Mic. Sci., XXVI. (1886), pp. 175-212 (36 figs.).

President's Address, The (Royal Microscopical Society) : W. H. DALLINGER.

Jour. Roy. Mic. Soc., VI. (1886), pp. 193-207 (43 figs.).

Photo-Micrography (V.) : R. HITCHCOCK.

Am. Mon. Mic. Jour., VII. (1886), pp. 67-70.

Renal Tube Casts, The Detection of : A. Y. MOORE.

The Microscope, VI. (1886), pp. 80-3.

Reproduction.

Ency. Brit., 9th Ed. (1886), pp. 407-31 (16 figs.).

Rotifers, A Group of (Notes on the Genus *Euchlanis*) : J. E. LORD.

Sci.-Gos., 1886, pp. 83-6 (7 figs.).

Staining Tissues in Microscopy (HANS GIERKE, *Zeitschr. für Wiss. Mic.*) (X.) : Translated by W. H. SEAMAN.

Am. Mon. Mic. Jour., VII. (1886), pp. 70-3.

Staining, Double : See Microscope, The, and How to Use it.

Tissue, Larval Theory of the Origin of : A. HYATT.

Am. Jour. Sci., XXXI. (1886), pp. 332-47.

Water, Notes on the Biological Examination of : THEOBALD SMITH.

Am. Mon. Mic. Jour., VII. (1886), pp. 61-4.

JOURNAL
OF THE
NEW-YORK MICROSCOPICAL SOCIETY.

VOL. II.

JUNE, 1886.

No. 6.

THE MICROSCOPICAL STRUCTURE OF THE IRON
PYRITES.

BY ALEXIS A. JULIEN, PH.D.

(*Read May 7th, 1886.*)

IN the black mud of ditches and pools, and of the flats exposed at low tide, in the muck of salt-marshes and the peat of fresh-water swamps, in the soil, in the very mud between the stones in the pavements of our streets, there is a substance constantly present and yet very unfamiliar, of whose office in nature, or even of whose very existence, man rarely becomes conscious. Continually formed by the contact of iron oxide with the sulphur separated from decaying organic matter, it is yet in the highest degree unstable, and continually in a state of decomposition back again into its two constituents, under the action of the air and of vegetable acids. Then the fetid vapors of hydrogen sulphide which it evolves testify decidedly to its existence, at least before the court of one of our senses—sometimes as an offensive stench, when these vapors rise from a ditch in a Long Island or a New Jersey salt-marsh—and sometimes as a rather welcome though quaint odor, delightfully associated with all the mirth and music and sanitary expectations of a summer visit to the Sulphur Springs of New York or Virginia. On the other hand, mineralogists recognize that this substance rarely, if ever, becomes concentrated in masses visible to the eye, never crystallizes, and is never found as a pure, isolated mineral, except, strange to say, within some meteorite which falls from the sky, and shows among its constituents dark rounded grains of the same material in the form of troilite. Even its innumerable black particles, scattered through the marsh-mud, are dull and amorphous, and almost always indistinguishable under the microscope, resembling mere granules of

carbonaceous matter. Nevertheless, it is everywhere diffused in enormous quantities throughout the softer deposits at the bottoms of the ocean, lakes, and running waters, quantities perhaps equalling or exceeding those of the pyrites visible in the rocks. Its constant and universal formation doubtless serves the important purposes of rendering the iron oxides freely soluble in water, of assisting their later distribution as a cement through sandstones, and of causing their final accumulation as bodies of iron ore.

The substance to which I refer, is termed Iron protosulphide. It has a very simple composition, a single molecule containing one atom of iron to one atom of sulphur, indicated by the formula FeS . I have but repeated the ordinary view in stating that it does not occur on the earth as a distinct, isolated mineral; nevertheless, there are grounds, long ago advanced by the chemist Frankenheim, for believing that this substance, iron protosulphide, does exist as a well-known crystallized mineral; and it is from this point of view that you are asked to-night to examine in the first slide, the rare, hexagonal crystals of brown-colored pyrrhotite from a vein at Elizabethtown, Canada. The brilliant iridescent tarnish which these display, perhaps accounts for the few occurrences of the unstable mineral in that form. Under the name iron pyrites, with which all are familiar, there are really comprised three distinct minerals; namely, Pyrrhotite, Marcasite, and Pyrite, three comrades, clinging closely, hard to be parted. Where one is, one or both of the others may be found not far off. The one I have already mentioned, pyrrhotite, is, I believe, the elder brother, almost always the first one to be born—when metamorphism sets in and a rock comes into being—out of the black mother-slime, rich in iron sulphide, which permeates the silt and soil and mud-banks of the earth's crust. But oxygen, all pervading, is the constant foe of this simple compound, robbing it at its very birth of a variable portion of its iron, so that the number of its atoms of sulphur always exceeds those of iron; *e. g.*, thus, $Fe^7 S^8$, instead of $Fe^8 S^8$, which should comprise eight molecules of pure iron protosulphide.

In the further course of the subterranean conflict, in which the oceanic sediments consolidate, the robbery to which I have referred is consummated by the disappearance of half the

original amount of iron. Thus, marcasite is born, consisting of iron di-sulphide, $Fe^4 S^8$, or more simply expressed, $Fe S^2$. This is a steely-grayish white mineral, often affected by a greenish tinge, crystallizing after an entirely different fashion, the rhombic, and having a peculiar tendency to originate in calcareous rocks; *e. g.*, the chalk of England and the Carboniferous and Trenton limestones of this country. From a pound of the latter rock from Jefferson County, New York, digested in acid, over an ounce of marcasite, in drusy crusts of pure and brilliant crystals, was left as a dark sediment. A glance at the second slide will convey a sufficient idea of the steely color, the curious involved crystallization, and the deeply striated faces which commonly characterize this mineral.

You will notice also, in the same slide, here and there, delicate white needles in radiating groups, planted on the surface of the marcasite crystals. These consist of "copperas," or "white vitriol," *i. e.*, sulphate of iron, and are the first evidences of the attack and absorption of oxygen from the air.

But in the next slide, the marcasite from Galena, Illinois, we have a striking example in miniature of that iridescent tarnish, examples of which are to be found in the cabinet of every mineralogist, a gaudy display of color, which, like that of the autumnal foliage of our forest, is only a proof of weakness, of oxidation by the air, and of coming dissolution, but in the case of the mineral, with no hope of the re-birth and of the new term of life which follows in the case of the tree.

The last member of the triad of the pyrites is Pyrite, which is found in brass-yellow cubes or octahedra, breaks with a conchoidal fracture like porcelain, and yet has exactly the same composition as marcasite, $Fe S^2$. In general, it is also found at the last stage of the alteration of crystalline rocks, where a high temperature has prevailed, as in the gneiss and magnesian marbles of New York Island. In its pure form, which almost defies oxidation, you may see it in the polished faces of this cube from Chili, in which you will notice that the microscope only confirms the ocular evidence of its density and purity. But here, on the other hand, is a granular form of the mineral from New Jersey, decaying so fast that the formation and expansion of the vitriol crystals within it are rending it to pieces. In the next slide, a fragment of this granular mass presents to the eye an

aggregate of little bright cubes of pyrite, but no apparent reason for this speedy destruction. To solve this difficult problem of the varying stability and instability of crystals of the very same mineral, I ask your attention next to the octahedral crystals of pyrite from Weehawken, New Jersey. You will notice that the faces of these are covered by a more or less marked iridescence, reminding you of that already shown on the marcasite crystals of Galena, Illinois, although no visible trace of that mineral can here be detected. It is significant, also, that, in these crystals of pyrite, the tarnish is not uniformly dispersed over the surface, but very often presents alternating narrow stripes of color, blue or green with red. These lie sometimes in a set parallel to one edge of a triangular face, sometimes in two or even three intersecting sets, parallel respectively to the three edges of a face of the octahedron. This implies that the oxidation of the material has not progressed uniformly, and can hardly be explained except on the supposition that the pyrite encloses some unstable impurity, arranged in correspondence to crystallographic symmetry. The mineralogical microscopist will recall many analogous instances of a similar internal arrangement of impurities, caught up during crystallization, such as those in the cruciform macles of chialstolite from Lancaster, Massachusetts. In these bright pyrite-crystals, it is true, the secret enemy, which effects their destruction on weathering, is diffused in a form far more minute, almost one of molecular isolation. But although the distinction of its particles exceeds all the powers of the microscope, its presence is here clearly revealed, as I believe, through the play of chemical forces and the subtle testimony of light.

The oxidation of the Weehawken pyrite, however, does not stop with this iridescent tarnish. The last change of all is shown in its complete alteration into a liver-colored limonitic iron ore, and yet, as displayed in the next slide, with the almost perfect preservation of the surface polish, and of the sharpness of its edges. Some mystery has always been attached to the origin of such hepatic pseudomorphs of iron oxide, presenting the crystalline form, properly belonging to pyrite. Your attention is further invited, therefore, in these Weehawken pseudomorphs, to the delicate reddish-brown crusts, deposited upon some of the crystal faces. On a cross-section, these crusts show

alternating brown and white lines, evidently the edges of alternating films of red iron oxide, and white gypsum, of which these crusts are made up.

The chemist will understand that, as fast as the iron sulphate has been formed by slow oxidation of this pyrite, the iron oxide has been at once precipitated by calcium carbonate, derived from the surrounding calcite-gangue; the gypsum resulting has been mostly washed away, except in the case of occasional films thus protected by envelopment.

We are here met by questions of great practical importance. Is it safe to roof a house with slates full of cubes of golden-yellow pyrites? Practical roofers and scientific observers agree that there is no danger of decay and discoloration with the pyrites of some slate quarries. What makes this difference, and how can we determine whether to accept or reject enormous bodies of pyritiferous slates which are found ready for quarrying? Again, when coal is brought out from the mines of Pennsylvania, it is piled up ready for shipment; but these piles must often remain for months exposed to the weather, until the market requires their delivery. Why is it that the product of some collieries soon crumbles to a powdered condition, with great injury to its market value, while that from other localities resists decomposition and crumbling? This variation has been suspected to have connection with some conjectured peculiarity in the little bright grains of pyrites, abundantly scattered through most varieties of coal. But what is its real cause, and how can such disastrous results be anticipated, and therefore prevented?

Again, most residents of New York City have noticed the offensive and unequal yellow discoloration which has attacked the once pure white marble of our Court House building, a stone which was brought from a quarry in West Stockbridge, Massachusetts. This stone is full of decaying particles of pyrites, and yet the marbles from other beds in the same State, and in Vermont, contain forms of pyrites which appear to be perfectly stable in character. How can a builder distinguish between the two kinds of the same mineral, pyrite, whether stable or unstable, and decide whether to accept or reject a stone? In illustration of this last subject, I present a slide of the white marble of Lee, Massachusetts (from a block exposed to the weather for a few months), with a band of discoloration around a decaying particle

of unstable pyrite; also another, on which are mounted a number of the crystals, yet unaltered, and from the same marble, which were obtained by dissolving away five pounds of the stone. There was some doubt whether so unstable a form of pyrites might not consist of marcasite only; but these crystals show the form of an ordinary modification of cubes of pyrite of pale brass-yellow color and apparent purity, with no visible reason for decay. In another slide are mounted the siliceous and insoluble minerals associated with the pyrite in the same marble; viz., tourmaline, phlogopite, tremolite, quartz, and rutile, all in such small quantities as to have escaped detection in the chemical analyses of this rock, though easily recognized in this way under the microscope.

In searching for the cause of these great differences in the same mineral, little use has hitherto been made of the microscope. Berzelius alone has recorded a microscopical examination of an efflorescent marcasite, simply stating that, "seen under the microscope, it presented a mass seamed by little cracks filled with a white and efflorescent salt, whose interstices appeared to consist of white pyrite unattacked and more or less crystalline;" also, on dissolving out the efflorescent salt, he could distinguish no sulphur in the residue.

In connection with a chemical examination which has been presented elsewhere (before the New York Academy of Sciences), I have resorted to the microscope in the hope of getting new light. I selected, as a material most promising of results, a portion of a nodule of pyrite in a state of decomposition, from Marsden's Diggings, Illinois. The conical specimen consisted of a finely fibrous material, with fibres about eight centimetres in length, and mostly 0.2 millimetre in thickness, radiating from the apex of the cone (the centre of the original nodule), becoming coarser toward their outward extremities, and there terminating in a close aggregation of distorted cubes, 4 to 8 mm. on a side. The inner material was of a pale yellowish-white color, and exceedingly brilliant lustre, crossed by three or four concentric lines of concretionary growth; an easy cross-fracture occurred at the lines, leaving a surface—across the ends of the fibres—which appeared to the eye perfectly aphanitic in texture, exceedingly brilliant and slightly mammillary. At the outer surface the aggregated cubes were stained to a brownish-black,

variegated by delicate whitish efflorescence within the interstices. This efflorescence was found to penetrate to a depth of about 1 to 2 centimetres below the surface along the fibres, and even to the very centre of the nodule, at a depth of 8 centimetres along certain widened fissures among the fibres. The material differed little from that of similar fibrous nodules from Galena, Illinois; Linden, Wisconsin, and other localities. Various fragments of this material were mounted for examination by reflected light, and for this purpose, low magnifying powers, up to 200 diameters, were found sufficient, with the help of the plane mirror of a Sorby reflector.

The following materials were thus examined:—

A. A fibrous plate of the fresh and brilliant material from the interior. The surface of this natural fragment was divided up, through the fibration, by strongly marked lines, sometimes perhaps indicating open fissures, 0.033 to 0.134 mm. apart. Within these, in many places, a still finer lining occurred, the lines being sometimes only 0.014 mm. apart. These finer lines, coinciding with the cubic cleavage, were sometimes parallel to the main fibration, sometimes perpendicular to it. Elsewhere, they were commonly arranged obliquely, at an angle of 45° to 53° from the general direction, sometimes even in two sets, passing obliquely off in opposite directions from a median line; these latter oblique lines doubtless mark the octahedral cleavage of pyrite, often greatly distorted by pressure, and even, thereby, rendered curvilinear. A want of homogeneity was suggested by a number of bright, angular, yellow particles and grains scattered over the white and duller surface; their size usually varied from 0.013 to 0.084 mm.

B. A fragment from a plane at right angles to that of *A*, presenting the polished mammillary, and curved surface from the cross-fracture. The entire surface was found to be not uniform as it appeared to the eye, but seamed and slightly roughened by short fissures, marking the cubic cleavage, running at right angles to each other, but rarely intersecting, dividing up the surface into square spaces about 0.01 to 0.015 mm. on a side.

The same bright-yellow grains appeared here and there, as in *A*, but mostly as lines or thin branching veins, apparently the edges of films of yellow material, enclosed in the paler-colored pyrite.

C. A portion of the side of a fissure evidently—to the eye—darkened and roughened by incipient decomposition, but still apparently perfectly dense and compact. This showed under the microscope a remarkable subdivision and disintegration, the whole surface being seamed by minute cracks, mostly along and across the fibres, and also irregularly pitted and even honey-combed with cavities of the most irregular shape and size : all this surface was sprinkled and coated with granules and needles of the white efflorescence. The phenomena differed widely on every surface examined, but mostly comprised the following points of structure in the pyrite itself :—

1. A coarse columnar structure, that of the fibration, presenting a width of about 0.08 to 0.25 mm. between the parallel fissures, whose lips were separated about 0.005 mm. This was crossed, with more or less irregularity, by fissures at right angles, often producing the effect of an imperfect tessellated pavement, or of rude masonry. In places, the disintegration had gone so far that the mass consisted of dark roughened needles, attached at one end, or both.

2. The surface intervening between these cracks was pitted with cavities of the utmost irregularity of size and form, though commonly approximating 0.004 to 0.009 mm. in diameter, scattered in rows and in large groups. As a result of the subdivision produced by these cracks and pits, I estimated that the greater part of the mass was separated into little grains, approximately cubical in form, and about 0.01 mm. on a side. It would require about a thousand millions of such little grains to make up a cubic centimetre of the material, and the surfaces of these would present a superficial area about ten million times that of the superficies of a solid cubic centimetre.

3. The surface between the little pits further shows a very delicate striation, apparently caused by fine cracks or by minute ribs and furrows, all parallel to the line of fibration, but slightly wavy. On an average, about 555 of such lines occupied the distance of one millimetre across the fibration ; *i. e.*, they were about 0.0018 mm. apart. They projected very slightly above the intervening furrows, and produced the impression that they were lines of accretion running in the direction of the general fibration, and originally producing that structure ; that they represented the edges of thin films of a compact material,

flattened out by intense lateral pressure, whose irregularity had produced the wavy disturbance of their lines ; also, that their material was harder and perhaps brighter than that in the intervening furrows, and that their projection above the surface was but a feature of the general erosion, caused by their greater resistance to decomposition than that offered by the intervening films.

4. The suspicion of the want of homogeneity of the material was increased by the occasional distribution, over the dull eroded surface, of minute bright grains, scales, pellicles, and angular, sometimes branching rods, contrasting with the general surface by their brilliant lustre, yellow color, and sometimes, a slight projection. Many consisted of barely visible particles and lines, but some were noticed of the size of 0.005 to 0.035 mm.

Occasionally, triangular and rectangular outlines 0.056 mm. in length, and rarely two or three faces of a flattened polished cube could be distinguished. Their compact, bright material appeared identical with that of the striation films, and, in fact, many of their forms appeared as mere expansions or projections of these films. All the facts strengthened the idea that the material of this fibrous pyrite is not uniform, as it appears to the eye, but that these grains and minute lines indicate the planes of successive envelopment of two materials, the one yielding rapidly to decomposition, the other more dense and yielding more slowly.

The little pits or cavities were also closely examined to determine whether they ever presented symmetrical outlines, which might signify the eating away of crystals of a softer substance, but no such indications were recognized.

D. The darkened surface of a cube from the outer surface, slightly marked to the eye by minute particles of the vitriol-efflorescence. This presented under the microscope a finely granular mass of the pyrite material, seamed and interspersed with the white particles, grains, and sometimes needles of copperas in an almost continuous network. The surface was, in general, deeply and very irregularly eaten out and honeycombed in pits and cavities divided by jagged angular septa ; these cavities often presented a diameter of 0.06 to 0.10 mm., with a depth of about the same amount. Many of the grains of pyrite displayed cubical outlines, about 0.025 mm. on a side, which indicated the full development of the cubical cleavage.

On similar corroded and effloresced surfaces, on the side of fissures below the point where the cubes were developed, the eroded pits were a little larger, about 0.167 mm. in diameter, but the grains of pyrite did not exhibit cubical forms.

From these observations we may gather :—

1. In these fibrous nodules of pyrites, the fibres consist of elongated cubes, whose outward growth and mutual compression have produced a condition of great tension.

2. The material consists mainly of a diluted mixture of pyrite with a paler-colored and unstable impurity. Through this mixture more or less pure pyrite is diffused in alternating films, or in scattered strings and crystals of deeper-yellow color than their matrix.

3. The oxidation of the material has been facilitated by its heterogeneous composition, by its fissured structure, and by the tension among its fibres. It has progressed more rapidly in the predominant pale-colored mixture, has penetrated along the seams between the fibres, and has then been hastened by the development of the more minute fissuring as the result of the tension.

4. The development of this system of minute fissures has furnished an enormous area for the internal condensation of gases and vapors from the atmosphere, chiefly oxygen and moisture, which has resulted in the speedy oxidation, pitting, decay, production of crystals of vitriol, expansion, and final disintegration observed in such forms of pyrites.

A consideration of all the facts leads, I think, to the conclusion that the readiness to decompose in certain forms of pyrite is connected, only to a slight extent, with the nature of the surfaces of its crystals, and but in part with any visible internal peculiarities of structure. We may rather be inclined to infer a want of homogeneity in unstable pyrite, produced by an intimate intermixture with some unstable though invisible impurity, and analogy leads us to attribute the latter to the presence of some proportion of marcasite.

I have so far brought before you to-night the various peculiarities of texture revealed by the microscope in the crystals and nodular forms of the three pyrites, and have exhibited in miniature, in the slides, very nearly all the modes of decomposition by which these minerals are attacked. Some new facts of the

same nature are yet to be described, which have been observed in the pyritiferous valves of the diatoms of the London clay, whose novel constitution was explained in 1881, by Messrs. Shrubsole and Kitton. They were found only in the lower portion of this stratum which underlies the London basin, often at a depth of 360 feet. Their numbers were so great as to be largely concerned in producing the distinct lamination of the clay, on whose planes they appeared as bright shining films. Several species of *Coscinodiscus*, *Triceratium*, *Arachnoidiscus*, *Trinacria*, etc., have been identified: 20 genera in all, and nearly 42 species. Count Castracane attributed the formation of their pyritiferous material to an electro-chemical process, and many others have looked upon it as a mere plating "deposited upon the siliceous skeleton, as in the electro-galvanic deposition of metals." F. Kitton, however, found that, on digestion in weak nitric acid, the entire frustule disappeared, and concluded that the silica had been replaced by a deposit of pyrites. He also noticed the occurrence of small globules of pyrites, $\frac{1}{2000}$ of an inch in diameter, resembling pewter balls or marbles.

I think you will agree with me, on an examination of several preparations of these diatoms here exhibited, that the following points of mineralogical interest are established:—

First. That the material referred to by all writers under the broad name of pyrites, consists substantially of the single mineral pyrite. To determine this point I searched for minute cavities in which the substance might have found opportunity to crystallize, and discovered not only minute drusy surfaces, but also little spherules covered by projecting crystals. The globules which Mr. Kitton detected, appear to have been round and smooth, probably concretionary. On those exhibited to-night may be seen triangular faces, which appear to belong to octahedra; these crystals must therefore consist of pyrite. This conclusion will be confirmed by a glance at the slide on which is mounted a crystalline crust from a specimen of fossil fruit, converted into pyrites, from the London clay at the Island of Sheppey. This drusy surface shows distinct, sharp octahedra of larger size, so that this crystalline form probably prevails in the pyrite crystals throughout the London clay.

Second. The true color of the pyrite films, when examined on

a fresh cross-fracture, appears to be a grayish white. This indicates that the crystals are far from pure, probably mixed with a large proportion of marcasite.

Third. The incipient decomposition of the mineral is characteristic of the presence of marcasite, beginning with a golden-yellow tarnish within, and assuming a bronze color without. As the decay progresses, the valves become covered by a reddish film of iron oxide, and finally, the entire material passes into reddish-brown iron-ochre, sometimes blackened, as if by the intermixture of oxide of manganese. The mode of deep subterranean decomposition is, therefore, hepatic, and vitriolence is never observed in these altered diatoms; although the latter form of decay attacks the nodules of pyrites lying nearer the surface in the London clay, at other points along the Thames, as at the Island of Sheppey.

In conclusion, I may state that I have found in the study of pyrites, many rich and interesting fields of investigation, in which the testimony of microscopical observation has proved indispensable.

THE CARPET-BEETLE.

BY THE REV. J. L. ZABRISKIE.

(Read May 7th, 1886.)

THE Carpet-Beetle (*Anthrenus Scrophulariæ*, L.) is noted for the striking colors of the mature insect and the ravages of the larva upon our household goods. The insect was first noticed in the United States in 1872, although it has been known in Europe more than a century. It is now found spread over our country from the Atlantic coast to California. It was doubtless imported from Europe in infested carpets, and its distribution has been largely traced to a certain Boston Carpet-House.

The Beetle is about $\frac{1}{3}$ th of an inch long, and prettily marked with regular patches of white and red upon a prevailing black-ground. It feeds upon the pollen of flowers, preferring species of Spiræa. And in our locality it will be found in infested houses in the latter part of April and throughout May, upon the windows, endeavoring to escape to the outer air to find its food.

The ravages are committed by the larva, which when fully grown are about $\frac{1}{4}$ th of an inch in length, ovoid in form, and thickly covered with stout black bristles, causing it to appear

like a little ball of black lint. It has been named very inappropriately the Buffalo Moth, perhaps from the shaggy appearance, and also from the fact that it was first noticed as injuring carpets at Buffalo, N. Y. In some parts of our country it has become so destructive that carpets have been dispensed with, and matting has been used in their stead. It has not been reported as injuring carpets in Europe, probably, it is said, because there, carpets are very generally taken up in summer and carefully stowed away. The larva prefers wool for its food, but greedily devours nearly all animal substances, especially furs, feathers, leather and entomological and animal collections.

The reports that it feeds occasionally on cotton goods and vegetable substances have not been confirmed, and it does not seem to affect silks. Carpet linings will protect the carpets from these pests. But where the carpet meets the base board of a room, they are sure to be found at work if they have the opportunity. Benzine is the best remedy known. A convenient vessel for applying it is a tin can, with a slender spout, and having a nozzle made from the point of an old silver pencil case. This will pour a stream about the size of a steel knitting-needle, and the benzine can be quickly and easily directed by it to the right place, as one making the application passes the can along the edge of the carpet. Benzine applied in this manner every fortnight in spring, and once a month throughout the year, will doubtless preserve a carpet on the floor, and also will preserve woolen goods, furs and feathers, when stowed in chests, where the stream of fluid can be poured upon the inner surfaces of the chests and not upon the goods themselves.

The scales here exhibited—white, red, and black, $\times 250$ —are from the back of the beetle, where they are larger and brighter than elsewhere, although they cover the entire surface of the insect.

This beetle belongs to the family Dermestidæ, of which over forty species are reported in this country.

With the imago and larva of the Carpet-Beetle some related species are exhibited, as *Anthrenus varius*, Fab., a well-known museum pest, and the destructive Bacon-Beetle (*Dermestes lardarius*, L.); also, *Dermestes vulpinus*, Fab., and *Dermestes talpinus*, Mann. Also, two relatives, which are working with the Carpet-Beetle and which may become equally destructive: *Attagenus megatoma*, Fab., and *Trogoderma tarsalis*, Mels.

PROCEEDINGS.

MEETING OF MAY 7TH, 1886.

The President, the Rev. J. L. Zabriskie, in the chair.

Twenty-five persons present.

OBJECTS EXHIBITED.

1. Pyrrholite, iridescent hexagonal crystals; Elizabethtown, Canada.
2. Marcasite, with needles of white vitriol; from Trenton limestone, Jefferson County, New York.
3. Marcasite, with iridescent tarnish; Galena, Illinois.
4. Pyrite, with naturally polished faces; lines of growth parallel to cubical faces; Chili.
5. Pyrite (granular), minute cubes; New Jersey.
6. Pyrite, octahedra, iridescent with bands of color; Weehawken, New Jersey.
7. Limonite (Bog-Iron Ore), in pseudomorphous octahedra, after Pyrite; Weehawken, New Jersey.
8. Pyrite decaying in marble; Lee, Massachusetts.
9. Fibrous Pyrite, showing abundant fissures; Marsden's Diggings, Illinois.
10. Diatoms (*Coscinodiscus*), altered into Pyrite; London clay.
11. Pyrite, octahedra, from altered fossil fruit; London clay, Island of Sheppey.

The above objects were exhibited by Dr. A. A. JULIEN, in illustration of his paper on "the Microscopic Structure of Iron Pyrites."

12. Crystals of Oxalate of Calcium on Mycelium of fungus in decayed wood of *Pinus Strobus*, L: by P. H. DUDLEY.

13. The Carpet-Beetle (*Anthrenus scrophulariæ*, L.), with some related species: by Rev. J. L. ZABRISKIE.

14. Scales—white, red, and black—of *Anthrenus scrophulariæ*, L.: by Rev. J. L. ZABRISKIE.

15. Spiracles of *Platysamia cecropia*: by F. W. LEGGETT.

IRON PYRITES.

Dr. A. A. Julien read a paper on "The Microscopic Structure of Iron Pyrites."

CRYSTALS OF OXALATE OF CALCIUM.

Mr. Dudley: "These crystals were obtained from a specimen

of Nicholson pavement laid some sixteen or seventeen years ago, in one of the streets of New York. They were found in abundance on the mycelium of fungus in the decayed wood. In examining almost any specimen of decayed wood, the crystals will be found in large numbers, but this is the only specimen in which I have found them upon the mycelium."

ANTHRENUS SCROPHULARIÆ.

The President read a paper on the "Carpet-Beetle (*Anthrenus scrophulariæ*, L.)."

Messrs. Arthur J. Wolf, M.D., and Edmund Tweedy, were elected active members of the Society.

MEETING OF MAY 21ST, 1886.

The President, the Rev. J. L. ZABRISKIE, in the chair.

Twenty-five persons present.

OBJECTS EXHIBITED.

1. Typhoid-fever Bacilli, from a pure culture, prepared by Dr. Prudden: by C. E. PELLEW.
2. Carbons made from paper, cotton, silk, bamboo, etc., used in incandescence electric lamps: by H. L. BREVOORT.
3. Transverse Section of Anther of *Lilium*: by W. H. MEAD.
4. Head of the Beetle *Eupholus Schenherrii*: by B. BRAMAN.
5. Young of the Nine-Pronged Wheel-Bug (*Reduvius novemarius*, Say), just emerged from the egg; also egg-mass, showing about 120 eggs: by J. L. ZABRISKIE.
6. Section of Coal, showing vegetable structure: by F. W. LEGGETT.

TYPHOID-FEVER BACILLI.

Mr. Pellew reported to the Society some investigations recently made in regard to the Typhoid-fever bacillus, and in the course of his remarks exhibited several specimens of pure cultures of the bacilli, growing in gelatine tubes and upon potatoes. After giving a short sketch of the previous history of the subject, Mr. Pellew said: "Typhoid fever has long been recognized as peculiarly a germ disease, and as early as 1871, observers began to find varieties of bacteria in the tissues of patients. In 1882, however, Eberth discovered in the spleen and other organs, characteristic colonies of short bacilli with rounded ends, and his observations were confirmed immediately

by Dr. Robert Koch and other careful workers. It was not until 1883, however, after the introduction of the new methods of bacteria cultivation, that these bacilli were isolated and studied in pure cultures. This was done by Dr. Gaffky, in Wurtzburg. Gaffky's work ceased at this point, as he was unable to reproduce the disease in either mice, rabbits, guinea pigs, doves, chickens, calves, or monkeys, by inoculation with these pure cultures. During the past year Dr. Pfeiffer, of Uresbaden, announced that he had been able to isolate the bacilli from the excreta of typhoid-fever patients, thereby confirming previous ideas as to the cause of epidemics of the disease.

“Within a few months past Dr. E. Fraenkel and Dr. M. Simmonds, of Hamburg, have published a pamphlet¹ containing their experiments, which, if confirmed, will practically prove that these bacilli are the cause of the disease. They worked on over thirty fatal cases, in an epidemic in their city, and in twenty-five of these cases were able to isolate the typhoid bacilli. They also isolated these bacilli from the excreta, and made an elaborate series of inoculations with their pure cultures on mice, rabbits, and guinea pigs, and in quite a number of cases obtained positive results.”

NINE-PRONGED WHEEL-BUG.

The President : “I exhibit a recently hatched specimen of the Nine-pronged Wheel-bug (*Reduvius novenarius*, Say). It belongs to the order Hemiptera, and the sub-order Heteroptera, of which the Squash bug is a familiar example. It receives its popular name from a singular crest, situated longitudinally on the back of the thorax of the mature insect, resembling an erect segment or a wheel, provided on its outer edge with nine projections like short spokes or cogs. This creature is an eminent assistant to the gardener and farmer. From the very moment of its birth, it employs its time in searching for noxious insects, which it destroys in great numbers. It is said, the adult must be handled with care, for with its powerful beak it is able to inflict a wound more painful than the sting of a hornet.

“In this young specimen it may be noticed, that the legs are long and stout, the tarsal claws well developed ; the antennæ have the distal joints of an orange hue ; the large beak is bent

¹ Die Aetiologische Bedeutung des Typhus Bacillus. Von Dr. E. Fraenkel und Dr. M. Simmonds. Hamburg & Leipzig : Leopold Voss, 1886.

from the under side of the head towards the breast, and the general color of the insect is a deep black, excepting the abdomen, which is blood red, with conspicuous black spiracles on the sides of the abdominal rings.

“I also exhibit the egg-mass of the same insect. This comprises about 120 eggs, glued to the bark of a tree, resembling a collection of minute, slender, black jars standing upright and very near each other, each jar having a contracted neck, and a light-colored lid, the latter being ornamented with a horizontal fringe of projecting rays.”

BROWNIAN MOVEMENT IN MILK.

Mr. Brevoort made some remarks on the Brownian movement in freshly-drawn human milk, stating that he had observed that the movement varied, being most active at the birth of the offspring, and diminishing in rapidity as time elapsed.

Mr. George E. Ashby was elected an active member of the Society.

PUBLICATIONS RECEIVED.

Le Microscope à l'Exposition Universelle d'Anvers; pp. 35. By Dr. Henri Van Heurck.

The Canadian Record of Science : Vol. II., No. 2 (April, 1886); pp. 72.

The Microscopical Bulletin and Science News : Vol. III., No. 2 (April, 1886); pp. 8.

Brooklyn Entomological Society. Entomologica Americana : Vol. II., No. 2 (May, 1886); pp. 24.

Indiana Medical Journal : Vol. IV., No. 10 (April, 1886); pp. 22.

National Druggist : Vol. VIII., No. 18 (April 30th, 1886); pp. 12. No. 19 (May 7th); pp. 12. No. 20 (May 14th); pp. 16. No. 21 (May 21st); pp. 12. No. 22 (May 28th); pp. 12.

Journal of Mycology : Vol. II., No. 5 (May, 1886); pp. 12.

The Naturalists' World : Vol. III., No. 29 (May, 1886); pp. 18.

North Staffordshire Naturalists' Field Club. Annual Report, 1885; pp. 135.

Anthony's Photographic Bulletin : Vol. XVII., No. 9 (May 8th, 1886); pp. 32. No. 10 (May 22d); pp. 36.

Smithsonian Institution. Annual Report of the Board of Regents for the year 1884, pp. 904.

Bulletin of the Torrey Botanical Club : Vol. XIII., No. 5 (May, 1886); pp. 20.

Comptes-Rendus des Séances de la Société Royale de Botanique de Belgique: April 10th, 1886; pp. 8.

The Electrician and Electrical Engineer : Vol. V., No. 53 (May, 1886); pp. 40.

The Microscope : Vol. VI., No. 5 (May, 1886); pp. 24.

The American Monthly Microscopical Journal : Vol. VII., No. 5 (May, 1886); pp. 20.

The Botanical Gazette : Vol. XI., No. 5 (May, 1886); pp. 24.

The Hosier Naturalist : Vol. I., Nos. 9 and 10 (April and May, 1886); pp. 16.

Johns Hopkins University. Circulars : Vol. V., No. 47 (March, 1886); pp. 14. No. 49 (May); pp. 18. Studies from the Biological Laboratory : Vol. III., No. 6 (May, 1886); pp. 83.

Proceedings of the Davenport Academy of Natural Sciences : Vol. IV. (1882-1884); pp. 10+347.

INDEX TO ARTICLES OF INTEREST TO MICROSCOPISTS
WHICH HAVE RECENTLY APPEARED IN OTHER
JOURNALS.

- Algæ of Fresh Water, Provisional Key to Classification of (VIII): R. HITCHCOCK.
Am. Mon. Mic. Jour., VII. (1886), pp. 95-7.
- Blood, Observations upon the, of *Limulus Polyphemus*, *Callinectes hastatus*, and a Species of Holothurian: W. H. HOWELL.
Studies Biol. Lab., Johns Hopkins Univ., III. (1886), pp. 267-87 (11 figs.).
- Blood, On the so-called "New Element" of the, and its Relation to Coagulation: GEO. T. KEMP.
Studies Biol. Lab., Johns Hopkins Univ., III. (1886), pp. 293-349 (14 figs.).
- Corn Mildew and Barberry Blight: WORTHINGTON G. SMITH.
Sci.-Gos., 1886, pp. 103-5 (2 figs.).
- Duct Formation in Chestnut Wood: P. H. DUDLEY.
Bul. Tor. Bot. Club, XIII. (1886), pp. 91-2.
- Diatoms, On the Finer Structure of certain: E. M. NELSON, and G. C. KAROP.
Jour. Quek. Mic. Club, II. (1886), pp. 269-71 (5 figs.).
- Fine Adjustments, The Cam: EPHRIAM CUTTER.
The Microscope, VI. (1886), pp. 101-4.
- Focal Planes and Diatomic Images (Under title Microscopical Advances.—X): DR. ROYSTON-PIGOTT.
Eng. Mech., XLIII. (1886), pp. 247-8 (5 figs.).
- Focal Planes, and their Measurement by the Focimeter (Under title Microscopical Advances.—IX): DR. ROYSTON-PIGOTT.
Eng. Mech., XLIII. (1886), pp. 203-4 (8 figs.).
- Gamasus*, On a New Species of: A. D. MICHAEL.
Jour. Quek. Mic. Club, II. (1886), pp. 260-8 (18 figs.).
- Infusoria, Notices of New Fresh-Water: ALFRED C. STOKES.
Am. Mon. Mic. Jour., VII. (1886), pp. 81-6 (18 figs.).
- Interpretation of Microscopic Images with High Powers, On the: E. M. NELSON.
Jour. Quek. Mic. Club, II. (1886), pp. 255-9.
- Julus terrestris*, The early development of: F. G. HEATHCOTE.
Quar. Jour. Mic. Sci., XXVI. (1886), pp. 449-70 (33 figs.).
- Leeches of Japan, The: C. O. WHITMAN.
Quar. Jour. Mic. Sci., XXVI. (1886), pp. 317-416 (71½ figs.).
- Live Box, Note on a New Form of: C. G. DUNNING.
Jour. Quek. Mic. Club, II. (1886), pp. 249-51 (2 figs.).

- Marine Collecting with the surface net, On : G. W. M. GILES.
Sci.-Ges., 1886, pp. 110-11.
- Microscopical Research, Results of : CHARLES H. STOWELL.
The Microscope, VI. (1886), pp. 107-11.
- Nemertea*, Contributions to the Embryology of the : A. A. W. HUBRECHT.
Quar. Jour. Mic. Sci., XXVI. (1886), pp. 417-48 (15 figs.).
- Parasites, Animal, Chapters on : W. A. HYSLOP.
Sci.-Ges., 1886, pp. 108-10 (3 figs.).
- Photo-Micrography.—VI : R. HITCHCOCK.
Am. Mon. Mic. Jour., VII. (1886), pp. 92-5.
- Proterospongia Pedicellata* : ALFRED C. STOKES.
The Microscope, VI. (1886), pp. 105-6.
- Schizophyta, The Pleomorphism of the : E. RAY LANKESTER.
Quar. Jour. Mic. Sci., XXVI. (1886), pp. 499-505.
- Spongilla fragilis*, On, Found in the Thames : B. W. PRIEST.
Jour. Quek. Mic. Club, II. (1886), pp. 252-4 (5 figs.).
- Staining Tissues in Microscopy.—X. (HANS GIERKE, *Zeitschr. für. Wiss. Mic.*) : Translated by W. H. SEAMAN.
Am. Mon. Mic. Jour., VII. (1886), pp. 97-9.
- Syllis*, On the Structure of the so-called Glandular Ventricle (Drüsenmagen) of :
 WILLIAM A. HASWELL.
Quar. Jour. Mic. Sci., XXVI. (1886), pp. 471-80 (13 figs.).

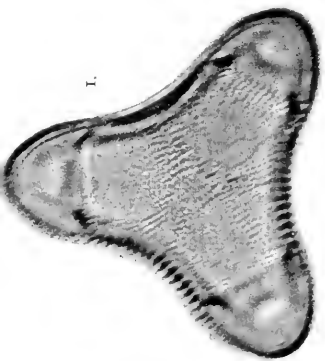

I.

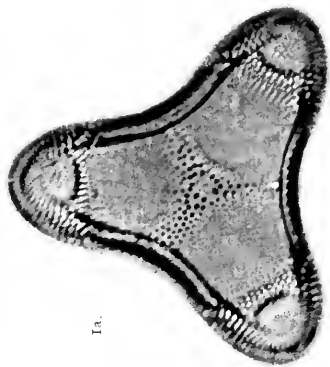

Ia.

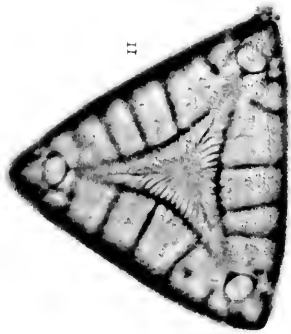

II

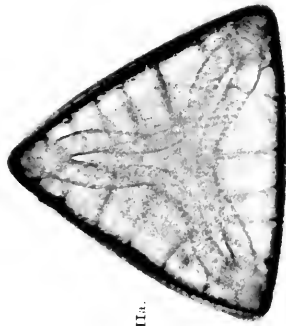

IIa.

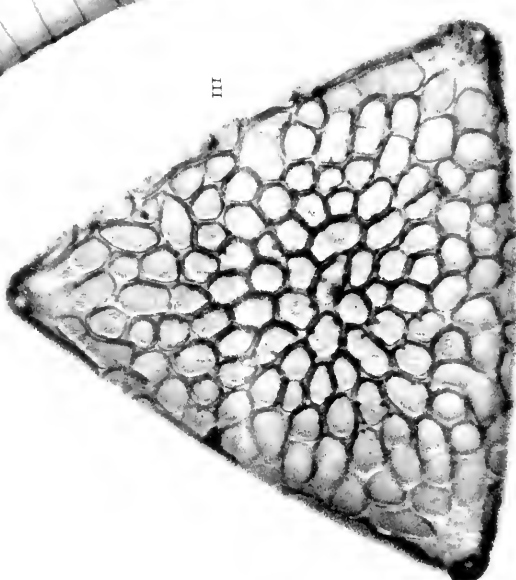
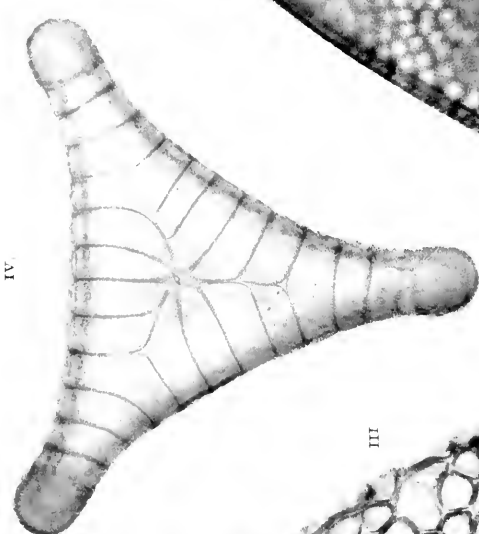
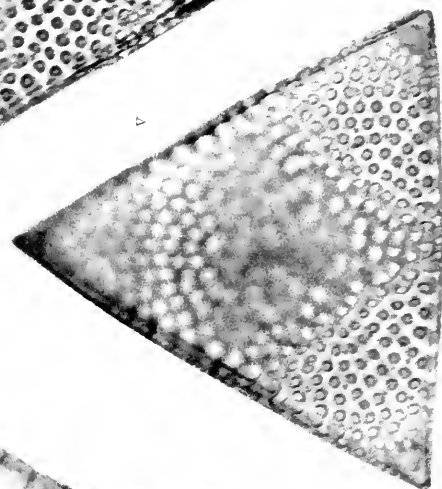
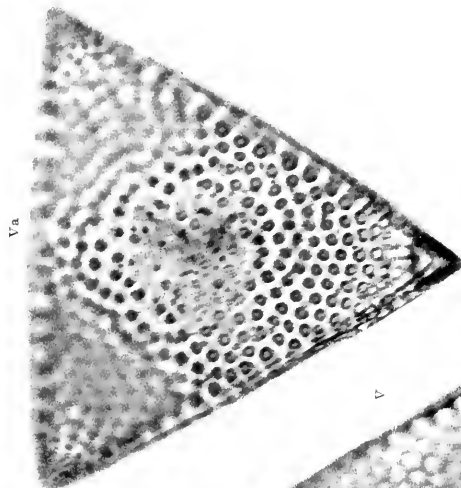

JOURNAL
OF THE
NEW-YORK MICROSCOPICAL SOCIETY.

VOL. II.

JULY, 1886.

No. 7.

LIVERWORTS.

BY THE REV. J. L. ZABRISKIE.

(Read June 4th, 1886.)

The Liverworts (*Hepaticæ*) are closely allied to the Mosses. And while it may be difficult to separate them from the Mosses by description, still a very slight acquaintance serves to distinguish them by sight.

They are divided into two main sections, with a nearly equal number of genera in each. The first section includes those genera whose vegetation is frondose; *i. e.*, whose stem and leaves are confluent in a leaf-like mass. The second section includes those genera whose vegetation is foliaceous; *i. e.*, whose leaves are distinct from the stem, as is the case with the Mosses.

I exhibit entire fruiting specimens, in vials of water, of two species of Liverworts, both belonging to the first, or frondose section.

1. The Brook-Liverwort (*Marchantia polymorpha*, L.). It frequents shady, moist places; especially shady springs. The frond grows flat upon the wet soil, moss, &c. It is frequently from one to three inches in length, and one inch wide, usually forked at the growing end, of a bright green color, and has numerous rootlets underneath. The staminate, or male organs of reproduction, are little shield-like, lobed bodies on the upper surface of the frond.

Besides these there are sometimes also found, in the same situation, little cups, which contain buds, like minute green lenses, which are capable of originating new individuals. The pistilate, or female organs of reproduction, start from the edge of the frond, and ascend in a slender peduncle, sometimes two or three inches high. And at the summit of this there expand,

in a wheel-like form, from nine to thirteen horizontal, lobed, green rays. Underneath these rays are found the spore-cases, enclosed in their involucre. These spore-cases are globular, depending from a slender pedicel, and rupturing by irregular lobes, when mature, to discharge their spores.

The Liverworts have curious organs, known as elaters, or springs. These are slender, lengthened cells, growing in the spore-cases, with the spores, and furnished inside with one or two spiral fibres. Their office is, by a sudden expansion, to violently project the spores from the spore-case, when the latter is ruptured at maturity.

2. The other species is the Small Liverwort (*Fimbriaria tenella*, Nees.). This was found growing abundantly on the ground along a hedge-row in an upland field at Nyack, N. Y. The frond is scarcely half an inch in length,—at first light-green, then turning purple. The peduncle of the pistillate receptacle is sometimes an inch and one-half long, and the receptacle at its summit is hemispherical, concave underneath, expanding at the margin into two to four pendent, bell-shaped involucre, each containing an ovoid spore-case. These spore-cases rupture, at maturity, by an irregular line near the horizontal circumference.

The spores and elaters of this second species are here exhibited under the microscope. These spores are nearly triangular, with a roughened outer coat, divided into irregular areas by numerous ridges. And the elaters are short and stout, each containing two spiral fibres.

THE STRUCTURE OF QUERCUS ALBA.

BY P. H. DUDLEY, C. E.

(Read June 18th, 1886.)

This wood possesses a structure not only of scientific interest, but one which renders it of economic value. The large ducts forming in the early spring growth are arranged in the inner portion of the ring, in one, two, and sometimes three quite distinct concentric rows. Surrounding these ducts are small tracheides, which form at the same time and have numerous small thin places on their sides; their cross section is like that of the ducts, elliptical.

In the normal growth of an annual ring, hard dense fibres, in masses, begin to thicken the layer, soon after the ducts are formed, and generally continue through to the outer portion.

In wood of dense growth these fibres form the largest portion of the layer, and the wood has a high specific gravity, reaching in some specimens from .82 to .85; a cubic foot weighing 51 to 53 lbs., the ordinary weight being 42 to 45 lbs. These hard fibres are very small, being only .0006 to .0075 of an inch in diameter, and with the magnification of 100 diameters the lumen is just visible. I have not been able to find thin places in these fibres, though fluid communications may exist. These hard fibres do not occur as a complete zone, as the hard fibres do in several of the conifers, but are divided into radial layers or masses, if the ring be thick, by smaller ducts which diminish in size as they approach the exterior of the ring. These ducts are also surrounded by the small tracheides. The medullary rays are distributed through all classes of the fibres, the cells becoming flattened as they curve around the ducts. These masses of hard fibres are further subdivided by rows of cells running at right angles to the medullary rays, and which, in the alburnum, contain starch, except during the season of most active growth. Such abundant provision for the nourishment of the hard fibres indicates that only a limited circulation takes place in them, probably little more than is required for their development. Some have considered these fibres purely mechanical, and only added for strength. This prompts the inquiry, What additional strength and hardness does the oak require in growing, more

than many other species of trees which grow of equal size and height and do not have similar fibres? The *Liriodendron Tulipifera*, a tree of even more stately dimensions and broader leaf, has a series of ducts interspersed entirely through the annual layer, but has no hard fibres, and has only about one-half the specific gravity of the oak.

The climatic conditions have much to do with the growth of the hard fibres in the oak, for in some seasons the same tree will only have a few in the annual rings. This lack of hard fibres is noticeable in the timber which now comes to market; timber which contained more and which was, therefore, of a superior quality, having been, apparently, exhausted. White oak, which has but a few of the hard fibres in the rings, is brash, and not as strong as that first described. In the transverse section, of which I exhibit a photo-micrograph, only the small medullary rays are seen, running through the masses of hard fibres. In other sections, the primary rays can be seen passing through the hard fibres. The starch-carrying cells, which also divide the hard fibres, at right angles to the medullary rays, are clearly indicated in the photo-micrograph. In the radial longitudinal section, the medullary rays and the exterior and interior of one of the ducts can be seen; the latter are filled with tissue, and are never empty; the section also shows hard, dense fibres, also, the interspersed starch-carrying cells.

In the tangential section, can be seen the end of one of the large primary bundles of medullary rays, also, those of the single rows, the characteristic markings of the tracheides, and smaller ducts. The short cells are those which at one time contained starch.

STAMEN OF THE DEERBERRY.

(VACCINIUM STAMINEUM, L.)

BY THE REV. J. L. ZABRISKIE.

(Read June 18th, 1886.)

This plant is related to the Cranberries and Huckleberries. There are fourteen species of *Vaccinium* in the Northern United States. This species is one of the Huckleberries, known popularly as the Deerberrry, and sometimes as the Squaw-Huckleberry. It is a shrub, two or three feet high. The fruit is globular, one-half inch in diameter, of a greenish color, rather nauseous, although sweet to the taste, but possessing a most agreeable aroma, as of delicious apples.

Some time ago, I had a dozen of these berries, wrapped in paper and enclosed in a book-case. For several weeks, every time that book-case was opened the entire room was filled with the agreeable odor of the fruit.

The corolla of this species, instead of being an oblong tube, with terminal reverted lobes, as is common in the order, is open, bell-shaped, and greenish-white, or purplish. The style is slender, and about three times the length of the corolla. The stamens are ten, about twice the length of the corolla, standing in a close bundle around the style, and of a curious form. The filament of the stamen is a white strap, hairy, and having attached to the inner face two large, elliptical pouch-like anthers, each anther extending in a slender tube, opening at the extremity by four or five ornamented lanceolate lobes. Each anther, also, is furnished with a slender awn of about one-half the length of the anther tube, arising from the outer and upper portion of the pouch. The pair of awns, extending horizontally in opposite directions, out from the longitudinal axis of the stamen, and being of a sinuous form, resemble a pair of spreading ox-horns. The entire surface of the anthers, also, is very prettily ornamented by hexagonal cells, each surmounted in the centre by a slender prominent papilla.

FIVE SPECIES OF TRICERATIUM.

BY E. A. SCHULTZE.

Plates IV. and V.

The slides from which the five species of *Triceratium*, figured on Plates IV. and V., were taken, are the work of Prof. Thum, in Leipzig, and the frustules are selections from the Barbadoes material.

I am indebted to my friend H. L. Brevoort, for his kind assistance in the preparation of these plates, his camera having furnished the negatives, which were taken with a Wales $\frac{1}{2}$ -inch, and a Spencer $\frac{1}{8}$ -inch objective, respectively, and which show a magnification of about 650 diameters. So far, I am only able to identify one of the five species; viz., (II.) "*Entogonia marginata*," of which IIa. represents the same diatom taken under a different focus. This specimen will be found figured in A. Schmidt's Atlas, Plate 88, No. 6. The other four have been sent to A. Schmidt for identification, the result of which I shall communicate to the Society as soon as I hear from him. No. III. is, I believe, a new species. I can find no specimen among the 125 at my command with which it might be classed as a variety, on account of the peculiar markings. The interior network is an embossed and sharp structure, interwoven here and there with lines of exceeding fineness. No. IV. is, I think, a variety of *Triceratium venosum*, figured in Schmidt's Atlas, Plate 88, No. 12; while V. (Va. a different focus) appears to be a variety of "*Triceratium caelatum*," Schmidt's Atlas, plate 81, No. 19.

PROCEEDINGS.

MEETING OF JUNE 4TH, 1886.

The President, the Rev. J. L. Zabriskie, in the chair.

Thirty-one persons present.

OBJECTS EXHIBITED.

1. Micrococci of Pyæmia—from Human Heart : by CHARLES E. PELLEW.
2. Bacteria of Putrefaction—from Human Liver : by CHARLES E. PELLEW.
3. Arranged Diatoms : by C. S. SHULTZ.
4. Photo-micrograph of transverse section of *Larix Americana* : by P. H. DUDLEY.
5. Fruiting specimens of Liverworts—*Marchantia polymorpha*, L. and *Fimbriaria tenella*, Nees.: by J. L. ZABRISKIE,
6. Coralline Limestone, from Northern Ohio : by E. B. GROVE.

BACTERIA OF PUTREFACTION.

Mr. Pellew, in describing the preparations exhibited by him, said that the slide showing "Bacteria of Putrefaction" illustrated the care that must be taken when tissues are examined for specific bacteria. The preparation was a section of human liver in a case of typhoid fever. On double staining, quantities of bacteria appeared which did not, however, resemble typhoid bacilli, either in shape, size, or mode of grouping. On inquiry, it was ascertained that the organs had been left exposed some time before immersing in alcohol, hence they were quite honey-combed by these putrefactive bacteria of all sorts.

LIVERWORTS.

The President read a paper on Liverworts, in explanation of the specimens exhibited by him.

Mr. Briggs presented to the Society fourteen slides of mica, prepared for use with the polariscope. On motion the thanks of the Society were tendered to the donor.

MEETING OF JUNE 18TH, 1886.

The President, the Rev. J. L. ZABRISKIE, in the chair.

Thirty-two persons present.

OBJECTS EXHIBITED.

1. *Tetraspora cylindrica*, two slides : by P. H. DUDLEY.
2. Section of *Quercus alba* : by P. H. DUDLEY.
3. Photo-micrographs of transverse, tangential, and radial sections of *Quercus alba* : by P. H. DUDLEY.
4. Pond-life : by C. S. SHULTZ.
5. Crystallized Gold from Ontario Mine, Colorado : by G. F. KUNZ.
6. Markings on Hydrolites from Thomaston, Georgia : by G. F. KUNZ.
7. Bacteria lactis from Human Milk, and Culture Tube of same : by W. H. BATES, M. D.
8. Five species of *Triceratium* from Barbadoes material ; mounted by Prof. ED. THUM, Leipzig : by E. A. SCHULTZE.
9. Fore-wing of the bombycid moth *Utetheisa bella*, L. : by B. BRAMAN.
10. Anthers of the Deerberry (*Vaccinium stamineum*, L.) : by J. L. ZABRISKIE.
11. *Hydrodictyon utriculatum* : by W. G. DE WITT.

STRUCTURE OF QUERCUS ALBA.

Mr. Dudley read a paper on the "Structure of *Quercus Alba*," illustrated by prepared sections and photo-micrographs.

TRICERATIUM.

Mr. E. A. Schultze exhibited five slides prepared by Prof. Thum, of Leipzig, showing as many species of *Triceratium* obtained from Barbadoes material, some of which he had been unable to identify.

[Plates containing photo-micrographs of the species exhibited, with a description of the same, will be found in this number of the Journal.]

STAMEN OF THE DEERBERRY.

The President read a paper on the Stamen of the Deerberrry, illustrating the same by drawings on the black-board.

Mr. Sereno N. Ayres, of Jamestown, N. Y., was present at the meeting, and exhibited a number of micro-photographs prepared by him.

On motion, the Society adjourned to meet the first Friday in October.

PUBLICATIONS RECEIVED.

Proceedings and Transactions of the Natural History Society of Glasgow : Vol. I., New Ser., Pt. II. (1884-5); pp. 325. Index to Proceedings, Vols. I. to V. (1851-1883); pp. 67.

Brooklyn Entomological Society. Entomologica Americana: Vol. II., No. 3 (June, 1886); pp. 20.

The Naturalist's World : Vol. III., No. 30 (June, 1886); pp. 20.

The Botanical Gazette : Vol. XI., No. 6 (June, 1886); pp. 32.

The Microscope : Vol. VI., No. 6 (June, 1886); pp. 22.

The American Monthly Microscopical Journal : Vol. VII., No. 6 (June, 1886); pp. 20.

Bulletin of the Torrey Botanical Club : Vol. XIII., No. 6 (June, 1886); pp. 16.

Peabody Academy of Science. Eighteenth (1885) Annual Report ; pp. 30.

Journal of Mycology : Vol. II., No. 6 (June, 1886); pp. 12.

Mineralogical Notes ; pp. 22. By George F. Kunz.

Proceedings of the Colorado Scientific Society : Vol. II., Pt. I. (1885); pp. 36.

Bulletin of the Washburn College Laboratory of Natural History : Vol. I., No. 5 (May, 1886); pp. 20.

Anthony's Photographic Bulletin : Vol. XVII., No. 11 (June 12th, 1886); pp. 36. No. 12 (June 26th); pp. 32.

Indiana Medical Journal : Vol. IV., No. 11 (May, 1886); pp. 22. No. 12 (June); pp. 22.

The Microscopical Bulletin and Science News : Vol. III., No. 3 (June, 1886); pp. 8.

The Hoosier Naturalist : Vol. I., No. 11 (June, 1886); pp. 13.

National Druggist : Vol. VIII., No. 23 (June 4th, 1886); pp. 12. No. 24 (June 11th); pp. 18. No. 25 (June 18th); pp. 12. No. 26 (June 25th); pp. 16.

The Electrician and Electrical Engineer : Vol. V., No. 54 (June, 1886); pp. 49.

Journal of the Royal Microscopical Society. Ser. II., Vol. VI., Pt. 3 (June, 1886); pp. 184.

Nottingham Naturalists's Society. Transactions and Thirty-third (1885) Annual Report : pp. 43.

Transactions of Vassar Brothers Institute (Poughkeepsie, N. Y.) and its Scientific Section : Vol. III. Pt. I (1884-1885); pp. 216.

Johns Hopkins University, Baltimore, Md. Studies from the Biological Laboratory : Vol. III., No. 7 (June, 1886); pp. 51. Circulars : Vol. V., No. 50 (June, 1886); pp. 12.

Proceedings of the Natural Science Association, of Staten Island : May 8th and June 12th, 1886 ; pp. 2.

Comptes-Rendus des Séances de la Société Royale de Botanique de Belgique: May 2d, 1886 ; pp. 13.

Monatsblätter des Wissenschaftlichen Club in Wien : Vol. VII., No. 8 (May 15th, 1886); pp. 16.

INDEX TO ARTICLES OF INTEREST TO MICROSCOPISTS
WHICH HAVE RECENTLY APPEARED IN OTHER
JOURNALS.

- Acarus, Upon the Life-history of an, one stage whereof is known as *Labidophorus talpæ*, Kramer; and upon an unrecorded species of *Disparipes*:
A. D. MICHAEL.
Jour. Roy. Mic. Soc., VI. (1886), pp. 377-90 (23 figs.).
- Algo-Lichen Hypothesis, A Résumé of the: T. H. KNOWLTON.
Am. Mon. Mic. Jour., VII. (1886), pp. 101-5.
- Animal Parasites, Chapters on (No. II): W. A. HYSLOP.
Sci.-Gos., 1886, pp. 132-4 (10 figs.).
- Balanoglossus Kowalevskii*, Continued Account of the Later Stages in the Development of, and of the Morphology of the Enteropneusta: WILLIAM BATESON.
Quar. Jour. Mic. Sci., XXVI. (1886), pp. 511-33 (126 figs.).
- Blood Corpuscles of Mammals, Measurements of: A. WATERHOUSE.
The Microscope, VI. (1886), pp. 97-101.
- Cell Researches, Carnoy's: ARTHUR BOLLES LEE.
Quar. Jour. Mic. Sci., XXVI. (1886), pp. 481-97 (20 figs.).
- Chilodon*, Food-habit of a: ALFRED C. STOKES.
The Microscope, VI. (1886), pp. 121-4.
- Chordata*, The Ancestry of the: WILLIAM BATESON.
Quar. Jour. Mic. Sci., XXVI. (1886), pp. 535-71.
- Desmidiæ*, Key to the: ALFRED C. STOKES.
Am. Mon. Mic. Jour., VII. (1886), pp. 109-14.
- Diatomic Beading and Images (Under title Microscopical Advances.—XI.):
DR. ROYSTON-PIGGOT.
Eng. Mech., XLIII. (1886), pp. 313-4 (7 figs.).
- Diatoms, The Resolution of, whose Striæ are of Unequal Fineness. EDWARD M. NELSON.
Eng. Mech., XLIII. (1886), p. 328.
- Disparipes*, an unrecorded species of: See Acarus.
- Foraminifera, On the Collection and Method of Studying: J. M. FLINT.
Am. Mon. Mic. Jour., VII. (1886), pp. 105-8.
- Fungus Hunting in Spring.—II.: W. B. GROVE.
Mid. Nat., IX. (1886), pp. 164-7.
- Histological Examination, The Preparation of the Eye for: JAMES W. BARRETT.
Quar. Jour. Mic. Sci., XXVI. (1886), pp. 607-21.
- Human Skin, Structure of the: CHARLES S. MINOT.
Am. Nat., XX. (1886), pp. 575-8 (2 figs.).
- Labidophorus talpæ*, Kramer. See Acarus.

Marine Collecting with the surface-net, On: G. W. M. GILES.

Sci.-Gos., 1886, pp. 121-2.

Micrococcus Pasteuri (Sternberg), On: G. M. STERNBERG.

Jour. Roy. Mic. Soc., VI. (1886), pp. 391-6 (6 figs.).

Microbe of Rabies, The: G. F. DOWDESWELL.

Eng. Mech., XLIII. (1886), p. 343.

Newt (*Triton cristatus*), Notes on the Development of the: ALICE JOHNSON
and LILIAN SHELDON.

Quar. Jour. Mic. Sci., XXVI. (1886), pp. 573-89 (38 figs.).

Neurenteric Canal in Rana, Note on the Presence of a: HERBERT E. DUR-
HAM.

Quar. Jour. Mic. Sci., XXVI. (1886), pp. 509-10 (6 figs.).

Oogenesis, Recent Researches on: ARTHUR THOMPSON.

Quar. Jour. Mic. Sci., XXVI. (1886), pp. 591-606.

Pleurosigma angulatum, What is the True Cause of the Dotted Appearance
on the: J. B. DANCER.

Eng. Mech., XLIII. (1886), p. 329.

Pleurosigma angulatum, The Interpretation of the Six Spectra of: EDWARD
M. NELSON.

Eng. Mech., XLIII. (1886), pp. 337-8 (5 figs.).

Polarizing Prism, New: C. D. AHRENS.

Jour. Roy. Mic. Soc., VI. (1886), pp. 397-8 (1 fig.).

¹ *Thalassema*, Life-History of: H. W. CONN.

Studies Biol. Lab., Johns Hopkins Univ., III. (1886), pp. 351-401 (51 figs.).

Tadpoles of the Common Frog (*Rana temporaria*), On the Development of:
CLARA KINGSFORD.

Sci. Gos., 1886, pp. 124-6 (6 figs.).

Teeth, Sections of: W. C. BRITTAN.

The Microscope, VI. (1886), pp. 128-9.

Triton cristatus, Development of: See Newt.

Vaucheria, Some Abnormal Forms of: DOUGLAS H. CAMPBELL.

Am. Nat., XX. (1886), pp. 552-3 (7 figs.).

JOURNAL

OF THE

NEW-YORK MICROSCOPICAL SOCIETY.

VOL. II.

NOVEMBER, 1886.

No. 8.

BACTERIA IN DRINKING-WATER.

BY CHARLES E. PELLEW, M. E.

(*Read March 16th, 1886.*)

The question of a supply of pure drinking-water has been a very important one for many hundreds of years. A commandment, and a very good one, among the ancient Egyptians was, "Thou shalt not pollute thy river-supply." The ancient Romans, as we know, drew their supply of pure water from great distances. Much attention was given during the middle ages to the problem of furnishing cities with good potable water, less, however, for private than for public uses. Within the last century the belief that diseases may be disseminated through the medium of polluted water, has attracted increased attention to methods of obtaining pure water for drinking purposes. Among the diseases so disseminated is typhoid fever. So cholera is supposed to be spread; likewise, other contagious diseases. It is, therefore, important to the world at large as well as to scientific people, that means be devised whereby pure water can be distinguished from water which is impure.

The chemist was the first to attempt this by analyzing water after the simplest methods. A quantity of the water to be tested was evaporated to dryness, and the residue was found to consist partly of mineral matter—lime, potash, etc.; but the healthfulness or unhealthfulness of the water tested was not ascertained by this plan. The nitrogenous organic matter contained in the water was next considered the disease-producing element, and of late years the chemist has directed his analyses toward determining what proportion of this matter, particularly in the form of ammonia, the water examined by him contained.

In his investigations, the microscope, if used by him, was used simply as an adjunct. That instrument might show what algae were present discoloring the water and giving off bad odors, but it was subordinated to the chemical analysis. Meantime, however, the study of bacteria, particularly of bacteria in water, began to occupy the attention of students, and when it was found that the nitrogen and ammonia discovered in water by the chemists were not the causes of diseases such as typhoid fever, the theory was advanced that those diseases were caused by bacteria germs; for example, typhoid fever by a typhoid fever germ, cholera by a cholera germ. Pasteur and Koch were relied upon as authority for such theories, and it was claimed that in Germany far better results could be obtained in the examination of water for impurities by means of the microscope than by any chemical analysis, upon the ground that the germs of disease, bacterial in their nature, were undiscoverable except through the microscope. Hence, the existence of bacteria in water, their propagation, functions and effects, have become questions of the utmost importance, more perhaps because of what has been said concerning them than of what has been done. As all the new processes of analyzing water by biological methods depend upon the cultivation of bacteria in water, a few words about bacteria in general may not be inappropriate.

The bacterium is the lowest of organic forms. Its place in nature is on the boundary between animal and vegetable life. Van Leuwenhock made it known to science two hundred years ago. In examining with a microscope the tartar from his teeth, he found it swarming with actively moving minute organisms. These were bacteria; and their number was as great in the mouth of every human being, so the discoverer thought, as the population of the habitable globe. At that time spontaneous generation was a subject of discussion, and the bacteria were studied with a view of elucidating it. Later, it was ascertained that these living forms abound in the atmosphere, and that they will not generate in preparations from which the air is excluded. Pasteur has demonstrated the impossibility of spontaneous generation. In his studies of atmospheric germs he worked among bacteria and separated them into classes. He also studied them in connection with disease. In this field of investigation the Germans are now the most advanced students.

Bacteria occur everywhere. They are supposed to live and grow in the water and in the soil, but their extreme minuteness and lightness permit them under various conditions to be carried into the atmosphere, so that, practically, they are everywhere. What sort of things are bacteria? What do they look like? These are difficult questions to answer. Observed singly they are translucent. They are simply very minute cells whose walls enclose a fluid substance. If magnified about ten million times they would look like white grapes. They have neither heads nor tails, and they are generally either round, rod-like or corkscrew shaped. Certain varieties are so minute that the most powerful microscopes are required for their proper examination. *Bacterium termo* is only $\frac{1}{125000}$ th of an inch in length. The means of locomotion possessed by some bacteria consist of flagella. These appendages have not been discovered on all kinds. The micrococci, as a rule, do not appear to move about. Bacteria proper multiply by fission. The cell elongates, and finally separates into two parts. Each of these parts subsequently elongates and divides in the same manner; and so on without limit. Fission takes place in some cases hourly. On the first day or two the increase is comparatively slow, but afterwards it becomes very rapid. A single *Bacterium termo* would, in twenty-four hours, produce of its kind sufficient to occupy the space of about $\frac{1}{10000}$ th of an inch. In five days enough would be generated to fill the ocean, if the generations could find enough food for their support. In the yeast plant, multiplication takes place as follows: The cell puts forth a little bud which increases in size until it attains the dimensions of the parent cell, and then drops off and itself proceeds to develop buds in a similar manner. Some bacteria have a very curious way of continuing their existence under adverse circumstances—a very objectionable fact in the case of those forms which are inimical to the health of man. Generally, the bacteria perish when their food is exhausted; but some of them at such times curl up and remain quiescent until they are supplied with additional food. Then they revive. This process can be watched under the microscope. The bacterium, as its food becomes scanty, shrivels up, and a little bright spot shows itself. This is the spore. Around it the cell-wall of the bacterium contracts and becomes exceedingly hard and firm.

In this condition, the organism, though able to bear for a long time the heat of boiling water, neither grows nor multiplies. Nevertheless, upon the return of favorable conditions, the spore expands and resumes its power to multiply. For destroying bacteria the student pursues the following method: The solution containing them is boiled ten minutes. This kills the bacteria but not their spores. Next, the solution is put in a warm place and left there for two or three days, during which the spores develop into bacteria, and it is then subjected to boiling heat again. This process is repeated until all the spores have developed into bacteria and have in that form been destroyed. Steam or dry heat is equally efficacious for this purpose.

Certain substances have been found which destroy bacteria. These we call disinfectants. Carbolic acid is one. In our laboratory we use corrosive sublimate of the strength of one part to a thousand. With this we wash our hands. It does not hurt the hands, but effectually destroys the bacteria. In this are washed also the implements used in experiments with bacteria.

Bacteria absorb their food through the cell-wall, and through the same pass out the rejected material. They feed on all animal and vegetable substances which decay, and from them eliminate the original elements of which those substances are composed. They separate the carbon, hydrogen, nitrogen and sulphur from dead animal tissue, sending off therefrom as carbonic acid and nitric acid the carbon and nitrogen. In the absence of bacteria the earth would be cumbered with things dead that once had lived. Bacteria, the yeast plant, mould plants, etc., are necessary to our existence. They ripen our cheeses, and through their agency the curd or cream of milk is transformed into cheese. They bleach linen and cotton. They combine the oxygen and nitrogen of the atmosphere. Without them there would be no gunpowder nor nitro-glycerine. They are supposed to have been largely instrumental in the production of coal, and in changing coal into petroleum. They are, perhaps, involved in the process of animal digestion.

But bacteria do not always perform welcome offices. Occasionally, products of certain of them bring disease and death to man. Sausage and other meats, containing such products, have

destroyed human life. The disease called tuberculosis is supposed to be caused by a bacterial organism, which enters the lungs, multiplies, and occasions the wasting called consumption. The fact that bacteria have been found connected with some forms of disease would apparently indicate that those diseases are of bacterial origin, although it has not yet been fully determined whether the bacteria may not be merely the accompaniments of such diseases. Inoculation with the bacteria which are supposed to be the cause of a certain disease would seem to offer means for determining this question, but even this method of experiment is beset with difficulties. If, for example, a man were inoculated with the bacterium of, say, typhoid fever, satisfactory information might be the result. But men are not available for such purposes; hence, resort is had to the inferior animals, some of which are not susceptible to the diseases of man. Definite results, therefore, are as yet unobtainable; although Pasteur's experiments with splenic fever demonstrate, apparently, the truth that vaccination with the *Bacillus anthracis*, whose virulence has been weakened by successive cultivations, affords protection to certain animals from splenic fever. The hope is entertained that many kinds of disease may yet be avoided by means similar to those employed by Pasteur in the case just cited.

There are different theories as to the way in which vaccination protects. One is, that when a crop of bacteria enters the system they consume all the food necessary for their support which the system contains, leaving none for a second crop. Another is, that the bacteria introduced generate not only the poison which causes the illness for which they are introduced, but also a poison destructive of themselves. But, in my opinion, the theory generally accepted is, that the blood contains that which kills the bacteria. A curious feature of tuberculosis is, that a dweller in cities, say New York, affected with it, on removing to certain parts of the country, the Adirondack mountains, for example, can, by proper exercise and diet, practically recover from his ailment, although the bacteria which are supposed to cause that ailment may be present in his system all the time. But on his returning to his city home the disease resumes its ravages. This would indicate that the mountain air and the conditions under which the sick man lived in such air, so

acted upon the blood as to enable it to resist the effects of the *Bacillus tuberculosis*—possibly, by driving the organism into recesses where it could do no harm.

In the study of bacteria a well-made microscope is essential—one having an accurately moving stage and a good substage condenser. The objectives should be a $\frac{1}{4}$ th and $\frac{1}{12}$ th of the first quality. Staining fluids are used, some for coloring the organisms and some for coloring the tissues containing them. A good way of studying them without staining is as follows: Put a drop of gelatine on a cover glass, touch the gelatine with the bacteria, and then place the cover, prepared surface under, over the depression in a hollow-centred slide. By this means their development can easily be watched. Much, however, is required besides mere observation of occasional individuals under the microscope. They must be studied in large quantities. Pasteur's method involved the use of liquid media, such as soup, bouillon, milk, and various chemical fluids. While much valuable work was done by this method, accurate results are more easily reached by the use of solid media, in which the German investigators are proficient. Potatoes and fruits were first made use of for this purpose. I have here to-night, on potatoes, specimens of *Micrococcus prodigiosus*. In one specimen the growth is in the shape of the letters C. F. C. The bacteria were planted yesterday. The *Micrococcus prodigiosus* has been the cause of considerable discussion. Its presence in bread gave rise in former times, to wonder and fear, and its mysterious appearance, as a blood-red I. H. S. on the holy wafers, through the agency of some shrewd priests, was looked upon by many devout laymen as miraculous. In preparing these media, care must be used to destroy such bacteria as may be already present. From a potato, the bad spots, also the "eyes," must be removed. Then the remainder should be placed for an hour or two in a bath of, say, corrosive sublimate. Next, it should be put into a steam sterilizer under which a flame keeps the water boiling furiously, forcing the steam through the grating, and cooking the potato resting upon it. The potato is then put into a moist chamber previously sterilized, and is therefore protected from atmospheric germs by coverings of filter paper kept saturated with the sublimate solution. The hand and the implements used in the operation should also be sterilized. To inoculate the potato,

place upon it some of the bacteria to be studied, using therefor a needle or platinum wire sterilized by passage through a flame. The *prodigiosus* develops in about two days, and can be identified by its deep red color, which, as far as we know, is peculiar to this bacterium. Some bacteria are green, some are white, some are yellow, etc., and by means of their colors one kind can be distinguished from another.

An important step in advance was taken when Dr. Koch hardened, by the addition of gelatine, the bouillon and other transparent media in which he cultivated bacteria. I have here a culture so prepared. The transparency of the entire mass allows easy observation of the colors by which the different bacteria can be identified. Sometimes, instead of gelatine, isinglass or agar-agar is used. The gelatine or other hardening agent must be sterilized before it is used. Koch devised the method of culture in gelatine thinly spread on pieces of glass, which possesses many advantages. He also contrived a plan for counting bacteria, as follows: Place over the glass plate upon which is the gelatine containing bacteria, a plate of glass ruled to a scale in minute squares. The number found in three or four squares can be used for computing the sum total in a specified space. Uncertainty, however, attends methods of ascertaining the productiveness of bacteria, and for a variety of reasons. Some do not grow in gelatine, some live in blood-cells only; and while half a million of a certain species may, after cultivation, be found in the space of a cubic centimetre, perhaps another species with which the gelatine was simultaneously inoculated may not multiply at all in that medium, leaving us, as to the productiveness of that species, entirely in the dark. So, too, does uncertainty follow the study generally of these organisms. Some species will not live in air or in oxygen. Cultures under observation are very liable to become infected with atmospheric germs. The vessel used may not have been sterilized, the hand the knife, anything employed in manipulating during the process of cultivation, may convey outside bacteria to the culture, and render the experiment nugatory, or void of satisfactory results.

The bacteria found in drinking-water may or may not be harmless to man. They may be very abundant, yet not deleterious, or they may be few in number and may consist, in part,

of the deadly cholera germ, or the germ of typhoid fever. When they resemble the poisonous varieties they must be separated from the others, isolated, cultivated, and not until after they have undergone long and careful study and experiment can judgment be pronounced as to the salubrity of the water in which they were found.

Compared with its vital importance, very few satisfactory results have yet been reached in the study of Bacteriology. But it is a new subject, and the keen intellects now pursuing it will doubtless before long illuminate many parts of it which are at present shrouded in uncertainty.

PROCEEDINGS.

MEETING OF OCTOBER 1ST, 1886.

The President, the Rev. J. L. Zabriskie, in the chair.

Twenty-eight persons present.

OBJECTS EXHIBITED.

1. *Cladocarpus flexilis* : by H. W. CALEF.
2. Gizzard of Cricket : by J. D. HYATT.
3. Section of Chalcedony : by J. D. HYATT.
4. Section of *Coscinodiscus* : by E. A. SCHULTZE.
5. Diatoms (218 forms) from the newly discovered deposit at St. Peter, Hungary : by E. A. SCHULTZE.
6. Crystals of Native Gold from California : by W. G. DE-WITT.
7. Seeds of Common Carrot (*Daucus Carota*, L.) : by W. E. DAMON.
8. Stamen of Moth Mullein (*Verbascum Blattaria*, L.) : by J. L. ZABRISKIE.
9. Ovary of Moth Mullein (*Verbascum Blattaria*, L.) ; transverse section : by J. L. ZABRISKIE.
10. Natural and Artificial Rubies : by G. F. KUNZ.

A COVER-CARRIER FOR IMMERSION AND DRY LENSES.

Mr. Wales exhibited a non-adjustable 1-5th inch objective with a cover-carrier, or cap.

He said that the idea of affixing a cover-carrier to a lens occurred to him because of the fact that opticians are frequently held responsible for errors of the manipulator in the use of non-adjustable lenses—that a non-adjustable lens corrected for a ten-inch tube would sometimes be used on an eight-inch tube, and, this failing to produce good results, the optician would get the credit for making a poor lens.

Hence he had fitted a cover-glass to a cap made to screw on to the front cell, or fitting over the objective, and had adjusted and corrected the lens for that particular cover-glass, so that

the objective could be plunged down into any fluid without injuring it, and would always be correct for a ten-inch tube without adjustment.

In using an oil-immersion lens with the cover-cap, a drop of oil is placed on the inside of the cover-glass, and the lens can be used in urine, blood, or other liquids.

The oil can be allowed to remain there if the lens is perfectly tight, saving time and trouble in repeated examinations of this kind. The cap also serves as a protection to the lens. It can be easily removed and cleansed at any time, and the cover-glass can be replaced if broken.

Mr. DeWitt said that he had used the objective and fitting exhibited by Mr. Wales, in the examination of pond-life in small aquaria, by plunging it down into the water as suggested by Mr. Wales, and had found it useful and convenient, in that it made possible the repeated examination of certain forms like *Vorticella*, *Lacinularia*, etc., without removal to the slide or live-box and without injury to the objective.

GIZZARD OF THE CRICKET.

Mr. Hyatt : "The gizzard of the cricket differs from that of the chicken in that the chicken swallows its food whole, or in large pieces, passing it first into the crop and from there into the gizzard, which is a powerful muscular organ. This is always stored with small gravel or rough stones, which, being compressed by the contraction of the muscular bands, grind up the food, which afterwards passes into the stomach. But the gizzard of the cricket is lined with very curious teeth, and does not contain gravel or pieces of stone. The food when swallowed is passed along to the crop in the same manner as in the chicken. There is first a small expansion, then follows another, which we may call the gizzard, and from that the food passes to the stomach. In this gizzard are bands running down from one side to the other, the space between being set with very curiously shaped teeth, which are pointed toward the centre. The compression of the muscular fibres of the gizzard upon these teeth grinds up the food."

STAMENS AND GLANDULAR HAIRS OF THE MOTH MULLEIN.

The President, in explanation of the objects exhibited by him, said: "The three species of Mullein common to the Northern United States are much inclined to hybridization. The specimen from which these exhibits were taken had the filaments of the stamens clothed with an abundant violet-colored wool, which is characteristic of *V. Blattaria* ; but it also had the entire surface abounding with whitish glandular hairs, which is characteristic of *V. Lychnitis*, L. The woolly fibres of the stamens are long, attenuated, with an enlarged, pear-shaped distal extremity.

"The glandular hairs are advantageously shown on a thin transverse section of the ovary. These hairs are so abundant that they project from the cuticle of such a thin section in the manner of the teeth of a cog-wheel. The hairs are comparatively short and stout, and composed of three or four cells, so as to resemble a turned column, or baluster, of an elegant pattern. The gland at the summit of each hair is in the form of a glassy globe about four times the diameter of the supporting hair ; and the globe is ornamented with a beautiful closely-fluted pattern which extends from the horizontal diameter to the point of support."

 MEETING OF OCTOBER 15th, 1886.

The President, the Rev. J. L. Zabriskie, in the chair.

Twenty-five persons present.

OBJECTS EXHIBITED.

1. Section of fossil Palm (agatized) : by J. D. HYATT.
2. Section of Agate : by J. D. HYATT.
3. Section of Obsidian containing Microliths : by J. D. HYATT.
4. Bryozoa on frond of *Sargassum bacciferum* from the Gulf Stream : by W. E. DAMON.
5. *Hydractina echinata* : by F. W. LEGGETT.
6. Transverse section of Maize-Leaf with the fungus *Puccinia Sorghi*, Schw. : by J. L. ZABRISKIE.
7. Spores of *Puccinia Sorghi*, Schw : by J. L. ZABRISKIE.

BRYOZOA.

Mr. Damon : "Whoever sails through the Gulf Stream is sure to encounter extensive fields of the floating sea-weed called *Sargassum*. When closely examined it is seen to be laden with little spherical air-vessels which serve to float it. Many of these will be found to be completely enveloped in a lace-like calcareous case, a rare specimen of marine architecture, which remains entire even after the death of the colony of Bryozoa which formed it. An attempt has been made by an expert jeweller to copy this delicate structure, in gold, as an ornament ; but success was impossible—so fine and intricate was the model found to be.

"*Sargassum* is a rich field for the microscopist, being the habitat of many interesting creatures besides Bryozoa. Among these are myriads of minute, gorgeously-colored crustaceans, and many forms of the beautiful *Sertularia*, and a small fish which has a curious dorsal lock-hinged fin, and, being of the same color as the plant, is often overlooked by the collector."

Mr. Schultz said that he had been requested to present to the Society on behalf of Mr. Charles E. Alling, of Rochester, N. Y., a copy of a blank-book published by Mr. Alling, entitled "Microscopical Records," and containing suitable blanks for cataloguing and describing five hundred slides, with an index and space for recording and preserving Formulæ used in preparing specimens.

On motion, the thanks of the Society were extended to Mr. Alling.

Mr. Ludwig Riederer was elected an Active Member of the Society.

PUBLICATIONS RECEIVED.

Bulletin of the Torrey Botanical Club: Vol. XIII., Nos. 7-10 (July-October, 1886); pp. 92.

The Naturalist's World: Vol. III., Nos. 31-34 (July-October, 1886); pp. 80.

Brooklyn Entomological Society. Entomologica Americana: Vol. II., Nos. 4-6 (July-September, 1886); pp. 60.

Proceedings of the Canadian Institute, Toronto: Third Ser., Vol. III., Fasc. No. 4 (June, 1886); pp. 184.

Johns Hopkins University. Circulars: Vol. V., No. 51 (July, 1886); pp. 28.

The West-American Scientist: Vol. II., Nos. 16-18 (June-September, 1886); pp. 53.

Anthony's Photographic Bulletin: Vol. XVII., Nos. 13-20 (July-October, 1886); pp. 256.

The Journal of Microscopy: Vol. V., Pts. 19 and 20 (July and October, 1886); pp. 132.

The Journal of Mycology: Vol. II., Nos. 7-10 (July-October, 1886); pp. 48.

The Microscope: Vol. VI., Nos. 7-10 (July-October, 1886); pp. 96.

The American Monthly Microscopical Journal: Vol. VII., Nos. 7-10 (July-October, 1886); pp. 80.

The Chemung Review: Vol. I., No. 5 (May 1886); pp. 12.

Transactions of the Massachusetts Horticultural Society: 1885, Pt. 2; pp. 182.

Transactions of the Wisconsin Academy of Sciences, Arts and Letters: Vol. VI., 1881-83; pp. 356.

The Naturalist: Nos. 126-135 (January-October, 1886); pp. 320.

The School of Mines Quarterly: Vol. VII., No. 4 (July, 1886); pp. 88.

The Journal of the Cincinnati Society of Natural History: Vol. IX., No. 2 (July, 1886); pp. 64.

Indiana Medical Journal: Vol. V., Nos. 1-4 (July-October, 1886); pp. 82.

The Botanical Gazette: Vol. XI., Nos. 7-10 (July-October, 1886); pp. 128. Index, Vols. I.-X. (1875-85); pp. 28.

The Electrician and Electrical Engineer: Vol. V., Nos. 55-58 (July-October, 1886); pp. 160.

National Druggist: Vol. IX., Nos. 1-17 (July-October, 1886); pp. 204.

Monatsblätter des Wissenschaftlichen Club in Wien: Vol. VII., Nos. 9-12 (June-September, 1886); pp. 42. Ausserordentliche Beilage: No. 4; pp. 14.

Bulletin de la Société Impériale des Naturalists de Moscou: Vol. LXI., Pts. 2, 3, and 4 (1886); pp. 516.

Bulletin de l'Académie d'Hippone: No. 21 (1886), Fasc. 3 and 4; pp. 136.

The Hoosier Naturalist: Vol. II., Nos. 1 and 2 (August and September, 1886); pp. 24.

Proceedings of the Natural Science Association of Staten Island: July-October, 1886; pp. 6.

Penzance Natural History and Antiquarian Society. Report and Transactions: 1885-86; pp. 95.

The Canadian Record of Science: Vol. II., No. 3 (July, 1886); pp. 64.

Bulletin of the Washburn College Laboratory of Natural History: Vol. I., No. 6 (July, 1886); pp. 20.

The Microscopical Bulletin and Science News: Vol. III., Nos. 4 and 5 (August and October, 1886); pp. 16.

Drugs and Medicines of North America: Vol. II., No. 1 (June, 1886); pp. 32.

Proceedings of the American Academy of Arts and Sciences: New Ser., Vol. XIII., Whole Ser., Vol. XXI., Pt. 2 (October, 1885, to May, 1886); pp. 327.

Journal of the Royal Microscopical Society: Ser. II., Vol. VI., Pts. 4 and 5 (August and October, 1886); pp. 352.

Bulletin of the Illinois State Microscopical Society. On the Microscopical Examination of Butter; pp. 5. By John H. Long.

Bulletin de la Société Royale de Botanique de Belgique: Tome Vingt-Cinquième. Fasc. 1 (1886); pp. 185.

Bulletin of the California Academy of Sciences: Vol. II., No. 5 (September, 1886); pp. 92.

Twenty-fourth Annual Report, State Board of Agriculture, State of Michigan. October 1, 1884, to September 30, 1885; pp. 312.

Bulletin of the American Museum of Natural History: Vol. I., No. 7 (July, 1886); pp. 94.

Bulletin de la Société Belge de Microscopie: Vol. XII., Nos. 3-9 (1885-6); pp. 60.

Journal and Proceedings of the Hamilton (Canada) Association: Vol. I., Pt. II. (1884-5); pp. 134.

Michigan Agricultural College. Annual Catalogue, 1885-6; pp. 68.

The London Botanical Exchange Club. Report of the Curators for 1886, and List of Desiderata for 1867; pp. 22.

The Naturalists' Companion: Vol. II., No. 1 (August, 1886); pp. 16.

Catalogue of Lichens collected in Florida in 1885; pp. 3. By W. W. Calkins. (Reprint from Journal of Mycology.)

Jahrbücher des Nassauischen Vereins für Naturkunde: Jahrgang 39 (1886); pp. 196.

Mittheilungen aus dem Osterlande: New Ser., Vol. III. (1886); pp. 123.

Jahresbericht der Naturhistorischen Gesellschaft zu Nürnberg, 1885; pp. 47.

Jahresbericht des Wissenschaftlichen Club: 1885-1886 (Tenth year); pp. 53.

INDEX TO ARTICLES OF INTEREST TO MICROSCOPISTS
WHICH HAVE RECENTLY APPEARED IN OTHER
JOURNALS.

Algæ of Fresh Water, Provisional Key to Classification of (IX., X., XI.): R. HITCHCOCK.

Am. Mon. Mic. Jour., VII. (1886), pp. 133-4; 142-4; 170-1.

Alkaloids and other Crystalline Bodies, Notes on the Identification of, by the aid of the Microscope: A. PERCY SMITH.

Jour. of Mic., V. (1886), pp. 210-8 (50 figs.).

Anagallis arvensis: R. H. MOORE.

Jour. of Mic., V. (1886), pp. 133-43 (18 figs.).

Annelid, On the Occurrence of a Thread-Spinning: M. H. ROBSON.

Sci.-Gos., 1886, pp. 152-3 (1 fig.).

Bacteria for Microscopical Examination, A few simple Methods of Obtaining Pure Cultures of: THEOBALD SMITH.

Am. Mon. Mic. Jour., VII. (1886), pp. 124-5.

Bird-Lice. See *Mallophaga*.

Chelonia, On the Formation of the Germinal Layers in: K. MITSUKURI and C. ISHIKAWA.

Quar. Jour. Mic. Sci., XXVII. (1886), pp. 17-48 (35 figs.).

Desmidiæ, Key to the: A. C. STOKES.

Am. Mon. Mic. Jour., VII. (1886), pp. 125-31; 144-8; 163-9.

Desmid Fishing: C. L. WILBUR.

The Microscope, VI. (1886), pp. 169-71.

Diatomaceous Deposit, A Fossil Marine, from Oamaru, Otago, New Zealand: E. GROVE and G. STURT.

Jour. Quek. Mic. Club, II. (1886), pp. 321-30.

Diatom Structure, On: HENRY MORLAND.

Jour. Quek. Mic. Club, II. (1886), pp. 297-307.

Diatom Valve, On the Microscopical Structure of the: JULIEN DEBY.

Jour. Quek. Mic. Club, II. (1886), pp. 308-18.

Dinophelus Gigas, On: W. F. R. WELDON.

Quar. Jour. Mic. Sci., XXVII. (1886), pp. 109-11 (16 figs.).

Earthworms, Studies on.—II: WILLIAM BLAXLAND BENHAM.

Quar. Jour. Mic. Sci., XXVII. (1886), pp. 77-108 (43 figs.).

Floridæ, Notes on the Structure and Evolution of the: GEORGE MASSEE.

Jour. Roy. Mic. Soc., VI. (1886), pp. 561-73* (20 figs.).

- Freezing Apparatus, A Simple : FRANK W. BROWN.
The Microscope, VI. (1886), pp. 217-9 (1 fig.).
- Fungus Spots on Sycamore Leaves. W. B. GROVE.
Sci.-Gos., 1886, pp. 228-30 (5 figs.).
- Histology, Studies in : C. H. STOWELL.
The Microscope, VI. (1886), pp. 150-5 (5 figs.).
- How Plants Climb : H. W. S. WORSLEY-BENISON.
Jour. of Mic., V. (1886), pp. 198-209.
- Human Tooth, The : C. H. STOWELL.
The Microscope, VI. (1886), pp. 193-6 (6 figs.).
- Insects, On Making Useful Collections of ; A Plea for the More General Use of the Compound Microscope by Collectors : ROBERT GILO.
Jour. of Mic., V. (1886), pp. 168-78.
- Madreporaria, The Anatomy of the.—II. : G. HERBERT FOWLER.
Quar. Jour. Mic. Sci., XXVII. (1886), pp. 1-16 (10 figs.).
- Mallophaga*, Grosse's Classification and Structure of the Bird-Lice, or : Abstract by G. MACLOSKIE.
Jour. of Mic., V. (1886), pp. 159-67 (10 figs.).
- Microscope, Half-an-Hour at the : E. M. WEST.
Jour. of Mic., V. (1886), pp. 239-40 (4 figs.).
- Microscopy in Medicine : A. G. FIELD.
The Microscope, VI. (1886), pp. 145-9.
- Microscopical Mountings, Wax as a Material for : C. M. VORCE.
Am. Mon. Mic. Jour., VII. (1886), pp. 123-4.
- Microscope, The, and How to Use it (Pts. VII. and VIII.—Hardening Agents) : V. A. LATHAM.
Jour. of Mic., V. (1886), pp. 179-84 ; 230-8.
- Microzoa, On some, from the London Clay exposed in the Drainage Works, Piccadilly, London, 1885 : CHARLES D. SHERBORN and FREDERICK CHAPMAN.
Jour. Roy. Mic. Soc., VI. (1886), pp. 737-63 (144 figs.).
- Myxine glutinosa*, L., On the Structure and Development of the Reproductive Elements in : J. T. CUNNINGHAM.
Quar. Jour. Mic. Sci., XXVII. (1886), pp. 49-76 (14 figs.).
- Orchidaceæ, The, of the Bath Flora, Fertilisation, etc. : WILLIAM G. WHEATCROFT.
Jour. of Mic., V. (1886), pp. 218-30 (13 figs.).
- Parasites, Animal, Chapters on : W. A. HYSLOP.
Sci. Gos., 1886, pp. 148-9 (6 figs.) ; 176-7 (6 figs.) ; 200-1 (7 figs.).
- Photo-Micrography.—VII., VIII. : R. HITCHCOCK.
Am. Mon. Mic. Jour., VII. (1886), pp. 131-3 ; 141-2.

- Photo-Micrography, Actinic Contrast in : GEORGE A. PIERSOL.
Am. Mon. Mic. Jour., VII. (1886), pp. 121-3.
- Porcelio*, A Parasite of : W. F. DURAND.
Am. Mon. Mic. Jour., VII. (1886), p. 161.
- Power of Movement in Plants, On the : H. W. S. WORSLEY-BENISON.
Jour. of Mic., V. (1886), pp. 143-59.
- Rotifers, A Group of (Notes on the Genus *Colurus*) : J. E. LORD.
Sci.-Gos., 1886, pp. 195-7 (4 figs.).
- Rotifera and other Pond Organisms, The Natural Preservation of : E. B. L. BRAYLEY.
Sci.-Gos., 1886, pp. 149-50.
- Salt-Water Monad, Note on a : E. M. NELSON.
Jour. Quek. Mic. Club, II. (1886), pp. 319-20.
- Sclerostoma duodenale* ; A Human Parasite : HAYGARTH ADDISON.
Sci.-Gos., 1886, pp. 171-2 (2 figs.).
- Spermatozoa, Human, Staining : R. N. REYNOLDS.
The Microscope, VI. (1886), pp. 196-7.
- Staining Tissues in Microscopy.—XI. (HANS GIERKE, *Zeitschr. für Wiss. Mic.*): Translated by W. H. SEAMAN.
Am. Mon. Mic. Jour., VII. (1886), pp. 150-2.
- Tint-Reflector, How to Make a : H. D. GOWER.
Sci.-Gos., 1886, p. 172 (4 figs.).
- Woods and Their Destructive Fungi : P. H. DUDLEY, C. E.
Pop. Sci. Mon., XXIX. (1886), pp. 433-43 ; 604-17 (23 figs.).

JOURNAL
OF THE
NEW-YORK MICROSCOPICAL SOCIETY.

VOL. II.

DECEMBER, 1886.

No. 9.

THE LIFE OF A DIATOM.

BY PROF. SAMUEL LOCKWOOD, PH. D.

(Read December 3d, 1886.)

What word more mysterious than that little one, Life? And as for those other monosyllables, Light and Sound, the mind must open widely to take in the conception of them required by modern science. Forsooth, both light and sound are non-entities, since each is but the manifestation of a form and measure of motion. One is the experience of the beating upon the optic nerve of the waves of the infinitely subtile ether, and the other the experience of the billowy lashing of the greatly grosser air upon the auditory nerve. Let the retina be injured, and, though the ether waves still impinge, there is neither light nor color. Similarly, sound waves make no impression on the injured ear. And what may Madame Science not yet exact? We are bidden to regard Life as a nonentity—merely a mode of motion of some odic or vital force. And this force—but no one knows what that is. And yet what it does, or, more correctly, what comes of it, that appeals to our judgment: hence, its manifestations may be intelligible, the object of experience, and the subject of verification. And endowed with this force is the atomy called a diatom. Of diatoms, there are many genera. A very large genus, in the numbers of its species, is *Navicula*, whose *maxima* or giant species is *Navicula dactylus*; and, speaking roughly, if we could place side by side 8,000 of these, the giants of the diatoms, the line so made would not exceed an inch in length. Of the Lilliputians of this race, 12,000 placed side by side might fail to make a line an inch in length. And

even these infinitesimals have their life activities and phenomena.

Of such an atomy it falls to us to narrate, as best we may, the life-history.

First, then, what does the name Diatom denote? Literally, it means something cut through at even distances. The word was coined by the earlier naturalists, whose studies of these organisms seem to have been confined to those species which in the living state are found in series like a chain, broken nearly across in clean fractures, as if cut, at uniform distances along the chain. Sometimes they were called "brittleworts." This chain-like feature is shown in the species *Diatoma vulgare*. But as this peculiar habit is true of a very few species only, the name, Diatoms, given to these organisms, was not well chosen.

Second. Let us now look at the general form, or, rather, the typical structure of a diatom; for the variety of forms is very great. Indeed, in the production of this vast group, the Diatomaceæ, and its allied order the Desmidiaceæ, Nature seems to have set herself the task of showing how many symmetrical-geometrical forms she could devise between a straight line and a circle—between the hair-like *Nitzschia*, on the one hand, and the gorgeous *Arachnoidiscus*, a discoidal, circular-box-shaped diatom, on the other. There are forms quadrate, oblong, rhomboidal, triangular, arcuate, ellipsoidal, ovate, spiral. These may be set down as geometrical. Then there are shapes which bear more or less resemblance to well-known objects, as spatulas, boats, stars, bottles (*Amphoræ*), crosses, etc.; and many of the diatoms, surprising to add, are sculptured with designs too delicate, too ornate, for pencil to delineate or words to describe. Throughout this multiplicity of forms the family likeness is never entirely lost. The ordinary systematist can in every instance recognize the diatom.

As to the skeletal structure of a diatom: For illustration, here is a little oblong chest. You will notice that the lower part has a flange over which the upper part shuts. The interior has no compartments. Let us be a little technical, and instead of calling this a box, call it a cell. Now, suppose it to be covered with morocco, like my lady's jewel-case. This covering must be called a membrane, or epidermis. What is wood in our little casket is, in the diatom, silica. I do not state that I

myself have seen the epidermal membrane. I simply say that accomplished microscopists aver that they have seen it. Besides, in science we often know more than we have learned through the medium of the eye. I have never seen, with the physical eye, the enclosing pellicle that sustains the sphericity of the dewdrop which enjewels the petals of the summer rose. Yet to the eye of reason it is visible. Then, is the dewdrop a cell? No, because, though the seat of the play of wonderful forces, it is not organic at all. It is without structure. Except that it is a fluid, it is like a pure quartz crystal, homogeneous throughout. Even the encasing pellicle differs from the enclosed contents only in this, that the molecules of water which compose it adhere to one another more closely and with greater tenacity than do the molecules within. As to the diatom, the film entirely invests each half of the little box, while within, according to a recent view, are two silicate layers, the one next to the film containing the pattern of the sculpture of the little box.

So, we have simplified our cell into a tiny box. Indeed, years ago, Prof. H. L. Smith described the diatom as a siliceous box in two halves; in some, such as the *Pinnularia*, one part slipping over the other, as the upper half of a pill box slips over the lower half; in others, the two halves simply touching, as in *Fragillaria*. As to the parts of this tiny box: The part exposed to view when we are looking at the line where the two valves touch, is the front view, just as when we look at the keyhole of a trunk we see the front of the trunk. But the trunk has a back, as well as a front; whereas, the diatom, somewhat anomalously, has its front all around. What we call the top and the bottom of the trunk, in the diatom we call the sides. It is observable, too, that the aspects of the two sides frequently differ.

Third. Let us now look inside this diatom casket, and, if possible, inspect its contents. It contains a glairy substance which we will call protoplasm. Much of this has passed through its differentiation. Some of it, however, is still but little more than unaltered life-stuff. The larger part is a yellowish-brown viscid matter. If we take a leaf from any ordinary plant of flowering rank, say a *Pelargonium*, we observe that the soft parts of the leaf are green, and this green matter the botanists call chlorophyl. Of this the uni-celled algæ, such as the

green slime of our ponds, are chiefly composed. But when we come to the higher algæ, the so-called seaweeds, though some of these are green, the green ones are in the minority. Some are black, some are purple. Others are olive-colored, but the most beautiful are red. Hence, the word chlorophyl, applicable to the green substance only, was supplemented by the word endochrome, which indicates this substance in all its colors except green. Thus, so much of the protoplasm as is elaborated into this yellowish substance in the diatom, we call endochrome. In recent vegetable chemistry the coloring matter in each of the lower orders of plant life is regarded as a principle and has its chemical name. For example, the yellow-brown pigment in the diatom is called diatomine, and similarly of the rest. It is highly probable that this diatomine is chiefly iron with a little chlorophyl; and that in some modified way chlorophyl, or leaf-green, as a protoplasmic form of nitrogen, is present to a greater or less extent in all of these plant substances. In them, Prof. H. L. Smith showed by spectrum analysis, long ago, indications of both chlorophyl and cellulose. So the little diatom, besides stocking its house with endochrome, eliminates and elaborates from the water, cellulose, silica, and iron. It also adjusts and fixes each particle of its coloring contents one by one in place, as does the artist in mosaic arrange the variously colored patterns of his work. Within the endochrome is a central spot which we may call the nucleus, around which appears a ring of dots, chromic-iron granules, each of which begins a line of unconnected dots or granules that reaches to the outer boundaries of the endochrome. And shall we doubt that within this diatom-cell the beautiful phenomenon of life-force, circulation, cyclosis, is active? Some students of these tiny forms think that they have observed it.

Fourth. How does the diatom feed? How take in its pabulum? How it lays down or secretes the silica is conceivable, for we may regard it as an infiltration upon a pattern; but whence the beautiful pattern, who can tell? And by what vital alchemy does it take from the water the constituents of its endochrome of amber, of its walls of glass, and of its protecting membrane of pellucid keratose? No one knows. But how it takes in its unelaborated pabulum, how the closed box permits food to enter, is a process which perhaps we can explain. Let

us again observe the line of contact of the upper and lower parts of the diatom. This line is called the suture. It is a delicate membrane, and extends around the very middle of the outside of the endochrome. It prevents the endochrome from protruding, doing in this respect for the endochrome what the investing film does for the dewdrop. It does more; it feeds, as well as protects. In the complicated system of man, physiologists recognize the play of what is called the osmotic force. After the food is digested, its nutrient principles are given to the blood. They are then distributed by the circulation and transfused through the walls of the veins. So all along the sutural line of the diatom a sort of endosmosis lets the food-bearing water pass into the cell. As already shown, some diatoms are elongated and others circular in shape. On the top of an elongated one we observe along its centre a line or canal with a break at the middle, where the line is interrupted by a vesicular space called a vacuole. The line has also a similar but smaller cavity at each end. These terminal vesicles, it has recently been stated, contain a fine sort of protoplasm which exercises an influence over the organism not unlike that exercised over certain of the desmids by the contents of their terminal vesicles. Whatever this may mean, the line and the vesicles are covered with a non-porous membrane, and the question which concerns us is this: Is the function of the membrane which covers these vacuoles and the median line osmotic, like the sutural membrane? The discoidal diatoms do not have this central canal. In its place and performing the same function, is a series of cavities around their edges.

Fifth. How do the diatoms reproduce or continue their species? I purposely left unmentioned a part of the skeleton known as the band or hoop. After a while, the membrane which we have called the sutural, becomes covered with a siliceous deposit which grows into a band or hoop reaching ultimately entirely around the diatoms in the sutural space between the two valves. Let us now return and consider the endochrome again. The endochrome in the diatom is surrounded by a tissue more highly organized than any other part of the cell contents. This tissue is cellulose. Now, inside of it and close to it is a thin layer of reserve protoplasm which encloses the endochrome and constitutes the formative layer. It is to

all intents the "primordial utricle." It is the chemist and modeller of this tiny workshop, for it transforms the protoplasm into the cellulose which invests the mass and makes two diatoms out of one. The dividing process is as follows: The hoop or band widens and pushes apart the valves of the diatom and, having thus performed its office, is disposed of by absorption or by becoming ruptured and then dropping off, which latter is the usual way. The restriction of the hoop removed, the endochrome grows rapidly. A vital ferment becomes active in the entire mass, the cellulose rind disappears or undergoes a radical modification, and in the body of the endochrome constriction begins, by means of which the mass is cut through in the middle. Meantime, the process which produces for each part its cellulose film and its secretion of silica, goes on, and when absolute separation takes place the one diatom has become two. This is what is called cell-division. It is really a multiplication by division—a process only found in the arithmetic of nature.

But what becomes of the parent diatom? You will notice that the new diatom carries off one-half of the parent cell or box. That is, one of the two is the mother valve, the other is the daughter valve. You will also observe that the daughter is the smaller. Though there are exceptions, yet this is really a general law. When these daughter valves become in turn mother valves, the old valves, then grandmothers, will die; and the daughters of this second generation will be smaller than their mothers. Now, unless nature had some way of meeting this point, the species would, by gradual diminution of size, become extinct. We are all familiar with that phenomenon of old age in the human race called rejuvenation—a brightening of the failing faculties, as when grandmama gets her second sight. Something similar takes place, I think, in the diatom. The period is near when the entire individual must die. Then comes a spurt of the vital force, and nature sets up a mystic marriage. Two of the diatoms, we will call them old ones, come together, and the phenomenon of conjugation takes place. Each extrudes its endochrome, the two masses coalesce for the purpose, so to speak, of bequeathing their united substance to their posterity, the silicate encasing supervenes, and a diatom larger than either of those which came together is produced. And what about this enlarged individual? The books, in

language less pellucid than obscure, tell us that it is a sporangium—that it is now a different organism from what it was before and is destined to emit spores or seed-like bodies capable of starting fresh generations of its kind. Whether this sporangium, having cast its spores, then dies, or lives to start another round of those cell-divisions which beget the mother valves larger than the daughter valves, in a series constantly decreasing in size, I do not know.

Sixth. A word as to the movements of these little bodies : A *Navicula* in motion looks exactly like a two-prowed boat. It moves in the water in a straight line, pushing aside obstacles that lie in its path, until, for no apparent reason, it stops, then suddenly moves straight backward. As yet, this movement is a mystery. There is, at times, observable when the diatom is in motion, a white line or coma of light all round the tiny boat, which looks like the effect that would be caused by the oars of an infinitesimal trireme. But no microscopist has ever seen the oars of the diatom. *Bacillaria paradoxa* has motions more remarkable than mere progression and retrogression. These diatoms are associated in ribbon-like bands of tiny rods, each rod or frustule being an independent individual. "These frustules slide over each other in one direction until they are all but detached and then slide as far in the opposite direction." Their movements are apparently contrary to all known laws of motion. In some of their positions they look like a flight of stairs, in others, like fascies ; in some, not unlike the staves of a barrel, a spiral flight of stairs, &c. From such positions they will quickly fall back into the communal ribbon or band.

Seventh. The motions of the diatoms induced the belief among earlier observers that these organisms are of an animal nature, a notion which spectrum analysis, it seems to me, entirely sets aside. Ehrenberg believed that the pair of spots usually seen in a diatom, technically called the oil globules, were stomachs, and hence designated the order, Polygastrica. He defended this interpretation of the spots by stating that he had placed indigo in the water containing diatoms, portions of which he subsequently detected in these stomach-like places. Many of us remember the tradition which tells us that years ago the rosy-hued hydrangea when watered with indigo-water produced blue-colored flowers. The indigo experiment proved

nothing in the case of the diatoms. They are simply plants, notwithstanding the fact that one of our British cousins has recently declared his belief in their animal nature.

Eighth. The diatoms hold no insignificant place in the economy of nature. Their siliceous skeletons, deposited on the bottoms of seas and estuaries in enormous quantities, have, in places, built up geological strata of considerable importance. These, having in some cases subsequently emerged, afford material for several industries, among them the manufacture of the polishing stone called Tripoli, and, singularly enough, the manufacture of the terrible explosive dynamite. In their living state, diatoms become food for a large number of animals: for example, oysters and other delicious bivalves; also, acalephs, which draw them into their stomachs in immense quantities and thrive and fatten upon them, and which in turn, thus rendered very acceptable, serve as food for the arctic whale.

NOTE.—The foregoing paper was followed by the exhibition of a large number of lantern slides, illustrative of the text, photographed by Prof. W. Stratford.

THE MAPLE LEAF-SCALE.

BY PROF. SAMUEL LOCKWOOD, PH. D.

(Read November 5th, 1886.)

In the month of October last, Mr. F. W. Devoe sent me a fragment of a maple leaf on which were several black, shiny scales. I recognized the scales as those of the fungus, *Rhytisma acerrimum*, which, to some extent, had, for several seasons, attacked the maple trees in the vicinity of my home at Freehold, New Jersey. This is a fungus which has, unfortunately, become too common. Its generic name is derived from a Greek word signifying a patch or darn. During the past summer, the fine maple trees for which Freehold is noted, were affected by this fungus to an extent almost appalling. On some trees scarcely a leaf was free from it, and upon each of some of the leaves were as many as ten of these unsightly black patches. One windy day the sidewalks presented a curious sight. They seemed to be sprinkled with tiny flakes of anthracite coal, an appearance caused by the falling of these patches of fungus from the dying

leaves of the maples. This, be it said in passing, is an unusual occurrence, because nature has furnished this scale with means of secure attachment to the leaf, as it is really the *nidus* in which are stored the propagating parts of the fungus. The windy day mentioned, it is proper to say, was preceded by a night of severe frost.

Under a low power of the microscope, these black, shiny scales are seen to be composed of mycelia, or rootlets, cemented together in a scale-like form and so convoluted as to present an ornate appearance, a sculptured surface, not unlike that of the large dorsal scales of a sturgeon. The scale is upon the upper side of the leaf, where it rounds up somewhat like a shiny, black blister. It, so to speak, puckers up the leaf. Its under side is not black, and is, moreover, the true leaf structure. It is not a single membrane. It is composed of an upper and a lower skin, between which is contained the life-stuff out of which shall come the organs necessary for propagating its species. The elaboration of these organs takes place in winter, when the leaves are on the ground. There they are subject to not a few casualties, hence the need of a housing for the protection of the germinating process; and this protection is afforded by the black pellicle or blister. The housing is perfect. I tried in vain to dissolve some of this black substance in alcohol. Water softens it, but strengthens it, as it does the paper shell of the *Argonauta*—making it impenetrable except to the admission of what may be necessary in elaborating the organs within. Such being the house, what about the commissariat? Every one knows how generous is the supply of starch in a grain of corn, a supply on which the embryo plant depends for its nourishment. Now, inside this black vesicle is a white mass, a grumous substance. This is the life-stuff out of which, in this tiny laboratory, shut in from the winter's storms, nature will develop the organs necessary for the propagation of the species.

The fungologist speaks of *asci* and *sporidia*. And these terms have a preciseness of meaning which fully warrants their use. But it will serve our purpose if we speak of spores, and of the *ascus*, or little sac, as the spore-containing cell or cup. Now, in this mass of grume, begins the marvellous making up of the tiny cups, the *asci*, by the mysterious potter, Nature, who, for that purpose, uses the grume as clay. And in each tiny cup,

before the warm spring has come, are developed eight vital little objects, each of which is a slender thread-like thing. These are the spores, or sporidia. Let one of them be sown on a maple leaf during a warm, murky day, and it will beget its kind. So it comes about that with the earliest summer sun-warmth, the black housing crust cracks open, and the little cups eject their sporidia and entrust them to the summer winds, which find lodgment for them in the trees.

FRUIT OF THE FUNGUS *UNCINULA FLEXUOSA*,
PECK, ON LEAVES OF THE HORSE-CHESTNUT
(*ESCULUS HIPPOCASTANUM*, L.).

BY THE REV. J. L. ZABRISKIE.

(Read November 5th, 1886.)

This fungus is of the family Ascomycetes, or sack-bearing fungi. It is one of the Blights, of which M. C. Cooke has described twenty-two species in his Hand-Book of British Fungi, and of which Prof. C. H. Peck mentions forty-eight species in two of his publications in 1872.

One characteristic of these Blights is, that the mycelium of the fungus, parasitic on living leaves of plants, is spread as a white film on the surface of the leaf. Some species occur on the under surface only, other species on both surfaces of leaves.

Another characteristic is, that the fruit of the fungus takes the form of a nearly spherical conceptacle, from .003 to .008 of an inch in diameter, usually of a dark color, and containing one or more spore-sacks, or sporangia, each sporangium containing two or more spores.

A third characteristic is, that each little sphere of the fruit is provided with from eight to forty or more appendages, which are glassy, generally colorless, as long as the diameter of the sphere, or occasionally in some species four times the length of that diameter, radiating from the spherical surface like the spokes of a wheel, usually, until maturity, lying flat upon the surface of the leaf, and furnished at the distal extremity with a form sometimes of elaborate ornamentation, which is an important point in the determination of species.

The fruit here exhibited is of the genus *Uncinula*, so named

because the tips of the appendages are uncinatè, or furnished with a little hook ; and of the species *flexuosa*, so named because about one-half of the appendage, next to the hook, is flexuous, or wavy in outline, sometimes appearing to be twisted in the form of an auger.

This species is common in our section of the country on the under surface of the leaves of the Horse-Chestnut tree. The mycelium is so thin that it is not readily discernible. But the conceptacles when mature can be seen, on close inspection, without a lens, appearing as minute black specks, scattered on the surface of the leaf. The conceptacles of this species have from thirty to fifty appendages, are about .005 of an inch in diameter, and contain about eight sporangia, while the sporangia each contain eight spores.

PROCEEDINGS.

MEETING OF NOVEMBER 5TH, 1886.

The President, the Rev. J. L. Zabriskie, in the chair.

Thirty-three persons present.

OBJECTS EXHIBITED.

1. *Laomedea* : by F. W. LEGGETT.
2. *Sertularia pumila* : by F. W. LEGGETT.
3. Embryo Hermit-Crab : by F. W. LEGGETT.
4. *Aulacodiscus Thumii* ; very rare : by E. A. SCHULTZE.
5. *Lepidodiscus elegans* : by E. A. SCHULTZE.
6. Fruit of the fungus *Uncinula flexuosa*, Peck, from leaves of the Horse-Chestnut (*Æsculus Hippocastanum*, L.) : by J. L. ZABRISKIE.
7. Section of a Quartz crystal with cavities enclosing a fluid and a moving bubble : by J. D. HYATT.
8. Suction-Cups from a gigantic Cephalopod (*Architeuthis princeps*—Devil-Fish), showing their marginal serrated edge : by W. E. DAMON.

SUCTION-CUPS FROM DEVIL-FISH.

Mr. W. E. Damon : "The microscope shows the sharp saw-like teeth, hard as steel, with which the suction-cups are armed. The Devil-fish applies these cups, of which it has about two thousand, to its prey, and by a kind of half turn sinks the teeth into the flesh, and holds all fast. The cups are arranged in two rows along the inside edge of each of the ten arms of this formidable creature. The probable use of the front pair of arms, which are much longer than the others, is to reach out for food, and to secure, with the help of the suckers, an anchorage to rocks or to the sea-bottom during stormy weather. These creatures have also a powerful horny, hawk-like beak, with which they destroy anything that their arms may bring within its reach.

"The suction-cups under exhibition were taken from a Devil-fish which was caught in our northern seas and which measured

thirty-eight feet from tip to tip of arms. We have evidence, from fragments of this animal which have been found in the stomach of the sperm whale, that there exist in the Pacific seas specimens many times larger than the one from which these suction-cups were taken."

LAOMEDEA, SERTULARIA PUMILA, AND EGGS OF THE
HERMIT-CRAB.

Mr. F. W. Leggett: "Under the first microscope, I have placed a branch of *Laomedea* which was hardened in alcohol and mounted in glycerine. Some of the polypes are partially expanded as in life. Death overtook the creature while its tentacles were conveying food to its mouths. This zoophyte attaches itself to floating sea-grass, and a person not using a magnifying glass in looking at it might consider it an accumulation of shore filth. It is, however, exceedingly interesting, as the whole branch represents one family, each polype being one of its many mouths, which not only act as the collectors of food for the household, but are also the seat of the reproductive organs—for from them are shot into existence objects resembling Medusæ in appearance, the ova of which, subsequently developed, become in time *Laomedea*.

"Under the next microscope, I have placed a specimen of *Sertularia pumila*, prepared similarly to the *Laomedea*. This, also, was found attached to sea-grass. Unfortunately, the polypes died in their closed cells; but, as these are perfectly transparent, the inmates can be seen, in appearance looking like beautiful tassels.

"Under the third microscope is a cluster of the eggs of the Hermit-crab. The young in the eggs are well grown and ready to emerge. I have found these eggs fastened to the long hairs of the mother crab. I have also found them, in the same condition, attached to floating grass. Some authors say that the eggs remain fastened to the parent until they are able to 'paddle their own canoes.' I have here, in this bottle, some of the zoophytes I have just described, attached to weeds. There is in the bottle a snail-shell also, occupied by a Hermit-crab. To the shell is attached *Hydractinia*, a specimen of which I exhibited at the last meeting."

ROCK INCLUSIONS.

On this subject, Mr. Hyatt, who exhibited a section of quartz crystal, containing a cavity in which was a moving bubble, said that he did not know what the contents of the cavity were, and he thought considerable uncertainty existed as to the nature and formation of these cavities generally. Heat, he said, was usually thought to be involved in their production; but, he suggested, might it not be well to ask whether or not cold had any part in their formation? Would not a particle of frozen water, caught in quartz during the crystallization of the quartz, on subsequently melting leave a cavity with an air space similar to the specimen shown? As to the effects of heat on these inclusions, he said that the specimen present had been subjected to a temperature equal to that of boiling water without being in any way affected by it.

Mr. Van Brunt: "A number of rock inclusions, liquids containing bubbles, etc., were shown before the Academy of Sciences and afterwards by oversight left out of doors exposed to severe cold weather. On subsequent examination, several of the specimens were found to be split or cracked and their inclusions gone."

 MEETING OF NOVEMBER 19TH, 1886.

The President, the Rev. J. L. Zabriskie, in the chair.

Twenty-four persons present.

The Code of By-Laws for the government of the Society, reported at the meeting of October 1st, 1886, was adopted, to go into effect immediately, and to take the place of the Constitution and By-Laws as they existed on the first day of October, 1886.

OBJECTS EXHIBITED.

1. *Pyrgodiscus armatus*: by E. A. SCHULTZE.
2. *Aulacodiscus Thumii*: by E. A. SCHULTZE.
3. *Caprella acuminifera*; female with eggs: by F. W. LEGGETT.
4. Fruit of the fungus *Microsphaeria extensa*, C. & P., from leaves of the Pin-Oak (*Quercus palustris*, Du Roi.): by J. L. ZABRISKIE.

CAPRELLA ACUMINIFERA.

Mr. F. W. Leggett: "This singular crustacean, sometimes called the 'ghost-shrimp,' is pictured and described by Milne-Edwards in his great work published in Paris in 1837. Save in the Encyclopedia Britannica, I have been unable to find it described elsewhere. Milne-Edwards says it is an habitué of the shores of the English Channel. These animals are nest-builders. Some of their nests resemble those of birds, while others are merely tubes; and they are constructed of wood, stones, and mud-clay, fastened together by a cement excreted by the animal.

"I have on the slide a male and female, the pouch of the female being filled with eggs, one of which has been forced out in the process of mounting. The male is larger than the female, and has a much larger claw. This is characteristic of the species. I found these specimens at Black Rock, Connecticut. Their houses were tubular, and had been built on sea-grass. It is said that these creatures are destructive to timber. For such destruction their sharp jaws seem to be well adapted."

FRUIT OF THE FUNGUS MICROSOPHÆRIA EXTENSA.

The Rev. J. L. Zabriskie: "This fungus is one of the Blights, of which another species was exhibited at the last meeting. It is common in our region on the upper surface of the leaves of various oaks, as the Pin-Oak, the White Oak, and the Red Oak. The web-like mycelium of the fungus is quite durable on the leaf surface, giving the latter a dusty, soiled appearance. The spherical conceptacles are black at maturity, about .005 of an inch in diameter, each containing four sporangia or sacks, and each sporangium containing from four to eight spores.

"The appendages of this species are quite striking in appearance. They number from eight to sixteen. They radiate horizontally from the periphery of the conceptacle, are delicate, colorless except for a short distance near their origin, about four times as long as the diameter of the conceptacle, and are elaborately ornamented at the tip. The extremity of the appendage is from four to five times dichotomously branched; *i.e.*, successively divided into two portions, and the pairs of ultimate divisions tend to take the form of the double volute of an Ionic

column. These combinations of divisions at the extremities of the appendages lie nearly in a horizontal plane, with an approximately square outline, giving somewhat the appearance of the expanded foot of an animal, furnished with many claws. And it is probable that these structures serve one purpose of such feet. For it can be seen that when such a conceptacle is carried away from its native situation, these multitudes of little hooks would cause it to adhere to any suitable surface on which it might lodge.

PUBLICATIONS RECEIVED.

The Journal of the Cincinnati Society of Natural History : Vol. IX., No. 3 (October, 1886) ; pp. 96.

Brooklyn Entomological Society. Entomologica Americana : Vol. II., No. 8 (October and November, 1886) ; pp. 40.

Bulletin of the Torrey Botanical Club : Vol. XIII., No. 11 (November, 1886) ; pp. 32.

The Botanical Gazette : Vol. XI., No. 11 (November, 1886) ; pp. 32.

The Microscope : Vol. VI., No. 11 (November, 1886) ; pp. 24.

The American Monthly Microscopical Journal : Vol. VII., No. 11 (November, 1886) ; pp. 20.

The Microscopical Bulletin and Science News : Vol. III., No. 5 (October, 1886) ; pp. 8.

The West-American Scientist : Vol. II., No. 19 (October, 1886) ; pp. 16.

Journal of Mycology : Vol. II., No. 11 (November, 1886) ; pp. 12.

The School of Mines Quarterly : Vol. VIII., No. 1 (October, 1886) ; pp. 92.

Transactions of the Massachusetts Horticultural Society : 1886, Pt. 1 ; pp. 226.

Proceedings of the Canadian Institute, Toronto : Third Ser., Vol. IV., Fasc. No. 1 (November, 1886) ; pp. 139.

The Canadian Record of Science : Vol. II., No. 4 (October, 1886) ; pp. 64.

The Naturalist's World : Vol. III., No. 35 (November, 1886) ; pp. 20.

The Naturalist : No. 136 (November, 1886) ; pp. 32.

Proceedings of the Bristol Naturalists' Society : New Ser., Vol. V., Pt. 1 (1885-6) ; pp. 148.

Proceedings of the Natural Science Association of Staten Island : November 13th, 1886 ; pp. 2.

Anthony's Photographic Monthly : Vol. XVII., Nos. 21-22 (November, 1886) ; pp. 64.

Indiana Medical Journal : Vol. V., No. 5 (November, 1886) ; pp. 20.

Johns Hopkins University Circulars : Vol. VI., No. 53 (November, 1886) ; pp. 20.

The Electrician and Electrical Engineer : Vol. V., No. 59 (November, 1886) ; pp. 40.

National Druggist : Vol. IX., Nos. 18-22 (October 29th, November 5-26, 1886) ; pp. 60.

Bulletin de la Société Impériale des Naturalistes de Moscou : Vol. LXII., No. 1 (1886) ; pp. 240 + 14.

Comptes-Rendus des Séances de la Société Royale de Botanique de Belgique : July 11th, and October 9th, 1886 ; pp. 41.

Sitzungsberichte der Gesellschaft zur Beförderung der gesammten Naturwissenschaften zu Marburg : 1884, pp. 124 ; 1885, pp. 70.

Monatsblätter des Wissenschaftlichen Club in Wien : Vol. VIII., No. 1 (October 15th, 1886) ; pp. 8.

The Physicians' Visiting List for 1887. P. Blakiston, Son & Co., Philadelphia.

Chronik des Wiener Goethe-Vereins : Vol. I., No. 1 (October 17th, 1886) ; pp. 8.

INDEX TO ARTICLES OF INTEREST TO MICROSCOPISTS
WHICH HAVE RECENTLY APPEARED IN OTHER
JOURNALS.

- Bacterium of Swine-Plague : D. E. SALMON and THEOBALD SMITH.
Am. Mon. Mic. Jour., VII. (1886), pp. 204-5.
- Choano-Flagellata, S. K., New Members of the Infusorial Order : ALFRED C. STOKES
Am. Mon. Mic. Jour., VII. (1886), pp. 227-9 (3 figs.).
- Cobra, The Blood of : W. J. SIMMONS.
Sci.-Gos., 1886, p. 269 (1 fig.).
- Desmarestella irregularis*. See Choano-Flagellata.
- Flagellated Protozoa in the Blood of Diseased and Apparently Healthy Animals :
EDGAR M. CROOKSHANK.
Jour. Roy. Mic. Soc., VI. (1886), pp. 913-28 (19 figs.).
- Germ Theory : ROMYN HITCHCOCK.
Am. Mon. Mic. Jour., VII. (1886), pp. 208-9.
- Hydra, A Sketch of its Structure, Habits, and Life-History : A. H. BRECKEN-
FELD.
Am. Mon. Mic. Jour., VII. (1886), pp. 221-7 (10 figs.).
- Microscopical Notes. SIMON H. GAGE.
The Microscope, VI. (1886), pp. 265-8 (2 figs.).
- Monosiga limnobia*. See Choano-Flagellata.
- Pathogenic Organisms, On the Variability of ; as Illustrated by the Bacterium
of Swine-Plague : THEOBALD SMITH.
Am. Mon. Mic. Jour., VII. (1886), pp. 201-3.
- Petalomonas carinati*, The Food Habit of : ALFRED C. STOKES.
Sci.-Gos., 1886, pp. 273-4.
- Polariscope, A Simple : R. W. WOOD, JR.
The Microscope, VI. (1886), pp. 268-9 (1 fig.).
- Rotifera : A. G. BOURNE.
Ency. Brit., 9th Ed., XXI. (1886), pp. 4-8 (6 figs.).
- Salpingarca curvostoma*. See Choano-Flagellata.
- Schizomycetes : H. MARSHALL WARD.
Ency. Brit., 9th Ed., XXI. (1886), pp. 398-407 (16 figs.).
- Teeth of Flies : W. H. HARRIS.
Sci.-Gos., 1886, pp. 251-4 (2 figs.) ; 271-2 (1 fig.).
- Trichodina as an Endoparasite : T. B. ROSSETER.
Jour. Roy. Mic. Soc., VI. (1886), pp. 929-33 (7 figs.).

INDEX.

- Achenia* of *Cyperus flavescens*, L., and *C. diandrus*, Torrey, . . . 36
- Annual Reception, The, 55
- Anthrenus Scrophularice*, L. (Carpet-Beetle), 96
- Architeuthis princeps* (Devil-Fish), Suction-cups from, . . . 146
- Bacilli, Typhoid Fever, 99
- Bacillus parvicans*, 42
- Bacteria of Putrefaction, 111
- in Drinking-Water, 117
- Balaninus nucum* (Nut-Weevil), Vitality of the Larvæ of the, 30
- Banana Stalk, Spiral Fibre of the, 71
- Black-Ground Illuminator, A Simple and Inexpensive Form of, 28
- BOOK NOTICES :—
- Second Annual Report of the Injurious and Other Insects of the State of New York : by J. A. Lintner, 62
- Notes on Histological Methods : by Simon H. Gage, . . 62
- How to Photograph Microscopic Objects : by I. H. Jennings, 63
- BREVOORT, H. L., Fur Fibres, . . 69
- Brownian Movement in Milk, . . 101
- Bryozoa, 128
- Caprella acuminifera*, 149
- Carpenter, Dr. Wm. B., Resolutions relative to the Death of, 19
- Carpet-Beetle (*Anthrenus Scrophularice*, L.), The, 96
- Cartilage, 67
- Castanea vulgaris*, Observations on the Structure of, . . 73, 78
- Cast Iron, Structure of, 58
- Cement, Cover-Glass, The Best, 25
- Chrysopa oculata*, Say, Eggs of the, 60
- Cotton Fibre, 81
- Cover-Carrier, A, for Immersion and Dry Lenses, 125
- Cover-Glass Cement, The Best, 25
- Cricket, Gizzard of the, 126
- Crystals of Oxalate of Calcium, 98
- Cyperus flavescens*, L., and *C. diandrus*, Torrey, *Achenia* of, 36
- Devil-Fish (*Architeuthis princeps*), Suction-Cups from, . . 146
- Diatom, The Life of a, 135
- Diatoms, Raising, in the Laboratory, 153
- Drinking-Water, Bacteria in, . . 117
- DUDLEY, P. H., Notes on *Protococcus viridis*, 9
- , Observations on the Structure of *Castanea vulgaris*, 73
- , The Structure of *Quercus alba*, 107
- Eggs of the *Chrysopa oculata*, Say, 60
- , Hermit-Crab, 147
- Election of Officers, 32
- Electrical Illumination for the Microscope, 16
- Exhibition of Objects at Annual Reception, 55
- Fermentation, Panary, The Microbes of, 41
- Fibre, Cotton, 81
- , Spiral, of the Banana Stalk, 71
- Fibres, Fur, 69
- Fimbriaria tenella*, Nees, 106
- Foraminifer (*Haplophragmium cassis*), a Rare, Notice of a New Locality for, 77
- Fruit of the Fungus *Uncinula flexuosa*, Peck, on Leaves of the Horse-Chestnut (*Æsculus Hippocastanum*, L.), 144
- , *Microsphaeria extensa*, C. & P., 149
- Fungi which cause Decay in Timber, 36
- Fur Fibres, 69
- Gall, The, *Rhodites bicolor*, Harris, 61
- Gizzard of the Cricket, 126
- Glandular Hairs and Stamens of the Moth Mullein (*Verbascum Blattaria*, L.), 127
- Hairs, Glandular, of *Verbascum Blattaria*, 127

<i>Haplophragmium cassis</i> , a Rare Foraminifer, Notice of a New Locality for,	77	MISCELLANEA :—	
Hermit-Crab, Eggs of the, ...	147	Cartilage.....	67
HEYDENREICH, L., The Best Cover-Glass Cement,	25	The Microscope in Jurisprudence,.....	68
High-Refractive Mounting Medium, A New,.....	13, 18	Mounting Medium, A New High-Refractive,.....	13, 18
Illumination, Electrical, for the Microscope,.....	16	— Media, High-Refractive,...	75
Illuminator, Black-Ground, A Simple and Inexpensive Form of,	28	Nut-Weevil (<i>Balaninus nucum</i>), Vitality of the Larvæ of the,	30
Inclusions, Rock,.....	148	Objects, Exhibition of, at Annual Reception,	55
Index to Articles of Interest to Microscopists, 22, 39, 51, 65, 83, 103, 115, 131, 152.		Officers, Election of,	32
Iron Pyrites, The Microscopical Structure of the,.....	85	Oxalate of Calcium, Crystals of,	98
Itch Mite (<i>Sarcoptes scabiei</i>), ..	35	Parasite, A, on the Gall of the Swamp-Rose,.....	61
Jasperized Wood from Arizona, Geological Period of the, ...	47	PELLEW, CHARLES E., Bacteria in Drinking-Water,	117
JULIEN, ALEXIS A., The Microscopical Structure of the Iron Pyrites,.....	85	<i>Philopterus Corvi</i> ,.....	53
Jurisprudence, The Microscope in,.....	68	<i>Plagiogramma validum</i> , a newly discovered Diatom,	79
<i>Laomedea</i>	147	Pollen of <i>Strelitzia Regineæ</i> , ...	17
Larvæ, Vitality of the, of the Nut-Weevil (<i>Balaninus nucum</i>),	30	President, Report of the, on the State of the Society,....	33
LAURENT, EMILE, The Microbes of Panary Fermentation, ..	41	PROCEEDINGS :—	
Leaf-Scale (<i>Rhytisma acerrium</i>), Maple, The,	142	Meeting of Dec. 4th, 1885, ..	16
LEGGETT, F. W., Vitality of the Larvæ of the Nut-Weevil (<i>Balaninus nucum</i>),.....	30	18th,.....	18
<i>Lentinus lepideus</i> causing Decay in Timber,.....	36	Jany. 1st, 1886, ..	32
Librarian, Report of the,.....	34	15th,.....	33
Liverworts (Hepaticæ),.....	105	Feby. 5th,.....	46
LOCKWOOD, SAMUEL, The Life of a Diatom,	135	19th,.....	49
—, The Maple Leaf-Scale (<i>Rhytisma acerrium</i>),.....	142	Mar. 5th,.....	55
—, Raising Diatoms in the Laboratory,	153	19th,.....	58
<i>Marchantia polymorpha</i> , L., ..	105	Apr. 2d,.....	78
MAYER, ALFRED M., A simple and Inexpensive Form of Black-Ground Illuminator, ..	28	16th,.....	80
Microbes, The, of Panary Fermentation,	41	May 7th,.....	98
Microscope, The, in Jurisprudence,.....	68	21st,.....	99
Microscopical Structure, The, of the Iron Pyrites,	85	June 4th,.....	111
<i>Microsphaeria extensa</i> , C. & P., Fungus, Fruit of the,	149	18th,.....	112
		Oct. 1st,.....	125
		15th,	127
		Nov. 5th,.....	146
		19th,.....	148
		<i>Protococcus viridis</i> ,.....	1
		— —, Notes on,.....	9
		PUBLICATIONS RECEIVED, 21, 38, 50, 64, 82, 102, 114, 129, 151.	
		Putrefaction, Bacteria of,.....	111
		<i>Quercus alba</i> , The Structure of, ..	107
		<i>Reduvius novenarius</i> , Nine-Pronged Wheel-Bug,.....	100
		Report of the President on the State of the Society,.....	33
		— Treasurer,.....	34
		— Librarian,.....	34
		Resolutions relative to the Death of Dr. Wm. B. Carpenter,	19
		<i>Rhodites bicolor</i> (Gall), Harris, ..	61
		<i>Rhytisma acerrium</i> , The Maple Leaf-Scale,.....	142

Rock Inclusions,	148	<i>Uncinula flexuosa</i> , Peck, Fruit of the Fungus, on Leaves of the Horse-Chestnut (<i>Aesculus Hippocastanum</i> , L.),	144
Ropiness in Bread,	45	<i>Vaccinium stamineum</i> , L., Stamen of the,	109
<i>Sarcoptes scabiei</i> (Itch Mite), . .	35	<i>Verbascum Blattaria</i> , L. (Moth Mullein), Stamens and Glandular Hairs of the,	12~
SCHULTZE, E. A., Five Species of <i>Triceratium</i> ,	110	<i>Volvox globator</i> kept alive for three months,	48
<i>Sertularia pumila</i> ,	147	Wheel-Bug (<i>Reduvius novemarius</i> , Say), Nine-Pronged, . .	100
SMITH, H. L., A New High-Refractive Mounting Medium, 13, 18		WOODWARD, A., Notice of a New Locality for <i>Haplophragmium cassis</i> , a Rare Foraminifer,	77
—, High-Refractive Media, . .	75	ZABRISKIE, J. L., Spiral Fibre of the Banana Stalk,	71
SOUTHWICK, E. B., <i>Protococcus viridis</i> ,	1	—, The Carpet-Beetle (<i>Anthrenus Scrophularice</i> , L.),	96
Stamen of the Deerberry (<i>Vaccinium stamineum</i> , L.),	109	—, Fruit of the Fungus <i>Uncinula flexuosa</i> , Peck, on Leaves of the Horse-Chestnut (<i>Aesculus Hippocastanum</i> , L.),	144
Stamens and Glandular Hairs of the Moth Mullein (<i>Verbascum Blattaria</i> , L.),	127		
Steel Rails, Concerning,	59		
<i>Strelitzia Reginae</i> , Pollen of, . .	17		
<i>Streptococcus Vaccinae</i> , Animal and Human,	79		
Suction-Cups from Devil-Fish (<i>Architeuthis princeps</i>),	146		
<i>Torymus</i> parasitic on the Gall of the Swamp-Rose,	61		
Treasurer, Report of the,	34		
<i>Triceratium</i> , Five Species of, . .	110		
Typhoid-Fever Bacilli,	99		

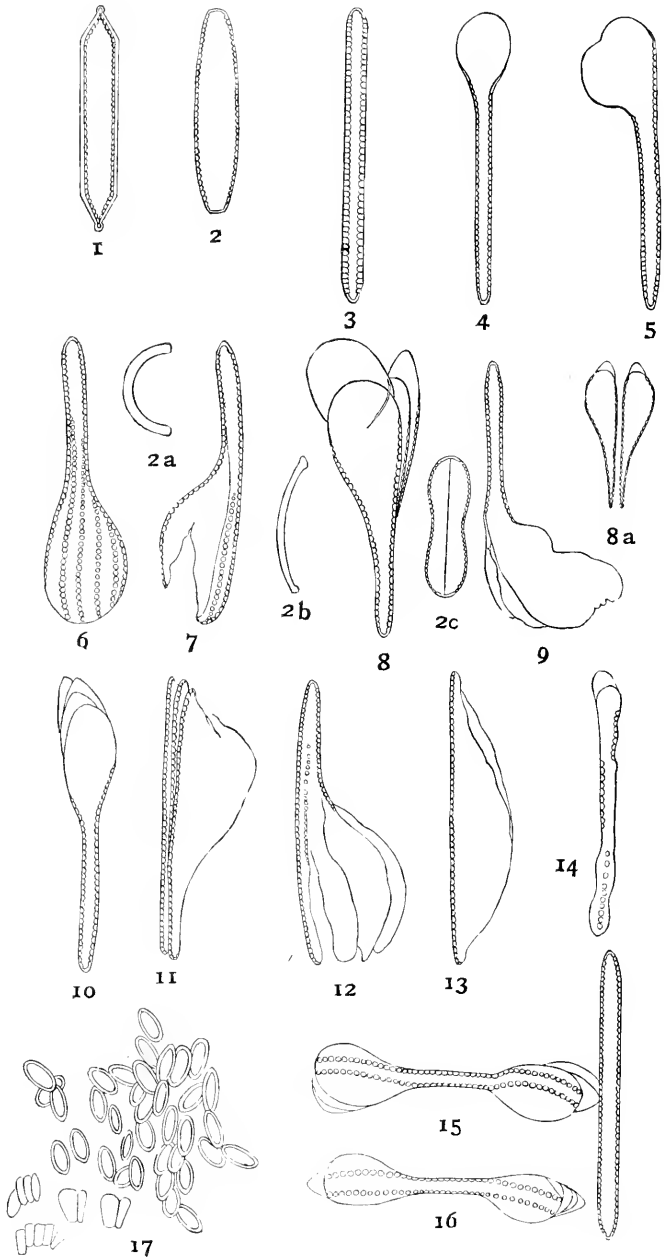

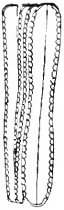

18

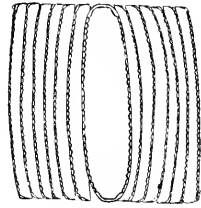

19



20



21

SUPPLEMENTAL NUMBER.

JOURNAL

OF THE

NEW-YORK MICROSCOPICAL SOCIETY.

VOL. II.

DECEMBER, 1886.

No. 9a.

RAISING DIATOMS IN THE LABORATORY.

BY PROF. SAMUEL LOCKWOOD, PH. D.

(*Read December 17th, 1886.*)

Plates VI and VII.

April 1st, 1870, brought to a close the writer's residence of sixteen years at Keyport, New Jersey, on the south side of Raritan Bay. The place has long been noted for its oyster industry. From the oystermen there I sometimes obtained living marine objects which afforded incentives and opportunities for study. About to move to Freehold, fourteen miles inland, I besought these oystermen, friends of mine, not to forget to send me anything they found which they thought would interest me. To be prepared for the reception of such favors, I took with me a large demijohn of sea-water, so that an aquarium could be improvised. The water was taken at high tide from the Bay near the steamboat landing, and, owing to the mud held in suspension, it was very turbid. Trusting that the water would come out right after sedimentation, I put the vessel containing it in the cellar of my new house at Freehold. The black glass of the demijohn, its opaque encasing and its situation in a dark cellar, effectually prevented light from reaching its contents. This exclusion of light was, however, the result of mere chance, and not of design. The years rolled by, the sea-water was undisturbed and almost forgotten. "Out of sight, out of mind." No specimens came from my oystermen until the first week in December, 1882, when one of them sent me, "some oyster-moss just got from the Bay." It disappointed me, because it was a common object, *Sertularia*

argentea, one of the Hydroidea. Though it was crisp and dry and apparently dead, I indulged the hope that it might have a spark of life, and so be revived. In truth, I had a pleasant memory of the delight experienced by me many years ago while watching with a hand-lens the little flower-like polypes which build up this graceful plant-like structure, catching their diminutive prey. So I improvised an aquarium in a specie-jar. Remembering the turbid condition of the water when I put it into the demijohn, I now poured it out with some misgiving. Barring a little sediment which became disseminated in the water but which soon settled, the water proved to be in excellent condition, and in it my pretty *Sertularia*, anchored to a bit of shell, rose like a fairy tree. Its very beauty increased my hope that it would revive. Two days passed without any sign of life in the hydroid, and then I became satisfied that it was dead. Still, as something attractive, the jar with its pretty object was permitted to keep its place in the window.

Some of the streamlets near my home are impregnated with iron oxide. A spring remarkable for its apparent purity yields a sparkling water, which, if allowed to stand in a glass a few hours, will deposit a yellow film of protoxide of iron. A few days after establishing my miniature aquarium, I noticed a yellowish-brown sediment at the bottom of the jar, and a similar but thinner deposit on the sides. Query: Was this an oxide of iron? A drop of the substance at the bottom was put under the microscope, and, to my astonishment, it proved to consist of diatoms. A scraping was taken from the film on the sides of the jar and examined, and this also was composed of diatoms. Their immense numbers showed that they had been bred in the jar. But what and where was the originating stock? I assumed that they were the product of diatoms parasitic on the *Sertularia*. The inference was at least natural. Science has, however, but little toleration for assumptions and inferences unless they are well supported, so I set out to learn more about that oysterman's "specimen." I sought the man, and, failing to find him, saw his wife, from whom I got information in this wise: "That oyster-moss? Yes, I remember. You see, one day, as the Cap'n was smoking his pipe, he happened to look up at it on the wall, and, said he, 'Likely, Mr. Lockwood would admire that, as he used to like anything out o' the water, and it is a good

while since I've given him anything.' So it was agreed to send it at first chance. Though when it come to the point, I did kind o' hate to take it down from granny's photo' which it had dressed up for a round year." This was indeed a damper, but happily not an extinguisher. It was now evident that the *Sertularia* had nothing to do with my crop of diatoms. Resolved, to get at the bottom of the mystery, if possible, I began a series of experiments, and designated this initial experience "Experiment No. 1." To the jar used I attached a label bearing the letter *A*. As the jar was really an aquarium, it had not been covered, but I now put on the top a piece of glass.

Again was the demijohn brought from the cellar, and a pint jar was nearly filled with the water a little roiled. This was labelled *B* and, covered with glass, was placed in the window beside *A*. This experiment No. 2 was started early in January, 1883. In about four weeks I detected a trace of sediment in the jar. A fertile drop of this was placed under the microscope, and lo! there they were, diatoms again. But this was only the beginning of experiment No. 2. In a few weeks the sediment at the bottom of the jar had thickened, as also had the film on the sides. In a word, this second crop of diatoms had become very abundant, and promised soon to quite equal in numbers the first one.

I was now firm in my belief that I was raising diatoms from the spores, although I could not yet say that this was proven. I next began a careful examination of the sediment in the demijohn, supposing that if there were any diatoms in the mud which caused the discoloration of the water when it was obtained from the Bay, be they now dead or alive, something should be learned from them. I found a number of forms, all, however, quite large in comparison with those bred in the jars. There were *Pleurosigma*, *Surirella*, a large *Navicula*, an *Achuanthes*, a *Coscinodiscus*, and several discoidal and other forms. They were, however, all dead, and, of them all, only one genus, and but one species, was represented among the diatoms in the breeding jars. True, in the sediment of the jars would be found, but very rarely, one of these dead forms which had been carried there in the agitated sediment from the demijohn.

This examination and comparison was entered as experiment No. 3. It seemed to furnish reasonable ground for the

conviction that the diatoms I was raising had no originative connection with those diatoms in the old sediment.

It was the beginning of March. I had given much thought to this subject, and I now proceeded to make a crucial experiment—not that its failure would disprove anything, but that its success would, I thought, demonstrate the correctness of my conviction. This was set down as experiment No. 4. The demijohn was again resorted to, and from it into a jar similar to the preceding ones, water, equal in amount to what each of them contained, was passed through druggist's filtering paper. This done, the jar, labelled *C*, and covered with glass, was placed beside *B* in the window.

At this point in my experiments, I collected as well as I could all the diatomaceous material in jar *A*, my first experiment, put it in a small phial, which, together with a letter, I sent to Prof. H. L. Smith. In my letter, which was written and posted on the 12th of March, 1883, I did not mention that the diatoms had been raised in my study, but simply said that they had been obtained from water which came from Raritan Bay. I received from him a letter, also a mounted slide of the diatoms. This slide I have here under a microscope for your inspection. I have here also a number of slides of those diatoms mounted by myself. The Professor's letter stated that the slide contained three genera, *Nitzschia*, *Amphora*, and *Navicula*; and that the *Nitzschia* were by far the most numerous, the *Amphoræ* next in number, and the *Naviculæ* least.

About the end of March, 1883, appeared that, to me, welcome sign, the yellowish-brown film on the bottom of jar *C*. Almost nervously I took a drop of it with a pipette, put it on a slide, and then placed the slide under the microscope, and what a sight! The diatoms were there in immense numbers, many of them in lively motion. The *Nitzschia* and *Naviculæ* were of larger size than those in crops *A* and *B*. But this crop *C* yielded forms entirely new, and in numbers that would thrill a species-monger with delight. Of the symmetrical forms, five figures are given in the plate, 1, 2, 2^a, 2^b, 2^c. Figure 1 with its beaded borders and trim geometrical lines is an exquisite form, but is rare. Figure 2, a pretty, truncated ellipse, is of interest as constituting the nucleus in such nests or series of layers as are shown in Figures 19, 20, and 21. And, similarly, Figure 2c, an

ellipse, constricted at the middle, is concerned with such layer-groupings as are indicated by Figure 18. These singular nests were very common, but I am not able to interpret them. Figure 2^a is an arcuate form of uniform thickness and with obtuse or rounded ends. There were many delicate rings, some broken, but most of them whole. These were hoops, and indicated frequent divisions, hence free propagation by the diatoms.

Figure 3, a front view, is the normal type of an eccentric group of asymmetrical forms, for from it have come all those *outré* and capricious forms, represented by Figures 4 to 16, inclusive. There seems to be no limit to their diversity. The figures represent but few of the large number of forms on the one slide, which slide I exhibit here. Figure 4, a spatulate form, shows the mildest or first aberrance from the type. Figure 5 suggests an alembic or retort, and so does Figure 6, which is excessively and capriciously ornate. Figure 7 has begun to divide, but the fission is on the wrong plane, being through the side instead of the front. It is also jaggedly irregular. In Figure 8, the division has stopped before going through the entire length. Four valves are noticeable, and if the division were normal and complete it would give two diatoms from the one in the usual way; but, not only is the division incomplete, it is also abnormal. Normally, the two new diatoms would have, each, one old or mother valve and one new or daughter valve, the daughter valves being usually shorter than the mother valves; whereas, in Figure 8, the two inside valves, the daughter valves, are, the one to the right disproportionately small, and the one to the left large even to deformity. Figure 8^a, which, like 2^c, is drawn to half the scale of the others, has developed into a pinna or mussel form and, thus being symmetrical, has made a complete division; still, the daughter valves are abnormal, being longer than the mother valves. Figure 9, so like a club-foot in appearance, is also dividing into similar monster forms. Figures 10, 11, 12, and 13, each show in a different way abortive efforts at propagating by division. Figure 14 has begun to divide, but is itself a monstrous deformity. 15 and 16 are dumb-bell shaped, double headed monsters in the act of dividing. The figure which is at right angles to them and touching Figure 15, and which differs so slightly from Figure 3, the initial form, seems to be the normal of the abnormals 15 and 16.

Is there not a law of the cosmic force in certain orders of living things whose activity, to use a mechanic's phrase, "works true" on bi-symmetrical lines? Surely, in the diatomaceæ this is apparent. Could it be, in these experiments of mine, that the diatom spores, by the long abeyance (fourteen years) of their life-force in an environment of darkness and quiescence, had lowered this force on some developmental line of the germ, and thus unbalanced it, so that these deformities are but the outcome of unkindly conditions?

In crops *A* and *B* I observed that the *Amphoræ* were often in groups or swarms. This I have noticed in the species when collected in the ordinary way. So in crop *C* this gregarious habit was seen to prevail. But, in addition to these groups of recognizable forms, I found swarms of minute bodies whose frustules were proved to be silicate by their indestructibility under the treatment of boiling nitric acid and of liquor potassæ. Figure 17 shows one of these swarms, but does not give their varying forms due to the progress of development. The individuals were sharp in outline and in shape varied from a broad oval, $\frac{1}{4000}$ in. long and $\frac{1}{4500}$ in. wide, to a narrow oval, $\frac{1}{4000}$ in. long and $\frac{1}{6000}$ in. wide. Some were elliptical, having a length of $\frac{1}{2400}$ in. and a width of $\frac{1}{6000}$ in. They are not circular in transverse section, but depressed, and, the more elliptical they are, the flatter they seem to be. Often, several lie together like a rouleau of coins. These embryos vary in size in the same manner as do the adult *Amphoræ*. Of these swarms, so numerous on the slides, I can give no interpretation other than that they are embryonal *Amphoræ*.

In scientific research, the intellectual is supposed to dominate the emotional. But, in the mind excited by novel discoveries, the latter will sometimes assert itself. Thus it was in my case; and during a spurt of joyful "gush" I took a naturalist friend into my confidence.

In May, 1883, I started my fifth experiment. A jar like those before described was used, and was marked *D*. The water in this instance was simply decanted from the demijohn. It seemed to me possible that there might be two kinds of spores, the swimming and the resting. If so, the agitation of the sediment in the demijohn must have given both kinds to the water used in the previous experiments. It was quite possible that,

notwithstanding the care taken to exclude them in the present instance, some resting spores might have got into the jar, although very few could have done so.

In due time *D* produced a plentiful crop of diatoms. The normal species seen in the other jars were found in this one, but they were more robust. Besides them, were diatoms of a small oval form, and one of a slender build with a curve or bend and somewhat enlarged at each end, not unlike a rib (Figure 2^b). There was also a large number of very delicate *Nitzschia*. They were invisible in balsam, but quite distinct in a dry mount. Their tenuity entitles them to the specific name *attenuatissima*. Though this experiment gave novel results, it shed but little light on the question of motile and resting spores.

The month of May had come, and my official duties kept me much from home. The propagating jars were all left undisturbed in the study window until Fall, receiving meanwhile an occasional inspection. It occurred to me to try one more experiment. A fresh supply of water was procured from the Bay where the demijohn had been filled. A jar filled with this, marked *E*, was set in the window. In it was a small living frond of the sea-lettuce, *Ulva latissima*. Two months passed, during which not a diatom appeared. Evidently that water was sporeless.

The six experiments herein detailed were virtually completed, and it was now well on in January, 1884. Begun in December, 1882, the series had occupied my attention for a little over two years. For fourteen years had the water which I used been kept in a vessel closely corked and in complete darkness. Perhaps I ought to have published my work at the conclusion of the six experiments. I was urged to do so, but determined not to go into print until I had made a second series of experiments in order to correct or confirm the previous ones.

The old jars were guarded with zealous care, and occasionally examined until the Spring of 1886, when I began the new experiments. The first series of jars had the advantage of being kept in a window with a south-eastern exposure, thus receiving the stimulus of direct sunlight. In April, 1886, I changed my residence. Except during this removal, the jars had not been disturbed. Having put these old jars in a favorable place, I began five more experiments, using similar jars and lettering

them as in the first series. This new series was commenced in May, 1886. In jar *A* roiled water was put, the demijohn having been purposely shaken. Jar *B* was supplied with water which I decanted carefully before shaking the demijohn. The water was a second time roiled and enough of it filtered to fill jar *C*, the filter paper at the start passing 100 drops per minute, but requiring 90 minutes to filter a pint. This jar *C* was then placed beside jar *B*. The filter used was laid aside and kept wet. I then shook the demijohn again, and took from it enough roiled water to fill two jars. This was carefully filtered, and the filters were kept. This filtered water was then boiled for twenty minutes and, when quite cool, enough to fill it was poured into jar *D*, which was then placed in the window by the side of *C*. In jar *E* the remainder of the cooled water was put, and in it were washed all the filter papers that had been used. Jar *E* was then set next to *D*. It should be noted that the jars of this series were subjected to a lower temperature than were those of the first series—a circumstance entirely unavoidable. For two weeks the tops of the jars were uncovered, thus exposing the water in them to the air, which, as microscopists know, is mischievously prolific of germs of confervæ and infusoriæ. However, this could not vitiate my work. Called away from home almost constantly by my official duties, I gave the jars no serious inspection until in the first part of the month of July. I then found in *A* a fine crop of diatoms, though they were not so numerous as they were in jar *A* of 1882. I observed with some surprise that the *Naviculæ* were now greatly in the ascendant. In fact, of the genera *Nitzschia* and *Amphora* there were very few representatives. I next examined *B*. To this jar I had looked for results equivalent to those of *D* in the first series, but could scarcely believe my eyes when, after many dips had been examined, I could find only one diatom, a *Navicula*. The film at the bottom of the jar was made up of one-celled confervæ. The water had been decanted so carefully that the spores, which doubtlessly lay on the sediment in the bottom of the demijohn, had not passed out with the water. Hence I infer that the spores are resting and not motile spores.

Jar *C* was next examined. Into this the roiled water had been filtered. It contained a rich crop of diatoms consisting almost wholly of *Naviculæ*, the *Nitzschia* and *Amphora* being

rare. Many of the *Naviculæ* were in pairs, as if in conjunction. This fact made it possible to measure two at a time, which was done in quite a number of cases, with the surprising result that the pairs were all of exactly the same size. Some of these thus in opposition presented their sides to view, and some their fronts, thus enabling me to get the three dimensions, and the result showed entire uniformity of size, namely, length $1\frac{1}{2}\sigma$ in., thickness $\frac{1}{2}\sigma$ in., and width $1\frac{1}{2}\sigma$ in. Could such remarkable agreement mean that these diatoms had all attained their full size, or could it mean arrest of growth at a certain point consequent upon exhaustion of pabulum? Hence arose a necessity for an analysis of the waters.

Jar *D*, into which was put the water that had been filtered and afterwards boiled, was next examined. It did not contain one diatom. The deposit in it was composed entirely of confervæ, the germs of which had entered from the air during the two weeks of exposure mentioned. This showed that the atmosphere had nothing to do with sowing diatom spores in my jars. Also, it proved in this case, that diatom seed could not survive the temperature of boiling water, though possessing a viability which survived an arrest or abeyance of the life-force through sixteen years of inertness in total darkness. True it is, that the silicate frustules or skeletons of diatoms are found in the hot springs or geysers of the West, in waters of temperatures varying from 140° to 200° F.; but not a living diatom has been found therein, and, from our experiment just described, we must believe that none living ever will be found.

With large expectations I next examined jar *E*, the last of the series. During the course of these discoveries, I felt sure that the last experiment would be, like the last wine at the feast, the best, the most satisfactory. In this jar *E* had been rinsed the filter papers used in filtering three jars of water, and from such a generous sowing what might I not expect! Strange to say, the first dip of the sediment in the bottom yielded nothing but unicelled algæ. So did the second, and the third, and others that I made, until my disappointment at such unexpected results amounted to chagrin. Only an occasional *Navicula* was found, and still more rarely a forlorn *Amphora*; nevertheless, the great number of confervæ showed that good growing conditions were present in the jar. The few diatoms seen

were of normal size and form, and appeared to be in the best condition. On reflection, I attached much importance to this negative result, for it impressed me with the conviction that the diatom seed was so exceedingly small that all of it, practically, passed through the filters used.

Through all these experiments excepting No. 1 and No. 2 of the first series, one is struck with the apparent discrepancies, differences in the amount of the several crops, in the species and in the sizes of individuals of the same species. The diatoms in experiments No. 1 and No. 2 of the first series, must, I think, be considered normal, and I give herewith a table of measurements, in parts of an inch, of individuals of the three genera contained in each of the jars used in those experiments.

<i>Nitzschia.</i>		<i>Amphora.</i>		<i>Navicula.</i>		
LONG.	THICK.	LONG.	THICK.	LONG.	THICK.	
1.	$\frac{1}{414}$	$\frac{1}{6000}$	$\frac{1}{1333}$	$\frac{1}{4000}$	$\frac{1}{2400}$	$\frac{1}{6000}$
2.	$\frac{1}{414}$	$\frac{1}{6000}$	$\frac{1}{1333}$	$\frac{1}{3000}$	$\frac{1}{1500}$	$\frac{1}{6000}$
3.	$\frac{1}{414}$	$\frac{1}{6000}$	$\frac{1}{1333}$	$\frac{1}{4000}$	$\frac{1}{1500}$	$\frac{1}{6000}$
4.	$\frac{1}{414}$	$\frac{1}{4000}$	$\frac{1}{1090}$	$\frac{1}{2400}$	$\frac{1}{2400}$	$\frac{1}{9000}$
5.	$\frac{1}{430}$	$\frac{1}{6000}$	$\frac{1}{1333}$	$\frac{1}{4000}$	$\frac{1}{2575}$	$\frac{1}{6000}$
6.	$\frac{1}{460}$	$\frac{1}{6000}$	$\frac{1}{2000}$	$\frac{1}{4000}$	$\frac{1}{3000}$	$\frac{1}{6000}$
7.	$\frac{1}{414}$	$\frac{1}{4000}$	$\frac{1}{1333}$	$\frac{1}{3000}$	$\frac{1}{2400}$	$\frac{1}{6000}$
8.	$\frac{1}{414}$	$\frac{1}{6000}$	$\frac{1}{1200}$	$\frac{1}{3000}$	$\frac{1}{1500}$	$\frac{1}{5000}$
9.	$\frac{1}{430}$	$\frac{1}{6000}$	$\frac{1}{1712}$	$\frac{1}{4000}$	$\frac{1}{2575}$	$\frac{1}{6000}$
10.	$\frac{1}{430}$	$\frac{1}{4000}$	$\frac{1}{1090}$	$\frac{1}{3000}$	$\frac{1}{4000}$	$\frac{1}{9000}$
11.	$\frac{1}{430}$	$\frac{1}{4000}$	$\frac{1}{1333}$	$\frac{1}{3000}$	$\frac{1}{2575}$	$\frac{1}{12000}$
12.	$\frac{1}{430}$	$\frac{1}{6000}$	$\frac{1}{1090}$	$\frac{1}{2370}$	$\frac{1}{2400}$	$\frac{1}{9000}$
13.	$\frac{1}{430}$	$\frac{1}{6000}$	$\frac{1}{1500}$	$\frac{1}{4000}$	$\frac{1}{1500}$	$\frac{1}{6000}$
14.	$\frac{1}{430}$	$\frac{1}{6000}$	$\frac{1}{1250}$	$\frac{1}{5000}$	$\frac{1}{1090}$	$\frac{1}{4500}$
15.	$\frac{1}{430}$	$\frac{1}{6000}$	$\frac{1}{1333}$	$\frac{1}{3000}$	$\frac{1}{1500}$	$\frac{1}{6000}$
16.	$\frac{1}{414}$	$\frac{1}{6000}$	$\frac{1}{1090}$	$\frac{1}{3000}$	$\frac{1}{1200}$	$\frac{1}{6000}$
17.	$\frac{1}{414}$	$\frac{1}{4000}$	$\frac{1}{1333}$	$\frac{1}{4000}$	$\frac{1}{1333}$	$\frac{1}{6000}$
18.	$\frac{1}{414}$	$\frac{1}{6000}$	$\frac{1}{1333}$	$\frac{1}{4000}$	$\frac{1}{1500}$	$\frac{1}{4500}$
19.	$\frac{1}{430}$	$\frac{1}{6000}$	$\frac{1}{1333}$	$\frac{1}{3000}$	$\frac{1}{2000}$	$\frac{1}{9000}$
20.	$\frac{1}{430}$	$\frac{1}{6000}$	$\frac{1}{1090}$	$\frac{1}{2370}$	$\frac{1}{2400}$	$\frac{1}{9000}$

The *Navicula* column shows much diversity of sizes, and yet the diatoms whose measurements are there given were of the same species as those in jar C of the second series, which showed complete uniformity in size. As to the Figures 1, 2, and 3 in

the plate, they measured respectively $\frac{1}{300}$ by $\frac{1}{300}$, $\frac{1}{300}$ by $\frac{1}{300}$ and $\frac{1}{300}$ by $\frac{1}{300}$.

It is with regret that I allow this paper to go to press without containing a full determination of the species of the diatoms spoken of. For this determination I had depended upon Prof. H. L. Smith, but the serious accident which befel that eminent diatomist made it impossible for him to furnish the list.

RÉSUMÉ.

1. My experiment of December, 1882, the results of which I have confirmed by so many observations made since, demonstrates that diatoms originate in spores, or seed-like bodies.

2. These spores are exceedingly minute, passing easily through filter-paper.

3. They are probably resting spores not motile, and may be held in suspension awhile like the mineral matter in turbid water.

4. The viability of these spores is remarkable. The diatoms raised in the first series of experiments were from spores whose life-force had lain dormant in total darkness for thirteen or fourteen years; those in the second series, for sixteen years.

5. The viability of some genera is greater than that of others. This is notable of *Navicula* in these experiments, and is consonant with the numerical lead of this genus in forms or so-called species.

6. Owing to the environment becoming abnormal, development may be rapid and erratic to a surprising degree, but upon aberrant and asymmetrical lines. Suppressed at some points, the life-energy is precociously active at others.

7. Diatoms have embryonal stages or forms, with silicate fronds.

8. As to kind and quantity, the crops are capricious and vary without apparent reasons.

9. As to the parentage or begetters of the spores in my experiments: They were not generated in the vessel which contained the water, but were begotten of sporangial mother cells in the Bay.

ANALYSIS OF THE WATER.

The fact that in one crop the diatoms of one species were all of the same size, caused me to suspect that they had ceased to grow

in consequence of having exhausted the silica in the water. So I submitted four one-pint bottles of the water to the skillful analyst Prof. Peter T. Austen, of Rutgers' College, New Brunswick, N. J. These bottles were labelled *A*, *B*, *C*, and *D*, respectively. The first two contained water that had not been used in my experiments, *A* being from the large demijohn, *B* from the smaller one, the water in both having come from the same place in Raritan Bay; but while the water in the smaller demijohn had been in my cellar not quite two years, that in the larger one had been there nearly seventeen years. Samples *C* and *D* were from the jars of the first series of experiments, which had been so fruitful of diatoms. To my surprise, the following was the report of the analyst:—

Amount of Silica in grains per gallon.

Sample *A*, 1.71

Sample *B*, 1.24

Sample *C*, 3.78

Sample *D*, 4.44

The Professor wrote me: "You will notice that the samples in which the samples have been grown are much richer in silica than the original water. This is probably because the water has stood for a long time in glass vessels and has hence dissolved silicates from the glass. It is probable that this silica is combined as silicate of soda or potash. Water has a very appreciable solvent action on glass, indeed, so much that in chemical analysis we have to correct the error introduced by the use of glass vessels. Without large samples and exhaustive analyses it is difficult to interpret these results. A possible hypothesis for the refusal of the diatoms to grow any longer may be that they only take up free (that is) uncombined silica, or, if they take the silica away from the base, the setting free of the base may leave the water more or less alkaline, which may possibly be detrimental to their development. It is very difficult in a case like this to get all the conditions."

It should be noted that the unused water in samples *A* and *B* had, so far as being in glass vessels is concerned, been all the time in darkness; also, that *A*, from the larger demijohn, is richer in silica than is *B*. But *C* and *D* had been exposed nearly five years to daylight; hence, in my opinion, the solvent action of

the water was, in *C* and *D*, more energetic than in the others, because of the photochemical stimulus of the solar light. When the quantity of the diatoms raised is considered, we are impressed with the elaborating and assimilating energy of these tiny organisms which use up and yet conserve so large an amount of silica.

EXPLANATION OF PLATES VI. AND VII.

The figures on the plate were drawn from a careful study of a single slide of material from jar *C*, of the first series. They are magnified 1600 diameters excepting 2^a , 2^b , 2^c , and 8^a , which are magnified about 800 diameters; and excepting also Figure 17, the individuals of which are magnified about 350 diameters. Only in Figure 2^c was I able to detect the median line, and in none could I find the central or the terminal vacuoles.

Figure 1. This beautiful form was very rare.

Figure 2. Not rare, and often found as the nucleus of a double nest of layers, as shown in Figures 19, 20, and 21, of the text.

Figures 3 to 16 inclusive. Figure 3 is a side view of the typical form from which the others are monstrous aberrants.

Figures 15 and 16. Dumb-bell forms, or wider aberrancies.

Figure 17. A swarm of embryonal *Amphora*, simply a diagram.

Figure 18. Shows one side of the nesting, of which 2^c is the nucleate centre.

Figures 19, 20, and 21, Nests, of which Figure 2 is the nucleus.

All these figures are described more fully in the text, where their exact magnitudes are also given.

I am indebted to my friend, Dr. Alfred C. Stokes, the infusorist, for the measurements given in this paper, and to his facile pencil for the drawings. The measurements were made with a Rogers micrometer eye-piece and a Fasoldt stage-plate, and the objective used was a Herbert R. Spencer homogeneous-immersion $\frac{1}{10}$ of N. A. 1.35.

A NOTE.

Under date April 6th, 1886, Dr. Alfred C. Stokes wrote

me: "Do you have access to the Journal of the Royal Microscopical Society? I hope you do, but if you do not, the following from the December (1885) number may interest you. * * * It becomes more than interesting when taken in connection with your 'mysterious diatoms' experience; and your observation as a whole is much more remarkable and valuable than Mr. Kitton's. I wish you would publish it, although it may be somewhat incomplete. * * * I am sorry you did not publish your observations long ago and so have been the first to announce the discovery."

The article in the Royal Microscopical Society's Journal, which is taken from the Journal of the Quekett Club, in brief, says, that Mr. F. Kitton, observing a film on some water in his laboratory, found to his surprise that it was composed of *Achnanthes linearis*. He then filtered some of the same water and, in time, obtained from it another film made up of the same diatoms, although he burnt and decarbonized the filter-paper without finding any diatoms in it. My own discovery antedates Mr. Kitton's by more than two years, and I think it was at least a year before his discovery and when my first series of experiments had for some time been completed, that I made a verbal statement of the main facts at a meeting of the New-Jersey State Microscopical Society.

JOURNAL
OF THE
NEW-YORK MICROSCOPICAL SOCIETY.

VOL. III.

JANUARY, 1887.

No. 1.

THE BROWNIAN MOVEMENT.

BY H. L. BREVOORT.

(*Read January 21st, 1887.*)

I have from time to time for the past four years given a good deal of attention to this still unexplained movement. As you all know, small particles of any substance, when suspended in water, will show and continue to show for an indefinite period of time, a rapid movement. Apparently as long as the slide lasts, the movement will continue. I have slides some four years old and the movement is as rapid now as on the day they were mounted. Prof. Stanly Jevons says, if I remember correctly, that, he had slides over ten years old which showed the movement as when new. I have found the common water-color paint, "flake-white" to give the most satisfactory results. Rub a little of this up with water till the water is milky; then let it settle for a few minutes and decant the upper and clearer portion of the liquid. Repeat this several times. Then mount in a cell, say $\frac{1}{100}$ of an inch deep. Observe with a $\frac{1}{8}$, or still higher objective and the movement will be clearly seen. It is best to make the cell of less depth, if very high objectives are to be used. Finely powdered glass may be used in place of "flake-white." Vermilion is a good material, but the particles are so small and move so rapidly that it is difficult to observe them. Carmine does not make a lasting slide, though a very effective one while it does last. Cobalt makes a good slide, but the particles are very small. In all cases proceed to mount as directed. The difficulty is that every one uses too much material in the water. Use so little that no color is apparent to the eye in the mounted slide, or, only a tinge at most.

If a mounted slide is kept for a long time with one part lower than the other, the particles will by gravity settle and compact themselves in the low part of the cell, and then if the mass is so compact that shaking the slide will not break it, the slide is spoilt.

The stratum of water between the cover-glass and slide is not equally filled with moving particles. Most of the particles which are large enough to be observed satisfactorily are close to the slide's surface, though smaller and more rapidly moving particles are found in all parts of the stratum of water. If only these latter could be enclosed in the cell, I do not think they would ever be affected by gravity and would not form themselves into a compact mass. However, these particles are comparatively few, and it seems impossible to crowd them into a mount—they seem to require room and are not friendly.

By mounting some material upon a ruled glass slide, it will be seen by carefully focusing with a high power, that most of the moving particles are on, or, are close to the surface of the slide. There they move about, some sliding as it were, some rotating, some moving in one direction and some moving in another direction. Only the small particles seem to rotate. Almost all the particles partake of several motions at once, sliding, rotating or partly rotating, and bodily moving about at the same time. The motion cannot be described, it must be seen. The smaller globules in milk show the movement well, if the milk is confined in a cell. If not in a cell, the flowing of the milk on the slide makes the observation difficult. The standard books, such as Carpenter, Beale, etc., differ widely on this subject: Some say that heat increases and others say that heat does not affect the movement, or, rapidity of the movement of the particles. I have never found that heat affects the movement one way or the other. To this end I have illuminated the microscope by a ray of moonlight and have found the movement the same, as when a strong ray of light from a lamp was used. I have heated the slides on a hot stage up to 180° F. and above, and have found no change in the movement. I have also used non-actinic light, but have found no change. Some have attributed the movement to electricity, but it is difficult to see in what condition it could be and give such results. It is a question whether the movement would be shown unless the water was between two glasses, but I believe I have observed it in an exposed drop of fluid, but of this I am not certain.

I am under the impression that light in some way is the cause. We see the radiometer turn when a ray strikes its veins. Perhaps each of the moving particles is exposing facets, which are light and dark by turn, to the upward ray of light in the microscope, and as the particle moves, other facets are exposed, and thus as long as the ray passes, so long will the particles move. The refractive index of the water may in some way affect the facets of the particles; so also the combination of the glass slide and the water may work together to this end. Thus a facet which is bright when the particle is in one position will perhaps be dark when the particle is in another position, and thus the veins of each of these minute radiometers may be for each particle limitless in number and ever changing in hue. I have taken two bottles, subjecting them to precisely the same conditions. In each I placed water in which particles of "flake-white" were suspended. One bottle I kept in the light, day and night for a week, the other in total darkness for the same period. The bottle exposed to the light appeared at the end of the period to contain a greater number of particles moving in it than the bottle which had been in the dark. This difference was visible to the naked eye. The bottle exposed to the light being the one which contained at the end of the time the most turbid fluid. I have not been able to confirm the truth of this experiment. In fact experiments with vermilion did not show the same result, or else the difference between the bottles was so slight as not to be noticeable. These experiments could be carried on and important results could perhaps be reached through the lessons they taught. Any explanation of the mysterious movement would be of interest.

HORN AND EYE OF ARION.

BY LUDWIG RIEDERER.

(Read January 21st, 1887.)

Arion, Lam. is a slug or snail without shell, respiring by means of lungs. It belongs to the class of Gasteropods, Mollusks.

Like all nude snails it carries the eyes on the end of the two longer ones of their four tentacles or horns.

The horn is simply a continuation of the skin. By contraction of muscles extending from the muscles of the foot, right up through the horn to the base of the eye, this can be retracted very suddenly, deep into the body, while the horn in like way is turned over inward.

On the end plate of the horn, between epithelial cells singularly formed, is found an accumulation of sensitive cells, most likely for the sense of touch.

The eye is of the plain type, and corresponds to a Camera obscura of spherical shape, with Iris, a globular lens, retina, opposite to the side giving entrance to the light, and choroidea with pigment of black color enclosing the whole enclosed surface.

The method to prepare cuts for microscopical observation and of durability for longer time, consists in putting the (while extended) freshly cut horn in aqueous saturated solution of Corrosive Sublimate, during twenty-four hours for fixing. After this it is hardened by 95 per cent. alcohol. Another way is to fix first by immersion in solution of Osmic Acid of 0.1 per cent. for ten minutes, and to harden after in solution of Bichromate of Potash of 2 per cent. during twenty-four hours. After extracting with water it is brought in diluted alcohol, increasing the strength of this slowly till alcohol absolute.

Treated in one of these two ways it is in the known way transferred in Chloroform and Chloroform-Paraffine.

The cuts fastened to the slide may be tinted by some of the solutions of Carmine, Haematoxylin or Safranin (and enclosed), to make more distinct the different tissues.

PROCEEDINGS.

MEETING OF DECEMBER 3^D, 1886.

The Vice-President, Mr. P. H. Dudley, in the chair.

Sixty-three persons present.

On motion the regular order of business was suspended.

Prof. Samuel Lockwood, Ph. D., was introduced to the Society, and delivered a lecture entitled, "The Life of a Diatom." This lecture was profusely illustrated by lantern slides, of remarkable excellence, by Prof. W. Stratford, of the College of the City of New York. The slides were exhibited by the lime-light, showing among many noted objects, Habishaw's photograph of *Pleurosigma*, with lines one-third of an inch broad, and beautifully clear, and views of Mr. Christian's new and very curious diatoms. The lecture is published in this Journal, in the number for December, 1886, pp. 135-142.

MEETING OF DECEMBER 17TH, 1886.

The President, the Rev. J. L. Zabriskie, in the chair.

Forty-one persons present.

On motion the regular order of business was suspended.

The President introduced Prof. Samuel Lockwood, Ph. D., who read a paper entitled, "Raising Diatoms in the Laboratory;" giving methods and results of experiments made upon sea-water, and extending through several years; the objects being raised from spores, and carried through their entire life career. This paper was illustrated by numerous slides, shown under the microscope, and is published with an accompanying plate in this Journal, in the supplemental number for December, 1886, pp. 153-166.

MEETING OF JANUARY 7TH, 1887.—THE ANNUAL MEETING.

The Vice-President, Mr. P. H. Dudley, in the chair.

Twenty-four persons present.

The special committee, appointed to nominate a list of officers for the ensuing year presented their report.

The Annual Report of the President was read by the Corresponding Secretary.

The reading of the reports of the Treasurer, the Librarian and the Curator, was, on motion, postponed until the next meeting.

The resignation of Active Membership by Mr. John A. Bagley, and Prof. A. M. Mayer, was accepted.

Prof. Samuel Lockwood, Ph. D., made some remarks supplementary to his paper of December 17th, 1886, on "Raising Diatoms in the Laboratory." He dwelt particularly on the great variety of hitherto unknown forms developed in his experiments, and suggested the title—"Heterogeny of the Diatom" for his paper. He further presented a sheet of very delicately made drawings, by Prof. Alfred C. Stokes, of these curious forms.

Mr. P. H. Dudley read a paper, illustrated by photo-micrographs and specimens of the White Cedar (*Chamaecyparis sphaeroidea*) showing its structure, and also showing its fungus (*Agaricus campanella*).

The President announced the closing of the polls, and the following was declared the result of the balloting:—

- For President, J. L. ZABRISKIE.
 For Vice-President, P. H. DUDLEY.
 For Recording Secretary, H. W. CALEF.
 For Corresponding Secretary, B. BRAMAN.
 For Treasurer, C. S. SHULTZ.
 For Librarian, A. WOODWARD.
 For Curator, W. BEUTTENMÜLLER.
 For Auditors, { F. W. DEVOE,
 { W. R. MITCHELL,
 { F. W. LEGGETT.

MEETING OF JANUARY 21ST, 1887.

Mr. B. Braman, President *pro tem.*, in the chair.

Twenty persons present.

SUMMARY OF THE REPORT OF THE TREASURER, MR. CHARLES S. SHULTZ.

Balance, Jan. 15th, 1886.....	\$122.69	
Receipts, to Jan. 7th, 1887.....	337.50	\$460.19
Disbursements to Jan. 7th, 1887.....		381.08
Balance, Jan. 7th, 1887.....		\$79.11

Drs. Frank M. Hoyt and H. Fearn were elected Active Members, and Prof. A. M. Mayer was elected a Corresponding Member of the Society.

On motion, the names of the following persons designated as Associate Members under the old Constitution and By-Laws, were directed to be printed in the forthcoming list of members of the Society as Corresponding Members ; viz.:—

D. F. BRIGGS, M. D., Germantown, Pa.

Prof. W. WHITMAN BAILEY, Brown University, Providence, R. I.

ALBERT H. CHESTER, Hamilton College, Clinton, N. Y.

ANTONIO DE GORDON Y ACOSTA, Havana, Cuba.

EUGENE MAULER, Travers, Switzerland.

CARL SEILER, Philadelphia, Pa.

CHARLES L. SWASEY, New Bedford, Mass.

THOMAS TAYLOR, M. D., Washington, D. C.

JAMES W. WARD, Grosvenor Library, Buffalo, N. Y.

On motion, the Society ordered the following names of Honorary Members to be printed, in the forthcoming list of Members, as the Honorary Members of the Society under the new By-Laws, viz.:—

Prof. HAMILTON L. SMITH, Geneva, N. Y.

J. H. MORTIMER, 113 Maiden Lane, N. Y. City.

Hon. JACOB D. COX, Cincinnati, Ohio.

FRANK CRISP, LL.B., London, England.

On motion, it was resolved that the names of the former Active Members of the Society be printed in the same list as Resident Members.

The Corresponding Secretary, Mr. B. Braman, reported the receipt of a gift of nine Photographs, from Dr. Henri Van Heurck, with an accompanying description. The said photographs were taken with an apo-chromatic No. 10, Zeiss homogeneous immersion lens—power, 800 diameters—and a further magnification of the same to 3,000 diameters. The Corresponding Secretary read the description, and exhibited the photographs of *P. angulatum*, *S. gemma*, and *A. pellucida*.

On motion, the thanks of the Society were tendered Dr. Henri Van Heurck, for these well executed and instructive photographs.

Mr. H. L. Brevoort addressed the Society on the Brownian

Movement, illustrated by drawings on the black-board. This address is published in full in the present number of this Journal.

OBJECTS EXHIBITED.

The objects exhibited were :

1. Vanessa ; sections through the head : by L. RIEDERER.
2. Arion ; sections through the eye : by L. RIEDERER.
3. Larva of Lace-wing Fly : by F. W. LEGGETT.
4. Head and Jaws of Lace-wing Fly : by F. W. LEGGETT.
5. *Arachnoidiscus Ehr.*, plated with gold ; mounted by A. Y. Moore : by C. S. SHULTZ.
6. Arranged Diatoms : by C. S. SHULTZ.

The Chairman announced a course of Lectures to be given at Columbia College, to which the Members of the Society were invited.

MEETING OF FEBRUARY 4TH, 1887.

The President, the Rev. J. L. Zabriskie, in the chair.

Seventeen persons present.

Mr. Arthur H. Sleigh was elected a Resident Member of the Society.

OBJECTS EXHIBITED.

1. Cray-fish (*Astacus fluviatilis*) ; sections through the organs: by L. RIEDERER.

Of these sections, the muscles were mounted in glycerine, and the remainder in balsam, showing *vas deferens* with ciliated cells. Also the sexual organs, showing spermatozoa. Mr. Riederer explained at length his methods of section-cutting and staining.

2. *Closteria ; Epistylis, Cephalosiphora* and *Limnias* : by W. G. DE WITT.

3. Brucine ; by polarized light : by M. M. LE BRUN.

4. Section of Granite ; by polarized light : by T. B. BRIGGS.

Messrs. Hyatt and Briggs explained their methods of cutting sections of minerals.

The President expressed his thanks for his reëlection to office, and urged upon the members the need of greater efforts during the current year in the matter of exhibition of objects.

MEETING OF FEBRUARY 18TH, 1887.

On account of a severe storm only seven persons were present. There being no quorum the meeting was informal.

ANNUAL RECEPTION OF 1887.

The Ninth Annual Reception of the Society was held at Lyric Hall, 723 Sixth Avenue, on the evening of March 4th, 1887.

Regularly disposed in the large auditorium were ten tables, holding fifty-two microscopes, with their respective objects, displayed and explained by thirty-four exhibiting members. The large adjoining hall, in which was stationed an excellent orchestra, afforded additional space for the movement and social intercourse of a larger number of visitors than had ever been welcomed on any previous similar occasion.

THE OBJECTS EXHIBITED WERE AS FOLLOWS:

1. Widmannstatten Figures on Meteoric Iron, from Glorieta Mountain, New Mexico : by GEORGE F. KUNZ.
2. Essonite, or Cinnamon Garnet : by GEORGE F. KUNZ.
3. Cyclosis in Nitella : by W. R. MITCHELL.
4. *Trichina spiralis* : by L. SCHÖNEY, M. D.
5. Platino-cyanide of Magnesium : by G. S. WOOLMAN.
6. Fern-leaf Gold Crystals : by G. S. WOOLMAN.
7. Spiral Fibre from the Fruit-stalk of the Banana (*Musa sapientum*), by polarized light : by the REV. J. L. ZABRISKIE.
8. Brownian Movement : by H. L. BREVOORT.
9. Plant-hairs of Sea Buck-Thorn (*Hippophaë rhamnoides*) : by C. F. COX.
10. Plant-hairs of Yellow Water-Lily (*Nuphar advena*) : by C. F. COX.
11. Spider's Silk ; shown in comparison with No. 120 spool cotton : by F. W. DEVOE.
12. Cyclosis in Vallisneria : by F. W. DEVOE.
13. Arranged Diatoms : by F. W. DEVOE.
14. Head of a Moth : by WILLIAM WALES.
15. Globules of Copper, ejected from a Siberian Volcano : by WILLIAM WALES.
16. Tongue of House-fly (*Musca domestica*) : by WILLIAM WALES.

17. Feathered-oar of Water-Boatman (*Notonecta undulata*) : by A. G. LEONARD.
18. *Sphæria pilifera*, on Yellow Pine : by P. H. DUDLEY.
19. *Pencillium glaucum*, on Potato : by CHARLES E. PELLEW.
20. *Bacillus anthrax*, in blood of Mouse : by CHARLES E. PELLEW.
21. Scales from wing of Mosquito : by W. H. BATES, M. D.
22. Moving Crystals of Tartrate of Lime : by H. M. DICKINSON.
23. Section of Human Scalp : by H. M. DICKINSON.
24. Section of Stigmæria, Coal fossil from Oldham, England : by F. W. LEGGETT.
25. Bouquet of Butterfly Scales : by C. W. McALLISTER.
26. Arranged Diatoms : by C. W. McALLISTER.
27. Circulation of Blood in the tail of a Fish : by WALTER H. MEAD.
28. Siliceous Framework of Cuticle of *Equisetum*, or Scouring-Rush : by BENJAMIN BRAMAN.
29. "File" of Katydid (*Platyphyllum concavum*, Harris): by BENJAMIN BRAMAN.
30. Circulation of Blood in the Frog : by J. L. WALL.
31. Some living animals from our Croton water : by W. E. DAMON.
32. Plant-hairs, on *Deutzia scabra* : by W. E. DAMON.
33. Brucine : by F. COLLINGWOOD.
34. Foraminifera from the Harlem river : by A. WOODWARD.
35. A Group of Insect Eggs : by M. M. LEBRUN.
36. Crystals of Silver : by M. M. LEBRUN.
37. Section of Coniferous Wood from Stomach of Mastodon : by H. W. CALEF.
38. Feather of Sun-Bird (*Cinnyris*): by H. W. CALEF.
39. Comma Bacillus of Asiatic Cholera : by LUCIUS PITKIN.
40. Sting of Wasp, with Poison Gland attached : by J. A. CHAMBERS.
- 41 and 42. Pond-life : by W. G. DEWITT.
43. Ovipositor of Saw-fly (*Cimbex connata*): by LUDWIG RIEDERER.
44. Fibrous Malachite with Azurite (Carbonates of Copper): by C. S. SHULTZ.
45. *Hydra viridis* : by C. S. SHULTZ.

46. Cilia of Mussel : by J. D. HYATT.
 47. Pulmonary Tracheæ of Drone-Fly : by EDWARD G. DAY.
 48. Capillaries in Human Lung : by EDWARD G. DAY.
 49. Composite Cluster Cups (*Æcidium compositarum*): by GEORGE E. ASHBY.
 50. Sporangia of *Aspidium ascendens* : by E. B. GROVE.
 51. Arranged Diatoms : by MARK H. EISNER.
 52. Head of Wasp, showing the Mouth-parts : by MARK H. EISNER.

MEETING OF MARCH 18TH, 1887.

The President, the Rev. J. L. Zabriskie, in the chair.

Thirty-two persons present.

In the absence of the Secretary, Mr. M. M. LeBrun was appointed Secretary *pro tem*.

On motion, the following recommendation of the Board of Managers was adopted :—

That the number of microscopic objects exhibited at each regular meeting of the Society shall never be fewer than nine.

That the Curator, or, in his absence, the Librarian, shall, under the Curator's direction, be responsible for the exhibition of the said number of objects ; that the Curator shall prepare the list of objects, with suitable descriptive text, in season for publication by the Committee on Publications ; and that for the said services the Curator shall be paid, out of the Society's Treasury, compensation at the rate of fifty dollars per annum.

Dr. Henri Van Heurck was elected an Honorary Member of the Society.

The President appointed the Committees for the current Society-year as follows :—

I. THE STANDING COMMITTEES.

1. *On Admissions* : J. D. HYATT, WM. WALES, F. W. DEVOE, F. W. LEGGETT, W. E. DAMON.

2. *On Publications* : F. W. LEGGETT, LUCIUS PITKIN, E. B. SOUTHWICK, P. H. DUDLEY, W. H. MEAD.

II. SPECIAL COMMITTEES.

1. *On Entomology* : J. D. HYATT.

2. *On Improvements in Microscopes and Microscopical Apparatus*: WM. WALES.

3. *On Medical Science*: L. SCHÖNEY, M. D.

4. *On Mineralogy*: A. A. JULIEN, Ph. D.

5. *On Cryptogamic Botany*: C. VAN BRUNT.

6. *On Phanerogamic Botany*: N. L. BRITTON, Ph. D.

7. *On Adulterations*: B. BRAMAN.

8. *On Structure of Materials*: P. H. DUDLEY, C. E.

9. *On Textile Fibres*: H. L. BREVOORT.

10. *On Bacteriology*: C. E. PELLEW, M. E.

Mr. W. H. Mead requested to be excused from service on the Committee on Publications, and, on motion, it was resolved that the President be substituted in his place on said Committee.

The resignation of Resident Membership by Gen. Wager Swayne was presented and accepted.

OBJECTS EXHIBITED.

Mr. J. D. Hyatt exhibited the following objects, representing the Cretaceous Formation of Alabama:—

1. A supposed new Infusorial Earth.
2. Tripoli Rock, containing Micro-fossils.
3. A Coal Shale, containing Jaws and Teeth of Microscopic Animals.
4. A Bituminous Shale, filled with Spicules of Sponge.
5. A true Chalk, containing Fossils similar to those of the English Chalk.
6. Lithographic Stone, containing numerous Foraminifera.
7. Specimens of Silicified Wood.

There were also exhibited:—

8. Proboscis of Drone-fly.
9. Proboscis of Blow-fly.
10. A Polyporus from Panama: by P. H. DUDLEY.
11. A gigantic Cockroach, from Panama: by P. H. DUDLEY.
12. Eggs of Lepidoptera: by WM. BEUTTENMÜLLER.

Prof. Samuel Lockwood, Ph. D., addressed the Society on casts found in the Cretaceous clays of New Jersey.

PUBLICATIONS RECEIVED.

The American Monthly Microscopical Journal : Vol. VII., No. 12 (December, 1886), Vol. VIII., Nos. 1-5 (January-May, 1887) ; pp. 120.

The Microscope : Vol. VI., No. 12 (December, 1886), Vol. VII., Nos. 1-4 (January-April, 1887) ; pp. 152.

Bulletin of the Torrey Botanical Club : Vol. XIII., No. 12 (December, 1886), Vol. XIV., Nos. 1-5 (January-May, 1887) ; pp. 130.

Journal of Mycology : Vol. II., No. 12 (December, 1886), Vol. III., Nos. 1, 2, 3, and 5 (January, February, March, and May, 1887) ; pp. 60.

Drugs and Medicines of North America : Vol. II., Nos. 2 and 3 (September and December, 1886) ; pp. 62.

Dr. Thomas Taylor's Reply to Science. Relating to the Crystals of Butter, Animal Fats, and Oleomargarine : 1886 ; pp. 8.

Indiana Medical Journal : Vol. V., Nos. 6-11 (December, 1886-May, 1887) ; pp. 136.

The West-American Scientist : Vol. III., Whole Nos. 20-24 (December, 1886-April, 1887) ; pp. 106.

The Hoosier Naturalist : Vol. II., Nos. 3-10 (October, 1886-May, 1887) ; pp. 125.

Anthony's Photographic Bulletin : Vol. XVII., Nos. 23 and 24 (December, 1886), Vol. XVIII., Nos. 1-10 (January-May, 1887) ; pp. 382.

The Hahnemannian Monthly : Vol. VIII., No. 12 (December, 1886), Vol. XXII., Nos. 1-3 (January-March, 1887) ; pp. 256.

The Cosmopolitan : Vol. II., No. 1 (September, 1886) ; pp. 66.

Proceedings of the Natural Science Association of Staten Island : December, 1886-April, 1887 ; pp. 10.

Johns Hopkins University, Baltimore, Md. Studies from the Biological Laboratory : Vol. III., No. 9 (February, 1887) ; pp. 18. Circulars : Vol. VI., Nos. 54-57 (December, 1886-April, 1887) ; pp. 52.

Department of the Interior. U. S. Geological Survey, J. W. Powell, Director. Mineral Products of the United States : Calendar years 1882, '83, '84 and '85.

The Electrician and Electrical Engineer : Vol. V., No. 60 (December, 1886), Vol. VI., No. 61 (January, 1887) ; pp. 80.

National Druggist : Vol. IX., Nos. 23-26 (December, 1886), Vol. X., Nos. 1-21 (January-May, 1887) ; pp. 310.

Grevillea : Vol. XV., Nos. 74 and 75 (December, 1886, and March, 1887) ; pp. 101.

The Naturalist : Nos. 137-141 (December, 1886-April, 1887) ; pp. 158.

The Naturalist's World : Vol. III., No. 36 (December, 1886), Vol. IV., Nos. 37-40 (January-April, 1887) ; pp. 94.

Bulletin de la Société Royale de Botanique de Belgique : Vol. XXV., Fasc. 1 (1886) ; pp. 398. Comptes-Rendus des Séances : November 13th, 1886-March 12th, 1887 ; pp. 49.

The Microscopical Bulletin and Science News : Vol. III., No. 6 (December, 1886), Vol. IV., No. 1 (February, 1887) ; pp. 16.

Brooklyn Entomological Society. Entomologica Americana : Vol. II., Nos. 9-12 (December, 1886-March, 1887), Vol. III., Nos. 1-3 (April-June, 1887) ; pp. 135.

The Botanical Gazette : Vol. XI., No. 12 (December, 1886), Vol. XII., Nos. 1-5 (January-May, 1887) ; pp. 158.

Monatsblätter des Wissenschaftlichen Club in Wien : Vol. VIII., Nos. 2-8 (November, 1886-May, 1887) ; pp. 68. Jahresbericht : 1886-1887 (Eleventh year) ; pp. 45. Ausserordentliche Beilage : Nos. 1-4 ; pp. 56.

Chronik des Wiener Gothe-Vereins : Vol. I., Nos. 2 and 3 (November and December, 1886), Vol. II., Nos. 4-8 (January-May, 1887) ; pp. 36.

Bulletin of the Washburn College Laboratory of Natural History : Vol. I., No. 7 (December, 1887) ; pp. 24.

Massachusetts Horticultural Society : Schedule of Prizes offered for the year 1887 ; pp. 42.

JOURNAL
OF THE
NEW-YORK MICROSCOPICAL SOCIETY.

VOL. III.

APRIL, 1887.

No. 2.

THE LARVA OF THE CHRYSOPA.

BY F. W. LEGGETT.

(*Read January 21st, 1887.*)

Of the Chrysopa (Lace-wing Fly), of which the two specimens I exhibit are the larva, Packard says "the body is slender, with delicate gauze-like wings, and it is generally green with golden eyes. When disturbed it emits a fœtid odor, its eggs supported by long pedicels, are often laid in a group of aphides or on plants infested by them. When hatched the voracious larva finds its food ready at hand, and destroys immense numbers of plant-lice, whence its name "Aphis Lion." It turns to a pupa late in summer, and thus passes the winter within a very dense round whitish cocoon, situated in the crevice of bark. In Europe, gardeners search for these Aphis Lions, and place them on fruit trees overrun with lice, which they soon depopulate." There are two peculiarities about this insect which I do not find noted in authorities consulted. First, retained powers of locomotion while in their white cocoon-like covering, for the pair I have here this evening fell on my hand when riding, and would have been brushed off as a particle of floating wool had I not noticed that they were moving rapidly away. Secondly, they have four distinct mandibles, two on either side of the head, those on the same side being flat on the inner and rounded on the outer surface, fitting so closely and accurately together, that when not in use and crossed, as they appear under one of the microscopes, the dividing line is not perceptible. These mandibles are formidable weapons, being about one-quarter the length of the body. I have read somewhere, but am unable to find it, that this white

silky covering is not a cocoon spun by the occupant, but is borrowed for the purpose of disguise, and the little "varmint" is a veritable wolf in sheep's clothing. As this covering is composed of all sorts of odds and ends, it lends color to this fiction—if fiction it be.

The specimen under the inch objective, has been bleached in potash, and is mounted in balsam. That under the two inch is as found, except that its covering has been disturbed so as to show the mandibles in a position of rest.

NOTE ON THE FORAMINIFERAL FAUNA OF THE
MIOCENE BED AT PETERSBURG, VIRGINIA ;
WITH LIST OF SPECIES FOUND.

BY ANTHONY WOODWARD.

(Read May 6th, 1887.)

The evidence of the very remarkable abundance of Foraminifera in the Miocene bed at Petersburg, Virginia, was found by me accidentally while examining some coarse material from between two valves of *Pectunculus lentiformis*, Conrad, containing by weight $\frac{1}{2}$ oz. of sand and fragments of shells.

This specimen, formerly the property of Mr. C. M. Wheatly, an old collector, has lain undisturbed in the private collection of Mr. Sanderson Smith for over thirty-five years.

By a hasty glance with a hand lens, I saw that the material was very rich in foraminifera. On a second and more careful examination, with the aid of the microscope, I identified the following genera and number of species :

Spiroloculina, 2 ; *Miliolina*, 1 ; *Lagena*, 1 ; *Cristellaria*, 1 ; *Discorbina*, 2 ; *Anomalina*, 2 ; *Pulvinulina*, 1 ; *Nonionina*, 3 ; *Polystomella*, 1 ; *Amphistegina*, 1.

The last named genus was found in such numbers that it almost equals the great *Amphistegina* beds at Nussdorf, near Vienna, Austria. It is also found in Maryland, South Carolina and Alabama.

List of species and the number of each found :

Spiroloculina planulata, Lamarck, sp., 1.

Spiroloculina limbata, d'Orbigny, 2.

- Miliolina seminulum*, Linné, sp., 26.
Miliolina oblonga, Montagu, sp., 2.
Miliolina venusta, Karrer, sp., 15.
Miliolina tricarinata, d'Orbigny, sp., 16.
Miliolina subrotunda, Montagu, 1.
Miliolina bicornis, Walker and Jacob, sp., 1.
Lagena aspera, Reuss, 1.
Cristellaria italica, DeFrance, 1.
Discorbina orbicularis, Terquem, sp., 2.
Discorbina bertheloti, d'Orbigny, 3.
Truncatulina lobatula, Walker and Jacob, sp., 7.
Truncatulina dutemplei, d'Orbigny, 1.
Anomalina grosserugosa, Gumbel, sp., 4.
Anomalina ariminensis, d'Orbigny, sp., 7.
Pulvinulina canariensis, d'Orbigny, sp., 1.
Nonionina depressula, Walker and Jacob, sp., 2.
Nonionina umbilicatula, Montagu, sp., 3.
Nonionina seapha, Fichtel and Moll, sp., 10.
Amphistegina lessonii, d'Orbigny, 2,000.
Total, 2,106.

From these figures I am inclined to believe that the microscopic life in the miocene period must have exceeded the fauna of our waters of the present age.

The water in the miocene age evidently was shallow and warm, as *Amphistegina* is not found so plentifully, only under these conditions, in the tropical regions.

The *Amphistegina* of the Virginia miocene bed are not so large and robust as the ones from Nussdorf, but much larger than the living species.

PROCEEDINGS.

MEETING OF APRIL 1ST, 1887.

The President, the Rev. J. L. Zabriskie, in the chair.

Thirty-one persons present.

A new form of programme for the regular meetings, containing an extended explanation of the objects announced for exhibition, recommended by the Board of Managers and issued by the Committee on Publications, was approved by the Society.

The resignation of Resident Membership, by Mr. Max Levy, was accepted by the Society.

Mr. George E. Ashby presented for the Cabinet of the Society four slides of Sections of Agate.

Mr. J. D. Hyatt addressed the Society on the similarity between the structure and inclusions of Furnace Slag, exhibited by him, and those of Obsidian, heretofore believed to be characteristic of the latter substance.

Mr. Wm. Wales exhibited Photo-micrographs by Mr. Wright, taken under a magnification of from 40 to 400 diameters.

Mr. A. Woodward read a Paper on Kaolin, with reference to its antiquity and uses.

Mr. C. S. Shultz read a letter written by Mr. Max Levy, enclosing Photo-micrographs, which latter were exhibited to the Society.

Mr. A. Woodward exhibited a collection of Photo-micrographs, made by the late Dr. J. J. Woodward.

Mr. C. F. Cox remarked that, with all the improvements that had been made, during late years, in the construction of lenses, it was noticeable that the quality of Dr. Woodward's work in photography, had not been materially excelled. He thought, for example, that no better photograph of *Surirella gemma* had ever been taken than this one of Dr. Woodward's. In one respect, however, workers with the camera had learned a good lesson, and that was to let their negatives alone after they were once taken. For scientific purposes the value of their work was much impaired by any treatment given the negative itself. Dr. Wood-

ward was justly criticised for painting out the back-ground and surrounding objects in his earlier photographs. But even he profited by criticism as his very latest work shows.

Mr. Shultz remarked that he had a photograph of *Surirella gemma* taken by Dr. Van Heurck which he thought was better than Dr. Woodward's.

Mr. Cox replied that perhaps he had not seen the particular photograph referred to, but that he thought Dr. Van Heurck's work generally showed evidence of very decided manipulation of the negatives, which was greatly to be regretted. He said it was a coincidence that the subject of photography was under discussion at a recent meeting of the Royal Microscopical Society, and that substantially this same criticism was made upon Dr. Van Heurck's work, which he had just made.

Mr. Cox further remarked that he thought it might be a subject, not only of general interest in connection with this discussion, but also of society pride in a fellow-member, if he should say that he had recently received testimony from a gentleman, who makes good use of the camera and of the best modern objectives, that much of his most satisfactory photographic work is still done with a fifteenth, made by Mr. William Wales about twenty years ago.

On motion, it was resolved that the Committee on Publications be instructed to publish the Journal of the Society as a Quarterly.

PROGRAMME OF OBJECTS ANNOUNCED FOR EXHIBITION.

1. Moss Agate : by GEO. E. ASHBY.
2. Blood-stone : by GEO. E. ASHBY.
3. Eggs and Scale of *Mytilaspis pomorum*, Bouche. The Oyster-shell Bark-louse of the Apple : exhibited by W. BEUTENMULLER.

The scale insects, or bark-lice, belong to the family known to entomologists as the *Coccidæ*. This is a division of the sub-order *Homoptera*, to which belong also the plant-lice (*Aphides*), the *Cicadas*, the leaf-hoppers, and certain other insects. One of the most common and injurious bark-lice is *Mytilaspis pomorum*, which infests the apple, and does more injury to that tree than any other insect known. (?) It is also found on the following

trees and plants : linden, hop-tree, horse-chestnut, maple, locust, raspberry, pear, plum, hawthorn, currant, ash, elm, hackberry, willow, poplar, and yucca, etc., etc.

There is but a single generation of this species each year in the North, where the eggs hatch in the latter part of May or early in June, and two generations in the South. The female lays from twelve to one hundred white eggs under the scale. The young at first are reddish, and resemble mites. They run over the twigs and leaves, and in two or three days fix themselves to one spot, settle for life, and suck the sap of the tree.

4. Eggs and Scale of *Chionaspis Pinifoliæ*, Fitch. The Pineleaf Scale-Louse : exhibited by W. BEUTTENMULLER.

This species, which belongs to the same family as the preceding, infests the leaves of various species of pines and spruces throughout the eastern United States, from New York to Florida. The female lays from twenty-five to thirty-five pinkish, oval eggs, which are crowded in the scale. When the female has laid all her eggs, she dies and dries up at the smaller end of the scale.

5. Steel from Tire of a Locomotive Driving Wheel : exhibited by P. H. DUDLEY.

The size of the so-called "Crystals" is the largest of any yet seen by the exhibitor in rolled or hammered steel. The tire did not have sufficient tensile strength to stand the usual shrinkage of other tires, and broke after being put on the wheel, while standing in the shop.

6. Section of Furnace Slag containing Crystal and Micro-liths : exhibited by J. D. HYATT.

OBJECTS FROM THE SOCIETY'S CABINET.

7. "Challenger" soundings, 1850 fathoms.

8. Diatoms from Santa Monica.

9. Palate of *Buccinum obsoletum*.

The palate, tongue, or odontophore, as it is sometimes designated, is a very interesting object, though quite unlike the tongue or palate of the higher animals.

Carpenter says : "It is a tube that passes backwards and downwards beneath the mouth closed at its hinder end, whilst in front it opens obliquely upon the floor of the mouth, being (as it were) slit up and spread out so as to form a nearly flat

surface. On the interior of the tube, as well as on the flat expansion, we find numerous transverse rows of minute teeth which are set upon flattened plates, each principal tooth sometimes having a basal plate of its own, while in other instances one plate carries several teeth. The former applies to the terrestrial Gasteropods, while the latter to the marine Gasteropods" (as general rules).

Buccinum obsoletum, belonging to the latter, apparently shows three rows of plates, a central row having small teeth, while each outer one has large lateral teeth. Each distinct, arched transverse plate of the central row has seventeen curved but sharp-pointed teeth, the centre one being the largest. It is stated that the *Buccinum* (Whelk) and its allies use the flattened portion of their palates as a file, with which they bore (?) holes through the shells of the mollusks, that serve as their prey.

In the specimen the teeth on one end of the palate are much worn, showing that it has been used as a cutting or grinding instrument.

QUERY.—Is the cutting done by a pushing or drawing stroke?

10. Hair of Chinchilla.

11. Hair of Mouse.

12. Tingis Hyalina.

13. Proboscis of *Tabanus Atratus* (horse-fly).

14. Section of Stomach (?) of Cat (injected).

15. *Salisburia Adiantifolia* (Ginkgo tree): portion of leaf (stained).

The tree, native of China and Japan, has broad, fan-shaped leaves, parallel-veined, while the structure of the wood is quite similar to the Conifers, having needles, or narrow parallel-veined leaves. The leaves have an abundance of stomata, while the so-called veins are composed of spiral (tracheal) tissue. It is quite a distinct and exceptional type of tree. Its fruit is a drupe.

Fine specimens of the tree can be seen in Central Park and in Boston Common.

MEETING OF APRIL 15TH, 1887.

The President, the Rev. J. L. Zabriskie, in the chair.

Thirty persons present.

The Corresponding Secretary, Mr. B. Braman, presented to the Society cards of admission to, and programmes of the Public Reception of the Brooklyn Microscopical Society, to be held at the Adelphi Academy in Brooklyn, on the evening of April 19, 1887.

On motion it was resolved that the thanks of this Society be tendered the Brooklyn Microscopical Society, for this kind invitation to attend the said reception.

Dr. Frank D. Skeel and Mr. Charles L. Tiffany were elected Resident Members of the Society.

Dr. N. L. Britton announced the proposed Thirty-sixth Meeting of the American Association for the Advancement of Science, to be held in this city on the 10th of August, proximo.

On motion of Mr. B. Braman, it was resolved, that the request of the New York Academy of Sciences, for the formation of a Local Committee of Arrangements, for the reception of the American Association for the Advancement of Science, be acceded to; and that, to this end, the President of this Society be requested to appoint delegates to represent the Society, at a meeting of such committee, to be held on the evening of May 30th, at the Hotel Brunswick, in this city.

The President appointed such delegates as follows:—P. H. Dudley, F. W. Devoe, and C. E. Pellew; and as substitutes, F. W. Leggett, C. Van Brunt and A. A. Julien.

On motion, it was resolved that the President be added to the number of such delegates.

The resignation of Resident Membership, by Dr. Frank Odell was accepted.

Dr. N. L. Britton exhibited, *Trichomes* from leaf of American Mistletoe, and remarked upon the abundance of chlorophyll which was found, even in the pith of the plant.

PROGRAMME OF OBJECTS ANNOUNCED FOR EXHIBITION.

1. Sori (or fruit-dots) of *Hemitelia horrida*, from Jamaica, W. I.: exhibited and described by Mr. E. B. GROVE.

The indusium (or involucre) in this fern takes the form of an egg-shaped capsule, surrounding the *sporangia* (or spore cases), opening at the summit at maturity to allow the expanding of the *sporangia*. It resembles a small *Hydra* or a small *Octopus* :

hence the exhibitor thinks its specific name *horrida*, and, further, believes it is confined to the West Indies.

2. Cocoon of Ichneumon—Parasitic on Larvæ of *Orgyia Leucostigma*, Harris: exhibited and described by Mr. E. B. GROVE.

It is a free cocoon formed outside of the body of the larvæ or cocoons of the female of *O. leucostigma* (have never noticed any on the larvæ or cocoons producing the male imago). The material of which it is composed resembles spun-glass. Imago (or perfect-fly) escapes through a peculiar trap-door arrangement at upper end of cocoon.

3. *Mucor Racemosus* growing *en masse*: exhibited and described by Mr. CHARLES E. PELLEW, M. E.

4. *Mucor Racemosus* (*sporangia*), isolated and mounted: exhibited and described by Mr. CHARLES E. PELLEW, M. E.

A not uncommon form of Mould, distinguished from others by its extremely rapid growth. The mycelium is at first white, but turns dark-colored when the *sporangia* ripen. This variety has proven a serious source of contamination of "Cultures" in the "School of Mines Laboratory" the past winter.

The Moulds are interesting microscopic objects for study, and can be readily cultivated. The air is so full of spores of various species, that a piece of bread moistened with water, and put under a tumbler or bell-glass in a room of 60° to 80° Fahr., will in two or three days have several spots of Mould.

A small fragment of meat boiled and kept in a moist condition, and covered as above, will show a growth of Moulds in a day or two.

The function of the Moulds is to destroy the substances upon which they grow. They are unbuilders, and to prevent their growth, and that of *Microbes*, upon fresh meats, these must be kept at a temperature below that in which the spores can germinate.

5. Proboscis of Blow-fly: (?) exhibited by Mr. A. G. LEONARD.

6. Sea Life: exhibited and explained by Mr. M. M. LEBRUN.

7. *Blatta Orientalis*, Harris, Cockroach: exhibited and explained by Mr. F. W. LEGGETT.

8. Reticulation of the Tunics of *Crocus Vernus*, Allione: exhibited and described by Mr. E. B. SOUTHWICK.

This crocus belongs to the spring-flowering species and the

Involucrate division, with a basal spathe springing at the base of the scape from the summit of the corm. The "Reticulati Section" has a corm tunic of distinctly reticulate fibers.

The corm is oblate, from one-half to three-fourths of an inch in diameter, and three-eighths to one-half an inch high, the tunic finely reticulated, while the basal tunic covering the lower half of the corm is composed of unbranched radiating fibers. The specimens show the reticulation of the cap, main and basal tunics.

OBJECTS FROM THE SOCIETY'S CABINET.

9. *Heliopelta* (Diatom).

This specimen is one of the type having two radial divisions, the central star being five-pointed. It differs in many essential features from the one given by Carpenter, in Plate I, Fig. 3, between the 14th and 15th pages of his sixth edition of the "Microscope and its Revelations,"—description pages 350 and 351. Five of the radial divisions have *hexagonal areolæ*, while in the five which alternate with them, the areolation is formed by equilateral triangles; the points of the star extend into the radial divisions, having the triangles, instead of in the other form, as shown by Carpenter. The beaded appearance on under plate is plainly seen.

The dark corners, which Carpenter figures as divided equally between the two types of the radial divisions, in this specimen are confined to the corners of the radial divisions marked by the equilateral triangles. It is the latter divisions which are depressed, though they are above the border of the rim.

The specimen is 225 micras in diameter.

10. Gizzard of a Cricket.

Shows several rows of horny teeth, (?) which are used in the reduction of its food.

11. Precious Serpentine.

(Polariscope Object.)

PUBLICATIONS RECEIVED.

The Journal of Microscopy and Natural Science : Vol. VI., Pts. 21 and 22 (January and April, 1887) ; pp. 132.

Field Naturalists' Club of Victoria, Australia. The Victorian Naturalist : Vol. III., Nos. 5-12 (September, 1886-April, 1887) ; pp. 120.

Bulletin de la Société Belge de Microscopie : Vol. XII., Nos. 10 and 11 (July and October, 1886), Vol. XIII., Nos. 1-4 (October, 1886-January, 1887), No. 6 (March, 1887) ; pp. 148.

Smithsonian Institution : Annual Report of the Board of Regents for the year 1884, Pt. II., pp. 458.

Notes on Histological Methods ; pp. 36. By Simon H. Gage.

The Source of the Mississippi (Reprinted from *Science*) ; pp. 16.

The Journal of the Cincinnati Society of Natural History : Vol. IX., No. 4 (January, 1887), Vol. X., No. 1 (April, 1887) ; pp. 115.

Journal of the Trenton Natural History Society : Vol. I., No. 2 (January, 1887) ; pp. 44.

Cambridge Entomological Club. Psyche : Vol. IV., Nos. 135-137 (July-September, 1885) ; pp. 26.

Proceedings of the Newport Natural History Society : 1885-6, Document 4 ; pp. 30.

Bulletin of the American Museum of Natural History : Vol. I., No. 8 (December 28th, 1886) ; pp. 56.

Le Moniteur du Praticien : Vol. II., No. 12 (December 15th, 1886), Vol. III., No. 1 (January 25th, 1887) ; pp. 56.

Journal of the Royal Microscopical Society : Ser. II., Vol. VI., Pt. 6a (December, 1886), 1887, Pts. 1 and 2 (February and April) ; pp. 465.

Transactions of the Connecticut Academy of Arts and Sciences : Vol VII., Pt. 1 (1886) ; pp. 259.

School of Mines Quarterly : Vol. VIII., Nos. 2 and 3 (January and April, 1887) ; pp. 196.

Journal and Proceedings of the Royal Society of New South Wales for 1885 : Vol. XIX. ; pp. 49-240.

Ottawa Field Naturalists' Club : Vol. II., No. 3 (1885-6) ; pp. 85.

The Ottawa Naturalist : Vol. I., Nos. 1 and 2 (April and May, 1887) ; pp. 32.

Journal and Proceedings of the Hamilton (Canada) Association : Vol. I., Pt. 3 (1885-6) ; pp. 324.

Proceedings of the Canadian Institute : Third Ser., Vol. IV., Fasc. 2 (March, 1887); pp. 84.

Bulletin de la Société Impériale des Naturalists de Moscou : Vol. LXII., Nos. 2 and 3 (1886); pp. 540.

Annals of the New-York Academy of Sciences : Vol. III., Nos. 11 and 12 (September, 1886); pp. 76. Transactions : Vol. V., Nos. 7 and 8 (April and May, 1886); pp. 106.

The Canadian Record of Science : Vol. II., No. 6 (April, 1887); pp. 64.

North Staffordshire Naturalists' Field Club. Annual Report, 1886; pp. 154.

New Treatment of the Affections of the Respiratory Organs and of Blood Poison, by Rectal Injections of Gases, After the Method of Dr. Bergeon; pp. 21. By Dr. V. Morel. Translated from the French, by L. E. Holman.

FROM DR. HENRI VAN HEURCK.

Le nouvel objectif $1\frac{1}{6}$ e à immersion dans l'essence de cèdre de M. Carl Zeiss; pp. 5.

Ross's Patent Stand; pp. 4.

La chambre claire du Dr. J. G. Hoffman; pp. 4.

Note sur les objectifs à immersion homogène. Formules de nouveaux liquides propres à cette immersion; pp. 10.

La Lumière Électrique appliquée aux Recherches de la Micrographie; pp. 19.

De l'emploi du styrax et du liquidambar en remplacement du baume du Canada; pp. 5.

Le Microscope à l'Exposition Universelle d'Anvers; pp. 35.

Notice sur une série de photomicrogrammes faits en 1886; pp. 6.

Nouvelle préparation du medium à haut indice (2, 4) et note sur le liquidambar; pp. 5.

Comparateur à employer dans les recherches microscopiques; pp. 3.

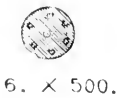
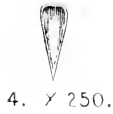
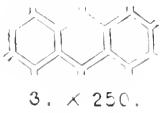
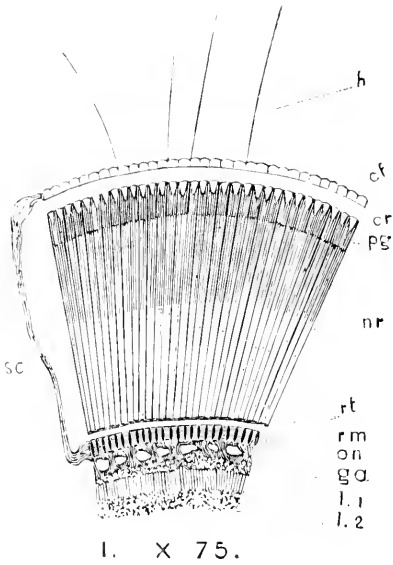

J. L. Z. Del. ad Nat. et Sc.

JOURNAL
OF THE
NEW-YORK MICROSCOPICAL SOCIETY.

VOL. III.

JULY, 1887.

No. 3.

THE COMPOUND EYE OF VANESSA IO, L.

BY LUDWIG RIEDERER.

(Given May 6th, 1887.)

In making a full series of continuous sections through the head of an insect with compound eyes, a lepidopter for instance, if we begin in a plane adjacent to and parallel with the front, the first sections of either of the compound eyes will be tangential to the globular mass of the combination. As the cutting approaches the centre of the combination, the sections will eventually lie in the plane of some of the "ommatidia," which all diverge somewhat in the manner of the radii of a sphere, and these may be called radial sections. The term ommatidium, or little eye, is the name given to each entire slender column, with its component parts of lenses, pigment, nerve-fibres, and layers, which parts render it in reality a distinct organ of vision. The multitudes of these ommatidia, standing side by side, in some instances amounting to many thousands, combine to form the globular mass of the compound eye.

Explanation of Plate 8.

- FIG. 1.—Portion of a radial section of the compound eye of *Vanessa Io*, L.: **h**, hairs upon the cornea; **cf**, cornea-facets; **cr**, crystalline cones; **pg**, pigment-layer; **nr**, nerve-rods; **rt**, separated layers of the retina; **sc**, sclæra; **rm**, enlarged ends of the rhabdoms in pigment; **on**, fibres of the optic nerve; **ga**, ganglion-cells; **1, 1, 1, 2**, layers of brain, or optic nerve.
- FIG. 2.—Three ommatidia, with the nerve-rods and crystalline cones slightly separated, the various portions being indicated by the same lettering as that of Fig. 1.
- FIG. 3.—The exterior surface of three cornea-facets.
- FIG. 4.—A longitudinal section of a crystalline cone.
- FIG. 5.—A transverse section of a crystalline cone.
- FIG. 6.—A transverse section through the central portion of a nerve-rod, with the central rhabdom, surrounded by six retinulæ.

The tangential sections will show the ommatidia, as these might be seen, by looking directly into the compound eye from its outer surface, and consequently, and as a general rule, especially in the central region of each slice, they will give more or less exact transverse sections of these ommatidia.

The radial sections, on the other hand, because they lie in the planes of the above-mentioned radii, and cut them longitudinally, will show the various portions of the ommatidia in their natural superimposed connection.

The outer surface of the compound eye is formed by a skin of chitine, which may be easily peeled off in continuity, and which is as transparent as glass. This surface is divided into a great number of small areas—"cornea-facets,"—each one of which is the distal end of an ommatidium, and is itself outwardly convex. These facets have their junctures strengthened by a rim of chitine, and their contour is that of a more or less regular hexagon, with rounded corners. But this contour is not nearly so constant and regular, over the whole compound eye, as it was usually thought to be. At the juncture of three or four facets the rim often supports stiff hairs or bristles.

From the periphery of the transparent cornea the chitine skin lined within by a pigmented layer, resembling a chorioid coat, encloses the whole remaining globular mass of the compound eye, embedded in the head, and appears to correspond with the sclera, or sclerotic of the ball of the eye of vertebrates.

Next below the cornea follow in a layer the lenses, or "crystalline cones" of the ommatidia. These cones are embedded in pigmentous cells, which separate them respectively from their neighbors. The evolution of these crystalline cones from four cells is readily to be understood. We see in their transverse section four nuclei, with distinct septa in the form of a cross.

Below the crystalline cones lies a thick layer, comprising the greater part of the bulk of the globular mass, and consisting of the "nerve-rods." These nerve-rods occupy the greater portion of the length of the ommatidia, and are respectively composed of a central fibre, which has been named the "rhabdom," surrounded by five to seven other delicate fibres, which are the retinulae.

The rhabdom is of extreme tenuity in proportion to its length. It extends through the entire nerve-rod, from the crystalline

cone inwardly, until it ends in a spindle-shaped enlargement, embedded in the pigmented retina. In this enlarged end the rhabdom shows its nucleus.

Close to the retina follows the above-mentioned sclæra, or capsule of the whole compound eye, through which pass the fibres of the optic nerve in bundles. Here the fibres cross each other, and develop into a distinct layer, containing many ganglion-cells. They then pass into another more striped layer, forming the ganglion of the eye, and so finally over into the brain.

Tracheæ, dissolved into the finest bundles of tubes, surround the ommatidia, passing up inside of the sclæra.

POLYPORUS SANGUINEUS.

BY P. H. DUDLEY, C. E.

(Presented in connection with the specimen from Panama, exhibited by him, March 18th, 1887.)

This beautiful Polyporus, of cream colored cup, occasionally tinged with pink, and having scarlet pores underneath, attracts attention by its varied and brilliant colors. I have only seen it growing, upon the Isthmus, first, upon Cyprus ties, from Florida, where it is said to be common; second, upon the sap-wood of the Lignum-vitæ ties, in the tracks of the Panama railroad. The fact of finding it growing upon these two kinds of woods was surprising and interesting; for the structure and cell-contents of these two woods are so dissimilar, that I did not expect to find the same species of fungus growing upon both woods. It shows that the mycelium of the fungus is able to sufficiently disorganize each of the woods, as specified, for the growth of its fruit. I found more specimens on the Cyprus, than on the Lignum-vitæ ties, probably because the latter are so durable, as the heart-wood lasts from twenty to twenty-five years in the track; while the Cyprus only lasts from two to three years. Lignum-vitæ is the only wood, in its natural state, when used for ties, that is able to resist decay for any length of time on the Isthmus. Many of the native woods decay in less than a year.

Near the Atlantic coast but one specimen of *Polyporus sanguineus* was found, and this was upon a Cyprus tie, in the Aspin-wall freight-yard. *Trametes pini*, Fr. and *Lenzites abietina*, Fr.

were abundant upon other Cyprus ties in this yard. This wood is not used for ties in the main line of the Panama railroad. Lignum-vitæ ties, near the Atlantic coast, had been in service many years ; yet only a little fungus was found upon them.

A few specimens of *Lenzites striata*, as identified by Prof. Charles H. Peck, were obtained. At Bujio Quarry, sixteen miles inland, this latter fungus was very abundant on the sap-wood of the Lignum-vitæ ties. At Frijoles, three miles further inland, I found the same fungus, and also *Polyporus sanguineus*, on Lignum-vitæ ties, in a recently constructed switch-track. In many cases, both species were found upon opposite sides of the same tie. The *Lenzites striata* was dry and firm, and had evidently ceased growing, shortly after the beginning of the dry season. *Polyporus sanguineus*, on the contrary, was fresh and growing. At Paraiso, on the Pacific slope, this fungus was found, in conjunction with *Lenzites abietina*, Fr., on Cyprus ties, in the temporary track of the Panama Canal, and also on ties piled three and four feet high.

These specimens of fungi were collected in January and February, of the present year, during what is called there, "the dry season," which commences in December, and lasts until April or May. The remaining months are called "the wet season ;" the rain-fall on the Atlantic coast being from ten to twelve feet per annum, which decreases to one-half this amount on the Pacific coast. The mean annual temperature of about 80° Fahr., and the humidity of the air, form the most favorable conditions for the growth of fungi, and consequent rapid decay of woods, on the Isthmus of Panama.

CHAMÆCYPARIS SPHÆROIDEA, SPACH ; WHITE
CEDAR. AND ITS FUNGUS, AGARICUS CAM-
PANELLA, BATSCH.

BY P. H. DUDLEY.

(Read January 7th, 1887.)

This is the White Cedar of the Atlantic coast, which grows in dense masses in cold, deep swamps, "from Southern Maine to Northern Florida, and along the Gulf coast to the valley of the

Pearl river, Mississippi." According to Prof. C. S. Sargent, in Tenth Census Report.

In many respects it is an exceptional tree, and one of great economical value, growing from seventy to ninety feet in height, and two to four feet in diameter; the latter is not common.

In the North especially it is a slow grower, the annular layers being narrow, from $\frac{1}{32}$ to $\frac{1}{16}$ of an inch in thickness, and as seen in the photomicrograph, Fig. I., the tracheids are small, thin walled, the wood being classed as soft and fine grained.

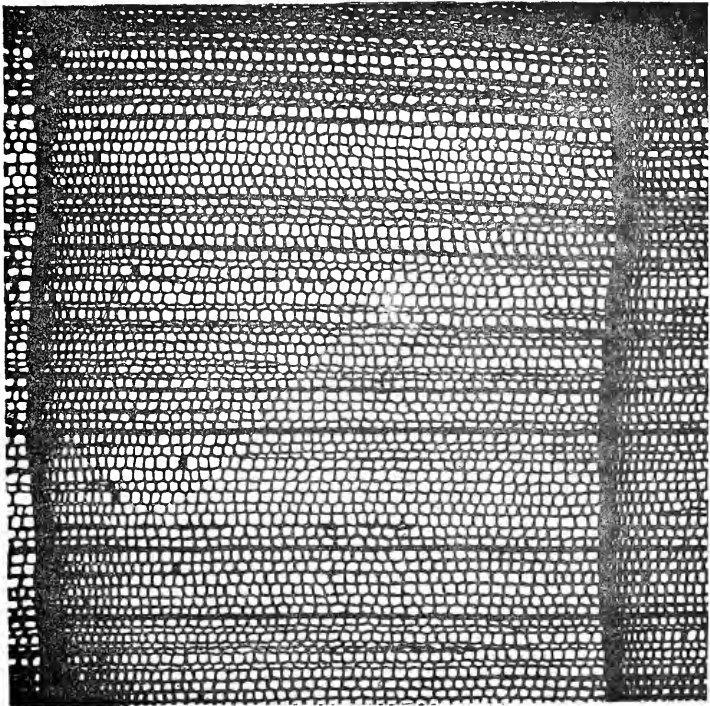

FIG. I. WHITE CEDAR. TRANSVERSE SECTION MAGNIFIED 50 DIAMETERS.

Its specific gravity ranges from 0.29 to 0.45, the latter being uncommon, 0.30 to 0.35 being the general range of the wood from the North. It is one of the group of the light coniferous woods. *Sequoia gigantea*, Decsn, Big Tree, *Thuja occidentalis*, Arbor vitæ, are as a rule 0.01 or 0.02 lower in specific gravity.

The durability of White Cedar in situations where it is alternately wet and dry or in contact with the ground, is in strong contrast to many other woods of much harder and firmer texture, and for this reason it is so largely used in ship building, for telegraph poles, fence posts and railway ties. The decay of this wood is so slow that when used for railway ties, the rails crush the fibres under them before the ties decay in the ballast, and are removed more on account of mechanical destruction than decay—as a rule.

The photomicrograph of the transverse section, Fig. 1., indicates at once, by the nearly uniform thickness of the cell walls for the entire annular layer, that it is not a strong wood, as only a few rows of cells in the last of the season's growth are tabular and thickened, this is in strong contrast to the number of rows in a layer of Yellow Pine, *Pinus palustris* (Mill).

The tracheids in White Cedar are comparatively small in diameter, only ranging from 0.0013 to 0.0015 of an inch, while the lumen is from 0.0011 to 0.0013 of an inch, showing that the walls are very thin, which fact to a great extent accounts for the low specific gravity and softness of the wood.

Another feature to be noticed in Fig. 1. is the comparatively small number of bands of medullary rays, showing as dark lines, crossing the (Fig.) page. The bands are only of single width of cells, and the latter so small that the lumen does not show in a magnification of 50 diameters. In a tangential section the bands are seen to be composed of only 2, 3, 4, 6 or 8 superimposed cells, the first three predominating. In a square inch of wood only about 400 of these bands occur, a comparatively small number, and these do not furnish much resistance to indentation, but are very effectual in checking the tendency of decay, from spreading laterally.

Another feature shown by the transverse section is the absence of resin ducts, common to many of the other coniferous woods. Much of the resin is confined to special resin cells, the ends of which appear as dark cells in the photomicrograph. This feature is common to the most durable of the coniferous woods. The medullary rays of the duramen especially, also contain deposits of resinous matter, which in most cases remains intact after the surrounding tissue is well advanced in decay.

Beside the visible resinous matter in the cells mentioned, tests indicate that in the duramen there is resinous matter on and in the walls of the ordinary tracheids. They do not absorb or imbibe water readily or in sufficient quantities to cause the wood to become "water-logged" after being submerged many years.

The delicate middle lamellæ can be traced in the lenticular markings so there is not a free and unbroken communication between the tracheids, water being prevented from passing freely from cell to cell.

The thinness of the cell walls in this wood gives a greater percentage of weight, of the middle lamellæ, to the whole weight than in some other woods, and this may help account for a portion of its non-absorbing properties.

The physical properties of the tracheids as regards strength are not proportionally as great according to their specific gravity as those of many others of the coniferous woods, it having but few of the fibres per layer which contribute most of the strength and elasticity to a wood.

This is well shown in the following table :—

Name of wood.	Specific gravity.	Crushing strength in pounds per sq. inch.	Ratio.
White Cedar,	0.3429.	3697.	10781.
Yellow Pine,	0.7229.	9081.	12564.
Hemlock,	0.4240.	5549.	13086.
Tamarack,	0.6197.	8297.	13888.
<i>Larix occidentalis</i> ,	0.6420.	9991.	15563.

The data were compiled from a series of tests upon woods made upon the U. S. Testing Machine at the Watertown Arsenal. The specific gravities and crushing strengths are the average of 4 to 8 specimens of each wood.

The ratio means the number of pounds per square inch required to crush the wood, provided the specific gravity was 1. The specific gravity of pure cellulose has not been determined, but is estimated to be from 1.25 to 1.45. The relatively low crushing resistance of the white cedar, according to its specific gravity, is very marked, in comparison with the other woods given in the table, and has given rise to the hypothesis, that there is a difference in the chemical composition between the thick and the thin walled tracheids. I had a series of chemical analyses made to determine the matter if possible. A slight differ-

ence was found, but neither series gave satisfactory formulas for cellulose, so the matter is still unsettled.

Under the microscope, it seems to be the second lamellæ of the tracheid, which is principally increased, in the thick walled tracheids; and woods which do not have a portion of the annular layer composed of the thick walled tracheids, do not have as high specific gravity, or as much strength.

THE FUNGUS AGARICUS CAMPANELLA, BATSCH.

Pileus only three-eighths to one-half inch broad. The mycelium is composed of very coarse dark threads. The numerous decayed spots, from one-fourth to one inch in diameter extending longitudinally in the wood, found in many of the railroad ties cut from live White Cedar trees, are exceptional, rarely being found in other woods. How the decayed spots are started and checked, for the time being, forms one of the many interesting questions in the decay of woods.

The young tree sends out an abundance of limbs near the base and as the tree increases in height, the lower limbs become shaded then die, and being so durable, do not quickly break off close to the body of the tree, the latter soon forming a layer of wood over the wound. The moisture which collects at the junction of the limb and tree, germinates the spores of its special fungus, and starts the growth of a mycelium inducing a decay in the upright cells, spreading laterally but little. This continues until the growing wood closes up the orifice, by shutting off the air supply, and further decay is arrested.

In case the sapwood does not close the orifice, the decay continues, the result being a hollow tree.

PROCEEDINGS.

MEETING OF MAY 6TH, 1887.

The President, the Rev. J. L. Zabriskie, in the chair.

Twenty-five persons present.

The Corresponding Secretary read a letter from Dr. Henri Van Heurck, of Antwerp, Belgium, expressing thanks for his election to Honorary Membership in this Society.

The Corresponding Secretary also acknowledged the receipt of copies of Dr. Van Heurck's Communications to Scientific Societies at Antwerp.

The Librarian, Mr. A. Woodward, read a letter from Mr. G. S. Woolman, who presented to the Society a copy of the new work by Dr. Alfred C. Stokes, entitled, "Microscopy for Beginners."

Mr. A. Woodward also read a Paper, entitled, "The Foraminiferal Fauna of the Miocene Bed at Petersburg, Va.," which Paper is published in this volume of this Journal, at page 16.

PROGRAMME OF OBJECTS ANNOUNCED FOR EXHIBITION.

1. *Meyenia fluviatilis*, var. *asperrima*, Dawson, from Calumet River: exhibited and described by A. WOODWARD.

Fresh-water sponge. Spicules birotulate, that is, consisting of two wheels or disks, connected at their centres by a short shaft, or they may be flat or umbonate disks.

"The first sponge found in Niagara River by Prof. Kellicott, belongs to this genus. Mr. G. M. Dawson had found the same species in Canada, and named it *Spongilla asperrima*, but according to our present classification it must be *Meyenia asperrima*. It differs very slightly, if at all, from *Meyenia fluviatilis*."

2. *Spongilla fragilis*, Central Park, New York City. A dried specimen: exhibited and explained by A. WOODWARD.

3. Specimens of *Amphistegina lessonii*, d'Orb., from Petersburg, Va. Also others from Nussdorf, near Vienna, Austria: exhibited and explained by A. WOODWARD.

4. *Laminaria longicruris*, Dela, Portland Harbor, Me. Broken up and distributed to the members: exhibited and explained by A. WOODWARD.

5. Section of Concord Granite (under the Polariscope): exhibited by T. B. BRIGGS.

6. Bryozoa: exhibited and described by W. E. DAMON.

This specimen shows the delicate lace-like structure of the corallaceous deposit of this compound polyp animal; formed on the inside of the neck of a bottle—hence the honey-comb like cells have been well protected, and are very perfect.

7. Eggs of Bot-Fly (*Gasterophilus equi*) on horse hairs, with the larvæ emerging: exhibited by CHAS. S. SHULTZ.

The larvæ of this species live in the intestines of horses, producing the disease called Bots (Harris).

The female fly has a long and flexible *ovipositor*, with which she deposits her eggs upon the hairs of the fore legs of the horse, while sustaining herself in the air by reduced motion of the wings. The eggs are covered with glutinous matter causing them to adhere to the hairs, and few are deposited out of the reach of the mouth of the horse.

8. Head of the Mosquito, with lancets. Showing five minute stings (?), two of them barbed : exhibited by CHAS. S. SHULTZ.

9. Snail's Eggs. Young snail, within egg ; polarized : exhibited and explained by F. W. DEVOE.

10. Egg shells of the *Vanessa Antiopa*, Linn. : exhibited by E. B. GROVE.

The Eggs of the *Vanessa* differ from those of other Lepidopterous insects, in having a much harder shell.

MEETING OF MAY 20TH, 1887.

The President, the Rev. J. L. Zabriskie, in the chair.

Seventeen persons present.

The President announced the receipt of various Publications, in exchange for the Journal of the Society.

Messrs. James Walker and T. B. Briggs were elected Resident Members of the Society.

The President presented to the Cabinet of the Society the slide exhibited by him, displaying the three main sections—transverse, radial and tangential—of the wood of the Black Mangrove.

PROGRAMME OF OBJECTS ANNOUNCED FOR EXHIBITION.

1. Quill of Canada Porcupine (*Erethizon dorsatus*) : exhibited and described by B. BRAMAN.

“The quills of the Canada Porcupine are from one inch to three inches long. They are loosely attached to the skin, and are barbed at the point. They easily penetrate the flesh of the animal which attacks it, strongly retain their hold, and tend continually to become more deeply inserted.”

2. Consecutive Sections through Head of *Salamandra maculosa* (larva) : exhibited and described by L. RIEDERER.

The eye shows all the constituent parts as : cornea, iris, lens, sclerotic, choroid, vitreous humor, retina, nerve granules and fibers, rods and cones, and entrance of optic nerve (blind spot).

3. Black Mangrove (*Avicennia nitida*, Jacq.), transverse section of wood of : exhibited and described by J. L. ZABRISKIE.

This tree is a native of the West Indies, and also of the Florida coast. The wood is heavy, hard, coarse-grained, and of dark brown color. The transverse section shows the very eccentric manner of growth of the annual rings, the irregular position of the large ducts, and the abundance of resinous material.

4. Head of a Bishop's Mitre, one of the *Asopidae* : exhibited and described by F. W. LEGGETT.

This relative of the "Cimex" is a great nuisance to fruit growers, not only sucking the juice of fruit, but rendering it unpalatable because of a fluid possessing an abominable smell, which exudes from two little pores between the hind feet. The compound eyes, the two red ocelli, the antennæ and the rostrum, within which are the toothed lances, can be plainly seen.

OBJECTS FROM THE SOCIETY'S CABINET.

5. Trans. sec. of the False Truffle (*Melanogaster ambiguus*, Tul.), showing the spores in situ ; collected at Poughkeepsie, N. Y., and prepared by W. R. GERARD ; $\times 250$.

This fungus (see Species No. 1,048, Cooke's Hand-Book Brit. Fung.) is subterraneous, but it is more closely related to the Puff-Balls than to the genuine Truffle. Species of the latter have their spores situated in sacks, while *Melanogaster* has the spores diffused in patches throughout the pulpy, dark, globose *hymenium*. And this species is distinguished by its large, ovate, papillate spores, "and its abominable smell, which resembles that of assafœtida. A single specimen in a room is so strong as to make it scarcely inhabitable."

6. Scale of Common Sun-fish (*Lepomis gibbosus*) ; by polarized light ; $\times 30$.

This scale strikingly exhibits the characteristics of the Perch family ; the rows of sharp, alternating spines, projecting from the posterior free margin, and the prominent radiating rows of transverse ridges, extending to the anterior margin, which is imbedded in the skin.

7. Hairs of Edelweiss : the famous Alpine plant, nearly exterminated for the gratification of tourists.

8. *Polycystina* from Barbadoes ; $\times 30$; very neatly arranged in a symmetrical pattern.

MEETING OF JUNE 3d, 1887.

The President, the Rev. J. L. Zabriskie, in the chair.

Twenty-four persons present.

In the absence of the Recording Secretary, Mr. Geo. E. Ashby was appointed Secretary *pro tem*.

The Corresponding Secretary read a communication from the Royal Danish Academy of Sciences, at Copenhagen, expressing thanks for the presentation of copies of the Journal of this Society.

Mr. Wilson Macdonald was elected a Resident Member of the Society.

Mr. L. Riederer read a Paper, in continuation of his remarks at the last meeting, on the Head of *Salamandra maculosa*, illustrated by a large and finely executed diagram, and by many excellent consecutive sections under the microscope, as set forth in the exhibits of this meeting.

Mr. F. W. Leggett read a Paper describing his exhibit, referring especially to the ability of the Roach to walk, when inverted, and suspended on the under surface of a horizontal sheet of glass.

He arrived at the conclusion that the tarsal joints were cup-shaped, and of peculiar construction, and that the insect attached its feet by suction.

OBJECTS EXHIBITED.

1. *Salamandra maculosa* ; sections through the head ; showing constituents of tissues of skin, skull with brain, the eyes, the ciliated membranes in cavity of mouth, the tongue, ducts to gills, &c.

2. Pulvillus and unguis of Roach (*Blatta*): by F. W. LEGGETT.

3. Pulvilli on tarsal joints of Roach (*Blatta*): by F. W. LEGGETT.

4. Sections of Felspar, perpendicular to, and parallel with the lines of cleavage : by T. B. BRIGGS.

5. Wood of the Maple (*Acer*), with the structure much broken down by decay, but beautifully showing the plates of the medullary rays, and certain of the hard longitudinal cells ; by reflected light : by M. M. LE BRUN.

OBJECTS FROM THE SOCIETY'S CABINET.

6. Pyrite, showing free Gold, Grass Valley, California.

7. Diatoms, from Santa Monica, California.

8. *Isthmia nervosa*, on Algae, Monterey, California.

9. Spicules of Sponge, from California.

10. Sherzolite, from the French Pyrenees.

11. Volcanic Glass, from the Sandwich Islands.

12. Quartz, from inclosure in Muscovite, Grafton, N. H.

13. Quartzite, from the Black Hills.

Mr. C. E. Hanaman, F. R. M. S., Curator of the American Postal Microscopical Club, being present as a visitor, on request, addressed the Society, giving information concerning the operations of the Club.

MEETING OF JUNE 17TH, 1887.

The President, the Rev. J. L. Zabriskie, in the chair.

Twenty persons present.

Mr. C. S. Shultz remarked upon the Stage Micrometer exhibited by him, and ruled by Prof. Wm. A. Rogers, dwelling particularly upon the numerous difficulties met in operations of this kind.

Mr. P. H. Dudley followed with further particulars respecting the Dividing Engine employed by Prof. Rogers, and the mode of correcting errors in its practical working : also respecting the comparative advantages and disadvantages of rulings on glass and metal. In explanation of his own exhibit—the Fasoldt Eye-piece Micrometer—he said, that the lines were exceedingly delicate, and spaced at a distance of 500 to the inch.

Mr. E. B. Grove, in connection with the exhibit by Mr. F. W. Leggett, maintained, regarding the motion of the ovipositor of the Saw-flies, that their action was not direct, but with a twisting

thrust, and that these cutting instruments might be more appropriately termed rasps than saws.

Mr. C. S. Shultz presented to the Cabinet of the Society two slides of Diatoms, prepared by Miss M. A. Booth.

This being the last meeting before the summer recess, the President wished for the members a pleasant vacation, and a safe return to the operations of the Society, and urged upon them the duty and advantage of the prompt commission to writing, and the preservation of some notes of their microscopical vacation experiences.

OBJECTS EXHIBITED.

1. Stage Micrometer—in squares—upon Speculum metal : exhibited by CHAS. S. SHULTZ.

This was ruled by Prof. Wm. A. Rogers, upon his dividing engine, in two sections ; in one the divisions are parts of an inch, in the other, parts of a millimeter. Much longer ruled micrometers on metal, of which the error of the ruling of each division has been fully investigated, are now used as the standards of measure for the accurate construction of tools and machine work.

These measures are placed upon instruments known as Comparators, each of which has two reading microscopes with eye-piece cobweb micrometers. The objectives are provided with a Tolles' vertical illuminator, so the divisions on the micrometer appear very black. The system is so practical that mechanics are able to work within an error of $\frac{1}{80000}$ of an inch.

2. *Triceratium Javanicum* : exhibited by CHAS. S. SHULTZ.

3. Section from Scalp of White Collared Monkey : exhibited by CHAS. S. SHULTZ.

4. Albany City Water : exhibited by P. H. DUDLEY.

5. Eye-piece micrometer, made by Mr. Chas. Fasoldt : exhibited by P. H. DUDLEY.

The lines are said to be ground in the glass, not ruled.

6. Spores of *Merulius lachrymans*, Fr., from Hartford, Ct. : exhibited by P. H. DUDLEY.

This fungus is the one which often causes the so-called "dry rot" of houses, especially those of pine wood. It is commonly in the form of a placenta, but also effuso-reflexed. The forms are from two inches to thirty in diameter. The hymenium is pulverulent, and throws off great numbers of spores—those thrown

off from one form, about 20 by 30 inches in area, from which these are part, were sufficient to give a decided ferruginous shade to 350 square feet of flooring.

7. Cuticle of *Cyperus umbellatus*: exhibited by M. M. LE BRUN.

8. Ovipositor of a Saw-fly: exhibited by F. W. LEGGETT.

9. Section of Limestone; polarized: exhibited by T. B. BRIGGS.

EXHIBITS FROM THE SOCIETY'S CABINET.

10. Section of Petiole and Leaf of the White Water Lily.

11. Section of Leopard Skin.

12. Scales of *Telea Polyphemus*.

13. *Zea Mays*: Portion of Leaf.

14. *Deutzia gracilis*: Portion of Leaf.

SAN FRANCISCO MICROSCOPICAL SOCIETY.

MEETING OF JUNE 22D, 1887.

The regular semi-monthly meeting of the San Francisco Microscopical Society was held last evening at its rooms, President Wickson occupying the chair.

Series 2 and 3 of Walker & Chase's "New and Rare Diatoms," consisting of photo-engravings of interesting forms, with descriptive text, were donated by Dr. H. H. Chase.

A communication was received from A. J. Doherty, of Manchester, England, the well-known preparer of microscopic objects, announcing his intention of visiting this city in a few months. Arrangements have been made with him for a series of demonstrations of the most approved methods used in the preparing and mounting of objects for the microscope, and from the admitted ability of the gentleman in this line his discourses cannot fail to be interesting and instructive. A series of slides mounted by him and comprising a wide range of subjects, were shown under a number of microscopes last evening by J. G. Clark, and the excellence of workmanship shown by these mounts, elicited the warmest commendation.

J. A. Sladky, of Berkeley, was duly elected a resident member.

The useful little device known as "Griffith's Focus Indicator," was shown by Mr. Riedy. Its object is to enable an approxi-

mate focus to be obtained almost instantly, and to prevent the accidental crushing of a slide or cover-glass by the objective, in focusing.

Mr. Norris announced that through the kindness of Mrs. Ashburner, he had come into the possession of a number of exquisite slides, mounted by the late Prof. Ashburner, and comprising a number of preparations of the celebrated "original Santa Monica" find. No better disposition could be made of these, Mr. Norris thought, than to distribute them among the members of the society, and this he proceeded to do. As appropriate mementoes of a departed friend, as evidences of his rare skill as a microscopist, and as the last remaining examples of mounts from the remarkable fragment whose history has been so closely connected with that of the society, these slides will be considered treasures by their fortunate possessors.

Specimens of rich diatomaceous earths from near San Pedro, and from near Santa Monica, collected by Mrs. Bush, of San José, were also handed in by Mr. Norris.

A. H. BRECKENFELD, *Recording Secretary.*

EDITORIAL.

Although not sufficiently acquainted with the difficult, and at present much examined and much disputed subject of the compound eye, to be able to endorse all the interpretations of Mr. Riederer, in his article in this number of this Journal, we nevertheless take great pleasure in stating that his sections of the compound eye of *Vanessa Io*—sixty-eight sections on four slides—,exhibited before the Society, were skilfully cut and beautifully stained and mounted.

The illustrations of his article were drawn by means of the prism, directly from his slides, and, it is hoped, give a moderately fair representation of what was there seen.

They who are acquainted with the nature of the compound eye, will understand that the parts are, in life, all in juxtaposition. And the divisions between cornea-facets and crystalline cones, between the sclera and the nerve-rods, and between the separated layers of the retina, shown in the preparations, are occasioned by the shrinkage, due to the methods of staining and mounting.

The following extract from an article by M. A. Forel, in *Rec. Zool. Suisse*, iv. (1886) pp. 1-50, published in the *Journ. Royal Micros. Soc.*, June, 1887, p. 379, will be of interest, in connection with the article by Mr. Riederer, in this number of this Journal.

VISION OF INSECTS.—M. A. Forel gives an account of past and recent experiments on the vision of insects, and sums up the conclusions as follows :—

(1) Insects direct themselves in flight almost wholly, and on the ground partially by means of their faceted eyes. The antennæ and buccal sensory organs cannot serve for directing flight. Their extirpation makes no difference.

(2) J. Müller's mosaic theory is alone true. The retinulæ of the compound eyes do not each receive an image, but each receives a simple ray more or less distinct in origin from that of its neighbors. Gottsche's theory is false. (Müller, Grenacher, Exner.)

(3) The greater the number of facets, the more elongated the crystalline cones, the more distinct and the longer the vision. (Müller, Exner.)

(4) Insects can see particularly well the movements of bodies, and better during flight than when at rest, the image being displaced in relation to the eye (Exner). This perception of the mobility of objects diminishes as the distance increases.

(5) Contour and form are only indistinctly appreciated, and the more indistinctly the fewer the facets, the shorter the crystallines, the farther and smaller the object. Insects with big eyes with several thousand facets can see with tolerable distinctness.

(6) In flight, insects can by means of their compound eyes appreciate with accuracy the direction and distance (not too great) of objects. When at rest they can also estimate the distance of fixed objects.

(7) Certain insects (bees and humble-bees) can clearly distinguish colors, and that better than form. In others (wasps) the perception of color is very rudimentary. Ants perceive the ultra-violet rays (Lubbock).

(8) The ocelli seem to furnish only very incomplete vision, and to be simply accessory in the insects which possess also compound eyes.

PUBLICATIONS RECEIVED.

Johns Hopkins University. Studies from the Biological Laboratory : Vol. IV., No. 1 (June, 1887); pp. 53. Circulars : Vol. VI., No. 58 (July, 1887); pp. 26.

The Microscopical Bulletin and Science News : Vol. IV., No. 3 (June, 1887); pp. 8.

Journal of the Royal Microscopical Society : 1887, Pt. 3 (June); pp. 176.

The School of Mines Quarterly : Vol. VIII., No. 4 (July, 1887); pp. 26 + 96.

Proceedings of the American Academy of Arts and Sciences : New Ser., Vol. XIV., Whole Ser., Vol. XXII., Pt. 1 (May to December, 1886); pp. 269.

Bulletin of the Torrey Botanical Club : Vol. XIV., Nos. 6-7 (June-July, 1887); pp. 46.

The West-American Scientist : Vol. III., Whole Nos. 25-26 (May-June, 1887); pp. 33.

National Druggist : Vol. X., Nos. 22-25 (June, 1887), Vol. XI., Nos. 1-4 (July, 1887); pp. 100.

Proceedings of the Natural Science Association of Staten Island : May-June, 1887; pp. 3.

The Electrician and Electrical Engineer : Vol. VI., No. 66 (June, 1887); pp. 40.

Grevillea : No. 76 (June, 1887); pp. 48.

Le Moniteur du Praticien : Vol. III., Nos. 5-6 (May-June, 1887); pp. 64.

Jahresbericht der Naturhistorischen Gesellschaft zu Nurnberg : 1886; pp. 68.

Bulletin of the California Academy of Sciences : Vol. II., No. 6 (January, 1887); pp. 243.

The American Monthly Microscopical Journal : Vol. VIII., Nos. 6-7 (June-July, 1887); pp. 40.

Bulletin de la Société Belge de Microscopie : Vol. XIII., No. 7 (1886-1887); pp. 26.

The Botanical Gazette : Vol. XII., Nos. 6-7 (June-July, 1887); pp. 50.

Transactions and Annual Report of the Manchester Microscopical Society, 1886; pp. 36 + 91.

Monatsblätter des Wissenschaftlichen Club in Wien : Vol. VIII., No. 9 (June 15th, 1887); pp. 8. Ausserordentliche Beilage : No. 5 (March 7th, 1887); pp. 19.

The Hoosier Naturalist : Vol. II., No. 9 (April, 1887); pp. 16.

The Journal of the Cincinnati Society of Natural History : Vol. X., No. 2 (July, 1887); pp. 58.

Entomologica Americana : Vol. III., No. 4 (July, 1887); pp. 20.

Manitoba Historical and Scientific Society, Winnipeg. Annual Report for the year 1886-7; pp. 12. Transactions 22-29 (April, 1886-April, 1887); pp. 104.

Indiana Medical Journal : Vol. V., No. 12 (June, 1887); pp. 22.

The Pacific Record of Medicine and Surgery : Vol. I., No. 11 (June 15th, 1887) ; pp. 32.

The Ottawa Naturalist : Vol. I., Nos. 3-4 (June-July, 1887) ; pp. 32.

Anthony's Photographic Bulletin : Vol. XVIII., Nos. 11-14 (June-July, 1887) ; pp. 128.

Journal of Mycology : Vol. III., Nos. 6-7 (June-July, 1887) ; pp. 24.

The Hahnemannian Monthly : Vol. XXII., Nos. 5-7 (May-July, 1887) ; pp. 192.

The Microscope : Vol. VII., Nos. 6-7 (June-July, 1887) ; pp. 64.

The Naturalist : Nos. 143-144 (June-July, 1887) ; pp. 64.

Transactions of the Massachusetts Horticultural Society for the year 1886, Pt. 2 ; pp. 187.

The Canadian Record of Science : Vol. II., No. 7 (July, 1887) ; pp. 64.

The Journal of Microscopy and Natural Science : Vol. VI., Pt. 23 (July, 1887) ; pp. 64.

Nottingham Naturalists' Society. Transactions and Thirty-fourth Annual Report, 1886 ; pp. 76.

Penzance Natural History and Antiquarian Society. Report and Transactions, 1886-87 ; pp. 84.

Bulletin de l' Académie d' Hippone No. 22 (1887), Fasc. 1 ; pp. 176.

Biological Instruction in Universities ; pp. 13. By C. O. Whitman.

Bulletin of the American Museum of Natural History : Vol. II., No. 1 (May, 1887) ; pp. 39.

Smithsonian Institution. Annual Report of the Board of Regents to July, 1885, Pt. 1 ; pp. 996.

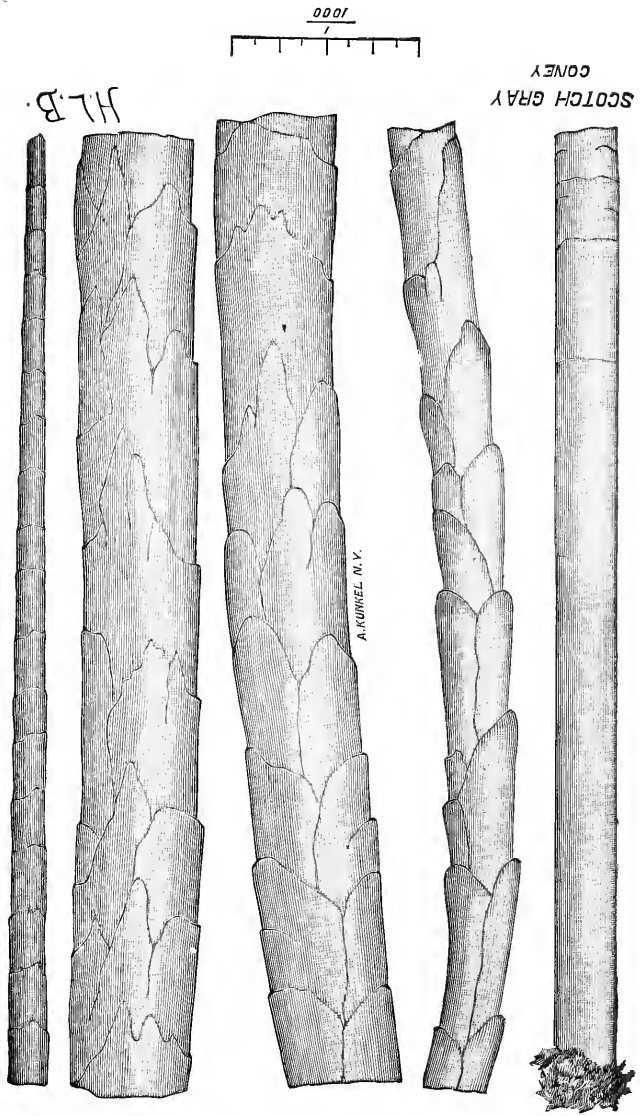

FUR FIBRES.

1000

H.L.B.

SCOTCH GRAY
CONEY

A. KUNNEL N.Y.



JOURNAL
OF THE
NEW-YORK MICROSCOPICAL SOCIETY.

VOL. III.

OCTOBER, 1887.

No. 4.

FUR FIBRES

BY H. L. BREVOORT.

(Received Sept. 26th, 1887.)

Plate 9.

In the Journal of the Society, Vol. II, No. 5, some notes appeared relating to the structure of the fur fibre.

These observations related more especially to what the writer knew about the subject, rather than to that which he did not know. As a matter of fact the latter field is so much larger than the former, that a few words in relation thereto may set others working in a field, believed to be rich in results of a commercial nature.

The fur of animals now so largely enters into manufactures, that the question of its exact structure and mode of growth becomes one of commercial importance. The writer has penetrated this field, it is believed, as far and further perhaps than anyone else, but that which has been observed amounts to so little, and that which has not been observed amounts to so much, that to the latter field the writer feels that he may invite other workers, confident that they will find a rich reward for their labors.

In the accompanying illustrations, the plate in front shows views of the fur of the Scotch Grey Coney, or Rabbit. The fur of this animal is largely used in the manufacture of hats.

The fibre is enlarged one thousand diameters. Its length on this scale would be some eighty or ninety feet, consequently only portions of its length have been shown. The view on the left of the figure showing a tuft of dirt at its top or where it

emerges from the skin is that portion of the fibre immediately adjacent to the skin. This portion in almost all animals bearing fur (some water animals excepted) is smooth, perfectly transparent, and the writer has never, by any method known to him, been able to find any tube or duct therein. The portion next on the right in the plate shows the fibre having pronounced scales or projections, and is a representation of the fibre at a short distance from the skin, say at a point about one-sixth or one-eighth of its length.

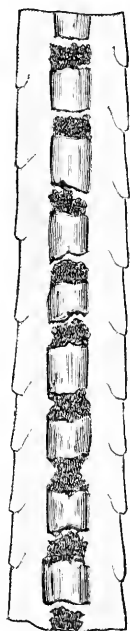

GRAY
CONEY
FIG. 1.

The next portion towards the right in the plate shows the center or middle portion of the fibre, and the part on the right next adjacent shows the fibre at some three-quarters of its length. The extreme right hand portion represents the point of the fibre.

Thus it will be seen that the fibre starts from the skin, small in diameter and smooth as to external appearances, that next it enlarges and shows pronounced external scales or projections, and that then at and about the center the maximum diameter is reached; the scales are large but do not project much, and towards the point or outer end of the fibre the diameter decreases and a marked decrease in the size of the scales is also observed.

The attention of the reader is now invited to Fig. 1.

This shows the center lengthwise of a fibre of the kind of fur illustrated in the plate, after it has been soaked in glycerine for a short time to make it transparent.

It will now be seen that air cells, separated by pigment cells, alternate; the dark bands representing the pigment cells, and the intermediate light portions the air cells.

After prolonged soaking in glycerine, these dark bands of pigment cells separate, and individual pigment cells drop into the air cells, showing that each dark band is composed of many minor cells closely compacted.

The pigment cells are supposed to contain that greasy or water repellant material, which exudes from under the scales, and which keeps the exterior of all fur fibres in an anointed

condition, enabling the animal, so protected, to resist moisture by reason of the grease (or whatever it is) having a disinclination to permit moisture to remain upon the fur of the animal.

Now the first question to be solved by some observers is this. How do fur fibres grow? It is ridiculous to think that they are projected from the skin of the animal point first in a completed condition.

This view appears to be answered by the scales themselves, which would prevent any such growth. If this is not so, how do the pigment cells find their way through the ductless portion adjacent to the skin, or butt end of the fibre, to the points between the air cells? In fact the question presented is, how does a fur fibre grow? The writer has never been able to solve this problem. Some worker with the microscope is invited to take up this question and find its solution.

The next question to be answered is this. Do the scales themselves by their union at their butts, or inner ends, form the wall of the fibre; or do the scales grow out from a separate and distinct wall of substance, forming a tube as it were around the air and pigment cells, and inside of the roots or inner ends of the outer scales? The writer has never been able to solve this problem.

It cannot be doubted that the pigment cells find their way to the exterior of the fibre, emerging from under the scales. The question here presented is: How, or through what channels do they find their way, from the interior to the exterior of the fibre?

While referring to the pigment cells this question is presented: Are the pigment cells massed in a solid disc across the central tube of the fibre; or are they merely a lining, surrounding an opening through the fibre? Do they oppose themselves as a barrier to the passage of other pigment cells; or do they merely form a ring, at approximately equi-distant portions of the fibre's length? The great difficulty of cutting sections in any direction of a fur fibre has prevented further light on these interesting points from being obtained.

Somewhat imperfect sections have been made, and they go to show that each fibre is oval; and it would appear that a clear passage existed through the mass of pigment cells, but such observations have been altogether too uncertain to allow of any definite answer being given to the questions here asked.

Fur fibres appear to grow in groups, that is, from a pocket in the skin. A number of fibres are projected (usually an uneven number, seven, nine, eleven or thirteen) from each pocket, and the individual fibres do not appear to possess the mechanism for growth, common in the case of a human hair.

How they grow is yet a mystery. Do new fibres project themselves each year? Do the animals that change color between Summer and Winter get a new growth of fur, or is the old fur in the wet season charged with new pigment cells, and in the dry season deprived of pigment cells? In the first place, the wet season would call for a more thorough greasing of the fibres, so that the water could be easily shed; while in the second case there would not exist this necessity, but to resist dry cold, the maximum air space would be required in each fibre, and then the pigment cells could be discarded to advantage, for the purpose of obtaining an enlarged air space in each fibre.

No one worker with the microscope can hope to answer these questions. The answer must be found in the observations made by widely separated students, who each have an opportunity to observe fur bearing animals under different climatic conditions..

The writer having accomplished the practical results he desired by his observations, and with the assistance of others, the interesting scientific questions referred to must be left to those, whose devotion to the microscope will induce them day after day to work with powers not below $\frac{1}{8}$, and who are willing to search long and faithfully to find out some of nature's secrets, the discovery of which may not repay the students in other coin than the satisfaction of an increased knowledge, but which probably may come back to them in the shape of a substantial recompense for their time and labor.

Many other questions could be asked, but if the writer is not mistaken, to give correct answers to these propounded, with the proof of their correctness, will require a great deal of study and observation.

NOTES ON THE ROACH (*BLATTA ORIENTALIS*, L.).

BY F. W. LEGGETT.

(Read June 3d, 1887.)

I. Respiration.

Under the first microscope I have a living specimen, and under the other the stigmata and tracheæ of the *Blatta orientalis*. This aristocratic insect can boast a pure lineage reaching back to, if not beyond the coal measures.

The part to which I desire to call attention is the breathing process. Of this Huxley says, "There are ten stigmata on each side of the body, eight in the abdomen and two in the thorax. The latter are situated between the prothorax and the mesothorax, the mesothorax and the metathorax respectively, above the attachment of the coxæ, and beneath the terga. The abdominal stigmata lie in the soft integument which connects the sterna and terga of the somites. All the stigmata are situated in conical thickened elevations of the integument. The thoracic stigma are the largest, and the anterior pair have a distinctly two-lipped aperture, the anterior lip being notched in the centre. The openings of the abdominal stigmata are more oval, and are inclined backward. Immediately within each stigma the tracheal trunk into which it opens is provided with a valvular arrangement, by which the passage can be closed or opened. The large tracheæ which take their origin from these stigmata immediately divide and give off dorsal and ventral branches; the former unite in a series of arches on each side of the heart, while, on the ventral side, the branches are connected by trunks which run parallel with the abdominal ganglia."

Huxley is less explicit in his description of the breathing apparatus, than of other parts of the Roach, and fails to notice the bellows-like motion of the upper and lower shell of the animal. That this takes place, will, I think, be apparent to anyone looking at the living specimen under the microscope. And the question suggests itself—Is not this the process by which the creature draws in the air, and forces it through the entire system of the tracheæ? And again, does this air find inlet and outlet at the same place, or does it enter at the thoracic spiracles, to be expelled through the abdominal stigmata? Answers

to these questions become of some importance as suggesting a possible means of exterminating these pests. My own experiments indicate that they require a large amount of air and that insect powder, sprinkled upon them causes speedy destruction from suffocation.

In the living Roach, when placed in a proper position, the stigmata are plainly apparent ; but when dead, it requires dissection to discover them. The cerci do not appear to be connected with vital functions, and can be eliminated without apparent discomfort, for I have two, in happy captivity, with these appendages removed.

These creatures possess highly organized sensory apparatus. They scratch their bodies against projections, as one sees swine rubbing their sides against the pen.

There appear to be at least three varieties of Roach in this city ; the so called croton bug, also a creature three times the size of this last, and finally the common Roach. All are similar in construction, but they have different habits. The Roach proper hates the light, while the others although preferring darkness, are quite active in daylight, and are free from the disgusting Roach odor. Another peculiarity I have to complain of is the difficulty of procuring specimens when wanted. An offer of five cents a head has procured me only a limited supply, although I have been assured that, when a price was not set, they held regular camp-meetings, and could be obtained by the hundreds ! This last fact suggests that their hearing must be remarkably acute !

2. Action of the Pulvilli.

While looking at some Roaches confined in a glass-covered box, I saw a large female walk across the glass, body downward. Her movements being deliberate I noted the following facts. She placed the pulvillus, which is situated at the extreme point of the tarsus, and between the ungues, against the glass, pressing it firmly until it adhered, and then bent all the tarsal joints until their pulvilli, which surmount each joint, came in contact with the glass and became attached. The foot by this process was so firmly fastened that it required considerable effort to dislodge it, prior to its use for another step. It was loosened however by releasing first the pulvillus of the toe, and then the pulvilli of the other joints in succession.

Being interested in these movements I amputated a great many legs, looked at them in a variety of ways, and became convinced that the means of attachment was exhaustion of air. Finding no authority on this subject, I have some hesitation in giving my own conclusions, but do so in the hope that, if I am in error, some member, better informed than myself, will correct me. It seems to me that the pulvillus between the unguis is bell-shaped, but has a rounded, or cushioned cover, which is tightly shut when suction is not required. The pulvilli at the extremity of each tarsal joint have each a like cover, which is withdrawn, disclosing triangular lips, which are pressed against the glass, when attachment is desired.

All the *Blatta* do not have these organs equally developed. For this female is the only one I have caught in the act of walking head downward. While of a dozen I had in a bottle only two succeeded in climbing to its mouth, and resting on its mosquito-net covering.

THE HEAD OF *SALAMANDRA MACULOSA*.

BY LUDWIG RIEDERER.

(*Read June 3d, 1887.*)

The consecutive sections of the Head of *Salamandra maculosa*, larva, were received so favorably at our last meeting that I was desired to exhibit them at another time, and to give a more explicit description. For this purpose I have prepared these enlarged diagrams.

The amphibia show under the microscope, more advantageously and more distinctly than any other class of animals, the final constituents of the tissues, such as cells, their nuclei, and the fibres and fibrils of the muscles and nerves. While in the process of development the exhibition of these tissues is more instructive than in the condition of their maturity.

To give first a general survey of the diagram, we see the skin enclosing the whole, the skull, with the brain central in the upper part, the eyes on both sides of the skull, the cavity of the mouth, the tongue, and the conduits leading to the openings of the gills.

The skin is formed by a single layer of cells. The skull is a capsule formed by a cartilaginous substance of varying thickness, which in course of development ossifies. Only at a few places is it perforated for the passage of nerves, blood-vessels and spinal marrow. The enclosed brain shows the bilateral, symmetrical form, and the white and gray substance—this latter with large ganglion cells, and their nuclei.

The eyes are enclosed by a hard skin, the *sclerotica*, which in front becomes thinner and transparent, forming the cornea. In our object the skin over the cornea is not yet perforated. The eye in the larval state is still internal, and consequently the animal is either blind, or at least not sharp-sighted. The *chorioidea*, a layer of pigmented cells, lines the inside of the *sclerotica*, leaving the iris, as a perforation in the front part of the eye. In this perforation, framed like a window, lies the spherical lens.

Inside of the *chorioidea* is the retina, the third layer of the eye. Between the cornea and the lens is the aqueous humor, and between the lens and the retina is the vitreous humor. This latter is of a more consistent nature than the former. Retina is a complex name for different layers, formed by the ends of the fibres of the optic nerve.

The optic nerve, coming from the cerebrum, penetrates the three layers of the eye, the sclerotic, the chorioid and the retina; spreads on the inner surface of the latter, radially from the center to the periphery on the rear of the eye-ball; and there forms layers of ganglion cells, internal fibres, internal nuclei, external fibres, external nuclei and rods and cones. These rods and cones lie close to the *chorioidea*.

Here is shown again the advantage of the eye of an amphibian in the larval stage for microscopical observation. The different layers of the retina are composed of large elements, and show very distinctly; while the eye in the mature state mostly shows the retina as a thin layer, the constituent parts of which can be seen only by dissection by means of needles.

In the cavity of the mouth, the roof, as well as the surface of the tongue, is covered by a membrane of ciliated cells. In the tongue we see the cartilaginous formation of the bone, and muscle-fibres, in both longitudinal and transverse section, prov-

ing that they are running in all directions, and with these also are seen the blood-vessels.

On both sides of the tongue are the lower and upper maxillary bones, in the form of cartilage, the masseters, which raise the lower jaw for chewing, and the ducts, through which the water is led to the gill-openings for respiration.

THE NEW ARTIFICIAL RUBIES.

BY GEORGE F. KUNZ.

(From "*Transactions of the New York Academy of Sciences*,"
October 4th, 1886, p. 4.)

The subject of artificial gems is at the present moment of considerable interest, not only financially, but also as furnishing an example of the manner in which the microscope is constantly called into use by almost every profession. Early this summer, the *Syndicate des Diamants et Pierres Precieuses* were informed that certain stones, which had been sold as rubies from a new locality, were suspected to be of artificial origin. They were put upon the market by a Geneva house; and it was surmised that they were obtained by the fusion of large numbers of small rubies, worth at the most a few dollars a karat, into one fine gem worth from \$1,000 to \$2,500 a karat.

Some of these artificial stones were kindly procured for me by Messrs. Tiffany & Co. I was not, however, permitted to break them for analysis, to observe the cleavage, or to have them cut so that I could observe the optical axes more correctly. I would at any time have detected the artificial nature of this production with a mere pocket lens, as the whole structure is that peculiar to fused masses. Examination elicited the following facts: The principal distinguishing characteristic between these and the genuine stones is the presence in them of large numbers of spherical bubbles, rarely pear-shaped, sometimes containing stringy portions showing how the bubbles had moved. These bubbles all have rounded ends, and present the same appearance as those seen in glass or other fused mixtures. They are nearly always in wavy groups or cloudy masses. When examined individually they always seem to be filled with gas or air, and often form part of a cloud, the rest having the waviness of a fused

mixture. Some few were observed inclosing inner bubbles, apparently a double cavity, but empty. In natural rubies, the cavities are always angular or crystalline in outline, and are usually filled with some liquid, or, if they form part of a "feather" as it is called by the jewelers, they are often arranged with the lines of growth. Hence the difference in appearance between the cavities in the natural gem and those in the fused gem is very great, and can readily be detected by the pocket

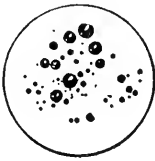

Fig. 1.—Spherical cavities in artificial ruby as seen at one time (enlarged 75 diameters).

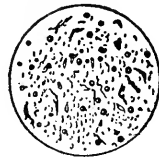

Fig. 2.—Spherical and irregular cavities in artificial ruby as seen at one time, evidently from the lower part of the crucible (enlarged 25 diameters).

lens. I have failed to find in any of the artificial stones even a trace of anything like a crystalline or angular cavity. Another distinguishing characteristic is that in many genuine rubies we find a silky structure (called "silk" by the jewelers), which, if examined under the microscope, or under a $\frac{1}{10}$ to $\frac{5}{10}$ inch objective, we find to be a series of cuneiform or acicular crystals, often iridescent, and arranged parallel with the hexagonal layers of the crystal. When in sufficient number, these acicular and arrow-shaped crystals produce the asteria or star effect, if the gem is cut *en cabochon* form with the centre of the hexagonal

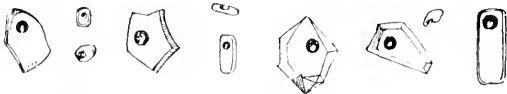

Fig. 3.—Liquid cavities in natural ruby and sapphire (enlarged 100 diameters).

prism on the top of the cabochon. I have failed to find any of them in the stones under consideration, or even any of the marking of the hexagonal crystal which can often be seen when a gem is held in a good light, and the light allowed to strike obliquely across the hexagonal prism. Dr. Isaac Lea has suggested¹ that these acicular crystals are rutile, and interesting facts and illustrations have been published by him. From my

¹ Proc. Philad. Acad. Sc., Feb. 16, 1869, and May, 1876.

own observations on many specimens, I believe there is little doubt of the truth of this hypothesis.¹ My explanation is, that they were deposited from a solution, either heated or cold, while the corundum was crystallizing, and I doubt very much whether they will ever be found in any substance formed by fusion.

The hardness of these stones I found to be about the same as that of the true ruby, 8.8, or a little less than 9, the only difference being that the artificial stones were a trifle more brittle. The testing point used was a Siamese green sapphire, and the scratch made by it was a little broader but no deeper than on a true ruby, as is usually the case with a brittle material. After several trials I faintly scratched it with a chrysoberyl, which will also slightly mark the true ruby.

The specific gravity of these stones I found to be 3.93 and 3.95. The true ruby ranging from 3.98 to 4.01, it will be seen that the difference is very slight, and due doubtless to the presence of the included bubbles in the artificial stones, which would slightly decrease the density. As a test, this is too delicate for jewelers' use; for if a true ruby were not entirely clean or a few of the bubbles of air that sometimes settle on gems in taking specific gravities were allowed to remain undisturbed, it would have about the same specific gravity as one of these artificial stones.

I found, on examination by the dichroscope, that the ordinary image was cardinal red, and the extraordinary image a salmon red, as in the true ruby of the same color. Under the polariscope, what I believe to be annular rings were observed. With the spectroscope, the red ruby line, somewhat similar to that in the true gem, is distinguishable, although perhaps a little nearer the dark end of the spectrum.

The color of all the stones examined was good, but not one was as brilliant as a very fine ruby. The cabochons were all duller than fine true stones, though better than poor ones. They did not differ much in color, however, and were evidently made by one exact process or at one time. Their dull appearance is evidently due in part to the bubbles. The optical properties of these stones are such that they are evidently individual or parts of individual crystals, and not agglomerations of crystals or groups fused by heating.

¹ Paper on star garnets, N. Y. Acad. Sc., May, 1886.

In my opinion, these artificial rubies were produced by a process similar to that described by Fremy and Feil (*Comptes Rendus*, 1877, p. 1029), by fusing an aluminate of lead in connection with silica in a siliceous crucible, the silica uniting with the lead to form a lead glass, and liberating the alumina, which crystallizes out in the form of corundum in hexagonal plates, with a specific gravity of 4.0 to 4.1, and the hardness and color of the natural ruby, the latter being produced by the addition of some chromium salt. By this method rubies were formed that, like the true gem, were decolorized temporarily by heating.

It is not probable that these stones were formed by Gaudin's method (*Comptes Rendus*, xix., p. 1342), by exposing amorphous alumina to the flame of the oxyhydrogen blowpipe, and thus



FIG. 4.—Acicular crystals in sapphire (enlarged 100 diameters).



FIG. 5.—Cuneiform crystals in ruby and sapphire (enlarged 200 diameters).

fusing it to a limpid fluid, which, when cooled, had the hardness of corundum, but only the specific gravity 3.45, much below that of these stones. Nor is it at all likely that they were produced by fusing a large number of natural rubies or corundum of small size, because by this process the specific gravity is lowered to that of Gaudin's product. The same also holds good of quartz, beryl, etc.

The French syndicate referred the matter to M. Friedel, of the Ecole des Mines, Paris, supplying him with samples of the stones for examination. He reported the presence of the round and pear-shaped bubbles, and determined the hardness and specific gravity to be about the same as in the true ruby. On analysis, he found them to consist of alumina, with a trace of chromium for the coloring matter. The cleavage was not in all cases distinct, and the rough pieces given to him as examples of the gem in its native state had all been worked, so that nothing could be learned of their crystalline structure. When properly cut according to axes, they showed the annular rings. The extinction by parallel light was not always perfect, which he believed to be due to the presence of the bubbles. He states that he

himself has obtained small red globules with these inclusions by fusing alumina by oxyhydrogen flame ; and, although having no positive evidence, he believes these stones to be artificially obtained by fusion.

On the receipt of M. Friedel's report, the syndicate decided that all cabochon or cut stones of this kind shall be sold as *artificial*, and not precious gems. Unless consignments are so marked the sales will be considered fraudulent, and the misdemeanor punishable under the penal code. All sales effected thus far, amounting to some 600,000 or 800,000 francs, shall be cancelled, and the money and stones returned to their respective owners.

The action taken by the syndicate has fully settled the position which this production will hold among gem dealers, and there is little reason to fear that the true ruby will ever lose the place it has occupied for so many centuries. These stones show the triumph of modern science in chemistry, it is true ; and although some may be willing to have the easily attainable, there are others who will want, what the true ruby is becoming to-day, the almost unattainable. One will be nature's gem, and the other the gem made by man.

NOTE ON VANESSA ANTIOPA, L.

BY E. B. GROVE.

(Read May 6th, 1887.)

The objects which I have on exhibition to-night are, as mentioned in the programme—"Egg-shells of the Vanessa Antiopa," and the reason for their being selected for exhibition was not that they in themselves are either very beautiful or rare objects, but rather for certain facts concerning the life-history of the insect.

It is known to entomologists by the various names of "*Vanessa Antiopa*, cloaked Vanessa, *Papilio Antiopa*," and "Camberwell Beauty ;" but the name generally used in its classification, is the one originally given to it by Linnæus, *i. e.*, "*Vanessa Antiopa*."

It is one of the most common butterflies, both in this country and in Europe. Dr. Packard thinks that it has probably been

imported into America, and is not indigenous to this country. Its wings are of a purple-brown on the upper side, with a broad buff-yellow border, in which is a row of pale blue spots. Of course like all of the Lepidoptera, variations, more or less in the general coloring, have been noticed—*vide* the *Canadian Entomologist* for September, 1876, which mentions that a large number of the *Vanessa* had been seen that year, having the border of the wings of a creamy white color, instead of the usual orthodox buff.

The larvæ are of a cylindrical shape, covered with black spines, spotted with small white spots, and with a row of darkish red spots on the back. They are rather social when young, and, like all of the *Vanessa* family, are extremely destructive to the vegetation on which they feed. They are not at all fastidious, or delicate in their food selections. I have found them feeding on the Willow, Elm, Poplar, Balm of Gilead and Ailanthus trees, and also on various plants, such as the Castor-Bean, and Geranium.

In this connection I noticed a very peculiar fact last Summer in my garden. There was a colony of the larvæ feeding on a large Castor-Bean leaf, and I discovered that they were arranged in a segment of a circle, their heads all pointing inward to a common centre. This same fact was also noticed in a second brood, later in the season.

This butterfly has two broods each season. The second, or Fall brood hibernates through the Winter, hiding in hollow trees, under logs and bridges, and in barns and other out-houses. I once found in December, under a foot-bridge over a small creek, a colony of at least fifty of these butterflies, all hanging by their feet, with antennæ and wings folded, and to all outward appearance lifeless. But, when touched or breathed upon, they showed signs of life, by slowly unfolding their wings. They have often been seen, on bright, sunny days, in the months of January and February, flying lazily around, and hovering over the snow.

The perplexing query to my mind is, how do they exist during their period of hibernation? What supports life and supplies animal heat? We know that their food consists simply and only of the honey-like nectar, secreted by flowers, that their digestive apparatus is the same as that of other Lepidoptera; and that they are not provided with any supplementary stomachs, or other

organs of a like nature, in which a supply of food could be stored away for use when required. Neither do they make any provision, as do the Bees and Ants, in view of such a prolonged existence through the Winter months. Yet there must be some supply of food to keep their temperature above the freezing point. I have examined closely, and dissected many of them, after their long Winter sleep, and could not find that they had suffered at all from the want of food, nor had their internal organs any appearance of starvation. Yet take a perfect butterfly, of the first, or Summer brood ; confine it without food or water, and its life is of very short duration.

The bears, during their Winter sleep, are said to suck their paws ; but our poor flutterer has no paws to suck. Neither has it a mouth fitted to suck the paws.

It is known that all the hybernating animals keep up their heat—and heat is *life*—by utilizing the stores of fat, deposited next to the skin ; these stores of fat being secreted during the Summer months. But no matter how fat they may be when they go into their hybernating sleep, they invariably come out in the Spring in an almost starving condition.

But, as stated above, careful examination of specimens of the *Vanessa*, both before and after hybernation, fails to show any perceptible difference in the appearance of either the internal or external organs, that could be attributed to the want of food.

It is a well-known fact, that the chrysalis, or pupa form, can withstand an extreme degree of cold, as has been shown by the numberless experiments made by Reaumur, and also by Kirby and Spence. But is not that due to the facts, that the larva has stored up, for just this purpose, a large quantity of fatty matter—*corpus adiposum*—and that it is virtually in a transition period—neither larva nor imago ? The hybernating beetles, and certain long-lived larvæ of both beetles and butterflies, are either in, or surrounded by their natural food. But where can the food be found for the butterfly, during the Winter months ?

Newport states that “ during hybernation, the act of breathing, like the circulation of the blood, almost ceases ; that the heat of the body is greatly lowered ; and the development of heat, in invertebrates as well as in vertebrates, depends upon the quantity and activity of respiration, and the volume and velocity of the circulation.” This is true. But, even during the sluggish

torpor of hybernation, there must be a degree of temperature sufficiently high to prevent freezing.

There is no perceptible difference between the imago—the butterfly—of the early and late broods of the *Vanessa*. But I think, that the shells of the eggs, deposited in the Spring, by the hybernating female, are much harder and more “shell-like” in their nature, than those deposited by the females of the next brood; and that the larvæ of the second brood consume more food than those of the first brood. In point of fact I am positive of the last assertion. I have in years past reared large numbers of the *Vanessa*, from the egg to the butterfly, in my cocoonery. And, for a number of seasons, I have selected several larvæ of each brood, of as nearly as possible the same size and healthfulness, and weighed the quantity of food consumed by each lot. I found, in every case, that the larvæ, which produced the late, or hybernating butterflies, consumed between five to ten per cent. more food, during the period embraced between the tenth day after hatching, and the day of transformation into the pupa, than those of the earlier brood.

In closing these brief and dry notes, I will say, that there are many points connected with the life of the *Vanessa*, and many obscure data to be cleared up, that are worthy of the attention and close study of any one, whether he be an entomologist or not.

HAIRS OF THE PEACH IN RELATION TO HAY FEVER.

BY THE REV. J. L. ZABRISKIE.

(Read Oct. 7th, 1887.)

Dr. Edward Woakes, of London, Senior Aural Surgeon, and Lecturer on diseases of the Ear at the London Hospital, in a work published by him during the present year, entitled “Nasal Polypus with Neuralgia, Hay Fever, and Asthma in relation to Ethmoiditis,” London, 1887. pp. 140, remarks on p. 74, “Leaving for a moment all references to the exciting causes of Hay Fever, it will be desirable to devote some preliminary remarks to what may be described as the persistent pathological state of the nasal organs in this disease. Dr. Daly, of Pittsburgh, U. S.

A., was the first to publish any observed data on this subject, in 1881, when he clearly established the important fact that Hay Asthma was due in numerous instances to intra-nasal hypertrophies; and further, that the cure of these was followed by the disappearance of the disease. This position he ably supported at the International Medical Congress of 1884. Corroborative testimony to the same effect was given on this occasion by Dr. Roe, of Rochester; and numerous writers have since confirmed this view. At the same congress, Dr. Bosworth, of New York, recorded the important case, in which a foreign body had been impacted in the nose for many years, and had given rise to Hay Fever over a period of eight years. Dr. Bosworth adds, 'The attacks disappeared on removal of the stone' (Transactions of the International Congress, eighth session, Copenhagen, vol. iv., p. 110)."

And on p. 75, "Now the conditions present in the nose of a patient prone to Hay Fever are, according to the author's observations, one of two kinds, both of which implicate this tear-flowing zone. Either there is ethmoiditis in an early stage, often with very little enlargement of the spongy process—though this may, however, be very marked—but showing a glazed or shiny surface from loss of its epithelial covering, this denuded surface being readily irritated by external causes, and resenting these by excitation of normal reflexes; or there exists a narrow conformation of the nose—which may be quite natural, and possibly congenital—in which the opposing surfaces of the septum and middle spongy bones lie in near approximation throughout, and in some places actually touch each other. Such a nose as this last described might present even to a careful observer nothing to suggest abnormality. And yet it is abundantly clear that the close contact of sensitive surfaces designed normally for free exposure in the breathway, whether induced by disease or congenital formation, must compress, and therefore become a source of irritation to the delicate nerve-fibrillæ with which their investing membrane is endowed.

"Perhaps this latter fact may explain the observation that the disease under discussion is most prevalent among the aristocratic classes, who are generally accredited with the possession of that refined contour and delicate 'chiselling' of the nasal organ, which necessarily diminishes the space for the internal struc-

tures, and compels some of these to lie in contact with each other."

And again, p. 79 "Given this condition of preparedness, and it is clear that many emanations, too subtle for the healthy subject to detect, become transformed into very real sources of irritation to those who are so circumstanced as to possess it. The tendency to suffer such derangement is in no case, probably, the consequence of any peculiarly irritating endowment of the emanation itself. The phenomena following its access to the nose result from the fact that it falls, not upon healthy tissues, but upon a surface rendered susceptible by the loss of its epithelium, and already irritated by structural disease, or its equivalent—pressure. A trivial additional irritant then suffices to excite the reflexes proper to the nerve-supply of the affected area."

Whatever may be the doubts and disputations on this subject in other countries, it is evident that among the numerous sufferers from this disease in the United States there is overwhelming testimony to the fact that the distressing symptoms of Hay Fever are induced by the inhalation of vegetable substances, such as pollen, dust, hairs, the odorous exhalation of certain grasses, as of the Sweet Vernal-Grass (*Anthoxanthum odoratum*, L.), &c.

It is well known that Hay Fever patients are sometimes peculiarly susceptible to distressing symptoms induced by contact with the skin of the Peach. There are subjects of this malady who could not be enticed by any considerations even to pass wittingly under a fruit-laden peach-tree. For they know that the consequence of even a near approach to the tree would be a more or less severe attack by their old enemy.

An esteemed acquaintance, a subject of Hay Fever, who, during our late war, in the Fall of 1863, commanded a large body of dismounted troopers of the Ninth Michigan Cavalry, in East Tennessee, reports that, while his men were deployed as skirmishers, and pushed well up the side of the mountain at Cumberland Gap, engaged in almost continuous fighting for three days, his head-quarters were in a peach-orchard, and his tent pitched under a large peach-tree, where he was obliged to remain when not called to other parts of the field. When the enemy surrendered and the excitement of the conflict was over,

he found that his insidious, feverish foe had plied him so hard, that his eyes were useless, and the discharge from his nose so copious, and the accompanying cough so continuous that his fellow officers considered him to be in the last stages of consumption. But a few days rest at Knoxville, some fifty miles distant, restored him to duty. Great excitement, in his case at least, seemed to arrest the symptoms of the disease. For he also reports, that, on another occasion, he went into battle while suffering severely from Hay Fever, and during the intense excitement of action the symptoms passed away, only, however, to return with redoubled violence when the fighting ceased.

In the former days of "low necks and short sleeves" we have known of little girls, who could not be tempted twice, even by the abundant and luscious fruit of a New Jersey peach-orchard, to venture under the trees and secure the coveted prize, without the protection of some large outer garment thrown over the shoulders. They had been warned by an almost unendurable, burning irritation of the exposed, delicate cuticle, occasioned by the soft, but deceptive down from the beautiful fruit.

This down is formed by an abundant growth of vegetable hairs, springing from every portion of the skin of the Peach. A usual number, apparently, is about 7,000 hairs to the square inch. If a Peach of fair size has about twelve square inches of surface, then there may be found upon the one specimen no less than 84,000 hairs. And the abundance of these minute instruments of torture upon even one tree in full fruit is almost inconceivable.

These hairs are slender, cylindrical, unbranched, smooth, glassy, quite sharply pointed at the distal end, and suddenly tapered at the base. They are from .01 to .06 of an inch in length, and about .001 of an inch in average diameter. They are provided with a tubular cavity running through the entire length nearly to the pointed extremity. In the plump, vigorous and apparently growing hairs this cavity is extremely small in diameter, and is often interrupted, or at least invisible, in numerous portions of its length. In the hairs which appear to be older, the cavity is larger in diameter, and is frequently filled in detached portions with granular matter, and also frequently, and especially near the base, shows bubbles of air. And finally there are some of the longest hairs which are evidently exhausted ;

for they are twisted, flattened and collapsed, until there appears to be nothing remaining excepting the thin cellular walls.

The thickly felted surface of the fruit affords an excellent trap for entangling particles floating in the atmosphere. Occasionally lepidopterous scales, and delicate scales of other orders

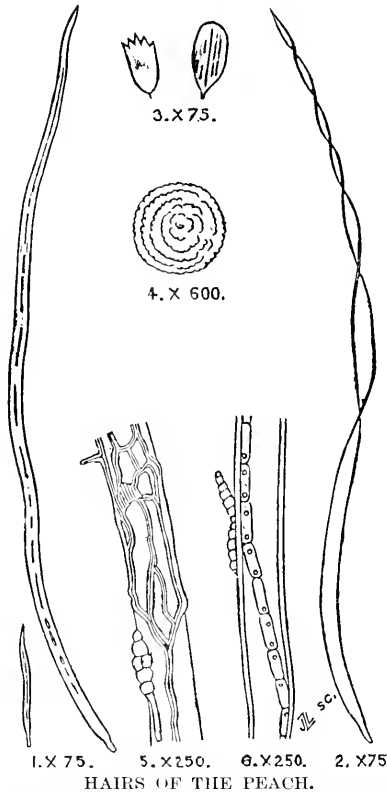

HAIRS OF THE PEACH.

- FIG. 1.—Two Hairs; one, of the greatest observed length, showing bubbles in the lower portion of the central cavity; the other of the least length.
 FIG. 2.—An exhausted Hair; dried, flattened, and twisted.
 FIG. 3.—Lepidopterous scales.
 FIG. 4.—A pollen grain.
 FIG. 5.—A spore, and fungoid growth upon the surface of a Hair.
 FIG. 6.—Two spores upon, and nucleated fungoid growth within an exhausted Hair.

of insects will be observed clinging to the hairs. Very frequently pollen-grains will be found, especially those of the most common Rag-weed (*Ambrosia artemisiifolia*, L.) Various minute particles of inorganic matter of all colors abound. And

what perhaps is most ominous, fungoid spores will be seen continually, especially the spores of some *macrosporium*, which genus grows abundantly parasitic upon languishing vegetation. In the lower left-hand portion of Fig. 5 is a representation of one of these spores adhering to the surface of a hair—a compound, six-celled spore with a lengthened pedicel. These spores vary greatly in their number of cells, and their general outline, but this is a typical specimen. On one occasion fifteen of these spores were found clinging to one hair. Where spores abound there will also frequently be observed threads and meshes of mycelium, extending sometimes over the entire length, and evidently upon the surface of the hair; because the threads of the mycelium can be seen frequently to extend beyond the contour of the hair, and occasionally to send out delicate processes beyond that contour, nearly at right angles to the general direction of growth. Occasionally within the older, flattened hairs may be detected a very striking nucleated fungoid growth, as represented in Fig. 6.

The action of the Hairs of the Peach in a case of Hay Fever is probably mechanical. We may well suppose that multitudes of these microscopic needles, lodging in the air-passages, would have the effect of making the inflamed membranes ten times more inflamed. But there may be something more. It may be that the multitudes of pollen-grains and spores, caught in this remarkable trap, so set day and night continually while the fruit is growing, and then liberated on the occasion of their insidious attack, accomplish a chemical and poisonous action upon the exposed and susceptible membranes.

It may be a sufficient hint on this matter to refer to the record given in Ziemssen's Cyclopædia of the Practice of Medicine, concerning the systematic experiments, made upon himself with various substances by C. H. Blackley. When in these experiments he used the spores of the mould, *penicillium glaucum*, the effects were hoarseness increasing to aphonia, bronchial catarrh, etc., which lasted for some days. (Am. Ed. by A. H. Buck, M. D., 1875, Vol. II., p. 545.)

Dr. Woakes, in the publication already cited, p. 79, says: "The radical treatment of Hay Fever, as the foregoing observations will suggest, is chiefly surgical." He refers to the removal or reduction of abnormal irritating growths in the nasal pass-

ages, and continues—"One caution only is necessary ; it is that the patient should not be submitted to surgical manipulations during an acute access of symptoms ; an interval of repose should be chosen for this purpose either before or after an attack."

While disclaiming any knowledge of the disease, which would enable me to intelligently indorse or controvert the statements of Dr. Woakes on its nature and proper treatment—which matters are left to the physicians and surgeons—I nevertheless consider his chapter on Hay Fever a remarkably clear exposition of some of the characteristics and accompaniments of this disease, and have quoted that chapter as an introduction to what I have seen and heard of the Hairs of the Peach.

MISCELLANEA.

PHOTOMICROGRAPH VERSUS MICROPHOTOGRAPH.—By A. Clifford Mercer, M. D., Syracuse, N. Y.—The confusion of the terms "photomicrograph" and "microphotograph" has led the writer to try to discover the paternity and original meaning of the more important word, photomicrograph.

During the past eighteen months, through the kind interest of Dr. R. L. Maddox, himself, and through him of the editors of the *British Journal of Photography* the looked-for paternity has been discovered. Traced to Mr. George Shadbolt, he has acknowledged the child, writing : "I believe I am responsible for drawing attention to the necessity of a distinction between a photographic picture of an enlarged object, and the minute photographic picture of a large object, the former being correctly described as a 'photomicrograph,' and the latter as a 'microphotograph,' in accordance with the meaning of the original Greek derivatives. This will have been in an early number of the *British Journal of Photography*, probably while it was still called '*The Liverpool Journal of Photography.*'"

The exact date of the birth of the word is still somewhat doubtful, but Dr. Maddox writes : "I think we may safely put it at '59 or '60, although we cannot put our finger on the page, even after much research."

The two acknowledged leaders in photomicrographic literature in the two great English-speaking countries, Drs. Maddox and Woodward, throughout their writings have used the words in question with the clearly defined Shadbolt distinction; and the writer trusts, with this historical note recorded in our Proceedings, the American Society of Microscopists, as a body and as individuals will insist upon the correct usage of these terms.

A photomicrograph is a macroscopic photograph of a microscopic object; a microphotograph is a microscopic photograph of a macroscopic object.

DISCUSSION.—In discussing this paper, Professor W. A. Rogers took occasion to recommend the use of the term *mikron* instead of micromillimeter, in which Professor W. H. Seaman concurred.—*Proc. Am. Soc. Microscopists* in *Microscopical Bulletin and Science News*.

TESTS FOR DEFINITION, PENETRATION, &C.—The *Microscopical Bulletin and Science News*, Aug., 1887, takes the following admirable extract from the *English Mechanic*, by E. M. Nelson.

“This is an important subject, about which a great amount of misconception exists. Let us first get at the meaning of the words. According to Goring, Pritchard, and Brewster in 1837, ‘Quekett,’ second edition, 1852, ‘Jabez Hogg,’ second edition, 1855, penetration or ‘separating power’ = resolving power; definition = freedom from spherical and chromatic aberrations. So also *Micrographic Dictionary*, third edition, 1875, with this exception, that according to it, separating power = magnifying power. In ‘Carpenter,’ fifth edition, 1875, penetration = focal depth; so also in ‘Beale,’ fifth edition, 1880. Probably the term ‘penetration’ came to mean resolution from the phraseology used in connection with Herschel’s monster telescope ‘penetrating’ into space, and resolving very minute stars, which were thought to be immensely farther off than the more conspicuous ones.

“The word ‘penetration’ is now used solely with reference to depth of focus.

“The qualities of an object glass are six in number :

1. Magnifying power.
2. Resolving power.

3. Penetrating power.
4. Illuminating power.
5. Flatness of field.
6. Defining power.

“1. No test is required for this, as it can be directly measured. Imagine anyone saying that a scale of *Morpho Menelaus* was a good test of magnifying power!

“2. Resolving power is simply numerical aperture, or *N. A.* This can also be directly measured, therefore no test is necessary.

“3. Penetrating power is the reciprocal of resolving power, $\frac{1}{N. A.}$; no test is necessary.

“4. Illuminating power is $(N. A.)^2$, or *N. A.* multiplied by itself; no test is necessary.

“5. Flatness of field. Tests: for low powers, a microphotograph; for medium powers, a stage micrometer; for high powers, a slide of minute bacteria or micrococci, dried on cover and stained. This is not so important as usually supposed, especially in high powers.

“6. Defining power depends, as we have seen, on the freedom of the lens from spherical and chromatic aberrations. Of these two, the spherical is the all-important one.

“Of the method of testing lenses for this point, I have treated already at length in these columns, and therefore will merely say that it is performed by viewing a suitable object illuminated by solid right cones of light, the object being placed in the apex of the cone. Cones of small angles should first be used, and then enlarged until the object begins to get pale, milky, or foggy. On removing the eye-piece and looking down the tube at the back lens of the objective, it will be seen what portion of the lens is filled with light, thereby determining at what point in the aperture of the objective the spherical aberration begins to operate, the best lens being that which will stand the most light. Flooding an object with too much light is only another name for spherical aberration in the object-glass. A good objective is one which cannot be flooded.

“Suitable tests for spherical aberration:

“Very low powers, 3, 2, $1\frac{1}{2}$ in.; wing of *Agrion pulchellum* ♀ (Dragon-fly).

“Low powers, 1, $\frac{2}{3}$ in.; proboscis of Blow-fly, squeezed flat.

“Medium powers, $\frac{1}{2}$, $\frac{4}{10}$, low-angled $\frac{1}{4}$ in.; minute hairs on proboscis of Blow-fly; hair of Pencil-tail (*Polyxenus lagaries*); diatoms on a dark ground.

“Medium powers, wide angled, $\frac{1}{4}$, $\frac{1}{5}$, $\frac{1}{8}$ in.; *P. formosum* and *N. Lyra* in balsam or styrax; bacteria and micrococci stained.

“High powers, wide angled immersions; the secondary structure of diatoms, especially the fracture through them. *Navicula rhomboides* in balsam or styrax, bacteria and micrococci stained.

“Chromatic aberration is not so important as the spherical, because some very fine object-glasses have a great deal of outstanding color.

“Tests for low powers; thin sections of deal, the coarse structure. Medium powers; the discs in ditto. High powers; *Podura* scale and *P. formosum*. So it will be seen that there is only one point of paramount importance in an objective to be tested, and that is its spherical aberration. The other qualities can be measured.”

MOUNTING DIATOMS IN SITU.—The following correspondence, published ten years ago, will well bear repetition, on account of the excellence of the methods advocated, and may perhaps, be a valuable reminder to some one looking for advice. “It is often desirable to mount diatoms *in situ*, as they grow attached to algæ or other aquatic plants, either to illustrate their mode of growth, or to obtain them when in too small quantity for any of the processes of separating or cleaning.

“I have never found any method of mounting satisfactory until I tried the following, which with all the algæ that I have tested, gives satisfactory results.

“The algæ are thoroughly dried, as usually stuck on paper. It is presupposed that all extraneous dirt has been removed. I have provided a slide with a circle of ink, marking the center on the reverse side, after the plan of my friend, Prof. C. Johnston, cover glass, a bottle of Canada balsam solution in chloroform, a bottle of chloroform and a watch-glass, all ready, as the operation must be carried through quickly. I select a bit of the seaweed, just large enough for the mount; put a drop or more of the chloroform in the watch-glass, and immerse the bit. The chloroform seems to be as efficient as water in restoring the dried alga to its natural shape. As the chloroform evaporates rapidly

it is well to add more drops to the watch-glass, until the alga is well permeated by the fluid and appears natural ; it is then transferred to the slide with a drop or two of chloroform, arranged for exhibition, and then the balsam dropped on immediately before the fluid has evaporated, and then the cover may be applied.

“Prepared in this manner, the balsam follows the chloroform, and penetrates the cells of the sea-weed, making them translucent, and showing the details of their structure admirably, while the diatoms are displayed conspicuously in their natural connection. The balsam must be hardened slowly, as it will not do to apply heat of a temperature that will shrivel the alga. Of course every algologist knows that in this mode but seldom can the specific marks of a diatom be made out ; but the not less important facts of the mode of growth, can be shown, as they cannot be with cleaned diatoms.

“I have now before me a slide holding a *Ptilota* from the Pacific, which displays finely several species of diatoms that I have seen no trace of until this method was tried. I can heartily recommend it to those who have collections of algæ.”—CHARLES STODDER.

“N. B.—Instead of putting the specimen in a drop of chloroform in a watch-glass, where it evaporates in a few minutes, when it is convenient it may be better to put several specimens in a very small bottle of the menstruum, and take them out as wanted, transferring direct to the slide, or to the watch-glass, as preferred. In this way they may be well saturated with chloroform. The next important matter is to add the balsam before the chloroform has all evaporated.”—C. S. in *The American Journal of Microscopy*, Vol. II. (1877), p. 142.

MOUNTING ALGÆ.—“The article by Mr. Charles Stodder in your last number on ‘Mounting Diatoms in Situ,’ was not without considerable interest to me, and no doubt to others who have tried their hands at mounting marine algæ in a way to show their best points. I believe that workers in microscopy should do as good camp-meeting attendants do—everyone should get up and relate his or her experience. Now as I have done considerable lately in the way of mounting marine algæ, I think it my duty to advocate the use of the material that has given me the most satisfactory results, *i. e.* salicylic acid. My process is

as follows : by using sea-salt (which can be bought for a trifle at any first-class druggists) and distilled or rain water, a good substitute for sea-water is obtained ; into this I immerse the rough dried specimens of algæ, and in an hour or two they have resumed their natural shape. Now picking out and clipping off such pieces as are best adapted for mounting, I transfer them to a bowl of distilled water and wash them clean, and from thence transfer them to a small saucer, containing a saturated solution of salicylic acid. The shallow cell into which they now go is built up of shellac cement made by dissolving bleached shellac in cologne spirits. Cells made of this substance are ready for use twelve hours after being laid on to the slide. I pick up the specimen with forceps, put it on the slide, and fill up the cell with the salicylic acid. I now breathe on the covering glass and put it in its place, and by the use of blotting paper absorb the superfluous fluid. A thin coating of gold size completes the work for the time being ; in a day or two I lay on more gold size, and afterwards white zinc cement or brunswick black—the finish, of course, being a mere matter of fancy.

“In mounting a piece of algæ having *Isthmia* parasitic on it, it is almost impossible to fill these diatoms if balsam is used, whereas by the use of salicylic acid every valve will be filled. In some cases the medium I have used has robbed the alga of its color, but this occurs but rarely.

“I have now before me a slide of *Ptilota hypnoides* in full fruit, the beauty of which could never be brought out except by first immersing the specimen in the sea water I have referred to. For the study of algæ, direct light should be used, but using dark field illumination is the best way of making it a genuine ‘Oh my!’ slide.”—H. F. ATWOOD, in *The American Journal of Microscopy*, Vol. II. (1877), p. 154.

THE “CURL” OF PEACH LEAVES, AND THE FUNGUS, *EXOASCUS DEFORMANS*.—The *Botanical Gazette*, Vol. XII., No. 9 (Sep., 1887), p. 216, publishes from “Contributions from the Botanical Laboratory of the University of Michigan, 1887,” a most admirable article, by Etta L. Knowles, on “the disease of peach leaves, known as ‘the curl,’” caused by the fungus “*Exoascus deformans*.” The article is illustrated by a plate, with drawings of marked distinctness and beauty by the writer.

DEAD BLACK ON BRASS, AND AS GROUND FOR OPAQUE MOUNTS.—“The following process for preparing a dead black surface on brass, for optical instruments, &c., is given by *The Locomotive*: ‘Take two grains of lamp-black, put it into any smooth, shallow dish, such as a saucer or small butter-plate, add a little gold size and thoroughly mix the two together. Just enough gold size should be used to hold the lamp-black together. About three drops of such size as may be had by dipping the point of a lead pencil about half an inch into the gold size will be found right for the above quantity of lamp-black; it should be added a drop at a time, however. After the lamp-black and size are thoroughly mixed and worked, add twenty-four drops of turpentine, and again mix and work. It is then ready for use. Apply it thin with a camel’s-hair brush, and when it is thoroughly dry, the articles will have as fine a dead black as they did when they came from the optician’s hands.’”—*The American Monthly Microscopical Journal*, Vol. VII. (1886), p. 37.

Mr. W. C. Brittan, says (*The Microscope*, Vol. VI. (1886), p. 41, “This paint will also be found just the thing when a dead black ground is required for opaque mounts.”

THE SAN FRANCISCO MICROSCOPICAL SOCIETY.

MEETING OF AUGUST 10th, 1887.

A CALIFORNIA DIAMOND.

PROFESSOR HANKS EXHIBITS A RARE GEM FOUND IN AMADOR COUNTY.

DISEASE GERMS AGAIN.—INTERESTING FINDS AT THE SEASIDE.
—SINGING SAND AT PESCADERO.

The regular meeting of the San Francisco Microscopical Society was held in the society’s rooms last evening, President Wickson and a large number of members being present. In the absence of Secretary Breckenfeld, Dr. C. P. Bates, of Berkeley, acted as Secretary.

Among donations to the cabinet were four slides of tubercular bacilli from Dr. Riehl, of Alameda, stained with different preparations. William Norris presented a recently issued part of Walker and Chase’s series of “New and Rare Diatoms.”

Mr. Norris remarked the singular beauty of some of the newly discovered diatoms. Those shown were from the Barbadoes deposits, a locality which has yielded fine finds of foraminifera.

Professor Henry G. Hanks read an interesting paper, illustrated by diagrams, concerning a diamond found in this state. The first diamond, he said, was found by Mr. Lyman, of New England, who saw in 1850, in the new gold mines, a crystal about the size of a small pea. It was slightly straw-colored and had convex faces. From that time to the present these gems have been occasionally found in our state, but never in large numbers nor of unusual size. Professor Hanks said it has been long his opinion that if hydraulic mining had been allowed to continue a system of concentration would have been adopted which would result in a larger production of gold and platinum and in the finding of more diamonds. At the present time we know of the existence of diamonds in five counties in the state, as follows: Amador, Butte, El Dorado, Nevada and Trinity. It is not unlikely that they may yet be found in California more plentifully than before.

A very beautiful and remarkable diamond has lately come into the possession of J. Z. Davis, a member of the Microscopical Society, and this one Professor Hanks submitted for examination. It was found in 1882 at Volcano, Amador county, by A. Schmitz. It weighs 0.361 grammes, or 5.570 grains, equal to 1.571 carats. It is a modified octahedron about three-tenths of an inch in diameter, very nearly if not quite colorless, perfectly transparent, but not without some trifling inclusions and faults. The form of the crystal is unusual. Professor Hanks has not found such a one described or figured in books. The general form as shown by examination is that of a regular octahedron, but the faces seem convex. The whole crystal assumes a somewhat spherical form and the edges of the pyramids are channels instead of planes, but on closer examination it will be seen that the channeled edges, the convex faces and the solid angles are caused by an apparently secondary building up of the faces of a perfect octahedron, and for the same reason the girdle is not a perfect square, but has a somewhat circular form. These observations were well shown by drawings showing in enlarged form the outlines of the gem. The faces seem to be composed of thin plates overlying each other, and each slightly

smaller than the last. These plates are triangular, but the lines forming the triangles are curved, and the edges of the plates themselves are beveled. Mr. Hanks remarked further that it could be seen by the enlarged crystal shown under the microscope and by drawings exhibited that each triangular plate was composed of three smaller triangles and that all the lines were slightly curved. The building up of plate upon plate causes the channeled edges and the somewhat globular form of this exquisite crystal. The sketches shown were made from the diamond, while in the field of the microscope by the aid of the camera lucida, being enlarged about ten diameters.

A close examination of the crystal revealed tetrahedral impressions as if the corners of minute cubes had been imprinted on the surface of the crystal while in a plastic state. These are the result of the laws of crystallography, as were seen by the faint lines forming a lace work of tiny triangles on the faces when the stone is placed in a proper light. Professor Hanks concluded with the remark that it would be an act of vandalism to cut the beautiful crystal which is a gem in two senses, and he protested against it ever being defiled by contact with the lapidary's wheel.

The diamond was placed under the microscope and arranged by Professor Hanks to demonstrate the points of his very accurate description. It was a beautiful object and was admired by all present.

Dr. Riehl, of Alameda, gave a demonstration of discovering tubercular bacilli in the sputum of consumptives. He proceeded with the operation of staining, decolorizing, etc., and finally showed the minute germs clearly under the lens. Dr. Riehl made no claim to originality in the method employed, but showed how he handled the material so as to disclose the bacilli quickly for purposes of diagnosis. Discussion ensued as to the value of different methods, Dr. Ferrar and Dr. Mouser maintaining the value of the careful and exact methods of procedure laid down by the German investigators for purposes of exact determination. Dr. Mouser showed a very handsome piece of apparatus called "Schlessing's Thermo Regulator," which he had just received from Germany. It is to be attached to the incubator used in cultures of bacilli, etc., in such a way that the water of the incubator comes in contact with the rubber plate of the regulator and expands it. This expansion of the rubber presses upon the

other parts in contact with it and partly closes the pipe, admitting gas to the jets which heat the incubator. The appliance is so delicate that an elevation of one-tenth of a degree in the heat will act upon the gas flame and reduce it.

President Wickson exhibited a specimen of sonorous sand sent to Professor Hilgard by W. G. Thompson, of Pescadero, and referred to him for examination. Mr. Thompson's letter explained that the sand when driven over or walked on or even disturbed with a stick or the hand, gives out a distinct musical sound. Perhaps the strangest thing about it is that the persons longest in the vicinity of Pescadero, seem not to know of the existence of such a place. It is away from the usual places of resort. The much-talked of "singing beach" of Manchester, Mass., is only one-fifth of a mile long while Mr. Thompson has traced this sand at Pescadero along the beach for over a mile and a half. Mr. Wickson remarked that the subject of sonorous sand had been before the society some years ago in connection with specimens sent from the Sandwich Islands and had been studied by Professor Hanks. The society's cabinet contains a slide of the Sandwich Island sand. The Pescadero material would be studied in the light of these facts, comparisons made, and the subject presented at a subsequent meeting. Specimens of the sand were distributed to those present.

J. Z. Davis showed a sample of kelp from the southern coast covered with minute shells of mollusca so that the green kelp seemed almost white. The subject was referred to Dr. H. W. Harkness, with the request that he report at a subsequent meeting.

The society then adjourned.

MEETING OF AUGUST 24TH, 1887.

INTERESTING MEETING.—WOOD FROM AN ARTESIAN WELL.—
CURIOSITIES FROM MOUNT SHASTA.

The regular semi-monthly meeting of the San Francisco Microscopical Society, was held last evening at its rooms, 120 Sutter street. President Wickson occupied the chair.

Dr. Harkness made a preliminary report on the kelp covered by mollusca, which was referred to him at the last meeting. A more complete examination of the material will be made in due course.

The resignation of A. H. Breckenfeld, offered on account of his approaching departure for San Diego, was accepted. President Wickson spoke feelingly of the exceedingly pleasant relations which had always existed between the retiring officer and the society, and at the conclusion of his remarks a cordial vote of thanks was tendered Mr. Breckenfeld for his services as Recording Secretary. Under a suspension of the rules he was duly elected an honorary member of the society, and thereupon fittingly expressed his appreciation of the honor conferred. His successor will be elected at the next meeting.

A piece of wood, apparently fossilized, was sent in by Geo. A. Raymond, with the information that it had been struck at a depth of 325 feet in an artesian well now being bored in Kern county, Cal. The overlying material was mostly clay and the surrounding country was entirely destitute of timber. After an interesting discussion the specimen was referred to Prof. Hanks for microscopical examination.

Dr. Riehl donated a slide of a very minute larval form of insect, in which the vascular system was particularly clearly shown.

A varied assortment of entomological, botanical and mineralogical specimens was donated by F. L. Howard, who had collected them on the slopes of Mount Shasta. Some peculiar varieties of porous obsidian attracted much attention.

Mr. Riedy stated that the work of stamping the books, plates, etc., in the library with the cut recently adopted by the society had been commenced and would soon be completed.

The meeting thereupon adjourned to the 14th prox.

A. H. BRECKENFELD, *Recording Secretary*

PUBLICATIONS RECEIVED.

- Bulletin of the Torrey Botanical Club : Vol. XIV., Nos. 8-9 (August-September, 1887) ; pp. 56.
- Entomologica Americana : Vol. III., No. 5 (August, 1887) ; pp. 20.
- The Hoosier Naturalist : Vol. II., No. 12 (July, 1887) ; pp. 10.
- The Botanical Gazette : Vol. XII., No. 8 (August, 1887) ; pp. 32.
- Proceedings and Transactions of the Natural History Society of Glasgow : Vol. I. (New Series), Pt. III. (1885-1886) ; pp. 144 + LXVIII.
- The Ottawa Naturalist : Vol. I., No. 5 (August, 1887) ; pp. 16.
- Berichte der Naturforschenden Gesellschaft zu Freiburg : Vol. I. (1886) ; pp. 224.
- Anthony's Photographic Bulletin : Vol. XVIII., Nos. 15-16 (August 13-27, 1887) ; pp. 64.
- Monatsblätter des Wissenschaftlichen Club in Wien : Vol. VIII., Nos. 10-11 (July-August, 1887) ; pp. 24. Ausserordentliche Beilage : No. 6 (March 31, 1887) ; pp. 11. Chronik des Wiener Goethe-Vereins : Vol. II., No. 9 (June 26, 1887) ; pp. 8.
- The Journal of Mycology : Vol. III., No. 8 (August, 1887) ; pp. 11.
- Book Chat : Vol. II., No. 7 (July, 1887) ; pp. 28.
- Indiana Medical Journal : Vol. VI., Nos. 2-3 (August-September, 1887) ; pp. 48.
- Johns Hopkins University. Studies from the Biological Laboratory : Vol. IV., No. 2 (August, 1887) ; pp. 53. Circulars : Vol. VI., No. 59 (August, 1887) ; pp. 17.
- National Druggist : Vol. XI., Nos. 5-7 (August 1-September 1, 1887) ; pp. 68.
- The Hahnemannian Monthly : Vol. XXII., Nos. 8-9 (August-September, 1887) ; pp. 144.
- The Microscope : Vol. VII., No. 8 (August, 1887) ; pp. 31.
- The Naturalist : Nos. 145-146 (August-September, 1887) ; pp. 63.
- The Canadian Entomologist : Vol. XIX., No. 8 (August, 1887) ; pp. 20.
- The West-American Scientist : Vol. III., Nos. 27-28 (July-August, 1887) ; pp. 28.
- The Cosmopolitan : Vol. III., No. 6 (August, 1887) ; pp. 84.
- United States Geological Survey. Sixth Annual Report (1884-1885) ; pp. 557.
- The Journal of the Quekett Microscopical Club : Vol. II., No. 16 (September, 1886). Vol. III., No. 19 (August, 1887) ; pp. 114.
- Bulletin de la Société Impériale des Naturalistes de Moscou : 1886, No. 4 ; pp. 169. 1887, Nos. 1 and 2 ; pp. 482.
- Meteorologische Beobachtungen ausgeführt am Meteorol. Observ. d. Landwirth. Akademie bei Moskau von A. A. Fadéiéff : 1886 ; pp. 12.

The Microscopical Bulletin and Science News: Vol. IV., No. 4 (August, 1887); pp. 8.

Bulletin de la Société Royale de Botanique de Belgique: Vol. XXVI. (1887); pp. 241.

Bulletin de la Société Belge de Microscopie: Vol. XIII., No. 8 (1886-1887); pp. 18.

The Naturalist's Monthly: Vol. I., No. 1 (September, 1887); pp. 20.

Journal of the Royal Microscopical Society: 1887, Pt. 4 (August): pp. 164.

Memoires de la Société des Naturalistes de Kiew: Vol. VIII., No. 2 (1887); pp. XC. + 258.

JOURNAL
OF THE
New-York
Microscopical Society.

Vol. III.



NEW-YORK:
PUBLISHED FOR THE SOCIETY,
QUARTERLY.

INDEX TO VOLUME III.

<p><i>Agaricus campanella</i>, Batsch, 34</p> <p>Algæ, Mounting, 72</p> <p>Am. Association for the Adv. of Science, Delegates to local Com. on Arrangements, 22</p> <p>Annual Reception, The, 9</p> <p>Appointment of Committees, 11</p> <p><i>Arion</i>, Horn and Eye of, 4</p> <p>Artificial Rubies, 55</p> <p><i>Avicennia nitida</i>, Jacq. (Black Mangrove), 37</p> <p>Bark-louse, The Oyster-shell, of the Apple, 19</p> <p>BEUTENMÜLLER, W., <i>Mytilaspis pomorum</i>, Bouche; the Oyster-shell Bark-louse of the Apple, 19</p> <p>—, <i>Chionaspis Pinifolie</i>, Fitch; The Pine-leaf Scale-louse, 20</p> <p>Black Mangrove (<i>Avicennia nitida</i>, Jacq.), 37</p> <p>—, Dead, on Brass, 74</p> <p>— —, for Opaque Mounts, 74</p> <p><i>Blatta orientalis</i>, 38, 51</p> <p>BRAMAN, B., Canada Porcupine (<i>Erethizon dorsatus</i>), 36</p> <p>Brass, Dead Black on, 74</p> <p>BREVOORT, H. L., The Brownian Movement, 1</p> <p>—, Fur Fibres, 47</p> <p>BRITTON, DR. N. L., <i>Trichomes</i> from leaf of Am. Mistletoe, 22</p> <p>Brooklyn Microscopical Society, Public Reception of the, 22</p> <p>Brownian Movement, 1</p> <p><i>Buccinum obsoletum</i>, Radula of, 20</p> <p>Cabinet, objects from the, to be exhibited, 11</p> <p>—, see Donations,</p> <p><i>Chamaecyparis spherioidea</i>, Spach, 30</p> <p><i>Chionaspis Pinifolie</i>, Fitch, 20</p> <p><i>Chrysope</i>, The larva of, 15</p> <p>Committees, Appointment of, 11</p> <p>COX, C. F., on Photography, 18</p> <p>Cretaceous Formation of Alabama, Objects representing, 12</p> <p><i>Crocus vernus</i>, Allione, Reticulation of, 23</p> <p>Crystals from Steel of Locomotive Driving-Wheel, 20</p> <p>Curator, The, to exhibit objects from the Cabinet, 11</p>	<p>“Curl,” The, of Peach leaves, 73</p> <p>Dead Black on Brass, 74</p> <p>— —, for Opaque Mounts, 74</p> <p>Definition, Tests for, 69</p> <p>Delegates to local Com. of Arrangements for reception of the A. A. A. S., 22</p> <p>Diatoms, Supplementary remarks on, by Prof. Lockwood, 6</p> <p>—, <i>Heliopelta</i>, 24</p> <p>—: “Santa Monica Find,” Mementoes of the, 42</p> <p>—, Mounting, <i>in situ</i>, 71</p> <p>Dividing Engine of Prof. W. A. Rogers, 39</p> <p>Donations to the Cabinet and</p> <p style="text-align: center;">LIBRARY:—</p> <p>Nine photographs, by Dr. Henri Van Heurck, 7</p> <p>Four slides, sections of Agate, by Geo. E. Ashby, 18</p> <p>Slide, sections of <i>Avicennia nitida</i>, Jacq., by J. L. Zabriskie, 36</p> <p>Two slides of Diatoms, by C. S. Shultz, 40</p> <p>Scientific Communications, by Dr. Henri Van Heurck, 35</p> <p>“Microscopy for Beginners,” by G. S. Woolman, 35</p> <p>Driving Wheel, Steel of Locomotive, 20</p> <p>DUDLEY, P. H., Steel from Locomotive Driving Wheel, 20</p> <p>—, <i>Polyporus sanguineus</i>, 29</p> <p>—, <i>Chamaecyparis spherioidea</i>, Spach, and its fungus <i>Agaricus campanella</i>, Batsch, 30</p> <p>—, Fasoldt Eye-piece Micro-meter, 39</p> <p>—, <i>Merulius lacrymans</i>, Fr., 40</p> <p style="text-align: center;">EDITORIAL:—</p> <p>Note on Eye of <i>Vanessa Io</i>, L., 42</p> <p>Vision of Insects, by M. A. Forel, 43</p> <p>Eggs and Scale of <i>Mytilaspis pomorum</i>, Bouche, 19</p> <p>Election of Officers, 6</p> <p><i>Erethizon dorsatus</i> (Canada Porcupine), 36</p> <p><i>Ecoascus deformans</i>, 73</p>
---	---

Eye, Horn and, of <i>Arion</i>	4	LOCKWOOD, PROF. SAM'L., Sup-	
— of insects, Experiments on,	43	plementary Remarks on Dia-	
— of <i>Fanessa</i> , Note on.....	42	toms,.....	6
—, The Compound, of <i>Fan-</i>		—, on Casts in Cretaceous	
<i>essa Io</i> , L.....	27	Clays of N. J.,.....	12
Fasoldt Eye-piece Micrometer,	39	Locomotive Driving Wheel,	
Fibres, Fur,.....	47	Steel of,.....	20
Foraminiferal Fauna at Peters-		<i>Melanogaster ambiguus</i> , Tul.	
burg, Va.,.....	16	(False Truffle),.....	37
FUNGI:—		Members, List of Correspond-	
<i>Mucor racemosus</i> ,.....	23	ing,.....	7
<i>Polyporus sanguineus</i> ,.....	29	—, List of Honorary,.....	7
<i>Agaricus campanella</i> , Batsch,	34	—, Resident,.....	7
<i>Melanogaster ambiguus</i> , Tul.		<i>Merulius laeeymans</i> , Fr.,.....	40
(False Truffle),.....	37	<i>Mejenia fluviatilis</i> , var. <i>asperima</i> , Dawson.....	35
<i>Merulius laeeymans</i> , Fr.,.....	40	Micrometer Stage on speculum	
<i>Exoascus deformans</i> ,.....	73	metal,.....	40
Fur Fibres,.....	47	—, Eye-piece, by Charles Fa-	
Furnace Slag inclusions similar		soldt.....	39
to those of Obsidian,.....	18	Microphotograph, Photomicro-	
Ginkgo Tree (<i>Salisburia Adian-</i>		graph versus,.....	68
<i>tifolia</i>),.....	21	Miocene, Foraminiferal fauna	
GROVE, E. B., Sori of <i>Hemitelia</i>		of, at Petersburg, Va.....	16
<i>horrida</i> ,.....	22	MISCELLANEA:—	
—, Ichneumon, parasitic on		Dead Black on brass, and for	
<i>Orygia leucostigma</i> ,.....	23	opaque mounts,.....	74
—, Ovipositor of Saw-flies, ...	39	Tests for definition, penetra-	
—, Note on <i>Fanessa Antiopa</i> .		tion, etc.....	69
L.....	59	The "Curl" of peach leaves, ..	73
Hairs of the Peach in relation		Mounting diatoms <i>in situ</i> , ...	71
to Hay Fever,.....	62	—, Algae,.....	72
Hay Fever, Hairs of the Peach		Photomicrograph versus Mi-	
in relation to,.....	62	crograph,.....	68
<i>Heliopelta</i> ,.....	24	Mistletoe, <i>Trichomes</i> from leaf	
<i>Hemitelia horrida</i> , Sori of,.....	22	of American,.....	22
Honorary Members, List of ...	7	Mounting Diatoms <i>in situ</i> ,....	71
HYATT, J. D., Inclusions of Furn-		—, algae,.....	72
ace Slag,	18	Mounts, Dead Black for,.....	74
—, objects from Cretaceous		<i>Mucor racemosus</i> ,.....	23
Formation of Alabama,.....	12	<i>Mylilaspis pomorum</i> , Bouche,..	19
Ichneumon, parasitic on <i>Orygia</i>		Obsidian, Inclusions of Furnace	
<i>leucostigma</i> ,.....	23	Slag similar to those of,.....	18
Inclusions of Furnace Slag sim-		Officers, Election of,.....	6
ilar to those of Obsidian,.....	18	Opaque mounts, Dead Black	
Insects, Experiments on vision		for,.....	74
of,.....	43	<i>Orygia leucostigma</i> , Parasite of, ..	23
JOURNAL, The, to be published		Ovipositor of Saw-flies, ...	39
quarterly.....	19	Oyster-shell Bark-louse of the	
Kaolin,.....	18	Apple,.....	19
KUNZ, GEORGE F., The New Ar-		Peach, Hairs of the, in relation	
tificial Rubies,.....	55	to Hay Fever,.....	62
Larva of <i>Chrysopa</i> ,.....	15	PELLEW, CHARLES E., <i>Mucor</i>	
LEGETT, F. W., The larva of		<i>racemosus</i> ,.....	23
<i>Chrysopa</i> ,.....	15	Penetration, Tests for,.....	69
—, Pulvilli of Roach (<i>Blatta</i>),	38	Photographs donated by Dr.	
—, Notes on the Roach (<i>Blatta</i>)		Henri Van Heurck,.....	7
Library: see Donations.		Photography, C. F. Cox on,....	18
List of Members,.....	7		

Photography, C. S. Shultz on..	19	"Santa Monica Find," Memen-	42
Photomicrograph versus Micro-	68	toes of the,	42
photograph,		Saw-flies, Ovipositor of,	39
Photomicrographs by Mr.		Scale-louse, The Pine-leaf,	20
Wright,	18	SHULTZ, C. S., Photographs by	
—, by Mr. Max Levy,	18	Mr. Max Levy, exhibited by,	18
—, by Dr. J. J. Woodward, ..	18	—, Stage micrometer on spec-	
Pine-leaf Scale-louse,	20	ulum metal,	39
<i>Polyporus sanguineus</i> ,	29	Slag Furnace, Inclusions of,	
Porcupine, Quills of the Canada,	36	similar to those of Obsidian, ..	18
PROCEEDINGS:—		SOUTHWICK, E. B., Reticulations	
Meeting of Dec. 3d, 1886, ..	5	of Tunics of <i>Crocus vernus</i> .	
17th,	5	Allione,	23
Jany. 7th, 1887, ..	5	Sponges: <i>Meyenia shviatilis</i> ,	
21st,	6	and <i>Spongilla fragilis</i> ,	35
Febv. 4th,	8	<i>Spongilla fragilis</i> ,	35
18th,	9	Steel of Locomotive Driving	
Mar. 4th,	9	Wheel,	20
18th,	11	Summer recess,	40
Apr. 1st,	18	Tests for Definition, Penetra-	
15th,	21	tion, etc.,	69
May 6th,	34	Treasurer, Report of the,	6
20th,	36	<i>Trichomes</i> from leaf of A. m.	
June 3d,	38	Mistletoe,	22
17th,	39	<i>Vanessa Antiopa</i> , L., Note on, ..	59
Programme, New form of, for		—, editorial note on,	42
regular meetings,	18	—, <i>Io</i> , L., The Compound Eye	
PUBLICATIONS RECEIVED, .13, 25,		of,	27
44, 78		Van Heurek, Dr. Henri, Dona-	
Quarterly, The JOURNAL to be		tion and description of photo-	
published,	19	graphs by,	7
Radula of <i>Buccinum obsoletum</i> ,	20	—, elected an Honorary Mem-	
Reception, The annual,	9	ber,	11
Recess, The Summer,	40	—, Skill of, in photography, ..	19
Report of the Treasurer,	6	Vision of insects,	43
RIEDERER, LUDWIG, Horn and		WALES, W., Photographs by	
Eye of <i>Arion</i> ,	4	Mr. Wright exhibited by,	18
—, <i>Salamandra maculosa</i> , 36,	38	Whelk, The radula of the (<i>Buc-</i>	
—, The Compound Eye of		<i>cinum obsoletum</i>),	20
<i>Vanessa Io</i> , L.,	27	White Cedar, The, and its fun-	
—, The Head of <i>Salamandra</i>		gus,	30
<i>maculosa</i> ,	53	WOODWARD, A., Photographs	
Roach. The (<i>Blatta</i>),	38, 51	by Dr. J. J. Woodward exhib-	
Rogers, Prof. W. A., Dividing		ited by,	18
Engine of,	39	—, Foraminiferal Fauna at	
Rubies, The New Artificial,	55	Petersburg, Va.,	16
<i>Salamandra maculosa</i> , .. 36, 38,	53	—, on Kaolin,	18
<i>Salisburia Adiantifolia</i> (Gink-		Woodward, Dr. J. J., Photo-	
go Tree),	21	graphs by, exhibited by A.	
SAN FRANCISCO MICROSCOPICAL		Woodward,	18
SOCIETY:—		—, Skill of, in photography, ..	18
Proceedings, June 23d, 1887, ..	41	ZABRISKIE, J. L., Black Man-	
—, August 10th, 1887,	74	grove (<i>Avicennia nitida</i> ,	
—, August 24th, 1887,	77	Jacq.),	37
		—, Hairs of the Peach in rela-	
		tion to Hay Fever,	62

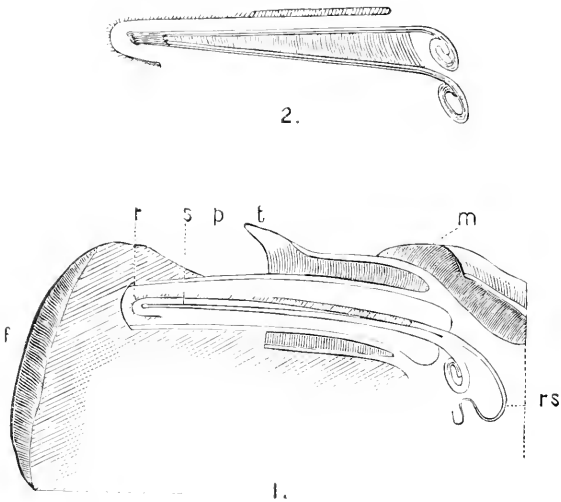

2.

1.



3. X 15.



4. X 15.



5. X 15.

J. L. Z. Del. ad Nat. et Sc.

RADULA OF THE CONCH.

JOURNAL
OF THE
NEW-YORK MICROSCOPICAL SOCIETY.

VOL. IV.

JANUARY, 1888.

No. 1.

THE RADULA OF THE CONCH, SYCOTYPUS CANALICULATUS, GILL.

BY THE REV. J. L. ZABRISKIE.

(Read November 18th, 1887.)

This species is, with one exception, the largest univalve mollusk inhabiting the coast waters of our State. It is common from the eastern borders of New England southward along the shores of New Jersey. The exception in size occurs in the case of *Fulgur carica*, Conr., a near relative, which is found from Cape Cod southward along the shores of the Southern States. The size of the adult shell of the first species is given as six inches in length, and that of the second species as eight inches. In the warmer waters of the South, this latter species is said to grow much larger. Both species are popularly known as the "Winkle," "Periwinkle," or "Conch." This latter name is prevalent among the dealers of the New York markets, where they are sometimes offered for sale.

These mollusks are now assigned to different genera, and are

Explanation of Plate 10.

- FIG. 1.—Longitudinal-vertical section of the anterior portion of the Conch, *Sycotypus canaliculatus*, Gill, natural size; *f*, surface of the foot; *m*, the mantle; *t*, one tentacle; *p*, the proboscis; *s*, the skeleton; *r*, the radula; *rs*, the radular sack.
- FIG. 2.—A perspective view of the skeleton, with the radula divested of some of its membranes, and elevated above its natural position; natural size.
- FIG. 3.—One row of teeth, from the media portion of the radula, enlarged 15 diameters.
- FIG. 4.—One row of teeth with worn and broken points, from the distal end of the radula, enlarged 15 diameters.
- FIG. 5.—One row of teeth, from the proximal end of the radula, enlarged 15 diameters.

readily distinguished by the shell. *Fulgur carica* has the lower three volutions of the spire furnished with a series of distinct, triangular tubercles; while *Sycotypus canaliculatus*, devoid of tubercles, has the suture of the spire furnished with a deep, sub-quadrangular canal, gradually decreasing in size as it approaches the summit.

The shell of both species has a brown epidermis. In the case of *Sycotypus* this epidermis supports bristly hairs, about one-quarter of an inch in length, whose bases are so regularly disposed on longitudinal ridges of the epidermis as to give the appearance of minute longitudinal and transverse striations, separated by a distance of about one-fortieth of an inch.

The horny, flat operculum, which effectually closes the orifice only when the animal has deeply retired within the shell, is perhaps comparatively small as respects the size of that shell.

The egg-cases of both species, from their large size and curious form, are always objects of interest when first observed. They are popularly known as "sea-necklaces." They consist of a number of capsules—from fifty to one hundred—of a very tough, parchment-like material, of a flattened, elliptical form, about one inch broad, in close succession overlapping each other, and connected at one edge by a stout and very strong filament of the same material, two feet or more in length. The capsules of *Sycotypus* have the edge acute, and the broad, upper surface crossed by ten to twelve prominent radiating ridges. The capsules of *Fulgur* have the edges truncate and ridged, with the broad surfaces smooth. These capsules contain each sometimes as many as forty eggs. The young, as they mature, issue from the capsule by breaking through a small, thin portion of the membrane near the edge opposite the retaining cord of the "necklace." The "necklace" is always imperfect at one end, this portion consisting merely of the strong cord and a few scattered immature capsules. Until recently it has been doubtful which end is first extruded from the oviduct. But I have found the late accounts confirmed by the testimony of an acquaintance who is observant, and well-versed in the habits of these mollusks. He informs me that he has often captured them with the "necklace" half extruded, and that the imperfect end is always laid first attached to some object just below the surface

of the sandy bottom, in the shallow waters where they are seen to spawn.

On account of the opportunity of seeing it alive, in its native haunts, I have been interested in *Sycotypus*, especially since July just passed. My first living specimen was presented by Mr. Duffield Prince, who captured it in the Wallkill, a branch of Flatlands Creek, near Coney Island. My second living specimen was presented by Mr. Stephen Williamson, of Gravesend, Long Island, and was also captured near the place mentioned above. This is the specimen exhibited at the present time. The shell is unusually large, measuring $6\frac{1}{16}$ inches long, by $4\frac{1}{16}$ inches broad. This specimen was spawning at the time of capture. The "necklace" of egg-capsules, fourteen inches long, also here exhibited, was partially extruded; each fully-formed capsule containing a number of eggs. I have also been kindly presented with a number of specimens by the Hon. E. G. Blackford, Chief of our State Fishery Commission.

THE RADULA.—This organ of mollusks known by the names, "tongue," "palate," "lingual ribbon," "lingual membrane," "odontophore," or "radula," has always been interesting to microscopists on account of its singular mechanism and beautiful form. It is so universally present in the univalve mollusks that, in modern works of any extent, mention of its form at least is expected, if its dentition is not figured, under every important genus.

Prof. E. Ray Lankester, in the ninth edition of "The Encyclopædia Britannica," divides all the groups of *Mollusca* into two main branches—(1) *Lipocephala*, or headless; with the head-region undeveloped, no cephalic eyes, and the buccal cavity devoid of biting, rasping, or prehensile organs; containing only one class, the *Lamellibranchia*, including the mussels, oysters, cockles and clams. (2) *Glossophora*, the tongue-bearing mollusks; having not only a "well-developed head, but a special aggressive organ in connection with the mouth which on account of its remarkable nature, and the peculiarities of the details of its mechanism, seems to indicate a very close genetic connection between all such animals as possess it." In the *Glossophora* he includes the three great classes, *Gasteropoda*, *Scaphopoda* and *Cephalopoda*, intimating that as a rule, all the numerous orders of the *Glossophora* possess the radula.

Huxley, in his "Anatomy of Invertebrated Animals," states that the Odontophorous Mollusks, in which division he includes all which stand in contradistinction to the acephalous Lamelli-branches and Brachiopods, possess the radula, with the exception of a very few genera, *e. g.*, *Tethys*, *Doridium* and *Rhodope*.

Tryon, in his "Structural and Systematic Conchology," says "in a few Gasteropods the tongue is unarmed."

Our admirable Government Report on "The Fisheries and Fishery Industries of the United States" (Section I., p. 695, 1884), makes an unfortunate slip in stating that the Conch is not provided with a "file-like tongue."

But our Conchs are not lacking in this armature. Here is the radula, preserved entire in glycerine, of the identical specimen of *Sycotypus*, whose shell is at present exhibited. The armed portion is a little more than two inches in length, and about one-eighth of an inch broad, at the flattened, distal end. And here is the radula of *Fulgur*, preserved in the same manner, entire, and quite closely agreeing in size and form with that of its relative.

Prof. Lankester, in "The Encyclopædia Britannica," already cited, gives an admirable longitudinal-sectional illustration of the mouth-parts of a glossophorous mollusk, and in the accompanying explanation clearly describes the action of the radula in life, *i. e.*, the forward, effective portion of the organ rasps off the food by an alternate backward and forward motion, caused by the alternate rolling of a globular mass of cartilage firmly attached to the under side of the bed of the radula, near the oral aperture. And he adds, "But in many *Glossophora* (*e. g.*, the Whelk) the apparatus is complicated by the fact that the diverticulum itself, with its contained radula, rests but loosely on the cartilage, and has special muscles attached to each end of it, arising from the body-wall; these muscles pull the whole diverticulum, or radular sack, alternately backwards and forwards over the surface of the cartilage."

This is very nearly the description of the organ and its action in the species under consideration. In *Sycotypus*, the radula, as usual, consists of an assemblage of transverse rows of chitinous teeth, situated upon the upper surface of a thin, but very strong chitinous ribbon, lying longitudinally in the floor of the long

proboscis-like mouth. The ribbon, firmly attached to a strong bed, or subradular membrane, rests loosely upon, and passes over and under the anterior end of a cartilaginous apparatus, named the "skeleton."

Huxley's description of the skeleton is that it is "composed of two principal masses of partially fibrous, or completely cartilaginous tissue, *odontophoral cartilages*, which may be more or less confluent, and are further united together in the middle line by fibrous and muscular tissue. Their anterior ends and oral faces are free and smooth, and are usually excavated so as to present a trough-like surface to the subradular membrane, which rests upon them."

In *Sycotypus* this skeleton has the form of an attenuated truncated triangle. The "odontophoral cartilages" forming the longitudinal borders of the triangle, are connected by a tough, transversely striated substance, and they each present along their entire upper surface a distinct, smooth, white trough for the free action of the subradular membrane. The radula, with its strong bed, rests upon this cartilaginous triangle, and its forward portion is bent over and underneath the truncated end of the triangle, in order to accomplish its intended work, which we will notice presently. The radula, when at rest and especially as regards the posterior portion, has the form of a tube, slit along the entire upper surface, causing the points of the teeth of this tubular portion to converge towards the axis of the tube. But where the anterior portion is flattened out, the teeth lie in transverse rows, with the points directed backwards; and where the radula curves over the forward end of the skeleton the teeth necessarily raise their points, nearly perpendicularly to the surface of the membrane, giving the appearance of a very formidable weapon. The radular membrane is continued posteriorly in the form of a white, opaque, closed tube, constituting the radular sack. And the radula itself is the product of growth from the inner surface of this radular sack. As the teeth and the membrane are worn away by use at the anterior end, new teeth come into service, and the whole apparatus is preserved in its effectiveness by the growth of the radula at its posterior end, and its advancement along its entire length. The line of origin of the teeth in the radular sack is quite sharply defined, and the radula easily separates from the sack at this line of origin.

The radula of *Sycotypus* is so large that it is easily obtained by dissection. The following method was employed in the present instances. The living animal was dropped into boiling water, and allowed to remain there for five minutes. A steel fork was thrust into the muscular foot, and a forward, spiral, oscillating motion soon extracted the animal from its shell. The viscera being discarded, the mantle was slit backward along its upper region, disclosing the head, and the remaining mass was divided by a longitudinal incision through the great muscular foot, slightly at one side of the median line, disclosing, but leaving intact, the proboscis. Then by inserting one point of the dissecting scissors into the oral aperture, feeling the radula so as to be certain the instrument was lying upon, and avoiding all risk of injuring the desired organ, the proboscis was slit along its entire upper surface. The radula was then easily seen, seized with a forceps, and dissected out as far as could be followed.

As far as I have been able to ascertain the radular sack of *Sycotypus* continues inwardly for a length at least equal to that of the radula itself, until it becomes an attenuated thread, dips downwards and forwards in several loops, and has its origin underneath and near the junction of the proboscis with the foot. The specimens examined died with the radula bent over the forward end of the skeleton, continuing backward and underneath for varying distances, such as $\frac{1}{8}$, $\frac{1}{4}$, $\frac{1}{2}$ or $\frac{3}{16}$ ths of an inch. The specimens of radula here exhibited were cut into lengths of $\frac{3}{8}$ ths of an inch, flattened by soaking in alcohol while compressed between two pieces of glass, and mounted in glycerine.

Under the first microscope is exhibited the central portion of the radula of *Sycotypus*, by polarized light, the teeth being in perfect condition, and giving strong contrasts of colors. There are three teeth in each row. Each tooth consists of a transversely extended plate, supporting several denticles. The central tooth has three denticles, and each lateral tooth has four, with sometimes an additional rudimental fifth denticle.

Under the second microscope is exhibited the distal end of the radula, where it will be observed the membrane itself is ragged, and the teeth sometimes entirely dislodged, and when remaining having the points broken and worn from hard usage.

Under the third microscope is exhibited the proximal end of the radula. The teeth gradually become smaller and fainter,

and yet their origin, as well as that of the chitinous foundation is sharply defined.

The teeth lie quite flat upon the horizontally extended radula, with their points directed backwards towards the interior of the mouth. And it is evident that the effective stroke of the organ when acting upon food, must necessarily be the retracting stroke. Huxley gives a vivid description of the action of the radula in general, comparing this action to that of a chain-saw. The muscles attached to either end of the radula cause it to travel backwards and forwards over the upper surface, and, with a sharp bend, under the lower surface of the forward end of the skeleton, forming a most effective instrument for rasping any substance with which the teeth are brought in contact. The only chain-saw with which I am acquainted, is a surgical instrument, consisting of a chain formed of links with rectangular transverse section, having teeth along one of the narrow edges, and a short, transverse handle at either end of the chain. In action the chain is passed around a bone, or similar object, with the teeth occupying the inner contour of the curve, and then by an alternate pull of the hands of the operator these teeth gradually sink themselves into the substance operated upon. But the chain-saw of *Sycotypus* has the teeth upon the outer contour of the curve, and, as the appropriate muscles cause the formidable weapon to travel over the end of the skeleton, we may well believe the statement of Stimpson, that "with a sudden jerk of the lingual ribbon, inward and sidelong, it can take a strip of flesh" from any unfortunate mollusk on which it may be feeding.

A METHOD OF PREPARING, FOR MICROSCOPICAL
STUDY, THE RADULÆ OF SMALL SPECIES
OF GASTEROPODA.

BY CHARLES E. BEECHER.

(Read November 18th, 1887.)

One of the early methods employed to obtain the lingual membranes of Gasteropoda, was by actual dissection. This process, in many cases, is very laborious and the results unsat-

isfactory. Advantage was next taken of the resistance of the radulæ to the action of ordinary chemical reagents. The resistance to acids and alkalis induced the early belief in the silicious composition of the teeth, and it is only quite recently that the fallacy has been eradicated from text books on natural history, and from special works on the mollusca. It is now known that the teeth are composed of a substance closely related to chitine. Its behavior under the influence of the ordinary staining fluids used in microscopical work, is quite varied and interesting, and affords some points of comparison with true chitine.

Another method, applied in the study of the extremely small radulæ of minute species of snails, was to crush the animal, and examine the dentition through the translucent tissues. Of course, this plan is in itself not altogether satisfactory, on account of the difficulty of distinctly studying the characters of the lingual membrane. Besides, it was not conducive to the production of clean, beautiful and permanent preparations, such as ought to be retained, to serve as the types from which descriptions and illustrations have been made, and from which important deductions have been drawn.

When the characters of the odontophore came to be studied, it was first thought that they would furnish a simple means of classification, and an infallible method of determination. At the present time, the best authorities have abandoned nearly all the classifications of the Gasteropoda based upon the characters of this member alone, and give to it an importance about equal in value to that of the shell. Thus it will be seen that the radula still holds an important position in the study of the mollusca, but is not of the greatest value.

Several of the steps indicated in the following directions for preparing the radulæ of the Odontophora, for microscopical study, and for permanent preservation, have been employed by previous investigators in this department of research ; but it is believed that some novel features are here described, and the entire sequence of processes is reduced to a system, which will be found to produce uniform and satisfactory results. At first, I adopted the methods in common use, and found that for the work which I had undertaken, namely, the study of the lingual dentitions of the American fresh-water species of *Rissoideæ*, I

could not attain the desired degree of excellence in the preparation of the radulæ, which would enable me to make a complete study of their various features. This led to a long series of experiments, performed with all the principal reagents used in microscopical investigation. An enumeration of these experiments would add but little to our knowledge, beyond the fact that most reagents are useless for this work, and many are of but little value.

When manipulating with such small objects as the lingual ribbons of our *Rissoideæ*, small species of *Planorbis*, *Goniobasis*, *Pupa*, *Vertigo*, etc., simplicity is of the greatest moment, for in transferring the radula from one dish to another, and passing it through successive reagents, it is very likely to be lost, or so mutilated in handling as to be worthless. Therefore, a complicated or laborious method is to be avoided if possible.

The transparency of the objects is also another obstacle to be overcome, and while mounting media can be selected of a different refractive index, yet the loss of absolute and reliable differentiation, from the reflection of light from the polished denticles, the interference of perspective in media of low refractive indices, and the diffraction lines produced by the minute denticles, render it extremely desirable to stain the specimens, and to mount them in a highly refractive medium, or one that nearly agrees with the refraction of the objects themselves.

METHOD OF PREPARATION.—The shells having first been boiled or placed in alcohol to kill the organisms, the animals are extracted from their shells by drawing them out with a mounted needle or hook, and in the larger species the head is cut off, and the remainder of the animal rejected. In the minute species, the shell may be removed by hydrochloric acid. Either process may be employed, to equal advantage, upon shells which contain the dried remains of the animals.

The specimens are then placed in a small porcelain crucible containing water, in a sand bath over a Bunsen burner. A little boiling will soon render them in a condition for the rapid action of a small piece of caustic potash, which is next placed in the crucible, and the whole allowed to boil until the tissues have become disintegrated and partially combined with the potash. The action of the potash should not be continued after it has completed its work upon the tissues, as continued boiling will

attack the thin membrane, upon which are situated the lingual teeth, and which holds them in position.

After removal from the burner, water is added and the undissolved material allowed to precipitate. With a pipette having a rubber bulb, or by decanting, the fluid is nearly all removed, and clean water again added. This is repeated, until the potash and light flocculent matter are eliminated.

The residue is then washed into a flat-bottomed dish, or large watch crystal, and the radulæ, in the majority of cases, can be perceived by the unassisted eye, and removed, by means of fine, mounted needles, to another receptacle containing a very small amount of water. In case the radulæ are very small, the material is transferred drop by drop, with a pipette, and examined, under a one inch or three-quarter inch objective, on the horizontal stage of a microscope, preferably furnished with an erector. They can then be removed from the mass of extraneous matter, and placed in a separate receptacle, as in the former instance.

A drop of strong chromic acid is added to the specimens, and in from one to two minutes the teeth on the radulæ are stained a light yellow or amber color. After washing out the chromic acid, the specimens are dehydrated in the usual way, and after removing the alcohol with a pipette, absorbent paper, and partial evaporation, oil of cloves is added, and the specimens are ready for mounting in Canada balsam.

The lingual membranes will be found to be more or less coiled, and usually attached to the jaws. It is desirable, in the mounted specimen, to have the membrane flattened out, with the dentiferous side uppermost, and dissociated from the jaw. Some species have a large strong jaw, which, if left with the lingual membrane, will raise the cover glass so far above the denticles as to exclude the use of the higher powers of the microscope. Therefore, some mechanical work is necessary to unfold the radula, and remove the jaw. Having provided a clean glass slide on the turn-table, the specimen is taken from the clove oil and centered on the slide. Now placed under the microscope provided with an erector, and using mounted needles, the radula is easily unrolled with the dentiferous side uppermost and the jaw removed. Replaced upon the turn-table, a thin cover-glass is superimposed and centered. The cover-

glass should be put on before the balsam is added as it prevents the specimen from again becoming coiled or displaced. A drop of balsam in benzole is put adjacent to the edge of the cover, and the slide held an instant over a gas burner or alcohol lamp, which will cause the balsam to flow by capillarity under the cover-glass. A small spring-clip is then used to press the cover down and hold it in place. The slide is removed to a drying oven, and left until the balsam has hardened, so that the portion outside the cover can be scraped off. The slide is then cleaned by washing in strong alcohol, using a piece of soft tissue paper to rub it dry. It is quite essential to use cover-glasses of known thickness. Many radulæ require a one-tenth inch objective. The convexity of the object combined with the thickness of the cover, necessitates the use of very thin glass. For the *Rissoïde*, I have usually employed glass of .004 inch thickness.

The finishing and labelling of the slide are matters of individual taste, and are not requisite to the success of the preparation, except that the cover must not be piled high with varnishes and cements, which will interfere with the use of high magnifying powers. My usual method is to run a small ring of shellac around the edge of the cover, and, in case of bad centering, or other slight defects of mounting and cleaning, or often for pure ornament, to add colored rings with a very fine brush. The colored varnishes are composed of the best tube oil colors, dissolved in chloroform and reduced with balsam in benzole. These colors are translucent, permanent and ornamental.

The advantage of using an erector, for delicate manipulations under the microscope, cannot be overestimated, as the best success can thus easily be obtained. We may learn to use one hand in reversed movement, but it is almost impossible to govern both hands, so that these delicate objects may be safely handled.

Some good preparations were obtained by substituting nitrate of silver for the chromic acid, as a staining reagent; but the specimens require boiling in the silver solution, and this additional step further complicates the process, and makes it less possible to retain small specimens. Besides, too much action of the silver renders the objects opaque.

In conclusion, I may say that with rare and minute species of shells, the entire sequence of steps, in the preparation of the radula, may be performed upon the slide, with the assurance that the object cannot easily escape.

CHOLERA ASIATICA.

BY WILLIAM H. BATES, M. D.

(Read October 21st, 1887.)

The name chosen to designate this disease was extremely inappropriate, having been used since the days of Hippocrates for a complaint attended with a flux of bile—Χολή. Whereas the Indian disease was marked by an absence of bile in the matters vomited, or discharged from the bowels. For a time, therefore, there was much confusion, and the epithets "Asiatic," "epidemic" and "malignant" were commonly applied to the new malady, by way of distinction from the former affection.

In the winter of 1817-'18 there appeared in the camp of the Marquis of Hastings, then engaged in the Mahratta war, on the banks of the Sind, a very fatal malady, attended with vomiting and purging. It is now believed to have prevailed in India from time to time during the previous century, and indeed as far back as history goes. But it was then taken for a new disease, and created the utmost terror. During the next few years it spread over a large part of Asia, in the following order: In 1818 in Burmah, Arracan and Mallacca; 1819 in Penang, Sumatra, Siam, Ceylon and the Mauritius; 1820 in Tonquin China and China; 1822-'23-'24 in all China; and in 1827 in Chinese Tartary. Turning to the West, we find it in July, 1821, at Muscat and the Persian Gulf; in 1823-'29-'30 in Persia; and in 1823 in Astrachan, without spreading further westward for some time, *i. e.* until 1829, when it made its appearance at Orenburgh through Tartary, revisited Astrachan in 1830, and then started on its course through Europe. It continued slowly westward, and in May, 1831, it was severe at Moscow and Warsaw; and in July of the same year at St. Petersburg and Cronstadt; and in October at Berlin and Vienna. The first cases in England appeared at Sunderland in October, 1831. This fatal malady ravaged the whole of Europe, and left that quarter of the globe in 1837, the last place affected being Rome. In 1832 it crossed the Atlantic and reached Quebec, and extended over the United States. Besides the first great epidemic above mentioned, the western parts of the world have suffered from two severe visitations of Cholera, *viz.*, in 1848-'49 and in 1853-'54. In 1866 Europe and America were again visited, and in

1868 it was very severe in South America. In 1872, and again in 1873-'74 it was destructive in Hungary, Poland and Prussia. In 1873 it caused great mortality in several towns in the Mississippi valley. Yokohama, Japan, and Canton, China, were severely visited in 1877. Cholera seems to have spread East, South, West and North from its birth-place in Bengal, which became but the centre of an epidemic area, comprising nearly all the world. It travelled slowly at first, and not continuously, but in irregular waves—checked sometimes, but not destroyed by winter's cold. Neither climate, nor season, nor earth, nor ocean seem to have arrested its course, or altered its features. It was equally destructive at St. Petersburg and Moscow, as it was in India; as fierce and irresistible amongst the snows of Russia as in the sunburned regions of India; as destructive in the vapory districts of Burmah as in the parched provinces of Hindostan.

The onset of this malady may be gradual or sudden. After exposure to the exciting cause of the disease, there is a period of incubation, which is believed to be generally two or three days, but sometimes not more than twelve or twenty-four hours. Dr. Goodeor, in Reynold's System of Medicine, cites an instance, recorded by Dr. Barry, in which a detachment of Sepoys, on their march from one place, free from Cholera, to another passed through a village where it was raging. One of the Sepoys was attacked after forty hours, and fresh cases appeared subsequently.

When the disease sets in gradually the earliest symptom is generally diarrhœa, which is often called "premonitory," and which may be attended with a sense of exhaustion. In some cases occur depression of spirits, malaise, headache, vertigo, noises in the ears and oppression of the epigastrium. The countenance of a patient during the premonitory stage is often pallid, anxious, and sorrowful. Cases have been cited where the approach of Cholera has been suspected mainly from the aspect of the patient, hours before the characteristic symptoms appeared. The premonitory stage may last from a few hours to two or three days. In many instances it is altogether absent. In more than half the cases it is said to begin in the early morning, perhaps waking the patient up from sleep. It sets in with violent purging. The contents of the bowels are rapidly swept

out in a fluid form, and the discharges soon become almost colorless, like whey, or like water, in which rice has been boiled ; so that they are commonly spoken of as "rice-water" evacuations. On standing, this fluid deposits a loose, whitish gray material, which consists of mucous flocculi, containing numerous leucocytes, and immense numbers of granules, including many bacteria. This flow is sometimes most profuse. The specific gravity of this liquid is 1.006 to 1.013. It has a neutral or slightly alkaline reaction, and contains chiefly sodium chloride with a quantity of albumen. So profuse is the flow that several pints or quarts may be voided in a few hours. When collected in a vessel it may be of a light yellowish color at first, owing to a slight admixture of bile. Sometimes a pinkish tinge is caused by the admixture of blood. Often there is no pain in the bowels, but sometimes patients complain of griping pains in the abdomen. After an interval vomiting sets in. The fluid rejected from the stomach, unless mixed with food, is pale and watery, being identical with the "rice-water" liquid. There are also crampings of the muscles of the feet and calves of the legs, and sometimes cramps of the thighs, hands, chest and abdomen are among the early symptoms. In many cases they may be absent.

These symptoms are usually followed, more or less rapidly, by the development of a very remarkable condition known as "collapse," sometimes described by some writers as the "algid stage" of the disease. It usually occurs within six or seven hours after the commencement of the purging, and often earlier. Occasionally the patient dies collapsed, before there has been any evacuation, the rice-water being found in the intestines after death. This collapsed condition is due to the failure of the circulation, beginning at the periphery, but afterwards affecting parts nearer the heart. The pulse at the wrist becomes more and more feeble and thread-like, until it is altogether imperceptible. This condition of collapse frequently leads directly to a fatal termination, which usually takes place between twelve and twenty-four hours after the commencement of the attack ; but sometimes earlier, and sometimes during the second day. Reaction not infrequently, where collapse in extreme form has existed, takes place in from twenty-four to forty-eight hours. Improvement occurs slowly.

Regarding the cause of Cholera much has been learned during

the last fifty years. It may be taken as an established fact, that its diffusion over the world from India results from human intercourse. During its first entry into Russia, and its spread through northern Europe in a north-westerly direction, it was supposed by many physicians to owe its dissemination to some mysterious atmospheric, or telluric agent. But its slow and halting progress rendered such a view improbable. A remarkable circumstance regarding Cholera is, that although it has spread to almost every part of the world, and has sometimes prevailed under widely different thermometric and other conditions, it seems to be capable of establishing itself permanently only in India, and in a particular region of that country.

With regard to the mode of diffusion of Cholera, it but seldom passes from a sick person to one who nurses him. It is believed, and I might say pretty conclusively demonstrated, that the contagion of Cholera escapes with the rice-water evacuations, and these are believed to be only infective at a certain stage of their decomposition, and not when fresh. Evidence in support of this view resulted from the experiments made by Thiersch and Sanderson. In experiments on mice by Sanderson, with the liquid one day old, 11 per cent. of them died; two days old, 36 per cent. died; three days old, 100 per cent.; four days old, 71 per cent.; five days old, 40 per cent.; and at six days old, it became innocuous again. The morbid appearance, found in mice after death, appeared to be consistent with the view that death resulted from Cholera.

Regarding the more recent views, and the discovery of the Comma Bacillus by Koch, which is usually found in the evacuations, I will say nothing. The gentlemen, who present their views this evening, will exhibit and explain the peculiarities and mode of growth distinguishing it from other forms similar in appearance.

NEUROSIS OF CHOLERA.

BY L. SCHÖNEY, M. D.

(Read October 21st, 1887.)

One of the ingenious theories propounded with regard to the cause of Cholera is that of Dr. Chapman. We may call it the Neurotic Theory. Dr. Chapman ascribes Cholera to a dis-

turbance of the nerve centres. Diarrhœal discharges have been frequently claimed to have a purely neurotic origin.

It means an excessive activity in the spinal cord, and in the sympathetic nervous centres, combined with a superabundance of blood in these organs. Dr. Auzont, a French physician, says "Cholera is to the great sympathetic (nerve) what Epilepsy is to the brain. From pursuing the symptoms of different cases any unbiased observer must admit, that Cholera is to a large extent a disorder of the nervous system, notably the sympathetic."

Dr. Chapman's treatment consists of the spinal ice-bag. At the last meeting I mentioned another treatment, which reports enthusiastic success, and whose author is Dr. Peacan, of Buenos Ayres, S. A. He bases his treatment on the Neurotic Theory, and applies actual cautery to the condyle of the lower jaw, behind the right ear, with a view of *stimulating the pneumogastric nerve, and thus paralyzing the action of the sympathetic on the abdomen.*

RECONCILIATION OF THEORIES OF CHOLERA.—This Neurotic Theory is not adduced here merely to add something to the innumerable theories, all of which have a more microscopical origin and demonstration, while the Sympathetic Nerve Theory has only clinical results to show ; but for the sake of reconciling the vehement opposition and contradiction of the two schools—the German and the English schools—notably those of Koch and Klein.

To this end I propose the following compromise: Every one, who has lived in an epidemic, like Cholera, Typhus, Yellow Fever, or even Smallpox, has seen cases of a simulating character, caused by nervous shock. They may appear, or begin as imaginary at first, yet they become real—real in a symptomatic sense, real as a true nervous shock, real even in fatal result. I was in Paris in '67, during an endemic of Puerperal Fever in the lying-in ward of the Hotel Dieu. One morning, when we came in inquiring about a certain number in a ward, which were sick a few days before, we met the nurses in the court-yard of the Hospital in a frantic condition. "They are all dying," was their frightened report. Even those who were not sick a day before, and had no contact by nurses or otherwise with distant wards, had through nervous shocks been severely attacked with

fever, simulating in many symptoms Puerperal Fever. Some of these died ; while others really sick with specific puerperal poison, recovered. During epidemics of Smallpox even, I saw persons from mere fright not only become nervously shocked and highly fevered, but affected with a rash, which was of course of neurotic, or indigestive origin.

To be short : in Cholera epidemics thoroughly neurotic cases are not only not rare, but of a very intensive nature. There is a form which the French call, Cholera "foudroyant"—lightning-quick, or thunderstruck. It is a form, as you may infer from the term applied to it, acute—very acute, a very severe form. Now in these acute cases, Dr. Klein, of London, who is the chief opponent of Dr. Koch's Comma Bacillus theory, found no specific bacteria. But these, as we explained above, were indeed no specific cholera cases, but were mere neurotic cases, while the cholera patients, who developed the regular symptoms, never failed to reveal the commas in the intestines, after an honest search at the necropsy. In short there is a bacillous Cholera, and a non-bacillous, or neurotic Cholera. The bacillous, or genuine Cholera Asiatica is also to a great extent of neurotic character in its action. Yet the non-bacillous is merely one purely so—neurotic "kat exochen." There is an analogy to be found in Phthisis. There exists a bacillous and a non-bacillous Phthisis as Dr. Tradeau has shown. Perhaps also there is a dualism in Hay Fever.

To differentiate the three Comma Bacilli of Asiatic Cholera of Koch, Cholera nostras of Prior and Finkler, and the one discovered by Deneke in old cheese, which cannot be distinguished by the microscope, we must resort to the test by culture. They behave quite differently in their mode of growth. The pure culture of the germ of Asiatic Cholera, when planted in a test tube of gelatine, grows in the form of a funnel, but does not liquify the gelatine. It spreads in a granular mass. The Hog-Cholera germ liquifies slowly, and the Cheese bacillus liquifies rapidly the gelatine in which it is planted.

Another easier test is the chemical test discovered by Dr. Beijwid (*Zeitschrift für Hygiene*). If a five per cent. solution of hydrochloric acid is mixed with a bouillon of cholera germs, the mixture will turn rose-violet, and this color will intensify for half an hour, after which it will remain stationary.

THE COMMA BACILLUS, THE REPUTED CAUSE OF
ASIATIC CHOLERA.

BY P. H. DUDLEY, C. E.

(Read October 21st, 1887.)

Dr. Billings, Surgeon General of the United States Army, in a Lecture before the New York Academy of Sciences, stated that the home of Asiatic Cholera was in the Delta of the Ganges, the home of Yellow Fever in the West Indies, and the home of the Plague in the Valley of the Euphrates. It seems to be a well-established fact, that Cholera breaking out in other territory can be traced back to its home as the origin of the epidemic, the germs having been carried by travellers on land or sea, and in many cases not by the persons, but in clothing packed in trunks, etc.

Koch, the discoverer of the Comma Bacillus, the reputed cause of Cholera, is reported as saying that "the germs are destroyed by drying." While this may be true of the Bacilli, when in the form of those shown in the unmounted photomicrograph, taken from a slide said to be from his Laboratory, it is doubtful whether the spores would be killed by drying. Probably some of the members have made culture slides of this Bacillus, and can answer the question.

It seems probable that the spores can be disseminated some distance by the air, as they are found in collected rain-water in India. How far this distance may be is of considerable interest, but it is hoped it is quite within the limits of Quarantine of this city.

What will destroy the germs is another question of great importance. For upon proper germicides largely depends the success of the efforts at Quarantine to prevent the ingress of the Cholera to this country. Does experience show that fuming clothing and vessels with sulphur effectually kills the germs? Must heat above 212° also be employed?

The Photomicrograph, showing the destruction of the mucous coat of the intestines, will be of interest. It is thought that a few Bacilli can be seen in this view.

THALLOPHYTES IN MEDICINAL SOLUTIONS.*

BY ROBERT G. ECCLES, M. D.

(Read before "The Medical Microscopical Society of Brooklyn," N. Y., October 5th, 1887.)

Most educated Pharmacists are aware of the fact, that aqueous supplies of medicine are subject to pollution during warm weather, even if prepared with, what is ordinarily considered, scrupulous care as to cleanliness. Unidentified forms of cryptogamous vegetation develop therein from spores, which the air, water, drug or vessel supplies. Finding proper conditions for development, they soon form slimy, stringy masses of what is no doubt the mycelium of plants, which on more solid support would fructify aerially. Soda water and ginger ale dealers have the same pests to contend with. Technically they speak of their beverages as "ropy" when so infected. Among the branching masses are usually found great numbers of motile bacteria and micrococci.

It is now becoming a pretty well understood fact that these lower forms of life protrude their unwelcome presence wherever anything can be found for them to live upon. No longer is civilized man compelled to contend with wild beasts for the mastery of the earth. Lions, tigers, wolves and hyenas are almost entirely suppressed. Guns and bows now give place to microscopes and culture tubes, as we hunt up foes our fathers knew not. They were then even more subject to attack from this quarter than we are, but fancied they had to deal with demons, or visitations of heaven for their sinfulness. We can still truthfully say, however, that their name is legion.

These lowly organisms wage incessant war upon our foods, beverages, and medicines, and as is now well known spare not even our bodies. Butchers, bakers, millers, grocers, fish-men, farmers, fruit-dealers and gardeners all have to fight them. To their presence is due all kinds of sickening deteriorations and decompositions. Their approach to omnipresence has given rise to the canning of milk, meat, fish and vegetables, and to the keeping and transportation of such goods by refrigeration. They wage incessant and relentless war against biological weak-

* For the illustrations of this article we are indebted to the courtesy of the Editor of the *Pharmaceutical Record*.

ness. As soon as vitality is diminished in an organized body their hungry attack begins.

If they were all of a kind, or even of but a few kinds, we might hope to exterminate, or fully control them. Their habits, appearances, and powers vary so widely that their study is almost hopelessly complex. Even their classification is a matter of dispute and doubt. Some of them are so unlike either plants or animals, that the proposal has been made to give them a sub-kingdom of their own. They have been referred to as fungi and algæ, but the lines run so confusedly into each other, that this method of distinction is being abandoned for that of Sachs, which includes the whole debatable ground under the name, Thallophytes.

The number of known Thallophytes, formerly included under the title, fungi, rises up among the hundreds of thousands. Many of them pass through successive changes in their life history, which at various stages give such diverse characteristics, that the most careful investigators are baffled in attempting to find their place in nature. Two Mycologists, viewing the same genera, species, or even varieties, in different stages, may give them totally different names, as well as descriptions, and put them in families exceedingly remote. It will probably be a long time before this trouble is obviated.

Of the forms that infect our medical supplies, no less than thirty different kinds are found in the solutions presented here to-night. It is quite probable that an increase in the number of samples would add materially to the number of kinds that could be discovered.

Exhibit 1., under the first microscope, is a sample of infected dilute Phosphoric Acid (Fig. 1). The engraving represents one view of this object. The long, branching, obscurely jointed stems constitute the most conspicuous thing in sight. A closer inspection will reveal numerous minute motile specks, and little rod-like masses squirming and twisting, like the larvæ of flies in a piece of spoiled meat. The very minute bodies are living micrococci, and the somewhat larger ones are innominate bacteria. Some of them are probably *Bacterium termo*. It is unusual to see these minute plant-forms in their active state. Generally such exhibits are of dead, stained forms. What adds greater interest to these is the fact, that every slide before us to-night is

a closed cell, where they have been hermetically sealed for two years and three months. In spite of their long confinement they are yet alive, but their movements are not as quick as when first mounted.

When first mounted, and in fresh specimens generally, what are apparently transition forms, between the bacteria and the jointed mycelium, can be found. These led your essayist to believe that the latter were spores, from which the former developed. Prof. Farlow, the Mycologist of Harvard University, thought this must be a mistake, when told of it. That these



FIG. 1.—From Dilute Phosphoric Acid.

transition forms are there is certain, but that the smaller masses are veritable bacteria may be doubtful. Polymorphism is a well-known fact among Thallophytes, but to trace direct relationship between gutter-bacteria and higher fungi would indeed be startling. When some of the threads were transplanted to moist bread under a bell glass, a crop of *Pencillium glaucum* appeared. Other solutions, having growths differing markedly in appearance from those of dilute Phosphoric Acid, when transplanted in a similar manner, gave a variety of *Pencilliums*,

Mucors, *Zasmidium*s, etc. These may have been sown during transplantation, or have pre-existed as spores in the bread. That they appeared, and that a repetition of the experiment gave nearly the same results, made it look as if an actual kinship existed between the aerial growth and fructification, and the subaqueous threads.

From the Orange-Flower Water specimen, no growth on the bread resembled in the least the spiral structure shown in the



FIG. 2.—From Orange-Flower Water.

drawing (Fig. 2). Prof. Farlow thought it might be a parasite, known to exist in southern forests. A large variety of strange forms can usually be found in this water. The writer has never seen a specimen free from them.

The most interesting specimen to watch is that from a solution of Strychnine (Fig. 3). The peculiar, swollen appearance of the joints at various places, and the motile protoplasm they contain, either as their own spores or attacking parasites, make them well worth studying. This drawing, as well as most of the others, was executed by following the branches, while lowering and raising the objective to suit the sight. In this

way every dip is traced upon the level surface. The minute motile masses appear to the eye as if endowed with independent will. Now they are spinning like a top with only the tips visible, and again writhing like a serpent at full length. Like caged animals, they run from end to end of the imprisoning sheath, and sometimes roll over and over each other, like boys playing a game of leap-frog. The sheath is like the segment of a joint-rush, with a septum at each end, but having transparent walls.

In Orange-Flower Water we find living spirilla that are like-

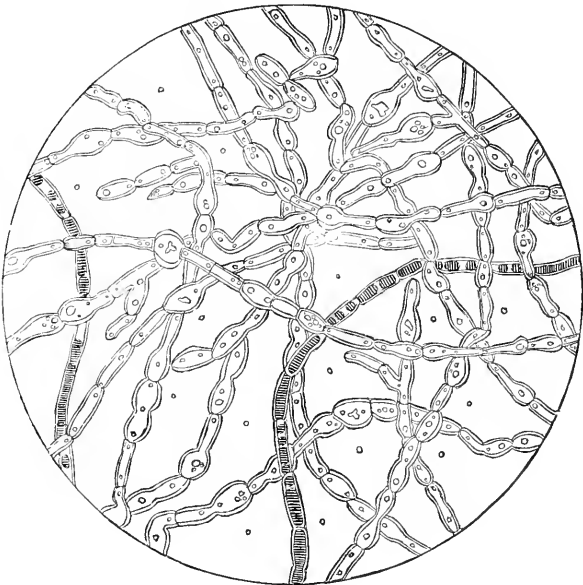

FIG. 3.—From Sulphate of Strychnia.

wise motile at the proper season. When death overtakes them they look like Koch's Comma bacilli.

In Cinnamon-Water only bacterial forms have yet been seen, and these evidently decompose the essential oil. As they increase the water weakens, and cinnamonic acid crystals appear.

In Sulpho-Cyanate of Potassium (Fig. 4), Carbonate of Barium and Phosphate of Sodium organisms containing Chloro-

phyll appear. At first they are very like Micrococci, and appear in chains. Finally some of them enlarge, and develop a distinct nucleus containing the green color. By the old method of classification these would have been Fungi if seen young, and Algæ in old age. Now we make them Thallophytes in either condition.

In solutions of the Salts of Morphia (Fig. 5) the long stringy masses that invade other solutions of alkaloidal salts seldom, if ever, appear. After a successive series of trials, only motile bacteria and innominate bacilli have been developed. Coinci-

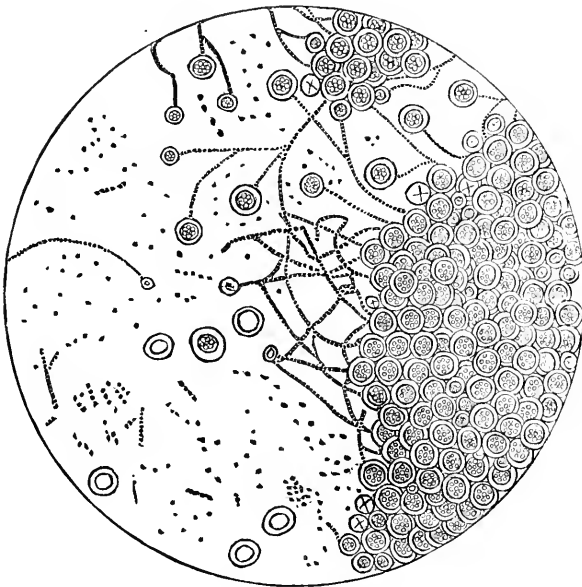

FIG. 4.—From Sulpho-Cyanate of Potassium.

dent with their appearance, a crystalline precipitate is found at the bottom of the containing vessel. This has not yet been examined chemically. Its brownish hue would seem to indicate that some sort of decomposition had occurred. The claim was put forth about a year ago that Apomorphia appeared under such circumstances, where only a salt of Morphia had been before. Patients are said to have acted as if an emetic had been swallowed, on the administration of old specimens. An

English chemist got negative results, on examining an old sample a few months ago.

The reason, why tinctures containing alcohol, and fluid extracts containing glycerine, took so largely the place of infusions and decoctions, probably resides in the fact, that alcohol and glycerine are antiseptic, and protect for an indefinite period their solutions from infection. A number of proprietary syrups, and so-called fluid extracts, prepared by men badly posted in pharmacy, cannot be kept long when the bottle is open. Doctors often order these in their prescriptions. If you are among



FIG. 5.—From Muriate of Morphia.

those who do so, and you find them bacteria-laden and mouldy, blame yourself only. Elixirs, like wines and tinctures, contain enough alcohol to protect them against these growths. With solutions of alkaloids and their salts, other methods of protection must be resorted to, or they must be prepared in small quantities, and as needed. Camphor-Water, Chloral, Corrosive Sublimate, Salicylic Acid, Boric Acid and Benzoic Acid are a few of the antiseptics now used. The two last are probably the best, all things considered. Such alkaloids as Strychnine and

Morphine, that will not decompose at a low temperature, can be sterilized in solution, by raising to the boiling point and securely corking. In this way they will keep for years.

The hygienic considerations connected with this subject are of the first importance to us as medical men. Can it be conducive to health to swallow any of these, whatever their name, shape or order? It is positively known that *Mistura Creta*, prepared from decomposed Cinnamon-Water, has made cases of summer complaint in children worse, and induced emesis at every dose. The *London Lancet* (Jan. 29th, 1885, p. 224.) showed that solutions containing such growths, irritated and eroded mucous membranes to which they were applied. The Mucors have been found in the stomachs of dogs in full fruition, in spite of the presence of gastric juice. They grew and flourished there embedded in its walls. Almost every tissue of birds and beasts have been found infested with them. Sternberg, in his work on Bacteria, p. 293, gives a drawing of a growth from the fauces of patients suffering with Anginal Scarlatina, that is exceedingly like some of these we are studying to-night. Hypodermic injections of solutions of alkaloids often produce bad abscesses in an unaccountable manner. After investigation clears up the trouble, by showing the solutions to be infected with these plants. Too much care cannot be taken in seeing to the purity and cleanliness of the drugs we prescribe. Probably half the druggists of the country never notice these changes in their solutions, or suppose them to be mere precipitates of the active agents, and therefore harmless. Very few of them indeed know that wriggling, twining maggot-like bodies are there, the thought of swallowing which is enough to turn one's stomach, even if they did not physically act as emetics. Until they are taught these facts no effort at improvement can be so much as hoped for. Some of them even melt ice, and use it as distilled water, to put up such solutions with, and we all know, that our supply of ice from the Hudson is contaminated with the sewerage of Albany and Troy, containing typhoid fever germs. Our bodies may have strength enough to resist the small number of these, introduced from a glass of ice-water, but when druggists deliberately use our medical supplies as culture fluids, who knows when they may raise the number so high, that the disease is given to patients with minor affections?

The question as to whether these growths act as ferments, and decompose the solutions in which they are found, has been raised. Those that develop in such solutions, as Barium Carbonate, Phosphoric Acid, Boric Acid and Zinc Sulphate, cannot possibly act on these salts. Experiments show that, after standing for many months, diluted Phosphoric Acid loses none of its strength. The same is the case with Solution of Strychnia Sulphate. Other alkaloids that have been tried show a decrease in quantity, but they are such as are likely to decompose spontaneously, like Eserine, Morphine, Atropine and Cocaine. Old solutions of Sodium Phosphate (HNa_2PO_4) containing algæ give off oxygen gas; whether by decomposition of the salt, or of carbonic acid has not been determined. Those that do not live upon the dissolved salts must depend for sustenance upon carbonic acid, absorbed from the air. Several trials, made to determine this point, all gave a common result. Vials, containing spores and aqueous solutions, being weighed, with duplicates having the same solutions sterilized, were found to steadily gain in weight over the sterilized ones, as the plants grew larger. They would not grow if hermetically sealed, and grew most vigorously when often exposed to the air by removal of the stoppers.

The bacteria no doubt act as ferments, but the larger growths of stringy, jointed organisms probably have some means of decomposing carbonic acid, as higher plants do. This is, of course, contrary to the generally accepted doctrine, that makes them either parasites or saprophytes, and denies them this ability. If fungi are the primitive forms of plant life, surely at some time in their career they all must have been carbonic acid decomposers. In the early genesis of things, they could neither have been parasites nor saprophytes, unless upon each other, and then some of them evidently decomposed carbonic acid. It is irrational and improbable to suppose that they would all lose even the power of reversion to their primitive state. No one has ever experimentally demonstrated that they do not decompose this gas. The distinction is only traditional. Fermenting fungi doubtlessly do, like animals, exhale vast quantities of carbonic acid. But all plants exhale some. Does this prove that they never decompose this gas and release oxygen? Further examination of this subject is needed, and

we venture to assert that present notions will be modified, if not revolutionized, when it is done. The earliest synthetic, organic chemists of our globe have not lost all their early knowledge, and developed totally into ignorant freebooters.

STRIATED MUSCLE-FIBRE OF THE HEAD OF
HARPALUS CALIGINOSUS, FAB.

BY E. B. GROVE.

(Read October 7th, 1887.)

All at some time have noticed the extraordinary strength, out of all proportion to their size, possessed by insects of all genera, but especially by those which are classed with the coleoptera. Numbers of anecdotes and accounts of what has been witnessed of feats of strength can be found, not only in books treating of scientific subjects, but also, from time to time, in newspapers and periodicals not strictly scientific.

It may safely be said that at least two-thirds of these accounts have reference to the various feats performed by insects, walking under and moving heavy weights, or in drawing the same. The remaining one-third is of feats performed by the mandibles, and can be explained by the wonderful muscular system seated in the head.

From time immemorial the strength of the mandibles of the *Lucanus cervus*, the European stag-beetle, has been commented upon by all naturalists. There is an authentic account of one having gnawed or rasped a hole one inch in diameter through the side of an iron canister in which it was imprisoned. And our American species of the *Lucanus*, also, will at least speedily free itself from any pasteboard or thin wood box in which it is confined.

While making no pretence to being either a histologist or anatomist, I have always been interested in the economic anatomy of all insects, especially of their digestive and muscular systems. Many fine specimens of butterflies, moths and beetles have I ruthlessly "cut up," in the quest for knowledge as to their life and habits, rather than mount them and place them in my cabinet.

Muscles are structures of an elastic nature, which under the effect of certain irritations are capable of altering their form, *i.*

e., becoming shorter and thicker. In all vertebrates, but especially of the higher orders, they constitute the mass that is called flesh. They are covered by tendinous sheaths, and are united by the so-called connective tissue. But in insects the fibres are not so united. They are deficient in the tendinous sheaths, and are attached directly to the cutaneous exo-skeleton, as in the crustacean.

These muscle-fibres are divided into two kinds—striated and smooth. The striated fibres are thus named because they are apparently streaked at right angles across the longitudinal direction of the fibre. And they may be compared, as viewed microscopically, to a roll of coin. It is a grave and unsettled question as to what these striations or streaks are. When fibres are treated with certain reagents, they separate along the lines of the striations into discs. Other reagents, on the contrary, cause them to split up longitudinally into still finer fibres. Dr. Rosenthal, in his work on "Muscles and Nerves," says: "It is impossible to affirm that either the discoid or fibrilloid structures actually exist in the muscle-fibre itself," and "it can be shown that the fibre, when taken from the living animal, is of a semi-fluid consistency, and it must rather be assumed that both forms of structure are really the results of the application of the reagents, that solidify the semi-fluid mass, and split it up in a longitudinal or transverse direction."

These striated muscle-fibres, in all animal life, are acted upon directly through the nervous system by the will, and for this reason are called the voluntary muscles. The smooth muscle-fibres, on the contrary, are not so acted upon, and are termed the involuntary muscles. There is but one exception to this rule. The heart is provided with striated muscle-fibres, and yet works independently of the will. Smooth muscle-fibres contract by local irritation, produced by certain matter in the organs which they surround, or of which they form a component part.

Wagner states that the muscular system of insects consists of distinct, isolated, straight fibres, which are not gathered into bundles, nor united by common tendons, and are *often* striated. Siebold, on the contrary, states that not only the voluntary muscles are striated, but often those of the organic life—*i. e.*, the involuntary muscles of the digestive organs—are striated.

Upon dissection of a beetle, either in its larval or perfect form, it will be found that the muscular system is most complex in the head. This is rendered necessary by the work demanded of the head-organs, especially the mandibles. *Harpalus caliginosus*, which I have selected as a type, belongs to the *Carabidæ*, or carnivorous beetles, and, like all of its family, renders great service to mankind by feeding upon other insects, which are injurious to vegetation. It is one of our most common American species, and may be seen, in company with the more gaudily-colored *Calosomæ*, busily engaged in hunting for its prey. And although not so attractive to the eye as the others, it is fully as destructive to insect life. Woe betide any insect that comes within the range of its eyes. From the soft-bodied Aphis to the almost metallic-coated Buprestian, all is "fish" that comes to its net, in either larval or perfect form. Its larva is equally as destructive. I have seen a female *Harpalus* seize a *Buprestis*—the *Chrysobothris Harrisii*, the body-crust of which is hard enough to turn the edge of the best scalpel made—and rend it to pieces with its mandibles, in a shorter time than I have taken in the description.

By examining the inner surface and contents of the head, it can readily be seen from what source the immense strength possessed by the mandibles is obtained. Almost the whole contents of that portion of the body consist of muscle-fibres, acting directly upon its organs. A look at the hurriedly-prepared dissection of the head of one of these beetles, which is here on exhibition, will show this fact. Everything but the muscle-fibres has been removed, and only the large flat or round fibres remain. Several of these at their front ends form their connections with the mouth appendages, but still connect with the head by their rear ends. It can be seen that they are arranged in various layers, or, as Newport calls them, *systems*. Lyonnet counted in the head of the *Cossus* some 228 distinct muscles. I have not counted those in the head of *Harpalus*, but should judge that they were fully as many. This number seems almost incredible. Yet, when we consider the various appendages of the head which are dependent upon these muscles for their various movements, it is not so wonderful. The movements of the antennæ, of the mandibles, of the various other parts of the

mouth and tongue, and also of the head itself, are produced by these muscles.

These striated muscle-fibres, when dissected out, as may be seen in the other slide on exhibition, consist, as stated before, of fibres that are streaked or striated across their length. They seem to be more strongly and coarsely marked than the corresponding muscles in man. A slide of human striated fibre is on the table, and can be compared with that of the *Harpalus*, and the difference will be noticed.

The commonly-accepted theory has been that the striated muscle-fibres of insects are not rounded at the ends, as they are in the vertebrates. But you will notice in the slide under the microscope, that a number of the *round* fibres have perfectly-rounded ends.

The contractile powers of the striated muscle-fibres in vertebrates have been minutely and carefully studied and described by many eminent histologists and biologists, of both this country and Europe. But little has been done in the way of study or description of these movements in insects. There is a wide field open for such investigations to any who may possess the necessarily-required time and patience. It certainly would be well worth the time spent to ascertain, if possible, by careful dissections and microscopical examinations, whether the nerves enter directly into the muscles, as in the vertebrates, and produce their excitation, and the consequent shortening in length, by a direct so-called nervous-electric shock; or whether they surround the muscle-fibres, and produce the result by a species of induced, or secondary current.

These striated muscle-fibres are of two kinds—flat and round. I have not as yet been able to find the pyramidal fibres, mentioned by anatomists, in the head. These muscles are arranged in layers. Newport and others call each layer a separate system. But there is not as yet any definite opinion on that point, and it can only be settled after long and patient study and examination.

The head muscles are stronger, less easily separated, and of a whiter color than those in other parts of the insect body. And I think it will be found that in the various carnivorous beetles, and their larva, that the fibres are larger than in other beetles.

In closing I would state that in dissecting insects, to reach

any certain results, such dissections must be made as soon as possible after their death, because the character of the internal organs, especially of the muscle and nerve-fibres, changes very quickly when the life is extinct. The best plan is to bring the insect home alive, kill it in the cyanide bottle, and dissect it immediately.

The slides here exhibited were made, unfortunately, from beetles that had been dead some three days before I could get the time to work upon them. Consequently the preparations do not present the same appearance that they would have, were they made from insects recently killed. They are simple laboratory mounts, and are not finished, nor are they intended for the cabinet.

CORRECTION OF THE ARTICLE, "RAISING DIATOMS IN THE LABORATORY."—The following correction of a slight error in the Article, "Raising Diatoms in the Laboratory," published in this JOURNAL, Vol. II., p. 153, has been received from Dr. Lockwood:

"There is a little discrepancy in my Paper on 'Raising Diatoms in the Laboratory,' read before the New-York Microscopical Society, December 17th, 1886, and published in the JOURNAL of the same. Referring, on page 7, to the first series of experiments, they are made to extend 'a little over two years.' This should read, 'a little over one year.' The actual time was nearly fourteen months, as the context plainly shows."—S. LOCKWOOD, Freehold, N. J., October 18th, 1887.

SUPPLEMENT I. TO THE BIBLIOGRAPHY OF THE
FORAMINIFERA, RECENT AND FOSSIL, IN-
CLUDING EOZOON AND RECEPTACULITES.

(PRINTED IN THE FOURTEENTH ANNUAL REPORT OF THE GEOGRAPHICAL AND
NATURAL HISTORY SURVEY OF MINNESOTA, pp. 167-311, 1885.)

BY ANTHONY WOODWARD.

(Received October 26th, 1887.)

EOZOON.

- ANON. On *Eozoon canadense*; by Prof. Wm. King, S. C. D., and T. H. Rowney, Ph. D. *Amer. Journ. Sci.*, ser. 3, vol. i, pp. 138-142, 1871.
- ANON. On the Geological Age and Microscopic Structure of the Serpentine Marble or Ophite of Skye; by Professors W. King and T. H. Rowney (Proc. Roy. Irish Acad., Jan. 1871). On the Mineral Origin of the so-called "Eozoon Canadense," by same (Ib., Apr. 10, 1871). *Amer. Journ. Sci.*, ser. 3, vol. ii, pp. 211-215, 1871.
- ANON. The Eozoon Question—An American Mistake. *Month. Micro. Journ.*, vol. xiii, p. 244, 1875.
- ARBEITEN der geologischen section der Landesdwichforschung in Böhmen, Prag, 1869.
- BAILY (MR.) expresses his doubt that "Eozoon," "the thing in question, was a fossil at all." *Journ. Geol. Soc. Dublin*, vol. i, n. s., 1865.
- BAILY, W. H. The Cambrian Rocks of the British Islands. *Geol. Mag.*, vol. ii, p. 388, 1865.
- BONNEY, T. G. On Serpentine and Associated Rocks of the Lizard District. *Quart. Journ. Geol. Soc.*, vol. xxxiii, pp. 884-924, 1876.

During the discussion which followed the reading of this memoir, and in answer to a question put by the President, the writer replied that "for his own part he believed in the organic nature of *Eozoon*." How this reply is to be reconciled with the following statement Prof. Bonney has lately made—"I have never myself seen a serpentine which was not intrusive" (*Geol. Mag.*, Feb. 1881, p. 94)—is a puzzle to us, as it must be to eozoonists, considering that their doctrine is based on the sedimentary or "aqueous deposition" of "eozoonal" serpentines (see last citation). But is not eozoonism full of inconsistencies? (King and Rowney. An old chapter of the *Geol. Rec.*, p. xlv, 1881.)

- DAWSON, J. W. Origin and History of Life on our Planet. An Address before the Amer. Asso. Adv. Sci. (Detroit meeting), vol. xxiv, 1875. Reprint 26 pp., Montreal, 1875.
 Remark on Eozoon.
- DAWSON, J. W. On the Geological Relations and Mode of Preservation of *Eozoon canadense*. *Rep. Brit. Asso.*, liii, p. 494, 1884.
- DAWSON, J. W. Notes on *Eozoon canadense* (abstract of a paper read before the British Association at Southport, 1883). *The Canadian Rec. of Sci.*, vol. i, pp. 58, 59, 1884.
- DAWSON (SIR), J. W. Remarks on Eozoon, in his Presidential Address before the British Association for the Advancement of Science, Sept., 1886. *The Canadian Rec. Sci.*, vol. ii, pp. 201-228, 1886.
- DE STEFANI, C. Sulle Serpentine Italiane. Estratte dagli *Atti del R. Istituto veneto di scienze, lettere ed arti*, vol. ii, ser. vi., (18 pp.), 1884.
- DUNCAN, P. M. Note on *Eozoon canadense*. *Journ. Roy. Micro. Soc.*, vol. iii, pp. 615, 616, 1883.
- GRATACAP, L. P. The Eozoonal Rock of Manhattan Island. *Amer. Journ. Sci.*, ser. 3, vol. xxxiii, pp. 374-378, 7 woodcuts, 1887.
- GÜMBEL, C. Geognostische Beschreibung des ostbayerisches, Grenzgebirges, 1868.
- HAHN, O. Die Urzelle, nebst dem Beweis dass Granit, Gneiss, Serpentin, Talk, gewisse Sandsteine, auch Basalt, endlich Meteorstein und Meteoreisen aus pflanzen bestehen, 1879.
- HARKNESS (PROF.), R. "*Eozoon*" having been brought under the notice of the Geological Section of the British Association, held in Birmingham of the year, Prof. R. Harkness declared his disbelief in it. "*Reader*," Sept. 30, 1865.
- HARKNESS (PROF.), R. On the Metamorphic and Fossiliferous Rocks of the county of Galway. *Quart. Journ. Geol. Soc.*, vol. xxii, pp. 510, 511, 1866.

With reference to the occurrence of serpentine in connection with the limestones of the metamorphic series of Connemara, this has of late become a matter of some interest, in consequence of the statement that these deposits afford the *Eozoon Canadense*. . . . The supposed organic portions of the serpentinous limestones of Connemara do not result from animal structure, but purely from mineral association. Had fossils of

any kind presented themselves in this district, they ought to have occurred in that portion of the limestone which has been least affected by metamorphic action. (King and Rowney. An old chapter of the Geol. Rec., pp. xx, xxi, 1881.)

HEDDLE, M. T. The Geognosy and Mineralogy of Scotland. *Mineral Mag.*, vol. v, pp. 271-324, figs. 1-11, supports the view of the inorganic origin of the Scotch and Canadian Eozoon. (*Zool. Rec.*, vol. xxi, 1884.) 1884.

HOFFMANN, R. *Eozoon* from Raspenau, in Bohemia. *Journ. für prakt. Chemie*, May, 1869.

An abstract is published in the "American Journal of Science," 3rd ser., vol. i, 1871. (King and Rowney. An old chapter of the Geol. Rec., p. xxii, 1881.)

HUNT, T. S. Note on Eozoon. *Bull. Essex Inst.*, vol. iii, pp. 53, 54, 1871.

HYATT, A. Remarks upon the Eozoon canadense. *Proc. Essex Inst.*, vol. v, p. 110, 1867.

HYATT, A. On the Geological Survey of Essex county. *Bull. Essex Inst.*, vol. iii, pp. 49-53, 1871.

Notes on Eozoon.

J. T. R. A notice of Möbius's Der Bau des Eozoon. *Ann., and Mag. Nat. Hist.*, ser. 5, vol. iii, pp. 314-316, 1879.

KINAHAM, G. H. *Nature*, vol. iii, p. 267, 1871.

The writer draws attention to the fact of its having been announced that Mr. Sandford had "proved the existence of *Eozoon*" in the ophites of Connemara, which, according to Sir R. I. Murchison and Prof. Harkness, are of Lower Silurian (Cambro-Silurian) age. "In other parts will be found square miles upon square miles of rocks of some geological age, often having inliers of limestone; yet in them there is no *Eozoon* Canadense, it only being found in a peculiar rock (pseudomorph dolomite) in this small tract of Lower Silurian rocks, in Far-Connaught." (King and Rowney. An old chapter of the Geol. Rec., p. xxvii, 1881.)

KING, W. and T. H. ROWNEY. On the Geological Age and Microscopic Structure of the Serpentine Marble or Ophite of Skye. *Proc. Roy. Irish Acad.*, ser. 2, vol. i, pp. 137-139, 1871.

This rock, which is well known to be of Jurassic age, contains all the "*Eozoon*" features—"chamber-casts," "intermediate skeleton," "canal system" and "proper wall;" and, as in specimens from Canada, the "chamber-casts are occasionally preserved in, besides serpentine, a dark mineral resembling loganite, also white pyroxene or malacolite! This last mineral occurs in crystalloids which frequently exhibit themselves in a decreted condition internally and externally, the interspaces between them

and their hollowed-out interior being filled with calcite : this substance has clearly resulted from the carbacidization of the calci-magnesian silicate, malacolite. Some of the crystalloids are in shape strikingly resembling the "curiously curved canal system" of Gumbel's "*Eozoon Bavaricum*." (King and Rowney. An old chapter of the Geol. Rec., p. xxviii, 1881.)

KING, W., and T. H. ROWNEY. Remarks on "The Dawn of Life," by Dr. Dawson ; to which is added a supplementary note. *Ann. and Mag. Nat. Hist.*, ser. 4, vol. xvii, pp. 360-377, 1876.

Dr. Dawson, in the work cited, replying to our statement that the laminated character of "*Eozoon*" is a mineralogical phenomenon (of which we had adduced instances), asserts that "the lamination is not like that of any rock, but a strictly limited and definite form, comparable with that of *Stromatopora*." We draw his attention to a specimen of granite from Harris (Hebrides) which consists of alternating laminae of feldspar and quartz, the lamination being *strictly limited* and of *definite form*, and even far more "*Eozoon*" like in this respect than *Stromatopora concentrica*. The specimen was presented to us by our respected friend, the late Prof. R. Harkness. (King and Rowney. An old chapter of the Geol. Rec., p. xxxiv, 1881.)

KING, W., and T. H. ROWNEY. On the Serpentinite of the Lizard, its original Rock-condition. Methyloitic Phenomena, and Structural Simulations of Organisms. *Phil. Mag.*, ser. 5, vol. i, pp. 280-293, 1876.

The rock in many places has undergone a change into saponite, and occasionally into calcite. The former contains bodies of various kinds, strikingly simulating minute corals, vermiform and foraminiferal organisms; the latter contains cylindrical forms and clusters of spherical bodies, resembling Dawson's "*Archæospharinæ*," and branching configurations identical with the "canal system" of *Eozoon*. What appears to be tremolite contains spherical and other bodies wonderfully mimetic of perforated foraminifers, also rods, consisting of saponite, serpentine, flocculite, or calcite. The rods, especially those composed of the last mineral, throw some light on the origin of the "calcareous" examples of the "canal system" inasmuch as their component mineral carbonate is clearly the result of chemical alteration. The serpentine contains examples of chrysotile passing into the "nummuline" or pectinated condition. (King and Rowney. An old chapter of the Geol. Rec., xliii, 1881.)

KING, W., and T. H. ROWNEY. On the Origin of the Mineral, Structural, and Chemical characters of Ophites and related Rocks. *Proc. Roy. Soc.*, No. 197. *Nature*, No. 544, 1879.

The present work is, to a great extent, based on the original memoir, of which the paper under notice is an "abstract." The latter notices the occurrence of "beautiful examples of 'canal system,' resulting from the

waste of crystalloids of malacolite, in the calcaire saccharoïde (hemithrene) of St. Philippe (Vosges), rivalling those in Canadian ophite."

When speaking of this hemithrene (pp. 51, 52) we omitted to mention that besides the "canal system," there are also present rounded grains or crystalloids of pyrosclerite (a serpentinous mineral), occasionally invested with an abestiform mineral related to, if not identical with, chrysotile; the investing fibres, usually in contact, are in many places separated by interpolations of calcite (pl. iii, figs. 2, 3), a fact proving them to correspond with those of the "proper wall" of *Eozoon Canadense*. (King and Rowney. An old chapter of the Geol. Rec., p. xlvii. 1881.)

KING, W., and T. H. ROWNEY. An old chapter of the Geological Record with a new interpretation; or, Rock-Metamorphism (especially the methylosed kind) and its resultant imitations or organisms, with an introduction giving an annotated history of the controversy on the so-called "*Eozoon Canadense*," and an appendix, pp. i-lvii., 1-142; 4 woodcuts, 7 plates, 8°, London, 1881.

KUNTZE, OTTO. *Zur Eozoon-Frage*, 1879.
Anti-eozoonal.

LOGAN (SIR), W. E. The first announcement in connection with the subject of "*Eozoon*" was made by the Sir Wm. E. Logan, Director-General of the Geol. Survey of Canada, in his Report of the year, 1858.

LOGAN (SIR), WM. E. Exhibited at the Meeting of the American Association for the Advancement of Science at Springfield, in August, 1859, some *Stromatopora*-like specimens (noticed in the above Report) from the Grand Calumet and Perth (Canada), which he was "disposed to look upon as fossils." Quart. Jour. Geol. Soc., vol. xxi, p. 48. (King and Rowney. An old chapter of the Geol. Rec., p. ix, 1881.)

LOGAN (SIR), W. E. Report of the Geology of Canada, 1863.

In this Report (pp. 48, 49) the discovery of specimens, supposed to be fossils, is noticed as having been made "by Mr. J. M'Mullen, of the Canada Geological Commission, in the crystalline limestone of the Grand Calumet river, Ottawa), which present parallel or apparently concentric layers, composed of crystalline pyroxene, while the interstices are filled with crystalline carbonate of lime. Dr. James Wilson, of Perth, found loose masses of limestone near the same place containing similar forms—the layers composed of dark green concretionary serpentine, while the interstices are filled with crystalline dolomite. If both are regarded as the results of unaided mineral arrangement, it would seem strange that identical forms should be derived from minerals of such different composi-

tion. If the specimens had been obtained from the altered rocks of the Lower Silurian series, there would have been little hesitation in pronouncing them to be fossils." (King and Rowney. An old chapter of the Geol. Rec., pp. ix, x, 1881.)

MACALISTER (DR.), A. President's Address. *Journ. Roy. Geol. Soc. Ireland*, new ser., vol. iii, p. 101, 1873.

A paragraph devoted to the "Eozoon controversy," and pronounced from the President's Chair of Royal Geological Society of Ireland, requires some little notice. Referring to some memoirs (not named), it is stated that they "occasioned a controversy which, if it did nothing else, turned some attention to the study of micro-petrography, and some at least of the writers displayed a very considerable practical ignorance not only of the appearance of sections of large foraminifera, but also of sections of common forms of rock and of the interpretation of rock-forms as seen by the microscope. With a larger experience of micro-petrography will come, I believe, a full conviction of the true organic nature of *Eozoon Canadense*." It is now eight years since these remarks were made; and undeniably their author had taken considerable pains to master the bibliography of points connected with the subject-matter he touched upon; it is therefore to be assumed that Dr. Macalister still takes a deep interest therein, also that he is perfectly aware his "full conviction" has not yet been realized; hence we would urge on him to endeavour himself to bring about the outcome which he so confidently predicted in his "Address." (King and Rowney. An old chapter of the Geol. Rec., p. xxx, 1881.)

MOORE, C. On the Organic Nature of *Eozoon Canadense*. *Brit. Assoc. Meeting, Swansea*, pp. 582, 583, 1880.

"Possessed of only two slices, and two small blocks weighing but twelve ounces, both in their original condition," the writer detected in "separated twenty grains" belonging thereto "a clear siliceous-looking fibroid growth, scarcely more substantial than the motes or fibres seen floating in the sunbeam;" while "a close examination occasionally revealed another form not thicker than a spider's web, like mycelium growth of the present day," also what he takes to be "ova or gemmules" and a coloured filmy membrane, etc. We leave these evidences of organic structure to be appreciated by Eozoonists. (King and Rowney. An old chapter of the Geol. Rec., p. lii, 1881.)

NICHOLSON, H. A. Supposed Laurentian Fossil. *Ann., and Mag., Nat. Hist.* ser. 4, vol. xviii, p. 75, 1876.

A letter withdrawing the statement that the specimens noticed in his former letter "were essentially calcarious in their composition," as "upon investigation, the specimens proved to be composed of alternating layers of felspar and silica." The writer concludes with a remark by which he identifies himself with Dr. Carpenter in His *ipse dixit*:—"Whether the peculiar arrangement of the minerals which constitute these specimens can

be assigned wholly to the operation of inorganic causes or not, is a question which does not in the meanwhile admit of solution !”

We embrace the present opportunity to mention a few points connected with the Harris graphic granite. Fig. 1, pl. i., represents a portion of the specimen presented to us by the late Prof. R. Harkness, showing lamellæ of quartz and feldspar (both represented vertically); also the striping or “striation” (characteristic of plagioclases) intersecting the feldspar layers nearly at a right angle, and taken by Dr. Carpenter for “tubular structure.” Fig. 3, pl. ix., represents a small portion, slightly under the natural size, of a beautiful and interesting specimen (5 inches by 2 inches) which has been kindly placed, with others, in our hands by Dr. Heddle, the mineralogist of Scotland. The inter-lamellation of the quartz (brown in the figure) and the feldspar purple is both “strictly limited” and of “definite form.” The feldspar, which from its silvery appearance, seems to be of the variety called “moon-stone,” is obliquely intersected by what appear to be laminae of a triclinic feldspar, inasmuch as they are crossed with striæ; similar laminae are seen in the specimens of orthoclase represented in fig. 4, pl. i. Our figure of Dr. Heddle’s affords but a poor idea of its beauty and remarkable structural character. (King and Rowney. An old chapter of the Geol. Rec. pp. xli, xlii, 1881.)

PERRY, J. B. A Review of Sir Charles Lyell’s Student’s Elements of Geology. *Bibliotheca Sacra*, July, 1872.

Notices unfavourably Sir Charles’s acceptance of “Eozoon.” (King and Rowney. An old chapter of the Geol. Rec., p. xxix, 1881.)

PHILLIPS (PROF.), J. Geology of Oxford and the Valley of the Thames. 1871.

“Only in another part of the world among strata of gneiss as old, if not older, than these of Malvern, has one solitary organic body been found—*Eozoon Canadense*. This foraminifer or sponge has not obtained its certificate, ‘proved by the ends of being, to have been,’ without protest,” p. 61. (King and Rowney. An old chapter of the Geol. Rec., pp. xxvi, xxvii, 1881.)

SCHULTZE (PROF.), M. *Eozoon Canadense*. *Sitzungs, der niederrheinischen Gesell. für Natur- und Heilkunde*, July 7, 1873.

A translation is published in the “Annals and Magazine of Natural History,” ser. 4, vol. xiii, pp. 324, 325.

Prof. Schultze, having examined specimens of the presumed fossil, avers “there can be no serious doubt as to the foraminiferous nature of *Eozoon Canadense*.” (King and Rowney. An old chapter of the Geol. Rec., p. xxix, 1881.)

SIX, A. *Soc. Géol. du Nord. Annales*, tome vi, 1878–79. 1879. Eozoon.

SMYTH, W. W., in his Anniversary Address. *Quart. Journ. Geol. Soc.*, vol. xxiii, p. lxiv, 1867.

As President of the Geological Society, noticing the announcement made by Dr. Dawson of "the occurrence of *Eozoon* preserved simply in carbonate of lime," declared that this "discovery of *Eozoon* preserved in carbonate of lime pure and simple would appear to close the discussion." (King and Rowney. An old chapter of the *Geol. Rec.*, pp. xxi, 1881.)

VON COTTA, B. *Die Geologie der Gegenaart (Eozoon)*, pp. 29, 94, 95, 99, 118, 266, 1872.

WILSON, C. M. Corals or Reef-building Animals. ["Protozoa" (*sic* and repeated in text) is the title of the head.] *Trans. Clifton Coll. Sci. Soc.*, vol. ii, pt. ii, pp. 63-70, 1877.

Describes the structure of *Eozoon* and the growth of Corals. (*Geol. Rec.*, p. 323, 1877.)

ZIRKEL (PROF.), F. *Neues Jahrb. f. Mineralogie*, 1870, p. 828, 1870.

ZIRKEL, F. *Die mikroskopische Berschaff. der Min. und Ges-teine*, pp. 313, 1873.

Note on *Eozoon*.

After describing the roundish grains of serpentine (which are considered to have been originally peridotite) occurring in the crystalline limestones (hemithrenes) of Aker, Pargas, Modum (Scandinavia), the author's investigations, it is stated, "did not reveal the canal system which is called eozoal structure." But it must be mentioned that we have detected in specimens from Aker beautiful examples of "canal system." (King and Rowney. An old chapter of the *Geol. Rec.*, p. xxvi, 1881.)

ZITTLE, K. A. and W. P. SCHIMPER. *Handbuch der Paläeontologie*, 1879.

The authors reject the organic origin of "*Eozoon*." (King and Rowney. An old chapter of the *Geol. Rec.*, p. xlix, 1881.)

NORTH AND SOUTH AMERICA.

AGASSIZ, A. (Letter No. 1.). To C. P. Patterson, Superintendent Coast Survey, Washington, D. C., from Alexander Agassiz, on the Dredging Operations of the United States Coast Survey Steamer "Blake," during parts of January and February, 1878. *Bull. Mus. Comp. Zoöl.*, vol. v, pp. 1-9, 1878.

- ALDRICH, T. H. Observations upon the Tertiary of Alabama. *Amer. Journ. Sci.*, ser. 3, vol. xxx, pp. 300-308, 1885.
- ALDRICH, T. H. Notes on the distribution of Tertiary Fossils in Alabama and Mississippi. *Journ. Cinn. Soc. Nat. Hist.*, vol. viii, pp. 256, 257, 1886.
- ANON. Fossil Foraminifera in the Greensand of New Jersey —Prof. J. W. Bailey. (Extract from Silliman's Journ., July, 1841.) *Ann. and Mag. Nat. Hist.*, vol. viii, pp. 158, 159, 1842.
- ANON. Globigerinæ. *Amer. Journ. Micro. and Pop. Sci.*, vol. i, pp. 125-128, 3 woodcuts, 1 pl., 1876.
- ANON. Separating Foraminifera from Sand. *Amer. Journ. Micro. and Pop. Sci.*, vol. v, p. 96, 1880.
From the *American Naturalist*.
- BAILEY, J. W. Letter from Professor J. W. Bailey, U. S. Military Academy, at West Point, relative to the characteristics deducible from specimens of bottom, brought up in sounding the Florida section of the Gulf Stream. U. S. Coast Surv., 1855, p. 360, 1855.
- BAILEY, J. W. The Basin of the Atlantic, according to the deep-sea soundings. Microscopic Examination. *Maury's Sailing Directions*, Eighth Edition, vol. i, pp. 167-175, 1858.
- BAILEY, J. W. General Report of the results of my microscopic examination of the soundings made by Lieutenant O. H. Berryman, in his recent voyage, in the United States Steamer Arctic, to Ireland and back. *Maury's Sailing Directions*, Eighth Edition, vol. i, pp. 163-165, 1858.
- BARTLETT, J. R. The Gulf Stream. Additional Data from the Investigations of the Coast and Geodetic Steamer "Blake." *Journ. Amer. Geog. Soc.*, vol. lxiv, pp. 69-84, 1882.
- CONRAD, T. A. Observations on a portion of the Atlantic Tertiary Region, with a description of new species of organic remains. *Second Bull., of the Proceed. of the National Institution*, pp. 171, 192, 1842.
Mentions the finding of Nummulites Mantelli in the Southern States.

- CONRAD, T. A. Observations on the Geology of a part of East Florida, with a Catalogue of Recent Shells of the Coast. *Amer. Journ. Sci.*, ser. 2, vol. ii, pp. 36-48, 1846.
- CONRAD, T. A. Tertiary of Warren Co., Mississippi. *Amer. Journ. Sci.*, ser. 2, vol. ii, pp. 124, 125, 1846.
- CONRAD, T. A. Check List of the Invertebrate Fossils of North America. Eocene and Oligocene. *Smith. Misc. Coll.*, No. 200, pp. 1, 21, 33, 1866.
- DANA, J. D. Note on the Discovery of Rhizopods in the Azoic. *Amer. Journ. Sci.*, ser. 2, vol. xl, p. 391, 1865.
- DAWSON, G. M. "On a new species of *Loftusia* from British Columbia." *Ann. and Mag. Nat. Hist.* ser. 5, vol. ii, p. 344, 1878.
Abstract for the Proc. Geol. Soc., 1878.
- DAWSON, J. W., in C. B. Fuller's Report on the Fossils in the Marine Clays. *Sixth. Ann. Rept. Maine Bd. Agriculture*, pp. 275-282, 1861.
- DRAPER, H. On the chemical and physical facts collected from the Deep-Sea Researches made during the voyage of the Nautical School-ship "Mercury," undertaken by their order in the Tropical Atlantic and Caribbean Sea, 1870-71. *Rept. Comm. of Pub. Charities and Correction*, pp. 11-33, 6 woodcuts, map, 1871, New York.
- GRANT, C. E., and W. DAWSON. Notes on Pleistocene Fossils from Anticosti. *Can. Rec. Sci.*, vol. ii, pp. 44-48, 1886.
- GRIFFING, C. S. G. Origin of Flint. *Cinn. Quart. Journ. Sci.*, vol. ii, pp. 168-174, 1875.
- HEILPRIN, A. Distribution of Animals. The International Scientific Series, vol. lvii. The Geographical and Geological Distribution (Foraminifera), pp. 234-240, 1887.
- HEILPRIN, A. Explorations on the West Coast of Florida and in the Okeechobee Wilderness. With special reference to the Geology and Zoölogy of the Floridian Peninsula. *Trans. Wagner. Free Institute of Science of Phila.*, vol. i, 1887.

- HITCHCOCK, R. Lower Invertebrates. Standard Natural History, vol. i., pp. 1-23 ; woodcuts, 1885.
- HUXLEY, T. H. The Problems of the Deep-Sea. *The Popular Science Month.*, vol. iii, pp. 451-466, 1873.
- HYATT, A., in a paper read before the American Association for Advance. Sci. (Science, iv. p. 340), regards the anomalous fossil *Beatricea* as a Foraminifer (Zool. Rec. vol. xxi, 1884), 1885.
- LEIDY, J. Observations on some Marine Rhizopods. *Month. Micro. Journ., Lond.*, vol. xiv, pp. 26-30, 1875.
- JULIEN, A. A. On the Geological Action of the Humus Acids. *Proc. Amer. Assoc. Adv. Sci.*, vol. ix, 1879, pp. 311-410, 1880.
- JAMES, J. F. Protozoa of the Cincinnati Group. *Journ. Cinn. Soc. Nat. Hist.*, vol. ix, pp. 244-252, 1887.
- LYELL, C. Travels in North America, in the years 1841-2 ; with geological observations on the United States, Canada, and Nova Scotia, vol. i, p. 64, 1845.
Upper Cretaceous, Timber Creek, New Jersey, Foraminifera, genera *Cristellaria*, *Rotalina*, and *Nodosaria*.
- LYKINS, W. H. R. List of Fossils in Kansas City and Vicinity. *Kansas City Rev. Sci. Inds.*, July, 1884, pp. 1-6, 1884.
Fusulina cylindrica. *Ptychostylus heterocostalis*, nov. sp.
- MARCOU, M. J. Une reconnaissance géologique au Nebraska. *Bull. de la Soc. Géol., de France*, ser. 2, vol. xxi, pp. 132-147, 1864.
Fusulina cylindrica.
- MEEK, F. B. Check List of the Invertebrate Fossils of North America. Cretaceous and Jurassic. *Smith. Misc. Coll.*, No. 177, p. 1, 1864.
- MEEK, F. B. Carboniferous and Jurassic fossils. *Paleontology of California* (Whitney), vol. i, pp. 1-16, 2 pls., and pp. 39-53, pls. vii and viii, 1864.
Fusulina robusta, n. s., Meek, 1864, pl. ii, figs. 3 and 3 a. c.
F. gracilis, n. s. Meek, 1864, pl. ii, fig. 1 and 1 a. c.
F. cylindrica, Fischer(?), 1837, pl. ii, figs. 2 and 2 a.

MEEK, F. B. Remarks on the Carboniferous and Cretaceous Rocks of Eastern Kansas and Nebraska, and their relations to those of the adjacent States, and other localities farther eastward ; in connection with a review of a paper recently published on this subject by M. Jules Marcou, in the Bulletin of the Geological Society of France. *Amer. Journ. Sci.*, ser. 2, vol. xxxix, pp. 157-174, 1865.

Fusulina cylindrica.

MEEK, F. B. Report on the Paleontology of Eastern Nebraska, with some remarks on the carboniferous rocks of that district. *Final. Rept. of the U. S. Geol. Surv. of Nebraska and portions of the adjacent Territories*, pp. 83-239, 11 pls., 1872.

Fusulina cylindrica, Fischer, 1837, pl. i, fig. 2 ; pl. ii, fig. 1 ; pl. v, figs. 3 a. b ; pl. vii, figs. 8 a. b. pp. 140-141.

MEEK, F. B., and F. V. HAYDEN. Paleontology of the Upper Missouri. *Smithsonian Contributions to Knowledge (172)*, pp. 1-135, pls. i-v, 1864, Wash. 1865.

Carboniferous.—

Camerinidae, pp. 11-13. *Fusulina cylindrica*, Fischer, 1837, pl. i., figs. 6 a. i.

MEEK, F. B., and A. H. WORTHEN. Paleontology. *Geological Survey of Illinois*, vol. iii, pp. 291-565, pls. i-xx, 1868.

Fossils of the Galena Beds.

Receptaculites globularis, Hall, 1861, pl. ii, figs. 2 a. b., p. 301.

R.—(?) pl. ii, figs. 1 a. b., pp. 301, 302.

R. oweni, Hall, 1861, pl. ii, fig. 3, pp. 302, 303.

MEEK, F. B., and A. H. WORTHEN. Descriptions of New Species and Genera of Fossils from the Paleozoic rocks of the Western States. *Proc. Acad. Nat. Sci. Phila.*, vol. xxii, pp. 22-56, 1870.

Receptaculites formosus, M. and W., 1872, pp. 22, 23.

MEEK, F. B., and A. H. WORTHEN. Paleontology. Descriptions of Invertebrates from the Carboniferous System. *Geological Survey of Illinois*, vol. v, pp. 323-619, pls. i-xxxii, 1873.

Fossils of the Coal-Measures.

Fusulina gracilis, Meek, 1864, pl. xxiv, fig. 7, pp. 560.

F. ventricosa, M. & H., 1864, pl. xxiv, fig. 8, pp. 560.

- MEEK, F. B., and A. H. WORTHEN. Paleontology of Illinois. Descriptions of Invertebrates. *Geological Survey of Illinois*, vol. vi, section ii, pp. 491-532, pls. xxiii-xxxii, 1875.
Upper Silurian species.
Receptaculites, M. and W., 1870, pl. xxiv, fig. i, p. 500.
- MEYER, O. Observations on the Tertiary and Grand Gulf of Mississippi. *Amer. Journ. Sci.*, ser. 3, vol. xxxii, pp. 20-25, 1886.
- MILLER, S. A. *Pasceolus Darwini*, P. Claudi. *Cinn. Quart. Journ. Sci.*, vol. i, pp. 4-7, 3 woodcuts, 1874.
- MILLER, S. A. North American Mesozoic and Cænozoic Geology and Palæontology. *Journ. Cinn. Soc. Nat. Hist.*, vol. ii, pp. 236-244, 1879.
- MURRAY, J., and RENARD, O. On the Nomenclature, Origin, and Distribution of Deep-Sea Deposits. *Rept. U. S. Comm. Fish and Fisheries*, 1885, pp. 758-786, 1887.
- NEWBERRY, J. S. Palæontology. *Report upon the Colorado River of the West*, by Lieut. Joseph C. Ives. Part iii, chapter xi, pp. 116-132, pls. i-iii, 1861. *Fusulina cylindrica*, Fischer, p. 129.
- OWEN, D. D. Report of a Geological Exploration of part of Iowa, Wisconsin, and Illinois. (*Receptaculites*.) pls. vii, xviii, 1840.
- OWEN, D. D. Descriptions of new and imperfectly known Genera and Species of Organic Remains, collected during the geological survey of Wisconsin, Iowa and Minnesota. *Rept. Geol. Surv. of Wisconsin, Iowa and Minnesota*, and incidentally of a part of Nebraska Territory, by David Dale Owen. Appendix, Article I, pp. 573-587, pls. i-id, ii-iiB, iii-iiia, iv-v, vii-viiia, Philadelphia, 1852.
Selenoides, n. g. D. D. Owen, 1852, figs. 3a (and b?), p. 586.
Selenoides, Iowensis, n. s. D. D. Owen, 1852, tab. iiB, fig. 13, p. 587.
- PATRICK, G. E. Protozoan Remains in Kansas chalk. *Trans. Kan. Acad. Sci.*, vol. viii, pp. 26, 27, 1883.
- POURTALES, L. F., in A. A. Humphreys' Record of the examination of specimens of borings from the New Orleans Artesian wells. Memorandum No. 1, 2. *Report of the Chief of Engineers*, 1870, pp. 370-375, 1870.
Foraminifera found, *Globigerina*, *Polymorphina*, *Rosalina*, *Nonionina*.

SHUMARD, B. F. Notice of Fossils from the Permian Strata of Texas and New Mexico, obtained by the United States Expedition, under Capt. John Pope, for boring Artesian Wells along the 32d Paral., with Descriptions of New Species from these Strata and the Coal Measures of that region. *Trans. Saint Louis Acad. Sci.*, vol. i, pp. 388, 389, 1859.

Fusulina elongata, Shumard, pp. 388, 389.

ULRICH, E. O. Contributions to American Palæontology, vol. i, pp. 34, 35, pl. iii, 1886.

Foraminifera, *Moellerina Greeni*, n. sp.

VERRILL, A. E. Explorations of the Deep-Sea Faunæ. *Amer. Journ. Sci.*, ser. 2, vol. xlix, pp. 129-134, 1870.

WALCOTT, C. D. Palæontology of the Eureka District. *Monograph* viii, *U. S. Geol. Surv.*, pp. i-xiii, 1-298, pls. i-xxiv, figs. 1-7 in text, Washington, 1884.

Fossils of the Lower Silurian.

Receptaculites mammillaris, MSS., Newberry, 1880, pl. xi, fig. 11, pp. 65, 66.

R. elongatus, n. s., Walcott, 1884, pp. 66, 67.

R. ellipticus, n. s., Walcott, 1884, pl. xi, fig. 12, p. 67.

WHITE, C. A. Report upon the Invertebrate Fossils collected in portions of Nevada, Utah, Colorado, New Mexico, and Arizona, by Parties of the Expeditions of 1871, 1872, 1873, and 1874. *Report upon Geographical and Geological Explorations and Surveys West of the 100th Meridian*, in charge of First Lieut. Geo. M. Wheeler, Corps of Engineers, U. S. Army, vol. iv, part i, Palæontology, pp. 1-219, pls. i-xxi, 1875.

Receptaculites —(?) p. 50.

Fusulina cylindrica, Fischer, 1837, pl. vi, figs 6A and b, pp. 96-98.

WHITE, C. A. (Review of) C. Schlumberger. Remarks upon a species of *Cristellaria*. (*Journ. Cinn. Soc. Nat. Hist.*, vol. v, No. 3, p. 119, pl. v.) *Neues Jahrbuch für Mineralogie, Geol., etc.* 2 Bd., p. 409, 1883.

WHITE, C. A. Fossils of the Indiana Rocks, No. 3. Indiana, Department of Geology and Natural History. *Thirteenth Annual Report*, John Collett, State Geologist, pp. 105-180, pls. xxiii-xxxix, 1884.

Fusulina cylindrica, Fischer, pl. xxiii, figs. 1-3, pp. 116-117.

WHITE, C. A., and ST. JOHN, O. H. Preliminary Notice of new genera and species of fossils. By C. A. White, M. D., State Geologist, and O. H. St. John, Assistant (pp. 1-3), Iowa City, May 8, 1867.

This small publication of only fifty copies, was made by the Iowa State Geological Survey. Four species are described. The genus *Meeckella* proposed, *Cryptacanthia* suggested; and the whole, together with other matter, was republished in vol. i, Transactions of the Chicago Academy of Sciences. (Marcou. Bull. U. S. Nat. Mus., No. 30, p. 120.)

Remarkson Amphistegina, White and St. John, 1867.

WHITFIELD, R. P. Descriptions of New Species of Fossils from Ohio, with Remarks on some of the Geological Formations in which they occur. *Ann. N. Y. Acad. Sci.*, vol. ii, pp. 198, 236, 1882.

Describes *Receptaculites Devonicus*, n. sp.

WHITEAVES, J. F. On Recent Deep-Sea Dredging Operations in the Gulf of St. Lawrence. *Can. Nat.*, vol. vii, pp. 257-267, 1874.

"*From the Amer. Journ. Sci. and Arts*, March, 1874."

WHITEAVES, J. F. Notes on a Deep-Sea Dredging Expedition round the Island of Anticosti, in the Gulf of St. Lawrence. *Can. Nat.*, vol. vii, pp. 86-100, 1874.

Reproduction of one contributed to the "Annals of Natural History, Nov., 1872," with additions, the results of a year's study.

WHITEAVES, J. F. On some Invertebrata dredged or otherwise collected by Dr. G. M. Dawson, in 1885, in the northern part of the Strait of Georgia, in Discovery Passage, Johnstone Strait, and Queen Charlotte and Quatsino Sounds, British Columbia; with a Supplementary List of a few land and fresh water shells, fishes, birds, etc., from the same region. *Trans. Roy. Soc. Canada*, vol. iv, pp. 111-137, 4 woodcuts, 1886.

WOODWARD, A. The Bibliography of the Foraminifera, Recent and Fossil, including Eozoon and Receptaculites, 1565-Jan. 1, 1886. *Fourteenth Ann. Rept. Geol. and Nat. Hist. Surv. of Minnesota*, pp. 169-311, 1886.

WOODWARD, A. Notice of a new Locality for *Haplophragmium casis*, a Rare Foraminifer. *Journ. N. Y. Micro. Soc.*, vol. ii, pp. 77, 78, 1886.

WOODWARD, A. Note on the Foraminiferal Fauna of the Miocene Bed at Petersburg, Virginia; with List of Species found. *Journ. N. Y. Micro. Soc. (Quarterly)*, vol. iii, pp. 16, 17, 1887.

WOODWARD, A. in Dr. Otto Meyer's Paper on Invertebrates from the Eocene of Mississippi and Alabama. *Proc. Acad. Nat. Sci. Phila.*, 1887, p. 55, 1887.

List of Foraminifera.

WOODWARD, A., in Dr. Otto Meyer's Beitrag zur Kenntnis der Fauna des Alttertiärs von Mississippi und Alabama. *Bericht über die Senckenbergische Nat. Gesell., in Frankfurt a. M.* (separate), 12 pp., 1887.

List of Foraminifera, identified from the Eocene of Mississippi and Alabama.

ENGLAND, IRELAND, SCOTLAND AND WALES.

ALCOCK, J. On *Polymorphina tubulosa* from Dogs' Bay, Roundstone. *Quart. Journ. Micro. Sci.*, vol. xv, pp. 237-240, 1867.

ANON. *Microscopic Work of the 'Challenger.'*—Professor Huxley writes as follows to 'Nature' (August 19), enclosing a letter from Professor Wyville Thomson:—'The following extracts from a letter dated Yeddo, June 9, 1875, addressed to me by Professor Wyville Thomson, will I think, interest the readers of 'Nature': *Month. Micro. Journ.*, vol. xiii, pp. 288-290, 1875.

ANON. The 'Challenger' Soundings. *Month. Micro. Journ.*, vol. xiii, pp. 245, 246, 1875.

ANON. The 'Challenger' Report on the Globigerinæ-ooze. *Quart. Journ. Micro. Sci.*, vol. xv, pp. 312, 313, 1876.

A Review.

ANON. Foraminifera from Chalk. *Amer. Journ. Micro. and Pop. Sci.*, vol. ii, p. 7, 1877.

Title should read Foraminifera.

ANON. Discovery of Nuclei in Foraminifera. *Quart. Journ. Micro. Sci., n. s.*, vol. xvii, pp. 93-100, 1877.

ANON. On a supposed Organism from the Marble of Sutherland. *Proc. Roy. Soc. Edin.*, 1881-82, pp. 634-636.

- ANON. Dimorphism of Foraminifera.—MM. Meunier-Chalmas and Schlumber. *Journ. Roy. Micro. Soc.*, vol. iii, p. 380, 1883.
- ANON. Dimorphism of the Foraminifera. *Journ. Roy. Micro. Soc.*, vol. iii, pp. 671, 672, 1883.
A Review of MM. Munier-Chalmas and Schlumberger, on the above subject.
- ANON. Fully-formed Embryos within a Rhizopod. *Journ. Roy. Micro. Soc.*, vol. iii, pp. 672, 673, 1883.
- ANON. Conchology, or Natural History of Shells, containing The Figures of Shells correctly and finely engraved, and accompanied Their Descriptions in English and French. The whole exhibited in a systematical manner. By a Collector. Number III, pl., xii, figs. 19-27. Folio, London, n. d.
- ANON. Detection of Polycystina within the Hermetically-closed Cavities of Nodular Flints. *Journ. Roy. Micro. Soc.*, vol. iii, p. 673, 1883.
Review of Dr. Wallich's paper.
- ANON. New Type of Arenaceous Rhizopoda.—H. B. Brady. *Journ. Roy. Micro. Soc.*, vol. iii, p. 672, 1883.
A Review.
- ARMSTRONG, J., and YOUNG, J. Notes on the Fossils of the Orchard Limestone Series. *Trans. Geol. Soc. of Glasgow*, vol v, pp. 250-261, 1877.
- AUSTEN, R. A. C. On the position in the Cretaceous series of Beds containing Phosphate of Lime. *Quart. Journ. Geol. Soc. Lond.*, vol. iv., pp. 257-262, 1848.
- BASTIAN, H. C. The Beginnings of Life. 2 vols., London, 1872.
Foraminifera, vol. ii, pp. 104, 611, 613.
- BENECKE, ——. Geognostisch-paläontologische Beiträge, Foraminiferen der Zone des Ammonites Sowerbyi. 1867.
Not seen.
- BRADY, H. B. Note on *Orbitolites italica*, Costa, Sp. (*Orbitolites tenuissima*, Carpenter.) *Ann. and Mag. Nat. Hist.*, ser. 5, vol. xviii, pp. 191, 192, 1886.

BREE, C. R. Lower Forms of Life, comprising : 1, Proto-phyton; 2, The Protozoon; 3, The Cœlenterata. Plates and numerous engravings, 8vo., 1868.

Not seen.

BROWNE, A. J. J. The Origin of the Green-Sand. *Amer. Journ. Micro. and Pop. Sci.*, vol. i, pp. 67-69, 1876.

From Science Gossip.

CARPENTER, W. B., and BRADY, H. B. Description of *Parkeria* and *Loftusia*, two gigantic Types of Arenaceous Foraminifera. *Proc. Roy. Soc. Lond.*, vol. xvii, pp. 400-404, 1869.

CARPENTER, W. B. The Temperature and Life of the Deep Sea.

A Lecture delivered in the Hulme Town Hall, Manchester, February 8, 1871.

CARPENTER, W. B. On the Conditions which Determine the Presence or Absence of Animal Life on the Deep-Sea Bottom. *Proc. Geol. Assoc.*, vol. iv, No. 3, pp. 176-202, 1875.

CARPENTER, W. B. The Origin of the Red Clay found by the 'Challenger.' *Month. Micro. Journ.*, vol. xiv, pp. 255-257, 1875.

CARPENTER, W. B. On a Piece of Limestone. *Good Words*, vol. xvi, pp. 713-720, 1875.

A lecture to the workmen of Bristol.

CARPENTER, W. B. "Remarks on Prof. Wyville Thomson's Preliminary Notes on the Nature of the Sea-bottom procured by the soundings of H. M. S. 'Challenger.'" *Ann. and Mag. Nat. Hist.*, ser. 4, vol. xv, pp. 286-287, 1875.

Extract from the Proc. Roy. Soc.

CARPENTER, W. B. Summary of Recent Observations on Ocean Temperature made in H. M. S. 'Challenger' and U. S. S. 'Tuscarora'; with their bearing on the Doctrine of a General Oceanic Circulation sustained by Difference of Temperature. *Proc. R. Geog. Soc.*, vol. xix, pp. 493-514, 1875.

CARPENTER, P. H. The Bottom of the Sea. *Science for All*, vol. —, pp. 76-83, 5 woodcuts.

CLARKE, W. B. Remarks on the Sedimentary Formations of New South Wales. Fourth edition, 1878.

- DAWKINS, W. B. "On the Geography of Britain in the Carboniferous Period." *Trans. Man. Geol. Soc.*, vol. xix, pp. 37-47, 1887.
- DAWSON, J. W. Inaugural Address (The British Association). *Nature*, vol. xxxiv, pp. 409-420, 1886.
- DUNCAN, P. M. On the Zoological Position of the Ophiurans obtained by Dr. Wallich, F.L.S., during the voyage of H. M. S. 'Bulldog' in 1860. *Ann. and Mag. Nat. Hist.*, ser. 5, vol. iii, pp. 382-384, 1879.
Remarks finding the stomachs of one specimen crowded with *Globigerina*.
- EHRENBERG, C. G. On Microscopic Life in the Ocean at the South Pole, and at considerable depths. *Ann. and Mag. Nat. Hist.*, vol. xiv, pp. 169-181, 1844.
From the Proceedings of the Berlin Academy for May, and communicated by the author (*Ann. and Mag. Nat. Hist.*).
- ETHERIDGE (JUN.), R., in R. L. Jack's Notes on a Till or Boulder Clay with Broken Shells, in the Lower Valley of the River Endrick, near Loch Lomond, and its Relation to certain other Glacial Deposits. *Trans. Geol. Soc. of Glasgow*, vol. v, pp. 5-25, 1877.
- ETHERIDGE (JUN.), R., and NICHOLSON, H. A. On the Genus *Palæacis*, and the species occurring in British Carboniferous Rocks. *Ann. and Mag. Nat. Hist.*, ser. 5, vol. i, pp. 206-227, pl. xii, 1878.
- FOX, A. L. On some Fossils from Mount Lebanon. *Trans. R. Geol. Soc. Cornwall*, vol. ix, part i, pp. 46-48, 1875.
- FREEMAN, H. E. Foraminifera, to fix to the slide. *Journ. Postal Micro. Soc.*, vol. iv, p. 260, 1885.
- GRANT (DR. R. E.). Syllabus of Four Lectures on Foraminiferous Animalcules and Polyperous Animals, etc. 1860.
- GRAY, J. E. On *Carpenteria* and *Dujardinia*, two genera of a new form of Protozoa with attached multilocular shells filled with sponge, apparently intermediate between Rhizopoda and Porifera. *Proc. Zool. Soc. Lond.*, part xxvi, pp. 266-271, 4 woodcuts, 1858.
- GREEN, J. Microscopic Object Hunting. *Amer. Journ. Micro. and Pop. Sci.*, vol. vi, pp. 45, 46, 1 pl. 1881.

- HAEUSLER, R. Bemerkungen über einige liasische Milioliden
Neues Jahrbuch Min. Geol. Pal., vol. i, pp. 190-194, pls.
vi, vii, 1887.
- HINDE, G. J. On the Structure and Affinities of the Family of
the Receptaculitidæ, etc. London, 1884.
- HUXLEY, T. H. On the recent work of the "Challenger" Ex-
pedition, and its Bearing on Geological Problems *Proc.*
R. Inst., vol. vii, pp. 354-357, 1875.
- HUXLEY, T. H. On some of the Results of the Expedition of
H. M. S. "Challenger." *Contemporary Review*, vol. xxv, pp.
639-660, 1875.
- JEFFREYS, J. G. The Post-tertiary Fossils procured in the late
Arctic Expedition ; with Notes on some of the Recent or
Living Mollusca from the same Expedition. *Ann. and Mag.*
Nat. Hist., ser. 4, vol. xx, pp. 229-242, 1877.
- JONES, T. R. Notes on Prof. Rupert Jones's Memoir on the
Variability of Foraminifera. *Quart. Journ. Micro. Sci.*, vol.
xv, pp. 200, 201, 1876.
- JONES, T. R. Address on Foraminifera. *Proc. Geol. Assoc.*,
vol. ix, pp. 74, 75, 1885.
- JONES, T. R. On *Nummulites elegans*, Sow., and other English
Nummulites. *Quart. Journ. Geol. Soc. Lond.*, vol. xliii, p. 132,
1887.
- JONES, T. R. Notes on *Nummulites elegans*, Sow., and other
English *Nummulites*. *Nature*, vol. xxxv, pp. 236, 237, 1887.
A Review.
- JONES, T. R., and W. K. PARKER. On the Foraminifera of the
London clay. *The Geologist*, vol. vii, pp. 85-89, 1864.
- LANKESTER, E. Half-hours with the Microscope. Fifteenth
edition, p. 71, pl. i., 1882.
- LOBLEY, J. L. Cretaceous Rocks of England. *Trans. Wat-*
ford Nat. Hist. Soc., and Hertford Field Club, vol. i, pp. 1-
13, 2 woodcuts, 1875.
- MACDONALD, J. D. Examination of Deep-Sea Soundings ;
with Remarks on the Habit and Structure of the Polycys-
tina. *Ann. and Mag. Nat. Hist.*, ser. 4, vol. viii, pp. 224-
226, 1871.

- MACDONALD, J. D. Examination of Two Soundings obtained in 62 and 68 Fathoms respectively, Latitude $41^{\circ} 52'$ Longitude $9^{\circ} 8'$; and the Discovery of Buccal Teeth in the Genus *Firola*. *Quart. Journ. Micro. Sci.*, vol. xi, pp. 273-275, 1871.
- MACGILLIVRAY, W. The Conchologist's Text-Book, embracing the arrangements of Lamarck and Linnæus. Seventh edition, 12mo, 1853.
- MACKIE, S. J. Foraminifera of the Chalk. *Proc. Geol. Soc.*, vol. vi, p. 234, pl. xv, 18—.
- MANTELL, G. A. Notice of "Molluskite" or the fossilized remains of soft parts of Mollusca. *Amer. Journ. Sci.*, vol. xlv, pp. 243-247, 1843.
- MANTELL, G. A. Notes of a Microscopical Examination of the Chalk and Flint of the South-east of England; with remarks on the Animalculites of certain Tertiary and Modern Deposits. *Ann. and Mag. Nat. Hist.*, vol. xvi, pp. 73-88, 1845.
- MARTYN, W. F. New Dictionary of Natural History; or, complete universal display of animated Nature with representations of the most curious and beautiful animals elegantly coloured, vol. ii, plate xcvi, fig. 4, 1785.
- MCCHARLES, A. Notes on the Geology of the Winnipeg District, Manitoba. *Trans. Edinburgh Geol. Soc.*, vol. v, pp. 331-333, 1887.
- The Receptaculites found are no doubt from the Lower Trenton.
- MITCHELL, W. S. The "Lost Atlantis" and the "Challenger" soundings. *Nature*, vol. xv, pp. 553-556, 1877.
- MILLETT, F. W. Recent Foraminifera of Mount's Bay, Plymouth, 8vo., 1885.
- MOSELEY, H. N., in a lecture entitled "Deep-sea Dredging and Life in the Deep Sea." *Nature*, vol. xxi, pp. 543, 599, 591, 1880.
- Gives an account of the leading forms obtained in the deep sea, and among them figures pelagic spined Globigerinæ, p. 569, fig. 10. (*Zool. Rec.* vol. xvii, p. 2, Prot. 1880.)
- MULLER, C. J. Instructions for Cleaning Foraminifera of the Chalk. *Month. Micro. Journ.*, vol. xv, p. 241, 1876.

- MULLER, C. J. Foraminifera from Chalk. *Amer. Journ. Micro. and Pop. Sci.*, vol. i, p. 104, 1876.
- MURCHISON, R. I. Address to the Royal Geographical Society of London; delivered at the Anniversary Meeting on the 25th May, 1857, pp. 116, 1857.
- MURRAY, J. Distribution of *Foraminifera* in tropical waters, and especially on coral reefs. *Nature*, vol. xxii, p. 352, 1880.
The pelagic *Foraminifera* probably live at the surface. (*Zool. Rec.* vol. xvii, Prot. p. 6, 1880.)
- NICHOLSON, H. A., and R. ETHERIDGE. A Monograph for the Silurian Fossils of the Girvan district in Ayrshire with special reference to those contained in the Gray collection. *Rhizopoda*, pp. 1024,, 1878. Woodcuts.
Genera *Nidulites*, *Ischadites*, *Saccammina*, *Girvanella*.
- O'MEARA, E. Foraminifera from the Flint-nodule. *Quart. Micro. Journ.*, vol. xv, p. 103, 1875.
- ROBERTSON, D. Lists of Foraminifera, etc., of Davis' Straits and Baffin's Bay, are reprinted in the "Arctic Manual," pp. 192-195, 1875.
Not seen.
- ROBERTSON, D. Note "Upon the discovery of marine forms at a higher level than previously known in the neighbourhood of Glasgow." *Trans. (Proc.) Geol. Soc. of Glasgow*, vol. v, pp. 333-334, 1877.
- ROBERTSON, D., in Wallaces' Shells in Glacial Clay at Fort-George, Inverness-shire. *Trans. Edin. Geol. Soc.*, vol. iv, pp. 143, 144, 1882.
- ROPER, F. C. S. What is Chalk? *Papers Eastbourne Nat. Hist Soc.*, 1873-74, pp. 7-9, 1874.
Not seen.
- SHERBORN, C. D., and CHAPMAN, F. On some Microzoa from the London Clay exposed in the Drainage works, Piccadilly, London, 1885. *Journ. Roy. Micro. Soc., Lond.*, vol. vi, ser 2, pp. 737-763, pls. xiv, xv, 1886.
- SIDDALL, J. D. Report upon the Foraminifera of the L. M. B. C. District. *Proc. Lit. Phil. Soc.*, Liv., vol. xl. Appendix, pp. 42-71, pl. i, 1886.

SIDDALL, J. D., in *The First Report upon the Fauna of Liverpool Bay and the Neighbouring Seas*. Pls. x, maps 2, 1886.

“The following are new:—Foraminifera: *Miliolina spiculifera*, p. 51, pl. i, fig. 3. *Reophax moniliforme*, p. 54, pl. i, fig. 2. *Placopsilina kingsleyi*, p. 54, pl. i, fig. 1. (None of these are properly described by Mr. J. D. Siddall.)

Mr. Siddall alone compares his record (Foraminifera) with published lists from the other side of the Irish Sea, but patriotism in his case has somewhat overruled judicial impartiality, as a few instances will show. *Haliphysema tumanowiczii*, previously recorded from Dublin, in Balkwill and Wright's Report (Tr. R. Irish Ac. 1885, p. 354), and in Brady's 'Challenger' Report, ix, p. 281 *Reophax moniliforme*, N. Sp., was described and figured, but not named by Balkwill and Wright, who also found *Lagena lyellii* (p. 338), and *L. lucida* (p. 340), at Dublin.” (The Zoologist, vol. x, No 117, pp. 374, 375, 1886.)

SMITH, H. L. A New Mode of Mounting Foraminifera. *Quart. Journ. Micro. Sci.*, vol. xv, pp. 269, 270, 1876.

SOLLAS, W. J. On the Flint Nodules of the Trimmingham Chalk. *Ann. and Mag. Nat. Hist.*, ser. 5, vol. vi, pp. 384-395, 437-461, pls. xix, xx, 1880.

SORBY, H. C. On the Organic Origin of the so-called 'Crystalloids' of the Chalk. *Ann. and Mag. Nat. Hist.*, ser. 3, vol. viii, pp. 193-200, woodcuts, 1861.

SOWERBY, J., and G. B. The Genera of Recent and Fossil Shells for the Use of Students in Conchology and Geology. Vol. ii. *Nodosaria*, pl. cclxix.

STEWART, S. A. The Greensand and its Origin. *Sci. Goss.*, No. 131, p. 243, 1875.

STEWART, S. A. The Origin of the Greensand. *Sci. Goss.*, No. 136, pp. 81, 82, 1876.

THOMPSON, W. The Natural History of Ireland, vol. iv, pp. 477-479 (Foraminifera), 1856.

THOMSON, W. On the Depth of the Sea. *Ann. and Mag. Nat. Hist.*, ser. 4, vol. iv., pp. 112-124, 1869.

THOMSON, C. W. “On Dredgings and Deep-sea Soundings in the South Atlantic, in a Letter to Admiral Richards, C. B., F. R. S.” *Ann. and Mag. Nat. Hist.*, ser. 4, vol. xiv, pp. 231-237, 1874.

Extract from the Proc. Roy. Soc.

- THOMSON, C. W. Short Notes on abyssal Protozoan fauna given, in Report on the scientific results of the voyage of H. M. S. 'Challenger,' Zoology, vol. i, pp. 41-44, 1880.
- VANDEN BROECK, E. A New Microscopic Slide communicated by Professor Rupert Jones (Read before the Royal Microscopical Society, April 5, 1876). *Month. Micro. Journ.*, vol. xv, pp. 221, 222, pl. cviii, 1876.
- VON KOENEN, on T. R. Jones; On *Nummulites elegans*, Sow., and other English Nummulites. (*Quart. Journ. Geol. Soc.*, No. 170, vol. xliii, May 2, 1887, p. 132.) *Neues Jahrbuch für Min. Geol. u. Palæontologie*, vol. ii, 1887, p. 394, 1887.
Notice.
- WALLACE, A. R., in "Island Life," pp. 87-94, discusses the distribution of Globigerina-ooze and the formation of chalk, 1880.
- WALLICH, G. C. On the Mineral Secretions of Rhizopods and Sponges. *Amer. Journ. Sci.*, vol. xxxviii, ser. 2, pp. 131, 1864.
- WALLICH, G. C. Deep-sea Researches on the Biology of Globigerina. *Ann. and Mag. Nat. Hist.*, ser. 4, vol. xvii, pp. 245, 246, 1876.
Bibliographical Notice.
- WALLICH, G. C. On Silicious Sponge-growth in the Cretaceous Ocean. *Ann. and Mag. Nat. Hist.*, ser. 5, vol. vii, pp. 261-263, 1881.
- WALLICH, G. C. On the Origin and Formation of the Flints of the Upper or White Chalk; with Observations upon Prof. Sollas's Paper in 'The Annals and Magazine of Natural History' for December, 1880. *Ann. and Mag. Nat. Hist.*, ser. 5, vol. vii, pp. 162-204, pl. xi, 1881.
- WALLICH, G. C. Supplementary Notes on the Flints and the Lithological Identity of the Chalk and Recent Calcareous Deposits in the Ocean. *Ann. and Mag. Nat. Hist.*, ser. 5, vol. viii, pp. 46-58, 1881.
- WILLIAMSON, W. C. On the real nature of the Minute Bodies in Flints, supposed to be Sponge Spiculæ. *Ann. and Mag. Nat. Hist.*, vol. xvii, pp. 467, 468, 1846.
Remarks on Foraminifera.

- WILLIAMSON, W. C. Deep-sea Researches. *Month. Micro. Journ.*, vol. xiii, pp. 126-128, 1875.
- WRIGHT, E. P. Notes on Foraminifera. *Ann. and Mag. Nat. Hist.*, ser. 4, vol. xix, p. 40, 1877.
- WRIGHT, J. Foraminifera of the Belfast Naturalists' Field Club's Cruise off Belfast Lough, in the Steam-Tug "Protector," June, 1885. Also, Foraminifera found by Dr. Malcomson, at Rockport, Belfast Lough. *Proc. Bel. Nat. Field Club.*—Appendix, 1885-1886, pp. 317-325, pl. xxvi, 1886.
- WRIGHT, J. A List of the Cretaceous Foraminifera of Keady Hill, County Derry. *Proc. Bel. Nat. Field Club.*—Appendix, 1885-1886, pp. 327-332, pl. xxvii, 1886.
- YOUNG, J. On the Occurrence of *Saccamina Carteri* (Brady) in the Limestone Series of the Lanarkshire Coalfield. *Trans. Geol. Soc. of Glasgow*, vol. iv, pp. 263-266, 1874.
- YOUNG, J. On some recently discovered Foraminifera from the Lanarkshire Coalfield. *Proc. Nat. Hist. Soc. Glasgow*, vol. ii, pt. 1, 1875.

FRANCE AND ITALY.

- BROCCHI, G. *Conchiologia fossile subappennina, con osservazioni geologiche sugli Appennini e sul suolo adiacente*, vol. ii, 1814.
- BROCCHI, G. *Conchiologia fossile subappennina*. Ediz. 2, vol. ii, 1843.
- BOUBÉE, N. *Nummulite, Nummulites*. *Magasin de Zool.*, vol. ii, pl. xv, 1832.
Describes *N. mille-têtes*. Figures *N. mille-têtes* and *N. mille-caput*, *N. Boubée*.
- CAFICI, I. La formazione miocenica nel territorio di Licodia Eubea (provincia di Catania). *Atti Acc. Lincei*, ser. 3 vol. xiv, 1883.
Not seen.
- CAIROL, M. F. Recherches sur le Terrain Crétacé Inférieur de la clape et des corbières. *Ann. de Sci. Géologiques*, vol. iii, pp. 1-171, 1872.
Remarks on *Orbitolina conoidea*, Alb. *O. discoïdes*, Alb.

- CIOFOLO, S. Cenni sul terreno nummulitico dei dintorni di Termini-Imerese (Nummulitic of Imeretia). *Ann. Soc. Nat. Modena*, ser. 2, ann. ix, pp. 4, 1875.
- CIOFALO, S. Enumerazione dei principali fossili che si rinven-
gono nella serie delle rocce stratificate dei dintorni di Ter-
mini-Imerese. *Atti Acc. Gioenia*, ser. 3, vol., xii, Catania,
1877.
Not seen.
- COPPI, F. Paleontologia Modenese o Guida al Paleontologo
con nuove specie. Modena, 1881.
- CORNUEL, —. Liste des fossiles du terran crétacé inférieur
de la Haute-Marne. *Bull. Soc. Géol. de France*, ser. 3, vol.
xiv, pp. 312-323, 1886.
List of Foraminifera.
- DE AMICIS, G. A. L'Amphistegina del calcare lenticolare di
Parlascio *Atti della Soc. Toscana di Sci. Nat.*, vol. iv, pp.
222-226, 1885.
- DEECKE, W. Les Foraminifères de l'Oxfordien des environs de
Montbéliard (Doubs.), Sep. aus *Mém de la Soc. d'émulation
de Montbéliard*, vol. xvi, 49s., pls. 2, 1886.
- DE LA HARPE, P. Étude sur les Nummulites de la Suisse (con-
clusion). *Abh. Schw. pal. Ges.* x, pp. 141-180, pls. 5.
Not seen.
- DE LA HARPE, P. Une Echelle des Nummulites ou tableau de
la distribution stratigraphique des Êspeces de Nummulites.
(Extrait.) *Verhandlungen de la Société Helvétique des Sci.
Nat.*, 6 pp., 1879.
- DE LA HARPE, P. Description des Nummulites des Falaises de
Biarritz. Additions et conclusions. (Extrait, 15 pp.) *Bull.
de la Soc. de Borda à Dax.*, p. 229, 1881.
- DE LA HARPE, P. Description des Nummulites appartenant a
la Zone inférieure des Falaises de Biarritz des environs de
la Villa Bruce Jusqu'à Handia. (Extrait, 14 pp.) *Bull. de
la Soc. de Borda à Dax.*, p. 27, 1881.
- DE STEFANI, C. Sugli studi dell'ufficio Geologico nelle Alpi
Apuane e nell' Apennino. (Estrate dal *Boll. della Società
Geol. Ital.*, vol. iii, fasc. 1, 20 pp.), 1884.

- DOLFUS, G. Note géologique sur les terrains crétacés et tertiaires du Cotentin. [Cretaceous and Tertiary Beds of the Cotentin.] *Bull. Soc. Géol. France*, sér. 3, vol. iii, pp. 460-477, with folding table and 4 figs., 1875.
Not seen.
- DUJARDIN, —. Art. Rhizopodes. *Diction. Univers. d'Hist. Natur.*, vol. xi, 1848.
- FERUSSAC (LE BARON DE). Sur l'Animal du Genre Argonaute. Plate, 1824.
- FILHOL, H. La vie Fond des Mers les Explorations sous-Marines et les Voyages du Travailleur et du Talisman. Protozoaires, pp. 290-301, figs. 93-96, 1885.
- FOLIN, M. DE. Sur les *Amphistegina* de Porto Grande-in: *Compt. Rend. Ac. Sc. Paris*, T. 102, No. 26, pp. 1575-1576, 1886.
Not seen.
- FORNASINI, C. Lagene Fossili nell'Argilla giallastra di San Pietro in Lama Presso Lecce. *Boll. della Soc. Geol. Italiana*, vol. iv, pp. 1-11 (Extra), 1885.
- FORNASINI, C. Textularina e altri Foraminiferi fossili Marna Miocenica di San Rufillo presso Bologna. *Boll. della Soc. Geol. Italiana*, vol. iv, pp. 1-16 (Extra), pl. vi, 1885.
- FORNASINI, C. Il Nautilus Legumen di Linneo e la Vaginulina elegans di D'Orbigny. *Boll. della Soc. Geol. Italiana*, vol. v, pp. 1-8, pl. i, 1886.
- FORNASINI, C. Foraminiferi illustrati da Soldani e citati dagli autori, contribuzione allo studio dei Foraminiferi fossili negli strati neogenici D'Italia e viventi nel Mediterraneo. *Boll. d. Soc. Geol. Ital.*, vol. v (Extra, pp. 1-126), 1886.
- FORNASINI, C. Di Alcune Bilociuline fossili negli strati a Pecten hystrix del Bolognese. *Boll. d. Soc. Geol. Italiana*, vol. v (separate, 11 pp.), 1886.
- FORNASINI, C. Varietà di Lagena fossile negli strati a Pecten hystrix del Bolognese. *Boll. d. Soc. Geol. Italiana*, vol. v (Extra), 4 pp., plate viii, 1886.
- FORNASINI, C. Sulla Glandulina aequalis di Reuss. *Boll. d. Soc. Geol. Italiana*, vol. v (Extra), 6 pp., pl. vii, 1886.
- FORNASINI, C. Textularia gibbosa e, T. tuberosa. *Boll. Soc. Geol. Italiana*, vol. vi (Estratto, 4 pp.), pl. ii, 1887.

- FORNASINI, C. Di alcuni Foraminiferi Provenienti Dagli strati Miocenici dei Dintorni di Cagliari. *Boll. Soc. Geol. Italiana*, vol. vi, 7 pp., 1887.
- FORNASINI, C. Foraminiferi illustrati da Bianchi e da Gualtieri. *Boll. Soc. Geol. Italiana*, vol. vi, 22 pp., 1887.
- GIORGI, C. DE. Note geologiche sulla provincia di Lecce, vol. i. Lecce, 1876.
Not seen.
- GMELIN, J. F. *Systema Naturae Linnaci*. Ediz. 13a. Lione, 1789.
Not seen.
- GÜMBEL, C. W. Kurze Bemerkung über die Nummulitenschichten am Nordrande der Alpen. *Verd. d. K.K. Geol. Reichsanstalt*, 1886, pp. 367, 368, 1886.
- HAUG, M. E. Note préliminaire sur les dépôts jurassiques du nord de l'Alsace. *Bull. Soc. Géol. de France*, ser. 3, vol. xiv, pp. 47-63, 1886.
Not seen.
- HÉBERT (PROF.). Observations sur les tableaux de M. Renevier. (Remarks on Prof. Renevier's Tables.) *Bull. Soc. Géol. de France*, ser. 3, vol. iii, pp. 15, 16, 1875.
- HOERNES, R. Aufnahmen in Sexten, Cadore, und Comslico. *Verh. K. K. Geol. Reichs.*, pp. 266-269, and *Boll. R. Com. Geol. Ital.*, pp. 378-381, 1875.
Fusulina, Remarks on.
- JACQUOT, M. E. Description Géologique des Falaises de Biarritz, Bidart, Guétary et Saint-Jean-de-Luz. *Actes., la Soc. Linnéenne de Bordeaux*, ser. 3, vol. xxvi, pp. 58, 1868.
- KÜNSTLER, J. *Dumontia opheliarum*, type nouveau de la sous-classe des Sarcodines. *Bull. Soc. Zoöl. France*, vol. x, pp. 309-336, pl. iv, Abstr. *J. R. Micro. Soc.* (2), vi. p. 263, 1885.
- LACVIVIER, M. DE. Étude comparative des Terrains Crétacés de l'Ariège et de l'Aude. *Bull. Soc. Géol. de France*, ser. 3, vol. x, pp. 628-642, 1886.
- LEYMERIE, A. Note 1° sur les terrains supérieurs de la Montagne-Noire; 2° sur l'ensemble des dépôts suprà-nummulitiques du bassin de Carcassonne. [1. Upper Beds of the Montagne-Noire; 2. Suprà-nummulitique deposits of the

Carcassonne Basin.] *Bull. Soc. Géol. de France*, ser. 3, vol. ii, pp. 68-80, plate iv, 1874.

Not seen.

- LORIOI, P. DE., et JACCARD, A. Étude Géologique et Paléontologique de la formation d'eau douce infracrétacée du Jura et en particulier de Villers-Le-Lac. *Mém. Soc. de Phys. a'Hist. Nat. de Genève*, vol. xviii, pp. 63-128, 3 pls., 1865.
- LOTTI, B. Scoperta di strati nummulitici presso Prata e Gerfalco in provincia di Grosseto. [Discovery of Nummulitic beds, etc.] *Boll. R. Com. Geol. Ital.*, pp. 140-144, 1875.
- LOTTI, B. Il terreno nummulitico del versante orientale della Cornata di Gerfalco. [Nummulitic beds of Gerfalco.] *Boll. R. Com. Geol. Ital.*, pp. 227-231, 1875.
- LOTTI, B. La creta e l'eocene nei dintorni di Firenze. *Atti della Soc. Toscana di Sci. Nat.*, vol. iv, pp. 216-222, 1885.
- MARTIN, J. Zone a *Avicula* contorta ou Étage Rhætien. *Mémoires de l'Acad. de Dijon*, ser. 2, vol. xii, pp. 263, 264, 1865.
- MODEER, A. In opus egregium R. D. D. Ambrosii Soldani Saggio Oritografico dictum illustrationes quaedam. In: Soldani, Testaceographia ac Zoophytographia parva et microscopica, vol. i, 1789.
- MOLON, F. Catalogo dei corallari fossili nel Terreno Nummulitico delle prealpi Veneto, compilato dal Dott. F. D'Achiardi, cenno critico. (Catalogue of Nummulitic Corals of Venetia.) 1877.
- MURCHISON, R. I. On the Relation of the Tertiary and Secondary Rocks forming the Southern Flanks of the Tyrolese Alps near Bassano. *Phil. Mag. and Ann. of Philosophy*, n. s., vol. v, pp. 401-410, 1829.
- NOGUÈS, A. F. Les oscillations de la mer nummulitique. [Oscillations of the Nummulitic Sea.] *Compt. Rend. 2 Sess. Assoc. Franç.*, pp. 409-433, 1874.
- NORMAN, A. M. Notes on the French exploring Voyage of 'Le Travailleur' in the Bay of Biscay. *Ann. and Mag. Nat. Hist.*, ser. 5, vol. vi, pp. 430-436, 1880.

- PFAFF (DR.) F. Die Naturkräfte in den Alpen oder Physikalische Geographie des Alpengebirges. Die Tertiärformation zeigt sich in den Alpen, pp. 274, 275, 4 woodcuts, 1877.
 Nummulites.
- PONZI, G. I fossili del monte Vaticano Rizopodi. *Atti Acc. Rom.* (2), vol. iii, 2, pp. 451, 452, 1876.
 Not seen.
- RAULIN, V. Coupes Géologiques des Sondages exécutés dans le sud-ouest de la France. *Actes., la Soc. Linnéenne de Bordeaux*, ser. 3, vol. xxvi, pp. 241-268, 1868.
- SCHLUMBERGER, C. Note sur un Procédé permettant d'exécuter des sections minces dans les Foraminifères. *Feuille des Jeunes Naturalistes*.
- SCHLUMBERGER, M. Sur le Biloculina depressa D'Orb. au Point de vue du Dimorphisme des Foraminifères. *Association Français pour l'Avancem. des Sci.*, pp. 520-527, 7 woodcuts, 1883.
- SCHLUMBERGER, M. Sur l'Orbulina universa, d'Orb. *Compt. Rend.* vol. xcvi, pp. 1002, 1004, figs. 1, 2, 1884.
- SCHLUMBERGER, C. Note sur le genre Adelosina. *Bull. Soc. Zoöl. de France*, ser. 3, vol. xi, pp. 91-104, pl. xvi, 1886.
- SCHLUMBERGER, C. Note sur le genre Adelosina. *Bull. de la Soc. Zoöl. de France*, ser. 3, vol. xi, pp. 544-557, 7 woodcuts, pl. xvi, 1886.
- SILVESTRI, O. Sulla illustrazione delle opere del P. Ambrogio Solani e della fauna microscopica fossile del terreno pliocenico italiano, seguita da un catalogo dei rizopodi pliocenici del territorio senese. *Atti X. Congr. Scienz. Ital.*, Siena, 1862.
- SIMONELLI, E. Nuovo genere de Rizopodi del Calcare a Nullipore delle vicinanze de S. Quirico d'Orcia. *Atti Soc. Tosc.* (P. v.), 1879, p. lxxvi. Cited from *Zoöl. Jahr Bericht*, Naples, 1879. (*Zool. Rec.*, vol. xvi, p. 18, Prot. 1879.)
- TERRIGI, G. Le formazioni vulcaniche del Bacino romano considerate nella loro fisica costituzione e giacitura. *Atti Acc. Line.*, ser. 3, vol. x, p. 389, 1881.
 Not seen.

TERQUEM, M. O. II. Les Foraminifères et les Ostracodes du Fuller's-Earth des environs de Varsovie. *Mém. Soc. Géol. de France*, ser. 3, vol. iv, pp. 1-112, pls. vii-xviii, 1886.

TERQUEM, M. O., et TERQUEM, E. Foraminifères et Ostracodes de l'Islande et du sud de la Norvège. *Bull. de la Soc. Zoöl. de France*, vol. xi, pp. 328-339, 1 pl., 1886.

TOURNOUËR, ——. (Nummulitic Fossils from Biarritz.) *Bull. Soc. Géol. de France*, ser. 3, vol. ii, pp. 262, 263 (1874).

TURPIN, ——. Analyse ou étude microscopique des différens corps organisés et autres corps de nature diverse qui peuvent, accidentellement, se trouver enveloppés dans la pâte translucide des silex. *Ann. d. Sci. Nat.*, ser. 2, vol. vii, pp. 129-156, pls. vi, vii, 1837.

VILLA, A. e G. B. Cenni Geologici sul Territorio dell' Antico distretto di oggiono. *Atti Soc. Ital. di Sc. Nat.*, vol. xxi (extra, 19 pp.), 1878.

AUSTRO-HUNGARY, BELGIUM, DENMARK, FINLAND, GERMANY, HOLLAND, NETHERLANDS, NORWAY, SWEDEN, SWITZERLAND.

ALTH, A. O galicyjskich gatunach skamienialych otworinc rodzaju Gyroporella (Ueber die versteinerten galicischen Arten der Foraminiferen gattung Gyroporella). *Rozprawy i Sprawozdany posieden Wydzialu Matem.—Przyrodn Akad. Umietjetnosu, Cracow* (3 spp. nn.), 1880.

ANDREAE, A. Beitrag zur Kenntniss des Elsässer Tertiärs. II. Theil die Oligocänschichten im Elsass, pls. vi-xii, 2 maps, 1884.

Describes many new species.

ANDREAE, A. Ueber Meeressand und Septarienthon. *Mittheilungen der Commission für die geologische Landesuntersuchung von Elsass-Lothringen*, vol. i, 10 pp. (separate), 1887.

ANDRUSSOW, N. Ueber das Alter der unteren dunklen Schieferthone auf der Halbinsel Kertsch. *Verhand. d. K.K. Geol. Reichsanst.*, 1885, pp. 213-216, 1885.

ANON. On the Foraminifera of Barbadoes. (Étude sur les Foraminifères de la Barbade, etc.) By M. Ernest Vanden

Broeck, etc. 8vo., 98 pages, with 2 plates. Brussels, 1876. (From the 'Annales de la Soc. Belge de Microscopie.') *Ann. and Mag. Nat. Hist.*, ser. 4, vol. xix, p. 260, 1877.

A Review.

- BARROIS, C. Note sur les foraminifères arénacés (Arenaceous Foraminifera). *Ann. Soc. Géol. Nord.*, vol. iii, pp. 18-20, 1876.
- BORNEMANN, J. G. Beiträge zur Kenntniss des Muschelkalks, insbesondere der Schichtenfolge und der Gesteine des Unteren Muschelkalks in Thüringen. *Jahrbuch d. Kon. Preus. Geol. Landesanstalt und Bergakademie zu Berlin*, 1885, pp. 267-320 (Foraminifera), pl. xiii, 1886.
- BOUTILLIER, LOUIS. Notice sur un dépôt alluvial de Saint-Aubin-sur-Mer (Calvados) contenant des Nummulites. (Alluvial Deposit containing Nummulites.) *Bull. Soc. Sci. Nat. Rouen*, ser. 2, ann. 12. pp. 183-185, figure, 1877.
- BRANDT, K. Ueber die morphologische und physiologische Bedeutung des Chlorophylls bei Thieren. *M. T. Z. Stat. Neap.*, vol. iv, pp. 191, pls. xix, xx, 1883.
Not seen.
- BRIART, M. A. Sur les dépôts tertiaires des environs de Mons. *Ann. de la Soc. Géol. de Belgique*, vol. ix, pp. 173-184, 1881.
- BRIART, M. A. Sur les dépôts tertiaires des environs de Mons. *Ann. de la Soc. Géol. de Belge.*, vol. ix, pp. 173-184, 1881-1882.
- BURBACH, O. Beiträge zur Kenntnis der Foraminiferen des mittleren Lias vom grossen Seeberg bei Gotha. I. Die Gattung *Frondicularia* Defr. Mit 2 Taf. in: *Zeitschr. f. Naturwiss.* (Halle), 59 Bd. I Hft., pp. 30-53, 1886. (9 n. sp.)
- BURBACH, O. Beiträge zur Kenntniss der Foraminiferen des mittleren Lias vom grossen Seeberg bei Gotha. II. Die Milioliden. *Zeitschr. f. Naturwiss.*, Bd. lix, Heft 5, pp. 25-34, pl. v, 1887.
- CORNET, M. F. L. Quelques mots sur certaines assises crétacées du bassin de Mons. *Ann. de la Soc. Géol. de Belge.*, vol. ix, pp. 184-216, 1881.

- CORNET, M. F. L. Quelques mots sur certaines assises crétaées du bassin de Mons. *Ann. de la Soc. Géol. de Belge.*, vol. ix, pp. 184-266, 1881-82.
- DEWALQUE, G. Sur l'extension verticale de quelques fossiles dévonienus réputés caractéristiques. (Vertical range of some reputed Devonian fossils.) *Ann. Soc. Géol. Belge.*, vol. i, Bull. pp. 62, 63, 1874.
Receptaculites Neptuni, DeFr.
- DITTMAR, —. Die Contortazone und ihre organischen Einschlüsse. München, 3 pls., 1864.
Not seen.
- DRYGALSKI, E. VON, Murray, John, et Renard, A. Notice sur la classification le mode de formation et la distribution géographique des sédiments de mer profonde. Bull. Mus. Roy. Hist. Nat. Belg., 1884, vol. iii, pp. 25-62. *Neues Jahrbuch für Min.*, vol. iii, pp. 228-232, 1886.
Review.
- DUNIKOWSKI, E. Die Spongien, Radiolarien und Foraminiferen der unterliassischen schichten vom Schafberg bei Salzburg, *Denkschr. d. Mathemat. Nat. Cl. d. K. Akad. d. Wiss.*, vol. xlv, pp. 34, 6 plates, 1882.
- D'URBAN, W. S. M. The Zoology of Barents Sea. *Ann. and Mag., Nat. Hist.* ser. 5, vol. vi, pp. 253-277, 1880.
- EHRENBERG, Berichte über die zur Bekanntmach. geeignet. *Verhandl. der konigl. preuss. Akademie. der Wissenschaften*, 1842.
- FOLIN, M. DE. On a new locality containing the nummulitic formation, 1886.
Not seen.
- FUCHS, TH. Zur Bildung der Terra Rossa. [On Terra Rossa.] *Verh. K. K. geol. Reichs.* pp. 194-196. 1875.
Supplementary to Prof. Neumayr's paper; notices its large development in Greece, where it is derived from freshwater limestones. Hence it is always due to Globigerina remains, and the climate of the country has more to do with its formation than the nature of the limestone. (E. B. T., Geol. Rec. p. 65.)
- FUCHS, TH. Ueber den sogenannten "Badner Tegel" auf Malta. (So-called Baden Clay of Malta.) *Sitz. K. Ak. Wiss. Wien. Math. Cl. Abth. i*, vol. lxxiii, pp. 67-84, 1 plate, 1876.

- FUCHS, TH. Die Pliocänbildungen von Zante und Corfu. (Pliocene of Corfu, etc.) *Sitz. k. Ak. Wiss. Wien. Math. Nat. Cl.* vol. lxxv, pp. 309-320, plate 1, 4 woodcuts, 1877.
- FUCHS, TH. Tertiärfossilien aus dem Becken von Bahna (Rumänien). *Verhandl. d. R. K. Geol. Reichsanst.*, 1885, pp. 70-75, 1885.
- FUCHS, TH. Über eine Mikrofauna aus den westgalizischen Karpathen. (Verhandl. Geol. Reichsanst, 1885-87.) *Neues Jahrbuch für Min.*, vol. ii, p. 317, 1886.
Review.
- FUCHS, TH. F. Sandberger : Fossile Binnenconchylien aus den Inzensdorfer (congerien) Schichten von Leobonsdorf in Niederösterreich und aus dem Süsswasserkalke von Baden. (Verhandl. Geol. Reichsanst, 1885, 393. *Neues Jahrbuch für Min.*, vol. ii, p. 302, 1886.
Review.
- FUCHS, TH., Rzehak, A. : Über das Vorkommen der Foraminiferen-gattungen *Ramulina* und *Cyclammmina* in den älteren Tertiär Schichten Österreichs. (Verhandl. Geol. Reichsanst, 1885, 186). *Neues Jahrbuch für Min.*, vol. ii, p. 316, 1886.
Review.
- FUCHS, TH., Penecke, A.: Das Eocän des Krappfeldes in Kärnthen. (Sitzber. Wien. Akad. 1884, vol. xc., 327.) Mit einer geolog. Karte, einer Profil und drei Pertrefacten-tafeln. *Neues Jahrbuch für Min.*, vol. ii, pp. 254-256, 1886.
Review.
- FUCHS, TH. On Ch. Mayer-Eymar : Zur Geologie Egyptens (Vierteljahrschrift der Züricher Naturforsch. Gesellsch., 1886). *Neues Jahrbuch für Min. Geol. u. Pal.*, vol. ii, pp. 353-356, 1887.
A Review.
- FUCHS, TH., Review of ; A. Rzehak : Bemerkungen über einige Foraminiferen der Oligocänformation. (Verh. Naturforsch. Vereines in Brünn, vol. xxiii, 1884.) *Neues Jahrbuch Min. Geol. u. Pal.* vol. i. pp. 380, 381, 1887.
- GRUBER, A. Contributions to the Knowledge of the Physiology and Biology of the Protozoa. Translated by W. S. Dallas, F. L. S., from a separate impression of the paper in the

Berichte der naturforschenden Gesellschaft zu Freiburg, Band i (1886), Heft 2. Communicated by Dr. Wallich. *Ann. and Mag. Nat. Hist.*, ser. 5, vol. xvii, pp. 473-494, woodcuts, 1886.

GÜMBEL, C. W. Verh. Geol. Reichsanst, 1880, p. 214.

Mentions finding the green granules of the Flysch deposits not uncommonly retaining the outline of the chambers of Foraminiferal shells.

HAECKEL, E. v. *Biologische Studien*. Erstes Heft. Studien ueber Moneren und andere Protisten. (Translation.) *Quart. Journ. Micro. Sci.*, vol. xi, n. s., pp. 60-68, 1871.

Review.

HAEUSLER, R. Die Lageninen der schweizerischen Jura und Kreideformation. *Neues. Jahrbuch Min. Geol. u. Pal.*, vol. i, pp. 177-194, pls. iv-vii, 1887.

HAEUSLER, R., Bemerkungen über einige liasische Milioliden. *Neues. Jahrbuch Min. Geol. u. Pal.*, vol. i, pp. 190-184, pls. vi, vii, 1887.

HAGENOW, —. Monographie der Rügenschon Kreide-Versteinerungen. *Leon., und Bronn. Jahrbuch für Min.*, p. 568, 1842.

HARTING, P. Bijdrage tot de kennis der mikroskopische fauna en flora van de Banda-Zee. *Verhand. K. Akad. Wetensch.*, vol. x, pp. 1-34, pls. i-iii, 1864.

This paper contains an examination of the sea-bottom at various depths, and gives a description, with figures, of some new species of Diatoms, Foraminifera, Polycystina, and Sponges. (*Zool. Rec.* vol. ii, 1865, p. 786.)

HAUER, FR. v. Sammlung von Nummuliten aus Ungarn (Hungarian Nummulites). *Ver. K. K. Geol.*, pp. 161-162, 1876.

HILBER, V. Geologie der Gegend zwischen Krzyzanowice wielki bei Bochnia, Ropczyce und Tarnobrzeg. *Verhandl. d. K. K. geol. Reich.*, pp. 117-133, 1884.

HOFMANN, K. Die geologischen Verhältnisse des Ofen-Kovács-Gebirges. (Jahrb. d. K. ung. geolog. Anstalt, 1871.) *Verhandl. K. K. geol. Reich.*, pp., 36-38, 1872.

KARRER, F. Die Untergegangene Thierwelt in den Baumaterialien Wien's. *Ein Vortrag Gehalten im Wissenschaftlichen Club in Wien am Jänner, 1878.*

- KAYSER, H. E. v. Ueber die Billings'sche Gattung *Pasceolus* und ihre Verbreitung in paläozoischen Ablagerungen. *Zeitschr. d. Deutsch. geol. Ges.*, vol. xxvii, pp. 776-782, pl. xx, 1875.
- KEYSERLING, GRAF ALEX. Wissenschaftliche Beobachtungen auf einer Reise in das Petschora-Land, p. 194, 1846.
Not seen.
- KÖLLIKER, A. On the frequent Occurrence of Vegetable Parasites in the Hard Tissues of the Lower Animals. *Quart. Journ. Micro. Sci.*, vol. viii, pp. 171-188, 1860. (Abstracted from the '*Zeitsch. f. Wiss. Zoolog.*,' vol. x, p. 215, 1859.)
- KÜBLER, F. K. J. Pfarrer in Heftenbach und Heinrich Zwingli weil, Pfarrer in Dättlikon, Die Foraminiferen des Schweiz, Jura. Winterthur, Steiner. *Verhandl. K. K. Geol. Reich.* pp. 126-128, 1872.
- LEUCKART, R. v. Bericht über die wissenschaftlichen Leistungen in der Naturgeschichte der niederen Thiere während der Jahr, 1876-1879. (Schluss). *Archiv. fur Naturgesch.*, vol. vi, Rhizopoda, pp. 752-812, 1880.
- MAYER-EYMAR, C. Classification des terrains crétaçés conforme à l'équivalence des périhélies et des étages, 3 pp., 1885.
- MENTEATH, P. W. Stuart. Note préliminaire sur les gisements métallifères des Pyrénées occidentales. *Bull. Soc. Geol. de France*, ser. 3, vol. x, pp. 587-607, 1886.
- METZGER, A. B. Faunistische Ergebnisse der im Sommer 1871, unternommenen Excursionen. Die Expedition zur physikalisch-chemischen und biologischen Untersuchung der Ostsee in Sommer 1871, auf S. M. Avisodampfer *Pomerania* (Foraminifera), p. 176, 1873.
- M. J. Exploration of the North Sea. (Die Ergebnisse der Untersuchungsfahrten S. M. Knbt. "Drache.") (Kommandant Korvetten-Kapitän Holzhaur) in der Nordsee in den Sommern 1881, 1882, und 1884. Veröffentlicht von dem Hydrographischen Amt der Admiralität, 1886. *Nature*, vol. xxxv, pp. 73, 74, 1886.
A Review.

- MÖBIUS, K. Drei Arbeiten über Foraminiferen. *Biol. Centralbl.* iv, pp. 645-650, 1885.
- OLSZEWSKY, DR. STANISLAW. Zapiski Paleontologiczne. (Palaeontological Notes.) *Sprawozd. Kom. Fizyogr. Krakow*, vol. x. pp. 95-149, pls. i, ii (1875).
- Describes and figures the following new species—*Nodosaria sceptriformis*, *N. pauperculoides*, *N. tenuis*, *N. adtuens*, *N. marginula*, *Glandulina lagenoides*, *Frondicularia elongata*, *Cristellaria althi*, *C. bistegia*, *C. carinata*, *Polymorphina simplex*, *P. adhaerens*, *P. acuta*, *Bulimina frons*, *Discorbina lepolitana*, *Polystomella* (*D. Orb.*) *Karrereri*, *Haplostiche depressa*, *Verneuillina convexa*, *Plecanium depressum*, and *Heterostomella lepolitana*, besides many previously known species, all cretaceous. (*W. H. D. Geol. Rec.* p. 331, 1877.)
- ORTLIEB, J. Compte-rendu d' une excursion à Cassel. [Excursion to Cassel.] *Ann. Soc. Géol. Nord.*, 1870-74, pp. 101-109, 1874.
- Not seen.
- PAUL, C. M., and E. TIETZE. Studien in der Sandsteinzone der Karpathen. (Carpathian Sandstone-zone.) *Jahrb. K. K. Geol. Reichs.*, vol. xxvii, pp. 33-130, 7 cuts, 1877.
- PHILIPPSON, A. Ueber das Vorkommen der Foraminiferen-Gattung Nummoloculina Steinmann in der Kreideformation der Ostalpen. *Neues Jahrbuch für Mineralogie Geol. u. Paläontologie*, vol. ii, pp. 164-165, 7 woodcuts, 1887.
- QUENSTEDT, F. AUG. Handbuch der Petrefactenkunde, p. 819, tab. 68, fig. 53.
- Not seen.
- RADIMSKY, V. Die Insel Pago in Dalmatien und deren Lignit-Vorkommen. (Geology of Pago and its Lignite-beds.) *Berg-hütt. Jahrb.*, vol. xxv, pp. 325-353, pl. vi, 1877.
- RAMMELSBERG, C. Memoir of Christian Gottfried Ehrenberg. *Ann. and Mag. Nat. Hist.*, ser. 4, vol. xix, pp. 113-116, 1877.
- REICHERT, K. B. Ueber die contractile Substanz (Sarcode protoplasma) und deren Bewegungserscheinungen bei Polythalamien und einigen anderen Thieren. *Reichert's u. Du Bois-Reymond's Archiv.*, pp. 749-761, 1865.
- ROBOZ, Z. v. *Calcutuba polymorpha*, g. & sp. n n. *S. B. Ak. Wien*, vol. lxxxviii, Abth. 1, pp. 421-432, 1 pl., and *Anz. Ak. Wien*, vol. xiv, pp. 117, 118, 1883.

- RUTOT, A., and E. VAN DEN BROECK. Esquisse Géologique de la Belgique. Extrait de L'Annuaire Géologique Universel de M. Le Dr. Dagincourt, vol. ii, pp. 131-149, 1886.
- RUTOT, M. M., et E. VAN DEN BROECK. Documents nouveaux sur la base du terrain tertiaire en Belgique et sur l'âge du Tufeau de Ciplu. *Bull. de la Soc. Géol. de France*, ser. 3, vol. xv, pp. 157-162, 1886.
- RUTOT, A. Détermination de l'allure Souterraine de couches formant le sous-sol des Flandres entre Bruxelles et Ostende. *Mém. de la Soc. Belge. de Géol. de Paléon., et D'Hydro.*, vol. i, pp. 1-19, 1887.
- RUTOT, A. Sur L'Age du Grès de Fayat. *Mém. de la Soc. Belge. de Géol. de Paléon., et D'Hydro.*, vol. i, pp. 42-48, 1887.
- RZEHAK, A. Bemerkungen über Foraminiferen der Oligocänformation. *Verhandl. d. Naturf. Vereines in Brünn*, vol. xxiii, pp. (separate, 7 pp.), 1884.
- RZEHAK, A. Ueber das Auftreten der Foraminiferengattung *Epistomina Terquem* im Eocän Nieder-Oesterreichs. *Verhandl. d. K. K. Geol. Reich.*, pp. 332, 1885.
- RZEHAK, A. Die Foraminiferenfauna de Neogenformation der Umgebung von Mähr.—Ostran *Verh. Naturf. Ver. Brünn*, xxiv, Bd. 1, Heft. *Abhandl.*, p. 77, pl. i, 1887.
- RZEHAK, A. Die Foraminiferenfauna des grünen Oligocänthones von Nikolschitz in Mähren. *Verhandl. d. K. K. Geol. Reichsanst.*, pp. 87, 88, 1887.
- RZEHAK, A. Die Foraminiferenfauna des blauen Oligocänthones von Nikolschitz in Mähren. *Verhandl. d. K. K. Geol. Reichsanst.*, pp. 133-135, 1887.
- SCHWAGER, C. Zittel's—Handbuch der Palaeontol., vol. i, pp. 103, 104, 1876.
- SARS, M. Remarks on the Distribution of Animal Life in the Depths of the Sea. *Ann. and Mag. Nat. Hist.*, ser. 4, vol. iii, pp. 423-441, 1869.
- Translated from the 'Videnskabs-Selskabs Forhandling' for 1868, pp. 246-275, by Rev. A. Bethune, M. A., late President of the Tyneside Naturalists' Field Club; and communicated by the Rev. A. M. Norman. (*Ann. Mag. Nat. Hist.*, p. 423.)

- SIEBOLD, C. Th. Anatomy of the Invertebrata. Translated by W. J. Burnett, 1874.
- STEINMANN, —. On W. Deecke: Les Foraminifères de l'oxfordien des environs de Montbéliard (Doubs). Mém. d. l. soc. d'émul. d. Montbéliard, ser. 3, vol. xvi. Separatabdruck 47 S. und 2 Tafeln., 1886. *Neues Jahrbuch für Min. Geol. u. Palaeontologie*, vol. ii, pp. 393, 394, 1887.
- Review.
- STEINMANN, —. On O. Burbach: Beiträge zur Kenntniss der Foraminiferen des mittleren Lias vom grossen Seeberg bei Gotha. I. Die Gattung *Frondicularia* Dfr. II. Die Milioliden. (Zeitschr. f. Naturw. Halle, B. LIX., Heft. 1 u. 5, Tafel 1, 2 u. 5, 1886–87.) *Neues Jahrbuch für Min. Geol. u. Palaeontologie*, vol. ii, pp. 393, 1887.
- Notice.
- STEINMANN., Review of V. Uhlig eine Mikrofauna aus dem Alttertiär der westgalizischen Karpathen. (Jahrb. d. K. K. Geol. Reichsanstalt, Bd. 36, 1 Heft., p. 141–214, t. II.—V und 13 Holzschnitte, 1886.) *Neues Jahrbuch Min. Geol. u. Palaeontologie*, 1 Bd., pp. 379, 380, 1887.
- STUR, D. Prof. Jos. Clemens. Beitrag zur Kenntniss des älteren Tertiär im Oberen Gran—Thale. *Verhandl. K. K. Geol. Reichst.*, pp. 332–334, 1874.
- SZAJNOCHA, L. (DR.) Ueber das Karpathensandsteingebiet in der Gegend von Saybusch und Biala in West-Galizien. *Verhandl. d. K. K. Geol. Reichsanst.*, pp. 54–58, 1885.
- TELLER, F. Oligocänbildungen im Feistritzthal bei Stein in Krain. *Verhandl. d. K. K. Geol. Reichsanst.*, pp. 193–200, 1885.
- UHLIG, V. Zur Stratigraphie der Sandsteinzone in West-Galizien. *Verhandl. d. K. K. Geol. Reichsanst.*, pp. 33–46, 1885.
- UHLIG, V. Ueber eine Mikrofauna aus den West-Galizischen Karpathen. *Verhandl. d. K. K. Geol. Reichsanst.*, pp. 82–83, 1885.
- UHLIG, V. Foraminiferen von Jan Mayen. Die internationale Polarforschung von 1882–1883. Die österreichische Polarstation, Jan Mayen, 3 Bd., 1886.

- UHLIG, V. Foraminiferen von Jan Mayen, in Österr. Polarstation, Jan Mayen, Beob. Ergebn., 3 Bd. Zool. p. 1-8, 1886. (30 sp.)
- VANDEN BROECK, E. Observations sur la *Nummulites planulata* du panisélien. *Bull. Soc. Géol. de France*, ser. 3, vol. ii, p. 559, 1875.
- VANDEN BROECK, E. Description d'un Nouveau système de slide pour le Montage des préparations a sec spécialement applicable aux collections de Foraminifères d'Entomostracés, etc. *Ann. de la Soc. Belge. de Micro.*, vol. iv (Extra), pp. 111-118, 1877-78.
- VANDEN BROECK, E. Note sur un Modèle simplifié du Nouveau système de slide. *Ann. de la Soc. de Micro. de Belge*, vol. v. *Mémoires*, p. 5 (extra 10 pp.), 1879.
- VANDEN BROECK, E. Sur la Constitution Géologique des Dépôts Tertiaires, Quaternaires et modernes de la région de lierre. *Ann. de la Soc. Géol. de Belg.*, vol. xiii (*Mémoires*, 1877), pp. 376-423, 1887.
- VAN CAPPELLE (JR.), H. Het Karakter van de Ned.—Indische Tertiaire Fauna, 198 pp., 1885.
- VIGUIER, M. Note sur la position du Pondingue de Palasson, dans l'Aude. *Bull. Soc. Géol. de France*, ser. 3, vol. x, pp. 582-586, 1886.
- VON COTTA, B. Die Geologie der Gegenwart. (Foraminifera), pp. 82, 92, 101, 138, 1872.
- VON HANTKEN. Foraminiferen—Fauna des Kleinzeller Tegels. Pest, 2 Taf., 1868.
Not seen.
- V. U. A. Rzehak. Die Foraminiferenfauna der Neogenformation der Umgebung von Mährisch-Ostrau. (Verhandl. d. Naturf.-Vereines in Brünn, xxiv, Bd., mit 48 Seiten und einer Tafel.) *Verhandl. K. K. Geol. Reich.*, p. 104, 1887.
A Review.
- WOLF, H. Die Dolomitbreccie und der Amphisteginen—Thon von Baden bei Wien. *Verhand. K. K. Geol. Reich.*, pp. 167-169, 1872.

ZUGMAYER, H. Ueber Petrefaktenfunde aus dem Wiener Sandstein des Leopoldsberges bei Wien. (Fossil from Vienna Sandstone). *Verhand. K. K. Geol. Reichs.*, pp. 292-294, woodcut, 1875.

RUSSIA AND TURKEY.

ANDRUSSOW, N. Zur Geologie der Halbinsel Kertsch., II. Th. *Mém. de la Société de Nat. de la Nouvelle-Russie*, vol. xi, pp. 69-89, 1887.

BARBOT DE MARNY, NICOL. Geognost. Reise in die Nördlichen Provinzen des Europ., Russlands (in russ. Sprache), *Siehe Verhandl. der kais.-russ. miner. Gesellsch.*, ser. 2, III. Theil., pp. 237-239, 1868.

Not seen.

GUROFF, ALEX. Fossilien der donischen Carbon-Ablagerungen (in russ. Sprache), p. 19, 1873.

Not seen.

KARPINSKY, ALEX. Geolog. Beobachtungen im Gouvernement Orenburg (in russ. Sprache), *S. Verhandl. der kais.-rus. mineral. Gesellsch.*, ser. 2, IX Theil, pp. 225, 233-235, 1874.

Not seen.

RSCHESKY. Bemerkungen über die Versteinerten Roggen-Körner im Gouv. Rjasan. *Russ. Berg.-Journal*, vol. iii, pp. 202, 203, 1826.

Not seen.

SCHTSCHUROFFSKY, GR. Geschichte der Geologie des Moskauer Bassins (in russ. Sprache), vol. i, p. 100, 1866.

Not seen.

STUCKENBERG, A. Bericht über eine Reise in das Petschora-Land und d. Timan-Gebirge (in russ. Sprache), S. Beiträge zur Geologie Russlands, herausgegeben von der kais.-russ. miner. Gesellsch. zu St. Petersburg., vol. vi, pp. 102, 103, 1875.

TRAUTSCHOLD, H. Grundzüge der Geologie, II. Theil, Palæontologie (in russ. Sprache), p. 8, 1875.

TRAUTSCHOLD, H. The Urals. *Zeitsch. Deutsch. Geol. Ges.* Heft. iii, pp. 703-706, 1875.

Fusulina shells.

AFRICA AND ASIA.

- BLANFORD, W. T. On the Geology of Sind. *Rec. Geol. Surv. Ind.* vol. ix, pp. 8-22, 1876.
- COQUAND, H. Note sur la Craie supérieure de la Crimée et de l'Aquitaine, des Pyrénées et de l'Algérie. *Bull. Soc. Geol. de France*, ser. 3, vol. v, pp. 86-99, woodcuts, 1877.
- ETHERIDGE (JUN.), R. South Australian Post-Tertiary Foraminifera and Ostracoda. *Geol. Mag.* dec. ii, vol. iii, p. 334, 1876.
- HECTOR, J. Geological Survey of New Zealand. *Reports of Geological Explorations* during 1873-74, pp. 9, xx, 164, 1877.
- HOWCHIN, W. Occurrence of a Deep-Sea Foraminifer in Australian Miocene Rocks. *Amer. Nat.*, vol. xix, p. 1092, 1885.
- JACK, R. L. Handbook of Queensland Geology, (Foraminifera), p. 69, 1886.
- LARTET, L. M. Essai sur la Géologie de la Palestine et des contrées avoisinantes telles que l'Égypte et l'Arabie. *Ann. d. Sci. Géologiques*, vol. i, Terrains secondaires, pp. 149-336, 1869.
- LARTET, L. M. Essai sur la Géologie de la Palestine et des contrées avoisinantes telles que l'Égypte et l'Arabie. *Ann. d. Sci. Géologiques*, vol. iii, 96 pp., pl. 9, 1872.
Foraminifera pp. 84-91.
- MARTIN, K. Tertiärschichten auf Java, Leyden, 1879-80, pp. 154-163, pls. xxvii and xxviii (reprinted in *Niederl. Arch. Zool.* v. p. 185, pls. xii, xiii).
Describes and figures *Cycloclypeus* and *Orbitoides*, 3 spp. n n. each, *vide infra*. (*Zool. Rec.* vol. xvii, Prot. p. 15, 1880.)
- MARTIN, K., UND A. WICHMANN. Beiträge zur Geologie Ost-Asiens und Australiens. ser. 1, vol. i, 1881-83.
- MAVER-EYMAR, C. Zur Geologie Egyptens. *Vierteljahrsschrift d. Zür. Natur. Gesellsch.* (August), 1886.
(Separate 28 pp.)
- M'KAY, A. Geological Survey of New Zealand. *Reports of Geological Explorations* during 1874-76, pp. 9, xiii, and 191.

- M'KAY, A. Reports relative to the collections of Fossils in S. E. District of the Province of Otago, pp. 59-73, plate, 1877.
- M'KAY, A. Report on Country between Cape Kidnapper and Cape Turnagain, pp. 43-53, 1876.
- MÖLLER, V. v. Ueber einige Foraminiferenführende Gesteine Persiens. *Jahrbuch. Geol. Reich.*, vol. xxx, p. 573, pls. ix, x, 1880.
Describes the *Foraminifera* contained in various Persian deposits, and among them *Stacheia grewingki*, sp. n., from Carboniferous Limestone of Central Persia. (*Zool. Rec.* vol. xvii, Prot. p. 15, 1880.)
- MONTGOMERIE, T. G. Memorandum on the Results of an Exploration of the Namcho, or Tengri Nur Lake, in Great Tibet, made by a Native Explorer during 1871-72. *Journ. R. Geogr. Soc.*, vol. xlv, pp. 325-330, 1875.
- NEWBOLD (LIEUT.) On the Geology of Egypt. *Quart. Journ. Geol. Soc. Lond.* (Proc.), vol. iv, pp. 324-357, 1848.
- SAUVAGE, H. E. Poissons Fossiles D'Oran et de Licata. Deuxième Partie. Description Géologique des Gisements de Licata en Sicile et D'Oran (Algérie). *Ann. d. Sci. Géologiques*, vol. iv, pp. 50-73, 1873.
- VANDEN BROECK, E. "On some Foraminifera from Pleistocene Beds in Ischia." Preceded by some Geological Remarks by A. W. Waters. *Ann. and Mag. Nat. Hist.* ser. 5, vol. ii, p. 100, 1878.
Abstract for the *Geol. Soc.* 1878.
- VERBEEK, R. D. M. Ueber die Gliederung der Eocänformation auf der Insel Borneo. [Eocene of Borneo.] *Paleontographica Suppl.* iii, Pt. 1, pp. 3-9, woodcut, 1875.
- VERBEEK, R. D. M. De Nummulieten mit den Eocenen Kalsteen van Borneo, mit twee platen [Nummulites in the Eocene Limestone of Borneo]. *Jaarb. Mijn. Ned. O.—Ind.*, vol. ii, pp. 133-161, pls. 2, 1875.
- VERBEEK, R. D. M. Geologische Beschrijving der Distrikten Riam-Kiwa en Kanam in de zuider en ooster-afdeeling van Borneo; volgens opneming in de Jaren 1869 en 1870. [Geological Description of the Districts of Riam-Kiwa and Kanam in the S. and E. parts of Borneo.] *Jaarb. Mijn. Ned. Oost.—Ind.* Jaarg. 4, Deel i, pp. 1-130, 1875.

- WRIGHT, E. P. Notes on Foraminifera. (Seychelles and Cagliari Foraminifera.) *Ann. and Mag. Nat. Hist.* ser. 4, vol. xix, pp. 40-44, 1877.
- WRIGHT, E. P. Note on a small collection of Foraminifera from the Seychelles. *Proc. Roy. Irish Acad.* (2) vol. ii, pp. 586-588, 1876.
Not seen.
- WYNNE, A. B. The Trans-Indus Salt Region in the Kohát District. *Mém. Geol. Surv. Ind.*, vol. xi, pt. 2, pp. 220, 1875.
Nummulites.
- ZITTEL, K. Géologie et paléontologie du désert lybien. *Ann. Soc. Geol. du Nord*, vol. xi, pp. 148-157, 1884.

INDEX TO AUTHORS OF SUPPLEMENT I.

	PAGE		PAGE
Agassiz, A	40	Draper, H	42
Alcock, J	48	Drygalski, E. von	65
Aldrich, T. H.	41	Dujardin	59
Alth, A	63	Dunikowski, E	65
Andraea, A	63	Duncan, P. M.	34, 51
Andrussow, N	63, 73	D'Urban, W. S. M	65
Anon	33, 41, 48, 49, 63	Ehrenberg, C. G.	51, 65
Arbeiten	33	Etheridge, R	54
Armstrong, J	49	Etheridge, (Jr.), R	51, 74
Austen, R. A. C	49	Ferussac (Le Baron De)	59
Bailey, J. W.	41	Filhol, H	59
Baily (Mr.)	33	Folin, M. de	59, 65
Baily, W. H.	33	Fornasini, C	59, 60
Barbot, M. N. de	73	Fox, A. L	51
Barrois, C	64	Freeman, H. E	51
Bartlett, J. R.	41	Fuchs, Th	65, 66
Bastian, H. C	49	Giorgi, C. de	60
Benecke	49	Gmelin, J. F	60
Blanford, W. T	74	Grant, C. E	42
Bonney, T. G	33	Grant (Dr.) R. E	51
Bornemann, J. G	64	Gratacap, L. P	34
Boubée, N	57	Gray, J. E	51
Boutillier, L	64	Green, J	51
Brady, H. B	49, 50	Griffing, C. S. G	42
Brandt, K	64	Gümbel, C. W	34, 60, 67
Bree, C. R	50	Guroff, A	73
Briart, M. A	64	Gruber, A	66
Brocchi, G	57	Haeckel, E. v	67
Browne, A. J. J	50	Haeusler, R	52, 67
Burbach, O	64	Hagenow	67
Cafici, I	57	Hahn, O	34
Cairol, M. F	57	Harkness, R	34
Carpenter, P. H	50	Harting, P	67
Carpenter, W. B	50	Hauer, F. V	67
Chapman, F	54	Haug, M. E	60
Ciofalo, S	58	Hayden, F. v	44
Clarke, W. B	50	Hébert	60
Conrad, T. A	41, 42	Hector, J	74
Coppi, F	58	Heddle, M. T	35
Coquand, H	74	Heilprin, A	42
Cornet, M. F. L	64, 65	Hilber, V	67
Cornuel	58	Hinde, G. J	52
Dana, J. D	42	Hitchcock, R	43
Dawson, G. M	42	Hoernes, R	60
Dawson, J. W	34, 42, 51	Hoffman, R	35
Dawkins, W. B	51	Hofmann, K	67
DeAmicis, G. A	58	Howchin, W	74
Deecke, W	58	Hunt, T. S	35
De la Harpe, P	58	Huxley, T. H	43, 52
De Stefani, C	34, 58	Hyatt, A	35, 43
Dewalque, G	65	Jaccard, A	61
Dittmar	65	Jack, R. L	74
Dolfus, G	59	Jacquot, M. E	60

	PAGE		PAGE
James, J. F.	43	Nicholson, H. A.	38, 51, 54
Jeffreys, J. G.	52	Noquès, A. F.	61
Jones, T. R.	35, 52	Norman, A. M.	61
Julien, A. A.	43	Olszewsky (Dr.)	69
Karpinsky, A.	73	O'Meara, E.	54
Karrer, F.	67	Ortlieb, J.	69
Kayser, H. E. v.	68	Owen, D. D.	45
Keyserling, G. A.	68	Parker, W. K.	52
Kinaham, G. H.	35	Patrick, G. E.	45
King, W.	35, 36, 37	Paul, C. M.	69
Kölliker, A.	68	Pfaff, F.	62
Kubler, F. K. J.	68	Perry, J. B.	39
Künstler, J.	60	Phillips, J.	39
Kuntze, O.	37	Phillipson, A.	69
Lacvivier, M. de.	60	Panzi, G.	62
Lankester, E.	52	Pourtales, L. F.	45
Lartet, L. M.	74	Quenstedt, F. A.	69
Leidy, J.	43	Radimsky, V.	69
Leuckart, R. v.	68	Rammelsberg, C.	69
Leymerie, A.	60	Raulin, V.	62
Lobley, J. L.	52	Reichert, K. B.	69
Logan, W. E.	37	Renard, O.	45
Loriol, P. de	61	Robertson, D.	54
Lotti, B.	61	Roboz, Z. v.	69
Lyell, C.	43	Roper, F. C. S.	54
Lykins, W. H. R.	43	Rowney, T. H.	35, 36, 37
Macalister, A.	38	Rschewsky.	73
Macdonald, J. D.	52, 53	Rulot, A.	70
Macgillivray, W.	53	Rzechak, A.	70
Mackie, S. J.	53	Sars, M.	70
Mantell, G. A.	53	Sauvage, H. E.	75
Marcou, M. J.	43	Schimper, W. P.	40
Martin, J.	61	Schlumberger, C.	62
Martin, K.	74	Schlumberger, M.	62
Martyn, W. F.	53	Schultzze, M.	39
Mayer-Eymar, C.	68, 74	Schtschuroffsky, Gr.	73
M'Charles, A.	53	Schwager, C.	70
Meek, F. B.	43, 44, 45	Sherborn, C. D.	54
Menteath, P. W.	68	Shumard, B. F.	46
Metzger, A.	68	Siddall, J. D.	54, 55
Meyer, O.	45	Siebold, C. T.	71
M. J.	68	Silvestri, O.	62
Miller, S. A.	45	Simonelli, E.	62
Mitchell, W. S.	53	Six, A.	39
Millett, F. W.	53	Smith, H. L.	55
M'Kay, A.	74, 75	Smyth, W. W.	40
Möbius, K.	69	Sollas, W. J.	55
Moder, A.	61	Sorby, H. C.	55
Molon, F.	61	Sowerby, G. B.	55
Möller, V. v.	75	Sowerby, J.	55
Moore, C.	38	Steinmann.	71
Montgomerie, T. G.	75	Stewart, S. A.	55
Moseley, H. N.	53	St. John, O. H.	47
Muller, C. J.	53, 54	Stuckenber, A.	73
Murchison, R. I.	54, 61	Stur, D.	71
Murray, J.	45, 54	Szajnocha, L.	71
Newberry, J. S.	45	Teller, F.	71
Newbold (Lieut.)	75	Terquem, E.	63

	PAGE		PAGE
Terquem, M. O	63	V. U.	72
Terrigi, G.	62	Walcott, C. D.	46
Thomson, C. W.	55, 56	Wallace, A. R.	56
Thomson, W.	55	Wallich, G. C.	56
Thompson, W.	55	White, C. A.	46, 47
Tietze, E.	69	Whiteaves, J. F.	47
Tournouër.	63	Whitfield, R. P.	47
Trautschold, H.	73	Wichmann, A.	74
Turpin.	63	Williamson, W. C.	56, 57
Uhlig, V.	71, 72	Wilson, C. M.	40
Ulrich, E. O.	46	Wolf, H.	72
Van Cappelle (Jr.) H.	72	Woodward, A.	47, 48
Vanden Broeck, E.	56, 70, 72, 75	Worthen, A. H.	44, 45
Verbeek, R. D. M.	75	Wright, E. P.	57, 76
Verrill, A. E.	46	Wright, J.	57
Viguier, M.	72	Wynne, A. B.	76
Villa, A. e. G. B	63	Young, J.	49, 57
Von Cotta, B.	40, 72	Zirkel, F.	40
Von Hantken.	72	Zittel, K. A.	40, 76
Von Koenen.	56	Zugmayer, H.	73

THE FUNGUS, PHYLLACTINIA GUTTATA, LEV., ON
LEAVES OF CELASTRUS SCANDENS, L.,
CLIMBING BITTER-SWEET.

BY THE REV. J. L. ZABRISKIE.

(*A Description of Exhibit No. 2, of the Programme of October 21st, 1887.*)

The Fungi under which this exhibit is classified, popularly known as "Blights," are interesting on account of both their destructive nature, and their peculiar fruit. To those who examine them for the first time, they usually afford quite a surprise in the fact that such striking forms of fruit are borne by such abundantly common, but to them, hitherto unknown plants.

Phyllactinia guttata, Lev., is no exception to this statement.

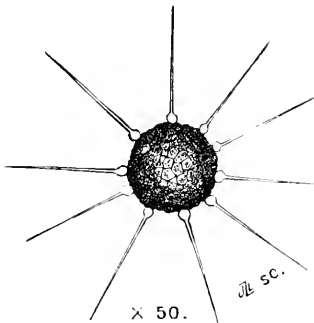

Phyllactinia Guttata, Lev.

The mycelium is found as a delicate, evanescent web, on both sides of the leaves of many trees and herbs of our country. The fruit is a globular, dark-brown conceptacle, nearly .01 of an inch in diameter, with a reticulated surface, and furnished with from eight to twelve appendages, which radiate from the horizontal circumference of the conceptacle, and lie nearly flat upon the surface of the host-plant.

These appendages are hyaline, rigid, and simple. They arise from a prominent bulb at the periphery of the conceptacle, taper gradually to a point, extend for a distance a little greater than the diameter of the conceptacle, and bear a striking resemblance to empty thermometer tubes. Each conceptacle contains from four to twenty sacks, or sporangia, and each sporangium has from two to four smooth, elliptical spores, filled with granular contents.

THE MOUTH-PARTS OF CICADA.

BY F. W. LEGGETT.

(A Description of Exhibit No. 2, of the Programme of November 4th, 1887.)

The specimens exhibited this evening are implements contained within the proboscis of *Cicada*. They are six in number; but a careless examination would lead one to suppose their number to be but four. This is because the hooked gouges appear as one piece, until separated; when they are found to be a serrated gouge within a gouge; the hooks turned in different directions, and one projecting beyond the other. The two other implements are long rods, sloped, near the outer ends, to a rather sharp point. On this slope are located six knobs. The inner side is straight and finely serrated.

There is a peculiarity about *Cicada* that does not appear to be noted, that is, its ability to retain life, when deprived of that generally-considered necessary appendage, the head. On August 17th I captured one, just emerging from its pupa-state. In some way one of its wings was injured. At 4 P. M., of the same day, I amputated its head, and mounted its mouth-parts. At 10 P. M., as the trunk exhibited vigorous signs of life, I laid it carefully away. At 7½ A. M., of the next day—August 18th—the trunk was moving the legs, and endeavoring to move the wings; at 5 P. M., still living and twitching the wings and feet; at 10 P. M., when I went to bed, it was still alive. It died sometime during the night, at what hour I am unable to state, but it lived 30 hours, at least, without its head. Query: Did it die from the effect of the amputation, or lack of food?

REPORT UPON THE EXAMINATION OF THE FASOLDT TEST-PLATES.

BY P. H. DUDLEY, C. E.

(Presented October 21st, 1887.)

Being in Albany recently I accepted an invitation from Mr. Chas. Fasoldt to examine Test-Plates of his ruling, as shown by his new vertical illuminator, lamp, and specially-constructed microscope. It was an interesting and instructive evening. For,

besides the delicate rulings, there was much to interest the microscopist in the special apparatus for comparing micrometers and measures.

The stand is one constructed by Mr. Fasoldt, substituting a screw movement to the body of the microscope, instead of the ordinary rack and pinion. It is quick, but firm, and cannot be displaced by accident and crush a ruling.

His vertical illuminator has, like Beck's, a thin glass for a reflector. But the method of mounting, construction of the diaphragms, and means to control the light, are entirely different, making it a valuable accessory. The mechanical stage is constructed for the purpose of making fine measurements, and comparing micrometers. The screw is of recent construction, 100 threads to the inch, carrying on one end a wheel $2\frac{1}{4}$ inches in diameter, and $\frac{1}{4}$ inch broad, graduated with 100 spaces, each 0.07 of an inch long, for each $\frac{1}{10000}$ forward movement of the screw. The pitch of the screw is very uniform, and enables the manipulator to readily place the different bands of the ruling under high power objectives; then by focussing it can be determined whether they can be resolved.

The eye-piece carries a delicate micrometer, which has three delicate steel prongs, in lieu of cobwebs, or lines on glass. Each prong is adjustable, extending part way across the field. One is in the upper part, and two are in the lower part of the field. The advantages of the prongs are many, one being that but part of the line is covered.

The lamp has a single wick, two inches wide. In trimming, the wick is curved from edge to edge; the centre being fully $\frac{1}{8}$ of an inch higher than the edges. The chimney is specially formed of a metallic frame, carrying parallel plate-glass sides; those opposite the width of the flame are about 3×4 inches, and those opposite the edges are 3×2 inches. On the top of the frame is put a metallic tube, about $1\frac{1}{4}$ inches diameter, and 14 inches high, to produce the draught. The flame is large, and burns very white and steady. In use the lamp is placed from two to four feet from the microscope, the edge of the flame being turned towards the illuminator. A small condenser, of two inches focus, is placed before the illuminator, so as to throw an image of the flame obliquely across the band of lines. The entire field is not equally illuminated, as better results are ob-

tained by having different portions of different degrees of brightness.

Photomicrograph No. 1 is of a Test-Plate having 19 bands—said to have bands ranging from 5,000 lines per inch, to the 18th, which has 120,000 lines per inch. The 19th band only has 50,000 lines per inch of the same depth of cutting as the 18th band. These bands all having been resolved, new plates were ruled, having finer bands.

Photomicrograph No. 2 is of a Test-Plate with bands in the metric measures. In one important respect the system of ruling on this plate was modified. Each band, for a short portion of its length, was only ruled with one-half of the number of lines in the rest of the band. The label sent to put on this No. 2 is probably not the proper one, as the bands do not agree.

Photomicrograph No. 3 is of a Test-Plate having 23 bands; the highest having, it is said, 200,000 lines per inch. The ruling is very delicate, and the lines quite shallow, as must be the case. Mr. Fasoldt says twelve persons have seen the lines in the last band, under his method of illumination, and with a Bausch & Lomb $\frac{1}{12}$ objective, N. A. 1.35 (?).

The first evening I looked at the Test-Plate, I saw the lines in the band of 130,000, clear and well defined, after the instrument was focussed. Unaided I was unable to go beyond the 90,000 band. This trial was made after a railroad trip of ten week-days and five nights. The vision was not as acute, and the touch of the fingers was not as sensitive as usual. In about a week afterwards, at a second trial, I saw all of the lines to the 160,000 band, which I was unable to resolve. The 170,000 and 180,000 bands I did not resolve, but the 190,000 band came out sharp and clear. This was all I could do at that time. The delicacy of focussing is probably as difficult as the discerning of the lines.

Photomicrograph No. 4 is of a quadruple ruling, the central bands being 80,000 per inch. When both sets of lines are illuminated the spectra produced are gorgeous. Mr. Fasoldt states that rulings, which do not produce spectra, are not resolvable. And he discards such rulings, as the lines are ruined.

These rulings are of very great interest to the microscopist, as a measure of what can be done by different methods of illumination. After many trials by transmitted light, the band of

90,000 lines per inch was the most I could resolve. Mr. Falsoldt says the 110,000 band is the highest one he knows to have been resolved by the same $\frac{1}{2}$ objective by transmitted light. It would be very interesting to know what kind of rulings Prof. Abbe used in determining the theoretical resolving power of an objective, as well as the method of illumination.

AN ICHNEUMON-FLY, *MICROGASTER*, PARASITIC
ON THE LARVA OF A HAWK-MOTH.

BY F. W. LEGGETT.

(Read October 7th, 1887.)

This parasite lays its eggs within the body of the larva of the Hawk-Moth. For this purpose it pierces the softer parts of the body with its ovipositor, but carefully avoids vital spots.

When the egg is hatched, the grub eats the body of the larva until fully fed, makes a hole through its skin, and, emerging, commences spinning a beautiful white cocoon, attaching this carefully to the still-living body of its late home.

This cocoon is provided with a very perfectly-fitting door, which, when the imago is ready, he opens, and a full-fledged Ichneumon-fly appears, winged for flight. All cocoons, however, do not have the door attachment. When this is absent the imago bites a hole through the cocoon with its mandibles.

It is remarkable how completely these parasites consume the larva, and how long the larva retains life. When it dies it collapses, and its skin can be inflated like a bladder.

If I am not in error, these parasites are infested with parasites, which can be seen, both in the larva and imago, under the microscopes.

Under one microscope is the larva of an Ichneumon-fly fully fed, taken as it emerged from the body of the larva of a Moth. Under the other microscope are some cocoons with the imago emerging, and also free. In a bottle is a Hawk-Moth larva with Ichneumon cocoons attached. The glass-covered box contains some cocoons, and a number of Ichneumon-flies, living and dead. It will be observed that these cocoons do not have doors, or covers.

THE FUNGUS, PHRAGMIDIUM MUCRONATUM, LK.,
VAR. AMERICANUM, PECK, THE ROSE BRAND.

BY THE REV. J. L. ZABRISKIE.

A Description of Exhibit No. 1, of the Programme of November 4th, 1887.)

This Fungus infests both surfaces of living leaves of the cultivated Rose. It has two forms of fruit : (1) the earlier Uredospores, which are unicellular, sub-oval, and of bright orange color ; (2) these later Brand-spores, which are dark brown, five to nine septate, terminal joint mucronate ; the compound spore being supported on a lengthened peduncle, which is hyaline, fusiform and incrassated below.



X 250.

Phragmidium Mucronatum,
Lk., Var. Americanum,
Peck.

Our State Botanist, Prof. C. H. Peck, says, "American specimens generally have the spores more opaque, and with two or three more septa than the typical form. This variant form might be called, var. *Americanum*." (28th Rep., p. 86.)

The specimen here exhibited has an eight-celled spore, with a nucleus visible in each cell, notwithstanding the dark color of the cell-walls.

The specimen may perhaps be interesting from the fact that it was mounted in glycerine, and sealed with white-zinc cement on March 17, 1885, more than seven and a half years ago, and still seems to be in perfect condition.

PROCEEDINGS.

MEETING OF OCTOBER 7TH, 1887.

The President, the Rev. J. L. Zabriskie, in the chair.

Thirty-four persons present.

Mr. C. W. Brown was elected a Resident Member, and Mr. C. E. Beecher was elected a Corresponding Member of the Society.

A telegram from Mr. P. H. Dudley, dated Springfield Depot, Mass., expressing his regret for his inability to be present, and presenting his congratulations to the Society on the opening of its Autumn sessions, was received during the meeting, and was read from the chair.

The Committee on Publications reported on the difficulties unavoidably connected with the issue of the current volume of the JOURNAL of the Society.

The President read a Paper on "Hairs of the Peach in relation to Hay Fever," illustrated by diagrams and mounted objects. This Paper is published in the JOURNAL, Vol. III., p. 62.

Mr. F. W. Devoe criticised the views of Dr. Woakes, quoted in this Paper, especially deprecating the treatment of the disease by surgery, and advancing the opinion, that to the pollen of the Rag-weed was attributable much of the nasal irritation suffered by the victims of this malady.

Mr. F. W. Leggett read a Paper on "An Ichneumon Fly, *Microgaster*, parasitic on the Larva of a Hawk-Moth." This Paper is published in this number of the JOURNAL, p. 84.

Mr. E. B. Grove read a Paper on "The Striated Muscle-Fibre of the Head of *Harpalus caliginosus*, Fab." This Paper is published in this number of the JOURNAL, p. 28.

Dr. L. Schöney addressed the Society on the Comma Bacillus of Koch.

PROGRAMME OF OBJECTS ANNOUNCED FOR EXHIBITION.

1. Section of the Cuticle of the Peach ; showing hairs *in situ* : Exhibited by J. L. ZABRISKIE.
2. Hairs from the Cuticle of the Peach ; showing spores of Fungus and Mycelium : Exhibited by J. L. ZABRISKIE.
3. *Volvox globator* : Exhibited by C. S. SHULTZ.
4. Spiracles of the Great Water-Beetle, *Dytiscus marginalis* : Exhibited and explained by C. S. SHULTZ.

5. Ovipositor of *Cicada septendecim*, L., the Seventeen-year Locust, and twigs pierced by the same : Exhibited and explained by C. S. SHULTZ.

6. Larva, Cocoon and Imago of an Ichneumon Fly, *Microgaster*, attached to the Larva of a Hawk-Moth : Exhibited and explained by F. W. LEGGETT.

7. Striated Muscle-Fibre of the Head of *Harpalus caliginosus*, Fab. : Exhibited by E. B. GROVE.

8. Diamond Mica, from Pike's Peak : Exhibited and explained by E. B. GROVE.

OTHER EXHIBITS.

9. Pollen of the Rag-weed, *Ambrosia artemisiifolia*, L. : Exhibited by F. W. DEVOE.

10. Section of Felspar ; polarized : Exhibited by T. B. BRIGGS.

11. Type-slide of marine *Navicula*, mounted by Thum, of Leipsic : Exhibited by E. A. SCHULTZE.

12. Oolitic Sand, from Australia : Exhibited by H. W. CALEF.

13. Fruit of the Zanzibar Lily, *Nymphaea Zanzibar* : Exhibited by W. E. DAMON.

OBJECTS FROM THE SOCIETY'S CABINET.

14. *Megilla maculata*, De Geer.

The *Coccinellidae*, Lady-birds, to which this species belongs, can be distinguished by the short legs, tarsi three-jointed ; the body hemispherical in form ; the antennæ usually short and retractile, enlarged at the tips, and inserted at the inner front margin of the eyes ; the maxillæ with two ciliate lobes, palpi four-jointed, last joint hatchet-shaped ; the coloration usually of a red or yellow ground with black spots, or black ground with red or yellow spots.

Over 1,000 species are at present known, from all parts of the globe. 142 species, and 18 varieties inhabit America, north of Mexico ; and 126 species, and 89 varieties are found in Europe.

15. Mouth-parts of the Honey-Bee.

MEETING OF OCTOBER 21ST, 1887.

The President, the Rev. J. L. Zabriskie, in the chair.

Thirty-seven persons present.

Messrs. A. S. Brown and Thomas Craig were elected resident members of the Society.

On motion of Mr. W. H. Mead, Prof. Samuel Lockwood, Ph.D., was invited to address the Society, on such subject and at such time as would suit his own convenience.

Mr. L. Riederer described the sections of the Head of the House-fly exhibited by him, as announced in the present programme. This exhibit consisted of several hundred consecutive sections, stained, fixed and mounted on nine slides.

The President illustrated his exhibit by a black-board drawing, and read a description of the same. This description is published in this number of the JOURNAL, p. 80. The President also donated this slide to the Cabinet of the Society.

Mr. George F. Kunz described his exhibit of sections of Meteorite, and of Meteoric Iron, and donated to the Library of the Society, reprints of Articles, published by him, as follows:—

1. "On the New Artificial Rubies," from *Transactions of the New York Academy of Sciences*, Oct. 4th, 1886
2. "Two new Meteorites from Carroll Co., Kentucky, and Catorze, Mexico," from *The American Journal of Science*, Vol. xxxiii., March, 1887.
3. "Meteoric Iron, which fell near Cabin Creek, Johnson Co., Arkansas, March 27th, 1886," from *The American Journal of Science*, Vol. xxxiii., June, 1887.
4. "Gold and Silver Ornaments from Mounds of Florida," from *The American Antiquarian*, July, 1887, read at the Buffalo meeting of the Am. Association for the Adv. of Science.
5. "Gold Ornaments from the United States of Columbia," from *The American Antiquarian*, September, 1887.

Mr. Charles E. Pellew, M. E., addressed the Society upon "The History of the Comma Bacillus," and described his exhibits of the same.

Dr. William H. Bates addressed the Society on "The History of Asiatic Cholera." This address is published in this number of the JOURNAL, p. 12.

Dr. L. Schöney addressed the Society on "Neurosis of Cholera." This address is published in this number of the JOURNAL, p. 15.

Mr. P. H. Dudley, C. E., being unavoidably absent, a communication by him on "The Comma Bacillus, the reputed cause

of Asiatic Cholera," describing the Photographs exhibited by him, as announced in the programme, was read by the Corresponding Secretary, Mr. B. Braman. This communication is published in this number of the JOURNAL, p. 18.

Mr. Wilson Macdonald also addressed the Society on his personal experiences in epidemics of Cholera.

A Report upon the examination of Test-plates, ruled by Mr. Charles Fasoldt, of Albany, N. Y., was presented to the Society by Mr. P. H. Dudley, C. E., and was read by the Recording Secretary, Mr. H. W. Calef. This Report is published in this number of the JOURNAL, p. 81.

PROGRAMME OF OBJECTS ANNOUNCED FOR EXHIBITION.

1. Head of House-fly in consecutive sections, transverse and longitudinal; showing the single and compound eyes, with their optic nerves, antennæ with ganglion and tracheæ, mouth-parts, etc.: Exhibited by L. RIEDERER.

2. Fruit of the Fungus *Phyllactinia guttata*, Lev., from leaves of *Celastrus scandens*, L., climbing Bitter-sweet: Exhibited by J. L. ZABRISKIE.

3. Section of Meteorite found near Forsyth, Taine Co., Mo.: Exhibited by G. F. KUNZ.

4. Section of Meteorite found at Powder Mill Creek, Cumberland Co., Tenn.: Exhibited by G. F. KUNZ.

5. Meteoric Iron from Waldron Ridge, near Taswell, Tenn.: Exhibited by G. F. KUNZ.

6. Meteoric Iron from Holland's Farm, Chattooga Co., Ga.: Exhibited by G. F. KUNZ.

All these exhibits by Mr. KUNZ were new, and were described by him.

7. Comma Bacilli; specimens of the Koch, Finkler, Prior, and other Bacilli: Exhibited by C. E. PELLEW, and used in illustrating his remarks.

8. Photomicrograph of cultures of Comma Bacillus, the reputed cause of Asiatic Cholera: Exhibited by P. H. DUDLEY.

9. Photomicrograph, showing destruction of the mucous membrane of intestine of cholera patient: Exhibited by P. H. DUDLEY.

10. Photomicrographs by dark-ground illumination of four of Mr. Charles Fasoldt's test-plates, showing the number and position of the bands: Exhibited and explained by P. H. DUDLEY

By Mr. Fasoldt's special apparatus and method of illumination, several persons have seen the lines of the band, said to be ruled at the rate of 200,000 lines per inch.

11. *Lacinularia socialis*, and *Bacillaria paradoxa*, living and in full action : Exhibited by W. E. DAMON.

OBJECTS FROM THE SOCIETY'S CABINET.

12. Scales of *Lepisma*, sp.

These scales belong probably to *Lepisma saccharina*, Sugar-runner, or *L. domestica*. Both species are sometimes very common about houses, where they eat holes in silks, mutilate the edges of books, and consume sugar, &c.

Lepisma saccharina, L., is uniformly dull silvery, with pale yellowish antennæ and feet. Head with fine scattered hairs; caudal stylets finely hairy with a few larger hairs. The longer caudal stylets are about half as long as the body; antennæ about two-thirds as long as the body. Length, .32 inch.

Lepisma domestica, Pack., is pearly white; body broad, covered densely with scales and mottled with dark spots, with silky white hairs. A dense fringe of long hairs at base of head, extending around in front of the eyes, and grouped in two tufts; vertex bare. The three thoracic segments are mottled with dark scales, the third being the darkest; basal abdominal segments mottled like the thoracic ones, while a few dark scales are scattered over the remaining segments, except the last one. On each side of all the segments behind the head is a sub-dorsal row of carneous tubercles, each supporting a pencil of 6-8 radiating hairs; a similar row of thicker tubercles on the side of the body. Around edge of thoracic segments a fringe of hairs, arising from short lines directed inwards, at right angles to the edge of the segments, there being seven on the mesothoracic, and three on the prothoracic ring; on metathoracic ring six lines on a side. Antennæ and median caudal stylet nearly as long as the body. Length, .50 inch. (Packard.)

13. Longitudinal and transverse sections of Whalebone.

MEETING OF NOVEMBER 4TH, 1887.

The President, the Rev. J. L. Zabriskie, in the chair.

Twenty-three persons present.

In the absence of the Recording Secretary, Mr. G. E. Ashby, was appointed Secretary *pro tem*.

The Corresponding Secretary Mr. B. Braman, read a letter from Dr. S. Lockwood, accepting the invitation extended at the last meeting to address the Society, appointing the time as the 16th of December, and announcing as his subject, "The Pathology of Pollen in *Æstivis* or Hay Fever."

The Chairman of the Committee on Publications, Mr. F. W. Leggett, reported the completion of Vol. III., of the JOURNAL of the Society, and the encouraging condition of the fund for the same.

The President described his exhibit, as announced in the Programme, illustrating the same by a black-board drawing. This description is published elsewhere in this number of the JOURNAL.

Mr. F. W. Leggett described his exhibit as announced in the Programme. This description is published elsewhere in this number of the JOURNAL.

PROGRAMME OF OBJECTS ANNOUNCED FOR EXHIBITION.

1. Fruit of the Fungus, *Phragmidium mucronatum*, Lk., var. *Americanum*, Peck, the Rose Brand; mounted in glycerine, and sealed with white-zinc cement more than seven years ago: Exhibited and described by J. L. ZABRISKIE.

2. Mouth-parts of *Cicada*: Exhibited and described by F. W. LEGGETT.

OTHER EXHIBITS.

3. Section of Granite, from Round Pond, Me.: Exhibited by T. B. BRIGGS.

4. Pond-life; Rotifers: Exhibited by W. E. DAMON.

5. Consecutive sections of the head of a Wasp, *Vespa*, showing the optic nerve, &c.: Exhibited and explained by L. RIEDERER.

6. Entire head of minute Fly: Exhibited by L. RIEDERER.

7. *Amphiptera pellucida*; mounted in Prof. H. L. Smith's new medium; shown with a Powell and Lealand $\frac{1}{13}$ in. apochromatic, homogeneous immersion objective, with compensation eye-piece: Exhibited by W. G. DEWITT.

8. Head of the Soldier Beetle, *Chauliognathus Americanus*, Forst., showing a modification of the maxillæ into organs resembling "the tongue" of the Honey-Bee: Exhibited and explained by G. E. ASHBY.

OBJECTS FROM THE SOCIETY'S CABINET.

9. *Pterophorus periscelidactylus*, Fitch, the Grape Vine Plume. This species was first described by Dr. Fitch, in his first Report, 1854. The larva is pale green, with two rows of whitish tubercles along the dorsal region, and a row along each side; from all the tubercles spring rather long, sordid white hairs. The body is also covered with very short, sordid, white hairs. Head, pale yellowish green. Length, when full grown, about 13 mm. Feeds on Grape Vine, living in the edges of one or more leaves, drawn together by silken threads. It appears in the latter part of May, or early in June, and sometimes in such numbers as to do serious injury to the vines.

The larva changes to a chrysalis in the latter part of June, and the imago emerges in about six or eight days after.

10. Transverse section of root of *Convolvulus Scammonica*.

11. Section of Kidney of Cat, stained and injected.

 MEETING OF NOVEMBER 18TH, 1887.

The President, the Rev. J. L. Zabriskie, in the chair.

Thirty-nine persons present.

Mr. Edgar J. Wright was elected a Resident Member of the Society.

The matter of an Annual Reception was discussed by the Society in Committee of the Whole, of which Mr. C. Van Brunt was chosen chairman. The President appointed the following members as Committee on the Annual Reception:—Messrs. Le Brun, Wales, Beuttenmüller, Mitchell and Mead. On motion it was resolved that this Committee be instructed to provide for the holding of the next Annual Reception in the Rooms of this Society.

The following members were appointed by the President as Committee on Nominations of Officers for the ensuing year:—Messrs. DeWitt, Wall and Mead.

Communications from Dr. N. L. Britton and Mr. A. J. Doherty, read by the Corresponding Secretary, were, on motion, referred to the Board of Managers.

The President read a Paper on "The Radula of the Conch," illustrated by diagrams, and objects as announced in the pro-

gramme. This Paper is published in this number of the JOURNAL, p. 1.

The President donated to the Cabinet of the Society the slide containing the median portion of the Radula of the Conch.

The Corresponding Secretary, Mr. B. Braman, read a Paper, presented by Mr. Charles E. Beecher, of the State Museum of Natural History, Albany, N. Y., and a Corresponding Member of the Society, entitled "A Method of Preparing, for Microscopical Study, the Radulæ of small species of Gasteropoda." This Paper was illustrated by two slides of Radulæ, prepared by the author, and donated to the Cabinet of the Society; and the Paper is published in this number of the JOURNAL, p. 7.

Dr. L. Schöney, in explanation of his exhibit, gave interesting information on human cancerous growths.

Mr. K. M. Cunningham, of Mobile, Ala., being present as a visitor, on request by the President, addressed the Society on the work of Microscopists in Europe, and explained his exhibits mentioned in the present programme.

PROGRAMME OF OBJECTS ANNOUNCED FOR EXHIBITION.

Ten objects illustrating the Paper, "The Radula of the Conch:" exhibited by J. L. ZABRISKIE:—

1. Shell of *Sycotypus canaliculatus*, Gill.
2. Operculum of the same.
3. Egg-capsules of the same.
4. The entire Radula of the same, in glycerine.
5. A slide, containing the distal end of the Radula of the same, with broken teeth.
6. A slide, containing the median portion of the Radula of the same, with perfect teeth.
7. A slide, containing the proximal end of the Radula of the same, with forming teeth.
8. The shell of our remaining species of Conch, *Fulgur carica*, Conr.
9. The entire Radula of the same, in glycerine.
10. Egg-capsules of the same.

Two objects, illustrating the Paper, "A Method of Preparing, for Microscopical Study, the Radulæ of small species of Gasteropoda":—

11. Radula of *Somatogyrus subglobosus*, Say, from the Mohawk River: Exhibited by C. E. BEECHER.
12. Radula of *Ammicola limosa*, Say, from the Potomac River: Exhibited by C. E. BEECHER.
13. Embryo Ants, mounted in glycerine-jelly: Exhibited by F. W. LEGGETT.
14. So-called Gizzard of *Blatta*, Island of St. Thomas, showing horny plates, or teeth: Exhibited by E. B. GROVE.
15. So-called Gizzard of (*Edipoda Carolina*, L., showing horny plates, or teeth: Exhibited by E. B. GROVE.
16. Radula of *Zonites cellarus*: Exhibited by W. G. DE WITT.
17. *Pleurosigma angulatum*, under an apochromatic, homogeneous-immersion objective: Exhibited by W. G. DE WITT.
18. Larva of *Corethra plumicornis*, commonly known as the Shadow-gnat: Exhibited by C. S. SHULTZ.

OTHER EXHIBITS.

19. Radula of *Haliotis*: Exhibited by H. W. CALEF.
20. Radula of *Paludina vivipara*: Exhibited by H. W. CALEF.
21. Cancerous growth (human): Exhibited by L. SCHÖNEY.
22. Models of the tongue and throat (human): Exhibited by L. SCHÖNEY.
23. "The Rotifera; or Wheel Animalcules, by C. J. Hudson, LL. D., Cantab., assisted by P. H. Gosse, F. R. S." 2 vols., 4°, illustrated; Longmans, Green & Co., London: Exhibited by C. W. BROWN.
24. Slides, and numerous photomicrographs of Diatoms: Exhibited by K. M. CUNNINGHAM, of Mobile, Ala.

PROCEEDINGS OF OTHER SOCIETIES.

SAN FRANCISCO MICROSCOPICAL SOCIETY.

MEETING OF SEPTEMBER 28, 1887.—Vice President Dr. Ferrer took the chair, and a large number of members were present.

Dr. Henry Ferrer exhibited a new rectilinear lens, made by Steinheil, of Munich, especially for enlarging and reducing copies of drawings and charts in photographic operations. This lens secures as perfect definition at the periphery as at the center. It is accompanied by a table, by means of which one can easily calculate the needed extension of camera, and distance from the object, to secure any desired enlargement or reduction in a photograph.

Dr. Ferrer exhibited some of his work with this lens in reduced, photographic copies of his large India ink drawings of his sections of the human eye. He also exhibited these sections, which were prepared by hardening the eye in bichromate of potash, and embedding in celloidin.

Secretary Wickson read a letter, recently received from Dr. Frank L. James, of St. Louis, Editor of the *St. Louis Medical and Surgical Journal*, referring to mountings of *Bacillus anthracis in situ* in lung tissue, made by Dr. S. M. Mouser of this Society, and stating "that a better preparation never has been made." The letter also cited the verdict of Dr. D. V. Dean, of St. Louis, a thorough microscopist, who pronounced "the slide the best he had ever seen."

Dr. Henry Ferrer was elected President of the Society, to fill the vacancy occasioned by the resignation of Mr. Wickson, who retired from the Presidency to take the office of Recording Secretary.

MEETING OF OCTOBER 12.—President Dr. Ferrer in the chair. A large number of members were present.

A letter was read from Mr. Isaac C. Thompson, F. R. M. S., of Liverpool, England. Mr. Thompson desires to secure material for the study of minute crustaceans, a special line of investigation which he has pursued for some time, and upon which he has made valuable reports to the Liverpool Microscopical Society. His letter prescribed the following as a solution best fitted to preserve specimens of marine life: Water, one part; proof spirits, two parts; glycerine, one part; with one per cent. of carbolic acid added. By securing gatherings from the Pacific Mr. Thompson hopes to add to his previous finds of new *Copepoda*. In an expedition to the Canary Islands he captured from forty to fifty new species. The San Francisco Society will endeavor to obtain the material desired.

A letter was read from Mr. W. F. Barraud, of Wellington, New Zealand. The Wellington Microscopical Society meets fortnightly, and its members are investigating and cataloguing the fresh-water infusoria of the district. Mr. Barraud sent a sample of the rich diatomaceous deposit at Oamaru, New Zealand, and a sample of the Nevada salmon-colored diatomaceous earth, found some time ago by Prof. Hanks, will be sent to Mr. Barraud in exchange.

The chief part of the evening was given to an exhibition of high power objectives recently received. Drs. Ferrer and Mouser exhibited one-twelfth Zeiss objectives, and Dr. Le Conte used Spencer's one-tenth and one-eighteenth. Dr. Mouser worked his one-twelfth up to 2,250 diameters with admirable effects. The performance of the Spencer glasses was also very satisfactory.

Mr. William Payzant, of Berkeley, was elected Vice President, to fill the vacancy caused by the election of Dr. Ferrer to the Presidency.

MEETING OF OCTOBER 26.—President Ferrer in the chair. Dr. Julius Rosenthirn of San Francisco, was elected a regular member.

A letter was received from A. H. Breckenfeld, of Los Angeles, accompanying specimens of marine diatoms on sea-weed, from Prof. Romyn Hitchcock, and collected at Sakai, Japan.

Dr. Ferrer exhibited accessories. He had just received from Zeiss, of Jena, a number of low power objectives and oculars, made of the new apochromatic

glass. Among these were projecting eye-pieces, for use with the micro-camera in photography. Comparisons were also made between the Zeiss ordinary eye-piece and the "compensating eye-piece."

The Society received donations of material intrinsically valuable, and highly prized because of its associations. "Moeller's typen platte" and "probe platte," a number of valuable photomicrographs, and a large number of slides, part of the collection of the late Prof. W. Ashburner, were donated by Mrs. Ashburner, through Mr. Norris. Mr. Norris also donated a number of slides, and prepared diatomaceous material.

Mr. Norris exhibited a slide, mounted by Bourgoyne, of Paris, which contained 215 distinct varieties of diatoms from the Santa Monica earth, all arranged in beautiful form.

MEETING OF NOVEMBER 9.—President Ferrer in the chair. Dr. Douglas Montgomery and Dr. Kahn, of San Francisco, were elected regular members.

A sample of Mono lake water was handed in by Dr. Mouser, and it was referred to Mr. Payzant for the determination of its contained crustaceans.

Mr. Henry G. Hanks read a paper on Rock Salt, found at San Bernardino County, California. This salt occurs in blocks, usually of such transparency that print can easily be read through cubes of it which may be several inches thick. Some specimens exhibit faint lines and spangles which are the angles and surfaces of box-like cavities, probably containing gas or atmospheric air, which fact causes these specimens to explode violently when heated. Mr. Hanks illustrated his paper with specimens under the microscope.

William Irelan, Jr., State Mineralogist, donated to the Society two specimens of diatomaceous earth, one from Dos Pueblos Creek, Santa Barbara County, and the other from Shasta County. These specimens were referred to Mr. Riedy and Dr. Riehl for examination and report.

BROOKLYN MICROSCOPICAL SOCIETY.

MEETING OF NOVEMBER 21, 1887.—The regular meeting was held—twenty-nine persons being present—at the new Laboratory and Lecture Room of the Packer Institute, at the invitation of Prof. W. Le Conte Stevens.

On request of the members Prof. Stevens explained the improvements in the Lecture Room, made under his supervision, and the members were then conducted through the Laboratory.

Dr. J. H. Hunt then took the chair, in the absence of the President, G. D. Hiscox, and the routine business of the Society was transacted.

The Society was then entertained by a lantern exhibition, prepared by Prof. Stevens, in which, among numbers of beautiful objects, there were shown by polarized light various rock-sections, chemical crystals, stained glass, selenite films in many designs, including geometrical patterns, and many uniaxial and biaxial crystals.

MEETING OF DECEMBER 5.—A regular meeting was held for the first time at the new permanent home of the Society in the Pratt Institute—Kyerson Street, near Willoughby Ave., Brooklyn—twenty-three persons being present.

Objects exhibited:—

Fern-leaf Gold crystals; by Dr. A. J. Watts.

Crystals of native Gold; by E. A. Chapman.

Crustaceans and specimens of Pond-life; by C. H. Taylor.

Pigeon-post Film, of the siege of Paris, and a Hydrzoan, *Eucratia chilata*; by H. W. Calef.

Cancerous growth, *Carcinoma*; by H. A. Tucker, Jr.

Lozenge-shaped crystals of Asparagine; by Geo. B. Scott.

Slides of mineral substances—Chromium, Silicon, Boron, Cadmium, &c.; by Geo. M. Mather.

Various slides of native Copper, and cabinet specimens of the same; by Dr. J. H. Hunt.

Sections of Black Granite and Felspar ; by T. B. Briggs.

Pyrite, said to be volcanic ; by G. D. Hiscox.

Sori of a rare West Indian Fern ; by G. E. Ashby.

Pseudo-scorpion ; by H. S. Woodman.

Seeds of Wild Carrot ; by J. W. Freckleton.

Fragment of shell of *Echinus*, with a spine ; by James Walker.

Transverse section of stem of Potatoe, showing collenchyma ; and lactiferous vessels of *Scorzonera Hispanica* ; by J. W. Martens, Jr.

MEDICAL MICROSCOPICAL SOCIETY OF BROOKLYN.

This Society meets at the residences of the members, on the first Wednesday of each month, excepting the months of July and August.

The officers for the year 1887 are, Pres., Dr. W. H. Bates ; Cor. Sec., Dr. H. D. Bliss ; Treas., Dr. Albert Brinkman ; Rec. Sec., Dr. J. M. VanCott, Jr.

The membership is limited to twenty active members, who must be physicians and working microscopists, each one of whom is expected to present one paper each year, on some subject pertaining to the object of the Society ; and five associate members, who must be physicians, and interested in microscopy, although they may not be working microscopists.

MEETING OF SEPTEMBER 7, 1887.—Held at the residence of Dr. J. M. Van Cott, Jr. A good number of the members were present. Dr. Van Cott read the paper of the evening, which was illustrated by microscopical sections, stained with alum-carmine, and which elicited full discussion, and the presenting of some clinical histories.

MEETING OF OCTOBER 5.—Held at the residence of Dr. R. G. Eccles. Dr. Eccles read a paper, entitled "Thallophytes in Medicinal Solutions." This paper was amply illustrated by microscopical preparations, diagrams, and specimens of solutions containing Thallophytes, and it led to a vigorous discussion of the subject.

MEETING OF NOVEMBER 2.—Held at the residence of Dr. Herbert Fearn. Dr. Arnold Stub read the paper of the evening, which was thoroughly discussed by the large number of members present.

ESSEX COUNTY MICROSCOPICAL SOCIETY OF NEW JERSEY.

MEETING OF NOVEMBER 2, 1887.—Held at the residence of the Rev. F. B. Carter, Montclair, N. J. A large number of members was present.

After the transaction of routine business a paper on the *Rhizopoda* was read by Mr. Carter, who has studied these low forms of animal life during several years. The paper, which treated of the different species of Rhizopods, their classification, habits, external and internal structure, modes of reproduction, &c., was followed by a lantern exhibit ; the slides used for this purpose being prepared by Mr. Carter.

Among many representations thrown upon the screen, may be specially mentioned those of *Amoeba princeps*, with its nucleus, contractile vesicle, and pseudopodia ; also the reproduction by division through the nucleus, in the case of *Amoeba proteus*, and by spores, in the case of *Microgromia socialis* ; and the structure of the tests of many other species.

A paper on the subject, "Tooth Development," by the President, Geo. S. Allan, D. D. S., was announced for the next meeting, to be held on November 17.

THE JOURNAL OF MORPHOLOGY.—We hereby acknowledge the receipt from the publishers, Ginn & Co., Boston (7 Tremont Place), New York and Chicago, of the first number of the *Journal of Morphology*, edited by C. O. Whitman, Ph. D., Director of the Lake Laboratory, Milwaukee, Wis., recently of the Museum of Comparative Zoölogy, Cambridge, Mass., with the co-operation of Edward Phelps Allis, Jr., Milwaukee, Wis.

This journal is devoted to the presentation of original research in embryology, anatomy and histology. It is in crown octavo form; intended to be issued in annual volumes, of from two to four numbers, of 150 to 200 pages each, with from five to ten lithographic plates. Subscription price: for Vol. I (two numbers), \$6.00; single numbers, \$3.50.

The first number, dated September, 1887, embraces 226 pages, with seven double lithographic plates, and one heliotype plate, illustrating the following articles:

I. *Sphyranura Osleri*, a contribution to American Helminthology. By Prof. R. Ramsay Wright and A. B. Macallum, University College, Toronto, Canada.

II. The Development of the Compound Eyes of *Craugon*. By Dr. J. S. Kingsley, Professor of Zoölogy in the State University of Indiana.

III. Eyes of Mollusks and Arthropods. By Dr. William Patten, Assistant in the Lake Laboratory, Milwaukee, Wis.

IV. On the Phylogenetic Arrangement of the *Sauropsida*. By Dr. G. Baur, Assistant in Yale College Museum, New Haven, Conn.

V. A Contribution to the History of the Germ-layers in *Clepsine*. By C. O. Whitman, Ph. D., Director of the Lake Laboratory, Milwaukee, Wis.

VI. The Germ-bands of *Lumbricus*. By Prof. E. B. Wilson, Bryn Mawr College, Bryn Mawr, Pa.

VII. Studies on the Eyes of Arthropods. By Dr. William Patten, Assistant in the Lake Laboratory, Milwaukee, Wis. 1. Development of the eyes of *Vespa*, with Observations on the Ocelli of some Insects.

Number 2 of this volume, to be dated December, 1887, is announced to embrace ten lithographic plates, and the following contents:

I. The Kinetic Phenomena of the Egg during Maturation and Fecundation (*Oökinesis*). By C. O. Whitman, Ph. D.

II. The Embryology of *Petromyzon*. By Dr. W. B. Scott, Princeton College, N. J.

III. A contribution to the Embryology of the Lizard. By Dr. Henry Orr, Princeton, N. J.

IV. The Fœtal Membranes of the Marsupials. By Dr. H. F. Osborn, Princeton College, N. J.

V. Some Observations on the Mental Powers of Spiders. By George W. and Elizabeth G. Peckham, Milwaukee, Wis.

It is a magnificent publication. In it our country may take pardonable pride as a noble initial effort of its kind within our own borders. We are gratified to know that the Publishers state to their patrons, "The *Journal* has without question taken the very first rank among periodicals of its kind both here and abroad." And we hope the rising scientific interest in our country will clearly and effectually see the advantage of sustaining such a publication of our own, and of assisting it to attain a grand financial success.

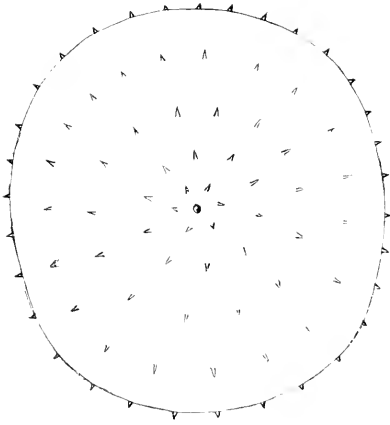

1

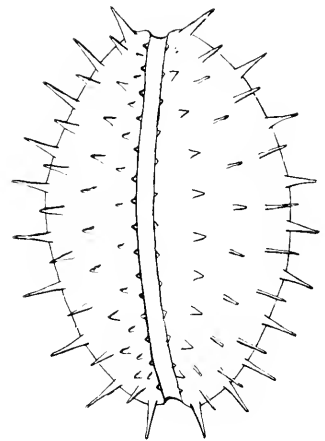

3

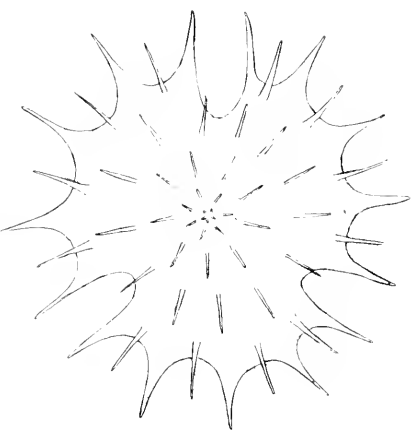

2

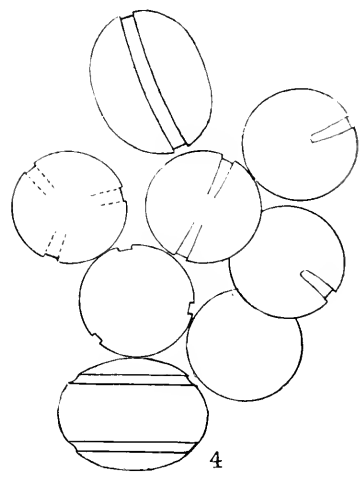

4

LOCKWOOD ON POLLEN.

JOURNAL
OF THE
NEW-YORK MICROSCOPICAL SOCIETY.

VOL. IV.

APRIL, 1888.

No. 2.

THE PATHOLOGY OF POLLEN IN ÆSTIVIS, OR
HAY-FEVER.

BY PROF. SAMUEL LOCKWOOD, PH. D.

(Read December 16th, 1887.)

Certain places in the White Mountains of New Hampshire have become notable as summer resorts for sufferers from Æstivis, or Hay-Fever. A number of these sanatoria lie more or less contiguous to the sources of the Saco river, on the one side, and the sources of the Connecticut on the other.

When the South winds prevail in either of these long tracts, there is a lowering of the barometer, and at the same time a nervous depression of the subjects of Hay-Fever. There is also another change in the atmosphere, which is then laden with the dust-produce of these valleys. A marked element in this dust is pollen, chiefly that of Rag-weed and Golden-rod, which, especially the former, abounds in the South, in the months of August and September. At such a time the suffering among

Explanation of Plate 11.

- FIG. 1.—Pollen of Rag-weed, *Ambrosia artemisiifolia*, L.: size, $\frac{1}{1200} \times \frac{1}{1500}$ inch.
FIG. 2.—Pollen of Golden-rod, *Solidago squarrosa*, Muhl.: end view, showing spines of two lengths, and trilobate depressions; size, $\frac{1}{800} \times \frac{1}{1000}$ inch.
FIG. 3.—Pollen of *S. squarrosa*: side view, showing one of the three longitudinal grooves, which, in figure 2, are indicated by the trilobes.
FIG. 4.—A diagram of a group of pollens of *S. squarrosa*. Two are side views, and six are end views.

The figures are necessarily diagrammatic. For figures 1, 2 and 3 I am indebted to Dr. Alfred C. Stokes. S. Lockwood.

the Hay-Fever guests is severe and general. Happily it does not continue, but passes off with the change of wind. On the theory of a *neurosis*, the cause seems plain to me. With the sudden humidity of the atmosphere, and low barometer, the tonic of the mountain air is dissipated, and nervous depression results. Then, since the air in this condition is surcharged with pollen, and other impurities, the nerve endings of the respiratory passages are irritated unto acute inflammation.

At the closing session of the United States Hay-Fever Association, last September, at Bethlehem, N. H., a long-cherished desire was revived to learn the relative hygienic quality of the favored sanitarium, and that of places where the malady prevails. Owing to my official relation, it fell to me to state the factors in such a determination.

The problem to be solved might be called the Hygiene of the Atmosphere. It would involve, all through, consideration based upon instrumental work. This would need such records of the winds, humidity, range of the barometer and thermometer, as fall to the meteorologist. The impurities, organic and inorganic, of the atmosphere must also be considered, which side of the work would fall to the microscopist. If density were added, this would cover all.

A word as to the conveyability of material particles by the atmosphere. There is something *ad captandum* in the splurge of the lugubrious poet :—

“The dust we tread upon was once alive.”

But, in the present tense, how true is this of the dust we breathe ! Can we not recall the painful interest excited by Tyndall's experiments on the impurities of the atmosphere ? And, for our purpose, how easy to repeat some of them. Let a beam of sunlight through a hole in the shutter enter a dark room. It appears as a slanting, living column. I say *living*, for every particle seems in motion, due to the incessant dancing movements of millions of motes.

If now a small spirit-flame, yielding no smoke, be held under this beam, there will soon be seen a dark hole right through the column. Withdraw the flame, and soon the contiguous motes dance into it ; it is again illumined, and the dark hole disap-

pears. If now we pass a red-hot bar through it, the beam will be divided into two parts by a black space. The bar withdrawn, soon the neighboring notes dance into it, and the beam is all light again.

The deduction, for our purpose, is that the so-called impurities present are chiefly organic, and the heat burns them out. The spores, infusoria, and microbic matter are thus destroyed—the air literally being purified by fire.

All these things, even the mineral matter constitute the aerial dust so distressing to the sufferer from Hay-Fever. And I hold that a prominent irritant in the air, during the Hay-Fever season, is pollen.

But what is pollen? It is the fertilizing granule produced by the stamens of a flower. These granules vary greatly in size and form, in the different flowers. Some are smooth, others are angular, but those, with which this discussion will deal, are globular, or elliptical, spiny, and very minute. Not noticing the pollen of the grasses, which particularly affect the early forms of the disease, perhaps the most mischievous of the pollens are those of the Rag-weed, and the Golden-rods. I have here specimens of the plants; Rag-weed, *Ambrosia artemisiæfolia*, L., and the Golden-rods, *Solidago altissima*, L., *S. lanceolata*, L., and *S. squarrosa*, Muhl., which three forms are typical. I have here also, under these microscopes, pollen of all these plants, mounted on slides; also here are enlarged drawings of the pollens.

Fresh Rag-weed pollen is very nearly spherical. The granule measures in these specimens, which are a little distorted by long drying, $\frac{1}{1200}$ inch in length by $\frac{1}{1300}$ inch in width. In a fresh specimen, or such as floats in the summer air, so fine are the points of the spines that they are to that of a cambric needle, as it is to the point of a marling-spike, or even a crow-bar. And yet this object, with its subtle armature is literally invisible to the unaided sight. See Fig. 1.

The pollen-grains of the Golden-rods are sub-elliptical, both ends being of the same size. They are very spiny, and the spines are relatively longer than those on the pollen of the Rag-weed. They are of two lengths on the same granule. The pollen of *S. altissima*, the most abundant, in these parts, of the many species, is in length $\frac{7}{8000}$ inch, and in width $\frac{1}{1000}$ inch.

The flowers are in a recurved panicle, not unlike the graceful spray of an ostrich plume.

An abundant species is the *S. lanceolata*, whose flowers are borne in scattered corymbs, or flattish topped clusters, something in the manner of the Wild Carrot, which habit is in striking contrast with the Golden-rods generally. This pollen makes a narrower ellipse than the one just mentioned, the two diameters being $\frac{1}{1000}$ and $\frac{1}{1500}$ inch respectively.

S. squarrosa is less common than the other two species. The flowers are more conspicuous, and arranged in a showy wand, or sceptre-like spike. Its pollen measures $\frac{1}{800}$ by $\frac{1}{1000}$ inch, hence it is larger than that of *S. altissima*.

And exceedingly interesting is the end view, since it shows a tripartite disposition, being as it were depressed at three points. Now these depressions are simply the terminations of three longitudinal canals on the sides. The end view is shown in Fig. 2; and Fig. 3 shows one of the longitudinal grooves. I find these marks much fainter in *S. altissima*, and barely discernable in *S. lanceolata*.

We have now noticed three points which are pertinent to the discussion, as will appear, namely: the minuteness of these pollen-grains, their spiny armature, and the naked grooving at the surface.

1.—The first effect noticeable of pollen then is due to its presence in the air as an impurity. The granules are taken in at breathing, as a foreign element. Except that it is more pungent, their action is in common with that of other impurities—namely suffocating. Advanced Hay-Fever is always more or less asthmatic, and impurities in the air will cause spasms, and in some instances even the odor of domestic animals will bring this about.

2.—But pollen, taken into the respiratory tubes, is a mechanical irritant. In severe Hay-Fever all the air-passages are in a state of inflammation. The starting spot is in the vicinity of the nares. At first the patient does not dislike the tickling of the pungent grains of titillating dust. But it very soon becomes serious, and nature summons all the sternutatory forces to eject the intruders. So violent does this sternutation become, and so long continuous, that the blood is started from the nostrils. The

mucous membrane of the nose, and the immediate air-passages become super-sensitive. In fact the entire mucous surface is soon in a scalded state, and every nerve-ending is a participant of torture. Suppose a person's back to be in that state of eczema, in which inflammation has reached suppuration, and a thistle-bur to be put down the back. The rest may be left to imagination. Now suppose that a number of grains of pollen of Rag-weed, or Golden-rod, with which the air is laden, to be inhaled, when the whole nasal region and the ducts beyond are scalded with the incessant discharge of acrid secretions. Is not each one of these infinitesimal teasels a lacerator of the tender and inflamed membrane? Hence when these enter in myriads—what a combination for exquisite torture! I have been caught in a place where Rag-weed pollen was prevalent in the air, and have been seized with sudden spasms, so violent that I have had to cling to a fence for support under suffering that was inexpressible.

3.—Besides being a mechanical irritant because of the spines, I am persuaded that pollen has a toxic quality in Hay-Fever. In plainer words it poisons the already inflamed tissues of the respiratory passages. No one doubts that, to some persons, skin-poisoning is a certainty, upon walking on the lee-side of the toxic Sumach, *Rhus venenata*, in its flowering time. Why not then a toxic effect of pollen upon the mucous linings already super-sensitive, and even lacerated by their presence?

In the old herbals the *Solidago*, as the word almost implies, had a reputation for vulnerable virtues, it being used in treating wounds. One of the species, *S. odorata*, yields an aromatic oil, on distillation. It cannot then, I think, be inert upon the surface of the inflamed, and minutely lacerated mucous membrane.

The laceration facilitates the poisoning. But there is another possibility in this matter. The copious nasal secretions, acrid and warm—have they no power for extracting the toxic principle?

4.—And, lastly, I am constrained to believe that pollen, in *Æstivis*, is a vital automaton—that it can, as a living organism, perforate the mucous lining, actuated on the principle of a pseudo-instinct; not altogether unlike the Carrion-fly, when it deposits its eggs, by mistake, on the decaying, nitrogenous

fungus, instead of putrid flesh. If we are to understand by instinct, "inherited experience," it is to be found even in plants. It is true that we are told *how* the Hop twines to the left, and the Scarlet-runner to the right, but back of the "how" lies the "why?" And occasionally we find a change of habit in an individual plant, as left-handness is found among rational beings.

I must be permitted now to deal with some elementary ideas on the subject of fertilization by the pollen-grain. In respect to the several pollens herein described, each must be regarded as a highly organized cell, with a twofold shell—an outer rind, which is thick, and carries the armature of spines; and an inner one, which is thin, in fact, a membrane, which is exposed at the surface in grooves, spots or pores, and these exposed places are always smooth. In the Golden-rods, as shown in the figures, these depressions are longitudinal grooves. The interior of the pollen consists of a viscid life-stuff, or protoplasm, whose function is to fertilize the ovule, at the base of the style in the pistillate flower. To effect this a curious play of the life-force sets in. The style is composed in part of a loose, or more or less spongy tissue, while the stigma at the top is charged with a saccharine, sticky mucilage. A pollen-grain, borne by the wind, or an insect, usually, now falls upon the stigma, and is anchored to it by the spines sinking into the gum. The moisture causes the grain to swell. There is a protrusion of the membrane at one or more of the thin places at the surface, whence a tube, or root-like process emerges, and penetrates the stigma. It seems to be an extension in tubular form of the membrane, and is filled with the protoplasm of the cell. If the kid-glove on a lady's hand could be pinched at the back, and that nip of the glove pulled out or extended, and the flesh could flow into this extemporized little pipe, it would roughly represent the pollen tube. Having pierced the outer coat of the stigma, this tubule, by a sort of growth, keeps on lengthening, and pushing its way down through the loose tissue of the style, until it has reached the ovule at the base, when its mission ends, and the future seed of that flower is assured.

Now to return to my statement of mistaken instinct in the insect. Pseudo-instinct is also found in plants, even in the

initial life-processes. The surcharged nectary of a flower may appear in a place approachable to a pollen-grain. Should the granule alight upon that viscid spot, out would pop the pollen-tube, with the usual effort to pierce the epidermis of the flower, but in vain. Indeed we can easily deceive the pollen-grain, by dropping it upon moistened sugar, and even witness this out-put of the tubule.

The point I would now make is this—that a similar pseudo-instinct prevails with the pollen-grain, when it is inhaled, and falls upon the moist and tender tissues of the inflamed linings of the respiratory passages. All the favoring conditions are there—moisture, softness and warmth. Hence results an instinctive protrusion of the pollen-tube into the puffy, inflamed and exquisitely sensitive tissues. I think this parasitical action has to do with that acute stinging sensation in the nostrils so frequent in *Æstivis*.

Thus have been instanced four possible modes of action for pollen in Hay-Fever.

1.—Its suffocating effect as an impurity of the atmosphere, thus exciting asthma.

2.—As a mechanical irritant begetting inflammation, even to excoriation of the mucous membrane.

3.—As a toxic agent, poisoning the tissues.

4.—As a pseudo-parasite, penetrating the soft and sensitive parts.

It should be added that these activities are here supposed to operate upon the system while in an abnormal state. In a word behind all there is a Hay-Fever neurosis. As the nasal ducts are the first to show suffering in Hay-Fever, and the malady thence extends to all the respiratory organs, as well as other parts of the system, I think it bodes good that in addition to the long-known "Laryngological Association," the medical fraternity have effected a new organization under the name "Rhinological." This new society is to concern itself with the ailments of the nose hypothecating the fact that diseases of the throat and larynx almost always have their origin in the nasal region.

INAUGURAL ADDRESS OF THE PRESIDENT,
CHARLES F. COX.

(Delivered January 20th, 1888.)

I appreciate very highly the good will and good opinion implied in my election to the presidency of this Society, and shall feel greatly gratified if I am able to serve you acceptably in the position to which you have chosen me, and to assist you in the promotion of that department of science in which we are all most deeply interested. I hope that, during the year upon which we have just entered, the Society will continue in the successful path which it has followed hitherto and that we shall work on with the same quiet, unpretentious and undemonstrative zeal with which we have pursued our course heretofore, and which is certainly the habit of mind most befitting the humble devotees of Nature.

There are times in the history of every organization like this when the question : *Is any really worthy purpose being accomplished?* comes home to the membership with oppressive force ; and I cannot help thinking that there is too strong a tendency to test the matter by the narrow criterion of merely visible results.

But our success is not to be measured by the amount of stir which we are able to make in the world around us ; nor is it to be gauged by the quantity of so-called original matter which we may produce and publish. It can never be less than an unspeakable pleasure to discover a new fact or to devise a novel and useful process, and I am sure that every such achievement by one of our members will be regarded as a credit to the Society and a subject of just pride to us all. Nevertheless, I cannot consider *origination* as our chief and paramount aim. On the contrary, it seems to me that the object of such an association as this must be the acquisition and accumulation of knowledge for ourselves much more than the propagation and dissemination of it amongst others. In my opinion, it will be no serious reproach to us if we are looked upon as "a mutual benefit society," and I judge that we shall furnish a sufficient reason for our organized existence if we keep alive amongst ourselves an intelligent and progressive interest in our particular branch of

learning, and stimulate and develop in one another a true love for and devotion to the worthy cause of scientific truth. More than this we may indeed hope to do ; but beyond this we are not really bound to go. I do not know who may rightfully complain if, as a society, we even hold to the character which Emerson has ascribed to the great man, " who, in the midst of the crowd, keeps with perfect sweetness the independence of solitude ;" for discoveries worth proclaiming to the world are not made every two or three weeks, but inspiration and elevation *are* to be obtained from the frequent contemplation of the facts made known to us by the instrument around which it is our pleasure to gather and from which it is our pride to take our name.

And yet it is not long since some professed advocates of the popularization of science went through the form of reading us microscopists out of the general body of scientists, on the ground that we were not entitled to fellowship or encouragement because we were only "*amateurs*" (that is to say *lovers* of science), were "hangers-on to the regular scientific army," were "universal gatherers," and were undertaking to divide the sciences according to the tools used ;" and we were spoken of contemptuously as "delighting in a formidable and extensive deal of brass stand."

To most of these charges it was hardly necessary to put in any formal defense, for it was obvious that the *animus* of the attack upon us was the old-fashioned delusion that there is some kind of merit in doing scientific work with poor appliances. But another phase of this general notion has recently manifested itself in a vigorous onslaught upon American microscopes, for which, with evident appropriateness, the vehicle selected has been the journal which three years ago promulgated the now celebrated bull of excommunication. According to the latest champion of scientific orthodoxy, who declares that he has "seen and examined a great many different stands, and the lenses of many manufacturers,"—"it is undesirable to recommend a student to purchase any microscope whatsoever of American manufacture," but it *is* desirable "to always counsel him to obtain, if possible, one of the German or French instruments," which, as nearly as I can make out, conform to the common

model of twenty-five or thirty years ago. The general objection to American stands seems to be that they furnish more mechanism than the particular worker who wrote the complaint happens to require for his particular work. He makes a more specific charge, however, that they have a joint in the body by means of which they *may* be tipped out of a vertical position, when the makers ought to have known that he and his pupils never *care* to tip their microscopes; and another specification is made of the fact that the length of the tube has not been determined solely with reference to the height of the table or the chair which this rather exacting critic commonly employs;—at least this is the inference I draw from his demand that tubes should never be made longer than suits *his* convenience.

Now, I presume you find it as difficult as I do to understand why all supposed faults are laid at the doors of American manufacturers; for surely all bad microscopes are not American, even if all American microscopes are bad. But the unreasonable and sweeping denunciation in which this somewhat self-opinionated iconoclast indulges is only another illustration of the familiar phenomenon of blotting out all the rest of the world by holding a comparatively small object close to one's eye; for here is an acknowledged expert in histology who is so completely absorbed in his specialty as to be entirely oblivious to, or regardless of, the instrumental needs of all other branches of microscopy. In common with others who have lately made public display of their ignorance of the vastness and variety of microscopical research, he would actually prescribe "for one that uses the microscope for real work" a single simple pattern which, as you may imagine, would be pretty strictly limited to the requirements of his own restricted field of investigation. Instruments which perhaps meet the demands of different classes of observers are "constructed with a view of entrapping inexperienced purchasers."¹

1. It is only right to say that since these remarks were written, Dr. Minot has replied to some of his critics by a letter, published in *Science*, in which he disclaims having made an exhaustive examination of all forms of American microscopes and professes to have written previously "only in regard to microscopes suitable for biological and particularly histological work." I feel bound to say, however, that, taking his first letter by itself, the inferences I have drawn seem to me entirely justified, and I believe them to be such as must have occurred to nearly every reader of that letter. It is therefore to be regretted that he did not, in the first instance, exercise that calmness of judgment and carefulness of expression which are incumbent upon one who makes public announcement of a grave opinion. But, even in reference to biological or histological stands, he has to confess that he had overlooked the work of one of our oldest and best known manufacturers, and perhaps he will now learn that there are still others of whom he ought to have been informed before giving out his all-inclusive condemnation.

Unfortunately, this sort of narrow opposition to the inevitable elaboration of scientific implements is not a thing which decreases with the general increase of knowledge. It has accompanied every step in the development of the microscope and its accessories, and I suppose it will go right on in the future ; for I can hardly imagine a time when some specialist will not think it praiseworthy to contemn "the latest improvements," and take personal pride in pointing to the results of his own labors accomplished by the use of only the simplest mechanical aids.

Within a short time we have heard learned sermons preached upon the superiority of specimens prepared without the employment of circular cover-glasses and, of course, without the assistance of the turn-table. It was admitted that they were not very attractive to the naked eye ; but then there was "no nonsense" about them,—they were intended "*for use!*" So, too, we have witnessed a later contest over the microtome. What earnest homilies we have listened to upon the superlative excellence of the German method of free-hand section-cutting, and how positively we have been assured that all mechanical section-cutters were only delusions and snares ! I have to admit that some of the later developments of this accessory are rather formidable-looking engines which seem capable almost of cutting timber for commercial purposes ; but I notice that the gentleman who denounces all American microscopes, as being too complicated, is himself the inventor of one of these elaborate slicing machines. Yet the automatic microtome plainly has come to stay. So have the mechanical stage, the swinging sub-stage, and many other contrivances over which we have seen battle waged.

Shall we ever forget the terrific struggle with which the homogeneous-immersion lens was obliged to win its way to a footing in the microscopical world ? Men of no small importance blocked the road, not with drawn swords, but with drawn diagrams which most certainly proved, if they proved anything, that an angle of more than 180° was an optical impossibility and that, no matter what people might *think* they saw, they at all events could not see round a corner ; for, as old John Trumbull wrote,

"Optics sharp it needs, I ween,
To see what is not to be seen."

But now how perverse and prejudiced all that opposition seems, and how simple and reasonable the new system of numerical aperture is seen to be !

Before our time, the fight was fought over the binocular body, the achromatic objective, and even the "compound" principle itself. I happened, only the other day, to take up one of Dr. Hill's volumes published in 1752,¹ in which I found an illustration of the spirit of opposition of which I have been speaking ; for he iterates and reiterates his belief in the general superiority of the single microscope over the compound, for all genuine investigation. We can easily believe that the compound microscope, previous to the invention of the achromatic objective, was a rather inefficient instrument. Still, in the light of our present knowledge, it is exceedingly amusing to read such a passage as the following :

"Thus much I have thought it necessary to say in Favour of the Use of single Magnifiers of great Power, in the more nice Investigations, because I know their being difficult and Disagreeable in the using has thrown them into an unmerited disregard, a Neglect that Will clip the Wings of all succeeding Discoveries. The Microscope, as we hear of it in the Hands of Lewenhoek, and in those of all the other Authors, who have so amazingly seen the Minima of Nature, and who have inspired the World with a Love for its Investigations, was a single Glass of this kind. Almost all the great Discoveries which have rendered the Instrument famous, were made by single Glasses. These are the only ones to trace with Accuracy the Ways of Nature in these her minutest Productions ; nor are those who are acquainted only with the Use of that Plaything the double Microscope, to wonder that they cannot follow the Discoveries of Men who have used these single Glasses in the making them ; or accuse People of Imposition or Fancy who have used in their Investigations an Apparatus which is so superior in real Value to that by which they vainly attempt to follow their steps. The double Microscope is the Instrument for those who would be diverted by the Powers of magnifying, but this is that which ought to be understood and employed by all who would make real Discov-

1. *Essays in Natural History and Philosophy*, containing a Series of Discoveries by the Assistance of Microscopes, by John Hill, M. D.

eries ; that may be necessary as a first Step to this, but 'tis the single Glass of the first Power that is to determine all." With a little change,—so as to make it apply to the simple, rigid European stand as against the ample, adjustable English and American model,—the foregoing paragraph would appear quite modern.

And yet, while we must deprecate the practice of belittling and berating every new instrumental aid placed at our disposal, we must admit that there is another extreme to which enthusiasts or charlatans occasionally go and which also is deserving of unsparing condemnation. I refer to the making of extravagant and unwarranted statements as to the capabilities of the microscope or of efforts to excite undue wonder at the results of its use. This is not a fault common to the class of microscopists, and is not exactly the sin charged upon us by our would-be excommunicators. This is merely the showman's trick of picturing his prodigies just a little more prodigious than the living realities. It is the subterfuge of the quack, an artifice of the cheap lecturer. Even when it is resorted to in sober earnest it has its droll and entertaining aspect, as well as its serious and instructive side.

Thus, not unlike Sam Weller's "patent double million magnifyin' gas microscope of hextra power," with which one might "see through a flight o'stairs and a deal door," must have been that astonishing instrument with which Dr. Highmore claimed that it was possible to see the magnetic emanation of the loadstone. And a still more amusing case of circumstantial mendacity or of clever fiction is that quoted from Father Noel D'Argonne,¹ in that curious work, attributed to Dr. John Campbell, entitled "*Hermippus Redivivus, or the Sage's Triumph over Old Age and the Grave.*" According to this extraordinary relation, the author, while on a visit to London, made the acquaintance of a tradesman who, in return for a slight courtesy, with some show of mystery, presented to the Frenchman "an instrument in a tortoiseshell case, which proved to be a most excellent microscope." Our author goes on to say : "I may well bestow this epithet upon it, since it was so excellent as not only to discover an infinity of bodies imperceptible to the naked

1. *Mélange d'histoire et de littérature*, par M. De Vigneul—Marville, Paris, 1700.

eye, but even the atoms of Epicurus, the subtile matter of Des Cartes, the vapours of the earth, those which flow from our own bodies, and such as derive to us here the influence of the stars."

"The first experiment I made," he continues, "was looking on the person from whom I receiv'd it, at the distance of four or five paces, which gave me the opportunity of discerning an infinite number of little worms that were feeding most voraciously upon his cloaths, by which I perceived that contrary to the common opinion it is not we who wear out our cloaths but they are fairly eaten off our backs by these invisible insects."

Amongst other astonishing performances of this remarkable instrument was its disclosing the secret of personal sympathy and antipathy, which is set forth by the imaginative Frenchman in the following words :

"Going out of the house, we saw four young men playing at ball. I, at first sight, felt a strong inclination in favour of one, and as strong an aversion against another, whence I began earnestly to wish that this might win and that might lose. I examined both with the microscope and thereby easily distinguished the source of these passions. As the men were extremely heated with their exercise, they perspired strongly, so that clouds of the matter flowing from them reached us. My glass shewed me distinctly that the matter perspired by him for whom I had an inclination was exactly similar to what was perspired by myself ; whereas the matter flowing from the other person was absolutely unlike to mine in all respects, and so jagged and bearded that it seemed to wound and pierce me like so many arrows. Hence I discerned that the true cause of our sudden inclinations and aversions consists in the figures of the matter perspiring from us and from others, and in the similarity or contrariety of these insensible vapours."

It may be that the writer of this ingenious narrative was dealing only in allegory. But, without doubt, it is in the utmost seriousness that the author of a book but lately published in Boston puts forth even more astounding revelations,¹ professedly in the words of an anonymous "Scientist," who, by means of an original arrangement of lenses, hit upon the awful discovery of "the departing soul with its astral covering." But

1. *The Hidden Way Across the Threshold*, by J. C. Street.

there was a preliminary experiment which is worth describing in the "Scientist's" own language, although that language is not always strictly grammatical. "My attention," says he, "was first attracted to these truths by a patient of mine lying upon a sofa suffering with pain in his foot, and yet *there was no foot*, the leg having been amputated nearly to the hip and the wound had healed quite nicely. I found that not until I had the limb and foot disinterred and placed in a natural position (the foot having been thoughtlessly placed beside the amputated limb at burial), did the patient's suffering cease. This being done, he gained in flesh, slept well, grew strong, and never again complained of his foot. For a long time this incident ran in my mind, until at last I resolved upon an experiment. Procuring the most powerful lenses I could find, I completed an invention of my own, and, when my light was so perfectly arranged that I could examine the microbes in the air, called upon a patient who had lost his arm, and had also suffered in a similar manner, explaining to him that I wanted him to put his imaginary hand where I directed. He laughingly accompanied me to my rooms and did as I desired. The moment I adjusted the glass, a new world and light of revelation broke upon me. *The dual hand lay beneath my glass*. I asked him to make letters with his imaginary finger. He did so, and, to his wonder and astonishment, I spelled out the sentences he thus wrote. This was to me conclusive evidence of an ethereal second self."

After being led along to this point, we can readily imagine how the grand climax was reached in "a second experiment of great difficulty" which was then undertaken. "The time finally arrived," says our "Scientist," "where I had proper conditions of light, etc., where a man of more than ordinary spirituality was being called over to the silent majority. I watched the hours go by till the moment came when he was about to cease breathing and a sudden tremor passing through his body announced his hour had come. 'Now is our time,' I whispered to the friend who was assisting me. We passed our heads under a black cloth and bent our eyes intently upon the object-glass. Particles of dust in the air were magnified several thousand times, and for a time their motion kept a perfect dazzle upon the glass. Then a thin violet column of vapor gathered into a soft cloud * * *."

But why continue the touching details ! You must know the rest already. You who have often focused down upon the floating specks in a trembling drop of water, have groped your way in search of the nervous rotifer, and at last have "caught" him in the wavering field of your objective, can perhaps bring to your minds the sensations of this accomplished "Scientist" when at last he turned his truly wonderful lens from the floating dust of the atmosphere upon a materializing human spirit and beheld it "gather its forces into a little sphere and pass out into the sunlight of the everlasting morrow."

This I take to be the very sublimity of humbuggery, but a useful lesson may be learned from even such nonsense if, upon seeing to what absurd lengths a pretence of knowledge and the spirit of wonder-working can go, we are strengthened in our determination to resist every temptation to exaggeration,—to oppose every tendency to mere sensation. Old George Baker¹ pointed out the only good and safe position, when he said, "Some People have made false Pretences and ridiculous Boasts of seeing, by their Glasses, the Atoms of Epicurus, the subtile Matter of Des Cartes, the Effluvia of Bodies, the Emanations from the Stars and other such like Impossibilities. But let no ingenious and honest Observer give Credit to these romantic Stories, or misspend his Time and bewilder his Brains in following such idle Imaginations, when there lies before him an Infinity of real Objects, that may be examined with Ease, Profit and Delight."

Now, I have not spoken of this subject because I suppose that this society has any special need of the warning conveyed in the quotations just made. Indeed, I may say with entire sincerity that there is here as little necessity to preach a healthful conservatism as in any organization with which I have ever been connected. I have, however, purposely brought into juxtaposition the two extremes of error with reference to our favorite instrument, because I cannot see anything better in underrating the value of our mechanical appliances than in overestimating the capabilities of our lenses ; and I have hoped to point a moral which, perhaps, might be expressed in Wordsworth's couplet :

1. *The Microscope Made Easy*. London, 1743.

“ He is oft the wisest man
Who is not wise at all.”

The microscope is an instrument of precise investigation, capable of application in many various directions. It is, therefore, as a product of evolution in the domain of mechanics and optics, a collection of numerous parts possessing, as a whole, “a definite, coherent heterogeneity,” and it is vain to expect a return to the condition of “indefinite homogeneity” which characterized the simple stand of a third of a century ago. We of this society take delight in and are proud of all that has been done to evolve and perfect the useful and noble instrument with which we are privileged to work; but we fully recognize the fact that this beautiful mechanism is but the key to the treasury of minute nature. The pursuit of truth is our ultimate aim as well as our immediate employment; and in this pursuit we find our present benefit and final greatest good. For, as Edgar A. Poe has said, “*Not in knowledge is happiness, but in the acquisition of knowledge. In forever knowing we are forever blessed.*”

BEAUTIFUL MICRO-POLARISCOPE OBJECTS.

BY D. H. BRIGGS.

(Read January 6th, 1888.)

Aside from strictly scientific uses the micro-polariscope has a field of interest in exhibiting some of the most splendid phenomena in the whole range of microscopical manipulation.

Not only do many substances exhibit beautiful forms and colors in what may be called their normal mode of crystallization, but, when the crystals are formed under peculiar conditions, the effects are sometimes truly wonderful.

Having experimented to a considerable extent in this matter, I thought it might be of some interest to this Society to give the results of my experiments.

Out of a large number of substances, I select two, which are capable of being prepared in such a manner, that they will exhibit forms and colors of uncommon beauty. These are Salicin and Hippuric Acid.

First, however, I will name the necessary implements for the work. For a source of heat, I find a coal-oil lamp, with tall

glass chimney the best. I use the "Harvard burner," with a tin reservoir for the oil, six inches in diameter by about two inches in depth. I would remark, by the way, that the crystals appear much better by lamp-light than by day-light.

For a vessel, in which to heat and dissolve the substances, I find a small chemical flask, of two fluid ounces capacity, the most convenient, as it can be held over the lamp by grasping the neck with forceps, of which I find steel, artery forceps, of five inches length, the best. One advantage of the flask is that it does not lose the contained liquid very rapidly by evaporation. The forceps will also be needed for holding the glass slip, and the thin glass cover.

A block of cast-iron, five by eight by two inches, with one side planed, is used for the rapid cooling of the preparations. Glass slips, thin covers and Canada balsam will suggest themselves.

Salicin is soluble in 5.6 parts cold, and very largely in boiling water. The crystals deposited from a solution by cooling are in the form of needles, and frequently stellate groups appear, even under these circumstances. But to get the finest crystalline formations of this substance, I use the following method:—

First, prepare in the little flask, before mentioned, a solution in hot distilled water. The best results are obtained with a solution somewhat below the point of saturation. Add a trace of clean, pure gum-arabic, pulverized, a piece as large as a moderate sized grain of wheat, to each one-half fluid ounce of the solution. The use of the gum is to retard the formation of the crystals, and thereby enable the operator to obtain much better results. If, however, too much gum is added, persistent bubbles will be formed in the deposit on the slide.

Next filter the hot solution, being careful that funnel, flask, etc., are clean, and free from all traces of oily matter.

To prepare the slide, which first must be made clean, hold the slip in the forceps by one end; warm over the lamp; remove, and pour on the end, opposite the forceps, enough of the hot solution to flow over as much of the slide as possible, and not come in contact with the forceps, being very careful not to allow any of the solution to run over. Now heat the slide over the lamp, mostly at the end opposite to that held by the forceps, causing some boiling; and then, by slight motion of the slide,

make the liquid to circulate so as to keep the solution of uniform temperature and concentration. Remove from over the lamp, and, after one or two seconds, run off the liquid from the corner of the slip into the flask. Then hold the slide over the lamp until rosettes begin to form, and, when these are almost as large as desired for the central discs, place the slide at once on the cold iron. This will stop the process of crystallization, and after the slide is cooled, crystallization can be started again by heating, when a rim will be formed on the rosettes of any size, depending on the length of time during which the heat is applied. The growth of the rim can be stopped by cooling.

When the crystals are satisfactory, and just sufficiently cold to stop crystallization, immediately put a drop of balsam on a thin cover, which, held by the forceps, can be heated over the lamp, and applied to the slip. The balsam can be made to spread by warming the slide, cover side down, over the lamp.

If properly prepared, the amorphous deposit of Salicin will remain in that condition, and cause the rosettes to appear on a black back-ground, when viewed with the prisms at right angles in the microscope.

Another substance, which can be made to crystallize in very beautiful forms with much less trouble than Salicin, is Hippuric Acid.

Of this substance a concentrated but not saturated solution in hot, absolute alcohol is prepared in the little flask; the glass slip heated over the lamp; the hot solution poured on the end of the slip, and flowed over the centre, with some ebullition, and immediately run off into the flask. Wait a few seconds until the rosettes begin to form on the slide, and then quickly place on the cold iron, until the slide is cool. Now examine with the microscope, when presently the rosettes will begin to radiate a fringe around their circumference. This can be accelerated by allowing the breath to come in contact with the slip. When the discs are nearly of the size desired the process will be stopped, or rather changed in character, by slightly warming over the lamp for one or two seconds, and then cooling, and proceeding as before, if further developments are desired. When the crystals cover the surface seal on the thin glass cover.

If properly prepared these slides are very vivid in color in the polariscope, and exhibit also very pleasing forms.

PROCEEDINGS.

MEETING OF DECEMBER 2D, 1887.

The President, the Rev. J. L. Zabriskie, in the chair.

Thirty-seven persons present.

The Rev. A. B. Hervey was elected a Corresponding Member, and Mr. Frank Healy was elected a Resident Member of the Society.

Messrs. Mead, Woolman, Wales, Calef and Devoe gave full and interesting explanations of their several exhibits, as announced in the present programme.

Mr. P. H. Dudley read the following notes on fungi, in explanation of his exhibits, Nos. 7 and 8 of the programme of this meeting.

NOTES ON *Lentinus lepideus*, FR., AND *Trametes pini*, FR.

“ Finding these two species of fungus fruiting upon the same piece of Yellow Pine, *Pinus palustris*, Mill., is of considerable scientific, as well as of practical importance.

“ SCIENTIFIC INTEREST:—1. It shows that the difference in appearance, between mycelium so often found in the upper portion of Yellow Pine railroad ties, and that generally found in the lower portion, is due to distinct species of fungus, and not to a polymorphism of mycelium of one species.

“ 2. That two species of fungus, having distinct external characteristics, are, by growth, able to break down and reduce similar compounds under nearly the same external conditions.

“ PRACTICAL IMPORTANCE:—1. For this immediate vicinity, so far as yet observed, the rate of destruction, caused by *Lentinus lepideus*, Fr., in the duramen of Yellow Pine ties, is over three times that caused by *Trametes pini*, Fr.

“ 2. *Lentinus lepideus*, Fr., in gravel or cinder ballast, attacks first the portions of the ties which are imbedded, and grows upward; while *Trametes pini*, Fr., attacks first the exposed ends of the ties, the mycelium working slowly inward and downward.

“ This shows that the former needs more moisture, and exclusion from air-currents, for its growth. Therefore, if the Yellow Pine ties are only imbedded in the ballast sufficiently for the stability of the track, the rate of decay for the entire tie, as

caused by *Lentinus lepideus*, Fr., will be retarded ; though the exposed ends of the ties will be more subject to the attacks of *Trametes pini*, Fr. Nevertheless, the rate of decay, caused by the last-named fungus, being slower, the service of the Yellow Pine Ties is prolonged by the less depth of imbedding in the ballast.

“It must be understood, that the decay of ties of all species of wood will not be retarded by less imbedding in the ballast. On the contrary the decay of ties of some woods is retarded by full imbedding.

“In securing pieces of decayed Yellow Pine ties from the main tracks of a railroad for microscopical study, it is rare to find, in fruit, the fungus which has induced decay. The mycelium, and its method of destruction only remain to indicate what caused the decay. A slight difference in color was frequently noted between the mycelium found in the lower, and that found in the upper portion of the Yellow Pine ties ; but the cause was not understood until, in the Fall of 1886, I found both species of fungus, herein mentioned, fruiting upon the same Yellow Pine track-stringer for the transfer-table, at the Grand Central Station. Both species also fruited on the same stringer the present season. Specimens of each fungus are in the boxes for exhibition.

“*Sphæria pilifera*, Fr., often attacks new Yellow Pine ties in transit from the South. The mycelium penetrates the resin-ducts and cells of the medullary rays of the alburnum, the dark filaments discoloring the portion of wood attacked. If such wood dries, or is treated before putting it in the ground, the decay, for the time being, is arrested. The final decay of the wood may be due to a subsequent attack of another species of fungus, the mycelium of each often being found in the same wood-cell. This is especially true of decayed sheathing from freight-cars. Much of it is attacked by fungi, discoloring the wood, to some extent, before it is used on the cars. In many cases painting such wood hastens, instead of preventing decay.”

Mr. Dudley also exhibited a Heliostat, of his own construction, made after the model of the Fahrenheit Heliostat, and showed the method of operating the same.

In this connection Mr. Dudley also exhibited Daguerreotypes

of microscopical objects, taken by the late Prof. John W. Draper, in 1853 or 1854, by means of a Heliostat of this same model.

Mr. George P. Scott, of Brooklyn, being present as a visitor, on request, explained the peculiar points of his microscope and its case, as announced in the programme. This microscope possesses many ingenious appliances connected with the body, the stage, and the sub-stage of the instrument. Especially noticeable among these are the contrivances by which, with a quarter revolution, the polarizer, the selenite, and the analyzer of the polarizing apparatus can instantly be brought into use, or turned to one side, so as to avoid all interference with the examination of an object by ordinary light.

Mr. W. Wales gave the Society interesting information concerning the difficulties encountered in the construction of apochromatic objectives.

A discussion followed upon the construction of sub-stages, with especial reference to the necessity of a centring arrangement for the Abbe condenser.

Mr. C. S. Shultz exhibited nine slides, beautifully prepared, and donated to the Cabinet of the Society, through him, by Miss Mary A. Booth, of Longmeadow, Mass., as announced in the programme.

On resolution the thanks of the Society were tendered Miss Booth for this gift.

Mr. G. S. Woolman presented, for distribution among the members, diatomaceous material from marine soundings, taken at the depth of 1,000 fathoms in the Gulf Stream, off the coast of New England.

Mr. A. M. Cunningham, of Mobile, Ala., through the Corresponding Secretary, donated, for distribution among the members, diatomaceous material, employed as a "Silver-polish," containing many perfect and elegant diatoms. On resolution the thanks of the Society were tendered Mr. Cunningham for this donation.

According to a request, previously made by the President, that this should be especially an "Apparatus-evening," many interesting and valuable pieces of apparatus were exhibited, as appears in the programme.

PROGRAMME OF OBJECTS ANNOUNCED FOR EXHIBITION.

1. The Abbe Stereoscopic Binocular Eye-Piece: exhibited by WALTER H. MEAD.

2. Cyclosis in *Vallisneria*, under a $\frac{1}{20}$ Powell and Lealand objective, and the above-mentioned eye-piece: exhibited by WALTER H. MEAD.

3. "Acme" Microscope: exhibited by G. S. WOOLMAN.

4. A Zentmayer Pocket Microscope: exhibited by W. WALES.

5. Bausch and Lomb's Concentric Microscope: exhibited by H. W. CALEF.

6. A Microscopist's Box, home-made, containing necessary articles and apparatus for work, mounting, etc.: exhibited by F. W. DEVOE.

7. Fruit and Mycelium of *Lentinus lepideus*, Fr.: exhibited by P. H. DUDLEY.

8. Fruit and Mycelium of *Trametes pini*, Fr.: exhibited by P. H. DUDLEY.

9. A Heliostat, made after the model of the Fahrenheit Heliostat: exhibited by P. H. DUDLEY.

Nine slides, prepared and donated to the Cabinet of the Society by Miss M. A. Booth: exhibited by C. S. SHULTZ, as follows:—

10 (1). *Biddulphia pulchella*, and *B. Edwardsii*; South Sea.

11 (2). *Triceratium Javanicum*; Tangaroon Mt., Java.

12 (3). Shell-scrappings; Is. of Amboina, East Indian Archipelago.

13 (4). Diatoms of the Water-supply of Leipsic, Germany.

14 (5). Diatoms from mud, found floating off the west coast of South America.

15 (6). Diatoms from mud, from Beaufort, North Carolina.

16 (7). *Aulacodiscus orientalis*, and *Chiuacospongia monilifera*; from the Sandwich Islands.

17 (8). Diatoms from Santa Monica, California.

18 (9). Spores and elaters of Liverwort, *Conocephalus conicus*.

19. Podura-scale, under a $\frac{1}{12}$ Powell and Lealand objective: exhibited by WILLIAM G. DEWITT.

20. Larva of *Dermestes*: exhibited by F. W. LEGGETT.

21. A Microscope, with convenient appliances, and a compact case: exhibited by GEO. P. SCOTT.

OBJECTS FROM THE SOCIETY'S CABINET.

22. *Sertularia* from New Zealand.
23. Arsenious Oxide Crystals.
24. Transverse section of Rhizome of Wild Yam, *Dioscorea villosa*.
25. Proboscis of the Horse-Fly, *Tabanus atratus*.
26. Foraminifera from Dog's Bay, Connemara, Ireland.

 MEETING OF DECEMBER 16TH, 1887.

The President, the Rev. J. L. Zabriskie, in the chair.

Forty-eight persons present.

On motion of Mr. Walter H. Mead the order of business was suspended, with the exception of attention to the following matters, viz.—the nomination and election of members, the Report of the Committee on nomination of Officers, and the Report of the Committee on the Annual Reception.

The Rev. K. F. Junor, M. D., was elected a Resident Member.

The Committee on nomination of Officers for the ensuing year presented their report.

Prof. Samuel Lockwood, Ph. D., addressed the Society on "The Pathology of Pollen in *Æstivis*, or Hay-Fever." This Address was illustrated by herbarium-specimens of the Rag-weed and Golden-rod, by slides of Pollens of the same under microscopes, and by drawings of the same Pollens, and is printed in full in this number of the JOURNAL, p. 99.

On the conclusion of the Address the thanks of the Society were tendered Prof. Lockwood.

 MEETING OF JANUARY 6TH, 1888.

The President, the Rev. J. L. Zabriskie, in the chair.

Thirty-two persons present.

The President presented a brief Report upon the condition of the Society.

The Treasurer, Mr. C. S. Shultz, presented his Report, of which the summary is as follows:—

Receipts, to Jan. 6th, 1888	-	-	-	\$436.61
Disbursements. to Jan. 6th, 1888	-	-	-	392.55
				<hr/>
Balance, Jan. 6th, 1888	-	-	-	\$44.06

Mr. C. F. Cox said it would be remembered that some months ago Dr. Julien read a very interesting paper upon a remarkable exhibition of phosphorescence observed in the ocean and on the beach at Long Branch, and that he (Mr. Cox) had suggested that the organism which Dr. Julien had found abounding in the water was a flagellate bacterium which was supported by the abundance of dead jelly-fish present at that time. It would be remembered, also, that Dr. Julien was inclined to attribute the phosphorescence to this bacterium-like creature, while he (Mr. Cox) was disposed to believe it to be due to the decaying substance of the acalephs. He now wished to call attention to a summary, in the Royal Microscopical Society's Journal for December, 1887, p. 1009, of investigations by Prof. J. Forster and Dr. C. B. Tilanus, into the phosphorescence of bacteria, which seemed to furnish facts in support of Dr. Julien's theory.

Mr. Cox further called attention to a communication to the Royal Microscopical Society by Dr. Henri Van Heurck (December, 1887, p. 1068), in which he replied to criticisms which he (Mr. Cox) had made upon photomicrographs sent to this Society some time ago, which criticisms, however, were erroneously attributed to Hon. J. D. Cox, of Cincinnati. Mr. Cox said he was not willing that his brother should be held responsible for any of his views. In questions relating to photomicrography General Cox was an acknowledged authority, whereas he himself professed only the most general acquaintance with the subject. He had, however, just taken from the Society's cabinet, and held in his hand, the set of photographs which had been the subject of criticism, and a re-examination of them proved that in most of them the back-ground had been painted out. He was glad to learn, from Dr. Van Heurck's letter to the Royal Microscopical Society, that he had abandoned this unde-

sirable mode of treatment, and he (Mr. Cox) felt sure that this Society would be glad to receive the new set of photographs which Dr. Van Heurck said he had sent, in illustration of his new and improved method.

Mr. P. H. Dudley being unavoidably absent, a communication from him, explaining his exhibits as announced in the programme, was read from the chair, as follows :

ROCK-SECTIONS, FROM THE ISTHMUS OF PANAMA.

“The section of rock (Wacke) from the Bujio quarry of the Panama railroad, is of considerable interest, from the fact of its extensive use for heavy masonry by the Railroad Company on the Isthmus.

“The rock is friable and porous, as a glance at the slide indicates. The fragments composing it are only feebly united, while some portions have undergone decomposition. Most of the Olivine has disappeared. Pyroxene crystals are present, sufficient in number to deepen the color of the rock, and to increase its specific gravity, the latter ranging from 2.3 to 2.5.

“In this climate exposed blocks of such rock would not withstand one winter's freezing and thawing, without extensive, if not complete disintegration. In a tropical climate it stands much better, and of necessity the Panama Railroad Company used it for all of their bridge abutments and other masonry, in which it has rendered good service, when laid in cement and kept well pointed. When used for road metal or ballast, for the railroad, it is rapidly converted into mud in the ‘wet season.’

“SECTIONS OF PEBBLES.—The pebbles found in the Chagres River, at Gorgona, are from both igneous and sedimentary rocks, the former being the most abundant. The sedimentary pebbles were all argillaceous, the corners being well rounded.

“The pebbles from the igneous rocks were not, as a rule, as well rounded, many of them being quite angular.

“In slide No. 5 of the programme are a number of sections of crystals (Orthoclase), each seeming, at first sight, to form a nucleus for the surrounding material. The want of sharpness of many of the corners of the crystals, and the fact of several being broken, favor the hypothesis, that they were undergoing a process of dissolution, which was subsequently checked.

“Slide No. 6.—In the nearly transparent portions are small acicular crystals.

“Slide No. 7.—Presents the appearance of each quartz grain having a delicate cell-wall. This was originally a sedimentary rock, subsequently altered by heat, under pressure.”

A communication by Mr. D. H. Briggs, of Germantown, Pa., a Corresponding Member of the Society, entitled “Beautiful Micro-polariscope Objects,” illustrated by slides of crystals of Salicin, and of Hippuric Acid, as announced in the programme, was read from the chair.

These slides were prepared and donated to the Cabinet of the Society by Mr. Briggs, and the communication is published in this number of the JOURNAL, p. 115.

ELECTION OF OFFICERS.

The President announced the closing of the polls, and declared the result of the balloting to be the election of the persons, nominated at the last meeting by the Committee on nomination of Officers for the ensuing year, as follows :—

For President, C. F. COX.

For Vice-President, P. H. DUDLEY.

For Recording Secretary, G. E. ASHBY.

For Corresponding Secretary, B. BRAMAN.

For Treasurer, C. S. SHULTZ.

For Librarian, L. RIEDERER.

For Curator, W. BEUTTENMÜLLER.

For Auditors, { F. W. DEVOE,
W. R. MITCHELL,
F. W. LEGGETT.

PROGRAMME OF OBJECTS ANNOUNCED FOR EXHIBITION.

- | | |
|--|----------------------------------|
| 1. Section of Granite, from Monson, Mass. | } Exhibited
by
T.B.Briggs. |
| 2. Section of Granite, from Stony Creek, Conn. | |
| 3. Section of Pegmatite, or Graphic Granite, | |

PEGMATITE, OR GRAPHIC GRANITE.

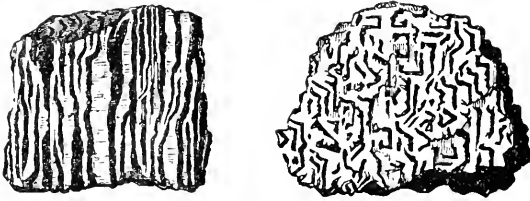

Fig. 1.—Section parallel to laminæ. Fig. 2.—Section transverse to laminæ.

“Feldspar, quartz, and mica are usually considered as the minerals essential to granite, the feldspar being most abundant in quantity, and the proportion of quartz exceeding that of mica. These minerals are united in what is termed a confused crystallization; that is to say, there is no regular arrangement of the crystals in granite, as in gneiss, except in the variety termed graphic granite, which occurs mostly in granitic veins. This variety is a compound of feldspar and quartz, so arranged as to produce an imperfect laminar structure. The crystals of feldspar appear to have been first formed, leaving between them the space now occupied by the darker colored quartz. This mineral, when a section is made at right angles to the alternate plates of feldspar and quartz, presents broken lines, which have been compared to Hebrew characters.”

4. Section of Wacke, from Bujio Quarry, Panama R. R.

5. Section of Gravel;

6. Section of Gravel;

7. Section of Gravel, metamorphic;

} From Chagres River,
at Gorgona.

Nos. 4, 5, 6 and 7 exhibited by P. H. DUDLEY.

8. Slides of Heads of Hemiptera, including mouth-parts: exhibited by L. RIEDERER.

9. A slide of Diatoms from Rembang Bay, 31 generæ, 319 forms, obtained from washings of coral: exhibited by E. A. SCHULTZE.

10. A slide of Diatoms from Santa Monica, 348 forms: exhibited by E. A. SCHULTZE.

11. A slide of Diatoms from the Lystran Deposit, Siberia: exhibited by E. A. SCHULTZE.

12. Hair of *Ornithorhynchus paradoxus* : exhibited by H. W. CALEF.

13. Crystals of Salicin : exhibited by D. H. BRIGGS.

14. Crystals of Hippuric Acid : exhibited by D. H. BRIGGS.

OTHER EXHIBITS.

15. Section of Amazon Stone ; polarized : exhibited by J. WALKER.

16. Scales of *Tillandsia* : exhibited by F. W. LEGGETT.

17. *Chaetophora pessiformis* : exhibited by T. CRAIG.

OBJECTS FROM THE SOCIETY'S CABINET.

18. Hydraulic Gold, from New Granada, S. A.

19. Hydraulic Gold, from California.

20. Gold Sand, from California.

21. Hornblendic Granite, from Egypt.

22. Granite from New York City.

23. Diatoms, from Lake Superior.

24. *Gyrosigma Balticum*, Port Morris, N. Y.

MEETING OF JANUARY 20TH, 1888.

The President, Charles F. Cox, in the chair.

Thirty-four persons present.

Messrs. C. B. Orcutt and Geo. B. Scott were elected Resident Members.

The President made the following appointments :—

Committee on Admissions : F. W. Devoe, W. R. Mitchell, W. E. Damon, G. F. Kunz, and W. Wales.

Committee on Publications : J. L. Zabriskie, William G. De Witt, E. B. Grove, Walter H. Mead, and J. L. Wall.

On motion, an intermission of twenty minutes was taken to view the exhibits.

After such intermission the President, Charles F. Cox, delivered his Inaugural Address, which is published in this number of the JOURNAL, p. 106.

OBJECTS EXHIBITED.

1. Leaf of *Erythroxylon coca*, bleached and stained : exhibited by E. B. GROVE.

2. Mites from June-Bug : exhibited by F. W. LEGGETT.

PUBLICATIONS RECEIVED.

The Botanical Gazette : Vol. XII., Nos. 9-12 (September-December, 1887) ; Vol. XIII., Nos. 1, 2 (January, February, 1888).

The American Monthly Microscopical Journal : Vol. VIII, Nos. 93, 95, 96 (September, November, December, 1887).

The Journal of Mycology : Vol. III., Nos. 9, 10, 12 (September, October, December, 1887) ; Vol. IV., No. 1 (January, 1888).

Entomologica Americana : Vol. III., Nos. 6, 8-11 (September, November, December, 1887, and January, February, 1888).

The Microscopical Bulletin and Science News : Vol. IV., Nos. 5, 6 (October, December, 1887).

Bulletin of the Torrey Botanical Club : Vol. XIV., Nos. 10, 12 (October, December, 1887) ; Vol. XV., Nos. 1, 2 (January, February, 1888).

The School of Mines Quarterly : Vol. IX., No. 2 (January, 1888).

Transactions of the New-York Academy of Sciences : Vol. IV. (October, 1884-June, 1885).

Anthony's Photographic Bulletin : Vol. XVIII., Nos. 17-24 (September 10-December 24, 1887) ; Vol. XIX., Nos. 1-4 (January 14-February 25, 1888).

The Microscope : Vol. VII., Nos. 9-12 (September-December, 1887) ; Vol. VIII., Nos. 1, 2 (January, February, 1888).

The Journal of the Cincinnati Society of Natural History : Vol. X., Nos. 3, 4 (October, 1887, January, 1888).

Bulletin of the California Academy of Sciences : Vol. II., No. 7 (June, 1887).

Proceedings of the American Academy of Arts and Sciences, Boston : New Series, Vol. XIV., Part 2 (December, 1886-May, 1887).

Proceedings of the Newport Natural History Society : 1886-7, Document 5.

Proceedings of the Academy of Natural Sciences of Philadelphia : Part I., January-April, 1887 ; Part II., April-August, 1887.

Journal of Morphology : Vol. I., No. 1 (September, 1887).

Proceedings of the Natural Science Association of Staten Island : December 10, 1887, January 14 and February 11, 1888.

Proceedings of the San Francisco Microscopical Society : December 15, 1887; and January 12, 1888.

Davenport Academy of Natural Sciences : Proceedings of the Twentieth Annual Meeting, and Address of the President, January 4, 1888.

National Druggist : Vol. XI., Nos. 8, 9, 10, 12 (September 15, October 1, October 15, November 15, 1887) ; Vol. XII., No. 4 (February 15, 1888).

The Electrical Engineer : Vol VI, No 67-70, 72 (July-October, December, 1887) ; Vol. VIII., No. 74 (February, 1888).

Rocky Mountain Mining Review : Vol. XVI., Nos. 14, 21, 24, 25 (October 6, November 24, December 15 and 22, 1887).

Mining and Scientific Review : Vol. XX., Nos. 3-8 (January 19, 1887-February 23, 1888).

The Brooklyn Medical Journal : Vol. I., No. 1 (January, 1888).

The Pacific Record of Medicine and Surgery : Vol. II., Nos. 2-5 (September 15-December 15, 1887).

Johns Hopkins University Circulars : Vol. VII., Nos. 60-63 (November, 1887-February, 1888).

The Swiss Cross : Vol. II., Nos. 1-6 (July-December, 1887).

The Hahnemannian Monthly : Vol. XXII., Nos. 10-12 (October-December, 1887).

Psyche : Vol. V., Nos. 141, 142 (January, February, 1888).

The West-American Scientist : Vol. III., Whole Number 29 (September, 1887) ; Vol. IV., Whole Number 32 (December, 1887).

Indiana Medical Journal : Vol. VI., Nos. 4, 6, 7, 8 (October, December, 1887, January, February, 1888).

The Naturalist's Monthly : Vol. I., Nos. 4, 6 (December, 1887, February, 1888).

Journal of the Royal Microscopical Society : Parts 3-6 (June-December, 1887).

Grevillea : Vol. XVI., Whole Nos. 77, 78 (September, December, 1887).

Nottingham Naturalists' Society. Transactions and Thirty-fifth Annual Report : 1887.

North Staffordshire Naturalists' Field Club. Annual Report and Transactions : 1887).

Bristol Naturalist's Society. List of Officers and Council, 1887 ; Proceedings, New Series, Vol. V., Part 2 (1886-7).

The Naturalist : Nos. 147-151 (October, 1887-February, 1888).

The Journal of Microscopy and Natural Science : Vol. VI., Part 24 (October, 1887).

The Canadian Record of Science : Vol. II., No. 8 (October, 1887) ; Vol. III., No. 1 (January, 1888).

The Ottawa Naturalist : Vol. I., Nos. 6-11 (September, 1887-February, 1888).

The Victorian Naturalist : Vol. IV., Nos. 5, 6 (September, October, 1887).

The Indebtedness of Photography to Microscopy. By A. Clifford Mercer, M. D. (Reprint from the Photographic Times Almanac, 1887.)

Method of Staining and Fixing the Elements of Blood. By Alice Leonard Gaule. (Extracted from the American Naturalist, July, 1887.)

O. Schultze's Method of Preparing the Amphibian Egg. By John A. Ryder. (Extracted from the American Naturalist, June, 1887.)

On the New Artificial Rubies. By George F. Kunz. (From the Transactions of the New York Academy of Sciences, October 4, 1886.)

On Two New Meteorites from Kentucky and Mexico. By George F. Kunz. (From the American Journal of Science, Vol. XXXIII., March, 1887.)

Meteoric Iron which fell near Cabin Creek, Johnson County, Arkansas, March 27th, 1886. By George F. Kunz. (From the American Journal of Science, Vol. XXXIII., June, 1887.)

Gold and Silver Ornaments from Mounds of Florida. By George F. Kunz. (Reprint from American Antiquarian, July, 1887.)

Gold Ornaments from the United States of Colombia. By George F. Kunz. Reprint from American Antiquarian, September, 1887.)

Practical Electricity : Vol. I., No. 4 (November, 1887).

The Cosmopolitan : Vol. IV., No. 1 (September, 1887).

Annual Report of the Curator of the Museum of Comparative Zoölogy at Harvard College : 1886-87.

Report of the State Entomologist to the Regents of the University of the State of New York : 1886. (From the 40th Report of the N. Y. State Museum of Natural History.)

Journal of the Elisha Mitchell Scientific Society : 1887.

Schedule of Prizes offered by the Massachusetts Horticultural Society : 1888.

Journal and Proceedings of the Royal Society of New South Wales : Vol. XX (1886).

Monatsblätter des Wissenschaftlichen Club in Wien : Vol. VIII., No. 12 (September 15, 1887); Vol. IX., Nos. 2, 3, 4 (November 15, December 15, 1887, January 15, 1888).

Chronik des Wiener Goethe-Vereins : Vol. II., Nos. 11, 12 (November 15, December 15, 1887).

Jahrbücher des Nassauischen Vereins für Naturkunde, Wiesbaden : Vol. XL. (1887).

Monatliche Mittheilungen des Naturwissenschaftlichen Vereins des Regierungsbezirks Frankfurt a. Oder. Vol. IV. (1886-87).

Jahres-Berichte des Naturwissenschaftlichen Vereins in Elberfeld: Vol. VII. (1887).

Bulletin de la Société Belge de Microscopie : Vol. XIII., Nos. 9, 10, 11 (June 25, July 30, October 9, 1887) ; Vol. XIV., No. 1 (October 29, 1887).

Le Moniteur du Praticien : Vol III., Nos. 9, 10, 11, 12 (September-December, 1887).

Comptes-Rendus des Seances de la Société Royale de Botanique de Belgique : Vol. XXVII., Pt. 1 (November 12, December 4, 1887); Pt. 2 (January 14, 1888).

Bulletin de la Société Impériale des Naturalistes de Moscou : Année 1887, No. 3.

Memorias de la Sociedad Científica " Antonio Alzate," Mexico : Vol. I., Nos. 4, 5 (October, November, 1887).

Nuovo Giornale Botanico Italiano, Florence : Vol. XX., No. 1 (January 31, 1888).

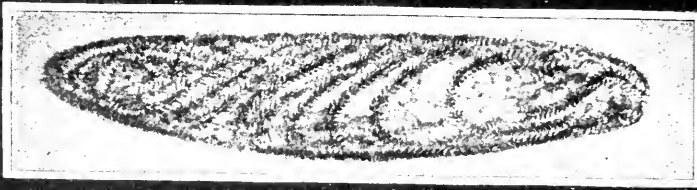

Fig. I.

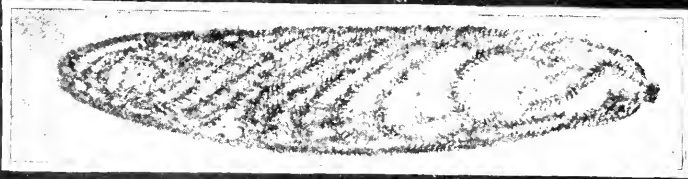

Fig. II.



Fig. III.

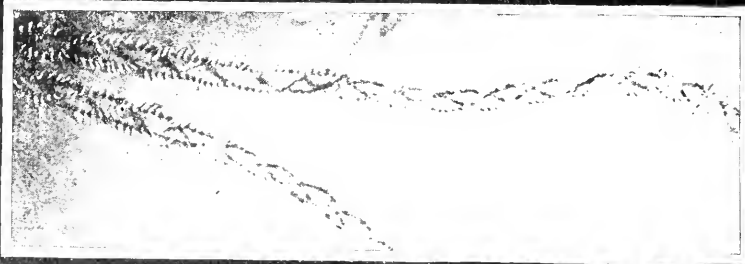

Fig. IV.



Fig. V.

JOURNAL
OF THE
NEW-YORK MICROSCOPICAL SOCIETY.

VOL. IV.

JULY, 1888.

No. 3.

NOTES ON THE THREAD-CELLS OF CERTAIN CŒLENTERATE ANIMALS.

BY CHARLES F. COX.

(Read March 2d, 1888.)

Thread-cells, lasso-cells, filiferous capsules, urticating organs, cnidæ, or nematocysts, as they are variously called, are usually set down as characteristic of the whole sub-kingdom Cœlenterata, although their existence has not been actually demonstrated in every order of either the *Hydrozoa* or the *Actinozoa*. Nor is it certain that they are confined to cœlenterate animals. Prof. Allman claims to have observed the emission of urticating filaments by a species of *Bursaria*, and there is reason to believe that they occur in other infusoria, and perhaps in some annelids. They have been reported to exist likewise in certain naked mollusks, though it is still a disputed question whether in such cases they are not derived from cœlenterate animals upon which the mollusks feed. In general, however, they may be said to be the peculiar property of tentacled animals, and there is good evidence upon which to regard them as organs of offence and defence.

When matured and fitted for their special function, these organs are situated in the outer layer, or ectoderm, and are

Explanation of Plate 12.

FIGS. III., IV. and V., are process reproductions of photographs from nature ; Fig. III. showing the cell with the thread partially emitted, Fig. IV. the fully extended thread, and Fig. V. two empty cells with the clear spaces at the bases of the attached threads.

FIGS. I. and II., are modifications of Fig. III., made as diagrammatic representations of the cell before and at the beginning of the extrusion of the thread.

usually collected into reniform groups, or knobs. They are, however, found, in various stages of development, scattered through the deeper tissues and in widely separated parts of the animal. When seen before excitation has caused the ejection of the thread, they consist of a thin-walled sack, either globular in form or of an elongated egg-shape, within which is coiled a long and elastic filament, and which is probably filled by a fluid.

These cells vary greatly in size, in different orders and genera. In the "Ruby Medusa," *Turris Neglecta*, Mr. Philip H. Gosse estimated their length at not over the $\frac{1}{3000}$ of an inch, while in the "Red-lined Medusa," *Chrysaora cyclonota*, he says "the largest were about $\frac{1}{2500}$ inch in length, the smallest about $\frac{1}{5000}$ inch, with the thread occupying an oval cavity about two-thirds of the entire volume." In the tentacle of the "Portuguese Man-of-war," *Physalia pelagica*, which I have under one of my microscopes this evening, the cells average about $\frac{1}{2500}$ of an inch in diameter, and are perfectly circular in outline; but in the "Bermuda Madrepore," *Isophyllia dipsacea*, of which I have a preparation under another microscope, they are all of an oval form, and, in the largest kind, attain to the very unusual magnitude of about $\frac{1}{225}$ th of an inch in the longest direction, by about one-quarter to one-fifth of that measurement at the widest part of the short diameter. In some of the *Hydrozoa*, however, and in most of the *Actinozoa* several entirely different sorts of thread-cells occur in the same individual. Thus, in my specimen from *Isophyllia*, I find three quite distinct forms, the largest of which is represented in the drawings. These forms are so unlike in size and construction that it seems beyond doubt that they serve dissimilar purposes in the economy of the Madrepore; but I am unable to say what position they respectively occupied in the living creature.

By far the larger part of all recorded knowledge of thread-cells has been derived from Mr. Gosse's observations, made some twenty-five or thirty years ago. He classifies these organs mainly according to the manner in which the filament is disposed within the capsule. Thus, he describes *chambered*, *tangled* and *spiral* cnidæ. But, in the three kinds observable in the specimen now under the microscope, the differences extend to the size and shape of the capsule, to the presence or absence of a smaller capsule within the larger, to the way in which the thread

is coiled before ejection, to the dimensions and form of the filament after protrusion, and to the size of the setæ and their mode of arrangement on the thread.

The largest cells are slightly curved, and there is little difference in the size of the two extremities. The point from which the thread is discharged is, however, usually a trifle blunter, or broader, than the other. The thread lies loosely coiled within, filling the whole cavity of the cell, and it is impossible to discover any interior capsule. The anterior end of the thread, which appears to be tipped with a hard point, something like an arrow-head, may be seen distinctly, lying properly directed and ready for emission; but the posterior end cannot be made out satisfactorily.

The second form of nematocyst is straighter than the first, of a symmetrical oval outline, and about $\frac{1}{500}$ th of an inch in length by about $\frac{1}{2500}$ th of an inch in width. At the forward end is a tight roll of thread, occupying less than one-third of the narrow diameter of the cell and extending to not quite its middle, whence it is continued, in a loose, irregular mass, nearly to the posterior wall.

The third sort of nematocyst is more egg-shaped and much smaller than either of the other two, being from $\frac{1}{850}$ th to $\frac{1}{900}$ th of an inch in the longer direction and about $\frac{1}{3700}$ th in the shorter. It contains no inner capsule, unless the thread is wound about it and thus conceals it, as may well be the case in any of the three forms under observation. The thread is coiled very tightly at one end and lies in a loose mass at the other, as in the case of the larger cell just described.

In the largest of these cells, represented in Fig. I., with a magnification of 700 diameters, the setæ are easily seen upon the thread before its emission. In the others, however, the parts are too small, and the thread is too closely twisted to permit of our distinguishing the setæ with any power I have had at my disposal.

When these thread-cells are subjected to pressure in the compressorium, a short neck is at first protruded, as shown in Fig. II., and then the thread is emitted from it and forcibly projected to a length many times greater than that which it possessed while enclosed by the capsule. It is not at all clear that the projectile force is derived entirely from com-

pression of the cell, for during and after emission of the thread the capsule retains its oval form, with only a slight narrowing and elongation, as appears in Fig. V. There is therefore ground for the suggestion, which has been made, that the unexcited cell contains a highly expansible liquid or perhaps a mixture of gas and liquid, the expansive force of which is liberated by the protrusion of the neck, above referred to, and the formation of an opening; and I am inclined to believe that the only effect of the exciting cause, whether simple mechanical pressure upon the separated cell or some kind of nervous irritation in the living tissues, is to initiate the explosion by giving vent to the internal pressure of the confined fluid.

It is altogether probable, if not entirely certain, that, after the thread has once been emitted, the end of the nematocyst has been fulfilled and that it is then speedily sloughed off. Other cells must therefore come to the surface, ready for a new discharge of threads. This accounts for the presence of cells in the lower layers of tissue, where they cannot put forth their lassos, but it leaves still unexplained the existence of what are usually regarded as weapons in the walls of the stomach, in portions of the reproductive organs, and in other positions from which it would seem as if they could never reach the ectoderm and come into play against an enemy or an object of prey.

In the specimen from *Isophyllia*, which I now have under the microscope, it is possible to find a series of the largest cells exhibiting various stages in the process of expulsion, from the first movement, shown in Fig. II., to the full extension of the thread, shown in Fig. V. As the thread is seen coiled in the cells, the setæ lie closely appressed, so that the total width is only about $\frac{1}{11000}$ th or $\frac{1}{12000}$ th of an inch. But, after the thread is completely extended, its diameter, exclusive of the setæ, is about $\frac{6}{1000}$ th of an inch and the setæ themselves are about $\frac{1}{12000}$ th of an inch in length; so that the thread and setæ together have about four times the diameter they had within the cell.

When the thread is set free by the violent disruption of the cell, it remains of the same size and as closely coiled as it was before; and, after it is shot forth from an unbroken cell, in the normal manner, it exhibits no tendency whatever to resume a contracted form. In other words, the thread is in itself a wholly passive instrument,—a mere missile propelled from its miniature gun by a power applied to it at the time of its flight.

Now, as to the mode of emission of the thread (or *ecthoræum*, as it is technically called), Mr. Gosse says, with reference to a Madrepore generically related to the one we are examining: "On several occasions of observation on the chambered *cnide* of *Cyathina Smithii*, I have actually seen the unevolved portion of the *ecthoræum* running out through the center of the evolved ventricose portion;" and in another place he speaks more particularly thus: "I have offered a conjecture that the projection of the thread is an evolution of its interior, and I believe that it is a complete one through its whole length. I have, even since I wrote that conjecture, seen an example of the process, which I can scarcely describe intelligibly by words, but the witnessing of which left on my own mind scarcely a doubt of the fact. It was effected not with the flash-like rapidity common to the propulsion, but sufficiently slowly to be watched, and *by fits or jerks*, as if hindered by the tip of the lengthening thread being in contact with the glass. In consequence, probably, of this impediment, it took a serpentine, not a straight form, and *each bend of the course was made and stereotyped* (so to speak) *in succession*, while the tip went on lengthening; and the appearance of this lengthening tip was exactly like that of a glove finger turning itself inside out." In the "Standard Natural History" it is said, with reference to the common Hydra, "Now when any stimulus brings a cnidocell into activity, it forcibly ejects the larger part of the tube by a process of evagination or a turning of this part of the tube inside out, as one turns the finger of a glove: this movement is quickly followed by the ejection of the smaller part of the tube in the same manner, by evagination." In Huxley's "Anatomy of Invertebrated Animals," referring to the nematocysts of the *coelenterata* generally, it is stated that "the filament is hollow, and is continuous with the wall of the sac at its thicker or basal end, while its other pointed end is free. Very slight pressure causes the thread to be swiftly protruded, apparently by a process of evagination, and the nematocyst now appears as an empty sac, to one end of which a long filament, often provided with two or three spines near its base, is attached."

In these last quotations the use of the word *evagination* is noticeable, because in the one it is employed with a definition which makes very clear what the writer meant, while in the

other the absence of any explanation leaves his intention entirely to the choice of the reader. In fact Prof. Huxley is the only authority with whom I am acquainted whose utterances on this subject are at all open to doubt. All the rest are of opinion that the ecthoræum is turned completely inside out, though the word *evagination*, which some of them use to designate the operation, is defined by Worcester as "the act of unsheathing," which well describes a drawing or pushing of the thread through the sheath or neck which forms at the anterior end of the capsule just before the movement of the thread begins.

If it were not for the drawings which Prof. Huxley gives us in close proximity to the sentence I have taken from his book, I should not hesitate to think that he accepted the prevailing idea, derived from Gosse's observations and descriptions,—particularly in view of his explicit declaration that the filament is hollow. But Huxley's pictures of nematocysts with extended neck and thread are not the traditional representations, and do not seem to be consistent with the traditional theory of introversion. On the contrary, they appear to illustrate, with regard to one of the *Hydrozoa*, a process of direct propulsion which, I believe, is also demonstrated, in respect to one of the *Actinozoa*, by the specimen which we have under the microscope this evening.

The internal capsule, which is visible in many of the unexploded nematocysts of the smaller forms, disappears when the thread is emitted, and I think it is turned inside out and then forms the neck of the bottle-shaped cell, and that through it the thread is shot. I feel confident that the eversion of the neck is all the turning inside out that takes place in any of the thread-cells of *Isophyllia*, and that the thread itself goes straight forward. It is probable that, if one could see the movement of the thread immediately after the eversion of the neck, it would be correctly described in the words used by Mr. Gosse when he said he had "seen the unevolved portion of the *ecthoræum* running out through the centre of the evolved ventricose portion;" for of course, at that stage of the operation, he could not tell whether there was any connection or not between the enveloping neck and the enclosed swiftly gliding thread. Mr. Gosse is an accurate observer, and I do not question his statements of what

he actually saw; but his interpretations of his observations are not the only ones of which the facts are capable.

After the thread is fully extended there remains at its base a clear space, devoid of setæ, about equal in length to the shorter diameter of the cell, which is shown in Fig. V., and which I believe to be the everted tube, or neck, above referred to. This I take to indicate that the thread runs out to the extreme point of the neck, where it is checked and held by some formation at the posterior end of the thread which acts as a wedge, or jam, in the mouth of the tube, making an invisible joint and producing an appearance as if the tube and the thread were actually continuous.

But the nematocyst pictured in Fig. III. affords us very strong and unexpectedly striking proof that the thread is simply pushed forward and not turned inside out, in the arrangement of the setæ upon the thread as seen both within and without the capsule. We know that whatever slant the setæ have upon a wholly emitted thread is backwards, and we observe that the setæ upon the partly extended thread in Fig. III. have this same inclination. We perceive, however, that there is no difference in the direction of the setæ upon that portion of the thread which is still within the capsule, as there certainly would be if the thread were being turned inside out. If a tube covered with hairs were being thus treated, the hairs would not only have opposite positions upon the two reversed sections of the tube, but upon the everted portion they would be exterior and upon the unturned part they would be interior to the tube. If, therefore, the thread in Fig. III. were being ejected in the manner described by Mr. Gosse, all the setæ within the cell should be on the inside of the thread, whereas they are clearly and unmistakably on the outside, like those already without the cell.

Having made up our mind, then, that the thread is merely driven through the neck of the bottle-like cell, it remains for us to inquire what part the setæ perform in this curious, but comparatively simple operation. This brings us to consider their form and their mode of arrangement on the thread. Because of the minuteness and delicacy of these really bristle-like appendages, the best qualities of our modern objectives are required to discern their character with any degree of certainty. It is not strange, therefore, that at one time the threads of certain

cœlenterate animals were described as wholly smooth, which are now known to be clothed with very fine hairs, and that others were said to be merely serrate, which better lenses now prove to be setaceous. If the largest threads are to be taken as typical of the whole class, the general disposition of the setæ upon the thread is in spiral lines. According to Mr. Gosse's description of the ecthoræum of *Tealia crassicornis*, "the screw is formed of a single band, having an inclination of 45° to the axis;" while in *Sagarfia parasitica* "we find a screw of two equidistant bands, * * * having an inclination of 70° ;" and "in *Cyathina Smithii*, the *strebla* is composed of three equidistant bands, * * * with an inclination of about 40° from the axis." The threads from the largest cells of our *Isophyllia* (shown in Fig. IV.) correspond with those last described by Mr. Gosse, in respect to the number of the spiral lines, as I suppose we might expect from the relationship of the two genera.

It has generally been assumed that the setæ serve the same purpose as does the barb of an arrow or a spear,—namely, of fixing the weapon in its wound. But this inference is somewhat weakened by the fact, in the first place, that many organisms which possess thread-cells manifest very little or no power of stinging; by the further fact that the same organism is often provided with several different kinds of thread-cells, apparently adapted to more than one office, and sometimes located in parts of the animal which cannot be brought into use offensively; and, finally, by the fact that the setæ are not always situated upon a part of the thread likely to penetrate, or which would even reach, the integument of an animal attacked,—an exception which is exemplified by the narrow band of long hairs placed near the base of the filament of the smallest cells of *Isophyllia*, which are confined to a space of only about $\frac{1}{400}$ th of an inch, from which to its tip the thread appears to be smooth. Taking all these things into account, and considering also the analogies of the case and the collateral circumstances to which I have already referred, I am of the opinion that the main purpose of the setæ, instead of being similar to that of the arrow-barb, is rather like that of the "feather" on the dart of the air-gun, or, perhaps more exactly, like that of the piston-head in the cylinder of the steam engine;—for I take it that the setæ fill out the neck-like tube of the nematocyst and receive the impact of the propelling force applied from within the cell.

THE MICROSCOPICAL INVESTIGATION OF ROCKS.
A PLEA FOR THE STUDY OF PETROLOGY.

BY DR. H. HENSOLDT.

(*Delivered April 20th, 1888.*)

Mr. President, Ladies and Gentlemen :—

It is not without reluctance that I have accepted the invitation to deliver this address, because the subject is not altogether, a popular one. I have often wondered why there are so few in the ever increasing army of microscopists, who take an interest in the microscopical investigation of minerals and rocks, and why there are fewer still, who have selected this department as their special field of study.

Of course I am aware that this army is mainly composed of amateurs. They do not lack the ability, but, in nine cases out of ten, they have not the time necessary for thorough and methodical work. Yet among these very amateurs we find a large number of enthusiastic workers, who, in spite of all drawbacks, accomplish wonderful things, make original discoveries, and lead the way to entirely new fields of microscopical research.

Now it may be doubted whether within the whole range of practical microscopy there is a subject which so well repays study—a subject so eminently calculated to afford pleasure and satisfaction to the lover of the microscope as the investigation of the minute structure of minerals and rocks. It is questionable whether the whole field of zoology and botany, in fact the entire organic division of nature can present to the inquirer a greater complexity of forms, a more wonderful display of colors, a more startling array of problems—problems strange and fascinating in their mystery—than this neglected world of stones.

Here we have a field as yet almost untrodden, and affording endless opportunities for research to an army of workers. We all know what the proboscis of the blow-fly looks like. When we are about to examine it under the microscope we know exactly what to expect—we have seen it before, and could

describe or draw it at any moment. But we do not know what to expect when we come to examine a thin section of granite. We may have seen hundreds of sections of granite before, yet, even if we had seen thousands and tens of thousands, this would not warrant us to draw any conclusions as to the appearance of the specimen in question. For the chances are a thousand to one against our having ever seen anything like it.

There are no two granites alike, just as there are no two lavas, basalts, or other igneous rocks alike. The differences in their microscopical structure are perfectly astonishing, especially in specimens of the same kind of rock from different localities. But even different pieces of granite from the same locality may present an almost infinite variety of structural detail. And of twenty sections from one small piece, not larger than a walnut, not two will be found alike. The only kinds of rocks which exhibit a close resemblance, even if taken from different localities, are certain fine-grained sandstones, slates and other sedimentary formations; and even these, if carefully examined, will be found to show marked differences.

The conclusions, which such variations and differences enable us to draw, do not affect the life-history of some obscure insect, or the derivation of a fungus, but involve cosmic problems of universal importance; the history of the crust of our planet, cycles of marvellous changes in the abysmal ages of the past, the disintegration and re-formation of the earth's material, and the life of those extraordinary and mysterious bodies, the crystals.

The time is fast approaching, when the microscope will be as indispensable to the progressive geologist, as it has been already, for a considerable number of years, to the zoologist, the botanist and the physician. Indeed, even at the present moment, the foremost inquirers in some of the most important departments of geological science depend so much on the aid of the microscope in their researches, that they would be almost helpless without it. If that instrument has vastly added to our knowledge of vegetable or animal structure, if it has enlarged our horizon to an immeasurable extent in the domains of the organic world, it is accomplishing at present equally important results in the domain of inorganic nature, for it has completely revolutionized the study of rocks. Some of the facts which have already been

demonstrated by the microscopical investigation of rocks border on the marvellous.

Minerals may be termed the individuals of the inorganic world. Each has its characteristic features or properties, which distinguish it from every other mineral. Quartz, feldspar and mica, separately considered are minerals; but, when occurring in a state of mixture, they constitute a true rock—granite. And it is the determination of these minerals, and of the conditions under which they assumed the forms in which we now find them, which is the chief aim of microscopical petrology.

Thirty years ago, the only optical apparatus, employed by geologists for the examination of rock-specimens, consisted of an ordinary pocket-lens, with a magnifying power of from four to fifteen diameters. This was deemed quite sufficient for all ordinary requirements, and some even disdained the use of magnifying glasses altogether. Specimens were only examined externally. It was noted what kind of appearance a freshly broken surface presented; whether the specimens were rough or smooth, coarse-grained or the reverse; what kind of odor they emitted when breathed against; how they felt to the touch; whether they yielded to the scratch of a piece of iron or the finger-nail—in fact, the tests, which were deemed sufficient in those days, appear quite ludicrous in the light of modern achievement.

To Prof. Sorby, still living in England, is due, in a great measure, the credit of having first pointed out the fact that a vast deal of information can be obtained from a microscopical investigation of rock-specimens. Indeed, he may be called the father of modern petrology. It occurred to him to prepare thin slices of rocks, reducing them by grinding and other processes to a state of extreme thinness, so as to render them more or less transparent. These he mounted in Canada-balsam on glass-slips, and placed them under his microscope, applying magnifying powers of from 40 to 700 diameters.

The result surpassed his most sanguine expectations. Dull and shapeless stones, some picked up by the road-side, and presenting to the naked eye nothing but a uniform tint of gray, black or dirty-red, transformed themselves under the microscope into fields strewn with beautiful crystals of wondrous colors and forms, or literally blossoming as the rose. Every component

mineral could be distinguished by the form, color, etc., of its crystals, and it was found that even the most fine grained rock was not, as formerly believed, a mixture of shapeless ingredients, but consisted of minute crystals, sometimes of the most exquisite outlines.

Especially striking and lovely is the appearance of many of the volcanic or igneous rocks, when reduced to thin sections, and examined under the microscope. The dullish green lava, called pitch-stone, which is found in dykes on the isle of Arran, on the west coast of Scotland, exhibits under the microscope whole forests of fern-trees, garlands, leaves and flowers of marvellous magnificence. A certain granite from Cornwall contains needle-shaped crystals of tourmaline, radiating star-like from a common centre. Basalts, obsidians, porphyries, serpentines from various localities show labyrinths of multicolored crystals, resembling rows of pillars, turreted castles and fairy caves, glowing in all tints of the rain-bow.

The sedimentary or stratified rocks, while they cannot equal under the microscope their plutonic rivals, in brilliancy of color or gorgeousness of crystalline display, make up this deficiency by other features of interest, compensating the inquirer by revelations of a different character, but none the less remarkable.

Many marbles and limestones are found to be literally composed of foraminifera, the tests of rhizopods, resembling tiny shells of the most delicate and beautiful forms, which were deposited on the ancient sea-bottoms, accumulating in the course of ages to a height of hundreds, nay, thousands of feet, every inch of which represents at least several centuries. Thin sections of almost any piece of flint exhibit under the microscope quite a little world of curious organic remains, such as sponge spicules, xanthidia, small fragments of coral, and the foraminifera already mentioned, furnishing very strong evidence that the flints are silicified fossil sponges.

It would be in vain for me to attempt here anything like a detailed description of the discoveries, which have resulted from the microscopical examination of rocks. This branch of study, though barely thirty years old, has already contributed such a vast deal of new information to natural science, that it has, in

more than one respect, revolutionized our old-fashioned conceptions of geological research.

A number of very excellent works have been published by eminent specialists, notably Germans, such as Rosenbusch, Zirkel and others ; but, like most works of the kind, they are too dry and technical to attract or to satisfy the amateur, who wants something explicit and popular to make a study pleasant. These books take too much for granted, and presuppose knowledge which not one in a thousand, of even well-educated persons, is likely to possess. They invariably assume that the reader has a thorough knowledge of crystallography, a subject full of complexities and difficulties, and abounding in puzzles sufficient to try the patience of a Job. They also expect the student to be well acquainted with optics, especially that most difficult and exasperating branch, which relates to the polarization of light, and the chromatic phenomena presented by crystals under crossed Nicol-prisms. Of all subjects difficult to understand, this last is the worst, and the explanation of it generally given in books leaves one more bewildered than instructed. It took me over two years to penetrate the mystery, and now I find that I can explain in a quarter of an hour what has taken me so long to learn.

What is wanted is a popular work, consisting of two parts ; the first to give a clear and intelligible account of crystallography, optics and other necessary or desirable preliminary information; the second, to treat of the structure of rocks, the whole to be written in as light and attractive a manner as the subject permits, and to take as little for granted as possible. I am perfectly aware that such a book would necessarily lack in thoroughness and completeness, but to the beginner it would be of incalculable value.

Rutley's work, "The Study of Rocks, an Elementary Text Book of Petrology," contains much useful information, and is a very good book for a beginner; but what it says on crystallography and the phenomena of polarization is altogether too short and fragmentary.

But let those of you, who have a mind to enter the field of microscopical petrology, who have a general desire to join the ranks of workers in this very attractive and interesting de-

partment, take consolation in this: it is not by any means absolutely necessary to be intimately acquainted with the intricacies presented by the world of crystals, or the phenomena of polarization in order to take up this study. If you can master these things, if you can lift the veil of Isis, so much the better for you, so much the greater the enjoyment which you will derive, so much the more will you be enabled to accomplish for science. But you may do a great deal without these things. Many, if not most of the minerals, of which a rock is composed, may be determined without a detailed, or even general knowledge of crystallography, and it is not always, or even generally necessary to resort to the polariscope in order to identify the constituents of a rock. Happily, a number of other features, which are quickly learned and easily remembered, help us in our investigation, and it is almost needless to add that before long even those formidable subjects, crystallography and polarization, lose much of their grim aspect.

You will then be able to determine at a glance the principal rock-forming minerals which you behold in a thin section, and you will then also find that the microscopical investigation of rocks affords you, in the endless variety of forms which it presents, in the gorgeousness of the colors which it reveals, in the wealth of its unsolved problems, a greater, richer and fuller field for study than any of the old and well-beaten paths of animal and vegetable morphology.

Even the general microscopist, the mere onlooker or collector of specimens, might turn with advantage to this subject. It will furnish him with some of the loveliest objects within the whole domain of practical microscopy, and will open up to him one of the most enchanting prospects in the wonderland of science.

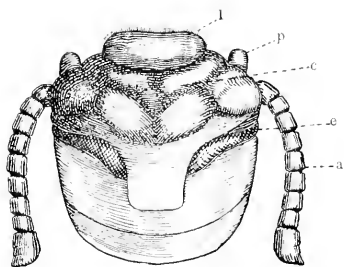

1

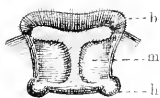

2

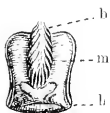

5

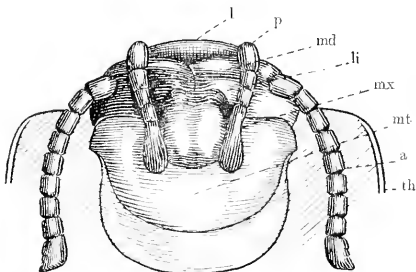

3



4

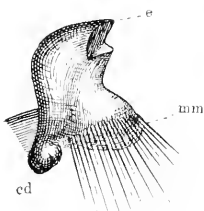

7

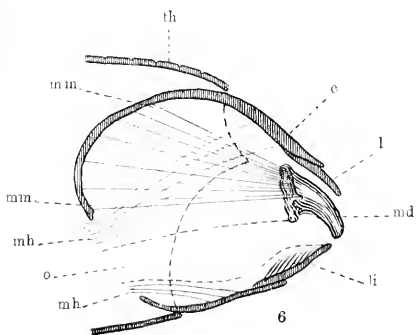

6

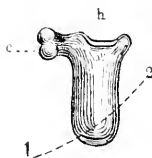

8

THE BEETLE, ZOPHERUS MEXICANUS, SOL.,
CUTTING METAL.

BY F. W. DEVOE.

(Read May 4th, 1888.)

The beetle, to which your attention is directed, is *Zopherus mexicanus*, Sol., a native of Central America, where it is popularly known as "Makeche." Specimens average in length from 4.5 to 5 centimetres, and in width from 1.5 to 2 centimetres. The thorax and elytra are yellowish gray, this color being due to a coating of scales, which may be scraped away, when the underlying normal black color will appear. The dorsal surface is marked by many knobs arranged in lines, and more prominent in the middle than at the sides. The general color of the under surface and of the legs is black, but this is more or less concealed in numerous places by the yellowish scales before mentioned. The head is retracted as far as the eyes into the pro-thorax. The antennæ are nine to eleven jointed, the outer two or three joints being connate, and, when at rest, the antennæ lie in two deep grooves on the under surface of the pro-thorax.

The character is indicated by the structure. A slow, deliberate walker—it never flies, for its hind wings are not developed, and it never hurries. A lover of darkness—it

Explanation of Plate 13.

- FIG. 1.—Dorsal aspect of the head of *Zopherus mexicanus*: *l*, labrum; *p*, palpus; *c*, clypeus; *e*, eye; *a*, antenna.
- FIG. 2.—Inner face of the labrum: *b*, fringing bristles; *m*, insertion of muscles; *h*, deep hinge, with insertion of muscles, joining to clypeus.
- FIG. 3.—Ventral aspect of the head: *l*, labrum; *p*, palpus; *m d*, mandible; *l i*, labium; *m x*, maxilla; *m t*, mentum; *a*, antenna; *th*, thorax.
- FIG. 4.—Ventral aspect of the left maxilla with its palpi: *e p*, external palpus; *i p*, internal palpus.
- FIG. 5.—Inner face of the labium: *b*, bristles of tongue-groove; *m*, insertion of tongue muscles; *h*, hinge, connecting the labium with the mentum.
- FIG. 6.—Longitudinal-vertical section of the head: *th*, thorax, *c*, clypeus, *l*, labrum; *m d*, mandible; *l i*, labium; *m m*, *m m*, muscles of the mandible; *m h*, *m h*, muscles, moving the head on the thorax; *o*, œsophagus.
- FIG. 7.—Ventral aspect of the right mandible: *e*, cutting edge; *c d*, double headed pivot, or condyle; *m m*, insertion of the muscles.
- FIG. 8.—External, lateral aspect of the right mandible: *h*, the hinge; *c*, the condyle; *1*, *2*, direction of cutting movement.

dwells in the woods, hidden under the bark of trees, in canes, or in chips left by the wood-cutter. Strong jawed it goes its way.

Much has been said regarding the strength of insects, and especially of beetles. It has been asserted that they have made their way through sheet-lead (*Hylotrupes*), and even through iron pipes. Fortunately I have been able to watch this beetle while engaged as a metal-worker, and to learn something of its powers.

My first specimen was from Yucatan, presented to me last summer by a friend from Mexico. It was contained in a cardboard box, which I enclosed in my desk over night. The next morning I found the creature had eaten a large hole in the side of the box, and was enjoying its liberty with a commingling of deliberation and satisfaction. Having recaptured it I placed it in a small glass jar, to which I fitted a cover of wood, after boring a few holes in the latter for ventilation. The next day I found on the bottom of the jar numbers of chips of the Black Walnut wood of the cover. I then substituted the metal cover, which belonged to the jar, after punching through the metal several holes, about three-eighths of an inch in diameter, and supplied the captive with some sugar.

About one week after this I left home for a day, and, when I returned, I found that the beetle had cut out in small bits all the metal between two holes in the cover, and through this enlargement had thrust out its pro-thorax, in such manner as to give evidence that if left alone it would soon regain its liberty. This work upon the metal was all done within the space of forty-eight hours. Upon examination, the cutting edges of the mandibles appeared to be unbroken, and in perfect condition. About three weeks after this time this beetle died.

Several attempts were made during the winter to secure some more living beetles of the same species. But they all died before reaching New York. About a month since, however, I had the good fortune to receive two lively specimens. These were

Explanation of Plate 14.

FIG. 1.—The metal cover, showing the enlargement between two holes, made by the beetle.

FIG. 2.—Edge of this enlargement, grooved by the mandibles, magnified 10 diameters.

FIG. 3.—View of the metal chips, magnified 10 diameters.

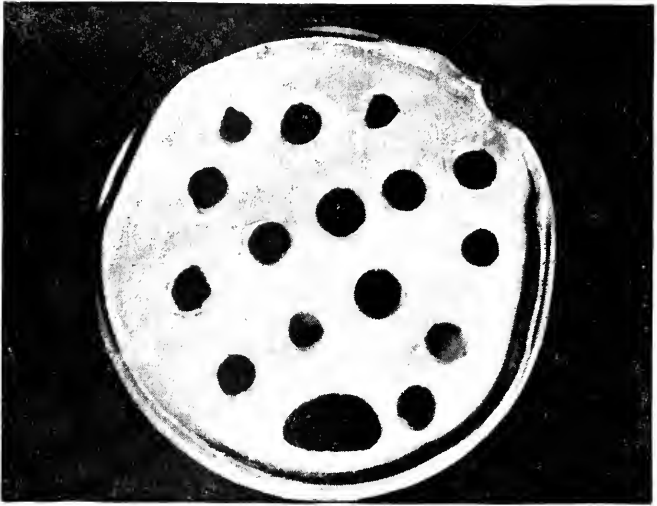

FIG. 1.



FIG. 2.



FIG. 3.

ZOPHERUS MEXICANUS, SOL.

placed in glass jars, like that just mentioned, fitted with their respective metal covers.

One of these beetles I exhibit here alive to-night. This one has accomplished metal-working precisely like that of the first specimen, and I have had no little satisfaction in watching the process, and in listening to the sound, caused by the mandibles while cutting the chips from the cover. During this operation the beetle passed the feet through the ventilating holes, and hung suspended, back downwards, from the under surface of the cover. This metal is pewter; probably composed of three parts of lead, and one part of tin, and is about one thirty-second of an inch in thickness. Under experiment it was found that a force of 369 grammes was necessary to remove chips corresponding to those cut by the beetle.

Your attention is called to the fact that the cutting edges of the mandibles of the dead beetle are in good condition, while those of the living beetle are badly broken. Both insects did the same kind of work, under the same circumstances; but I am unable to account for the different effects upon the tools they employed.

THE LARVÆ OF THE STAG-BEETLE, EATING RAILROAD TIES.

BY PROF. SAMUEL LOCKWOOD, PH. D.

(Read May 4th, 1888.)

On the 28th *ult.*, I received some old ties, which, to be replaced by new ones, had just been taken up from the track of the Pennsylvania Railroad, where it passes through the village of Freehold, New Jersey. They were of oak, and measured eight feet and six inches in length, with an average thickness of about seven inches. The ties being hewn and not sawed, the width varied a great deal, depending on the age of the trees employed.

These old ties were purchased for the purpose of building a barricade. I noticed that while the under and the upper surfaces were sound, the sides were dozey, or decayed. Wishing to know the depth of this condition of the wood I used a chisel, and found numbers of the larvæ of a lamellicorn beetle, each

one more or less curved, and lying in a groove, which it had made by eating the softened wood down to the solid part. The decay was caused by a fungus. And even at the solid part of the wood, or bottom of the burrow made by the insect, the wood was already softening under the continued action of the fungus.

There was thus an interesting combination of labor between both parasites—the larva and the fungus. Similarly the Red Man, who once occupied these parts, had his own way of making a dug-out canoe. After plastering the sides of the selected log with clay, a fire could be made on the uncovered part, and the charred, or burnt portion, to the depth of a small fraction of an inch, could then be removed with a stone adze, and fire again applied, and the process repeated. It was even thus with these ties. The mycelia, or fungoid roots softened the woody tissues, and these were excavated by the cutting or gouging jaws, and so passed into the stomach of the larva, which all the time kept moving along, and furnishing the fungus a new surface for its operations.

The road-master took up forty-eight ties in the village, replacing them with new ones. All these were delivered at my house. Everyone was attacked by fungus and larvæ, in the manner here described, throughout the entire length and surface of its two sides; while the flat, hewn surfaces, above and below, were not attacked. The larvæ were present in great numbers. I have some here in alcohol; also a specimen of each sex of the imago, or perfect beetle.

As to the extent of the mischief done:—as mentioned, not an inch of surface of the sides escaped, and the depth of the timber thus consumed was from an inch and a half to three and a half inches. If we should call it an average of two and a quarter inches, as these ties were eight feet and six inches in length, and averaged fully seven inches in thickness, we should have, in round numbers, one hundred and nineteen cubic feet of oak thus eaten up on forty-eight ties.

It is a question now; how long did it take to accomplish this? As to the time occupied by the fungus, the data are lacking. I think, however, we are better off in respect to the time taken by the larvæ. It was my good fortune to determine the length of time required by the larvæ of the Goldsmith Beetle, *Cotalpa lanigera*, to attain, from the egg, the imago state. I found this

to be three years. According to Rözels, the European *Lucanus* takes six years. My long-continued observations of the larval growth of *Cotalpa* gave me a capacity of determining their respective ages among a mixed number of larvæ of different sizes.

You may notice that these larvæ of *Lucanus*, which I have in alcohol, are of three quite distinct sizes. I regard the largest as three years old, and the smallest but one year. The mischief accomplished, therefore, in this combination of insect and fungus has been done, I think, in three years. But the most startling facts are these. Here is shown, to put it in business form, the existence of four contracts, or agreements to attack these railroad ties—the one-year larvæ having five years to run, the two-year larvæ four years, and the three-year larvæ three years; while the fungus, the most insidious of them all, has a license of indefinite duration; or, omitting metaphor, unlimited opportunity for mischief, simply requiring the one condition—dampness.

There is also an interesting bit of negative testimony here. After long searching, I did not find one pupa. And it is certain, that, as the imago appears in June, none of the larvæ, even the oldest, had time to pupate for an imago of this year. Moreover, this passing from the active, feeding state of the larva, into the sleeping, pupal condition, occurs when the summer is over. Hence it is certain that *Lucanus dama* at three years has not even reached the pupal state.

An interesting fact too is this versatility of habit. The mother stag-horn deposits her eggs in decayed spots in oak and other trees, as they stand in the forest. In this instance the insect does its work in timber, laid in position and partly sunk into the ground; over which, at the very season of the ova-positing, namely the summer, immense trains are passing at intervals of but a few minutes. And even in the night, at which time the insect probably deposits her eggs, the trains are almost hourly, as the freight then has its opportunity. As respects the larvæ too, one would think the action of the passing trains would be against their welfare.

I regret my inability at this writing to find the fungus in fruit, hence I cannot even hint as yet at its species.

PROCEEDINGS.

MEETING OF FEBRUARY 3D, 1888.

The President, Mr. Charles F. Cox, in the chair.

Thirty-four persons present.

Dr. Fred. A. Mandeville was elected a Resident Member of the Society.

The President suggested the designation of some particular class of objects for exhibition at particular meetings, and also desired the members to hand in to himself, or to the Recording Secretary, a list of objects, such as they would exhibit, and from which a selection might be made as needed.

OBJECTS EXHIBITED.

1. Radula of Marine Snail, *Ilyanassa obsoleta*, Stim.; by J. L. ZABRISKIE.
2. Woody fibre, found in a Termite's nest, from Colon, South America : by P. H. DUDLEY.
3. Section of Rhubarb root, *Rheum officinale*, showing crystals of calcium oxylate : by E. B. GROVE.
4. Section of Limestone, from Indiana : by JAMES WALKER.
5. A slide of 88 Diatoms ; arranged by C. L. Peticolas : by C. S. SHULTZ.
6. Mouth-parts of *Cantharis Nuttallii*, and also a dissection of the spiracles, with the tracheæ attached : by L. RIEDERER.
7. Section of Fortification Agate; polarized: by J. D. HYATT.
8. Transverse section of stem of Papyrus, from the Nile : by H. W. CALEF.

OBJECTS FROM THE SOCIETY'S CABINET.

9. Polycystina, from Barbadoes.
10. *Rhabdonema arcuata*, from the "Kills," N. Y.
11. Gold Crystals, from White Bull Mine, Oregon.

WOODY FIBRE, FOUND IN A TERMITE'S NEST.

In the absence of Mr. P. H. Dudley, a communication from

him, explaining his exhibit, was read from the chair, as follows :

“ The slide of woody fibre, or pulp, prepared from a fragment of a Termite's, or White Ant's, nest, from Colon, is of special interest.

“ The wood has been so thoroughly comminuted, that it is doubtful whether it could be recognized as woody particles under the microscope, unaided by chemical reagents.

“ A study of similar slides throws some light upon their work of destruction on many kinds of wood, in structures.

“ The particles of wood do not have as sharp, angular corners as one would naturally expect of chips cut from solid wood ; on the other hand, they seem as though made from softened wood, or that undergoing decay. The particles have more the appearance of little pellets than cuttings, which in some measure is doubtless due to the form, motion and pressure of the mandibles. After they are cut the next step is not clear. Some cuttings serve as food for the insects, as they are found in the alimentary canal. Others are mixed with some substance which causes the particles to adhere, and then are fashioned into the walls, which form the galleries of the nest.

“ The walls are built up of a number of thin layers of the cuttings, give evidence of being prepared with great care, and become quite hard and solid. A fragment thrown into water does not disintegrate by soaking, and after many hours it requires trituration to separate the particles.

“ On burning a piece, nearly all of the substance is consumed; the residuum, however, being much more than the natural ash of the wood—some clay is present. Phloroglucin gives a reaction, showing some lignin is still in the woody particles. In many of the specimens I found fragments of the mycelium of a fungus, and upon examining the stick of yellow pine, 6 x 12 inches, which contained the nest, found it was in process of decay at the point of attack.

“ The rainfall at Colon is over eleven feet *per annum*, and many species of wood, in the form of lumber, absorb and retain much more moisture than the same kind of lumber contains here ; consequently the fibres are much softer. Several specimens of white ash furniture were shown me, of which the boards had been completely tunnelled by the Termites. They

give no evidence on the exterior of the destruction they have made in the interior of the timber or lumber. Some writers have stated that the Termites often fill in with clay the timbers needed for strength of the building. I only found the cuttings of the wood repacked, mixed with the same substance as that used in forming the nests.

"The only exterior evidence of the Termites in a building will be the little covered gallery, about three-eighths of an inch wide, and one-fourth of an inch high, which they run up the walls or posts. In this little passage-way the ants go back and forth.

"Undoubtedly exaggerated stories have been told and written about the Termites destroying all kinds of wood. On the Isthmus, hard woods are not attacked until decay has softened the wood-fibres. It is but proper to say that woods decay there much faster than here, the conditions for the growth of fungi being continuous; while here, in out-of-door structures, they are interrupted by the winter. In many of the large buildings, which could not be well protected from the dampness of the climate, the timbers of the roofs decay, and are eventually attacked by the termites. The roof timbers of the church, built by the Panama Railroad Company, have just been examined and found to be completely tunnelled by the Termites."

Mr. James Walker donated the slide exhibited by him to the Cabinet of the Society.

MEETING OF FEBRUARY 17TH, 1888.

The President, Mr. Charles F. Cox, in the chair.

Thirty-one persons present.

Mr. Alfred Pell was elected a Resident Member, and Mr. Marshall D. Ewell was elected a Corresponding Member of the Society.

OBJECTS EXHIBITED.

1. A selected group of *Astromma Aristotelis* (one of the *Polycystina*): by GEORGE B. SCOTT.

2. *Tubularia larynx*, L. (*Calenterata*): by L. RIEDERER.

3. *Eudendrium ramosum*, L. (*Cœlenterata*): by L. RIEDERER.
4. Pinna of Fern, *Trichomanes lucens*: by E. B. GROVE.
5. Radula of *Crepidula fornicata*, Lam.: by J. L. ZABRISKIE.
6. Pollen, on anther and stigma of *Abutilon roseum*: by FRANK HEALY.
7. Pollen, on anther and stigma of *Althæa officinalis*: by FRANK HEALY.
8. Skin of Chameleon: by J. D. HYATT.
9. Section of Fossil Coral (Siliceous): by J. D. HYATT.
10. Section of Fossil Wood (Siliceous): by J. D. HYATT.
11. *Pleurosigma angulatum*, by oblique light: by E. J. WRIGHT.

HYDROMEDUSÆ.

Mr. L. Riederer, in explanation of his exhibit, read the following note:

"*Tubularia larynx*, L. and *Eudendrium ramosum*, L. are two *Hydromedusæ*. They belong to the *Cœlenterata*, or *Zoophyta*. The *Hydromedusæ* are marine; only one of them, *Hydra*, lives in fresh water. The single animal forms a cup, fastened by one end to a stem; at the other end is a mouth-opening, surrounded by retractile tentacles, numbering four, six, or their multiples. The mouth opens directly into the stomach, or gastrovascular space. By a tube through the stem, filled by the food-juice for the entire colony, there is a communication between all the animals on one stem.

"The animal consists of two distinct layers of cellular tissue; the inner, or endoderm, and the outer, or ectoderm. On the distal parts of the tentacles there are found, in large numbers, cells, or nematocysts, furnished with nettles, or stinging threads. The slightest touch causes these cells to burst, and the fine threads contained in them are forcibly thrown out. By this means small animals, their principal food, are paralyzed and killed. Some of the larger species of *Cœlenterata* give rise to a painful nettle-rash, when their tentacles come in contact with the human skin.

"Some animals of this family have highly differentiated cells, acting as sensories for feeling, hearing and seeing.

"The single polypes on one stem are not always similar.

Some are employed only in procuring food, the tentacles pushing the prey, maimed by the nettles, into the mouth. Others produce separating buds, furnishing the principal means of propagating the species. But also medusoid gemmæ are formed, which swim around, resembling free medusæ; and only after passing through this kind of a larval stage do they settle again to become polypes."

THE FERN, TRICHOMANES LUCENS.

Mr. E. B. Grove, in explanation of his exhibit, said :

"*Trichomanes lucens* belongs to the *Hymenophyllaceæ*, or filmy ferns. It has very delicate and translucent fronds, seemingly of a lace-like character. The involucre is goblet, or funnel-shaped, and are formed on the ends of each of the pinnæ of the fertile fronds, and at the end of a vein. The vein penetrates the involucre, and, dividing into thread-like filaments, bears the spore-cases.

"The specimen was bleached in a solution of chlorinated soda, stained with iodide-green, and mounted in balsam."

Mr. Grove also mentioned his method of removing air-bubbles from balsam mounts, viz., employing a very minute alcohol flame, applied to that portion of the slide where the bubble is situated, and, as soon as the bubble begins to expand, following it up with the flame to the edge of the cover.

SKIN OF THE CHAMELEON.

Mr. J. D. Hyatt, in connection with his exhibit of the cast skin of the Chameleon, reviewed the theories proposed in the past to account for the remarkable changes of color accomplished by the animal. He stated that the skin was covered with minute papillæ, conical and hollow, composed of thin scales, which rendered them rather nacrous in structure.

In the specimen under the microscope the color depended upon the angle upon which the light struck these prominences, and, by swinging the mirror from the extreme right to the extreme left, there would be caused a variation from a dull red to a green. The same result would be attained if the animal possessed the power to elevate and depress the papillæ, so that the

light would strike upon them at different angles. Allowing that the animal has this power, the explanation is complete.

Mr. Hyatt also stated that he kept the animal, which furnished the specimen of cast skin exhibited, alive in a cage, and that it gave no evidence of change of color corresponding to that of the object upon which it might be resting; but showed a red color when displeased, and a green color when pleased, as in the act of receiving food.

The Rev. K. F. Junor, called attention to a cuttle fish, in which the change of color is caused by the transference of a fluid, contained in the skin, from a lower to a more superficial layer of pigment-cells, or *vice versa*.

Mr. L. Riederer also mentioned the frog, in whose skin a change of color is occasioned by contraction of pigment-cells.

ANNUAL RECEPTION OF 1888.

The Tenth Annual Reception of the Society was held at Lyric Hall, 723 Sixth avenue, on the evening of February 24th, 1888.

The large hall was filled with an apparently interested and gratified audience, and the occasion was enlivened by music, furnished by an excellent orchestra.

Fifty-two objects were displayed and explained by forty exhibiting members.

The objects exhibited were as follows:—

1. Meteoric Diamonds : by GEORGE F. KUNZ.
2. *Peridotite*, var. *Kimberlite*, Lewis, from Elliott Co., Kentucky : by GEORGE F. KUNZ.
3. *Peridotite*, var. *Kimberlite*, from Kimberly, South Africa : by GEORGE F. KUNZ.
4. *Utricularia neglecta*, an insectivorous aquatic plant : by GEORGE S. WOOLMAN.
- 5 and 6. *Trichina spiralis* : by L. SCHÖNEY.
7. Seeds of *Orthocarpus purpurascens* : by EDWARD G. DAY.
8. California Gold-Sand : by EDWARD G. DAY.
9. The Diamond Beetle, *Entimus imperialis* : by MARK H. EISNER.
10. Arranged Diatoms : by MARK H. EISNER.
- 11 and 12. Cyclosis : by F. W. DEVOE.

13. Circulation of Blood in the Tail of a Newt : by F. W. DEVOE.
14. *Bugula avicularia*, a marine Polyzoan : by A. S. BROWN.
15. Foot of the Water-Beetle, *Dytiscus marginalis* : by A. H. SLEIGH.
16. Radula of the Conch, *Sycotypus canaliculatus*, Gill : by J. L. ZABRISKIE.
17. Insects in fossil Gum Copal, from Zanzibar, Africa : by GEORGE E. ASHBY.
18. Hair of a Mouse : by WILSON MACDONALD.
19. Lace-Bark, from the Lace-Bark Tree, *Lagetta linearia* : by EDWIN B. GROVE.
20. Living Desmids : by EDGAR J. WRIGHT.
21. Seeds of Portulaca : by W. R. MITCHELL.
22. Spore-cases and Spores of the Fern, *Anemia Mexicana* : by HENRY M. DICKINSON.
23. *Polycystina*, from Barbadoes : by HENRY M. DICKINSON.
24. Mouth-parts of a Mosquito : by F. W. LEGGETT.
25. Cilia of a Mussel : by J. D. HYATT.
26. Portion of wing of the Blue Butterfly, *Morpho Menelaus* : by CHARLES S. SHULTZ.
27. Brownian Movement : by CHARLES F. COX.
28. "File" of Katydid, *Platyphyllum concavum*, Harris : by BENJAMIN BRAMAN.
29. A piece of the Skin of a Dog-Fish, *Acanthias* : by WALTER H. MEAD.
30. Circulation of Blood in the Frog : by J. L. WALL.
31. Leaf of the *Deutzia scabra* : by W. E. DAMON.
32. Bouquet, formed of Scales from the Wings of Butterflies : by C. W. BROWN.
33. Transverse section of the Thistle, *Carduus* : by F. COLLINGWOOD.
34. *Leucite*, in lava from Vesuvius, Italy : by A. WOODWARD.
35. Crystals of Silver : by M. M. LEBRUN.
36. Transverse section of Hair, from an Elephant : by HORACE W. CALEF.
37. Diatoms. Type-Plate of 183 forms, from the *Holothuridea* of Java : by E. A. SCHULTZE.
38. Diatoms. Type-Plate of 195 forms, from the *Holothuridea* of Sumatra : by E. A. SCHULTZE.

39. Diatoms. Type-Plate of 378 forms, from the *Holothuridea* of the China Sea : by E. A. SCHULTZE.
40. Objects from fresh-water Aquaria : by WILLIAM G. DEWITT.
41. Markings on a Diatom : by WILLIAM WALES.
42. Illuminating organ of the Glow-Worm, *Lampyris noctiluca* : by T. CRAIG.
- 43 and 44. Compound eye of Peacock Butterfly, *Vanessa Io*, shown in consecutive sections : by LUDWIG RIEDERER.
45. Scale of the Amber-Fish : by KENNETH F. JUNOR.
46. Tongue of House-fly, *Musca domestica* : by C. W. MCALLISTER.
47. Stamens and Pollen of the Mallow, *Malva rotundifolia* : by WILLIAM BEUTTENMÜLLER.
48. *Foraminifera*, from New Jersey : by JAMES WALKER.
49. Section of Granite : by T. B. BRIGGS.
50. Section of "Quill" of the Porcupine, *Hystrix cristata* : by E. B. SOUTHWICK.
- 51 and 52. Termites, or White Ants, from Colon, South America : by P. H. DUDLEY.

MEETING OF MARCH 2D, 1888.

The President, Mr. Charles F. Cox, in the chair.

Twenty-three persons present.

OBJECTS EXHIBITED.

1. The longitudinal-radial section of the wood of the Sugar Pine, *Pinus Lambertiana*, Dougl. : by J. L. ZABRISKIE.
2. Section of Coal, showing woody structure : by P. H. DUDLEY.
3. Section of *Chlorastolite*, from Isle Royal, Lake Superior : by JAMES WALKER.
4. Thread-cells, from tentacle of Portuguese Man-of-War, *Physalia pelagica* : by CHARLES F. COX.
5. Thread-cells, of the Bermuda Madrepore, *Isophyllia dipsacea* : by CHARLES F. COX.
6. Skin of Chameleon : by J. D. HYATT.
7. The Lord's Prayer, written by Mr. Webb, of London : by C. S. SHULTZ.

OBJECTS FROM THE SOCIETY'S CABINET.

8. Hair of Rat.
9. Hair of Badger.

THE BLACK CROSS OF THE SUGAR PINE.

The Rev. J. L. Zabriskie : "The object exhibited is the longitudinal-radial section of the wood of *Pinus Lambertiana*, Dougl., the Sugar Pine of the western slopes of the mountains on the Pacific coast. The popular name is due to an occasional use of a sweet exudation from the stump of the tree, as a substitute for sugar.

"I desire to mention especially the appearance of the 'lenticular markings' of the section, as shown by polarized light. These markings are in the Sugar Pine about .001 of an inch in diameter—the largest of any of the coniferæ, as far as I am aware. By polarized light—in common with the similar markings in all the coniferæ—they show a distinct, diagonal, black cross. But, either on account of their large size, or some peculiarity of their structure, the black cross is shown with unusual distinctness in the markings of this tree.

"Dr. Thomas Taylor, of the Agricultural Department at Washington, has called my attention to the fact of the similarity of this cross to the cross of the crystals of butter. If you turn to his beautiful representations of the photomicrographs of the butter crystal, in the *American Monthly Microscopical Journal*, for August, 1887, you will see how striking this similarity is.

"I take pleasure in donating the slide to the Cabinet of the Society."

WOODY STRUCTURE IN COAL.

Mr. P. H. Dudley : "This section was prepared by the late Dr. Allen Y. Moore. The woody structure shown is identical with that of *Sequoia gigantea*, the Giant Tree of California."

The President, Mr. Charles F. Cox, read a Paper, entitled "Notes on the Thread-cells of certain cœlenterate Animals," which Paper is published in this number of the JOURNAL, p. 131.

Mr. J. D. Hyatt, in remarking upon his exhibit, stated that the prominences upon the skin of the Chameleon are not, properly speaking, papillæ, but scales, which are covered with smaller scales, and that these smaller scales are marked with fine dots, averaging about 4,500 to the linear inch ; that each main scale, in those parts of the body where change of color appears, has a rib, like a stout spine, embedded longitudinally in its outer surface ; and that the change of color is produced by the elevation

and depression of these spines, causing a change in form of the surface of the scales.

A "WEBB" WRITING OF THE LORD'S PRAYER.

Mr. Charles S. Shultz stated that the slide exhibited by him, the property of Mr. Stephen Helm, was written by Mr. Webb, of England, and that, with the use of letters of the same size, twenty Bibles could be written in the space of a square inch.

In the London *Monthly Microscopical Journal*, October, 1876, p. 172, it is recorded, that Mr. Frank Crisp of London had then in his possession a diamond engraving of the Lord's Prayer, written at the rate of fifty-nine Bibles to the square inch.

CONTINUOUS CENTERING OF A COVER-GLASS.

The Rev. J. L. Zabriskie : "I find that a very satisfactory method for the continuous centering of a cover-glass, for subsequent operations with the self-centering turn-table, with either a glycerine or a balsam mount, when no cell is employed, is to run a very delicate ring of india-ink with a fine pen upon the upper, or clean side of the glass slip, while the slip is revolving upon the turn-table, and one thirty-second of an inch larger than the cover about to be used, as the first step in the operation of mounting.

"I have heard of such rings being employed on the under side of the slip. But very few of the latter are such accurate parallelograms that a ring on the under side will be central for the upper side, because, when the slip is turned over, it is liable to be held on the turn-table by the pair of diagonal corners, which were not employed in the first instance. And moreover when the ring is run on the under side, the thickness of even a thin slip renders difficult the subsequent centering of a cover by sight.

"If the ring of ink is run on the clean side of the slip it is accurately centered for each subsequent operation ; the cover can be centered within it accurately without returning to the turn-table; and if the application of a spring-clip causes the cover to slide, the latter can still be immediately readjusted by sight.

"The india-ink dries at once, and does not, as might be supposed, cause any practical difficulty by running in under the

cover-glass. "In case of a glycerine mount, if there is excess of glycerine around the cover, a small stream of cold water, used to wash away the excess of glycerine, also instantly carries away the ring of ink. If there is no excess of glycerine the ring of ink may be left, and it will be entirely hidden by the sealing of the mount, if any dark colored cement is used. In case of a balsam mount the ring of ink will be scraped away when cleaning the slide, or if there is no excess of balsam, it may be quickly removed, when the mount has hardened, by the moisture of the breath and gentle rubbing with a handkerchief."

MEETING OF MARCH 16TH, 1888.

The President, Mr. Charles F. Cox, in the chair.

Twenty-five persons present.

Dr. William S. Gottheil, Dr. Paul Hoffman and Mr. William E. Simpson were elected Resident Members; and Dr. R. H. Ward was elected a Corresponding Member of the Society.

OBJECTS EXHIBITED.

1. Section of palpus of *Pieris oleracea*, Harris, showing organ of smell : by L. RIEDERER.

2. Section of palpus of *Pieris rapæ*, Schrank, showing organ of smell : by L. RIEDERER.

3. Transverse section of Hair of Horse, $\frac{1}{1800}$ of an inch thick : by J. L. ZABRISKIE.

4. Longitudinal section of Hair of Horse, $\frac{1}{1800}$ of an inch thick, showing medulla, cortex and external scales : by J. L. ZABRISKIE.

5. Leaf of *Croton tiglium*, showing hairs *in situ* : by KENNETH F. JUNOR.

6. Transverse section of spine of *Echinus cidaris*: by KENNETH F. JUNOR.

7. Section of *Monazite* : by T. B. BRIGGS.

8. Section of pebble from Chagres River, the quartz containing fluid inclusions, each having a moving vacuole : by P. H. DUDLEY.

9. Musical organs of the Seventeen-year Harvest-fly, *Cicada septendecim*, L.: by F. W. LEGGETT.

ORGANS OF SENSE IN THE PALPUS OF *PIERIS OLERACEA*, HARRIS.

Mr. L. Riederer read the following description of his exhibit:

"The labial palpi of *Pieris oleracea*, Harris, are three-jointed, and bent upward, and are covered, especially on the forward edge, with long, narrow, feather-like hairs. They are so long that they overreach the head, and between them the maxillæ are rolled up when not in use.

"In the distal end of the last joint, which is much smaller than the other two joints, is an opening leading to a tube, which finally widens into a chamber of the shape of a segment of a sphere. The inside of the tube is covered with short hairs, or bristles, all pointing towards the opening as if to bar intruders from entering. The chamber shows a surface of disks, each one of which bears in the middle of a depression an articulated, fine hair. Below the surface, corresponding to each one of these disks, are ganglion cells with nucleus and nucleolus. From this layer of ganglion-cells a nerve-connection runs down the palpus.

"In comparing the structure of this organ with corresponding organs of other insects, and organs of higher animals, there appears a striking similarity to the organ of smell. But it cannot be overlooked that the organ of smell is, in animals generally, exposed where, most likely, large volumes of air are to pass, while here such opportunity is not apparent. Muscles may distend and contract the cavity, and perhaps may augment in this way the changing of air.

"*Pieris rapæ*, Schrank, shows similar arrangements.

"Dimensions were observed as follows :

Palpus: 1st joint, length,	1.3 mm.;	width,	0.4 mm.
2d " "	1.3 mm.;	" "	0.4 mm.
3d " "	0.37 mm.;	" "	0.1 mm.
Cavity : full depth,	0.16 mm.		
Chamber : width,	0.05 mm.		
Disk : diameter,	0.009-0.012 mm.		
Sense-hairs : length,	0.024 mm.		
" " diameter,	0.0018 mm."		

SECTIONS OF HAIR OF THE HORSE.

The Rev. J. L. Zabriskie : "The sections are from hair of the tail of the Horse, jet-black in color, and of very dense, solid

structure. Streaks of black pigment appear in the longitudinal section. This section, lying in a plane slightly removed from the longitudinal axis of the hair, shows the external scales upon the narrow inclined edges. I take pleasure in donating both slides to the Cabinet of the Society."

The Rev. Kenneth F. Junor, gave a very interesting résumé of the structure and habits of *Echinus*, illustrating his remarks by the exhibition of a number of specimens.

MEETING OF APRIL 6TH, 1888.

The Vice-President, Mr. P. H. Dudley, C. E., in the chair.

Twenty-eight persons present.

Dr. R. W. St. Claire, and Mr. J. W. G. Angell were elected Resident Members of the Society.

OBJECTS EXHIBITED.

1. Pond Life : by CHARLES S. SHULTZ.
2. Meteorite, containing Diamonds, from Novy Urej, Krasnoslobodsk, Siberia : by GEORGE F. KUNZ.
3. Transverse section of Bone, from the Vertebral Plate of the Finback Whale, *Sibbaldius tectirostris*, Cope : by J. L. ZABRISKIE.
4. *Acraspeda*, a Discomedusa : by LUDWIG RIEDERER.
5. *Rhopalonema*, a Trachomedusa : by LUDWIG RIEDERER.
6. Orchid-seeds : by N. L. BRITTON.
7. Section of Fossil Wood, from California : by T. B. BRIGGS.
8. Photomicrographs of multiple image in the eye of the Roach, photographed by J. Lee Smith : by F. W. LEGGETT.
9. The August Becker Sledge-Microtome : by LUDWIG RIEDERER.

OBJECTS FROM THE SOCIETY'S CABINET.

10. Diatoms from the Sandwich Islands.
11. Specimens of Corallines.

METEORITE CONTAINING DIAMONDS.

Mr. George F. Kunz being absent, the following explanation of his exhibit, furnished by him, was read from the chair :

"Small pieces of the Novy Urej, Krasnoslobodsk, Siberian

Meteorite were boiled, first in nitric acid, then in sulphuric, and finally in nitro-muriatic acid. This removed the iron, magnetite, olivine, enstatite, etc., leaving, as a residue, some small, transparent bodies, twelve in all. I herewith exhibit some of these. One, which was unfortunately lost, was either a cube, with faces of the tetra-hexahedron, or else a distorted trigonal tris-octahedron. These exhibited are very much distorted, and two resemble the latter form. This is one of the principal forms of the Diamond. The colors are either pink or light brown. The size has prevented me from trying the hardness. But, having scratched nine sapphires with pieces of the Meteorite, producing the fine, delicate lines characteristic of the Diamond, there can be little doubt that these bodies, the only residue, were those which produced the scratches."

SECTION OF BONE OF THE FINBACK WHALE.

The Rev. J. L. Zabriskie :

"The specimen is taken from bone, collected from the skeleton of a Finback Whale, 62 feet long, which was brought ashore and cut up for oil at Fisher's Island, at the eastern extremity of Long Island Sound, in 1869.

"The skeleton of the Whale is remarkable for the pairs of vertebral plates, or epiphyses, situated between the vertebral joints. These plates never become consolidated with the body of the adjoining bone, as they do usually in other mammalia. They have one surface nearly flat, and deeply pitted for the attachment of cartilage, and have the other surface slightly convex and comparatively smooth. The flat, rough surface is turned towards, and is attached to its own joint of the vertebral column; while the convex, smooth surface is opposed to, and articulates with the convex surface of another plate, belonging to the succeeding vertebra.

"The plate here exhibited, from which the section was taken, was situated towards the hinder extremity of the skeleton. It is comparatively small, being about $\frac{7}{8}$ of an inch thick by 10 inches in width, over its longer diameter. In the thorax of the same skeleton the plates were much larger. For they correspond in size with the diameter of that portion of the vertebral column to which they belong.

“The bone is remarkably light and porous. The pores are so large and abundant that they give the appearance of a miniature honey-comb, and pass directly through the substance of the bone, parallel with the longitudinal axis of the vertebral column, leaving only a thin shell of solid bone at either surface of the plate. These pores are slightly flexuous, frequently branched, usually of an elliptical outline in transverse section, frequently $\frac{1}{16}$ th of an inch in diameter, and occasion an extreme example of porosity of bone structure.”

THE MEDUSÆ.

Mr. Ludwig Riederer read the following note in explanation of his exhibits of Medusæ :

“Another order of the *Polycomedusæ* is formed by the DIS-COMEDUSÆ. These are Medusæ of considerable size—the edge of the umbrella lobed—the sense-organs covered. The umbrella is thick ; its gelatinous connective tissue is richly developed, and contains a quantity of strong fibrillæ and a network of elastic fibres, which structures confer upon it great firmness. The edge of the umbrella is divided by a regular number of indentations, usually into eight groups of lobes, between which the sense-organs are contained in special pits.

“The flat disk of the *Ephyra*, which is split into eight pairs of lobes, contains a central gastric cavity, into which the canal of the short, wide, four-cornered mannorium leads. From this central cavity there diverge eight canal-like, peripheral diverticula (radial pouches), between which there are found the same number of short, intermediate canals (intermediate pouches). At the gastric cavity are placed worm-like, movable tentacles, not found in any *Hydromedusa*. The marginal bodies, as well as the pit-like depressions (olfactory pits), on the dorsal side of the excavations, in which the marginal bodies are placed, must be considered as sense-organs. They appear in all cases to unite the functions of ocular and auditory apparatus. The auditory function is provided for by a large sack, which originates from the cells of the entoderm, and contains crystals. The eye consists of a mass of pigment, lying on the dorsal, or ventral side near the end of the stalk.

“TRACHYMEDUSÆ : These have a body-like cavity, which

serves alike for circulation and digestion (gastro-vascular space). The tissues are consistent—not pierced by a system of pores. The osculum is replaced by a mouth, with thread-cells in the epithelial tissues.

“The *Polycomeduse* have an œsophageal tube, with simple gastro-vascular cavity. The generative elements are developed in medusoid forms, which may be either free-swimming, or permanently attached to hydroid forms.

“The *Trachymeduse* are Medusæ with a firm, gelatinous umbrella, supported by cartilagenous ridges, with stiff tentacles, filled with solid rows of cells. These may be confined to the young stage. Development takes place by metamorphosis, without hydroid, asexual individuals. The family *Trachynemidæ*, to which *Rhopalonema* belongs, is characterized by stiff marginal tentacles, which are scarcely capable of motion. The genital organs are developed on vesicle-like swellings of the eight radial canals.”

Dr. N. L. Britton explained with drawings on the black-board the main points of his exhibit—Seed-coats of the Orchid, *Habenaria Hookeri*, Torr.

Dr. Britton also donated to the Library of the Society the following publications: Ten numbers of the *Bulletin de la Société Belge de Microscopie*; Memoir of the Rev. Elisha Mitchell, D. D.; and *Journal of the Elisha Mitchell Scientific Society*, for 1883–84, and 1884–85.

Mr. Ludwig Riederer explained the mechanism and method of operating the August Becker Sledge-Microtome, exhibited by him.

Mr. Charles S. Shultz introduced the Rev. E. C. Bolles, D.D., of New York city, who tendered his congratulations to the Society.

The Vice-President announced from the chair that Dr. H. Hensoldt, an expert lithologist, was expected to illustrate his methods of preparing rock-sections before the Society at the next meeting.

Mr. William Wales announced the death of Mr. Joseph Zentmayer, of Philadelphia, and followed the announcement with remarks eulogistic of the character and work of the deceased.

On motion, the chair appointed the following committee to

draft resolutions relating to the death of Mr. Zentmayer: William Wales, N. L. Britton, J. L. Zabriskie.

MEETING OF APRIL 20TH, 1888.

The President, Mr. Charles F. Cox, in the chair.

Forty-nine persons present.

Prof. E. G. Love, Ph.D., and Mr. J. T. C. Grow were elected Resident Members of the Society.

OBJECTS EXHIBITED.

1. Nephelinite, Odenwald, Germany.
2. Luxulyanite, Cornwall, England.
3. Tachylite, Giessen, Germany.
4. Augite—lava, Nassau.
5. Olivine—serpentine, Saxony.
6. Foraminiferous Limestone, Kent, England.

These six objects were prepared and exhibited by DR. H. HENSOLDT in illustration of his address, delivered at this meeting.

7. Transverse and longitudinal sections of the Hair of the Prong-horn Antelope, *Antilocapra Americana*, Ord: by J. L. ZABRISKIE.

8. *Candeina nitida*, d'Orbigny, found in the North Atlantic and in Torres Straits : by A. WOODWARD.

9. Crystals of Meconic Acid: by C. F. COX.

10. Films of Silicate of Soda: by C. F. COX.

11. A Sertularian: by W. E. DAMON.

12. Human Blood in a Current-Slide: by DR. D. S. HOLMAN.

Dr. H. Hensoldt, Lithologist, was introduced to the Society, and delivered an Address entitled "The Microscopical Investigation of Rocks." This Address is published in this number of the JOURNAL, p. 139.

Dr. Hensoldt also, by means of specially devised apparatus, exhibited before the Society the operations of slicing, grinding and polishing minerals, and explained his methods of mounting thin mineral sections.

On motion, the thanks of the Society were tendered Dr. Hensoldt for this Address and demonstration.

HAIR OF THE PRONG-HORN ANTELOPE.

The Rev. J. L. Zabriskie: "This animal has become celebrated on account of admirable published descriptions of its structure and habits, and also on account of its frequent domestication, in his private grounds, by the Hon. John D. Caton, of Chicago, Illinois.

"The creature stands alone, the only species of its genus. Its horns are hollow, and yet are shed at regular intervals, so that it fills a gap in classification between the ruminants, which have hollow, persistent horns, and those which have them solid and deciduous. Its habitat is confined to the New World, and to a very limited portion of our own country—the dry gravelly regions west of the upper waters of the Missouri river.

"The hair on most portions of its body shows in extreme degree the characteristics usually found in the deer-family—a large diameter compared with the length, and the interior filled with a copious medulla, consisting of very large cells, leaving only a thin cylinder of cortex, thus allowing the hair, between the root and the suddenly attenuated point, to bend easily without breaking.

"The specimens exhibited were taken from a dried hide, attached to a piece of the skin, cut from the margin of the bullet-hole, where the missile had entered which killed the animal. The hairs were deeply stained with blood. I was informed that it had been found impossible to wash this blood from the hairs. The sections show the reason of this to be the fact that the blood does not cling to the surface of the hairs, but has penetrated and still occupies the large cells of the medulla.

"I take pleasure in donating the slide to the Cabinet of the Society."

INORGANIC FORMS RESEMBLING DIATOMS.

Mr. Charles F. Cox: "The slides which I exhibit contain inorganic forms most strikingly resembling Diatoms and their markings. One exhibit consists of crystals of Meconic Acid from opium, and the other of films of Silicate of Soda."

Dr. Holman, of Philadelphia, on request, addressed the Society on the construction and operation of the Current-Slide,

devised and exhibited by him, illustrating his remarks by drawings on the black-board.

Dr. Holman said that the old fashioned concave slide allowed speedy evaporation, but on his slide *Protococcus* may be kept alive many days; *Amoeba*, three weeks; and Bacteria for six months. In the minute canal, $\frac{1}{100}$ inch wide and $\frac{1}{1000}$ inch deep, between the two concavities with shallow margins in his slide, blood corpuscles may be caused to flow in either direction, to roll over, or to stand on edge by the warmth of the hands of the operator, brought towards the stage of the microscope at a distance of about six inches.

On motion, the thanks of the Society were tendered Dr. Holman for his exhibit and explanation.

MEETING OF MAY 4TH, 1888.

The President, Mr. Charles F. Cox, in the chair.

Forty-six persons present.

OBJECTS EXHIBITED.

1. The living Beetle, *Zopherus mexicanus*, Sol., "Makeche."
2. The mandibles of the dead Beetle.
3. Metal cover, in which the Beetle had cut and enlarged the holes made for ventilation.
4. The metal cuttings.
5. Diagrams of the head and mandibles of the Beetle, and photographs of the cuttings, etc.

These five exhibits were by Mr. F. W. DEVOE, in illustration of his Paper, read at this meeting.

6. Fore leg of the Beetle, *Harpalus Pennsylvanicus*, Deg., showing the "Brush and Comb:" by J. L. ZABRISKIE.

7. Larva of *Psephenus Lecontei*, Hald. (an aquatic Beetle), found at Delaware Water Gap: by A. WOODWARD.

8. A collection of Beetles from Yucatan: by EDGAR J. WRIGHT.

9. A collection of Beetles from New York City: by EDGAR J. WRIGHT.

10. *Belostoma Americana*, captured in New York City : by F. W. LEGGETT.

11. A Beetle in amber : by JAMES WALKER.

12. A collection of Beetles from China : by K. F. JUNOR.

Mr. F. W. Devoe read a Paper, entitled "The Beetle, *Zopherus mexicanus*, Sol., cutting metal," and illustrated by objects, as announced above. This Paper is published in this number of the JOURNAL, p. 145.

Professor Samuel Lockwood, Ph. D., read a Paper, entitled "On the Larva of the Stag-Beetle, eating Rail Road Ties." This Paper is published in this number of the JOURNAL, p. 147.

"BRUSH AND COMB" OF THE FORE LEG OF THE BEETLE, *HARPALUS PENNSYLVANICUS*, DEG.

The Rev. J. L. Zabriskie : "On the inner edge, and near the distal extremity of the tibia of the fore leg in this Beetle is seen a large, movable spine, lying over and extending beyond a gently curved notch fringed with hairs, which apparatus is doubtless intended for cleaning the antennæ.

"Eleven years ago I published in the *American Journal of Microscopy*, vol. II (1877), p. 77, an article, applying the name "Brush and Comb" to a similar apparatus in the Hymenoptera.

"This is found in all the Hymenoptera, excepting a few of the lower genera, as a striking feature of the external structure. There need be no mistake concerning its use in the Hymenoptera. As far as I am aware this use is most clearly seen in the case of our common paper-making wasps, *Polistes anularis*, Fab., and *P. metricus*, Say. When these wasps alight they habitually employ part of the time in cleaning the antennæ, by throwing a fore leg over the adjoining antenna, catching the antenna between the notch and spine of the leg, and, by a downward movement of the leg, drawing the antenna through the circular opening formed by this apparatus. After this has been repeated a few times the leg is cleaned, by being drawn through the mandibles, and thoroughly washed off with vigorous motions of the mouth-parts.

"There is this difference to be noted in the form of this apparatus in the Hymenoptera, and in the case of this Beetle. In the Hymenoptera the spine is situated near the distal end of the

tibia, and the notch near the proximal end of the adjoining large tarsal joint. While in this Beetle the spine and notch are both situated on the tibia near the distal end."

VITALITY OF THE LARVA OF DERMESTES.

Mr. F. W. Leggett announced the death of his Larva of *Dermestes*, which had withstood, for five months and twenty days, solitary confinement in a closed cell, and had subsisted during that period upon its own cast skins, having moulted five times.

Mr. George F. Kunz donated, for distribution among the Members, a packet of eleven varieties of Textile Fibres, received from the National Museum, Washington, D. C.

PUBLICATIONS RECEIVED.

- The Botanical Gazette : Vol. XIII., Nos. 3-5 (March-May, 1888).
 Entomologica Americana : Vol. III., No. 1, Vol. IV., No. 2 (March-May, 1888).
 The Microscope : Vol. VIII., Nos. 3-5 (March-May, 1888).
 The Microscopical Bulletin and Science News : Vol. V., Nos. 1, 2 (February, April, 1888).
 Bulletin of the Torrey Botanical Club : Vol. XV., Nos. 3-5 (March-May, 1888).
 Journal of Mycology : Vol. IV., Nos. 2-5 (February-May, 1888).
 The Natural Science Association of Staten Island : Proceedings of March 10, April 14, May 12, 1888 ; Special No. 7 (May, 1888).
 Bulletins of the Agricultural College of Michigan : Nos. 35, 36.
 Anthony's Photographic Bulletin : Vol. XIX., Nos. 5-10 (March 10-May 26, 1888).
 The West-American Scientist : Vol. IV., Nos. 33-36 (January-April, 1888).
 The Brooklyn Medical Journal : Vol. I., Nos. 2-5 (February-May, 1888).
 The Hahnemannian Monthly : Vol. XXIII., Nos. 1-6 (January-June, 1888).
 "Psyche." Vol. V., Nos. 141-145 (January-May, 1888).
 Indiana Medical Journal : Vol. VI., Nos. 9-12 (March-June, 1888).
 The Swiss Cross : Vol. III., Nos. 1-6 (January-June, 1888).
 Journal of the Trenton Natural History Society : No. 3 (January, 1888).
 Transactions of the Massachusetts Horticultural Society : 1887, Part I.
 Journal of the Elisha Mitchell Scientific Society : 1887, Part II.

JOURNAL
OF THE
NEW-YORK MICROSCOPICAL SOCIETY.

VOL. IV.

OCTOBER, 1888.

No. 4.

LIVING ACTINIA, OR SEA-ANEMONES.

BY WILLIAM E. DAMON.

(*Read June 15th, 1888.*)

These animals, inhabiting only salt water, are found upon almost every sea-coast in the world, attached to rocks, logs, algæ, and any object that will serve them as anchorage. They can be found better at low water, on the rocks or piles, which they sometimes so thickly cover as to hide the object, on which they are tenaciously adhering by their suctorial base, appearing like a living flower-garden.

It would be difficult to exaggerate in speaking of the beauty of these flower-beds, as they may well be called. The vivid tints which they often display, and the gracefulness of their form, with their moving tentacles ever on the alert for food, make them always objects of fascinating study.

Their history is long and interesting. However, I do not propose to enter into minute histological detail, for the time would not allow this, and such detail would be out of place in a general sketch like the present. I will only say a few words more particularly about their life and habits.

For a long time, even until a few years ago, it was questioned whether they were plants or animals. But that these very interesting objects are animals there now is no doubt. Their structure consists of a sac, divided by vertical partitions into distinct cavities or chambers. These partitions are not all formed at once in the Anemone. First there are six chambers, all opening into a corresponding number of tentacles, then come twelve, twenty-four, forty-eight, and so on, each division mean-

ing another set of tentacles on the crown or head of the Anemone arranged around the mouth, which occupies the center of these soft waving tentacles, all forming the flower-like shape, from which they very appropriately take their name.

The body may be described as a circular, gelatinous bag, the bottom of which is quite flat, sometimes spreading unevenly around the margin. The upper edge of this bag is turned in, so as to form a sac within a sac. The inner sac is the stomach, or digestive cavity, with an aperture in the bottom, through which the food can pass into the outer cavity. The eggs are attached to, and hang on the inner edge of the partitions, and, when mature, they drop into the main body-cavity, and enter the inner digestive sac, through the hole in its lower portion, and are passed out through the mouth. The creature, however, does not ignominiously eject its young. The little ones are very tenderly taken from its mouth by two tentacles, which become wonderfully elongated for the occasion, and with their prehensile touch each young Anemone, now perfect in form and all its functions, no larger than a pin's head, is carefully and slowly let down, and deposited upon the rock around the base and close to the mother Anemone, and where these, which I show you to-night, have remained ever since their birth, some six weeks ago.

They may remain for some time in one place, tenaciously adhering by their base. They are, however, capable of motion, and are very likely to move about from one spot to another. I have seen them move clear across the tank in a few hours. This movement is effected by a double set of muscles, one running around the body, and the other arranged longitudinally.

I have brought with me to-night one of these animals and her young. This species is named *Actinia mesembryanthemum*. I have fourteen young Anemones, all born in my aquarium since my return from Bermuda, March 12th last, their ages varying from three months down to the youngest, which was born last Monday, and which you can see here under the microscope. These little ones vary in color from light pink to bright scarlet, red, dark blue, and almost black. This youngest Anemone, however, like most all favorite children, I believe, is a wonderful child! As you will see, it already has its second row of tentacles, numbering twelve, and it is only five days old!

We will now speak of its method of feeding, *etc.* The young have the same means of warfare and defense as those possessed by their parents—poisoned arrows, or lasso-cells, sometimes called cnidæ, or nematocysts, thread-cells, *etc.* These weapons are cells, imbedded in the outer skin-substance, filled with fluid, and containing a long and delicate projectile thread, capable of being shot out with considerable force and inconceivable rapidity. These threads bury themselves in any object against which they may be directed, and probably convey into the wound some poisonous matter, thus rendering their prey a helpless victim to their greedy mouths.

These animals also have a sense of taste, their likes and dislikes, the sense of smell, and eyes—only rudimentary eyes, however, and probably not of much use. They are very voracious, the little ones especially so. I feed mine with small pieces of oyster or clam, or fresh meat, scraped fine and dropped into the water over them, where every piece is seized by their outstretched arms or tentacles, and passed hurriedly to their mouths. The daintiest food for them, however, is the small oyster-crab, which we sometimes find in the oyster-shell. On this they fairly revel. An Anemone, like this one in the glass jar, easily disposes of a whole crab at a meal.

PROCEEDINGS.

MEETING OF MAY 18TH, 1888.

The President, Mr. Charles F. Cox, in the chair.

Thirty-two persons present.

OBJECTS EXHIBITED.

1. Spicules of *Synapta*, from New Zealand: by CHARLES F. COX.
2. Mouth-parts of *Belostoma Haldimanum*: by F. W. LEGGETT.
3. Section of Itacolumnite (Flexible Sandstone), from North Carolina: by JAMES WALKER.
4. Parts of *Echinus*: by K. F. JUNOR.
5. A group of *Bryozoa*: by W. E. DAMON.

The Report of the Committee, appointed to draft resolutions relative to the death of Mr. Joseph Zentmayer, was adopted, as follows:—

Whereas this Society has received with sorrow the announcement of the death of Mr. Joseph Zentmayer, which occurred at Philadelphia, Pa., on March 28th, 1888, it is hereby

Resolved:—

1. That in the death of Mr. Joseph Zentmayer the laborers in the various branches of science employing optical instruments have lost the inspiring presence and helpful coöperation of an eminently intelligent and successful author, inventor and mechanic, whose knowledge of optical principles has been attested by his brilliant publications, whose attainments have been recognized by his election to membership in various organizations, and whose mechanical skill and conscientious carefulness are still shown in the large variety of instruments issued from his establishment.

2. That a record of this action be forwarded to the family of Mr. Zentmayer as a token of our heart-felt sympathy with them in this bereavement.

WILLIAM WALES.	}	Committee.
N. L. BRITTON.		
J. L. ZABRISKIE.		

The Rev. K. F. Junor read a Paper, as announced in the programme of this meeting, entitled "The Microscopical Characteristics of the Echinodermata," which Paper was illustrated by slides under several microscopes, and by numerous other specimens.

The Rev. Mr. Junor also invited the Members of the Society to attend an illustrated lecture, entitled "Life in Ponds and Ditches," to be delivered by Mr. Stephen Helm, at 160 West 29th Street, on the evening of May 24th.

The President announced the donation to the Library of the Society of a copy of "Essays on the Microscope," by George Adams, London, 1787, from Dr. W. Alfred McCorn, of the City Asylum, Wards Island, New York.

MEETING OF JUNE 1ST, 1888.

In the absence of the President and Vice President, Mr. J. D. Hyatt was elected Chairman *pro tem*.

Twenty persons present.

The Rev. E. C. Bolles, D. D. was elected a Resident Member of the Society.

The Recording Secretary announced the presentation to the Members of this Society, by the Microscopical Section of the Brooklyn Institute, of Programmes and Tickets of Admission to the Annual Reception of said Microscopical Section, to be held in the Hall of the Brooklyn Institute on the evening of June 5th.

On motion, the thanks of the Society were tendered the Microscopical Section of the Brooklyn Institute for this presentation.

OBJECTS EXHIBITED,

1. A degraded Hymenopterous Insect, with veinless and fringed wings, in Gum Copal: by GEORGE E. ASHBY.
2. A Spider in Gum Copal: by GEORGE E. ASHBY.
3. An insect containing a fluid, which encloses a movable bubble, in Gum Copal: by GEORGE E. ASHBY.
4. Insects in Amber, from the Baltic Sea: by CHARLES S. SHULTZ.
5. Mouth-parts of an Ant: by L. RIEDERER.
6. Section of Mica Schist, from New York City: by T. B. BRIGGS.

INSECTS IN GUM COPAL.

Mr. George E. Ashby, in connection with his exhibits, remarked, that the main supply of Gum Copal is obtained from sand, at the depth of several feet, along the coast of Zanzibar, in localities where no trees are now found. The Gum has an oxydized and pitted surface, to which the sand does not adhere. Copal is more recent than Amber. The insects enclosed in Amber belong to extinct species, while those enclosed in Copal belong frequently to living species. The price of Gum Copal is One Dollar or more a pound, depending upon the transparency.

HABITAT OF VOLVOX.

Mr. J. D. Hyatt mentioned a pond, in a marshy tract, just beyond a ridge on the easterly side of the Harlem Railroad, and one-quarter of a mile beyond Jerome Park Station on that road, as the only place known to him in this vicinity where *Volvox* can be found in abundance.

On a late occasion Mr. Stephen Helm exhibited and distributed abundant gatherings of *Volvox*, collected by him in a small pond north of the Cypress Hills reservoir, Brooklyn, N. Y.

MEETING OF JUNE 15TH, 1888.

The President, Mr. Charles F. Cox, in the chair.

Thirty-two persons present.

OBJECTS EXHIBITED.

1. Pond-Life: by CHARLES S. SHULTZ.
2. Young Actinia, *Actinia mesembryanthemum*, from Bermuda Island, born in an aquarium: by WILLIAM E. DAMON.
3. Mouth-parts of Wasp: by LUDWIG RIEDERER.
4. Monazite Sand, from McDowell, Co., N. C.: by GEORGE F. KUNZ.
5. Monazite Sand, from Brazil, S. A.: by GEORGE F. KUNZ.
6. Inclusions in Oligoclase, from Bakersville, N. C.: by GEORGE F. KUNZ.
7. Fossil Infusoria, from Guano, prepared by J. W. Bailey: by A. WOODWARD.
8. Calcareous Marl, from an artesian well 110 feet deep, at Charleston, S. C., prepared by J. W. Bailey: by A. WOODWARD.
9. Section of *Astylospongia inornata*, from the Lower Helderberg Limestone, Rondout, Ulster Co., N. Y.: by A. WOODWARD.
10. Section of a Silicious Oyster, from Colorado: by A. WOODWARD.

On motion it was Resolved:—

1. That this Society hereby tenders its thanks to the Editor of the *New York Evening Sun* for the full and accurate reports of the proceedings of the Society which have appeared in the columns of that journal.

2. That the Corresponding Secretary be hereby directed to send a copy of these resolutions to the Editor of the *New York Evening Sun*.

Mr. George F. Kunz, in behalf of the New York Mineralogical Club, invited the Society to attend the Saturday afternoon excursions of the Club, stating that programmes would be sent to each member of the Society.

On motion it was Resolved:—

That the thanks of this Society be tendered to the New York Mineralogical Club for this invitation to participate in its excursions.

MONAZITE SAND.

Mr. George F. Kunz, in connection with his exhibits, explained the recently increased demand for monazite, on account of its use for the lately invented incandescent gas burner. This increased consumption has led to a search by the collectors and dealers in minerals in England, Germany, France, Russia, Norway and Brazil, and more especially in the United States; and so thorough has been the search, that the prices of minerals, which were considered rare a short time ago, are now quoted at one-tenth to one-hundredth of former figures. Monazite has been found at the following localities: Villeneuve, Ottawa County, Canada (a crystal of fourteen pounds and a half); Alexander County, N. C., at Milholland's Mill; Amelia County, Va. (in twenty pound lump); Norwich, Conn.; Ural Mountains; Mount Sorel (var. turnerite), Tavetch (var. turnerite), and Binnenthal, Switzerland; River Sanarka, Southern Ural; Arendal, Norway. At these localities the occurrence is of mineralogical interest only. At the North Carolina, Georgia, and Brazilian localities it can be obtained in quantity for commercial use. In the North Carolina gold gravels of Rutherford, Polk, Burke, McDowell, and Mecklenburg Counties, monazite is found in considerable quantities in small brown or greenish or yellowish brown monoclinic crystals associated with chromite, garnet, zircon, anatase, corundum, menaccanite, xenotime, fergusonite, epidote, columbite, samarskite, and other minerals. With these associations have been found several of the North Carolina diamonds; and at the Glade Mine, Georgia, diamonds have been found with the monazite, which exists in some abundance also. These localities will furnish tons of monazite within the next twelve months. The Brazilian monazite is found at Caravallas, Bahia, where its existence was made known about eight years ago by Dr. Orville A. Derby, geologist of Brazil. It occurs in large quantities as a beach-sand, almost free from other minerals, as if concentrated. As it occurs on the coast, it can easily be shipped to any point where it is wanted, and a number of tons have been sent to the

United States. The best North Carolina zircon locality is on the old Meredith Freeman estate, Green River, Henderson County, N. C., which was leased for twenty-five years in the hands of Gen. T. L. Clingman of that State, who, as early as 1869, mined one thousand pounds of it, and during that whole period never lost faith in the incandescent properties of zirconia; but when the time of its adoption actually came, through some legal difficulties the general had forfeited his leases, and hence failed to reap his reward. In Henderson County, N. C. and in Anderson County, S. C., zircon is found in large quantities loose in the soil, as the result of the decomposition of a felspathic rock. The crystals are generally remarkable for their perfection, being distinctive of each locality, weighing occasionally several ounces. The recent demand has also brought to light the existence of enormous quantities of zircon in the Ural Mountains and in Norway. Although in Canada, in Renfrew and adjoining counties, enormous crystals have been found up to fifteen pounds each, yet they are so isolated, that it would be impossible to obtain a supply there. The new demand has brought together more than twenty-five tons of zircon, ten tons of monazite, six tons of cerite, thousands of pounds of samarskite, and tons of allanite and other minerals. As a consequence, zircon is now offered at less than ten cents a pound, monazite at twenty-five cents, and samarskite at fifty cents.

PUBLICATIONS RECEIVED.

The Botanical Gazette : Vol. XIII., Nos. 6-8 (June-August, 1888).

Entomologica Americana : Vol. IV., Nos. 3-5 (June-August, 1888).

The Microscope : Vol. VIII., Nos. 6-8 (June-August, 1888).

The Microscopical Bulletin and Science News : Vol. V., Nos. 3, 4 (June, August, 1888).

Bulletin of the Torrey Botanical Club : Vol. XV., Nos. 7-9 (July-September, 1888).

Journal of Mycology : Vol. IV., Nos. 6, 7 (June, July, 1888).

The Natural Science Association of Staten Island : Proceedings of June 9, 1888 ; Special No. 8 (June, 1888).

Bulletins of the Agricultural College of Michigan : Nos. 37, 38 (June-August, 1888).

Anthony's Photographic Bulletin : Vol. XIX., Nos. 11-16 (June 9-August 25, 1888).

The West-American Scientist : Vol. IV., Nos. 37, 38 (May, June, 1888).

The Brooklyn Medical Journal : Vol. I., No. 6—Vol. II., Nos. 7, 8 (June-August, 1888).

The Hahnemannian Monthly : Vol. XXIII., Nos. 5-9 (May-September, 1888).

"Psyche : " Vol. V., Nos. 146-148 (June-August, 1888).

- Indiana Medical Journal : Vol. VII., Nos. 1-3 (July-September, 1888).
 The Swiss Cross : Vol. IV., Nos. 1-3 (July-September, 1888).
 Journal of the Trenton Natural History Society : Vol. I., Nos. 1, 2 (January, 1886, January, 1887).
 Transactions of the Massachusetts Horticultural Society : 1887, Part II.
 Transactions of the New York Academy of Sciences : Vol. VII., Nos. 3-6 (1887-1888).
 Bulletin of the California Academy of Sciences : Vol. II., No. 8 (November, 1887).
 The School of Mines Quarterly : Vol. IX., Nos. 3, 4 (April, July, 1888).
 Bulletin of the Essex Institute : Vol. XIX., Nos. 1-12 (January-December, 1887).
 Proceedings of the Academy of Natural Sciences of Philadelphia : 1887, Part III.; 1888, Part I.
 New York State Museum of Natural History. Annual Reports, Thirty-sixth, Thirty-ninth (1883-1886) ; Bulletins, Vol. I., Nos. 2, 3 (May, 1887, March, 1888).
 Charity Organization Society of the City of New York : Sixth Annual Report (1888).
 Boston Society of Civil Engineers : Report of Committee on Weights and Measures (1887).
 Michigan Board of Agriculture ; Twenty-sixth Annual Report (1887).
 Johns Hopkins University : Studies from the Biological Laboratory, Vol. IV., Nos. 3, 4 (April, June, 1888) ; University Circulars, Vol. VII., Nos. 64-67 (March, April, July, 1888).
 The Electrical Engineer : Vol. VII., Supplement (March 22, 1888) ; Nos. 76-80 (April-August, 1888).
 The National Druggist : Vol. XII., No. 5—Vol. XIII., No. 5 (March 1-September 1, 1888).
 Mining and Scientific Review : Vol. XX., No. 9—Vol. XXI., No. 10 (March 1-September 6, 1888).
 The Druggist : Vol. IX, No. 2 (February, 1888).
 The Pacific Record of Medicine and Surgery : Vol. II., No. 7—Vol. III., No. 1 (February-August, 1888).
 The American Lancet : Vol. XII., Nos. 3, 4, 6-9 (March-September, 1888).
 The Rocky Mountain Druggist : Vol. I., Nos. 1-5 (1888).
 Proceedings of the American Academy of Arts and Sciences : Vol. XXIII. Part I (May, 1887-May, 1888).
 The American Museum of Natural History : Annual Report (1887-8).
 The Journal of the Cincinnati Society of Natural History : Vol. XI., No. 1 (April, 1888).
 The Sanitary Inspector : Vol. I., No. 9 (March, 1888).
 North Carolina Desmids (Ex. Journal of the Elisha Mitchell Scientific Society, May, 1888) : from the Author, W. L. Poteat.
 Smithsonian Institution : Report, Part II., 1885.
 Lomb Prize Essays : Nos. 1-4 (1886).
 The Canadian Institute : Proceedings, Vol. V., No. 2 (April, 1888) ; Annual Report, 1887.
 The Canadian Record of Science : Vol. III., No. 2 (April, 1888).
 The Ottawa Naturalist : Vol. I., No. 12 ; Vol. II., No. 2 (March, May, 1888).
 The Historical and Scientific Society of Manitoba : Annual Report, 1887.
 Journal of the Royal Microscopical Society : 1887, Part 6a (December) ; 1888, Parts 1-4 (February-August).
 The Scientific Enquirer : Vol III., No. 28 (April, 1888).
 The Journal of Microscopy and Natural Science : Vol. I., Parts 2, 3 (April, July, 1888).
 The Naturalist : Nos. 152-158 (March-September, 1888).
 The Journal of the Quekett Microscopical Club : Vol. III., Nos. 21, 22 (April, July, 1888).

Grevillea : Nos. 80, 81 (1888).

Bristol Naturalists' Society : Proceedings, Vol. V., Part 3 (1887-8).

Penzance Natural History and Antiquarian Society ; Report and Transactions (1887-8).

Belfast Naturalists' Field Club ; Annual Report and Proceedings : Vol. II., Part 7 (1886-7).

Journal of the Royal Society of New South Wales : Vol. XXI., (1887).

The Victorian Naturalist : Vol. IV., Nos. 7-10 (November, 1887-February, 1888); Vol. V., No. 2 (June, 1888).

Société Belge de Microscopie : Bulletin, Vol. XIV., Nos. 1-7 (October, 1887-April, 1888).

Société Royale de Botanique de Belgique, Comptes-Rendus (February 11-July 2, 1888).

Wissenschaftlichen Club in Wien (Twelfth Report 1887-8); Monatsblätter, Vol. IX., Nos. 5-11 (February 15-August 15, 1888); Auserordentliche Beilage, Vol. IX., Nos. 2-4 (1888).

Le Moniteur du Praticien : Vol IV., No. 3 (March, 1888).

Introduction a L'Étude des Diatomées par M. Deby, Paris, 1888. From the Author.

Bulletin de la Société des Naturalistes de Moscou : 1887, No. 4.

Naturwissenschaftlichen Verein für Schwaben und Neuburg (a. V.) in Augsburg : Twenty-ninth Report (1887).

Naturhistorischen Verein zu Passau : Fourteenth Report (1886-7).

Siebenbürgischen Verein für Naturwissenschaften in Hermannstadt : Vol. XXXVII (1887).

Gesellschaft zur Beförderung der gesammten Naturwissenschaften zu Marburg : Proceedings (1886-7).

Bolletino della Società Africana D'Italia : Vol. VI., Nos. 11, 12 (November, December, 1887); Vol. VII., Nos. 3, 4 (March, April, 1888).

Nuovo Giornale Botanico Italiano, Vol. XX., Nos. 1-3 (January, April, July, 1888).

Memorias de la Sociedad Científica " Antonio Alzate," Mexico : Vol. I., No. 9 (March, 1888).

Naturhistorischen Gesellschaft zu Hannover : Thirty-fourth-Thirty-seventh Annual Reports (1883-7).

Bulletin de la Société Linnéenne de Normandie : Vol. I., Part 4 (1886-7).

Memoires de la Société Nationale des Sciences Naturelles et Mathématiques de Cherbourg : Vol. XXV. (1887).

Naturwissenschaftlichen Verein des Reg.-Bez. Frankfurt (a. O.) : Monatliche Mittheilungen, Vol. VI., Nos. 1-3 (April-June, 1888); Societatum Litteræ, Vol. II., No. 5 (May, 1888).

Naturhistorischen Gesellschaft zu Nürnberg : Annual Report (1887) ; Festschrift zu Begrüssung des XVIII. Kongresses der Deutschen Anthropologischen Gesellschaft (1887).

Revista Trimestral de Histologia Normal y Patológica, Barcelona : Vol. I., No. 1 (May, 1888).

Académie D'Hippone, Bone, Africa : Bulletin, No. 22, Fascicles 2-4 (1887-8); Comptes-Rendus, Nos. 23, 24 (1887-8).

Museu Nacional do Rio de Janeiro : Archivos, Vol. VII. (1887).

Royal Bohemian Society of Sciences, Prag : Transactions of the Section of Mathematics and Natural Sciences (1885-7) ; Annual Reports (1885-7) ; Memoirs, Series VII., Vol. I. (1885-7).

New York Botanical Garden Library



3 5185 00267 0345

