

LIBRARY OF
THE NEW YORK BOTANICAL GARDEN

Given by C. F. Cox, Esq.
1903

Sept. 1899

R. W. Gibson. inv.

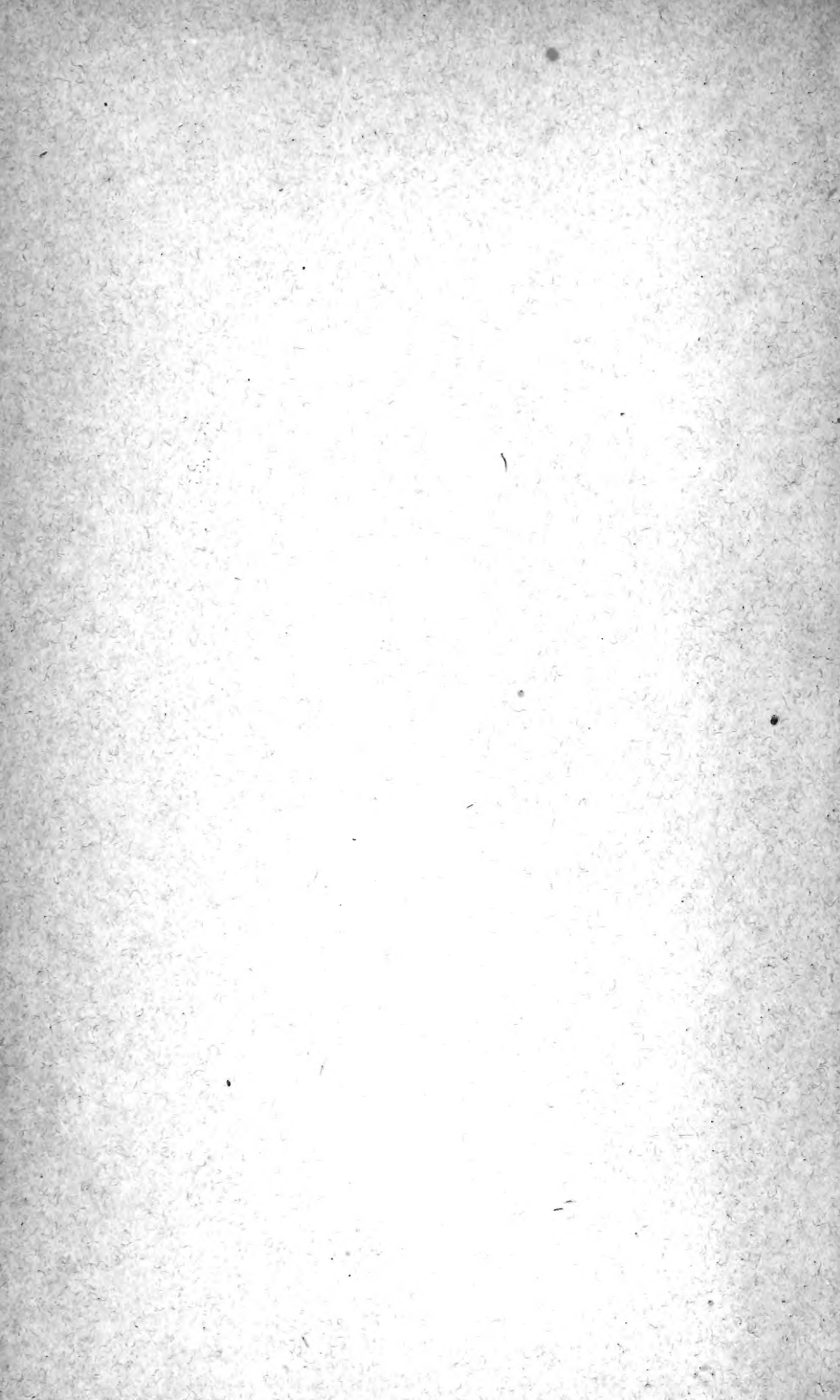

JOURNAL
OF THE
ROYAL
MICROSCOPICAL SOCIETY;

CONTAINING ITS TRANSACTIONS AND PROCEEDINGS,
AND A SUMMARY OF CURRENT RESEARCHES RELATING TO
ZOOLOGY AND BOTANY
(principally Invertebrata and Cryptogamia),
MICROSCOPY, &c.

LIBRARY
NEW YORK
BOTANICAL
GARDEN

Edited by

FRANK CRISP, LL.B., B.A.,

One of the Secretaries of the Society

and a Vice-President and Treasurer of the Linnean Society of London ;

WITH THE ASSISTANCE OF THE PUBLICATION COMMITTEE AND

A. W. BENNETT, M.A., B.Sc., F.L.S.,

Lecturer on Botany at St. Thomas's Hospital,

JOHN MAYALL, JUN., F.Z.S.,

B. B. WOODWARD, F.G.S.,

Librarian, British Museum (Natural History),

F. JEFFREY BELL, M.A., F.Z.S.,

Professor of Comparative Anatomy in King's College,

FRANK E. BEDDARD, M.A., F.Z.S.,

R. G. HEBB, M.A., M.D. (Cantab.),

AND

J. ARTHUR THOMSON, M.A.,

FELLOWS OF THE SOCIETY.

Ser. II.—VOL. V.



PUBLISHED FOR THE SOCIETY BY
WILLIAMS & NORGATE,
LONDON AND EDINBURGH.

1885.

.87551

Ser. 2

vol. 5

pts. 1-3



From a Photo by Elliott & Fry.

SIR RICHARD OWEN,
K.C.B., M.D., D.C.L., F.R.S.

First President of the Microscopical Society of London.



ARTHUR FARRE, M.D., F.R.S.
1850-1.



JAMES S. BOWERBANK, LL.D., F.R.S.
1846-7.



JOHN LINDLEY, PH.D., F.R.S.
1842-3



GEORGE BUSK, F.R.S.
1848-9.



WILLIAM B. CARPENTER, C.B., M.D., LL.D., F.R.S.
1854-5.



THOMAS BELL, F.R.S.
1844-5.



GEORGE JACKSON, M.R.C.S.
1858-7.



GEORGE SHADBOLT.

PRESIDENTS

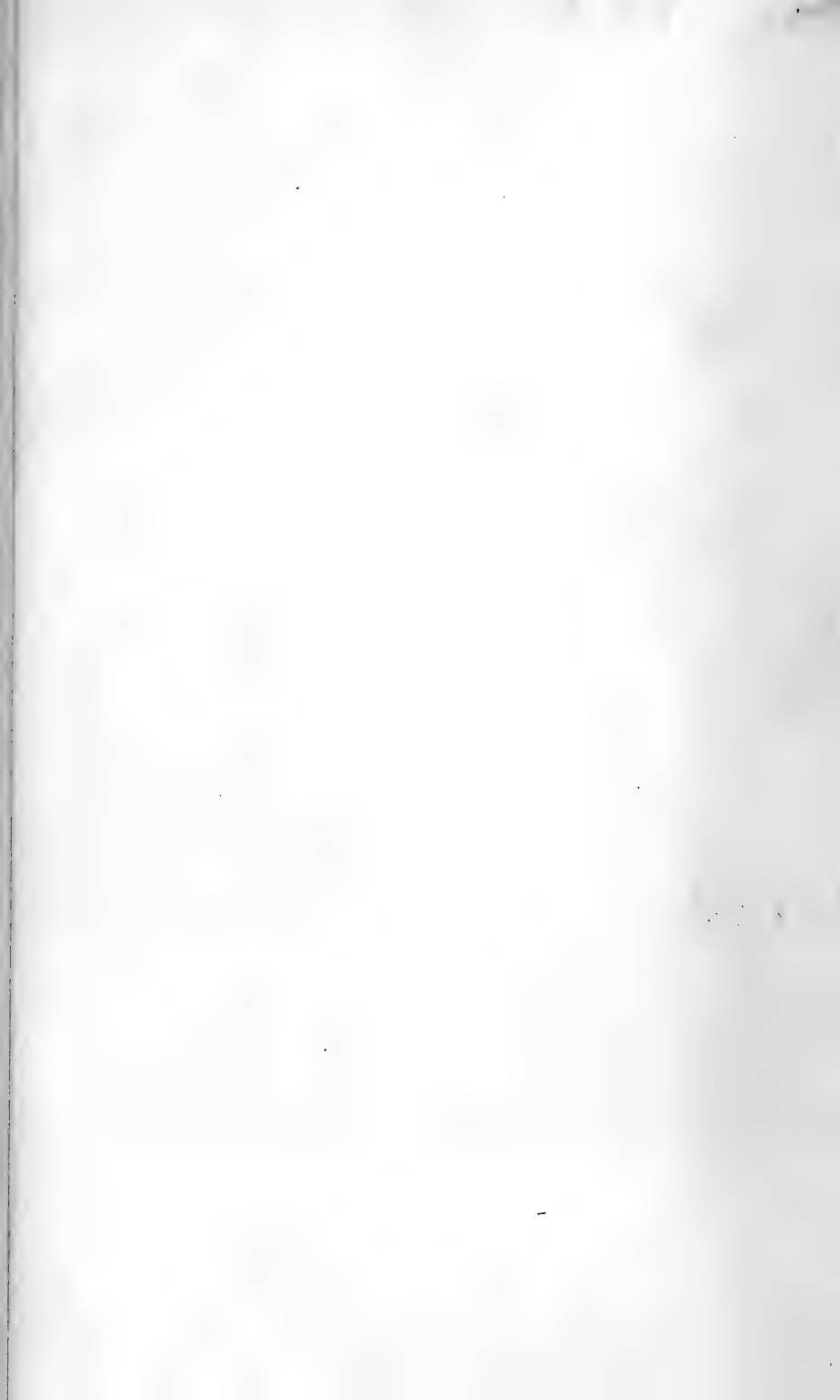



Portrait of James M. Smith

JAMES M. SMITH

1807 - 1877

Member of the Board of Trustees of the University of Michigan

1850 - 1877



REV. J. B. READE, M.A., F.R.S.
1869-70.



EDWIN LANKESTER, M.D., LL.D., F.R.S.
1858-9.



JOHN T. QUEKETT, F.R.S.
1860.



W. KITCHEN PARKER, F.R.S.
1871-2.



HENRY C. SORBY, LL.D., F.R.S.
1875-6-7.



CHARLES BROOKE, M.A., F.R.S.
1863-4, 1873-4.



ROBERT J. FARRANTS, F.R.C.S.
1861-2.

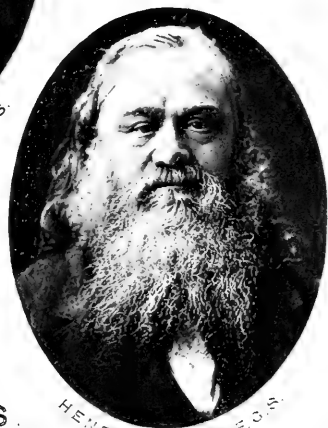

HENRY J. SLACK, F.R.S.
1878

PRESIDENTS.

1858 - 1878.

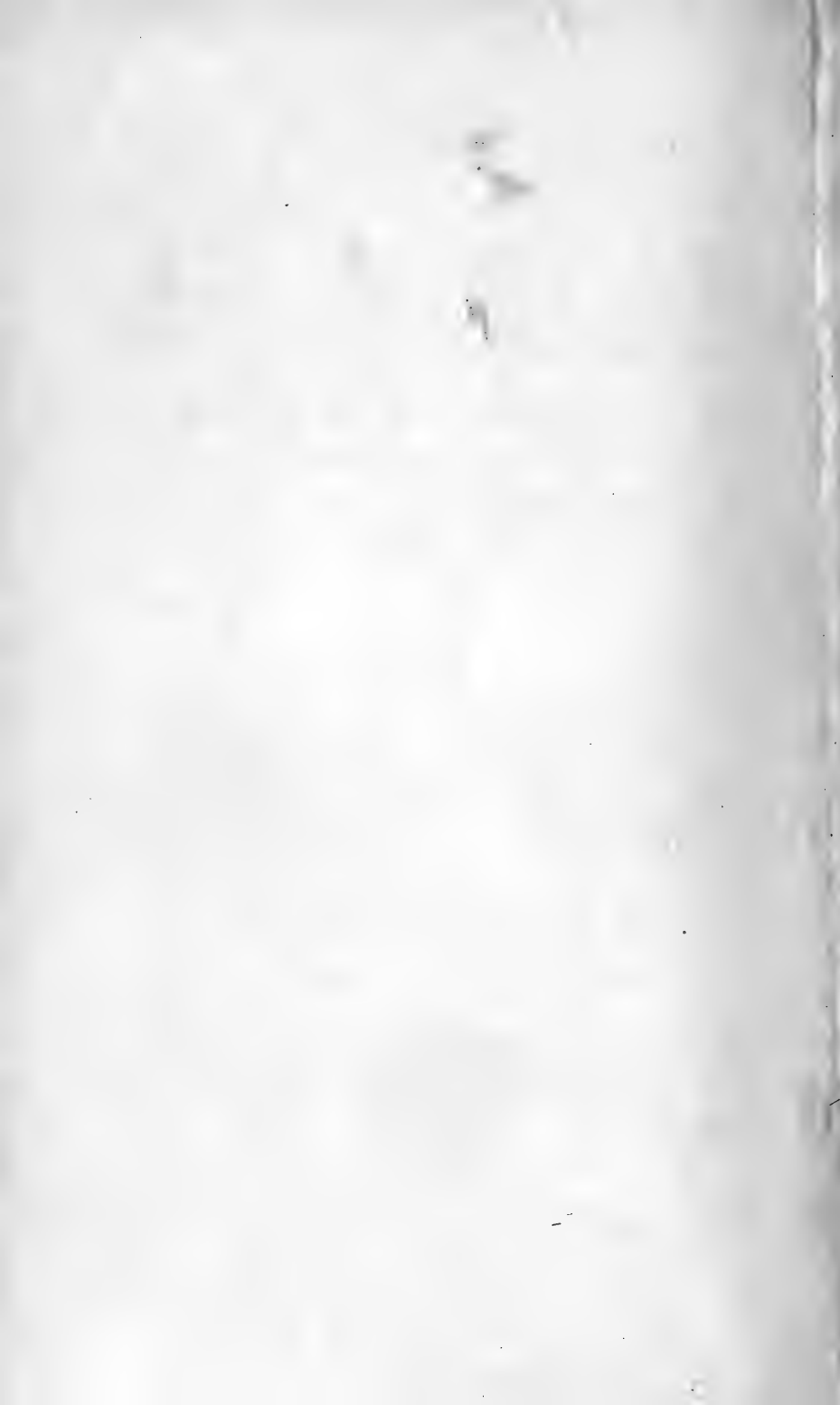

JOURNAL
OF THE
ROYAL
MICROSCOPICAL SOCIETY;

CONTAINING ITS TRANSACTIONS AND PROCEEDINGS,
AND A SUMMARY OF CURRENT RESEARCHES RELATING TO
ZOOLOGY AND BOTANY
(principally Invertebrata and Cryptogamia),
MICROSCOPY, &c.

Edited by

FRANK CRISP, LL.B., B.A.,

One of the Secretaries of the Society

and a Vice-President and Treasurer of the Linnean Society of London ;

WITH THE ASSISTANCE OF THE PUBLICATION COMMITTEE AND

A. W. BENNETT, M.A., B.Sc., F.L.S.,
Lecturer on Botany at St. Thomas's Hospital,

F. JEFFREY BELL, M.A., F.Z.S.,
Professor of Comparative Anatomy in King's College,

JOHN MAYALL, JUN., F.Z.S.,

FRANK E. BEDDARD, M.A., F.Z.S.,

B. B. WOODWARD, F.G.S.,

R. G. HEBB, M.A., M.D. (Cantab.),

Librarian, British Museum (Natural History),

AND

J. ARTHUR THOMSON, M.A.,

FELLOWS OF THE SOCIETY.

Ser. II.—VOL. V. PART 1.



PUBLISHED FOR THE SOCIETY BY
WILLIAMS & NORGATE,
LONDON AND EDINBURGH.

1885.



DARWIN

THE Royal Microscopical Society.

(Founded in 1839. Incorporated by Royal Charter in 1866.)

The Society was established for the communication and discussion of observations and discoveries (1) tending to improvements in the construction and mode of application of the Microscope, or (2) relating to Biological or other subjects of Microscopical Research.

It consists of Ordinary, Honorary, and Ex-officio Fellows.

Ordinary Fellows are elected on a Certificate of Recommendation signed by three Fellows, stating the names, residence, description, &c., of the Candidate, of whom one of the proposers must have personal knowledge. The Certificate is read at a Monthly Meeting, and the Candidate balloted for at the succeeding Meeting.

The Annual Subscription is £2 2s., payable in advance on election, and subsequently on 1st January annually, with an Entrance Fee of £2 2s. Future payments of the former may be compounded for at any time for £31 10s. Fellows elected at a meeting subsequent to that in February are only called upon for a proportionate part of the first year's subscription, and Fellows absent from the United Kingdom for a year, or permanently residing abroad, are exempt from one-fourth of the subscription during absence.

Honorary Fellows (limited to 50), consisting of persons eminent in Microscopical or Biological Science, are elected on the recommendation of three Fellows and the approval of the Council.

Ex-officio Fellows (limited to 100) consist of the Presidents for the time being of such Societies at home and abroad as the Council may recommend and a Monthly Meeting approve. They are entitled to receive the Society's Publications, and to exercise all other privileges of Fellows, except voting, but are not required to pay any Entrance Fee or Annual Subscription.

The Council, in whom the management of the affairs of the Society is vested, is elected annually, and is composed of the President, four Vice-Presidents, Treasurer, two Secretaries, and twelve other Fellows.

The Meetings are held on the second Wednesday in each month, from October to June, in the Society's Library at King's College, Strand, W.C. (commencing at 8 P.M.). Visitors are admitted by the introduction of Fellows.

In each Session two additional evenings are devoted to the exhibition of Instruments, Apparatus, and Objects of novelty or interest relating to the Microscope or the subjects of Microscopical Research.

The Journal, containing the Transactions and Proceedings of the Society, with a Summary of Current Researches relating to Zoology and Botany (principally Invertebrata and Cryptogamia), Microscopy, &c., is published bi-monthly, and is forwarded post-free to all Ordinary and Ex-officio Fellows residing in countries within the Postal Union.

The Library, with the Instruments, Apparatus, and Cabinet of Objects, is open for the use of Fellows daily (except Saturdays) from 10 A.M. to 5 P.M., and on Wednesdays also from 7 to 9.30 P.M. It is closed for four weeks during August and September.

Forms of proposal for Fellowship, and any further information, may be obtained by application to the Secretaries, or Assistant-Secretary, at the Library of the Society, King's College, Strand, W.C.

Patron.

HIS ROYAL HIGHNESS
ALBERT EDWARD, PRINCE OF WALES,
K.G., G.C.B., F.R.S., &c.

Past-Presidents.

	Elected.
SIR RICHARD OWEN, K.C.B., D.C.L., M.D., LL.D., F.R.S.	1840-1
JOHN LINDLEY, Ph.D., F.R.S.	1842-3
THOMAS BELL, F.R.S.	1844-5
JAMES SCOTT BOWERBANK, LL.D., F.R.S.	1846-7
GEORGE BUSK, F.R.S.	1848-9
ARTHUR FARRE, M.D., F.R.S.	1850-1
GEORGE JACKSON, M.R.C.S.	1852-3
WILLIAM BENJAMIN CARPENTER, C.B., M.D., LL.D., F.R.S.	1854-5
GEORGE SHADBOLT	1856-7
EDWIN LANKESTER, M.D., LL.D., F.R.S.	1858-9
JOHN THOMAS QUEKETT, F.R.S.	1860
ROBERT JAMES FARRANTS, F.R.C.S.	1861-2
CHARLES BROOKE, M.A., F.R.S.	1863-4
JAMES GLAISHER, F.R.S.	1865-6-7-8
REV. JOSEPH BANCROFT READE, M.A., F.R.S.	1869-70
WILLIAM KITCHEN PARKER, F.R.S.	1871-2
CHARLES BROOKE, M.A., F.R.S.	1873-4
HENRY CLIFTON SOBRY, LL.D., F.R.S.	1875-6-7
HENRY JAMES SLACK, F.G.S.	1878
LIONEL S. BEALE, M.B., F.R.C.P., F.R.S.	1879-80
P. MARTIN DUNCAN, M.B., F.R.S.	1881-2-3

COUNCIL.

ELECTED 11TH FEBRUARY, 1885.

President.

REV. W. H. DALLINGER, LL.D., F.R.S.

Vice-Presidents.

JOHN ANTHONY, Esq., M.D., F.R.C.P.L.
G. F. DOWDESWELL, Esq., M.A., F.L.S.
PROF. P. MARTIN DUNCAN, M.B., F.R.S.
ALBERT D. MICHAEL, Esq., F.L.S.

Treasurer.

LIONEL S. BEALE, Esq., M.B., F.R.C.P., F.R.S.

Secretaries.

*FRANK CRISP, Esq., LL.B., B.A., V.P. & TREAS. L.S.
PROFESSOR F. JEFFREY BELL, M.A., F.Z.S.

Twelve other Members of Council.

JOSEPH BECK, Esq., F.R.A.S.
ALFRED WILLIAM BENNETT, Esq., M.A., B.Sc., F.L.S.
*ROBERT BRAITHWAITE, Esq., M.D., M.R.C.S., F.L.S.
JAMES GLAISHER, Esq., F.R.S., F.R.A.S.
*J. WILLIAM GROVES, Esq.
JOHN MATTHEWS, Esq., M.D.
JOHN MAYALL, Esq., Jun.
*JOHN MILLAR, Esq., L.R.C.P., F.L.S.
URBAN PRITCHARD, Esq., M.D.
STUART O. RIDLEY, Esq., M.A., F.L.S.
*PROFESSOR CHARLES STEWART, M.R.C.S., F.L.S.
WILLIAM THOMAS SUFFOLK, Esq.

Librarian and Assistant Secretary.

MR. JAMES WEST.

* Members of the Publication Committee.

CONTENTS.

TRANSACTIONS OF THE SOCIETY—

PAGE

I.—The Apparatus for differentiating the sexes in Bees and Wasps. An Anatomical Investigation into the Structure of the Receptaculum Seminis and adjacent parts. By Frank R. Cheshire, F.R.M.S. (Plates I. and II.) Part 1	1
II.—On the Occurrence of Variations in the Development of a Saccharomyces. By G. F. Dowdeswell, M.A., F.L.S., F.R.M.S., &c. „	16
II.—Notes on the Life-Histories of some of the little-known Tyroglyphidæ. By A. D. Michael, F.L.S., F.R.M.S., &c. (Plate III.) „	19
IV.—The President's Address. By the Rev. W. H. Dallinger, LL.D., F.R.S. (Plates IV.—VI.) Part 2	177
V.—The Lantern Microscope. By Lewis Wright. (Figs. 40–42) ..	196
VI.—On some unusual Forms of Lactic Ferment— <i>Bacterium lactis</i> . By R. L. Maddox, M.D., Hon. F.R.M.S. (Fig. 43) ..	205
VII.—On a Cata-dioptric Immersion Illuminator. By J. Ware Stephenson, F.R.A.S., F.R.M.S. (Fig. 44) „	207
VIII.—New British Oribatidæ. By A. D. Michael, F.R.M.S., F.L.S., F.Z.S., &c. (Plate VII.) Part 3	385
IX.—Structure of the Diatom Shell. Siliceous Films too thin to show a broken edge. By Jacob D. Cox, LL.D., F.R.M.S. „	398
X.—On the Structure and Origin of Carboniferous Coal Seams. By Edward Wethered, F.R.M.S., F.G.S., F.C.S. (Plates VIII. and IX.) „	406
XI.—The Pathogenic History and History under Cultivation of a New Bacillus (<i>B. alvei</i>), the Cause of a Disease of the Hive Bee hitherto known as Foul Brood. By Frank R. Cheshire, F.R.M.S., F.L.S., and W. Watson Cheyne, M.B., F.R.C.S. (Plates X. and XI. and Fig. 134).. .. Part 4	581
XII.—Experiments on Feeding some Insects with the Curved or “Comma” Bacillus, and also with another Bacillus (<i>B. subtilis</i> ?). By R. L. Maddox, M.D., Hon. F.R.M.S. ..	602
XIII.—On Four New Species of the Genus Floscularia, and Five other New Species of Rotifera. By C. T. Hudson, LL.D., F.R.M.S. (Plate XII.) „	608
XIV.—New British Micro-Fungi. By G. Massee, F.R.M.S. (Plate XIII.) Part 5	757

	PAGE
XV.—On Erosion of the Surface of Glass, when exposed to the Joint Action of Carbonate of Lime and Colloids. By William M. Ord, M.D., F.R.M.S., F.L.S.	Part 5 761
XVI.—On a Septic Microbe from a High Altitude. The Niesen Bacillus. By G. F. Dowdeswell, M.A., F.R.M.S., F.L.S., &c.	,, 769
XVII.—On the use of the Avicularian Mandible in the determination of the Chilostomatous Bryozoa. By Arthur Wm. Waters, F.R.M.S., F.L.S. (Plate XIV.)	,, 774
XVIII.—On some new and rare Desmids. By W. Barwell Turner, F.R.M.S., F.C.S. (Plates XV. and XVI.)	Part 6 933
XIX.—Further Experiments on Feeding Insects with the Curved or "Comma" Bacillus. By R. L. Maddox, M.D., Hon. F.R.M.S.	,, 941
XX.—On the Cholera "Comma" Bacillus. By G. F. Dowdeswell, M.A., F.R.M.S., F.L.S., &c.	,, 953
XXI.—Improved Form of Stephenson's Binocular Prisms. By C. D. Ahrens. (Figs. 220 and 221)	,, 959
XXII.—Remarks on Prof. Abbe's 'Note on the proper Definition of the Amplifying Power of a Lens or Lens-System.' By E. Giltay, Ph.D., Teacher of Botany at the State Agricultural School at Wageningen (Netherlands). (Figs. 222 and 223)	,, 960
XXIII.—On the limits of Resolution in the Microscope. By Frank Crisp, LL.B., B.A., V.P. and Treas. Linn. Soc., Sec. R.M.S. (Figs. 224-8)	,, 968
SUMMARY OF CURRENT RESEARCHES RELATING TO ZOOLOGY AND BOTANY (PRINCIPALLY INVERTEBRATA AND CRYPTOGAMIA), MICROSCOPY, &c., INCLUDING ORIGINAL COMMUNICATIONS FROM FELLOWS AND OTHERS.*	
	33, 212, 421, 615, 780, 974

ZOOLOGY.

A.—GENERAL, including Embryology and Histology of the Vertebrata.		PAGE
CALDWELL, W. H., W. HAACKE, and T. GILL— <i>Oviparous Reproduction in the Monotremes</i>	Part 1	33
CALDWELL, H.— <i>Embryonic Membranes of Marsupials</i>	,,	34
HERMANN, L., and R. v. GENDRE— <i>Electromotive Function of the Fowl's Egg</i>	,,	34
BROOK, G.— <i>Development of the Lesser Weaver-fish (Trachinus vipera)</i>	,,	34
MINOT, C. S.— <i>Vesiculæ seminales of Guinea-pigs</i>	,,	35
LWOFF, W.— <i>Histology of Hairs, Setæ, Spines, and Feathers</i>	,,	35

* In order to make the classification complete, (1) the papers printed in the 'Transactions,' (2) the abstracts of the 'Bibliography,' and (3) the notes printed in the 'Proceedings' are included here.

	PAGE
CAMERANO, L.— <i>Distribution of Colour in the Animal Kingdom</i> Part 1	37
GRABER, V.— <i>Sense of Colour and of Brightness in Animals</i>	38
HUNT, A. R.— <i>Influence of Wave-currents on Fauna of Shallow Seas</i>	38
CLAUS' (C.) <i>Elementary Text-book of Zoology</i>	38
SCHIMKEWITSCH, W.— <i>Development of the Heart in Vertebrates and Invertebrates</i>	Part 2 212
STRAHL, H.— <i>Embryology of Lacerta viridis</i>	212
HERTWIG, O.— <i>Spindle-shaped Bodies in the Yolk of Young Ova of Frogs</i> ..	213
RYDER, J. A.— <i>Development of the Rays of Osseous Fishes</i>	213
BROOK, G.— <i>Origin of the Hypoblast in Pelagic Teleostean Ova</i>	214
DÜSING, K.— <i>Regulation of the Proportion of the Sexes in Man, Animals, and Plants</i>	214
SCHLECHTER, J., & H. BERNER— <i>Causes of Sex</i>	215
BROOKS, W. K.— <i>New Law of Variation</i>	216
RAEL, C.— <i>Cell-division</i>	217
LÖWIT, M.— <i>Formation of Red and White Blood-corpuses</i>	220
LIST, J. H.— <i>Unicellular Glands in the Cloaca of Rays</i>	221
MITROPHANOW, P.— <i>Intercellular Spaces and Bridges in Epithelium</i> ..	221
MÜLLENHOFF, K.— <i>Size of the Surfaces of Organs of Flight</i>	221
HERDMAN, W. A.— <i>Phylogenetic Classification of Animals</i>	221
LOEW, O.— <i>Protoplasm and its Powers of Resistance</i> Part 3	421
HERTWIG, O.— <i>Problem of Fertilization and of the Isotropy of the Ovum</i> ..	421
RAUBER & SACHSSE.— <i>Influence of external conditions on the development of Ova</i>	423
BENEDEN, E. VAN, & C. JULIN.— <i>Fœtal Appendages of Mammals</i>	423
SOLGER, B.— <i>Development of the Cœlom and Cœlomic Epithelium of Amphibia</i>	423
SPENCER, W. B.— <i>Fate of the Blastopore of Rana temporaria</i>	425
HENNEGUY, L. F.— <i>Primitive Streak in Osseous Fishes</i>	425
PERRAVEX, E.— <i>Formation of Egg-shell in Dogfish</i>	425
FOL, H.— <i>Cell-continuity</i>	426
HERTWIG, O.— <i>Influence of Gravity on Cell-division</i>	426
HÄCKEL, E.— <i>Origin and Development of Animal Tissues</i>	426
ADAMKIEWICZ, A.— <i>Parietal Cells in Nerve-fibres</i>	428
WOOLDRIDGE, L. C.— <i>New Constituent of the Blood and its Physiological Import</i>	428
NIKOLAIDES, R.— <i>Phenomena of Contraction in Striated Muscle</i>	428
LEWIS, W. J.— <i>Hair Microscopically examined and Medico-legally considered</i>	429
MACMUNN, C. A.— <i>New Organic Spectra</i>	429
SHARP, B.— <i>Homologies of the Vertebrate Crystalline Lens</i>	430
BROOKS, W. K.— <i>Recognition by Marine Animals of the Hour of the Day</i> ..	431
CLAUS' (C.) <i>Elementary Text-book of Zoology</i>	431
LAULAINÉ, F.— <i>Unity of the Process of Spermatogenesis in Mammalia</i> .. Part 4	615
DUVAL, M.— <i>Formation of the Blastoderm in the Bird's Egg</i>	615
DARESTE, C.— <i>Physiological Purpose of Turning the Incubating Hen's Eggs</i>	617
LASCHENBERG, O.— <i>Colours of Birds' Eggs</i>	618
SARASIN, P. B. & C. F.— <i>Development of Epicrium</i>	618
RYDER, J. A.— <i>Translocation forwards of the Rudiments of the Pelvic Fins in the Embryos of Physoclist Fishes</i>	618

	PAGE
LOEW, O., & T. BOKORNY— <i>Silver-reducing Animal Organs</i>	Part 4 619
COLEMAN, J. J., & J. G. M'KENDRICK— <i>Effects of Very Low Temperatures on Living Organisms</i>	" 619
BELL'S (F. J.) ' <i>Comparative Anatomy and Physiology</i> '	" 620
DOHRN, A.— <i>Primitive History of the Vertebrate Body</i>	Part 5 780
MINOT, C. S.— <i>Formative Force of Organisms</i>	" 780
FOL, H.— <i>Tail of Human Embryo</i>	" 781
LAULAINÉ, F.— <i>Nature of the Placental Neof ormation and the Unity of Composition of the Placenta</i>	" 783
DENIKER, J.— <i>Fœtus of Gibbon and its Placenta</i>	" 783
BROWN, H. H.— <i>Spermatogenesis in the Rat</i>	" 783
GERLACH, L.— <i>Hatching of Birds' Eggs after Lesion of the Shell</i>	" 784
SPENCER, W. B.— <i>Early Development of Rana temporaria</i>	" 785
BROOK, G.— <i>Development of Motella mustela</i>	" 785
RYDER, J. A.— <i>Development of the Salmon</i>	" 786
EWART, J. C., & G. BROOK— <i>Spawning of the Cod</i>	" 786
RETTNERER— <i>Development of Vascular Glands</i>	" 787
MELLAND, B.— <i>Simplified View of Histology of Striped Muscle-fibre</i>	" 787
HOWES, G. B.— <i>Atlas of Practical Elementary Biology</i>	" 787
LAULAINÉ, F.— <i>Development of Sexuality</i>	Part 6 974
FLEMMING, W.— <i>Formation of Spindles in Mammalian Ova during the Degeneration of the Graafian Follicle</i>	" 975
KÖLLIKER, A.— <i>Significance of Cell-nuclei in the Processes of Heredity</i>	" 975
SELENKA, E.— <i>Development of the Opossum</i>	" 976
BELLONCI, J.— <i>Karyokinesis in Segmentation of Axolotl Ovum</i>	" 976
KÖLLIKER, A.— <i>Epidermic Cells of Tadpoles</i>	" 977
SWAEN, A.— <i>Early Developmental Stages of Torpedo</i>	" 977
RYDER, J. A.— <i>Position of the Yolk-Blastopore as determined by the Size of the Vitellus</i>	" 978
" " <i>Development of Viviparous Osseous Fishes</i>	" 978
BIONDI, D.— <i>Origin of the Spermatozooids in the Seminiferous Canals</i>	" 979
LIST, J. H.— <i>Wandering Cells in Epithelium</i>	" 980
BARFURTH, D.— <i>Comparative Histochemical Observations on Glycogen</i>	" 981

B. —INVERTEBRATA.

CARRIÈRE, J.— <i>Eyes of some Invertebrata</i>	Part 1 39
HOGG, J.— <i>Indestructible Infusorial Life</i>	" 39
LEIDY, J.— <i>Organisms in Ice</i>	" 40
SCHIMKEWITSCH, W.— <i>Development of the Heart in Vertebrates and Invertebrates</i>	Part 2 212
MÜLLENHOFF, K.— <i>Size of the Surfaces of Organs of Flight</i>	" 221
HALLIBURTON, W. D.— <i>Chitin as a Constituent of the Cartilages of Limulus and Sepia</i>	" 222
NIEMIEC, J.— <i>Morphology of Suckers of Animals</i>	Part 3 431
VERRILL, A. E.— <i>New Cœlenterates and Echinoderms</i>	" 432
ZACHARIAS, O.— <i>Fauna of the Pieces of Water of the Riesengebirge</i>	" 433
POTTS, E.— <i>Minute Fauna of Reservoirs</i>	" 433
RICHARD, J.— <i>Action of Cocain on Invertebrates</i>	Part 4 621
MACMUNN, C. A.— <i>Enterochlorophyll and Allied Pigments</i>	" 621
CONN, H. W.— <i>Marine Larvæ and their Relation to Adults</i>	Part 5 788

	PAGE
RANSOM, W. B.— <i>Cardiac Rhythm of Invertebrates</i>	Part 5 789
VARIGNY, H. DE— <i>Physiology of the Unstriated Muscles of Invertebratu</i>	,, 791
FRENZEL, J.— <i>Temperature Maxima for Marine Animals</i>	,, 791
McINTOSH, W. C.— <i>Phosphorescence of Marine Animals</i>	Part 6 981
VARIGNY, H. DE—"Latent Period" of unstriped Muscles in Invertebrates	,, 982
HASWELL, W. A.— <i>Symbiosis of Worms and Sea-Anemones</i>	,, 982
THOMPSON, D'A. W.— <i>Thompson's Bibliography of Protozoa, Sponges, Cœlenterata, Worms, and Molluscoida</i>	,, 983

Mollusca.

GIROD, P.— <i>Integument of Cephalopods</i>	Part 1 40
GRENACHER, H.— <i>Retina of Cephalopoda</i>	,, 41
PANETH, J.— <i>Histology of Pteropods and Heteropods</i>	,, 42
HADDON, A. C.— <i>Generative and Urinary Ducts in some Chitons</i>	,, 42
WEGMANN, H.— <i>Natural History of Haliotis</i>	,, 43
BERGH, R.—'Challenger' Nudibranchs	,, 43
EHRENBAUM, E.— <i>Structure and Formation of the Shell of Lamellibranchs</i>	,, 44
HALLIBURTON, W. D.— <i>Chitin as a Constituent of the Cartilages of Limulus and Sepia</i>	Part 2 222
HILGER, C., & O. BÜTSCHLI— <i>Eye of Gastropoda</i>	,, 222
LACAZE-DUTHIERS, H. DE— <i>Epipodium of Gastropoda</i>	,, 223
MOSELEY, H. N.— <i>Eyes of Chitonidæ</i>	,, 224
LACAZE-DUTHIERS, H. DE— <i>Nervous System and Embryonic Forms of Gadina garnotii</i>	,, 224
IHERING, H. v.— <i>Uropneustic Apparatus of Helicinæ</i>	,, 225
DAVIS, J. R.— <i>Habits of the Limpet</i>	,, 225
OSBORN, H. L.— <i>Gill in Neptunea</i>	,, 226
BERGH, R.— <i>The Genus Melibe</i>	,, 226
HOEK, P. P. C.— <i>Development of the Oyster</i>	,, 226
BARROIS, T.— <i>Byssoogenous Glands and Aquiferous Pores in Lamellibranchs</i>	,, 227
JOURDAIN, S.— <i>Nervous System of Embryos of Limacina, and the Relations of the Otocyst</i>	,, 228
GÜMBEL, v.— <i>Shells of Molluscs</i>	,, 228
NEUMAYR, M.— <i>Hinge of the Shells of Bivalves</i>	,, 229
MÜLLER, W.— <i>Shell of Lamellibranchiata</i>	,, 230
RÖSSLER, R.— <i>Radula of Cephalophorous Molluscs</i>	Part 3 434
HOYLE, W. E.— <i>New 'Challenger' Cephalopoda</i>	,, 434
NALEPA, A.— <i>Intercellular Spaces of Epithelium, and their significance in Pulmonate Mollusca</i>	,, 435
SIMROTH, H.— <i>Cyclostoma and Pomatias</i>	,, 436
HORST, R.— <i>Development of the Viviparous Edible Oyster</i>	,, 436
McINTOSH, W. C.— <i>Reproduction of Mytilus edulis</i>	,, 437
FLEISCHMANN, A.— <i>Movement of the Foot in Lamellibranchs</i>	,, 437
VIALLETON, L.— <i>Buccal Membrane of Cephalopoda</i>	Part 4 622
GRIFFITHS, A. B.— <i>Pancreatic Function of the Cephalopod Liver</i>	,, 622
PATTEN, W.— <i>Artificial Fecundation of Mollusca</i>	,, 623
BROCK, J.— <i>Development of Generative Organs of Pulmonata</i>	,, 623
FOL, H.— <i>Microscopic Anatomy of Dentalium</i>	,, 623

	PAGE
BOUTAN, L.— <i>Nervous System of Fissurella</i>	Part 4 624
POIRIER, J.— <i>Anatomy and Systematic Position of <i>Halia priamus</i> Risso</i> ..	,, 624
VAYSSIÈRE, A.— <i>Tectibranchiata of the Gulf of Marseilles</i>	,, 624
NEUMAYR, M.— <i>Classification of the Lamellibranchs</i>	,, 625
ZIEGLER, H. E.— <i>Development of <i>Cyclas cornea</i></i>	,, 625
CATTIE, J. T.— <i>Manner in which Lamellibranchs attach themselves to Foreign Objects</i>	,, 626
MACDONALD, J. D.— <i>General Characters of <i>Cymbulia</i></i>	,, 627
FRENZEL, J.— <i>Mid-gut Gland (Liver) of the Mollusca</i>	Part 5 792
HALLER, B.— <i>Renal Organ of the Prosobranchiata</i>	,, 793
BOUVIER, E. L.— <i>Nervous System of Buccinidæ and Purpuridæ</i>	,, 793
BOURNE, A. G.— <i>Communication of the Vascular System with the Exterior in Pleurobranchus</i>	,, 794
GRIESBACH, H.— <i>Inception of Water among Mollusca</i>	,, 794
SCHÜLER, P.— <i>Relations of Cavernous Spaces in the Connective Tissue of Anodonta to the Blood-vascular System</i>	,, 794
GRIFFITHS, A. B., & H. FELLOWS— <i>Organs of <i>Bojanus</i> in <i>Anodonta</i></i> ..	,, 795
OSBORN, H. L., & E. B. WILSON— <i>Mimicry among Marine Mollusca</i> ..	,, 795
VIALLETON, L.— <i>Fecundation in Cephalopoda</i>	Part 6 983
HOYLE, W. E.— <i>Loligopsis and Allied Genera</i>	,, 984
KRUKENBERG, C. F. W.— <i>Distribution of Chitin</i>	,, 984
HOYLE, W. E.— <i>New Cephalopoda</i>	,, 984
LACAZE-DUTHIERS, H. DE— <i>Anatomy of <i>Dentalium</i></i>	,, 984
BOUTAN, L.— <i>Anatomy of <i>Fissurella</i></i>	,, 985
VAYSSIÈRE, A.— <i>Respiration of <i>Truncatella</i></i>	,, 986
WILCOX, J.— <i>Spawning of <i>Fulgur perversus</i></i>	,, 986
BLUNDSTONE, E. R.— <i>Glycogen in "Vesicular Cells" of Molluscs</i>	,, 986

Molluscoida.

a. Tunicata.

SABATIER, A.— <i>Follicular and Granular Cells of Tunicates</i>	Part 1 44
ROULE, M.— <i>Two New Species of Simple Ascidiæ</i>	,, 45
HERDMAN, W. A.— <i>Evolution of the Blood-vessels of the Test in Tunicata</i>	Part 2 230
LACAZE-DUTHIERS, H. DE— <i>Microscopic Elements serving for the Determination of the <i>Cynthidæ</i></i>	,, 230
ULJANIN, B.— <i>Doliolum</i>	,, 231
" " <i>Structure of <i>Distaplia</i></i>	,, 233
LENDENFELD, R. v.— <i>Slimy Coatings of certain <i>Bottenias</i></i>	,, 233
MAURICE, C. H., & SCHULGIN— <i>Development of <i>Amaracium proliferum</i></i>	Part 3 437
SEELIGER, O.— <i>Development of Social Ascidiæ</i>	Part 4 627
BARROIS, J.— <i>Genetic Cycle and Germination of <i>Anchinia</i></i>	,, 630
ROULE, L.— <i>New Species of Simple Ascidiæ</i>	,, 631
BENEDEN, E. VAN, & C. JULIN— <i>Postembryonal Development of <i>Phallusia scabroides</i></i>	Part 5 795
JOURDAIN, S.— <i>The Synascidian <i>Diplosomidæ</i></i>	,, 796
SABATIER, M. A.— <i>Eggs of Ascidiæ</i>	Part 6 987

β. Polyzoa.

LANKESTER, E. R.— <i>Rhabdopleura</i>	Part 1 46
POTTS, E.— <i>New Species of <i>Paludicella</i></i>	,, 47
BUSK, G.— <i>Challenger's Polyzoa</i>	,, 47

	PAGE
BROWN, G. D.— <i>Use of the Chitinous Element in Classification</i>	Part 2 381
VIGELIUS, W. J.— <i>Morphology of the Bryozoa</i>	Part 3 438
LEIDY, J.— <i>Urnatella gracilis</i>	" 439
HINCKS, T.— <i>New Polyzoa</i>	" 439
HARMER, S. F.— <i>Structure and Development of Loxosoma</i>	Part 4 631
MACGILLIVRAY, P. H.— <i>Australian Bryozoa</i>	" 633
WATERS, W.— <i>Use of the Avicularian Mandible in the Determination of the Chilostomatous Bryozoa</i>	Part 5 774
LANKESTER, E. R.— <i>Polyzoa</i>	" 797
OSTROUMOFF, A.— <i>Metamorphosis of Cyphonautes</i>	" 798

γ. Brachiopoda.

SCHULGEN, M. A.— <i>Argiope Kowalevskii</i>	Part 1 49
JOUBIN, M.— <i>Digestive and Reproductive Organs of Crania</i>	Part 2 233
BLOCHMANN, F.— <i>Brachiopoda</i>	Part 3 440
JOUBIN— <i>Anatomy of Crania</i>	Part 4 633

Arthropoda.

α. Insecta.

CHESHIRE, F. R.— <i>The Apparatus for Differentiating the Sexes in Bees and Wasps. An Anatomical Investigation into the Structure of the Receptaculum seminis and adjacent parts. (Plates I. and II.)</i> ..	Part 1 1
CHATIN, J.— <i>Appendages of the Jaw of Mandibulate Insects</i>	" 50
RADOSZKOWSKI, O.— <i>Copulatory Apparatus of Male Bombus</i>	" 50
KAISER, W.— <i>Luminosity of the Glow-worm</i>	" 50
CHOLODKOVSKY, N.— <i>Testes of Lepidoptera</i>	" 51
" " <i>Malpighian Vessels of Lepidoptera</i>	" 51
COVERDALE, G.— <i>Action of Ammonia upon Lepidopterous Pigments</i> ..	" 52
OSTEN-SACKEN, C. R.— <i>Comparative Chætotaxy</i>	" 52
WILLISTON, S. W.— <i>Edible Dipterous Larvæ from Alkaline Lakes</i> ..	" 53
PATTEN, W.— <i>Development of Phryganids</i>	" 53
WITLACZIL, E.— <i>Development of Aphides</i>	" 53
ANTHONY, J.— <i>Structure of the Tongue of the Blow-fly</i>	" 174
LOWNE, B. T., & S. J. HICKSON— <i>Compound Vision and the Morphology of the Eye in Insects</i>	Part 2 234
ADOLPH, E.— <i>Wings of Hymenoptera</i>	" 234
CAMERON'S (P.) <i>British Phytophagous Hymenoptera</i>	Part 3 440
TICHOMIROV— <i>Composition of the Ova of Bombyx</i>	" 441
DAVIDSON, J.— <i>Influence of some Conditions on the Metamorphosis of the Blow-fly</i>	" 441
BARTHÉLEMY, A.— <i>Head and Mouth of the Larva of Insects</i>	" 441
FOREL, A.— <i>Sensorial Organs of the Antennæ of Ants</i>	" 441
POLETAJEW, N.— <i>Spinning Glands of Saw-flies</i>	" 442
BEAUREGARD, H.— <i>Alimentary Canal of Insects</i>	" 442
DIMMOCK, G.— <i>Scales of Coleoptera</i>	" 442
SCHIMKEWITSCH, W.— <i>Change of Sarcopsylla penetrans through Parasitism</i>	" 447
" " <i>New Genus of Sarcopsyllidæ</i>	" 447
OSBORNE, J. A.— <i>Embryology of Botys hyalinalis</i>	" 447
WILLS, L.— <i>Developmental History and Morphological Value of the Ova of Nepa cinerea and Notonecta glauca</i>	" 447

	PAGE
KÖHLER, R.— <i>Marine Hemipterous Insect, Æpophilus Bonnairei</i>	Part 3 488
HICKSON, S. J.— <i>Eye and Optic Tract of Insects</i>	Part 4 633
ZEILLER, R.— <i>Tracts of Insects resembling the Impressions of Plants</i> ..	,, 635
WALTER, A.— <i>Morphology of the Lepidoptera</i>	,, 635
PACKARD, A. S.— <i>Number of Abdominal Segments in Lepidopterous Larvæ</i>	,, 636
LEE, A. B.— <i>Structure of the Halteres of Diptera</i>	,, 636
ROMBOUTS, J. E.— <i>Movement of Flies on Smooth Surfaces</i>	,, 636
CREUTZBURG, N.— <i>Circulation in Ephemera Larvæ</i>	,, 637
SOMMER, A.— <i>Macrotoma plumbea</i>	,, 637
WRIGHT, H. G. A.— <i>Tongue of Blow-fly</i>	,, 751
BEAUREGARD, H.— <i>Natural Development of Cantharis</i>	Part 5 798
WIELOWIEFSKI, H. v.— <i>Formation of Ova in Pyrrhocoris</i>	,, 798
KOROTNEFF, A.— <i>Development of Gryllotalpa</i>	,, 798
VIALLANES, H.— <i>Optic Ganglion of Aeschna</i>	,, 800
POULTON, E. B.— <i>Nature of the Colouring of Phytophagous Larvæ</i> ..	,, 801
DEWITZ, H.— <i>How insects adhere to flat vertical surfaces</i>	,, 801
SLATER, J. W.— <i>Influence of Magnetism upon Insect Development</i> ..	Part 6 988
LENDENFELD, R. v.— <i>Flight of Insects</i>	,, 988
DAHL, J.— <i>Foot-glands of Insects</i>	,, 989
CHATIN, J.— <i>Morphology of the Mouth-organs of Hymenoptera</i>	,, 989
LUBBOCK, Sir J., & G. J. ROMANES— <i>Homing Faculty of Hymenoptera</i>	,, 990
LÖW, E.— <i>Insects as Fertilizers</i>	,, 990
PACKARD, A. S.— <i>Unusual number of Legs in the Caterpillar of Lagoa</i> ..	,, 990
HALLEZ, P.— <i>Orientation of the Embryo and Formation of the Cocoon of</i> <i>Periplaneta orientalis</i>	,, 991
GRIFFITHS, A. B.— <i>Physiology of the Alimentary Canal of Blatta peri-</i> <i>planeta</i>	,, 991
ROSSETER, T. B.— <i>Uses and Construction of the Gizzard of Larvæ of</i> <i>Corethra plumicornis</i>	,, 991
BEAUREGARD.— <i>Structure of the Wings of Vesicating Insects</i>	,, 992
RATTE, F.— <i>Larvæ and Larva-cases of some Australian Aphrophorida</i> ..	,, 992

β. Myriopoda.

SAZEPIN, B.— <i>Nerve-terminations on the Antennæ of Myriopoda</i>	Part 3 448
LATZEL, R.— <i>Myriopods of Austria</i>	Part 4 638

γ. Prototracheata.

KENNEL, J. v.— <i>Development of Peripatus</i>	Part 1 56
SEDGWICK, A.— <i>Development of Peripatus capensis</i>	Part 5 802

δ. Arachnida.

MICHAEL, A. D.— <i>Notes on the Life-histories of some of the little-known</i> <i>Tyroglyphide. (Plate III.)</i>	Part 1 19
MACLEOD, J.— <i>Structure of the Fore-gut of Arachnida</i>	,, 56
DAHL, F.— <i>Organs of Sense in Spiders</i>	,, 58
MACLEOD, J.— <i>Coxal Gland in the Phalangida</i>	,, 58
,, ,, <i>Hermaphroditism of the Male of Trombidium</i>	,, 58
HALLIBURTON, W. D.— <i>Chitin as a Constituent of the Cartilages of</i> <i>Limulus and Sepia</i>	Part 2 222
BERTKAU, P.— <i>Digestive Apparatus of Spiders</i>	,, 235
McMURRICH, J. P.— <i>Structure and Affinities of Phytopus</i>	,, 236

	PAGE
TROUSSERT, E. L.— <i>Acari inhabiting the Quill of Feathers</i>	Part 2 236
MACLEOD, J.— <i>Presence of a Coxal Gland in Galeodes</i>	" 236
MICHAEL, A. D.— <i>New British Oribatidæ (Plate VII.)</i>	Part 3 385
BLOCHMANN, F.— <i>Direct Nuclear Division in the Embryonic Investments</i> <i>of Scorpions</i>	" 448
BARROIS, J.— <i>Development of Chelifer</i>	449
HALLER, G.— <i>Descriptions of New Acarina</i>	" 449
LABOULBÈNE, A., & P. MÉGNIN— <i>Sphærogyra ventricosa</i>	" 449
KELLER, C.— <i>Spiders in Relation to Forestry</i>	" 450
LANKESTER, E. RAY— <i>New Hypothesis as to the Relationship of the</i> <i>Lung-book of Scorpio to the Gill-book of Limulus</i>	Part 4 639
PELSENER, P.— <i>Coxal Glands of Mygale</i>	" 639
DAHL, F.— <i>Anatomy of Spiders</i>	" 640
MCCOOK, H. C.— <i>Hibernation and Winter Habits of Spiders</i>	" 640
DAHL, F.— <i>Season Dimorphism in Spiders</i>	Part 5 803
TROUSSERT, E. L.— <i>Sarcoptidæ</i>	" 803
LANKESTER, E. R., W. B. S. BENHAM, & MISS E. J. BECK— <i>Muscular</i> <i>and Endoskeletal Systems of Limulus and Scorpio</i>	Part 6 992
SCHIMKEWITSCH, W., & P. BERTKAU— <i>Sense-Organs of Spiders</i>	" 993
BERTKAU, P., & F. KARSCH— <i>Seasonal Dimorphism in Spiders</i>	" 993
HASWELL, W. A.— <i>Australian Pycnogonida</i>	" 994

e. Crustacea.

PLATEAU, F.— <i>Absolute Force of the Muscles of Invertebrates</i>	Part 1 58
ANDREWS, E. A.— <i>Anatomy of the Spider Crab</i>	" 60
CLAUS, C.— <i>Circulation of Schizopoda and Decapoda</i>	" 60
FRENZEL, J.— <i>Enteric Glands in the Crustacea</i>	" 61
HOEK, P. P. C.—'Challenger' <i>Cirripedia</i>	" 61
SABATIER, A.— <i>Spermatogenesis in Decapod Crustacea</i>	Part 2 237
BLANC, H.— <i>Development of the Egg and Formation of the Primitive</i> <i>Layers in Cuma Rathkii</i>	" 238
PACKARD, A. S.— <i>Brain of Asellus and Cecidotea</i>	" 238
FOREL, F. A.— <i>Deep Fauna of Swiss Lakes</i>	" 238
STEBBING, T. R. R.— <i>New Amphipodous Crustacean</i>	" 238
HASWELL, W. A.— <i>Crustacean inhabiting the Tubes of Vermilia</i>	" 238
CHILTON, C.— <i>Marine Species of Philougria</i>	" 239
ZACHARIAS, O.— <i>Amœboid Movements of Spermatozoa of Polyphemus</i> <i>pediculus</i>	" 239
WRIGHT, R. R.— <i>Parasitic Copepod of the Clam</i>	" 239
VIALLANES, H.— <i>Optic Ganglion of Palinurus vulgaris</i>	Part 3 450
WEBER, M.— <i>Isopoda of the 'Willem Barents' Expedition</i>	" 450
HARTOG, M. M.— <i>Morphology of Cyclops and Relations of the Copepoda</i> <i>Smith, S. I.—New Decapod Crustacea</i>	" 452
SMITH, S. I.— <i>New Decapod Crustacea</i>	" 453
HESSE, R.— <i>New or Rare Crustacea</i>	" 453
MURDOCH, J.— <i>New Crustacea from Arctic Alaska</i>	" 453
CHILTON, C.— <i>New Species of Idotea</i>	" 454
CAR, L.— <i>Copepoda of the Adriatic</i>	" 454
POPPE, S. A.— <i>Copepoda of the North Pacific</i>	" 454
DELAGE, Y.— <i>Evolution of Sacculina</i>	" 454
SPENCER, W. B.— <i>Urinary Organs of Amphipoda</i>	Part 4 640

	PAGE
BLANC, H.— <i>Development of the Egg and Formation of the Primitive Layers in Cuma Rathkii</i>	Part 4 641
URBANOVICS, F.— <i>Development of Cyclops</i>	" 641
HOEK, P. P. C.— <i>Anatomy of the Cirripedia</i>	" 641
NASSONOW, N.— <i>Embryology of Balanus</i>	" 643
CLAUS, C.— <i>Morphology of Crustacea</i>	Part 5 803
SCHIMKEWITSCH, W.— <i>Development of Astacus</i>	" 805
GRIFFITHS, A. B.— <i>Extraction of Uric Acid Crystals from the Green Gland of Astacus fluviatilis</i>	" 805
SAINT-LOUP, R.— <i>Parasites of Mæna vulgaris</i>	" 805
PELSENEER, P.— <i>Nervous System of Apus</i>	" 805
PACKARD, A. S.— <i>Embryology of Limulus polyphemus</i>	" 806
DYBOWSKI, B.— <i>Crustacea of Lake Baikal</i>	" 807
SMITH, S. I.— <i>New Crustacean</i>	" 807
FRENZEL, J.— <i>Alimentary Canal of Crustacea</i>	Part 6 994
ISHIKAWA, C.— <i>Development of Atyephira compressa</i>	" 996
IMHOF, O. E.— <i>Sense-organs of Calanidæ</i>	" 997
CHILTON, C.— <i>Polymorphism in the Amphipoda</i>	" 997
HASWELL, W. A., & C. CHILTON— <i>Australian Crustacea</i>	" 998

Vermes.

FRAIPONT, J.— <i>Nervous System of Archiannelides</i>	Part 1 62
ORLEY, L.— <i>Respiration of the Serpulaceæ in Relation to their Tegumentary Pigments</i>	" 64
VIGUIER, C.— <i>Lower Animals of the Bay of Algiers</i>	" 65
MANSON, P.— <i>Metamorphosis of Filaria sanguinis hominis in the Mosquito</i>	" 65
PLATE, L.— <i>Structure of Rotatoria</i>	" 65
BEARD, J.— <i>Structure and Development of Myzostoma</i>	" 66
GRAFF, L. v.— <i>'Challenger' Myzostomida</i>	" 68
SPENGLER, J. W.— <i>Anatomy of Balanoglossus</i>	" 69
CONN, H. W.— <i>Formation of Trochosphere in Serpula</i>	Part 2 240
HASWELL, W. A.— <i>Anatomy of the Serpulea with Characteristics of Australian Species</i>	" 241
BERGH, R. S.— <i>Metamorphosis of Nephelis</i>	" 241
CALDWELL, W. H.— <i>Blastopore, Mesoderm, and Metameric Segmentation in Phoronis</i>	" 242
BEDDARD, F. E.— <i>Structure of the Body-wall in Earthworms</i>	" 243
LANG, A.— <i>Excretory Organs of Worms</i>	" 243
MÉGNIN, P.— <i>Sclerostoma bouharti</i>	" 244
HÜBRECHT, A. W.— <i>Excretory Organs of Nemertines</i>	" 244
NIEMIEC, J.— <i>Nervous System of Tænia</i>	" 244
LANG, A.— <i>Polycladidea</i>	" 245
REPIACHOFF, M.— <i>New Turbellarian</i>	" 248
ZACHARIAS, O.— <i>Reproduction and Development of Rotifer vulgaris</i>	" 249
HUDSON, C. T.— <i>New Floscularia</i>	" 250
KÜKENTHAL, W.— <i>Lymphoid Cells of Annelids</i>	Part 3 454
FIELDE, A. M.— <i>Tenacity of Life and Regeneration of Excised parts in Lumbricus terrestris</i>	" 455
NUSBAUM, J.— <i>Development of the Sexual Organs of Clepsine</i>	" 455
ROHDE, E.— <i>Muscles of Chætopoda</i>	" 456

	PAGE
JOURDAN, E.— <i>Elytra of some Polynoina</i>	Part 3 456
MURDOCH, J.— <i>New Arenicola from Arctic Alaska</i>	" 456
FOETTINGER, A.— <i>Histiobdella homari</i>	" 456
HORST, R.— <i>Problematical Organ in Chloræmidæ</i>	" 457
HASWELL, W. A.— <i>Segmental Organs of Serpula</i>	" 458
BÜTSCHLI, O.— <i>Origin of the Nervous System of Nematodes</i>	" 458
VILLOT, A.— <i>Host of the Larva of Echinorhyncus clavæiceps</i>	" 459
NIEMIEC, J.— <i>Nervous System of Tæniæ</i>	" 459
LOOSS, A.— <i>Anatomy of the Trematoda</i>	" 460
BATESON, W.— <i>Development of Balanoglossus Kowalevskii, and the Affinities of the Enteropneusta</i>	" 461
HUDSON, C. T.— <i>On four new Species of the Genus Floscularia, and five other new Species of Rotifera. (Plate XII.)</i>	Part 4 608
VOIGT, W.— <i>Oogenesis and Spermatogenesis in Branchiobdella</i>	" 643
LEIDY, J.— <i>New Parasitic Leech</i>	" 643
MICHAELSEN, W.— <i>Archenchytræus Möbii</i>	" 643
PRUVOT, G.— <i>Nervous System of Polychætous Annelids</i>	" 644
FEWKES, J. W.— <i>Larval forms of Spirorbis borealis</i>	" 644
SCHARFF, R.— <i>Skin and Nervous System of Priapulid and Halicryptus</i>	" 645
JOLIET, L.— <i>Development of Spherularia bombi</i>	" 646
FOURMENT, L.— <i>New Nematodes from Merlangus</i>	" 646
NIEMIEC, J.— <i>Nervous System of Bothriocephalidæ</i>	" 646
ZSCHORKE, F.— <i>Parasites of Fresh-water Fishes</i>	" 647
RAMSAY-WRIGHT, R.— <i>Free-swimming Sporocyst</i>	" 648
PEREYASLAWZEW, S.— <i>Development of Turbellaria</i>	" 648
SILLIMAN, W. A.— <i>Fresh-water Turbellaria of North America</i>	" 648
BATESON, W.— <i>Later Stages in the Development of Balanoglossus</i>	" 650
SAINT-LOUP, R.— <i>Organization of the Hirudinea</i>	Part 5 807
HATSCHEK, B.— <i>Development of the Head of Polygordius</i>	" 808
HALLEZ, P.— <i>Development of Nematodes</i>	" 809
LEUCKART, R.— <i>Development of Sphærulearia bombi</i>	" 810
LEIDY, J.— <i>New Bothriocephalus</i>	" 810
OUDEMANS, A. C.— <i>Circulatory and Nephridial Apparatus of the Nemertea</i>	" 810
SALENSKY, W.— <i>Development of Monopora vivipara</i>	" 811
BEDDARD, F. E.— <i>Nephridia of Acanthodrilus sp.</i>	" 813
ZACHARIAS, O.— <i>Nephridia of Microstoma lineare</i>	" 813
DUPLESSIS-GOURET, G.— <i>Fresh-water Monotidæ</i>	" 813
PERRONCITO, E.— <i>Action of Sodium Chloride on Cercariæ</i>	" 814
GRAFF, L. v.— <i>New Species of Myzostoma</i>	" 814
IMHOF, O. E.— <i>Pelagic and Fresh-water Rotatoria</i>	" 814
HASWELL, W. A.— <i>Symbiosis of Worms and Sea-Anemones</i>	Part 6 982
VIGUIER, C.— <i>Pelagic Annelids</i>	" 998
HARKER, A.— <i>Coloration of the Anterior Segments of the Maldanidæ</i>	" 999
BEDDARD, F. E.— <i>Nephridia of a new species of Earthworm</i>	" 999
SAINT-LOUP, R.— <i>Organization of Pachydriilus enchytræoides</i>	" 1000
HASWELL, W. A.— <i>Parasite of the Rock Oyster</i>	" 1000
REIGHARD, J.— <i>Anatomy and Histology of Aulophorus vagus</i>	" 1001
LINSTOW, O. v.— <i>Angiostomum</i>	" 1001
BELL, F. J.— <i>Gordius verrucosus</i>	" 1002
THOMAS, J. D.— <i>Experimental Breeding of Tænia Echinococeus</i>	" 1002

	PAGE
THOMAS, J. D.—Frequent occurrence of <i>Tænia Echinococcus</i> in Domestic Dogs	Part 6 1002
POIRIER, J.—Trematoda	" 1002
FRITSCH, G.—Anatomy of <i>Bilharzia hæmatobia</i>	" 1003
SONSINO, P.—Small Rod-like Cell-contents of certain Cercariæ	" 1003
IMHOF, O. E.—Deep-water Turbellarians of Lakes	" 1004
HÜBRECHT, A. W.—Development of Nemertines	" 1004
DELAGE, Y.—Nervous System of Acalomate Planarians and new Sensory Organ of <i>Convoluta Schultzi</i>	" 1004
LACAZE-DUTHIERS, H. DE— <i>Phænicurus</i>	" 1005
ZACHARIAS, O.—Relationship of Rotifers and Nematodes	" 1006
PEREYASLAVTSEFF, MISS C.—Development of Rotifers	" 1006
MILNE, W.—New Rotifer	" 1007

Echinodermata.

JICKELI, C. F.—Process resembling Copulation in <i>Comatula mediterranea</i>	Part 1 70
VERRILL, A. E.—New Cœlenterates and Echinoderms	Part 3 432
BELL, F. J.—Colton-spinner	" 462
WALTER, A.—Echinodermata of Ceylon	" 462
NACHTRIEB, H. F.—Phylogeny of Echinoderms	Part 4 651
DUNCAN, P. M., & W. P. SLADEN— <i>Arbaciadæ</i>	" 652
HAMANN, O.—Histology of <i>Asterida</i>	" 652
CARPENTER, P. H.—Stalked Crinoids of the 'Challenger' Expedition	" 653
PERRIER, E.—Development of <i>Comatula</i>	" 655
CARPENTER, P. H.—Vascular System of Echinoids	Part 5 814
PERRIER, E.—Ambulacra of Echinoderms	" 815
PROUHO—Anatomy of <i>Dorocidaris</i>	" 815
DUNCAN, P. M.—"Tag" of <i>Cælopleurus Maillardi</i>	" 815
CARPENTER, P. H.—New Species of <i>Metacrinus</i>	" 815
LAMPERT, K.—Variation in <i>Holothurians</i>	Part 6 1007
HAACKE, W.—Morphology of Echinoids	" 1008
PROUHO, H.—Larval Form of <i>Dorocidaris papillata</i>	" 1008
AYERS, H.—Structure and Functions of the <i>Sphæridia</i> of the <i>Echinoidea</i>	" 1009
DÖDERLEIN, L.—Japanese <i>Echinoidea</i>	" 1009
PERRIER, E.— <i>Brisingiæ</i> of the 'Talisman' Expedition	" 1009
LORIOU, P. DE— <i>Asteroidea</i> of Mauritius	" 1009

Cœlenterata.

LENDENFELD, R. V.—Local Colour-varieties of <i>Scyphomedusæ</i>	Part 1 71
" " <i>Scyphomedusæ</i> of the Southern Hemisphere	" 71
HAACKE, W.— <i>Pseudorhiza hæckelii</i>	" 71
LENDENFELD, R. V.—Development of the <i>Versuridæ</i>	" 72
" " <i>Flexor Muscle</i> of the <i>Hydroid Polyp</i> of <i>Sarsia radiata</i>	" 72
BOURNE, A. G.—Hydriform Phase of <i>Limnocodium Sowerbii</i>	" 72
THOMPSON, D'A. W.— <i>Hydroid Zoophytes</i> of the 'Willem Barents' Expedition, 1881	" 73
RIDLEY, S. O.—Structures Liable to Variation in the <i>Astrangiaceæ</i> (<i>Madreporaria</i>)	" 73
PARSONS, F. A.— <i>Hydroid Form</i> of <i>Limnocodium Sowerbii</i>	" 168

	PAGE
HARTLAUB, C.— <i>Origin of Sexual Cells in Obelia</i>	Part 2 250
BOURNE, A. G.— <i>Hydroïd Phase of Limnocoodium Sowerbii</i>	" 251
BROOKS, W. K.— <i>Life-history of Eutima mira</i>	" 251
VIGUIER, C.— <i>Tetraplatia volitans</i>	" 252
LENDEFELD, R. v.— <i>Australian Hydromedusæ</i>	" 252
KOWALEVSKY, N.— <i>Development of Lucernaria</i>	" 253
HERDMAN, W. A.— <i>Structure of Sarcodictyon</i>	" 253
VERRILL, A. E.— <i>New Calenterates and Echinoderms</i>	Part 3 432
THALLWITZ, J.— <i>Development of Male Germinal Cells in Hydroids</i>	" 462
BEDOT, M.— <i>Histology of Porpita mediterranea</i>	" 463
M'INTOSH, W. C.— <i>Identity of the two British Species of Cyanea</i>	" 464
MACMUNN, C. A.— <i>Chromatology of Actiniæ</i>	" 464
BALE, W. M.— <i>Australian Hydroïd Zoophytes</i>	Part 4 656
LENDEFELD, R. v.— <i>Calenterates of the Southern Seas</i>	" 656
MACMUNN, C. A.— <i>Chromatology of the Actiniæ</i>	" 656
FAUROT— <i>Adamsia palliata</i>	Part 5 816
HASWELL, W. A.— <i>Symbiosis of Worms and Sea-Anemones</i>	Part 6 982
FEWKES, J. W.— <i>Development of Agalma</i>	" 1009
CLAUS, C.— <i>Cyclical Development of Siphonophora</i>	" 1010
BEDOT, M.— <i>Structure of Velella</i>	" 1010
BELL, F. J.— <i>New Minyas</i>	" 1010
LENDEFELD, R. v.— <i>Metamorphosis of Bolina Chuni</i>	" 1010
" " <i>Beroïd of Port Jackson</i>	" 1011
" " <i>Australian Hydromedusæ</i>	" 1011

Porifera.

SOLLAS, W. J.— <i>Development of Halisarca lobularia</i>	Part 1 73
LENDEFELD, R. v.— <i>Mode of Digestion in Sponges</i>	" 74
VOSMAER, G. C. J.— <i>Note on Sponges</i>	" 75
POTTS, E.— <i>Modification in the form of Sponge Spicules</i>	" 75
LENDEFELD, R. v.— <i>Australian Sponges</i>	" 76
POTTS, E.— <i>Wide Distribution of some American Sponges</i>	" 76
LENDEFELD, R. v.— <i>Nervous System of Sponges</i>	Part 2 253
" " <i>Occurrence of Flesh-spicules in Sponges</i>	" 254
" " <i>Fibres of certain Australian Hircinidæ</i>	" 254
GOETTE, A.— <i>Development of Spongilla</i>	" 254
VEJDOVSKY, F.— <i>Observations on some Fresh-water Sponges</i>	" 255
CARTER, H. J.— <i>Spongilla fragilis, and a New Species of Spongilla</i>	" 255
SOLLAS, W. J.— <i>Structure of the Skeleton in the Anomocladina</i>	Part 3 464
MILLS, H.— <i>New American Fresh-water Sponges</i>	" 464
CARTER, H. J.— <i>New Sponges from South Australia</i>	" 465
SCHULZE, F. E.— <i>Relationship of Sponges to Choano-flagellata</i>	Part 4 657
CARTER, H. J.— <i>New Variety of Meyenia fluviatilis</i>	" 658
POTTS, E.— <i>New Fresh-water Sponge</i>	" 658
HANSEN, G. A.— <i>Sponges of the Norwegian North Sea Expedition</i>	" 658
MARSHALL, W.— <i>Calenterate Nature of Sponges</i>	Part 5 816
CARTER, H. J.— <i>Circulation in Spongida</i>	" 816
GOETTE, A.— <i>Development in Spongilla</i>	" 817
POTTS, E.— <i>New Fresh-water Sponge</i>	" 817
LENDEFELD, R. v.— <i>Histology and Nervous System of Calcareous Sponges</i>	Part 6 1011

	PAGE
MARSHALL, W.— <i>Reproduction of Spongilla lacustris</i>	Part 6 1011
LENDENFELD, R. v.— <i>The Phoriospongiæ</i>	" 1012
VOSMAER, G. C. J.— <i>Sponges of the 'Willem Barents' Expedition</i>	" 1013
LENDENFELD, R. v.— <i>New Sponges from South Australia</i>	" 1013
POTTS, E.— <i>Fresh-water Sponge from Mexico</i>	" 1014
LENDENFELD, R. v.— <i>Australian Sponges</i>	" 1014

Protozoa.

HERTWIG, R., & VOGT, C.— <i>Erythrospis agilis, a New Protozoon</i>	Part 1 77
KEL LICOTT, D. S.— <i>New Vorticellid</i>	" 78
RYDER, J. A.— <i>Chlorophylloid Granules of Vorticella</i>	" 78
HENNEGUY, L. F.— <i>New Ciliated Infusorian</i>	" 79
STOKES, A. C.— <i>New Fresh-water Infusoria</i>	" 80
ENTZ, G.— <i>Infusoria of the Gulf of Naples</i>	" 80
KERBERT, C.— <i>New Infusorian Parasite</i>	" 81
STOKES, A. C.— <i>New Parasitic Infusoria</i>	" 81
HENNEGUY, L. F.— <i>Flagellate Infusorian Parasitic on Trout</i>	" 82
KÜNSTLER, J.— <i>New Rhizopod</i>	" 82
SCHNEIDER, A.— <i>Ophryocystis bütschlii</i>	" 82
BELL, F. J.— <i>Peculiar variety of Acineta grandis</i>	" 167
HERTWIG, R.— <i>Erythrospis agilis</i>	Part 2 255
GRUBER, A.— <i>Protozoa of the Gulf of Genoa</i>	" 256
STOKES, A. C.— <i>New Fresh-water Infusoria</i>	" 257
" " <i>New Choano-Flagellata</i>	" 258
IMHOF, O. E.— <i>Flagellata (Dinobryon) as Members of the Pelagic Fauna of Lakes</i>	" 258
ROBOZ, Z. v.— <i>Calcutuba polymorpha</i>	" 258
LANKESTER, E. RAY— <i>Archerina Boltoni</i>	" 259
GRUBER, A.— <i>Studies in Amæbæ</i>	" 260
KÜNSTLER, J., & A. PITRES— <i>Psorosperm in the Human Pleural Cavity</i>	" 261
PARONA— <i>New and Little-known Protista</i>	" 261
WEISMANN, A.— <i>Immortality of Unicellular Organisms</i>	Part 3 466
GRUBER, A.— <i>Multinucleated Protozoa</i>	" 467
KLEBS, G.— <i>Peridinizæ</i>	" 468
POUCHET, G.— <i>Marine Peridinizæ</i>	" 469
ENTZ, G.— <i>Tintinnodea</i>	" 470
BLANC, H.— <i>Variability and Mode of Reproduction of Ceratium hirsutinella</i>	" 470
KEL LICOTT, D. S.— <i>New Infusoria</i>	" 470
STOKES, A. C.— <i>New Vorticella</i>	" 470
FOLIN, DE— <i>Structure of Reticular Rhizopods</i>	" 471
FRENZEL, J.— <i>Marine Gregarinidæ</i>	" 471
WITLACZIL, E.— <i>New Gregarine</i>	" 471
DANILEWSKI, B.— <i>Hæmatozoa in Cold-blooded Animals</i>	" 472
NUSSBAUM, M., & A. GRUBER— <i>Artificial Division of Infusoria</i>	" 472
GRUBER, A.— <i>Further Experiments on the Artificial Division of Infusoria</i>	Part 4 658
STOKES, A. C.— <i>Vorticellæ with two Contractile Vesicles</i>	" 659
" " <i>New Fresh-water Infusoria</i>	" 659
KENT, W. S.— <i>Infusorial Parasites of the Tasmanian White Ant</i>	" 662
BUCK, E.— <i>Unstalked Variety of Podophrya fixa</i>	" 662
LOCKWOOD, S.— <i>Pseudo-cyclosis</i>	" 663

	PAGE
DEECKE, T.— <i>New Protozoon</i>	Part 4 663
RUSCHHAUPT, G.— <i>Development of Monocystid Gregarines</i>	,, 665
LANKESTER, E. R.— <i>Protozoa</i>	Part 5 817
HALLIBURTON, W. D.— <i>Chemical Composition of Zoocytium of Ophrydium versatile</i>	,, 818
MÖBIUS, K.— <i>Freia Ampulla O. F. Müll., the Flask-animalcule</i>	,, 818
BALBIANI, E. G., & A. SCHNEIDER— <i>Anoplophrya circulans</i>	,, 818
STOKES, A. C.— <i>New Vorticella</i>	,, 819
IMHOF, O. E.— <i>Diffugia cratera</i>	,, 819
BLANCHARD, R.— <i>New Type of Sarcosporidia</i>	,, 820
ZACHARIAS, O.— <i>Experiments on Formation of Pseudopodia</i>	Part 6 1014
MAUPAS, E.— <i>Coleps hirtus</i>	,, 1015
BURCH, G. J.— <i>Supposed New Infusorian</i>	,, 1015
METSCHNIKOW, E.— <i>Erythrospis agilis</i>	,, 1016
FISCH, C.— <i>Flagellata and allied Organisms</i>	,, 1016
BÜTSCHLI, O.— <i>Marine Rhizopoda</i>	,, 1016
FOLIN, DE.— <i>New Condition of Reticular Rhizopods</i>	,, 1017
LENDENFELD, R. v.— <i>Amœba infesting Sheep</i>	,, 1018
WALLICH, G. C.— <i>Critical Notes on Amœbæ</i>	,, 1018
„ „ <i>Pseudocyclosis in Amœba</i>	,, 1019

BOTANY.

A.—GENERAL, including the Anatomy and Physiology of the Phanerogamia.

a. Anatomy.*

SCHAARSCHMIDT, J.— <i>Connection of Protoplasts and Intercellular Protoplasm</i>	Part 1 83
HILLHOUSE, W.— <i>Intercellular Relations of Protoplasts</i>	,, 84
VRIES, H. DE— <i>Plasmolysis</i>	,, 84
FLEMMING, W.— <i>Division of the Nucleus</i>	,, 86
FROMMANN, C.— <i>Structure, Vital Phenomena, and Reactions of the Cell</i>	,, 86
PENZIG, O.— <i>Cystoliths of Cucurbitaceæ</i>	,, 87
HANSEN, A.— <i>Chlorophyll</i>	,, 87
REINKE, J.— <i>Fluorescence of Chlorophyll in Leaves</i>	,, 88
TSCHIRCH, A.— <i>Morphology of Chlorophyll-grains</i>	,, 88
FRANK, B., F. TEMNE, & A. MEYER— <i>Formation of Gum in Wood</i>	,, 88
LANGÉ, J.— <i>Oil-receptacles in the Fruit of Umbelliferæ</i>	,, 89
HÖHNEL, F. v.— <i>Influence of Cortical Pressure on the Bast-fibre</i>	,, 89
KOCH, A.— <i>Course and Termination of the Sieve-tubes in the Leaves</i>	,, 90
KLERCKER, J. E. F. AF— <i>Mechanical Function of the Epidermis</i>	,, 91
BORODIN, J.— <i>Comparative Anatomy of Leaves of Chrysosplenium</i>	,, 91
JOHOW, F.— <i>Adaptation of Leaves to their environment</i>	,, 91
DU SABLON, M. L.— <i>Dehiscence of Anthers</i>	,, 91
VOLKENS, G.— <i>Calcareous Glands of Plumbaginæ</i>	,, 92

* This subdivision contains (1) Cell-structure and Protoplasm (including the Nucleus and Cell-division); (2) Other Cell-contents (including the Cell-sap and Chlorophyll); (3) Secretions; (4) Structure of Tissues; and (5) Structure of Organs.

	PAGE
HILDEBRAND, F.— <i>Protective Contrivances in the Bulbs of Oxalis</i> Part 1	92
BARY'S (A. DE) <i>Vegetative Organs of Phanerogams and Ferns</i> "	93
GUIGNARD, L.— <i>Structure and Division of the Nucleus</i> Part 2	262
BRASS, A., & FRAISSE, & H. FOL.— <i>Chromatin in Cell-division</i> "	263
FAMINTZIN, A.— <i>Siliceous Membrane with Properties of the Cell-wall</i> "	263
TSCHIRCH, A.— <i>Chemical Reactions of Chlorophyll</i> "	264
HANSEN, A.— <i>Colouring-matters of Flowers and Fruits</i> "	264
PICK, H.— <i>Red Pigment of Phanerogams</i> "	265
BACCARINI, P.— <i>Mechanical Function of Crystals of Calcium Oxalate</i> "	265
TSCHIRCH, A.— <i>Starch-meal</i> "	265
LEBLOIS, A.— <i>Function of Latex in the Compositæ</i> "	266
GROSLIK, S.— <i>Influence of Light on the Development of the Assimilating Tissue of Leaves</i> "	266
TIEGHEM, P. VAN.— <i>Cortical Fibrovascular Bundles of Viciæ</i> "	266
SCHENCK, H.— <i>Formation of Centrifugal Thickenings in the Walls of Hairs and in the Epidermis</i> "	267
MÖBIUS, K.— <i>Mechanical Sheaths to Secretion-receptacles</i> "	267
TIEGHEM, P. VAN.— <i>Curvature of Ovules</i> "	267
MEEHAN, T.— <i>Sexual Characters in Zinnia</i> "	267
" " <i>Elasticity in the Filaments of Helianthus</i> "	268
GRAY, A.— <i>Movements of Andræcium in Sunflowers</i> "	268
SCHRENK, J.— <i>Huustoria of Parasitic Phanerogams</i> "	268
MAYR, H.— <i>Organs of Secretion in Pines and Larches</i> "	269
MACFARLANE, J. M.— <i>Distribution of Honey-glands in Pitchered Insectivorous Plants</i> "	269
FOERSTE, A. F.— <i>Nectar-Glands of Apios tuberosa</i> "	269
WETHERED, E.— <i>Structure and Origin of Carboniferous Coal Seams (Plates VIII. and IX.)</i> Part 3	406
TANGL, E.— <i>Continuity of Protoplasm</i> "	473
GUIGNARD, L.— <i>Structure and Division of the Cell-nucleus</i> "	474
BERNIMOULIN, E.— <i>Division of the Cell-nucleus in Tradescantia</i> "	475
SCHWARZ, F.— <i>Behaviour of the Nucleus after Division</i> "	475
TSCHIRCH, A.— <i>Morphology of Chlorophyll-grains</i> "	475
WEISS, A.— <i>Soluble Yellow Pigment in the Petals of Papaver</i> "	476
" " <i>Spontaneous Movements of Pigment-bodies</i> "	476
KRAUS, C.— <i>Excretion of Healing Substances into Wounds</i> "	476
SCHWENDENER, S.— <i>Firmness of Tissues</i> "	476
ZIMMERMANN, A.— <i>Behaviour of the Optical Axes of Elasticity of Cell-walls under Tension</i> "	476
FISCHER, A.— <i>Sieve-tube System of Cucurbitaceæ</i> "	477
FAMINTZIN, A.— <i>Development of the Sclerenchymatous Fibres of the Oleander</i> "	478
KRABBE, G.— <i>Growth of the Thickening-ring in Exogens</i> "	478
ROTHROCK, J. T.— <i>Internal Cambium Ring in Gelsemium sempervirens</i> "	478
TSCHIRCH, A.— <i>Penetration of the Mechanical Ring for the Transport of Food-material</i> "	479
MÜLLER, C.— <i>Stolons of Sagittaria sagittæfolia</i> "	479
VUILLEMIN, P.— <i>Anatomical Structure of the Stem of Compositæ</i> "	480
COSTANTIN, J.— <i>Structure of the Stem of Aquatic Plants</i> "	480
HILLER, G. H.— <i>Epidermis of Petals</i> "	481

	PAGE
STEINBRINCK, C.— <i>Bursting of Ripe Fruits</i>	Part 3 481
GODFRIN, J.— <i>Comparative Anatomy of the Cotyledons and Endosperm</i> ..	,, 481
JURANYI, L.— <i>Pollen of Gymnosperms</i>	,, 484
BECCARI, O.— <i>Ant-harbours of Plants</i>	,, 484
KRASAN, F.— <i>Malformations caused by Insects</i>	,, 484
BOWER (F. O.) & (S. H.) VINES'S <i>Practical Botany</i>	,, 484
VBIES, H. DE.— <i>Circulation and Rotation of Protoplasm as a means of Transport of Food-material</i>	Part 4 665
GUIGNARD, L.— <i>Division of the Cell-nucleus in Plants and Animals</i> ..	,, 666
FROMMANN, C.— <i>Changes in the Cell-walls of Epidermal Cells and in the Hairs of Pelargonium zonale</i>	,, 668
CARNOY'S (J. B.) <i>Biology of the Cell</i>	,, 669
REINKE, J.— <i>Decomposition of Solutions of Chlorophyll by Light</i>	,, 669
WEGSCHEIDER, R.— <i>Spectra of the Pigments of Green Leaves and their Derivatives</i>	,, 670
WORTMANN, J.— <i>Red Pigment in Flowering Plants</i>	,, 670
ARNAUD— <i>Identity of the Orange-red Colouring Matter of Leaves with Carotine</i>	,, 670
CUBONI, G.— <i>Formation of Starch in the Leaves of the Vine</i>	,, 670
FISCHER, A.— <i>Starch in Vessels</i>	,, 671
MAUMENE, E. J.— <i>Presence of Manganese in Plants</i>	,, 671
GIRARD, A.— <i>Nutritive Properties of the various portions of the Grain of Wheat</i>	,, 671
PFITZER, E.— <i>Assimilating Cavities in the interior of Tubers of Bolbo- phyllum</i>	,, 671
HEINRICHER, E.— <i>Idioblasts containing Albuminoids in some Cruciferæ</i> ..	,, 672
TIEGHEM, P. VAN— <i>Annular and Spiral Cells of Cactaceæ</i>	,, 672
HECKEL, E.— <i>Formation of Secondary Cortex</i>	,, 673
MOROT, L.— <i>Pericycle of the Root, Stem, and Leaves</i>	,, 673
SCHENCK, H.— <i>Changes of Structure in Land-Plants when growing submerged</i>	,, 674
COSTANTIN, J.— <i>Epidermis of the Leaves of Aquatic Plants</i>	,, 674
MARIÉ, P.— <i>Structure of Ranunculaceæ</i>	,, 674
RUSBY, H. H.— <i>Opening of the Anthers in Ericaceæ</i>	,, 675
VESQUE, J.— <i>Anatomy of the Leaf in Vismieæ</i>	,, 675
HEINRICHER, E.— <i>Reduced Organ in Campanula</i>	,, 675
SAVASTANO, L.— <i>Hypertrophy of the Bud-cones of the Carob</i>	,, 675
TOWNSEND, F.— <i>Homology of the Floral Envelopes in Gramineæ and Cyperaceæ</i>	,, 676
DUCHARTRE, P.— <i>Bulbils of Begonia socotrana</i>	,, 676
MASTERS, M. T.— <i>Petalody of Ovules</i>	,, 676
HABERLANDT'S (G.) <i>Physiological Anatomy of Plants</i>	,, 677
BEHRENS'S (W. J.) <i>Text-book of General Botany</i>	,, 677
RUSSOW, E.— <i>Protoplasm in the Intercellular Spaces</i>	Part 5 820
HENNUN, J. O.— <i>Forms of Cells</i>	,, 820
ZACHARIAS, E.— <i>Structure of the Nucleolus</i>	,, 821
GUIGNET— <i>Chlorophyll and its Combinations</i>	,, 822
BORODIN, J. P.— <i>Crystals in the Leaves of Leguminosæ</i>	,, 823
TIEGHEM, P. VAN— <i>Secreting Canals of Plants</i>	,, 823
TICHOMIROV, W. A.— <i>Peculiar Structures in the Flesh of the Date</i> ..	,, 824

	PAGE
PAX, F.— <i>Anatomy of Euphorbiacæ</i>	Part 5 824
KLERCKER, J. E. F. AF— <i>Anatomical Structure and Development of</i> <i>Ceratophyllum</i>	" 825
ZAILBRUCKNER, A.— <i>Lenticels</i>	" 825
PFURTSCHELLER, P.— <i>Anatomy of the Wood of Conifers</i>	" 825
FISCHER, H.— <i>Comparative Anatomy of the Tissue of the Medullary Rays</i> <i>and Annual Zones of Growth in Conifers</i>	" 826
MARKFELDT, O.— <i>Behaviour of the Leaf-trace-bundles of Evergreen</i> <i>Plants as the stem increases in thickness</i>	" 826
TIEGHEM, P. VAN— <i>Gum-canals of the Sterculiacæ</i>	" 827
HÖHNEL, F. V.— <i>Striated Woody Tissue</i>	" 828
HÉRAIL, J.— <i>Structure of Stem of Strychnos</i>	" 828
TSCHIRCH, A.— <i>Mechanical Tissue-system</i>	" 828
BACHMANN, E.— <i>Structure and Function of the Aril in certain Legu-</i> <i>minosæ</i>	" 829
WORONIN, M.— <i>Leaves of Statice monopetala</i>	" 829
EBELING, M.— <i>Absorbing Organs of Albuminous Seeds</i>	" 829
STRASBURGER, E.— <i>Embryo-sac of Santalum and Daphne</i>	" 830
BACCARINI, F.— <i>Morphology of the Receptacle</i>	" 831
BALDINI, A.— <i>Spur of Cucurbitacæ</i>	" 831
ADLERZ, E.— <i>Anatomy of the Fruit of Ranunculacæ</i>	" 831
CUGINI, G.— <i>Anatomy of the Female Inflorescence of Dion edule</i>	" 832
COSTANTIN, J.— <i>Influence of the Medium on the Structure of Roots</i>	" 832
SABLON, LECLERC DU— <i>Structure and Dehiscence of Anthers</i>	" 832
GRAVIS, A.— <i>Vegetative Organs of Urtica dioica</i>	" 833
LABORIE, E.— <i>Anatomy of Peduncles compared with that of the Primary</i> <i>Axes and of Petioles</i>	" 833
HEGELMAIER, F.— <i>Wolffia microscopica</i>	" 834
LOEW, O.— <i>Various Degrees of Resistance in Protoplasm</i>	Part 6 1019
GILTAY, E.— <i>Peculiar Structure of Protoplasm in the Paratracheal</i> <i>Parenchyma</i>	" 1020
HARTWICH, C.— <i>Tannin and Lignin in Galls</i>	" 1020
GILBERT, J. H., & W. J. RUSSELL— <i>Conditions of the Development and</i> <i>of the Activity of Chlorophyll</i>	" 1020
FISCHER, A.— <i>Sieve-tubes in the Leaves of Dicotyledons</i>	" 1020
WILSON, A. S., & G. MURRAY—"Sclerotoids" of Potato	" 1022
SCHWENDENER, S.— <i>Laticiferous Vessels</i>	" 1022
KNY, L., & A. ZIMMERMANN— <i>Spiral Cells of Nepenthes</i>	" 1023
COSTANTIN, J., & L. MOROT— <i>Fibrovascular Bundles of Cycadææ</i>	" 1023
PENHALLOW, D. P.— <i>Relation of Annual Rings of Exogens to Age</i>	" 1023
HECKEL, E., & J. CHAREYRE— <i>Anatomy of Pitcher-plants</i>	" 1024
KAMIENSKI, F.— <i>Vegetative Organs of Monotropa</i>	" 1025
FLEISCHER, E.— <i>Protection of Leaves from excessive Transpiration</i>	" 1025
BRIOZI, G.— <i>Heterophylly of Eucalyptus globulus</i>	" 1025
BEYERINCK, W.— <i>Cecidomyia-galls on Poa</i>	" 1026
BESSEY, C. E.— <i>Opening of the Flowers of Desmodium sessilifolium</i>	" 1026
" " <i>Inflorescence of Cuscuta glomerata</i>	" 1026
COULTER, J. M.— <i>Relation of Ovary and Perianth in the development of</i> <i>Dicotyledons</i>	" 1026
MEEHAN, T.— <i>Elasticity in the Fruit of Cactacææ</i>	" 1027
" " <i>Use of Spines in Cactuses</i>	" 1027

β. Physiology.*

	PAGE
ADRIANOWSKY, A.— <i>Influence of Light on the Germination of Seeds</i> .. Part 1	93
WOLLNY, E.— <i>Effect of Depth of Sowing on the Germination and Growth of Plants</i>	93
HELLRIEGEL— <i>Influence of Water on the Growth of Plants</i>	93
MÖLLER, H.— <i>Respiration of Plants</i>	94
BONNIER, G., & L. MANGIN— <i>Respiration of Tissues not containing Chlorophyll</i>	94
SCHÜTZENBERGER, P.— <i>Respiratory Combustion</i>	95
AMBRONN, H.— <i>Heliotropic and Geotropic Torsion</i>	95
FIRTSCH, G.— <i>Geotropic Sensitiveness of the Apex of the Root</i>	96
MOLISCH, H.— <i>Deviation of Roots from their Normal Direction through the Influence of Gases</i>	96
SCHULZE, C.— <i>Albuminoid Constituents of Plants</i>	97
VRIES, H. DE— <i>Periodical Formation of Acids in Succulent Plants</i>	97
JORISSEN, A.— <i>Production of Hydrocyanic Acid by Plants</i>	97
BRASSE, L.— <i>Presence of Amylase in Leaves</i>	97
SORBY, H. C.— <i>Autumnal Tints of Foliage</i>	97
DETMER, W.— <i>Formation and Fermenting Action of Diastase</i>	98
KRUTTSCHNITT, J., & N. L. BRITTON— <i>Fecundation of Ovules in Angiosperms</i>	Part 2 270
TREUB, M.— <i>Embryo of Cycadææ</i>	270
„ „ <i>Embryo of Barringtonia</i>	271
MEEHAN, T.— <i>Fertility of Hybrids</i>	271
JORISSEN, A.— <i>Germination of Flax and Sweet Almond</i>	271
RULF, P.— <i>Behaviour of Tannin in Germination</i>	272
WETTSTEIN, R. v.— <i>Laws of Growth of Vegetable Organs: Roots</i>	272
WIESNER, J.— <i>Motions of Roots during Growth</i>	272
FRASER, A. T.— <i>Autumnal Foliage</i>	272
BONNIER, G., & L. MANGIN— <i>Respiration of Germinating Seeds</i>	272
DUFOUR, J.— <i>Influence of Gravitation on the Movements of Stamens</i>	272
MER, E.— <i>Nyctitropic Movements of Leaves</i>	273
WIESNER, J.— <i>Mechanical Explanation of Spontaneous Nutations</i>	273
WORTMANN, J.— <i>Secondary Geotropic Phenomena</i>	273
ELFVING, F.— <i>Ascent of Water in Plants</i>	274
EMMERLING, A.— <i>Formation of Albumen in Green Plants</i>	274
DETMER, W.— <i>Formation of Hydrochloric Acid in Plants</i>	274
LAWES, J. B.— <i>Source of the Nitrogen in Plants</i>	275
BERTHELOT & ANDRÉ— <i>Formation of Nitrates in Plants</i>	275
JORISSEN, A.— <i>Reducing Properties of Seeds and Formation of Diastase</i>	276
CARNOL, A.— <i>Composition of Mineral Oil in relation to the Plants which have produced it</i>	276
JOHANNSEN, W.— <i>Development of the Endosperm in Hordeum</i>	Part 3 485
HELLRIEGEL, H.— <i>Influence of Light and Heat on Plant Development</i>	485
„ „ <i>Evaporative Surfaces of Plants and Influence of Moisture in Soils on Plant Growth</i>	486

* This subdivision contains (1) Reproduction (including the formation of the Embryo and accompanying processes); (2) Germination; (3) Nutrition; (4) Growth; (5) Respiration; (6) Movement; and (7) Chemical processes (including Fermentation).

	PAGE
KORSCHOLT, P.— <i>Apical Growth of Phanerogams</i>	Part 3 487
ZIMMERMANN, A.— <i>Causes of Anisotropy of Organic Substances</i>	" 487
PHIPSON, T. L.— <i>Chemical Phenomena of the Respiration of Plants</i>	" 488
BONNIER, G., & L. MANGIN— <i>Respiration of Leaves in Darkness</i>	" 488
VESQUE, J.— <i>Movement of Ascending Sap</i>	" 489
GODLEWSKI, E.— <i>Movement of Water in Plants</i>	" 490
WESTERMAIER, M.— <i>Importance of Dead Tubes and Living Cells for the Conduction of Water in Plants</i>	" 490
HANSEN, A.— <i>Supply of Air to the Roots and Root-pressure</i>	" 490
RIMMER, F.— <i>Nutations of Seedlings</i>	" 490
STAHL, E.— <i>Influence of Light on Geotropism</i>	" 491
HANSEN, A.— <i>Peptonizing Ferments in Secretions</i>	" 491
HOFFMANN, H.— <i>Production of Male and Female Plants</i>	Part 4 677
JÖNSSON, B.— <i>Fertilization of Naias and Callitriche</i>	" 677
BUYSMAN— <i>Influence of direct Sunlight on Vegetation</i>	" 678
DEHÉRAIN, P. P., & L. MAQUENNE— <i>Absorption of Oxygen and Evolution of Carbon dioxide in Leaves kept in Darkness</i>	" 678
BONNIER, G., & L. MANGIN— <i>Variation of Respiration with Development</i>	" 679
WORTMANN, J.— <i>Thermotropism of Roots</i>	" 679
SCHIEIT, M.— <i>Air in Water-conducting Wood</i>	" 679
LADUREAU, A.— <i>Ammoniacal Ferment</i>	" 680
DIETZELL, B. E.— <i>Source of the Nitrogen of the Leguminosæ</i>	" 680
ATWATER, W. O.— <i>Absorption of Atmospheric Nitrogen by Plants</i>	" 680
CORRY, T. H.— <i>Fertilization of Asclepias Cornuti</i>	Part 5 834
KRAUS, G.— <i>Blooming of Arum italicum</i>	" 835
BRONOLD, A., HOLDEFLEISS, & SCHÖLLER— <i>Influence of Electricity on the Growth of Plants</i>	" 835
BONNIER, G., & L. MANGIN— <i>Respiration of Plants</i>	" 835
" " <i>Respiration of Plants at different seasons</i>	" 836
BRUNCHORST, J.— <i>Galvanotropism of Roots</i>	" 836
JANSE, J. M.— <i>Movement of Water in Plants</i>	" 836
KRAUS, C.— <i>"Bleeding" of Parenchymatous Tissues</i>	" 837
BURGERSTEIN, A.— <i>Physiological and Pathological Effect of Camphor on Plants</i>	" 837
TIMIRIAZEFF, C.— <i>Chemical and Physiological Action of Light on Chlo- rophyll</i>	" 837
STRASBURGER, E.— <i>Theory of Descent</i>	Part 6 1027
STURTEVANT, E. L.— <i>Hybridization and Cross-breeding of Plants</i>	" 1028
FOERSTE, A. E.— <i>Fertilization of the Wild Onion</i>	" 1028
BARNES, C. R.— <i>Fertilization in Campanula americana</i>	" 1028
DUCHARTRE, P.— <i>Influence of Want of Moisture on the Growth of the Chinese Yam</i>	" 1029
BURRILL, T. J.— <i>Mechanical Injury to Trees by Cold</i>	" 1029
JAMIESON, T.— <i>Essential Food of Plants</i>	" 1029
MARTIN, S.— <i>Digestion of Proteids in Plants</i>	" 1030
HANSEN, A.— <i>Ferments and Enzymæ</i>	" 1031
VESQUE, J.— <i>Ascent of Sap</i>	" 1031
RISCHAWI, L.— <i>Galvanotropism</i>	" 1032
HANSEN, A.— <i>Transpiration-currents</i>	" 1032
KNOP, W.— <i>Absorption by the Plant of Non-nutrient Substances</i>	" 1032
SCHRODT, J.— <i>Bursting of the Sporangium of Ferns and the Anther of Flowering Plants</i>	" 1032

B.—CRYPTOGAMIA.

	PAGE
SCHAARSCHMIDT, G.— <i>Cell-wall-thickenings and Cellulin-grains in Chara and Vaucheria</i>	Part 5 838
Cryptogamia Vascularia.	
BABY'S (A. DE)— <i>Vegetative Organs of Phanerogams and Ferns</i>	Part 1 93
DRUERY, E. T., F. O. BOWER, & W. T. T. DYER— <i>Apospory in Ferns</i> ..	,, 99
SOUTHWORTH, E. A.— <i>Stomata of Equisetum</i>	,, 99
DU SABLON, LECLERC— <i>Dehiscence of the Sporangia in Vascular Cryptogams</i>	Part 2 276
KLEIN, L.— <i>Development of Organs and Growth at the Growing-Point of Dorsicentral Ferns</i>	,, 276
TREUB, M.— <i>Prothallium of Lycopodium</i>	,, 277
FRANCHET, A.— <i>South American Isoetes</i>	,, 279
BRUCHMANN, H.— <i>Development of the Vegetative Organs of Selaginella spinulosa</i>	,, 279
DRUERY, C. T., & F. O. BOWER— <i>Apospory in Ferns—Singular Mode of Development in Athyrium Filix-femina</i>	Part 3 491
TERLETZKI, P.— <i>Anatomy of the Vegetative Organs of Struthiopteris Germanica and Pteris aquilina</i>	,, 492
CAMPBELL, D. H.— <i>Third Coat in the Spores of the Genus Onoclea</i> ..	,, 493
ZEILLER, R.— <i>Fructification of Sigillaria</i>	,, 493
„ „ <i>Affinities of Laccopteris</i>	Part 4 681
DIEULAFAIT— <i>Composition of the Ash of Equisetaceæ, and its bearing on the Formation of Coal</i>	,, 681
TÖPFFER, A.— <i>Transitional Equisetum</i>	,, 681
LACHMANN, P.— <i>Apical Growth of the Root of Todea</i>	Part 5 839
BRUCHMANN, H.— <i>Prothallium of Lycopodium</i>	,, 839
GALLOWAY, D. H.— <i>Spores of Lycopodium</i>	,, 839
CROZIER, A. A.— <i>Node of Equisetum</i>	,, 840
SCHRODT, J.— <i>Bursting of the Sporangium of Ferns, and the Anther of Flowering Plants</i>	Part 6 1032
LACHMANN, P.— <i>Root-organs of Nephrolepis</i>	,, 1033
BOWER, F. O.— <i>Apex of the Root in Osmunda and Todea</i>	,, 1033
PRANTL, K.— <i>Structure and Classification of Ophioglossaceæ</i>	,, 1034
BOWER, F. O.— <i>Morphology of Phylloglossum Drummondii</i>	,, 1034
Muscineæ.	
PHILIBERT— <i>Peristome of Mosses</i>	Part 1 100
MÜLLER, K.— <i>Solmsiella, a new genus of Mosses</i>	,, 101
LEITGEB, H.— <i>Spore-coats and Germination of Hepaticæ</i>	,, 101
HY, L'ABBÉ— <i>Archegonium and Sporogonium of Muscineæ</i>	Part 2 279
BRIDLER, J., & G. BECK— <i>Trochobryum, a new genus of Seligeriaceæ</i> ..	,, 281
BOULAY, M.— <i>Mosses of France</i>	,, 281
WARNSTOFF, C.— <i>European Sphagnaceæ</i>	,, 281
STEPHANI, F.— <i>Radula</i>	,, 282
OLTMANN, F.— <i>Movement of Water in Mosses</i>	Part 3 493
HABERLANDT, G.— <i>Conduction of Water in the Stem of Mosses</i>	Part 4 681
SCHLIEPHACKE, K.— <i>Pottia Güssfeldti, a new Moss</i>	,, 682
SABLON, L. DU— <i>Elaters of Hepaticæ</i>	,, 682
„ „ <i>Development of the Sporangium of Frullania</i>	Part 5 840

	PAGE
BREIDLER, J., & G. BECK— <i>Trochobryum</i> , a new genus of <i>Mosses</i> Part 5	841
LEITGEB, H.— <i>Exudation of Water from the Female Receptacle of Corsinia</i> Part 6	1035
PHILIBERT— <i>Peristome of Bryaceæ</i> „	1035
VENTURI, G.— <i>Spores of Pottia</i> „	1036
BARNES, C. R.— <i>Stomata of Marchantia</i> „	1036
SCHLIEPHACKE, K.— <i>Pleurocisia</i> , a new genus of <i>Mosses</i> „	1036
MÜLLER, C.— <i>Mosses of Terra-del-Fuego</i> „	1036
Characeæ.	
SCHLAARSCHMIDT, G.— <i>Cell-wall-thickenings and Cellulin-grains in Chara</i> <i>and Vaucheria</i> Part 5	838
Lichenes.	
CROMBIE, J. M.— <i>Algo-Lichen Hypothesis</i> Part 1	103
FÜNFSTÜCK, M.— <i>Development of the Apothecia of Lichens</i> Part 3	499
HARTOG, M. M.— <i>Nature of Lichens</i> „	500
ZUKAL, H.— <i>Structure of Lichens</i> Part 4	687
CROMBIE, J. M.— <i>Algo-Lichen Hypothesis</i> „	688
FÜNFSTÜCK, M.— <i>Formation of Thalli on the Apothecia of Peltidea</i> <i>aphthosa</i> Part 5	843
MÜLLER, J.— <i>Müller's 'Contributions to Lichenology'</i> Part 6	1042
FORSSELL, K. B. J.— <i>Anatomy and Development of Lecanora granatina</i> ..	1043
Algæ.	
ARDISSONE, F.— <i>Floridææ of the Mediterranean</i> Part 1	102
LAGERHEIM, G.— <i>Occurrence of Chromatophores in the Phycochromaceæ</i> ..	102
SCHLAARSCHMIDT, J.— <i>Gongrosira</i> „	103
LANZI, M.— <i>Diatoms from Lago Trajano</i> „	103
KAIN, C. H.— <i>Schmidt's 'Atlas der Diatomaceen-Kunde'</i> „	103
HANKS, H. G.— <i>New Diatomaceous Deposit at Santa Monica</i> „	173
COX, J. D.— <i>Structure of Diatoms</i> „	168 & 175
HANSEN, A., & A. TSCHIRCH— <i>Chlorophyll of Fucaceæ</i> Part 2	282
MARCHESETTI, C. DI— <i>New Instance of Symbiosis</i> „	282
SCHLAARSCHMIDT, G.— <i>Vegetative Changes of Form in Chlorosporeæ</i> ..	283
WILL, H.— <i>Anatomy of Macrocystis</i> „	284
SCHLAARSCHMIDT, G.— <i>Hibernation of Zygnemaceæ</i> „	284
BATES, F.— <i>Sexuality in the Zygnemaceæ</i> „	285
ROSENWINGE, L. K.— <i>Parthenogenesis in Spirogyra</i> „	285
WOLLNY, R.— <i>Geminella interrupta</i> „	285
FLAHAULT, C.— <i>Lithoderma fontanum</i> , a new <i>Fresh-water Phæospore</i> ..	285
DURKEE, R. P. H.— <i>Structure of the Diatom Valve</i> „	286
WALLICH, G. C.— <i>Structure of Diatoms</i> „	286
LAGERSTEDT'S (N. G. W.) <i>Diatom-synonymy</i> „	287
MACADAM, W. T.— <i>Diatomaceous Deposits in Scotland</i> „	287
KITTON, F.— <i>Asteromphalus flabellatus</i> „	380
COX, J. D.— <i>Structure of the Diatom Shell, Siliceous Films too thin to</i> <i>show a broken edge</i> Part 3	398
SIRODOT, S.— <i>Bactrachospermum</i> „	494
HIERONYMUS, G.— <i>Stephanosphæra pluvialis</i> „	495
HANSGIRG, A.— <i>Classification of the Lower Algæ</i> „	495
WOLLE, F.— <i>New Fresh-water Desmids</i> „	497
KITTON, F.— <i>New Diatoms from the "Saugschiefer" of Dubrávica</i> ..	497

	PAGE
MÜLLER, O.— <i>Cell-division in Melosira</i>	Part 3 497
CASTRACANE, F.— <i>Deep-sea Diatoms</i>	498
" " <i>Fossil Diatoms</i>	498
HEURCK, H. VAN— <i>Structure of the Diatom-valve</i>	498
MILLS, H.— <i>Filamentous Projections on Diatoms</i>	571
HICK, T.— <i>Protoplasmic Continuity in the Fucaceæ</i>	Part 4 682
BERTHOLD, G.— <i>Fertilization of Cryptonemiaceæ</i>	683
WILLE, N.— <i>Sieve-hyphæ in Algæ</i>	684
HANSGIRG, A.— <i>Algæ of Bohemia</i>	684
SOLLA, R. F.— <i>Pelagic Algæ</i>	684
RABENHORST'S <i>Cryptogamic Flora of Germany (Marine Algæ)</i>	685
TAYLOR, H., & F. KITTON— <i>Diatoms and Bladderwort</i>	685
MÜLLER, O.— <i>Structure of the Cell-wall of Diatoms (Fig. 135)</i>	685
VAN HEURCK'S (H.) <i>Synopsis of the Diatoms of Belgium</i>	686
SCHAARSCHMIDT, G.— <i>Cell-wall-thickenings and Cellulin-grains in Chara and Vaucheria</i>	Part 5 838
WILLE, N.— <i>Physiological Anatomy of Algæ</i>	841
MÖBIUS, M.— <i>New Epiphytic Florideæ</i>	842
BUFFHAM, T. H.— <i>Conjugation of Rhabdonema arcuatum</i>	842
PRINZ, W.— <i>Sections of Diatoms from the Jutland "Cementstein"</i>	843
PICCONE, A.— <i>Phytophagous Fishes as Disseminators of Algæ</i>	843
TURNER, W. B.— <i>Some new and rare Desmidiæ (Plates XV. and XVI.)</i>	Part 6 933
HANSGIRG, A.— <i>Polymorphism of Algæ</i>	1037
HANSEN, A.— <i>Chlorophyll-green of Fucaceæ</i>	1038
BESSEY, C. E.— <i>Bisexuality of the Zygnemaceæ</i>	1038
SAPORTA, G. DE— <i>Problematic Organisms of the Ancient Sea</i>	1039
KJELLMAN, F. R.— <i>Algal-flora of the Arctic Ocean</i>	1039
FOSLIE, M.— <i>Laminariaceæ of Norway</i>	1039
REINHARDT, L.— <i>Morphology and Classification of Black Sea Algæ</i>	1039
KLEBS, G.— <i>Movement and Formation of Mucilage by the Desmidiææ</i>	1040
CASTRACANE, AB. F.— <i>Internal Spore-formation in Diatoms</i>	1041
KITTON, F.— <i>Mysterious Appearance of a Diatom</i>	1041
" " <i>Navicula Durrandi n. sp. F. K.</i>	1042
CLEVE, P. T.— <i>Fossil Marine Diatoms</i>	1042
Fungi.	
BONNIER, G., & L. MANGIN— <i>Respiration and Transpiration of Fungi</i>	Part 1 104
WHARTON, H. J.— <i>Fries' Nomenclature of Colours in the Agaricini</i>	105
WINTER, G.— <i>Corynelia</i>	105
HESSE, R.— <i>Cryptica: a New Genus of Tubercææ</i>	105
MORINI, E.— <i>Parasitic Fungi</i>	105
PENZIG, O.— <i>Fungi Parasitic on Aurantiaceæ</i>	106
GÖTHE, R.— <i>"Cancer" of Apple-trees</i>	106
BREFELD, O.— <i>Conidiobolus, a New Genus of Entomophthoreæ</i>	106
PIROTTA, R.— <i>Cystopus capparidis</i>	107
WEBER, C.— <i>Fungus of the Root-swellings of Juncus bufonius</i>	107
FOEX, G., & P. VIALA— <i>"Pourridiæ" of the Vine</i>	107
STRASBURGER, E.— <i>Development of the Sporangium of Trichia</i>	107
BARY'S (A. DE) <i>Fungi, Mycetozoa, and Bacteria</i>	108
PLOWRIGHT, C. B.— <i>Life-history of certain British Heteræcismal Uredinææ</i>	Part 2 288

	PAGE
MORINI, F.— <i>New Ustilaginea</i>	Part 2 288
ERRERA, L.— <i>Law of Growth of the Fructification of Phycomyces</i>	,, 288
SCHNETZLER, J. B.— <i>Remarkable Development of Aspergillus niger</i>	,, 289
SEYNES, J. DE— <i>Mycelial Conidia of Polyporus sulfureus</i>	,, 289
COOKE, M. C.— <i>Monograph of Polyporus</i>	,, 289
TIEGHEM, P. VAN— <i>Development of Pyronema confluens</i>	,, 289
RIBBERT, M.— <i>Development of Osteomyelitis-cocci in the Organism</i>	,, 290
DUNCKER, H. C. J.— <i>Actinomyces in Swine's-flesh</i>	,, 290
PASSERINI, G., P. M. SACCARDO, O. PENZIG, & T. POGGI— <i>Fungi Parasitic on the Mulberry</i>	,, 290
BÄUMLER, J. A.— <i>Parasitic Fungus on the Red-currant</i>	,, 291
THÜMEN, F. v.— <i>Fungi of the Vine and Willow</i>	,, 291
TIEGHEM, P. VAN— <i>Monascus, a New Genus of Ascomycetes</i>	,, 291
TRELEASE, W.— <i>Relations of Two Cecidomyians to Fungi</i>	,, 291
HANSEN, E. C.— <i>New Fermenting Fungus</i>	,, 292
GROVE, W. B.— <i>Pilobolidae</i>	,, 292
GOEBEL, K.— <i>Tetramyxa parasitica</i>	,, 292
TIEGHEM, P. VAN— <i>Cænonia, a New Genus of Myxomycetes</i>	,, 293
JOURNAL of Mycology	,, 293
FISCHER, E.— <i>Development of the Gasteromycetes</i>	Part 3 501
FISCH, C.— <i>Development of Doassansia</i>	,, 502
PLOWRIGHT, C. B.— <i>Reproduction of the Heterœcious Uredineæ</i>	,, 503
ERRERA, L.— <i>Glycogen in the Basidiomycetes</i>	,, 503
LUDWIG, F.— <i>Spectroscopic Examination of Photogenic Fungi</i>	,, 505
FEUILLEAUBOIS— <i>Structure of Phallus impudicus</i>	,, 505
HESSE, R.— <i>Hysterangium rubricatum, a New Hymenogaster</i>	,, 505
KERVILLE, H. G. DE— <i>New Entomogenous Fungus</i>	,, 505
COMES, O.— <i>New Parasitic Oidium</i>	,, 505
HARTIG, R.— <i>Dry-rot</i>	,, 505
BAINIER, G.— <i>Zygosporos of Mucorini</i>	,, 505
SCHRÖTER, J.— <i>Classification of Fungi</i>	Part 4 689
FISCH, C.— <i>Development of Ascomyces</i>	,, 689
KLEIN, L.— <i>Nocturnal Spore-formation in Botrytis cinerea</i>	,, 690
WINTER, G.— <i>Rabenhorst's Cryptogamic Flora of Germany (Fungi)</i>	,, 690
ZOPF'S (W.) <i>Myxomycetes</i>	,, 690
MASSEE, G.— <i>New British Micro-Fungi (Plate XIII.)</i>	Part 5 757
WORTMANN, J.— <i>Thermotropism of the Roots of Æthaliu septicum</i>	,, 844
MÖLLER, H.— <i>Plasmodiophora Alni</i>	,, 844
FRANK, B., & M. WORONIN— <i>Nutrition of Trees by means of Underground Fungi</i>	,, 844
POLECK— <i>Composition and Spore-cultivation of Merulius lacrymans</i>	,, 845
HARTIG, R.— <i>Germination of the Spores of Merulius lacrymans</i>	,, 845
FISCH, C.— <i>New Chytridiaceæ</i>	,, 846
BORZI, A.— <i>Nowakowskia, a New Genus of Chytridiaceæ</i>	,, 846
ERIKSSON, J.— <i>New Fungus-parasite on the Rose</i>	,, 847
HECKEL, E.— <i>Mycological Monstrosities</i>	,, 847
COOKE, M. C.— <i>Some Remarkable Moulds</i>	,, 848
SCHÜTZ— <i>Pneumonomycosis of Birds</i>	,, 848
ERRERA, L.— <i>Hydro-carbon Reserve-products of Mushrooms</i>	Part 6 1044
PATOUILLARD, N.— <i>Helicobasidium, a New Genus of Hymenomycetes</i>	,, 1045

	PAGE
VUILLEMIN, P.— <i>Puccinia Thlaspidis</i>	Part 6 1045
COHN, F.— <i>Mould-fungi as Ferments</i>	" 1045
COCARDAS, E.— <i>Penicillium-Ferment in Pharmaceutical Extracts</i>	" 1046
WETTSTEIN, R. v.— <i>Rhodomyses, a New Human Parasite</i>	" 1046
GUILLEBEAU, A.— <i>Fungus-disease in Daphnia</i>	" 1046

Protophyta.

DOWDESWELL, G. F.— <i>On the Occurrence of Variations in the Development of a Saccharomyces</i>	Part 1 16
SCHMITZ, F., & G. KLEBS— <i>Structure of Chromatophores</i>	" 109
WIGAND, G.— <i>Development of Bacteria</i>	" 110
MIQUEL, P.— <i>Hourly Variations in Aerial Bacteria—Miquel's Nutritive Paper</i>	" 111
KOCH, R., E. R. LANKESTER, & E. VAN ERMENGEM— <i>Cholera-bacillus</i>	" 113
METZDORF— <i>Bacillus of Cattle Plague</i>	" 114
ROMMIER, A.— <i>Cultivated Wine-yeast</i>	" 114
BOUTROUX, L.— <i>Preservation of Alcoholic Ferments in Nature</i>	" 114
DALLINGER, W. H.— <i>The President's Address (Plates IV.-VI.)</i>	Part 2 177
MADDOX, R. L.— <i>On some unusual forms of Lactic Ferment—Bacterium lactis</i>	" 205
SCHMITZ, F.— <i>Structure of Chromatophores</i>	" 293
REESS, M.— <i>Systematic Position of Saccharomyces</i>	" 293
FISCH, C.— <i>Systematic Independence and Position of Saccharomyces</i>	" 294
WINOGRADSKY, S.— <i>Influence of External Conditions on the Development of Mycoderma vini</i>	" 294
DUCLAUX, E., L. PASTEUR, & A. BÉCHAMP— <i>Origin of Microzymes and Vibrios of Air, Water, and Soil</i>	" 295
DUCLAUX, E.— <i>Vitality of Germs of Microbes</i>	" 296
KOUBASSOFF, M.— <i>Passage of Pathogenous Microbes from the Mother to the Fœtus</i>	" 296
TIEGHEM, P. VAN— <i>Development of Bacillus Amylobacter in Plants in a Normal Condition of Life</i>	" 297
ARLINO, S.— <i>Influence of Light on the Vegetation and on the Pathogenous Properties of Bacillus anthracis</i>	" 297
PRAZMOWSKI, A.— <i>History of Development and Morphology of Bacillus anthracis</i>	" 297
MÜLLER, F.— <i>Diagnostic Value of Tubercular Bacilli</i>	" 298
NICATI, W., & RIETSCH— <i>Odour and Poisonous Effects of the Fermentation produced by the Comma Bacillus</i>	" 298
KLEIN, E., & G. M. STERNBERG— <i>Relations of Bacteria to Asiatic Cholera</i>	" 298
TAYOU, M.— <i>Microbe of Human Typhoid Fever</i>	" 299
EMMERLICH, R.— <i>Pneumonia-cocci in Dormitories as a Cause of Pneumonia</i>	" 300
NEELSEN & EHLERS— <i>"Rauschbrandpflz," a Parasitic Cattle-disease</i>	" 300
KÜNSTLER, J.— <i>Bacterioidomonas undulans</i>	" 300
FOWKE, F.— <i>First Discovery of the Comma Bacillus of Cholera</i>	" 383
GÖBI, C.— <i>Amæboidæ</i>	Part 3 506
RICHTER, P.— <i>Beggiatoa roseo-persecina</i>	" 508
DUCLAUX, E.— <i>Influence of Sunlight on the Vitality of Germs</i>	" 508
KRAUSE, F.— <i>Micrococcus in Acute Infectious Osteomyelitis</i>	" 508
VANDEVELDE, G.— <i>Chemistry of Bacillus subtilis</i>	" 508

	PAGE
JOHNE, BUCHNER, & DOYEN— <i>Cholera Bacillus</i>	Part 3 509
ERMENGEM, E. VAN— <i>Inoculation of Guinea-pigs with Comma Bacillus</i> ..	,, 509
SÉE, G.— <i>Infectious and Parasitic Pneumonia</i>	,, 510
CHAIRY— <i>Action of various Compounds on Tyrothrix</i>	,, 510
FREUDENREICH, DE— <i>Purity of Air in Alpine Regions. Resistance of Aerial Bacteria to Cold</i>	,, 511
NELSON, E. M.— <i>Comma Bacillus</i>	,, 566
KAROP, G. C.— <i>Bacilli of Hydrophobia (Fij. 133)</i>	,, 573
CHESHIRE, F. R., & W. W. CHEYNE— <i>Pathogenic History and History under Cultivation of a new Bacillus (B. alvei), the cause of a Disease of the Hive Bee hitherto known as Foul Brood (Plates X. and XI. and Fig. 134)</i>	Part 4 581
MADDOX, R. L.— <i>Experiments on Feeding some Insects with the Curved or "Comma" Bacillus, and also with another Bacillus (B. subtilis?)</i> ..	,, 602
HANSGIRG, A.— <i>Distribution of Chromatophores and Nuclei in the Schizophyceæ</i>	,, 691
BILLET, A.— <i>Formation of the Spores of Cladothrix</i>	,, 692
BORNET, E., & C. FLAHAULT— <i>Aulosira</i>	,, 692
RICHTER, P.— <i>Microcystis</i>	,, 692
BUNGENER, H.— <i>Degeneration of Yeast</i>	,, 693
CERTES, A., & D. COCHIN— <i>Effect of High Pressures on the Vitality of Ferments and on Fermentation</i>	,, 693
BÉCHAMP, A.— <i>Organisms Productive of Zymosis</i>	,, 693
WOLLNY, E.— <i>Microbes in the Soil</i>	,, 693
FREIRE, D., & REBOURGEON— <i>Microbe of Yellow Fever</i>	,, 694
LÖFFLER— <i>Micro-organisms as a cause of Diphtheria in Man, Pigeons, and Calves</i>	,, 694
BRIEGER, L.— <i>Bacteria</i>	,, 695
BILLET, A.— <i>Bacterium ureæ</i>	,, 696
MOORE, S. LE M.— <i>Identity of Bacterium fetidum (Thin) with Soil Cocci</i> ..	,, 696
KOCH, GAFFRY, & LÖFFLER— <i>Artificial Attenuation of Bacillus anthracis</i> ..	,, 696
BIGELOW, H. R.— <i>Cholera Bacillus</i>	,, 697
HERICOURT, J.— <i>Curved Bacilli in Air and Water</i>	,, 697
WOODHEAD (G. S.) & (G. W.) HARE'S 'Pathological Mycology'	,, 698
DOWDESWELL, G. F.— <i>On a Septic Microbe from a High Altitude. The Niesen Bacillus</i>	Part 5 769
HANSEN, E. C.— <i>Ferments</i>	,, 849
BIZZOZERO, G.— <i>Microphytes of Normal Human Epidermis</i>	,, 849
FISCH, C.— <i>Systematic Position of the Bacteria</i>	,, 850
BUCHNER, E.— <i>Influence of Oxygen on Fermentation by Schizomycetes</i> ..	,, 850
CHEYNE, W. W., & E. VAN ERMENGEM— <i>Cholera Bacillus</i>	,, 850
KOCH, R.— <i>Etiology of Tuberculosis</i>	,, 851
HAUSER, G.— <i>Development and Pathogenous Properties of a Bacterium</i> ..	,, 852
CORNIL (A. V.) & BABES' (V.) 'Bacteria'	,, 853
MADDOX, R. L.— <i>Further Experiments on Feeding Insects with the Curved or "Comma" Bacillus</i>	Part 6 941
DOWDESWELL, G. F.— <i>On the Cholera "Comma" Bacillus</i>	,, 953
SCHNETZLER, J. B.— <i>Beggiatoa alba</i>	,, 1046
THORE, J.— <i>Algæ of Thermal Waters</i>	,, 1047
LÉPINE, R., & G. ROUX— <i>Cystitis and Nephritis produced by Micrococcus ureæ</i>	,, 1047

	PAGE
DUCLAUX, E.— <i>Effect of Sunlight on Micrococcus</i>	Part 6 1047
HÜPPE, F.— <i>Decomposition and Fermentation of Milk</i>	" 1048
KÜNSTLER, J.— <i>Systematic Position of the Bacteriaceæ</i>	" 1048
HAUSER, G.— <i>Pleomorphy of Pathogenic Bacteria</i>	" 1049
ARLOING, S.— <i>Influence of the Sun on the Growth and Activity of Bacillus anthracis</i>	" 1050
FINKLER & PRIOR, & POUCHET— <i>Cholera Bacillus</i>	" 1050
FERRAN, J.— <i>Morphology of the Comma Bacillus</i>	" 1051
NICATI, W., & RIETSCH— <i>Attenuation of the Choleraic Virus</i>	" 1051
KOUBASSOFF— <i>Passage of Pathogenic Microbes from the Mother to the Fœtus</i>	" 1051
„ <i>Passage of Microbes by means of Milk</i>	" 1052
TAYOU, M.— <i>Microbe of Typhoid Fever in Man</i>	" 1052
SALMON, D. E., & T. SMITH— <i>New Chromogenous Bacillus—B. luteus suis</i>	" 1052
SCHLEN, V.— <i>Bacilli of Malaria</i>	" 1052
COMES, C.— <i>Gummosis of Figs</i>	" 1053
CORVO, L. A.— <i>Bacillus of the Vine</i>	" 1053
ARTHUR, J. C.— <i>Pear Blight</i>	" 1053
COLEMAN, J. J., & J. G. M'KENDRICK— <i>Action of Ozonized Air upon Micro-organisms and Albumen in Solution</i>	" 1053

MICROSCOPY.

a. Instruments, Accessories, &c.*

BECK'S (MESSRS.) <i>Portable National Microscope (Fig. 1)</i>	Part I 115
„ „ <i>Combined Substage Apparatus (Fig. 2)</i>	" 115
LEHMANN'S (O.) <i>Crystallization Microscope (Figs. 3-6)</i>	" 117
QUEEN & CO.'S <i>Class Microscope (Fig. 7)</i>	" 119
SWIFT-WALE <i>Microscope (Fig. 8)</i>	" 119
SOBY'S (H. C.) <i>Dichroiscope (Fig. 9)</i>	" 121
MAYALL'S (J. JUN.) <i>Mechanical Stage (Fig. 10)</i>	" 122
ABBE'S (E.) <i>Condenser (Figs. 11 and 12)</i>	" 123
BEHRENS, W., & T. CURTIES— <i>Modification of the Abbe Condenser (Figs. 13-16)</i>	" 124
SWIFT'S (J.) <i>Cone and Achromatized Immersion Paraboloid Condenser (Figs. 17 and 18)</i>	" 126
WALLICH'S (G. C.) <i>Condenser</i>	" 127
F. W.— <i>Osborne's Diatomscope, Modified Wenham Disc Illuminator</i>	" 128
HEURCK, H. VAN, E. M. NELSON, & F.R.M.S.— <i>Oblique Illuminators</i>	" 129
SCHRÖDER, H.— <i>Bertrand's Polarizing Prism</i>	" 133
BULLOCH'S (W. H.) <i>New Lamp (Fig. 19)</i>	" 133
LIVE-CELL (Fig. 20)	" 134
GILES (G. M.) <i>Live-Cell (Figs. 21 and 22)</i>	" 135
JUNG'S (H.) <i>Compressorium (Fig. 23)</i>	" 136
VIGUIER'S (C.) <i>Compressorium (Figs. 24-26)</i>	" 137
DAVIDSON, J.— <i>Navicula cuspidata as a Test-object</i>	" 140
HITCHCOCK, R.— <i>Schröder's Camera Lucida</i>	" 142

* This subdivision contains (1) Stands; (2) Eye-pieces and Objectives; (3) Illuminating Apparatus; (4) Other Accessories; (5) Photo-micrography; (6) Manipulation; (7) Microscopical Optics, Books, and Miscellaneous matters.

	PAGE
TOLLES Memorial Fund, Donation of Society to	Part 1 168
HEURCK'S, H. VAN— <i>Amphipleura pellucida</i> resolved into "Beads"— Nature of the Striæ of Diatoms	169 & 173
BECK'S Portable Battery for Small Incandescence Lamps for the Microscope ..	172
WRIGHT, L.—The Lantern Microscope (Figs. 40-2)	Part 2 196
STEPHENSON, J. W.—On a Cata-dioptic Immersion Illuminator	207
SCHIECK'S (F. W.) Bacteria Microscopes (Figs. 45 and 46)	301
REICHERT'S (C.) No. VII. Microscope (Fig. 47)	302
STEIN'S (S. T.) Microscopes for use with the Electric Light (Figs. 48-54) ..	303
SWIFT'S Sheep-scab Microscope (Fig. 55)	307
WINKEL'S Demonstration Microscope (Figs. 56 and 57)	308
TOLLES' (R.) Clinical Microscope (Fig. 58)	308
KLÖNNE & MÜLLER'S Pocket Microscope (Figs. 59 and 60)	309
JANNEY'S (R.) Simple Solar (or Projection) Microscope (Fig. 61)	309
THOMPSON'S (W. G.) Projection Microscope (Fig. 62)	310
HALLIER, E., L. EDINGER, & C. J. TAYLOR—Apparatus for Botanical Lectures (Figs. 63 and 64)	313
BRUNN, A. v.—Westien's Universal Lens-holder (Figs. 65-67)	316
WARD'S (R. H.) & QUEEN'S (J. W.) Lens-holders (Figs. 68-69)	317
DISSECTING Microscopes with Brücke Lens (C. ZEISS, KLÖNNE & MÜLLER, F. W. SCHIECK, & W. BÜCKER) (Figs. 70-75)	319
STANDARD Eye-pieces	322
NELSON, E. M., E. ABBE, & L. DIPPEL—Testing the different Sectors of Objectives (Fig. 76)	324
COST of Objectives of large Aperture	325
FRANCOTTE, P.—Finder (Fig. 77)	325
WARD'S (R. H.) Iris Illuminator (Fig. 78)	326
NELSON'S (E. M.) Simple Condenser (Fig. 79)	327
MADAN'S (H. G.) Method of isolating Blue Rays for Optical Work	327
" " Modification of Foucault's and Ahrens's Polarizing Prisms (Fig. 80)	328
ILLUMINATION of Microscopes and Balances	328
NELSON, E. M., A. D. MICHAEL, & W. B. CARPENTER—Standard Thickness of Glass Slips	329
RABL'S (C.) Slide for Viewing Objects on both Sides (Fig. 81)	329
WHITNEY'S (J. E.) Life-Box	330
ROGERS, W. A.—Micrometers Mounted in media of High Refractive Index	330
ATWOOD'S (H. F.) Apparatus for Photo-micrography (Fig. 82)	330
COX, J. D.—Actinic and Visual Foci	331
VORCE, C. M.—Compound Negatives	331
FRITSCH, G.—Monocular Stereoscopic Vision	332
JOURNAL of the New York Microscopical Society	332
STRASBURGER'S (E.) Practical Botany	332
HITCHCOCK, R.—Microscopical Societies	332
"What is a Microscopist?"	333
BAUSCH, E.—Universal Screw for Microscope Objectives	335
BULLOCH, W. H.—Magnifying Power of Objectives and Position of Wollaston Camera	335

	PAGE
CHEESEMAN, E. L.— <i>Growing Slide</i>	Part 2 335
HARDY'S (J. D.) <i>Direct Vision Camera</i>	336
HOMOLOGOUS <i>Sections, Electric Light, and Molecules</i>	337
ROYSTON-PIGOTT, G. W.— <i>Limit of Angular Vision</i>	339
ST. CLAIR, R. W.— <i>New Electric Lamp</i>	339
MAYALL, J. JUN.— <i>Nobert's Ruling Machine</i>	377
BECK, C.— <i>Modification of the "Complete" Lamp</i>	380
HEURCK, H. VAN—"Beads" of <i>Amphipleura</i>	380
TOLLES <i>Memorial Fund</i>	380
BECK'S "Star" <i>Microscope (Fig. 99)</i>	Part 3 512
CLASS <i>Microscopes (A. NACHET, and MURRAY & HEATH) (Figs. 100 and 101)</i>	514
GIACOMINI'S (C.) <i>Microscope with large Stage (Figs. 102 and 103)</i>	515
MICROSCOPES <i>with Bent Body-tube (Figs. 104 and 105)</i>	517
OLD <i>Italian Microscope (Fig. 106)</i>	518
MÜLLER'S (P.) <i>Insect-catcher with Lens—Insect-Cages (BECK & TILLINGHAST) (Figs. 107-109)</i>	519
TOLLES'S (R. B.) <i>Centering Stage (Fig. 110)</i>	521
DIAPHRAGMS <i>for Beck's Vertical Illuminator (Fig. 111)</i>	522
STEPHENSON'S (J. W.) <i>Immersion Illuminator (Fig. 112)</i>	523
WEST'S (F. L.) <i>Adjustable Dark-ground Illuminator (Fig. 113)</i>	523
MIRROR <i>Diaphragms (BAUSCH & LOMB OPTICAL CO.) (Fig. 114)</i>	523
QUEEN, J. W.— <i>Centering the Illuminating Beam (Fig. 115)</i>	524
BERTRAND'S (E.) <i>Adapter Nose-piece (Fig. 116)</i>	525
RINGS <i>for throwing the Coarse Adjustment out of Gear (BECK, and POWELL & LEALAND) (Figs. 117-119)</i>	525
FABRE-DOMERGUE'S (P.) <i>Current Apparatus</i>	526
MOIST <i>Chamber</i>	526
MACMUNN, C. A.— <i>Arrangement of the Microspectroscope</i>	527
BOWER, F. O., & S. H. VINES— <i>Examining the Spectrum of Chlorophyll</i>	527
VORCE, C. M., & R. HITCHCOCK— <i>Multiplying Drawings</i>	527
WHITE, T. C.— <i>Value of Photo-micrographs</i>	528
PUMPEREY, W.— <i>Parallel Rays in Photo-micrography</i>	528
ROUX & H. VAN HEURCK— <i>Small Negatives—Robinson's and Van Heurck's Miniature Microscopic Camera</i>	528
AMPHIPLEURA <i>PELLUCIDA and the Diffraction Theory</i>	529
BANKS, C. W.— <i>Rinnbock's Slides of Arranged and Isolated Diatoms</i>	530
BRECKENFELD, A. H.— <i>Graduated Glass Modifier</i>	530
FABRE-DOMERGUE, P.— <i>New Movable Stage</i>	530
FOULIS— <i>Oxyhydrogen Light</i>	530
LANCASTER, W. J.— <i>Lengthening Tubes</i>	531
MONOCULAR <i>v. Binocular</i>	532
MOORE, A. Y.— <i>Homogeneous Immersion Objectives</i>	532
NELSON, E. M.— <i>Short v. Long Tubes</i>	533
ROB. CRUS.— <i>Amateur Objectives</i>	533
NOBERT'S <i>Diamonds</i>	574
MAYALL, J. JUN.— <i>Nobert's Ruling Diamonds</i>	574
CRISP, F., & J. MAYALL, JUN.— <i>Gray's Water Microscopes</i>	578
MAYALL, J. JUN.— <i>Nobert's Ruling Machine</i>	580
VÉDY'S <i>Revolving Stage Microscope (Fig. 136)</i>	Part 4 699

	PAGE
NACHET'S, COLLINS'S, & "BOX" Portable Microscopes (Figs. 137-40) ..	Part 4 700
PFAFF'S (F.) Microgoniometer (Figs. 141 and 142)	702
DOUBLE-DRUM Microscope (Fig. 143)	703
THEILER'S (M. & SONS) "Universal (Achromatic) Pocket Microscope" (Fig. 144)	704
TOLMAN, H. L., & M. D. EWELL—Eye-piece Micrometers	704
BOECKER'S Holder for Analysing Prism and Goniometer (Figs. 145 and 146)	705
GUNDLACH, E.—"An Improvement in Objectives"	705
WALES, W.—Care and Use of Objectives	708
GRIFFITH'S (E. H.) Mechanical Finger Objective (Fig. 147)	709
HUNT, G.—Right-angled Prism instead of a Plane Mirror	709
ZENTMAYER'S Abbe Condenser (Fig. 148)	710
TÖPLER'S (A.) Illuminating Apparatus (Figs. 149-151)	710
BAUSCH & LOMB Optical Company's "Universal Accessory" (Figs. 152 and 153)	713
NELSON, E. M., & A. C. MALLEY—Illumination (Figs. 154-170)	713
HAWKINS'S (R.) Observatory Trough	719
PRINGSHEIM'S (N.) Gas Chambers (Figs. 171 and 172)	720
DEBY, J.—Test for the Hand-Lens	720
APERTURE Puzzle (Figs. 173-175)	721
GOVI—Discovery of Pseudoscopy	722
CARPENTER, W. B.—Focal Depth with the Binocular	726
M'ALLISTER—Slide showing Path of Electric Spark	727
SCHOOLROOM, Microscope in the	728
DEBY'S (J.) Twin Microscope (Fig. 180)	Part 5 854
KLEIN'S (C.) Mineralogical and Petrological Microscope (Figs. 181-183)	856
REICHERT'S (C.) Mineralogical-Geological Microscope (Fig. 184)	858
WATSON-WALE Microscope (Fig. 185)	860
SCHIECK'S Microscope with Screw Stage-Micrometer (Fig. 186)	861
HART, C. P.—Microtome-Microscope	861
DUBOSQ'S (T. & A.) Projection Microscope	861
"TWIN" Simple Microscope (Fig. 187)	862
LAURENT'S (L.) Apparatus for Registering the Curvature and Refraction of Lenses (Figs. 188 and 189)	863
GUNDLACH'S Improved Objectives	863
STODDER, J. C.—Series of Objectives	863
NELSON, E. M.—Right-angled Prism instead of a Plane Mirror	864
HEURCK, H. VAN—Hélot-Trouvé Apparatus for Electrical Illumination (Figs. 190-192)	864
D'ARSONVAL, MALASSEZ, & HÉNOUQUE—Illumination for Projection Microscopes	866
VORCE, C. M.—Lantern Transparencies	866
MICROSCOPICAL Electrical Apparatus (Figs. 193-207)	867
REGNARD, P.—Apparatus for watching the Phenomena that animals subjected to great pressure present (Figs. 208 and 209)	877
WESTIEN'S (H.) Apparatus for Comparing symmetrical parts of the Webs of the right and left Feet of a Frog (Fig. 210)	879
SOLLAS, W. J.—Apparatus for Determining the Specific Gravity of Minute Objects under the Microscope (Figs. 211 and 212)	879

	PAGE
NELSON, E. M.— <i>Keeping both Eyes open in Observation</i>	Part 5 881
APERTURE Puzzles (Figs. 213 and 214)	" 882
THE 'TIMES' on the Microscope	" 883
BANKS, C. W.— <i>Electric Spark under the Microscope</i>	" 888
HIPPISLEY, J.— <i>A Pocket Field Microscope—Water and Melted Glass Lenses</i>	" 890
REPAIRING Nicol Prisms	" 891
AHRENS, C. D.— <i>Improved Form of Stephenson's Binocular Prism (Figs. 220 and 221)</i>	Part 6 959
GILTAY, E.— <i>Remarks on Prof. Abbe's "Note on the proper Definition of the Amplifying Power of a Lens or Lens-system" (Figs. 222 and 223)</i>	" 960
CRISP, FRANK— <i>Limits of Resolution in the Microscope (Figs. 224-8)</i> ..	" 968
D'ARSONVAL'S <i>Water Microscope (Figs. 229-231)</i>	" 1054
AMYOT, T. E.— <i>Direct Vision Microscopes</i>	" 1056
ULMER, J.— <i>Microscope with Catgut Focusing Adjustment (Fig. 232)</i> ..	" 1057
INOSTRANZEFF'S <i>Double Microscope</i>	" 1058
MICROSCOPES with <i>Accessory Stages (Fig. 233)</i>	" 1058
RIDDELL'S (J. L.) <i>Binocular Compound Microscope (Figs. 234 and 235)</i> ..	" 1059
ROCHER, B. DU— <i>Megaloscopy</i>	" 1061
WATSON'S <i>Swinging Substage Microscope (Fig. 236)</i>	" 1062
" <i>Camera or Lantern Microscope (Fig. 237)</i>	" 1064
LECKENBY'S <i>Microscope Pencil-case</i>	" 1065
MALCOLM, E. D.— <i>Adjusting the Eye-pieces of Binoculars to eyes of unequal focal length</i>	" 1065
GRUNOW, J.— <i>Abbe Condenser (Fig. 238)</i>	" 1065
SMITH, H. L.— <i>Device for Testing Refractive Index (Fig. 239)</i>	" 1066
QUEEN, J. W.— <i>Table of Colour-Corrections</i>	" 1068
JOLY'S (J.) <i>Meldometer (Figs. 240 and 241)</i>	" 1068
STOKES-WATSON <i>Electric Spark Apparatus (Fig. 242)</i>	" 1069
HITCHCOCK, R.— <i>Optical Arrangements for Photo-micrography, and Remarks on Magnification</i>	" 1070
COX, J. D.— <i>Actinic and Visual Foci in Photo-micrography with High Powers</i>	" 1070
NELSON, E. M.— <i>Images in the Binocular Microscope (Figs. 243-248)</i> ..	" 1073
" " <i>Position of Objects with the Binocular</i>	" 1074
MICROSCOPES at the <i>Inventions Exhibition</i>	" 1076
SWIFT, M. J.— <i>Photo-micrograph of Tongue of Blow-fly</i>	" 1077
CONNOR, R.— <i>Pen-and-Ink Drawings of Microscopic Objects</i>	" 1077
SUPPOSED <i>Increase of the Aperture of an Objective by using highly Refractive Media</i>	" 1077
BANKS, C. W.— <i>Electricity under the Microscope</i>	" 1079
BLACKING <i>Brass Diaphragms, &c.</i>	" 1079
HYDE, H. C.— <i>The Electric Light in Microscopy</i>	" 1080
SMITH, H. L.— <i>The Influence of Science Studies</i>	" 1081
W., E. D.— <i>Measurement of Power and Aperture of Microscopic Objectives</i>	" 1082
WARD, R. H.— <i>Choice of Objectives and Oculars</i>	" 1082
ROBIN, C.— <i>Death of</i>	" 1118
CARPENTER, W. B.— <i>Death of</i>	" 1119

	PAGE
PRESIDENTS, <i>Portraits of</i>	Part 6 1121
BECK'S <i>Portable "Star" Microscope</i>	" 1121
CANTOR <i>Lectures on the Microscope</i>	" 1124
B. Collecting, Mounting and Examining Objects, &c.*	
CURTIES (T.) <i>Improved Hardy's Collecting-bottle</i>	Part 1 145
SALMON'S (D. E.) <i>Culture-tube</i>	" 145
COLLECTING <i>Microscopic Algæ</i>	" 146
EDINGER, L.— <i>Preparations of the Central Nervous System for Pro- jection</i>	" 146
WITLACZIL, E.— <i>Treatment of the Ova and Embryos of the Aphides</i>	" 147
SÄFFTIGEN, A.— <i>Preparing Echinorhynchi</i>	" 147
VIRCHOW, H.— <i>Action of Light on Objects hardened in Chromic Acid</i>	" 148
HAACKE'S (W.) <i>Dehydrating Apparatus (Fig. 27)</i>	" 148
FRANCOTTE, P.— <i>Imbedding in Paraffin by means of a Vacuum (Fig. 28)</i>	" 149
KINGSLEY, J. S.— <i>Rapid Imbedding</i>	" 150
CALDWELL'S (W. H.) <i>Automatic Microtome (Figs. 29-31)</i>	" 150
BECK'S (MESSRS.) <i>Automatic Microscope</i>	" 153
THOMA'S (R.) <i>Microtome (Figs. 32-39)</i>	" 153
MEYER'S <i>Microtome Clamp</i>	" 156
JUNG, R.— <i>Strop for Knives</i>	" 157
GRAVIS, A. & C. O. WHITMAN— <i>Cutting Ribbons of Sections</i>	" 157
HEIDENHAIN, R.— <i>New Application of Hæmatoxylin</i>	" 158
WEIGERT, C., & W. T. COUNCILMAN— <i>Weigert's Staining Method for the Central Nervous System</i>	" 158
FREND, S.— <i>Method for Displaying the Course of the Fibres in the Central Nervous System</i>	" 159
HARMER, S. F.— <i>Method for the Silver Staining of Marine Objects</i>	" 160
GRAY, W. J.— <i>Balsam of Tolu for Mounting</i>	" 160
ZENGER'S (C. V.) <i>Mounting for Diatoms, to view them on both sides</i>	" 161
BROWN, J. D.— <i>Mounting dry Opaque Objects without Cover-glass</i>	" 161
CEMENT for Glass, Porcelain, &c.	" 162
GRIFFITH, E. H.— <i>A Beautiful Slide</i>	" 163
HANAMAN, C. E., & R. HITCHCOCK— <i>White Zinc for Mounting</i>	" 163
HITCHCOCK, R.— <i>Simple Culture-chamber</i>	" 163
JAMES, F. R.— <i>Preparing Slides with Shellac</i>	" 164
KALCHBRENNER, K.— <i>Müller's Methylized Alcohol for Fungi and other Plants</i>	" 164
OWEN, D.— <i>Mounting Sections Stained with Picrocarmine</i>	" 164
PEDLEY, P. R.— <i>Stupefying Active Forms of Aquatic Life</i>	" 165
PRATT, W. F.— <i>Staining Vegetable Tissues in Picrocarmine</i>	" 165
ROYSTON-PIGOTT, G. W.— <i>Note on the Structure of the Scales of Butter- flies</i>	" 165
STOWELL, C. H.— <i>Dissecting Insects</i>	" 166

* This subdivision contains (1) Collecting Objects; (2) Preparing, (a) in general, (b) special objects; (3) Separate processes prior to making sections; (4) Cutting, including Imbedding and Microtomes; (5) Staining and Injecting; (6) Mounting, including preservative fluids, cells, slides, and cabinets; (7) Examining objects, including Testing; (8) Miscellaneous matters.

	PAGE
THURSTON, E.— <i>Staining Bacteria for Photo-micrographic Purposes—</i> <i>Balsam for Mounting Bacteria</i>	Part 1 166
BREVOORT, H. L.— <i>Construction of Fur Fibres</i>	" 173
GIACOMINI, C.— <i>Modified Hardening Process for the Central Nervous</i> <i>System</i>	Part 2 340
KUPFFER, C.— <i>Preparing Meroblastic Ova</i>	" 340
HYATT, J. D.— <i>Hydrogen Peroxide as a Bleaching Agent</i>	" 340
DIPPEL, L.— <i>Binioidide of Mercury and Potassium as a Swelling Agent</i>	" 341
ERLICKI'S <i>Hardening Solution</i>	" 341
BÖHM'S <i>Carmine Acetate</i>	" 341
BAUMGARTEN, P.— <i>Staining Method for Karyokinetic Figures</i>	" 341
FOL, H.— <i>Ribesin and Eosin</i>	" 342
PLAUT'S <i>Staining Process for the Demonstration of Saprogenous and</i> <i>Pathogenous Micro-organisms</i>	" 342
NEGRI, A. F.— <i>Staining the Spores of Bacillus tuberculosis</i>	" 342
FRANCOTTE'S (P.) <i>Paraffin Filter (Fig. 83)</i>	" 343
FOL, H.— <i>Parabolic Mirror for Correction of too hard or too soft Paraffin</i>	" 343
BECK'S (MESSRS.) <i>Universal Microtome (Fig. 84)</i>	" 344
REICHERT'S (C.) <i>Simple Hand-Microtome (Figs. 85 and 86)</i>	" 346
" " <i>Microtome Object-clamp (Figs. 87 and 88)</i>	" 347
FRANCOTTE, P.— <i>Improvements in Microtomes and Knives</i>	" 347
ROGERS'S (W. A.) <i>Section-cutter</i>	" 347
EHRENBAUM, E.— <i>Preparing Thin Sections of Shells and Teeth</i>	" 348
NEALEY, E. T.— <i>Rapid Method for Making Bone and Teeth Sections</i> ..	" 348
BROWNELL, J. T.— <i>Staining and Mounting Pollen and Smuts</i>	" 349
BROWNELL'S (J. T.) <i>Turntable (Figs. 89-91)</i>	" 351
SMITH'S (H. L.) <i>Mounting Media</i>	" 352
KITTON, F., J. AMANN, C. VAN BRUNT, & E. G. DAY— <i>Balsam of</i> <i>Tolu as a Medium for Mounting</i>	" 352
KINGSLEY, J. S.— <i>Glycerin and Balsam Mounts</i>	" 353
HITCHCOCK, R.— <i>Mounting in Phosphorus</i>	" 353
DIPPEL, L.— <i>Diatoms in Phosphorus</i>	" 354
JAMES'S (F. L.) <i>Cover-glass Cleaner (Figs. 92 and 93)</i>	" 354
COLE'S (A. C.) ' <i>Studies in Microscopical Science</i> '	" 355
LEE'S (A. B.) <i>Microtometist's Vade Mecum</i>	" 355
" <i>WORKING SESSION</i> " of American Society of Microscopists	" 356
HYATT, J. D.— <i>Compound Eyes and Multiple Images</i>	" 356
TAYLOR, T.— <i>Examination of Butter and Fats</i>	" 356
DIPPEL, L.— <i>Polarized Light in Vegetable Histology (Figs. 94-98)</i> ..	" 357
CAPUS, G.— <i>Direct Observation of the Movement of Water in Plants</i> ..	" 359
MOLISCH, H.— <i>Microchemical Detection of Nitrates and Nitrites in Plants</i>	" 359
FOL, H.— <i>New Method for the Transfer of Sterilized Broths, and the</i> <i>Determination of the Number of Living Germs in Water</i>	" 359
BAUMGARTEN, P.— <i>Discrimination of Bacillus lepræ and B. tuberculosis</i>	" 362
THURSTON, E.— <i>Examining Bacteria</i>	" 362
BIENSTOCK— <i>Double-staining Bacillus subtilis, &c.</i>	" 363
BOOTH, M. A., R. HITCHCOCK, & F. L. JAMES— <i>White Zinc Cement</i> ..	" 363
	& 365
BROWNELL, J. T.— <i>Wax Cells</i>	" 363
D., E. T.— <i>Preserving Hydrachnæ</i>	" 364
" " <i>Glass Slips for Collecting</i>	" 364

	PAGE
FIELD, A. G.— <i>Mounting Urinary Deposits</i>	Part 2 365
GRIFFITH, E. H.— <i>Microscopist's Working Cabinet</i>	" 365
LETT, H. W.— <i>Cloudy Mounts</i>	" 366
OWEN, D.— <i>Clearing Fluid for Vegetable Tissues</i>	" 366
STOWELL, C. H.— <i>Microscopic Geissler Tube</i>	" 367
WHITNEY, J. E.— <i>Cheap Punches for Sheet Wax</i>	" 367
ZENGER, C. V.— <i>New Mounting Medium</i>	" 377
ORD, W. M.— <i>Erosion of Glass exposed to Carbonate of Lime and a Colloid</i>	" 381
BLANC, H.— <i>Collecting Rhizopods</i>	Part 3 534
ISRAEL, O.— <i>Cultivation of Actinomyces</i>	" 534
BREFELD, O.— <i>Cultivation Methods for the Investigation of Fungi</i>	" 534
WALTERS, H. A.— <i>Net for Microscopists</i>	" 535
OSBORN, H. F.— <i>Preparing Brain of Urodela</i>	" 536
HARRIS, V. D.— <i>Method of Preparing permanent specimens of Stained Human Blood</i>	" 537
BAYERL, B.— <i>Demonstrating the Origin of Red Blood-corpuscles in Cartilage at the Margin of Ossification</i>	" 537
KOESTLER, M.— <i>Preparing the Sympathetic Nervous System of Periplaneta orientalis</i>	" 538
CATTANEO, L.— <i>Fixing, Staining, and Preserving Infusoria</i>	" 538
KLEBS, G.— <i>Preparing Euglena</i>	" 539
LUSTGARTEN, S.— <i>Preparing the Bacillus of Syphilis</i>	" 539
HICK, T.— <i>Methods for observing Protoplasmic Continuity</i>	" 540
HOLL, M.— <i>Tolu instead of Chloroform for Imbedding in Paraffin</i>	" 541
GERLACH, L.— <i>Imbedding Small Objects</i>	" 541
GOTTSCHAU, M.— <i>Advantages and Disadvantages of Different Forms of Microtome (Figs. 120-129)</i>	" 541
SCHANZE'S (M.) <i>Microtome (Fig. 130)</i>	" 547
BULLOCH'S (W. H.) <i>Combination Microtome (Fig. 131)</i>	" 548
CAMBRIDGE <i>Rocking Microtome (Fig. 132)</i>	" 549
LEE, A. B.— <i>"Ribbon" Section Cutting</i>	" 552
HÖHNEL, F. v.— <i>Rapid Method of making Sections of hard Organized Substances</i>	" 553
HOLZNER, G.— <i>Contribution to the History of Staining</i>	" 553
GIERKE, H.— <i>Staining for Microscopical Purposes</i>	" 554
FLEMMING, W.— <i>Staining Technique</i>	" 554
EHRLICH— <i>Susceptibility of the Different Tissues to Colouring Matters</i>	" 554
CYBULSKY, J.— <i>Staining the Nervous System of the Muzzle and Upper Lip of the Ox</i>	" 555
CERTES, A.— <i>Employment of Colouring Matter in the Study of Living Infusoria</i>	" 555
SCHAARSCHMIDT, J.— <i>Staining Vaucheria and Chara</i>	" 557
FRANKEL, B.— <i>Staining of Koch's Bacillus</i>	" 557
RIBBERT— <i>Staining Bacteria with Dahlia</i>	" 558
PERGENS'S <i>Picrocarmine</i>	" 558
FLESCHE, M.— <i>Application of the Colouring Matter of Red Cabbage in Histology</i>	" 558
BRUN, J.— <i>Double Staining</i>	" 558
PIERSOL, G. A.— <i>Staining Tissues for Photo-micrography</i>	" 559
BERGONZINI— <i>Collodion and Phenol in Microscopical Technique</i>	" 559

	PAGE
ROGERS, W. A.— <i>Dry Mounting of Opaque Objects</i>	Part 3 560
TIEMANN— <i>Examination of Water for the Development of Micro-organisms</i>	" 560
CARPENTER, H. S., & W. O. NICHOLSON— <i>Examination of Water for Organisms</i>	" 560
CHAMBERLAND, C.— <i>Removal of Microbes by Filtering</i>	" 561
FOL, H., & P. L. DUNANT— <i>Effect of Prolonged Repose and Filtration through Porcelain on the Purity of Water</i>	" 561
FOL, H.— <i>Determination of the Number of Germs in Air</i>	" 561
MEYER, A.— <i>Examining Vegetable Powders</i>	" 562
GAUTIER, A.— <i>Sterilization of Fermentable Liquids in the Cold</i>	" 562
COLE, A. C.— <i>Mounting Spiders</i>	" 563
DAVIS, J. J.— <i>Simple Cover Compressor</i>	" 564
QUEEN, J. W.— <i>Stratena for Protecting Slides from the Oil of Immersion Lenses, &c.</i>	" 566
KAIN, C. H.— <i>Tolu for Mounting</i>	" 570
LÖWE, L.— <i>Preparing Embryos</i>	Part 4 729
BRASS, A.— <i>Methods of Investigating Animal Cells</i>	" 729
LADOWSKY, M.— <i>Demonstrating the Nuclei in Blood-corpuses</i>	" 730
TIZZONI— <i>Demonstration of Karyokinesis in Epithelial Tissues</i>	" 730
STILLING, J.— <i>Investigating the Structure of the Central Nervous Organs</i>	" 730
SAHLI, H.— <i>Application of Borax-methylen-blue in the Examination of the Central Nervous System</i>	" 731
GOLGI, C.— <i>Preserving Sections of the Nervous System treated with Bichromate of Potash and Nitrate of Silver</i>	" 731
ZAWARYKIN, T.— <i>Study of Fat-absorption in the Small Intestine</i>	" 731
LIST, J. H.— <i>Preparing the Cloacal Epithelium of Scyllium Canicula</i> ..	" 731
MAURICE, C., & A. SCHULGIN— <i>Preparing Embryos of <i>Amarœcium proliferum</i></i>	" 731
GILLO, R.— <i>Mounting Insects without Pressure</i>	" 732
SHARP, H.— <i>Mounting the Proboscis of the Blow-fly in Biniodide of Mercury</i>	" 733
EMERY, C.— <i>Preparing <i>Luciola italica</i></i>	" 733
KENNEL, J. v.— <i>Preparing Embryo of <i>Peripatus Edwardsii</i> and <i>P. torquatus</i></i>	" 734
COURROUX, E. S.— <i>Preparing Diatoms from the Stomachs of Mollusca and Crustacea</i>	" 734
BAYBERRY <i>Tallow for Imbedding</i>	" 735
FISCHER, P. M., & J. BIEHRINGER— <i>Imbedding and Examining Trematodes</i>	" 735
HATFIELD'S (J. J. B.) <i>Rotary Section-cutter (Figs. 176 and 177)</i>	" 735
MARK, E. L.— <i>Notes on Section-cutting</i>	" 737
SPEE, F.— <i>Sections in Series</i>	" 740
HAMANN, O.— <i>New Carmine Solution</i>	" 740
HICKSON, S. J.— <i>Method of Preparing Hæmatoxylin Staining Fluid</i> ..	" 741
BIZZOZERO, G., & TORRES— <i>Staining for the Study of Red Blood-corpuscles</i>	" 741
SAHLI, H.— <i>New Double Stain for the Nervous System</i>	" 741
ADAMKIEWICZ, A.— <i>New Method of Staining the Spinal-Cord</i>	" 742
KUPFFER, C.— <i>Staining the Axis-cylinder of Medullated Nerve-fibres</i> ..	" 742
TURNER, W. B.— <i>Staining Desmids</i>	" 742
WIRE, A. P.— <i>Boro-glyceride for Mounting</i>	" 742
DOUGLAS, J. C.— <i>Litharge and Glycerin as a Cement</i>	" 743

	PAGE
HAMLIN'S (F. M.) <i>Ideal Slide (Figs. 178 and 179)</i>	Part 4 743
HAYS, J. E.— <i>Finish for Slides</i>	744
HANSEN, E. C.— <i>Counting of Microscopic Objects for Botanical Purposes</i> ..	744
AUBERT, A. B., & J. DEBY— <i>Styrax and Balsam</i>	744
BUREAU of Scientific Information	745
A NEW <i>Departure</i>	745
DOANE, L. G.— <i>Gold and Silver Ferns</i>	746
REX, G. A.— <i>Collecting and Preserving Myxomycetes</i>	748
SMITH, E.— <i>Varnish for Ringing Slides</i>	748
VAN BRUNT, C.— <i>Diatoms Fastened by Heat</i>	749
BOTTONE, S., & F. GRANT— <i>Keeping Alive and Mounting Volvox globator</i> ..	749
WEDDING, H.— <i>Examination of Malleable Iron</i>	749
SUFFOLK, W. T.— <i>Collecting-bottle with Flat Sides</i>	750
CHESHIRE, F. R.— <i>Glycerin Mounting</i>	753
ORD, W. M.— <i>On Erosion of the Surface of Glass when exposed to the joint action of Carbonate of Lime and Colloids</i>	Part 5 761
OLIVIER, L.— <i>Method for Observing Protoplasmic Continuity</i>	892
NOLL, F.— <i>Eau de Javelle as a Medium for Clarifying and Dissolving Plasma</i>	893
RICHARD, J.— <i>Cocaine for Mounting Small Animals</i>	893
RABL, C.— <i>Preparing Tissues to show Cell-division</i>	893
BECKWITH, E. F.— <i>Method for showing the Distribution and Termination of Nerves in the Human Lungs</i>	894
COLE, A. C.— <i>Preparing Tail of Puppy</i>	894
HERTWIG, O.— <i>Demonstrating Spindle-shaped Bodies in the Yolk of Frog's Ova</i>	895
WARLOMONT, R.— <i>Microscopical Technique of the Eye</i>	895
HILGER, C.— <i>Preparing Eyes of Gasteropods</i>	895
LOOSS, A.— <i>Method of Softening Chitin</i>	896
SAZEPIN, B.— <i>Demonstrating Nerve-end Organs in the Antennæ of Myriopods</i>	896
HELLER— <i>Sources of Error in the Examination of Fresh Tissues</i>	896
BRAUN, M.— <i>Mounting Media for Nematodes</i>	897
BEARD, J.— <i>Preparing Myzostoma</i>	897
IHL, A.— <i>Sensitive Tests for Wood-fibre and Cellulose</i>	897
HAY, O. P.— <i>Modification of Semper's Method of making Dry Pre- parations</i>	898
W., D. S.— <i>Freeing Objects from Air</i>	898
DEBES, E.— <i>Cleaning and Preparing Diatom Material—Mounting Diatoms</i> ..	898
GOWEN'S (F. H.) <i>Microtome</i>	899
JACOBS'S (F. O.) <i>Freezing Microtome (Figs. 215 and 216)</i>	899
ETERNOD'S (A.) <i>Microtome with Triple Pincers</i>	900
MINOT, C. S.— <i>Gannett's Dripping Apparatus (Fig. 217)</i>	900
GIERKE, H.— <i>Staining for Microscopical Purposes</i>	900
LIST, J. H.— <i>Staining Methods</i>	902
MAYS, K.— <i>Staining Nerves in Muscle</i>	903
LIST, J. H., & P. SCHIEFERDECKER— <i>Anilin-green</i>	903
MONDINO, C.— <i>Perchloride of Mercury in the Study of the Central Nervous System</i>	904
POMMER, G.— <i>Decalcification and Staining of Osseous Tissue</i>	905
WIELOWIEFSKI, H. v.— <i>Staining the Nucleus of the Germinal Vesicle in Arthropoda</i>	905

	PAGE
HAY, O. P.— <i>Double Injections for Dissecting Purposes</i>	Part 5 905
” ” <i>Double Injections for Histological Purposes (Fig. 218)</i>	” 906
ZENGER, C. V.— <i>Double-sided Slide</i>	” 908
MARK, E. L.— <i>Uses of Collodion</i>	” 908
SHARP, H.— <i>Mounting in Cells with Canada Balsam</i>	” 909
ZENGER, C. V.— <i>Monobromide of Naphthalin and Tribromide of Arsenic</i>	” 909
MAYER'S (P.) <i>Carbolic Acid Shellac</i>	” 909
SLIDE-BOXES (Fig. 219)	” 910
CHAPMAN'S Mould for Cells	” 911
STERNBERG, G. M.— <i>Selection and Preparation of Objects for Photog- raphing</i>	” 911
DOLLEY'S (C. S.) <i>Technology of Bacteria Investigation</i>	” 917
TAYLOR, T., & S. B. BETTS— <i>Discrimination of Butter and its Substitutes</i>	” 918
ASSMANN, R.— <i>Microscopical Observations on the Constituents of Clouds</i>	” 919
LINDT, O.— <i>Micro-Chemical Test for Brucin and Strychnin</i>	” 920
WICHMANN, A.— <i>Micro-chemical Examination of Minerals</i>	” 920
STRENG, A.— <i>Isolating Minerals in Sections for Micro-chemical Ex- amination</i>	” 921
WILLIAMS, G. H.— <i>The Microscope in Geology</i>	” 921
TICHBORNE— <i>Application of the Microscope to Practical Mineralogical Questions</i>	” 922
JOLY, J.— <i>Microscopical Examination of Volcanic Ash from Krakatoa</i>	” 923
GUNNING, J. W.— <i>Examination of Potable Waters</i>	” 923
FRANKLAND, P. F.— <i>Removal of Micro-organisms from Water</i>	” 923
COX, C. F.— <i>Hard-rubber Cells</i>	” 925
DAVIS, J. J.— <i>A Simple Cover-compressor</i>	” 925
HITCHCOCK, R.— <i>Microscopical Exhibitions</i>	” 926
QUEEN'S (J. W. & Co.) <i>Prepared Diatoms in Fluid ready for mounting</i>	” 927
TECHNICAL NOTES	” 928
HOYLE, W. E.— <i>Preserving Eggs of Cephalopoda and preparing Blas- toderns</i>	Part 6 1083
LOCY, W. A.— <i>Treatment of the Eggs of the Spider</i>	” 1083
BALKWILL'S (F. P.) <i>Foraminifera Slides (Figs. 249 and 250)</i>	” 1084
SACHS, J.— <i>Preparing Leaves to show Starch-grains</i>	” 1084
BARNES, C. R.— <i>Studying Pollen-grains</i>	” 1085
SELENKA, E.— <i>Imbedding in Paraffin (Fig. 251)</i>	” 1086
ANDREW'S (E. A.) & (H. F.) NACHTRIEB'S <i>Water-bath (Figs. 252-254)</i>	” 1086
BARRETT'S (J. W.) <i>New Microtome</i>	” 1089
BAUSCH & LOMB <i>Optical Co.'s Laboratory and Student's Microtomes (Figs. 255-257)</i>	” 1089
SELLER'S (C.) <i>Microtome Attachment</i>	” 1091
WHITMAN, C. O.— <i>Cambridge Rocking Microtome</i>	” 1091
WRIGHT, R. R.— <i>Suggestions as to the Preparation and Use of Series of Sections in Zoological Instruction</i>	” 1091
LENDENFELD, R. v.— <i>Series of Sections. Thickness of Sections</i>	” 1092
FOL'S (H.) <i>Injection Table (Fig. 258)</i>	” 1092
OSBORN, H. F.— <i>Simple Method of Injecting the Arteries and Veins in small Animals (Fig. 259)</i>	” 1093
ARCANGELI, G.— <i>New Methods of Preparing Carmine Staining Fluids</i>	” 1094
KULTSCHIZKY, N.— <i>Staining Salivary Glands</i>	” 1095
HASWELL, W. A.— <i>Staining with Hæmatoxylin</i>	” 1095

	PAGE
HASWELL, W. A.— <i>Imbedding in Paraffin</i>	Part 6 1096
STRASBURGER, E.— <i>Eau de Javelle for Clearing</i>	" 1097
BRUNT, C. VAN— <i>Fixing Objects to the Cover-glass</i>	" 1097
SMITH'S (H. L.) <i>Mounting Media of High Refractive Index (Fig. 260)</i> ..	" 1097
" " <i>New Cement</i>	" 1099
MILES, J. L. W., T. W. LOFTHOUSE, & E. WARD— <i>Dry Mounting</i> ..	" 1100
JAMES, F. L.— <i>White Zinc Cement</i>	" 1101
" " <i>Leakage of Cells</i>	" 1102
STRASBURGER, E.— <i>Coloured Crayons for Marking Preparations—Finder</i>	" 1103
HAUSHOFER, K.— <i>Filtering Minute Quantities (Fig. 261)</i>	" 1103
RALPH, T. S.— <i>Examining Blood in Typhoid Fever</i>	" 1104
EWELL, M. D.— <i>Measurement of Blood-corpuscles</i>	" 1105
BESSEY, C. E.— <i>Styles of Indian Corn for Examining Movement of</i>	
<i>Protoplasm</i>	" 1106
HAUSHOFER'S (K.) <i>Microscopical Reactions</i>	" 1106
JAMES, F. L.— <i>Examining Diamonds and Cut Gems</i>	" 1108
CAMPBELL, D. H.— <i>Growing the Spores of Botrychium ternatum</i>	" 1109
GRABER, V.— <i>Preparing Eyes of Annelids</i>	" 1110
JAMES, F. L.— <i>Cement</i>	" 1110
RYDER, J. A.— <i>A Cheap Bell-glass for the Laboratory Table</i>	" 1111
GREELY <i>Arctic Expedition</i>	" 1115
PENHALLOW, D. P.— <i>Handle for Cover-glasses</i>	" 1115
KITTON, F., & C. H. KAIN— <i>Balsam of Tolu</i>	" 1116
BIBLIOGRAPHY—MICROSCOPY α	Part 1 139
" " " " " " " " " " " " " " " " "	" 2 335
" " " " " " " " " " " " " " " "	" 3 530
" " " " " " " " " " " " " " " "	" 4 726
" " " " " " " " " " " " " " " "	" 5 888
" " " " " " " " " " " " " " " "	" 6 1078
MICROSCOPY β	Part 1 161
" " " " " " " " " " " " " " " "	" 2 363
" " " " " " " " " " " " " " " "	" 3 562
" " " " " " " " " " " " " " " "	" 4 745
" " " " " " " " " " " " " " " "	" 5 924
" " " " " " " " " " " " " " " "	" 6 1109
PROCEEDINGS OF THE SOCIETY—	
December 10, 1884	Part 1 167
January 14, 1885	" 171
February 11, 1885 (Annual Meeting)	Part 2 368
Report of the Council for 1884	" 372
Treasurer's Account for 1884	" 373
March 11, 1885	" 376
April 8, 1885	Part 3 568
May 13, 1885	" 576
June 10, 1885	Part 4 750
November 26, 1884 (Conversazione)	Part 5 929
April 22, 1885 (Conversazione)	" 931
October 14, 1885	Part 6 1112
November 11, 1885	" 1119
INDEX	" 1125

Ser. II.
Vol. V. Part 1.

FEBRUARY, 1885.

{ To Non-Fellows,
Price 5s.

JOURNAL

OF THE

ROYAL

MICROSCOPICAL SOCIETY;

CONTAINING ITS TRANSACTIONS AND PROCEEDINGS,

AND A SUMMARY OF CURRENT RESEARCHES RELATING TO

ZOOLOGY AND BOTANY

(principally Invertebrata and Cryptogamia),

MICROSCOPY, &c.

Edited by

FRANK CRISP, LL.B., B.A.,

One of the Secretaries of the Society

and a Vice-President and Treasurer of the Linnean Society of London;

WITH THE ASSISTANCE OF THE PUBLICATION COMMITTEE AND

A. W. BENNETT, M.A., B.Sc.,
Lecturer on Botany at St. Thomas's Hospital,

F. JEFFREY BELL, M.A.,
Professor of Comparative Anatomy in King's College,

JOHN MAYALL, JUN., FRANK E. BEDDARD, M.A., AND

B. B. WOODWARD, *of the British Museum,*

FELLOWS OF THE SOCIETY.



WILLIAMS & NORGATE,
LONDON AND EDINBURGH.

CONTENTS.

TRANSACTIONS OF THE SOCIETY—

PAGE

I.—THE APPARATUS FOR DIFFERENTIATING THE SEXES IN BEES AND WASPS. AN ANATOMICAL INVESTIGATION INTO THE STRUCTURE OF THE RECEPTACULUM SEMINIS AND ADJACENT PARTS. By Frank R. Cheshire, F.R.M.S. (Plates I. and II.)	1
II.—ON THE OCCURRENCE OF VARIATIONS IN THE DEVELOPMENT OF A SACCHAROMYCES. By G. F. Dowdeswell, M.A., F.L.S., F.R.M.S., &c.	16
III.—NOTES ON THE LIFE-HISTORIES OF SOME OF THE LITTLE-KNOWN TYROGLYPHIDÆ. By A. D. Michael, F.L.S., F.R.M.S., &c. (Plate III.)	19

SUMMARY OF CURRENT RESEARCHES.

ZOOLOGY.

CALDWELL, W. H., W. HAACKE, & T. GILL.— <i>Oviparous Reproduction in the Monotremes</i>	33
" " <i>Embryonic Membranes of Marsupials</i>	34
HERMANN, L., & A. V. GENDRE.— <i>Electromotive Function of the Fowl's Egg</i>	34
BROOK, G.— <i>Development of the Lesser Weaver-Fish</i>	34
MINOT, C. S.— <i>Vesiculæ seminales of Guinea-pigs</i>	35
LWOFF, W.— <i>Histology of Hairs, Setæ, Spines, and Feathers</i>	35
CAMERANO, L.— <i>Distribution of Colour in the Animal Kingdom</i>	37
GRABER, V.— <i>Sense of Colour and of Brightness in Animals</i>	38
HUNT, A. R.— <i>Influence of Wave-currents on Fauna of Shallow Seas</i>	38
CLAUS' (C.) <i>Elementary Text-book of Zoology</i>	38
CARRIÈRE, J.— <i>Eyes of some Invertebrata</i>	39
HOGG, J.— <i>Indestructible Infusorial Life</i>	39
LEIDY, J.— <i>Organisms in Ice</i>	40
GIROD, P.— <i>Integument of Cephalopods</i>	40
GRENACHER, H.— <i>Retina of Cephalopoda</i>	41
PANETH, J.— <i>Histology of Pteropods and Heteropods</i>	42
HADDON, A. C.— <i>Generative and Urinary Ducts in some Chitons</i>	42
WEGMANN, H.— <i>Natural History of Haliotis</i>	43
BERGH, R.— <i>'Challenger' Nudibranchs</i>	43
EHRENBAUM, E.— <i>Structure and Formation of the Shell of Lamellibranchs</i>	44
SABATIER, A.— <i>Follicular and Granular Cells of Tunicales</i>	44
ROULE, M.— <i>Two New Species of Simple Ascidians</i>	45
LANKESTER, E. R.— <i>Rhabdopleura</i>	46
POTTS, E.— <i>New Species of Paludicella</i>	47
BUSK, G.— <i>'Challenger' Polyzoa</i>	47
SCHULGIN, M. A.— <i>Argiope Kowalevskii</i>	49
CHATIN, J.— <i>Appendages of the Jaw of Mandibulate Insects</i>	50
RADOSZKOWSKI, O.— <i>Copulatory Apparatus of Male Bombus</i>	50
KAISER, W.— <i>Luminosity of the Glowworm</i>	50
CHOLODKOVSKY, N.— <i>Testes of Lepidoptera</i>	51
" " <i>Malpighian Vessels of Lepidoptera</i>	51
COVERDALE, G.— <i>Action of Ammonia upon Lepidopterous Pigments</i>	52
OSTEN-SACKEN, C. R.— <i>Comparative Chatotaxy</i>	52
WILLISTON, S. W.— <i>Edible Dipterous Larvæ from Alkaline Lakes</i>	53
PATTEN, W.— <i>Development of Phryganids</i>	53
WITLACZIL, E.— <i>Development of Aphides</i>	53
KENNEL, J. VON.— <i>Development of Peripatus</i>	56
MACLEOD, J.— <i>Structure of the Fore-gut of Arachnida</i>	56
DAHL, F.— <i>Organs of Sense in Spiders</i>	58
MACLEOD, J.— <i>Coxal Gland in the Phalangida</i>	58
" " <i>Hermaphroditism of the Male of Trombidium</i>	58
PLATEAU, F.— <i>Absolute Force of the Muscles of Invertebrates</i>	58
ANDREWS, E. A.— <i>Anatomy of the Spider Crab</i>	60
CLAUS, C.— <i>Circulation of Schizopoda and Decapoda</i>	60
FRENZEL, J.— <i>Enteric Glands in the Crustacea</i>	61
HOEK, P. P. C.— <i>'Challenger' Cirripedia</i>	61
FRAIPONT, J.— <i>Nervous System of Archannelides</i>	62
ORLEY, L.— <i>Respiration of the Serpulaceæ in Relation to their Tegumentary Pigments</i>	64
VIGUIER, C.— <i>Lower Animals of the Bay of Algiers</i>	65
MANSON, P.— <i>Metamorphosis of Filuria sanguinis hominis in the Mosquito</i>	65
PLATE, L.— <i>Structure of Rotatoria</i>	65
BEARD, J.— <i>Structure and Development of Myzostoma</i>	66

	PAGE
GRAFF, L. V.—'Challenger' <i>Myzostomida</i>	68
SPENGLER, J. W.— <i>Anatomy of Balanoglossus</i>	69
JICKELI, C. F.— <i>Process resembling Copulation in Comatula mediterranea</i>	70
LENDENFELD, R. V.— <i>Local Colour-varieties of Scyphomedusæ</i>	71
" " <i>Scyphomedusæ of the Southern Hemisphere</i>	71
HAACKE, W.— <i>Pseudorhiza haeckelii</i>	71
LENDENFELD, R. V.— <i>Development of the Versuridæ</i>	72
" " <i>Flexor Muscle of the Hydroid Polyp of Sarsia radiata</i>	72
BOURNE, A. G.— <i>Hydriform Phase of Limnocoedium Sowerbii</i>	72
THOMPSON, D'ARCY W.— <i>Hydroid Zoophytes of the 'Willem Barents' Expedition, 1881</i>	73
RIDLEY, S. O.— <i>Structures liable to Variation in the Astrangiaceæ (Madreporaria)</i>	73
SOLLAS, W. J.— <i>Development of Halisarca lobularis</i>	73
LENDENFELD, R. V.— <i>Mode of Digestion in Sponges</i>	74
VOSMAER, G. C. J.— <i>Note on Sponges</i>	75
POTTS, E.— <i>Modification in the form of Sponge Spicules</i>	75
LENDENFELD, R. V.— <i>Australian Sponges</i>	76
POTTS, E.— <i>Wide Distribution of some American Sponges</i>	76
HERTWIG, R.— <i>Erythrospis agilis, a New Protozoon</i>	77
KELLYCOTT, D. S.— <i>New Vorticellid</i>	78
RYDER, J. A.— <i>Chlorophylloid Granules of Vorticella</i>	78
HENNEGUY, L. F.— <i>New Ciliated Infusorian</i>	79
STOKES, A. C.— <i>New Fresh-water Infusoria</i>	80
ENTZ, G.— <i>Infusoria of the Gulf of Naples</i>	80
KERBERT, C.— <i>New Infusorian Parasite</i>	81
STOKES, A. C.— <i>New Parasitic Infusoria</i>	81
HENNEGUY, L. F.— <i>Flagellate Infusorian parasitic on Trout</i>	82
KÜNSTLER, J.— <i>New Rhizopod</i>	82
SCHNEIDER, A.— <i>Ophryocystis bütschlii</i>	82

BOTANY.

SCHAARSCHEIDT, J.— <i>Connection of Protoplasts and Intercellular Protoplasm</i>	83
HILLHOUSE, W.— <i>Intercellular Relations of Protoplasts</i>	84
VEIES, H. DE.— <i>Plasmolysis</i>	84
FLEMMING, W.— <i>Division of the Nucleus</i>	86
FROMMANN, C.— <i>Structure, Vital Phenomena, and Reactions of the Cell</i>	86
PENZIG, O.— <i>Cystoliths of Cucurbitaceæ</i>	87
HANSEN, A.— <i>Chlorophyll</i>	87
REINKE, J.— <i>Fluorescence of Chlorophyll in Leaves</i>	88
TSCHIRCH, A.— <i>Morphology of Chlorophyll-grains</i>	88
FRANK, B.— <i>Formation of Gum in Wood</i>	88
LANGE, J.— <i>Oil-receptacles in the Fruit of Umbelliferae</i>	89
HÖHNEL, F. VON.— <i>Influence of Cortical Pressure on the Bast-fibre</i>	89
KOCH, A.— <i>Course and Termination of the Sieve-tubes in the Leaves</i>	90
KLEROKER, J. E. F. AF.— <i>Mechanical Function of the Epidermis</i>	91
BORODIN, J.— <i>Comparative Anatomy of Leaves of Chryso-splenium</i>	91
JOHOW, F.— <i>Adaptation of Leaves to their environment</i>	91
SABLON, LECLERCQ DU.— <i>Deliscence of Anthers</i>	91
VOLKENS, G.— <i>Calcareous Glands of Plumbaginæ</i>	92
HILDEBRAND, F.— <i>Protective Contrivances in the Bulbs of Ocalis</i>	92
DE BARY'S (A.) <i>Vegetative Organs of Phanerogams and Ferns</i>	93
ADRIANOWSKY, A.— <i>Influence of Light on the Germination of Seeds</i>	93
WOLLNY, E.— <i>Effect of Depth of Sowing on the Germination and Growth of Plants</i>	93
HELLRIGEL.— <i>Influence of Water on the Growth of Plants</i>	93
MÖLLER, H.— <i>Respiration of Plants</i>	94
BONNIEB, G., & L. MANGIN.— <i>Respiration of Tissues not containing Chlorophyll</i>	94
SCHÜTZENBERGER, P.— <i>Respiratory Combustion</i>	95
AMBRONN, H.— <i>Heliotropic and Geotropic Torsion</i>	95
FIRTSCH, G.— <i>Geotropic Sensitiveness of the Apex of the Root</i>	96
MOLISCH, H.— <i>Deviation of Roots from their Normal Direction through the Influence of Gases</i>	96
SCHULZE, C.— <i>Albuminoid Constituents of Plants</i>	97
VRIES, H. DE.— <i>Periodical Formation of Acids in Succulent Plants</i>	97
JORISSEN, A.— <i>Production of Hydrocyanic Acid by Plants</i>	97
BRASSE, L.— <i>Presence of Amylase in Leaves</i>	97
SORBY, H. C.— <i>Autumnal Tints of Foliage</i>	97
DETMER, W.— <i>Formation and Action of Diastase</i>	98
DRUERY, E. T., F. O. BOWER, & W. T. THISELTON DYER.— <i>Apospory in Ferns</i>	99
SOUTHWORTH, E. A.— <i>Stomata of Equisetum</i>	99
PHILIBERT.— <i>Peristome of Mosses</i>	100
MÜLLER, K.— <i>Solmsiella, a new genus of Mosses</i>	101
LEITGER, H.— <i>Spore-coats and Germination of Hepaticæ</i>	101

	PAGE
ARDISSONE, F.— <i>Floridæ of the Mediterranean</i>	102
LAGERHEIM, G.— <i>Occurrence of Chromatophores in the Phycochromaceæ</i>	102
SCHAARSCHMIDT, J.— <i>Gongrosira</i>	103
LANZI, M.— <i>Diatoms from Lago Trajano</i>	103
SCHMIDT'S 'Atlas der Diatomaceen-Kunde'	103
CROMBIE, J. M.— <i>Algo-Lichen Hypothesis</i>	103
BONNIER, G., & L. MANGIN.— <i>Respiration and Transpiration of Fungi</i>	104
WHARTON, H. J.— <i>Fries' Nomenclature of Colours in the Agaricini</i>	105
WINTER, G.— <i>Corynelia</i>	105
HESSE, R.— <i>Cryptica, a New Genus of Tubercaceæ</i>	105
MORINI, E.— <i>Parasitic Fungi</i>	105
PENZIG, O.— <i>Fungi Parasitic on Aurantiaceæ</i>	106
GÖTHE, R.—"Cancer" of Apple-trees	106
BREFFELD, O.— <i>Conidiobolus, a new genus of Entomophthorææ</i>	106
PIROTTA, R.— <i>Cystopus Cappariidis</i>	107
WEBER, C.— <i>Fungus of the Root-swellings of Juncus bufonius</i>	107
FOEX, G., & P. VIALA.—"Pourridié" of the Vine	107
STRASBURGER, E.— <i>Development of the Sporangium of Trichia</i>	107
DE BARY'S (A.) <i>Fungi, Mycetozoa, and Bacteria</i>	108
SCHMITZ, F.— <i>Structure of Chromatophores</i>	109
WIGAND, G.— <i>Development of Bacteria</i>	110
MIQUEL, P.— <i>Hourly Variations in Aerial Bacteria—Miquel's Nutritive Paper</i>	111
KOCH, R., E. R. LANKESTER, & E. VON ERMENGEM.— <i>Cholera-bacillus</i>	113
METZDORF.— <i>Bacillus of Cattle Plague</i>	114
ROMMIEB, A.— <i>Cultivated Wine-Yeast</i>	114
BOUTROUX, L.— <i>Preservation of Alcoholic Ferments in Nature</i>	114

MICROSCOPY.

BECK'S <i>Portable National Microscope</i> (Fig. 1)	115
„ <i>Combined Substage Apparatus</i> (Fig. 2)	115
LEHMANN'S (O.) <i>Crystallization Microscope</i> (Figs. 3-6)	117
QUEEN & Co.'s <i>Class Microscope</i> (Fig. 7)	119
SWIFT-WALE <i>Microscope</i> (Fig. 8)	119
SORBY'S (H. C.) <i>Dichroscope</i> (Fig. 9)	121
MAXALL'S (J., JUNR.) <i>Mechanical Stage</i> (Fig. 10)	122
ABBE'S (E.) <i>Condenser</i> (Figs. 11 and 12)	123
BEHRENS, W., & T. CURTIS— <i>Modification of the Abbe Condenser</i> (Figs. 13-16)	124
SWIFT'S (J.) <i>Cone and Achromatized Immersion Paraboloid Condenser</i> (Figs. 17 and 18)	126
WALLICH'S (G. C.) <i>Condenser</i>	127
F., W., & H. VAN HEURCK.— <i>Osborne's Diatomscope. Modified Wenham Illuminator</i>	128
NELSON, E. M., & F. R. M. S.— <i>Oblique Illuminators</i>	129
SCHNÖDER, H.— <i>Bertrand's Polarizing Prism</i>	133
BULLOCH'S (W. H.) <i>New Lamp</i> (Fig. 19)	133
<i>Live-Cell</i> (Fig. 20)	134
GILES' (G. M.) <i>Live-Cell</i> (Figs. 21 and 22)	135
JUNG'S (H.) <i>Compressorium</i> (Fig. 23)	136
FIGUIER'S (C.) <i>Compressorium</i> (Figs. 24-26)	137
HARDY'S (J. D.) <i>Collecting-bottle</i>	145
SALMON'S (D. E.) <i>Culture-tube</i>	145
<i>Collecting Microscopic Algæ</i>	146
EDINGER, L.— <i>Preparations of the Central Nervous System for Projection</i>	146
WITLACZIL, E.— <i>Treatment of the Ova and Embryos of the Aphides</i>	147
SÄFFTIGEN, A.— <i>Preparing Echinorhynchi</i>	147
VIRCHOW, H.— <i>Action of Light on Objects hardened in Chromic Acid</i>	148
HAACKE'S (W.) <i>Dehydrating Apparatus</i> (Fig. 27)	148
FRANCOUPE, P.— <i>Imbedding in Paraffin by means of a Vacuum</i> (Fig. 28)	149
KINGSLEY, J. S.— <i>Rapid Imbedding</i>	150
CALDWELL'S (W. H.) <i>Automatic Microtome</i> (Figs. 29-31)	150
BECK'S <i>Automatic Microtome</i>	153
THOMA'S (R.) <i>Microtome</i> (Figs. 32-39)	153
GRAVIS, A., & C. O. WHITMAN— <i>Cutting Ribbons of Sections</i>	157
HEIDENHAIN, R.— <i>New Application of Hæmatoxylin</i>	158
WEIGERT, C., & W. T. COUNCILMAN.— <i>Weigert's Staining Method for the Central Nervous System</i>	158
FREUD, S.— <i>Method for Displaying the Course of the Fibres in the Central Nervous System</i>	159
HARMER, S. F.— <i>Method for the Silver Staining of Marine Objects</i>	160
GRAY, W. J.— <i>Balsam of Tolu for Mounting</i>	160
ZENGER'S (C. V.) <i>Mounting for Diatoms, to view them on both sides</i>	161

ROYAL MICROSCOPICAL SOCIETY.

COUNCIL.

ELECTED 13th FEBRUARY, 1884.

PRESIDENT.

REV. W. H. DALLINGER, F.R.S.

VICE-PRESIDENTS.

JOHN ANTHONY, Esq., M.D., F.R.C.P.L.

PROF. P. MARTIN DUNCAN, M.B., F.R.S.

JAMES GLAISHER, Esq., F.R.S., F.R.A.S.

CHARLES STEWART, Esq., M.R.C.S., F.L.S.

TREASURER.

LIONEL S. BEALE, Esq., M.B., F.R.C.P., F.R.S.

SECRETARIES.

FRANK CRISP, Esq., LL.B., B.A., V.P. & TREAS. L.S.

PROF. F. JEFFREY BELL, M.A., F.Z.S.

Twelve other MEMBERS of COUNCIL.

ALFRED WILLIAM BENNETT, Esq., M.A., B.Sc., F.L.S.

ROBERT BRAITHWAITE, Esq., M.D., M.R.C.S., F.L.S.

G. F. DOWDESWELL, Esq., M.A.

J. WILLIAM GROVES, Esq.

JOHN E. INGPEN, Esq.

JOHN MATTHEWS, Esq., M.D.

JOHN MAYALL, Esq., Jun.

ALBERT D. MICHAEL, Esq., F.L.S.

JOHN MILLAR, Esq., L.R.C.P.Edin., F.L.S.

WILLIAM MILLAR ORD, Esq., M.D., F.R.C.P.

URBAN PRITCHARD, Esq., M.D.

WILLIAM THOMAS SUFFOLK, Esq.







LIBRARIAN and ASSISTANT SECRETARY.

MR. JAMES WEST.

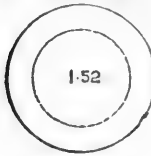
I. Numerical Aperture Table.

The "APERTURE" of an optical instrument indicates its greater or less capacity for receiving rays from the object and transmitting them to the image, and the aperture of a Microscope objective is therefore determined by the ratio between its focal length and the diameter of the emergent pencil at the plane of its emergence—that is, the utilized diameter of a single-lens objective or of the back lens of a compound objective.

This ratio is expressed for all media and in all cases by $n \sin u$, n being the refractive index of the medium and u the semi-angle of aperture. The value of $n \sin u$ for any particular case is the "numerical aperture" of the objective.

Diameters of the Back Lenses of various Dry and Immersion Objectives of the same Power ($\frac{1}{2}$ in.) from 0.50 to 1.52 N. A.	Numerical Aperture. ($n \sin u = a$.)	Angle of Aperture ($= 2u$).			Illuminating Power. (a^2 .)	Theoretical Resolving Power, in Lines to an Inch. ($A = 0.5289 \mu = \text{line E.}$)	Penetrating Power. ($\frac{1}{a}$)
		Dry Objectives. ($n = 1$.)	Water-Immersion Objectives. ($n = 1.33$.)	Homogeneous-Immersion Objectives. ($n = 1.52$.)			
	1.52	180° 0'	2.310	146,528	.658
	1.50	161° 23'	2.250	141,600	.667
	1.48	153° 39'	2.190	142,672	.676
	1.46	147° 42'	2.132	140,744	.685
	1.44	142° 40'	2.074	138,816	.694
	1.42	138° 12'	2.016	136,888	.704
	1.40	134° 10'	1.960	134,960	.714
	1.38	130° 26'	1.904	133,032	.725
	1.36	126° 57'	1.850	131,104	.735
	1.34	123° 40'	1.796	129,176	.746
	1.33	..	180° 0'	122° 6'	1.770	128,212	.752
	1.32	..	165° 56'	120° 33'	1.742	127,248	.758
	1.30	..	155° 38'	117° 34'	1.690	125,320	.769
	1.28	..	148° 28'	114° 44'	1.638	123,392	.781
	1.26	..	142° 39'	111° 59'	1.588	121,464	.794
	1.24	..	137° 36'	109° 20'	1.538	119,536	.806
	1.22	..	133° 4'	106° 45'	1.488	117,608	.820
	1.20	..	128° 55'	104° 15'	1.440	115,680	.833
	1.18	..	125° 3'	101° 50'	1.392	113,752	.847
	1.16	..	121° 26'	99° 29'	1.346	111,824	.862
	1.14	..	118° 00'	97° 11'	1.300	109,896	.877
	1.12	..	114° 44'	94° 56'	1.254	107,968	.893
	1.10	..	111° 36'	92° 43'	1.210	106,040	.909
	1.08	..	108° 36'	90° 33'	1.166	104,112	.926
	1.06	..	105° 42'	88° 26'	1.124	102,184	.943
	1.04	..	102° 53'	86° 21'	1.082	100,256	.962
	1.02	..	100° 10'	84° 18'	1.040	98,328	.980
	1.00	180° 0'	97° 31'	82° 17'	1.000	96,400	1.000
	0.98	157° 2'	94° 56'	80° 17'	.960	94,472	1.020
	0.96	147° 29'	92° 24'	78° 20'	.922	92,544	1.042
	0.94	140° 6'	89° 56'	76° 24'	.884	90,616	1.064
	0.92	133° 51'	87° 32'	74° 30'	.846	88,688	1.087
	0.90	128° 19'	85° 10'	72° 36'	.810	86,760	1.111
	0.88	123° 17'	82° 51'	70° 44'	.774	84,832	1.136
	0.86	118° 38'	80° 34'	68° 54'	.740	82,904	1.163
	0.84	114° 17'	78° 20'	67° 6'	.706	80,976	1.190
	0.82	110° 10'	76° 8'	65° 18'	.672	79,048	1.220
	0.80	106° 16'	73° 58'	63° 31'	.640	77,120	1.250
	0.78	102° 31'	71° 49'	61° 45'	.608	75,192	1.282
	0.76	98° 56'	69° 42'	60° 0'	.578	73,264	1.316
	0.74	95° 28'	67° 36'	58° 16'	.548	71,336	1.351
	0.72	92° 6'	65° 32'	56° 32'	.518	69,408	1.389
	0.70	88° 51'	63° 31'	54° 50'	.490	67,480	1.429
	0.68	85° 41'	61° 30'	53° 9'	.462	65,552	1.471
	0.66	82° 36'	59° 30'	51° 28'	.436	63,624	1.515
	0.64	79° 35'	57° 31'	49° 48'	.410	61,696	1.562
	0.62	76° 38'	55° 34'	48° 9'	.384	59,768	1.613
	0.60	73° 44'	53° 38'	46° 30'	.360	57,840	1.667
	0.58	70° 54'	51° 42'	44° 51'	.336	55,912	1.724
	0.56	68° 6'	49° 48'	43° 14'	.314	53,984	1.786
	0.54	65° 22'	47° 54'	41° 37'	.292	52,056	1.852
	0.52	62° 40'	46° 2'	40° 0'	.270	50,128	1.923
	0.50	60° 0'	44° 10'	38° 24'	.250	48,200	2.000

EXAMPLE.—The apertures of four objectives, two of which are dry, one water-immersion, and one oil-immersion, would be compared on the angular aperture view as follows:—106° (air), 157° (air), 142° (water), 130° (oil).

Their actual apertures are, however, as .80 .98 1.26 1.38 or their numerical apertures.

II. Conversion of British and Metric Measures.

(1.) LINEAL.

Micromillimetres, &c., into Inches, &c.

Inches, &c., into Micromillimetres, &c.

μ	ins.	mm.	ins.	mm.	ins.
1	·000039	1	·039370	51	2·007892
2	·000079	2	·078741	52	2·047262
3	·000118	3	·118111	53	2·086633
4	·000157	4	·157482	54	2·126003
5	·000197	5	·196852	55	2·165374
6	·000236	6	·236223	56	2·204744
7	·000276	7	·275593	57	2·244115
8	·000315	8	·314963	58	2·283485
9	·000354	9	·354334	59	2·322855
10	·000394	10 (1 cm.)	·393704	60 (6 cm.)	2·362226
11	·000433	11	·433075	61	2·401596
12	·000472	12	·472445	62	2·440967
13	·000512	13	·511816	63	2·480337
14	·000551	14	·551186	64	2·519708
15	·000591	15	·590556	65	2·559078
16	·000630	16	·629927	66	2·598449
17	·000669	17	·669297	67	2·637819
18	·000709	18	·708668	68	2·677189
19	·000748	19	·748038	69	2·716560
20	·000787	20 (2 cm.)	·787409	70 (7 cm.)	2·755930
21	·000827	21	·826779	71	2·795301
22	·000866	22	·866150	72	2·834671
23	·000906	23	·905520	73	2·874042
24	·000945	24	·944890	74	2·913412
25	·000984	25	·984261	75	2·952782
26	·001024	26	1·023631	76	2·992153
27	·001063	27	1·063002	77	3·031523
28	·001102	28	1·102372	78	3·070894
29	·001142	29	1·141743	79	3·110264
30	·001181	30 (3 cm.)	1·181113	80 (8 cm.)	3·149635
31	·001220	31	1·220483	81	3·189005
32	·001260	32	1·259854	82	3·228375
33	·001299	33	1·299224	83	3·267746
34	·001339	34	1·338595	84	3·307116
35	·001378	35	1·377965	85	3·346487
36	·001417	36	1·417336	86	3·385857
37	·001457	37	1·456706	87	3·425228
38	·001496	38	1·496076	88	3·464598
39	·001535	39	1·535447	89	3·503968
40	·001575	40 (4 cm.)	1·574817	90 (9 cm.)	3·543339
41	·001614	41	1·614188	91	3·582709
42	·001654	42	1·653558	92	3·622080
43	·001693	43	1·692929	93	3·661450
44	·001732	44	1·732299	94	3·700820
45	·001772	45	1·771669	95	3·740191
46	·001811	46	1·811040	96	3·779561
47	·001850	47	1·850410	97	3·818932
48	·001890	48	1·889781	98	3·858302
49	·001929	49	1·929151	99	3·897673
50	·001969	50 (5 cm.)	1·968522	100 (10 cm.=1 decim.)	
60	·002362				
70	·002756				
80	·003150	decim.		ins.	
90	·003543	1		3·937043	
100	·003937	2		7·874086	
200	·007874	3		11·811130	
300	·011811	4		15·748173	
400	·015748	5		19·685216	
500	·019685	6		23·622259	
600	·023622	7		27·559302	
700	·027559	8		31·496346	
800	·031496	9		35·433389	
900	·035433	10 (1 metre)		39·370432	
1000 (=1mm.)				= 3·280869 ft.	
				= 1·093623 yds.	

ins.	μ
$\frac{1}{250000}$	1·015991
$\frac{1}{200000}$	1·269989
$\frac{1}{150000}$	1·693318
$\frac{1}{100000}$	2·539977
$\frac{1}{80000}$	2·822197
$\frac{1}{60000}$	3·174972
$\frac{1}{50000}$	3·628539
$\frac{1}{40000}$	4·233295
$\frac{1}{30000}$	5·079954
$\frac{1}{20000}$	6·349943
$\frac{1}{15000}$	8·466591
$\frac{1}{10000}$	12·699886
$\frac{1}{7000}$	25·399772
	mm.
$\frac{1}{800}$	·028222
$\frac{1}{600}$	·031750
$\frac{1}{500}$	·036285
$\frac{1}{400}$	·042333
$\frac{1}{300}$	·050800
$\frac{1}{250}$	·056444
$\frac{1}{200}$	·063499
$\frac{1}{150}$	·072571
$\frac{1}{100}$	·084666
$\frac{1}{80}$	·101599
$\frac{1}{60}$	·126999
$\frac{1}{50}$	·169332
$\frac{1}{40}$	·253998
$\frac{1}{30}$	·507995
$\frac{1}{25}$	1·015991
$\frac{1}{20}$	1·269989
$\frac{1}{15}$	1·587486
$\frac{1}{12}$	1·693318
$\frac{1}{10}$	2·116648
$\frac{1}{8}$	2·539977
$\frac{1}{6}$	3·174972
$\frac{1}{5}$	4·233295
$\frac{1}{4}$	4·762457
$\frac{1}{3}$	5·079954
$\frac{1}{2}$	6·349943
$\frac{1}{1}$	7·937429
	cm.
$\frac{1}{7}$	1·111240
$\frac{1}{5}$	1·269989
$\frac{1}{4}$	1·428737
$\frac{1}{3}$	1·587486
$\frac{1}{2}$	1·746234
$\frac{1}{1}$	1·904983
$\frac{1}{1}$	2·063732
$\frac{1}{1}$	2·222480
$\frac{1}{1}$	2·381229
1	2·539977
2	5·079954
3	7·619932
	decim.
4	1·015991
5	1·269989
6	1·523986
7	1·777984
8	2·031982
9	2·285979
10	2·539977
11	2·793975
1 ft.	3·047973
	metres.
1 yd.=	·914392

Scale showing the relation of Millimetres, &c., to Inches.

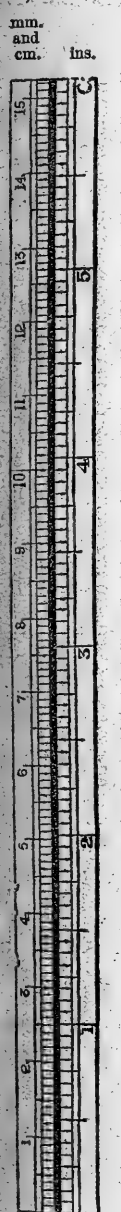

000 μ = 1 mm.
10 mm. = 1 cm.
10 cm. = 1 dm.
10 dm. = 1 metre.

JOURNAL
OF THE
ROYAL MICROSCOPICAL SOCIETY,
Containing its Transactions and Proceedings,
AND A SUMMARY OF CURRENT RESEARCHES RELATING TO
ZOOLOGY AND BOTANY
(principally Invertebrata and Cryptogamia),
MICROSCOPY, &c.

Edited by

FRANK CRISP, LL.B., B.A.,

one of the Secretaries of the Society and a Vice-President and Treasurer of the
Linnean Society of London;

WITH THE ASSISTANCE OF THE PUBLICATION COMMITTEE AND

A. W. BENNETT, M.A., B.Sc.,

Lecturer on Botany at St. Thomas's Hospital,

F. JEFFREY BELL, M.A.,

Professor of Comparative Anatomy in King's College,

JOHN MAYALL, Jun., FRANK E. BEDDARD, M.A., and

B. B. WOODWARD, of the British Museum,

FELLOWS OF THE SOCIETY.

THIS Journal is published bi-monthly, on the second Wednesday of the months of February, April, June, August, October, and December. It varies in size, according to convenience, but does not contain less than 10 sheets (160 pp.) with Plates and Woodcuts as required. The price to non-Fellows is 5s. per Number.

The Journal comprises:

- (1.) The TRANSACTIONS and the PROCEEDINGS of the Society: being the Papers read and Reports of the business transacted at the Meetings of the Society, including any observations or discussions on the subjects brought forward.
- (2.) SUMMARY of CURRENT RESEARCHES relating to ZOOLOGY and BOTANY (principally Invertebrata and Cryptogamia, with the Embryology and Histology of the higher Animals and Plants), and MICROSCOPY (properly so called): being abstracts of or extracts from the more important of the articles relating to the above subjects contained in the various British and Foreign Journals, Transactions, &c., from time to time added to the Library.

Authors of Papers printed in the Transactions are entitled to 20 copies of their communications *gratis*. Extra copies can be had at the price of 12s. 6d. per half-sheet of 8 pages, or less, including cover, for a minimum number of 100 copies, and 6s. per 100 plates, if plain. Prepayment by P.O.O. is requested.

All communications as to the Journal should be addressed to the Editor, Royal Microscopical Society, King's College, Strand, W.C.

Published for the Society by

WILLIAMS AND NORGATE,

LONDON AND EDINBURGH.

ROYAL MICROSCOPICAL SOCIETY.

MEETINGS FOR 1885, at 8 p.m.

Wednesday, JANUARY 14	Wednesday, MAY 13
" FEBRUARY 11	" JUNE 10
(Annual Meeting for Election of Officers and Council.)	" OCTOBER 7
" MARCH 11	" NOVEMBER 11
" APRIL 8	" DECEMBER 9

THE " SOCIETY " STANDARD SCREW.

The Council have made arrangements for a further supply of Gauges and Screw-tools for the " SOCIETY " STANDARD SCREW for OBJECTIVES.

The price of the set (consisting of Gauge and pair of Screw-tools) is 12s. 6d. (post free 12s. 10d.). Applications for sets should be made to the Assistant-Secretary.

For an explanation of the intended use of the gauge, see Journal of the Society, I. (1881) pp. 548-9.

New Edition, very much enlarged, 21s.

HOW TO WORK WITH THE MICROSCOPE.

BY LIONEL S. BEALE, F.R.S.,

TREASURER AND FORMERLY PRESIDENT OF THE ROYAL MICROSCOPICAL SOCIETY.

THE FIFTH EDITION.

Strongly bound and enlarged to 530 pages, with 100 Plates, some of which are Coloured.

HARRISON AND SONS, FOLL MALL.

ADVERTISEMENTS FOR THE JOURNAL.

Mr. CHARLES BLENCOWE, of 9, Bridge Street, Westminster, S.W., is the authorized Agent and Collector for Advertising Accounts on behalf of the Society.

CHARLES COPPOCK,

LATE
PARTNER WITH
R. & J. BECK.

PATHOLOGICAL
AND
PHYSIOLOGICAL
PREPARATIONS.

STAINING FLUIDS
AND ALL
ACCESSORIES
FOR STUDENTS'
USE.

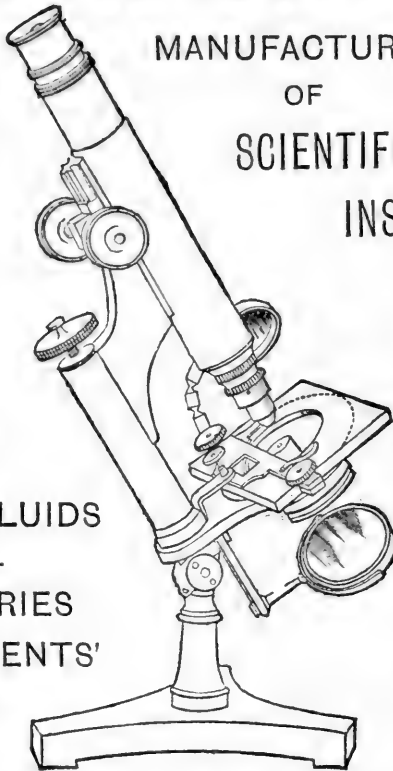

MANUFACTURER
OF
SCIENTIFIC
INSTRUMENTS.

Microscopes
for
Students and
Amateurs.

ILLUSTRATED
CATALOGUE,
2s.

100, NEW BOND STREET,
LONDON, W.

N.B. SPECTACLES!!

OCULISTS' PRESCRIPTIONS RECEIVE PERSONAL ATTENTION.

AGENT FOR W. H. BULLOCH, CHICAGO, ILLS., U.S.A.
R. H. SPENCER & CO., N.Y., U.S.A.
JAMES L. PEASE, MASS., U.S.A.
,, M. PRAZMOWSKI, PARIS.
M. A. NACHET, PARIS.

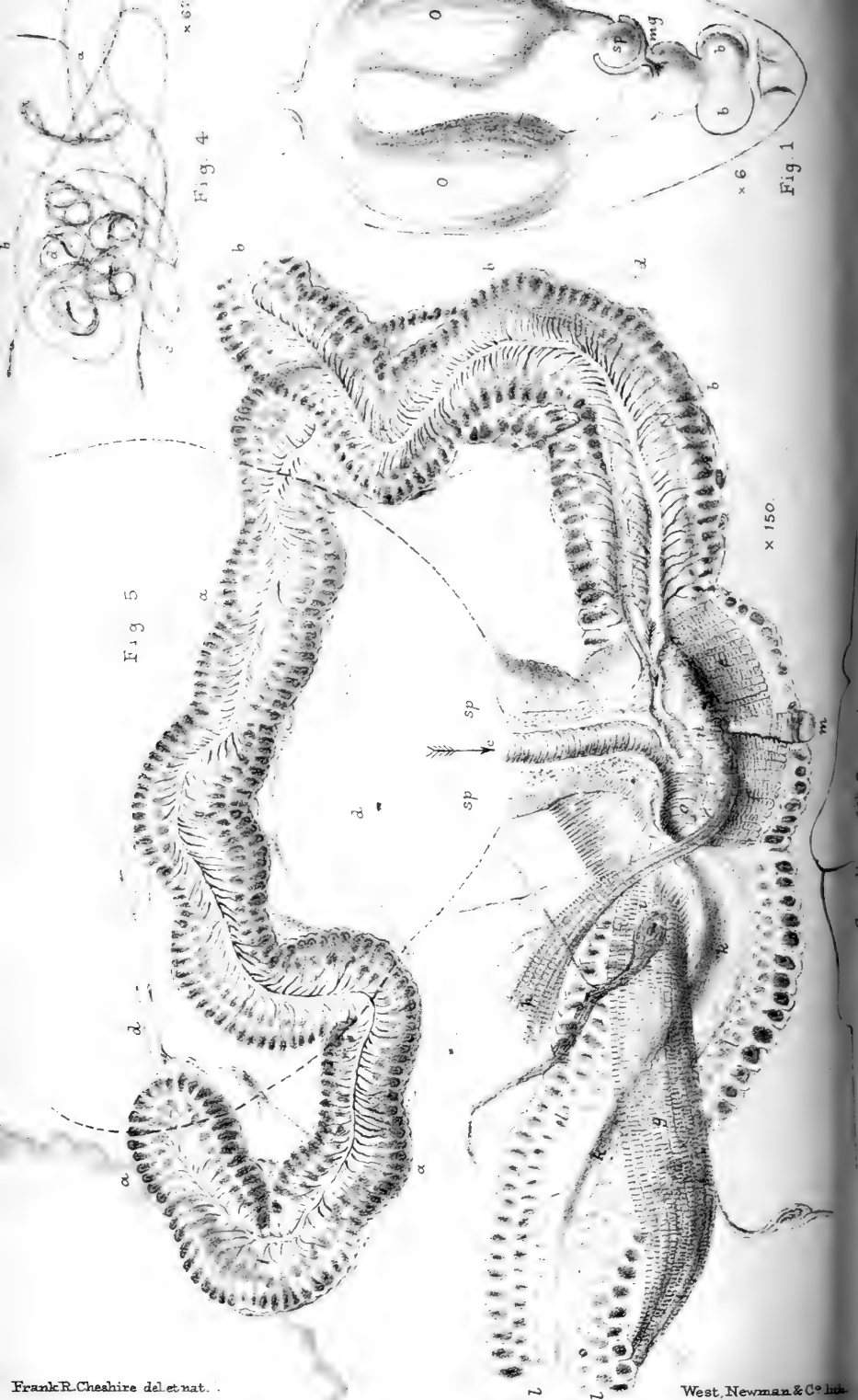

Fig. 4

Fig. 1

Fig. 5

x 150.

x 6

x 60

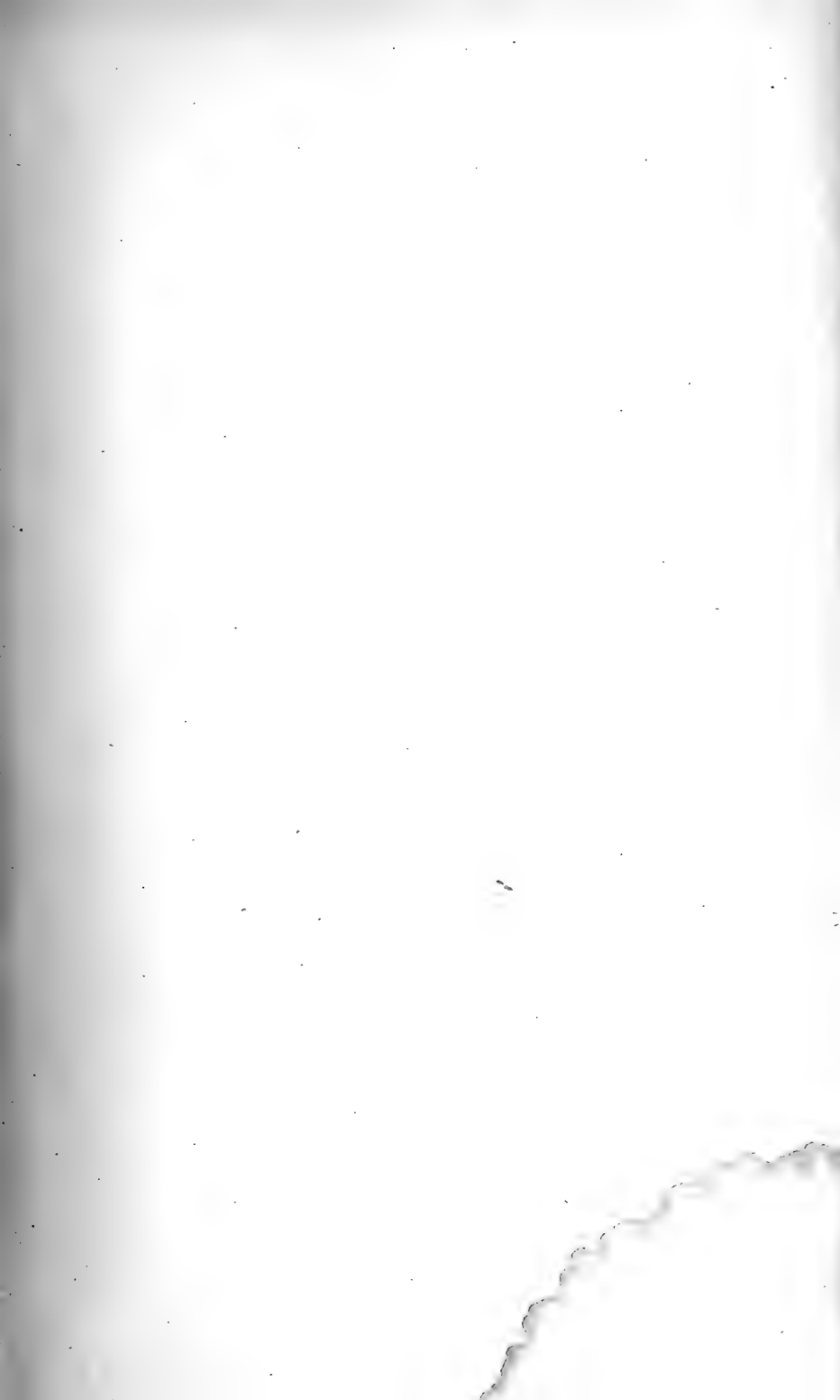

Fig 8

x 830

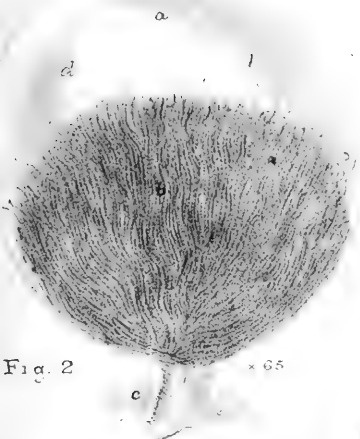

Fig. 2

x 65



Fig. 6.

Fig 3



Fig 7

x 150

JOURNAL
OF THE
ROYAL MICROSCOPICAL SOCIETY.
FEBRUARY 1885.

TRANSACTIONS OF THE SOCIETY.

I.—*The Apparatus for differentiating the Sexes in Bees and Wasps. An Anatomical Investigation into the Structure of the Receptaculum Seminis and adjacent parts.*

By FRANK R. CHESHIRE, F.R.M.S.

(Read 10th December, 1884.)

PLATES I. AND II.

THE labours of Siebold, Berlepsch, Leuckart, and others, have put the fact of parthenogenesis in bees altogether beyond dispute, but the argument, as these investigators have given it, although abundantly sufficient, has lacked that anatomical confirmation which it is the object of the present paper to supply.

Since the Honey Bee can be so readily kept under observation, and the modern hive which forms its habitat under domestication

EXPLANATION OF PLATES I. AND II.

Fig. 1.—General plan of reproductive organs of Queen Bee (*Apis mellifica*). *o*, ovaries, leading to oviducts. *sp*, spermatheca, or receptaculum seminis. *m g*, mucous or appendicular gland. *b b*, bursa copulatrix.

Fig. 2.—Spermatheca with tracheæ removed, from queen about two years old. *a*, space filled with mucus. *b*, spermatozoa *in situ* and at rest. *c*, spermathecal aperture. *d d*, spermatozoa in motion.

Fig. 3.—Right and left, and common oviducts. *a*, fertilizing pouch. *b* and *c*, *b'* and *c'*, upper and lower egg-channels. *d d*, bursa copulatrix. *e*, muscles contracting lower channel.

Fig. 4.—Spermatozoa from queen, length 250 μ , greatest diameter 0.5 μ . *a*, *b*, and *c*, parts showing a double filament (dorsal filament separated?). *d*, spermatozoa coiled. The position taken at death.

Fig. 5.—Spermathecal valve and glands of Queen Bee. *a a a*, *b b b*, right and left lobes of mucous or appendicular gland. *c*, aperture of spermatheca *sp*, bounded by dotted line. *d d d*, nerves and nerve-cells. *e*, mucous gland sphincter. *f*, spermathecal sphincter. *g*, muscle for extending valvular opening. *h*, muscle for closing valvular opening. *i*, ganglion lying under muscle *g*. *k k*, duct for spermatozoa. *l l l*, glandular structure surrounding duct. *m*, wedge-shaped disk between sphincters *e* and *f*. *n*, chitinous plate under common duct

can be so easily and completely manipulated, it will be not only more useful but more convenient to concentrate our attention somewhat upon this member of the family Apidæ, although no doubt the facts to be introduced will apply with certain modifications to every species in it.

It must be remarked by way of introduction, that it has long been known that a queen or mother bee is not doomed to total sterility if raised at a part of the year when drones (males) do not exist, but that she, although later than at the normal period, begins to deposit eggs, which, however, are in no instance converted into workers, but invariably produce drones, which must be of course, in this case at least, generated parthenogenetically. Similarly, if a queen of the Italian race (*Apis Ligustica*) which has consorted * with an Italian drone be placed in a hive containing English bees (*Apis mellifica*) only, and which is itself located in a neighbourhood where Italians are unknown, all her progeny, both workers and drones, will to the end of her life continue pure, carrying their characteristic yellow abdominal bands and a thousand other minor distinctive peculiarities; but should she leave with a swarm or die, the workers will raise a successor from one of her eggs. The queen resulting must of necessity mate with an English drone, and as a consequence the workers produced by her will partake of the two races, exhibiting amongst themselves those variations for which hybrids † are remarkable; but her drones, on the contrary, will still be absolutely Italian; again showing that although their mother was impregnated, her impregnation had in no way influenced *their* generation, or that they as before come from unfertilized eggs. Occasionally in the absence of a mother-

of spermatheca and appendicular gland. *o*, common duct. *p*, common appendicular duct. *t t t*, right and left appendicular ducts with tubules.

Fig. 6.—Oviducts, &c., of Queen Wasp (*Vespa vulgaris*). *O*, ova in ovarian tubes. *OT*, ovarian tubes. *OD*, *OD*, right and left oviducts. *COD*, common oviduct. *sp*, spermatheca or receptaculum seminis. *mg*, mucous or appendicular gland. *r*, ring to extend ovarian tubes.

Fig. 7.—Spermathecal valve and glands of Queen Wasp. *mg*, *mg*, mucous or appendicular gland. *sp*, spermatheca with spermatozoa *in situ*. *a*, structureless membrane. *b*, secretive layer. *c*, elastic coat. *d*, outer wrinkled membrane. *e*, aperture of spermatheca. *f*, closing muscle. *g*, common duct of mucous gland. *h i*, muscle to extend aperture of duct. *k*, wide channel for spermatozoa to pass upwards. *l*, narrow channel leading to point where eggs are fertilized. *n*, nerves connecting spermatheca and valve muscles. *n'*, nerves of mucous gland. *op*, outer and inner ducts. *t*, duct and tubules of mucous gland. *t'*, tracheæ of spermatheca.

Fig. 8.—Spermatozoa from Queen Wasp, length 200 μ , greatest diameter 0.4 μ . *a*, extended, *b*, coiled condition.

* All bees mate but once.

† The word hybrid is used here rather popularly than scientifically, and in obedience to custom. No assertion that *Apis mellifica* and *Apis Ligustica* are specifically distinct is conveyed. They may be merely well-marked varieties.

bee one or more of the workers* (which from their anatomical structure are incapable † of coition) will commence ovipositing, and these eggs, from reasons now clear, develop drones only. Beyond these facts and many similar ones, it has been demonstrated that the drone produces a vast number of spermatozoa, and that the queen after conjugation is found to contain these stored in a receptacle to which the names spermatheca (plate I. fig. 1, *sp*) and receptaculum seminis have been given, and that these threads are the active means for possibly converting an egg that would otherwise have yielded a drone into a worker, or it may be a queen. But many problems have had no answer, and most conspicuously those which asked *how* these threads were transferred to the eggs, and how a mother after her impregnation could as needed supply eggs either fertilized or unfertilized, and it is to these especially that I invite attention.

As however the investigation shows beautifully that the queen after mating becomes most completely a creature carrying all the essentials of the two genders within herself, it will be necessary to consider the organization of the male.

If the abdomen of a queen be cut open down the sides by fine scissors and the three first dorsal plates carefully removed, we discover two very large organs (plate I. fig. 1, *o*) filling nearly the whole of the enclosed space. These are the ovaries, and consist of from 100 to 120 tubes ‡ each, all lying side by side and gathered into a bundle by countless small tracheæ which act as connective tissue. These ovarian tubes are at the upper end very small, and here each egg is represented by an initial cell, but during development it passes on, room being made for it by the escape of the mature eggs at the wider lower end. Each tube merges into the oviduct (plate I. fig. 1), the commencement of which is formed by the opened out walls of the peripheral ovarian tubes.§ The two ovaries are thus covered below by very delicate but, as will be presently seen, highly organized membranous expansions which may be compared to funnels, the delivery pipes of which (the oviducts) unite into a single tube, the common oviduct. If a drone be now opened in like manner, we discover in the same relative part of his body two organs much smaller in size, containing about 300 tubes, individually minute, but from which are evolved the thread-like spermatozoa (plate I. fig. 4), much as the eggs are developed in the

* Such workers are known as fertile workers. They are abnormal amongst the hive bees, but amongst some members of the Apidæ and Vespidæ they perform no unimportant part in the regular building up of the colony.

† One exceptional instance is declared, but it must be received with reserve.

‡ In counting these tubes, it is needful to thoroughly dissect, as the ovaries are not equally active in every part, and some of the tubes, thin and flat, may otherwise easily escape detection.

§ The central tubes unite their lower edges and complete the covering above.

queen, so that the ovaries of the queen and the testes of the drone are homologues of one another. A canal also on each side of the body conveys these threads as matured to the vesicula seminalis, which is much larger than the testis, and here they await the object of their development. The homologue of this store-chamber is clearly the spermatheca of the queen. At the time of mating spermatozoa require a medium in which they may be floated into their proper destination, and to supply this a gland is provided—the glandula mucosa—into which the vesicula seminalis opens, and during ejaculation the mucous secretion of the gland and the spermatozoa are sent forward together. The mucous gland, we shall presently see good reason to believe, has also its homologue in the queen, which now we had better scrutinize.

Near the commencement of the common oviduct, which is fastened by very complicated muscles to the fifth abdominal ring, we find the before-mentioned globular body (plates I. and II. figs. 1 and 2), rather more than 1 mm. in diameter, glistening like burnished silver, because densely coated with the closest and most curiously felted plexus of tracheæ with which I am acquainted. This spermatheca is in structural communication with the common oviduct, but the smallest roughness will break it from its attachment, and will frustrate any endeavour to discover how it is filled up and used; but with it separated, should accident detach it, we may still study the exceedingly curious and complicated valvular apparatus with which it is furnished. Removing it to the stage of the dissecting Microscope,* and surrounding it with dilute glycerin, we get glimpses of a contained membrane between the meshes of the investing tracheæ. So far as I know, those who have studied this matter have failed to discover that these tracheæ merely closely embrace the actual spermatheca, and that they in no instance enter its walls; but such is the fact, and by very careful teasing and cutting with needle-knives we may so separate them that they may be peeled off as a rind from an orange. The sac itself (plate II. fig. 2) is now seen to have beautifully transparent sides, giving faint indications of originating in coalescing cells, but having no discernible structure except near its outlet where it has an epithelial lining. Through its sides, if the queen is unimpregnated, we discern only a perfectly clear fluid.† If, on the contrary, she has been recently mated, the whole interior is densely clouded and semi-opaque, since it is perfectly filled with spermatozoa; but as older and yet older queens are operated upon, the spermatozoa

* I use a "Stephenson's erecting binocular," and hardly think what I am describing could be accomplished with a simple "dissector."

† Leidy describes the fluid as granular, which is certainly erroneous. Leuckart says it is clear. Both of these observers appear to have merely ruptured the sac by pressure, afterwards examining the expressed matter.

decrease in number, but instead of being generally diffused are gathered into a tolerably compact mass (plate II. fig. 2, *b*), which lies near the aperture of the spermatheca, the remainder of the latter being filled with a clear fluid (*a*) as in virgin queens.

This collection of spermatozoa is seen by a $1/2$ in. objective to be arranged in large wavy floccus-like masses as indicated in the figure just referred to, the extremities of the motile threads pointing towards the aperture, while from its upper surface spermatozoa are observed to rise in different spots (fig. 2, *d d*) like microscopic eels, long and thin, curling and twisting with much grace as they hold on by their tails. After a few seconds they lapse into quietude, to be in turn succeeded by others, and in a warm room this most curious set of movements will be long continued, even though several hours have been occupied in dissecting the abdomen whence the spermatheca had been taken. It has been again and again asserted, as an echo of a bold guess made long since in America, that the narrower * worker cell in which worker bees are raised, by pressing upon the abdomen of the queen, was the effective means for the forcing out of spermatozoa and so causing these eggs to be fertilized. This notion, so repellent from its bald crudity, could only be previously met by negative evidence, and since there is no confidence like the confidence of ignorance, the error has died hard; and it is worth while in this connection to note that the closing valve *n*, fig. 5, of the spermatheca, which we are presently to examine, having been brought away *in situ*, holds so very strongly, that the sac may be squeezed flat in the compressorium without driving out a single spermatozoon. The pressure increased, the delicate bag at length bursts, and a true microscopical marvel awaits us. The spermatozoa escape in tufts, each containing hundreds of thousands. These tufts have a beautiful arrangement, reminding one of a girl's back hair combed out after plaiting; but each spermatozoon wriggles to be free, and quickly they are widely spread, curling and uncurling with a peculiar snapping movement, and with an energy that baffles description. Their powers in a few minutes begin to wane; then one after the other they take a form which with a $1/2$ in. or even $1/4$, closely resembles two 8's one over the other, surrounded by a rather larger O (fig. 4, *d*). When all have sunk to rest, this singular pattern, repeated with strange regularity, covers the field.†

* Honeycomb consists of two-sized cells—worker cells $1/5$ in. in diameter, and drone cells $1/4$ in. in diameter.

† This pattern is not always obtained. In some cases the arrangement is made up of comparatively large, round, dense masses, throwing off four tufts at right angles. These tufts join others from other similar masses, so that a pattern which might do well for a drugget is made up. I exhibited this pattern to the Fellows at a former meeting. The separated condition is the general result of using either extremely dilute glycerin or even water. No stain has with me succeeded at all like Spiller's purple. This if properly applied brings out the heads with great clearness, while the body remains a distinct but pale violet.

Let us suppose that a complete spermatheca is now before us; as we turn it we get it into such a position that its outline is not unlike the back of a man's head carrying two large and prominent ears. These latter are the upper ends of two glands (plate I. fig. 5, *a b*), something less than 200μ in diameter, and which are held in position by receiving very numerous twigs from the investing tracheal plexus. These glands passing down the opposite sides of the spermatheca, meet together and form a junction *p*, near the spermathecal duct *c*. They consist of nucleated gland cells surrounding a tube *t* which runs from end to end and enlarges somewhat during its course. This tube gives off thousands of tubelets which pass to the distinct cells, upon the walls of which they seem to expand; but after considerable painstaking I feel myself uncertain upon this point.

The spermathecal duct (fig. 5, *c*), which is short, stiff, and slightly rugose, points towards but does not immediately join the duct of the appendicular* gland. Attached to these ducts and valve are five main muscles, two of which are sphincters, but very faintly indicated at *e* and *f*, lest they should obscure the structure of the valve before which they in reality pass, and which are the main instruments for respectively and independently closing the spermathecal and appendicular gland ducts. These sphincters, which are separated by an intervening wedge-shaped disk *m*, lie towards each other at an angle of from 30° to about 60° , and may be beautifully shown by polarized light. The prisms being crossed, the object is so staged that one sphincter most completely resolves the polarized beam, by which every fibre in it can be perfectly dissociated from its companion, which is placed at such an angle that it gives no perceptible twist to the plane of polarization, and so remains out of view. The rotation of the stage plate now darkens the first observed sphincter, whilst the second becomes brightly illuminated. An indurated integument, probably a chitinous plate (*n* in the figure), is pushed towards the spermathecal duct by the contraction of its proper sphincter, and in this work it is aided by the muscle *h*, which is one of two, the tendinous extension of which is only about 25μ in diameter, or $1/24$ of the thickness of a human hair.† These muscles would, no doubt, all remain tense the insect being in a condition of repose; but should she be engaged in ovipositing and spermatozoa be required

* This name appears to me not well chosen, but since it has been given it had better be retained, although "mucous gland of the female" would have been more expressive.

† I fully feel the difficulty of interpreting a mechanism such as this, but very many dissections made with great care and most scrupulously examined, will, I hope, be thought to justify the explanation given, which certainly seems to me to satisfy fully both the natural history and the microscopy of the case.

for fertilization, the muscle *g* by contraction* would lift the plate lying above and between *o* and *k*, to which by a complex tendon it is attached. Into the cavity *o* thus opened spermatozoa would pass. The two sphincters at the same moment relaxing, an outflow of glandular secretion, as indicated by the arrow, would be ready to sweep the spermatozoa towards their destination in the common oviduct, and all would be at once driven on by the appendicular sphincter first contracting, followed in order by the second sphincter and muscles marked *h*, when the repose condition would again be established.

A most remarkable adaptation here arises. The spermatozoa yielded by the drone are probably about 4,000,000 in number; but these need to be economically utilized, as if they were shot out haphazard, they would be exhausted long before the queen's death, when she would breed of course drones only (a circumstance which does actually, although somewhat exceptionally, arise when queens run on without accident to the ripe old age of four or five years); but the duct *k k* through which they pass, I find to be the centre of another gland *l l*, which seems to the present to have entirely escaped attention. This gland is, no doubt, excited to secretion by the presence of the spermatozoa, just as food excites our salivary glands to the secretion of saliva, and the stomach to the secretion of gastric juice. Spermatozoa thickly present will cause the addition of large quantities of fluid which will dilute and more widely separate them. Their absence (for this gland is most richly provided with nerve-twigs, which send numerous loops to the muscles previously described and to the ganglion *i* seen lying under the muscle *g*) will yield the action which will send a new contingent forward as I have described, and so they come to be paid out with some regularity. The necessity for this regularity will be better appreciated if it be remarked that a prolific queen will lay 1,500,000 eggs, each about 1.8 mm. long, 0.4 mm. in diameter, and that these would fill, if systematically packed, a half-pint measure. Deducting a few thousand for drones, the remainder would each require an independent fertilization, and for this work probably not more than 4,000,000 and often very many less spermatozoa will be at command. We shall presently see that the number of spermatozoa and the size of the receptaculum appear to be proportioned to the laying capabilities of the insect, and hence in every case some such mechanism as we have been examining will be a necessity. In the common wasp, for example, the fecundity is much less than in the hive bee, but the spermatheca is much smaller, the capacity of that of the latter insect being about forty times

* I am fully satisfied that these muscular changes would be all produced by reflex action.

that of the former (plate II. fig. 7, *sp*), while the spermatozoa are nearly of the same size (plate II. fig. 8).

The channel *kk*, fig. 5, is fairly wide, and at first I supposed it tolerably straight and simple, but upon examining it with the low-angled front of a Powell oil 1/12 in. I discovered it to contain a membrane of extreme tenuity and remarkably convoluted, reminding me much of the curious structure of the epididymis of higher animals. The meaning of this peculiarity I can in no way explain. Tracing this channel onwards till it perforates the side of the common oviduct, a bifurcation is detected, one channel of which appears wide and indefinite and to be presently lost in the lower part of the oviduct, whilst the other enters a central* and curiously folded apparatus (plate II. fig. 3, *a*), which, for a reason to be presently explained, I shall denominate the fertilizing pouch. I have strong reasons for supposing that the path upwards from the bursa copulatrix (fig. 3, *d*) (where the male organs of the drone are retained at the time of copulation) and through the pouch aforesaid to the spermatheca is so involved that it would not be possible for the spermatozoa to enter the latter by following it, but that in the early life of the queen the second wider and straighter channel to which I have referred is fully open and by it the spermatozoa, with their inscrutable power of self-direction, pass upwards, avoiding the mazes of the fertilizing pouch and packing themselves for future use. The queen if still unmated at four or five weeks old becomes incapable of copulation or at least she evinces no desire for it, and this possibly marks the time when this lower passage closes; this closure in a mated queen forcing the spermatozoa in descending to take their way to the fertilizing pouch.

If a central comb be lifted from a hive during the summer months, eggs in number will be discovered. If one of these be removed from either a worker or drone cell by the wetted point of a camel-hair pencil, and then microscopically examined in water or glycerin, its surface will be found beautifully netted (the chorion), almost as though a tiny pearl had been covered with what the ladies call "blonde," hundreds of the meshes of which were required to coat it completely. Towards one end the netting makes its cells long and narrow and pointing towards a circular spot, just as the cordage of a balloon points towards the upper valve by which the gas is allowed to escape. This circular spot, I need not here explain, is really an opening called the micropyle, by which the spermatozoon enters and unites its material with the germ cell, so bringing about fertilization. It will be remembered that it has been already stated that in bees this fusion of male and female elements produces the

* The tracing of this channel I have found extremely difficult in the hive bee. The problem in the common wasp is far easier, since in the latter the walls are stronger and more definite.

female (partially developed as to sex in the worker, and fully so developed in the queen), which will possess qualities of both father and mother, so that the tiny spermatozoon not only differentiates the entire creature, but communicates unerringly differences of species or mere variety even. The spermatozoa from Cyprian, Italian, and English bees are to the most refined microscopical examination identical, and yet they contain differences which determine almost countless variations in form, colour, size, instinct, capability, and temper.

That the spermatozoon enters the egg is certain, for it may be found if the latter be carefully examined immediately after deposition. (It is my opinion, resting upon facts which do not fall within the scope of this paper, that Siebold * has possibly been in error in imagining that he has noticed more than one spermatozoon within an egg. The great length of the body, about 250 μ , necessitates many convolutions and would make misconception easy †). The head (see fig. 4) of the spermatozoon is very narrow in order that the micropylar aperture may be passed, but to effect this time must be occupied, and how is this given? It is clear from what I have already said that the spermatozoa pass not into a plain tubular cavity to meet the descending egg, but into a pouch which I find to be elastic and curiously formed of folds of the lining membrane of the common oviduct, and which takes up picric acid from picro-carmines far more freely than the oviduct proper, whilst its surface is dotted over with linear patches of setæ from two to six in a patch and from 1 to 3 μ in length. Its structure is particularly difficult to examine, and I should require to carefully dissect many more examples of it before I would commit myself to a drawing, but I am satisfied that into or against this pouch ‡ the eggs that are to form workers are conveyed, and that here they are brought into contact with the spermatozoa and fertilization is accomplished, while drones are evolved from eggs which are carried down by the path *c*, fig. 3, by the side of the pouch to the ovipositor and so escape all contact with the fertilizing fluid. The oviducts are very highly organized, containing a most beautiful system of longitudinal and transverse muscular fibres repletely provided with nerve-twigs, evidently giving to the oviducts the most complete control of the eggs which are to pass through them, while, as just hinted, they are not without strong indications of two

* Siebold 'On True Parthenogenesis,' p. 85 *et seq.*

† I have not failed to note that possibly the body of the spermatozoon is very elastic, measuring much less in the coiled than in the straight form.

‡ Is not the pouch described by Mr. Lowne as the bursa copulatrix of the blow-fly the same in use as the form now engaging our attention? The bursa copulatrix of the bee is lower down, and is sketched at plate II. fig. 3, *d*. It is worth noting here that the diameter of the pouch is about 60 μ greater than that of the egg.

specialized but confluent paths *b, c*, one towards the fertilizing pouch, and the other to its side. Near the junction of the oviducts also there are two thin muscles *e*, for which I can conceive of no purpose, unless it be to so reduce by their contraction the opening lying by the side of the fertilizing pouch *a*, that an egg could not except they are relaxed pass in this direction and so escape fertilization.*

The nerve structure of these parts would lead me quite beyond the intended scope of this paper, but it should be stated that the last large abdominal ganglion lies immediately beneath and in contact with the oviducts and spermatheca, and from it branches of nerves run in abundance into the oviducts, the spermathecal valve muscles, the sting and ovipositor, while small ganglia are distributed in profusion, a considerable one lying over the valve, and sending branches forward into the fertilizing pouch.

It has been lately noticed by some American beekeepers † that if a maturing queen, that has still some days to pass in her cell before gnawing out, has her cell opened at the upper end so that into the aperture a crushed drone larva may be put, the aperture being again carefully closed, she will in due course appear as an imago, but that she will already be fertilized. It is stated that in many cases queens so treated have commenced laying fertile eggs almost directly after leaving the cell. Incredible as this might at first appear, it is well worth the careful attention of microscopists. The testes are very early developed in the drone, in the full-grown larva of which I have found seminiferous tubes and spermatic filaments in active movement (this is quite in agreement with Mr. Lowne in his observations on blow-flies), and this fact will afford a probable explanation. The larva which is to be developed into a queen is provided by the workers with extremely large quantities of a specialized food of very nutritive character. This is inserted into the upper end of the pendulous cell, and being somewhat viscous the growing larva sticks upon its surface by capillarity. At this time there is of course no anus and no genital aperture. When the chrysalis condition is assumed, the body still adheres to the pappy unconsumed food, from which I have little doubt nutriment is still received by osmosis. The spermatozoa with their marvellous vitality, still surrounded by drone juices or nutrient food, would survive until the developing queen ruptures the very delicate integument which is thrown off at the last moult; they then

* The complicated structure which Mr. Lowne gives to corresponding parts in blow-flies and their general similarity to those I find in bees, leads me to ask, whether it is not at least possible, if indeed not highly probable, from what we know of members of other orders, that one of the sexes in the blow-fly may be parthenogenetically produced?

† The testimony appears satisfactory, but I have not yet tried the experiment.

would pass into the vulva and enter the spermatheca, giving us a queen fertilized from the birth, but one which, no doubt, would carry but few spermatozoa, and so be practically useless—a point which the Microscope could alone determine. But in this quaint performance practical men have given to the embryologist a method of experimenting which may yield good results. Every scientific investigator would see at once far better methods of procedure and possibilities, it may be, not only of tracing the course of the spermatozoa, but of producing hybrids and mules, the study of which may be of immense interest. I hope at any rate to institute experiments in this direction in the coming summer, by which one doubtful point may at any rate be made to pass from the region of speculation to that of knowledge. It is as follows:—

Although the drones produced by the fertile workers (to which reference was previously made) develop spermatozoa exhibiting microscopically all the appearances of those obtained from the normal drone, still the virility of the insect has been questioned, practical men supposing that because he was of doubtful origin he probably was impotent. This question has both a practical and scientific value. Practical, because if the spermatozoa from these fertile-worker-drones are equally effective as those from normal drones, the apiarian would have at command, by keeping a fertile worker ovipositing, a stock of drones at a season of the year when they would not be obtainable from an impregnated queen, and hence he would possess the means of raising and fertilizing queens either earlier or later in the season than would otherwise be possible. The scientific interest centres about the fact that it is well known that amongst the higher animals where a mother* has borne offspring the influence of *its* father may be impressed on her progeny afterwards begotten by a different parent, as in the case of the transmission of Quagga marks to a succession of colts both of whose parents were of the species Horse, the mare having been impregnated by a Quagga male; or in the instance (many cases of which I have observed amongst our own poultry) of a pullet being spoiled for the breeding of fancy stock by some accidental misalliance. The explanation of the first given phenomenon, which rests upon the statement that probably the blood of the female imbibes from that of the foetus through the placental circulation some of the attributes which the latter derived from the male parent, does not seem so directly to apply to the case of the insect as does that of the fowl, for it appears to me that it may be argued that in the queen-produced-drone, although there is no actual spermatogenic fusion, still the fluids of the queen generally are not uninfluenced by the constant presence of spermatozoa within her

* 'Philosophical Transactions,' 1832, and Carpenter's 'Physiology' by Power, 1881, p. 905.

body, and that this influence may in some unknown indirect way transfer to the drone some qualities of the male with which the mother mated, and it certainly is evident that these spermatozoa are not cells in the rest condition. They not only are in partial movement, but they are abundantly aerated, which seems at once to prove that they absorb nutrition which they subsequently oxidize, and that they as a consequence yield products which must pass into the general blood-current. On the opposite side it may be urged that facts known to entomologists would seem certainly to indicate that no such slight indirect influence derived from copulation as is here suggested is necessary, for amongst moths at least twenty generations of females have been produced without a single male individual making its appearance. The coming season will no doubt furnish some with an opportunity of testing the question by inserting larvæ or the testes of drones derived from fertile workers into queen cells. The marvellous persistence of the spermiatic cell is worthy of note in passing. One taken from a queen four years old is utterly indistinguishable from another derived direct from the drone testis, although the former must have existed in the queen's spermatheca the whole of her life, less from five to ten days, between which ages queens almost invariably mate.

Let us now turn our attention to the wasp: opening the abdomen of a hibernating queen as before by cutting down the sides with fine scissors so as to avoid the nerve-track and dorsal vessel, and lifting some of the plates, we shall find the viscera covered densely by fatty masses ("corps grassex"), which of course furnish material for oxidation during the period of repose and the earlier part of that of renewed activity. We may possibly at once be struck by the vast differences in the proportions of the several viscera of the two queens, the bee e. g. having small digestive organs and large ovaries, the wasp small ovaries and large digestive organs, for it would seem at first sight that the organs of reproduction should vary as those of assimilation. The explanation lies in this. The queen bee very largely, if not wholly, depends upon the worker for the production of the chyle, since the latter, more especially during the time the former is rapidly ovipositing, constantly extends the tongue to supply from her own chyle stomach food, the nitrogenous constituents of which have already been brought into a condition of solution; and indeed the queen herself probably never digests normally tissue-forming material (pollen). She does at intervals take honey from the cells of the comb she may be perambulating, but since this honey consists mostly of invert sugar already fitted for assimilation, it can hardly be regarded as requiring digestion. Her work of self-nutrition is thus almost wholly in the direction of absorption, and consequently

the tremendous drain upon her for egg-formation can be met by such a small alimentary canal as leaves abundant room within the abdomen for her extremely developed ovaries.

Removing cautiously viscus after viscus, we find at length the wasp ovaries placed well back, consisting of seven or eight ovarian tubes, each (plate II. fig. 6, O T*) quite separate from one another, while those of the queen bee are, as formerly stated, remarkably compact (plate I. fig. 1, O). The egg-tubes in the wasp are associated with extremely strong and large tracheæ, having for one of their objects undoubtedly the holding of the ovaries in accurate position whatever may be the state of the alimentary canal or the movements of the insect. The ovaries of the bee fill entirely the fore part of the abdominal cavity, the walls of which retain them in position and render any such tracheal strappings unnecessary; but there are other reasons also for this difference in arrangement. It might at first appear that the closely placed ovarian tubes of the bee could not be duly irrigated by the circulating fluid, but further investigation shows that this near contiguity of the tubes mainly secures the copious blood-flow which the rapid growth of the contained eggs demands, for the dorsal vessel, by constantly pumping the blood towards the head, induces a return flow through the petiole connecting the thorax with the abdomen. Against this petiole the small extremities of the ovarian tubes are gathered, tiny interstices are kept between them by the intervening small tracheæ, and so amongst *all* the tubes of the two ovaries, the blood must insinuate itself and pass on rapidly to return as much as the ever-beating dorsal vessel is propelling forwards. The wasp ovaries, on the contrary, stand in the middle of the widest part of the abdomen, and here the blood-flow is necessarily sluggish, but for this compensation is afforded by the very wide tracheæ, making due nutrition and oxidation certain; and further, the ovarian tubes are kept from falling into contact by a stiffish ring *r*, fig. 6, placed at the upper extremity of the oviduct. The very dissimilar egg-organs in both insects are therefore probably as well supplied as though the creatures possessed a vascular system. The walls of the oviducts (fig. 6, O D) we discover to be crowded with tracheæ, and supplied well with nerves and very numerous muscular fibres which are mostly arranged in two systems (a longitudinal and a transverse). Stiffly jutting out from the common oviduct we find a parenchymatous body at the extremity of which is placed the spermatheca *sp* carrying the mucous gland *mg*. These parts are held in position by numerous tracheæ and muscular attachments, and by the lateral support given by the large abdominal ganglion of the principal chain, as stated previously with regard to the bee. If

* The eggs in the figure are not nearly fully developed.

we now remove the spermatheca and its conduit and glands from the common oviduct, and examine by a $1/2$ in. in glycerin, we may bring the different parts of fig. 7 into view. The appendicular gland mg much resembles in structure that of the bee, but here close similarity ends. The spermatheca, about 4 mm. in diameter, has no investing coat of tracheæ, but is surrounded by four layers, $abcd$, the outer three of which are full of air-tubes, tt , fig. 7. The membrane forming the sac is exceedingly delicate; outside this the structure appears secretive while the next is elastic, the whole being protected by a very wrinkled membrane. By pressure the spermatozoa may be driven through the duct e , and in their passage they are accompanied by mucus containing minute oil-globules. The spermathecal duct is joined at g by the appendicular gland-duct. The common duct now enters and becomes central to the curiously formed body, which is clearly homologous with that in the bee, marked ll , fig. 5; the muscle hi , fig. 7, appearing to answer to g , fig. 5, while f and ph , fig. 7, are homologous with h , fig. 5. The nerve-threads uniting the several parts in the bee seem here to be in part represented by the numerous fibres n , fig. 7, running between the elastic and secretive coats, and the controlling muscles of the valve. These nerves n are not so exposed as would be judged by examining the figure, since the large ganglion which has been removed by dissection affords them every protection. The structure is clearly far less developed than that we previously examined, as here the duct seems simply closed by the contraction of the muscles at f and ph to prevent spermatozoa passing, the same muscles relaxing, allowing the duct to open, possibly under pressure brought to bear upon it by the elastic coat of the spermatheca itself. This greater simplicity answers completely to the habits of the insects we are considering.* In wasps the ability to produce fertilized or unfertilized eggs in rapid alternation is not necessary as it is with bees. There is abundant evidence that queens amongst the latter insects choose the cells in which they deposit eggs, at one time avoiding and at another searching out every drone cell, but this seems to be simply that workers or drones may be produced as the honey-yield and condition of the colony demand, for observation also shows that a queen can take cells pretty much as they occur, and adapt the egg at once. Amongst wasps, on the contrary, the production of males appears almost entirely a question of season, these being raised in a brood-batch to effect the fertilization of those females that are to hibernate. The accuracy and certainty with which this operation of fertilization can be accomplished by the queen-

* The fertile (unimpregnated) workers amongst wasps only produce males, and all the facts of the case point to the production of males by queen wasps from unfertilized eggs.

bee is attested by the fact that a careful scrutiny of slabs of brood, containing not less than 300,000 * sealed larvæ, showed that the failures were to the successes as 1 : 6300.

The great width of the common oviduct, C O D, fig. 6, in the wasp would lead us to expect some such arrangement for fertilization as in the bee (fertilizing pouch), and it undoubtedly exists, although in a less perfect condition, and the duct *l* can be without difficulty traced into it ; but while following this, we as before meet an indication of an entrance way for the spermatozoa to the receptaculum seminis after their reception from the male into the vulva, quite distinct from the road outwards towards the egg to be fertilized. At *k*, fig 7, the channel opens widely and unites with the lower part of the common oviduct. The walls of *k* in hibernating queens I found composed of a membrane formed by coalescing cells each about 8μ in diameter but from which all formative material has disappeared. It would be highly desirable to secure some queens immediately after copulation, when no doubt the whole history of this interesting point could be made out. I have not hitherto succeeded in obtaining such queens.

In drawing this paper to a conclusion, it seems but necessary to state that the rupture of the wasp spermatheca on the slide is followed by movements of the extruded spermatozoa comparable to, although much less energetic than those of the bee. Each spermatozoon measures about 200μ in length and somewhat less than 0.5μ in greatest diameter, whilst its narrower extremity is so remarkably delicate that its last 10 or 15μ can only just be seen even after careful staining by a Powell oil 1/12 or 1/25. Its inconspicuous head, beyond which the filament extends about 6μ , is scarcely wider than the broadest part of the filament itself and can only be detected with difficulty. A dorsal filament, which readily breaks from its attachments, also exists. The spermatozoon on passing into the rest-condition coils itself up precisely as does that of the bee. I venture to express the hope that this communication may be of some service in throwing light upon the difficult but extremely important and interesting question of parthenogenesis. In a future paper I may give some more definite information in reference to the movements of the spermatozoa immediately after their ejaculation into the body of the female.

* The production of a drone in a worker cell can be instantly seen by a very convex capping, raised to give room for the larger insect.

II.—On the Occurrence of Variations in the Development of a *Saccharomyces*. By G. F. DOWDESWELL, M.A., F.L.S., F.R.M.S., &c.

(Read 10th December, 1884.)

THE occurrence of pleomorphism in some of the higher fungi has been well established, and is generally accepted. In some cases, no doubt, the instances of asserted variations of form arise from erroneous observation, from the occurrence of contaminations, with the presence of different species in the cultivations; this has given rise to exaggerated views, so that the doctrine of pleomorphism has been extended to an extravagant length, as de Bary justly terms it.*

In regard to the *Saccharomycetes*, the observations asserting that yeast (*S. Cerevisæ*) is but the conidial form of *Penicillium glaucum* are well known; the development of branching hyphæ and endogenous spore-formation have been already described; but these form-variations have always been considered to be determined by external conditions, such as a difference in the nutrient medium, the exhaustion or insufficiency of which has been thought to occasion the formation of spores.

In cultivating some forms of fungoid blight lately, I observed the occurrence of innumerable cells of a species of *Saccharomyces*; it is one which I cannot exactly identify with any previously described. A growth of this is shown in the cultivating cell under the Microscope. In this it will be seen that development occurs both by means of gemmation, by fission, the formation of a mycelium with a slight tendency to branch, and also by endogenous spore-formation.

The nutrient fluid is here a 10 per cent. solution of cane sugar with the small proportion of mineral salts present in tap-water. In this it develops much more freely than in other solutions such as Cohn's fluid, or vegetable infusions. To originate the cultivation, as small a quantity of the cells as could be taken on the point of a platinum needle was placed on the centre of the slide; there were about a score, not many more, and they could be easily counted and examined individually under the Microscope. Over these, with a droplet of the solution, was placed the cover-glass, closed by oil round its margin, the groove in the slide affording a supply of air to the cultivation.†

* Vergleich. Morphol. u. Biol. der Pilze, &c., 1884, p. 136.

† The form of cell used is a plate-glass slide 3 by 1 in. and 1/10 in. thick. In this a circular groove is cut 1/10 in. wide and 1/20 in. deep; the centre stage, 6/10 in. in diameter, is countersunk 2/1000 in., but it may be either level or sunk 1/1000, 2/1000 or 4/1000 in. to suit the size of the micro-organisms cultivated.

Within twenty-four hours, at the temperature of the room—about 60° Fahr.—the cells were found to be in active proliferation, and they had multiplied three or four times, principally by gemmation; some few, however, were already forming hyphæ, in some cases having first or simultaneously developed buds; these hyphæ were already three or four times as long as the mother-cells, containing refractive granules, and becoming segmented. Shortly afterwards the occurrence of fission and the formation of endogenous spores was observed, the growth being still confined to a comparatively small spot towards the centre of the slide. These spores are ultimately set free, develop and proliferate as the parent cells.

It may be readily observed that the cells nearer the groove and more freely supplied with air, are larger than those in the interior of the cell, they look more robust, and the spores, which sometimes amount to a dozen or more in a single cell, are remarkably large and well defined; in this situation, too, the hyphæ in some few cases are remarkably long, extending over a considerable portion of the cell—i. e. some mm. in length—passing through the air of the groove, and continuing to grow in the oil on the outside of it. No aerial hyphæ, however, are formed.

Nevertheless, although an ample supply of air does favour the development of certain phases, yet in the same spot of the same nutritive medium, and apparently under, in every respect, precisely similar conditions, all these phases of development occur; and though the cultivation did not originate in a single cell, I do not think it is possible that different species were present. In most samples of brewer's or commercial yeast it is easy to detect foreign spores under the Microscope, but that was not so in this case; and it appears to me that we have here different forms of development, not owing to differences of external conditions, but to an inherent tendency to variation or sport, affording a confirmation of the Darwinian doctrine, that of the two factors which determine the liability of living organisms to variation—viz. the nature of the organism and the nature of its external conditions, the former

This, which I have found very useful and perfectly adapted for continuous observation of development with the highest powers, is merely a slight modification of a form long since used and described by, I think, Brefeld, and which I was myself in the habit of employing formerly. As I found great difficulty recently in getting them constructed, I may mention that those I now use are well and accurately made by Messrs. Beck. The "hanging drop" so frequently used in these cultivations, has some great and obvious disadvantages, the organisms in the lower part of the drop cannot be brought into the focus of a high power unless the drop is very minute, when it is liable, in spite of precautions, to be dissipated by evaporation; and again, unless the nutrient medium is viscid the preparation is apt to be spoiled, if the slide is tilted, by contact with the walls of the cell and the oil.

seems to be much the more important, for in this instance variations arise under conditions which appear to be perfectly uniform.

Some of the principal forms are shown in the accompanying sketch,* drawn with the camera lucida; the smaller figures are magnified about 300 diameters, and represent the earlier forms of development towards the centre of the cell; the larger and darker are magnified 500 times, and are those which have developed more recently, near the groove, with a more abundant supply of air. The cultivation is now two months old, and the cell is nearly filled with organisms: the nutrient fluid must be almost exhausted.

* To be seen in the Library.

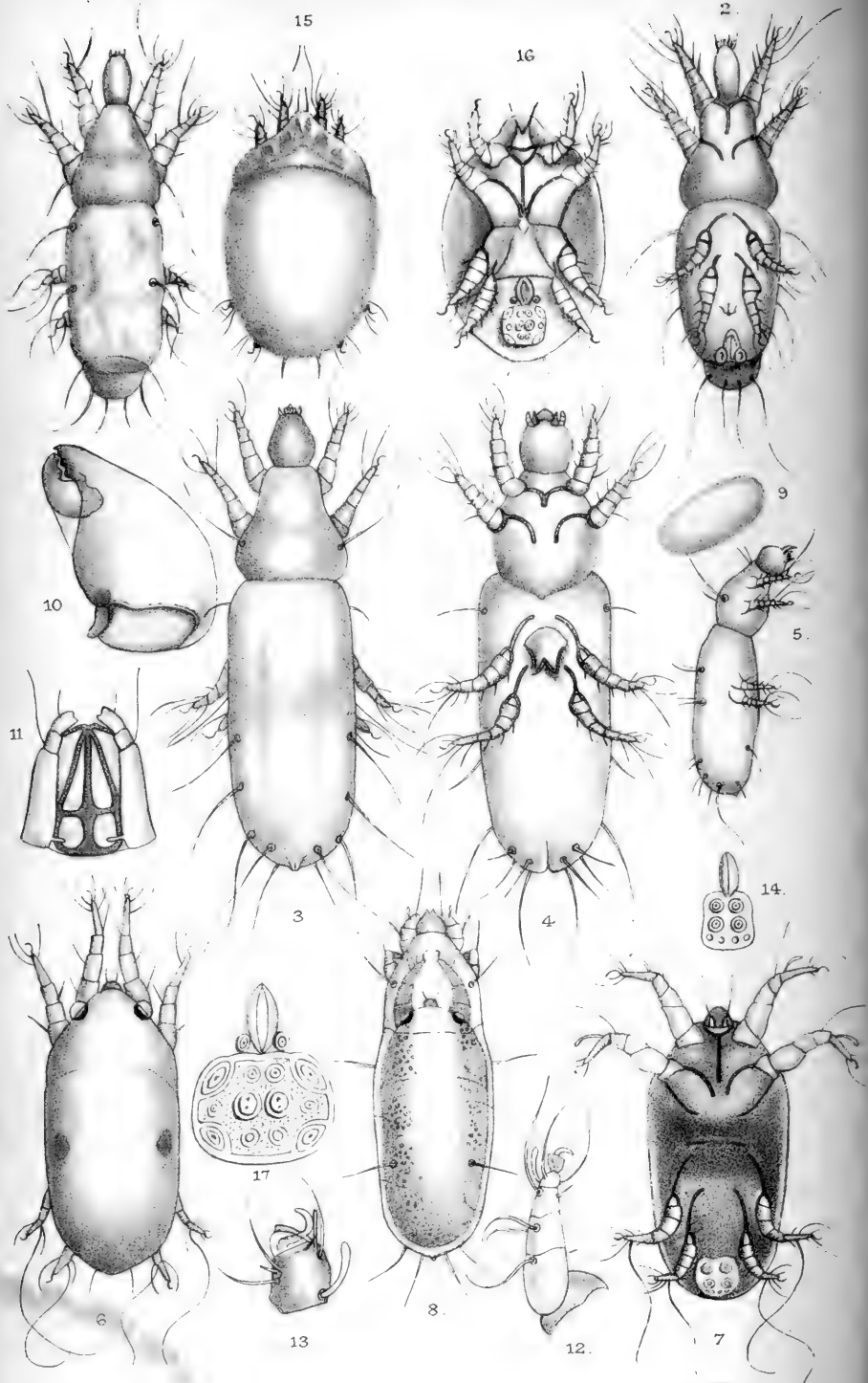

III.—Notes on the Life-Histories of some of the little-known *Tyroglyphidæ*. By A. D. MICHAEL, F.L.S., F.R.M.S., &c.

(Read 14th January, 1885.)

PLATE III.

ALTHOUGH the *Tyroglyphidæ* contain many creatures which are generally attractive, from the beauty of the plumes and leaflets with which they are ornamented, and from the general brilliancy of their appearance, when properly displayed, yet the genus *Tyroglyphus* itself is not one which includes any species likely to become favourites with slide-collectors from the elegance or singularity of their external forms; it is, however, a group the members of which obtrude themselves unpleasantly upon human notice, through their extreme destructiveness of animal and vegetable matters which are useful to man, either as food, medicine, or otherwise, and of his zoological and other collections. The common cheese-mite, *T. siro*, is the well-known type of the genus, and indeed it has been taken most frequently as the type of the whole of the *Acarina*; although, to most persons acquainted with the order, it may seem about as easy to typify it as to have a type Insect. *T. entomologicus* is the terror of entomologists, and the general feelings of the genus *Homo* towards the genus *Tyroglyphus* are decidedly hostile. Under these circumstances it is pleasant to find a member of this ill-reputed genus put forward on high authority as the friend and ally of man, if that view can only be supported.

Some years ago a serious alarm arose in America at the extent

EXPLANATION OF PLATE III.

- Fig. 1.—*Tyroglyphus corticalis*, male, dorsal view, $\times 140$.
 " 2.— " " " ventral view, $\times 140$.
 " 3.— " " female, dorsal view, $\times 140$.
 " 4.— " " " ventral view, $\times 140$.
 " 5.— " " nymph, side view.
 " 6.— " " Hypopus, dorsal view.
 " 7.— " " " ventral view.
 " 8.— " " " fully formed within the skin of the inert ordinary nymph.
 " 9.—*Tyroglyphus corticalis*, egg, $\times 100$.
 " 10.— " " right mandible of female, $\times 350$.
 " 11.— " " labium and other mouth-organs, $\times 300$.
 " 12.— " " first leg of female, $\times 250$.
 " 13.— " " tarsus of second leg of female, $\times 500$.
 " 14.— " " sucker-plate.
 " 15.—*Rhizoglyphus Robini*, Hypopus, dorsal view, $\times 100$.
 " 16.— " " " ventral view, $\times 100$.
 " 17.— " " " sucker-plate, $\times 300$.

to which the ravages of a *Coccus* (*Mytilaspis pomicorticis* of American authors,* which they popularly call "the mussel-shell bark-louse") were being carried upon their apple-trees. This naturally attracted the attention of State-entomologists amongst others, and Dr. Shimer wrote two articles on the subject in the 'Transactions' of the Illinois Horticultural Society in the years 1868 and 1869. In these papers he describes an *Acarus*, which he calls *A. malus*, and which, as far as I can ascertain from Riley's abstract, for I have not been able to obtain the original paper here, Dr. Shimer appears to consider as an enemy of the *Coccus* and therefore an ally of the cultivator. Dr. Shimer describes this *Acarus* and also mentions that he found with it a six-legged form which he treats as a separate species and names *A. Walshii*, but which doubtless was only the larval form of *T. malus*.

In the year 1873, the spread of the *Coccus* in Georgia was submitted to the notice of Mr. Riley who published a very interesting notice of the result of his investigations.† In this article he figures and slightly describes an *Acarus* which he considers, apparently from information received from others, and not from personal investigation, to be destructive of the bark-louse. Riley says, "It may be a form of the *A. malus* of Shimer," but he then proceeds to give such excellent reasons for not considering it to be identical, that I have ventured to treat it as a different species, although Riley himself does not name it but leaves it to be looked upon as Shimer's species; he winds up his article, or rather footnote, for that is all that he writes upon the *Acarus*, by saying, "It apparently belongs to the genus *Dermaleichus*." This is manifestly an error, as the *Dermaleichi* are not only all of them bird-parasites, but Riley's figure would be sufficient to show that the mite was one of the *Tyroglyphidæ*. Riley does not say anything about sexes, nor immature forms, nor does he describe or figure two sorts of adult which might be male and female; but his figures, which are very good, although on a small scale, are evidently drawn from a female specimen; this sex is usually much more abundant than the male in the *Tyroglyphidæ*.

Andrew Murray‡ reproduces Riley's figures, shortly abstracts his notice, and correctly places the creature among the *Tyroglyphidæ*; he says, however, that it is "either a *Tyroglyphus* or a *Rhizoglyphus*. Mr. Riley's beautiful figure is not on a sufficiently large scale to allow us to make out which." Murray would seem from this rather to have overlooked the fact that Riley's figures are helped by his description in this respect. Murray, however, in spite

* The usual name here for this creature is *Aspidotus conchiformis*, but it has also been called *Coccus arboreum linearis*, *Diaspis linearis*, *Chermes conchiformis*, &c.

† Fifth Missouri Report, 1873, p. 87.

‡ 'Economic Entomology. Aptaera,' 1876, p. 275.

of the doubt which he expresses, calls the species "*T. malus*," and in this generic name he is quite correct.

To pass now to what appears, at first, to be a totally different subject: Dr. P. Kramer of Halle, in October 1881,* described a new species of *Tyroglyphus* without saying where he found it, but the peculiarity of it was that the male had a thin, rounded, chitinous, horizontal plate projecting from the dorsal surface of the posterior margin. This plate, which was divided into four lobes by deep indentations of its distal (hind) margin, was entirely unknown in any other species of *Tyroglyphus*, or indeed of *Tyroglyphidæ*, and up to the present moment I believe that *T. Carpio*, as he named it, is the only known species furnished with this organ. Dr. Kramer very reasonably points out that this forms an analogy to the *Dermaleichi*, and that the species may be considered as indicating a closer relationship between the two groups than had been supposed. In addition to this marked characteristic, the anal suckers of Kramer's species, instead of being like those of ordinary male *Tyroglyphi*, are placed on the vertical part of the actual hind margin, and project straight backward when exerted.

Shifting once more to what appears like another entirely different subject, Professors G. Canestrini and F. Fanzago of Padua, in the year 1877, published what was then considered a monograph of the Italian *Acarina*.† This work was illustrated by six octavo plates, and as the last figure of the last plate the authors draw what they describe in the explanation of the plate as "A parasite of *Oribata*." I have not been able to trace any reference to this figure in the letterpress; I have however often looked at it and thought what a very strange creature it was, and wondered that I had not ever found it upon any of the thousands of *Oribatidæ* which I have from time to time examined; and not finding it I had concluded that it was not British. The creature in the plate had suspiciously the look of a *Hypopus*, but the hind legs were terminated by claws, not setæ; and it possessed the remarkable feature of having, on each side of the anterior margin, close by the insertion of the first leg, a large projecting simple eye, or eye-like organ, quite unknown amongst any other *Hypopi* which I am acquainted with. Its hypopial nature seemed therefore extremely doubtful.

To turn now to my own observations. During the past autumn (1884), while in the midland-counties of England, I was examining some stems of the common reed, *Arundo phragmites*, which were fading and decaying; and discovered, on stripping off

* "Ueber *Tyroglyphus carpio*, eine neue Art der Gattung *Tyroglyphus*," Zeitschr. f. d. ges. Naturwiss., 1882, pp. 183-6, pl. xiii.

† "Intorno agli Acari Italiani," Atti R. Inst. Veneto Sci. Let. ed Arti, ser. v. vol. iv.

the epidermis, that immediately below it were a number of mites corresponding exactly to those which Riley found on the bark of the apple: there was not here however any *Coccus* or other small creature for the *Acarus* to destroy, and it manifestly was destroying the reed, and not anything else; which process it was effecting by eating its way along under the epidermis, leaving small furrows behind it filled with dust, excremental matter, &c. It was in considerable numbers, and evidently in a locality which suited it. I secured plenty for observation, and for breeding from, transferred these into a breeding-cell without other *Acar*i, and eventually succeeded in tracing the whole life-history subsequent to the hatching of the egg. The greater number of specimens, as is usual in the family, were either nymphs or adult females, which latter appear to correspond in every respect with Riley's description and figures, which however are not very detailed, but with them I found, in lesser numbers, and I subsequently also obtained by breeding, a smaller *Acarus* which was evidently the male; it was interesting to find that this creature possessed the exceptional character of the male of Kramer's *T. Carpio*, although with such variations as might be anticipated in a different species; thus the thin chitinous plate or shelf projecting from the dorsal level of the hinder end is present and strongly developed, but its posterior margin, instead of being cleft into four lobes like *T. Carpio*, is even and unbroken, although, oddly enough, four long hairs, which arise from the under side of the plate a little within the posterior margin, and are directed horizontally backward, show through the semi-transparent chitin, and, by transmitted light, somewhat simulate clefts in appearance. The large protrusile suckers placed on the vertical part of the abdominal margin, one on each side of the anus, are also present, and of large size, so that the creature may fairly take its place as a close ally of Dr. Kramer's species.

Another surprise awaited me: among the *Tyroglyphi* were a number of *Hypopi* which I naturally suspected to be the hypopial nymphs of the species, a suspicion subsequently rendered a certainty by breeding the *Hypopus* from the *Tyroglyphus* nymph and by securing specimens and preparations of the *Tyroglyphus* nymph with the *Hypopus* inside. One of these is shown at fig. 8, which was carefully drawn from the life; the state figured being that shortly before the *Hypopus* emerges; the ordinary nymph being now little more than the cuticular parts, and the *Hypopus* being fully formed, and capable of considerable motion; it draws itself forward and backward within the nymphal skin, which is much longer than the hypopial form, moves its legs, and otherwise exhibits manifest signs of life. All this I might have anticipated from analogy; but what I could not have foreseen was that this

Hypopus, thus found, was neither more nor less than the "parasite of an *Oribata*" of Canestrini and Fanzago, precisely as the Italian professors had drawn it, with the two great eyes or eye-like organs quite as conspicuous as in their figure.

With regard to these organs I use the expression "eyes or eye-like organs," because one is rather dubious in pronouncing confidently on their optic nature when eyes have not hitherto been found in other *Hypopi* or other *Tyroglyphi*, and it would not have been thought probable that the species which developed them would be one which passed the greater part of its existence as a boring creature; although it may properly be replied that the stage during which the organs are present is one when its boring habits are suspended, and when eyes might be of service to it. The position of the organs would be rather unusual amongst *Acarina*, being actually on the anterior margin, instead of the dorsal surface, of the cephalothorax; on the other hand, the position is suitable, and the organs are fairly well protected by a projection of the dorsal chitin which half covers them. The organs have the appearance of large simple lenses, such as we are familiar with in *Hydrachnidæ*, &c., backed by a very black pigment-layer. To feel confidence, however, in their really being eyes we should trace an optic nerve to them, a process which I fancy would present no slight difficulty, but I incline to regard them as such.

A moment's reflection will suffice to show any one acquainted with the group that it is extremely likely that this *Hypopus* would be found sometimes temporarily parasitic upon *Oribatidæ* as its original discoverers say. The *Oribatidæ* are vegetable feeders and are constantly found under bark, the very places where this *Tyroglyphus* lives. The *Hypopus* is provided with an efficient sucker-plate, and, like other *Hypopi*, its habit doubtless is to attach itself by these suckers to small moving creatures, larger than itself, for the sake, probably, of conveyance; and thus it would get carried to new and suitable feeding-grounds. It is scarcely likely, however, that its attentions are solely confined to *Oribatidæ*: it is probable that they are much more widely distributed.

The discovery of this *Hypopus* enabled me to investigate further a question in which I have taken an interest for some years, viz. the question of what a *Hypopus* is, and the causes of its becoming a *Hypopus*.

I will remind my readers that different writers have expressed the following views:—

1. *Hypopus* is a separate family of adult *Acarina*.
2. *Hypopus* is an immature stage of *Gamasus*.
3. *Hypopus* is the adult of both sexes of some species of *Tyroglyphus*.

4. *Hypopus* is the male of *Tyroglyphus*.
5. *Hypopus* is an adult itch-mite.
6. *Hypopus* is a ferocious parasite, sometimes external, sometimes internal, which ends by entirely devouring its host from within, leaving only the skin.
7. *Hypopial* form is a travelling dress.
8. *Hypopus* is the cuirassed, heteromorphous, *adventitious* nymph of *Tyroglyphus*, &c., appearing only for the distribution and preservation of the species under adverse circumstances.

This eighth view, which is not inconsistent with the seventh, was that originated by P. Mégnin of Versailles, and has been that most ordinarily received of late years. Mégnin's opinion was that when the food of the *Tyroglyphus* became dry, and the atmosphere also too dry for the continued existence of the *Tyroglyphus*, &c., then the ordinary nymphs of these creatures changed into *Hypopi* which had the power of supporting greater draught and more unfavourable circumstances than the *Tyroglyphi*, and of attaching themselves to insects, &c., whereby they got conveyed to new and more favourable situations, when they once more assumed the form of *Tyroglyphus* nymphs. After a careful series of observations I have elsewhere* given my reasons for considering that, although Mégnin was correct in the major part of his contention, yet he was in error in that portion of it which ascribed the production of *Hypopus* to exceptional adverse circumstances, and that, in fact, although it was not all the individual nymphs of any species of *Tyroglyphus*, &c., that became *Hypopi*, yet the hypopial period takes the place of that between two ecdyses in the ordinary life-history, and that the change to *Hypopus* is not caused by unfavourable circumstances, and is not any extraordinary or exceptional occurrence, but is a provision of nature for the distribution of the species occurring irrespective of adverse conditions. I found a very strong confirmation of my views on the point in the species which I have been dealing with in this paper: they were apparently under circumstances which suited them; they had ample food which they appeared to feed upon readily; the moisture was abundant but apparently not in excess; the adult males and females, and the ordinary nymphs and larvæ did not die nor dry up, but on the contrary appeared healthy and well fed, but yet the *Hypopi* were present among the specimens in their natural locality in the reeds, and kept on appearing in my breeding-cells in considerable numbers. The more ordinary nymphs I had, the more *Hypopi* I got, and in order to obtain *Hypopi* I adopt precisely the same means as I should use to keep *Acari* which do not assume the hypopial form in perfect

* "The *Hypopus* Question," Journ. Linn. Soc. (Zool.) xvii. (1884) pp. 371-94.

health. The advantage of the hypopial condition to the present species is evident; the adult is a creature incapable of rapid or extended motion; its food-plant would frequently die down and decay, and the whole colony would be in danger of extinction were it not that the *Hypopus* can use other more active creatures as means of conveyance to new localities.

It remains to be considered whether it is likely that this *Acarus* really did destroy the *Coccus* of the apple-tree in the manner it is credited with doing. I know that Mr. Riley, whose opinion on all questions of economic entomology should have very great weight, considers that many of the *Tyroglyphidæ* are predatory: this is contrary to the general view taken by arachnologists, and I am not able to agree with him: a *Tyroglyphus* pressed by hunger may occasionally attack other *Acaris* or small insects, but, as far as my observations extend, they do not habitually or as ordinary food prey upon living creatures. They are themselves devoured by numerous enemies, but I have not ever been able to find any indications of their feeding upon other living animals; nor do their mouth-organs appear fitted for the purpose; they are not in any way those which we usually find in predatory *Acarina*, and they are very similar to those which are possessed by the well-known vegetable-feeders. I have carefully drawn these organs in the present species (figs. 10 and 11), in order that arachnologists may be able to judge of the probabilities in this respect. There is an entire absence of the lancets and sucking apparatus which we should expect to find in a predatory *Acarus*. The present species clearly can live on vegetable food; and, with its slow movements, short and weak legs, and elongated defenceless body, does not appear fitted for the capture of other creatures, but does seem eminently adapted to the life of a cortical or sub-cortical vegetable-feeder, and very analogous to others leading a similar existence, such as the nymphs of *Hoplophora*, &c. The *Tyroglyphidæ* are, in most instances, unquestionably vegetable-feeders, but they do undoubtedly also feed very readily upon preserved or dried animal matter of some sorts, as the owners of cheese, cantharides, or collections of insects, know to their cost; and it is to be remembered that a *Coccus* is a peculiar insect, it does not show much sign of life or much movement (excepting the winged males), and a large portion of it is very like a preserved specimen, so that it is possible that a *Tyroglyphus* not ordinarily predatory might regard a *Coccus* as suitable for gastronomic purposes.

I have appended to this paper a description of the species in all stages; and, to summarize the results, I conclude that it is a species feeding primarily upon the bark of vegetables, and not confined to the bark of one particular tree; that the female is the creature figured by Riley; the male, now described and figured by

me for the first time (as far as I know), is closely allied to that of Kramer's *T. Carpio*, and the hypopial nymph is the "Parasite of an *Oribata*," of Canestrini and Fanzago.

Finally, it appears to me that Riley has really recorded a new species, although he does not claim to have done so, and I propose to call it *T. corticis*.

RHIZOGLYPHUS ROBINI.

There is another member of the family of *Tyroglyphidæ* which has been making itself unpleasantly conspicuous in this country in 1884. It was first described by Claparède* in 1868; he found it upon hyacinth, potato, and dahlia roots; he describes it, names it, and figures both the male and female with his accustomed skill and exactitude, but, by some strange error, he has misplaced the sexes, calling the male the female, and *vice versâ*. This does not appear to be a mere printer's error: had the able Swiss naturalist seen the female with fully developed eggs in the oviducts, as I have done very frequently of late, it could not have occurred; but possibly Claparède, who after all was not a specialist in the study of the *Acarina*, was somewhat misled as to the whole sex question in the *Tyroglyphidæ*, by the error he fell into in supposing *Hypopus* to be the male of *Tyroglyphus*. I have not even noticed the species in England until 1884, but it may probably have existed, for I have not ever searched for it. In the latter half of 1884 I have been receiving it from numerous quarters, always accompanied by complaints of the damage it was doing. The first instance came from the Duke of Sutherland's famous hot-houses at Trentham. Mr. Stevens, the skilful and energetic head of that establishment, found the *Eucharis* bulbs in their hot-houses attacked, and sent some to Mr. E. Bostock, of Stone, for microscopical examination. That gentleman detected a *Rhizoglyphus*, and despatched the bulb to me in order that I might identify the species. Mr. Bostock also sent me about the same time a hyacinth bulb for examination for other purposes, which I found to be swarming with the same *Acarus*. About the same time I received it from Exeter, from Mr. Parfitt, and from numerous other sources. The mite not merely attacks the exterior of the bulb, but also forces itself in between the scales, and thus devours the fleshy parts of the interior, the wounds thus caused becoming coated in the case of the *Eucharis* bulbs with a hard brown gummy matter. The hyacinth bulbs were utterly destroyed. It would seem wise therefore that at present importations of Dutch or other European bulbs should be submitted to some examination

* "Studien an Acariden," Zeitschr. f. Wiss. Zool., xviii. (1868) p. 506, pl. xxxviii., figs. 7-11.

before being mixed with other bulbs of value; and that, if they be infected, sulphur, carbolic acid, or some other insecticide should be tried.

In keeping the present species, I soon began to breed *Hypopi* from the nymphs. The *Hypopus* is very different from that of *T. corticis*, not only from its greater size, but also from its shorter and broader form, different sucker-plate, the entire absence of the eye-like organs, and many other particulars. In this instance again I found what seems to me strong confirmation of my view as to the circumstances under which *Hypopi* are produced. The *Rhizoglyphus* was swarming on the hyacinth bulbs; both sexes were thriving; breeding was going on very much more freely than the owners of bulbs would approve of; the creatures were all only too healthy, and were not in any way dried up or subject to any adverse circumstances; and yet *Hypopi* kept on appearing in large numbers, and, at the moment of writing this, they are swarming in my cells, accompanied, both there and on the bulbs, by numerous smaller *Hypopi*, being those of some species of the genus called *Serrator* by Mégnin (his original *T. rostro-serratus*), *Philostoma* by Kramer, and *Histiostoma* by Canestrini and Berlese.

As Claparède's admirable figures exist in a journal so easily accessible as the *Zeitschrift für Wiss. Zool.*, I have not thought it right to re-draw it in this Society's publications, but I have figured the *Hypopus*, which I believe to be unrecorded.

TYROGLYPHUS CORTICALIS.

Dermaleichus malus Riley, 5th Missouri Report, 1873, p. 87.

But not *Acarus malus* Shimer, Trans. Ill. Hort. Soc. 1868-9.

Tyroglyphus malus Murray, Economic Entom., Aptera, p. 275.

The most striking characteristics of this species are the fact that in the adult state the length is nearly four times the breadth; the shortness of the legs; and the posterior chitinous projection of the male.

Male.

Average length about	·35 mm.
„ breadth „	·09 „
„ length of legs	·07 „

Colour of rostrum and legs, light-reddish, chitinous, brown; of the remainder of the body semi-transparent milky-white.

Texture smooth.

Cephalothorax. Rostrum almost like a separate head, being movably articulated to the remainder of the cephalothorax, into

the cavity of which (camerostrum) it can be almost entirely withdrawn, or from which it can be protruded to a considerable extent. When fully exerted, it is nearly one-sixth of the entire length of the creature, and is bluntly pointed, narrow, but gradually and slightly widened until near the posterior margin, where it is sharply constricted, so as to give the appearance of a neck. There is a pair of fine, nearly straight rostral-hairs. The palpi show from the dorsal aspect projecting beyond the rostrum; the chelate mandibles, which are large, also show from the dorsal aspect; they are short and wide; each limb of the chela is tridentate, two of the teeth of the movable limb being close together like one bifid tooth; there is also a very small inner tooth near the distal end of the fixed limb. The mandibles are ordinarily protruded alternately. There is a well-marked transverse line dividing the rostrum from the remainder of the cephalothorax, which part widens gradually until near its posterior margin, and in its widest part is almost as broad as the abdomen; its lateral margin is slightly curved and very slightly undulated. There is a sharp and strongly-marked constriction where the cephalothorax abuts on the anterior margin of the abdomen, and this constriction extends right across the dorsal surface. There is a curved, fine hair of moderate length, a little in front of the postero-lateral angle. The sternal surface shows an indentation between the first and second pairs of legs. There is a short, longitudinal, chitinous sternum extending from near the rostrum about one-third of the length of the cephalothorax; it is joined anteriorly by the epimera of the first pair of legs, each of which is a single curved, chitinous blade, arising from the anterior part of the insertion of the coxa. The epimera of the second legs are similar in shape, but longer and more curved; they do not reach the median line, and are not joined to the sternum.

Legs short. The front pair scarcely passing the tip of the rostrum, the hind pair not nearly reaching the posterior margin; all somewhat curved inward. The first pair inserted close behind the rostrum, the second near to them, the two hind pairs are abdominal, placed near together, but far from the two front pairs. Coxæ large and rounded, other joints gradually diminishing in thickness to the distal end. Joints of nearly equal length; tarsi blunt, terminated by a short, stout, single claw, which can be almost withdrawn between two membranous flaps, projecting one from each side of the tarsus; there is also a short caruncle above the claw. There is a long, flexible, tactile hair arising from each tibia, several fine hairs on the tarsi, and a pair of short, straight hairs on each of the other joints except the coxæ. There is a strange transparent, chitinous rod, on each tarsus of the first two pairs of legs; it arises from the proximal extremity of the joint, and

curves forward and downward. There is a much shorter chitinous knob in the same position on each tarsus of the third pair.

Abdomen. Slightly narrower posteriorly than anteriorly, dorsal surface rounded, lateral margin somewhat undulated. The anterior margin almost straight and well marked off from the cephalothorax. The true hind margin is rounded, but only the commencement of it can be seen, from the dorsal surface being hidden by a broad chitinous, rounded, shelf-like projection which is rather narrower than the true hind margin of the body, and considerably darker in colour. This chitinous piece is on the dorsal level, the abdomen curving up to it from the ventral surface. The chitinous shelf carries four long, diverging, flexible hairs, inserted on its under surface a little within the margin. These hairs project backward. The anus is a terminal median slit, but passes on to the ventral surface; and on each side of it, on the vertical part of the hind margin, is a large copulative sucker, which can be exerted or retracted; when projected, the real hind margin is also inflated, and then the chitinous shelf appears narrow. The genital organ is placed very far back, not far from the anus, and consists of a short chitinous intromittent organ within a narrow chitinous ring (flattened at the base). The epimera of the abdominal legs are biforked, one branch arising from each proximal angle of the coxa, and joining after a length about equal to their original distance apart, so that they enclose an equilateral triangle, from the point of which a curved, chitinous blade runs forward and inward, but does not reach the median line. The fourth epimeron is also slightly biforked at the inner end. The lateral margin of the abdomen carries three or four long flexible hairs.

Female.

Average length about	·47 mm.
„ breadth „	·12 „
„ length of legs (1st and 2nd pairs)	·7 „

The principal differences of the female from the male consist in the much greater size, the smaller *proportionate* length of the legs, the entire absence of the chitinous shelf at the posterior margin of the abdomen, and of course the position of the sexual organ. There are also the following minor differences.

Cephalothorax. The rostrum is slightly broader and more powerful, and the mandibles greatly stronger and larger than in the male, the other trophi also are better developed.

Abdomen. The hind margin is rounded; the anus is protected by two thin, chitinous blades, which are ordinarily closely pressed against each other, and form a small median projection when viewed from the dorsal aspect, from beneath they rather form an

indentation. The vulva of parturition is placed between the third and fourth pairs of legs; it consists of two somewhat chitinized labia, protected on each side by a band-like sclerite, and anteriorly by a horseshoe-shaped sclerite; there are a pair of suckers concealed beneath each labia. The hind margin has three pairs of hairs, at different levels.

The female is far less active than the male.

Nymph.

This when fully grown, except in the absence of external reproductive organs, so closely resembles the female that it is scarcely worth describing it separately.

Hypopial Nymph.

Proportion of length to width about 13 to 6.

This curious stage is chiefly remarkable amongst *Hypopi* for the conspicuous eye, or eye-like organ, which is found on each side of the anterior edge of the cephalothorax.

Colour, light chitinous brown.

Texture hard and polished, the notogaster almost transparent. A large number of round free cells, quite irregularly placed, lie immediately beneath the chitin, and give the creature a dotted appearance.

Cephalothorax. Covered with a semi-transparent carapace, from beneath which the point of the rostrum slightly projects. The mouth-organs are the usual two papillæ, each terminating in a bristle. There are not any markings on the cephalothorax, but a very large, simple eye, or eye-like organ, is situated on each side of the rostrum, on the anterior edge of the body, and just above the first leg. This organ is half beneath the carapace and half projecting beyond it; the side beneath the carapace (the inner side) is coated internally with a conspicuous layer of black pigment, while the portion projecting has the appearance of a lens.

The legs are long and robust for a *Hypopus*; the two anterior pairs projecting clear of the body almost the whole length of the four anterior joints; the hind legs also project substantially. All the legs are terminated by a single claw without sucker or caruncle. The hind legs do not terminate in hairs, as is so frequently the case; but each leg of the two hind pairs has an extremely long, flexible hair springing from the upper side of the tarsus; these joints are clothed with the usual fine hairs, and there are a few fine hairs on the other joints.

Abdomen considerably arched, anterior margin rounded, posterior margin with a slight tendency to be pointed; it is almost

parallel-sided for the greater part of its length. There are not any markings, but there are two hairs on the hind margin; and the two dark-coloured vesicles, usually supposed to be excretory organs and found in so many *Acarina*, show through from the transparency of the chitin. The sucker-plate on the ventral surface, immediately behind the anus, carries, near to its anterior edge, a pair of large suckers which almost touch in the median line; further back is another pair of rather larger suckers further apart, and still nearer the hind margin of the plate is a row of four very minute suckers.

Larva.

This resembles the ordinary nymph in all respects except its smaller size and the possession of only three pairs of legs instead of four.

The Egg

Is white and polished, without markings, rather larger at one end than the other, and rather more than twice as long as it is wide.

HYPOPUS OF RHIZOGLYPHUS ROBINI.

Average length about .33 mm.

„ breadth „ .19 „

A short, somewhat rounded *Hypopus*.

Colour moderately dark brown, sometimes very light brown, becoming darker in places, particularly near the edges.

Texture highly polished, semi-transparent.

Cephalothorax without markings, considerably overhung by the anterior margin of the abdomen. Rostrum not reaching the anterior edge of the dorsal carapace, but both it and the two anterior pairs of legs are seen through the carapace from its transparency. Second pair of epimera joined to the sternum.

Legs short and stout, diminishing rapidly in thickness, even the two front pairs not projecting far beyond the carapace, the two hind pairs scarcely project at all. The tibiae of the front pair have longish tactile hairs, and all the tarsi have numerous hairs, but there are not any of conspicuous length. All the legs are terminated by a single claw without sucker or caruncle.

Abdomen much arched, rounded at the sides, anterior margin curved, posterior almost a semicircle. There are not any markings, but there are two straight hairs on the posterior margin. The arrangement of the suckers is as follows. There is one sucker on each side of the posterior end of the anal opening; these

two are outside the sucker-plate which is oblong and broader than long ; there are two longitudinal rows of three circular suckers, one row on each side of the median line, the two central suckers being the largest ; on the outer side of each of these is a smaller circular sucker, and each corner of the plate is occupied by an oval sucker. Thus there are twelve suckers on the plate and two outside it. The plate appears to have a strengthened margin and a rim round each oval sucker.

SUMMARY
 OF CURRENT RESEARCHES RELATING TO
 ZOOLOGY AND BOTANY
(principally Invertebrata and Cryptogamia),
 MICROSCOPY, &c.,

INCLUDING ORIGINAL COMMUNICATIONS FROM FELLOWS AND OTHERS.*

ZOOLOGY.

A. GENERAL, including Embryology and Histology
 of the Vertebrata.

Oviparous Reproduction in the Monotremes.†—W. H. Caldwell has succeeded in demonstrating that the eggs of Monotremes contain a quantity of yolk, and are large in size; segmentation, consequently, is meroblastic in character. *Ornithorhynchus* lays two eggs which she places at the end of one of her burrows, and *Echidna* one, which she deposits in her ventral pouch. Almost cotemporaneously—it is hard to say whether a little before or a little after the date of Mr. Caldwell's observations—the oviparous reproduction of Monotremes was confirmed by Dr. W. Haacke, who on 2nd September, 1884, exhibited to the Royal Society of South Australia an egg found in the pouch of a female *Echidna*, as he stated “in support of the theory that the *Echidna*, although a milk-giving animal, lays eggs, which are hatched in the pouch.” The eggs were found in the mammary pouch (not in the uterus) of a living *Echidna hystrix*.

Mr. T. Gill ‡ reviews the history of the idea that the Monotremes are oviparous. He mentions that Geoffroy Saint-Hilaire, in 1829, published a paper, illustrated by a figure of an egg of the natural size.§ Still earlier, Fleming, in his ‘Philosophy of Zoölogy’ (ii. p. 215), published in 1822, remarks that “if these animals are oviparous (and we can scarcely entertain a doubt on the subject, as the eggs have been transmitted to London), it would be interesting to

* The Society are not to be considered responsible for the views of the authors of the papers referred to, nor for the manner in which those views may be expressed, the main object of this part of the Journal being to present a summary of the papers *as actually published*, so as to provide the Fellows with a guide to the additions made from time to time to the Library. Objections and corrections should therefore, for the most part, be addressed to the authors. (The Society are not intended to be denoted by the editorial “we.”)

† Ann. and Mag. Nat. Hist., xiv. (1884) pp. 375-6.

‡ Science, iv. (1884) pp. 452-3.

§ Ann. Sci. Nat.—Zool., xviii. (1829).

know the manner of incubation;" and his belief led him to separate, in his classification of Vertebrates, the Monotremes from the Mammals. Mr. Gill states other facts bearing on the subject.

Embryonic Membranes of Marsupials.*—H. Caldwell finds, from a study of *Phascolarctus cinereus* and *Halmaturus ruficollis*, that "there is no vascular connection developed in any stages of development between the embryo and the uterine wall." The attachment of one to the other is effected by the cells of the subzonal membrane beginning to enlarge and become amoeboid; pseudopodia-like processes are thrown out, which fit in between the cells of the uterine epithelium, and serve to attach the blastodermic vesicle to the uterus; the attachment, however, is entirely non-vascular. The allantois has an area of about 12 mm. in diameter, when best developed; and, though it becomes vascular in later stages, it never gives off villi. The arrangement in the Didelphia is so unique, that it throws little light on the evolution of the placenta in the Monodelphia.

Electromotive Function of the Fowl's Egg.†—L. Hermann and A. v. Gendre find on applying electrodes to the developing egg of a fowl that there is an *electric current passing from the yolk to the embryo*; the latter therefore is positive towards the yolk. The current is so strong that it frequently suffices to drive the index off the field of vision. The electromotive power may reach so high a point as 1/100 Daniell. It appears to increase in strength in the first stages of development, and reaches its maximum after about eighty hours; it then decreases. A similar condition has been recently shown by Hermann and J. Müller-Hettlingen in developing plant embryos.

Development of the Lesser Weever-Fish (*Trachinus vipera*).‡—G. Brook describes the development of this fish.

The egg, which is laid in the summer, is about 1.32 mm. in diameter, and contains from twenty to thirty small oil-globules, thus differing from the majority of floating fish-eggs hitherto described.

In the unfertilized egg a vitelline membrane is easily distinguishable, but afterwards this comes in close contact with the zona radiata, and often requires the action of reagents to show it properly.

The author's observations confirm those of Henneguy, that the invagination observed in optic section in the living egg is an inward folding of the lower layer of cells of the epiblast, and that afterwards the alimentary tract is built up from this layer, together with material derived from the intermediary layer. This point cannot, however, be settled definitely without a careful examination of sections of this stage.

Ryder's observations are also confirmed as to the nature and persistence of the segmentation-cavity, and in this respect pelagic teleostean eggs seem to differ from all others hitherto described.

Although the heart appears early on the fourth day, its venous end remains closely applied to the vitellus up to several days after

* Quart. Journ. Micr. Sci., xxiv. (1884) pp. 655-58 (1 pl.).

† Pflüger's Arch. f. gesamt. Physiol., xxxv. (1884) pp. 34-5.

‡ Journ. Linn. Soc. Lond. (Zool.) xviii. (1884) pp. 274-91 (4 pls.).

hatching, and the author was not able to find any vascular system either in the embryo or vitellus up to fourteen or fifteen days after development begins, that is four or five days after hatching. In this respect the observations of Ryder, Kingsley, and Conn agree with his, although in non-pelagic teleostean eggs an elaborate circulatory system is developed both in the vitellus and in the embryo a considerable time before hatching.

Mr. Brook has nothing new to record in the later stages of development.

Vesiculæ seminales of Guinea-pigs.*—The contents of these organs are a secretion composed of microscopic spheres of a slimy consistency. Spermatozoa occur only in small quantities, and are not to be considered, according to C. S. Minot, as being normally stored in these organs. The proper secretion is probably formed within the vesiculæ by its lining epithelium of granular cylindrical cells with oval nuclei basally disposed. This epithelial membrane is raised into numerous folds, composed of the two approximated layers separated merely by a thin connective tissue. No parallel is found for this arrangement in Mammalia, but Minot compares Coelenterata and the gastric diverticula of crickets.

There is no similarity between the contents of the vesiculæ seminales of guinea-pigs and the fluid of the human prostate. Hence there is no ground for identifying the two secretions as having a common origin, or for assuming that the vesiculæ of the guinea-pig serve merely as reservoirs to store up the secretion of the prostate.

Histology of Hairs, Setæ, Spines, and Feathers.†—W. Lwoff gives an account of his work which has already appeared *in extenso* in Russian. The chief constituent of hairs and feathers is the so-called cortical substance, from which, after treatment with caustic potash and teasing, spindle-shaped cells with fine filamentar nuclei may be obtained. Some of the cells break up into extraordinarily fine filaments. The cells are held together by an intermediate substance. The spines of the hedgehog likewise break up into fine fibrils which have the appearance of those of connective tissue, but do not, however, swell up or undergo any change under the influence of acetic acid; they appear rather to consist of a horny substance.

In order to study the process of the formation of the fibrils in the cell-substance, the author investigated the structure of young feathers; after two or three days' maceration in weak acetic acid the cells were easily isolated; they were found to be rounded or cubical, to be arranged in long rows, to be faintly coloured, and to contain a large nucleus, with nucleoli; the surface of connection between the cells is uneven, and is provided with extremely fine processes, like denticles. These cells elongate and become more or less long cylinders, while their nuclei likewise elongate, and become oval in form; at the same time the boundaries between the cells become indistinct. The median part of the cell becomes convex and passes into prolongations, by

* Arch. f. Mikr. Anat., xxiv. (1884) pp. 211-6 (1 pl.).

† Bull. Soc. Imp. Nat. Moscou, 1884, pp. 141-74 (4 pls.).

means of which the cells become united with one another; a striation then becomes apparent in these prolongations, which is the first indication of the fibres. Finally, similar striæ appear in the middle of the cell around the nucleus, and when the end of the cell is free the striæ become distinct fibrils, which appear as uncommonly fine filaments. It is difficult to say certainly whether, as is probable, each fibril extends along the whole length of the cell. It is clear, however, that the fibrils are formed from the protoplasm of the cell, by its differentiation; and the greater part of the cell is so used. The fibrils run parallel to the cell.

In a longitudinal section through the bristle of a pig the papilla was seen to have the form of a high cone with an elongated tip, which projected into the cells of the medullary substance; in transverse section this papilla had the appearance of a rounded corpuscle with some processes radiating round it. Around the papilla the epithelial cells lie in folds, which correspond to notches in the papilla. This is an arrangement unlike that which obtains in other hairs, and calls to mind rather the spines of the hedgehog. The cortical substance forms a ring with irregular processes, which project into the interior of the medullary substance; bristles seem, then, to be intermediate between spines and hairs.

The hedgehog's spines are next described, and it is pointed out there are two kinds of them; the majority are completely formed spines, are cylindrical in form, taper at either end, and end quite sharply above. Inferiorly there is a bulb-shaped enlargement which is fixed in the skin, and prevents the spine from being drawn out complete. Among the completed spines we find others which are younger, and which can be easily drawn out from the skin as they have no terminal bulb; these two stages may be paralleled in the history of a hair. The bulb is largely composed of cortical substance, the elements of which have a direction parallel to the axis of the spine.

After describing the development of feathers, the author compares the four structures which he has examined, and comes to the conclusion that the greater development of the papilla is always accompanied by a more complicated arrangement and greater differentiation of the parts which are adjacent to it. This is due not only to the elongation of the papilla, but to the concomitant ingrowth of it into the surrounding epithelial cells. Of hairs, the least developed are bristles, and in them the papillæ are longer than in other hairs. At the same time the bristle presents an indication of that regular differentiation which is seen in the spine; and, in correspondence with this, the papilla is still better developed in the spine, being both higher and more deeply set among the epithelial cells than is the case with that of the bristle. In the embryonic feather the papilla extends to the end of the rudiment, passes more deeply among the surrounding cells, and breaks up into as many groups as there are to be rays. In the completed feather, in which the papilla is still more developed, there is a still greater complication in structure. The author thinks that the importance of the papilla for all hair-like structures must

now be evident. His other results are: (1) In young cells of the cortical substance of hairs, spines, and feathers, the cell-protoplasm becomes differentiated into fibrils of horny substance, and into an intermediate substance; (2) the cell-elements of spines are exactly similar to those of hairs; and (3) the so-called pith of a feather consists of elements of connective tissue, and is nothing more than the dried papilla.

Distribution of Colour in the Animal Kingdom.*—L. Camerano discusses this subject at length. Colours may be arranged in accordance with the frequency of their occurrence, thus: (1) Brown; (2) black; (3) yellow, grey, and white; (4) red; (5) green; (6) blue; (7) violet. Black, brown, and grey are more common in Vertebrata than in Arthropoda, while red and yellow are more generally met with in the lower forms. Green is very frequent in the lower forms, less so in Mollusca, and still more rare in Vertebrata. Violet and blue are the colours most seldom met with, but they occur in all groups of the animal kingdom. White is irregularly distributed, but more characteristic of aquatic animals. The colours of animals bear a relation to the medium in which they live; parasites are less varied in colour than free-living animals. Aquatic animals are commonly more evenly and less brilliantly coloured than land animals; pelagic animals, as might be predicted from their transparency, are not strikingly coloured. Among birds, the strongest fliers are most soberly tinted. Of inhabitants of the sea, those that live among Algae are more vividly coloured than those which live under stones or on a sandy bottom; similarly land animals that inhabit forests are on the whole more conspicuous for their bright coloration than animals which live in deserts. There is no relation between the colour of an animal and its food, as Grant Allen has asserted; insectivorous animals that live among plants and flowers have often varied and brilliant colours; on the other hand, herbivorous animals, if they do not habitually live among shrubs and herbs, are dull and uniformly coloured.

The development of colour stands in no relation to light, but depends far more upon the condition of the animal; ill-health and insufficient food cause a diminution in the brilliancy of its coloration.

In very dry climates the colours appear to be darker, while the reverse is the case in damp climates. The various zoological regions of the earth are characterized by a certain dominant range of colour in their inhabitants: grey, white, yellow, and black characterize the animals of the palæarctic region; yellow and brown those of the Ethiopian; green and red are the prevailing tints of the neotropical, red and yellow of the Indian region. Australia is distinguished from the rest by the great abundance of black animals.

In a given group of animals the larger species are usually more uniformly coloured than the smaller. Sexual colours bear a general correspondence to development of the animal; the males are mostly more brilliantly coloured; in many cases, however, where the females

* Zool. Anzeig., vii. (1884) pp. 341-3.

are larger and stronger than the males, the former show the more brilliant coloration. Young animals are often differently coloured to the adults, their colours are generally more like those of the adult female. The young of several species that are most dissimilar in their colours when adult, are often hardly distinguishable in this respect.

Sense of Colour and of Brightness in Animals.*—V. Graber has investigated the sense of colour and of illumination in animals. To decide whether animals had a sense of light or of colour he placed them in a box so arranged that qualitative or quantitative rays fell on one or other of its two divisions, which communicated with one another. Five mammals, seven birds, two reptiles, three amphibians, two fishes, three mollusca, twenty-seven insects, two spiders, and two worms were experimented with. It was found that the sense of colour as well as of the power of perceiving light was much more widely distributed among animals than has been generally supposed. The variations in the sense of colour in various animals is very great, but a much greater number of observations must be made before a definite solution of the problem can be obtained.

Influence of Wave-currents on Fauna of Shallow Seas.†—A. R. Hunt points out that the power of submarine wave-action, hitherto neglected by naturalists, is sometimes considerable at depths of 40 fathoms and more, and that the fauna is influenced thereby to an extent scarcely possible to be overrated.

He specially dwells on the case of animals, chiefly Mollusca and Crustacea, living on, or in, a sandy or muddy bottom outside the tide marks. Such animals as seek safety in their capacity for maintaining themselves to a greater or less extent below the surface of such a bottom, do so either by their power to burrow rapidly, as *Psammobia tellinella*, or by the power of retaining a safe position when once secured, as in *Cardium* and the Veneridæ, which are provided with special mooring apparatus in their roughened exteriors and spinous processes. The group of animals that live on the sea bottom on sand or mud, exhibit great variety of special adaptations of structure to resist or evade wave action, and examples are adduced from the Gasteropoda (*Aporrhais*, *Murex*, *Pteroceras*, and *Strombus*), Echinodermata (*Asterias* and *Antedon*), Crustacea, and fishes.

In conclusion, the author shows how under the influence of wave-currents, the variation of species may be promoted and their local extinction brought about.

Claus' Elementary Text-book of Zoology.‡—The reputation of the original work and its author is deservedly great, and Mr. Sedgwick

* Graber, V., 'Grundlinien zur Erforschung des Helligkeits und Farbensinnes der Tiere,' 8vo, Leipzig, 1884, viii. and 322 pp. See *Naturforscher*, xvii. (1884) p. 473.

† Journ. Linn. Soc. Lond. (Zool.) xviii. (1884) pp. 262-74.

‡ Claus, C., 'Elementary Text-book of Zoology. General part and special part: Protozoa to Insecta. Translated and edited by Adam Sedgwick, M.A., with the assistance of F. G. Heathcote, B.A.,' 615 pp. and 491 figs. 8vo, London (W. Swan Sonnenschein & Co.) 1884.

has done an invaluable service to English students in providing this translation. From many points of view it is by far the best work that can be put into the hands of a zoological student.

B. INVERTEBRATA.

Eyes of some Invertebrata.*—J. Carrière, after pointing out the different methods by which an optic organ is developed among animals, and describing in detail the eyes of *Musca* and of *Leptodora hyalina* as the two extreme forms of the fan-shaped eye, gives a short notice of the fan-shaped eyes of Lamellibranchs. These are simplest in *Arca* and *Pectunculus*, where they consist of a small number of large cells of the form of an elongated cone, with the point directed inwards; there is pigment peripherally, which forms a sheath for the cell-body. In *Arca* every cell has a kind of lens formed by its cuticular border. The optic cells are not sharply distinguished from the epithelial cells of the mantle, but are connected with them by a number of stages; these eyes, therefore, as much as those of *Patella* and of the ocellate Medusæ, “may be classed among the most beautiful examples for the study of the origin of the organs of sight by the modification of epithelial cells”; while they afford yet another proof of the truth of the doctrine that similar organs of sight in different classes and orders of the animal kingdom may originate independently, and in fact may still originate without in any way implying that such eyes have been inherited from a common ancestor.

Indestructible Infusorial Life.†—J. Hogg describes some further experiments he has made on this subject, supplementing those previously recorded on Rotifers. Some Ciliata and Tardigrada have been included, and these have, although not to the same degree, exhibited a remarkable tenacity of life. The intervals of sleep and vigorous life have likewise been brought into strict accord with the durations of dry and wet periods of the year, so that the subjects of the experiments have been kept in a perfectly dry condition during the whole of the long drought which characterized the past summer.

Moreover, some older dried specimens were subjected to an artificial process of desiccation. They were kept for a time in a hot-air chamber, the heat in which was raised to 200° F., and subsequently the miniature aquarium in which they were inclosed was plunged into a freezing mixture. Neither process killed them nor greatly diminished their vital powers, their revivification in both cases being somewhat delayed. Certain toxic agents known to exert a baneful influence over higher animals were added to the water supplied to the rotifers, but in no way did they produce discomfort; on the contrary, portions were taken into the stomach and partly digested. On the other hand, a drop of sewage water caused marked discomfort; they immediately retracted their rotating organs and

* Quart. Journ. Micr. Sci., xxiv. (1884) pp. 673–81 (1 pl.).

† ‘Times,’ January 5, 1885, p. 4. See also further letter, Engl. Mech., xl. (1885) p. 430, and criticism, *ibid.*, p. 452.

sank to the bottom of the cell. These were, so far as could be ascertained, poisoned, and this was probably owing to the free sulphide of hydrogen evolved by the putrescent sewage. From his observations the author is led to infer that rotifers will live and multiply on a very scanty supply of organic matter, provided only that the water is fairly well oxygenated. Attention is also called to the greatly diminished or no longer developed eye, due, no doubt, to the withdrawal of the stimulus of light, the rotifers being nearly always kept in the dark.

Organisms in Ice.*—Prof. Leidy relates that he had placed in his hands, for examination, a vial of water obtained from melting ice which is used for cooling drinking-water. From time to time, among some sediment taken from a water-cooler, his informant had observed what he supposed to be living worms, which he suspected were introduced with the water into the cooler, and not with the ice. Upon melting some of the ice alone, the worms were still observed, and the water submitted for examination was some that was thus obtained. Prof. Leidy was surprised to find a number of worms among some flocculent sediment, mainly consisting of vegetal hairs and other débris. Besides the worms, there were also immature *Anguillula*, and a number of *Rotifer vulgaris*, all living. It would appear that these animals had all been contained in the ice, and had been liberated on melting. It was an unexpected source of contamination of drinking-water, that Prof. Leidy had previously supposed to be very improbable.

The worms were probably an undescribed species of *Lumbriculus*. Several dead worms swarmed in the interior with large, ovate, beaked, ciliated infusorians measuring from 0·05 to 0·06 mm. long by 0·04 to 0·48 mm. broad.

Mollusca.

Integument of Cephalopods.†—In his second † essay on this subject P. Girod deals with the suckers of Cephalopods; his observations were made on *Octopus vulgaris* and *Sepia officinalis*, which, as is well known, differ from one another by the fact that in the latter, as in all Decapods, the suckers are stalked and not sessile as in *Octopus*; with this difference other secondary points are associated. In *Sepia* the cavity of the sucker is single and not, as in *Octopus*, provided with an infundibular antechamber; there is a horny ring with terminal teeth which is absent in *Octopus*, and there is also a projecting piston-like apparatus.

The differences in form are associated also with differences in texture, for while the Octopod has an elastic cup constricted in its middle by a contractile ring, which is the seat of insertion of extrinsic dilator muscles, and is able to modify considerably the extent of its internal cavity, the Decapod sucker is much less mobile,

* Proc. Acad. Nat. Sci. Philad., 1884, p. 260.

† Arch. Zool. Expér. et Gén., ii. (1884) pp. 379–401 (1 pl.).

‡ For the first, see this Journal, iv. (1884) p. 36.

and forms a kind of pump in which a piston is moved by powerful muscles.

In *Octopus* there is a sub-epithelial tissue which is connected with dermal connective tissues, but in *Sepia* the ring is supra-epithelial, and forms merely a simple thickening of the cuticular layer to which it is attached by its extremities only.

These structural differences have an effect on the mode of action of the suckers, for in *Octopus* it is the wall of the sucker which is the chief agent in the movements of fixing the apparatus, while in *Sepia* fixation is effected by means of a central piston which works independently of the rigid wall.

In the Octopod the sucker, carried by the flexible and undulating arms, is slowly conveyed towards the object which it desires to seize, and the muscles which move it are highly elaborated; in the Decapod the arms which correspond to the eight arms of *Octopus* are reduced; they are, so to speak, immobile, and their suckers are greatly reduced in size; these no longer seize objects, they only hold them near the opening of the digestive tube. The two tentacular arms either move slightly like the rest, or are retractile and have a special mobility; even in the latter case, which is, of course, the more perfect, the sucker is merely a fixing apparatus, it does not go to seek the prey, it is thrust out suddenly from the cavity which contains it, and the suckers are best developed at its free end.

Retina of Cephalopoda.*—H. Grenacher finds that the retina of the Cephalopoda cannot be said to be striated in the same sense as that of the Vertebrata. It consists only of a single layer of elongated retinal cells which, directed radially and fixed against one another in palisade-fashion, represent the whole of the percipient apparatus. Each cell consists of three regions, of which the nuclear is external; the region of rods consists of cells which have the form of two groove-like semi-cylinders, which inclose between them the corresponding portion of the cell; but these halves are grouped in such a way that four go to make up a rhabdome, and the two halves of the rod of a retinal cell belong to different but neighbouring rhabdomes. The supporting or socle-region which forms the shortest part of the retinal cell is especially characterized by the rich aggregation of granular pigment in its interior, and there are also cuticular investments more or less well developed. The nuclear region has likewise a well-developed investment, and at its outer pointed end each retinal cell passes into a nerve-fibre. The final portion of these fibres appear, in all probability, to be represented by fine fibres which extend within the retinal cell as far as the membrana limitans. This last owes its origin partly to the cells which are found at the periphery of the retina, and partly to the limiting cells found between the retinal elements. The latter give off one to five processes through the bacillar region to the side of the limiting membrane, which is turned towards the retina; and these, notwithstanding that they run within the rhabdome, are not, as was previously sup-

* Abh. Naturf. Gesell. Halle, xvi. (1884) pp. 207-56 (1 pl.).

posed, nerve-fibres, but materials which serve to make up the limiting fibres.

The author regards as one of his most striking results the knowledge of the mode of formation of the rhabdome—a structure which is so characteristic of the Arthropod eye. The difference in the mode of formation must clearly have some influence on the process of perception, into the consideration of which Grenacher enters.

Histology of Pteropods and Heteropods.*—Dr. J. Paneth deals chiefly with the “foot” of *Pterotrachea*, *Cymbulia*, and *Tiedemannia*.

The external investment is a unilaminar pavement—epithelium, except on the borders of the “foot” and in certain other regions, where it consists of a cubical or cylindrical ciliated epithelium which Dr. Paneth terms a sense-organ because of its rich nerve-supply and tactile hairs. Epithelial in nature are certain papillæ on the foot in *Pterotrachea*, which are apparently sensory in function. The “cartilage,” underlying the epithelium of the foot, contains (1) in Heteropoda, “stellate cells”; (2) in Pteropoda, “fibrillar cells.” Amœboid cells occur in both classes with these characteristic elements. Gegenbaur would appear to be wrong in saying that Pteropoda do not possess “cartilage.”

The muscles of both classes consist of bundles of cells resembling the involuntary muscles of Vertebrata. The cells are spindle-shaped, with a long nucleus, with homogeneous protoplasm. There are traces of transverse striation.

Both in Heteropoda and in Pteropoda the peripheral nerves show a distinct fibrillar structure, the finer nerves showing a homogeneous character. Aggregations of protoplasm occur at the points of nerve-division and where trunks cross one another. A nucleus is generally found in these protoplasmic masses, which have been by some thought to be ganglionic in nature. Dr. Paneth has never seen any relation between them and the nerves that pass near them.

The nerves end (1) in the cartilage (corresponding to the connective tissue of higher animals) by a ramifying terminal network of “primitive fibrils,” which do not enter into any union with other histological elements; and (2) in muscles by means of a rete, the fibrils of which reunite to form a trunk which issues from the muscle much as it entered. A Doyèrian eminence marks the entrance of the nerve.

Generative and Urinary Ducts in some Chitons.†—Prof. A. C. Haddon describes the generative and urinary ducts in some Chitons, in which he shows that the previous investigations on the presence or absence of genital ducts in this group are not to be accepted without verification. The posterior fenestrated area on the under surface of the mantle is in reality glandular, and it is suggested that they may be the homologues of the cœcal glands described by Hubrecht in *Proneomenia*.

* Arch. f. Mikr. Anat., xxiv. (1884) pp. 230–88 (3 pls.).

† Sci. Proc. R. Dublin Soc., iv. (1884) p. 223.

Natural History of Haliotis.*—H. Wegmann has published in full the essay of which a preliminary notice has already appeared, and which has been noted in this Journal.† The following points may now be noticed:—The digestive organs attain a high grade of differentiation, and are divided into a series of very distinct parts, and they occupy the greater part of the abdominal cavity; there are two pairs of buccal cartilages, whereas most Gastropods have only one pair, and *Patella* has three (Geddes). The author, by the way, defends the use of the term fibro-cartilage, to which exception has been taken by Lebert. The “saliva” is whitish in colour, and mucous in consistency; the “liver” is enormous, and is essentially divided into a right and left lobe. The author discusses the function of the rudimentary gills, which he allows to be the same as the organ to which notice was directed by Spengel, and which sometimes bears his name; but he doubts whether the generally accepted view that the part in question has a sensory function is correct; he does not find that it is any richer in nerves than the true gill, and he is inclined to look upon them as being a pair of rudimentary branchiæ.

‘Challenger’ Nudibranchs.‡—Dr. R. Bergh reports on the Nudibranchs of the ‘Challenger’ expedition. As few shallow-water dredgings were made during the cruise, it is not to be wondered at that the number of Nudibranchs collected was but twenty-five, including only one deep-sea form.

The majority of the forms belonging to the Phylliroidæ and Æolidiadæ which were collected are pelagic, and are represented by the genera *Phylliroë*, *Glaucus*, *Fiona*, &c.; some are littoral, such as *Janolus australis*, a single specimen of which was taken in the Arafura Sea, and one like the last referred to a new genus and species, *Cuthonella abyssicola*, was taken in the Faroe Channel from a depth of 608 fathoms. Several new species belonging to the Tritoniadæ are described. Of the Dorididæ, two new genera and several new species were diagnosed. Of these the most interesting is *Bathydoris abyssorum*. This differs from all others of the family in the semi-globular form of the body, which is somewhat like that belonging to the genus *Kalinga* of Alder and Hancock, and which it also resembles in the characters of its branchia, these being composed of several separate branchial tufts, also in the development of soft conical papillæ upon the back. It has no frontal appendage, and the dorsal margin is very slightly pronounced. This new genus would appear to form a remarkable connecting link between the Tritoniadæ and the Dorididæ. The only specimen found was taken from a depth of 2425 fathoms, in the middle of the Pacific.

In an appendix, Dr. Bergh describes the only *Onchidium* in the collection as *O. melanopneumon*. Only one specimen was taken in shallow water, at Kandara, Fiji. For comparison with the new species details of the anatomy of *O. tonganum* and *O. verruculatum* are given.

* Arch. Zool. Expér. et Gén., ii. (1884) pp. 289–378 (5 pls.).

† See this Journal, iv. (1884) p. 730.

‡ Report of the Voyage of H.M.S. ‘Challenger,’ Zoology, x. (1884) 154 pp. (14 pls.). See Nature, xxxi. (1884) p. 165.

Structure and Formation of the Shell of Lamellibranchs.*—The observations of E. Ehrenbaum are founded on the species of lamellibranchs most common in the Bay of Kiel. After some introductory remarks of an historical and critical character, *Mytilus edulis* is discussed; the periostracum is divided into (1) an extremely delicate very clear marginal fringe, (2) a delicate cuticular lamella, (3) layer of cavities, (4) second cuticular lamella, and (5) a dark-coloured finely homogeneous cuticular layer, which forms the boundary of the blue shell-substance. The author was unable to detect the vertical canals which have been seen and figured by earlier authors in the nacreous substance of the shell; those so regarded by Tullberg are thought to be conchiolin-membranes, and they are not so straight and parallel to one another as they are represented in figures. Two interesting modifications of the white substance are described.

Cyprina islandica, *Astarte borealis*, and species of *Cardium*, *Scrobicularia*, and *Tellina* are discussed in order; these are followed by *Corbula gibba*, *Solen pellucidus*, and *Mya arenaria*.

The proportion of inorganic to the organic constituents of the shell varies considerably, and to this we must ascribe the great differences in the specific gravity and hardness of lamellibranch shells.

Nothing of importance has been added to our knowledge of the physiological processes of the secretion of the hard part of the shell since the studies of C. Schmidt in 1845, although indeed Harting has made some important experiments on the process of crystallization; the problem of shell-formation might be reduced to a mechanical question by further observations along the lines of that distinguished observer. Our knowledge of the formation of the epicuticle is much better, owing especially to the studies of Tullberg. The great result of the author appears to be to confirm the old doctrine that all the parts of the lamellibranch shell are to be regarded as true cuticular structures or, in other words, as cell-secretions.

Molluscoïda.

a. Tunicata.

Follicular and Granular Cells of Tunicates.†—A Sabatier deals with the criticisms made by Fol on his work on the ovum of Ascidians.

With Fol and Roule he thinks that the follicular cells arise in the interior of the ovum, near the nucleus, and that they then make their way to the surface of the yolk; the difference between them is as to the mode of formation of these elements. Fol and Roule think that they start from one element which is derived from the germinal vesicle, Sabatier believes that they arise from the elements of the yolk which are differentiated in the layer which surrounds the germinal vesicle; and that the latter takes no essential share in their formation.

Sabatier now points out that if we observe young ova of *Ciona* at

* Zeitschr. f. Wiss. Zool., xli. (1884) pp. 1-47 (2 pls.).

† Rev. Sci. Nat., xii. (1884) pp. 106-40 (2 pls.).

the moment when the first follicular cells are about to appear, we see that the germinal vesicle has but one highly refractive nucleolus, set in a hyaline liquid in which coloured granules are more or less scattered—the chromatin grains. It is to be noted that if fresh ova are observed in the blood of the animal, the grains only appear after the addition of reagents; this leads us to think, with Flemming, that the nucleolar and the chromatin-granules are not of exactly the same nature. Outside the vesicular membrane and in the yolk of the egg there are granules, sometimes in considerable numbers, which have exactly the same aspect, form, and reactions as the granules within it.

When we examine ova in which the follicular cells are in course of formation we see that, near the vesicle, the chromatin granules of the yolk are multiplying and aggregating; so that they form a refractive mass. At first this mass is perfectly homogeneous, but, as it becomes organized, one, two, or even a larger number of more highly refractive granules become apparent. The corpuscles thus formed by the aggregation of the chromatin granules vary a good deal in form; they may touch the wall of the germinal vesicle, but it is quite clear that they are altogether outside it, and that they have no relation to its contents.

Sabatier is convinced that the appearances seen by Fol are due to an extroflexion of the wall of the vesicle, and he thinks that Fol's own figures, which are very exact, suffice to demonstrate this point. After further criticisms on the criticisms of Fol and Roule, some more general problems are considered. The author asks whether it is true that chromatin is only found normally in the nucleus, and whether every chromatinated portion in the protoplasm has arisen from fragments of the nucleus. He thinks not, basing his view chiefly on the consideration that we do not know what chromatin really is, and that all we can say is that it represents a condition of protoplasm which possesses a more marked affinity for certain colouring substances, and is sometimes also a little more refractory than the rest. He is inclined to regard chromatin as the result of a modification introduced into the constitution of the cell, and found in relation with the nutrient activity of its elements; if this be so, there is nothing astonishing in our finding that, in certain cases, the chromatin is met with, and that in considerable quantities, not only in the nucleus but also in the protoplasm of the cell; this hypothesis may explain the intracellular plexuses described by Klein. Sabatier firmly believes that in the young eggs of Tunicates a notable quantity of chromatinated substance appears in the yolk, that it increases from the periphery to the centre, and so attains its maximum near the germinal vesicle. Too much importance seems to have been attributed by Flemming to the chromatin.

Two New Species of Simple Ascidians.*—M. Roule describes two new species of simple ascidians belonging to the family Phallusiadæ.

For the first of these he proposes the name *Ciona Edwardsi*, and

* Comptes Rendus, xcix. (1884) pp. 613-4.

finds the subgenus *Pleurociona* to receive it. It differs from the other species of the genus in being attached throughout the whole length of its left side from the posterior extremity to the base of the siphons. The exterior layers of the tunic are of a greenish yellow colour owing to the impurities attached to it, whilst the inner layers are hyaline and transparent as in other species of the genus, besides which certain figured bodies in the ground-substance of the tunic contain a tolerably large vacuole. The peritoneal layer is inclined at a highly oblique angle to the axis of the body.

The second species, *Ascidia elongata*, in its general aspect approaches nearest to *A. metula*, from which, however, it is distinguished by the greater length of the body. The latter, moreover, is rounded instead of being flattened; whilst the tunic is entirely covered over with different foreign bodies, and the siphons, which are scarcely prominent and of a red colour, only bear small and obtuse tentacles.

B. Polyzoa.

Rhabdopleura.*—E. Ray Lankester commences his contribution to our knowledge of this remarkable Polyzoon by an account of the tubarium; each tube is found to be built up of a series of rings, and each ring is separately secreted and added to its predecessors by the so-called buccal shield or præoral lobe of the polypide; the axis is branching, but has no characters by which it can be distinguished into primary, secondary, or tertiary portions. The substance of which it is composed is transparent and horny.

Prof. Lankester finds that the polypide-stalk or gymnocaulus has no relation to the funiculus of the Phylactolæmatous Polyzoa, as was supposed by Allman after an examination of imperfectly preserved specimens. The buccal shield or disk acts as a locomotive organ, and serves apparently to raise the polypide in its tube, and also, as has been said already, as a secreting organ. On the aboral surface of each lophophor arm there is a ciliated tubercle, which is possibly related to the osphradium of the Mollusca, and it is, further, not improbable that the lophophoral arms of the Polyzoa are the genetic equivalents of the ctenidia of the Mollusca.

There is a consistent and extensively developed internal (mesoblastic) skeleton, which consists of two chief parts—the skeleton of the lophophoral arms and that of the gymnocaulus. It is cartilaginous in consistency. A precisely similar skeleton is to be found in *Cephalodiscus*. In addition to this new discovery, the author has been able to make out the testis; which is remarkable for its position, inasmuch as it projects from the surface of the body. It has the form of a much elongated sac, which is blind at one end, and opens at the other by a special pore. It has nothing to do, as it seems, with a nephridium, and belongs therefore to that class of gonads which the author has previously distinguished as idiodinic, in contradistinction to nephridinic.

If *Rhabdopleura* and *Phoronis* are both Polyzoa, that group can no

* Quart. Journ. Micr. Sci., xxiv. (1884) pp. 622-47 (5 pls.).

longer be associated with the Mollusca, now that Caldwell has shown that the epistome of *Phoronis* is the modified præoral hood of the actinotrocha-larva. But this is a *certainty* with regard to *Phoronis*, but by no means so with regard to *Rhabdopleura*, the development of which must be studied before we can say certainly whether Allman is right in regarding the buccal-shield of *Rhabdopleura* as representing the mantle-area of Lamellibranchs, and whether it and *Cephalodiscus* are not degraded Lamellibranchs. The author suggests some questions to future students of this enigmatic form.

New Species of Paludicella.*—E. Potts describes a new species of *Paludicella* (*P. erecta*). The genus has heretofore contained only the single clearly defined species *P. Ehrenbergi*. The present form is strikingly different from the old one, both in the number of its ciliated tentacles and in the character of the cœncœcial cells. The form was first noticed in a small stream, perhaps 50 feet above tide-water. A few days after, it was gathered within tidal limits near Philadelphia. In the creek, it was found most abundantly in the pools amongst the rapids, frequently covering the upper surface of stones at the depth of a foot or more to the extent of many square inches. The erect portions of the cœncœcial cells in the denser parts of the colonies are about a line in height, and standing very closely, suggest a comparison with the surface of a chestnut-bun. In the river they were found penetrating the masses of incrusting sponges, particularly *Meyenia Leidyi*. "The nearly simultaneous observation of this species in three distinct localities, together with its abundance in each, indicate that it is probably not uncommon, and excites surprise that it does not appear to have been previously noticed."

'Challenger' Polyzoa.†—The description of the Polyzoa collected during the expedition of the 'Challenger' was undertaken by Mr. G. Busk, and the first part of his Report, comprising the Cheilostomatous forms, or those in which the mouth of the zoœcium or cell is provided with a movable lid which shuts down over the polypide when retracted, has just been published.

The number of species is 286, and when these came into Mr. Busk's hands he found no less than 180 of them new. In one genus alone, that of the *Retepora*, the number of known species has been raised from 31 to between 50 and 60.

Among the most important contributions of the Report to the systematic zoology of the Polyzoa is the revision which it contains of *Adeona* and allied genera. A critical comparison of the species of *Adeona* with species belonging to other genera which had been hitherto placed among the *Escharidæ* has necessitated the founding of a new family, Adeoneæ, in order to include the whole in a single natural group. This family has several peculiarities, among which the most interesting is the possession by all the species of three different kinds of cells, which the author terms zoœcial, oœcial, and avicularian.

* Proc. Acad. Nat. Sci. Philad., 1884, pp. 213-4.

† Zoology of the Voyage of H.M.S. 'Challenger,' xxx. "Report on the Polyzoa—the Cheilostomata," 216 pp. (36 pls.). 4to, London, 1884.

Oœcia of the ordinary type are entirely absent, and their function appears to be performed by special cells which differ in form from the others. When decalcified these oœcial cells appear as thick-walled sacs, containing in most cases an ovoid mass, which resembles the contents of an ordinary oœcium, and like these is almost certainly embryonal. Mr. Busk has further made the important observation that in some of them there is lodged instead of this mass a polypide similar to those inhabiting the zoœcial cells, and he concludes that the embryonal mass is derived from a polypide, which it finally replaces. Among other peculiarities of the Adeonœe is one which, notwithstanding its apparent triviality, derives importance from its constancy. This consists in the universal presence of a projecting point at each end of the base in the avicularian mandibles, both large and small. In doubtful fragments this character alone will often indicate the affinities of the species.

In a large proportion of the diagnoses the author has had recourse to the chitinous elements of the skeleton. These are the so-termed opercula or oral valves, and the chitinous parts of the avicularia and vibracula; and a very large number of accurately executed outlines are given in order to show the various forms assumed by these elements in the different species. The employment of the chitinous elements in the classification and descriptive zoology of the Polyzoa is due entirely to Mr. Busk, who has convinced himself that "their value for these purposes cannot be overrated, while their importance extends far beyond the mere distinction of genera and species."

The descriptions of the species are of course necessarily confined to the hard parts, whether calcareous or chitinous, for, except in living examples, it is rarely possible to determine any facts of importance regarding the soft parts of the colony. The author, however, gives two highly instructive figures of the avicularia of *Bicellaria pectogenma*, in which the muscular apparatus and other soft parts of these curious and still enigmatical bodies are clearly and beautifully represented. In one of his figures of *Carbæsea moseleyi* also—a form in which the calcareous walls are quite transparent—there is a very interesting view of the polypides in the interior of their cells.

The distribution of the species, geographical and bathymetrical, finds a prominent place in the Report. One of the most unexpected facts brought out is the very wide bathymetrical range enjoyed by certain species. Thus *Cribrilina monoceras* is one of the four species brought up from 3125 fathoms in the North Pacific, while the same species was obtained from 1325 fathoms in the South Pacific, from 69 fathoms in the South Indian or Kerguelen region, from 55 fathoms in the South Atlantic, and from 35 fathoms in the Australian region. This striking difference in the depths inhabited by one and the same species is, however, exceptional; and so is the wide range of geographical distribution which is here presented by a species occurring at great depths. The study of the bathymetrical distribution of the 'Challenger' Polyzoa shows that "the extent of geographical distribution is to a considerable degree correlative with the bathymetrical, the

wider geographical distribution being in most instances coincident with the shallower depths."

To this law another striking exception is afforded by the beautiful genus *Ctenicella*, a genus very rich in species, which, though from comparatively shallow water, are almost exclusively confined to the Australian region.*

γ. Brachiopoda.

Argiope Kowalevskii.†—M. A. Schulgin finds that the essential part of the internal skeleton—the brachial framework, to which, in most Terebratulids, the gills are attached, is wanting in *Argiope*. The lower part is alone present, and forms a ramus basilaris to which the lower end of the tentacular disk is attached. The shell is laid down over the whole extent of its surface, and is not a derivate of a gland as in the Mollusca. The tentacular disk is not a special respiratory organ, but a mere thickening of the mantle, and its long tubules are nothing more than tentacles; respiration is effected at all points of the body, and especially by means of the pallial outgrowths which traverse the shell and reach to the exterior. There is no heart nor any specially formed vessels; the blood is set in motion by the ciliated epithelium of the peritoneal cavity into which there open the blood-carrying lacunæ.

The nervous system consists of a feebly developed sub-oesophageal ganglion, a thin nerve-ring, and strongly developed peripheral branches. The tactile organs have the forms of high cells, and are found at the margin of the mantle; there is a special organ in the integument near the mouth. The author finds ten, but Kowalevsky describes only eight muscles; the former finds no basis for a comparison, such as that instituted by the latter, between these muscles and those of annelids. Although the embryos of *Argiope* have segments, yet the muscles and dissepiments of annelids are not represented. Semper's statement that the mesoderm takes no share in the formation of the segments is confirmed; it follows that the muscles have a different developmental history. Similarly, the setæ are not to be regarded as homologous, for similar structures are developed in Chitons and other molluscs; and these setæ are not on the "segments" but on the lobe (the future mantle), which has nothing to do with the segment.

The only organs which are both homologous and analogous are the brood pouch of *Argiope* and the segmental organs of adult annelids; a similar organ is found in *Pedicellina*. This form resembles *Argiope* in having the central nervous organ similar in position, its lophophor appears to be the homologue of the tentacular disk. It is probable that the Polyzoa and Brachiopoda arose from a side branch of a phylum which also gave rise to Annelids, and they may be separated from the Molluscoidea, and grouped together under the class of Vermoidea.

The author's essay was completed before the publication of Mr.

* Dr. G. J. Allman in 'Nature,' xxxi. (1884) pp. 146-7.

† Zeitschr. f. Wiss. Zool., xli. (1884) pp. 116-41 (2 pls.).

Shipley's paper; * and it is pointed out that in the latter the true ganglion is not described, but the external sensory regarded as the central nervous organ.

Arthropoda.

a. Insecta.

Appendages of the Jaw of Mandibulate Insects. †—J. Chatin discusses the maxillary palp and lobes of mandibulate insects; he points out that the palp is not only associated with certain sensory acts, but also takes part in the prehension and mastication of food; these two efforts may be equally realized, or one is predominant. After illustrating how it, and the two parts of the lobes may be modified, he states that three kinds of appended setæ may be distinguished. They are non-tactile setæ, tactile hairs, or soft cones. The tactile hairs are best developed on the maxillary palp, which is not, however, as highly sensitive as the labial palp. The soft cones are likewise found on the palp, where they are short, terminated by a convex edge, and invested in a delicate and almost transparent envelope; at their base there is a nerve-cell which is generally bipolar, and which on the one side is continued into the protoplasm of the cone, and on the other into a nerve-filament. These are probably organs of great importance in the tactile sensibility of Arthropods, though from their fragility and small size they have escaped the attention of most observers.

Copulatory Apparatus of Male *Bombus*. ‡—O. Radoszkowski, after reminding the student that the copulatory apparatus of the males of the genus *Bombus* consists of a penis, two sagittæ, two hamuli, and an "operculum genitalis," describes the typical arrangement of these parts and their constituents, and then enters upon an account of the differences which obtain in various species; these are grouped under the heads of *B. pratorum*, *B. lapidarius*, *B. wurficini*, *B. derhamellus*, *B. canus*, *B. sylvorum*, *B. tristis*, *B. fervidus*, *B. dumoncheli*, *B. terrestris*, *B. sorocensis*. The differences in form are shown by figures. The chief objects of this communication are to show that many authors have erred in uniting species which are clearly distinct, and to give better descriptions and figures of the organs in question than have yet appeared.

Luminosity of the Glowworm. §—W. Kaiser having captured a particularly fine female specimen, 13 mm. long, of *Lampyrus splendidula* Linn., prepared the luminous organ by cutting out the luminiferous papillæ, together with the chitinous substratum and a portion of the ventral chain. The organ had previously shown no luminosity; but when spread out upon a slide furnished with a caoutchouc ring, and brought somewhat into the shade, first one, then a second, and lastly, the third and fourth luminiferous papillæ shone with a green

* See this Journal, iv. (1884) p. 215.

† Comptes Rendus, xcix. (1884) pp. 939-42.

‡ Bull. Soc. Imp. Nat. Moscou, 1884, pp. 51-92 (4 pls.).

§ Anzeig. K. Akad. Wiss. Wien, 1884, p. 133. See Ann. and Mag. Nat. Hist., xiv. (1884) p. 372.

light. Two wires from a powerful galvanic battery were applied to that part of the preparation where the author believed there were still remains of nerves, but without thereby causing any alteration in the intensity of the light. He then closed the preparation by applying Canada balsam to the edges of the ring and fixing a cover-glass. After this the organ continued shining for a quarter of an hour. A quarter of an hour later he warmed the preparation to about 50° C. (= 112° F.), and then the luminosity gradually became fainter, passing finally into a yellow flicker like that of touch-wood, and then ceasing. On opening the cell and moistening the preparation with a drop of water, the luminous organ in about five minutes showed a faint green luminosity, and an hour after the dissection it still shone with a dull green light.

Testes of Lepidoptera.*—In the 150 varieties examined by Cholodkovsky, he found that each of the two vasa deferentia carried four seminal follicles. These latter were either quite distinct, or else united by a more or less definite investment into a pair of testes or even into a single testis, which may, or may not, retain traces of a primitive bilateral stage.

Each seminal follicle shows, in typical development (e. g. in *Papilio Machaon* or the pupæ of *Vanessa urticae*), the following four membranes, commencing from without, (1) the common membrane formed of tracheæ in part fused into a chitinous investment, (2) a separate membrane, formed from the fat-body, proper to each follicle, (3) a similarly separate chitinous coat, rich in tracheæ, and (4) the membrana propria, a delicate, structureless, transparent membrane which is not pierced by the tracheæ.

In conclusion, M. Cholodkovsky lays down the following fourfold division of Lepidoptera, according to their testicular characters:—

- I. *Embryonic or primitive* type, with two testes, with quite distinct seminal follicles, e. g. *Hepialus humuli*.
- II. *Larval or caterpillar* type, with two testes whose four follicles are inclosed in a common investment, e. g. *Bombyx Mori*.
- III. The *chrysalis* or *pupa* type (so called because it is first seen in pupæ) with an unpaired testis, showing externally a median furrow, e. g. *Lycæna*.
- IV. The *definitive or imago* type, with an unpaired testis, unfurrowed externally in the middle line, within which the follicles are, as a rule, coiled about the long axis of the testes. This type is common to the majority of Lepidoptera.

Malpighian Vessels of Lepidoptera.†—N. Cholodkovsky, by way of supplement to a previous paper ‡ describes the anatomy and metamorphoses of the Malpighian vessels of Lepidoptera.

The caterpillar of *Tineola biselliella* has the normal number of six Malpighian vessels. In the chrysalis stage, however, these vessels, except their basal trunks, undergo fatty degeneration and totally

* Zool. Anzeig., vii. (1884) pp. 564-8.

† Comptes Rendus, xcix. (1884) pp. 816-9.

‡ Ibid., xxviii. (1884) pp. 631-3. See this Journal, iv. (1884) p. 373.

dissolve; thus reverting to the embryonal type. The two basal trunks increase in length and form the Malpighian vessels of the moth.

From the dissection of a large number of both micro- and macro-lepidoptera, the author considers that three types of Malpighian vessels can be established in Lepidoptera.

1. The *normal* type of six Malpighian vessels.
2. The *embryonal* (or *atavic*) type of two Malpighian vessels, as in *Tineola bisellicella* Humm., *Tinea pellionella* L., and *Blabophanes rusticella* Hb.
3. An *abnormal* type in which the Malpighian vessels take a very arborescent arrangement, as in *Galleria cereana* L.

Action of Ammonia upon Lepidopterous Pigments.*—G. Coverdale calls attention to the changes of colour produced on the pigments of some lepidoptera, when subjected to the action of ammonia. *Melanargia galathea* when submitted to a saturated aqueous solution of ammonia turned a beautiful primrose yellow, but regained its normal white colour as the ammonia was allowed to evaporate. The black pigment remained unchanged throughout. Solution of potassium hydrate gave the same result. Other alkalis, such as solutions of sodium hydrate and barium hydrate were tried and gave similar results, the only difference being that with the fixed alkalis the primrose coloration was permanent, whereas with ammonia it was necessarily fleeting. By the use of acids the pigment was restored to its natural white colour. Whenever an exactly neutral liquid was employed or one in which the acid predominated, the pigment remained unchanged: thus this pigment is a good test for alkalinity. Experiments on other lepidoptera gave varying results, not a single species in some genera being affected by the treatment. Of the genus *Lycena* some species remained unaltered, whilst others were affected.

Comparative Chætotaxy.†—C. R. Osten-Sacken proposes the term chætotaxy (in analogy to phyllotaxy) for the arrangement of characteristic bristles (macrochætæ) on the different parts of the body of the Diptera, and divides this order into two groups according to the presence or absence of bristles:—Diptera chætophora and Diptera eremochætata.

Bristles easily fall off, and the scars which they leave are not always recognisable, so that statements about chætotaxy must be made, as well as received, with some caution. The author gives reasons for believing that the macrochætæ are organs of orientation, connected with the nervous system, being in their useful action not unlike the whiskers of a cat, and he further points out that the faculty of poisoning seems to be connected with contiguous eyes in the male sex. Thus the Diptera eremochætata are for the most part holoptic in the male sex and aerial insects; the Diptera chætophora,

* Nature, xxx. (1884) p. 571.

† Trans. Entom. Soc. Lond., 1884, pp. 497-517 (F fig.) (for the most part previously published in MT. Münch. Entom. Ver., v. (1881) pp. 121-38, and Wien Entom. Zeit., 1882, p. 91).

on the contrary, use their legs as much, sometimes more than their wings. The *Tipulidæ*, however, are neither aerial nor pedestrian, and at the same time neither holoptic nor chætophorous.

The author's present aim being the settlement of the terminology of the macrochætæ, and by that means the utilization of a set of characters which, he considers, have not yet been sufficiently appreciated in descriptive entomology, the rest of his paper is devoted to (1) terminology of the parts of the thorax, (2) terminology of the bristles, and (3) application of the latter to the principal large divisions of Diptera.

Edible Dipterous Larvæ from Alkaline Lakes.*—S. W. Williston describes and figures the imago and larva of the Dipterous insect *Ephydra californica*, which occurs in very large quantities on the shores of strongly alkaline lakes in the west of America (Nevada soda lakes), so that hundreds of bushels could be collected. They are annually gathered by the Indians, who eat them, and are said to get fat and sleek on them. They are dried in the sun, and the shell rubbed off by hand, leaving a yellowish kernel like a grain of rice. "This is oily, very nutritious, and not unpleasant to the taste . . . more like patent 'meat biscuit' than anything else."

Development of Phryganids.†—W. Patten found in the earliest stages which he examined that there were a number of germ-cells in the yolk, together with an irregular network of protoplasm; all the nuclei migrate to the surface and take part in forming a syncytium, which becomes converted into the blastoderm; this becomes thickened at one pole to form the ventral plate. True endoderm cells arise by delamination from the ectoderm. During the formation of the embryonic membranes a groove appears in the middle line, which, however, rapidly disappears; a second depression is soon seen, and then the nervous system begins to be formed; this is effected by the differentiation of a pair of lateral cords which arise from the division of the ectoderm cells on either side of the neural furrow, and by the addition of a median infolded portion of the ectoderm which may possibly form the cross commissures. Attention is directed to the "wonderful analogy at least" between the gastrular and neural invaginations of the insect and the corresponding ones in vertebrates, and especially birds; just as in vertebrates with mesoblastic ova there is a neurenteric canal; and another point of likeness is to be found in the fact that in both groups there is a differentiation into two kinds of nerve-cells.

Development of Aphides.‡—E. Witlaczil, after a somewhat elaborate introduction, divides his essay into a descriptive and a theoretical portion.

In the former he describes (1) the development of viviparous females in the mother; in the stage of thirty-two cells thirty cell-nuclei

* Trans. Connecticut Acad. Arts and Sci., vi. (1884) pp. 87-90 (1 fig.).

† Quart. Journ. Micr. Sci., xxiv. (1884) pp. 549-603 (3 pls.).

‡ Zeitschr. f. Wiss. Zool., xl. (1884) pp. 559-696 (7 pls.).

are to be found in the outer layer of protoplasm, and two in the middle of the yolk; the blastoderm does not yet form a continuous layer, but is here and there broken through by the subjacent yolk. Polar differentiation now commences, the cells at one pole appearing larger than those at the other, so that the egg becomes pyriform in shape; this becomes more marked in succeeding stages. Cleavage is effected very rapidly. After a detailed account of the whole process of development, the author passes to (2) the development of the oviparous females and of the males; the chief difference between the two sorts lies in the history of the generative organs. When their ecdyses are complete, the males fertilize the females, which produce eggs of proportionately very large size, brown in colour, filled with small yolk-granules and fat-drops. As there are four times as many females as males, each male must fertilize several females and live for a longer period than they; the egg, after the winter, produces an apterous viviparous female (of the first generation), which contains in its ovarian tubes a larger number of chambers than do the succeeding apterous generations. (3) The development of the viviparous female from the winter egg is next discussed, but here the author's opportunities were not so great as for the previous conditions; from what he has been able to see and from what Balbiani has taught us, he is inclined to ascribe such differences as there are to the possession of a large amount of nutrient yolk.

The process of formation of the blastoderm in insects generally appears to be of the following character: the mature ovum has a peripheral layer of protoplasm, within which are yolk-granules and fat-drops; the difference between proto- and deuto-plasm is not so sharply marked; in the yolk, and towards the pole which later on is the animal pole, there is the germinal vesicle, the nuclear membrane of which becomes absorbed, and the nuclear corpuscles undergo changes which are invisible in the fresh egg. The vesicle divides, as do its descendants, until there are a large number of nuclei, some of which make their way into the peripheral layer of protoplasm to form the blastoderm, while the rest go to form yolk-cells. In the periphery cells soon become differentiated, but in the yolk they are only formed slowly, or not at all; this is because of the smaller quantity of protoplasm which is there present. The gastrula is formed by emboly. Insects are distinguished by a peculiar arrangement of the formative and nutrient yolk; and, on account of the size of the egg, its contents cannot divide simultaneously with the germinal vesicle, so that the mode of change is "endovitellic." Before the formation of the blastoderm, the egg must be looked upon as being in a syncytial stage. The mechanical effect of gastrulation is produced by the passage of the nuclei into the peripheral layer. The peculiar mode of development of the insect ovum is to be explained by its size, by the position of the germinal vesicle, and by the fact that the whole egg is inclosed in a layer of protoplasm.

After discussing the germinal bands and the embryonic membranes which have received attention from various preceding writers, the author takes up the germinal layers; in insects, as in vertebrates, the

nutrient yolk appears to be the homologue of the endoderm of other animals; the sole difference of importance is that the endoderm does not here take any active part in the formation of the embryonic body, for even the enteric canal is formed in *Aphis* by the ectoderm; this divergence from the ordinary arrangement is explained by the size of the endodermal mass, but it is likely to modify our ideas as to the germinal layers. The mesoderm is the homologue of the typical mesoderm, and the ectoderm to that of other animals; in insects the blastoderm, together with the invaginated portion which forms the germ-bands, and the inner embryonic membrane is to be regarded as the ectoderm.

There seems to be no doubt that the breaking up of the nutrient yolk into yolk-spheres is nothing else than the end of the cleavage process, that the yolk-spheres represent endodermal cells, and that they give rise to the so-called wandering cells. It is doubtful, however, whether these cells do really wander.

In *Aphis*, where the ova are endoblastic, the mesoderm is formed by the cleavage along its whole surface of the germ-band; later, it divides into a median and two lateral bands, which become segmentally arranged; there are wanting, however, the lateral multi-laminate parts, which are to be found in ectoblastic ova. The difference in the history of the mesoderm of ecto- and endoblastic eggs is due to the different mode of formation of the germ-band; in the latter there is a proportionately delicate involution which forms the great part of the band, and as the mesoderm cannot be formed by involution it is formed by cleavage; in ectoblastic eggs the mesoderm is ordinarily formed before the band, which is of greater width. The heart of *Aphis* and its aorta are formed from a cord of mesodermal cells, which is at first solid, increases by cell-multiplication, and when it is hollowed out probably gives rise to the blood-corpuscles. The author's observations agree in many points with those made by Bobretzky on the heart of Crustaceans. The cœlom of insects is primary, for it arises from the cleavage-cavity. In *Aphis*, and probably in all insects, the intestine is formed from an anterior and a posterior ectodermal invagination, and there is no median arch-enteron.* These invaginations are, from the first, invested by mesoderm, which later on forms the muscles.

The tracheæ begin to be developed at a comparatively late period, and this seems to be due to the small size of the germ-band, which does not overlap the rudiments of the appendages in *Aphis*, or in other insects with endoblastic ova; the early appearance of the tracheæ in ectoblastic eggs is regarded as a secondary phenomenon. The nervous system, again, presents differences in endoblastic and ectoblastic eggs.

We may recognize three periods of development; in the first we have the phenomena which precede the formation of the organs—cleavage, formation of germinal layers, appearance of the germ-band

* We may point out that Witlaczil is in error in supposing that Prof. Balfour was the author of the words stomodæum and proctodæum; we owe these two useful terms to Prof. Ray Lankester.

and of the embryonic membranes; in the second the organs are laid down, and in the third they are developed. The postembryonal development of the larva may be regarded as a fourth period, during which the generative organs appear.

This essay is not only of importance on account of the author's own investigations, but also from the way in which the accounts of other workers at insect embryology are stated, compared, and criticized.

γ. Prototracheata.

Development of *Peripatus*.*—J. von Kennel has published in detail an account of his observations on the development of *Peripatus edwardsi* and of *P. torquatus*; his preliminary notice was reported on at such length † that it is now only necessary to direct attention to his concluding general remarks.

Like Balfour and Metschnikoff, he sees a great resemblance between the young stages of *Peripatus* and other Arthropods; the resemblances to the annelids are much less striking. The characters of the cephalic segment are discussed, and the "præoral portion" stated to be nothing more than the median mesoderm-free portion of the first and oldest segment of the body, which contains a small enteric caecal sac. It is true of Arthropods that the frontal lobes are the oldest segment of the body or head. The mode of origin of the coelom is such that it cannot be said to be either a schizocoële or an enterocoële; and the author proposes to speak of it as a neutrocoële.

Especial importance is attached to the amnion and the connected umbilical cord, but it is to be borne in mind that these terms are used in a physiological and not in a morphological sense. The former is compared with the embryonic investments of scorpions and insects, and the question is raised as to whether the so-called dorsal organ of various Crustacea is a comparable structure. Though the present state of our knowledge is far from satisfactory, it appears probable that all the investments of the egg of the Tracheata are comparable *inter se*, and, if so, the "amnion" and "umbilical cord" of the West Indian species of *Peripatus* are to be brought into the same category; the latter are, too, clearly seen to have a close resemblance to the dorsal organ of the Crustacea, and von Kennel cannot doubt the homology of the parts found in *Oniscus* and *Peripatus* respectively.

The direct descent of *Peripatus* from annelid or annelid-like ancestors can no longer be questioned, and the organs just mentioned seem to the author to be the representatives of the trochosphere.

δ. Arachnida.

Structure of the Fore-gut of Arachnida. †—J. MacLeod describes the structure of the "anterior intestine" of the Arachnida, by which he clearly means the part to which English morphologists are in the habit of applying Prof. Lankester's name of stomodæum.

* Arbeit. Zool.-zoot. Inst. Würzburg, vii. (1884) pp. 95-229 (7 pls.).

† See this Journal, iii. (1883) p. 833.

‡ Bull. Acad. R. Belg., liii. (1884) pp. 377-91 (15 figs.).

In a scorpion—*Buthus europæus* (?)—the structure of which has already been investigated by Huxley, the author finds what Prof. Huxley failed to see, the constrictor muscles by which the pharyngeal sac is closed; it will be remembered that Huxley ascribed the closure of the sac to the elasticity of its walls. Vertical or oblique muscles surround the organ and are inserted into its inferior border. At the upper border they are inserted into the two lips of a groove, which they cover like a bridge, and over which they are united. A section of the pharynx taken perpendicularly to its long axis shows that the organ has the form of a three-rayed star; the dilatator muscles are inserted between the ends of these rays, and the constrictors to their ends. The œsophagus has a muscular investment formed by several transverse bundles, but beyond it the heart is without any suctorial apparatus. Numerous acinous glands, which open separately on the surface, are to be found in the maxillary portions of the ambulatory legs; they may be compared to the maxillary glands of spiders.

The author confirms the accuracy of the account given by Plateau of the digestive tube of the Phalangida; the point of exit of the ducts of their acinous gland has not been exactly determined, but they probably open into the mouth. As it occupies the same position as the maxillary gland of spiders, as discovered by Campbell, and the poison-gland found by Cronenberg in the Solpugidæ, the three sets of organs may be regarded as homologous.

The descriptions given by Plateau and Schimkewitsch of the digestive tube of spiders are very exact, but MacLeod differs from the latter who thinks that all the muscles of the pharynx have a dilating action; he would rather ascribe a constricting function to those lateral muscles which are inserted into the anterior angles of the pharynx.

The stomodæum of the pseudoscorpions has considerable resemblance to that of scorpions and spiders; the section of the pharynx is four-rayed; there is only a rudimentary sucking stomach.

The various genera of the Acarina differ from those of the groups already considered by presenting very various arrangements among themselves; several forms are separately described.

The author concludes that the suctorial apparatus in all the Arachnida which were examined is localized in the part of the digestive tube which is in front of the œsophageal ring, with the exception of the spiders in which there is a sucking stomach behind the œsophageal ring, and in which the pharyngeal sac appears to be undergoing degeneration; and in the pseudoscorpions, where there is a very rudimentary sucking stomach. In scorpions, spiders, and pseudoscorpions the sucking apparatus is best developed at a definite point in the stomodæum; but in the Acarina and Phalangida the whole or nearly the whole of that portion of the digestive tube which is placed between the mouth and the nerve-ring plays the part of a sucker, and is provided with a system of dilatator and constrictor muscles which commences at a short distance from the mouth. Organs analogous to the pseudo-tracheæ are found in scorpions and Phalangida.

Organs of Sense in Spiders.*—F. Dahl gives a brief account of the zoological points of some recent observations on the psychological processes in spiders. Sight is imperfect, there being no power of accommodation. A very short distance suffices to make a spider mistake for a fly any small moving object, e. g. a pellet of paper. The sense of touch is, by way of compensation, highly developed. The spider, taking its stand in the centre, can by touch tell in what precise radius a foreign body strikes against its web. Smell and hearing are well developed. *Epeira patagiata* can distinguish between different smells.

In web-building several types regularly occur in the architectural life of an individual spider. The first web is of a regular circular shape with radiate strands, the animal taking up its dwelling in the centre. The next web is composite, showing several simple webs of the first type combined, and the abode or den of the spider is not in, but near, the web proper—a signal-line connecting its place of concealment with the centre of the web.

Spiders avoid bees, wasps, and other dangerous insects, and Dahl found that by dipping a given species of insect in turpentine (which spiders dislike), a spider learnt to shun the species, as such, whether anointed or not with the oil.

Coxal Gland in the Phalangida.†—J. MacLeod describes coxal glands in the Phalangida, which are comparable to those lately seen by Lankester in *Limulus*, scorpions, and tetrapneumonous spiders. They are there made up of a number of glandular tubes which form a closed system; the cells that line the tubes are distinguished by the fact that their external zone is strongly striated and well differentiated, while their internal portion appears to be formed of granular protoplasm, and to contain a nucleus; and the organs of the Phalangida have a similar structure. The presence of these glands seems to the author to be an important aid in settling the vexed question of the systematic position of these animals, and to favour the view, now generally adopted, that they belong to the group of the Arachnida; the facts noted in his preceding paper point in the same direction.

Hermaphroditism of the Male of Trombidium.‡—J. MacLeod finds that the cæcal sacs of the male gland of *Trombidium holosericum* contain ovules, situated among the mother-cells of the spermatozoa; they do not, however, complete their development or acquire the size of the ripe ovules in the female, which were examined at the same period of the year.

ε. Crustacea.

Absolute Force of the Muscles of Invertebrates.§—In his second || essay on this subject F. Plateau deals with the flexor muscles

* Zool. Anzeig., vii. (1884) pp. 591-5.

† Bull. Acad. R. Belg., liii. (1884) pp. 392-3 (1 fig.).

‡ Ibid., p. 393 (1 fig.).

§ Ibid., pp. 450-74 (1 pl.).

|| For the first part (on Lamellibranch Molluscs) see this Journal, iv. (1884) p. 212.

of the forceps of the decapodous Crustacea; *Carcinus mœnas* was found to adapt itself well to experiments of this nature; *Platycarcinus pagurus* and others were also used.

The experiments were thus performed: a rectangular piece of wood, pierced by several rows of holes, is suspended vertically by a fixed support, and several holes are made near its superior edge; the crab is fixed on the board with its mouth downwards, in such a way that the lateral regions of the sternal face of the carapace can be conveniently got at; the process of the propodite is superior and the movable dactylopedite inferior. The crab generally keeps its forceps closed; weights are then added till the forceps begin to open. To greatly stimulate the animal and cause it to put into play its maximum of muscular energy, a small stylet may be introduced between the thorax and the abdomen; the crab then closes its forceps with great force, raises, and often holds up, the weight. The weights are increased till the animal is only just able to raise the weight. Suitable weighings are made, and the second forceps, if present, is, after a short period of repose, experimented on in a similar fashion. The crab is then weighed, chloroformed, and its forceps put for some days in alcohol of 50 per cent. Though the action of the alcohol is to somewhat reduce the volume of the muscular masses, the inconvenience is atoned for by the facility with which one can make transverse sections so as to measure the surfaces. Suitable measurements having been obtained, the results are worked out; and it is found that, for the common crab, 851 gr. (when large), or 961.6 gr. (when smaller), are the mean weights, supported by a square centimetre of the flexor muscle of the right forceps; that of the left gives, respectively, 1336.7 gr. and 1181.2 gr.

When we compare the mean weight with that supported by other animals, we find that crabs give us 1008.75, as against 2000 for the frog, 4545.79 for the lamellibranchiate, and 7902.33 for man. It follows then that the absolute or static force of the muscles of the Crustacea is comparatively feeble.

If we look at the matter in another way, and consider the question of the muscular force of an animal without regarding either the dimensions of these muscles, or the number of contractile elements which enter into their composition, we get very different results. Proportionately to their weight molluscs, insects, and Crustacea have an enormous force, some much greater than that of mammals. Thus the proportion of the weight carried to that of the body is, for the horse 0.50 to 0.83; for man 0.86, for *Carcinus* 5.57, for insects from 14.3 to 23.5. A small number of special muscles give results of the same kind—the force of the muscles of the forceps of the common crab is forty times as great as that of the human hand.

It is clear that we cannot allow that the force of contraction of muscular fibre is the same throughout the animal kingdom.

The author has made some experiments with reference to the injuries which crabs can undoubtedly inflict on other animals, and he comes to the conclusion that it is not necessary to suppose that the Decapoda have any extraordinary force.

The lateral mode of locomotion of the Brachyura affords apparently an excellent opportunity for making experiments on traction, but in practice it is not found to be so; crabs appear to draw very badly, but it is possible that, on account of their fear, they do not exert themselves to the utmost; sometimes the animal does not use all its legs, or the different joints of one and the same leg do not move in the same plane, and the surface of the section of a muscle is so small that gross errors may easily intervene. The absolute force of the motor muscles of the joints of the legs may, however, be regarded as analogous to those of the mobile joints of the forceps.

Anatomy of the Spider Crab.*—E. A. Andrews describes in great detail the anatomy of the spider crab (*Libinia emarginata* Leach), illustrating the paper with 20 figures.

Circulation of Schizopoda and Decapoda.†—The disposition of the heart and the vascular system in general of the Schizopoda has been studied by C. Claus in several species of *Mysis* and in the genera *Siriella*, *Mysidopsis*, *Leptomysis* and *Pseudosiriella*; in *Siriella* the heart extends through the whole thorax, and may be recognized therefore as a more archaic type, similar to the Phyllopod heart; in *Mysis* the heart is considerably shorter, but the absence of an internal muscular network is a primitive character. In *Mysidopsis* the heart is still more curtailed and possesses only two pairs of ostia, which are so close together that they have been regarded by previous investigators as forming but a single pair. From the anterior end of the heart arise two lateral and a median aorta; from the lower surface of the heart arise two vessels, which supply the alimentary canal and its dependent glands, and the sexual glands; in the hinder region of the heart arises the "descending aorta," which communicates with the sternal artery; finally from the hinder extremity of the heart arise two rudimentary lateral trunks and the abdominal aorta.

The anterior median vessel, guarded at its exit from the heart by two valves, supplies the anterior region of the head, including the brain, eyes, and anterior antennæ; the vessels supplying the eyes divide up into an extraordinarily developed capillary plexus in the eye stalk.

The vessels which spring from the lower surface of the heart correspond to the single hepatic artery of the higher Decapoda, and in being three in number resemble the conditions observable in the Hyperidæ. In the Euphausidæ, on the other hand, there is only a single hepatic artery as in the higher Decapoda. The abdominal aorta, as in the Decapoda, runs along the upper side of the gut as far as the telson.

The fine capillary branches of the arterial trunk open freely into the body-cavity, and only form plexuses in the nerve-centres; the blood from these plexuses is returned into arterial vessels which themselves open into the body-cavity. There are no venous trunks, only incompletely defined spaces in the body-cavity, which occasionally (in

* Trans. Connecticut Acad. Arts and Sci., vi. (1884) pp. 99-121 (3 pls.).

† Arbeit. Zool. Inst. Univ. Wien, v. (1884) pp. 271-319 (9 pls.).

the limbs) have the form of canals. The blood returned from the eyes and antennæ flows over the masticatory stomach and the hepatic sacs, and is conveyed into the lateral portions of the carapace, whence it is returned to the pericardial cavity. The blood from the thoracic limbs traverses canal-like lacunæ, which project into the respiratory cavity, and finally reach the pericardium.

The circulatory system of the Decapoda was chiefly studied in living examples of *Phyllosoma*, *Alima*, &c., and other decapod larvæ, and detailed descriptions, copiously illustrated, of the disposition of the blood-vessels in various species are given. In the young zoeæ of the *Macrura*, and in the corresponding *Megalopa* stage of crabs, all the chief arterial trunks of the adult were plainly distinguishable, and the fact that the young larvæ have not merely the characters of the *Mysidæ* only, but also (in so far as regards the circulatory system) the characters of the higher Decapoda, appears to be an important piece of evidence against regarding them as representing a primitive form whence both have taken their origin.

Enteric Glands in the Crustacea.*—J. Frenzel describes the histological characters of the "liver" in Decapoda,† Isopoda, and Amphipoda, and the nature of its secretion; in all these Crustacea the liver contains an abundance of fat in uncoloured or coloured drops, which are either developed in special cells (Decapoda, Gammaridæ, Caprellidæ) or in the ordinary secretory cells (Isopoda Phronimidæ). With the sole exception of the Isopoda, these cells contain in addition small spherical bodies generally aggregated in masses. The most important element in the secretion, however, consists of a fine-coloured granular matter which is produced in special cells (Decapoda, Gammaridæ, Caprellidæ), or in the same cell as the fat-globules (Isopoda Phronimidæ). The structure of these cells is much the same in all Crustacea; the secretion is apparently more like that of the pancreas of Vertebrata.

'Challenger' Cirripedia.‡—Dr. P. P. C. Hoek concludes his report on the Cirripedia,§ by the present series of chapters on the anatomy of the group.

Unfortunately, the new forms of the deep-sea material being often represented by single specimens, it was impossible to work out their anatomy in any detail; but some excellent work has been done on forms formerly known. Thus the subject of the "complemental" male of *Scalpellum* is treated of, and every justice is done to the investigations of Darwin, who in 1851 first called attention to the strange phenomenon. "When we consider how much the methods of microscopical research have been improved in the thirty years which have elapsed, and that the male of *Scalpellum vulgare* which Darwin investigated is only 0.7 mm. in size, we can only wonder at the

* MT. Zool. Stat. Neapel, v. (1884) pp. 50-101 (1 pl.).

† See this Journal, iv. (1884) p. 375.

‡ Report of the Voyage of H.M.S. 'Challenger'—Zoology, x. (1884) 47 pp. (6 pls.). See Nature, xxxi. (1884) p. 165.

§. See this Journal, iv. (1884) p. 890.

thoroughness of the information which he has given, and at the soundness of the conclusions at which he arrived."

Dr. Hoek observed the complemental male in 19 out of the 41 new species described in the first part of the report, but the unique specimens were not, and could not without spoiling them, be thoroughly examined. The structure of these males varies; some do not show a division of the body into a capitulum and a peduncle; a second group, while not showing either, are furnished with rudimentary valves; and a third not only have these latter but also show a distinct capitulum and peduncle. Another chapter treats of the anatomy of the complemental male in *Scalpellum ornatum*, one of the largest known.

The subjects of the *Cypris*-larvæ, of the segmental organs in the Cirripedia, of the cement apparatus, of Darwin's "true ovaria" (believed to be a pancreatic gland), the eye in *Lepas*, and the gynoecial organs, are also treated of.

Vermes.

Nervous System of Archiannelides.*—J. Fraipont has investigated the central and peripheral nervous system of *Protodrilus*, *Polygordius*, and *Saccocirrus papilocercus*. After an historical review of what has been already done, he gives an account of the methods employed by him, the first of which was the study of living specimens; for microscopic examination specimens are best killed by the gradual addition of alcohol to the sea water in which they are living; the worms were then hardened by strong alcohol, osmic or picric acids, or hot or cold corrosive sublimate. The great point to be aimed at is getting the animals as extended as possible. Borax-carminine, picrocarmine of ammonia in 99 parts of alcohol, hæmatoxylin, and anilin dyes were the favourite staining reagents. Sections were made by Jung's microtome, and the fixing method of Giesbrecht was adopted.

The relations of the nervous system of *Protodrilus* to the ectoderm are very characteristic, and present as a permanent arrangement that which is seen only in the larval stages of higher annelids; it remains intimately connected with the epidermis; there is no differentiated wall by which the nervous cells are separated from the rest. But, further, its structure as well as its position is remarkable for its primitive character; in a single section one may see transitional stages between the ganglionic and the ordinary epidermic cells. We may say that the whole frontal lobe is cerebral; it is a thickening of the ectoderm which only contains ectodermal cells; such as are superficial in position retain the characters of investing cells; those that are deeper are nervous in nature. It is scarcely possible to distinguish a grouping of ganglionic cells, but two posterior masses must be regarded as representing two ganglia with the special function of innervating the ciliated pits. In the ventral cord the ganglionic cells are distributed uniformly over the

* Arch. de Biol., v. (1884) pp. 243-304 (5 pls.).

lower face of the cords for their whole extent; there are no ganglionic masses, and no transverse commissures.

The brain of *Polygordius* presents us with a higher stage, inasmuch as, though still in contact with the ectoderm, it is more distinctly individualized owing to the possession of a proper sheath; it is more strongly marked off into several ganglionic masses, each with special functions; the anterior ganglia innervate the tentacles; the median one, which is the most important portion of the brain, is in special relation to the epidermis of the cephalic segment, and is connected with the rest of the body by the ventral medulla; the posterior ganglia supply the ciliated pits.

The brain of *Saccocirrus* is in very intimate relation to the epidermis; there is no proper sheath, and the distinctness of the ganglia is less complete than in *Polygordius*; on the other hand the nervous cells are very distinct in character from those of the epidermis, which is not the case in *Polygordius*.

Fraipont thinks that E. Van Beneden has demonstrated that *Histriobdella* is one of the Archiannelides, and a paper in exemplification of this is to be published by Föttinger.* *Polyophthalmus* presents us with an advance in the morphological evolution of the nervous system, for this is separated by muscles from the epidermis, though it is connected with it by nervous branches; the special ganglia are differentiated, and we have here a true chaetopod brain.

In addressing himself to the difficult question of the origin of the nervous system of Annelids, the author repeats the doctrine of Kleinenberg that *Hydra* is provided with neuro-muscular elements, and says that these cells function as sensitive peripheral organs, as ganglionic cells, as sensory and motor nerves, and their internal prolongation as muscles. He then refers to the lately expressed opinion of Sedgwick that the whole of the central nervous system of Triploblastica is the homologue of the buccal nerve-ring of Actiniæ, and says that, if that view be correct, the polar plate of the young larvæ of *Polygordius* represents the anterior part of the buccal ring; against this it may be objected that the independent development of the dorsal and ventral portions of the central nervous system of *Polygordius* hardly favours the view that the two are the homologues of a single ring. An explanation is given in the suggestion that the tardy appearance of the ventral cord of *Polygordius* is due to the late development of the trunk. Fraipont thinks that we must consider the enormous development of the peripheral nervous system of the præoral lobe not as characteristic of the primitive forms of annelids, but as a secondary arrangement due to the great relative size of the præoral lobe as compared with the rest of the body. He thinks it probable that *Protodrilus*, which has a direct development, will be found to have the brain and ventral cord developed contemporaneously.

If we limit ourselves to forms in which the two parts of the nervous system appear separately, we may ally it to that of other known forms. In the Actiniæ there is an ectodermic nervous plexus, and another, which is independent of it, and which is exclusively related

* Since published. Arch. de Biol., v. (1884) pp. 435-516 (5 pls.).

to the elements of endodermal origin (muscles, &c.). The Chætognatha present us with one intermediate condition which is very instructive ; in them the nervous system, as has been shown by O. Hertwig, consists of an epidermic portion connected with the sensory fibres, and an intermuscular portion formed by central organs and peripheral motor elements. The epidermic portion is altogether comparable to that of *Actinia*. Hertwig thinks that we may regard the intermuscular nervous system of *Sagitta* as comparable to that which is found under the intermediate membrane in the sea-anemone ; and Fraipont thinks that this homologisation is justifiable.

If we go a step further, we may regard the brain and ventral cord of *Protodrilus* as answering to the supra-cesophageal connected with the ventral ganglion in *Sagitta* ; but what, then, has become of the ectodermal plexus of *Sagitta* in the Annelids ? It has disappeared as such in the Archannelides, but its constituent elements are probably to be found on the ventral surface of the medulla. It has no *raison d'être* the moment there are no ectodermic muscles. The author thinks that we must consider the membrane which, in *Polygordius*, separates the epidermis from the longitudinal muscular area, as representing the ectodermic muscular layer of the *Actiniæ* ; and this view is confirmed by the developmental history of *Saccocirrus*.

The question now arises, how did the very intimate relations which exist between the elements of the epidermis and the intermuscular plexus arise in the Archannelids, seeing they were not formed primitively in the Cœlenterata. If the plexus and the intermuscular nervous centres of the Chætognaths and Annelids have the same origin as the muscles, the relations between them and the ectodermal elements must be secondary ; they may have appeared in consequence of the atrophy of the ectodermal muscles. Later on there would be a condensation of the ectodermal plexus on the ventral surface, but this localization would not necessarily result in the complete interruption between the cells of the surface of the epidermis and the intermuscular plexus. A certain number of ectodermal cells would remain in relation with the plexus without there being any change in the function of the different elements. We should thus find in the lower Annelids a permanent arrangement, which would be transitional between what obtains in the Chætognatha on the one hand, and the Chætopoda on the other.

In presenting this hypothesis the author does not wish to be supposed to think the Annelids are derived from the Chætognatha, but he thinks that he has shown that it is possible to connect phylogenetically the nervous system of the lower Annelids with that of the *Actiniaria* by means of the Chætognatha, and so to associate the facts given by Hertwig with the hypothesis propounded by Sedgwick.

Respiration of the Serpulaceæ in Relation to their Tegumentary Pigments.*—L. Orley is not satisfied with a knowledge of the nature of colouring matters, but thinks that positive conclusions as to their functions can only be obtained when the vital processes of their

* Termesztet. Füzetek., viii. (1884) pp. 199-207.

possessors are also studied. The essay now before us may be taken as a biological supplement to the author's essay on the gills of the *Serpulaceæ*.*

The simplest coloration among the Sabellidæ obtains in *Myxiola*; it is more varied in *Branchiomma*, and still more so in *Spirographis*. In all these, however, the colours are sober. In *Serpula* they are brighter. As it is almost certain that these colours have no sexual significance, and hardly appear to serve as a means of defence, and as different shades of light or darkness seem to have no influence on the worms, we are led to inquire if they have no relation to respiratory phenomena. The Serpulaceæ are often found living in places poor in oxygen, and the pigments are only developed in such parts of their bodies as are exposed to a rich supply of water; for example, the tubicolous *Praxilla* has the fore-end of the body of a bright red colour, but the hinder part is colourless. The author recognizes the necessity of chemical investigations and of studies which shall be more complete from a physiological point of view.

Lower Animals of the Bay of Algiers.†—The first annelid discussed by C. Viguier is *Exogone gemmifera*, on which he published a short note in 1883;‡ as with this, so with the others, *Sphærosyllis pirifera*, *Syllides pulliger*, and *Grubea limbata*, especial attention was directed to the process of gestation. The chief results arrived at are (1) that we cannot draw useful arguments from the presence or absence of capillary setæ in determining the sexual or asexual condition of the worms; (2) that the position of the ova or the larvæ is not constant in the procreating females of the Syllidæ; for while they are ventral in *Exogone* and *Sphærosyllis*, they are dorsal in *Syllides* and *Grubea*; and (3) the history of development may differ remarkably in species which are very closely allied to one another; for example, the envelope of the ovum becomes the cuticle of the larva in *Exogone* and *Syllides*, while it is cast off in *Grubea*. The author particularly combats the views of Pagenstecher, and believes that his observations are far from confirming the results of that naturalist.

Metamorphosis of *Filaria sanguinis hominis* in the Mosquito.§—Dr. P. Manson gives a full account of the metamorphosis undergone by the embryo of *Filaria sanguinis hominis* in the body of the mosquito, and finds the results of his previous researches|| fully confirmed.

Structure of Rotatoria.¶—L. Plate finds that in the genital organs of the female, the so-called ovarian nuclei in the ventral sac of the cloaca are more properly to be considered as forming the yolk, the true ovary being discovered in a small mass of multinucleate protoplasm lying close to the yolk-mass (*Dotterstock*). The develop-

* See this Journal, iv. (1884) p. 745.

† Arch. Zool. Expér. et Gén., ii. (1884) pp. 69-110 (3 pls.).

‡ See this Journal, iii. (1883) p. 371.

§ Trans. Linn. Soc. Lond. (Zool.), ii. (1884) pp. 367-88 (1 pl.).

|| Proc. Linn. Soc., 7th March 1878.

¶ Zool. Anzeig., vii. (1884) pp. 573-6.

ment of the ova takes place at one end only of the ovary, and the deutoplasm is formed by diffusion from the yolk-forming mass to the developing ovum.

The characteristic sense-organ of Rotifers (absent only in Philodinæ) is found in the lateral sensory bristles at the beginning of the posterior third of the body, which are innervated by nerves running anteriorly on either side to end in the coiled cephalic termination of the water-vascular system. There is no connection between these nerves and the "brain."

The uniformity of shape in the male Rotifers is important phylogenetically, as pointing to the primitive type of the class. The nervous, excretory, and rotatory systems are simpler, and the rudimentary intestine is not always furnished with calcareous concretions. Copulation does not take place by the vagina; the penis of the male perforates the cuticle of the female at any point, and this holds good in cases where six to eight males impregnate the same female at one and the same time. The semen is thus introduced into the body-cavity in which it swims about freely.

Parthenogenesis occurs, but previous observers were wrong in stating that copulation had any effect in determining the character of eggs laid. Cohn was mistaken in his view that "winter-eggs" were only laid after copulation.

"It is also an error to imagine that the Rotatoria can be desiccated by absence of water and recover later in the presence of water. Very many perish in a short time if they come into contact with the air at the surface of the water in which they live."*

Structure and Development of Myzostoma.†—J. Beard adds considerably to our knowledge of the development of *Myzostoma*, and throws some light upon the affinities of the group, concerning which there are very different opinions among naturalists.

The ovary is not a well-defined organ, but more or less fills up all the space left between the skin and the other organs of the body; the ova when fully mature possess the so-called yolk-nucleus; before fertilization two polar bodies are extruded, but in some cases it was observed that the extrusion of these took place *after* segmentation had actually commenced; segmentation, as in the Chætopoda, is complete but unequal, and a gastrula is formed by epibole, six small epiblastic cells surrounding a single large hypoblast cell which subsequently divides. The blastopore closes, and at that spot is formed the mouth of the embryo. The larval stage may conveniently be divided into three periods, each of which is considered separately.

First period.—The newly hatched larva consists of a single layer of epiblast cells surrounding a smaller number of larger cells; the ciliation is not uniform, but the cilia are arranged in tufts, and are not found in the region of the future anus. The mouth is formed on the second day.

Second period.—The changes undergone during this period are the development of provisional setæ, and the restriction of the cilia to

* Cf. *supra*, p. 39.

† *MT. Zool. Stat. Neapel*, v. (1884) pp. 544-80 (2 pls.).

certain regions of the body. On the apex of the præoral lobe is a crown of stiff long cilia which do not represent the præoral ring of cilia characteristic of annelidan larvæ; there is a well-developed postoral and a preanal ring as well as a tuft of stiffish cilia on the postanal papilla. At the same time the provisional setæ make their appearance; on each side of the body behind the mouth is a single seta which grows rapidly, and finally comes to be much longer than the body itself; subsequently to the third day the number of setæ is increased, but they are never arranged metamERICALLY as e.g. in *Nereis dumerilii*; muscles are developed in connection with these setæ. There appear to be no larval segmental organs, but this fact does not militate against the affinities of the group for the Chætopoda, inasmuch as *Nereis dumerilii* is similarly without a larval nephridium; an embryonic nervous system is found in the præoral lobe, and traces of the future ventral cord are observable in this stage.

Third period.—The provisional setæ are cast off at about the seventh day, and the larva moves about with a worm-like motion; in no case were the parapodia developed in the free larvæ, and in the absence of any organs of locomotion it is difficult to understand how the larva finds its way to its host—the *Comatula*; the probability seems to be that the currents of water produced by the waving arms of the *Comatula* bring the parasites. Whatever may be the means by which the larval *Myzostoma* comes to a secure anchorage on the body of a *Comatula*, it undergoes fresh changes as soon as it arrives at that situation. The cuticle becomes thicker, the cilia spread over the whole surface of the body arranged in tufts; the parapodia are formed from before backwards. The functional nervous system of the larva contained within the præoral lobe entirely vanishes in the adult, where there is no supra-oesophageal ganglion; in the adult the nervous system consists only of a ventral mass which is formed by the fusion of several ganglia.

All the developmental facts appear to be in favour of regarding *Myzostoma* as a Chætopod degenerate through parasitism; the larva with its ciliated bands and provisional setæ can be compared to nothing else.

The paper concludes with some notes on the biology of the genus.

In *M. glabrum* during the winter months a number of small specimens were observed by Graff attached to the back of an adult, but it appears that these individuals are not immature as Graff supposed, but fully developed males with functional spermatozoa; this species therefore presents another instance of the remarkable phenomenon first described by Darwin in the Cirripedia, viz. the occurrence of "complemental males"; these small males resemble in all respects, except in that they possess no trace of female organs of generation, the hermaphrodites upon which they sit. Among the Cirripedia Darwin discovered all stages from unisexual forms to complete hermaphrodites; and the same is the case with the Myzostomidæ as recently proved by Graff from an examination of the 'Challenger' collection. It is of great interest to consider which is

the primitive form, hermaphroditism or unisexuality. Among the Annelida, the lowest forms are mostly unisexual; only in the highly modified forms, e.g. Oligochaeta and Myzostomida, is hermaphroditism found. Another important fact is that "most hermaphrodites have very complicated sexual ducts, &c.," which are clearly adaptations to bring about cross-fertilization; such ducts could only arise in somewhat highly developed forms, that is to say, could only be converted to secondary sexual uses in cases in which they were really present beforehand, and hence only in somewhat highly developed forms. This again points to hermaphroditism not being the primitive condition. In the genus *Myzostoma* the change from unisexuality to hermaphroditism has probably been brought about by the parasitic habit. The chance of the continuance of the species would be largely increased by the development in the female of testes in addition to the small males, since the possibility of two individuals of opposite sexes coming together on a single *Comatula* is clearly in many cases very small. Finally, as Weismann has suggested in the case of *Daphnia*, the males might become extinct by a tendency to a periodic appearance; the periodicity being lengthened it would in time become infinite, and the males cease to be developed altogether.

'Challenger' Myzostomida.* — Dr. L. v. Graff's report on the 'Challenger' Myzostomida may be regarded as in some sense a continuation of his monograph on this interesting and little-known group. Of the sixty-eight species enumerated, fifty-two are new.

These Myzostomes are small disk-shaped animals, living attached to Crinoids, about whose affinities there has been up to the present a good deal of doubt, some placing them among the Worms near *Tomopteris*; others, as von Graff, among the Arachnids, near the Tardigrades; and the discovery of a new form among the 'Challenger' collection seems to confirm the correctness of this latter view. The author's class of Stelechopoda embraces the Tardigrades, Lingualulids, and Myzostomes, thus constituting a group of very lowly organized Arthropods. The report shows that the Myzostomida do not form so uniform a group, either as to their habits or structure, as was formerly thought. It is prefaced by a very neat though brief account of the general structure of *Myzostoma* as far as it is known, with a graphic coloured diagrammatic representation and most minute details as to the general morphology, from which we condense the following important statements:—

While all the hitherto known forms were characterized by the peculiar radial arrangement of the organs of the body, several species are here described in which this arrangement is entirely lost; in some (*M. folium*) the body is greatly lengthened and the parapodia and suckers are found arranged in two parallel lines, while in a new genus (*Stelechopus*) not only has the external radial symmetry disappeared, but the muscular septa and parapodial muscles are not even convergent; hence, if, as the author believed long ago, the

* Report of the Voyage of H.M.S. 'Challenger'—Zoology, x. (1884) 82 pp. (16 pls.). See Nature, xxxi. (1884) pp. 165-6.

radial arrangement was an adaptation to the mechanism of fixation, or of the peculiar type of fixation, the want of it, as in *Stelechopus*, which doubtless is a freely moving form, must be regarded as the primitive arrangement, and thus intensifies the affinity to the Tardigrades. It is interesting to find several forms entirely unprovided with suckers, though in some they may exist as mere rudimentary bodies; in one species (*M. calycotyle*) the suckers are stalked. The suggestion so aptly made by von Willemoëns-Suhm that some of the Myzostomida were in all probability diœcious, has been amply verified by von Graff's researches. The two sexes when inhabiting the same cyst are at times unlike in appearance, the female being usually fifty to a hundred times as large as the male.

Of the sixty-seven species of Myzostomes described, elaborate illustrations are to be found of all the new ones, while one plate is altogether devoted to the illustrations of *Stelechopus hyocrini*. The body in this new type has a general similarity to a Tardigrade. Unfortunately the few specimens found being mounted in Canada balsam were somewhat altered in contour, but enough remained to surely indicate that the lateral margins of the body are nearly parallel in the middle, and become somewhat narrowed at either end. There is a conical caudal appendage. The largest specimen measured 3.5 mm. long, with a greatest diameter of 0.9 mm.; the cuticle was chitinous; the parapodia, five on each side, were independent in action one of the other. The specimens were taken from species of *Hyocrinus* and *Bathyrinus*, off the Crozets, at depths of 1000 and 1375 fathoms.

Anatomy of Balanoglossus.*—An addition to our knowledge of this interesting form has been made by J. W. Spengel.

The so-called proboscis is the chief organ of movement; it is made up of an outer epidermic and two muscular coats; the innermost of these, the longitudinal coat, is extremely thick, and only leaves a very small cavity in the interior of the proboscis, which is partially filled by a network of connective-tissue cells; this cavity communicates with the exterior by one (*B. minutus*, &c.) or two (*B. kuyfferi*) pores; the external half of the canal thus formed is ciliated; the pores as well as the muscular walls are the remains of the "water-vascular sac" of the *Tornaria*. The base of the proboscis is supported by a skeletal structure having much the shape of an hour-glass, two prolongations from which surround the alimentary canal; this structure is formed by the epithelium of the alimentary canal, and is a special local thickening of its basement membrane. On the dorsal side in the same region of the body is a sac-like structure which corresponds to the "heart" of the *Tornaria*; it does not appear, however, to have been well named, as no communication with the vascular system was observable. The next section of the body, the "collar," contains the anterior portion of the gut; the body-cavity is formed by irregular spaces left between the strands of connective tissue, which communicate with the exterior by two pores. On the dorsal side is a longitudinal blood-vessel which anteriorly fills up the space between a

* MT. Zool. Stat. Neapel, v. (1884) pp. 494-508 (1 pl.).

diverticulum of the fore-gut and the "heart"; it communicates by two trunks with a ventrally running blood-vessel; above the dorsal blood-vessel is a longitudinal chord of tissue which is the nervous system, and contains several cavities not communicating with each other: in certain species the nerve-cord is here often continuous with the epidermis by means of delicate cellular strands. Behind the "collar" comes that section of the body which is characterized by the presence of the branchial pouches; these latter are paired outgrowths of the dorsal wall of the alimentary canal; each opens by a narrow canal on to a groove which runs to one side of the median line of the dorsal surface of the body; the internal opening of the canal is guarded by a valve, which does not completely close it, but leaves a permanently open U-shaped space. This simple condition is found in *B. kuppferi* and *B. kovalerskii* throughout life. In *B. minutus* and *B. claviger* the structure of the branchial pouches is complicated; the U-shaped cleft is bridged over here and there, and the cavity communicates therefore with the exterior by a series of window-like orifices. The skeletal structures which support the walls of the branchial pouches are described in detail.

All the species of the genus are of separated sexes.

The glands are similar in both sexes, and consist of simple or branched tubes; they are arranged in a series of pairs, and each gland opens separately on to the exterior a little to the outside of the aperture of the branchial pouches; they are frequently, however, developed in the region of the body which follows the branchial pouches.

Echinodermata.

Process resembling Copulation in *Comatula mediterranea*.*—C. F. Jickeli has observed a process in *Comatula mediterranea* which, like that described by H. Ludwig in *Asterina gibbosa*, showed the closest resemblance to a copulation.

Two specimens were found one morning close together in the aquarium with the arms entwined. About twelve hours after the discovery of this condition of things, the two individuals were still united; but on the following morning, or twenty-four hours after the first observation, the union was dissolved. Another still less expected process now commenced. The arms fell off simultaneously with the separation of the pinnules, and broke up into the individual joints. At last only the two oral disks remained. The pinnules, when fished out, were in part filled with semen or covered with adherent ova in the blastula stage, so as to confirm the probable supposition that this entwining of the two individuals might be a process of fertilization. The ova passed through a normal development as far as the pentacrinus stage. The two armless *Comatula* disks continued for some days to live, and were then killed for histological investigation.

This observation seems to support Studer's supposition that (at

* Zool. Anzeig., vii. (1884) pp. 448-9. See Ann. and Mag. Nat. Hist., xiv. (1884) pp. 367-8.

least in many cases) the separation of the arms of many Asterida is connected with the evacuation of the sexual products.

Cœlenterata.

Local Colour-varieties of Scyphomedusæ.*—R. v. Lendenfeld points out that *Crambessa mosaica* in Sydney is brown, whilst in Melbourne it is deep blue. The brown colour is due to cells of parasitic Algæ—*Zooxanthella*, of which the Melbourne specimens never show any trace. In the cold water of Port Phillip it appears not to be advantageous for the Medusæ or the Algæ to live in symbiosis, whilst it would seem to be so in the warm water of Port Jackson. The author calls the Melbourne variety *Crambessa mosaica conservativa*, and the Sydney variety *Crambessa mosaica symbiotica*. He considers the difference between the two to be evidently the same as that between fungi and lichens, and should the variety *symbiotica* adapt itself so wholly to this symbiosis as not to be able to live without the *Zooxanthella* a new species will have been formed, which, as it has not been mentioned by any previous observer, may have been produced within the last forty years.

Cyanea annaskala R. v. L. occurring in the same localities differs in colour and in size in the two places.

The Melbourne specimens never grow beyond 10 cm. in diameter, and possess mouth-arms which are deep purple throughout; whilst those from Sydney are 20 cm., and the purple colour in the mouth-arms is found only at the margin. The author, therefore, distinguishes provisionally two varieties of this species—*Cyanea annaskala purpurea* and *C. annaskala marginata*.

These variations he considers to be due to difference in temperature of the water.

Scyphomedusæ of the Southern Hemisphere.†—R. v. Lendenfeld gives descriptions of all known Scyphomedusæ from the southern hemisphere, adopting Hæckel's classification. Of the 210 known species, 104 have already been found in the southern hemisphere. Only 26 of the 104 southern species are Australian, but this apparent poverty of the Medusæ is due to the limited investigations that have hitherto been made.

In a further paper on "The Geographical Distribution of the Australian Scyphomedusæ," ‡ the distribution at all events of the large Rhizostomes, is shown to be entirely controlled by the ocean currents.

Pseudorhiza haeckelii.§—W. Haacke looks upon this new species, which he found in the Gulf of St. Vincent, South Australia, as the terminal bud of the stem of the Discomedusæ. It belongs to the same genus as the *P. aurosa*, lately described by von Lendenfeld, but as to the exact systematic position of which that naturalist was in some doubt. It is particularly remarkable for the fact that the

* Ann. and Mag. Nat. Hist., xiv. (1884) pp. 409-12.

† Proc. Linn. Soc. N. S. Wales, ix. (1884) pp. 155-69, 242-9, 259-306 (2 pls.).

‡ Ibid., pp. 421-33.

§ Biol. Centralbl., iv. (1884) pp. 291-4.

edges of the grooves of only one of the eight primary arms are fused at their point of bifurcation, and it is the same arm that alone has a nematophore; *P. haeckelii* has, therefore, undergone degeneration, and is, consequently, a form which is phylogenetically younger than *P. aurosa*. The new species differs from all known acraspedote Medusæ in that it cannot be divided either into two congruent or two symmetrical halves. It is further remarkable for being commensal with a fish—*Enoplosus armatus*.

Development of the Versuridæ.*—The family of the Versuridæ, comprising large rhizostomous Medusæ, is comparatively rare in the northern hemisphere, and their development has only recently been described by Claus, who studied the Mediterranean *Cotylorhiza*; † R. v. Lendenfeld, having obtained several young stages of the spotted brown blubber which he has named *Phyllorhiza punctata*, has found its development to differ from anything observed hitherto. The eight marginal bodies (organs of sense) in the principal radii of the first and second order exist in the young larva. But besides these, the larva possesses a greater number of similar marginal bodies, which become less in number with increasing age. First there are 24, then 16, and finally 8. But the umbrella margin retains the power of producing marginal bodies; and if after an injury of the margin new margin-flaps are formed, marginal bodies are also produced between them. The character of the embryonic tissue to form marginal bodies between all flaps, again makes its appearance if a new formation of the umbrella margin takes place.

Flexor Muscle of the Hydroid Polyp of *Sarsia radiata*.‡—R. v. Lendenfeld gives an account *inter alia* of the muscular mechanism by means of which the hydroids of this *Sarsia* (n. sp.) perform their constant flexions, often through nearly 180°, so as to lie along the hydrocaulus. This characteristic bending takes place uniformly at one spot, namely, where the hydranth passes into the hydrocaulus and where the hydrocaulus-perisarc ends obliquely truncated. Sections show a bundle of longitudinal muscle-fibrils, lying peripherally to the supporting lamella. This muscle Dr. von Lendenfeld calls the *flexor*. The fibrils of the muscle proper, which show an irregular radial striation, embrace longitudinal folds of the supporting lamella, and are strictly comparable with those of Siphonophora and of the craspedote Medusæ, as described by the brothers Hertwig.

Hydriform Phase of *Limnocodium Sowerbii*.§—For more than four years the origin of the fresh-water jelly-fish, *Limnocodium Sowerbii*, in the Royal Botanic Gardens, Regent's Park, has been involved in obscurity, and during that time the tank has been cleaned out more than once. Frequent observations revealed no clue to the mystery, though it was of course certain that the contents of the tank must ultimately furnish it.

A more minute search was made by Prof. Lankester and Mr. A. G. Bourne on the occasion of the cleaning of the tank at the end of

* Proc. Linn. Soc. N. S. Wales, ix. (1884) pp. 307-9 (1 pl.).

† See this Journal, iv. (1884) p. 391.

‡ Zool. Anzeig., vii. (1884) pp. 584-91.

§ Nature, xxxi. (1884) p. 107.

last year, and the search was rewarded by Mr. Bourne discovering on some roots of *Pontederia*, imported from South America a few years ago, a minute organism which proved to be hydroid in nature, and obviously a phase in the life-history of the Medusa.

Mr. F. A. Parsons, as noted *infra* ('Proceedings'), found the organism in the previous April, though he was unable to identify it.

Hydroid Zoophytes of the 'Willem Barents' Expedition, 1881.*
—D'Arcy W. Thompson reports on the Hydroids collected during the Arctic voyage of the 'Willem Barents.' The fact that there are no new species is the natural result of the investigations of Sars, Allman, Hincks, and others. Twenty-four species were collected, some of which were hitherto rare. The most prominent and luxuriant are *Sertularia gigantea* and *Lafoëa fruticosa*, the former of which is common in shallow, and the latter in deep water. Most of the species are large and strong in comparison with specimens from further south. Fifteen of the species are common in British seas; two others present well-marked varieties; the rest have a very wide arctic or circumpolar distribution.

Structures liable to Variation in the Astrangiaceæ (Madreporaria).†—S. O. Ridley's object in this paper is to show that whatever may be the value for classification of the corresponding parts in the Turbinoliidæ and Oculinidæ, the columella, costæ, and paliform lobes must be employed with great caution in the study of the Astrangiaceæ. He describes two species of *Phyllangia*, which he regards as "critical"—*P. papuensis* Studer and *P. dispersa* Verrill. In the former he calls special attention to the variability of the central columellar mass from a papillose to a trabecular type, and to the variation in the source of gemmation, viz. from the stolon to the sides of the calyces. In the latter to the variability of the costæ, both as regards actual and relative prominence and to the occurrence in some individual corallites of some teeth on the margins of the largest septa.

Porifera.

Development of *Halisarca lobularis*.‡—W. J. Sollas finds that the segmentation of the ovum of *Halisarca* is very irregular; a segmentation cavity is the exception, not the rule. The morula consists of a large number of small cells imbedded in a structureless blastema. The cells next begin to collect into irregular strings and heaps, forming a rude kind of network. The singular mode of formation of the gastrula is regarded as being due to the absence of a segmentation cavity in the embryo, and may be considered as an "abbreviation" in adaptation to development in a confined space. "The blastula is not formed by the enlargement of a segmentation cavity, since this otherwise empty space can be more advantageously occupied by cells which subsequently became utilized in the formation of the gastrula." The gastrula as well as the blastula stage is slurred over.

The author suggests that the divergencies between his account and that given by Metschnikoff, Barrois, and Schulze are primarily due to

* Bijdr. tot de Dierkunde, Amsterdam, x. (1884) 10 pp. (1 pl.).

† Journ. Linn. Soc. Lond. (Zool.), xvii. (1884) pp. 395-9 (1 pl.).

‡ Quart. Journ. Micr. Sci., xxiv. (1884) pp. 603-21 (1 pl.).

the fact that they had to do with free-swimming larvæ, whilst his specimens were intra-uterine embryos. This difference again appears to be due to the differences between the two localities; in the Mediterranean there are no heavy tides and powerful currents, while in the English Channel, and particularly near Roscoff, the tides are high and the currents rapid, so that the young larvæ would not have the faintest chance of securing a safe settling-place. "The superfœtation thus induced by external conditions," gives us "the key to the anomalous development" which he describes.

With regard to the zoological position of the sponges, Prof. Sollas regards them as homoplastic with, but of independent origin to, the Metazoa, and he illustrates his views by the accompanying diagram:—

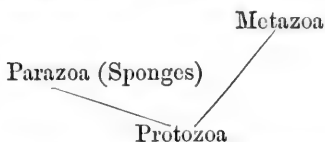

The gastrula of the Parazoa is essentially distinguished from that of the Metazoa by the possession of collared flagellate cells by the hypoblast.

A possible mode of origin of the sponges is suggested; starting from a colony of choano-flagellate Infusoria it is supposed that if some of the individuals became "en-jellied" at a different time to the rest the colony would become differentiated into a set of cytoblastic and a set of flagellate individuals; the *Protospongia haeckeli* of Saville Kent may be a stage in this process. After developing this idea Prof. Sollas suggests that the Chondrosiadae should be removed from the group Myxospongiae, which would then contain only the genus *Halisarca*.

Mode of Digestion in Sponges.*—R. v. Lendenfeld returns to the question whether the digestion of sponges is effected by the ectoderm or endoderm. In an account of the Australian *Aplysinidae* he concluded that the digestive function was centralized in the upper wall of the subdermal cavities, and that, where these are absent, it was effected by the epithelia of the introductory canal system; as this region appeared from Schulze's researches to be of ectodermal origin, Lendenfeld came to the conclusion that sponges absorbed their nourishment by means of the ectoderm.

He now points out that, if Marshall's observations on *Reniera* are correct, the premiss that the lining of the canals is ectodermal is wrong, and that, therefore, his conclusion is wrong also. He directs attention again to his observation that the nourishment is absorbed in the canals and not in the ciliated chambers, as taught by Carter; the intracellular digestion is probably effected by the amœboid wandering cells, while only the epithelial cells have the function of transmitting the nourishing material to them. Von Lendenfeld agrees with Poléjaeff in thinking it not improbable that both ectodermal and

* Proc. Linn. Soc. N. S. Wales, ix. (1884) pp. 434-8.

endodermal layers have a digestive function ; and that in the sponges the germinal layers are indifferent.

Note on Sponges.*—Two species of *Leucandra* (*L. crambessa* and *L. aspera*), supposed by Hæckel to be distinct, are shown by G. C. J. Vosmaer to be merely varieties of the same form, since their anatomy does not show sufficiently constant differences, and there is every transition between the two ; the polymorphosis of *L. aspera* is very remarkable, but may be accounted for by different conditions of life ; these, however, require working out.

Hæckel found in some calcareous sponges the cloacal cavity divided by irregular membranes ; in *L. aspera* these were frequently found by Vosmaer ; the canals and lacunæ formed by the anastomosis of these septa are quite different of course from the large excurrent canals, since they are remains of the primitive cloacal cavity, while the latter are developed as outgrowths from it.

The relationship between the Renieridæ and the Ceraosponges is undoubtedly a very close one, and v. Lendenfeld has stated that these Monactinellids probably have arisen directly from the Ceraospongiæ. It may, however, be the case that the Ceraospongiæ have originated from the Monactinellids, and the following facts seem to favour this supposition. In the oldest sponges, the Hexactinellids, there is no trace of spongin in recent or in fossil forms, and therefore it may be assumed that the cells which produce spicules are of an older form than those which produce spongin, and it follows that the Ceraospongiæ are younger than the Monactinellids, though this is not known on palæontological grounds. In the second place, the canal system of the Monactinellids is less complicated than that of the Ceraospongiæ. It appears, however, that there is spongin in *Reniera*, and that therefore some mesoderm cells of siliceous sponges gradually change into real spongioblasts, and that thus through certain qualities of the sea water or other causes true horn sponges have been formed.

Modification in the form of Sponge Spicules.†—E. Potts describes a singular modification in the spicules of *Meyenia Leidyi* found incrusting old pipes from water-works at Philadelphia, some portions of which were so deeply coloured with rust that the statoblasts seemed to be mere pseudomorphs in iron oxide. Fragments were boiled in nitric acid and compared with similarly treated portions which were free from discoloration.

The mature normal skeleton spicule of the latter is smooth, robust, shorter than that of any other American species, and the fine line of the axial channel very rarely visible ; but in the former, whilst the size and exterior appearance of the spiculæ remain the same, the axial channel has become a wide canal, open at both ends, and occupying more than one-half the breadth of the spicule. The birotulate spicules, usually short and of a peculiarly substantial appearance, with entire reflexed margins, can with difficulty be detected as mere ghosts of their normal shapes. The two disks rarely remain

* MT. Zool. Stat. Neapel, v. (1884) pp. 483-93 (2 pls.).

† Proc. Acad. Nat. Sci. Philad., 1884, pp. 184-5 (1 pl.).

together; their characteristic entire margins are gone, the rotules being represented merely by a line of very fine rays.

Australian Sponges.*—R. v. Lendenfeld's monograph of the Australian sponges is founded upon specimens collected by the author, and those belonging to the museums of Christchurch and Dunedin, New Zealand, and of Adelaide, South Australia. The paper is preceded by a summary of our knowledge of the sponges (with 178 bibliographical references) divided into four periods, the first from Aristotle to Belon, 350 B.C. to 1553 A.D., the second from Belon to Grant, 1553 to 1826, the third from Grant to F. E. Schulze, 1826 to 1875, and the fourth from Schulze to the present day.

This is followed by a general outline of the anatomy, minute structure, embryology, and physiology of the sponges, with remarks on their systematic position and classification. The author's classification differs somewhat from that of recent authors, and is arranged so as to suit the Australian as well as the European species. The sponges are considered as Metazoa, forming a class of the Cœlenterata, and divided into six orders:—(1) Calcispongiæ (calcareous skeleton); (2) Myxospongiæ (no skeleton or with only few and scattered siliceous bodies); (3) Ceraspongiæ (skeleton composed of horny fibre, which may contain foreign bodies, but never proper spicules. Siliceous bodies rarely developed as small scattered spicules in the ground substance); (4) Monacticeræ (skeleton composed of anastomosing horny fibres within which there are monoaxial spicules. Sometimes with flesh-spicules); (5) Hyalospongiæ (skeleton composed of siliceous spicules which have originally been formed as flesh-spicules and afterwards may coalesce to form hard skeletons); (6) Monactihyalæ (with a skeleton composed of biacerate or truncate spicules which may coalesce slightly, and which have originally been formed as flesh-spicules).

Wide Distribution of some American Sponges.†—E. Potts refers to the wide distribution of some North American fresh-water sponges, more especially *Spongilla fragilis*, which may be regarded as ranging throughout the American Continent; it has also quite recently been found in Russia. Amongst a number of specimens from Nova Scotia the author met with *Meyenia Everetti*, Mills, this being only the second instance in which the species has been discovered. In this specimen the birotulate spicules average one-third longer than those before examined, and are in every way more robust; thus confirming a rule long since observed by the author, that spicules of all species increase regularly in size and solidity as we descend from high altitudes towards the sea-level, where is found the extreme limit of the series. He does not attribute this gradation to a change of climatic conditions, but more probably to a gradual and constant improvement in the food supply or in the siliceous constituents of the water. The author instances species in which the working of this rule has been observed.

* Proc. Linn. Soc. N. S. Wales, ix. (1884) pp. 121-54, 310-44. See also the remarks on the author's paper on the Australian Monactinellida, this Journal, iv. (1884) p. 394.

† Proc. Acad. Nat. Sci. Philad., 1884, pp. 215-7.

Protozoa.

Erythropis agilis, a New Protozoon.*—R. Hertwig gives an account of a Protozoon remarkable for the high degree of its organization, and by the undoubted possession of a pigment-spot, which he cannot refuse to regard as an eye. He was unfortunately unable to find more than a single specimen, which he found when studying the development of the eggs of Echinoids. Its external appearance is that of an *Appendicularia*, for it has a longish rounded body which is continued into a very contractile tail-like process.

Like that of the Infusoria, the body of *Erythropis* is asymmetrical, and an anterior can be distinguished from a posterior, a right from a left, and a dorsal from a ventral surface. Ventrally there is a deep groove, which is deepest about the middle of the body, and becomes shallower towards either end. To the left of it is a pigment-spot, to the right a sporophor, and at its base the pigment-spiral. Anteriorly it is overlaid by the opercular apparatus, and from its hinder end there arises the caudal appendage.

The greater part of the body consists of solid protoplasm, altogether free of vacuoles, and having a number of coarser and finer granules scattered in it; among these there are many intensely coloured reddish-brown pigment-granules, a rod-like structure resembling bacteria and of a high refractive power. The structureless cuticle has a double contour. The eye of the observer is sure to be most attracted by the pigment-spot, in the centre of which there is a spherical body which calls to mind an otolith or even a lens; which latter name, indeed, Hertwig applies to it. During life it appeared to be completely homogeneous and highly refractive. The sporophor has its investing cuticle well developed and marked by fine ridges. Near it is a spiral filament about which Hertwig doubted whether it was a simple cuticular structure, or whether it was contractile.

The nucleus, which was coloured intensely red by picro-carmin, was seen to have the peripheral parts of its framework continued into a layer of fine and homogeneous granules. The cylindrical tail was, when most extended, three or four times as long as the body, and, when contracted, twice as long; its substance was homogeneous, highly refractive, and called to mind the stalk-muscle of the Vorticellidæ; it is a very powerful locomotor organ and enables its possessor to move rapidly through the water; it had no contained spiral.

Taking into consideration the high organization of *Erythropis* we cannot wonder at Hertwig's doubts as to whether it really does belong to the Protozoa; a positive proof is afforded by the presence of a single large nucleus, and by its reactions, and a negative one by the complete absence of any other nuclei, the presence of which would, on account of the transparency of the protoplasm, have hardly escaped a careful search.

The pigment-spot must not only be supposed to be an eye, but also to have nearly the same optical power as the ocelli of many

* Morph. Jahrb., x. (1884) pp. 204-13 (1 pl.).

Medusæ and worms; the fact that the spot is sharply separated off from the surrounding protoplasm speaks to its high grade of development. It would be very interesting to test this creature in its relation to the influence of light. The opercular apparatus and the spiral are probably connected with the ingestion of food, while the spores seem to have the duty of storing up the prey. Hertwig is inclined to associate this remarkable Protozoon with the Vorticellidæ. [Since the above was in type C. Vogt writes * that Hertwig's Protozoon is a Vorticellid torn from its attachment and killed just as it was about to swallow the marginal body of a dead Medusa!]

New Vorticellid.†—D. S. Kellicott describes and figures a new and unusual infusorian of the family Vorticellidæ, found near Buffalo, to which he gives the name of *Epistylis ophidioides* n. sp. It occurs in colonies comprising two very distinct types of zooids, one long, slender, snake-like, 1/45 to 1/37 in. in length; the other shorter and stouter, 1/90 to 1/60 in. in length, and trumpet shaped, while both possess peristomes, reminding one of the open mouth of an ophidian. The elongate, specialized or reproductive zooid is found in about the proportion of one to twenty of the ordinary type. The long, slender, brown pedicle is dichotomously and profusely branched; its surface finely striate lengthwise and articulate. The height of the largest dendroecia equals 1/6 in. The author discusses its relation to other forms and thinks it should be compared with *Epistylis galea*.

Chlorophylloid Granules of Vorticella.‡—J. A. Ryder takes exception to the conclusions of Prof. Engelmann on this subject.§

The author describes and figures a specimen of *Vorticella chlorostigma*, in which the green matter is not "diffuse," as stated by Engelmann in regard to the species studied by him, but is restricted with great regularity to individual granules, as in plants, and these form an exceedingly well-defined one-layered stratum, which is restricted to the ectoplasm alone.

It is true that there are certain Infusorians in which a bottle-green tint is diffused and not confined to distinct grains, as for instance, in *Stentor Mülleri* and *Freia producta*, but in *S. polymorphus* and the green species of *Ophrydium* the colour is confined to distinct granules, as in the species of *Vorticella* figured. The uncoloured species of *Ophrydium* (*O. adæ* Everts) does not differ much in other respects from its congeners, but the colourless *Stentor Röseli* does differ considerably in form and details of habit from its allies. These are facts which, it seems to the author, are almost fatal to the theory of the existence of green parasitic vegetable forms in Infusorians, the only facts favourable to the idea that the green colour is due to algal parasites, being those noted of *Ophrydium*, a genus which affords an instance of green and colourless forms, differing otherwise but slightly. In fact, individual zooids of *Ophrydium* are sometimes met with which are only partly green, or have only one-half the body coloured,

* Zool. Anzeig., viii. (1885) p. 53.

† The Microscope, iv. (1884) pp. 248-53 (2 figs.).

‡ Proc. U. S. National Museum, vii. (1884) pp. 9-12 (1 fig.).

§ See this Journal, iii. (1883) p. 860.

while alongside of them in the same colony individuals are found which are wholly green. Then, again, how are the so-called red and dark-coloured *Stentors* to be disposed of, both of which have been detected in the United States? For these, indeed, it may be claimed that degenerating chlorophyll would be capable of producing the red colour of the first, and that feeding on very dark coloured algæ might develop the latter. In spite of all this, however, there remains a residuum of facts which cannot be disposed of on any theory of symbiosis or parasitism, and this is especially the case with those forms which, as in *Stentor*, show three distinct types of coloration, viz. the diffuse bottle-green, that caused by coloured green granules, and the colourless; all of these differences at the same time being indicative, together with other features, of very distinct species.

As to the aggregation and development of Bacteria about living Infusorians, this the author noticed in a colourless marine species, *Zoothamnium alternans*, and the same fact has been observed by Stein. Both Stein and he have noticed bacilli mostly in this relation to other living colourless Infusorians, but in the case of dead and colourless Infusorians the remains of the animals are usually attacked at one side and gradually invaded by bacilli and micrococci, and altogether independently of any peculiarly local oxygen-yielding source in the vicinity.

“If there exist green *Vorticelle* which have the green colouring matter arranged diffusely in the ectoplasm in one species, and in another confined to distinct granules as observed in the species described, it is fair to presume that, as in the cases of the three species of *Stentor*, we also have here to do with two very distinct species of bell-animalcules. It is also fair to assume that if the different species present their colouring matters in diverse conditions and modes of arrangement such matters may have correspondingly different functions, and that it does not necessarily follow that the green granules even are a sure indication of the presence of true chlorophyll, though it may simulate that of the plant in its relation to the stratum of plasma covering the cell-wall. Why not suppose that some of these colouring matters of Infusorians have a function similar to hæmoglobin? It would, however, be much easier to suppose that the quasi-chlorophyll grains of *V. chlorostigma* were truly of the nature of chlorophyll than to assume as much regarding the diffuse green colour as observed in the ectoplasm of a supposed variety or closely affiliated species of *V. campanula*, as has been done by Engelmann.”

New Ciliated Infusorian.*—L. F. Henneguy describes, under the name of *Ascobius lentus*, a new genus of infusorians which lives fixed at the base of a chitinous sheath; the animal has the form of a *Bursaria*, belongs to the group of the Heterotricha, and in its mode of life resembles *Freia*, from which, however, it differs owing to the absence of membranous lobes to the lateral parts of the peristome. The specific name refers to the remarkably slow movement of its cilia. It is of fresh-water habitat; and the author found it in the Jardin des Plantes at Montpellier.

* Arch. Zool. Expér. et Gén., ii. (1884) pp. 412-5 (1 pl. not published yet).

New Fresh-water Infusoria.—A. C. Stokes has * changed the generic name *Solenotus*, given by him to a new genus of Infusoria, † to *Notosolenus*, the former name being preoccupied.

Infusoria of the Gulf of Naples. ‡—The Infusoria of the Gulf of Naples are treated of by G. Entz, in an elaborate memoir illustrated by a great number of plates. A list of seventy-one species found in the gulf is given at the commencement of the paper, which contains more or less full descriptions of about one-half of these. The paper concludes with some interesting remarks on the distribution of marine Infusoria, and the results to which the author has been led may be stated as follows:—

1. The infusorian fauna of the sea is strikingly different from that of fresh water; the two faunas have only a few species in common.

2. A considerable number of marine Infusoria are also found in salt land lakes.

3. The infusorian fauna of different seas is not more strikingly different than that of fresh waters of different regions.

This last conclusion differs considerably from that of Mereschkowsky, who stated that, while the fresh-water Infusoria presented but little diversity from whatever region they came, there was a noticeable difference in the case of the marine forms.

The number of new species described is sixteen, and of these, three form the types of as many new genera—*Stephanopogon colpoda*, *Rhabdodon falcatus*, and *Onychodactylus acrobates*.

S. colpoda is one of the most interesting types of the Ciliata; it has the form of a somewhat flattened flask with longitudinal bands which run in a slightly diagonal direction; along these bands the cilia are developed; a portion of the body, partly dorsal and partly ventral, is without the bands, and the animal cannot therefore be definitely classed with the Holotricha or the Hypotricha; at the truncated extremity round the mouth is a circlet of pointed cilium-like processes united at their bases; these are capable of movement; the neck has upon one side a series (four or eight) of hyaline groove-like structures which appear to be a special development of the hyaline ground-substance. There are two contractile vacuoles; the nucleus is horseshoe-shaped, and lies on the right-hand side of the body; occasionally the nucleus is spherical, with a crenated margin; this condition may be preparatory to fission. The genus belongs to the family Colepina.

R. falcatus may possibly be the same as Dujardin's *Loxodes marinus*; the form of the body is not fixed, but may be longer or shorter according to the state of contraction; the œsophageal tube has the appearance of being composed of sixteen rod-like bodies, and the mouth therefore appears as an oval aperture surrounded by a radiately striated ring; there is an anal aperture opening in common with the contractile vacuole. The nucleus is oval or spindle-shaped.

* Amer. Journ. Sci., xxviii. (1884) p. 158.

† See this Journal, iv. (1884) p. 907.

‡ MT. Zool. Stat. Neapel, v. (1884) pp. 289-444 (6 pls.).

O. acrobates is one of the commonest and at the same time one of the most interesting of the Infusoria to be met with in the Bay of Naples. The dorsal surface of the body is covered by a complete cuirass formed of prismatic rods closely applied to each other; the cuticle of the ventral surface is traversed by longitudinal grooves which bear the cilia. At the hinder end of the body is a strong structureless process which can be retracted; the mouth aperture is slit-like and bent, its sides are strengthened by a circle of rod-like bodies.

These species, as well as a large number of others, are described in great detail.

New Infusorian Parasite.*—C. Kerbert gives the name of *Chromatophagus parasiticus* to a protozoon which appears to be the cause of the small white spots which, in the spring of 1884, appeared to be endemic among the fishes in the fresh-water aquarium of the Zoological Gardens at Amsterdam. The infusorian was distinguished by its remarkable size, having a long diameter of 0·615 mm. and a breadth of 0·408 mm.; the body-wall consists of a thin delicate cuticle, regularly covered by very fine cilia; there are a large number of contractile vacuoles of very various dimensions; trichocysts were not to be detected. The nucleus was horseshoe-shaped. The pigment-granules were grouped into masses of various sizes; the mouth was lateral in position and there was a well-developed pharynx; there is no anus, and the fæces were seen to escape from various points of the body. Reproduction is effected, not by fission, but, after separation from the epidermis of the fish on which they are parasitic, and after a certain amount of free life, by a process of encystation which is succeeded by division; this always goes on in the dark. The process of division within the cyst takes about five hours; when it is completed the young forms make their way to some fish and on its epidermis complete their development. The parasite appears to belong to the family of the Trachelocercidæ of Saville Kent, and, if Kerbert's conclusions are correct, that author's family of Ichthyophthiridæ must be eliminated from our list.

New Parasitic Infusoria.†—A. C. Stokes describes some new parasitic Infusoria. *Opalina flava* n. sp., so called on account of its colour, inhabits the rectum of the spade-foot hermit toad (*Scaphiopus holbrookii*). The colour, which appears to be a stain and not an aggregation of particles, is collected in a layer near the cuticular surface, with a quite sharply defined line of demarcation between the lower margin and the internal body-sarcode. Its numbers are not great, neither is it always to be found. Compared with its more numerous associates, this yellow creature is a giant among pygmies. Its length is from 1/330 to 1/350 in.

Associated with the foregoing amongst a throng of *Bacteria*, *Bacilli*, &c., was found a flagellate infusorian:—*Evechlyga acuminata* n. gen. et sp. is more or less ovoid in form, with a somewhat pointed

* Nederl. Tijdschr. Dierk. Amsterdam, v. (1884) pp. 44–57 (1 pl.).

† Amer. Naturalist, xviii. (1884) pp. 1081–6 (4 figs.).

anterior extremity, which is furnished with three vibratile flagella. A narrow, rapidly undulating membrane extends along the entire length of one lateral border. From the terminal margin of this membrane a long thread-like filament springs, and follows the undulations of the tissue to which it is attached.

Chilodon megalotroche n. sp. is an ectoparasite of the social rotifer *Megalotrocha*.

Flagellate Infusorian parasitic on Trout.*—L. F. Henneguy describes in detail a new ectoparasitic flagellate infusorian which has been the cause of disease among young trout; it has now been seen for two seasons, but it has been found that there is a decrease in mortality when the young trout are placed in an aquarium through which a rapid current of water passes. The essential points in the structure of *Bodo necator* have been already noted.†

New Rhizopod.‡—J. Künstler describes a new form found in some *Ophelia* at Arcachon. It is somewhat elongated, pointed at either end, and has on each side pseudopodia of some length. In its middle there is a dark axial rod, which is intensely coloured by methylene-green; this rod is formed of a stratified substance, and is bifid or multifid at its extremities; its surface is often spotted with small knobs, which elongate, and becoming gemmiform detach themselves from the rod and pass into the peripheral protoplasm. Here each corpuscle becomes surrounded by a special protoplasmic layer.

The rest of the body has the form of a flattened protoplasmic lamella, divided into a central denser region, and a peripheral which is greatly vacuolated, so as to recall the substance of the body of certain Radiolaria. The pseudopodia, though apparently rigid, are capable of contracting and becoming pyriform in shape. Though they resemble those of the Radiolaria in their rigidity and rectilinear direction, they are distinguished from them by their thickness, structure, and localization at the sides of the body. The fluid within contains small rounded bodies with a central corpuscle; these take on the form of the adult, and appear to be derived from the gemmæ formed on the central rod.

Ophryocystis bütschlii. §—To our notice of A. Schneider's preliminary communication || on this subject, we may add some remarks drawn from the fuller memoir now published. *Ophryocystis* differs remarkably from other Sporozoa in that the amœbiform stage presents us with "un luxe de prolongements" and a facies altogether different to that of any known Sporozoon. The possession of a large number of nuclei in these amœboid forms has its analogue in certain Amœbina, and distantly in the Myxosporidia. Conjugation of two always uninuclear individuals has been observed, but conjugation is not known among the Coccidia, and this peculiarity allies *Ophryocystis* to the most differentiated Gregarines. The mode of sporulation allies

* Arch. Zool. Expér. et Gén., ii. (1884) pp. 403-11.

† See this Journal, iii. (1883) p. 379.

‡ Comptes Rendus, xcix. (1884) pp. 337-8.

§ Arch. Zool. Expér. et Gén., ii. (1884) pp. 111-26 (1 pl.).

|| See this Journal, iii. (1883) p. 522.

them, possibly, to the Myxosporidia, while, on the other hand, the production of falciform bodies or sporozoites in the spores is the exact opposite of what takes place in the Myxosporids. The author proposes to form for the genus a new order of *Amœbosporidia*, feeling that the process of conjugation and the mode of sporulation separate them from the Coccidia, as do the pseudopodia and the sporulation from the Gregarinidæ, and the falciform corpuscles from the Myxosporidia.

BOTANY.

A. GENERAL, including the Anatomy and Physiology of the Phanerogamia.

α. Anatomy.*

Connection of Protoplasts and Intercellular Protoplasm.†—
J. Schaarschmidt has made a series of observations on this subject, making as little use of reagents as possible, endeavouring to bring out the connecting threads by staining alone, in which he was successful with *Viscum album* and *Loranthus europæus*. A transverse section of the stem coloured with eosin shows the threads only in the pith, almost entirely inclosed by the cell-wall, and only very faintly visible as fine red streaks. The protoplasm which fills up the lumen of the pits sends six or eight delicate threads through the closing membrane. The investigations were made chiefly on prosenchymatous tissue.

In the epidermis the connection was beautifully shown in the leaves of *Glaucium Fischeri*, also in *Viscum* and *Loranthus*, especially where the radial walls of the cells are strongly pitted. The connecting threads are visible after only slight swelling, and the continuity of the protoplasts can be determined through the entire epidermis. When the epidermis consists of several layers, as in *Ficus elastica*, the continuity can be determined only by excessively careful treatment, in consequence of the great thinness of the protoplasm. In collenchymatous hypoderma, on the other hand, as in *Sambucus*, *Rhus*, *Cucurbita*, *Solanum*, *Liriodendron*, &c., even very slight swelling brings it out clearly, the swelling of the cell-walls exercising great compression on the protoplasts.

The cortical parenchyma is the tissue in which the connection is most readily demonstrated, after, or sometimes even without swelling, as in *Viscum*. When there is no hypoderma the epidermal cells are in direct communication with those of the cortex.

In the parenchyma of the leaf the connection can be shown in *Viscum* and *Loranthus*, and very beautifully in the cotyledons of *Phaseolus multiflorus*.

* This subdivision contains (1) Cell-structure and Protoplasm (including the Nucleus and Cell-division); (2) Other Cell-contents (including the Cell-sap and Chlorophyll); (3) Secretions; (4) Structure of Tissues; and (5) Structure of Organs.

† Magy. Növényt. Lapok, viii. (1884) pp. 65-79 (3 pls.). See Bot. Centralbl., xix. (1884) p. 265. See this Journal, iii. (1883) pp. 225, 524, 677; iv. (1884) pp. 76, 404, 405, 763. See also 'Nature,' xxxi. (1885) pp. 290-2.

In the parenchyma of the pith the most beautiful examples are furnished by the Loranthaceæ. In the Coniferæ it can only be shown in young twigs, as in *Salisburia*; while in *Abies alba* a connection among the cells of the medullary rays, between these and the bast-parenchyma, and in the sclerenchymatous cells which bound the xylem, can be directly made out. In the bast-fibres the connection is more difficult to determine; it occurs in *Viscum* and in *Coniferæ*. In the elements of the soft bast it is particularly well marked, especially in the sieve-vessels.

In the cambium it is very difficult to determine, and the author has at present made it out only in the Coniferæ.

The connection of the elements of the xylem can be detected especially in the Loranthaceæ; in Coniferæ it has been observed in the tracheids of *Salisburia*. In the wood-vessels none has yet been observed.

Secreting cells invariably manifest continuity: for example, the resin-passages in Coniferæ; and the same is true of the protoplasmic envelope of clusters of crystals.

Intercellular protoplasm is always in connection with the cell-protoplasm, and was found by the author not only in collenchymatous and parenchymatous tissues, but also in typical prosenchyma. It may even contain chlorophyll, and intercellular spaces may develop into true cells; it always occurs between the cells of parenchyma rich in protoplasm, but not between thin-walled cells containing but little protoplasm. It often occurs as a layer between the cell-walls of adjacent cells, and forms, in fact, a mantle surrounding the cells, and passing into the intercellular spaces. Good examples of the development of these intercellular spaces into cells, which takes place with very great rapidity, occur in the collenchymatous cortex of *Ficus elastica*, and in the xylem, between the wood-cells and the vessels, of *Rhus cotinus*. The formation of new cells in this way is of very great importance in the vegetable economy, and gives rise to fresh development of intercellular spaces.

The author suggests that the origin of this intercellular protoplasm may be that particles of cytoplasm become inclosed within the young cell-wall, which still remain in connection with the protoplasts; and that a layer of protoplasm which is found between the layers of adjacent cells may be the remains of the cell-plate.

Intercellular Relations of Protoplasts.*—W. Hillhouse gives a very useful epitome of the observations at present made on this subject, including his own researches. The paper contains a minute account of the structure and development of sieve-tubes and sieve-plates.

Plasmolysis.†—H. de Vries points out the importance of plasmolysis, or the separation of the living protoplasm from the cell-wall by desiccating solutions, in the study of physiological phenomena. He

* Midland Naturalist, vii. (1884) pp. 61-6, 101-5, 121-6 (1 pl.).

† Bot. Ztg., xlii. (1884) pp. 289-98.

has found that many protoplasts, when brought into contact with such solutions, lose their vitality slowly, and that it is often very difficult to decide at once whether they are still living or have undergone more or less change; the change from life to death may proceed very slowly, extending over hours, or even days. The processes described below can be followed with remarkable ease in the violet epidermal cells of the under side of the leaf of *Tradescantia discolor*.

If preparations of this object are left for some days in a neutral weak plasmolytic solution of sodium chloride, or for a few hours in a similar solution with addition of any poison, the following changes are ordinarily observed. When the magnifying power is low, the entire preparation appears to be still in a living and healthy condition, the cell-sap retaining its colour in its original intensity. But with stronger powers it is seen that the coloured cell-sap is surrounded only by a thin layer of living protoplasm, while the outer protoplasm, as well as the parietal layer and nucleus, are dead, and adhere, as it were, in tatters to the inner layer, which is hyaline and strongly refractive, and does not allow the colouring matter to pass through it, even for some days. The outer protoplasm and nucleus appear coagulated, opaque, and usually darkly coloured. This inner layer of protoplasm acts like a living protoplast, contracting and again expanding under different conditions; it is obviously the wall of the vacuole, which must be regarded as a special organ of the protoplasm. In the cells of *Spirogyra* it may often be completely isolated after the parietal layer, nucleus, and chlorophyll-bands are dead; in a weak plasmolytic solution it appears a tense hyaline, more or less globular vesicle with smooth surface in one half of the cell, while the rest of the protoplasm has collected into an amorphous lump in another corner. The greater resistance of this vacuole-layer against injurious agencies depends on its greater density and less permeability for soluble substances, as compared with the rest of the protoplasm, and especially with the parietal layer.

The ordinary test for distinguishing between living and dead protoplasm is the impermeability of the former to all coloured solutions; but De Vries finds that the protoplasm, in passing from one condition to the other, goes through various stages, in which it is permeable to some, but impermeable to other substances. Thus, for example, acids, and easily diffusible salts, such as sodium chloride and potassium nitrate, pass into the protoplasm more quickly and easily than more sluggish salts like magnesium sulphate or than sugar; while pigments, as a rule, would come in only in the last stages. The author details a variety of observations on protoplasm in the intermediate stage, when it is permeable for acids, but not for sugar or pigments.

De Vries gives the following rules, which should be observed in plasmolytic experiments:—

1. The degree of plasmolysis can only be determined during the healthy, completely normal condition of the protoplasm.

2. The preparations should remain in the solutions no longer than is absolutely necessary for the experiments.

3. The solutions must be completely neutral, and not poisonous. Want of attention to this rule is a constant source of error.

4. In doubtful cases the special characteristics of abnormal plasmolysis should always be observed.

Division of the Nucleus.*—W. Flemming gives in the 'Botanische Zeitung' an exceedingly useful *résumé* of the most recent contributions of Strasburger † and Heuser ‡ to the literature of this subject, pointing out the extent to which agreement has now been attained by various observers, and the points in which they still differ, and which still remain open to doubt. Flemming considers that one very valuable result of these publications is that the controversy with regard to indirect division of the nucleus has now ceased.

Structure, Vital Phenomena, and Reactions of the Cell. §—C. Frommann describes the phenomena observed in a number of different vegetable cells, and the changes which take place under the influence of various physical and chemical agencies.

The terminal cells of the glandular hairs of *Pelargonium zonale* are filled with white or yellowish homogeneous granules, varying in size and form, imbedded in a granular fluid which is usually traversed by a larger or smaller number of threads; these are sometimes accompanied by rod-like structures of various forms, not unfrequently combined together into nets. The nucleus is homogeneous or finely granular, sometimes invested by a delicate envelope, and containing a nucleolus-like structure which the author calls the "granule." The nucleus is frequently furnished with angular projections consisting of a similar substance, which often pass through the surrounding protoplasm to the neighbourhood of the cell-wall. In many cells the nucleus appeared to be altogether wanting.

The changes are then described which take place in these cells by the action of a 1–2 per cent. solution of sugar, under which the motion of the protoplasm continues for from one to three hours. These consist essentially in the change of form, size, and refrangibility of the granules, in the formation of vacuoles, the commencement of constriction and division, the breaking up into smaller granules, and their coalescence into larger structures. Induction-currents bring about similar changes more rapidly.

In the epidermal cells of the flower of *Coreopsis bicolor* two kinds of granule were observed, pale yellow and dark yellow, which the author believes to be simply pigments in various stages of disorganization.

The cells of the epidermis and mesophyll of *Sansevieria carnea* contain two kinds of nucleus, one refringent and of coarser structure, the other paler and more delicate, though one of these kinds often passes into the other. The internal structure of these nuclei is described as exceedingly complicated.

Very complicated is also the structure of the chlorophyll-bodies,

* Bot. Ztg., xlii. (1884) pp. 298–304.

† See this Journal, iii. (1883) p. 227.

‡ Ibid., iv. (1884) p. 407.

§ Jenaisch. Zeitschr. f. Naturw., xvii. (1884) (3 pls.). See Bot. Centralbl. xix. (1884) p. 68.

of which the author again distinguishes two kinds, smaller with sharper outline, and larger with less definite contour.

The portion of the protoplasm outside the nucleus may be classified under the following heads:—(1) Reticulate lamellæ and thicker reticulate layers with larger and smaller meshes. (2) Chiefly round the pale nuclei, especially those of epidermal cells, are pale, not sharply defined, round or fusiform structures, such as pale strings and threads, very commonly connected with the periphery of the nucleus, and frequently again inclosing larger or smaller granules. (3) In the epidermal cells are thinner or thicker layers of relatively coarse refringent fibrillæ, sometimes interwoven, sometimes running parallel to one another. (4) In some epidermal cells are also layers or flakes of a pale finely granular or striated substance.

Induction-currents act slowly on the refringent nuclei, very rapidly on the pale, not homogeneous, nuclei, changing them into the former kind. The chlorophyll-grains are also affected, with the exception of the larger less sharply defined ones. Great changes are also brought about in the protoplasm outside the nucleus. Alcohol and chromic acid also cause certain changes, which should be borne in mind when these agents are used as hardening materials.

The author finally describes certain slow vermiform movements which he observed in the protoplasmic threads and strings in the tentacles of *Drosera* and in the stinging-hairs of *Urtica*, which are somewhat more rapid in the threads which are separate or united into wide-meshed nets. This motion consisted sometimes of oscillations with clearly distinguishable bendings in and out, sometimes of a trembling motion, with scarcely perceptible bendings. The dancing motion of the granules he believes to be due to the same cause as the oscillations of the threads, viz. rapid changes in the molecular framework.

Cystoliths of Cucurbitacæ.*—O. Penzig describes the cystoliths which he has observed in the leaves and bracts of *Momordica echinata* and *M. charantia*, while they are absent from the stem, tendrils, and flower. In *M. echinata* they are found chiefly in greatly enlarged epidermal cells in the under side of the leaf, fixed to a lateral wall; not, as in the corresponding cells of *Ficus*, to the outer wall. Although the cystoliths are commonly found in adjoining cells formed by division of a mother-cell, they do not unite. In *M. charantia* numerous epidermal cells occur with cystoliths united into groups, radiating from a common centre of the group.

Chlorophyll.†—A. Hansen adopts the following method for obtaining chlorophyll-green, using for preference young plants of wheat. After boiling in water for half an hour, and drying, the material is extracted in the dark with 96 per cent. alcohol, the extract evaporated to one-eighth its volume, saponified with soda at the boiling temperature, the ley diluted with water and treated with sodium chloride. The green soap is then heated, first with petroleum-ether, next with pure ether; the former of which dissolves out the

* Arch. Ital. Biol., iii. (1884) 1 pl. See Bot. Ztg., xlii. (1884) p. 334.

† Arbeit. Bot. Inst. Würzburg, iii. (1884) pp. 123-43.

xanthophyll, Hansen's chlorophyll-yellow. The soap, deprived of this yellow pigment, is now extracted with alcohol-ether, and the pigment thus extracted, not yet quite pure, purified and crystallized by repeated solution in alcohol-ether. It crystallizes in sphero-crystals. The composition of this substance, resulting from two analyses, was as follows:—C 67·26–67·94, H 10·63–10·36, O 16·97–16·12, N 5·12–5·55 per cent.

Chlorophyll-green, as Hansen calls the substance thus obtained, is a black-green powder, easily soluble in dilute alcohol and water, moderately easily in alcohol-ether, chloroform, and fixed oils; with difficulty in pure ether, absolute alcohol and acetic ether; insoluble in petroleum-ether and bisulphide of carbon. It dissolves in concentrated sulphuric acid with a green colour; concentrated hydrochloric acid produces a green substance insoluble in ether; nitric acid dissolves it with a light red colour; nascent hydrogen bleaches its solution; solution of silver is energetically reduced by it. The aqueous solution of chlorophyll-green is very susceptible to light, as also is that in chloroform; a solution in ether is more persistent, one in alcohol still more so. The spectrum of a solution shows the four bands of the alcoholic extract of chlorophyll, but somewhat displaced towards the blue end of the spectrum.

The chlorophyll-yellow, which is separated from chlorophyll-green by petroleum-ether, crystallizes in dark yellow needles. The solutions are not fluorescent; the absorption spectrum has only three bands in the blue half, none in the red. It is soluble in alcohol-ether, petroleum-ether, and chloroform. The quantity of chlorophyll-yellow present in green leaves, as compared with that of chlorophyll-green, is only about 1 per cent.

Fluorescence of Chlorophyll in Leaves.*—J. Reinke corrects his previous statement that the chlorophyll of living leaves does not fluoresce. In the thick leaves of *Ficus elastica* he finds a certain amount of fluorescence, though very feeble compared to that of an alcoholic solution of chlorophyll.

Morphology of Chlorophyll-grains.†—A. Tschirch repeats evidence in favour of his view—as opposed to that of F. Schmitz—that every grain of chlorophyll is surrounded by its own membrane of protoplasm, the colouring matter of two different grains never actually being in contact. He also reaffirms the statement that every grain of chlorophyll is composed of a colourless matrix or framework, the spaces between the meshes of this being filled up by the colouring substance.

Formation of Gum in Wood.‡—B. Frank has examined the mode of formation and the physiological significance of gum in a number of exogenous trees, mostly belonging to the Leguminosæ and Amygdalæ. It is the universal product of special conditions, and

* Ber. Deutsch. Bot. Gesell., ii. (1884) pp. 265–8.

† Gesell. Naturf. Freunde Berlin, May 20, 1884. See Bot. Centralbl., xix. (1884) p. 254. Cf. this Journal, iii. (1883) p. 688; iv. (1884) p. 920.

‡ Ber. Deutsch. Bot. Gesell., ii. (1884) pp. 321–32.

can always be induced by the production of these conditions; as, for example, in the *Amygdaleæ* by the wounding of any part of the stem, and the process of gummosis can then be followed step by step. In the bird-cherry *Prunus avium*, this was found to be uniform at all periods of the year, though the process was slower in the autumn. The red colouring of the wood, which is always an indication of gummosis, has its seat chiefly in the medullary rays. The brown colour is due to the presence in the cells of gum in the form of small granules, which are found especially on the cell-wall, or surrounding the starch-grains, from which they partly result from metamorphosis, partly also being a new formation. After four or five weeks, the cells of the medullary rays are nearly filled with gum, and its formation commences in the cavities of the vessels and wood-cells; these also now assuming a more or less yellow or red colour. This is frequently accompanied by the formation of thyllæ, which also help to fill up the vessels. The purpose of this internal formation of gum, which is analogous to the formation of resin in the *Coniferæ*, is to form airtight plugs to the vessels. The dark colour of the duramen in many trees is due to similar causes.

A. Meyer * points out that a closing of open tracheids by plugs of a peculiar substance takes place also in the fleshy rhizomes of some monocotyledonous plants, e. g. *Veratrum album*. He doubts, however, whether, in either instance, this substance formed within the tissue is properly described as gum.

Oil-receptacles in the Fruit of Umbelliferæ. †—J. Lange describes the development of these organs, both in general terms and in a number of particular species. They originate from a group of four similar cells distinguished from the others in the pericarp by their greater refrangibility. They are arranged in corners of a square with an intercellular space between them, which gradually develops into the oil-receptacle. The secreting cells have very thin walls, and clear translucent protoplasm; the oil has a yellowish-grey colour.

Influence of Cortical Pressure on the Bast-fibre. ‡—F. von Höhnel calls attention to the displacement by which the bast-fibres of *Urticaceæ*, many *Asclepiadeæ*, *Mimoseæ*, and *Linaceæ*, when but slightly or not at all lignified, are broken up into a number of longer or shorter segments, usually separated from one another by knots composed of various simple or compound disks. This breaking up results from the different segments of the same bast-fibre being subjected to radial pressures of different intensities, by which they are pushed apart. They consist either simply of sharp curvatures of the fibres, or more often are connected with actual rupture of single layers or of masses of layers. These knots were detected in about two-thirds of between fifty and sixty species of dicotyledons examined, but appear to be entirely wanting in monocotyledons.

* Ber. Deutsch. Bot. Gesell., ii. (1884) pp. 375-6.

† Lange, J., 'Ueber die Entwicklung der Oel-behälter in den Früchten der Umbelliferen,' 16 pp. (1 pl.) Königsberg, 1884.

‡ Pringsheim's Jahrb. Wiss. Bot., xv. (1884) pp. 311-26 (3 pls.).

Course and Termination of the Sieve-tubes in the Leaves.*—

A. Koch has carried out a series of observations on this subject, of which the following are the general conclusions:—

1. At the periphery of the leaf are the blind ends both of the tracheids and of the sieve-tubes of strong fibrovascular bundles. The tracheids of the delicate bundles which run towards the margin of the leaf are attached at a right angle to those of the sympodial marginal bundle, and do not end blindly; and the same is the case with the sieve-tubes. In the interior of the leaf there are usually no sieve-tubes in the last ramifications of the bundles with free ends.

2. The sieve-tubes of the reticulate bundles are attached directly on all sides to one another, and form no blind ends. Anastomoses of sieve-tubes between the upper and lower sieve-portions, especially of stronger bundles, open a communication between the two groups of sieve-tubes.

3. The sieve-tubes never leave the immediate neighbourhood of the tracheids, as the laticiferous tubes do.

4. All the sieve-tubes of the leaves have conducting cells; the membranes between the two are perforated by numerous pores.

5. The sieve-tubes of the upper sieve-portion of all delicate bundles are surrounded, in the leaves of all species of Cucurbitaceæ examined, by green parenchymatous cells, and are in close apposition to the wall of the palisade-cells. According to Sachs's hypothesis of the formation of albuminoids in the sieve-tubes, this is a speciality of the upper sieve-tubes which is wanting in the lower sieve-portions. We have here a peculiarity of the Cucurbitaceæ; in other plants with bicollateral cauline bundles the delicate bundles which run through the green parenchyma have only lower sieve-portions.

6. A similar special function is also performed by the peripheral cells of the lower sieve-portions, which, in the Cucurbitaceæ examined, are very rich in albuminoids, as soon as the leaf is placed in favourable conditions for assimilation. These albuminoids are very often formed only in those cells whose wall is in direct contact with that of the palisade-cells.

7. Cells of this kind always accompany the rows of tracheids of the inner ends of the bundles up to the last, at least in all the Cucurbitaceæ examined, and in some other plants.

8. The sieve-tubes of the delicate bundles of Cucurbitaceæ were in summer found to be almost filled only with thin fluid contents, and to be free from mucilage; in November, on the contrary, in *Ecballium*, they were almost all full of mucilage. The cause of this phenomenon was not discovered. The same peculiarity was exhibited by the sieve-tubes of the cotyledons of *Cucurbita*, from winter sowings, at the time when the reserve materials were being transported.

9. The sieve-tubes of the cotyledons of *Cucurbita* dried in the ordinary way were closed by thick layers of callus after the disappearance of the mucilage. The same phenomena were observed in the sieve-tubes of the stem of plants of *Cucurbita* kept for a time in

* Bot. Ztg., xlii. (1884) pp. 401-11, 417-27 (1 pl.).

the dark. Experiments on dried cotyledons confirmed Wilhelm's idea that in annual plants the callus does not again disappear from sieve-tubes that have ceased to be active.

Mechanical Function of the Epidermis.*—J. E. F. af Klercker describes the peculiar structure of the epidermis of the nearly leafless stem of *Aphyllanthes monspeliensis*, which is provided with a number of longitudinal ridges, caused by great thickening of the walls of the layer of epidermal cells which immediately surrounds the internal tissue. This layer corresponds in function to the epidermal and sub-epidermal collenchyma- or bast-bundles of other stems. At the base of the stem the mechanical function of this epidermis is performed by the epidermis of the leaf-sheaths.

Comparative Anatomy of Leaves of Chrysosplenium.†—In a detailed comparative anatomy of the leaves of *Chrysosplenium*, J. Borodin mentions a peculiarity in the stomata of *C. alternifolium*. They are formed in groups, exclusively on the under side of the leaf, and in each group the separate stomata are developed at very different times. The same peculiarity was observed, though less strikingly, in other species of the genus.

Adaptation of Leaves to their environment.‡—F. Johow describes the various contrivances by which, in tropical countries, leaves are protected from the too intense direct sunlight which would otherwise destroy the chlorophyll. One very common arrangement for this purpose is the vertical position of the lamina of the leaf, which is either hereditary in all the leaves, or occurs only in those which are exposed to the sun. The same object is effected by the folding of the leaf on the mid-rib, a proceeding greatly facilitated by the parallel venation of most endogens. Another contrivance for the same purpose is the periodical movement of leaves or of segments of leaves. The red pigment of young leaves and branches, and the hairy covering of the veins of leaves, protect the conducting tissue from too intense light. Protection against too rapid transpiration is afforded, in some cases, by the partial or complete suppression of the lamina; in others by the very great development of the cuticle or epidermis, which in some tropical plants is carried to an excessive extent; in others again by the preponderance of palisade-tissue in the hypodermal region; while in leaves which remain in the shade, spongy parenchyma with large intercellular spaces is the prevalent form of tissue.

Dehiscence of Anthers.§—M. Leclerc du Sablon describes the mechanical contrivance which causes the dehiscence of anthers, produced by a "fibrous layer" beneath the epidermis, composed of cells with peculiar thickenings, but which are otherwise very thin-walled. The contraction of the anther-valves during dehiscence is always

* Bot. Centralbl., xix. (1884) pp. 215-21.

† Arbeit. St. Petersburg. Naturf.-Gesell., xiv. (1883) pp. 32-40 (Russian). See Bot. Centralbl., xix. (1884) p. 291.

‡ Pringsheim's Jahrb. Wiss. Bot., xv. (1884) pp. 282-310.

§ Comptes Rendus, xcix. (1884) pp. 392-5.

produced by the unequal contraction of the non-lignified parts and of the lignified thickenings. This is very strikingly the case with the spiral cells of the anther of *Iris*. The principle of dehiscence is the same whether it is longitudinal or by pores; in the latter case the fibrous layer has either disappeared or is functionless, except towards the summit of each anther-lobe. The layer may be only one cell or several cells in thickness, and presents various degrees of complexity. The dehiscence of the sporangia of some Hepaticæ, such as *Calypogeia* and *Jungermannia*, is brought about in precisely the same way.

Calcareous Glands of Plumbaginæ.*—G. Volken has examined the calcareous incrustation which is frequently so conspicuous on the surface of leaves of Plumbaginæ, in as many as seventy-five species, and finds it to be due to the presence of calcareous glands. These glands are globular, and are composed of eight cells which proceed from a single epidermal cell. This divides first by two septa vertical to the surface crossing one another at right angles; each of these four cells again dividing into two by a vertical wall. All the walls of these cells are remarkably thin; they all contain a dense finely granular protoplasm. These glands are secretion-organs, developing and excreting in the first place a large amount of water, which exudes as drops when evaporation is hindered. Their function in the greater number of species belonging to the order is therefore simply to counteract any abnormal relationship between the amount of water given off by the leaves and the amount absorbed by the root, and hence to serve as a preventative of excessive transpiration. But, in addition to this, the glands serve, in a large number of species, for the elimination of superfluous salts of calcium, in the form of the acid carbonate, which passes into the neutral salt on the evaporation of the water. In some species this causes a calcareous deposit as thick as the finger-nail. In order to prevent too great evaporation in xerophilous species, these glands are frequently depressed below the level of the remaining epidermal cells. The calcareous incrustation itself may also serve the same purpose.

Protective Contrivances in the Bulbs of Oxalis.†—F. Hildebrand describes the mode in which the bulbs of various American and South African species of *Oxalis* are protected against the injurious influences of the climate. In the former the bulbs consist of a large number of scales, only the outermost of which, from their membranous texture, are protective, the innermost serving only as reserves of food-material; while the intermediate scales, which form the bulk of the bulb, serve both purposes; these are often provided with silky or glandular hairs. In the South African species, the bulb consists of only a comparatively small number of scales, the innermost being composed almost entirely of starchy parenchyma, and serving therefore for nutrition, while the outer ones are protective only, and there is no transition from one to the other. This is accompanied by a difference

* Ber. Deutsch. Bot. Gesell., ii. (1884) pp. 334-42 (1 pl.).

† Ibid., pp. 108-11.

also in the mode of germination. Both kinds often form at the period of vegetation one or more bulbous or fusiform roots at the base of the bulb, frequently of great length, the cells of which are filled with water, and furnish a supply of this material to the young plant.

De Bary's Vegetative Organs of Phanerogams and Ferns.*—This excellent translation of a very valuable work is a great boon to English botanists. It treats in an exhaustive and masterly way of the forms of tissue found in vascular plants (which he classifies under (1) cellular tissue, (2) sclerenchyma, (3) secretory structures, (4) tracheæ, (5) sieve-tubes, and (6) laticiferous vessels); the primary arrangement of these forms of tissue; and the secondary changes produced by growth in thickness. The treatment of the vascular bundles is especially new and important.

β. Physiology.†

Influence of Light on the Germination of Seeds.‡—A. Adrianowsky has made a very large number of experiments with reference to this question. The general conclusion which he draws from them is that diffused light has no influence on the products of germination, but that it retards this process. In all cases he found germination to proceed more quickly in the dark than in full light; the retarding effect of green light was also very obvious in all the experiments; while all the other results varied greatly in the different experiments. In a few cases germination was even more rapid in violet and blue light than in the dark. As a general result it appears to be the illuminating rays of the spectrum that exercise a retarding effect on germination.

Effect of Depth of Sowing on the Germination and Growth of Plants.§—There are no definite results obtained by the experiments described by E. Wollny, but the general outcome seems to be that the deeper the seeds or tubers are laid in the soil the more irregularly and the later do the plants appear above ground, and there seems to be a definite depth for each kind of seed; but this is again dependent on weather and soil. In experiments with rye, it appeared that deeply sown seed suffered much more from winter cold than the shallow sown seeds, and when potatoes are sown deep there is less chance of their being attacked by disease.

Influence of Water on the Growth of Plants.¶—Hellriegel has investigated the questions: How much water does a plant transpire

* De Bary, A., 'Comparative Anatomy of the Vegetative Organs of the Phanerogams and Ferns. Translated by F. O. Bower and D. N. Scott.' 8vo, Oxford, 1884.

† This subdivision contains (1) Reproduction (including the formation of the Embryo and accompanying processes); (2) Germination; (3) Growth; (4) Respiration; (5) Movement; and (6) Chemical processes (including Fermentation).

‡ Nachr. d. Petrowskischen Agricultur u. Forstakad. Moskau, vi. (1883) pp. 171-92 (Russian). See Bot. Centralbl., xix. (1884) p. 73.

§ Bied. Centr., 1884, pp. 293-9. See Journ. Chem. Soc.—Abstr., xli. (1884) p. 1404.

¶ Bied. Centr., 1884, pp. 475-84. See Journ. Chem. Soc.—Abstr., xli. (1884) pp. 1401-2.

under normal conditions? How much water must be present in the soil? And how is the proper quantity of water to be retained? Barley was sown in quartz sand, to which had been added sufficient plant-food, and the amount of water present was 60 per cent. of the whole retainable water. The observations showed that the evaporation was much more dependent on the temperature of the air than on the evaporating surfaces; a rising temperature with dryness increased the evaporation, and *vice versa*. When the temperature remains constant, then the moisture of the air greatly affects the evaporation, which may in dry air be raised to double, and in moist air reduced to one-half that which is evaporated under normal conditions; but this alteration has no effect on the physiological functions of the plant so long as the condition of soil remains normal. A long account of the construction of the apparatus used in the research is given. The rapidity of the air-currents has much influence on the evaporation, but the effect is much less than those exerted by warmth and moisture. To observe the effect of light, two healthy and well-grown barley plants were examined, the one under a bell-jar painted white, the other under a clear glass jar, both of them connected with the ventilating apparatus above referred to; other coloured shades were also employed, but all with a similar result, that light has a very considerable influence, but not so great as that exercised by heat and moisture.

Experimenting with sunflowers, the author finds that the rise of the sap is independent of the leaves, and that moisture is carried up by the roots, so long as there is a certain degree of water in the soil; the minimum of moisture seems to be slightly above 8 per cent. of the dried soil.

Respiration of Plants.*—The second part of H. Möller's paper on this subject is devoted to intermolecular respiration. The method employed for measuring this is entirely the gasometric; and the apparatus used is described and figured. The observations were made on young seedling plants of about ten species of flowering plants. The results from the different plants were not uniform, the comparative intensity of the normal and the molecular respiration differing in different species, and apparently in the same plant under different conditions.

Respiration of Tissues not containing Chlorophyll.†—G. Bonnier and L. Mangin find their experiments on this subject generally confirm the results of those on fungi. But they have obtained some important results respecting the variation of respiration during the development of plants, and the constancy of the relationship between the amounts of gas absorbed and evolved. The experiments were made on roots, rhizomes, seeds, flowers, &c.

Solar light, direct or diffused, diminishes the interchange of gases; while the intensity of respiration increases with the temperature. The

* Ber. Deutsch. Bot. Gesell., ii. (1884) pp. 306-21 (2 pls.). Cf. this Journal, iv. (1884) p. 921.

† Ann. Sci. Nat., xviii. (1884) pp. 293-382 (2 pls.). See *infra*, p. 104; also this Journal, iii. (1883) p. 396.

intensity of respiration varies during development, attaining a maximum during the period of germination.

For the same individual, the fraction * $\frac{CO_2}{O}$ is the same in light and in darkness; it is also constant under variations of temperature and of pressure. The fraction is in general less than unity while plants are developing rapidly and storing up their food-materials, in the endosperm, cotyledons, rhizomes, bulbs, &c.; the net result of respiration is then an assimilation of oxygen. But during this period the value of the fraction varies, decreasing, reaching a minimum, and then increasing.

Respiratory Combustion.†—The experiments of P. Schützenberger were made with a view to ascertain the effect of the presence of certain organic substances on the respiratory combustion of yeast-cells. Similar flasks were filled with equal quantities of water saturated with oxygen, an equal amount of yeast was added to all of them, and then known weights of the particular substances employed, and after the lapse of a given time, the amount of oxygen which had been absorbed was determined by titration. The organic substances added were different varieties of sugar, mannitol, various alcohols, glycerol, acetic, butyric, tartaric and other acids, sodium acetate, Rochelle salt, and other salts, amido-compounds, hydrocyanic acid, and chloroform. Some of these substances have no appreciable effect on the respiratory combustion, others, such as hydrocyanic acid and chloroform, check or retard it considerably. Inverting sugar, ethyl alcohol, and sodium acetate accelerate the absorption of oxygen in a very marked manner, whilst glycerol and the higher homologues of ethyl-alcohol exert a similar but much less energetic action. Methyl-alcohol has little or no influence on the process. The effect of the most active substances is equally well observed with fresh yeast, or with yeast which has been exhausted and washed, but the effect of the less active substances is more clearly observed when the exhausted yeast is employed, because the substances naturally present in the fresh yeast are more combustible than those which are added.

The results show that ethyl-alcohol is particularly apt to undergo slow physiological combustion, its power in this respect being equal to that of inverting sugar. It is possible, indeed, that the inverting sugar is first converted into alcohol and then consumed, and if this be true, ethyl-alcohol and the alkaline acetates must be classed in the first rank amongst those substances which undergo combustion in the living organism.

Heliotropic and Geotropic Torsion.‡—H. Ambronn finds that leaves of *Coleus* display a torsion of the leaf-stalk as the result of illumination from one side, even when the weight of the lamina of the leaf is counterbalanced. The conditions in which torsions are

* See *infra*, p. 104.

† *Comptes Rendus*, xcvi. (1884) pp. 1061-4.

‡ *Ber. Deutsch. Bot. Gesell.*, ii. (1884) pp. 183-90.

affected by the influence of light or gravity he distinguishes under two cases. The first is when a curved organ is affected by either of these agents in a plane at right angles to the plane of curvature; apparent or even actual torsions may then result; and these probably play an important part in the mechanics of climbing plants. Torsions may also arise from light or gravitation acting from one side on symmetrical organs in such a way that the direction of gravity or of the rays of light does not coincide with the plane of symmetry of the organ. In this way are brought about the heliotropic torsions of the leaf-stalk of many plants.

Geotropic Sensitiveness of the Apex of the Root.*—G. Firtsch has determined by experiment the two following laws on this subject:—(1) If placed vertically, roots of seedlings from which the apex has been removed, grow as quickly, or nearly so, in length, as those that have not been decapitated. (2) The roots of seedlings, when placed in a horizontal position, if too large an extent of the apex has not been cut off, grow more quickly in length than those that have not been decapitated, but manifest no geotropic curvature. From these facts he draws the conclusion that geotropic curvature is prevented by the removal of that formative tissue which operates in the renewal of the root-cap; and that this cap-forming meristem is therefore the tissue which is geotropically sensitive.

Deviation of Roots from their Normal Direction through the Influences of Gases.†—For this phenomenon H. Molisch proposes the term “aërotropism,” and lays down the following laws as the result of observation:—

1. When a growing root is subjected on one side to the influence of certain gases in such a way that the gas is presented for a considerable time in unequal quantities on two opposite sides, the root deviates in a definite way from its normal direction of growth.
2. This influence of gases on growing roots has been determined in the case of oxygen, carbonic acid, chlorine, hydrochloric acid, carburetted hydrogen, ammonia, chloroform, ether, and others.
3. The roots are sensitive in different degrees to different gases; oxygen causes slight, carbonic acid more decided, and chlorine very great deviations.
4. If a gas acts too strongly on the root, it curves towards the source of the gas (positive aërotropism), but if to a moderate intensity only, away from it (negative aërotropism). The effect of oxygen is somewhat more complicated.
5. Positive aërotropism is the result of the concave side being injured, and hence growing less rapidly in length than the opposite side. It is difficult to explain why, in negative aërotropism, the side exposed to the action of the gas should grow most rapidly.
6. Decapitated roots display the same phenomena as uninjured with regard to aërotropism, but to a smaller extent.

* Ber. Deutsch. Bot. Gesell., ii. (1884) pp. 248-55.

† Anzeig. K. Akad. Wiss. Wien, 1884, p. 146. See Naturforscher, xvii. (1884) p. 366. Also Ber. Deutsch. Bot. Gesell., ii. (1884) pp. 160-9. Cf. this Journal, iv. (1884) p. 772.

Albuminoid Constituents of Plants.*—C. Schulze has determined the existence, in seedlings of lupin, besides asparagin, of phenylamido-propionic acid and amidovalerianic acid, and probably also of lucin and tyrosin. In addition there occur also peptone, bodies of the xanthin group—which must be regarded as products of decomposition of the nucleus—and lecithin. Important constituents of seedlings of the gourd are glutamin and tyrosin. The author has also investigated the albuminoid constituents of beet-root, potato-tubers, and of the young shoots of various trees. A specially interesting observation is that the young shoots of *Platanus orientalis*, in addition to asparagin, contain also not inconsiderable quantities of allantoin. In young shoots of the plant are also bodies of the xanthin-group.

Periodical Formation of Acids in Succulent Plants.†—H. de Vries has investigated the cause of the well-known phenomenon that in many plants the tissue has a strong acid reaction in the morning, while in the evening only a slight trace of free acid remains. The acid is chiefly malic acid, and the phenomenon is most strikingly displayed in succulent plants belonging to the order Crassulaceæ; the largest quantity was observed in *Echeveria metallica*. The cause of the periodicity is stated by De Vries to be the greater rapidity with which the decomposition of vegetable acids takes place in the light than in the dark, although this decomposition is progressing at all times, by day and by night, in all plants; while the production of acid, although originating from the action of light on the leaves, actually takes place only in the dark. The decomposition of these acids he regards as a process of oxidation, accompanied by the production of carbon dioxide and water.

Production of Hydrocyanic Acid by Plants.‡—A. Jorissen has demonstrated the existence of the power of eliminating hydrocyanic acid in a large number of plants belonging to widely separated natural orders, and in different parts of the plant; the list including one fungus, *Marasmius oreades*. In addition, he has found the same property of disengaging hydrocyanic acid and benzoin aldehyd in a myriopod of the genus *Fontaria* when excited.§

Presence of Amylase in Leaves.¶—L. Brasse has detected amylase as an invariable constituent of the leaves of plants. It was never accompanied by microbes; the starch was always transformed in the ordinary way, giving rise to a reducing sugar mixed with dextrine.

Autumnal Tints of Foliage.¶¶—H. C. Sorby points out that the autumnal tints of foliage are due to chemical changes in the pigments, consequent on a more or less complete loss of vitality. As a general rule the colour of leaves in their normal condition depends on variable mixture of two perfectly distinct green pigments and of at least four perfectly distinct yellow substances. The first

* Landwirthsch. Jahrb., xii. See Bot. Ztg., xlii. (1884) p. 364.

† Bot. Ztg., xlii. (1884) pp. 337-44, 353-8.

‡ Bull. Acad. R. Sci. Belg., liii. (1884) pp. 256-8.

§ See this Journal, iii. (1883) p. 53.

¶ Comptes Rendus, xcix. (1884) pp. 878-9.

¶¶ Nature, xxxi. (1885) pp. 105-6.

visible effect of reduced vitality is a change in the green pigments. The chlorophyll is changed into colourless products, or, by the presence of a weak acid, into a very stable brownish-green, which resists further change; thus giving rise to the production of bright yellows or dull browns, as in the alder. It is probable that under some conditions the chlorophyll in leaves is changed by the action of light into a red substance; the change depending on a certain amount of reduced vitality, as well as on little-understood conditions varying in different kinds of plants.

The next series of changes is best studied in the case of those leaves which in the first instance turn to a bright yellow, and depends mainly on the production of deeply coloured pigments by the oxidation of tannic acid and other more or less colourless substances; the difference in tint depending on the nature of these substances. Thus the tannic acid in the yellow oak leaves changes into a brown substance; whereas the quinotannic acid in yellow beech leaves changes into an orange-brown. Fine effect very much depends upon the production of each special tint in a fairly pure state. This seems to be influenced by the character of the weather. It is also important that the half-dead leaves should hang long on the trees, so as to develop their full colouring before being blown off by the wind.

Formation and Fermenting Action of Diastase.*—W. Detmer states his opinion that acids act directly on the ferment, increasing its activity, and consequently facilitating the conversion of starch into sugar. This takes place as the result of peculiar motions of the molecules and atoms, which increase the molecular movements of diastase. The physiological importance of this process consists in the promotion of the growth of the cell-wall, connected with the increased formation of sugar incited by the acids of the cell-sap. The chlorides of potassium and sodium accelerate the action of the ferment when the solution is only slightly acid, but retard it when the acid reaction is strong. In the absence of the ferment they exercise, within a short time, no perceptible influence on starch-paste. Detmer believes that the action of the chloride depends on the setting free of hydrochloric acid by the action of organic acids; and this he considers to be the function of chlorides in plants. The conversion of starch into sugar takes place at $10\cdot5^{\circ}$ C.; slowly cooling, even to -10° , followed by a quick rise of temperature, does not diminish the fermenting power. Higher temperatures destroy the ferment. The process continues when the reaction is slightly alkaline. The formation of diastase is not sensibly affected by light; the retarding influence of light on starch is probably due to increased respiration, or a greater reconversion of sugar into starch. Experiments made in January indicated the entire absence of sugar and diastase in the tubers of the potato; after germination commences, diastase is formed in continually increasing quantities. In the cells of the higher plants no diastase is produced in the absence of free oxygen.

* Detmer, W., 'Pflanzenphys. Unters. über Fermentbildung u. fermentative Prozesse,' 50 pp., Jena, 1884. See Bot. Centralbl., xix. (1884) p. 164.

B. CRYPTOGRAMIA.

Cryptogamia Vascularia.

Apospory in Ferns.*—W. T. Thiselton Dyer calls attention to a paper by Mr. E. T. Druery (not yet published) as containing a report of one of the most interesting botanical observations which has been made for some time.

Mr. Druery's paper relates to a singular mode of reproduction in *Athyrium Filix-femina* var. *clarissima*. In this fern the sporangia do not follow their ordinary course of development, but, assuming a more vegetative character, develop more or less well-defined prothallia, which ultimately bear archegonia and antheridia. From these adventitious prothallia the production of seedling ferns of a new generation has been observed to take place in a perfectly normal way.

Mr. F. O. Bower has confirmed Mr. Druery's observations, and obtained from him specimens of another fern (*Polystichum angulare* var. *pulcherrima*) which altogether eclipses the *Athyrium*, remarkable as that is. In the *Polystichum* the apex of the pinnules grows out into an irregular prothallium, upon which was demonstrated the existence of characteristic archegonia and antheridia. In this case the production of the prothallium is not even associated locally with the sporangia, but it appears as a direct vegetative outgrowth of the normal spore-bearing plant. The oophore is a mere vegetative process of the sporophore, a suppression of the alternation of the two generations which exceeds even that which obtains in the flowering plant.

Mr. Druery's discovery is the direct converse of the apogamy in the fern, discovered by Farlow. In this the sporophore is a vegetative outgrowth from the oophore. The parallel phenomena in the life-history of the moss have been known for some time. The obvious possibilities of discovery with regard to the reproduction of ferns may now be regarded as exhausted. It may be interesting to give the dates of the different steps:—

1597	Gerarde	..	Observed seedling plants near parents.
1648	Cæsius	..	Sporangia.
1669	Cole	..	Spores.
1686	Ray	..	Hygroscopic movements of sporangia.
1715	Morison	..	Raised seedlings from spores.
1788	Ehrhart	..	Prothallium.
1789	Lindsay	..	Germination of spores.
1827	Kaulfuss	..	Development of prothallium.
1844	Nägeli	..	Antheridia.
1846	Suminski	..	Archegonia.
1874	Farlow	..	Apogamy.
1884	Druery	..	Apospory.

Stomata of Equisetum.†—Miss E. A. Southworth gives the following account of observations on the stomata of *Equisetum arvense*

* Nature, xxxi. (1884) pp. 151 and 216. See also p. 119.

† Amer. Naturalist, xviii. (1884) pp. 1041-2 (1 pl.).

made at the University of Michigan. In the earliest stage the mother-cell of the stoma occurs as a cell of equal rank with the others, but divided into four guard-cells lying side by side, their longitudinal axes being parallel to that of the stem. As the ordinary epidermal cells develop they grow more in length than in breadth, while the stomata grow equally in both directions, and crowd upon the surrounding cells. In the meantime the outer pair of guard-cells arch over the inner pair, and finally completely cover them. When mature the guard-cells are loaded with silica arranged in radiating bars, and usually the inner pair is entirely hidden; but if a thin cross-section of a mature leaf is obtained, the two pairs of cells can be seen one above the other. In *E. arvense* the stomata are not, as stated by Sachs, found in the furrows only; in the leaves they are found, as a rule, invariably on the ridges. In this species the distribution of the stomata on the stem and stem-leaves is alike on the fertile and sterile plants, but on the branches the arrangement is different. On the leaf of the branch there is no central furrow, but its place is taken by a sharp ridge, and the ridges and furrows of the leaf are all continued on the branch. On the leaves the stomata are borne on either side of the ridge, but on the stem they pass down into the furrows, and lie on either side of the lowest part.

This arrangement of the stomata is peculiar to *Equisetum arvense*; in *E. limosum* and *hyemale* they lie, as regards the stem, exclusively in the furrows.

Muscineæ.

Peristome of Mosses.*—M. Philibert describes the structure of the peristome in various groups and species of mosses, and discusses its value as a character to determine genetic affinity. In opposition to the ordinary view that cleistocarpic and gymnostomous forms are the earliest, he believes the earlier structure to be the perfect peristome, from which the others have varied by degeneration. According to this view the Encalyptaceæ may be regarded as the central point whence all the other forms of moss have diverged; all those which have a peristome nearly identical in structure being probably of a common origin. It is difficult on any other theory to account for the almost complete identity of the peristome in *Dicranum*, *Fissidens*, *Campylopus*, *Dicranella*, *Cynodontium*, *Trematodon*, *Dichodontium*, and *Leucobryum*. The same form is found in the pleurocarpous Hypnaceæ, and in the acrocarpous Bryaceæ, Mniaceæ, and Bartramiaceæ. The peristome can therefore only be used for purposes of classification when present in a comparatively perfect state of development; when this index fails, recourse must be had to characters derived from the vegetative system.

In the Arthrodontaceæ the exterior peristome has two distinct forms; either the teeth have a double exterior and a single interior series of plates, or the exterior series is simple, and then the interior series is nearly always double. Philibert proposes the term *Aplolepidaeæ* for mosses with an articulated peristome and a simple series

* Rev. Bryol., xi. (1884) pp. 49-52, 65-72, 81-87.

of external plates, Diplolepidaceæ for those in which the external series is double; this latter section will comprise all mosses with a double peristome.

The type of structure in the Orthotrichaceæ is very uniform; sixteen single or eight double teeth, flat and thin, with sometimes prominent trabeculæ on the outside, never on the inside, reflexed when dry in many species, radiating in others; the external layer is thicker and ordinarily coloured, and is composed of two series of rectangular plates, papillose, or less often striated; the internal layer thin and hyaline, plane and uniform, composed of a single series of rectangular or square cells.

This is also the normal structure of the peristome in the Splachnaceæ; but certain species present curious specialities which are described in detail, and which attain their greatest complexity in the genus *Splachnum*. Here the peristome retains till maturity certain points of structure, which in other genera disappear in the course of development; otherwise the structure is that of *Tayloria*, *Tetraplodon*, *Dissodon*, and the typical Orthotrichaceæ.

Solmsiella, a new genus of Mosses.*—The following characters are given by K. Müller to a new genus of Musci obtained from Java by Count Solms-Laubach:—Musci hypopterygiacei minuti depressi prostrati jungermannioidei teneri chlorophyllosi viridissimi; folia tetrasticha caulem compressum sistentia, superiora majora oblongo-orbicularia obtusa, inferiora minora magis ligulata et magis distantia obtusata, omnia enervia, minute dense parenchymatice areolata; calyptra minuta cylindracea latere fissa dimidiata stylo terminata tenera fugax; theca in perichætio folioso brevi laterali tenero erecta ovalis leptoderma pallida gymnostoma exannulata breviter operculata fabroniacea. Inflorescentia monoica.

Spore-coats and Germination of Hepaticæ.† — H. Leitgeb describes in detail the formation and structure of the spores of *Sphaerocarpus terrestris*. They remain combined into tetrads inclosed in a common membrane, the perinium, on the surface of which is a connected network of delicate ridges. Each spore has a cuticularized extine, also reticulated on its surface, and a smooth homogeneous intine of cellulose. The mother-cells of the tetrads are inclosed in a thick cell-wall; the innermost lamella of this is differentiated into a dense layer, which becomes cuticularized and gradually less and less capable of swelling, and forms the reticulated perinium; the outer portions of the envelope are capable of swelling strongly. While this is proceeding, first the extine and then the intine of each spore is developed. Ultimately the outermost portion of the envelope is converted into mucilage, and the perinium assumes a deep brown colour.

In *Corsinia marchantioides* the structure of the spores is somewhat more complicated, their membrane consisting of three sharply separable layers, the outermost of which, the perinium, again consists of

* Bot. Centralbl., xix. (1884) pp. 147-9.

† Leitgeb, H., 'Ueber Bau u. Entwickelung der Sporenhäute u. deren Verhalten bei der Keimung,' 112 pp. (3 pls.) Graz, 1884.

three lamellæ. This perinium is also present in other Hepaticæ, as *Riccia*, in *Marchantia*, *Anthoceros*, some mosses, *Osmunda*, *Equisetum*, and *Lycopodium*, being sometimes known as the exospore, sometimes as the cuticle. It always results from metamorphosis of the innermost portion of the membrane of the special mother-cell of the spores.

In the germination of these spores both perinium and extine are ruptured by the swelling of the intine, which forces its way through them as the first rhizoid. The germinating tube is inclosed in the intine; in *Sphærocarpus* it does not break through the extine, but stretches it so greatly that it passes over immediately into the cuticle; while in *Reboulia* it bursts through it. Leitgeb does not find in the Hepaticæ examined any new formation of an additional inner layer of the membrane during germination. The function of the cuticularized extine appears to be to protect the spore against too rapid loss or access of water. The perinium, on the other hand, is permeable to air and water; its chief purpose appears to be to serve as a protection against the attacks of fungi.

Algæ.

Floridæ of the Mediterranean.*—The first part of F. Ardissonè's 'Phycologia Mediterranea' is devoted to the Floridæ, the genera and species of which are worked out and described with very great care and minuteness. Ardissonè divides the Mediterranean into three zones of depth: the first from the surface to 5 m.; the second from 5 to 35 m.; and the third down to the lowest limits of algal vegetation. The uppermost of these is again divided into three sub-zones; and all these zones and sub-zones have their peculiar and characteristic vegetation.

As to general results, it may be stated that the Mediterranean is especially rich in Bryopsidæ; then come the Halymeniæ, Cystosiræ, and Ceramiacæ; Laminariacæ and Fucacæ are only sparsely represented, as also the Caulerpeæ. Excluding diatoms, the algal flora of the Mediterranean amounts to about 600 species, of which about one-half are at present not known elsewhere.

The classification of the Floridæ adopted is nearly that of Agardh, viz. into 6 families:—(1) Gongylospermeæ, including Ceramiacæ and Cryptomeniacæ; (2) Cocospermeæ, including Gigartinæ only; (3) Nematospermeæ, including Dudresnaiacæ, Spiridiacæ, and Rhodymeniæ; (4) Hormospermeæ, including Squamariacæ, Sphærococceæ, and Delesseriæ; (5) Desmiospermeæ, including Helminthocladacæ, Hypneacæ, and Gelidiacæ; and (6) Corynospermeæ, including Wrangeliacæ, Gastrocloniacæ, Laurenciacæ, Rhodomelacæ, and Corallinacæ.

Occurrence of Chromatophores in the Phycochromacæ.†—G. Lagerheim describes distinct chromatophores in a phycochromaceous alga *Glaucocystis Nostochinearum*, nearly allied to the palmellaceous genus *Oocystis*, but differing in the nearly blue cell-contents. In the

* Mem. Soc. Crittogam. Ital., i. (1883) 516 pp.

† Ber. Deutsch. Bot. Gesell., ii. (1884) pp. 302-4 (3 figs.).

younger cells the chromatophores occur in the form of a band or thread; in the older cells in that of granules; in *Oocystis* they take the form of small parietal disks. The so-called "nucleus" described by Rabenhorst is really only a vacuole. The granules in the larger cells have a diameter of $0.5-2.0 \mu$, and form an open or closed sac lying at some distance from the cell-wall, and inclosing colourless cell-contents; they are themselves of a beautiful blue-green colour.

Gongrosira.*—J. Schaarschmidt has examined the structure and development of *Gongrosira de Baryana*, and finds that its chlorophore forms a large layer lining the cell; and that when division takes place, this layer splits in a direction corresponding to that of the septum. The cell-wall consists of two layers, an outer thicker one, which swells up greatly and may become converted into mucilage, and an inner much thinner one which shows a bluish refraction. The resting spores are of two kinds: one green, and multiplying by division, the other with reddish very granular contents, rich in starch, and a greatly thickened mucilaginous membrane.

With regard to the systematic position of *Gongrosira*, the author points out that the discovery in *G. de Baryana* of plates of chlorophyll destroys the distinction sought to be drawn by Borzi between the Chroolepidaceæ and the Ulotrichaceæ. The suggested identity with *Trentepohlia* cannot be affirmed until more is known about the germination of the zoospores.

Diatoms from Lago Trajano.†—M. Lanzi has examined the diatoms from Lago Trajano (the ancient Trajan's haven), now no longer in communication with the sea, and the adjacent Stagno di Maccarese, which has an outlet to the sea. He finds 120 species and varieties, partly brackish, partly fresh-water, and in addition 8 marine species. The limitation of the power of motion possessed by the frustules of *Bacillaria (Nitzschia) paradoxa* he considers to be due to the elastic sheath of mucilage in which the whole colony is imbedded. He confirms the statement of Hamilton Smith, Grunow, and Van Heurck, that the shells of *Craticula Ehrenbergii (Surirella craticula)* correspond to a single easily separable part of the shell of *Navicula*.

Schmidt's 'Atlas der Diatomaceen-Kunde.'—C. H. Kain has reproduced this work in blue photo-zincography, reduced from the original size of 12 in. \times 9 in. to 6 in. \times $4\frac{1}{2}$ in. It is impossible to say that the reproduction is wholly satisfactory so that it might be used as a substitute for the original, but no doubt many microscopists will find it useful both on account of the high price of the original and its scarceness.

Lichenes.

Algo-Lichen Hypothesis.‡—The Rev. J. M. Crombie deals with this hypothesis as enunciated by Schwendener, Bornet, and others.

* Magyar Növényt. Lapok, vii. (1883) pp. 129-38 (1 pl.). See Bot. Centralbl., xix. (1884) p. 321.

† Atti Soc. Crittogam. Ital., iii. (1884). See Bot. Centralbl., xix. (1884) p. 161.

‡ Journ. Linn. Soc. Lond. (Bot.) xxi. (1884) pp. 259-83 (2 pls.).

After noticing the various arguments and illustrations which have been adduced in its support, he discusses the results which have been obtained from experiments in lichen-culture, whether from the spore or by synthesis, which he considers were confessedly but small, owing to the very great difficulty of cultivation beyond a rudimentary stage. There are in the author's opinion two fatal objections to the theory: the one having reference to the very peculiar nature of the parasitism assumed, and the other to the fact that, notwithstanding a similarity of appearance, there are in reality no true fungal mycelia nor true algal colonies in lichens. As to any direct genetic or any indirect parasitical connection between the gonidia of lichens and the hyphal filament, they do not exist; but on tracing the evolution of the thallus from the germinating spore, it is seen that the gonidia originate in the cellules of the first parenchymatous tissue formed upon the hypothallus, and that subsequently, through the resorption of the lower portion of the cortical stratum, they become free, and constitute the thin gonidial stratum. Where seen lying amongst the medullary hyphæ they are often attached to these, not as the result of any copulation, but by means of the lichenin which permeates the whole thallus. "Schwendenerism, whether viewed anatomically or biologically, analytically or synthetically, is, instead of being true science, only the 'Romance of Lichenology'; and thus also the origin of the gonidia in, and their relation to, the rest of the lichen-thallus belong to the very rudiments of morphological botany, and constitute the A B C of Lichenology."

Fungi.

Respiration and Transpiration of Fungi.*—G. Bonnier and L. Mangin describe in detail a series of experiments on this subject, as well as the apparatus used, from which the following general results were obtained:—

Respiration is augmented by a rise of temperature; there is no optimum of temperature for respiration. Diffused light, on the other hand, retards respiration. The more refrangible rays of light are, as a whole, more favourable to respiration than the less refrangible. Respiration increases with the hygrometric state of the air. The value of the fraction $\frac{C O_2}{O}$, i. e. the proportion of carbonic acid evolved to that of oxygen absorbed, varies with different species; it is in general less than unity. Assimilation of oxygen does occur in fungi. For the same species the value of $\frac{C O_2}{O}$ does not vary with the pressure, nor with the temperature.

Transpiration increases with a rise of temperature, and diminishes as the hygrometric state of the air increases. Diffused light promotes transpiration in fungi.

* Ann. Sci. Nat., xvii. (1884) pp. 210-305. See *supra*, p. 97; also this Journal, iii. (1883) p. 396.

Fries' Nomenclature of Colours in the Agaricini.*—H. J. Wharton enumerates and seeks to elucidate the colour-names used for descriptive purposes by Fries, when treating of the Agaricini in his 'Hymenomyces Europæi,' as well as most of those used as specific names. Avoiding compounds, nearly 200 names of colours are here collected and discussed.

Corynelia.†—This genus of fungi, hitherto placed doubtfully among the Pyrenomycetes, has now been determined by G. Winter, from material obtained from Capetown, to be quite a typical representative of this group. The perithecia are of the ordinary structure of the Sphæriaceæ; but the form of the ascospores is very peculiar. They are composed of a roundish central piece, and of four, rarely five, somewhat conical portions, attached to the central piece by their bases, while their ends stand out. This is the form of the spores in *C. tripos*; while in the only other species known, *C. uberata*, they are of a much more ordinary nearly globular form.

Cryptica, a New Genus of Tuberaceæ.‡—Under the name *Cryptica lutea*, R. Hesse describes a fungus which he has found abundantly in beech-woods in Germany, and which he regards as the type of a new genus intermediate between *Hydnocystis* and *Genea*, and therefore near the boundary line between the Tuberaceæ and Discomycetes. It is readily distinguished at a glance by the flocculent nature of the upper yellow half of the pitted fructification (receptacle), and the reddish-brown colour of its lower portion.

The gleba is fleshy, and is permeated by a number of streaks (or veins) which spring from the inside of the peridium, of a brownish-yellow colour. Between each pair of these yellow veins is a colourless "vena lymphatica," which puts out asci and paraphyses right and left, reaching to the yellow veins, and in places even to the peridium. The asci are large and of beautiful cylindrical form, from 0.03 to 0.05 mm. in diameter, variable in length, and especially in that of their contracted lower portion; they are not unfrequently curved about their middle. They are enveloped by a large number of slender paraphyses. The spores are formed eight in an ascus with great uniformity. They are spherical, and when ripe their exospore is covered with blunt warts; they are about 0.02 mm. in diameter. *Cryptica* is hypogæic, and is found beneath a covering of beech-leaves along with other fungi of similar habit.

Parasitic Fungi.§—In connection with a descriptive account of all the fungi parasitic on animals, E. Morini proposes a genealogical tree of the class of Fungi generally, of which the following are the main outlines. Starting from the original group of Protomycetes, consisting of the Schizomycetes and Saccharomycetes, the tree branches into three main arms, viz. I. Entomophthoræ, Ustilagineæ, Uredineæ, Tremellineæ, Hymenomyces (Hymenolichenes), Gastero-

* Grevillea, xiii. (1884) pp. 25-31.

† Ber. Deutsch. Bot. Gesell., ii. (1884) pp. 120-3 (8 figs.).

‡ Pringsheim's Jahrb. f. Wiss. Bot., xv. (1884) pp. 19-208 (3 pls.).

§ Mem. Accad. Sci. Bologna, v. See Bot. Centralbl., xix. (1884) p. 79.

mycetes; II. Gymnoascus, Discomycetes (Discolichenes, Pyrenolichenes), Pyrenomycetes, Perisporiacei, Tuberacei; III. Plasmodiophora, Myxomycetes, Chytridiaceæ, (1) Saprolegniæ, Monoblepharidæ, (2) Peronosporæ, (3) Mucorini.

Fungi Parasitic on Aurantiaceæ.*—O. Penzig has paid further attention to the fungi parasitic on oranges and citrons in Italy, and especially on those growing in the open air, which he finds to be attacked by the same kinds as those grown in orangeries. He adds 13 fresh species to those already described, making in all 166.

"Cancer" of Apple-trees.†—R. Göthe has afresh investigated the cause of the so-called "cancer" of apple-trees, both that form of the disease in which the wounds still remain open, and that in which they are closed into tuberous outgrowths. In all cases he states that true cancer—distinguished by concentric rings round a central point, the death of the bark, and a conspicuous open wound—is always the result of the attacks of the parasitic fungus *Nectria ditissima*.

Conidiobolus, a new genus of Entomophthoræ.‡—O. Brefeld has observed a fungus to which he gives the name *Conidiobolus utriculosus*, growing as a parasite on cultures of Tremellini, and frequently going through all stages of development in the course of a single day or night. The spores or conidia are of a pear-shaped form, about 0.05 mm. long by 0.035 mm. broad. The germinating hyphæ proceeding from them give rise to secondary, and these again sometimes to tertiary conidia. All the conidia are characterized by the force with which they are thrown off when detached. When sown in nutrient fluids the conidia give rise to a copiously branched mycelium, which carries on the vegetative existence for a considerable period, and then has the faculty of breaking up by fragmentation into a number of detached pieces, as in the other Entomophthoræ, on which abundance of reproductive branches are produced.

The production of conidiophores is preceded by the appearance of septa in the hyphæ; their length varies considerably; but they have always a great tendency to bend towards the light.

The reproduction of *Conidiobolus* by means of conidia goes on for a number of generations, when the production of resting-spores begins, developing from protuberances in the mycelium. These protuberances grow into thick tubes which conjugate with one another. Before conjugating the apices of both tubes swell up, but one much more than the other, the contents of the smaller one passing entirely into the larger one, and thus giving rise to the resting-spore, the diameter of which is on the average about 0.08 mm. The wall of the resting-spore becomes finally differentiated into a thin yellowish warty exospore, and a three or four times thicker endospore. They begin to germinate in about ten days. The peculiarity in the con-

* Atti R. Ist. Veneto, ii. (1884). See Bot. Centralbl., xix. (1884) p. 163. Cf. this Journal, iii. (1883) p. 539.

† Bot. Ztg., xlii. (1884) pp. 385-9 (1 pl.).

‡ Brefeld, O., 'Unters. aus d. Gesamtgeb. der Mykologie,' Heft 6, pp. 35-78 (3 pls.) Leipzig, 1884.

jugation of *Conidiobolus* is that the extremities of the conjugating tubes are not first separated by septa before they conjugate.

A second species, *C. minor*, is described, also parasitic on Tremellini.

Cystopus Capparidis.*—R. Pirota has been successful in obtaining for the first time the oospores of this fungus, parasitic on the caper-plant, and, from their resemblance in form and structure to those on *C. candidus*, the common parasite on various Cruciferae, has determined the identity of the two species.

Fungus of the Root-swellings of *Juncus bufonius*.†—This fungus, discovered by Magnus in the roots of *Juncus bufonius* and *Cyperus flavescens*, and named by him *Schinzia cypericola*, is described in detail by C. Weber. The swellings caused by it vary in length from 3 to 10 mm.; the cells of the periblem, epidermis, and hypoderma being very much enlarged; the fungus, however, living only in the hypertrophied cells of the periblem. The hyphæ have the ordinary structure of the mycelium of the Ustilagineæ, the spores arising on spirally coiled branches. They are elliptical in form, with an average length of 17·5–20·5 μ and breadth of 15–17·5 μ , the wall being from 3–5 μ thick. The epispore consists of two layers, is covered with warts, and of an intense red or yellow colour. Formed in the summer, they do not germinate till the following February. Three or four germinating filaments then proceed from each spore, which perforate the epidermis of the host in small round openings, remain comparatively short, and act as a promycelium, producing each one sporidium at or near the apex, but never on sterigmata. The further development of these sporidia, which have a spiral form, could not be followed.

The fungus clearly belongs to the Ustilagineæ, differing from the typical forms in the plurality of the promycelia, in their very small diameter in comparison to the large spores, and in the spiral form of the sporidia. Weber regards it as the type of a distinct genus of Ustilagineæ, for which he proposes the name *Entorrhiza*.

"Pourridié" of the Vine.‡—G. Foex and P. Viala assign as the cause of this disease the flocculent growth between the bark and the wood of the root, known as "*Rhizomorpha fragilis*," the cultivation of which gives the well-known fructification of *Dematophora necatrix*, which can readily be proved to be a true parasite. The conglomerations of hyaline filaments known as "*fibrillaria*," also formed on the roots of the vine, and which are not known to be connected with any species of fungus, are not truly parasitic, being formed only on tissue already disorganized, and cannot therefore be regarded as the cause of the "*pourridié*."

Development of the Sporangium of *Trichia*.§—This process has been carefully followed by E. Strasburger in the case of *T. fallax*.

* Nuov. Giorn. Bot. Ital., xvi. (1884) pp. 362–3.

† Bot. Ztg., xlii. (1884) pp. 369–79 (1 pl.).

‡ Comptes Rendus, xcix. (1884) pp. 1033–5.

§ Bot. Ztg., xlii. (1884) pp. 305–16, 321–6 (1 pl.).

The process of hardening employed was the ordinary method, by 1 per cent. chromacetic acid (0·7 per cent. chromic acid and 0·3 per cent. acetic acid); the sporangia were carefully washed with boiling water, and then plunged in alcohol of 30 per cent.; at the end of some weeks transverse sections of the reproductive bodies were made and the protoplasmic matter coloured by hæmatoxylin.

The numerous nuclei found in the protoplasm are stated by Strasburger to be simply those of the myxamœbæ, persisting after their fusion. These nuclei only commence to divide when the capillitium is formed; the division taking place in the ordinary way, but arresting at the last stage, no cellular plate being formed. The mode of division of the nucleus in this myxomycete therefore approaches, like some others of its characteristics, that of animals.

The formation of the membrane of the sporangium is preceded by that of a dense cortical layer of protoplasm, provided with nuclei, the microsomes of which are disposed in radial threads. Like the microsomes of the cellular plate, and like the starch-generators, these generate a new substance; the membrane of the sporangium is formed by their coalescence. Its very fine radial striation results from the arrangement of these microsomes in radial threads; but in the innermost region of this envelope, the coloration of which is brown, these striæ are not seen. The membrane of the sporangium of *Trichia fallax* displays therefore two layers, recalling those of *Marsilea*, not only in their structure, but also in the mode of their formation. According to Strasburger, this membrane increases by the apposition of new layers of microsomes, not by intussusception, a theory which would not explain the following fact observed by the author. The membrane of the young sporangium becomes folded at certain spots; as development proceeds the wall becomes thickened on the inside at these spots, and a new cellulose-layer is formed covering all the sinuosities, the interior surface becoming smooth. There remains at the bottom of the original folds the residue of the protoplasm, which is not transformed into cellulose.

The transformation of the capillitium furnishes fresh arguments in favour of the theory of cell-formation held by Strasburger. The filaments of which it is composed, although hollow in their interior, cannot be compared to cells; they originate from vacuoles, and are therefore destitute of nuclei. The membrane of these vacuoles is at first composed of numerous microsomes, which rapidly multiply, following several spiral lines which subsequently constitute the ornaments of the capillitium. The mode of production of these spirals is therefore altogether identical with that of the spiral thickenings of spiral vessels.

De Bary's Fungi, Mycetozoa, and Bacteria.*—A. de Bary's book is divided into three parts: Fungi proper, Mycetozoa, and Bacteria or Schizomycetes. The first part is subdivided into sections, the first of these treating of the general morphology of fungi, and

* Bary, A. de, 'Vergleichende Morphologie und Biologie der Pilze, Mycetozoen und Bacterien,' 558 pp. and 198 figs. 8vo, Leipzig, 1884.

containing admirable chapters on the histology, the segmentation of the thallus, and the development, structure, and germination of spores. The second section of the first part deals with the life-histories of the groups of fungi, and sets out with an introductory chapter full of most significant and impressive elucidation of the grounds on which classification is built. The classification here adopted is virtually that published by Prof. de Bary in 1881. He here divides the fungi proper into two categories, thus:—

I. *The Ascomycetes Series*.—1. Peronosporæ (with Ancylisteæ and Monoblepharis). 2. Saprolegniæ. 3. Mucorini or Zygomycetes. 4. Entomophthoræ. 5. Ascomycetes. 6. Uredinæ.

II. *Groups diverging from the Ascomycetes Series or of doubtful Position*.—7. Chytridieæ. 8. Protomyces and Ustilagineæ. 9. Doubtful Ascomycetes (Saccharomyces, &c.). 10. Basidiomycetes.

Groups 1 to 4 are, from the approach to Algæ, classed together as Phycomycetes. Of those in category II., 7 and 8 are to be regarded as standing in relationship to the Phycomycetes; 9 in relationship, of course, with 5; and 10 with 6. In Chapter V. a comparative survey is made of the life-histories of each, which are discussed in detail.

The third section of the first part deals with the physiology of the fungi proper, and contains chapters on the phenomena of germination and vegetation, with a specially interesting treatment of parasites and saprophytes.

The second part is occupied with the Mycetozoa, their morphology and physiology.

The third part, devoted to the Bacteria or Schizomycetes, contains two chapters, dealing respectively with their morphology and physiology. The pathologist has had it all, or nearly all, his own way with them of late, and it is refreshing to find the subject treated by a botanist whose experience of such organisms and their allies is without doubt unrivalled.*

Protophyta.

Structure of Chromatophores.†—In pursuance of previous investigations on the chromatophores of algæ,‡ F. Schmitz has now made a very detailed examination of the structure of these bodies in a number of low-organized fresh-water organisms.

In the first place we have a description of the phenomena presented by the Euglenæ, including several species of *Euglena* and *Phacus*. The single cell of *E. viridis* contains a single irregularly stellate chromatophore (rarely two, one behind the other), the central portion of which is surrounded by a globular layer of small grains of paramylum, while its thinner prolongations pass through this layer of paramylum, radiating towards the surface of the cell, in the form of narrow slightly serpentine bands, along the surface towards the nearest end

* G. Murray in Ann. and Mag. Nat. Hist., xiv. (1884) pp. 363-6.

† Pringsheim's Jahrb. f. Wiss. Bot., xv. (1884) pp. 1-177 (1 pl.).

‡ See this Journal, iii. (1883) p. 405.

of the cell. This central portion shows, in proportion to its density, the reactions of the pyrenoids of other algae. A similar form of chromatophore is characteristic of *E. geniculata*; and from this there are transitions to the form found in other species of *Euglena* and *Phacus*, in which they occur as small flat disks with rounded corners, resembling those of Vascular Cryptogams and Phanerogams. In *E. viridis* and *E. geniculata* the entire mass of paramylum is composed of two kinds of grain, one kind developed along the surface of the central piece of the chromatophore, the other along the outer surface of the ribbon-shaped prolongations of the chromatophore.

The paramylum-grains of the Euglenæ appear to originate in the chromatophore, and to increase in size by the continuous apposition of new substances derived from it. Schmitz's researches have shown the chemical and physical properties of paramylum to resemble those of normal starch much more closely than had previously been supposed.

Similar observations on Flagellatæ which do not contain chlorophyll, such as the genera *Astasia*, *Rhabdomonas*, and *Monoideum*, show that here the starch- and paramylum-grains are formed directly out of the colourless protoplasm of the cell.

Observations on fresh-water diatoms, *Frustulia saxonica*, *Cymbella cymbiformis*, &c., showed that in these also the pyrenoids are always formed, as in *Euglena*, &c., in the interior of the substance of the chromatophores, and are never stored up outside them.

With regard to the finer structure of chromatophores, F. Schmitz thinks that we are not yet in a position positively to answer the question whether they have a reticulate framework, or whether small dense granules or drops are imbedded in a continuous matrix, or to state in what way the green or red colouring matter is distributed. He himself favours the idea that the colouring substance completely permeates the fibrillæ of the framework. But these points cannot be said to be at present determined by direct microscopical observation.

G. Klebs* contests the statement of Schmitz with regard to the origin of the paramylum-grains in the Euglenæ. He states that there is never any direct connection between them and the chromatophores; but that, on the contrary, the paramylum always originates in the cytoplasm, there being some Euglenæ in which the chromatophores are entirely wanting. In the finer structure of the paramylum-grains, Klebs maintains also the existence of a concentric lamination, which can be made evident by mechanical pressure, or by treatment with swelling reagents; and the same is the case also with the radial striation of the chromatophores of Euglenæ.

Development of Bacteria.†—G. Wigand maintains the development of bacteria by spontaneous generation from protoplasmic substances themselves without any pre-existent germs. Processes of decay consist essentially of two distinct stages: (1) the stage of maceration or morphological disintegration, in which the organized

* Bot. Ztg., xlii. (1884) pp. 566-73.

† Wigand, G., 'Entsehung u. Fermentwirkung der Bakterien,' 40 pp., Marburg, 1884. See Bot. Centralbl., xix. (1884) p. 359.

protoplasmic substance breaks up into the minute particles which develop into bacteria; (2) the stage of putrefaction in the narrower sense, in which the substance is decomposed into certain fluid and gaseous bodies, finally into ammonia, water, and carbonic acid. There is therefore no contradiction between the statements that bacteria are products of putrefaction, and that putrefaction is the result of bacteria. It is quite possible for contagious diseases to arise independently of infection. The author further describes the mode in which vibrios, spirilla, cocci, bacilli, and other bacteria are formed inside the cell out of its protoplasm. Their appearance is a sign of the disintegration of the cell, and is accompanied by a cessation of the current of the hyaloplasm.

Hourly Variations in Aerial Bacteria—Miquel's Nutritive Paper.*—Dr. P. Miquel, who for the last ten years has been carefully studying aerial bacteria, has published some very striking results showing that the number of bacteria vary from hour to hour, and have approximately regular maxima and minima in the course of the entire day. At 8 A.M., the number of bacteria is high and decreases up to midday. From midday to 1 P.M., there is a remarkable minimum and then a gradual increase. At 8 P.M., the air is strongly infected. From 10 to 11 P.M., the air is very impure, the impurity decreasing from 1 to 3 A.M., to be followed by a considerable morning increase in the number of aerial microbes. Two out of six experiments were disturbed by rain, but the remaining four gave identical results. Supposing the number to be 50 per c.cm. of air at midday, the rise may be up to 1000 in the same quantity of air at 8 P.M.

These daily fluctuations Dr. Miquel finds true for all seasons. The different directions of the wind do not modify them, provided the direction remains constant, and the speed of the wind causes no sensible variation on these periodicities. The law may be stated thus. The air is less pure morning and evening than at midday, or the air is more impure at the rising and setting of the sun than when it is near the zenith and nadir. The law for these variations remains to be discovered. Dr. Miquel suggests that oblique currents determined at the surface of the earth through its daily heating and cooling may go far to solve the difficulty. The winds that graze the ground are supposed to charge themselves with more germs than those which arrive at the place of the experiment at the incidence of 80° to 70°.

To determine these variations more correctly, led to the construction of a registering apparatus for hourly variations, and to the employment of a neutralized sterilized nutritive paper 10 cm. wide by 60 cm. long which is wound round a drum driven by clockwork, all being placed under a large glass shade with certain precautions. The air is aspirated upon the paper through a narrow slit in the side of the shade, to the top of which the tube of the aspirator is fixed, thus saving the enormous trouble of drawing air consecutively into 600 or 800 sterilized flasks containing neutral broth. The drum of ebonite makes one turn in twenty-four hours, this with its band of

* La Semaine Médicale, 6th Nov., 1884.

paper being previously sterilized for an hour at the temperature of 110°C . The air thus set in motion and entering through the narrow slit strikes the paper, which is marked at the time of starting and closing the experiment, and lasts twenty-four hours; whilst the current of air is made to traverse the space at the rate of 30 to 60 litres per hour according to circumstances. The drum with its paper is then placed in a second glass shade for incubation of the bacteria. Both vases have the air saturated with moisture from a sponge wetted with a solution of bichloride of mercury placed inside. Special precautions are taken in smearing the junctions with vaseline, and the mercury in which the shade stands with aseptic glycerin.

For use stout paper coloured upon one or both sides according to the object in view is preferred for covering with the lichen jelly. Dr. Miquel has prepared this for the last two years by dissolving from 25 to 30 gr. of *Fucus crispus* (Irish moss) in a litre of beef broth, then strained, neutralized, boiled for a short time, and filtered. To prevent loss by evaporation a jelly of the lichen is made with water and dried, and this, to the amount of about 1 per cent., is added to the broth. The prepared jelly melts at about 55° to 60°C ., thus serving for the incubation of bacteria requiring high temperatures. Sterilization by several boilings at short intervals is not relied upon. Coloured paper, of a blue tint preferred, is spread with the warm neutral lichen broth to the depth of two to three mm., then dried rapidly in a stove at 40°C ., and is then capable of indefinite preservation. For use it is heated in vapour at 110°C ., without any deterioration, and its hygrometric quality can be increased or restrained as desired, or it can be made alkaline for bacteria.

For the analysis of rain, Dr. Miquel has invented a special apparatus, his "Udobactériemètre," consisting, in brief, of a glass shade with its neck fitted with a stopper through which is passed the long stem of a metal funnel, that delivers by droplets the rain caught, and projects them upon the nutritive paper arranged as a very wide truncated cone, which is rotated at some speed by clockwork beneath. The droplets are carried by the rotation a little way along the sterilized paper cone, moistening the lichen surface of the paper in their course at different points, no troublesome liquefaction taking place as with ordinary gelatin. The cone of paper at the end of the experiment, like the former, is placed in the incubating stove with its damp atmosphere, and affords excellent results.

The paper has a third use. In a small precipitate glass with a foot, and closed by an emery-ground tubulated cap, like Pasteur's flasks, a little wetted cotton is placed. Through the tube is passed a platinum wire, crooked at the end to support a band of the nutritive paper covered on both sides, about 3 cm. wide and 8 long, equivalent to about half a decimetre square surface. All is sterilized at 110°C ., and then weighed to a milligramme. The mouth is now uncapped, the paper plunged for one to two minutes into the water to be analysed for the different organisms, then introduced into the éprouvette, and reweighed. If the water be impure, it is not long before small spots show the deposition and growth of the microbes,

which spots can be counted, and, knowing the weight of water, the impurity can be rated in terms of comparison according to the time of immersion, the increase in weight sometimes exceeding two gr. The various bacteria, in their development on the nutritive paper, offer different appearances even to the naked eye. Pure cultures can thus also be obtained. In any case when the germs are fully developed the paper is again dried at 30° to 40° C., by which the colonies are fixed and they can be preserved, photographed, or revived, if the paper is varnished with a solution of gum. If a resin varnish is used the microbes cannot be revived. Dr. Miquel furnishes numerous details which require attention in all these operations, and has yet much more to say upon the value and use of this nutritive paper.

Cholera-bacillus.*—Dr. R. Koch repeats his statements with regard to the occurrence of the peculiar “comma-bacillus” in the intestines of cholera patients. It never occurs in the blood, liver, or spleen. In cultivation this *Bacillus* assumes a remarkable development-form; growing not into straight filaments, but into long beautiful spirals, resembling *Spirochæte*, which leads Dr. Koch to regard it now as a *Spirillum* rather than as a true *Bacillus*. They grow well and rapidly in extract of meat; the optimum temperature lying between 30° and 40° C. He again finds them invariably in cholera cases (over 100), and never under any other circumstances; though they have not yet been experimentally proved to be the actual cause of cholera. Since they occur only in the intestines, it is only through cholera-stools that the infection can be carried. Their development is greatly promoted by moisture; hence the great danger of the spread of cholera by infected drinking water.

Prof. E. Ray Lankester,† in reply to an article ‡ summarizing Dr. Koch’s views on this subject, reiterates, in still stronger and somewhat personal terms, his protest against those views, and gives at length his reasons for considering that Dr. Koch is utterly mistaken in regard to the connection between the “comma-bacillus” and cholera.

In a further paper § Koch maintains the accuracy of his conclusions as to the “comma” bacillus, and points out differences between it and the forms found in the mouth of a healthy person, and shows that the two are totally distinct. He also shows that Finkler and Prior’s bacillus is larger and thicker and more rapid in growth. He produced cholera by the inoculation of 1/100 of a drop of a solution of a pure culture. Rabbits and guinea-pigs died in 1½–3 days with the same appearances as in the case of Asiatic cholera in the human subject.

Dr. E. van Ermengem || has made a most elaborate investigation of the comma bacillus, and independently came to the conclusion

* Deutsch. Med. Wochenschr., Nos. 32 and 32A, 1884 (7 figs.). See Bot. Centralbl., xix. (1884) p. 361. Cf. this Journal, iv. (1884) p. 596.

† Nature, xxxi. (1885) pp. 168–71 (6 figs.).

‡ Ibid., pp. 97–98.

§ Deutsch. Med. Wochenschr., No. 45, 1884.

|| Bull. Soc. Belg. Micr., xi. (1884) pp. 6–36.

that its peculiar shaped chain-like groups and occasional wavy filaments distinguish it completely from other bacteria. His views and those of Koch are also in accord in regard to the difference between the cholera bacillus and those of Lewis and Finkler and Prior. He subsequently exhibited* some pure cultures of the latter's microbes and showed that they were totally different in their external form from those of the comma bacillus. He also exhibited a number of photographs, and quotes the following passage of Bienstock† in connection with the statement that it is impossible to establish the identity of two micro-organisms simply from the resemblance of their morphological characters:—"In bacterial observations culture and not the Microscope is the important point. The Microscope is principally only an accessory checking apparatus. It gives exact information only in the study of the development of the micro-organisms, but in regard to their morphology it is an uncertain guide, and in physiology generally of no use at all."

Bacillus of Cattle Plague.‡—Metzdorf has observed a distinctive *Bacillus* in the blood of animals which died of the disease; it was also observed in the coats of the intestinal canal and the lymphatic glands. The microscopic examinations were made on the bodies immediately after death, so that there could not be any question of putrefactive germs.

Cultivated Wine-Yeast.§—The true wine ferment on the skin of the grape requires a considerable time and a comparatively high temperature for its development; and before it attains its full activity other ferments and moulds develop and produce secondary fermentations which impair the quality of the wine. A. Rommier finds, however, that if the fresh must is mixed with a suitable proportion of cultivated wine-yeast (about 15 cc. per kilo.), fermentation takes place rapidly, even at temperatures as low as 15°-22°, and is complete in about seven days. If the must is mixed with sugar, the latter is entirely decomposed; but in this case complete fermentation requires a much longer time. The rapidity with which the principal fermentation takes place under these conditions prevents the development of the secondary ferments, and the quality of the wine is much improved. The low temperature at which fermentation takes place, and the short time required for its completion, render this method especially valuable for the production of white wines.

Preservation of Alcoholic Ferments in Nature.||—L. Boutroux has made a very large number of observations for the purpose of determining the mode in which the species of *Saccharomyces* which always accompany the decay of ripe fruits are perpetuated and propagated.

* Bull. Soc. Belg. Micr., xi. (1884) pp. 50-63.

† Zeitschr. f. Klin. Med., viii. (1884) Heft 1-2.

‡ Bied. Centr., 1884, pp. 419-20. Journ. Chem. Soc.—Abstr., xlii. (1884) p. 1398.

§ Comptes Rendus, xcvi. (1884) pp. 1594-6.

|| Ann. Sci. Nat. (Bot.), xvii. (1884) pp. 144-209 (4 pls.).

Both before and during the period of ripe fruits, several species of *Saccharomyces* are found, both in flowers (chiefly in the nectaries) and on the bodies of insects; the former being derived no doubt from insects, who have obtained them either from other flowers, from decaying fruits or other substances, or from the soil, which has been proved by Hansen to be an inexhaustible storehouse of these organisms. A comparatively small number are, however, at any time to be found floating in the air. When the fruits are being first formed the flowers have withered and dried up; if these persist round the fruit, the ferments may reach the latter directly; but these organisms are comparatively rare on unripe and uninjured fruits. As soon as the fruit is ripe, it is attacked by various insects which puncture the skin, and thus convey to the cellular tissue of the leaf the ferments of which they are the carriers; the species thus found being chiefly *S. apiculatus* and *Wurtzii*. But, although this explanation suffices for most fruits, it fails in the case of the grape, the ferments of which are almost exclusively *S. ellipsoideus* and *S. conglomeratus*, species not found on insects or flowers. Of this difficulty the author is not able to offer any satisfactory explanation. With regard to fruits in general, it may be stated that in the autumn the ferment is present everywhere on ripe fruits that have been in any way injured; after they have fallen, the organisms are preserved partly on the débris of the fruits, partly in the soil, where they hibernate. From the commencement of spring they are carried by insects to flowers, and finally from them to the ripe fruits.

MICROSCOPY.

α. Instruments, Accessories, &c.

Beck's Portable National Microscope.—The object of Messrs. Beck in designing this instrument (fig. 1) has been to produce a Microscope which should retain the rigid Jackson-Lister limb, and combine with it great portability. This object has been effected by making the feet of the stand to fold up and the stage to swing on a strong joint, thus enabling the instrument with apparatus to be packed in a case measuring $10\frac{1}{2}$ in. \times $7\frac{1}{2}$ in. \times $3\frac{1}{2}$ in. A large amount of useful apparatus can be added without increasing the size of the case. The legs, which fold up in the smallest compass, are very firm when spread out. The substage has rack-and-pinion movement, and the stage, which rotates concentrically, can be replaced by one with mechanical movements by rack and pinion if so desired. None of the strength or stability of the instrument is sacrificed for its principal feature of portability.

Beck's Combined Substage Apparatus.—Whilst applicable to other forms of instruments, the combined substage apparatus (fig. 2) has been specially designed by Messrs. Beck for their portable "National"

stand (*supra*, p. 115). It consists of a wide-angle achromatic condenser with double diaphragms, dark-ground illuminator, and polarizing

FIG. 1.



apparatus. The condenser has an angle of 180° , that can be varied at will by the diaphragms. It can be drawn away when not in use

(as shown in the figure) by sliding it down the inclined fitting without altering the position of the substage. The front lens is removable for work with low powers, and for dark-ground illumination is replaced by a truncated lens. Below the condenser is placed a revolving polarizing prism which can be thrown out, as shown in fig. 2, when not in use. Between the polarizing prism and condenser are two revolving diaphragm plates; one containing a series of apertures for varying the angle of the condenser, the other containing two selenites and a blue glass disk for moderating the light. It will thus be seen that with this compound substage apparatus the polariscope may be used by itself, or in combination with the achromatic condenser, or with dark-ground illumination; and all the different modes of illumination requisite for general work may be obtained with it.

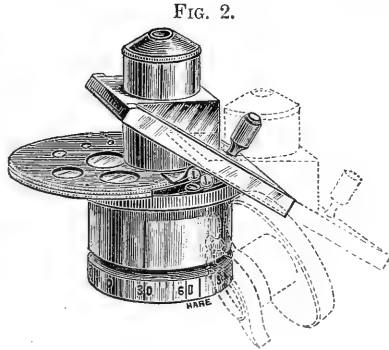

Lehmann's Crystallization Microscope.*—O. Lehmann describes the arrangement which he has devised for examining microscopically small crystals, amorphous deposits, gas bubbles, &c., under different conditions of temperature or pressure and with powers up to 100. The Microscope proper is shown in fig. 3, the work-table to which it is attached in fig. 4.

The body-tube of the Microscope is supported on a stout bar of iron, which is bent at right angles and is fastened at its base to the plate *a a* (fig. 3), which fits into the place marked *a a a a b* in fig. 4. The stage-plate *o* is attached to a revolving plate *p*, rotated by the handle *y*, and showing the extent of rotation by the graduations on the lower plate *z*, seen through an aperture closed with glass at *w*. A lamp and mirror are fixed at *r* and *s* respectively, with a bull's-eye interposed at *t*. A polarizing prism *u* is attached to a movable arm *m*, and an analyser at *n*, the latter supported on a hinge so as to be slipped in and out of the body-tube. For heating the objects a gas-burner *d c x* is introduced into the central aperture of the stage, the heated air passing off between *o* and *p*. The pipe is double, for conveying gas and air. The jet can be removed by the handle at *e*, and the two taps I and II regulate the admission of the gas and air. For cooling the object a pipe is provided at *f* in connection with the tap III, by which a stream of air is admitted. A board for camera lucida drawing is placed at *g*, and a photographic arrangement can be used as with an ordinary Microscope.

The work-table is symmetrical on both sides of the Microscope,

* Zeitschr. f. Instrumentenk., iv. (1884) pp. 369-76 (4 figs.).

only that on the right side being shown in fig. 4. There are four troughs *k k'* (two on each side).

FIG. 3.

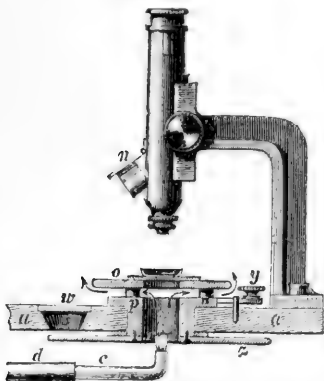

Three of these serve for reagents and utensils, while the fourth *k* is for washing slides, &c. At *h* is a contrivance for heating objects previous to their examination (two shown on a larger scale in section in fig. 5). They are placed on the supports at *l* when they are required to cool. The flaps 1, 2, and 3 cover the table when not in use, and can be used separately or together. When all are closed, only the Microscope stands out above the level of the table, but if required this can also be removed and put in a box under the lamp, a board filling up the opening in the top of the table. The table also contains the necessary appa-

FIG. 4.

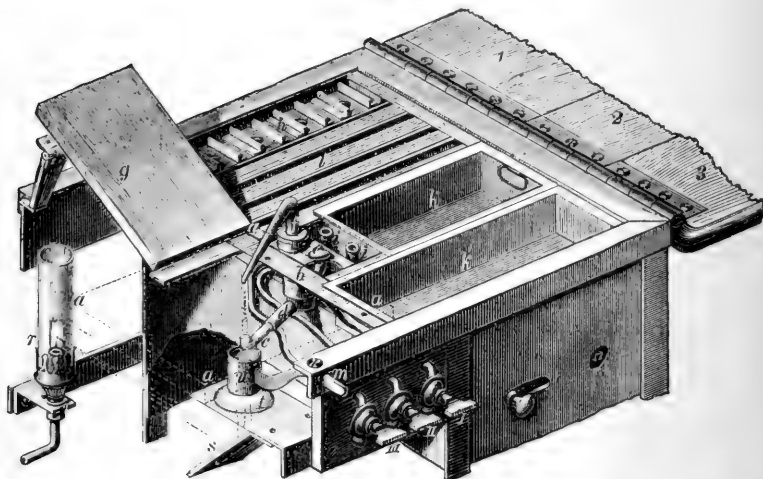

ratus for a hydrostatic blast or other means for obtaining the necessary air currents.

For experiments at very high temperatures a modification of the stage is made use of, shown in fig. 6. The object is placed on a small super-stage, and the objective is protected by a glass screen, through which cold water passes by means of the two tubes which are connected with *ii* in fig. 4. Two electrode holders with quicksilver cups are shown in the fig. for experiments on electrolysis of melted salts.

For experiments on the influence of pressure on physical and chemical combinations the substance to be examined should be enclosed in a very long spiral capillary tube, nearly filled with an

FIG. 5.

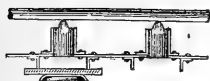
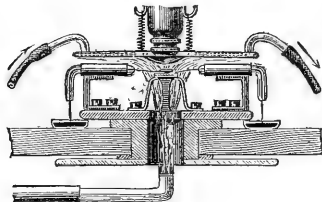

FIG. 6.



indifferent fluid which on being warmed will exert considerable pressure. By using liquefied gases the effect of low temperatures can also be observed.

Queen & Co.'s Class Microscope.* — This (fig. 7) is identical with Waechter's or Engell's instrument already described.† We have had one of the original forms in use for some time, and have found

FIG. 7.

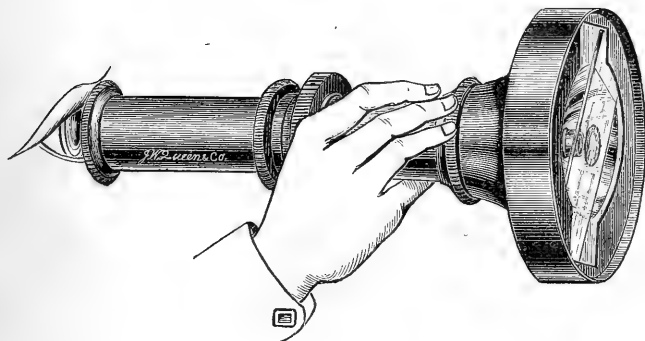

it very convenient for exhibiting objects. By daylight it is simply turned to the sky, and there is no difficulty in at once getting the proper illumination. By artificial light the instrument requires somewhat more adjustment, unless there is a large illuminating surface or the Microscope is brought close to the source of light.

Swift-Wale Microscope.—Messrs. Swift and Son have made further modifications in Wale's model, which is now constructed as shown in fig. 8. The original form was figured in Vol. I. (1881) p. 296.

* *Micr. Bulletin*, i. (1884) p. 47 (1 fig.).

† See this *Journal*, ii. (1882) p. 398.

The modifications consist in (1) an increase in the length of the radial inclining limb, so that the body-tube is carried more forward, thus providing space for the *complete* rotation of the ordinary form of mechanical stage; (2) the application of the fine adjustment to a slide

FIG. 8.



in front of the coarse-adjustment slide, so that the whole body-tube is acted upon, and not merely the nose-piece, as in their original form shown in Vol. I. (1881) p. 297, fig. 43; two adjusting screws enabling the movement to be regulated with great delicacy; (3) the application of the double "stepped" diagonal rackwork for the coarse adjustment

as suggested by Mr. J. Mayall, jun. ; and (4) an alteration in the form of the tripod, so that when the instrument is vertical the crank-arm of the mirror is allowed free lateral play.

By this system of fine adjustment (which is patented) the binocular prism is brought more than $1/4$ inch nearer the posterior surface of the objective-lenses than in any Microscope hitherto constructed by Messrs. Swift.

Sorby's Dichroscope.—Dr. H. C. Sorby's dichroscope (fig. 9), as made by Messrs. Beck, consists of four parts:—(1) An A eye-piece, between the two lenses of which slides a blackened brass plate with a circular aperture and a slit. The width of the latter can be varied by the small milled head acting on a spring. (2) A double-image prism. (3) An analyser; and (4) a direct-image prism. As the whole apparatus is somewhat heavy, the tube of the eye-piece does not terminate just below the field lens, but is continued for an inch further, so as to insure a firm hold in the body-tube. The field lens is attached to a separate inner tube, which slides (with a bayonet catch) in the outer, so that it may be readily removed for cleaning.

The method of using the apparatus is thus described by Dr. Sorby (extracted from letters from himself):—

“ In the examination of sections of granite and other minerals with polarized light, if the sliding plate be inserted in the eye-piece and the double-image prism placed over the eye-piece under the analyser, two images of the hole or slit are seen, of different colours if the object on the stage is dichroic, or if the colour is due to chemical change only one image will be coloured. If now the direct-image prism of a spectroscope be placed over the double-image prism and the analyser removed, the two spectra can be seen side by side.

The most useful application of the instrument is in studying small crystals or sections of rocks. We can then tell whether difference in colour is due to mere difference in position of the same crystal or not; for example, in many granites we see yellowish and orange crystals mixed up with the black. By means of the dichroscope we can see at once that these are the same mineral in different

FIG. 9.

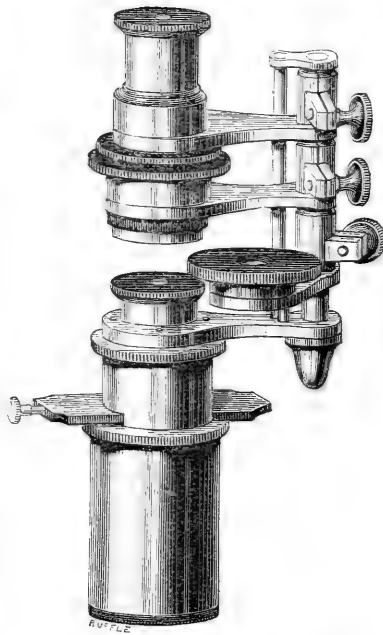

positions. If the crystal is doubly refracting and is strongly dichroic we may be sure that the colouring matter was formed along with the crystal, but if it is not dichroic we must conclude that the colour was due to a change which took place after the formation of the crystal. We may thus infer that the colour of the spiculæ of *Gorgonia* was formed at the same time and was not introduced afterwards."

Mayall's Mechanical Stage.—Mr. J. Mayall, jun., has improved Wenham's single-plate mechanical stage, by dispensing with the plate which from its thinness is liable to flexure. The slide is made to lie on the surface of the rotating stage-plate, being held in a hinged frame connected, by a sliding fitting, with the mechanical movements. The object-carrier is shown in fig. 10 as applied to the stage; the

FIG. 10.

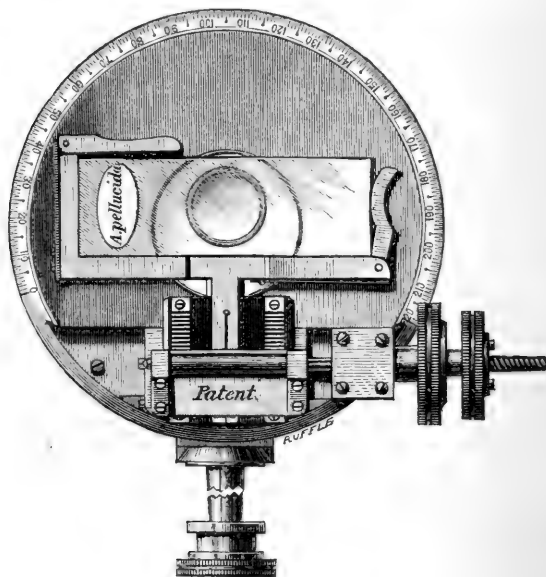

curved arm on the right and the straight arm on the left are hinged with sprung fittings and open like the blades of a pocket-knife, to admit the slide. The inner edges of the frame are bevelled inwards so that the sprung arms press the slide in close contact with the rotating stage-plate.

To obviate the inconvenience due to any unevenness of surface of the glass slides, a narrow strip of paper may be gummed near the ends of their under surface.

The use of this carrier is equivalent to a corresponding reduction in the thickness of the stage, and as the slide lies in contact with the surface of the rotating stage-plate, the flexure that is found more or less in every form of mechanical stage, acting by one or more superposed plates, is obviated.

Abbe's Condenser.—We are indebted to Dr. Zeiss for the accompanying woodcuts of this apparatus, which although of somewhat

FIG. 12.

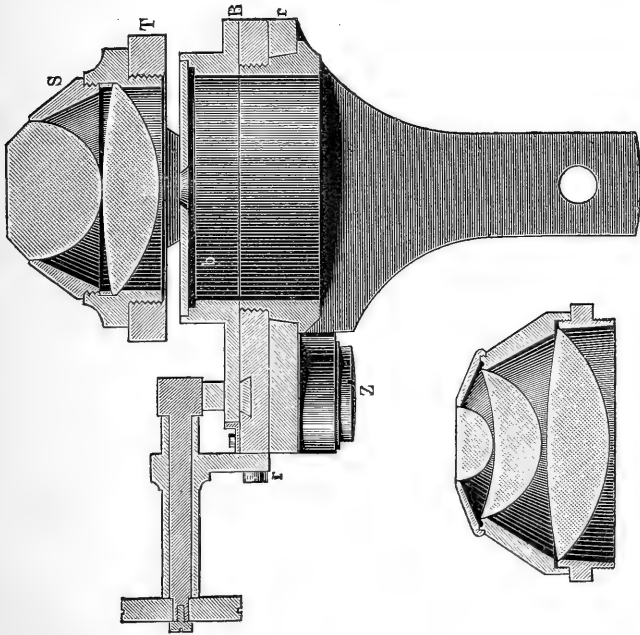
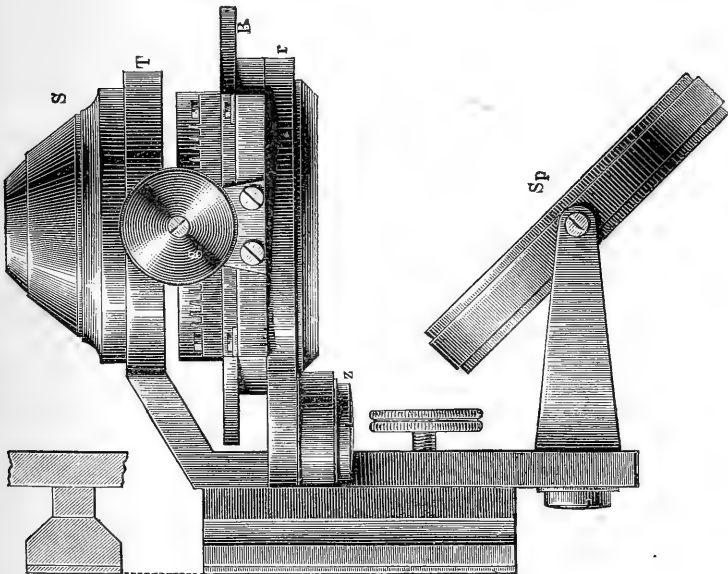

FIG. 11.



large scale (natural size) illustrate the construction of the illuminator better than any previously given.

Figs. 11 and 12 show the illuminator in side view and section as intended for application to the large Zeiss stand, *Sp* being the mirror, *z* the pin on which the outer diaphragm-carrier *r* turns, *B* the inner carrier for the diaphragm disks (*b*) moved by the milled head *g*, and *T* the holder for the optical combination *S*. The double combination is for use with objectives of aperture not exceeding 1.20 N.A., whilst the triple combination has an aperture of 1.40 N.A.

Modification of the Abbe Condenser.—*W. Behrens** modifies the mechanical part of this condenser in the manner shown in fig. 13, to correct principally two inconveniences; 1st, that the focus of the optical combination cannot be brought much below the object, and 2ndly, that the lenses cannot be removed and an ordinary cylinder-diaphragm substituted.

The bar *t* has at the lower end the mirror *s*, and at the upper end the carrier *i* for the lenses *l*. The bar is provided with rackwork, and

FIG. 13.

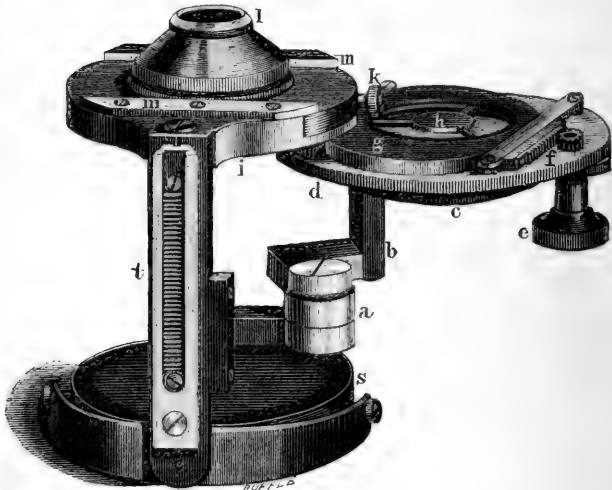

is raised or lowered in a vertical direction by a pinion and milled head beneath the stage. The two sets of lenses for use with high and low powers are each attached to a plate which slides (by the milled

* *Zeitschr. f. Wiss. Mikr.*, i. (1884) pp. 409-12 (1 fig.).

head *k*) between the guides *m m*. A third plate carries a cylinder for the ordinary cylinder-diaphragm. The diaphragm holder *c d g* is attached to the bar *t* by the double elbow-piece *b* turning on *a*, so that it can be brought out from under *i*, and the diaphragms (*h*) readily changed. When in its place there is nothing to prevent a complete revolution of the diaphragm-carrier by its milled rim, the elbow-piece allowing the milled head *e* of the pinion *f* to pass without obstruction. This is a third advantage claimed by the designer, as the original form will not allow of this complete rotation. The mirror by the addition of a simple contrivance could be made to move obliquely.

Either central or oblique illumination can therefore be used without, as heretofore, having to remove the whole apparatus from the Microscope and substitute a second form.

Mr. T. Curties informs us that he has for some time constructed the Abbe condenser so that it can be moved vertically beneath the stage. This he accomplishes by attaching to the bar a tube-fitting *t* (fig. 14) by means of which the condenser slides on the tail-piece of the Micro-

FIG. 14.

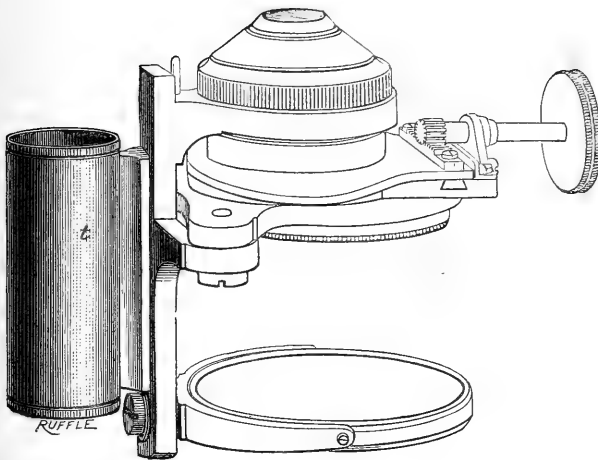

scope. A pin secures it in the optic axis. By this arrangement, moreover, the condenser is readily applied to the simplest forms of stands, which has long been a great desideratum.

For the larger stands with rackwork substages he has been in the habit of applying the same form of condenser, but without the tube-fitting, rackwork being added to the bar.

Some microscopists prefer Dr. Zeiss's modification for large English

stands with substages,* shown in figs. 15 and 16 (for 1.40 N.A.). Here the condenser slides into the substage, and can be accurately centered by the substage adjusting screws. It is, however, very heavy.

FIG. 15.

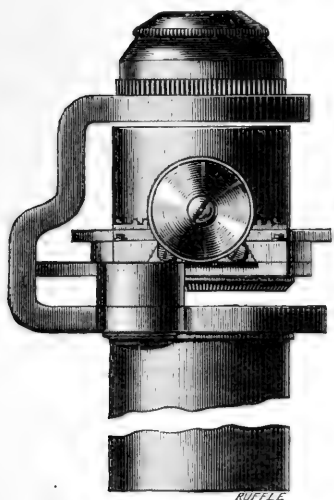
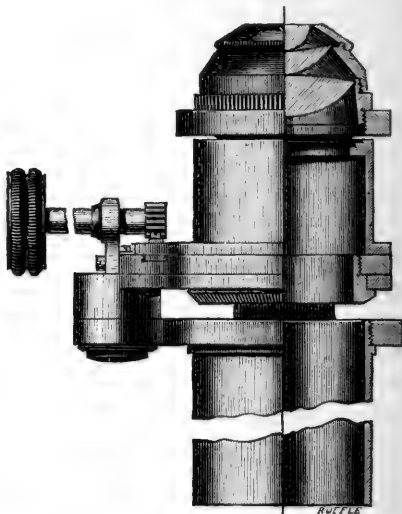

FIG. 16.



Swift's Cone and Achromatized Immersion Paraboloid Condenser.—Mr. J. Swift, referring to Dr. Wallich's condenser described

FIG. 17.

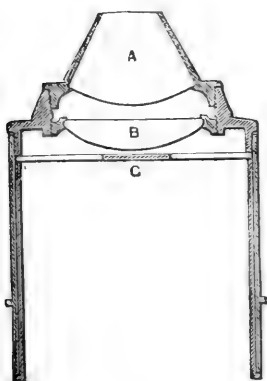
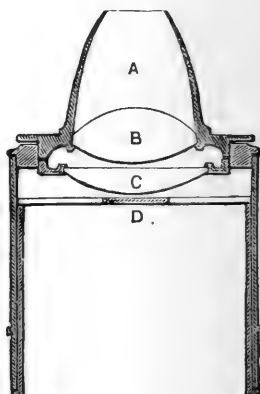

FIG. 18.



at p. 963 of Vol. IV. of this Journal, claims priority in the construction of such a condenser, and sends us the diagram, fig. 17, of the

* See also this Journal, ii. (1882) p. 411.

one which he made in 1883. A similar condenser was supplied to a Fellow of the Society in January of that year. As will be seen from the figure, there is a cone A with convex under-surface; the lens B is however nearly in contact with the convex surface, whilst Dr. Wallich separates them somewhat.

Mr. Swift further says that finding the cone gave confused pencils of light instead of convergent rays, he (in 1884) substituted for it an achromatized paraboloid, with a flat top for immersion. This is shown in fig. 18. A lens B is cemented to the lower surface of the paraboloid A, with a second lens at C. It screws on the same form of substage-fitting as the cone.

In each form an annular diaphragm (C and D) slides inside the adapter so as to be in contact with the lower lens.

Wallich's Condenser.*—Dr. G. C. Wallich more fully describes the advantages of his condenser as follows:—

“The principle I have kept in view in the production of the condenser is that for the illumination of transparent objects in the Microscope, the conditions as regards light should as closely as possible be assimilated to those under which we are accustomed to look at transparent objects with our unaided eyesight—that is to say, by an ‘all round’ light, in which, however, the rays proceeding from any selected azimuth are partially, or, if need be, wholly, cut off. This end is attained by a very simple and well-known mechanical contrivance, inasmuch as the condenser itself (when fitted, as it can quite easily be, to the substage of any Microscope) hardly ever requires to be moved out of the axis of the instrument. Hence, it may be regarded as supplying the very opposite mode of illumination to that usually implied by the term ‘oblique.’

Again, instead of seeking to bring the whole of the utilized rays to a focus in a point at the centre of the object under examination, or, in other words, instead of securing only a single brilliantly illuminated focal plane extending circumferentially and horizontally outwards from one focal point, it has been my aim to produce (both in the monocular and binocular Microscope) a succession of brilliantly and nearly equally illuminated horizontal planes extending to the very margin of the field, and yet allowing the formation of just sufficient shadow to secure the desired results.

What these results are I will now briefly describe, premising, however, that I expect no one to accept my statement without having an opportunity of testing its accuracy by ocular demonstration. I consider this proviso as all the more essential, inasmuch as, if my statement bears the test, two or three important dogmas in the theoretical optics in relation to the Microscope will, undoubtedly, have to undergo a certain amount of revision.

In the first place, I claim that the condenser increases to a very great extent the range of *penetration* at our command; and that through its means we are enabled to see a transparent object, or any number of transparent objects, at a single focusing, very nearly as distinctly as

* Engl. Mech., xl. (1884) p. 320.

we should be able to see a similar object or objects if they could be presented to our unaided vision, of the same size as the microscopic images, at the ordinary visual distance, and mounted in equivalent depths and thicknesses of mounting material. In short, that we see the objects suspended, as it were, in their true relative positions to each other in the mounting medium, those nearest to the eyes or lying in the plane to which the focus has been most perfectly adjusted being, of course, best defined, whilst those situated below or above that plane are seen very nearly, if not quite, as distinctly as they would be in ordinary vision were the conditions assimilated to the extent already indicated. Of course, I do *not* assert that any condenser can impart to any objective additional penetrative power to that already implanted in it. What I claim is that the new mode of illumination supplies those conditions which allow any objective to 'put its best leg foremost.'

In the second place, I claim that this method of illumination proves that there are such things in microscopic vision as *orthostereoscopic* projection and perspective." Dr. Wallich then goes to say that the existence of both of these "attributes has, as we all know, been "emphatically and unconditionally denied by more than one of our "most accomplished and deservedly renowned theoretical opticians." Dr. Wallich, however, in making this statement, has misapprehended the views to which he refers, which are not in conflict, as he supposes, with any results obtained by him.* The further statement that "Dr. Carpenter has for many years stood alone in contending that true stereoscopic vision does not take place in the Microscope," contains, we presume, a misprint, in that the "not" should have been omitted.

Osborne's Diatomoscope. Modified Wenham Disk Illuminator. †—W. F., whilst having no doubt that the diatomoscope will give a pencil of light sufficiently oblique for the various objectives used, considers that the same result can be got in a much simpler and cheaper way. Mr. Wenham's disk illuminator serves the object in view very well; but it has one serious defect—there is no provision for a shutter in front to narrow the band of light. He prefers to take a hemispherical lens about $\frac{1}{4}$ or $\frac{3}{8}$ in. in diameter, and after burnishing it into a setting, cut the setting almost entirely away at one side, leaving only sufficient to hold the lens. Slip this lens so mounted into the top of a tube of the proper size, and slit the tube at one side below the lens downwards for $\frac{1}{2}$ in. or so with a fine saw. The cut sides of the tube chemically blacken. When the tube is mounted beneath the stages so as to almost touch the object slide, and with a provision for turning it slightly round, the lamp being placed in front of the slit in the tube, it will be seen that the band of light transmitted by the lens may be made any breadth from the width of the cut in the tube

* See this Journal, iv. (1884) pp. 496-7.

† Engl. Mech., xl. (1884) p. 321.

to a hair's breadth by turning the tube, and any obliquity of the pencil may be got either by inclining the Microscope or raising the lamp. There is in this way no necessity for converting the lens into a disk. The hemisphere sent out by Zeiss with his oil-immersion lenses is, he thinks, too large.

Dr. H. Van Heurck,* in a note in commendation of the diatomoscope as an oblique condenser, says, "It has been said that oblique condensers were of no utility through giving false images. I am not of that opinion; certainly, if object-glasses could be constructed so as to resolve everything with an axial illumination (there are diatoms much more difficult to resolve than *Amphipleura pellucida*), and if these object-glasses could be supplied at so moderate a price that every one could have them, then I should say that oblique condensers could be done away with. But, unfortunately, such is not the case—at least, nowadays; yet we may foresee that by discovery of new media, our means of investigation may be considerably improved.

Meanwhile, the oblique condensers render notable services; in cases where it is not allowed us to *see*, we may *conceive*. We know that the valve of the diatoms is provided in most cases with alveoles, and in others with fine punctuations. The striæ, then, by the oblique condensers are the solid and thickened parts of the valve, and the distance between them allows us to judge of the size of the alveoles; also the direction of the striæ shows whether the alveoles are disposed in opposite series which produce longitudinal and transversal striæ, such as in *Pleurosigma balticum*, or in alternate series which produce oblique striæ, such as in *P. angulatum*."

Oblique Illuminators.—The value of oblique illuminators has recently been the subject of some controversy. Mr. E. M. Nelson † considers that "oblique illuminators, be they diatomoscopes, reflex illuminators, revolver prisms, or what not, should, in the interest of microscopical science, be consigned to the dust-bin. I am confident that by their use only false images can be obtained. In former days microscopists used this kind of illumination, and in consequence talked of the striæ on *Pleurosigma*, *N. rhomboides*, &c. Now, we know there are no striæ at all on these diatoms; the marks being isolated dots, the striæ owing their origin solely to the running together of these dots by improper illumination. In the case of *A. pellucida*, we have to content ourselves with the appearance of striæ, simply because it is beyond the powers of our widest angled objectives. I have not the slightest doubt that if an objective were made capable of completely resolving it, it would appear similar to *N. cuspidata*, having more dots to the inch transversely than longitudinally. Few have worked with oblique illuminators more than I have; my experience leads me to say that an oblique illuminator for the Microscope is *not* wanted."

* Engl. Mech., xl. (1884) p. 365.

† Ibid., p. 242.

"F.R.M.S." thinks * that in the interest of the *history* of microscopical science, Mr. Nelson should consider the service hitherto rendered by "oblique illuminators" towards the improvement of the Microscope. The category of oblique illuminators includes every condenser devised, from the days of Descartes' gigantic parabolic reflector applied at the nose-piece, down to the days of Powell and Lealand's achromatic condenser. The former was afterwards modified to its present form by Lieberkühn, and is now termed the "Lieberkühn," and Mr. Nelson gave it unqualified praise in his "demonstration" at the "Quekett"; the latter, on the same occasion, he extolled enthusiastically as "*the finest condenser in the world.*" Every form of condenser deals with oblique rays, and is, therefore, an oblique illuminator, and *as such* has contributed its quota towards the improvement of the Microscope. Nothing since the invention of the Microscope has done more to cultivate the critical eye for excellence in the optical construction than the striving to devise and utilise condensers. Without condensers the importance of increasing the apertures of the objectives might never have been discovered.

"Mr. Nelson says that a new oblique illuminator of nearly 1.5 N.A. is '*not wanted.*' I will endeavour briefly to show the use it may be put to, bringing him in as a witness.

Mr. Nelson has repeatedly admitted that the finest 'resolving' power of any objective is reached just before the obliquity of the illumination is so great as to be *beyond* the aperture of the objective, i. e. just before the dark field is reached. This is matter of common experience, and I assume it to be agreed upon. Moreover, I refer only to objectives of the best construction, which work accurately to the limit of their aperture. It would appear, then, that Mr. Nelson himself has not yet seen the finest resolving power of objectives of 1.43, 1.47, or 1.5 N.A. (the limit reached by Powell and Lealand in the 1/6ths made for the President and one of the Vice-Presidents of the R.M.S.), because, if I am rightly informed, he has never had the use of any oblique illuminator of higher N.A. than 1.4 (i. e. Powell and Lealand's truncated oil-immersion condenser referred to by Mr. Nelson on p. 240 of the current 'English Mechanic,' whence I quote its numerical aperture). In order to obtain the finest 'resolving' power of such objectives, an oblique illuminator of 1.5 N.A. is therefore required in spite of Mr. Nelson's negation, for with such a condenser alone can we approximate to the 'dark field'—the condition of '*finest resolution.*'

When Powell and Lealand issue their achromatic immersion condenser of 1.5 N.A., which has been on the way for many months past, we shall, doubtless, be enabled to run through our present range of apertures in a manner worthy of the splendid optical skill of these opticians. But achromatism with such an aperture must necessarily be costly. At present we are in the position of having objectives with apertures beyond the reach of any recognized form of condenser. We can, it is true, illuminate very near the limit of the apertures of

* Engl. Mech., xl. (1884) p. 261.

our finest objectives by means of Abbe's immersion condenser, Powell and Lealand's truncated ditto, using the mirror in the axis, or by means of Tolles's transverse lens or equivalent means, using complex reflecting prisms to reach the required obliquity of incidence, or by swinging the mirror from the axis. But I want to see our illumination brought conveniently on a par with or beyond the apertures of our finest objectives, so that we may readily test the value of the last zone of working aperture. We have been told by Prof. Abbe what is the *theoretical* resolving power of a numerical aperture of 1.5. I want to *see* the matter demonstrated practically by means of a convenient and inexpensive condenser—one that will not require an infinitesimally thin stage, or other elaboration of the mechanism of our Microscopes.

As to Mr. Nelson's observations on the 'true' structure of certain diatoms, I should have expected his rout on that point by 'Monachus' would at least have taught him that no amount of devotion to the inspection of the surface of *Amphipleura pellucida* would enable him to decide the question of its 'true' structure. If we really know anything of the true structure of the finer diatoms, our knowledge has been derived mainly from the comparison with coarser and coarser forms, of which the structure has been made out, more or less satisfactorily, by the examination of fractures or sections, and carefully tracing the correspondence with surface views—certainly not by mere examination of the surface. As Mr. Nelson still clings to his empirical views on the question of the determination of 'true' structure, I must counsel him to read more closely 'Monachus's' refutation of his views.

Oblique light is the most potent means we have of arriving at the *minimum visibile* with the Microscope. I do not say that by it alone can we arrive at *true* interpretations of minute structure; nor, on the other hand, can I agree with Mr. Nelson that we owe to its use all our erroneous interpretations. It appears to me that errors of interpretation are matters personal to the observer. If the observer will insist on pledging himself to this or that view, regardless of the fact that the *whole* of the necessary data may not be within his reach, then, as I take it, he alone is responsible for the blunders he may make; and he should not blame oblique illumination, for, with sufficient knowledge of the complexity of the conditions involved in accurately diagnosing the structure of fine diatoms and of the means at command towards the solution of the problem, he would give due weight to every mode of illumination, and no more than its due weight. Under such circumstances an oblique illuminator would be an important factor, and I think it probable that Mr. Nelson's dust-bin, if not already emptied, would yield up an odd contrivance or two which the 'scientific microscopist' would be glad to possess."

Mr. Nelson rejoined * that "F.R.M.S." is mistaken "if he thinks

* Eng. Mech., xl. (1884) p. 282.

that I do not value oblique illuminators as matters of history in the development of the Microscope. It was merely in their use as instruments of modern scientific research that I condemned them. Condensers and Lieberkühns cannot be justly called oblique illuminators, though they may be used as such. I cannot agree with the statement that 'oblique light is the most potent means we have of arriving at the *minimum visibile* with the Microscope.' So far as I know, the smallest object which has been publicly exhibited is the flagellum of a *Micrococcus* which I showed at the Q.M.C., and by invitation at the soirée of the R.M.S. The length of the double micro-organism was only $1/12,000$ in., the flagellum was barely half that length. Now if we take as a *maximum* estimate $\frac{\text{breadth}}{\text{length}} = 1/6$,

we shall have $1/144,000$ in. as the thickness of the filament. This ratio is probably greatly in excess of the truth. This object is only visible with *direct* light: *oblique* light completely obliterates it."

"F.R.M.S." in reply * considers that Mr. Nelson "has involved himself in the following paradox:—He considers that the diatomoscope, which provides oblique rays in *one* azimuth, is an oblique illuminator; whereas the Lieberkühn or a condenser which provides oblique rays in *all* azimuths, is *not* an oblique illuminator. In other phrase: Light incident in one azimuth is oblique; in *all* azimuths, *not* oblique! I will leave him to explain the paradox.

He does not agree with my remark that 'oblique light is the most potent means we have of arriving at the *minimum visibile* with the Microscope,' and as an example of what he regards as the *minimum visibile*, he cites a flagellum of a *Micrococcus* estimated at $1/144,000$ in. in thickness, 'which is only visible with *direct* light; *oblique* light completely obliterates it.'

On this I remark, firstly, that I think his *direct* light, if critically examined, will be found to consist chiefly of oblique light.

Secondly, by way of parallel example embodying the opposite view, I cite one of the most prominent items of what is generally admitted to be 'modern scientific research,' the original discovery of the flagellum of *B. termo* by the eminent microscopist Dr. Dallinger.† This discovery was made by the use of the most oblique light obtainable by the recognized condensers of that date, a method of research utterly condemned by Mr. Nelson. That in Mr. Nelson's hands the flagellum should be 'obliterated' by the same kind of illumination by which Dr. Dallinger first discovered a similar flagellum, is another paradox, which I leave for his consideration. I note, in passing, that Dr. Dallinger, in referring to the oblique illuminator he employed, wrote that it had 'the advantage of throwing the light in only from one direction [in azimuth].' Now, singular as it may appear, Mr. Nelson *condemns* the diatomoscope for possessing the qualification commended by Dr. Dallinger.

* Engl. Mech., xl. (1884) p. 299.

† Mon. Micr. Journ., xiv. (1875) pp. 105-8.

Thirdly, the flagellum of *Micrococcus*, though but $1/144,000$ in. in diameter, does not come within the range of what I should regard as the *minimum visibile* with the Microscope. During the past fifteen years we have known of the resolution of lines $112,000$ to the English inch. Assuming the lines and the interspaces to be equal (*vide* Dr. Woodward's photographs of Nobert's 19-band test plate), then they each represent $1/224,000$ in. Now, if we have already succeeded in resolving with the Microscope spaces of this degree of proximity, the mere perception or recognition of one single object of $1/144,000$ in. is no feat in microscopical manipulation in the direction of the *minimum visibile*. It would seem that Mr. Nelson, having found a difficulty in exhibiting the flagellum of *Micrococcus*, has made a random shot at an explanation of his difficulty, and has dropped upon the minuteness as the *vera causa*, strangely ignoring the conditions of visibility by which the object is easily or with difficulty differentiated from the medium in which it is placed."

Bertrand's Polarizing Prism.—Dr. H. Schröder writes us that the first form of this prism* was devised as long ago as 1869 by Jamin and himself, and later by Feussner.†

The second form is an impracticable one as no glass is known of the refractive index 1.65 and which has a perfectly white colour and will not tarnish in the air. The angle of field $98^{\circ} 41'$ given by Bertrand can only be obtained by moving the eye about from side to side. If the eye is fixed the field is only $47^{\circ} 27'$. If the prism were made of calc spar and cemented with linseed-oil the above angles would be $83^{\circ} 6'$ and $42^{\circ} 10'$.‡

Bulloch's New Lamp.§—W. H. Bulloch's new lamp is shown in fig. 19. The reservoir and base are similar to those of the "Beck Complete Lamp," but the burner, instead of being in the middle of the reservoir, is placed on one side. This gives room for a brass upright on the other side, which supports the bar carrying the bull's-eye. The latter is focused by sliding the bar in either direction, and the light is directed either upward or downward by swinging the arm as required, and clamping it in any position by the milled head shown. Only one side of the chimney is open, and the rectangular aperture is covered with a plane glass slip 3×1 , outside of which may be slipped in a blue slide or one with a ground surface to modify the light. There is also a brass slit, adjustable in width, which fits outside of all. This is intended to give a narrow line of light. The chimney turns about the burner, so that the broad face of the flame or the edge can be used at pleasure. The reservoir,

* See this Journal, iv. (1884) p. 965.

† *Ibid.*, p. 456.

‡ See also *Zeitschr. f. Instrumentenk.*, v. (1885) p. 30, from which part of Dr. Schröder's remarks are taken.

§ *Amer. Mon. Micr. Journ.*, v. (1884) p. 205 (1 fig.).

|| See this Journal, iv. (1884) p. 628.

carrying everything upon it, moves up and down, by a rack and pinion, on the upright bar from the base, as shown in the fig. The

FIG. 19.

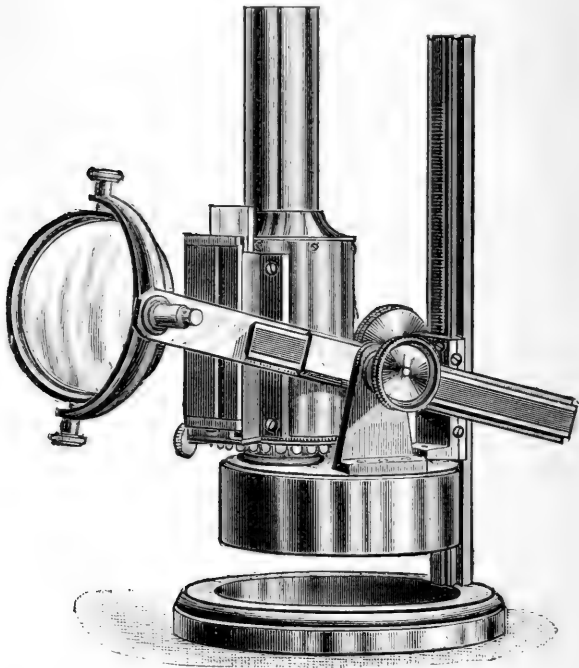

chimney and reservoir are nickel plated and the other parts of brass.

Live-Cell.—This cell (fig. 20) is of unknown authorship, but is claimed to be convenient when it is desired to keep the water cool in which any living objects are being examined. It dispenses with the alum cell, which is an objectionable adjunct, affecting as it does both illumination and definition. The inner circular cell (open at the top for the reception of the objects) is distinct from the outer rectangular cell, but has six minute holes in its circumference. These allow of a constant interchange between the water in the inner and outer cells, and that in the latter can of course be supplied at any desired temperature. Unless the holes are very small, there will of course be a danger of the minuter organisms making their escape into the outer cell.

The cell would seem to be likely to be more useful for lantern

demonstration (where the heat is often great) than for any other purpose.

FIG. 20.

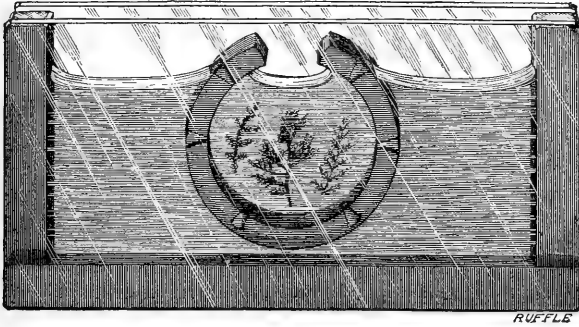

Giles' Live-Cell.*—G. M. Giles finds that the main drawbacks of most cells for the observation of living objects are that they either leak or are very difficult to clean, and suggests the following form (figs. 21 and 22) to obviate these defects. Take a stout ground-edged

FIG. 21.

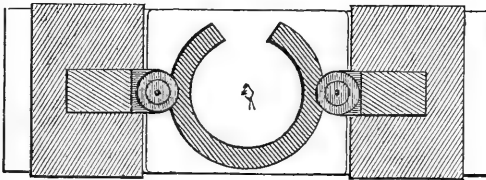

glass slip, and have fitted to it two sheaths of thin brass, about $\frac{3}{4}$ in. wide. These should be made to fit closely, but not so tightly as to prevent the glass slip from sliding easily through them. To the middle

FIG. 22.

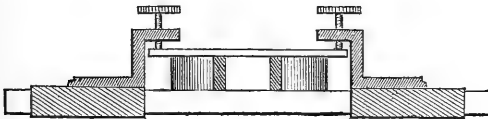

of one end of each sheath is soldered a small brass arm (shaped as in fig. 22), carrying a fine screw on one arm, which, when secured in position, projects about $\frac{1}{4}$ in. beyond the end of the sheath. A piece about $\frac{1}{4}$ in. long, cut off a thin glass slide, and a thick indiarubber

* Sci.-Gossip, 1885, pp. 7-9 (2 figs.).

ring (those used for Cod's patent soda-water bottles serve excellently) complete the requirements.

To put the parts together, slip the sheaths, one on to each end of the glass slide, with their two little screw arms projecting towards each other. Now cut a small piece out of the circumference of the indiarubber ring, and place it on the slide between the sheaths, with the opening towards one of the long sides of the slide. Place on the top of the ring the short piece of glass, and slide the sheaths towards each other, till the small screws project over its ends. Then, by turning down the screws, the ring is compressed between the two pieces of glass, and a perfectly water-tight cell results. By using rings of different thickness, cells of every convenient depth may be obtained.

When finished working, the whole can be taken to pieces in an instant and cleaned. If a well-polished piece of glass, free from flaws, be chosen for the upper plate, its thickness will not be found to interfere very materially with the performance of any power below $1/2$ in.

Jung's Compressorium.*—During some histological investigations on *Hydra*, &c., H. Jung was often obliged, in order to isolate the

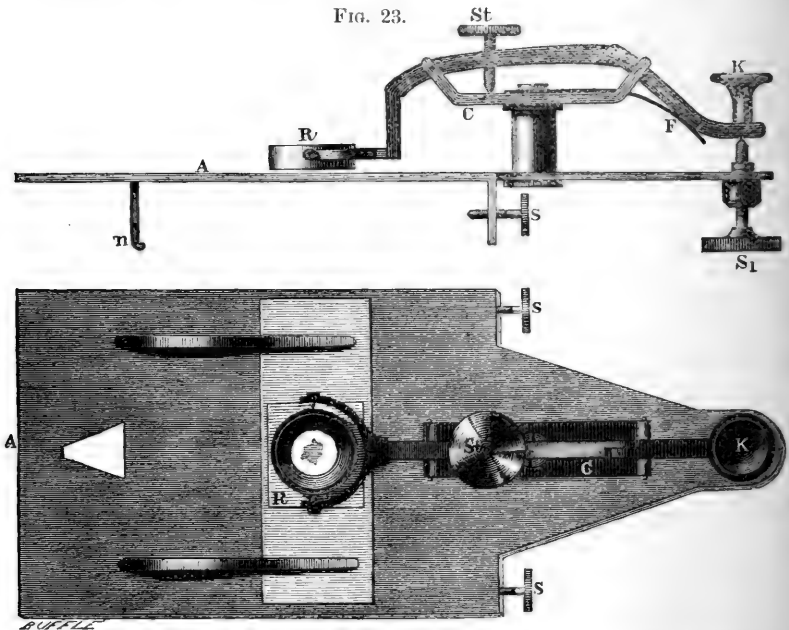

cells, tissues, &c., to adopt the process of "beating." This, however, he found an exceedingly tiresome process, especially when it has to be

* Zeitschr. f. Wiss. Mikr., i, (1884) pp. 248-50 (1 fig.).

carried on for hours with perhaps the handle of a dissecting needle, and the ordinary compressors being unsuitable for the purpose, he therefore devised the form shown in fig. 23.

The plate A is attached to the stage by the catch *n* and two screws S S. On this plate is a double lever, one arm of which has a movable ring R and adjusting screw St, and the other the knob K. The two levers are so connected with the bent piece C that when K is pressed down the ring R is also pressed towards the stage-plate. Conversely an upward movement of the knob, produced by the spring F, raises the ring again. The screw S₁ regulates the extent of movement of the end of the lever.

To use the apparatus the screw St is adjusted so that the ring lies nearly close to the large and thick cover-glass of the preparation, and S₁ is turned so that the lever can move but very slightly. The object is then focused, and by quick and continuous movement of the knob and the changing pressure on the cover-glass thus produced, tissues (after maceration) can be easily disassociated without danger of being destroyed. The object can also be continually watched with powers up to 600, and all the changes noted. When the cells are isolated they can be seen (by a slower movement of the lever) to move about in all directions, so that they can be observed from all sides.

If it is desired to press the object, S₁ is loosened and St screwed down as far as necessary, and the apparatus can then be used as an ordinary compressor.

Viguiet's Compressorium.*—C. Viguiet points out that whilst the compressors in common use enable us to study objects under favourable conditions, which it would be very difficult, if not im-

FIG. 24.

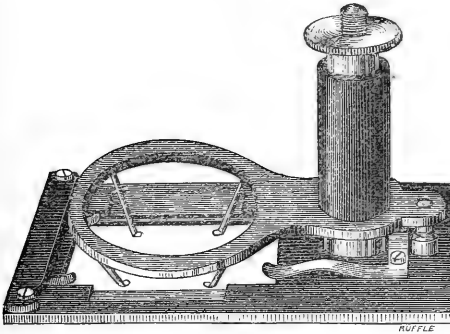

possible, to do without them, yet, on the other hand, the objects are almost always destroyed, it being but very exceptionally that a compressed object can be preserved as a permanent preparation, so as to resemble what has been seen in the compressor, and the evil is

* Arch. Zool. Expér. et Gén., ii. (1884) pp. xii.-xvi. (5 figs.).

still greater when there is only a very limited number or even only one specimen of an object.

Dr. Viguier's new form is intended to remove this inconvenience. It has no fixed glass plates, the ordinary slide and cover-glass being used. When the observation is over, the preparation is withdrawn just as it has been seen, and drawn or photographed or subjected to reagents, and definitively preserved. The management of the instrument is, moreover, very simple.

The compressor is shown in figs. 24 and 25, and it will be seen that for the motion of the upper plate the slow-movement screw is

FIG. 25.

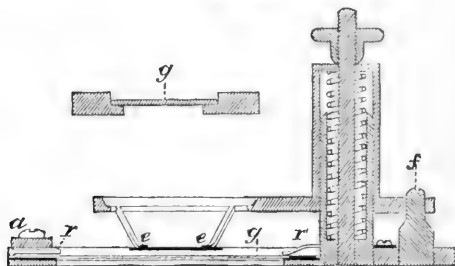

used which is found in so many Continental Microscopes and in Moulinié's compressor, the directing pivot *f* of the latter being, however, much longer, and placed on the side furthest from the glasses. The important point claimed by the author is the adjustment and removal of the glasses.

The bar which turns on *a* is opened, and the slide *g* is introduced (resting in a deep groove of the lower plate), its upper surface being entirely free except at the ends, where are four springs *r* and *r'* to keep it in its place. Two of these are attached to the movable bar *a*, which is closed after the introduction of the slide.

To fix the cover-glass, take the copper wire which has a little ball

FIG. 26.

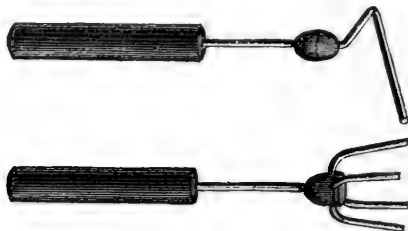

as a reservoir of heat (fig. 26), and slightly warm it over the spirit-lamp, and place a very little drop of paraffin under the four arms *e* of the

upper plate, which will take cover-glasses of 18–22 mm. The arms are flattened underneath and well adjusted in one plane. The thin glass is then put exactly in its place, which is indicated by two marks. By the screw the upper plate is lowered until the four drops of paraffin are in contact with the cover-glass and even press a little on it. The four-pronged wire (fig. 26) is then heated slightly and put on the ends of the four arms, which are thus all heated simultaneously; the paraffin melts, and as soon as the wire is raised the thin glass is found to be firmly attached by its four corners. The oblique position of the arms *e* enables the strongest objectives to be focused over almost the whole surface of the cover-glass.

When the observation is completed it is important to keep the cover-glass exactly in the position which it occupied relative to the slide and to free it from the arms *e*. Owing to its double curve the bent wire enables some warm paraffin to be conveyed along the edges of the cover-glass corresponding with the long sides of the slide, and the cover-glass is thus firmly fixed. To free the points, the four-pronged wire has only to be again heated and applied to them whilst releasing the screw. There is then nothing further to be done, to withdraw the preparation, than to open *a*. The preparation is still open on two sides, and the necessary reagents can be applied.

“AKAKIA.”—The Diatomscope.

[Objects to the non-coincidence of the axes of the two lenses and the want of coning of the settings, and questions the necessity of the diaphragm. And see *post*.]

Engl. Mech., XL. (1884) pp. 281–2.

American Society of Microscopists, photograph of members of, taken at Rochester, N.Y.

Amer. Mon. Micr. Journ., V. (1884) p. 219.

Rochester meeting of.

[Comments by the ‘National Druggist’ on the remarks of the ‘Amer. Mon. Micr. Journ.’ and ‘The Microscope.’]

The Microscope, IV. (1884) p. 273.

[Commendation of the “working-session” at the Rochester Meeting.]

Micr. Bulletin, I. (1884) p. 52.

B.Sc.—Microscopic.

[Recommendation, on the authority of Waldeger and Recklinghausen, to “always stick to the A eye-piece, otherwise you will hurt your sight.”]

Engl. Mech., XL. (1885) p. 414.

Beck’s and Bulloch’s Microscope Lamps.

[Beck’s, cf. Vol. IV. (1884) p. 628; Bulloch’s, *supra*, p. 133.]

Amer. Mon. Micr. Journ., IV. (1884) pp. 203–5 (2 figs.).

Blackburn, W.—See Dippel, L.

BRADBURY, W.—The Achromatic Object-glass. XXXVII.–XLIII.

Engl. Mech., XL. (1884–5) pp. 277–8, 294–5 (3 figs.), 314–5 (13 figs.), 334–5, 358–60 (7 figs.), 401–2, 445 (2 figs.).

BRUNN, A. v.—Der Westien’sche Universalloupenhalter. (The Westien Universal Lens-holder.) [*Post*.]

Arch. f. Mikr. Anat., XXIV. (1884) pp. 470–1 (1 fig.).

Bulloch’s Microscope Lamp, see Beck’s.

Chester Society of Natural Science.—A Short Handbook of Natural History for use at the Annual Conversazioni and other Meetings of the Society.

[Useful for the scientific arrangement of Zoological and Botanical objects at soirées, &c.]

28 pp., 8vo, Chester, 1884.

- Chiusoli, V.—Die Vergrößerung der dioptrischen Apparate. (The Amplification of Dioptric Apparatus.) Translated, and with a note, by G. Fischer. [*Post.*] *Zeitschr. f. Wiss. Mikr.*, I. (1884) pp. 558–60, from *Rev. Scientifique*, IV. (1884) p. 62.
- COMPTON, B.—Microscopic Illumination.
[Inquiry for a gradually adjustable stop for the condenser, like the iris diaphragm.] *Engl. Mech.*, XL. (1885) p. 475.
- CURTIES, T.—[Remarks on the R. Microscopical Society and its Journal] *Journ. of Microscopy*, IV. (1885) pp. 51–2.
- D., E. T.—Graphic Microscopy. XII. Eggs of Mottled Umber Moth (*Hybernia defoliaria*). XIII. The Red Water-Mite (*Eylais extendens?*). *Sci.-Gossip*, 1884, p. 265 (1 pl.), 1885, pp. 1–2 (1 pl.).
- [DAVIS, G. E.]—Our suspended publication.
[“No sooner is one month’s number out than the worry of the next commences. Few people are aware of the vast amount of work required to keep even a small journal like this in motion.” In our own case, we should be very well contented if the “worry of the next number” only commenced when the preceding number was out.—Ed. J.R.M.S.] *Micr. News*, IV. (1884) p. 304.
- DAVISON, J.—*Navicula cuspidata* as a test-object.
[Transverse striæ can be shown by a good 1/4 in. object-glass, but a good 1/8 fails to show any longitudinal striæ. With a good 1/16 and careful illumination, however, both sets of striæ can be seen. The double set of striæ is much easier shown when the frustules are mounted dry or in media less transparent than balsam, such as styrax.] *Sci.-Gossip*, 1884, p. 276.
- DIPPEL, L.—Grundzüge der allgemeinen Mikroskopie. (Outlines of General Microscopy.)
[Abridgment of his “Handbook.”] xiv. and 524 pp. (245 figs. and 1 pl.), 8vo, Braunschweig, 1885.
“ ” Endomersion-Objective. (Endomersion Objectives.) [*Post.*] *Zeitschr. f. Wiss. Mikr.*, I. (1884) pp. 485–90 (2 figs.).
- Dippel, L.—The use of polarized light in vegetable histology.
[Transl. by W. Blackburn of article noted Vol. IV. (1884) p. 482. *Post.*] *Micr. News*, IV. (1884) pp. 291–7 (5 figs.).
- ELSNER, F.—Mikroskopischer Atlas. (Microscopical Atlas.) Part V. 6 pp. and 2 pls. of 30 photo-micrographs.
[Contains Flour and Starch preparations.] 4to, Halle a. S. 1885.
- ERMENGEM, E. VAN.—
[Observations on Dr. van Heurck’s note on *Amphipleura pellucida*. *Infra.*] *Bull. Soc. Belg. Micr.*, XI. (1884) pp. 67–71.
- ERRERA, L.—Deux questions de terminologie. (Two questions of terminology.)
[Proposal (1) to substitute *lamæ* and *lamelle* for *porte-objet* and *couvre-objet*; (2) to use *micron* in place of *micromillimetre*. The second adopted but the first not adopted by the Society for the present.] *Bull. Soc. Belg. Micr.*, X. (1884) pp. 217–20; XI. (1884) pp. 36–8.
- EWELL, M. D.—Identification of Blood Corpuseles.
[Suggestion that writers should state what objectives, eye-pieces, length of tubes, stage or eye-piece micrometers they use.] *The Microscope*, IV. (1884) pp. 241–2.
- F., W.—The Diatomscope.
[Calls attention to Nachet’s “Eclairage à fond noir.” Also gives the note *supra*, p. 128.] *Engl. Mech.*, XL. (1884) p. 321.
- F.R.M.S.—Illumination for a Microscope. [*Supra*, p. 132.] *Engl. Mech.*, XL. (1884) p. 299.
- Fischer, G.—See Chiusoli, V.
“ ” See Guébardt, A.
- FLESCHE, M.—Ueber einige Versuche mit elektrischem Glüh- und Bogen-Licht. (On some experiments with incandescent and arc electric lights.) [*Post.*] *Zeitschr. f. Wiss. Mikr.*, I. (1884) pp. 561–3.

- FOL, H.—Lehrbuch der vergleichenden mikroskopischen Anatomie mit Einschluss der vergleichenden Histologie und Histogenie. (Compendium of comparative microscopical Anatomy, including comparative Histology and Histogeny.) Part I. Microscopical-Anatomical Technics. 208 pp. (84 figs.), 8vo, Leipzig, 1884.
- FRANCOTTE, P.—Marqueur traçant un cercle sur la lamelle pour retrouver facilement un lieu déterminé à une préparation. FINDER. (Marker for making a circle on the cover-glass to readily find a given place in a preparation. FINDER.) [Post.] *Bull. Soc. Belg. Micr.*, XI. (1884) pp. 48-50.
- FRITSCH.—Optical Phenomena. [Post.] *Nature*, XXXI. (1885) p. 212.
- GARBINI, A.—Manuale per la Technica moderna del Microscopio nelle Osservazioni zoologiche, istologiche ed anatomiche. (Manual of the modern technic of the Microscope in zoological, histological, and anatomical observations.) [Same as Vol. IV. (1884) p. 993. Contains a chapter on the Microscope and mode of using it, pp. 15-28 (9 figs.).] 208 pp. and 9 pls., 8vo, Verona, 1885.
- GEORGE, C. F.—Presidential Address to Postal Microscopical Society. [Mites.] *Journ. of Microscopy*, IV. (1885) pp. 1-5.
- GILES, G. M.—Description of a convenient form of live-cell for observation with the Microscope, and of an inexpensive Microtome. [Supra, p. 135.] *Sci.-Gossip* (1885) pp. 7-9 (4 figs.).
- GILTAI, E.—Inleiding tot het Gebruik van den Microscop. (Introduction to the use of the Microscope.) xii. and 254 pp. (2 pls.), 8vo, Leiden, 1885.
- GILFAY, E.—Ueber die Lage des Brennpunktes resp. der Brennlinie der Doppelkugel oder des Hohlcylinders. (On the position of the focal point or line of the double sphere or hollow cylinder.) *Zeitschr. f. Wiss. Mikr.*, I. (1884) pp. 479-85 (1 fig.).
- GRIFFIN, F. W.—Microscopic Objectives. [General remarks.] *Lancet*, 22nd November, 1884, p. 942.
- GRIFFITH, E. H.—The Working Department [of the American Society of Microscopists. Reasons for refusing to accept the Directorship]. *The Microscope*, IV. (1884), pp. 242-3 and 253.
- Guébbardt, A.—Elementare Erklärung der Untersuchungen von Gauss und Listing über die Kardinalpunkte der centrirten dioptrischen Systeme. (Elementary explanation of the investigations of Gauss and Listing on the cardinal points of centered dioptric systems.) Translated by G. Fischer from 'Ann. d'Oculistique,' lxxxii. *Central. Ztg. f. Opt. u. Mech.*, VI. (1885) pp. 4-9, 13-6 (6 figs.).
- GUNDLACH, E.—Magnifying power. [Post.] *Amer. Mon. Micr. Journ.*, V. (1884) pp. 205-6.
- „ „ Aperture and Working Distance. [Post.] *The Microscope*, IV. (1884) pp. 246-8.
- HEPWORTH, T. C.—The Magic Lantern and its Management. [Contains a chapter on the Lantern Microscope, pp. 61-6.] viii. and 75 pp. (9 figs.), 8vo, London, 1885.
- HEURCK, H. VAN.—Note sur la résolution en perles de l'*Amphipleura pellucida* Kutz. et sur la nature réelle des stries des Diatomées. (Note on the resolution of *Amphipleura pellucida* Kutz. into "beads," and on the true nature of the striæ of the Diatomaceæ.) [Nearly the same as given in this Journal, IV. (1884) p. 971.] *Bull. Soc. Belg. Micr.*, XI. (1884) pp. 63-7.
- „ „ The Diatomoscope. True nature of the striæ of diatoms. [Supra, p. 129.] *Engl. Mech.*, XL. (1884) p. 365.
- „ „ The Diatomoscope. [Reply to E. M. Nelson, *infra*. It will, he considers, render much service with Continental small Microscopes to which a condenser cannot be adapted and which have mirrors with insufficient movements.] *Engl. Mech.*, XL. (1885) pp. 452-3.
- HIRST, G. D.—Increase of angular aperture obtained by screwing the collar of Zeiss's 1/8 water-immersion objective to its utmost, and using 1 of glycerin to 2 of water for the immersion fluid. *Journ. and Proc. Roy. Soc. N. S. Wales*, XVII. (for 1883) p. 262.

[HITCHCOCK, R.]—Some general remarks.

Amer. Mon. Micr. Journ., V. (1884) pp. 212-3.

" " Choosing objectives. [*Post.*] *Ibid.*, p. 214.

" " Microscopical Societies. [*Post.*] *Ibid.*, pp. 215-7, 237-8.

" " Schröder's Camera Lucida.

["While commending this instrument in the highest terms, it is but fair to say that owing to the considerable distance the light has to travel through it from the eye-lens, it can only be used with oculars of low power, having a long focus back of the eye-lens. Otherwise the rays come to a focus within the prism or at least do not reach the point K far enough above the prism to afford a sufficiently large field of view." "No such objection applies to the camera lucida of Grunow, which is the only one comparable with it."]

Ibid., p. 221 (1 fig.).

" " Postal Club Boxes.

[Remarks on J. Kruttschnitt's theory of the fertilization of the ovule.]

Ibid., pp. 234-5.

" " Concerning Microscopes.

[Criticism of J. S. Kingsley's article, cf. this Journal, IV. p. 975. His list of names is too small and far from comprehensive.]

Ibid., pp. 236-7.

" " Discontinuance of the 'Microscopical News.'

Ibid., p. 239.

[HITCHCOCK, R.]—Electric light for the Microscope.

[Abstract of S. T. Stein's paper, *supra*, p. 466.] *Ibid.*, pp. 222-4 (4 figs.).

" INVICTA."—Microscope.

[Reply to inquiry for internal diameter and standard length of a full-sized English Microscope body-tube, and recommendation not to use a 10 in. tube. "A very well known and respected maker . . . most kindly and liberally gave me advice that was simply invaluable. . . 'Don't make your tube more than 8½ in. long, and shorter than that preferably.'"]

Engl. Mech., XL. (1885) p. 392.

JANNETTAZ, E.—Les Roches, description et analyse au Microscope de leurs éléments minéralogiques et de leur structure. (Rocks, description and microscopical analysis of their mineralogical elements and structure.)

[Contains a section on Polarizing Microscopes, pp. 112-7 (2 figs.)]

2nd ed., xii. and 486 pp., 215 figs. and 2 maps, 8vo, Paris, 1884.

JOSEPH, R. E.—Incandescent Lamps for Surgical and Microscopical purposes.

[Quotes Mr. Stearn's paper, III. (1883) p. 29.]

Trans. and Proc. Roy. Soc. Victoria, XX. (1884) pp. 84-7.

K.—The Phenomenon of Multiple Image.

[Has observed multiple images in diatoms, *Triceratium favus*. This phenomenon is well known in England. See this Journal, I. (1881) p. 555.]

The Microscope, IV. (1884) p. 272.

L., R.—Paul Müller's Insectenfänger mit Lupe. (Paul Müller's insect-catcher with lens.)

[See this Journal, IV. (1884) p. 632, and *post.*]

Entomol. Nachr., X. (1884) p. 52.

LANDOLT, T.—Natriumlampe für Polarisationsapparate. (Sodium lamp for polarisation apparatus.)

Zeitschr. f. Instrumentenk., IV. (1884) p. 390 (1 fig.).

LATHAM, V. A.—The Microscope and how to use it. I.

[Gives "some of the best methods for the preparation and mounting of microscopic objects," preceded by brief remarks on the Microscope and accessories.]

Journ. of Microscopy, IV. (1885) pp. 22-34.

- LEHMANN, O.—Ueber eine vereinfachte Construction des Krystallisations-Mikroskops. (On a simplified construction of the Crystallisation Microscope.) [*Supra*, p. 117.] *Zeitschr. f. Instrumentenk.*, IV. (1884) pp. 369-76) (4 figs.).
- MALLEY, A. C.—Illumination for a Microscope. [*Post.*] *Engl. Mech.*, XL. (1884) p. 299.
- Manchester Microscopical Society, presentation of Microscopes to, by Members. *Micr. News*, IV. (1884) p. 303.
- MANTON, W. P.—Beginnings with the Microscope: a working handbook containing simple instructions in the art and method of using the Microscope and preparing objects for examination. 73 pp. 8vo, Boston, 1884. Microscope is always ready.
[“A consideration that greatly recommends the use of the Microscope is the fact that it is never too cold or hot, too dry or wet, too cloudy or bright for work.”] *The Microscope*, IV. (1884) p. 279.
- Möller, J.—C. Reichert's Neues Präparirmikroskop. [*Abstract of note*, IV. (1884) p. 613.] *Zeitschr. f. Instrumentenk.*, V. (1885) p. 30.
- NELSON, E. M.—Microscopic. [Reply to five questions by “Al. Fard,” p. 198.] *Engl. Mech.*, XL. (1884) pp. 239-40.
- ” ” The Diatomoscope. *Ibid.*, p. 282.
- ” ” Illumination for the Microscope. IV. [*Post.*] *Ibid.*, p. 282 (6 figs.).
- ” ” Beetle's eye as a lens. [Directions for seeing the images of objects in beetle's eyes.] *Ibid.*, p. 327.
- ” ” Optical Records. [“It is a well-known fact that the great strides taken in the improvement of the Microscope during the past twenty years have been in a great measure due to diatom maniacs, who by purchasing glasses warranted to resolve such and such diatoms, stimulated the makers not only to increase the aperture of their lenses, but also to improve the instrument, apparatus, and mounting material. . . . Believing, as I do, that the literature of the resolution of test objects has had a material influence in the improvement of the Microscope, I see no reason why a similar kind of literature should not also prove beneficial to the telescope.”] *Ibid.* (1885) pp. 383-4.
- ” ” The Diatomoscope. [Challenges the validity of Dr. Van Heurek's statement, *supra*, p. 129, that it has “answered very well as an oblique condenser,” and considers that the result he obtained “is eminently unfavourable to the Diatomoscope.”] *Ibid.*, p. 410 (1 fig.).
- Obituary. [Discontinuance of ‘Science Record’ and ‘Microscopical News.’] *Micr. Bulletin*, I. (1884) p. 49.
- OSBORNE, LORD S. G.—The Diatomoscope. [Reply to “Akakia,” *supra*, that he found it better practically not to adjust the two lenses in the same axis.] *Engl. Mech.*, XL. (1884) p. 299.
- Osborne's Diatomoscope. [Cf. Vol. IV. (1884) p. 961.] *Sci.-Gossip* (1884) p. 276-7.
- P., T.—Beetle's eye. [Directions for seeing the images of objects in beetles' eyes.] *Engl. Mech.*, XL. (1884) pp. 327-8 (1 fig.).
- PENNY, W. G.—On the correction of colour aberration when lenses are in contact. *Engl. Mech.*, XL. (1885) pp. 474-5.
- RAYLEIGH, LORD.—Optics, Geometrical. [Contains a note on the “resolving power of optical instruments.”] *Ency. Britannica*, 9th ed., XVII. (1884) pp. 798-807 (16 figs.).

- Richmond Athenæum, opening of Microscopical Section in connection with.
Engl. Mech., XL. (1884) p. 297.
- S., J. T.—Beetle's eye as a lens.
[Directions for exhibiting the image through a beetle's eye.]
Engl. Mech., XL. (1884) p. 372.
- SLACK, H. J.—Pleasant Hours with the Microscope.
[On the selection of a Microscope.]
Knowledge, VI. (1884) pp. 476-7 (1 fig.).
- SLINGO, W.—Photographic Recreations.
[Contains a note on taking photo-micrographs and exhibiting them with a
Lauter Microscope.]
Knowledge, VI. (1884) pp. 485-7 (4 figs.).
- STOWELL, C. H.—The Student's Manual of Histology.
3rd ed., 370 pp., 178 figs., 8vo, Ann Arbor, 1884.
- STOWELL, C. H. and L. R.—Our Journal for 1885.
The Microscope, IV. (1884) p. 278 (and p. 279).
- STRASBURGER, E.—Das kleine Botanische Practicum für Anfänger. (The
small 'Botanisches Practicum' for beginners.)
[Abridged edition of the larger work, see IV. (1884) p. 633.]
viii. and 285 pp., 114 figs., 8vo, Jena, 1884.
- THOMPSON, W. J.—The Microscope for Class-room Demonstration. [*Post.*]
Science, IV. (1884) pp. 540-1 (1 fig.).
- VOGEL, J.—Das Mikroskop und die wissenschaftlichen Methoden der Mikro-
skopischen Untersuchung in ihrer verschiedenen Anwendung. (The
Microscope and the scientific methods of microscopical investigation in their
different applications.) 4th ed. by O. Zacharias.
8vo, Leipzig, 1884.
- VORCE, C. M.—Multiplying drawings. [*Post.*]
Amer. Mon. Micr. Journ., V. (1884) pp. 207-8.
- WALDEYER [W.]—
[Exhibition to Berlin Physiological Society of a "Microscope-stand which
he found very practicable, both for the ease and security with which it
enabled a Microscope to be turned in every direction, and for the way in
which it allowed the use of any system of lenses. (Apparently the
Westien Universal Lens-holder, *supra.*)]
Nature, XXXI. (1885) p. 212.
- WALLICH, G. C.—A new form of Condenser for the Microscope.
[Statement of the advantages of his condenser. Cf. IV. (1884) p. 962 and
supra, p. 127.]
Engl. Mech., XL. (1884) p. 320.
- " " Dr. Wallich's Condenser.
[Statement as to Mr. Swift's Cone Condenser.] *Ibid.* (1885) p. 474.
- WARD, P.—Illumination for a Microscope.
[Preliminary announcement of his "Anti-thermic Illuminator."]
Engl. Mech., XL. (1884) p. 299.
- WEYENBERGH, H.—Catálogo del laboratorio y gabinete de histología de la
Universidad Nacional en Córdoba. (Catalogue of the laboratory and cabinet
of histology of the National University at Córdoba.)
60 pp., 8vo, Córdoba, 1883.
- WILKIE, F. B.—The Great Inventions: their history, from the earliest period to
the present. Their influence on civilization, accompanied by sketches of lives
of the principal Inventors; their labors, their hardships, and their triumphs.
[Chap. XI. The Microscope and the Telescope, pp. 143-73.]
687 pp. (figs.), 8vo, Philadelphia and Chicago, 1883.
- WRIGHT, L.—The Lantern Microscope.
[As to his exhibition of it at the R. Micr. Soc. and Quekett Micr. Club.
Also as to a 1/4 or 1/5 in. for it, and as to showing diatoms.]
Engl. Mech., XL. (1884) pp. 299-300.

Year-Book of the Scientific and Learned Societies of Great Britain and Ireland, giving an account of their origin, constitution, and working. Compiled from official sources. With appendix comprising a list of the leading Scientific Societies throughout the World. 1st Annual Issue.

[R. Micr. Soc. p. 67.]

vi. and 226 pp., 8vo, London, 1884.

Z.—Neues Polarisation-Prisma von E. Bertrand.

[Abstract (with remarks) of note, Vol. IV. (1884) p. 965. Cf. also *supra*, p. 133.]

Zeitschr. f. Instrumentenk., V. (1885) pp. 30-1.

ZACHARIAS, O.—See Vogel, J.

B. Collecting, Mounting and Examining Objects, &c.

Hardy's Collecting-bottle.—Mr. T. Curties has improved this bottle by replacing the indiarubber strips forming the sides of the bottle by glass, it being difficult to cement the indiarubber with sufficient firmness to the glass.

Salmon's Culture-tube.*—The culture-tube of Dr. D. E. Salmon consists of a test-tube-like body or reservoir, of rather heavy glass, about 4 to 5 in. in length and $\frac{3}{4}$ in. in internal diameter. Over the top of this reservoir a second hollow piece or cap is fitted. Its internal surface is ground to fit snugly over the ground external surface of the upper end of the reservoir, thus forming a ground-joint union. This cap, about $2\frac{1}{2}$ in. long, abruptly contracts near its middle into a narrow tube with an internal diameter of about $\frac{3}{8}$ in. The third piece, or ventilating tube, is like an inverted U, one limb being about 3 in. long, and $1\frac{1}{2}$ in. longer than the limb, which fits by means of a ground joint over the narrow tube of the cap. The longer, free limb of the ventilating tube lodges a plug of glass-wool from $1\frac{1}{2}$ to 2 in. long. The limbs of the ventilating tube are about 1 in. apart.

The culture-liquid is introduced by removing the cap, which brings with it the ventilating tube, and it is sterilized in the tube. The liquid is inoculated by removing the ventilating tube only. To prevent the ground joints from sticking too firmly, a little sublimated vaseline is introduced between the surfaces of the joint.

The pipette, used to introduce a drop of fluid containing bacteria, consists of an ordinary glass tube about $\frac{1}{4}$ in. in diameter and 2 to 3 in. long, one end of which is drawn out into a very fine, almost capillary tube, which must be long enough to easily reach the bottom of the reservoir when introduced through the narrow tube of the cap. A plug of glass-wool occupies the other end, which is closed by a rubber ball.

The method of inoculating the culture-liquid is briefly as follows:—

The pipette is first thoroughly sterilized by flaming every portion of it from the tip of the capillary tube to near the rubber bulb, until the contained air is subjected to a temperature of at least 150° C. It is usual to bring it to a dull red heat, avoiding the contingency of melting the capillary tube. It is hung with the rubber bulb up to avoid its capillary portion coming in contact with anything while

* Amer. Mon. Micr. Journ., v. (1884) pp. 185-7.

cooling. When sufficiently cool the capillary portion is again drawn once or twice through the flame to destroy any particles that may have become attached meanwhile. The ventilator of the culture-tube, containing the bacteria to be sown, is flamed and removed and the narrow tube of the cap flamed, the rubber bulb slightly compressed, and the pipette introduced, a few drops drawn up, the pipette slowly withdrawn, the cap flamed again, and the ventilator replaced. The cap of the fresh tube is now flamed before and after removing the ventilator, the pipette introduced, a drop allowed to fall into the culture-liquid, the pipette removed, the narrow tube of the cap again flamed, and the ventilator replaced. When the source of the bacteria is an exudate, or the flow of the animal body, various methods are in use. The method above given may, however, be employed in most cases.

The reservoir may be variously modified. A flask-shaped body may be used for cultures that require an abundance of air, but the test-tube form will serve nearly all purposes. It enables the nature of the opacity in the liquid to be readily determined, while the earliest traces of a membrane or a deposit are more easily detected than with a broad body and a flat bottom.

The culture-tube recommends itself as a simple, very neat apparatus, readily filled, sterilized, and inoculated. It dispenses with the troublesome and dangerous expedients of disturbing cotton plugs, and of tying down various air-filtering materials. It is easily cleaned, and hence may be used over and over again, the original cost of the tube being in this way reduced to a minimum in the end. It does not break readily, nor are there any sharp or jagged edges to be feared in the manipulation of dangerous cultures. It is very compact, and occupies but very little space in a thermostat. Finally, the chances of contamination through the air during the process of inoculation are practically of no account.

Collecting Microscopic Algæ.*—An anonymous correspondent, referring to a suggestion for placing slides back to back and then suspending them from hoops in ponds, proposes a modification of this plan by taking waxed paper (from cakes of soap) and punching holes slightly smaller than the largest covers, then wrapping the paper about the slides in such a way as to bring the holes in the middle on each side. On suspending the slides, growths are secured on a space a little smaller than the covers, and good mounts can be obtained. Another suggestion is to take a slide with a spot of growing forms upon it, surround it with a cleft ring, as in Hardy's vivarium, bind on another slip, and the little world is ready for observation.

Preparations of the Central Nervous System for Projection.†—L. Edinger points out how much preferable actual sections of the central nervous system are for students as compared with diagrams. Hitherto, however, it has been very difficult to show them, for being

* Amer. Mon. Micr. Journ., v. (1884) p. 200.

† Zeitschr. f. Wiss. Mikr., i. (1884) pp. 250-1.

mostly very large preparations a small diaphragm cannot be used and hence there is too much light, which drowns the images. Stained preparations in balsam are for the most part unsuitable, and glycerin preparations must be very thin, and are therefore difficult to make of the necessary size. The difficulty may, however, be got rid of by placing the sections direct from the microtome in a solution of nitric acid 1 part, water 15 parts, and there leaving them until they are a dazzling white. They should then be mounted in glycerin without previous washing. Thus prepared the sections, even though not very thin, are not only in an admirable condition for the Sclipticon, but in the case of microscopic or low-power examinations, will be found to give sharper images than by any process hitherto known.

The author has also found the Sclipticon useful as a means of drawing large sections under low powers. For this purpose the nitric acid preparations are very suitable, as all the details are thrown on the drawing-paper with marvellous clearness.

Treatment of the Ova and Embryos of the Aphides.*—E. Witlaczil publishes a lengthy paper on the development of the Aphides, and gives the following information on methods:—

The embryos of the viviparous aphides were examined in a weak salt solution ($1\frac{1}{2}$ per cent.), in which they live for about an hour. The ovaries contain embryos in different stages of development, and have to be isolated for study.

The early stages in the development of the ova may be studied to advantage after treatment with hydrochloric acid (3 per cent.) or acetic acid, as these reagents partially dissolve the yolk elements and thus render the preparation more transparent. The later stages, on the contrary, are rendered more opaque by the same treatment.

Preparing Echinorhynchi.—In the paper by A. Säfftigen already noted,† the following methods of preparation are described:—

It is a very difficult matter to kill *Echinorhynchi* instantly. This cannot be done either with corrosive sublimate or strong osmic acid, even after preliminary treatment with tobacco smoke or chloroform. Thus treated, they contract strongly, and remain so after death.

Much the best results are obtained by killing gradually with 0·1 per cent. osmic acid, in which they contract during the first hours, but stretch out again and die fully extended. This method causes slight swelling, but does not seriously injure the object for histological investigation. In specimens left for twenty-four hours in the osmic acid, it is easy to isolate under the dissecting Microscope the subcuticula and the two layers of muscle-fibres (circular and longitudinal). For the study of the internal organs, the *Echinorhynchi* should be cut open immediately after death and transferred to a 0·01 per cent. solution of osmic acid. The preservation of specimens thus treated may be accomplished in the following manner:—After carefully

* Zeitschr. f. Wiss. Zool., xl. (1884) pp. 559-696 (7 pls.). Abstract, *supra*, p. 53.

† Morphol. Jahrbuch, x. (1884) pp. 120-71 (4 pls.). See this Journal, iv. (1884) p. 897.

washing away the osmic acid, place the objects in a very dilute solution of potassic acetate in an open vessel, and leave them for two or three days, during which much of the solution evaporates. Finally, transfer to a saturated solution in order to clarify so far as possible. Very beautiful preparations are said to be thus obtained.

The course of the nerves may be easily traced in specimens that have lain several days in 1 per cent. formic acid. The tissues swell up strongly and become quite transparent, so that the nerves can be seen. If the muscular layers be separated from the subcuticula in specimens thus treated, and then stained in gold chloride, the lateral nerve-trunks may be clearly shown. For the histological study of the nerves, the *Echinorhynchi* should be treated with chromic acid and then stained deeply with borax-carminc.

Chromic acid preparations are also best for the study of the subcuticula. *Echinorhynchi* live for days in a 0.1 per cent. solution of chromic acid, but eventually die in a fully extended condition. Such preparations, after treatment with alcohol, may be coloured at once; or, after washing a day or more in running water, exposed to the action of osmic acid, and then coloured in borax-carminc.

For the study of the sexual organs, a very dilute picro-sulphuric carminc, which according to Säftigen is the best staining fluid, must be allowed to act a long time (often one or more days); after a deep stain has been taken the preparation should be partially discoloured by the use of hydrochloric acid in the ordinary way.*

Action of Light on Objects hardened in Chromic Acid. †—Dr. H. Virchow shows that in tissues hardened in chromic acid, if subsequently placed in alcohol, a precipitation takes place, in the presence of light, of destructive secondary products of chemico-physical action. Part of the tissues is dissolved and thrown down as a fine brown granulation. In the dark, this result is avoided, as also when the tissue is first dehydrated before placing it in (absolute) alcohol in the presence of light.

Haacke's Dehydrating Apparatus. ‡—Dr. W. Haacke has devised the apparatus shown in fig. 27 for dehydrating objects so as to avoid the tedious process of placing them first in weak and afterwards in stronger and stronger alcohol.

It consists of a glass vessel 50 cm. high and 25 cm. in diameter, with a tap at the bottom and a top fitting air-tight, having one central and eight (smaller) peripheral apertures. These are closed by the tubes shown in the figure, also fitting air-tight (but easily removable), the lower end being drawn into a capillary point and the upper widened out to 5 cm. in diameter, and having a closely-fitting glass stopper. The tubes extend 25 cm. into the glass vessel and stand up 10 cm. above it. They should be thick and have a lumen of at least 1/2 cm. The central one should hold 100 c.cm. and the

* See Amer. Naturalist, xviii. (1884) p. 1291.

† Arch. f. Mikr. Anat., xxiv. (1884) pp. 117-19.

‡ Zool. Anzeig., vii. (1884) pp. 252-6 (1 fig.).

others 50 c.cm. The large vessel is to be filled with absolute alcohol and the tubes with distilled water (or alcohol of different strengths) and the preparation dropped in the latter (or attached to the hooks on the stoppers). An exchange then takes place between the alcohol and the water, the latter falling to the bottom of the vessel and absolute alcohol replacing it in the tubes. From time to time the dilute alcohol at the bottom of the vessel can be drawn off through the tap, first taking out the stopper in the cover. When the alcohol has sunk to the level of the points of the tubes the vessel should be filled up again through a funnel reaching half-way down and having a bent point. By regulating the sizes of the apertures at the bottom of the tubes the time required for the exchange of the alcohol and the water can be varied—from several days to a few hours—so as to suit all requirements. The tubes should be numbered and a table made showing their different periods.

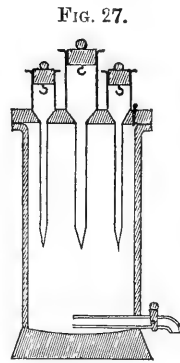
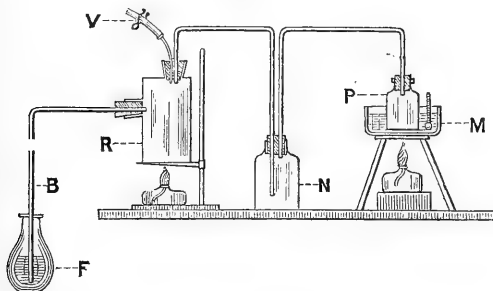

FIG. 27.

Imbedding in Paraffin by means of a Vacuum.*—P. Francotte has improved on Hoffmann's apparatus described Vol. IV. (1884) p. 820, which requires for producing the vacuum either a pressure of water or a very long aspirator. The former is often wanting and the latter very inconvenient.

Dr. Francotte at first attempted to obviate these inconveniences by boiling and then cooling ether (which requires only a temperature of 40°), but he now uses by preference steam. The vessel R (fig. 28)

FIG. 28.



holding about half a litre, has a barometer tube B, which passes into a vessel of mercury F, and another communicating with the flask P, containing the melted paraffin, heated by a water bath M. It is useful though not necessary to interpose a flask N to collect the steam if it is formed in too great quantity.

The water is boiled by a spirit-lamp and the air escapes by the

* Bull. Soc. Belg. Micr., xi. (1884) pp. 45-8 (1 pl.).

tube, which is provided with a pinchcock V. When the steam passes out in a jet, the lamp is removed, V is closed, and the vessel R cooled slowly by a wet sponge, by which means a vacuum is produced, and the mercury rises above 70 cm. The air is thus drawn out of the preparation and the paraffin penetrates. In half an hour the air may be readmitted.

Rapid Imbedding.*—In his studies on *Limulus* J. S. Kingsley adopted the following method of imbedding large numbers of specimens at once, thus effecting a considerable saving of time. The same method is applicable to any easily oriented object.

The embryos were taken from absolute alcohol and transferred to chloroform and then impregnated with paraffin in the normal way. When at last they were in pure paraffin they were transferred with a quantity of paraffin to a flat-bottomed watch-glass, and, the paraffin being kept in a melted condition, the embryos were arranged in a symmetrical position, the heads all pointing the same way and considerable space left between them. When arranged, the whole was allowed to cool, and then each embryo was cut out, together with a parallelogram of the surrounding paraffin, the longer axis of which corresponded with the axis of the embryo. The head end was marked, and then the crystal was slightly warmed, which allowed the little strips of paraffin to be readily removed. When it was desired to cut one of the specimens, it was a comparatively easy operation to place it in any desired position and fasten it by means of a hot needle on the end of a larger piece which fitted the clamp of the microtome.

The author tried various killing and hardening reagents (Kleinberg's fluid, Perenyi's fluid, Müller's fluid, chromic acid, Merkel's fluid, corrosive sublimate, and osmic acid), but for sections he had the best results with the use of alcohol of various grades, beginning with 50 per cent. and ending with absolute. For surface views nothing excels osmic acid used for about ten minutes in a 0.1 per cent. solution.

Caldwell's Automatic Microtome.—Mr. W. H. Caldwell's very novel and ingenious instrument has effected a revolution in the art of section-cutting, especially where it is desired to cut a very large number of sections of equal thickness in a very short time, and to insure their arrangement in their proper consecutive order and with the same side upwards. It may be easily made to deliver in one continuous ribbon sections at the rate of 100 per minute, and when driven by means of a motor, such as the water-motor used for it at Cambridge, more than double this number can be obtained.

The general form of the instrument, which is supported on a heavy iron frame 36 in. long, 8 in. wide, and 11 in. high, resting on four feet, is shown in fig. 29, the object-holder with its carrier (in enlarged view) at fig. 30, and the top plate of the microtome, with object, knife, and belt, at fig. 31.

The carrier, with the object, moves backwards and forwards beneath the razor (any ordinary razor does), which remains stationary

* Science Record, ii. (1884) p. 269.

FIG. 29.

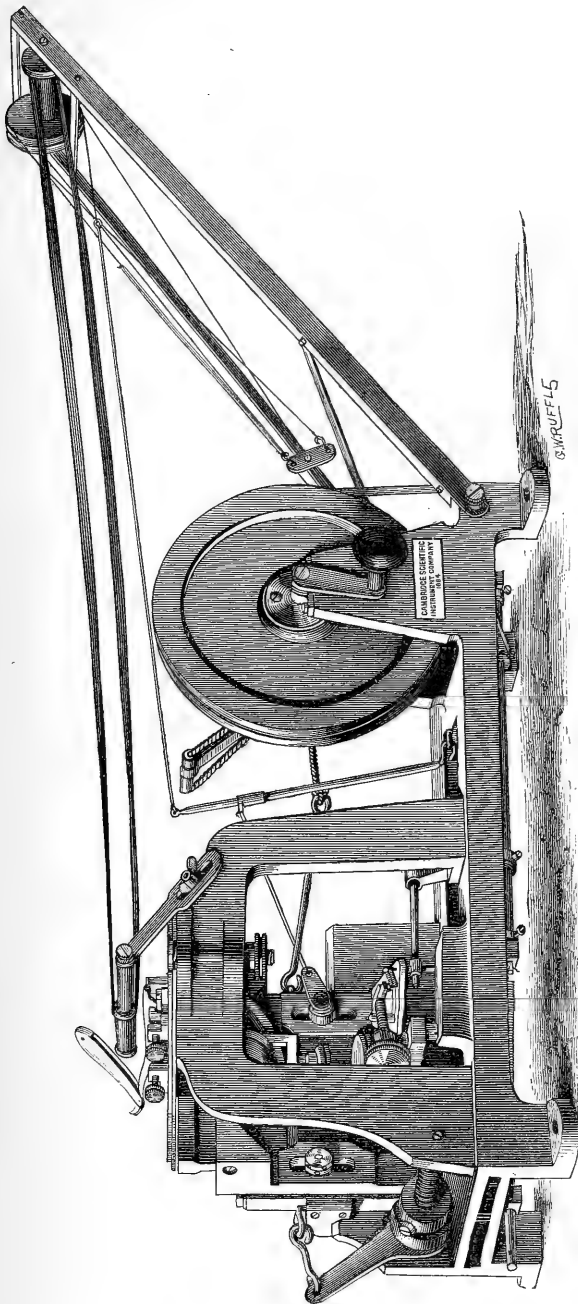

CALDWELL'S AUTOMATIC MICROTOME.

in the clamp in which it is fixed (figs. 29 and 31). The carrier is pulled forwards by the action of a roller fixed eccentrically to the axis of the large fly-wheel, and connected with it by the link and cords shown in fig. 29. It is drawn back again by the strong spring shown on the left. The extent of its motion is regulated so that the

FIG. 30.

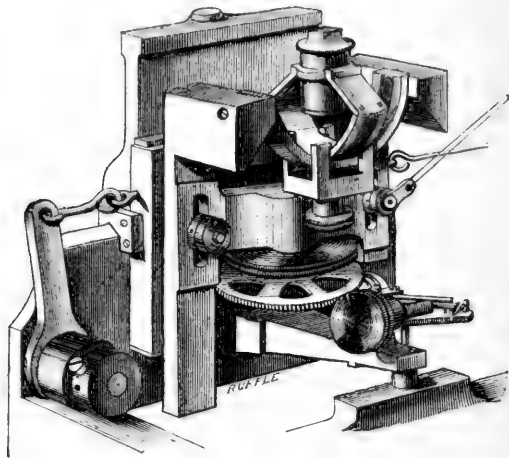

surface of the imbedding mass just clears the razor when the carrier is at its maximum and minimum distance from either end of the frame.

The cylindrical vessel which holds the imbedding mass and object is slipped into a tube or socket, in a cross-piece attached to two quadrants, arranged so that the socket may be set at any angle desired, and clamped by the vertical screw underneath (see fig. 30). This arrangement is for use when the object has not been symmetrically imbedded. For a rough adjustment of the object to the level of the knife the socket can be slipped up or down in the cross-piece. For more accurate, yet still rapid, adjustment the entire object-holder may be raised and lowered by the large micro-

FIG. 31.

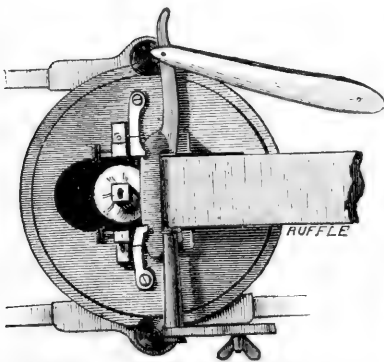

meter screw. To this screw is attached a ratchet wheel with clicks, which are controlled by the lower, horizontal, screw (fig. 30), and by means of which the object is raised automatically. When the clicks

engage half a tooth the sections will be 2.5μ (or $1/10,000$ in.) in thickness, a whole tooth 5μ , and so on.

The great novelty of the instrument, however, consists in the use of an endless band, 2 in. wide, to receive the sections as they come from the razor. With proper imbedding material the sections will adhere to one another and come off the razor in the form of a ribbon, and as soon as a sufficient length has been cut the end is picked up by a needle or scalpel and placed on the band which is just above the razor (see fig. 31). By the arrangement of cords and rods, shown in fig. 29, the band is adjusted so that at each "throw" of the object-carrier (or turn of the fly-wheel) it is moved forward through a distance equal to the breadth of the surface which is being cut. The ribbon of sections consequently travels up the band until the top is reached, when the sections can be cut off in convenient lengths for mounting.

The directions for using the instrument issued by its manufacturers, the Cambridge Scientific Instrument Co., have been republished,* and need not be repeated here. The most important points insisted upon are the sharpness of the razor and the accurate parallelism of the sides of the imbedding material from which the sections are cut, so that the ribbon of sections may be quite straight for convenient mounting. The Company supply special imbedding material, so that sections may be satisfactorily cut within a very considerable range of temperature, obviating the necessity of exactly adjusting the temperature of the room to the specimen of paraffin in use, or, as an alternative, of providing a number of specimens of paraffin with different melting points.

The ordinary 3×1 slides are not of course large enough for the ribbons, and slides of double the size (6 in. \times 2 in.) are found the most convenient, with cover-glasses 5 in. \times $1\frac{1}{2}$ in. On such a slide five or six rows of the ribbons may be placed, each row containing from fifty to one hundred sections or more.

Beck's Automatic Microtome.—At the January meeting of the Society, Messrs. Beck exhibited a simplified form of the Caldwell microtome, the cost of which is a little over a third only of that of the original.

The new form has an automatic movement and clamp arrangement similar to that of the Schanze (*post*), but to this is added the Caldwell endless band, which is driven by a very simple mechanism, and which has the special feature of being very readily detached from the microtome, so as to leave the latter free to be used for ordinary purposes other than the cutting of series of sections.

The new microtome will, we think, be found a great desideratum by those who are desirous of having a smaller and less elaborate instrument, and it will be illustrated in the April part of the Journal.

Thoma's Microtome.—Prof. R. Thoma sends us some further notes on this subject, and Herr Jung of Heidelberg the woodcuts.

It often occurs, he says, that in using the microtome, sections of

* Quart. Journ. Micr. Sci., xxiv. (1884) pp. 648-54.

hardened substances (aorta, eyes, cartilage, substances imbedded in paraffin, &c.) instead of being even are thicker at one point than at another, or the sections appear striped, their thickness varying in steps. He has found that the cause lies in the fact that hard substances bend the edge of the ordinary knife and that this can be prevented by using knives with stronger edges and shorter blade like E Z in figs. 32-4, which at the same time are cheaper. For convenience in sharpening the knife a movable handle F is attached to the blade by the screw *r*.

The knives should moreover be attached to the microtome in a different way to that ordinarily adopted. The new holder is also shown in figs. 32-4. This has two forks O and O' by which it can be fastened

FIG. 32.

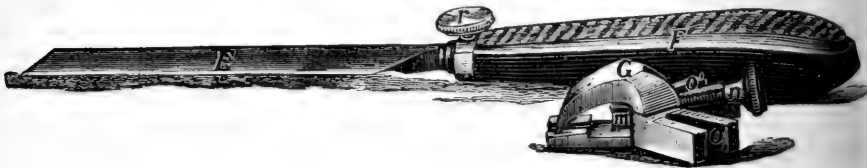

FIG. 33.

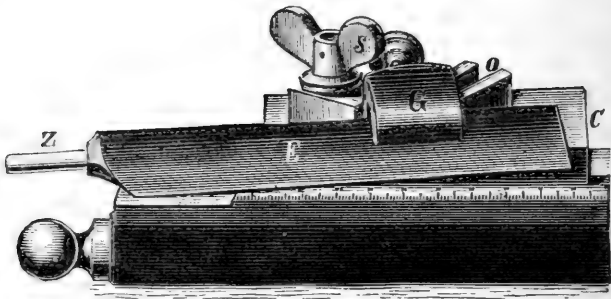
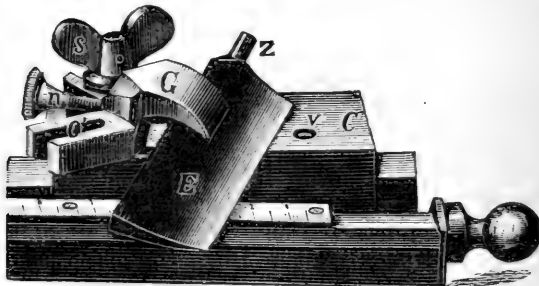

FIG. 34.



to the carrier V C of the microtome and clamped by S, the knife being clamped by *n* acting on the piece G. Fig. 33 shows the position

of the holder when the knife is intended to work with the whole length of its edge (fastened by the fork O'), for objects of moderate hardness, and fig. 34 when it stands more transversely to the long axis of the microtome (fastened by the fork O), for paraffin-embedded objects.

For the purpose of stropping the original knives with plane-concave surfaces, a small rod B (fig. 35) is recommended. This rod has a projection at O which is inserted in a hole near *t* on the triangular end

FIG. 35.

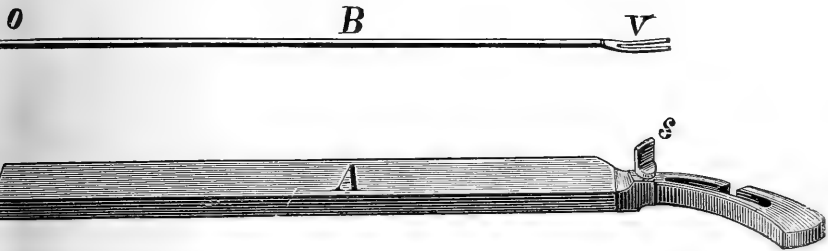

face of the knife A. The other end V of the rod is forked and is fixed to the handle of the knife by the screw *s*. The rod and screw are removed before cutting.

The construction of the carriers for the objects has also been varied according to different requests made by investigators. Fig. 36

FIG. 36.

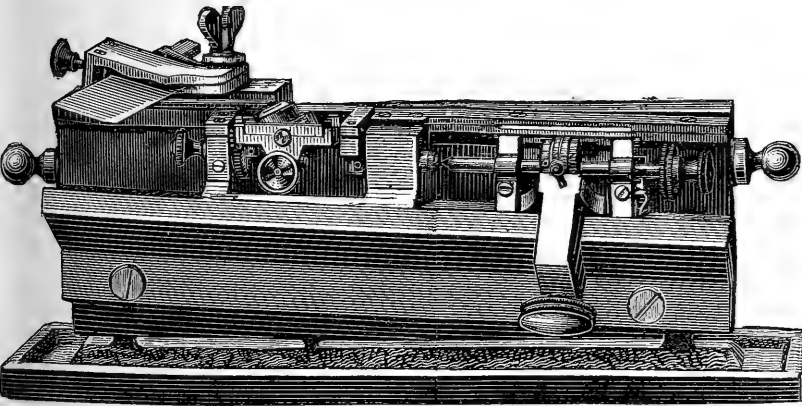

shows one of the new carriers with a clamp somewhat different from the original form.* This gives a few advantages of a secondary

* See this Journal, iii. (1883) p. 302.

character over the older form, particularly in avoiding the difficult working of the screw *d* in the latter.

A more perfect clamp is that shown in fig. 37, permanently attached to the sliding carrier. It is also made to fit the ordinary carrier. Rotation of the specimen on two horizontal axes can be per-

FIG. 37.

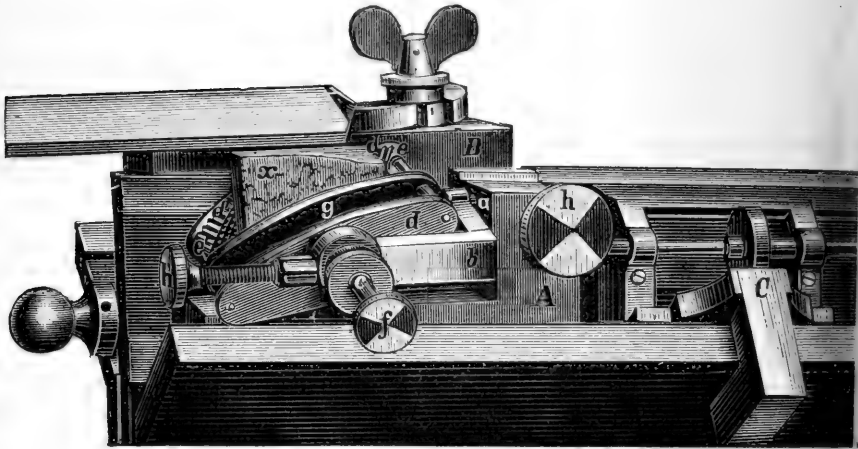

formed as in the clamp fig. 36. The axis which is parallel to the long diameter of the microtome is fixed by *h*. And in the same way *h'* will free the axis which works vertical to the former. The screw *f* moves the jaws *g* of the clamp, to fix the specimen. *A* is a part of the carrier and *C* the micrometer screw which moves it.

Fig. 38 represents a clamp devised by Dr. Meyer, of Naples.

FIG. 38.

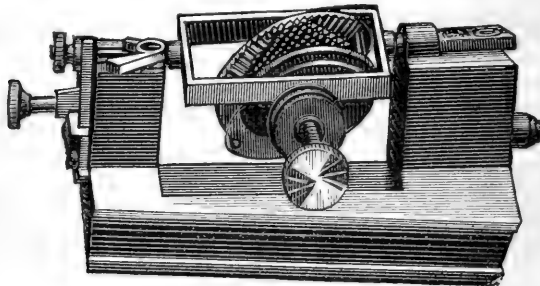

It can be turned round two horizontal axes, and the clamp can be easily removed from the carrier. The axes of rotation are very near to the cutting surface, which has certain advantages in adjusting

the object. Still more exact is the working of the clamp shown in fig. 39. There is rotation round two horizontal axes, as before, the position of the clamp being fixed at any given point by the two

FIG. 39.

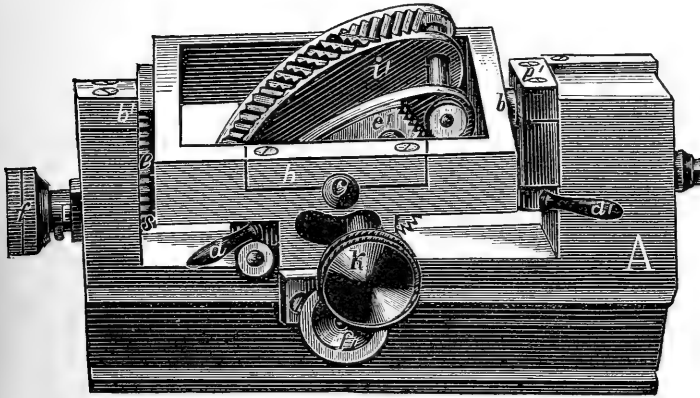

handles *d* and *d'*. The milled heads *f* and *f''* produce the rotation by means of toothed wheels. The jaws *i'* are moved by *K* to fix the specimen to be cut.

This clamp has received some more recent improvements, which allow also of a vertical movement of the specimen in the clamp, and rotation round a vertical axis. It also allows of the use of imbedding boxes.

The microtome is now made of non-oxidizable bronze.

Herr Jung also provides * a stop of large size for the knives. The edges of the leather are carried round beneath to obviate the wrinkling which the tension of the blade usually produces on the sides.

The placing of the knife in a transverse position is found to prevent to a great extent the curling up of the sections. It also enables the successive sections to adhere to one another, to form a continuous ribbon.

Cutting Ribbons of Sections.—M. A. Gravis enumerates † several conditions which are necessary to the success of this delicate process. The object must not be too large nor too friable; the melting-point of the paraffin must be chosen with great precision, and the temperature of the room must be in a certain relation to that of the melting-point of the paraffin. A hard paraffin is favourable for the thinnest sections; and a soft paraffin facilitates the adherence of the sections in ribbons. Mr. Harmer reconciles these two opposite advantages by using as hard a paraffin as the nature of the object permits; cutting out of the block of paraffin a small cube containing the object, then

* Bull. Soc. Belg. Micr., x. (1884) pp. 151-2.

† Ibid., pp. 117-9.

covering one of the vertical faces of this cube (the one turned in the direction of the knife) with a thin coat of soft paraffin, which insures the adherence of the sections to one another by their edges.

Dr. C. O. Whitman also points out * that it is important to use a moderately soft paraffin, which may be obtained by mixing in proper proportions soft and hard paraffin, and further to give the piece of paraffin to be cut a rectangular form. The piece must then be so placed in the holder that the side next to the knife is exactly parallel with the cutting edge. Thus placed, every section lies flat on the blade. The second section pushes on the first, adhering to its adjoining side; the third pushes on the first two, adhering to the second. A whole ribbon of sections may be cut in this way in a few moments without danger of losing their serial order. Thus three very important points are gained: the sections remain perfectly flat, the cutting may be as rapid as the hand can move, and the order of the sections is preserved without trouble to the manipulator. Care must be taken only that the opposite sides of the paraffin are parallel, otherwise the ribbon will curve to the right or left and the arrangement of the sections on the slide be less easily accomplished.

New Application of Hæmatoxylin.†—R. Heidenhain describes a process which gives an entirely different stain to that of the ordinary fluid. The ingredients are a 1/2–1 per cent. aqueous solution of hæmatoxylin and a 1/2–1% per cent. solution of bichromate of potash. Small pieces of tissue well hardened in alcohol are first placed in 8–10 c.cm. of the former fluid, and after 8–10 hours for the same time in a nearly equal quantity of the second solution. After they have taken a black colour throughout, the excess of bichromate of potash is removed by water. Then follows dehydration by alcohol, imbedding, &c. The sections must be cut extremely thin.

The nuclei are mostly black, and the tissue-elements a more or less dark grey or also black, but so that different elements take an entirely different shade of grey and are readily distinguished as if in an artistically finished woodcut. In epithelial tissue the outlines of the cells are extremely sharp. In the separate cells the protoplasm is darker than the other contents, so that the richness of different cells in protoplasm and its distribution in the separate cells is admirably shown. The markings of the primitive bundles and fibrillæ in muscle are much clearer than in the fresh tissue. Nerve-fibres are also well shown.

A blue stain is obtained if instead of treating the tissue with bichromate of potash, a 1 per cent. alum solution is used.

Weigert's Staining Method for the Central Nervous System.—C. Weigert, in 1882, described ‡ a method of staining the central nervous system in which acid fuchsin was used, and which left the

* Amer. Natural., xviii. (1884) pp. 106–7.

† Arch. f. Mikr. Anat., xxiv. (1884) pp. 468–70.

‡ Centralbl. f. d. Med. Wiss., xx. (1882) pp. 753, 772, and 819.

nerve-fibres of the white and grey matter a brilliant red, the other parts varying in tint to blue. This was much praised by all who used it as an exceptionally excellent method, but is now superseded by a new stain, which Prof. Weigert* considers to be still better, and which, according to all accounts, is specially valuable as being extremely simple and easy, and, above all, unailing.

The first solution used consists of hæmatoxylin 0·75 to 1·0, alcohol 10·0, and water 90·0, the mixture being boiled and left to stand several days before being used.

In this solution sections, cut with alcohol and not water, and hardened in Müller's or Erlicki's† fluid, are allowed to remain for 1–2 hours at a temperature of 35°–45° C. The sections are now coal black.

After washing with water they are placed in a solution of borax 2·0, potassium ferricyanide 2·5, and water 100·0, until the white is differentiated from the grey matter, the latter becoming indistinctly yellow, while the former remains black. They can then be washed, treated with alcohol, xylol, and Canada balsam in the usual way.

W. T. Councilman,‡ writing of this process, says that any one using it for the first time will be struck with the richness of the network of nerve-fibres in the grey matter of the cord. What was formerly spoken of as gelatinous substance or neuroglia will be found to be mostly nerve-fibres. They are not visible under ordinary circumstances, because the intermediate substance stains as intensely as the axis-cylinders. At first sight it will appear that the axis-cylinders are stained, but closer inspection with high powers will show that these are really unstained, and the white substance of Schwann has taken on the colour. In the middle of the bright red or purple spots which represent the cross sections of nerve-fibres, the unstained axis cylinder can be seen. It is in all respects just the opposite to the ordinary staining of carmine and hæmatoxylin. The method is also invaluable in the pathology of the cord in tracing degenerated nerve-tracts.

Method for Displaying the Course of the Fibres in the Central Nervous System.§—S. Freud proposes the following method for this purpose:—

Thin sections of brain hardened in bichromate of potash, after washing to free them from the alcohol with which the razor has been moistened, are placed in a watch-glass with 1 per cent. solution of gold chloride and left for 3–5 hours. They are then removed with a clean fragment of wood, washed in distilled water, and placed in a solution of caustic potash (1 part potash to 5 or 6 water) for about three minutes. The superfluous potash is removed by placing the sections on filter paper, and they are then placed in 10–12 per cent. sodium potash, where they acquire a red colour; in 5–15 minutes the staining is complete.

* Fortschr. d. Med., 1884, pp. 113, 190.

† Potassium bichromate 2·5; copper sulphate 0·5; distilled water 100·0.

‡ Amer. Mon. Micr. Journ., v. (1884) pp. 201–3.

§ Arch. f. Anat. u. Phys., 1884, pp. 453–60.

Such preparations show the fibres dark reddish brown on a light red, bluish, and even unstained ground. The most convenient hardening fluid is $2\frac{1}{2}$ parts bichromate of potash, $1\frac{1}{2}$ sulphuric acid, to 100 parts of water.

Method for the Silver Staining of Marine Objects.*—The principle of this method was suggested to Mr. S. F. Harmer by Dr. W. H. Ransom, and consists in the replacement of distilled water in the ordinary process of silver staining by a solution of a neutral salt not precipitable by silver nitrate, and of the same specific gravity as seawater. *Loxosoma* and *Pedicellina* were the first objects investigated, and these animals are not killed by an exposure of as much as half an hour to a 5 per cent. solution of potassic nitrate in distilled water. It is thus quite easy to free the tissues from the greater part of their chlorides by washing with the above-mentioned solution of potassic nitrate; from this the objects are transferred (naturally without the formation of any precipitate) for four or five minutes to a solution of silver nitrate ($\frac{1}{8}$ to 1 per cent. according to circumstances). After reduction of the silver during exposure to light in the nitrate solution, the tissues may be mounted permanently either in glycerin or in Canada balsam. Very beautiful preparations of *Loxosoma* were easily obtained by the use of osmic acid and picro-carmin after treatment with silver nitrate. The animal may either be transferred directly from the silver solution to osmic acid ($\frac{1}{2}$ per cent.) and thence to picro-carmin, reduction taking place during the process, or the osmic acid may be added after the silver has been already reduced in the potassic nitrate. In successful preparations made in the above manner, the limits of all the cells of the epidermis and of the alimentary canal are exceedingly sharply marked out, the nuclei of these cells as well as of the muscle cells, connective-tissue corpuscles, and other tissue elements, being very distinctly stained.

Few animals seem to resist the action of potassic nitrate to so great an extent as *Loxosoma* and *Pedicellina*, most forms being either immediately or after a few minutes killed by an immersion in a 5 per cent. solution of this substance. Even in many of these cases, the tissues suffer very little histological change, and can be easily stained by silver nitrate. It is possible that many other salts may be used more advantageously than potassic nitrate in washing the chlorides from the tissues without killing the animal. A $4\frac{1}{2}$ per cent. solution of sodic sulphate may be used instead of the potassic nitrate, over which, however, in most cases it has no obvious advantages.

Balsam of Tolu for Mounting.—Dr. W. J. Gray informs us that some years ago he tried this substance for mounting, but found that it was open to the great objection of the formation of crystals. Since Mr. C. H. Kain's recommendation of it † he has tried it again, and the slides are already full of crystals.

* *MT. Zool. Stat. Neapel*, v. (1881) pp. 44-56.

† See this *Journal*, iv. (1881) p. 985.

Zenger's Mounting for Diatoms, to view them on both sides.—Dr. C. V. Zenger writes us as follows:—"It is of the utmost importance for the study of diatoms and their structure, to view the preparations from opposite sides, and I have found very useful a simple and expeditious mode of obtaining a double-sided cell.

I use two circular covers just fitting on the plane surface of the Abbe condenser. After well rinsing with pure alcohol or benzine and drying, a circular disk of tin-foil is cut of exactly the diameter of the covers. A concentric hole is punched out, and the tin-foil ring thus obtained glued to one of the covers. After drying over a small gas-burner, the shallow cell thus formed is warmed and filled with a solution of tolu balsam in benzine; and the other cover with the diatoms burned on its surface is placed on the cell, squeezing out with the nail the superfluous imbedding liquid on blotting-paper, so that it will immediately suck away the liquid pressed out. Wool or cotton dipped in benzine or pure alcohol may be used to wipe the borders and surface of the cell to clean it, turning it round on the blotting-paper, so that the other side is equally cleaned. It is then dried over a small gas-burner very cautiously to get rid of air-bubbles, and to fasten the covers. Both covers having the same thickness and diameter, there is no fear of separating them. In order not to confound the different views, the tin-foil is painted with red lacquer on one side, so that the particular side under the object-glass can be readily distinguished. Immersion can be used on both sides, on that turned to the condenser or to the object-glass, or both sides at once."

ADY, J. E.—The Microscopic Study of Rocks. I.

[Includes methods of preparing.] *Sci. Monthly*, III. (1885) pp. 1-4.

ALMQVIST, E.—Die besten Methoden Bacterien rein zu cultiviren. (The best Methods for the pure cultivation of Bacteria.)

[(1) Pasteur, (2) Koch, (3) in a moist chamber. The last for observations on the development of an individual from spore to spore.]

Bot. Centralbl., XIV. (1883) pp. 286-7. Also *Hygiene*, 1883.

ARNOLD, C.—See Turntable.

B.Sc.—See Turntable.

BALDWIN, L. A.—Staining and Mounting Casts, &c.

[Inquiry for satisfactory process and reply by R. Hitchcock.]

Amer. Mon. Micr. Journ., V. (1884) p. 240.

BARRETT, J. W.—A new Method of Cutting Sections for Microscopical Examination.

[Describes the "Celloidin Method."—See Vol. IV. (1884) p. 822.]

Journ. Anat. and Physiol., XIX. (1884) pp. 94-6.

BECKE, F.—Ueber die Unterscheidung von Augit und Bronzit in Dünnschliffen. (On the Discrimination of Augite and Bronzite in thin Sections). [Post.]

Tschermak's Mineralog. und Petrogr. Mitthlg., V. (1883) p. 527.

BRAUN, M.—Die thierischen Parasiten des Menschen, nebst einer Anleitung zur praktischen Beschäftigung mit der Helminthologie für Studierende und Aerzte. (The Animal Parasites of Man, with instructions in practical Helminthology for Students and Physicians.) [Post.]

223 pp., 72 figs., 8vo, Würzburg, 1884.

BROWN, G. D.—Mounting dry opaque objects without cover-glass.

[His collection of Polyzoa is mostly so mounted. Objects are thus better seen by reflected light, there is no condensation of moisture on the cover-glass, and no fungi.]

Journ. of Microscopy, IV. (1885) p. 42.

Cement for Glass, Porcelain, &c.

["Take soft cheese, grind and wash it in hot water, and when freed from all soft matter, and nothing remains but pure caseine, press in a fine cloth so as to squeeze out all the liquid. The white matter is dried, reduced to powder, and preserved in a wide-mouthed bottle, or well-fitting box. To use it, grind it up with a small quantity of water, which makes a very adhesive paste. Use immediately, and in the cold. It sets rapidly, and when once dry, it cannot be redissolved, either by moisture or heat. It is suggested that the dry caseine should be ground up, not in water, but in ammonia, solution of borax, or in lime-water, and preferably to obtain the caseine from butter-milk, which is precipitated with acetic acid, using as little as possible. The precipitate to be repeatedly stirred up in hot water, and thus washed by decantation, until all the fatty matter is removed."]]

Journ. of Microscopy, IV. (1885) pp. 63-4,

from 'Moniteur des Produits Chimiques,' through the 'Chemical Review.'

COUNCILMAN, W. T.—The Microscopic Investigation of the Brain and Spinal Cord. [*Supra*, p. 159.] *Amer. Mon. Micr. Journ.*, V. (1884) pp. 201-3, 212.

DAVIES, T.—The Preparation and Mounting of Microscopic Objects. Edited by John Matthews. New ed.

[Not a new ed.—title-page redated.]

222 pp., 12mo, London, 1884.

DEKHUIJZEN, M. C.—Het Onderzoek van dierlijke Weefsels, voornamelijk van het Kraakbeen, in het gepolariseerde licht. (The investigation of animal tissues, especially cartilage, in polarised light.)

viii. and 108 pp. (1 pl.), 8vo, Leiden, 1884.

DELOGNE.—Instrument pour opérer le triage des diatomées sous des grossissements assez forts tels que ceux fournis par les objectifs Nos. 3 et 4 de Hartnack. (Instrument for sorting diatoms under powers as high as the Nos. 3 and 4 Hartnack objectives.)

[On the same principle as that of J. Chalon, *Assoc. Franc. Av. Sci.*, 1881 (See Vol. I., 1881, p. 847), but the movements are restricted to two rectangular planes.]

Bull. Soc. Belg. Micr., XI. (1884) p. 38.

DIETZSCH, O.—Die wichtigsten Nahrungsmittel und Getränke, deren Verunreinigungen und Verfälschungen. (The most important Foods and Drinks, their impurities and adulterations.) 4th ed., 352 pp., 8vo, Zurich, 1883.

FLESCHE, M.—Zur Weigert'schen Hämatoxylinfärbung der centralen Nervensystems. (On Weigert's hæmatoxylin staining for the central nervous system.) [*Post.*] *Zeitschr. f. Wiss. Mikr.*, I. (1884) pp. 564-6.

FRANCOTTE, F.—Moyen d'accélérer l'inclusion dans la paraffine à l'aide du vide. (Method of accelerating imbedding in paraffin by means of a vacuum.)

[*Supra*, p. 149.]

Bull. Soc. Belg. Micr., XI. (1884) pp. 45-8.

FRÄNKEL, B.—Ueber die Färbung der Koch'schen Bacillus und seine semiotische Bedeutung für die Krankheiten der Respirationsorgane. (On the staining of Koch's *Bacillus* and its semiotic importance in diseases of the respiratory organs.) [*Post.*] *Berl. Klin. Wochenschr.*, 1884, No. 13.

GARBINI, A.—See Bibliography a.

GIACOMINI, C.—Sezioni microscopiche dell' intero encefalo umano adulto. (Microscopical sections of the entire human adult brain.)

Sep. repr. from *Giorn. R. Accad. Med. Torino*, 1882, Fasc. 12, pp. 3-18.

" " Modificazione al processo classico di induramento dei centri nervosi. (Modification of the classical process for hardening the central nervous system.) [*Post.*] *Torino*, 1883, pp. 66-7.

GIERKE, H.—Färberei zu mikroskopischen Zwecken. (Staining for microscopic purposes.) [*Concl'd.*] [*Post.*] *Zeitschr. f. Wiss. Mikr.*, I. (1884) pp. 497-557.

GILES, G. M.—Description . . . of an inexpensive Microtome.

[Describes "a form of microtome which can be made by any one with a slight mechanical turn for about 1s. 6d. In many essential points it is almost identical with that of Mr. A. B. Chapman, described" Vol. IV. (1884) p. 642, though made more than ten years ago.]

Sci.-Gossip, 1885, pp. 7-9 (2 figs.).

- GOSSE, P. H.—Evenings at the Microscope. [*Post.*]
New ed., vi. and 412 pp., 112 figs., 8vo, London, 1884.
- GRAM, C.—Untersuchungen über die Grösse der rothen Blutkörperchen im Normalzustande und bei verschiedenen Krankheiten. (Researches on the size of the red blood-corpuscles in the normal condition and in different diseases.)
[On the methods used, pp. 33–6.] *Fortschr. d. Med.*, II. (1884) p. 33.
- GRIFFITH, E. H.—A beautiful slide.
[“Heat a slide until it will melt a small portion of a menthol pencil as it is drawn evenly back and forth over a perfectly clean surface. Do not use more heat than necessary to melt the material evenly. Then as it commences to crystallize, arrest its progress frequently by passing the slide quickly over the flame of your spirit-lamp. Soon the crystallization will be completed, a little at a time, and a very desirable slide will be the result.”]
The Microscope, IV. (1884) p. 241.
- HANAMAN, C. E.—White Zinc for mounting.
[Warning against its use. Of “27 slides 21 required re-cementing, and in every case the cement was so brittle that it needed but a touch of the knife-blade to cause the fragments which remained to leave the glass.”]
Amer. Mon. Micr. Journ., V. (1884) p. 220.
- HARMER, S. F.—On a method for the silver staining of marine objects.
[*Supra*, p. 160.] *MT. Zool. Stat. Neapel*, V. (1884) pp. 445–6.
- HASWELL, W. A.—On methods of studying the Annelida. [*Post.*]
N. Zealand Journ. Sci., I. (1883) p. 305.
- HEIDENHAIN, R.—Eine neue Verwendung des Hämatoxylin. (A new use of hæmatoxylin.) [*Supra*, p. 158.]
Arch. f. Mikr. Anat., XXIV. (1884) pp. 468–70.
- HENKING, H.—Neue Construction des Objecthalters am Schlittenmikrotom, eine genaue Einstellung des Objectes bezweckend. (New construction of the object-holder to the slide-microtome, allowing of an exact adjustment of the object.) [*Post.*]
Zeitschr. f. Wiss. Mikr., I. (1884) pp. 491–6 (2 figs.).
- HEURCK, H. VAN.—Structure microscopique de la valve des Diatomées. (Microscopic structure of the valve of the Diatomaceæ.) [*Post.*]
Bull. Soc. Belg. Micr., XI. (1884) pp. 71–3,
from ‘Synopsis des Diatomées de Belgique,’ pp. 35–7.
- HITCHCOCK, R.—Microscopical Technic. VIII. Concluding remarks on Mounting.
Amer. Mon. Micr. Journ., V. (1884) p. 210–1.
- ” ” Zinc White Cement again.
[“What we have said and still maintain as the result of practical experience is that zinc white cement cannot be depended upon. It may do as a finish, but not for the practical purposes of a cement.”]
Ibid., p. 218.
- ” ” Chromogene Bacteria.
[Contains directions for obtaining pure cultures of bacteria, simple culture-chamber (“glass tumbler inverted over a sauce-dish containing water with a salt-cellar projecting above the water to support the specimen”), directions for staining and mounting, and for preparing the culture-medium.]
Ibid., pp. 224–6.
- ” ” Material for Mounting for Distribution. *Ibid.*, pp. 235–6.
- ” ” W. C. Walker’s preparations of Diatoms.
[“These slides are unique from the ornamental mounting which must involve considerable expenditure of time.”]
Ibid., p. 239.
- ” ” J. L. Zabriskie’s wood sections, transverse, radial, and tangential. *Ibid.*, p. 239.
- ” ” See Baldwin, L. A.
- ” ” Pillsbury Cabinet for Slides.
[Commendation of it. Cf. this Journal, IV. (1884) p. 320.] *Ibid.*, p. 239.

- ISRAEL, O.—Ueber die Cultivirbarkeit des Actinomyces. (On the capacity for cultivation of Actinomyces.) [Post.]
Virchow's Arch. f. Pathol. Anat. u. Physiol., XCV. (1884) p. 140.
- JAMES, F. L.—The Microscope as an instrument for physical diagnosis.
[Discovery of *Sporotrichum dermatodes* as the cause of a disease to which French workmen manipulating reeds (*Arundo donax*) are subject.]
National Druggist (St. Louis), V. (1884) p. 216.
- ” ” Preparing Slides with Shellac.
[The slide should be put away to dry, cell side downward, or the heaped-up shellac will again spread over the glass.]
Ibid., p. 216.
- KALCHBRENNER, K.
[Describes a discovery of F. v. Müller, who has found in methylized alcohol a means by which fungi and other plants can be so dried that they retain their natural colours.]
Bot. Centralbl., XX. (1884) p. 391,
from 'Mathem. és Term. tud. Ertesitö,' II. (1884) pp. 97-8.
- KERREMANS.—[Sur la méthode de Wickersheimer.] (On the method of Wickersheimer.) *Comptes Rendus Soc. Entomol. Belg.*, No. 51 (1884) pp. cccxxxiv.-v.
- KLEBS, G.—Organisation einiger Flagellatengruppen und ihre Beziehung zu Algen und Infusorien. (Organisation of some Flagellata and their relationship to Algæ and Infusoria.)
[See Vol. IV. p. 68, and for methods, post.]
Unters. Bot. Instit. Tübingen, I. (1883) pp. 233-62 (2 pls.).
- KOESTLER, M.—Ueber das Eingeweidenervensystem von *Periplaneta orientalis*. (On the intestinal nervous system of *Periplaneta orientalis*.) [Post.]
Zeitschr. f. Wiss. Zool., XXXIX. (1883) pp. 572-95.
- LATHAM, V. A.—Staining Sections. *Sci.-Gossip*, 1884, p. 276.
- LEBOUCC, H.—Un mot sur la technique des Coupes en séries. (A word on the technics of series sections.) 2 pp. Sep. repr. *Ann. Soc. Médec. Gand*, 1884.
- LINCK, G.—Ein neues Reagens zur Unterscheidung von Calcit und Dolomit im Dünnschliff. (A new Reagent for Calcite and Dolomite in thin Sections.)
[Post.] *Ber. Oberrhein. Geolog. Vereins*, XVI. (1883).
- LISSAUER.—Ueber die Veränderungen der Clark'schen Säulen bei Tabes dorsalis; Zusatz zu dem Obigen von C. Weigert. [Infra.]
Fortschr. der Med., 1884, No. 4.
- LUDWIG, F.—Ueber die spectroscopische Untersuchung photogener Pilze. (On the spectroscopic investigation of phosphorescent Fungi.)
[See Vol. IV. (1884) p. 925 and post.]
Zeitschr. f. Wiss. Mikr., I. (1884) pp. 181-90.
- M. D.—Microscopic Mounting.
[Reply to query for directions for mounting bone, cartilage, and muscle.]
Engl. Mech., XL. (1884) p. 289.
- ” See Turntable.
- MAGGI, L.—Sull' esame Microscopico di alcune acque potabili della città di Padova. (On the microscopical testing of some Padua drinking water.)
106 pp., 8vo, Pavia, 1884.
- MANTON, W. P.—See Bibliography a.
- MARTINOTTI, G.—Sulle colorazione doppia coll' ematosilina e coll' eosina. (On double staining with hæmatoxylin and eosin.)
6 pp. Sep. repr. *Gazz. delle Cliniche (Torino)* 1883.
- ” ” Sull' uso dell' allume di cromo nella tecnica microscopica.
[Post.] *Zeitschr. f. Wiss. Mikr.*, I. (1884) pp. 361-6.
- MATTHEWS, J.—See Davies, T.
- MERIAN, A.—Beobachtungen am Tridymit. (Observations on Tridymite.)
[Post.] *Neues Jahrb. f. Mineral.*, I. (1884) pp. 193-5.
- OWEN, D.—On Mounting Sections stained with Picrocarmine.
[“On removing the section from the staining solution, do not wash it, but absorb the superfluous picrocarmine with blotting-paper, and then mount in glycerin containing 1 per cent. of formic acid. It is not

necessary to remove all the picrocarmine from the section; in fact it is advisable to leave a little adhering to the section, for, within a few days after mounting, the trace of dye left will be absorbed by the section.”]

Sci.-Gossip, 1884, p. 275.

PEDLEY, P. R.—Stupefying active forms of aquatic life.

[Advocates the addition of 1-3 per cent. of ordinary soda-water or water charged with carbonic acid gas.]

Journ. and Proc. Roy. Soc. N. S. Wales, XVII. (for 1883) p. 261.

PLAUT, H.—Färbungs-Methoden zum Nachweis der fäulniß-erregenden und pathogenen Mikro-organismen. (Staining methods for demonstrating the saprogenous and pathogenous Micro-organisms.)

[Gives in a tabular form a summary of all the more important investigation methods for Micro-organisms—*post*.]

2nd ed., 32 pp., 8vo, Leipzig, 1884.

Polycystina, cleaning and mounting.

The Microscope, IV. (1884) pp. 280-2.

PRATT, W. F.—Staining Vegetable Tissues in Picrocarmine.

[Place the sections in alcohol for 1 hour. Immerse in staining solution $\frac{1}{2}$ -3 hours. Wash in alcohol. Immerse in an alcoholic solution of picrate of ammonia for 1 hour, and for a 2nd hour in a like solution. Place in alcohol and then in oil of cloves for a short time. From Cole's 'Methods of Microscopical Research,' 1884, Part XI.]

Sci.-Gossip, 1884, p. 276; 1885, p. 18.

REYNOLDS, R. N.—Notes on Microscopic Work. A Rat followed from the Corn-crib to the Microscopist's Cabinet. 16 pp., Detroit, 1884.

RICHARD, O. J.—Instructions pratiques pour la formation et la conservation d'un herbier de Lichens. (Practical instructions for the formation and preservation of an herbarium of Lichens.) 2nd ed., 44 pp., 8vo, Paris, 1884.

ROYSTON-PIGOTT, G. W.—Note on the Structure of the Scales of Butterflies.

[Contains the following:—"Very much has been written whether the delicate membrane of these beautiful scales is complex—I mean double quadruple or single. The question seems settled by the following facts. The sap flows between the tubes; scales are apparently a kind of flattened hairs, most of which are more or less hollow and similarly endowed with molecules. Squeezed accidentally an oily sap escapes. But another fact of an optical nature is still more decisive. Under the very finest instruments extant the former hazy margin of the most delicate scales becomes brilliantly clear, sharp, and black—a thin black line about the hundred thousandth part of an inch thick. This sharp black line is as precious an indication of instrumental perfection as the black division is in Saturn's rings to the astronomer. This black line is thus caused. Light is stopped at the edge where the transparent membrane is folded back. As an illustration—if gold leaf, which is transparent and about 1/200,000 of an inch thick, be doubled back, at the line of doubling or folding a black line appears in the translucent blue of the leaf. I have seen the same thing on folding carefully a piece of goldbeater's skin. No light shows through at the line of folding. All transparent tubes visible in the best possible instruments show also too black for borders. In the same way each of the ribs of these scales when unclouded with beading or molecules exhibits these beautifully well-defined black lines. Any one who possesses an instrument which clearly and sharply displays these black margins in minute delicate scales may be congratulated on the superlative excellence of his instrument.”]

Engl. Mech., XL. (1884) p. 215.

SÄFFTIGEN, A.

[Contains "Method of Preparation." Abstr. in 'Amer. Natural,' XVIII. (1884) p. 1291. *Supra*, p. 147, and cf. also this Journal, IV. (1884) p. 897.]

Morphol. Jahrbuch, X. (1884) pp. 120-71 (4 pls.).

SAUNDERS, W. D.—Microscopic Slide Centering.

[Turn one or more rings in ink with a fine steel pen on the back of the slide.]

Sci.-Gossip, 1884, p. 276.

- SLACK, H. J.—Pleasant Hours with the Microscope.
 [Directions for making a "lead-tree" and "silver-tree."]
Knowledge, VI. (1881) pp. 518-9.
 [Some hints on mounting objects.] *Ibid.*, VII. (1885) pp. 77-8 (1 fig.)
- STOWELL, C. H.—Dissecting Insects.
 [The plan adopted by the author for holding the insects is as follows:—
 An empty blacking box is filled to a depth of about 1/8 in. with melted beeswax, and while this is still in a liquid condition, a grasshopper is placed in it in the desired condition, and the whole left to cool; when hard, water is poured in and the dissection begun. When one specimen is used up, the wax is again melted and another insect inserted.]
The Microscope, IV. (1884) p. 277.
- STRENG, A.—Ueber eine Methode zur Isolirung Mineralien eines Dünnschliffs behufs ihrer mikroskopische-chemischen Untersuchung. (On a method for isolating minerals in a thin section for the purpose of their microscopical and chemical investigation.) [*Post.*]
Ber. Oberhess. Gesellsch. f. Natur- u. Heilk., XXII. (1883) p. 260.
- [*Styrax* for] Mounting the Diatomaceæ. *The Microscope*, IV. (1884) p. 280.
- Technique, Hints on. *Ibid.*, pp. 243-6.
- THOULET, J.—Mesure par la réflexion totale des indices de refraction des mineraux Microscopiques. (Measurement of the indices of refraction of microscopic minerals by total reflection.) [*Post.*]
Bull. Soc. Mineral. France, VI. (1883) p. 183.
- THURSTON, E.—Staining Bacteria for Micro-photographic purposes.
 [Explains the process with vesuvine and Bismarck brown, both in the case of free bacteria and those occurring in the tissues. "The best form of balsam for mounting bacteria is that which is dissolved in xylol, which is very easy to work with and does not abstract the dye."]
Engl. Mech., XL. (1884) pp. 335-6, from 'Photographic News.'
- Turntable, Microscopical.
 [Replies to query as to ringing slides and "producing those fine lines of varnish which professionals put on their slides" by C. Arnold, B. Sc., and M.D.]
Engl. Mech., XL. (1885) p. 394.
- WEIGERT, C.—Ueber eine neue Untersuchungs-Methode des Centralnervensystems. (On a new method for investigating the central nervous system.)
 [Supra, p. 158.] *Centrabl. Med. Wiss.*, XX. (1882) pp. 753 and 772.
- " " Ueber Schnellhärtung der Nervösen Centralorgane zum Zweck der Säurefuchsinfärbung. (On hardening rapidly the central nervous system for staining with acid fuchsin.) [*Supra*, p. 158.] *Ibid.*, p. 819.
- " " Ausführliche Beschreibung der in Nr. 4 erwähnten neuen Färbungsmethode für das Centralnervensystem. (Description of the new staining method for the central nervous system.) [*Supra*, p. 158.]
Fortschr. d. Med., 1884, Nr. 6.
- " " See Lissauer, *supra*.
- WEST, T.—Hantsch's fluid.
 [Alcohol 3 parts, water 2 parts, glycerin 1 part.]
Journ. of Microscopy, IV. (1885) pp. 41-2 and 30.
- [WHITMAN, C. O.]—Modern Methods of Microscopical Research.
Amer. Natural., XIX. (1885) pp. 106-8.
- WITLACZIL.
 [Contains remarks on the treatment of the Ova and Embryos of the Aphides.
 Abstr. in 'Amer. Natural,' XVIII. (1884) p. 1290. *Supra*, p. 147.]
Zeitschr. f. Wiss. Zool., XL. (1884) pp. 559-696 (7 pls.).

PROCEEDINGS OF THE SOCIETY.

MEETING OF 10TH DECEMBER, 1884, AT KING'S COLLEGE, STRAND, W.C.,
THE PRESIDENT (THE REV. W. H. DALLINGER, F.R.S.) IN THE
CHAIR.

The Minutes of the meeting of 12th November last were read and confirmed, and were signed by the President.

The List of Donations (exclusive of exchanges and reprints) received since the last meeting was submitted, and the thanks of the Society given to the donors.

From

New Polarizing Prism *Mr. C. D. Ahrens.*

Mr. J. Mayall, Jun., described Dr. J. D. Cox's Microscope, exhibited by Mr. Crisp, and manufactured by the Bausch and Lomb Optical Co. It was in general design a modification of Wenham's radial Microscope, the principal point being that the inclining motion was obtained by using one sector only, carrying the optical body as in Wale's form. It was fitted with a Zentmayer swinging substage and a second swinging tail-piece carried the mirror; also Bausch and Lomb's frictionless fine adjustment. It had the perfection of balance of the "Wale" form, and was so steady that he should expect it to be very suitable for photomicrography. (See Vol. IV., 1884, p. 279.)

Mr. Mayall also exhibited a modified form of the Wenham single-plate mechanical stage which he had designed. It had occurred to him that in consequence of the flexure of the upper plate the original form was hardly sufficiently firm for much of the work required of a modern Microscope, and he had therefore devised a frame to carry the slide, thus getting rid of the plate entirely, the slide therefore lying on the rotating plate of the stage as in using the "friction" stage. For ordinary purposes the old form was very convenient, but for very delicate work with the highest powers, and especially when the vertical illuminator was employed, the new one would, he considered, be found the more advantageous. (*Supra*, p. 122.)

Mr. Crisp exhibited and described Dr. R. H. Ward's last modification of eye-shade. Also the Bausch and Lomb adapter for the spot-lenses of the smaller Microscopes, and Kain's mechanical finger made to fit over the fine adjustment of the ordinary Jackson-Lister Microscope.

Professor Bell called attention to a peculiar variety of *Acineta grandis* S. K., found by Mr. Bolton. The figure sent by Mr. Bolton was taken from Mr. W. Saville Kent's Manual, and showed the difference between this and the ordinary form.

Dr. J. D. Cox's letter with reference to Dr. Flögel's views on the structure of diatoms was read, as also a further communication on some broken diatom valves, of which a photograph accompanied. Dr. Cox considered "it was hard to avoid scepticism as to Dr. Flögel's very thin sections. Nobody pretends to cut sections of any other tissue even remotely approximating those he claims to make, and the fragile siliceous of a diatom would seem much less likely to stand thin cutting than the fibre of wood, &c."

Mr. Parsons said that in April last he found at the Royal Botanic Gardens in Regent's Park, an object which he considered to be a zoophyte. Desiring information upon it, he took it to a meeting of the Quekett Club, but unfortunately spoilt it. After this he found there was a recovery of the stock, and he obtained some more very good specimens, but these becoming starved, died out before he could identify them. In the course of the week, his attention was called to the letter of Prof. Lankester in the 'Times,' describing the hydroid form of *Limnocoedium Sowerbii*, found in the Victoria Regia house at the gardens, and having obtained some from the tank, he found them to be the same as those he had previously obtained, and he now exhibited some specimens.

In reply to a question from Prof. Bell, Mr. Parsons said he had none of the original find, but he had made a rough drawing of them which was handed round.

Mr. Crisp said the American Society of Microscopists had decided to establish a fund for a memorial to the late R. B. Tolles, and the Council had on consideration of the matter voted the sum of 5 guineas, as a contribution from the Society.

Dr. C. V. Zenger's communication was read, describing a method of mounting diatoms, so that both sides of the object could be inspected (*supra*, p. 161).

Mr. Cheshire gave a *résumé* of his paper on some new points in the anatomy of the bee, the subject being illustrated by numerous drawings on the board, and by specimens exhibited under the Microscope (*supra*, p. 1).

Prof. Stewart said he could hardly adequately express his admiration at the way in which the subject had been worked out by Mr. Cheshire. He considered the paper one of the most interesting that had been placed before them for several years.

Prof. Bell said that it seemed to him that the concluding remarks of Mr. Cheshire were of even more importance than the details which he had worked out so admirably. There were some hermaphrodite animals, concerning which they would like to know more; in fact the whole question of the mechanics of reproduction was one in which the Microscope might be expected to play an important part.

The President said he was sure that the Society would feel very much indebted to Mr. Cheshire for his paper, which apart from the skill which he had shown in such a remarkable degree in working out the minute anatomy, was valuable on account of its suggestions; and they would look forward with great interest to its publication.

Mr. Dowdeswell read a paper "On the Occurrence of Variations in the Development of a *Saccharomyces*" (*supra*, p. 16).

Dr. Maddox said he had examined many forms, but had not met with those mentioned, though he had seen some very similar to them in the case of lactic fermentation. From the extreme care taken, he did not think it was possible to have got it otherwise than pure. In the lactic ferment, the form taken was more pear-shaped, the filament being like a long chain divided in the centre by two eggs. The acetic ferment was somewhat similar, and he would at some future day print some photographs of that form. With respect to the "Comma" bacillus, he might say that he had examined and photographed them, and found that they differed from the cholera bacillus, the latter not being so much curved, but he thought that mere variation in form must not be taken as having any morphological value whatever, though the point was worth mentioning as the cholera bacillus had taken up so much attention of late.

The President said that for his own part he was quite convinced that it was impossible to study these organisms without finding that they varied under different circumstances. Too much reliance must not, therefore, be placed upon the variations observed.

Mr. T. B. Rosseter's paper, "On the Gizzard of the Larva of *Corethra plumicornis*, its structure and uses," was read by Prof. Bell, who referred to the observations of Prof. Lankester, published in 1865, and the paper was also discussed by Mr. Beck, Prof. Stewart, and Mr. Crisp.

Dr. Van Heurck's notes on "Amphipleura pellucida resolved into 'Beads,'—Nature of the Striæ of Diatoms," was read and the photographs exhibited (see Vol. IV., 1884, p. 971).

Mr. J. Mayall, jun., said that since this paper was communicated, Dr. Van Heurck had sent another short note upon the subject. He considered he had solved the difficulty of obtaining sharp photographs, believing it to be due to the tremor of the mechanical stage. By placing the object lower upon a very rigid stage, he was able to get a much better photograph. He finds that the longitudinal lines are distinctly coarser than the transverse, and that the alveoli do not exist on the black lines, but that they are between them, so that the space between would, he thinks, be resolved into "beads" if the optical means at disposal were sufficient. In viewing these objects with a vertical illuminator and in Canada balsam, the diatom was practically invisible, but Dr. Van Heurck has found that when mounted in the dense fluid of Prof. Hamilton Smith, the object was

able to scatter the light to a considerable extent, and hence became visible. He thought that this discovery would give a new value to the vertical illuminator. Dr. Van Heurck had obtained the resolution both with Powell and Lealand's $1/8$ of 1.47 N. A., and with Zeiss' $1/18$ homogeneous immersion, which had much less aperture, so that the extreme aperture was not absolutely essential except as giving slightly better results. Dr. Van Heurck also stated that the mere classing of *A. pellucida* and *A. Lindheimeri* in the same genus hardly expressed the closeness of relationship which he believed to exist between them. He thought it extremely probable that *A. Lindheimeri* was the sporangial form (reproduced by generation) of *A. pellucida*.

The President said it was a matter of some interest in these discussions on the resolution of *Amphipleura* to know what was the size of the frustule. He had a very large collection of the diatom, ranging through a great number of sizes, and he thought there were some intermediate ones in which it might be possible to get the dotting. So that it was simply a matter of variation whether a frustule was called *Amphipleura pellucida* or one of the larger forms. The same relation might also be said to exist between *Navicula rhomboides* and *Frustulia saxonica*, the one being only a different development of the other.

Mr. Beck said he noticed that the paper spoke of the "beads" of *Amphipleura pellucida*, and it also referred to these beads as depressions. He thought that in these matters there was nothing like being accurate, and he was himself at a loss to know how a "bead" could be a depression. If they looked like the small particles of a smashed drop of quicksilver, then he could understand the resemblance to beads, but it seemed to him to be a contradiction to talk of them as depressions.

Mr. Crisp said that in the paper the word "beads" was placed in inverted commas, showing that the author meant only that they looked like what were generally called "beads" by microscopists. He considered them in reality to be cavities.

Mr. Dowdeswell said that Dr. Maddox had suggested that the failure to get a good photograph might arise from the expansion of the slide by heat after focusing.

Mr. E. M. Nelson said that he thought it was impossible to infer anything as to *Amphipleura* from what was seen in the case of *Triceratium*, as the markings which were analogous to those of *Triceratium* were at the bottom of the pits. In Dr. Flögel's section of *Triceratium*, as shown by Mr. Powell at the *Conversazione*, the deep markings were very clearly seen, but it was only by very careful looking that they could see some little marks at the bottom of the pits. He thought that a section of a diatom was absolutely useless, because they could see more of the structure in the whole. Taking the larger form first—*T. punctata*—it looked as if there were a number of straight bars of siliceous with a sort of ridge or depression, and a number of minute columns between, like a section of a colliery pit, or not unlike a ladder. In the coarser ones this could be seen with central light, but in *Amphipleura* it was not possible to see them in

that way, because the limit of resolution had been nearly reached. He believed that the longitudinal markings were the finest.

Mr. J. Mayall, jun., said the President had asked if there were any data as to the fineness of the striations. From 95,000 to 105,000 seemed to be the estimate in the case of those seen by Dr. Van Heurck. Mr. Nelson had given special attention to the measurement of the striation, using preparations in every respect similar to those of Dr. Van Heurck; and these figures represented the limits of the striation of the largest specimens. The measurements had been made in his (Mr. Mayall's) presence.

The following Instruments, Objects, &c., were exhibited:—

- Prof. Bell:—*Acineta grandis* S. K.
- Mr. Bolton:—Larval form of "fairy shrimp."
- Mr. Cheshire:—Section of bees, illustrating his paper.
- Dr. J. D. Cox:—Photographs of broken diatom valves.
- Mr. Crisp:—(1) Ward's and Pennock's Eye-shades. (2) Cox's Radial Microscope. (3) Bausch's Spot-lens Adapter. (4) Mechanical Finger.
- Mr. Dowdeswell:—Cultivation of a *Saccharomyces*.
- Dr. Van Heurck:—Photographs of *Amphipleura pellucida* and *A. Lindheimeri*.
- Mr. J. Mayall, jun.:—Modification of Wenham's single plate mechanical stage.
- Mr. Parsons:—Hydroid form of *Linnocodium Sowerbii*.
- Mr. Rosseter:—Section of *Corethra plumicornis*.
- Dr. C. V. Zenger:—Diatoms in his reversible mount.

New Fellows:—The following were elected *Ordinary* Fellows:—

Messrs. Charles P. Alling, George Coppin, A. Cowley Malley, B.A., M.B., Frederick R. Mandeville, M.D., George L. Mullins, Charles E. West, D.D., and Mrs. Louisa R. Stowell, M.S.

MEETING OF 14TH JANUARY, 1885, AT KING'S COLLEGE, STRAND, W.C.,
THE PRESIDENT (THE REV. DR. DALLINGER, F.R.S.) IN THE
CHAIR.

The Minutes of the meeting of 10th December last were read and confirmed, and were signed by the President.

The List of Donations (exclusive of exchanges and reprints) received since the last meeting was submitted, and the thanks of the Society given to the donors.

	From
Fol. H.—Lehrbuch der Vergleichenden Mikroskopischen Anatomie, mit Einschluss der Vergleichenden Histologie und Histogenie. 1te Lief., 208 pp. (84 figs.). 8vo, Leipzig, 1884	The Author.
Diatomaceous Earth from Santa Monica	Mr. H. G. Hanks.
Two photo-negatives of <i>Amphipleura pellucida</i> , and six slides of his silvered diatoms	Dr. Van Heurck.
Slide of <i>A. pellucida</i> silvered	Dr. A. Y. Moore.

Mr. Crisp read the list of Fellows who had been nominated for election at the February meeting as Officers and Council for the ensuing year.

Mr. Curties and Mr. F. H. Ward were elected auditors of the Treasurer's accounts.

Mr. C. Beck exhibited and described a new form of portable battery for working small incandescence lamps for the Microscope. The battery consisted of three small bichromate cells closed by a cover rendered water-tight by a collar of vulcanized rubber. The battery, with once charging, would supply sufficient current for one lamp for about $2\frac{1}{2}$ hours.

Mr. Beck also exhibited a simplified form of the Caldwell automatic microtome, with an endless moving band to receive a continuous series of sections in the exact order in which they were cut. The band could be removed when required, and the instrument used as an ordinary microtome, either with freezing arrangement or without. It also had an automatic motion for raising the sections, and its cost was a little over a third of the original form.

Mr. Crisp said that the means of cutting a series of sections and preserving them in their proper order on an endless band was now felt to be a matter of very great practical importance, and to be able to accomplish this at such a reduction of complexity and expense, as with Messrs. Beck's machine, was a great advance. At Cambridge the Caldwell microtome was worked by water-power, and he asked if such a method of working could be applied to the machine before them.

Mr. C. Beck said it would be quite easy to apply a donkey motion to it for that purpose.

Mr. J. Beck said that he would only supplement what had been said by laying stress on the fact that in all studies of embryology it was of the greatest importance that the sections should be consecutive. One section taken here and there gave very little idea of the object as compared with what could be learnt from a consecutive series.

Mr. Groves inquired if it was possible to use the machine without the automatic feed, because it was sometimes very useful to be able to get a thick section as well as thin ones.

Mr. C. Beck explained that this could be readily done so that at any time a thick section could be obtained.

Mr. Crisp said that in the recent Schanze microtome an improvement had been effected by altering the position of the screw so that it was at the side, and not directly under the object cut, where it was likely to be clogged by drippings from the object.

Mr. C. Beck said that in his instrument the screw was placed a good inch away at the side.

Mr. Crisp described Behrens' modification of the Abbe condenser, and Mr. Curties exhibited the plan he used for attaching the condenser to English stands (*supra*, p. 124).

Mr. H. L. Brevoort's letter was read, asking for references to papers, &c., on the subject of the construction of fur fibres as distinguished from hair. "There is," he said, "a large field of practical usefulness open to any one who may acquire a fuller knowledge of the construction of and method by which fur fibres operate upon one another in the practical operation of forming felt goods."

Mr. Crisp said he could not call to mind any paper which had been published in which any distinction between hair and fur had been drawn, at any rate not scientifically.

Mr. J. Beck thought none had been, in fact, made, and that the distinction was merely a commercial one.

Mr. H. G. Hanks' letter was read as follows:—"I send a package for distribution to Fellows specially interested containing diatomaceous earth thrown up by the waves at Santa Monica, and deposited in the sea-beach débris, like the celebrated fragment found in March 1876. It has been examined by Mr. Wm. Ashburner, of the San Francisco Microscopical Society, and found to resemble the true Santa Monica, although not so rich."

Mr. Crisp called attention to Dr. Van Heurck's donation of two photo-negatives of *Amphipleura pellucida*, and six slides in which the diatoms had been burnt on the glass and silvered.

Mr. J. Mayall, jun., said that Dr. Van Heurck had sent two sets of slides for the Society's collection; one set of which had been prepared by Dr. A. Y. Moore's process and one by a new process devised by Dr. Van Heurck. In the former process there was a tendency for the silvering solution to get under the diatoms, and to obviate this Dr. Van Heurck put them into a muffle and heated them until the glass softened, and the diatoms became partially imbedded in it. The following translation of the letter which accompanied the photographs was then read:—

"I have the honour to submit to the Society a new photograph of the 'beads' of *A. pellucida*.

This new print exhibits the double striation well defined on a portion of the valve. I think it will be very difficult to resolve a larger portion in consequence of the special kind of illumination, which does not cover the whole valve at once.

The photograph was obtained by using a rigid stage, in order to obviate the flexure which I found to be a serious drawback in mechanical stages. The success I have had convinces me that my former less perfect results were principally defective through the use of a mechanical stage.

I must also add that I have recently found that it is necessary to give a longer exposure to the photographic negative than I formerly gave, for with such preparations and with this kind of illumination (the vertical illuminator) we cannot distinguish the 'beads' unless the diatoms appear green in the field of the Microscope. It is well known that this colour is unfavourably actinic for the development of

fine details in photography, and consequently the exposure of the plate has to be considerably augmented, with corresponding risk of movement of the image.

I venture to remark upon two points referred to at the preceding meeting:—

1. In reply to the President, the length of the valve photographed is about $8\frac{1}{2}$ hundredths of a millimetre—that is to say, slightly smaller than the valve photographed by the late Dr. Woodward, of Washington, which was about $9\frac{1}{2}$ hundredths of a millimetre. The average valves of *A. pellucida* vary, according to W. Smith, between 84 and 137 μ .

2. In reply to Mr. Beck, I used the term 'beads' in its popular sense, as remarked by Mr. Crisp. On this matter I may refer to the note 2, p. 7 of my *Synopsis*."

Dr. Gray's note was read, warning microscopists that balsam of tolu was a failure as a mounting medium on account of its tendency to develope crystals (*supra*, p. 160).

Mr. Crisp exhibited Robinson's "microscopic photographic" camera; Gibbes's membrane-stretcher; and new live-cell (*supra*, p. 134).

Mr. Swift exhibited the cone condenser (which he had made in January 1883) and achromatized immersion paraboloid condenser referred to *supra*, p. 126.

Dr. Anthony's letter as to Mr. Wright's observations on the structure of the tongue of the blow-fly was read, as follows:—

"Will you kindly make known the fact that the professedly new matter with respect to the 'tongue of the blow-fly,' narrated in Mr. Wright's letter, read at the November meeting, was communicated to the microscopical world some ten years ago. I had the honour to read a paper on this subject on May 6th, 1874, in which the soft parts of the fly's tongue in connection with the chitinous rings of the pseudo-tracheæ were fully described and figured; and this paper, with its illustrations, will be found on reference to the June number of the 'Monthly Microscopical Journal' for 1874, p. 242. The paper was undertaken for the purpose of calling attention to the existence of a singularly beautiful set of soft parts—presumably suctorial—in the tongue of the fly, which I believe that no one previously had observed, seeing that they were not visible in that popular microscopic object when mounted in the then usual mode—viz. in Canada balsam—the preparation showing only the chitinous skeleton of the tongue, and that not too well. I will not suppose for a moment that Mr. Wright has plagiarized wilfully, but rather that he has rediscovered the matter he described. At the time I wrote, Topping's 'tongue of the blow-fly,' duly squeezed flat, and put in that treacherous Canada

balsam, which obliterated all the soft and delicate parts, was looked upon by most microscopists as 'simply perfect.' I did not think so, and I used then, as I do now for most preparations, an exceedingly weak spirit, and I have found my account in it, seeing that I have choice dissections, which I made more than twenty years ago, which are practically unchanged. If I arrange a fly's tongue fresh, or look at one in a former preparation, of course I can see more detail now with my fine Tolles homogeneous $1/10$ than I could in 1874 with Powell and Lealand's or Ross's best objectives; but I am pleased to find that when I do look with the fine modern glasses I recognize the description I gave in my paper to be substantially correct, though if the matter were 'brought up to date' it might naturally need some small alterations and corrections."

Mr. Cheshire exhibited and explained four preparations—three of spermatozoa and one of the muscles of the valve of the receptaculum seminis of the queen bee, which he had recently succeeded in dissecting, and of which he gave an interpretation at a previous meeting.

Dr. J. D. Cox's letter was read as follows:—

"I differ but little from Dr. Flögel, and the proofs on which I rely were gathered without any knowledge of what was being done in section-cutting. So far as the latter method is constructive, I find great interest in it; but as a method, I cannot think it superior to the faithful use of the ordinary means of observation.

The points on which I find myself differing from Flögel are these:—

1. I find a thin but indisputably present film covering the outer surface of the hexagons in *Triceratium favus*, as well as the heavier dotted film on the inner surface.

2. I think there should be no doubt of the existence of a film on the *outer* (convex) surface of *Coscinodiscus* of all the species named by him. The real dispute has been in regard to the eye-spot film, which is the *inner* one, on the concave surface of the disk. Flögel seems to reverse the relative positions of the two films.

The point on which scepticism will continue to hang doubts is the thinness of the sections; and those who are experienced in the photography of diatoms will think they can judge (to some extent) of this by the parts of the print in or out of focus. I shall have some examples illustrating this, which I shall send hereafter. That the 'solid spherule' theory must go, and be reckoned among things exploded, seems demonstrable from either method of examination."

Mr. A. D. Michael read a paper, "Notes on the Life-histories of some little-known *Tyroglyphidæ*" (*supra*, p. 19).

The President said that this was another of the series of very interesting communications which Mr. Michael had made to the Society. He had made this subject so entirely his own, that unfortunately none of them were able usefully to discuss it with him.

Dr. Maddox read a paper "On Some Unusual Forms of Lactic Ferment (*Bacterium lactis*)." Photographs ($\times 460$) and drawings, in illustration of the subject, were handed round for examination.

Mr. C. Thomas's paper, "On a New Species of *Acineta*," was read, together with a letter from Mr. Badcock, who considered it to be *Trichophrya epistylidis* (Clap. and Lach.).

Mr. Curties exhibited an improved form of Hardy's collecting bottle, in which he had substituted strips of glass at the sides and bottom for those of indiarubber (*supra*, p. 145).

Mr. Hardy said that his original idea was to use glass, but he could not get strips of sufficient length. He was very glad to find that Mr. Curties had been successful in the matter, as it could now be proved which was the better material.

Dr. F. Ritter v. Stein's death was announced, he being one of the Honorary Fellows of the Society, and the author of 'Der Organismus der Infusionsthier.'"

The following Instruments, Objects, &c., were exhibited:—

Mr. C. Beck:—(1) Parsons' battery for working small incandescence lamps for the Microscope; (2) Simplified form of Caldwell's Automatic Microtome.

Mr. Cheshire:—Three slides of Spermatozoa from Queen Bee, Queen Wasp and Drone, and one of the muscle of the spermathecal valve.

Mr. Bolton:—*Clava squamata*.

Mr. Crisp:—(1) Gibbes' Membrane-stretcher; (2) Robinson's "Microscopic Photographic" Camera.

Mr. Curties:—(1) Abbe Condenser for attachment to English stands; (2) Hardy's collecting bottle.

Dr. Van Heurck:—Two photo-negatives of *Amphipleura pellucida*; and six slides of his silvered diatoms.

Mr. Michael:—Two slides of *Tyroglyphus Robini*, and Hypopus of *T. corticis*.

Dr. A. Y. Moore:—Slide of *A. pellucida* silvered by his process.

Mr. Swift:—Cone Condenser and Achromatized Immersion Paraboloid.

New Fellows:—The following were elected *Ordinary Fellows*:—Messrs. T. Theodore Cash, M.D., George C. Karop, M.R.C.S., Henry B. Preston, Edgar Thurston, M.R.C.S., and Joseph H. Wythe, M.D.

JOURNAL

OF THE

ROYAL

MICROSCOPICAL SOCIETY;

CONTAINING ITS TRANSACTIONS AND PROCEEDINGS,
AND A SUMMARY OF CURRENT RESEARCHES RELATING TO
ZOOLOGY AND BOTANY
(principally Invertebrata and Cryptogamia),
MICROSCOPY, &c.

Edited by

FRANK CRISP, LL.B., B.A.,

One of the Secretaries of the Society

and a Vice-President and Treasurer of the Linnean Society of London;

WITH THE ASSISTANCE OF THE PUBLICATION COMMITTEE AND

A. W. BENNETT, M.A., B.Sc., F.L.S.,
Lecturer on Botany at St. Thomas's Hospital,

F. JEFFREY BELL, M.A., F.Z.S.,
Professor of Comparative Anatomy in King's College,

JOHN MAYALL, JUN., F.Z.S.,

FRANK E. BEDDARD, M.A., F.Z.S.,

AND

B. B. WOODWARD, F.G.S.,
Librarian, British Museum (Natural History),

FELLOWS OF THE SOCIETY.



WILLIAMS & NORGATE,
LONDON AND EDINBURGH.

CONTENTS.

TRANSACTIONS OF THE SOCIETY—

	PAGE
IV.—THE PRESIDENT'S ADDRESS. By the Rev. W. H. Dallinger, LL.D., F.R.S. (Plates IV.—VI.)	177
V.—THE LANTERN MICROSCOPE. By Lewis Wright (Figs. 40—42)	196
VI.—ON SOME UNUSUAL FORMS OF LACTIC FERMENT—BACTERIUM LACTIS. By R. L. Maddox, M.D., Hon. F.R.M.S. (Fig. 43)	205
VII.—ON A CATA-DIOPTRIC IMMERSION ILLUMINATOR. By J. Ware Stephenson, F.R.A.S., F.R.M.S. (Fig. 44)	207

SUMMARY OF CURRENT RESEARCHES.

ZOOLOGY.

A. GENERAL, including Embryology and Histology of the Vertebrata.

SCHIMKEWITSCH, W.—Development of the Heart in Vertebrates and Invertebrates ..	212
STRAHL, H.—Embryology of <i>Lacerta viridis</i>	212
HERTWIG, O.—Spindle-shaped Bodies in the Yolk of Young Ova of Frogs	213
RYDER, J. A.—Development of the Rays of Osseous Fishes	213
BROOK, G.—Origin of the Hypoblast in Pelagic Teleostean Ova	214
DÜSING, K.—Regulation of the Proportion of the Sexes in Man, Animals, and Plants	214
SCHLECHTER, J., & BERNER, H.—Causes of Sex	215
BROOKS, W. K.—New Law of Variation	216
RAEL, C.—Cell-division	217
LÖWIT, M.—Formation of Red and White Blood-corpuscles	220
LIST, J. H.—Unicellular Glands in the Cloaca of Rays	221
MITROPHANOW, P.—Intercellular Spaces and Bridges in Epithelium	221
MÜLLENHOFF, K.—Size of the Surfaces of Organs of Flight	221
HERDMAN, W. A.—Phylogenetic Classification of Animals	221

B. INVERTEBRATA.

HALLIBURTON, W. D.—Chitin as a Constituent of the Cartilages of <i>Limulus</i> and <i>Sepia</i>	222
---	-----

Mollusca.

HILGER, C.—Eye of <i>Gastropoda</i>	222
LACAZE-DUTHIERS, H. DE— <i>Epipodium</i> of <i>Gastropoda</i>	223
MOSELEY, H. N.—Eyes of <i>Chitonidæ</i>	224
LACAZE-DUTHIERS, H. DE—Nervous System and Embryonic Forms of <i>Gadina garnotii</i>	224
IHERING, H. VON—Uropneustic Apparatus of <i>Helicinæ</i>	225
DAVIS, J. R.—Habits of the Limpet	225
OSBORN, H. L.—Gill in <i>Neptunea</i>	226
BERGH, R.—The Genus <i>Melibe</i>	226
HOEK, P. P. C.—Development of the Oyster	226
BROUIN, T.—Byssogenous Glands and Aquiferous Pores in <i>Lamellibranchs</i>	227
JOURDAIN, S.—Nervous System of Embryos of <i>Limacina</i> , and the Relations of the <i>Otocyst</i>	228
GÜMBEL, V.—Shells of Molluscs	228
NEUMAYR, M.—Hinge of the Shells of Bivalves	229
MÜLLER, W.—Shell of <i>Lamellibranchiata</i>	230

Molluscoida.

a. Tunicata.

HERDMAN, W. A.—Evolution of the Blood-vessels of the Test in <i>Tunicata</i>	230
LACAZE-DUTHIERS, H. DE—Microscopic Elements serving for the Determination of the <i>Cynthiidæ</i>	230
ULJANIN, B.— <i>Doliolum</i>	231
" " —Structure of <i>Distaplia</i>	233
LENDENFELD, R. V.—Slimy Coatings of certain <i>Boltenias</i>	233

γ. Brachiopoda.

JOUBIN, M.—Digestive and Reproductive Organs of <i>Crania</i>	233
---	-----

Arthropoda.

a. Insecta.

LOWNE, B. T., & HICKSON, S. J.—Compound Vision and the Morphology of the Eye in Insects	234
ADOLPH, E.—Wings of <i>Hymenoptera</i>	234

5. Arachnida.

PAGE

BERTKAU, P.— <i>Digestive Apparatus of Spiders</i>	235
McMURRICH, J. P.— <i>Structure and Affinities of Phytopus</i>	236
TROUSSART, E. L.— <i>Acari inhabiting the Quill of Feathers</i>	236
MACLEOD, J.— <i>Presence of a Coxal Gland in Galeodes</i>	236

c. Crustacea.

SABATIER, A.— <i>Spermatogenesis in Decapod Crustacea</i>	237
BLANC, H.— <i>Development of the Egg and Formation of the Primitive Layers in</i> <i>Cuma Ratlikii</i>	238
PACKARD, A. S.— <i>Brain of Asellus and Cecidotæa</i>	238
FOREL, F. A.— <i>Deep Fauna of Swiss Lakes</i>	238
STEBBING, T. R. R.— <i>New Amphipodous Crustacean</i>	238
HASWELL, W. A.— <i>Crustacean inhabiting the Tubes of Vermilia</i>	238
CHILTON, C.— <i>Marine Species of Philougrina</i>	239
ZACHARIAS, O.— <i>Amœboid Movements of Spermatozoa of Polyphemus pediculus</i> ..	239
WRIGHT, R. R.— <i>Parasitic Copepod of the Clam</i>	239

Vermes.

CONN, H. W.— <i>Formation of Trochophere in Serpula</i>	240
HASWELL, W. A.— <i>Anatomy of the Serpula with Characteristics of Australian Species</i>	241
BERGH, R. S.— <i>Metamorphosis of Nephelis</i>	241
CALDWELL, W. H.— <i>Blastopore, Mesoderm, and Metameric Segmentation in Phoronis</i>	242
BEDDARD, F. E.— <i>Structure of the Body-wall in Earthworms</i>	243
LANG, A.— <i>Excretory Organs of Worms</i>	243
MÉGNIN, P.— <i>Sclerostoma bouleri</i>	244
HÜBRECHT, A. W.— <i>Excretory Organs of Nemertines</i>	244
NEMEC, J.— <i>Nervous System of Tania</i>	244
LANG, A.— <i>Polycladidea</i>	245
REPIACHOFF, M.— <i>New Turbellarian</i>	248
ZACHARIAS, O.— <i>Reproduction and Development of Rotifer vulgaris</i>	249
HUDSON, C. T.— <i>New Floscularia</i>	250

Cœlenterata.

HARTLAUB, C.— <i>Origin of Sexual Cells in Obelia</i>	250
BOURNE, A. G.— <i>Hydroid Phase of Linnocodium Sowerbii</i>	251
BROOKS, W. K.— <i>Life-history of Eutima mira</i>	251
VIGUIER, C.— <i>Tetraplatia volitans</i>	252
LENDENFELD, R. v.— <i>Australian Hydromedusæ</i>	252
KOWALEVSKY, N.— <i>Development of Lucernaria</i>	253
HERDMAN, W. A.— <i>Structure of Sarcodictyon</i>	253

Porifera.

LENDENFELD, R. v.— <i>Nervous System of Sponges</i>	253
" " — <i>Occurrence of Flesh-spicules in Sponges</i>	254
" " — <i>Fibres of certain Australian Hircinidæ</i>	254
GOETTE, A.— <i>Development of Spongilla</i>	254
VEJDOVSKY, F.— <i>Observations on some Fresh-water Sponges</i>	255
CARTER, H. J.— <i>Spongilla fragilis, and a New Species of Spongilla</i>	255

Protozoa.

HERTWIG, R.— <i>Erythrospis agilis</i>	255
GRUBER, A.— <i>Protozoa of the Gulf of Genoa</i>	256
STOKES, A. C.— <i>New Fresh-water Infusoria</i>	257
" " — <i>New Choano-Flagellata</i>	258
IMHOFF, O. E.— <i>Flagellata (Dinobryon) as Members of the Pelagic Fauna of Lakes</i>	258
ROBOZ, Z. V.— <i>Calcituba polymorpha</i>	258
LANKESTER, E. RAY.— <i>Archerina Boltoni</i>	259
GRUBER, A.— <i>Studies on Amœbæ</i>	260
KÜNSTLER, J., & PITRES, A.— <i>Psorosperm in the Human Pleural Cavity</i>	261
PARONA.— <i>New and Little-known Protistæ</i>	261

BOTANY.

A. GENERAL. including the Anatomy and Physiology
of the Phanerogamia.

a. Anatomy.

GUIGNARD, L.— <i>Structure and Division of the Nucleus</i>	262
BRASS, A., & FRAISSE, & H. FOL.— <i>Chromatine in Cell-division</i>	263
FAMINTZIN, A.— <i>Siliceous Membrane with Properties of the Cell-wall</i>	263
TSCHIRCH, A.— <i>Chemical Reactions of Chlorophyll</i>	264
HANSEN, A.— <i>Colouring-matters of Flowers and Fruits</i>	264
PICK, H.— <i>Red Pigment of Phanerogams</i>	265
BACCARINI, P.— <i>Mechanical Function of Crystals of Calcium Oxalate</i>	265

TSCHIRCH, A.—Starch-meal 265
LEBLOIS, A.—Function of Latex in the Compositæ 266
GROSGLIK, S.—Influence of Light on the Development of the Assimilating Tissue of Leaves 266
VAN TIEGHEM, P.—Cortical Fibrovascular Bundles of Viciææ 266
SCHENCK, H.—Formation of Centrifugal Thickenings in the Walls of Hairs and in the Epidermis 267
MÖBIUS, K.—Mechanical Sheaths to Secretion receptacles 267
VAN TIEGHEM, P.—Curvature of Ovules 267
MEEHAN, T.—Sexual Characters in Zinnia 267
" " —Elasticity in the Filaments of Helianthus 268
GRAY, A.—Movements of Andræcium in Sunflowers 268
SCHRENK, J.—Haustoria of Parasitic Phanerogams 268
MAYR, H.—Organs of Secretion in Pines and Larches 269
MACFARLANE, J. M.—Distribution of Honey-Glands in Pitchered Insectivorous Plants 269
FOERSTE, A. F.—Nectar-Glands of *Apios tuberosa* 269

β. Physiology.

KRUTTSCHNITT, J., & BRITTON, N. L.—Fecundation of Ovules in Angiosperms .. 270
TREUB, M.—Embryo of *Cycadex* 270
" " —Embryo of *Barringtonia* 271
MEEHAN, T.—Fertility of Hybrids 271
JONISSEN, A.—Germination of Flax and Sweet Almond 271
RULF, P.—Behaviour of Tannin in Germination 272
WEITSTEIN, R. v.—Laws of Growth of Vegetable Organs: Roots 272
WIESNER, J.—Motions of Roots during Growth 272
FRASER, A. T.—Autumnal Foliage 272
BONNIER, G., & MANGIN, L.—Respiration of Germinating Seeds 272
DUFOUR, J.—Influence of Gravitation on the Movements of Stamens 272
MER, E.—Nycitropic Movements of Leaves 273
WIESNER, J.—Mechanical Explanation of Spontaneous Nutations 273
WORTMANN, J.—Secondary Geotropic Phenomena 273
ELFVING, F.—Ascent of Water in Plants 274
EMERLING.—Formation of Albumen in Green Plants 274
DETMER, W.—Formation of Hydrochloric Acid in Plants 274
LAWES, J. B.—Source of the Nitrogen in Plants 275
BERTHELOT & ANDRÉ.—Formation of Nitrates in Plants 275
JONISSEN, A.—Reducing Properties of Seeds and Formation of Diastase 276
CARNOL, A.—Composition of Mineral Oil in relation to the Plants which have produced it 276

B. CRYPTOGAMIA.

Cryptogamia Vascularia.

LECLERC DU SABLON, M.—Dehiscence of the Sporangia in Vascular Cryptogams .. 276
KLEIN, L.—Development of Organs and Growth at the Growing Point of Dorsiventral Ferns 276
TREUB, M.—Prothallium of *Lycopodium* 277
FRANCHET, A.—South American Isoetes 279
BRUCHMANN, H.—Development of the Vegetative Organs of *Selaginella spinulosa* .. 279

Muscineæ.

HY, L'ABBÉ.—Archegonium and Sporogonium of Muscineæ 279
BREIDLER, J., & BECK, G.—*Trochobryum*, a new genus of Seliigeriaceæ 281
BOULAY, M.—Mosses of France 281
WARNSTOFF, C.—European Sphagnaceæ 281
STEPHANI, F.—*Rudula* 282

Algæ.

HANSEN, A., & TSCHIRCH, A.—Chlorophyll of *Fucaceæ* 282
MARCHESETTI, C. DI.—New Instance of Symbiosis 282
SCHAARSCHMIDT, G.—Vegetative Changes of Form in *Chlorosporææ* 283
WILL, H.—Anatomy of *Macrocytis* 284
SCHAARSCHMIDT, G.—Hibernation of *Zygnemaceæ* 284
BATES, F.—Sexuality in the *Zygnemaceæ* 285
ROSENVINGE, L. K.—Parthenogenesis in *Spirogyra* 285
WOLLNEY, R.—*Geminella interrupta* 285
FLAHAULT, C.—*Lithoderma fontanum*, a New Fresh-water Phæospore 285
DURKEE, R. P. H.—Structure of the Diatom Valve 286
WALLICH, G. C.—Structure of Diatoms 286
LAGERSTEDT, N. G. W.—Lagerstedt's Diatom-synonymy 287
MACADAM, W. T.—Diatomaceous Deposits in Scotland 287

Fungi.

FLOWRIGHT, C. B.— <i>Life-history of certain British Heterocercal Uredineæ</i>	288
MORINI, F.— <i>New Ustilaginæ</i>	288
ERRERA, L.— <i>Law of Growth of the Fructification of Phycomyces</i>	288
SCHNETZLER, J. B.— <i>Remarkable Development of Aspergillus niger</i>	289
SEYNES, J. DE.— <i>Mycelial Conidia of Polyporus sulfureus</i>	289
COOKE, M. C.— <i>Monograph of Polyporus</i>	289
TIEGHEM, P. VAN— <i>Development of Pyronema confluens</i>	289
RIBBERT, M.— <i>Development of Osteomyelitis-cocci in the Organism</i>	290
DUNCKER, H. C. J.— <i>Actinomyces in Swine's-flesh</i>	290
PASSERINI, G.— <i>Fungi Parasitic on the Mulberry</i>	290
BÄUMLER, J. A.— <i>Parasitic Fungus on the Red-currant</i>	291
THÜMEN, F. V.— <i>Fungi of the Vine and Willow</i>	291
TIEGHEM, P. VAN— <i>Monascus, a new genus of Ascomycetes</i>	291
TRELEASE, W.— <i>Relations of Two Cacidomyces to Fungi</i>	291
HANSEN, E. C.— <i>New Fermenting Fungus</i>	292
GROVE, W. B.— <i>Pilobolida</i>	292
GEBEL, K.— <i>Tetramyxa parasitica</i>	292
TIEGHEM, P. VAN.— <i>Cœnonia, a new genus of Mycomycetes</i>	293
JOURNAL of Mycology	293

Protophyta.

SCHMITZ, F.— <i>Structure of Chromatophores</i>	293
REISS, M.— <i>Systematic Position of Saccharomyces</i>	293
FISCH, C.— <i>Systematic Independence and Position of Saccharomyces</i>	294
WINOGRADSKY, S.— <i>Influence of External Conditions on the Development of Mycoderma vini</i>	294
DUCLAUX, E., PASTEUR L., & BÉCHAMP, A.— <i>Origin of Microzymes and Vibrios of Air, Water, and Soil</i>	295
DUCLAUX, E.— <i>Vitality of Germs of Microbes</i>	296
KOUBASSOFF, M.— <i>Passage of Pathogenous Microbes from the Mother to the Fœtus</i>	296
TIEGHEM, P. VAN.— <i>Development of Bacillus Amylobacter in Plants in a Normal Condition of Life</i>	297
ARLOING, S.— <i>Influence of Light on the Vegetation and on the Pathogenous Properties of Bacillus anthracis</i>	297
PRAZMOWSKI, A.— <i>History of Development and Morphology of Bacillus anthracis</i>	297
MÜLLER, F.— <i>Diagnostic Value of Tubercular Bacilli</i>	298
NICATI, W., & RIETSCH.— <i>Odour and Poisonous Effects of the Fermentation produced by the Comma Bacillus</i>	298
KLEIN, E., & STERNBERG, G. M.— <i>Relations of Bacteria to Asiatic Cholera</i>	299
TAYOU, M.— <i>Microbe of Human Typhoid Fever</i>	299
EMMERLICH, R.— <i>Pneumonia-cocci in Dormitories as a Cause of Pneumonia</i>	300
NEELSEN & EHLERS.— <i>"Rauschbrandpilz," a parasitic cattle-disease</i>	300
KÜNSTLER, J.— <i>Bacterioidomonas undulans</i>	300

MICROSCOPY.

a. Instruments, Accessories, &c.

SCHIECK'S Bacteria Microscopes (Figs. 45 and 46)	301
REICHERT'S No. VII. Microscope (Fig. 47)	302
STEIN'S Microscopes for use with the Electric Light (Figs. 48-54)	303
SWIFT'S Sheep-Scab Microscope (Fig. 55)	307
WINKEL'S Demonstration Microscope (Figs. 56 and 57)	308
TOLLES' Clinical Microscope (Fig. 58)	308
KLÖNNE & MÜLLER'S Pocket Microscope (Figs. 59 and 60)	309
JANNY'S Simple Solar (or Projection) Microscope (Fig. 61)	309
THOMPSON'S Projection Microscope (Fig. 62)	310
HALLER, E.— <i>Apparatus for Botanical Lectures</i> (Figs. 63 and 64)	313
WESTEN'S Universal Lens-holder (Figs. 65-67)	316
WARD'S and QUEEN'S Lens-holders (Figs. 68 and 69)	317
DISSECTING Microscopes with Brücke Lens (Figs. 70-75)	319
STANDARD Eye-pieces	322
NELSON, E. M.— <i>Testing the different Sectors of Objectives</i> (Fig. 76)	324
COST of Objectives of large Aperture	325
FRANCOTTE, P.— <i>Finder</i> (Fig. 77)	325
WARD'S Iris Illuminator (Fig. 78)	326
NELSON'S Simple Condenser (Fig. 79)	327
MADAN'S Method of isolating Blue Rays for Optical Work	327
MADAN'S Modification of Foucault's and Ahrens's Polarizing Prisms (Fig. 80)	328
ILLUMINATION of Microscopes and Balances	328
NELSON, E. M., MICHAEL, A. D., and CARPENTER, W. B.— <i>Standard Thickness of Glass Slips</i>	329
RABL'S Slide for Viewing Objects on both Sides (Fig. 81)	329

	PAGE
WHITNEY'S <i>Life-Box</i>	330
MICROMETERS mounted in Media of High Refractive Index	330
ATWOOD'S Apparatus for Photo-micrography (Fig. 82)	330
COX, J. D.— <i>Artinic and Visual Foci</i>	331
VORCE, C. M.— <i>Compound Negatives</i>	331
FRITSCH.— <i>Monocular Stereoscopic Vision</i>	332
JOURNAL of the New York Microscopical Society	332
STRASBURGER'S <i>Practical Botany</i>	332
HITCHCOCK, R.— <i>Microscopical Societies</i>	332
"WHAT IS A MICROSCOPIST?"	333
BAUSCH, E.— <i>Universal Screw for Microscope Objectives</i>	335
BULLOCH, W. H.— <i>Magnifying Power of Objectives and Position of Wollaston Camera</i>	335
HARDY'S <i>Camera</i>	336
HOMOLOGOUS Sections, <i>Electric Light, and Molecules</i>	337

B. Collecting, Mounting and Examining Objects, &c.

GIACOMINI.— <i>Modified Hardening Process for the Central Nervous System</i>	340
KUPFFER, C.— <i>Preparing Meroblastic Ova</i>	340
HYATT, J. D.— <i>Hydrogen Peroxide as a Bleaching Agent</i>	340
DIPPEL, L.— <i>Binioidide of Mercury and Potassium as a Swelling Agent</i>	341
ERLICKI'S <i>Hardening Solution</i>	341
BÖHM'S <i>Carmine Acetate</i>	341
BAUMGARTEN, P.— <i>Staining Method for Karyokinetic Figures</i>	341
FOL, H.— <i>Ribesin and Eosin</i>	342
PLAUT'S <i>Staining Process for the Demonstration of Saprogenous and Pathogenous Micro-organisms</i>	342
NEGRI, A. F.— <i>Staining the Spores of Bacillus tuberculosis</i>	342
FRANCOTTE'S <i>Paraffin Filter</i> (Fig. 83)	343
FOL, H.— <i>Parabolic Mirror for Correction of too hard or too soft Paraffin</i>	344
BECK'S <i>Universal Microtome</i> (Fig. 84)	344
REICHERT'S <i>Simple Hand-Microtome</i> (Figs. 85 and 86)	346
REICHERT'S <i>Microtome Object-clamp</i> (Figs. 87 and 88)	347
FRANCOTTE, P.— <i>Improvements in Microtomes and Knives</i>	347
ROGERS' <i>Section-cutter</i>	347
EHRENBAUM, E.— <i>Preparing Thin Sections of Shells and Teeth</i>	348
NEALEY, E. T.— <i>Rapid Method for Making Bone and Teeth Sections</i>	348
BROWNELL, J. T.— <i>Staining and Mounting Pollens and Spores</i>	349
BROWNELL <i>Turntable</i> (Figs. 89-91)	351
SMITH'S <i>Mounting Media</i>	352
KITTON, F., AMANN, J., & BRUNT, C. VAN— <i>Balsam of Tolu as a Medium for Mounting</i>	352
KINGSLEY, J. S.— <i>Glycerin and Balsam Mounts</i>	353
HITCHCOCK, R.— <i>Mounting in Phosphorus</i>	353
DIPPEL, L.— <i>Diatoms in Phosphorus</i>	354
JAMES' <i>Cover-glass Cleaner</i> (Figs. 92 and 93)	354
COLE'S ' <i>Studies in Microscopical Science</i> '	355
LEE'S <i>Microtomists' Vade Mecum</i>	355
"WORKING SESSION" of American Society of Microscopists	356
HYATT, J. D.— <i>Compound Eyes and Multiple Images</i>	356
TAYLOR, T.— <i>Examination of Butter and Fats</i>	356
DIPPEL, L.— <i>Polarized Light in Vegetable Histology</i> (Figs. 94-98)	357
CAPUS, G.— <i>Direct Observation of the Movement of Water in Plants</i>	359
MOLISCH.— <i>Microchemical Detection of Nitrates and Nitrites in Plants</i>	359
FOL, H.— <i>New Method for the Transfer of Sterilized Broths, and the Determination of the number of Living Germs in Water</i>	359
BAUMGARTEN, P.— <i>Discrimination of Bacillus lepræ and B. tuberculosis</i>	362
THURSTON, E.— <i>Examining Bacteria</i>	362
BOOTH, M. A., HITCHCOCK, R., and JAMES, F. L.— <i>White Zinc Cement</i>	363 and 365
BROWNELL, J. T.— <i>Wax Cells</i>	363
D., E. T.— <i>Preserving Hydrachnæ</i>	364
" — <i>Glass Slips for Collecting</i>	364
FIELD, A. G.— <i>Mounting Urinary Deposits</i>	365
GRIFFITH, E. H.— <i>Microscopists' Working Cabinet</i>	365
OWEN, D.— <i>Clearing Fluid for Vegetable Tissues</i>	366
STOWELL, C. H.— <i>Microscopic Geissler Tube</i>	367
WHITNEY, J. E.— <i>Cheap Punches for Sheet Wax</i>	367

ROYAL MICROSCOPICAL SOCIETY.

COUNCIL.

ELECTED 11th FEBRUARY, 1885.

PRESIDENT.

REV. W. H. DALLINGER, LL.D., F.R.S.

VICE-PRESIDENTS.

JOHN ANTHONY, Esq., M.D., F.R.C.P.L.

G. F. DOWDESWELL, Esq., M.A.

PROF. P. MARTIN DUNCAN, M.B., F.R.S.

ALBERT D. MICHAEL, Esq., F.L.S.

TREASURER.

LIONEL S. BEALE, Esq., M.B., F.R.C.P., F.R.S.

SECRETARIES.

*FRANK CRISP, Esq., LL.B., B.A., V.P. & TREAS. L.S.

PROF. F. JEFFREY BELL, M.A., F.Z.S.

Twelve other MEMBERS of COUNCIL.

JOSEPH BECK, Esq., F.R.A.S.

A. W. BENNETT, Esq., M.A., B.Sc., F.L.S.

*ROBERT BRAITHWAITE, Esq., M.D., M.R.C.S., F.L.S.

JAMES GLAISHER, Esq., F.R.S., F.R.A.S.

*J. WILLIAM GROVES, Esq.

JOHN MATTHEWS, Esq., M.D.

JOHN MAYALL, Esq., Jun.

*JOHN MILLAR, Esq., L.R.C.P., F.L.S.

URBAN PRITCHARD, Esq., M.D.

STUART O. RIDLEY, Esq., M.A., F.L.S.

*CHARLES STEWART, Esq., M.R.C.S., F.L.S.

WILLIAM THOMAS SUFFOLK, Esq.

LIBRARIAN and ASSISTANT SECRETARY.

MR. JAMES WEST.

* Members of the Publication Committee.

MEETINGS FOR 1885, at 8 p.m.

Wednesday, JANUARY 14	Wednesday, MAY 13
„ FEBRUARY 11	„ JUNE 10
(Annual Meeting for Election of Officers and Council.)	„ OCTOBER 7
„ MARCH 11	„ NOVEMBER 11
„ APRIL 8	„ DECEMBER 9





ADVERTISEMENTS FOR THE JOURNAL.

MR. CHARLES BLENCOWE, of 9, Bridge Street, Westminster, S.W., is the authorized Agent and Collector for Advertising Accounts on behalf of the Society.

I. Numerical Aperture Table.

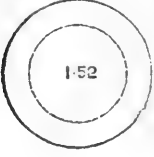
The "APERTURE" of an optical instrument indicates its greater or less capacity for receiving rays from the object transmitting them to the image, and the aperture of a Microscope objective is therefore determined by the ratio between its focal length and the diameter of the emergent pencil at the plane of its emergence—that is, the utilization diameter of a single-lens objective or of the back lens of a compound objective.

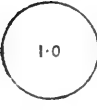
This ratio is expressed for all media and in all cases by $n \sin u$, n being the refractive index of the medium and u the semi-angle of aperture. The value of $n \sin u$ for any particular case is the "numerical aperture" of the objective.

Diameters of the Back Lenses of various Dry and Immersion Objectives of the same Power (1 in.) from 0.50 to 1.52 N. A.	Numerical Aperture. ($n \sin u = a$.)	Angle of Aperture ($= 2u$).			Illuminating Power. (a^2 .)	Theoretical Resolving Power, in Lines to an Inch. ($A=0.5269 \mu = \text{line } F.$)	Penetration Power. ($\frac{1}{a}$)
		Dry Objectives. ($n = 1$.)	Water-Immersion Objectives. ($n = 1.33$.)	Homogeneous-Immersion Objectives. ($n = 1.52$.)			
	1.52	180° 0'	2.310	146,528	.68
	1.50	161° 23'	2.250	141,600	.67
	1.48	153° 39'	2.190	142,672	.67
	1.46	147° 42'	2.132	140,744	.68
	1.44	142° 40'	2.074	138,816	.68
	1.42	138° 12'	2.016	136,888	.70
	1.40	134° 10'	1.960	134,960	.71
	1.38	130° 26'	1.904	133,032	.72
	1.36	126° 57'	1.850	131,104	.73
	1.34	123° 40'	1.796	129,176	.74
	1.33	..	180° 0'	122° 6'	1.770	128,212	.75
	1.32	..	165° 56'	120° 33'	1.742	127,248	.75
	1.30	..	155° 38'	117° 34'	1.690	125,320	.76
	1.28	..	148° 28'	114° 44'	1.638	123,392	.78
	1.26	..	142° 39'	111° 59'	1.588	121,464	.79
	1.24	109° 20'	1.538	119,536	.80
	1.22	106° 45'	1.488	117,608	.82
	1.20	104° 15'	1.440	115,680	.83
	1.18	101° 50'	1.392	113,752	.84
	1.16	99° 29'	1.346	111,824	.86
	1.14	97° 11'	1.300	109,896	.87
	1.12	94° 56'	1.254	107,968	.89
	1.10	92° 43'	1.210	106,040	.90
	1.08	90° 33'	1.166	104,112	.92
	1.06	88° 26'	1.124	102,184	.94
	1.04	86° 21'	1.082	100,256	.96
	1.02	84° 18'	1.040	98,328	.98
	1.00	180° 0'	97° 31'	82° 17'	1.000	96,400	1.00
	0.98	157° 2'	94° 56'	80° 17'	.960	94,472	1.02
	0.96	147° 29'	92° 24'	78° 20'	.922	92,544	1.04
	0.94	140° 6'	89° 56'	76° 24'	.884	90,616	1.06
	0.92	133° 51'	87° 32'	74° 30'	.846	88,688	1.08
	0.90	128° 19'	85° 10'	72° 36'	.810	86,760	1.11
	0.88	123° 17'	82° 51'	70° 44'	.774	84,832	1.13
	0.86	118° 38'	80° 34'	68° 54'	.740	82,904	1.16
	0.84	114° 17'	78° 20'	67° 6'	.706	80,976	1.19
	0.82	110° 10'	76° 8'	65° 18'	.672	79,048	1.22
	0.80	106° 16'	73° 58'	63° 31'	.640	77,120	1.25
	0.78	102° 31'	71° 49'	61° 45'	.608	75,192	1.28
	0.76	98° 56'	69° 42'	60° 0'	.578	73,264	1.31
	0.74	95° 28'	67° 36'	58° 16'	.548	71,336	1.33
	0.72	92° 6'	65° 32'	56° 32'	.518	69,408	1.36
	0.70	88° 51'	63° 31'	54° 50'	.490	67,480	1.42
	0.68	85° 41'	61° 30'	53° 9'	.462	65,552	1.47
	0.66	82° 36'	59° 30'	51° 28'	.436	63,624	1.51
	0.64	79° 35'	57° 31'	49° 48'	.410	61,696	1.54
	0.62	76° 38'	55° 34'	48° 9'	.384	59,768	1.61
	0.60	73° 44'	53° 38'	46° 30'	.360	57,840	1.66
	0.58	70° 54'	51° 42'	44° 51'	.336	55,912	1.71
	0.56	68° 6'	49° 48'	43° 14'	.314	53,984	1.78
	0.54	65° 22'	47° 54'	41° 37'	.292	52,056	1.83
	0.52	62° 40'	46° 2'	40° 0'	.270	50,128	1.90
	0.50	60° 0'	44° 10'	38° 24'	.250	48,200	2.00

EXAMPLE.—The apertures of four objectives, two of which are dry, one water-immersion, and one oil-immersion, would be compared on the angular aperture view as follows:—106° (air), 157° (air), 142° (water), 136° (oil). Their actual apertures are, however, as numerical apertures. .90 .98 1.26 1.38 or the

II. Conversion of British and Metric Measures.

(1.) LINEAL.

Micromillimetres, &c., into Inches, &c.

Inches, &c., into Micromillimetres, &c.

μ	ins.	mm.	ins.	mm.	ins.
1	·000039	1	·039370	51	2·007892
2	·000079	2	·078741	52	2·047262
3	·000118	3	·118111	53	2·086633
4	·000157	4	·157482	54	2·126003
5	·000197	5	·196852	55	2·165374
6	·000236	6	·236223	56	2·204744
7	·000276	7	·275593	57	2·244115
8	·000315	8	·314963	58	2·283485
9	·000354	9	·354334	59	2·322855
10	·000394	10 (1 cm.)	·393704	60 (6 cm.)	2·362226
11	·000433	11	·433075	61	2·401596
12	·000472	12	·472445	62	2·440967
13	·000512	13	·511816	63	2·480337
14	·000551	14	·551186	64	2·519708
15	·000591	15	·590556	65	2·559078
16	·000630	16	·629927	66	2·598449
17	·000669	17	·669297	67	2·637819
18	·000709	18	·708668	68	2·677189
19	·000748	19	·748038	69	2·716560
20	·000787	20 (2 cm.)	·787409	70 (7 cm.)	2·755930
21	·000827	21	·826779	71	2·795301
22	·000866	22	·866150	72	2·834671
23	·000906	23	·905520	73	2·874042
24	·000945	24	·944890	74	2·913412
25	·000984	25	·984261	75	2·952782
26	·001024	26	1·023631	76	2·992153
27	·001063	27	1·063002	77	3·031523
28	·001102	28	1·102372	78	3·070894
29	·001142	29	1·141743	79	3·110264
30	·001181	30 (3 cm.)	1·181113	80 (8 cm.)	3·149635
31	·001220	31	1·220483	81	3·189005
32	·001260	32	1·259854	82	3·228375
33	·001299	33	1·299224	83	3·267746
34	·001339	34	1·338595	84	3·307116
35	·001378	35	1·377965	85	3·346487
36	·001417	36	1·417336	86	3·385857
37	·001457	37	1·456706	87	3·425228
38	·001496	38	1·496076	88	3·464598
39	·001535	39	1·535447	89	3·503968
40	·001575	40 (4 cm.)	1·574817	90 (9 cm.)	3·543339
41	·001614	41	1·614188	91	3·582709
42	·001654	42	1·653558	92	3·622080
43	·001693	43	1·692929	93	3·661450
44	·001732	44	1·732299	94	3·700820
45	·001772	45	1·771669	95	3·740191
46	·001811	46	1·811040	96	3·779561
47	·001850	47	1·850410	97	3·818932
48	·001890	48	1·889781	98	3·858302
49	·001929	49	1·929151	99	3·897673
50	·001969	50 (5 cm.)	1·968522	100 (10 cm.=1 decim.)	
60	·002362				
70	·002756				
80	·003150	decim.		ins.	
90	·003543	1	3·937013		
100	·003937	2	7·874086		
200	·007874	3	11·811130		
300	·011811	4	15·748173		
400	·015748	5	19·685216		
500	·019685	6	23·622259		
600	·023622	7	27·559302		
700	·027559	8	31·496346		
800	·031496	9	35·433389		
900	·035433	10 (1 metre)	39·370432		
1000 (=1 mm.)			= 3·280869 ft.		
			= 1·093623 yds.		

ins.	μ
$\frac{1}{25000}$	1·015991
$\frac{1}{20000}$	1·269989
$\frac{1}{15000}$	1·693318
$\frac{1}{10000}$	2·539977
$\frac{1}{8000}$	2·822197
$\frac{1}{6000}$	3·174972
$\frac{1}{5000}$	3·628539
$\frac{1}{4000}$	4·233295
$\frac{1}{3000}$	5·079954
$\frac{1}{2000}$	6·349943
$\frac{1}{1500}$	8·466591
$\frac{1}{1000}$	12·699886
$\frac{1}{700}$	25·399772
$\frac{1}{500}$	mm.
$\frac{1}{400}$	·028222
$\frac{1}{300}$	·031750
$\frac{1}{200}$	·036285
$\frac{1}{150}$	·042333
$\frac{1}{100}$	·050800
$\frac{1}{75}$	·056444
$\frac{1}{50}$	·063499
$\frac{1}{35}$	·072571
$\frac{1}{25}$	·084666
$\frac{1}{20}$	·101599
$\frac{1}{15}$	·126999
$\frac{1}{10}$	·169332
$\frac{1}{7\frac{1}{2}}$	·253998
$\frac{1}{5}$	·507995
$\frac{1}{3\frac{1}{2}}$	1·015991
$\frac{1}{2\frac{1}{2}}$	1·269989
$\frac{1}{1\frac{1}{2}}$	1·587486
$\frac{1}{1\frac{1}{4}}$	1·693318
$\frac{1}{1\frac{1}{2}}$	2·116648
$\frac{1}{1}$	2·539977
$\frac{1}{\frac{3}{4}}$	3·174972
$\frac{1}{\frac{2}{3}}$	4·233295
$\frac{1}{\frac{1}{2}}$	4·762457
$\frac{1}{\frac{1}{3}}$	5·079954
$\frac{1}{\frac{1}{4}}$	6·349943
$\frac{1}{\frac{1}{5}}$	7·937429
$\frac{1}{\frac{1}{6}}$	9·524915
$\frac{1}{\frac{1}{7}}$	cm.
$\frac{1}{10}$	1·111240
$\frac{1}{8}$	1·269989
$\frac{1}{6}$	1·428737
$\frac{1}{5}$	1·587486
$\frac{1}{4}$	1·746234
$\frac{1}{3}$	1·904983
$\frac{1}{2}$	2·063732
$\frac{1}{1\frac{1}{2}}$	2·222480
$\frac{1}{1\frac{1}{3}}$	2·381229
1	2·539977
2	5·079954
3	7·619932
	decim.
4	1·015991
5	1·269989
6	1·523986
7	1·777984
8	2·031982
9	2·285979
10	2·539977
11	2·793975
1 ft.	3·047973
	metres.
1 yd.=	·914392

showing relation of millimetres, centimetres, and inches.

ins.

= 1 mm.
= 1 cm.
= 1 dm.
= 1 metre.

CHARLES COPPOCK,

LATE
PARTNER WITH
R. & J. BECK.

MANUFACTURER
OF
SCIENTIFIC

INSTRUMENTS.

—
PATHOLOGICAL
AND
PHYSIOLOGICAL
PREPARATIONS.

STAINING FLUIDS
AND ALL
ACCESSORIES
FOR STUDENTS'
USE.

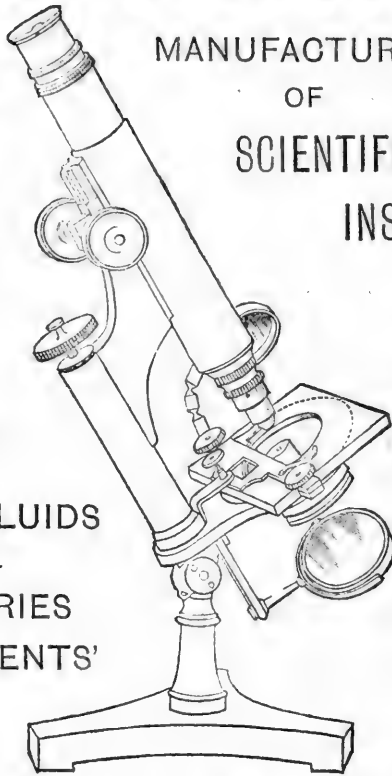

—
Microscopes
for
Students and
Amateurs.

—
ILLUSTRATED
CATALOGUE,
2s.

100, NEW BOND STREET,
LONDON, W.

N.B. SPECTACLES!!

OCULISTS' PRESCRIPTIONS RECEIVE PERSONAL ATTENTION.

AGENT FOR W. H. BULLOCH, CHICAGO, ILLS., U.S.A.
R. H. SPENCER & CO., N.Y., U.S.A.
JAMES L. PEASE, MASS., U.S.A.
" M. PRAZMOWSKI, PARIS.
M. A. NACHET PARIS.

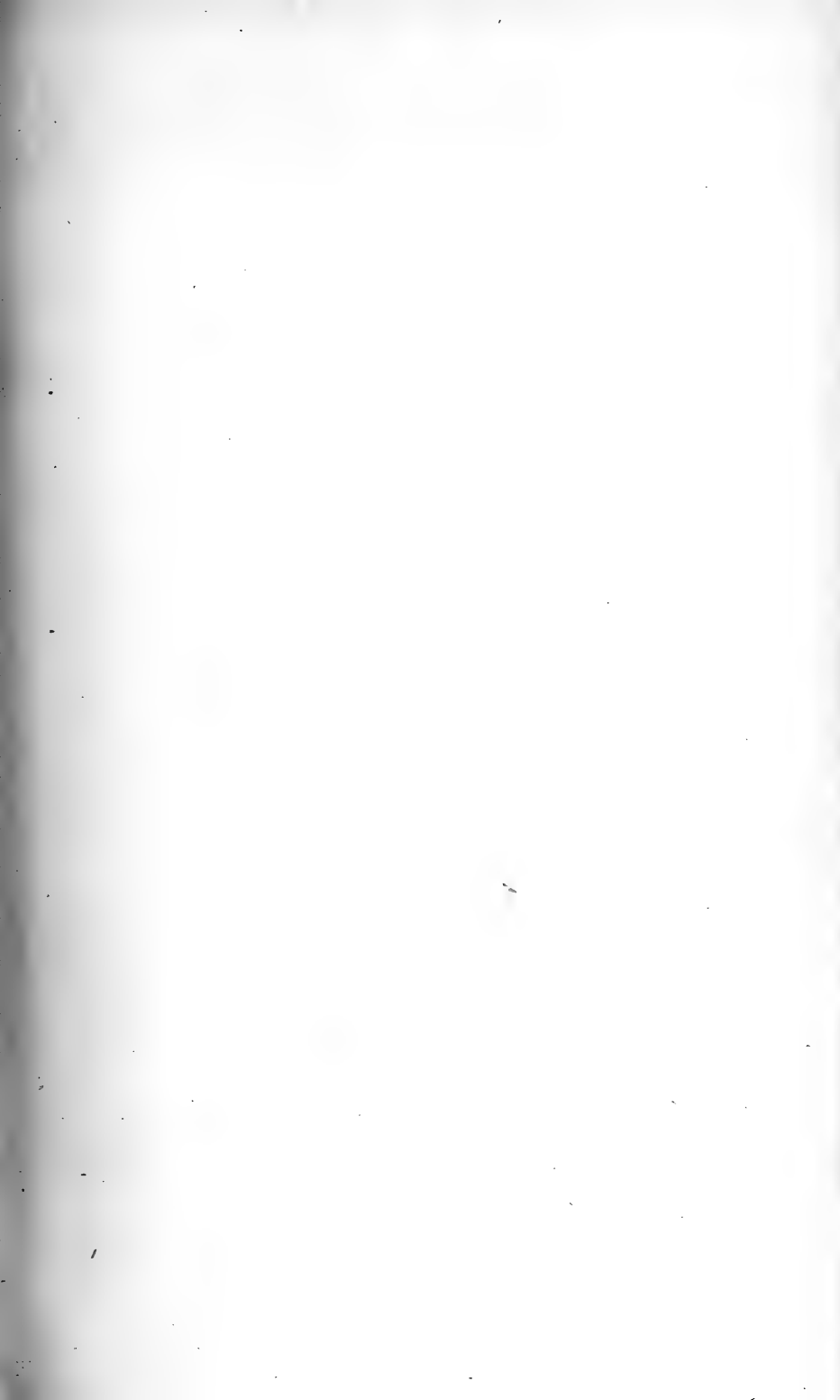



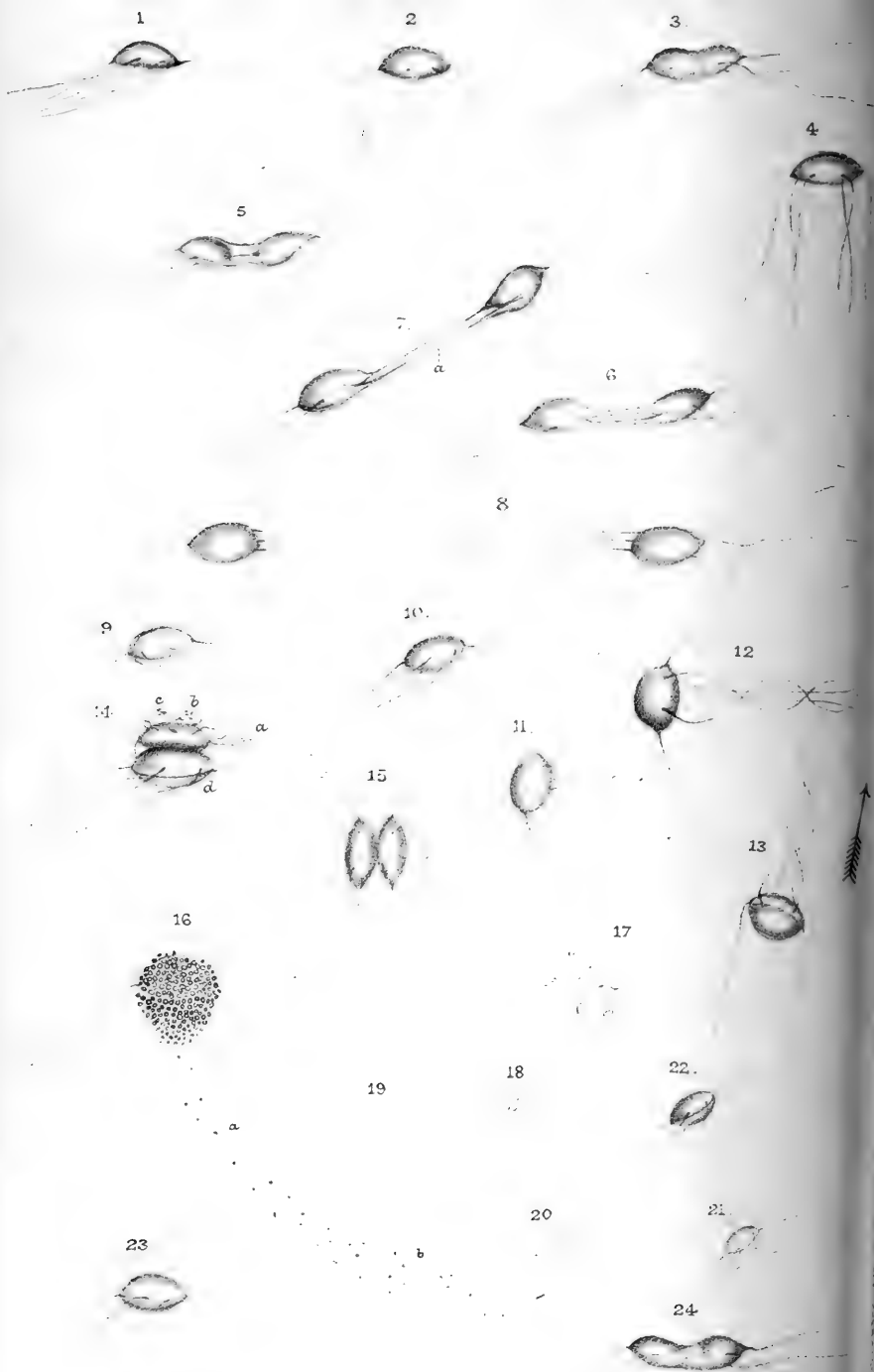

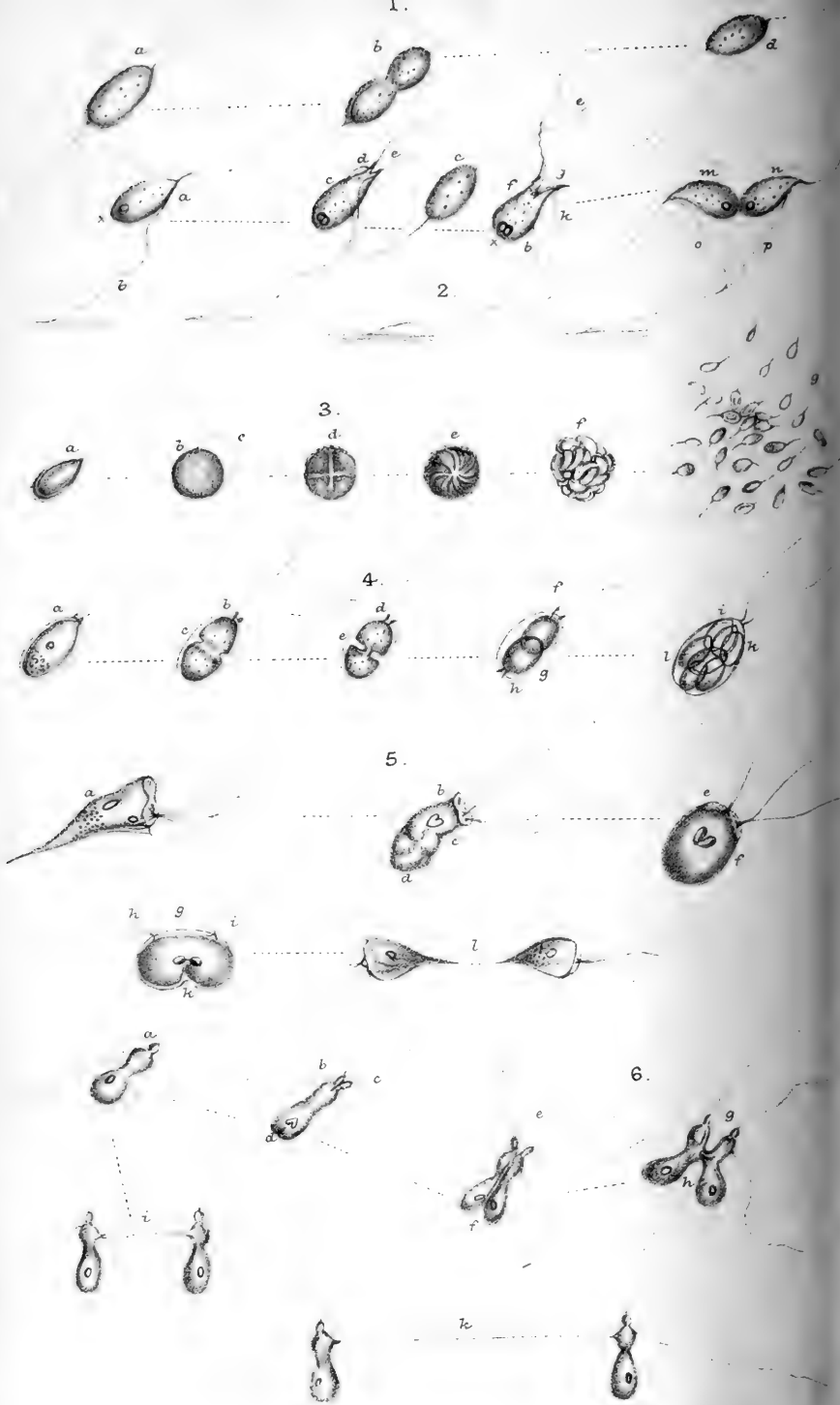

JOURNAL
OF THE
ROYAL MICROSCOPICAL SOCIETY.

APRIL 1885.

TRANSACTIONS OF THE SOCIETY.

IV.—*The President's Address.*

By the Rev. W. H. DALLINGER, LL.D., F.R.S.

(*Annual Meeting, 11th February, 1885.*)

PLATES IV.—VI.

THERE is a great temptation in the position which I have the honour to occupy to-night, to pass in review the more prominent and striking results of the work done in the year, touching the special branches of science to which the instrument, which we are constantly striving to bring nearer to perfection and to use perfectly, is ancillary.

The inducements to such a course have in fact rarely been stronger. The legitimate, patient, and scientific knowledge and use of the Microscope, has opened out not only unexpected areas of actual and potential knowledge, but has been the means of proving, at the same time, that this knowledge is most vital in its relations to the higher interests of our race and our civilization.

Nothing was more certain than that the work done in biology through the agency of the Microscope up to twenty years ago, was a distinct prophecy of far higher and more definite results.

Having touched the fringe of the minutest that was visible in living things, it was inevitable that a knowledge of all that was accessible concerning these, should be sought, and, if possible, found. The scientific certainty and value of the results would depend largely (1) on improvements of a thoroughly scientific character in the optical part of the instrument, and (2) on enlightened and patient manipulation of these.

We may, without undue exaltation, congratulate ourselves that by the combined ingenuity, knowledge, and skill of the Fellows of this and other Societies, and of the opticians, improvements of indefinitely great value have been effected in our lenses and

appliances, while the instrument itself has been advanced in perfectness.

But, on the other hand, the great doctrine of Charles Darwin, quickening, as it did, into new life and effort, every region of biology, gave immense impulse to work in all those departments of it which can only be dealt with and understood by means of our instrument.

The result has been the opening up of new knowledge, new methods, new directions and objects of research, and in one sense the formation of new biological sciences, within a couple of decades.

It would be impossible to follow this outspread of progress, due mainly to the Microscope, in the one science of biology; but, in only one direction, and within the years that lie closest to us, the value of this progress can be readily seen.

Our knowledge of the septic organisms has led an army of earnest workers to a relative and partial knowledge at least, of their pathogenic congeners; and in this, with our present resources, lie folded up as it were, indefinite possibilities for the future welfare of not man only—but man and beasts.

It is a little interesting to note in passing that an impetus was given to this question by the keen interest displayed some fourteen years, or more, ago, and onwards, in the question of abiogenesis *versus* biogenesis, and the masterly summary of the facts, and the inevitable deductions from them, made by Prof. Huxley in his address, as President, to the British Association in 1870.

Both biologists and, from a distinct point of view, physicists and chemists, as for instance Prof. Tyndall and Pasteur, continued to prosecute the inquiry; and during this series of researches two definite results were irresistible.

The first was that when the experiments were conducted with competent skill—as they certainly were in Tyndall's hands, in the laboratory of the Royal Institution, and on the Alps—it could be deduced absolutely that living things were never seen to arise in not living matter.

The second deduction, as made from the work effected by biological research pure and simple, was that the septic organisms, as such, do arise always, so far down as our researches have carried us, in the products, either genetic or fissionary, of like living things that had preceded them.

Abiogenesis was not a discoverable factor in nature's present condition, so far at least as our researches could carry us. And it is of moment to note that since Huxley's conclusions concerning Redi's doctrine of biogenesis were pronounced in 1870, not only has research in every direction of biological inquiry that could touch the question, confirmed that conclusion, but no facts with any

adverse bearing have been presented. Hence in the interval Huxley, taking into account all the factors of our ever-increasing knowledge of biological facts, affirms "that at the present moment there is not a shadow of trustworthy evidence that abiogenesis does take place, or has taken place within the period during which life has appeared on the globe";* and in another place, "the present state of our knowledge furnishes us with no link between the living and the not living." †

That there was a time when living matter did arise from matter not living there can be no question. How, is no present concern of science. With increased knowledge, deeper research, further penetration, even that question may be answered.

But the impossibility of present explanation is no scientific prejudice to the facts.

It is evidence of the deep insight of Darwin's mind that he nowhere suggested, or even hinted at, the operation of any unknown activity to give efficiency to the development of living things in all their incalculable variety. Out of the known and established phenomena of life he could deduce the evolution of all living forms. Granted the existence of living matter—primordial germs—he found no need of abiogenesis. And the long unbroken lines of life in definite forms, revealed by the geological and palæontological history of the earth, absolutely support this view.

The supposition that abiogenesis is a necessary sequence from the doctrine of evolution, has indeed no philosophical basis. The inevitable power of living forms, however lowly, to multiply without limit is enough. "In the eyes of a consistent evolutionist any further independent formation of protoplasm would be sheer waste." †

But the investigations that in our more immediate times confirmed these conclusions, also gave us a greatly enlarged knowledge of that remarkable group of organisms known as septic. So much so, that the morphology of the monads and the bacteria may be said to be approximately within our reach, always remembering the range of our present optical aids.

But beyond this, the life-histories of many, of both the monads and the bacteria, are fairly known; and their physiological characteristics are being carefully studied. There is, however, a possible difficulty before us. The whole group of septic organisms must, as a group, form the subject of complete and exhaustive study. If this be not done, we are in peril of false conclusions on a practical phase of the subject, which touches the highest interests

* *Anat. Invert. Animals*, p. 39.

† *Biology*, *Ency. Brit.*, 9th ed., pp. 67-9.

‡ *Anat. Invert. Animals*, p. 38.

of the whole animal world, with man as the most profoundly concerned.

Of the septic series as such, I have a long-continued incidental familiarity. It is the monad group that I have of course, so far as I have been able to go, thoroughly studied. Yet it would be difficult for any one not a pathologist, and without the resources of a pathological laboratory, to claim to be in the modern sense a bacteriologist. But it may well be doubted whether that modern sense is a really useful and correct one. The bacteria are without much question a botanical group, and to be thoroughly understood must be studied as such. Whoever has studied the same field of septic bacteria for say a week or a fortnight without change of conditions, will know the strange complexity of relations that are seen to arise. I do not profess to interpret them—I have avoided the immense temptation to try to do so, the better to use such facility as I could command in the more complete working out of the monad group. But I feel assured that until this complexity of relation in common forms is understood, we cannot make really assured advance. How the bacteria are interrelated, how far they are mutable, and under what conditions; and whether functional changes are as readily, or more readily, induced, than morphological changes, are questions of the largest moment.

I should wantonly occupy your time if I attempted to call your attention to the fact that all this bears upon that special modification of the septic group only, known at present as bacteria or bacilli, which are pathogenic in their functions.

In some instances possessed of a specific functional power, they are the direct excitants, the positive virus, of definite forms of disease. To the study of these and their behaviour and life-histories there is a strong and a natural tendency. But it is to the specific and perhaps biologically highly modified form *alone* that all the labour is directed.

What is its relation to the whole group? Has it become modified from normal septic forms? if so, by what means; these are in the broad and deep interests of science even larger questions than the morphology and functions of a definitely discovered and demonstrated bacilli-virus.

Manifestly the work cannot be done by any one group of observers: the pathologists do wisely and well, to pursue their own department of the research with exemplary zeal: but the microscopical botanists have such a rich field of inquiry before them, and one so large in its importance, as has scarcely fallen to them before in the entire history of the Microscope.

That there is a direct and discoverable relation between the septic and the pathogenic bacteria it would be puerile in these days to doubt. What is that relation? In some instances, certainly, the

morphological difference between the ordinary septic form and the form that is pathogenic is by no means striking.

Yet the one is innocuous, the other deadly. The one is an organism with the power of growing enormously in simple chemical fluids containing nitrogenous compounds, such as tartrate of ammonia. The other refuses wholly to grow and multiply in this, but requires more complex compounds, as the proteids, for its nurture. Hence it is found in the blood or tissues of man and animals, and becomes a veritable *virus*.

The difference, however acquired, is functional immensely more than morphological. And the probable relation between the two forms is one of the most important by-problems of modern biology. It seems on the surface at least that we have here evidence of the operation of the great secular processes of the Darwinian law bringing about, in forms that retain a general morphological resemblance, a distinct physiological specificity.

I grant fully that no direct evidence, by experiment, of the change has been yet given us.

It is true that from the close general resemblance between *Bacillus subtilis* and *Bacillus anthracis* it was held that the only difference between them was physiological. This is in all probability not strictly accurate. But there is something yet to be learned in relation to the life-history of both forms, and certainly in relation to their mutability. Now Hans Büchner tells us* that he did by successive cultivations of the *Bacillus anthracis* under the influence of continued alterations of the nutrition, see it gradually change into the *Bacillus subtilis*; that in fact this deadly form by being passed through successive cultures at a temperature of from 35° to 37° Centigrade loses its pathogenic qualities, becomes, in short, bereft of its specific physiological character.

But more striking yet is the affirmation made by the same *savant*, that he has changed the harmless *Bacillus subtilis* into the deadly *B. anthracis* by similar processes.

To one who has fully comprehended the meaning and the operation of the Darwinian law, it will be at once apparent that there must be error somewhere in this matter.

If the law of actual variation, with all that is involved in survival of the fittest, could be so readily brought into complete operation, and yield so pronounced a result, where would be the stability of the organic world? Nothing would be at one stay. There could be no permanence in anything living.

This immediately impressed me nearly four years ago on reading this remarkable paper, and there can be no shadow of doubt that

* "Ueber die experimentelle Erzeugung des Milz-brand-contagiums aus den Heupilzen." SB. Math. Phys. Classen K. Bayer. Akademie d. Wiss., 1880, Heft iii.

Dr. Klein in his valuable papers on "Micro-organisms and Disease" has given a definite form and certainty to the utter improbability of Büchner's so-called results being in any scientific sense accurate.

But the fact that there is no evidence of any direct relation evolutionally between two such forms as *B. subtilis* and *B. anthracis*, the fact that there is no ready way either naturally or artificially of their being changed into each other, must not blind us to the fact, as biologists, that such an evolutionary relation in the past is eminently probable, nay almost certain. It may, in all probability must, have taken an indefinite time in the past to effect; but being once effected, the specificity is continued as in every other form by inheritance.

That *no* means now at work, or capable of being brought into play, is sufficient to-day to change the *B. subtilis* into *B. anthracis*, it is decidedly both in harmony with fact and philosophy to doubt; while it is of the utmost importance, if it be within the compass of human research, to discover what these conditions are.

Cognate with this question is the true interpretation of the real meaning and value of the attenuated intensity of the virus cultures of Pasteur and others. Is the diminished virulence of a given culture, which, as in the case of inoculation for anthrax, produces a mild form of the disease, leading to subsequent immunity, attributable to true biological change in the organisms brought about by changed environment, or is it a mere physical and accompanying chemical attenuation, consequent upon enfeebled nutrition, or extended dilution, of some element of the original virus outside the organism?

We can only answer, it is highly probable. What we know of the septic organisms leads us to infer that their tendency to adapt themselves to considerable variation of external conditions is evident; but this does not of necessity involve permanent change in the organism.

Now you are well aware that there is at this moment very much more that is similar to, or cognate with, what I have hitherto passed in rapid review, that relates to microscopic biology, and that stimulates, almost provokes, our consideration.

But in it all there is so much happily that is progressive, and *therefore* that is of necessity tentative, that I am fain to turn from these multitudinous and deeply interesting matters, feeling that I can better promote the interests of knowledge such as we seek, by the addition of definite facts, than by the most careful and extended review of the progression of knowledge, where much is unfinished, and some things are still in doubt.

Any President of this Society may be the more satisfied with such a course, who remembers the state of comprehensive efficiency

to which our Journal has been brought. The whole compass of such special or collateral knowledge as any of us may desire to reach, is either summarized or indicated for us there. Remembering this, I shall call your attention to a study I have been able to make of the life-history of a septic organism which I believe is hitherto new to science.

Some four years have been embraced in completing the work, and I have had the advantage of the very best and finest lenses which our recent advances in the theory and practice of the construction of high-power lenses have afforded.

I may remark, however, that for all work of the class I am about to detail, it is absolutely needful that, for continuous research, an air lens of high power should be used. You are well aware that both oil and water, as immersion media on the surface of the delicate cover, imperil, every moment, the fluid *beneath* the cover, and within which the subject of investigation is in constant motion.

For this continuous work I rely on a $1/16$, of great merit in all respects, as an air lens; on a $1/25$, which has very fine qualities; and on a $1/50$, which greatly surpasses, in all the qualities we seek, a lens of the same power by the same makers used up to four years ago.

The lens, however, on which I still rely chiefly for this work is a $1/35$, which for an air lens possesses qualities of the highest order.

But beyond the work of continuous watching, when the opportunity presents itself, there is the work of developmental morphology, of discovering all the details of the adult form, and of thoroughly demonstrating the changes that ensue in the completion of a life-cycle.

It is here that first, water immersion, and now, above all, homogeneous lenses have been to me of untold value.

Happily I have no need to deal with, even in review, the mathematical laws of aplanatic combinations, nor the diffraction theory of microscopic vision, and all that attends it, on which this vast improvement depends. In that I have been anticipated by competent masters.

But I ought to yield to none in the sense of obligation under which I rest for such splendid optical advance. With these new lenses I have gone over again all the critical parts of the work which I have had the honour from time to time to present to this Society, and others; and although I have discovered no error of interpretation, I have been compelled to see that many of the delicate points of detail, discoverable only by the most persistent effort and careful manipulation then, could be demonstrated with comparative readiness now.

The benefit arising from their use in the study I am about to

detail has been unusually great, especially since the organism is of extreme minuteness, and complex in the arrangement of parts.

I have been able to use in this investigation a $1/10$ homogeneous of large aperture, a $1/12$ of 1.47 N.A., a $1/25$ of 1.38 N.A., a $1/50$ of 1.38 N.A., and lastly for a little of some part of the work a $1/6$ of 1.50 N.A.

All these lenses were made for me by Powell and Lealand.

Some four years since I was examining cursorily an exhausted maceration of cod-fish which had decomposed in a broth extracted from the boiling of rabbits. The maceration had been for many weeks under examination with another object, but it had now become relatively devoid of the organisms it had contained, and there was, in the glass vessel in which it was contained, a considerable precipitate at the bottom. It had been kept during the long time it was under examination at a temperature of from 90° to 95° Fahr., and it was at the former temperature at the time of which I speak.

There were still a vast number of *Bacterium termo*, *B. lineola*, and *Spirillum volutans* in the fluid. With a purpose in no way connected with the issue, I examined with a $1/10$ homogeneous lens the slightly viscid and granular sediment; and in two or three of the many globules which I took out with a fine pipette, I detected the presence of an intensely active organism which appeared to present features and movement that I could not reconcile with any septic form familiar to me. It was so small that at first it appeared almost bacterial in its relations; but it was so involved in the slightly viscid mass, and withal its movements were so quick and constant, that it seemed almost impossible to fairly understand it.

To add to the difficulty it was manifestly very sparsely diffused in the fluid—or rather in the slightly viscid sediment—for it was wholly confined to this; and it was on an average only once in a dozen drops that two or three of the forms appeared.

I was examining it upon a cold stage, and as there was at least 30° difference in temperature between the stage and the fluid, such organisms as I was able to secure very speedily became enfeebled, and ultimately still. In the slower movements, and in the state of inactivity, I got a glimpse of characters that were, so far as I know, quite unnoted amongst the septic series.

By a simple arrangement, I adapted a hollow heating plate in the place of the principal part of the glass plate of which my continuous stage was made, as used with the temperature of the surrounding air, and I placed this heating plate in connection with a vessel of water kept by a mercurial gas regulator, worked with an unchanging gas pressure, at a temperature of 93° F.

The apparatus, as far as it is needed to reveal its purpose, is before you.*

My earliest and continuous difficulty was to find specimens for study.

As in former instances, I determined first to follow out the morphological details separately, and if possible exhaustively; and to fix on a given organism with all the details of its form known, from one stage to another, until I had been able to trace it from its earliest to its latest condition.

The first step was a careful measurement of its visible body sarcode. The body was of sub-oval shape, with a lenticular form on the upper and under surfaces.

The general appearance of the body alone is seen in figs. 1, 2, 3, plate IV., and on the measurement of twenty-five forms I obtained an average length of the $1/10,000$ of an inch, and a breadth of $1/19,500$ of an inch.

But when closely and carefully examined with a $1/25$ oil lens, it presented the remarkable phenomenon of an organism so minute, with no less than six flagella, each one of which is nearly three times as long as the long diameter of its body.

It was soon evident that its movements were extremely varied, and some of them entirely unlike anything I had hitherto seen.

A not uncommon mode of locomotion was that of simple swimming, as seen in fig. 1, plate V., where the anterior and posterior flagella were in vigorous action, and the remaining four either trailed or participated but slightly in the direction of motion.

But a movement quite as often resorted to, was much more beautiful. The organism came to momentary rest much in the attitude seen in fig. 4, plate V., and fig. 10, plate IV., when by a sudden movement of the whole group of flagella, a series of wave-like leaps, reminding one of the movements of a shoal of porpoises, ensued, and was continued for from ten to fifteen undulations.

To actually make out the flagella and their movements required considerable "penetration" as well as the most delicate definition. A fine homogeneous $1/8$ of Zeiss's greatly helped me in this matter; but at the last I reaped my most perfect results with the new $1/6$ of 1.50 N.A. Indeed, I had the glass made with this special object; and the need of it will be seen more fully when I describe the essentially unique and characteristic movement of this monad.

In previous forms which I had studied, both with Dr. Drysdale and alone, I had observed and described forms that anchor the body by means of one or more long trailing flagella, which flagella are

* This will be illustrated in a subsequent part of the Journal.

made as it were the radii of a quadrant of a circle of which their fixed point is the centre; and by the rapid movement of the body to and fro in the circumference of the arc, the body was as many as thirty times per minute made to act hammer-like upon minute particles of decomposing matter. But in this organism, what was apparently the same result, was brought about in a manner wholly different.

The organism was never attached—had no power that I could discover of attaching itself for a moment; but by a free darting, down upon, and away from, minute particles of decomposing matter by the organism in large numbers, such matter was visibly, in the course of half an hour, reduced in size and altered in shape.

Fig. 9, plate IV., will give an idea of this mode of movement: *a* represents a minute particle of decomposing débris, and the arrows placed beside the organisms indicate the direction of motion.

Each one in turn, in a space of time occupying about two seconds, comes into contact with the particle *a*, and at once recedes to a distance of four to five times the length of the flagella, and instantly again darts upon the object, and this may be continued by given forms for hours.

No sight accessible to the human eye can be more fascinating or more beautiful than this, with delicate illumination and such definition as we can now obtain.

Fifty or even a hundred may be observed with ease, in one field, pursuing their untiring work. It is the more entrancing that it is apparently rhythmic, not like the measured march of a regiment, but the rhythmic movement of a peal of bells.

But the method in which the motion, with its manifest force, is brought about, is a matter of greatest interest, and the discovery of which is fraught with much difficulty.

The extreme minuteness of the organism, the large number of its delicate flagella, and the intense rapidity of its movement, are the three factors of difficulty.

It is absolutely needful first to familiarize oneself with its general movements before interpretation of this special action can be hoped for.

In swimming, and in the wave motion I have described, figs. 1, 2, 3, plate IV., and 1 and 4, plate V., all the flagella may be, with care, clearly seen; but in the act of darting down upon, and away from a piece of débris it is otherwise. Fig. 9 *b*, plate IV., shows one of the forms at the very moment of impact: *all* the flagella are behind, and (in this instance with the 1/12 objective, 1.47 N.A.) a spiral form is indicated in the arrangement of these flagella.

At *c* in the same figure, one of the forms, having accomplished impact, is receding. Two of the flagella now fall to the front.

But with much difficulty, though complete certainty, I was able to demonstrate a distinct movement of rotation.

The organisms start when at the greatest distance from the débris with the anterior and posterior flagella at an angle with the axis of the body, as in figs. 5, 6, 7, plate IV., and may, by close observation, aided with minute particles of carmine in the fluid, be seen to swirl rapidly from left to right, causing a screw-action, the middle four flagella presenting the spiral appearance seen in the figures; and the anterior and posterior rapidly approaching their final condition seen in *b*, fig. 9, plate IV.

In receding, the anterior and posterior flagella spread out as before, and swirl in the reverse direction, rapidly falling forward, as in *c*, fig. 9.

In this way the constant battering ensues.

Each of the drawings was made instantly, and they were made with different lenses. The whole of fig. 9 was made with the oil $1/25$, 1.37 N.A.; so was fig. 11, plate V. Fig. 11, plate IV., was drawn with a fine water $1/16$; fig. 6, plate IV., with the oil $1/50$, 1.37 N.A.; while figs. 7 and 5, plate IV., were drawn with the $1/6$ oil, 1.50 N.A.

A diagrammatic view of what I take to be the method of effecting this powerful movement, for accomplishing the final breaking-up of the last fragments of a decomposing mass, is seen in figs. 12 and 13, plate V.

The greatest perplexity at this point of my work was the relatively few forms I could find, and the difficulty of knowing in what way to promote their increase. I have not yet discovered this latter desideratum; but at a subsequent period I found the organism more freely, when the main difficulties of its life-history were overcome; and so I was able to complete the details here given.

But the incitements to proceed with the life-history of the organism, rather than linger over the details of its morphology and movements, were strong, for the drama partly observed was interesting in no ordinary sense.

From the large number of its flagella, I had hardly been prepared for fission as a feature of its life-cycle, although so universal in the group. But on steadily following one, and subsequently, in order to complete the observation, many others, I selected the free-swimming state, seen in figs. 4, 2, and 1, plate V., and fig. 10, plate IV. Soon, in the course of three or four minutes, I observed a sudden indenture, almost a constriction, in the middle of the body, as seen in fig. 3, plate V.; and directly this occurred, the flagella, previously acting together for the propulsion of the whole body, separated, and three of them acted in one direction and three in the opposite.

This pulled the constricted part out into a hyaline neck, as

in fig. 5, plate V. In the middle of this, at this time, there was a delicate line visible, parallel to its length. This became stronger as the neck lengthened, as in fig. 6. Still the dividing organism pulled its dividing parts away from each other, by the vigorous antagonism of the flagella; and the neck rapidly elongated, and split with considerable separation of the two lines of sarcode, as seen in fig. 7. But simultaneously with this there is a horizontal splitting of the cord α , fig. 7, which widely separates, and when the organism is seen on its dorsal aspect, shortly after this condition, it reaches that shown in fig. 8, where three flagella, of double length, are tightly stretched between the dividing organism, the upper one on a different plane to the two lower ones, and by a vigorous movement this is soon snapped in the middle, and two organisms quite complete are severed from each other, as in figs. 9 and 10, plate V., and fig. 12, plate IV.

It was impossible of course to follow both, but the one followed, in every case swam, after fission, with great vigour for from two to four minutes, when the first symptom of fission commenced again, and on the average occupied from four to five minutes in completion, from the moment when the first dorsal depression showed itself to the end of the process.

At this point the sparseness of my material greatly hampered me. I was deeply desirous of working out the history of the form to the end, while the actual material was before me. It was visibly diminishing; and although I had taken much pains to produce a new crop in other vessels, by sowing this one and subjecting it to the same conditions, I could have no certainty that it would succeed. Fortunately I did succeed twice afterwards in getting moderate quantities only; these were obtained respectively eighteen months and a little over three years subsequently.

It was not until about a year since that I was able to steadily follow the continuous fissions of three single and separate forms successively, by keeping one division continuously in view to the end. In one case there were forty-five and in two cases forty-two fissions, and the last divided form in each case entered upon the springing condition to which I have called attention.

It is in the next stage of the development of this organism that the real difficulty and the only incompleteness presented itself.

In all the monads hitherto studied, it will be remembered that besides the fissional stage, there is a state of *fusion* on the part of two individuals resulting in the production of spores: conditions no doubt representing in some sense the non-fertilized and the fertilized products of the micro-fungi.

But in all the cases known, the occurrence of this fusion is relatively rare. In this instance I had almost suspected that there

might be none, or that the small quantity I could obtain of the organisms would make the discovery hopeless.

But towards the close of the first set of observations my conviction that such a stage belonged to the organism was fully established, inasmuch as I met with the organism in the curious, but to me, extremely suggestive condition seen in fig. 14, plate V., where we have a distinct blending in part of two normal forms. The bodies were inverted in their relative positions; but in the upper one the flagella were, in a manner quite common to the group, fusing with each other, and with the body as at *a*, *b*, *c*, while the lower organism, *d*, was swimming with full vigour.

This observation was made, when nearly all the organisms had died out of my fluid, and although I observed this with the utmost care, I could only see for about an hour the slow absorption of the upper form into the under one, which increased slightly in size. But it fell to the floor of the stage, and after a couple of days observation it was abandoned as dead.

I had now to wait much over twelve months before I, in any of the very many cultures of the form which I had made, succeeded in obtaining it again. It is wholly confined to the nearly exhausted condition, of very powerful putrefaction, kept at temperatures ranging from 85° to 95° Fahr. and it is then extremely capricious.

My second find was however fairly copious at first; and I endeavoured to pursue the inquiry as to this method of fusion. Repeatedly I met with forms more or less approximately in the condition shown in fig. 14, plate V., and in every case save two (out of eleven) with the definite result I will describe immediately, but I was only successful three times in finding an earlier condition of this act of blending in all the period of my observation.

This earlier stage is fairly represented by one of the three, shown at fig. 15, plate V., where the two forms are in direct contact, and all the flagella are intact. Their movement was vigorous, and somewhat irregularly alternate; the flagella of one only being in action at once, until in one of the cases the flagella entangled and anastomosed with each other, and fused with the body as seen in fig. 14; then the other one assumed the horizontal position and swam freely; and slowly, the upper one was lost in the increasing sarcode of the lower until "each was melted into other." But there was no loss of swimming power. The motion was much slower, almost at times only a spinning on a perpendicular axis; but the body became vacuolated, and internally segmented in a rapid manner, but not easily discerned in the process from the movement of the mass.

In all preceding cases the sac of which this was the equivalent had been quite inactive at this stage: but in this case motion was unbroken, and in the course of from four to five hours a distinctly

granular mass was presented, as seen in fig. 16. The granules were more or less distinct, and were semi-opaque; but the flagella still were in active motion, and the whole mass was swirling and swaying with irregular movement over the whole field.

In earlier observations of this phenomenon, it was quite visible that when it had reached this stage, the mass grew gradually less; but how was not so readily discoverable, because it was so slowly effected.

But by careful arrangement it was subsequently seen with comparative ease that it was, as it swam, dropping a stream of semi-opaque granules, by no means difficult to see, as at *a, b*, fig. 16, plate V.

To study any changes that might happen in these was not a matter of difficulty. I did it chiefly with the dry $1/35$; but where any points of special detail were to be made out I used the oil lenses.

The granules or sporules, or whatever we may call them, are at first semi-opaque: but in the course of fifteen minutes they lose this, and become transparent and highly refractive. Within a few minutes from the assumption of this condition they are visibly elongated, as at fig. 17, plate V. This elongation continues with general enlargement as at fig. 18. In about an hour it has reached the state shown at fig. 19, but it is very difficult to determine the earliest appearance of the setæ-like origins of the flagella which begin to show themselves between the stages shown in figs. 19 and 20, but after this the progress is very rapid; for in three hours more the organism passes through the stages shown in figs. 19, 20, and 21, and in the last condition begins its earliest movements; and rapidly appropriating food as it moves, it reaches the final condition shown in figs. 22 and 23, and was in several instances followed into the process of fission, depicted in fig. 24, and which constitutes a completing and re-entering of the life-cycle.

To complete our knowledge concerning this form so far as could be, I made, as in former cases, a series of experiments on the thermal death-point of the germs.

The apparatus I employed for this purpose is that which I have before employed for the same purpose, and which I have described, both to this and the Royal Society.* It enables an examination of the immediately emitted germ to be subjected to such thermal conditions, in fluid, as may be desired, and the germ to be subsequently studied under any power, without the slightest disturbance, and in normal conditions.

From the nature of the spore-sac, and the slow mode of

* See this Journal, iii. (1880) pp. 1-16, and Proc. Royal Society, xxvii. (1878) p. 332 *et seq.*

emission, I was enabled to use this apparatus in its simplest condition, and so to ensure less complex results.

The death-point of the adult was first tested. I found that it was not killed under a temperature of 146° Fahr. This was from 4° to 6° higher than any other form I have studied.

After ten separate tests, carefully worked out, I found that the highest point which the spores or germs could endure, and still germinate, was 190° Fahr. After this point was passed the form never appeared in the closed cell. That is to say, that the spores seen to be deposited in the specially prepared cell, did germinate after being raised to any temperature intermediate between 146° and 190° Fahr., but beyond the temperature of 190° the spore lost its power of germination.

This is the eighth of these most interesting forms that, either in conjunction with my colleague or alone, I have been able to carefully follow through their principal developmental changes.

It may be well to indicate briefly some of the broader aspects of the study as a whole.

And first, whether these organisms are animal or vegetable, is without doubt an interesting question. But the more completely we know the organisms the more difficult does the determination of this question become. It may be taken as absolutely certain that, in common with the septic bacteria, they can live, thrive, and multiply indefinitely in fluids totally devoid of proteinaceous matter, and composed wholly of mineral salts and tartrate of ammonia—as Cohn's nutritive fluid. On the other hand, they are probably even more prolific in putrefactive animal and vegetable matters.

But no definite inference can be made from this; for a form so essentially animal as *Paramæcium aurelia*, and still more abundantly *Stylonychia pustulata*, will live and rapidly multiply with them in the same simple nitrogenous compounds.

To argue the vegetal character of these forms from their plant-like ability to produce protein when supplied only with carbonic acid, ammoniacal salts, some mineral salts and water, would be, with the fact I have stated, to reduce the genus *Paramæcium* to vegetal forms—a result which few thorough biologists could sanction. On the other hand their normal ability to dwell in putrescent animal and vegetable fluids, places them on a par with *Paramæcium aurelia* on its animal side; and thus their double capacity in this matter appears to give them an intermediate position, touching almost equally the animal and the vegetable series.

Not less interesting in its general biological bearing is the whole process of fission in this group, especially when its varieties are taken into account.

In some instances, as in the case we have considered to-night, the division of the sarcode is simple; it is, so far as our power to see can carry us, a mere cutting of the sarcode into two independent parts. But to secure the independence of each, the most complex arrangements for the supply of flagella have to be provided. The ease and simplicity with which this is wrought is indeed striking.

On the other hand, there are forms in which the division itself is a mere equi-partition of the sarcode of the body, devoid even of a discoverable nucleus, and the pulling out, at the point of division of the organism, of a simple neck of protoplasm into a single fibre making new flagella for the two separated parts.

This is shown in fig. 1, plate VI., *a* being the normal form, *b* the earliest discoverable state tending to fission; the constriction deepens, and each half by individual activity recedes from the other, as in *c*, *d*, pulling out the fibre *e*, which snaps in the middle and each half goes free.

But not only have we instances of simplicity and of complexity in the fissional provision of flagella; but there may be increased complexity in the process by the clean division into two of the nucleus.

In the form shown in fig. 2, this will be readily seen. *a* is the adult form of the organism. It can swim freely; but is usually "anchored" by a "trailing flagellum" *b*. It has a large hyaline nucleus *x*.

The first movement towards fission is a partial division of the front flagellum, as at *e*; then the sarcode of the body begins to divide as at *d*, accompanied by a splitting of the upper part of the trailing flagellum *d*. The incision in the sarcode deepens; and with this the vivid nucleus *x* shows an incision in its upper part. Rapidly the two halves of the dividing body are as it were torn from each other, the front flagellum is wholly divided, *f*, *j*, *k*, the trailing flagellum nearly so, as at *m*, *n*, *o*, *p*, and the nucleus is quite divided: immediately after which the two perfect halves are free.

This is a complex but exquisitely beautiful fission.

But there are two of the forms that present almost the same problem of how to accomplish a multiple fission; and each solves it in an independent manner. Their mode of multiple division is seen in figs. 3 and 4. In fig. 3, *a* is the simple normal form. It swims for a couple of minutes, then assumes a rounded discoid appearance, and becomes still, as at *b*, the flagellum *c* melting into the sarcode.

A white cross suddenly appears as at *d*, which is rapidly followed by another at right angles to the first; then it twists into

a turbinated shape *e*, which is at once followed by quick and continuous internal movement, which results in the breaking up of the mass into a condition shown at *f*, where there is no trace of investing membrane, and the parts are in a state of movement upon each other for some twenty minutes, when the whole breaks up into perfect, but minute adult-shaped forms, with complete power of motion, as at *g*.

In fig. 4, *a* is the adult form. It is always invested with a hyaline coat; after swimming for awhile the interior sarcode constricts as at *c* in *b*; the constriction deepens, as at *e* in *d*; and the two halves separate within the membrane, as two oval bodies, *g*, *h* in *f*. Subdivision goes on rapidly within, until sixteen perfect oval bodies with minute flagella lie within the mother body, and at length break the investment and go free.

Here we have the same result accomplished, with and without an investing envelope: and in both cases after a long-continued increase by each individual thus separated by fission, there is a perpetuation of the form by a fertilizing process and spore.

There are two other forms that present remarkable phenomena in self-division. They are shown in figs. 5 and 6.

In *a*, fig. 5, we see the common condition of the largest of the septic organisms I know. In the course of a few minutes, if followed, it is seen to lose its sharpness at the end opposite the flagella, and is amœboid, in the course of a couple of minutes presenting an appearance shown at *b*. The amœboid condition is seen at *d*, but in this state the root or base, out of which the four flagella spring, divides, and two pairs of flagella, each independent of the other, recede from each other, and the nucleus partially splits, as at *c*. The amœboid condition in a short time ceases, as at *e*, the flagella rapidly recede from each other, and the nucleus almost wholly divides, seen at *e*, *f*; at this point there is a sudden flattening of the organism from before backwards, and a lateral lengthening, as at *g*; the flagella still recede, as at *h*, *i*, and a constriction appears, as at *k*. Soon the flagella are at opposite poles, and pull against each other; the neck of sarcode is drawn out, as at *l*, and with it each half of the nucleus into its separate part. A moment or two after it has reached the state shown at *l*, a vigorous movement snaps the union, and two perfect forms are free.

The other and final instance is seen at *a*, fig. 6. The form has an anterior and two lateral flagella, and swims with supreme grace.

The first indication of fission is a delicate slit in the anterior knob of the body *b*, and with the opening of this the front flagellum splits.

At the same moment a slit *d* appears at the posterior end, and with this an incision in the nucleus. Both slits rapidly open; two anterior flagella are formed, as at *e*; the nucleus wholly divides, as at *f*, and soon only a neck of sarcode connects the dividing halves, as at *g*, *h*. Pulling in opposite directions then takes place, lengthening the cord, as at *i*, until it reaches the fineness, and double the length of the flagellum required for each divided form, as at *k*, when it snaps and each is free.

The mystery of all this simplicity of vital movement is deep; and although we can observe and in accurate manner record the process, its *modus operandi* is far beyond our present grasp.

One thing is certain, on this rapid power of self-multiplication depends the entire utility of these organisms, and in this function of self-division it would appear that they have reached the highest point of vital development. Lowly they are—we know of nothing living that is lowlier—but in the processes of vital evolution, amongst the lowly and simple as amongst the highly organized and most complex, we find the perfection of concurrent adaptation.

One other feature in these minute organisms claims a note. They are subject to no caprice; after twelve years of close observation I am convinced that the vital processes are as orderly, rigid and immutable as in the most complex organisms. Their life-cycles are as clearly definable as those of a crustacean or a bird. No vital phenomenon not to be found amongst higher and larger organisms, is discoverable here. Only the methods of specific mutation resulting from the secular processes enunciated in the Darwinian law are in operation.

But the action of these processes is certain; and from the rapidity of their increase, the shortness of their life-histories, and the ease with which vast multitudes may be studied, these organisms afford a splendid field—by changes of environment—for proving the action of the Darwinian law. But this must be a work in which it would be vain to enter, unless, relatively speaking, vast time were given. For, immense as their multitudes are, and rapidly as generation succeeds generation, and easily as changes of relative minuteness may be seen, it is manifest to a close observer that definite and discoverable change, in response to a marked change of environment, may be brought about; and there can be no doubt that the tendency to vary is fully operative in the group; and with it a tendency to conserve useful variation. This to an interesting extent I have proved, and shall hope on a future occasion to give you the evidence afforded.

Meantime, however, I may remark, that so far as my observation has extended it is never in the process of fission that variation

occurs—the divided organisms are always normal. It is, at least so far as my observation has extended, only in the forms arising from spore that there is any tendency to vary.

EXPLANATION OF PLATES.

PLATE IV.

Figs. 1-4 show the general form of the organism with its six flagella, and the attitudes assumed in ordinary movement.

Figs. 5-9 illustrate the special movement of the organism when engaged in large numbers in battering minute quantities of decomposing matter, as σ , fig. 9. The arrows indicate the direction of movement with the condition of the flagella. Figs. 5-8 and 11 are illustrations of the appearance of the flagella when the various stages of the battering are watched.

Fig. 10.—Attitude of the organism before fission.

Fig. 12.—The final stage of fission before actual breaking into two.

PLATE V.

Fig. 1.—Appearance of the form when in ordinary motion.

Figs. 2-8.—Various stages of the act of fission.

Figs. 9, 10.—Two forms separated by fission—the result of the division of the organism in the condition seen in fig. 8.

Fig. 11.—A drawing of the organism as it appears when seen in the best conditions for observation in the act of "battering."

Figs. 12, 13.—Diagrammatic view of what is in all probability the arrangement of the flagella in the state of motion shown in fig. 9, plate IV.

Figs. 14-24.—Various stages in the genetic fusion of two forms issuing in spores (fig. 16) and the development of young forms (figs. 17-24).

PLATE VI.

Various modes of fission in different forms of the monads already worked out.

V.—*The Lantern Microscope.* By LEWIS WRIGHT.

(Read 12th November, 1884.)

It is about three years since I was urged by several Fellows of this Society, and others, to turn my attention to the improvement of the oxyhydrogen Microscope, being assured that any instrument which would display objects *effectively* even on the scale of 600 or 700 diameters, would be an immense advance upon anything then obtainable. By one or the other of those interested, all the instruments of most repute were placed in my hands, and it appeared that there was indeed much to be desired; since not one of them, with the best lime-light possible, would exhibit the bulk of those slides which any demonstrator with a serious purpose in view would desire to place upon the screen.

My own efforts in this direction were to some extent hindered by my comparative ignorance of microscopy, as such. I do not even yet know, as stated further on, what my own instrument will perform in diatom work, and the problem was to me chiefly an interesting one in optical projection, whose difficulties constituted its main charm. An examination of the instruments lent me, however, presented the clearest internal evidence that previous failure to overcome those difficulties was due to either ignorance or neglect of the peculiar conditions of the oxyhydrogen lime-light.

The conditions alluded to are easily indicated. If a luminous point is placed at a conjugate focus of a lens, the diverging rays will unite in the other conjugate focus, or parallel rays will be brought to the principal focus. It is obvious, that under such conditions, by placing a small lens in various positions on one side or other of this focus, any possible kind of pencil may be obtained, or an illuminated surface of any desired size or minuteness. Accordingly, writers on the lantern Microscope and photo-micrography have described every possible use of a secondary condenser in this way; so that there is absolutely no room for any really novel (in theory) optical combination.

Now such a condition fairly represents the case with solar rays, which are sensibly parallel, though even the solar rays cannot be converged to a point. Hence the Duboseq Microscope, the best I have found, and which consists mainly of a small convex lens adjusted by rack and pinion anywhere near the focus of a large condensing lens, will produce good results with the heliostat. It will also produce fair results, though not so good, with the electric arc; because with this also the radiant point is tolerably small, while the light is ample to allow of waste. But the lime-light radiant is a luminous surface as large as the thumb-nail, and this quite upsets the whole matter; for the radiant having a very

material *size*, we have necessarily a very much larger image of the radiant instead of a point. The small movable lens will no longer collect more than a small part of the light; and taking the lime-light even at 500 standard candles, we have no light to spare. Hence the failure of all instruments modelled on the usual theoretical diagrams, or heliostat practice.

This is not quite all. It is plain that we must condense, as nearly as possible, all the light upon the object, however small its size. And it is further plain, that the smallness of this illuminated spot must be a function of the relative foci of the large lantern condenser, and the final secondary condenser. But if we use for the latter a large lens of very short focus, then we get such a high angle that most of the light crossing in and diverging from the object, never passes through the objective. If on the other hand we use a very small lens, most of the light never gets through this lens.

Hence the matter becomes one of practical adjustment, at every point; and each secondary, or as we may perhaps call it, substage condenser, must be specially constructed for powers of a certain range only, in focus *and angle*. Except for low powers, each substage condenser is almost necessarily composed of two lenses; one of fairly large size, to take up and condense or bring down all the cone of light; the other, to still further condense that light to the size of the object desired, without employing an angle too great for the objective. There was further to be studied perfect protection from the heat, which is very great; and absolute simplicity of parts and manipulation, without which work in the dark cannot be effectively performed. In regard to several of these objects, I felt it very desirable that such an instrument should be constructed by opticians specially familiar with lime-light projecting apparatus, and who would test every instrument actually upon the screen. For want of this latter precaution, one lantern Microscope lent me behaved far worse than another of the same make: copied unintelligently, and sent out without testing (for it never could have been tested), it was really unworkable, and no one had ever been able to do anything with it. It was also natural to expect that such opticians would more readily understand the reasons for some of my arrangement, and sympathize with my passion for *simplicity*, without contriving or urging upon me extra provisions of screws and other brasswork, so dear to the average instrument maker, and proper enough for many purposes, but which in the dark would be to a practical demonstrator a source of unmitigated distress.

All these expectations were realized, the instrument being completed by Messrs. Newton and Co., with both care and skill. It is shown in fig. 40. Some points in it they have, in the exercise of an equitable right I was bound to recognize, desired to protect

by patent; but these I need not particularize, and will only briefly describe the Microscope as constructed by them.

I had neither time nor inclination to study any false "originality," or which served no useful purpose. Finding therefore the general mechanical arrangement of the Duboscq Microscope, so far

FIG. 40.

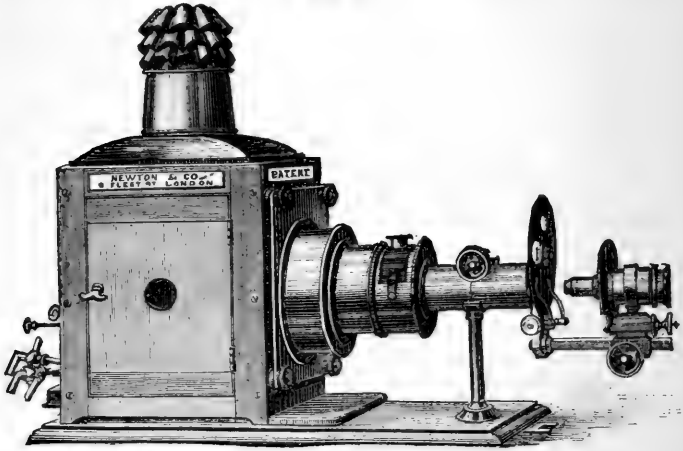

as regards the rack-bar for the coarse adjustment, and the internal rack-and-pinion movement for focusing the substage condensers, well adapted to all my purposes, I adopted it. The action of the French focusing rack, so awkward to English hands, was however reversed to the usual direction by Messrs. Newton, and the useless so-called fine adjustment replaced by a steady screw movement on the plan now so usual in histological stands. Optically the arrangement is far different. In the Duboscq instrument one small lens permanently fixed in the rack-tube is intended to (and with the heliostat does) produce various kinds and angles of illuminating pencil; whereas in mine various removable condensers are employed, suitable for their purposes, and always *before* the lantern focus is reached, except in the special case of an achromatic condenser presently described.

I prefer to use a special triple lantern condenser of high angle (95° or 100°) 5 in. in diameter, which is calculated to utilize the whole of the rays. In the nozzle of an ordinary good lantern the illumination is somewhat less; but as at the higher angle there is more loss by reflection, and by the third lens, there is not so much less as might be expected—not more in my opinion than about 15 per cent. A special double condenser can be made nearly equal to the triple form.

In the convergent cone of rays from the lantern condenser, is placed a parallelizing plano-concave lens, giving an approximately parallel beam (i. e. as nearly parallel as admitted by the conditions stated above) of about $1\frac{3}{4}$ in. diameter. This lens is of highly dispersive glass, and therefore to a large extent corrects the chromatic effects of the lantern condenser.

In the same position, nearly, is placed the alum trough. In but one lantern Microscope which I have examined, is there anything like adequate protection from heat for balsam slides. I have found it advisable to employ a full inch of alum solution, and in addition, to form the second side of the cell of a *double* plate of glass, the two cemented together by Canada balsam. This layer of balsam absorbs any special balsam-heating rays which get through the alum. With these arrangements protection from heat is not comparative, but absolute and perfect. Less than this is not real protection; for the heat in the conjugate focus of a good lime-light is sufficient to ignite black paper. I may remark that I have seen a layer of balsam employed to protect balsam slides years ago, but am not now certain by whom.

For ordinary purposes, I cement the concave lens with balsam on the alum trough, thus making this lens the second of the two glass plates. By this expedient the loss of light by two reflections is avoided.

From the parallelizing concave lens to the stage is about 5 inches. Less than this would suffice for mere focusing purposes, with plain work only; but this distance is not enough to produce much of the waste by scattering above alluded to, while it allows of a really good-sized polarizing prism being introduced when necessary, such as will give a polarized slide-disk of $3/4$ in. diameter—none too much for rock sections. Also it appeared to me, from such experiments as I could make, on the sole occasion I was able to borrow for a few hours an “achromatic condenser,” that the latter gave more light and worked better when not placed in parallel light, but just after allowing the rays to *cross* from the lantern condenser, without parallelizing them at all. I therefore provided for this, which is easily accomplished by having a spare alum-cell with a plane second side, instead of the concave lens. I since find that the same conclusion as to using crossed rays has been reached by Dr. Hayes,* though for somewhat different reasons. At all events, it seemed desirable to provide the widest possible range in the optical manipulation of achromatic condensers.

The end of the condenser-focusing rack-tube, is a tube-fitting of the standard $1\frac{1}{2}$ -in. substage gauge. I adopted this in order that any standard apparatus, such as a paraboloid, or achromatic condenser, may be used with facility. As the tube racks out

* See this Journal, iv. (1884) p. 805.

beyond the stage, any such can be inserted, or changed, in an instant. For ordinary use a simple series of condensers are provided, adapted to the different powers. Upon these condensers taking up the whole parallel beam, bringing it down to the required size, and so bringing it down at an angle approximately corresponding to that of the objective, or rather somewhat within it, depend both (1) the illumination and (2) the definition. A good objective will not give good definition with an unsuitable condenser, nor will its field be at all evenly illuminated.

The stage consists of a revolving diaphragm-plate; that is, of the very plate itself. A great point is, the most absolute simplicity; and nothing can be so simple as a perfectly free and open flat plate, with two ordinary stage springs to hold the slide. Any slide, or trough, or object, or apparatus can be adjusted on this without difficulty. Moreover, it is often desirable to have the apertures close to the slide; while the slide can always be elevated, if desired, by a packing of wood or card.

Of objectives not much need be said. For large whole insects, or other large objects (which can be shown brilliantly up to $1\frac{1}{4}$ in. diameter), I still find one of the old-fashioned double-plano un-achromatic form, a little over 2 in. focus, most useful. By careful adjustment of its stop in size and position, and adaptation of the condenser, such a lens will give much better results than might be supposed, and no achromatic form of the same focus will cover *nearly so large a field*. Such work is scarcely microscopy, but nevertheless such objects often have to be shown. With achromatic powers the great difficulty was to get lenses which would give a picture *flat* to the edges. It must be borne in mind that the screen shows an object three times the diameter of the image utilized from the same lens in the compound Microscope. A lens may be fairly flat to the edge of the compound field; but that will be the mere centre of the screen field. Very few lenses, out of many I tested, but broke down here. Absolutely the *only* half-inch powers that really gave a flat image, so far as my own trials went, were an old formula of the late Mr. A. Ross, lent me by Mr. Curties, and the 40° with correction collar of Messrs. Powell and Lealand, lent me by Mr. Crisp. An old Gundlach lens lent me by Mr. Teasdale, however, enabled me to get through Mr. Curties 6/10 and 4/10 lenses which performed well. The lower achromatic powers had to be specially worked out on the screen itself by Mr. Herbert Newton, the only good and flat lens I could find out of dozens, being an 8/10 made by Zentmayer. Though I think Mr. Newton's is still better, chiefly in *blackness* of image, this last is an extremely fine lantern lens. But there are doubtless many objectives I have not tried which will give good

results. I have not however, up to the date of this, yet found a $1/4$ or $1/5$ which gives a flat image, and shall feel exceedingly obliged for the loan, or trial under the owner's eye, or from any maker, of any promising objective. The most suitable angle is 90° to 100° .

The objectives screw into a short jacket or body, which has a sliding fitting into a socket. Thus by providing an extra jacket, powers can be rapidly changed.

A very important accessory to the objectives is a *concave amplifier*. Though it would be necessary to have one calculated for each objective to obtain perfect results with this, sufficiently good definition and flatness can be obtained with one only. In most cases a *slight* impairment of definition is observable when an amplifier is used, owing I believe as much to reflection from its surfaces as anything else. But it is not noticeable on many objects, and results are thus obtainable which are not so in any other way. Thus, if the concave doubles the amplification, a $1/2$ in. so amplified is not the same thing as a $1/4$ in., since (1) it covers *double the field*; (2) more light can be passed through it; (3) there is far more working distance; and (4) there is far more penetration or depth of focus. Again, a very low-power concave may be so adjusted (see past papers of the late Dr. Woodward) as to preserve the ordinary working distance at the far longer screen distance, and so keep all the corrections of an immersion lens unaltered. And still again, an amplifier, or one or two amplifiers, give a great *range* of scale on the screen, at various distances. In brief, while as a rule the unamplified image is best wherever it will give exactly what is desired, results can be got with an amplifier, in many cases, which could not possibly be got without one, especially as regards the *size of object* shown under a given power, or the depth of focus required.

Pretty good results can be got with the more brilliant opaque objects under a Lieberkühn, and many objects show beautifully under black-ground illumination. The most precious portion of the parallel beam is of course stopped by the dark disk or spot. To avoid this, I have devised a concave glass *cone*, which splits the rays from the centre, and so uses approximately all of them, in spite of the spot or opaque disk.

Some may wish to have an idea of what can be shown on the screen with the oxyhydrogen light, and how far any special slides are necessary. Where transparency is combined with opaque detail, 1200 or 1500 diameters are easily obtained; and a flea can be shown about 14 feet long, as sharply and nearly as brilliantly as a painted magic-lantern slide. Where extreme transparency of ground is combined with great opacity of detail, as in a fly's

cornea, a $1/5$ amplified, at 25 feet distance, passes enough light to exhibit it 2500 diameters. For this I prefer a Kellner eye-piece as condenser. What can be done with diatoms I do not know, having had no opportunity as yet of trying the completed instrument with those excellent condensers made for this express purpose; if any one interested is disposed to assist me in such trials, I shall feel exceedingly obliged, this class of work being rather out of my range, and depending so much upon experience, and technical knowledge, and apparatus, which I do not possess. So far as definition of the objectives goes, I have ascertained that a Zeiss homogeneous $1/8$ will give every dot in an image of *N. lyra* 4 $\frac{1}{2}$ feet long; but my condensers for lower powers do not give sufficient illumination. The best I have myself done with high powers has been, with this same lens, to show the cyclosis in *Vallisneria* so that the motion of the chlorophyll granules could be clearly seen about 12 feet away from the screen; but I am satisfied that more than this is possible with proper arrangements, and probably one of Powell and Lealand's new formula immersion lenses would do better than the Zeiss, fine lens though the latter is: for work in the dark, water is certainly preferable to oil or chemical solutions. Now that my instrument is done with for "pattern" purposes, I hope to experiment further in this direction.

As to slides, the better the slide the more can be shown in it, of course; but no more is required in the vast majority than any microscopist would select for himself with a pocket lens as the "best" out of half-a-dozen. In special cases, whatever he wants to exhibit, he must of course see is really clear in the slide. The conjugate focus on the screen is so enormously long in proportion to the other, that where no amplifier is employed "depth of focus" is of course diminished. Hence biological or other sections should be chosen rather *thin*, that the image may be as nearly in one plane as possible. This is the chief point to keep in mind; but I have found no difficulty amongst any lot of sections, in selecting one which would answer all purposes.

Before concluding, I should wish to suggest two ways in which a good lantern Microscope may, I think, render service to general microscopic work, besides its more proper task of screen demonstration. Original research is of course out of the question, since its magnifying power must always be far beneath that of the compound instrument, simply because an illumination amply sufficient when gathered into the small area of the pupil of the eye, is so tremendously diluted when spread over a large screen. Moreover, quite coarse detail on a screen cannot be seen *at any distance*: an image of a diatom a foot in diameter is really very coarse, and quite brilliant; but it is surprising at how small a distance off the details cease to be distinguished by the unaided eye, while still

plainly visible through an opera-glass. This is indeed the real difficulty.

But, first, such an instrument much facilitates *photo-micrography*, beautiful images being obtainable with facility, and with no other apparatus. Whether or not diatoms may be sufficiently shown by the lime-light on the screen for an audience to see the details, lovely images are easily obtained, either direct or with black-ground illumination (up to 12 in. in the one case or 6 in. in the other), of such brilliancy that very short exposures amply suffice. As any condenser or lens found to do good work can be employed, with no preparation whatever beyond stopping stray light by black cloth, I hope there may be some field for usefulness in this direction.

The other direction is, the *improvement of lenses* as regards their aberrations from flatness of field. My experiments have shown how far most lenses are from perfection in this respect. Now a moment's reflection will suggest, that if a lens called "flat" over all the field of the compound Microscope, breaks down utterly in flatness over a field three times the diameter, it is not *really* flat at all. If we are to express the deviation from flatness by a trace drawn to ordinates in the familiar way, it is for instance

FIG. 41.



FIG. 42.



utterly impossible that the field can be really flat from A to B as in fig. 41, and the aberration commence and rapidly increase from A to C and B to D. The whole must be a curve resembling C A B D in fig. 42, A to B being only *approximately* flat but not really so. And this is the case; for it will be found that if such a lens is focused for the centre of the field, the microscopist, for his own comfort, brings the point under examination to the centre. This is particularly the case with half-inch powers. But with the one modern half-inch lens which, as already stated, I found to "hold out" to the edge of the screen field, it is not so; the eye rests with *equal comfort* on any part of the field of view in the compound. *The best lens on the screen is the best on the compound*, as regards this particular point. It is perfectly true, that if a lens be worked out solely for the screen, it may prove very second-class for compound work; for there are other important elements which this test does not touch. But if the lens is properly computed for these other elements of general work, and *its corrections for flatness are worked out on the screen*, then I have every reason to believe that a far better result will be obtained. I only know one optician, to whom

I recommended this plan, who as yet has adopted it; but he is so far satisfied with the results that he tells me he shall continue to do so. Hence I hope that an instrument which allows objectives to be thus tested easily, and with ample illumination, may produce some improvement in this respect. Micro-photographs of lines of print are excellent tests for this purpose.

Finally, I wish to thank those who have aided me in my experiments. To the Rev. P. R. Sleeman, Mr. Adolf Schulze, and several others who do not wish their names mentioned, I am indebted for trial of previous lantern Microscopes. Mr. T. Sebastian Bazley, Mr. T. Curties, Mr. Washington Teasdale, and Mr. Crisp, have kindly furnished me with objectives, the two former with large and valuable collections. To Dr. Carpenter I have been indebted for both objectives, for valuable advice as to an assortment of test-objects and what ought to be made visible in them, and for some of his own slides for my earliest experiments. But to no one are my obligations greater than to Mr. A. Topping, who has given much personal effort to supply such slides as were deemed desirable, and who in particular, when he knew that I had in vain endeavoured for months to procure the section of a fly's eye sufficiently minute in detail, made it his special study to prepare one for me in time for the meeting on November 12th. It is not that such slides as some he thus prepared are specially easy to show; in some respects the contrary is the case, and a coarser slide would be easier; but the labour in preserving the utmost detail has been considerable. I am glad to report that Mr. Topping found in such a task something of the same personal fascination I found in my own; since others may find similar advantage in procuring, not only from his hands, but doubtless from others also, similar high-class work for special purposes.* I must not forget to add that from Dr. Maddox and Mr. Crisp I also received timely bibliographical help regarding certain points—especially the concave amplifier (which is by the way a very ancient *lantern expedient*)—concerning which I particularly wished to know what had been done by others.

I hope ere long to have an opportunity of testing what this lantern Microscope will perform with the electric arc. The smallness of the radiant, as well as its greater brilliancy, will give this a great advantage with high powers; and if any of the lamps obtainable will keep steadily in focus, I have every reason to believe that almost anything can be shown up to 5000 diameters.

* A blow-fly's proboscis thus prepared for me, was pronounced by one of the most able photo-micrographers in England, to be much the best he had tried, out of dozens, for photographic purposes; and exquisite photographs were sent me of it upon a very large scale.

VI.—*On Some unusual Forms of Lactic Ferment—Bacterium lactis.* By R. L. MADDOX, M.D., Hon. F.R.M.S.

(Read 14th January, 1885.)

THE different appearances which some of the Schizomycetes assume under variable conditions, such as excess or deficiency of proper nutriment and air, or from improper food, temperature, and possibly unrecognized circumstances, are in themselves exceedingly interesting, especially so, as when fully known, they are likely to diminish the number of described species. It is therefore of some importance to note such varieties in form as happen to be found in the examination of normal cultures, for they may be significant of such changes in the life-history of the individuals as portend either an increased vegetative, generative, or degenerative act. This pleomorphism of some of the well-recognized forms has already led to a different classification, which I suppose we may simply term "the reduction of nature to the scale of our own intelligence," and which may not be "the expression of the Divine veracity in nature." Unfortunately it too often happens that the alteration of the form visible under the Microscope cannot be accompanied by any definite statement of the changed conditions which have led to the variation of form, for the normal and abnormal, as in the present case, are found together; hence I am inclined to regard the latter as tending rather to a higher than to a lower phase. There is great difficulty in deciding this question with our present knowledge. As I have not seen in any publication figures quite similar to those which accompany this short notice, I consider it may be useful to record them. The drawings are made from my original negative photomicrographs which are magnified 460 diameters, by aid of a low power and the camera lucida, reaching to 1020 diameters; hence they do not represent the ordinary dull grey appearance of the organism as seen under the Microscope.

The lactic ferment or *Bacterium lactis* may be described as an elongated sphere in its simple or coccoid form, which in growth soon becomes lengthened, then contracted in the middle much like the links in solid chain work. These divide and form filamentous chains of very variable lengths. The size of an individual article or joint is generally stated at 0·5 or 0·6 μ , the breadth being less. Most of the chains present nothing of moment; others show the different articles or joints increased much in size in different parts of the chain in an irregular manner, fig. 43 (1); whilst in others some of the articles have become more or less globular and very enlarged; this is particularly the case with two cells united by a very narrow bridge occurring in the middle of a short chain (2); in others the tendency to the round shape is

more continuous, less inflated, and one of the ends may be terminated by a somewhat flattened, double-goose-head expansion, containing well-marked granular matter, which stains very deeply, as in (3). Out of a large number of examinations I could not find

FIG. 43.



in any of the specimens that these granules were ejected, though in some cases the terminal cells had been largely emptied of their granular contents.

The nearest approach to these figures I have seen are in the drawings of Sir Joseph Lister's paper on *Bacterium lactis*.* The simple filamentous form there figured I did not meet with. I had the pleasure of handing Dr. Roux, one of M. Pasteur's able assistants, a photonegative of (2), as he had not seen a similar example; a little later he informed me that M. Pasteur had seen a like form. The lactic ferment was prepared by my friend Mr. W. S. Squire, as he wished photo-micrographs of the same with some other ferments, for lantern exhibition in connection with his scientific lecture "On the processes concerned in the conversion of starch into alcohol," read before the London Section of the Society of Chemical

Industry, June 9th, 1884.† It was after leaving the sample of lactic ferment in an undisturbed state for nearly a month, in a test-tube closed with sterilized cotton, that I found these inflated chains near the surface of the fluid. One naturally asks, are we to consider the enlarged cells as the result of a generative effort by virtue of which the organism can be tided over such conditions as, if continued, would otherwise lead to its destruction, or are we to look upon them as a degenerative state, or a return to a primary phase in its life-history? My own opinion, as before stated, inclines to the former view, partly from the close resemblance to the generative forms in higher types, say for example *Edogonium ciliatum* of the Confervaceæ. Whether the terminal enlarged inflated granular cells may be antheroidal cells, and the granules immature androspores which ultimately set free antherozoids, and the globular connected cells as in (2) sporangium cells which when fertilized by the former furnish oospores or a sporangium, or resting spore, must in our present knowledge be taken as conjectural, and only to be decided by extended observations with the aid of the cultivating stage.

* Quart. Journ. Micr. Sci., N.S., xiii. (1873) pp. 380-408 (3 pls.).

† Journ. Soc. Chemical Industry, July 29, 1884.

VII.—*On a Cata-dioptric Immersion Illuminator.*

By J. WARE STEPHENSON, F.R.A.S., F.R.M.S.

(Read 11th February, 1885.)

THE continued and remarkable progress which has been made in the development of the homogeneous immersion principle has induced me to direct my attention to an immersion illuminator which shall exceed in numerical aperture that of any objective which has been hitherto constructed. Mr. T. Powell has now produced an objective of N.A. 1.5 (that is with an aperture half as large again as that of a dry objective of 180°), and a condenser in excess of this appears indispensable.

It is true that the full aperture of an objective can be utilized by the vertical illuminator, but, as the illuminating beam is on a dry object reflected from the under side of the diatom, it necessarily follows that such beam passes twice through the object (acting in a manner somewhat analogous to Lecount's polariscope*); but if diffraction spectra are generated on the side in contact with the cover-glass, they must subsequently pass through the same structure from which they originated, and evidently in some cases produce confusion of image.

It is unnecessary to dwell further on this point, as we all know that the appearances presented by *Coscinodiscus* and some other diatoms, when illuminated in the ordinary way, give no indication of the structure of the two individual plates of which those diatoms consist, the passage of the light through the lower side of the valve producing confusion when passing through the upper.

The cata-dioptric illuminator which I now describe has an aperture which is only limited by the refractive index of the flint glass used. The aperture of the one on the table ranges from 0 to 1.644 N.A. on a flint-glass slide of suitable thickness, and from 0 to 1.512 on a crown-glass slide of the same thickness, the glass having a refractive index of 1.52.

The first question which naturally arises is, what is the use of an aperture of 1.644 N.A., when no objective which has hitherto been made has an aperture exceeding 1.5, as far at least as I am aware?

The answer is that with an illuminator having a considerable excess of aperture, it is much easier to find what is required, than it is with one which by calculation gives us exactly what we want

* In this instrument the polarized beam passes downwards through the object, is reflected from a plane mirror beneath, and again passes through the object before reaching the analyser—so that the colour produced by a film of selenite indicates a plate of twice the thickness of that which is actually under observation.

and no more. Again, without venturing to say there is anything in the suggestion, may it not be that in the search for Bacteria a dark-ground illumination may be of use. Every microscopist knows that with a black ground, even the most minute speck glistens in the light, and how a single delicate diatom in balsam, which it might take one an hour to find in a bright field, instantly becomes visible on the dark ground.

The illuminator (fig. 44) consists of a segment C D E (cut from the edge inwards) of a plano-convex lens of crown glass of

FIG. 44.

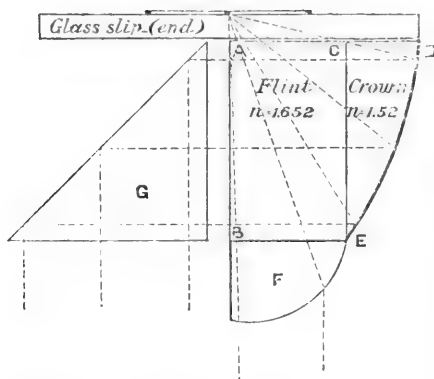

Radius of curvature = 1 inch.

A to B = 0.56

A to C = 0.34

C to D = 0.20

D to E silvered curved surface

F segment of plano-convex lens.

1 in. radius of curvature, the lens having a diameter of 1.2 in., and therefore a thickness of 0.2 in., the upper surface being black. The segment has a length of 0.56 in. and a depth of 0.5 in., and is therefore almost a square. The curved surface is silvered as in the catoptric lens described by me in 1879.* It is cemented to a rectangular piece of flint glass A B C E, the refractive index of which is 1.652. The thickness of the flint being 0.34 in., makes the total thickness, when the two are cemented together, rather more than half an inch.

The object of the flint glass is twofold. In the first place it

* See this Journal, ii. (1879) p. 36. Several catoptric lenses have been made for me of light, medium, and dense flints since 1879; one of these, of the numerical aperture of 1.561, was used by me to illustrate my paper on the visibility of minute objects in phosphorus, in 1880; but one made for me since then by Mr. Zeiss, of dense flint, has a numerical aperture of 1.628, in the same material, on a slide 0.03 in. thick.

disposes of three-fourths of the spherical aberration of a concave mirror of these dimensions, and enables one to use light which is practically parallel; and in the second place it has the very obvious one of securing greater aperture, which is the primary consideration.

As fig. 44 shows, rays which enter the flint glass horizontally are reflected at the silvered surface of the crown-glass segment, and apertures are thus obtained ranging from 0.77 to 1.644 N.A. in flint, and 1.512 N.A. in crown.

To obtain the smaller apertures, the plane surface of the under part of the flint is utilized by cementing to it a segment F (rather more than half) of a plano-convex lens of radius 0.25 in., with a focus in crown 0.04 in. above the upper surface of the flint, and therefore at the upper surface of a slide having a thickness of 0.04 in.

In order that the rays may be received from the mirror beneath (and not horizontally), a small right-angle reflecting prism G, is placed with one of its sides opposite to and parallel with the receiving side of the flint glass.

Stops of any form or kind can be used. They may consist simply of a piece of brass with round holes, say 1/9 or 1/10 in. in diameter, sliding in a groove, giving different obliquities, or they may be arranged around and gradually approaching the axis of a rotating wheel, or what is perhaps the simplest and best form, one hole in a piece of brass sliding up and down in front of a slot; but in any case, whatever the stop may be, it must be placed between the prism and the flint surface of the lens.

In the construction of illuminators it is of some importance that the surface by which they are connected with the slide should be as large as conveniently may be, and not of the small dimensions of many illuminators. The aperture is of course controlled by the ratio between the thickness of the slide and the semi-diameter of the lens, when, as may be assumed, the illuminator is centered. The following table shows how little the thickness of the slide

Thickness of Slide.	Aperture.	
	In Flint. ($n = 1.652$)	In Crown. ($n = 1.52$)
inches.		
0.03	1.644 N.A.	1.512 N.A.
0.04	1.637	1.507
0.05	1.629	1.499
0.06	1.620	1.490
0.07	1.609	1.480
0.08	1.596	1.469
0.09	1.582	1.456

operates in the present case in consequence of the semi-diameter of the lens being 0.3 in., representing therefore a condenser 6/10 of an inch in diameter.

It will be seen that by doubling the thickness of the slide we have lost only one-half per cent. of aperture, and even when trebled the loss is less than 4 per cent.

As I said above, the aperture of the illuminator is only limited by the refractive index of the flint glass used. If it is desired to have a larger aperture than 1.644 N.A., it can be obtained by using a flint glass of higher refractive index than 1.652. The aperture is always within half per cent. of the refractive index of the glass (on a slide of the same material 0.03 in. thick), so that if glass were used of the refractive index 1.721, the aperture of the illuminator would be 1.712 N.A., and so on to any extent with increasing densities. But when we use glass beyond about 1.65 we get into difficulties, as very dense glass is always more or less coloured, which, by quenching the more refrangible rays of the spectrum, has a tendency to diminish the effective aperture. It is, moreover, difficult to work, and involves the use of some fluid at least as refractive as itself. With flint of 1.65 we have monobromide of naphthaline to connect the lens and the slide, and the glass is practically colourless and easy to work; above all, we have an aperture which exceeds, by 8 per cent., a *balsam* angle of 180° .

To connect the ordinary crown glass with the illuminator, the homogeneous medium (oil or otherwise) used with the objective can always be employed, but with flint-glass slides a more refractive fluid, such as oil of cassia or monobromide of naphthaline, is necessary. The oil of cassia, if pure, will suffice for an aperture of say 1.62 N.A., and, in the opinion of most people, it has a less unpleasant smell, but for the full aperture of 1.644 this is insufficient, and monobromide or some equally refractive medium must be employed. Such solutions as biniodide of mercury, although inodorous, are objectionable for this purpose, from their chemical action and for other reasons.

As flint-glass slides are not at present articles of commerce, they must be specially prepared; but this is not difficult, as disks can be cut of any thickness and polished; these can be cemented with shellac into circular holes in slides of suitable material, such as vulcanite or ebony. As to the chromatic aberration of the arrangement, it is impossible to say anything definite, as in every case, it must depend on the refractive and dispersive powers of the medium in which the object is mounted; if a condenser is achromatic on an object in air, it cannot be so in balsam, any more than that which is achromatic in balsam, can be so in phosphorus. Looking merely to chromatic aberration, it may be said that if the imbedding medium has an index exceeding that of the flint glass

(1·652) its effect is to diminish, and in some cases to neutralize, the refraction at the junction of the flint- with the crown-glass lens, so that with some media it is achromatic when certain apertures— which are determinable by the stops—are employed.

This brings us to the question, whether, after all, spherical and chromatic aberrations are obnoxious in condensers as far as definition is concerned. On this point there is a conflict of opinion, but some at least of the greatest optical authorities certainly hold that, in this respect, these aberrations are and must be unobjectionable.

I may add, that the well-known property of the ellipse of accurately reflecting to one of its foci, rays diverging from the other, has induced me to experiment in that direction, and there is now on the table such a lens made for me by Mr. Anderson. The major axis of the ellipsoid, of which this is a small segment, is 12·6 in. in length and the distance between the foci 12 in. Hence it follows that its focal length is 0·3 in.

It is no doubt practically impossible to construct a *perfect* ellipsoid, but perfection of form is obviously of less importance in the case of an illuminator in which a sharp image of the illuminant is not required and a comparatively small portion of the lens is in action at one time, than it is in an instrument in which the production of a perfect image is indispensable.

That which I now produce is as far as range of aperture is concerned, absolutely identical with the cata-dioptic lens just described, and if accurately made would be free from both spherical and chromatic aberrations on any object mounted in a medium optically identical with the glass of which it is made.

I had hoped and believed that long ere this I should have been able to produce an objective constructed on the principle of the Cataoptic Immersion Illuminator described by me in January 1879, with an aperture at least as great as that of the illuminator now described; but the difficulty of effecting a *perfect* correction of the spherical aberration appears to be insurmountable. Had such an objective been made, it would not have been suitable for general use; its principal aim would have been to increase to the utmost possible extent the resolving power of the Microscope; this can only be effected by using rays of the utmost obliquity, and to this its action would necessarily have been confined. This subject is one of the greatest interest, and one must not despair of seeing still further progress in the aperture of our objectives.

SUMMARY

OF CURRENT RESEARCHES RELATING TO

ZOOLOGY AND BOTANY

(principally Invertebrata and Cryptogamia),

MICROSCOPY, &c.,

INCLUDING ORIGINAL COMMUNICATIONS FROM FELLOWS AND OTHERS.*

ZOOLOGY.

A. GENERAL, including Embryology and Histology of the Vertebrata.

Development of the Heart in Vertebrates and Invertebrates.†
 —W. Schimkewitsch's observations upon this subject show that the heart of vertebrates and invertebrates does not develop either from the somatopleure or splanchnopleure, but in a region corresponding to the dorsal mesentery of worms. The separation of the heart-cavity from the lumen of the mid-gut is only apparent in invertebrates; it is actually a remnant of the segmentation cavity in both vertebrates and invertebrates. The origin of the vertebrate heart from two separate cavities is in spite of Balfour's assertions a primitive mode of development.

Embryology of *Lacerta viridis*.‡—An earlier research of H. Strahl upon this subject has already been noticed.§ The results of additional observations mainly upon the neurenteric canal and associated structures are as follows:—After the invagination which forms the neurenteric canal the latter is found to be contained within a mass of cells, in contact above with the medullary plate and covered below by a thin layer of endoderm, which is mesodermic; in front the walls of the canal are continued on as a narrow cord without a lumen, which is accompanied moreover by no endoderm layer; in a later stage the canal acquires its internal opening behind, which in this and all subsequent stages is covered by a definite layer of endoderm; anteriorly the canal appears to rest directly upon the yolk; it is not covered by endoderm, but appears to be accompanied by a band of endoderm in

* The Society are not intended to be denoted by the editorial "we," and they do not hold themselves responsible for the views of the authors of the papers noted, or for any claim to novelty or otherwise made by them. The object of this part of the Journal is to present a summary of the papers *as actually published*, and to describe and illustrate Instruments, Apparatus, &c., which are either new or have not been previously described in this country.

† Zool. Anzeig., viii. (1885) pp. 37-40 (4 figs.).

‡ Abh. Senck. Naturf. Gesell., xiii. (1884) pp. 409-71 (5 pls.).

§ See this Journal, iv. (1884) p. 361.

which it is partially imbedded; in the next stage certain of the cells forming the upper wall of the neurenteric canal become aggregated together and form the chorda layer; the median cell process into which the walls of the neurenteric canal are prolonged in front gives off a row of cells which are free anteriorly but posteriorly connected with the canal walls; immediately in front of the lower aperture of the canal the median cell process becomes greatly widened, further forward it becomes narrower; posteriorly this layer of cells passes, gradually narrowing without any break, into the chorda layer. The mesoderm appears as a plate on either side near the chorda layer, and anteriorly is in contact with it, posteriorly it diverges from the middle line and is not in contact with the chorda layer; in a later stage the chorda has become formed throughout the whole embryonal layer; anteriorly it appears as a thickening of the endoderm without coming into contact with the free-lying plate of mesoderm which is placed between the endoderm and ectoderm; further back the chorda is attached laterally to the mesoderm while the endoderm lies beneath it and gets farther and farther separated from it.

In the concluding section of the paper the author discusses a number of points which arise out of the facts detailed, and criticises Hertwig's views on the chorda and the formation of the mesoderm as well as the observations of Kupffer and Weldon.

Spindle-shaped Bodies in the Yolk of Young Ova of Frogs.*—O. Hertwig, after a reference to the discoveries by Fol, Schäfer, and Balbiani, of nuclei in the ova of various animals, describes those which he himself has detected in the yolk of frogs' eggs. The spindles are peculiar in form; thickest in the middle. They pass out into long, thin, and fine points; they are never quite straight, and are ordinarily coiled in an S-shape. When present, they are always but few in number, three are rare, two are sometimes and one generally found. All possible intermediate stages may be seen between these and others which are much smaller; the latter are sometimes found in company with the former, or alone, when a larger number is always present.

The spindle-shaped bodies were always absent from very small ova; but in their place it was observed that several oval or spherical bodies were found lying near the germinal vesicle; they consist of a hyaline substance, which gives, with osmic acid, much the same reactions as the germinal spots and the spindle-shaped bodies. While the above description applies to what is seen in the ova of *Rana temporaria*, a general though not exact agreement obtains in the case of *R. esculenta*. The author is of opinion that further investigations are required before we can certainly say whether the structures he describes are true nuclei, or peculiar concretions.

Development of the Rays of Osseous Fishes.†—The main conclusion at which J. A. Ryder arrives is, that it is the mesoblast which is involved in giving origin to the fibrous embryonic rays, and

* Morphol. Jahrb., x. (1884) pp. 337-43 (1 pl.).

† Amer. Natural., xix. (1885) pp. 200-4 (5 figs.).

that that layer also effects their transformation into the rudiments of the permanent rays, and not the epiderm or embryonic integument, as heretofore generally held by anatomists. The whole history of the fin-folds, in fact, favours such a conclusion, since the horny fibres develop between the corium and epidermis or embryonic skin, in the plane of the *protomorphic* line of Huxley. The fin-folds of embryo fishes, it should be borne in mind also, are at first wholly epidermic, the corium or true skin being only developed during the later-larval or post-larval life.

Origin of the Hypoblast in Pelagic Teleostean Ova.*—G. Brook, on comparing notes with Dr. Whitman, finds that his conclusions are completely at variance with those of that naturalist, and gives therefore a detailed account of his own observations with careful drawings. An inspection of these is needed for a complete comprehension of the paper.

Regulation of the Proportion of the Sexes in Man, Animals, and Plants †—In the further elaborate essay of K. Düsing he starts from the fact that in animals, as in man, male and female individuals always and everywhere stand to one another in quite definite numerical relations; in *Homo sapiens* the proportion is about 106 boys to 100 girls; the former, however, are more frequently born dead, and a larger number die in childhood. The consequence of this is that, at the period of greatest reproductive activity the number of each sex is about equal. Nearly similar results obtain with domesticated animals. Nor is the constancy confined to animals, for Heyer has shown that a definite relation of the sexes obtains in the dioecious plant *Mercurialis annua*.

It is, however, well known that with small numbers very different results to those just enunciated are obtained; in other words, there is often a divergence from the norm. How is this corrected? Düsing answers that an excess of one sex brings about a larger number of births of the other. The author then discusses the statistics of births, and especially of births after wars, an account of which has already been given.‡

If Düsing's doctrine that nutriment has influence on the sex be correct, it is clear that animals with similar nutrition must be generally of the same sex; and this is true, we know, of twins and double abortions.

The author next investigates the effects of dissimilar nutritions, and commences with a study of human statistics. With bad nourishment a boy, with good a girl is developed; in the country there are more boys born than in towns, for the townspeople are, on the whole, better nourished. Parents in good condition have fewer boys than the poor. The age of the mother is also of importance; young females feed better than old, and have more girls. Where bodily exercise is considerable, as among the inhabitants of young countries,

* Quart. Journ. Micr. Sci., xxv. (1885) pp. 29-37 (1 pl.).

† Jenaisch. Zeitschr. f. Naturwiss., xvii. (1884) pp. 593-940.

‡ See this Journal, iv. (1884) p. 708.

such as North America and Australia, there is a preponderance of male births.

These principles may be applied to thelytoky which is caused and conditioned by an over supply of females, to arrenotoky, where one female is fertilized, and to asexual generation whether by fission, gemmation, or pædogenesis. The same rules will apply to plants.

It is a great advantage to be hermaphrodite as long as possible, as the tendency towards one sex can be altered at a comparatively late period in embryonic life; as we know, the embryos of nearly all animals are at first hermaphrodite.

Causes of Sex.*—J. Schlechter has investigated the reproduction of horses; dealing with 2064 births, and examining first of all the influence of the absolute and relative ages of father and mother, he finds that the proportion of female to male births was as 100 to 91·3; where the sire and dam were of the same age and between four and twelve years of age more females were born, but when they were between twelve and sixteen a considerably larger number of males. When the sire was older than the dam a larger number of males were born where the difference was slight, and a larger number of females when the difference was more extensive. When the dam was the older a larger number of fillies was produced.

The second problem is that of the influence of the first and of later copulations on the resulting sex; fillies were to young horses as 100 to 90·2 where the dams were covered for the first time; and the proportion was exactly the same where the dams had already been mothers. The time of year has this importance, that females are produced to males in the proportion of 100 to 90·2 in the cold months of the year, and as 100 to 89·5 in the warmer months. More males seem to be produced when the virile activity is at its highest point; males are on the average eight-tenths of a day longer during the gestation period. The first-born are rather more frequently males.

H. Berner † demonstrates that the hypothesis of Hofacker and Sadler, which explains the excess of boys born in Europe to the fact that the husband is ordinarily older than the wife is untenable. The author's results are based on the Norwegian statistics of population for 1871–5; there were 213,224 births, 109,431 of which were boys, or a proportion of 105·43 boys to 100 girls. Where the parents were of the same age, the proportion of boys to girls was as 106·23 to 100; when the father was one to ten years older, as 104·61 to 100; where he was more than ten years older, as 103·54 to 100; where the mother was one to ten years older than the father, as 107·45 to 100; where she was more than ten years older, as 104·10 to 100. On the whole, then, the results are just contrary to what we should expect from Hofacker and Sadler's hypothesis. Berner approves of the doctrine of Richarz that, if the mother is specially fertile, a boy, that is, the higher and more complete developmental form of the genus *Homo* is

* Rev. f. Thierheilkunde, 1884, Nos. 7 and 8. Cf. Biol. Centralbl., iv. (1884) pp. 627–9.

† Svo, Christiania, 1883, 70 pp. Biol. Centralbl., iv. (1884) pp. 461–5.

produced; while when the mother is weakly or less adapted for procreation the result is a girl. In the former case the mother's influence is predominant, in the latter she is more indifferent than the male; or, in other words (and, indeed, in the terms of a very widely distributed belief) the peculiarities of the mother pass as a rule to the son, and those of the father to the daughter. The predominant importance of the mother is to be explained by the facts that unfertilized eggs may become developed into viable organisms (parthenogenesis of insects), that ovarian dermoid cysts are due to a real though an incomplete development of the ovum, and that the spermatozoon lives for a shorter period than an ovum. The reviewer suggests that the cause of a larger number of males being produced after a war is not, as the author thinks, due to the increased social advantages dependent on less rivalry and to an increased activity, but to the enfeeblement of the males and to the quiet life led by females during the period of war. Polygamous marriages, one result of which is that females do not have children more than once in two or three years, have for another a great preponderance of male births, and so prove the influence of the mother on the birth of sons; prosperous years are also favourable for the production of males. The hypothesis of Richarz is supported by the facts that from unfertilized eggs among insects only males arise [but this, which is true of *Apis*, is not true of *Apus*, where we have thelytoky in the latter as well marked as arrhenotoky in the former case; and obviously parthenogenetic crustaceans, as well as insects, ought to be taken into consideration]; among hybrids—when the ovum is under its normal physiological conditions, but the semen under more or less abnormal—males are most common, and more resemble the mother. The experiment of Fiquet, a farmer in Texas, who was able to determine the sex of the progeny by different modes of feeding the mother, is referred to. On the other hand, madness seems most often to pass from father to son, and from mother to daughter; the proportion being 53·3 to 46·6 per cent.

New Law of Variation.*—W. K. Brooks quotes and approves Dr. Dusing's papers on the laws which regulate sex, and his statement that a favourable environment causes an increase in the number of births of female children, while an unfavourable environment causes an increase in the number of male births.

Mr. Brooks believes that this is only part of a still wider generalization, and quotes facts to show that the male cell causes variation, while the ovum transmits the hereditary characteristics of the species. The union of two sexual elements has been evolved for the purpose of securing variability, and the male element has gradually acquired, by division of labour, the peculiar function of exciting variability to meet changes in the condition of life. So long as the conditions of life remain favourable there is no need for variation, but whenever any unfavourable change takes place variation becomes necessary to restore the harmony between the organism and its environment. If this view be true, we have in Dusing's results an exemplification of

* Johns-Hopkins Univ. Circulars, iv. (1884) pp. 14-15.

one of the most far-reaching of all the adjustments in nature; an adaptation by means of which each organism remains unchanged so long as no change is needed, while it begins to vary whenever variation and race modification are called for.

Crossing is more advantageous under an unfavourable than under a favourable environment, because it gives variability, and variation is not advantageous when everything else is favourable, while it is advantageous when other things are unfavourable.

Cell-division.*—C. Rabl's long essay on this subject is divided into two portions; the first part deals with the cell in repose and during division, while the second will treat of some important histological problems. The author puts in the forefront an account of his methods; he has made use of the compound of chromic, osmic, and acetic acids, which has been so strongly recommended by Flemming, as well as of chromic acid simply, picric acid, and $1/3$ – $1/2$ per cent. solutions of chloride of gold; Retzius' formic acid has also been used. The objection to the use of Flemming's mixture is that the preparations easily darken; to chloride of gold, that in the summer, even when light is excluded, reduction takes place and the cell-substance is coloured violet; picric and formic have no advantages over chromic acid. The best results were obtained by a mixture of chromic and formic acids, and by a solution of platinum chloride. The former is prepared by adding to 200 grammes of a $1/3$ per cent. solution of chromic acid four or five drops of concentrated formic. The fluid must be freshly prepared before using. The objects are cut into small pieces, and after 12–24 hours well washed in water, then slowly hardened in alcohol, being placed first in alcohol of 60–70 per cent., and only after 24–36 hours being placed in absolute alcohol. Platinum chloride has the same advantages as chloride of gold, and has not the disadvantage of being reduced. In the chromo-formic solution the chromatin filaments swell up somewhat, so that the longitudinal cleavage of the filaments of the coil and the first stage of the mother-star are generally delayed. In platinum chloride the filaments shrink somewhat, and longitudinal cleavage is effected with extraordinary rapidity. It is clear, then, that the two methods compensate one another.

For the purposes of staining very intense blue is to be avoided, as the filaments and loops cannot be followed along the whole of their course; Grenacher's hæmatoxylin and saffranin have been almost exclusively used by Rabl. The hæmatoxylin must have stood for at least two months, and the solution must be very dilute. The best method is to use the hæmatoxylin and saffranin successively, for if they are mixed a precipitate is formed. Zeiss's $1/18$ homogeneous immersion and Abbe's illuminating apparatus were used in making the observations; green light was preferred; the slide used is explained with the aid of a diagram; the figures were drawn with the aid of a Nacet camera, and the drawings are stated to correspond exactly to the preparations; diagrammatic effects have been carefully

* Morphol. Jahrb., x. (1884) pp. 214–330 (6 pls.).

avoided, and every loop and filament shown in its exact arrangement, length, and form.

An account of the quantity of literature that has accumulated around the discussion of this subject is next given, and this is followed by a statement of the present condition of our knowledge of cell-division, of which the following are the more important points.

Indirect or karyokinetic cell-division is accompanied by a metamorphosis of the cell-nucleus, which consists in the formation of a figure—nuclear figure—composed of filaments; there is an achromatic figure, or nuclear spindle, and a chromatic figure. The former is composed of the substances of the nucleus (Flemming), or rather of the cell-body (Strasburger), which are not stained by the specific nuclear colouring matters, and forms a bundle of, ordinarily, spindle-shaped form, which connects the two fissive poles of the cell; from the ends of the spindle rays pass out into the cell-substance. The latter is formed of the colourable substance of the nucleus, and, during division, undergoes a regular series of formations. At first the whole chromatic substance is found in a filament which traverses and forms close irregular coils in the nucleus. As the filaments become gradually shorter and thicker, the loops get less numerous, and the filaments then break into segments; all these various formations are comprised under the name of the coil-form of the mother-nucleus. The filamentar segments now aggregate towards the equator of the nucleus, and around the middle of the achromatic filamentar bundle, and they become looped in such a way that the figure is stellate. This is succeeded by the equatorial-plate stage, which is caused by the sister halves of every loop, or those formed by longitudinal cleavage, separating from one another and passing to either pole. The two halves of the chromatic figure again take on a stellate form, and we have the daughter-stars of Flemming. The latter author has given the following scheme of the chief phases of nuclear division:

<i>Mother-nucleus.</i>	<i>Daughter-nucleus.</i>
1. Coil-form (Spirem).	5. Coil-form (Dispirem).
↓ 2. Star-form (Aster).	↑ 4. Star-form (Dyaster).
→ 3. Phase of change (Metakinesis).	

In the above account Rabl has chiefly followed Flemming.

Rabl's own observations on these different phases are then described and discussed in very great detail; and the resting stage is next considered.

The study of the structure and vital phenomena of the cells shows us better than anything else the defective condition of our knowledge; we find in the nucleus and in the cells special structures, and we do not know what they are for; in division we see most remarkable figures appear, and we are ignorant of their significance; indeed, we are not yet in a condition to give a definite answer to the question what is the cell-nucleus. Yet everything shows that some great law lies at the bottom of the phenomena which go on in that small structure that we call a cell; very much the same kind of process is observable not only in animal and vegetable cells, but in

those lower organisms of which we cannot certainly say whether they are animals or plants. We are fain to conclude that in the resting cells also there is a typical agreement in structure. Yet the differences are such as to forbid us from bringing all the phenomena under one head. It is, nevertheless, worth while to try and reduce all the various forms of nuclei to a common scheme.

It is certainly not due to chance that young daughter-coils are so extraordinarily like the first coils of the mother-nucleus; as soon as a nucleus begins to divide a polar and antipolar side become apparent, and on the polar side there is a definite polar area; the several regions are characterized by the course of the filaments, which extend from the antipolar side to the polar and into the polar area; here they loop round and return to the antipolar side; the daughter-coils differ only from the young mother-coils in having the filaments thicker and less looped. This typical agreement is found in vegetable as well as in animal cells. It is not conceivable that in the resting stages these filaments disappear altogether; after the formation of the nuclear network some remain, and have essentially the same course as in the coils; from these "primary filaments" fine secondary lateral processes are given off, and from these again, probably, tertiary filaments, and so on. The several filaments may either unite with one another, and at the nodal portions of the resulting network may collect to form nucleolar structures. If these chromatin-masses become more independent as compared with the nuclear plexus, they may give rise to true nucleoli.

If we allow this hypothesis we shall be the better able to understand the phenomena of cell-division; it is only necessary to suppose that, at the commencement of an act of division, the chromatic substance streams along paths already formed into the primary nuclear filaments. In this simple manner the mother-coil is formed. The angle which the primary filaments form on the polar area has been shown to be constant during the whole process of division, and to pass directly into the angle formed by the filaments of the daughter-coil. When this last settles down to rest, the filaments throw out lateral buds, which again send out processes; along these buds and processes the chromatic substance is more regularly distributed through the whole of the nucleus. The division of the chromatic substance of the nucleus is therefore ultimately due to a longitudinal cleavage of the filaments, and Rabl thinks that if his hypothesis be correct we cannot conceive of a more simple mode of nuclear division than that which we do in fact observe. This view is not affected by the supposition that the nuclear filaments consist of a single substance, or by that of Strasburger, who thinks that there are hypoplasmatic cords and interposed chromatic microsomes.

The author points out that his view is supported by the well-known fact that both the coarser filaments of the network, as well as the nucleoli have an excentric position, and that there is never a regular concentric or even radially concentric arrangement of the chromatic substance in the nucleus. It is clear that very various forms of nuclei must arise from differences in the development or retrogres-

sion of the primary nuclear filaments, and according to the kind of union that they or their outgrowths make; in other words, there is a great variety in the possible structural relations of the resting nucleus; it is quite conceivable, although it has not yet been shown, that definite form-stages of the nuclear network always correspond to definite functional stages of the nucleus. And it further appears quite possible, and, indeed, probable, that if in a resting nucleus we can observe only sharply separated chromatin-masses, but no chromatic nuclear plexus, the remains of the primitive filaments have become retrograded into delicate hypoplasmatic cords.

In these general considerations Rabl has left out of view the nuclear spindle, inasmuch as we do not yet know what it signifies, but it is probably the expression of streaming movements, the poles being centres of attraction.

Formation of Red and White Blood-corpusesles.*—M. Löwit finds that the red blood-corpusesles are developed from formative cells which are free from hæmoglobin, and become impregnated with it during the course of their development. They increase by indirect nuclear- or cell-division, and are to be found abundantly in the spleen of *Triton* in the spring; in the circulating blood of these animals some formative cells are to be found in various stages of indirect nucleus-division; the great number present in the spleen makes it probable that that organ is the chief, though not the sole seat of their origin.

Among the Mammalia the liver is more important than the spleen; in later stages of development, when the osseous medulla is developed, it appears to be the most important point of origin of the red blood-corpusesles. The nucleated red blood-corpusesles of the embryo are converted into non-nucleated by the gradual disappearance of the nucleus of the cell. The nucleated red blood-cells of adult animals agree in structure with similar elements in the embryo; they are most common in the osseous medulla, though found scattered in the spleen and lymphatic glands.

White blood-corpusesles are to be found in abundance in the spleen of *Triton*; in mammalian embryos the liver contains a large number of them, and in later stages they are numerous in the thymus, the spleen, the lymphatic glands, and the osseous medulla. They are sharply distinguished from the red cells by their structure; no intermediate stages between them can be demonstrated, and the structure is so different as to make it impossible for us to think that one could be converted into the other. The white cells exhibit direct cell-division only. The differences in the sizes of white blood-cells may be regarded as the expression of a continuous development. In some cases we observe polymorphic nuclei, which are probably due to degenerative division, which may possibly lead to a complete karyokinesis. The term polynuclear white blood-cells should be reserved for those forms in which two or more nuclei are to be seen, or where direct division can be observed. The author concludes with some reflections as to the bearing of his observations on leukæmia.

* SB. Akad. Wiss. Wien, lxxxviii. (1884) pp. 356-401 (2 pls.).

Unicellular Glands in the Cloaca of Rays.*—J. H. List records the presence of goblet cells conspicuous by their size among the epithelial cells of the cloaca in *Torpedo marmorata* and *Raja miraletus*; they occur even in the deepest layers, and are independent formations serving as unicellular glands.

Intercellular Spaces and Bridges in Epithelium.†—P. Mitrophanow, from a study of the integument in *Axolotl* and *Triton*, both in the embryonic and adult stages, and from other investigations, concludes that the cells of the deeper epithelial layers are connected with one another by bridges which are shown by development to arise from the protoplasm of growing cells. These bridges consist of a living protoplasm since they are parts of the substance of the cell; they are capable of elongation during the widening of the intercellular spaces under the pressure of a quantity of fluid, and they are also able to shorten; when the latter happens the cells may come to touch one another, and the lacunæ disappear altogether. The intercellular spaces form a complicated network of intercommunicating canals which stand in direct relation to the lymphatic vessels; they are during life more or less filled with lymph, which, in special circumstances, separates the epithelial cells from one another and gives abnormal dimensions to the spaces. The existence of these lacunæ explains the presence of the so-called wandering cells in the epithelium, the passage of pigment-cells, and the mode of entrance and termination of the nerves in the epithelium. And, further, they are of importance for their bearing on the theory of the uninterrupted structure of the animal organism.

Size of the Surfaces of Organs of Flight.‡—This forms the subject of a series of elaborate measurements by K. Müllenhoff. After giving an account of earlier investigations, beginning with those of De Lucy in 1865, he gives his own tabular statement of the results derived from measurements, &c., of the relations between body-weight and wing-surface, with a full account of the methods employed, and a classification of flying creatures (birds, insects, and others) according to the size of their organs of flight, and some calculations respecting rapidity of wing-strokes.

Phylogenetic Classification of Animals.§—W. A. Herdman has published a phylogenetic classification of animals for the use of students, in which considerable attention is directed to those hypothetical ancestral forms which are rarely mentioned in text-books. We note that Prof. Herdman still retains the group Mesozoa, and looks on them as being degenerated descendants of *Gastræa*; the Ctenophora are regarded as leaving the hydroid stock at the same point as the Gymnoblasteria and Hydrocorallina. The Crinoidea stand at the apex of the Echinoderm phylum, which starts from the prime axis above the Platyelmia together with the chordate stock

* Zool. Anzeig., viii. (1885) pp. 50-51.

† Zeitschr. f. Wiss. Zool., xii. (1884) pp. 302-9 (4 figs.).

‡ Pflüger's Arch. f. d. Gesammt. Physiol., xxxv. (1884) pp. 407-53.

§ Herdman, W. A., 'A Phylogenetic Classification of Animals,' iv. and 76 pp. (20 figs and 1 table), 8vo, London and Liverpool, 1885.

which first branches off, and with that of the Enteropneusta which is intermediate in position. The Tracheata and Crustacea are regarded as independent phyla, *Limulus* being placed with the former. The author is careful to recognize degradation as well as ascent. His work will be very useful to those for whom it is intended, and "along with a good text-book or as a supplement to a course of lectures on zoology."

B. INVERTEBRATA.

Chitin as a Constituent of the Cartilages of *Limulus* and *Sepia*.*
—W. D. Halliburton has submitted to chemical analysis the cartilages occurring in the head of *Sepia* and the entosternite of *Limulus*.

The basis of the cartilage is a chondrin-like body, which gives the reactions of mucin and gelatin. But the gelatinous element is exceedingly small, and no gelatinization occurs on the cooling of the hot water extract. The cartilage differs, however, from that of Vertebrates in containing a small percentage of chitin; in the case of the entosternite of *Limulus* 1.01 per cent. and of *Sepia* 1.22 per cent. He has also demonstrated that chitin exists in the liver of *Limulus*, though whether in the connective tissue or in the liver-cells themselves is undetermined. The method of analysis is fully described.

These results are especially interesting as showing that chitin is not confined to the epiblast, for in three instances it has been shown to occur in mesoblastic structures.

Mollusca.

Eye of Gastropoda.†—C. Hilger, finding that his predecessors in the investigation of the eyes of Gastropods, have examined a few species only, has studied those of a considerable number of species. He points out that two kinds of optic organs have come under his consideration.

In the first the eye remains in a somewhat embryonic condition, and forms but a slight invagination of the epithelium of the body; such are found in the lowest Prosobranchiata, the Cyclobranchiata and the Aspidobranchiata; *Margarita*, *Fissurella*, *Haliotis*, *Patella*, and *Trochus* may be cited as examples. In the second series the eye forms a completely closed capsule, which is invested by connective tissue; it is seen in *Conus*, *Cypræa*, *Fusus*, *Nassa*, *Murex*, and others.

In the simpler type the eye has the form of a cup- or bell-shaped invagination of the epithelium of the body; in most cases the cuticle seems to form an extremely thin lamella over the anterior part of the vitreous body; the invagination is lined by the retina which, anteriorly, passes directly into the epithelium of the body, and is invested externally by the outspread optic nerve. In *Haliotis* and *Trochus* the cavity is filled by a delicate gelatinous substance, and in *Patella* and *Nacella* by a finely granulated mass.

In the more advanced type, the larger and hinder part of the cor-

* Quart. Journ. Micr. Sci., xxv. (1885) pp. 173-81.

† Morphol. Jahrb., x. (1884) pp. 351-71 (2 pls.).

puscle is formed by the retina and the outspread optic nerve, while it is closed anteriorly by the inner cell-layer of the *pellucida*. Within there is either a lens or vitreous body or both; the eye is completely invested by the connective tissue of the tentacle or ommatophor.

The retina is formed of a number of similarly constituted groups of cells; each rod-cell is surrounded by a number of pigment-cells; as the former are thicker behind and the latter thinner, it follows that the pigment-cell of one rod-cell must pass between the neighbouring rod-cells. The rods have the form of many-sided prisms the anterior end of which, or that which is turned towards the lens or the vitreous body, is slightly convex. In the centre of each rod is an axial portion, but the author was not able to make out the central canal described by Hensen. The axis of the rod appears to be the direct continuation of the anterior part of the rod-cell.

The lens is always completely structureless in the adult, and no indications of any concentric layers were to be made out; in the embryo, on the other hand, there are both concentric and radial striations. Its substance is somewhat firm and elastic, and it becomes rather hard after treatment with reagents. The vitreous body is completely homogeneous and transparent. Although Hilger could find no refractive apparatus in the eye of cyclobranchs, he doubts whether it does not really there exist, and supposes that it is lost on treatment; a supposition which is reasonable enough, when one recollects the open cup-shaped form of the eye.

In a note to the above paper O. Bütschli* refers to the lately published essay by Grenacher† on the retina of Cephalopods, and points out the important resemblance in structure: both contain two kinds of cells, one with pigment, the other—Hilger's rod-cells—without pigment. He takes the opportunity of expressing the difficulty which he feels in accepting the doctrine that the so-called compound eyes of Arthropods owe their origin to the fusion of a number of small simple eyes; he inclines to the view of Lankester and Bourne that compound eyes have arisen by the differentiation of a common retina, and thinks that the distinct grouping of the retinal elements in the eye of the Gastropoda affords a support to this view. The eyes of Phyllopodods have compound retinae and undivided corneae, and though Copepodods have a single retinula, it is to be remembered that they are degenerated forms, whereas the Phyllopododa belong to the oldest group of Arthropods.

Epipodium of Gastropoda.‡—H. de Lacaze-Duthiers, referring to the criticisms of his account of the nervous system which have been somewhat recently made by Dr. Spengel, states that M. Wegmann has, under his direction, gone afresh into the subject, and confirmed the accuracy of his descriptions. After dealing with the question at some length he concludes by reminding his readers that, often as malacologists have stated that the auditory vesicles are connected

* Tom. cit., pp. 372-5.

† See this Journal, *ante*, p. 41.

‡ Comptes Rendus, c. (1885) pp. 320-5.

with the pedal ganglia, careful research has never failed to show that the auditory nerve can be followed to the cerebral ganglia; in the same way, whatever be the form of the mantle or the foot, whether they fuse or not, it is always possible to discriminate between them by means of the nerves which are distributed to them. "Sections only show what they inclose, and the explanations of them, which are sometimes based on deceptive phenomena, cannot invalidate the fixed and precise laws of morphology."

Eyes of Chitonidæ.*—H. N. Moseley makes some important additions to his earlier preliminary notice on the eyes of Chitons.† He finds that the best method of getting sections is to decalcify the shells rapidly with nitric acid, after hardening in strong alcohol. He applies the term of "megalæsthetes" to the papilliform bodies of Van Beneden; the smaller bodies found in the micropores are called micræsthetes; they are small and knob-like, exactly of the structure of the knobs of the macræsthetes. He does not, with Van Beneden, regard these organs of touch as homologous with the spines of the girdle, or rather with the funicles by which these spines are supported, but as having a quite peculiar and distinct structure. As eyes are absent from the Solenogastres he suggests that the æsthetes are "organs developed originally in connection with the shells in the Chitonidæ, still little differentiated in *Chitonellus*." As a comparatively late modification some of the megalæsthetes have in certain genera been converted into eyes. As these genera are mostly inhabitants of non-European seas it is difficult to get satisfactorily prepared specimens. The Sicilian *C. rubicundus* might yield results of value.

Nervous System and Embryonic Forms of *Gadinia garnotii*.‡—H. de Lacaze-Duthiers describes the head of *Gadinia* as very extensile and contractile, so that it and the lingual bulb suffer great changes in position; the œsophageal collar is proportionately large, and the ganglia which compose it very distinct; of these there are three pairs, the first of which is dorsal and subœsophageal or cephalic, the second which is abdominal or pedal, and the third sub-buccal or stomatogastric; these three pairs united by commissures and connectives form two collars; and in addition there is a third, formed of an unequal number of ganglia, and consequently asymmetrical. These ganglia, united transversely by a commissure which passes in front of the œsophagus, form what the author has long since called the asymmetrical centre; it innervates the reproductive, respiratory, and circulatory organs, as well as the mantle, or, in other words, all the organs that are asymmetrical. Something analogous is to be seen in the pulmonate Gastropoda, where, however, the asymmetrical centre is formed of five ganglia. The auditory nerve is very long and delicate, and excessively difficult to follow out; like that of all gastropods it arises from the brain and not from the pedal ganglion. The

* Quart. Journ. Micr. Sci., xxv. (1883) pp. 37-60 (3 pls.).

† See this Journal, iv. (1884) p. 728.

‡ Comptes Rendus, c. (1885) pp. 146-51.

cephalic lobes are very richly supplied with nerves, they correspond morphologically to the tentacles and to a large part of the head, and they would seem to have the same functions. The olfactory organ is to be found on the upper wall of the duct leading from the respiratory cavity to the exterior orifice which is placed on the edge of the mantle.

The genital gland is completely hermaphrodite, the same culs-de-sac producing ova and spermatozoa; at some distance from it its duct becomes very tortuous and glandular, and secretes a viscous substance. The efferent canal opens into the penis, while below there is the delicate and long neck of the copulatory vesicle which always contains a small central mass of brown material. The vaginal portion opens below the right eye, not far from the point of attachment of the mantle; the male canal opens above the right eye.

During development trochosphere and veliger stages are evident; particular attention is directed to the fact that the primitive form of the shell is not at all patelloid, as is the case with *Ancylus fluviatilis*; the patelloid appearance is only secondarily acquired, and even then the primitive whorls are still to be seen on careful examination. Various criticisms of facts stated by Mr. Dall are scattered through the paper.

Uropneustic Apparatus of Helicinæ.*—H. von Ihering is of opinion that the uropneustic apparatus is simple in the lowest forms of the Nephropneusta, and that it is only within the limits of the order that the differentiation into a respiratory portion (lung) and a renal-efferent (ureter) has been effected. If this be true it is very highly probable that the lungs of this division do not represent a modified branchial cavity but a portion of the renal-efferent apparatus. The absence of connecting forms forbids us from absolutely demonstrating this, but all the facts of comparative morphology point to it. It will be remembered that the author first enunciated these views in 1876, and though his own investigations have led him to believe in them more fully they have not yet met with general acceptance.

Habits of the Limpet.†—J. R. Davis details observations made on the feeding and sense of locality of *Patella vulgata*.

By far the larger number of limpets live upon rocks whose only covering consists of minute green algæ and nullipores, with numerous acorn barnacles: those of the latter immediately surrounding a limpet are invariably kept free from algæ by them. The limpet moves steadily on pretty much in a straight line, and continually sweeps its elongated snout from side to side, feeling probably for suitable patches. Those limpets which live near large seaweeds, such as *Fucus*, feed extensively upon them. They do not feed when covered by water, but always settle down firmly before the tide rises.

It was proved by marking individuals and their scars that every limpet has its fixed home to which it returns before the rising tide reaches it. The greatest distance at which a marked limpet was

* Zeitschr. f. Wiss. Zool., xli. (1884) pp. 257-83 (1 pl.).

† Nature, xxxi. (1885) pp. 200-1.

found was three feet; yet though extremely rough, this was re-traversed without difficulty. By what faculty the limpet finds its way back is not yet determined. Eyesight is out of the question owing to the insufficient development of the eye. In two cases where the tentacles were removed one found its way back speedily, and the other several days after the operation. To destroy any possibility of scenting out the track traversed, it was repeatedly washed with sea-water; but the individual found its way back. The author thinks that the snout plays some part in helping the limpet to get home, and that the object of this habit is to avoid being washed off the rocks by the tide, they being able to hold on best when fixed to their scars.

Gill in *Neptunea*.*—H. L. Osborn describes briefly the development of *Neptunea* with more special reference to the formation of the gill.

The head, foot, and vela arise as ectodermal thickenings upon one end of the oval egg; and soon upon one side, thereby designated as dorsal and opposite to the foot, the shell-gland appears. This, at first a small ring, increases in size and its rim spreads over the yolk at the end opposite the head, vela, and foot until it has covered half the egg, but the area immediately around the head, vela, and foot is still unencroached upon. This area is in part the region of the future mantle, and just in front of the margin of the shell-area it forms a thickened ridge. This mantle area is now broadly convex as though greatly bulged out upon the dorsal surface of the body. Upon its surface there appears a row of finger-like processes, these being mere folds or thickenings of the surface which form an interrupted ridge running antero-posteriorly upon the dorsal surface of the body. Later this dorsal surface begins to roll inward by an involution which begins near the head, and the mantle cavity is thus formed with the gill, which has been carried along during the involution, lying upon its roof. The formation of a gasteropod gill is here reduced to its simplest terms, namely, a series of dilatations upon the outer surface of the body. This mode of formation is entirely opposed to the conjecture of Spengel that the prosobranch gill is as a *ctenidium* which has secondarily become fused with the wall of the mantle cavity.

The Genus *Melibe*.†—R. Bergh has an essay on this genus, the representative of an aberrant group of the family of the *Æolidiæ*, which, like *Tethys*, have undergone retrograde metamorphosis. From *Tethys* it is distinguished by the absence of special gills from the base of the papillæ and by its much less developed foot, while its pharynx is still provided with the mandibles which are wanting in the *Tethyidæ*. Nine species have been described. The author selects for special study *M. papillosa* (de Filippi) from the Japanese seas, of which he has had three specimens.

Development of the Oyster.‡—P. P. C. Hoek, after a full account of previous work upon the subject, details some new facts respecting the development of the oyster.

* Johns-Hopkins Univ. Circulars, iv. (1884) p. 16.

† Zeitschr. f. Wiss. Zool.; xli. (1884) pp. 142-54 (1 pl.).

‡ Tijds. Nederl. Dierk. Ver. Supplement Deel i. (1883-4) pp. 257-317 (1 pl.).

It appears that the shell-gland is not formed by a mere thickening of the epiblast, but is an actual invagination as in other lamellibranchs and gasteropods; subsequently it becomes a simple thickening of epiblast and secretes a delicate chitinous membrane—the first trace of a shell; the two valves are not formed independently as was stated by Lacaze-Duthiers; thus the shell appears to originate in all Mollusca after the same fashion, and accordingly v. Ihering's idea that the Mollusca are diphylic must be received with great distrust. The embryo next acquires a preoral circle of cilia in the middle of which is a thickening of epiblast, the cephalic disk, which gives rise to the cerebral ganglia. In older larvæ the adductor muscle occupies a place which shows it to correspond to the anterior adductor of the Dimyaria, while in the adult the single adductor is the homologue of the *posterior* adductor. The branchiæ are developed as single filaments united only at their bases—an argument in favour of regarding filamentous branchiæ as a more ancient condition than the lamellar branchiæ of adult bivalves. Dr. Hoek made a number of very careful experiments (by means of an apparatus figured in the text) to determine how the young fix themselves; his results are not positive but he inclines to the belief that there is a small byssus present.

Byssogenous Glands and Aquiferous Pores in Lamellibranchs.*

—T. Barrois points out that, in the present state of our knowledge, it is generally admitted that the byssus is the secretion of special glands (glandula byssipara); he is now able to demonstrate that, with rare exceptions, all lamellibranchs exhibit more or less well-marked traces of this byssogenous apparatus.

Taking *Cardium edule* as our type, we there find the organ consisting of a groove, placed on the lower surface of the foot, of glands at the sides of the groove, of a canal which extends from it to the more or less spacious cavity of the byssus, and of compact masses of byssogenous glands which pass the products of their secretion into the cavity. This last, as well as the canal and the groove, is lined by a cylindrical epithelium. In *C. edule* the byssus is formed by a simple hyaline filament.

In more developed types (*Mytilus*, *Pinna*, &c.) the glands are much denser, and the anterior extremity of the foot is prolonged to form the linguiform muscle; the lamellæ of the cavity of the byssus are more numerous, and the filaments form a tuft. In *Anomia* differentiation is carried much further, for the byssus becomes charged with carbonate of lime, and forms the ossicle.

In the types where the organ undergoes retrogression, we find that there may be a very short groove, or none, and no glands (*Donax*, *Tellina*); sometimes the groove and cavity are present, but no glands (*Nucula*); sometimes only a delicate blind canal can be distinguished, formed by a simple layer of epithelial cells (*Psammobia tellina*). In *Pholas* or *Solen* there are no signs of groove, cavity, or glands.

As the author has examined more than fifty species and types of every family except the Trigoniidæ and Tridacnidæ, and has found

* Comptes Rendus, c. (1885) pp. 188-90.

the byssus apparatus almost always represented, he is inclined to regard it as a characteristic organ of the Lamellibranch type.

He has been led to think that the so-called pori aquiferi are nothing more than the orifices of degraded byssogenous glands. If water does really enter the circulatory system, Barrois is of opinion that it must do so by fine intercellular canals, or by endosmosis, or some other way, but not by the "pori aquiferi."

Nervous System of Embryos of Limacina, and the Relations of the Otocyst.*—S. Jourdain finds that in the embryos of *Limacina* the peri-oesophageal ganglionic masses differ considerably from those of the adult; the posterior post-oesophageal ganglia, which are markedly asymmetrical, are feebly developed, and widely separated from one another; the intermediate ganglia have distinct connectives, and the anterior are still connected by two commissural bands. In the adult there is a marked concrescence of all these parts. The auditory nerve arises from a small ganglionic nucleus, placed on the course of the connection which unites the intermediate mass of the post-oesophageal group of ganglia with the pedal ganglion; and the otocyst is at first provided with a stalk, which is formed by the auditory nerve. The author disagrees with the view of Lacaze-Duthiers that, whatever be the position of the otocyst, it is always innervated by the cerebroid ganglia. Jourdain does not regard the otocyst as a true auditory organ, but as an apparatus by means of which the animal becomes acquainted with the least changes in the nature of the surface to which its foot is applied, or in the water in which it moves.

Shells of Molluscs.†—In 1858 G. Rose explained the different powers of resistance observed in shells of molluscs within the same geological stratum by a theory that the parts that resisted best were composed of calcite, and the least resistant of aragonite. The external "prismatic" layer of a typical shell alone contained calcite, the "mother-of-pearl" and "porcelain" layers showing aragonite. Two axes of double refraction were seen in the "mother-of-pearl" layer, and the theory was proved by careful observations of hardness and specific weight.

Herr v. Gümbel has recently investigated the subject, and finds that the data for determining the question by specific weights are useless, because of the presence (1) of animal matter up to 1.5 per cent. in proportions varying in the different layers, and (2) of foreign and non-calcic matter. The typical shell consists (1) of an outer "honey-comb" layer, so called because calcification has taken place in vertical, hexagonal cells, largely subdivided, formed by a stout membrane; (2) of a "mother-of-pearl" layer made up of numerous parallel horizontal membranes, vertically united at intervals by connections of an organic nature with the small intervals between their parallel lamellæ filled with the calcifying substance; and (3) of an "ivory" layer

* Comptes Rendus, c. (1885) pp. 383-5.

† Zeitschr. Deutsch. Geol. Gesell., xxvi. (1884) p. 386. See Naturforscher, xviii. (1885) pp. 15-7.

(= the "porcelain" layer of Rose) made up of spindle-shaped needles of calcifying substance with a very small admixture of organic matter. The iridescence of the "mother-of-pearl" layer is due primarily to the above-mentioned fine lamellar structure, and, secondly, to the optical properties of the organic membranes. Finally, the organic membranes of all layers are in themselves biaxial.

The author was thus reduced to investigate the question of the heteromorphy of the calcification by subjecting like portions of the several layers, compared with like masses of calcite and aragonite in various modes of aggregation, to the action under atmospheric pressure of water through which for two months was passed a continuous stream of carbonic acid gas. The results proved that the state of aggregation was the measure of degradation. Compact masses were readily dissolved, whereas looser aggregations—alike of calcite, aragonite, or layers of shells—resisted dissolution in a degree commensurate with the compactness of their structure. Thus, in shells, the outer, compact, "honeycomb" layer resisted degradation much more than the scaly organization of the "mother-of-pearl" layer, and this latter again proved more resistant than the fibrillar "ivory" layer. This result is in harmony with geological experience, according to which the last-named layer is rarely found, and the compact "honeycomb" layer is the best preserved.

Hinge of the Shells of Bivalves.*—This has been systematically examined by M. Neumayr, who suggests the following classification of the bivalved Mollusca:—

I. CRYPTODONTA (Palæoconchæ). Palæozoic, thin-shelled forms, especially Silurian, with no teeth to the hinge, or at best feeble traces, and an entire pallial impression.

e. g. *Dualina*, *Antipleura*, &c.

II. DESMODONTA. Teeth absent or irregular, developed when present in intimate relation with the ligament-bearing portions of the shell.

e. g. *Pholas*, *Mya*, *Mactra*, &c.

III. TAXODONTA. Numerous teeth, undifferentiated, arranged in a series.

e. g. *Arca*, *Nucula*.

IV. HETERODONTA. Teeth few, clearly differentiated into alternating cardinals and laterals, which fill corresponding pits in the opposite valve.

e. g. *Cardium*, *Astarte*, *Cyprina*, *Donax*, &c.

(All the above four groups have two similar adductor-muscle impressions, and together form the old class of HOMOMYARIA.)

V. DYSODONTA (Anisomyaria). Teeth absent or irregular, with either two very dissimilar muscular impressions, or only one.

(α) Heteromyaria.

(β) Monomyaria.

* SB. K. Akad. Wiss. Wien, lxxxviii. (1884) pp. 385-420 (1 pl.).

Shell of Lamellibranchiata.*—An investigation of the structure and development of the shells of a great number of Lamellibranchiata had led W. Müller to distinguish two chief varieties—(1) Shells which are only here and there connected with the mantle; the organic substance of the mother-of-pearl layer is membranous. (2) Shells which are continuously grown to the mantle; the organic substance of the mother-of-pearl layer forms a network. Only *Cyclas* belongs to the second group; the former contains all other Lamelli-branches.

Molluscoida.

a. Tunicata.

Evolution of the Blood-vessels of the Test in Tunicata.†—W. A. Herdman describes the arrangement of the circulatory system in the test of Ascidiæ. The extent to which this is developed varies greatly in the different species. A series of simple Ascidiæ could be formed showing all conditions between the two extremes, and also exhibiting very varied arrangements. The most interesting modifications are in the genus *Culeolus*, in which there is a great development of the vessels just on the surface of the test, and separated from the surrounding medium by a very thin layer of tissue, and it may in this case act as an accessory organ of respiration, an idea supported by the condition of the corresponding system of vessels in some of the compound Ascidiæ.

The first stages in the evolution of the "respiratory" vessels the author imagines to be as follows:—As the ancestors of the Ascidiidæ lost the power of reproducing by gemmation, the vascular stolons became rudimentary, until they were useful merely as adhering organs. For some time they would only be produced at the posterior end of the test (their original position in the Clavelinidæ), but in course of time they would extend further forwards along the left side of the body (the side upon which most simple Ascidiæ lie), so as to anchor the animal more securely. They would then probably (in some not very remote ancestor of *Ciona*) begin, while still acting as adhering organs, to be of some slight use in respiration, and would consequently, by the action of natural selection, be evolved gradually into a larger system of vessels. The only difficulty is the passage from the Clavelinid to the Cionid arrangement, from the gemmiparous stolon to the first traces of a respiratory system. This can be explained by assuming that the rudimentary stolons after they had lost their primary function became useful as adhering organs, and consequently were retained or possibly increased by the action of natural selection until their respiratory function became established.

Microscopic Elements serving for the Determination of the Cynthiidæ.‡—H. de Lacaze-Duthiers describes a method of readily determining the species of Cynthiidæ by microscopic characters, without, however, injuring the specimens.

* Zool. Anzeig., viii. (1885) pp. 70-5.

† Nature, xxxi. (1885) pp. 247-9 (5 figs.).

‡ Comptes Rendus, xcix. (1884) pp. 1103-6.

Within the orifices of the Ascidiæ is a thin layer of tissue, which is evidently a continuation of the exterior tunic, and is styled by the author "tunique réfléchie." The free surface of this is in some species covered with three distinct forms of microscopic bodies—needles, scales with rounded margins, and forked scales. At their base, between the thicker prolongations of their margins, is a large nucleus, readily coloured by reagents, and often surrounded by protoplasmic particles endowed with a very marked movement, which evidently proves the cellular origin of these scales. Other species are free from the bodies in question, and the author therefore divides the Cynthiidae into *armed* and *unarmed*.

To determine the species of *Cynthia* all that is necessary is to remove a minute portion of the reflected tunic from an extended orifice with sharp scissors and place it under the Microscope. The scales require high powers, sometimes 400–500.

Doliolum.*—B. Uljanin has a monograph on this remarkable Tunicate, the life-history of which he groups somewhat differently to his predecessors—Gegenbaur, Fol, and Grobben. The larva gives rise to the "nurse-generation," which has a ventral stolon, and nine muscular bands; the stolon gives off primitive buds, which form the material for the sexual generation; this is polymorphous, and contains three forms; (α) the nutrient animals are abnormally constructed, have no generative products, and serve to nourish the nurses; (β) foster-animals, which have eight muscular bands, no generative products, but serve for the production of the buds whence the (γ) generative animals are formed; these last have eight muscular bands, and completely developed generative organs; their ova give rise to the tailed larvæ.

The first chapter gives a schematic account of the structure of *Doliolum*, of the structure of the generative animal, and of the mode of development of the ova in the ovary. In the second chapter we have a history of the development of the larva from the egg, from which it seems to be clear that the enteric cavity (including the pharyngeal cavity) of *Doliolum* is not the homologue of the same parts in the Ascidiæ, nor the cloacal cavity of *Doliolum* that of the atrium of Ascidiæ. It enables us also to come to some conclusions as to the morphology of the rudiment of the nervous system; it opposes the view of Julin that the ciliated pit of Tunicates is the homologue of the hypophysis cerebri of Vertebrates; the branchial nerve of *Doliolum* is not part of the peripheral nervous system, but can be best compared to the nerve-cord found in the tail of larval Ascidiæ. The third chapter deals with the conversion of the larvæ into the nurses, and the structure and metamorphosis of the nurse; many points with regard to the latter have been already well treated of by Grobben.

In the fourth chapter the separation of the primitive buds from the stoloniferous nurse is described; these buds wander, and divide again into buds, which, in their turn, become fixed to the out-

* Fauna und Flora des Golfes von Neapel, x. (1884) 140 pp. (12 pls.),

growth from the dorsal side of the nurse, and to the ventral outgrowth of the foster-animal. The development of the three different forms of the sexual generation from the buds, and the structure of the nutrient and foster-animals, are described in the fifth chapter. In the sixth, the first point discussed is the relation of the reproductive processes of *Doliolum* to those of other Tunicates; Uljanin believes that he has demonstrated that the alternations of generation in *Doliolum* are confined to two generations, and that the process is much simpler than has been generally supposed. There can be no doubt that the *Doliolum*-nurse corresponds to the nurse of other alternately generating Tunicata; like the solitary *Salpa* and the cyathozoid of *Pyrosoma*, it is provided with a stolo prolifer; the sexual generation clearly corresponds to the ascidozooids of *Pyrosoma* and the chain-form of the Salpidæ. But it is essentially distinguished by its polymorphism, which appears to be unique among the Tunicata. Its relations to *Anchinia*, *Distaplia*, and *Didemnum*, are afterwards considered.

The next question which arises is as to the origin of metagenesis among the Tunicata. The Appendiculata appear to be the oldest members of the group, and, like the Vertebrata to which they stand nearest, they are not metagenetic; the origin of the phenomenon must be sought for in the division of extremely early stages of development, in which the tissues were very slightly differentiated; this being of advantage, might in time come to be constant; later it would be converted into budding and carried on to somewhat later stages of development; this view is rendered the more probable by the observation of Rauber that divisions sometimes occur in vertebrate embryos, where they are of course only exceptional, and only lead to teratological cases, and is supported by the fact that asexual multiplication occurs at a very early stage in the development of Tunicates. The prolongation of the period of formation of the stolo prolifer led to the institution of the asexual and independent being which is known as the nurse; and this is very variously constituted in various Tunicates. The author gives a table to show the advantage to the species of the formation of buds, from which we learn that while in the simple Ascidiæ, which are exclusively produced by sexual means, sixty-four individuals come from one egg by the fourth generation, the Cyclomyaria, whose larvæ are converted into nurses, give rise by the fourth generation to 16,384 individuals. By the fourth generation of *Botryllus* one egg has given rise to six millions of individuals. What we know of the mode of reproduction of the Tunicata leads us to suppose that there is not in all cases a regular alternation of generations, but that agamic reproduction is sometimes combined with sexual.

The second or systematic part of the monograph first discusses the genealogy of the Tunicata; the author inclines to the view that they represent a side-branch of the vertebrate phylum, whose point of origin is near its root. As already said, the Appendicularia are regarded as the most primitive representatives of the group; they gave rise to the simple Ascidiæ; thence there branched off the Salpidæ on the one hand, and the compound Ascidiæ on the other; the latter gave rise to the social Ascidiæ, to *Botryllus*, and to *Pyro-*

soma, while the primitive stock was continued on through *Anchinia* to *Doliolum*.

The second chapter of the systematic part treats of the system of the Cyclomyaria, which contains *Anchinia* and *Doliolum*; of the latter, four species are known—*D. muelleri*, *D. rarum*, *D. ehrenbergi*, and *D. gegenbauri*, the last-named species being new. The two species from the Pacific, described by Quoy and Gaimard, are only imperfectly known—*D. denticulatum* and *D. caudatum*; *Anchinia savigniana* appears to be referable to this genus.

Structure of Distaplia.*—B. Ulianin has some remarks upon the development of this compound Ascidian. In the young larvæ that have not yet lost the tail the stolon is observable in the neighbourhood of the heart; this becomes segmented into about four buds, which soon become capable of independent movement and wander into the mantle of the larva and commence to divide. The free-swimming larva contains thus the commencing colony; presently it disappears and the mantle only is left behind, which forms the framework of the colony; the sexual organs of the colony are developed at different times, first the testes, then the ovaries. Contrary to the observations of Della Valle, it appears that each colony contains a number of individuals not produced from the stolon of the original larva; in all probability these are developed from ova produced by the colony, which, instead of wandering forth as free larvæ, make their way into the mantle of the colony and remain there. It is plain, therefore, that, as in other compound Ascidians, all the larvæ do not make use of their swimming-tail, but remain sometimes attached to the same colony.

Slimy Coatings of certain Boltenias.†—R. v. Lendenfeld states that a stalked solitary Ascidian, somewhat like *Boltenia australis*, occurring in Port Jackson, is characterized by its slimy surface. This slimy coating, which, however, does not extend to the stalk, is nothing else than the ova, which cover the surface to a depth of 2 mm. These ova are surrounded by follicula, which consist of prismatic cells about three times as high as broad. The follicle-cells are filled with highly refractive granules that are nothing else than a mucous substance which is pressed forth when the Ascidian is touched. Out of the breeding season these Ascidians are ordinary, not slimy Boltenias.

γ. Brachiopoda.

Digestive and Reproductive Organs of Crania.‡—M. Joubin describes the digestive and reproductive organs of these Brachiopods as represented in the Mediterranean species.

Contrary to what is observed in the other Ecardines, the anus is exactly in a line with the mouth, i. e. in the plane dividing the body into two lateral symmetrical halves. The mouth opens at the base of

* Zool. Anzeig., viii (1885) pp. 40-4.

† Proc. Linn. Soc. N. S. Wales, ix. (1884) p. 495.

‡ Comptes Rendus, xcix. (1884) pp. 985-7.

the brachial groove, and has the form of a flattened funnel, one of whose margins bears cirrhi. The œsophagus forms a curve which rises in front of and above the mouth; and the latter is therefore further back than the œsophagus which is suspended in a complicated system of lacunæ due to the enlargement of the brachial grooves. The stomach is large, piriform, and possesses towards its base a constriction to which a membrane is attached. The liver is well defined and more distinct from the stomach than in the Brachiopoda articulata. The intestine bends into a complete ring a little twisted at the side, and terminates in a cylindrical rectum placed obliquely. The rectum is much larger than the intestine and contains at the opening of the latter a sort of valvular fold. The anus is between the two great posterior muscles and traverses a thin membrane stretched between them. The general cavity of the body is divided into two symmetrical halves by a vertical membrane.

The sexes are separate; and the genital glands, which are fully described by the author, are identical in their general disposition and mode of evacuation of the products in the two sexes; their histological structure alone varies.

Arthropoda.

α. Insecta.

Compound Vision and the Morphology of the Eye in Insects.*—B. T. Lowne's paper, noticed Vol. III. (1883) p. 644, is now published *in extenso*. S. J. Hickson maintains that Mr. Lowne is wrong in denying that the so-called retinulæ are the nerve-end cells of the Arthropod eye and correspond with the rods and cones of the vertebrate eye, and he disputes the statements by which Mr. Lowne seeks to prove that all the parts of the eye in front of the basilar membrane are dioptric whilst the true retina is situated behind it. Both anatomical and physiological considerations prove the original theory to be true, and morphology also confirms it. In the ocellus of the water-beetle larva the retina is a simple cup of pigmented hypodermic cells in which the optic-nerve fibrils may be readily seen to terminate, and these cells are most certainly homologous with the retinula cells of the so-called "compound" Arthropod eye, as shown by Grenacher. Claparède and Weismann's researches on the development of the eye confirm the morphological deductions.

The "bacilli" of Lowne are connected with nerve fibrils on both sides and thus differ from "nerve-end cells" in one of their two fundamental characters. Moreover the bacillar layer is often quite devoid of pigment, no retina purple has been demonstrated and the layer is not always present.†

Wings of Hymenoptera.‡—An elaborate memoir by E. Adolph deals with the morphology of the wings of Hymenoptera from the point of view of the nervures and their relations in different species.

* Nature, xxxi. (1885) pp. 341-2.

† See also letter in reply by Mr. Lowne in support of his views, and rejoinder by Mr. Hickson. Nature, xxxi. (1885) p. 433.

‡ Verh. K. Leopold-Carol. Acad., xli. (1884) pp. 61-132 (6 pls.).

It contains a most minute comparison of the fore and hind wings of a great number of different species illustrated by figures, of which it is impossible to give any idea in a short abstract; the conclusions to which the author is led are, among others, that the Siricidæ represent the most primitive group among the Hymenoptera, since they retain the embryonic character of fully developed tracheæ in the wings; an immense number of details tabulated for the purposes of comparison are given of the wing nervures of specimens of *Apis mellifica* from various countries, and the varieties which they exhibit are thus rendered evident.

δ. Arachnida.

Digestive Apparatus of Spiders.*—This is the subject of an elaborate paper by Dr. Bertkau, who chiefly studied *Atypus piceus*.

The transverse curved mouth-opening is bounded by an "under lip" (= a direct prolongation of the breast-plate) and an "upper lip" (formerly styled "tongue") which is not homologous with the upper jaw of Crustacea and insects. The cavity of the mouth is lined by a superior and an inferior, corrugated, horny, palatal plate, each transversely convex upwards. A groove traverses the upper plate and is continued into the pharynx. The muscles to the pharynx serve not for altering its form or volume, but merely to hold the organ firm. The pharynx, piercing the central nervous system, runs sharply upwards to enlarge into the horizontal, quadrilateral stomach, X-shaped in section, which lies in a depression of the ento-skeleton, to which and to the surrounding parts it is joined by muscles. So far the digestive apparatus has been formed by the stomodæum. The mid-gut is characterized by the formation of cæca, which (1) in the cephalothorax are simple, in three pairs (in *Atypus*, but more in other genera) not connected together by special tissue, whilst (2) in the abdomen they are complicated by secondary, tertiary, &c., tubes, which are bound together by connective tissue to form a compact mass. Pigment appears in the intestine in the abdomen.

In the cephalothorax lies what Plateau has compared with the fat-body of Insecta, and Ray Lankester has called lacunar connective tissue. In part this is glandular, according to Bertkau.

In the abdomen the intestine runs at first along the upper convexity beneath the dorsal vessel, and at its highest point gives off on either side two pairs of ramifying cæca which form the "chyle-stomach" (formerly called "liver"), and then passes into the cloaca, a posterior dilatation of the final duct of the Malpighian organs. Dr. Bertkau then gives an interesting account of the histology of the digestive tract and its organs, pointing out that in winter the connective tissue joining together the offsets of the tract with the Malpighian vessels, is concerned no longer with assimilation of food, but with reproduction, as is the epithelium of the cæca of the intestine. Dr. Bertkau states that certain abdominal elliptical cells of this epithelium go to form for the most part ova, or spermatozoa, by means of their

* Arch. f. Mikr. Anat., xxiv. (1884) pp. 398-451 (2 pls.).

cell-contents combined with that of the cells of the connective tissue. What Gén  called a vesicula seminalis is really a lobated gland which forms a secretion capable of dissolving muscles and other protoplasmic portions of the spider's prey, food being always taken in a liquid form.

Structure and Affinities of Phytopus.*—J. P. McMurrich confirms Landois' statements as to the adult nature of *Phytopus* and the existence of two pairs of almost aborted limbs in addition to the two pairs developed. In *P. pyri* Sch. a pair of small tubercles may be seen on either side just anterior to the genital plate. They are smaller in the form observed than they are represented in Landois' figures; but nevertheless decidedly larger than the wart-like structures which support the body set . Of their existence the author has no doubt, but that they represent legs is not quite so clear, though, on *  priori* grounds, they must be supposed to do so. The *Phytopti* are, he considers, much more closely allied to *Demodex* than to any other forms.

Acari inhabiting the Quill of Feathers.†—E. L. Trouessart has met with *Syringophilus bipectinatus* in the quills of a very large number of birds, so that the genus may be considered to be wide-spread. The genus *Picobia*, found in the subcutaneous cellular tissue of *Picus canus*, forms a distinct though closely allied genus, and should have the same habits. The two genera constitute a small group, degraded by parasitism, of the subfamily *Cheliferid *, and are characterized by the elongated vermicular form of the body and the atrophy of the palpi.

Syringophilus occurs in the quills of the wing and tail feathers and often in those of the wing coverts. In the infected feathers the quill has lost its transparency; instead of the regular cones formed by the retreat of the pith, only an opaque and pulverulent substance is distinguishable, which under the Microscope is seen to be formed of living but almost inert *Syringophili* of all ages, surrounded by their cast skins, blackish f ces, and the d bris of the cones on which they have fed. It is probable that they escape in the autumn, when the dried-up feathers are ready to fall, and go in search of quarters in new feathers, into which they enter by the still open upper umbilicus. Their exit from the dried feathers is, on the contrary, made through the lower umbilicus which becomes free at the autumnal moulting; and it is through this orifice likewise that *Picobia* penetrate into the subcutaneous cellular tissue. Confirmation is lent to this by the facts observed in connection with the plumicolous Sarcoptid . In winter they retreat to the skin which is then covered by a thick down, and like *Pterolichus (Falciger) rostratus*, penetrate the subcutaneous cellular tissue, but always by way of the quill of the feather, which is thus only a passage and not the normal habitat as it is for *Syringophilus*.

Presence of a Coxal Gland in Galeodes.‡—J. Macleod reports the discovery of a coxal gland in the cephalothorax of *Galeodes*

* Johns-Hopkins Univ. Circulars, iv. (1884) p. 17.

† Comptes Rendus, xcix. (1884) pp. 1130-3.

‡ Bull. Acad. Belg., liii. (1884) pp. 655-6.

araneoides, very similar to that described by Ray Lankester in *Limulus* and various other Arachnids. In *Galeodes* it consists of a number of coiled glandular tubes, the epithelial wall of which is formed by a layer of cylindrical cells, at least four times as high as broad; the protoplasm, of which a fourth or a fifth of the cell is formed, is sometimes limited by a distinct membrane. The rest of the cell is composed of a refractive, radially striated mass; the lumen of the tube is partly filled by granular matter, which appears to be degenerated protoplasm.

The author adds that he has failed to find any trace of coxal glands in *Epeira corunta*, *E. diadema*, *Lycosa* sp., *Clubiona pallidula*, *Marpissa mucosa*, or *Argyroneta aquatica*.

6. Crustacea.

Spermatogenesis in Decapod Crustacea.* — A. Sabatier has especially studied *Astacus*, *Carcinus*, *Crangon*, *Pagurus*, and *Scyllarus*, but the facts observed were so uniform that he cannot doubt that what he saw will hold good for the whole group.

Taking *Astacus*, he found that some of the nuclei of the wall of the testicular culs-de-sac underwent direct segmentation, increased in size, became spherical, and projected into the cavity. These nuclei, which are composed at first of a homogeneous protoplasm with a central nucleolus, soon grow considerably, and exhibit a plexus of chromatin-grains; the zone of protoplasm which surrounds them is at first barely visible but gradually thickens. Thence result large cells, with large nuclei, which invest the wall of and almost fill the cul-de-sac. These are protospermatoblasts formed by the direct division of the spermatogonia.

In each protospermatoblast several chromatin-grains appear in the protoplasm; these fuse, and so give rise directly to several refractive and homogeneous masses; these deutospematoblasts undergo direct division; they grow, become spherical, and form in time the spermatozoa. While this is going on the nuclei of the protospermatoblasts become pale and atrophy; the cellular body undergoing disaggregation, the deutospematoblasts are set free. At a later stage all the nuclei of the protospermatoblasts are found to have disappeared, and the cul-de-sac is filled with deutospematoblasts imbedded in a granular medium, which contains no chromatin and is formed by the débris of the cell-body of the protospermatoblast.

The maximum size of the deutospematoblasts is 0.02 mm.; the chromatin is at first diffused, or, the nucleus is not yet differentiated; this appears by gradual condensation; highly refractive granules appear in the surrounding protoplasm, which at the same time rapidly loses its colour. The nucleus becomes flattened, undergoes some migrations, gradually atrophies, and finally disappears. A corona of protoplasmic prolongations completes the spermatozoon.

The author points out that the view of Grobben and others that

* Comptes Rendus, c. (1885) pp. 391-3.

the spermatozoa arise by true segmentation of the mother-cells is incorrect, and that it arises rather by direct genesis in the protoplasm of the protospermatoblast, and that it is, therefore, the homologue of the corpuscles which appear in the yolk of the egg and form the follicular cells. In fine, it obeys the laws already enunciated by Sabatier.

Development of the Egg and Formation of the Primitive Layers in *Cuma Rathkii*.*—H. Blanc in this paper seeks to establish an affinity between the development of the Cumaceæ and that of certain Isopoda, *Oniscus* amongst others.

Brain of *Asellus* and *Cecidotæa*.†—A. S. Packard has studied the structure of the brain and organs of sight of *Asellus communis*, and compared it with that of the same parts in the blind *Cecidotæa stygia*. The latter in its external form is a somewhat dwarfed *Asellus*, and is not usually totally eyeless, since in some individuals a rudimentary eye, in the shape of a minute black speck, is seen on each side of the head. *Cecidotæa* differs from *Asellus* in the complete loss of the optic ganglia and nerves, besides the sometimes nearly total loss of the pigment-cells and lenses. As regards the other parts of the brain, no differences were observed. The steps taken in the degeneration or degradation of the eyes seem to be (1) the total and nearly or quite simultaneous loss by disuse of the optic ganglia and nerves, (2) the breaking down of the retinal cells, (3) the disappearance of the lens and retina. These modifications are due to (a) change in the environment, and (b) heredity.

Deep Fauna of Swiss Lakes.‡—F. A. Forel enumerates the works of previous writers on this subject, and corrects the facts and theories which he had previously advanced on the origin of the blind *Gammarus* and *Asellus* of the deep parts of lakes. Formerly he attributed them to direct emigration from a littoral fauna, which, penetrating into a region devoid of light, had there lost the visual organ and pigment; new researches, however, now lead him to conclude that these blind crustacea are descended from cave-inhabiting animals, which had already become differentiated in the dark subterranean waters.

New Amphipodous Crustacean.§—T. R. R. Stebbing describes under the name of *Cyproidia damoroniensis* a new amphipodous crustacean collected at Straight Point, Devon. The mounted specimens are red in some parts and purple in others, the size, 1/10 in., agreeing with the diminutive proportions of the other species of this curious genus.

Crustacean inhabiting the Tubes of *Vermilia*.||—W. A. Haswell describes a new crustacean which he found inhabiting tubes of *Vermilia* (*Serpulide*), and names *Eisothistos vermiformis*. In some

* Arch. Sci. Phys. et Nat., xii. (1884) pp. 430-2.

† Amer. Natural., xix. (1885) pp. 85-6.

‡ Arch. Sci. Phys. et Nat., xii. (1884) pp. 444-5.

§ Ann. and Mag. Nat. Hist., lxxxv. (1885) pp. 59-62 (1 pl.).

|| Proc. Linn. Soc. N. S. Wales, ix. (1884) pp. 676-80 (2 pls.).

points this crustacean shows relationship to known families of Isopoda, notably Anthuridæ and Ægidæ. It differs from the Anthuridæ, however, not only by the anterior pereopoda being simple, but also by the position of the embryo in the egg, the flexure being towards the dorsal side. The male differs greatly in appearance from the female. On either side of the dorsal organ of the embryo is a remarkable jointed larval appendage, without parallel in any other Edriophthalm. These may point to the former existence in the Edriophthalm larva of embryonic locomotive appendages, of which they are a remnant, or may be simply developed for the attachment of the larva to the pinnate hairs of the abdomen of the female.

Marine Species of *Philougria*.*—C. Chilton describes a new species of *Philougria* (*P. marina*) from near Sydney, and attaches some importance to the peculiar setæ arising from the dactylos of each thoracic leg. All terrestrial Isopoda are descended from marine forms, but this specimen resembles the terrestrial *Philougria* so closely that the author considers it is a terrestrial form that has in the struggle for existence been forced to return to a life in the sea.

Amœboid Movements of Spermatozoa of *Polyphemus pediculus*. †—O. Zacharias gives us some further information as to the amœboid characters of the spermatozoa of *Polyphemus*, to which attention has been already directed by Leydig. The recent observer corroborates most of the earlier histologist's work, but takes exception to the limited number of the colossal seminal elements; he has seen almost always thirty to forty of these structures arise from the testis; the difference is to be perhaps explained by Zacharias having examined specimens that were fully adult. The spermatozoa are exceedingly active in 3 per cent. salt solution; experiments with a 10 per cent. solution of sugar revealed some extraordinary phenomena. While some became spherical, others retained their spindle shape and gave off an excessively long pseudopodium which, in extreme cases, equalled in length the male of *Polyphemus*; well may the author say that this is a unique case in animal histology. Other experiments are detailed, and the conclusion is come to that we know of no other organic structures which possess the power of forming pseudopodia in so remarkable a manner as the spermatozoon of *Polyphemus*.

Parasitic Copepod of the Clam. ‡—Prof. R. R. Wright describes a copepod, *Myicola metisiensis* (nov. gen. et sp.) from the clam (*Mya arenaria*), the female being parasitic in the gill-tubes and the male free in the mantle cavity. The genus approaches *Ergasilus* in the conformation of the posterior antennæ and in the absence of the posterior maxillipedes in the female, in other points it approaches the Lichomolgidæ. The anatomy of its soft parts appears to agree completely with Della Valle's *Lichomolgus sarsii*. Its development

* Proc. Linn. Soc. N. S. Wales, ix. (1884) pp. 463-6 (1 pl.).

† Zeitschr. f. Wiss. Zool., xli. (1884) pp. 252-8 (1 pl.).

‡ Amer. Natural., xix. (1885) pp. 118-24 (1 pl.).

closely resembles that of *Lichomolgus*. When freed from the gill-tubes the females swim about with considerable velocity considering their previous imprisonment. It is doubtful by what channel they reach their resting-place.

Vermes.

Formation of Trochosphere in *Serpula*.*—H. W. Conn describes the development of *Serpula* and founds on it and that of *Thalassema* a new theory as to the relations of larvæ.

In *Serpula* the segmentation is regular and complete, as Stossich has stated; but the history of the blastopore is very different from that described by him. The regular segmentation is followed by a typical invagination, giving rise to a gastrula. A band of cilia now makes its appearance around the blastopore and a tuft of sensory cilia at the opposite end. Now that part of the body within the circum-blastoporal ciliated ring, and therefore containing the blastopore, begins to elongate obliquely, causing an elongation of the blastopore. The axis of this elongation does not fall through the centre of the blastopore, but through one edge of it, and the elongation is therefore such that one end of the blastopore remains near the ring of cilia while the other is carried away at the end of the elongated portion of the body. As this elongation progresses the blastopore, which has become drawn out into a long slit, closes, and its lips fusing together become what proves to be the ventral median line of the full-grown larva. The endoderm is entirely within the body-cavity, connected with the ectoderm, however, throughout the whole extent of the closed blastopore. Soon the two extremities of this closed blastopore open again, the one near the ciliated band becoming the mouth, the other eventually becoming the anus, while the endoderm between these two points loses all connection with the ectoderm, except at the mouth and anus, and becomes hollowed out to form the alimentary canal. The blastopore is not therefore converted into the anus as Stossich asserts, but it elongates, one extremity eventually becoming the mouth, the other the anus, while the intermediate portion closes to form the median ventral line of the larva and full-grown adult.

Mr. Conn's theory is in brief as follows:—As a simplest type of larva and the most universal is found a form which agrees in essential respects with the young ptilidium of Nemertians. It consists of just such a gastrula as in *Serpula*. This type is present in Cœlenterata, Polyzoa, Brachiopoda, Vermes, and Molluscs, and, in a slightly modified form, i. e. without the circumblastoporal ring, in Echinoderms. Omitting the latter, the above groups are divided into two radically distinct classes. In the first class (Cœlenterata, Polyzoa, and Brachiopoda), the body of the larva and the adult is formed by the elongation of that part of the gastrula body situated *in front* of the circum-blastoporal ring, between it and the anterior ciliated tuft. In the second class (Molluscs, Annelids, and probably other worms), the body

* Johns-Hopkins Univ. Circulars, iv. (1884) pp. 15-16.

of the larva and adult is formed by the elongation of that part of the gastrula body situated *behind* or within the circumblastoporal ring. In Molluscs, however, the ventral surface grows out to form the foot, the dorsal surface develops a shell, while the whole animal remains relatively short and the resulting form is very different from the Annelid.

Anatomy of the Serpulea with Characteristics of Australian Species.*—W. A. Haswell gives the results of observations on the Serpulea of Port Jackson, including representatives of all the principal subdivisions of the group, which differ very little from their European allies. Two points in the anatomy are specially dwelt on: (1) the pseudohæmal system, and (2) the segmental organs and "tubiparous glands." The segmental organs in *Eupomatus elegans* serve not only as efferent ducts for the generative products, but also as seats of development of the ova.

The following species are described:—*Eupomatus elegans*, *Cymospira brachycera*, *C. mörchii*, *Pomatostegus bowerbanki*, *Pomatoceros elaphus*, *Vermilia strigiceps*, *V. cæspitosa*, *V. rosea*, *Serpula vasifera* n. sp., *S. jukesii*, *Salmacina australis* n. sp., *Sabella velata* n. sp., *S. punctulata* n. sp., *Spirographis australensis* n. sp.

Metamorphosis of Nephelis.†—R. S. Bergh finds that in *Nephelis*, just as *Aulostomum*, the provisional body-wall (ectoderm and musculature) is cast off, and the whole of the body, with the exception of the epithelium of the mesenteron, is built up from the fused head- and trunk-germs. Rathke seized on the truth as to the development of *Aulostomum* and *Nephelis*, but his results have been ignored by succeeding writers, who have all described it as being simple and direct; Semper alone recognized the head-germ and found that it gave rise not only to the cerebrum, but also to connective tissue and musculature.

The primitive kidneys bud out, in early stages of development, from the trunk-germs, which are still separated from one another by a wide interspace. While the earlier stages are as in *Aulostomum*, differences are to be observed in the character of the fully developed organs; for in *Nephelis* each may be divided into two primary parts, which may be known as ring and duct; in *Aulostomum* (and in *Hirudo*) the ring is alone present. In all the three genera the primitive kidneys are completely devoid of any orifices; the duct is formed of a single canal, the ring of two, which partly coil around one another. In some cases, however, it seems to be clear that the existence of two canals is only apparent, and that each archinephric ring consists of a single canal, which arises from the duct, is, so to speak, rolled up, and ends blindly.

With regard to the other processes of metamorphosis, Bergh states that the primitive ectoderm forms a single layer of flattened cells, the boundaries between which are apparent only in early stages; later on the cells become flattened out and their limits disappear. The mus-

* Proc. Linn. Soc. N. S. Wales, ix. (1884) pp. 649-75 (5 pls.).

† Zeitschr. f. Wiss. Zool., xli. (1884) pp. 284-301 (2 pls.).

culature of *Nepheleis* is feebly developed in comparison with that of *Hirudo* and *Aulostomum*; both the longitudinal and transverse muscles are very fine and thin. The provisional pharynx of the larva of *Nepheleis* is not differentiated into pharynx proper and oesophagus, as in *Aulostomum*. The author describes the formation of a provisional organ, the pharyngeal plate, but is not able to offer any suggestions as to its function.

The cephalic and trunk germs are paired, and unlike those of *Aulostomum* and *Hirudo*, do not unite till a late stage in development; just as in *Nepheleis*, they form the rudiments of all the ectodermal and mesodermal parts of the body, while the primitive epidermis, the provisional musculature, and the body of the leech are all lost.

Blastopore, Mesoderm, and Metameric Segmentation in Phoronis.*—W. H. Caldwell was led to the essay now published by a study of the origin of the mesoderm in *Phoronis*. In this remarkable form the gastrula is formed by invagination; the anterior end and the future præoral lobe are early indicated; during the gastrulation the extreme posterior end of the archenteric cavity becomes obliterated, and represented by a fused solid mass of cells; as the lips of the blastopore touch they fuse with one another, and this is effected from behind forwards: the posterior portion may, as in some vertebrates, be called the primitive streak, and the groove along the line of closure the primitive groove. The ventral surface grows rapidly, and the primitive streak thus becomes terminal. The anterior opening of the blastopore remains open and becomes the mouth of *Phoronis*.

Two pouchings which appear on either side of the blastopore bud off a mass of endodermal cells on either side; these arrange themselves into a sac inclosing a cavity; but they never communicate with the cavity of the gut. On either side of the primitive streak a few mesoblast cells are budded off from the cells that form it. The hinder part of the groove gives rise, by deepening, to a pit which grows out into two pouches, derived from cells that are homologous with those that have already given rise to mesoblast: the fact that in *Phoronis* the two ends of each mesodermic pouch are actually connected by an intermediate cord of cells depends on the formation of a primitive streak along the whole line of closure of the blastopore.

The anus, like the mouth, is derived from the blastopore.

“Given a gastræa already become bilaterally symmetrical by the elongation of the blastopore, and the differentiation of anterior inhalant and posterior exhalant currents, and in which the main development of organs takes place around the mouth, so that the mesoderm thus resulting comes to lie in development as two masses of cells on either side of the body;” the author proposes to show that the elongation of a long axis is a possible cause of:—

(1) The obliteration of the relation of blastopore to mouth and anus. (2) The masking of the original mode of mesodermic formation. (3) Metameric segmentation.

1. After noting the opinions of earlier naturalists, Mr. Caldwell

* Quart. Journ. Micr. Sci., xxv. (1885) pp. 15–28 (1 pl.).

suggests that the behaviour of the blastopore in *Phoronis* is obviously due to the attainment of a terminal anus; if we suppose the long axis of the body to increase still more rapidly, while the posterior part of the blastopore remains terminal, and, at the same time, suppose that the importance of a complete alimentary canal is not equal to the importance of the body form, "then the tendency of the endoblast to divide into anterior and posterior portions attached to anterior and posterior parts of the blastopore respectively might be consummated." When the anterior endoblastic mass is the larger we get the so-called oral blastopore, and when the posterior, the anal. If invagination of different endoblastic masses is not synchronous the extremes will give us stomodœa and proctodœa.

Phoronis, then, is the first step towards a complete division of the blastopore, and the inducing cause of this is the elongation of the body, while the endoblast is still in an embryonic condition.

2. The necessity of an early attainment of a terminal anus caused the ectoderm to grow more rapidly than the endoblast, and resulted in a division of the mesoderm into anterior and posterior parts; this division had as results the masking of the original mode of mesoderm formation, and,

3. Metameric segmentation.

Structure of the Body-wall in Earthworms.*—F. E. Beddard describes the structure of the body-wall of *Perionyx* and *Perichaeta*.

In *Perionyx* the epidermis closely resembles that of the common earthworm. The latter, however, is only vascular in the region of the clitellum, while in the former the terminal branches of the blood system penetrate within the epidermis of the general body surface. This intra-epidermic vascular plexus is entirely unrepresented in the common earthworm as well as in the two genera *Urochaeta* and *Pontodrilus*. The epidermis of *Perionyx* agrees with that of the leech, and differs from that of all other earthworms, in being pigmented.

In *Lumbricus* the epidermis is separated from the subjacent layer by a thin elastic membrane, from which are given off a number of fine processes, which ramify between the individual fibres of the transverse muscular coat. In both *Perionyx* and *Perichaeta* this elastic network is very highly developed: its function is probably to assist in extending the fibres after contraction. This structural peculiarity of the muscular layers is not found in all Oligochaeta.

Excretory Organs of Worms.†—A. Lang seeks to prove that the organs of secretion of the Platyhelminthes and particularly those of the Tricladea constitute the point of departure for those of the greater number of the higher worms.

Amongst the Annelida and in *Dinophilus* the segmental openings of the renal organ of the Tricladea are preserved, but the longitudinal canals have disappeared. In *Dinophilus*, the internal extremities of the segmental organs still present the vibratile cells characteristic of the Platyhelminthes, whilst in the Annelida cells of

* Proc. R. Phys. Soc. Edinburgh, viii. (1884) pp. 89-91.

† Arch. Sci. Phys. et Nat., xii. (1884) p. 432.

this kind are formed during the course of development, but are subsequently replaced by wide-mouthed vibratile funnels. These are not the homologues of the vibratile cells, but should rather be considered as neomorphs which originate in the blastema, distinct in their origin from those of the segmental organs. The longitudinal canals of the Platyhelminthes recur as ephemeral organs of transition in the ontogeny of *Polygordius*; in *Lanice conchilega* they persist even up to the adult stage. In the Rotifera it is the longitudinal canals and vibratile cells of the Platyhelminthes that are preserved, but the segmental orifices are lost.

Sclerostoma bouharti.*—P. Mégnin gives an account of a new Strongyle found by M. Boulart in the trachea of *Casuarium galeatus*; in many points it resembles *Syngamus trachealis*, but differs from it in that the sexes are not permanently united, as they are always found to be in the single species of *Syngamus* which is known to us. It becomes, indeed, doubtful whether the genus *Syngamus* ought to be retained at all, and not merged with *Sclerostoma*, as was done by Diesing.

After a few notes on the anatomical characters of the new species, Mégnin remarks that, if individuals are not ordinarily more numerous than they were in the cassowary dissected, where there were only six pairs, the most they can do is to produce some cough; in younger specimens a smaller number would, with the narrower trachea, produce suffocation than in adult forms, but even in that case some fifty would be required to block the passage of the trachea. At the same time it is to be remembered that the endoparasitic nematoids are blood-suckers, so that they must produce a certain amount of anæmia, the significance of which must not be left out of consideration.

Excretory Organs of Nemertines.†—A. W. Hübrecht has discovered in a species of Palæonemertine that the excretory system communicates on both sides with the lateral blood-vessels by several apertures; the excretory canals instead of being as in the Trematodes and Hirudinea, rows of perforated cells, are composed of a cylindrical mass of cells surrounding a central lumen which in most cases is richly ciliated. Dr. Hübrecht also records the discovery by Oudemans of numerous external apertures of the nephridia in *Lineus*, *Amphiporus*, &c.

Nervous System of Tænia.‡—J. Niemiec, after an expression of admiration for the investigations of Blanchard on the nervous system of the Cestoda, states that he has made investigations on *Tænia cœnurus*, *T. elliptica*, *T. serrata*, and *T. mediocanellata*, by means of sections. Immediately below the internal angle of the hooks of the rostrum (where such are present) there is a nervous ring which gives off superiorly a series of branches to the musculature of the hooks; inferiorly, the same ring gives off eight nerves, at the base of which is a slight swelling formed by ganglionic cells; these go by

* Journ. de l'Anat. et Physiol., xx. (1884) pp. 455-61 (1 pl.).

† Zool. Anzeig., viii. (1885) pp. 51-3.

‡ Comptes Rendus, c. (1885) pp. 385-7.

pairs to one of the principal ganglia of the scolex; the commissure which connects these last together presents at its centre a considerable enlargement which the author calls the central ganglion; the commissure may be called the principal commissure. From the central ganglia, and perpendicularly to the commissure, there are given off two other commissures, which bifurcate, and end in a pair of secondary ganglia; these are connected by four descending branches.

The commissure, which is bifurcated at either end, may be known as the transverse commissure. Each of the principal ganglia gives off posteriorly three nerves, of which the median is stronger than the lateral; the six nerves thus formed extend through the whole chain of proglottids; each lateral ganglion gives off four other filaments, two of which pass to the suckers.

All the nerves which unite the principal ganglia to the ganglionic swellings of the longitudinal nerves form together an octagonal figure to which the name of superior polygonal commissure is applied; below this is another or inferior polygonal commissure.

From the histological point of view it is to be noted that the nerve-fibres are not separated by any proper envelope from the parenchyma which they traverse; true ganglionic cells were found only in the scolex, and the other nervous cells have small oval nuclei.

From the point of view of comparative anatomy the system now described is difficult to explain; the polygonal commissures cannot, in consequence of the presence of the central ganglion, be regarded as an œsophageal ring.

Polycladidea.*—The second half of A. Lang's magnificent work on these worms has appeared; the first half, it will be remembered, † stopped in the course of an account of the male generative system. In the Planoceridæ these organs present some remarkable variations in structure. The female apparatus consists of (1) numerous ovaries which lie scattered through the lateral æræ, of (2) oviducts, (3) uterus, and (4) female copulatory apparatus. In many cases special glands are connected with the uterus, which may be distinguished as the accessory uterine glands. There are also various kinds of fixing organs which are of use either in copulation, or in the deposition of the ova. With this the first portion of the treatise ends.

The second deals with the ontogeny of the Rhabdocœlida, where, among others, the following results are stated:—

The first four blastomeres are not equal, and a bilateral symmetry is already indicated; the largest blastomere corresponds to the hinder end, the next largest to the front end, and the two smallest to the right and left sides of the embryo. The subsequent cleavage of these blastomeres and of their descendants takes place spirally around the primary axis of the egg; it is quite rhythmical in the sense that the descendants divide in the order of their size. The first four

* Fauna u. Flora des Golfes von Neapel, xi. (1884) pp. 241-686 (15 pls.).

† See this Journal, iv. (1884) pp. 385.

blastomeres divide into four smaller and aboral primitive ectoderm-cells, and into four larger and oral primitive endoderm-cells; some of the latter are used up as nutrient yolk; the enteron is at first solid (except, according to Goette, in *Stylochus pilidium*). There is epiboly, and the blastopore lies at about the middle of the future ventral side. Whether it remains open or closes, it always marks the point where the stomodæum is afterwards formed from the ectoderm. The aboral pole, and all the organs that arise in its neighbourhood, gradually migrate from the middle of the dorsal side towards the anterior end of the body, so that the oral orifice is pushed more and more backwards.

The ectoderm is never multilaminar; the rhabdites arise as concretions in its cells. The first two or three eyes arise in the ectoderm and thence pass into the mesoderm. All the other eyes arise in the mesoderm, but by division of the first two or three. The sensory and the motor portions of the brain probably arise from the ectoderm independently of one another; the latter appears at the aboral pole below or on either side of what will be the anterior median branch of the enteron; the former is at first isolated at the aboral pole, and only secondarily passes on either side of the anterior median branch to unite with the ventral sensory portion. The primary nerve-trunks arise from the brain.

The mesoderm, formed by the repeated division of the four primitive mesoderm-cells, never becomes distinctly divided into a dermo-fibrous and an entero-fibrous layer; the parenchyma and all the muscular elements of the body are derived from it.

In all the forms examined the central cavity of the enteron was found to be formed by the resorption of the central yolk-masses of the enteroderm, the enteric cells passing to the periphery and there forming an epithelium.

All the *P. cotylea* and all the *P. acotylea*, except the *Leptoplanidæ*, pass through a metamorphosis; and the metabolic forms leave the egg-shell much earlier than those which develop directly; they have a common larval form—the *Muellerian larva*—which is characterized externally by a pre-oral ciliated band, which is drawn out on eight processes. The mode of arrangement and movement of the cilia call to mind the ctenophores of the *Ctenophora*. All the metabolic forms have the *Muellerian larva* preceded by that of Goette, in which there are four processes; the only larval organs are the ciliated band and the processes; when these are absorbed, no portion of the larva is cast off. There are many facts which go to show that the development with metamorphosis recapitulates more primitive arrangements than does the direct mode of development. Of the metabolic *Polyclads*, those again seem to be the earliest whose embryonic life is shortest.

The neck-tentacles and the marginal tentacles are, from the first, different structures. The former are solid processes of the body, the latter thickenings and foldings of the most anterior edge of the body. There is no true anus, and the ectodermal spaces by which a small space is left cannot be regarded at most as being more than the

homologue of one of the openings of the branches of the funnel in the Ctenophora.

The third portion of the monograph deals with classification. After a review of what has been done by previous writers, the author discusses the principles on which a system should be based, and gives a phylum. The single line of descent has the Ctenophora and *Ceoloplana* branching off, one above the other; it then divides into two branches—Acotylea and Cotylea; of the former the three families are, in ascending order, the Planoceridæ, Leptoplanidæ, and Cestoplanidæ; of the latter the Anonymidæ, Pseudoceridæ, Euryleptidæ, and Prosthlostomidæ; the relative positions of the constituent genera are indicated. This is followed by a short review of the tribes, families, and genera, with differential diagnoses; and this by a regular account of the genera and species, in which various new forms are described. A "key" is then given for the species found at Naples.

The fourth section deals with chorology and oecology; all the Polyclads are marine, none being found even in brackish water. Of the 226 species recognized, 66 are European and 160 exotic; of the former, 10 are incompletely known, and of the latter not one is satisfactorily understood. Of the 66, 51 have been found in the Mediterranean. Many Neapolitan species live under stones, or in small cavities of rocks; many between the tubes of tubicolous annelids, some in mud. Mimicry and sympathetic coloration play a great part in their economy, while others again are very sharply distinguished from their surroundings. Some, especially the Pseudoceridæ, are excellent swimmers; many have a great capacity for regenerating lost structures, and most are very retentive of life. They cannot be said to be especially plentiful at any one season of the year; and when one species is very abundant at a certain date, we must not expect to find the same thing in the succeeding year.

The fifth and concluding section is entitled phylogeny, and in it a number of interesting problems are discussed.

The first is that of the genetic relation of Polyclads to the Cœlenterata, which was first suggested by Kowalevsky from a study of *Ceoloplana*; limiting himself by a reflection as to the incompleteness of our knowledge, the author agrees to the suggestion that *Ceoloplana* is an intermediate form between the Triclad and the ctenophorous Cœlenterata; the different organs of the two groups are carefully compared in detail; and the difficulties in the acceptance of the view are next pointed out. They are the present impossibility of finding anything in a Cœlenterate which can be compared to the excretory organs of the Turbellaria, and the apparently quite different mode of development of the mesoderm in the two groups. Further investigations may throw some light on the cause of the differences in the nervous system; the form to be attacked just now is *Ceoloplana*. Selenka's hypothesis as to the relation of the two groups is next considered, and the differences between the arguments advanced by him and by Lang are pointed out.

As to the relationship of the Polyclads to the Triclad the author

refers to his already published suggestion that the Triclad's were derived from the Polyclads by a reduction in the number of the enteric branches, testes, and ovaries, by a conversion of part of the ovary into yolk-glands, by a reduction of the lateral parts of the body, the loss of the primary enteron, and the greater development of bilateral symmetry. The detection of a water-vascular system in the Polyclads has diminished the gap between the two groups. Difficulties are presented to us by the cenogenetic modes of development which are so marked in Triclad's.

With regard to the relationship of the Turbellaria to the Trematoda, Lang's studies, confirmed by those of Gaffron on the nervous system, show that the relationship is closer than has been generally supposed. It is probable that the Trematodes arose from Triclad's in which the mouth had already taken up an anterior position; the two oral suckers of Tristomida have a close resemblance to the marginal tentacles of certain Triclad's, and their ventral sucker to that which is found in some members of the more primitive group.

Lang agrees with Hallez and Graff in thinking that the Triclad's are closely allied to the Alloiocœla among the Rhabdocœlida; only, in exact opposition to Graff and Braun, he thinks that the Alloiocœla arose from the Triclad's.

The difficult question of the position of the Accela is glanced at; as to the Nemertinea, the author expresses the opinion that it is impossible to compare their organs directly with those of the Turbellaria.

The last problem discussed is that of the morphology of the excretory organs of worms and their relation to the view that the Platyhelminths owe their origin to being degenerated from higher segmented worms. Against the view that the large open intercellular infundibula of Annelids are homologous with the excretory cells of the Platyhelminth kidney and that of the larva of Annelids, and in support of the doctrine that they are neomorphs, he refers to recent observations by Meyer on the development of *Terebella*; in this annelid the ciliated infundibulum is seen to be formed from a group of cells which are primitively completely separated from the rudimentary excretory organ, and only come secondarily into connection with it.

New Turbellarian.*—This was discovered living on *Nebalia* by M. Repiachoff. From his preliminary note the animal appears to be elongated in form, and ciliated mainly on the tapering, proboscisiform anterior extremity, which is marked off by a circular groove. Another groove, situated ventrally, forms a kind of sole, with a further median furrow subdividing that surface. The anterior extremity is so termed because it is to the front when the animal moves. It is at the posterior extremity, according to this nomenclature, that the pharynx and copulatory organs occur. The intestine runs through two-thirds of the body, and is coiled or straight according as the generative organs are little or well developed. The generative organs are paired throughout. The female organs (ovary and yolk-forming bodies) lie round the pharynx, whereas the round testes are found on either side

* Zool. Anzeig., vii. (1884) pp. 717-9.

of the "anterior" end of the intestine, internally to the lateral prolongations of the yolk mass. The male copulatory apparatus consists of a vesicula seminalis and a ductus ejaculatorius.

A paired canal with funnel-shaped internal opening, and apparently opening externally, may be a segmental organ. No nervous system, or water-vascular systems were observed.

Reproduction and Development of *Rotifer vulgaris*.*—In the waters from which O. Zacharias found the specimens of *Rotifer vulgaris* that served as the basis of his studies, he found also *Philodina roseola* and *Eosphora najas*. The former rotifer was found under two forms, one of which was very large (0.75 mm.) with a reddish cuticle, and the other smaller (0.50 mm.) with a completely colourless cuticle.

The author refuses to recognize any similarity between the external segmentation of the rotifer and the metamerism of the arthropod; the gastric glands have cells containing a pale granulated mass, in which bright nuclei are deposited. By the aid of high powers he has recognized that each "infundibulum" of the excretory system has the form of a cylindrical cup, which is connected with the excretory vessel by its narrower terminal piece. The cup is open above, and the cilia project for a short distance beyond the orifice. The author compares his results with those of Eckstein.

The coelom of *Rotifer* is characterized by being rarely quite free of embryos; as a rule three are found therein, one of which has advanced some way in development, while the two others are only just being formed.

True cells were not detected in the blood, but the fine spindle-shaped or rounded elements that are found in it have probably the function of the blood-cells.

The author describes the separation of the egg from the ovary, which takes three or four hours; the process is so effected that a part of the investing membrane of the ovary is brought away with it, and the embryo, during its development, lies in a hyaline circularly closed vesicle, which may be regarded as a functional uterus. The cleavage of the egg is very difficult to observe, on account of the movements of the animal, and of the contractions which result from the slightest pressure. By the exercise of patience during six months, Zacharias was able to convince himself that the egg when separated from the ovary has a central germinal vesicle and spot; the contours of the vesicle become indefinite, and at last it is invisible. The yolk-granules now show a tendency to collect into the middle of the egg, so that a dark central mass may be distinguished from a lighter peripheral portion. When, as soon happens, the contents clear up again, it may be seen that there has been a division of the germinal vesicle; the mode of division appears to have some relation to gemmation. There is an interval of some hours between the division of the vesicle and the formation of blastomeres.

The rudiments of the mesoderm were seen to arise by cleavage

* Zeitschr. f. Wiss. Zool., xli. (1884) pp. 226-51 (1 pl.).

from the hypoblast, and there are not inconsiderable resemblances between the rotifer and the larva (trochophore) of *Polygordius*.

With regard to the mode of reproduction of *Rotifer vulgaris* the author has only been able to confirm anew the well-known fact that this is effected by parthenogenetic means. The objects that Zacharias was at one time inclined to look upon as cavities filled with spermatozoa appear to be parasitic in origin. The author concludes with expressing the hope that Ganin will make more generally accessible the results of his observations on *Callidina parasitica*; these, which appear to indicate the existence of a second mode of formation of ova in the Philodinidæ, have as yet been published in the Russian language only.

New Floscularia.*—A preliminary description, stated to be by Dr. C. T. Hudson, is given of a new *Floscularia* (*F. mutabilis*) from localities near Birmingham. It is remarkable for having a disk with only two lobes; for possessing what appear to be two eyes on the dorsal lobe, near its summit; and for its habit of altering the shape of its disk till it somewhat resembles that of an *Æcistes* or *Limnias*, and then of swimming by vibrating the short setæ that surround the edge of the disk. It generally swims backwards, circling very slowly, and sure to be soon pulled up by some obstacle. Now and then it has a fit of energetic straight swimming, but even then it is usually stern foremost.

Coelenterata.

Origin of Sexual Cells in Obelia.†—C. Hartlaub was led to this investigation chiefly by the work of Weismann on the origin of the sexual cells in the Hydromedusæ. The specimens studied were most satisfactorily killed by hot sublimate or picrosulphuric acid; 1/2 per cent. osmic acid was found useful, but specimens treated with it must not be afterwards placed in alcohol.

The female cells were found to have their seat of origin in the ectoderm of the manubrium, and the first ova were constantly formed on the manubrium; here also the ova must have primitively been matured, and their present position at a varying distance from it is the result of some change that has been effected during their phyletic development; the young eggs in the ovary always lie in the ectoderm, but a number of them pass into the endoderm for maturation.

In the early days of free life the males of *O. adelungi* and *O. helgolandica*—two new species described at the commencement of the paper—exhibit a differentiation of germinal cells at the base of the manubrium, and eventually in the proximal third of the radial canal; in another species, however, a continuous development of germinal cells was observed outside the spermarium. In the two species just mentioned there is an ectodermal thickening, which is homologous to that which functions as the ovary in the female; in fact, it is probable that all the male germ-cells are differentiated in this, and make their way thence to the spot where they are matured.

The author thinks that he has succeeded in his aim of demon-

* Midland Natural., viii. (1885) p. 33 (1 pl.). Dr. Hudson writes us that this was extracted from a letter from him and published without his knowledge.

† Zeitschr. f. Wiss. Zool., xli. (1884) pp. 159-85 (2 pls.).

strating the phyletic migration of the maturation-point in the Eucopidæ; this it was necessary to do unless the position of their gonads could be allowed to contradict the views of Weismann that the primitive position of the germ-cells was the ectoderm of the manubrium of the free Medusæ.

Hydroid Phase of *Limnocodium Sowerbii*.*—A. G. Bourne now describes the organism which he found † on the root filaments of *Pontederia*, and which in its mode of growth somewhat resembles an encrusting sponge. The smallest pieces are mere knobs, the largest are produced into three or four lobes, about 1/8 in. long. No tentacles were seen, but they may develop subsequently; there is no trace of a true perisarc; the organism does not exhibit any active movement, but throws off nematocysts, when irritated; in preserved specimens there is only a very minute lumen, leading from the terminal aperture. The endoderm cells near the apex are peculiarly arranged, and "somewhat suggest in appearance the rudiment of a sub-umbrella found in such forms as *Hydractinia*"; in the basal region the endodermic cells are normal, and the cavity is well developed.

The author briefly notes the appearance of structures resembling buds formed by the medusiform persons; and gives a history of *Limnocodium* up to date. It is suggested that the Medusa did not establish itself at Kew because there was no *Pontederia* in the tank. "In dealing with the hydroid form here described, we must remember that *Limnocodium* is undoubtedly one of the Trachomedusæ. No trachyline form has before this been shown to be connected with any hydroid condition, but we know less about the Trachomedusæ than about the Medusæ derived from Gymnoblastic or Calyptoblastic hydroids. Direct development has been shown to occur in two or three genera of the Trachylinæ (*Geryonia* &c.), whereas regarding the life-cycle of the other forms we know nothing. The hydroid here described is now in an immature condition. It may be a creeping stolon, which when further developed will resemble the hydroids; it may turn out not to be comparable to other hydroids, and to be a fixed sporosac of some kind; but if it grows into an adult form resembling the form at present known, it may serve as the type of a new group of hydroids related to the Trachyline Medusoids."

Life-history of *Eutima mira*.‡—W. K. Brooks has reared the hydroid of *Eutima mira* from the egg. In the transparent pear-shaped planula the delamination of the entoderm from the inner ends of the ectoderm-cells takes place most rapidly at the small end, but entoderm-cells are formed over the whole inner surface.

After the entoderm is formed, the small end of the planula becomes elongated, and the entoderm is invaginated. The ventral surface of the small end is soon fastened to some solid substance, and the invaginated portion is protruded and pours out its cement. After

* Proc. Roy. Soc., xxxviii. (1884) pp. 9-14 (1 fig.).

† See this Journal, *ante*, p. 72.

‡ Zool. Anzeig., vii. (1884) pp. 709-11.

fastening itself, the planula elongates and forms a layer of perisarc, by means of which it is fastened throughout its entire length. It does not become a hydranth, but a hydrorhiza; the first hydranth is formed as a bud, which grows out at right angles to the long axis at the end opposite the adhering gland.

The formation of the first hydranth from the planula is therefore, in this species at least, a process of metagenesis rather than a metamorphosis, and this is also the case in *Hydractinia*, where the planula becomes a root, and produces the first hydranth by budding.

The young hydranth of *Eutima* has a tentacular web, and the tentacles are situated in definite radii, cp. *Podocoryne hæckelii*. There are five equidistant large tentacles which are the first to appear, and alternating with these five smaller and younger secondary or inter-radial tentacles.

Tetraplatia volitans.*—C. Vignier has a note on this rare Cœlenterate, which has recently been abundant in the Bay of Algiers; after a reference to the work of his predecessors—especially Krohn and Claus—he discusses the nature of the so-called otolith, which has been the chief cause of the animal being placed with the Medusæ. As a matter of fact, the organ is not prismatic in form, but more like a mushroom with a short stalk. There is a central chamber, which is almost entirely filled by the pedicel; with Claus, the author failed to detect any nerve-fibres passing to the organ. Further, with true otoliths, the addition of acetic acid results in the disappearance of the calcareous body, but here the refractive body takes on a brown colour, like the cells that surround it, and retains both its form and size. Lastly, Vignier has been able to note that the body may spontaneously become phosphorescent, and be of a blue colour; he explains the fact that this phenomenon has not been previously noticed by saying that, though he has kept a number of specimens, he only once observed it; but on that occasion it was very well marked.

Australian Hydromedusæ.†—R. v. Lendenfeld describes (Parts 1-3) a series of new species of Australian Hydromedusæ, and proposes a new classification, dividing the Hydromedusæ into four sub-orders and eighteen families. The most interesting of the new forms is *Eudendrium generalis*, the male polypostyls of which show a great similarity to Medusæ. They possess four aboral tentacles in the principal radii, and on these the spermatozoa reach maturity. These tentacular appendages are therefore homologous to the radial canals of the Craspedote Medusæ. *Diphosia symmetrica* nov. sp. produces perfectly bilateral symmetrical female gonangia.

In the 4th part the numerous Australian species of Graptolithidæ, Plumularidæ, and Dicorynidæ are catalogued, and a large number of new species and one new genus (*Pentandra*) discovered by the author are described and figured. The Australian Plumularidæ exceed in number of species those of all the rest of the world put together.

* Comptes Rendus, c. (1885) pp. 388-90.

† Proc. Linn. Soc. N. S. Wales, ix. (1884) pp. 206-41, 345-53 (1 pl.), 401-20 (2 pls.), 467-92 (6 pls.), 581-634 (10 pls.).

In the last part the Hydromedusinae, Hydrocorallinae, and Trachymedusae are dealt with, and the paper concludes with a table of all the known Australian species. The total number of species is 231 (69 genera). The most interesting of the thirty new species are illustrated.

Development of Lucernaria.*—N. Kowalevsky finds that the fertilized ovum divides in the usual manner till thirty-two blastomeres are formed, forming a compact unilaminar morula without a segmentation-cavity. The appearance of the entoderm took place about fifteen hours after the ovum was laid. A single, central, entodermal cell was observed, which may have originated from the central ends of the cells of one side of the morula, but possibly by one of the original cells withdrawing to the interior. Prof. Kowalevsky inclines to the former view, but states that he has seen the entoderm cell with a delicate prolongation extending between the outer cells to the periphery. Multiplication of entoderm cells leads to the previously spherical embryo becoming elongated, the larva assuming the form and structure of a simple hydroid tentacle. In this state the (unciliated) larva creeps about after the manner of a hydra. Towards the third day the formation of nematocysts in the ectoderm begins as small vesicles, and is completed by the end of the third day. On the fourth day the larvæ fixed themselves, and again became round, though somewhat flattened, bodies. The hitherto uniserial entoderm lost its linear character, and formed an entodermic mass sharply marked off from the ectoderm. It was not possible to decide positively whether at this stage there was an entodermic cavity. Soon after fixing themselves a cartilaginous cyst was secreted, and within this the larvæ existed about a fortnight, and then from time to time escaped, and could not be further studied.

Structure of Sarcodictyon.†—W. A. Herdman describes very fully the anatomy and histology of specimens of *Sarcodictyon catenata* Forbes, from Lamash Bay, Arran, and from Loch Fyne. Red and yellow varieties were found at the latter locality. He considers that Forbes' *S. agglomerata* and Pourtales' *S. rugosum* are possibly the same as *S. catenata*, in which case there is only one well-marked species of *Sarcodictyon* known to science.

Porifera.

Nervous System of Sponges.‡—R. v. Lendenfeld describes the presence of nervous elements and ganglion-cells in the Heterocoela (Poléjaeff); such appear to be absent in the Homocoela. In the Sycones the walls of the pores contain groups of spindle-shaped cells, mesodermal in origin, which are frequently connected with branched cells, apparently of a ganglionic nature. In the Leucones sensory cells are present, but not concentrated round the pores; they are scattered

* Zool. Anzeig., vii. (1884) pp. 712-7.

† Proc. R. Phys. Soc. Edinburgh, viii. (1884) pp. 31-51 (3 pls.).

‡ Zool. Anzeig., viii. (1885) pp. 47-50 (2 figs.).

here and there in groups over the general ectodermal surface: no ganglion-cells like those of *Sycones* were discovered. In the *Ascones* (*Homococlea*) the ordinary ectodermic cells appear to perform also the nervous functions. These results clearly show that the calcareous sponges at least can no longer be considered as Protozoa.

Our readers will remember that Prof. C. Stewart exhibited specimens of *Grantia compressa* showing "palpocils" in 1880.*

Occurrence of Flesh-spicules in Sponges.† — R. v. Lendenfeld points out that flesh-spicules are rare in other sponges than such as possess a fibrous reticulate skeleton composed of closely packed siliceous spicules. In confirmation of his hypothesis expressed in a previous paper,‡ that flesh-spicules are of no great systematic value and may occur in any family of sponges, he cites the discovery of a species of the *Aplysillidæ* with numerous anchors in the ground-substance, and a representative of the *Spongida*, a sponge which would otherwise be undoubtedly referred to *Cacospongia*, containing numerous truncate spicules in the ground-substance.

Fibres of certain Australian Hircinidæ.§ — R. v. Lendenfeld finds amongst sponges of the Australian shores a series of forms possessing the filaments characterizing the *Hircinidæ* of the same shape as those of *Hircina*, but which do not appear so smooth. Under a 1/12 in. it is possible to detect minute spots on their surface and on the fibres of the horny skeletons. Those on the latter he considers to be the expression of the spongioblasts, which may not impossibly also form the filaments and cause their spotted appearance. Filaments have been observed growing out from ordinary fibres with which they may have come in contact and been fixed there by succeeding layers of spongiolin. Or they may be *Oscillarians* that have become covered with a thin layer of horny substance, and subsequently absorbed by the sponge and the vacant space filled with horn-substance. A great number of the *Hircinidæ* possess a horn-fibre skeleton differing not only from that of known *Hircinidæ*, but from any known form of horny fibre. Numerous minute horny fibres running in various directions and anastomosing form a column of reticulate horny-substance which corresponds to an ordinary main fibre.

The pigmented cells in some horn sponges which possess filaments may possibly turn out to be small algæ living symbiotically with the sponge.

Development of Spongilla.|| — A. Goette has investigated the developmental history of *Spongilla*, with the result that he has established its fundamental identity with that of sponges in general, as previously described by him. The ectoderm of the larva atrophies gradually, commencing at the border of the ectodermal orifice.

The pseudogastrula of *Sycandra*, *Leucandra*, &c., is really a phenomenon of ectodermal atrophy, and points to a primitive gastrula as in

* See this Journal, iii. (1880) p. 560.

† Proc. Linn. Soc. N. S. Wales, ix. (1884) pp. 493-4.

‡ See this Journal, iv. (1884) p. 394.

§ Proc. Linn. Soc. N. S. Wales, ix. (1884) pp. 641-2.

|| Zool. Anzeig., vii. (1884) pp. 676-9 and 703-5.

all sponges. With regard to the *gemmae*, Dr. Goette agrees with Lieberkühn that these are groups of sponge-cells. At first they are round masses of sub-rotund sponge-cells which then form yolk centrally. The peripheral cells, radially disposed, eventually form a continuous epithelium, the cells of which end, internally, with broad truncated bases. The *amphidiscs* are formed in these bases, not in the convex external portions. A cuticle is developed, but the unorganized mass of gemmule-cells soon creeps from it to form a new sponge. This is really parallel to the manner in which, after disappearance of the ectoderm, the larval metamorphosis of *Spongilla* takes place from an unorganized mass of equivalent entoderm cells.

Observations on some Fresh-water Sponges.* — F. Vějdovsky describes some specimens of *Spongilla sibirica* from the Danici, which he states agrees essentially with the North American *S. fragilis* Leidy, whilst it differs from it in some details. The polar air-tube of *S. fragilis* plays an important part in the existence of the gemmules. It is in direct connection with the low superior process of the gemmule, which is generally regarded as an aperture of issue for the young sponge; but whether it is really an aperture cannot be stated with certainty. It rather appears much more probable that the polar process is completely closed by the horny membrane by which the space within the gemmule appears to be completely cut off from the air-tube. The air-tubes of the dry gemmules are occupied by large air-bladders. They are of comparatively more considerable dimensions than in any other species, and must contain a larger quantity of air in order to sustain the certainly heavier groups of gemmules for a time at the surface of the water.

Spongilla fragilis, and a New Species of Spongilla.† — H. J. Carter alludes to the discovery of *Spongilla fragilis* in the Wye, and describes a new species (*S. Mackayi*) from Nova Scotia.

The most remarkable point presented by the latter is that its flesh-spicule is identical with that of *Meyenia Everetti*, whose statoblast is covered with a thick crust of long and large birotules, denticulated with recurved teeth like those of *Meyenia Baileyi*, &c., showing that this kind of flesh-spicule may be present in totally different species of fresh-water sponges, unless it should be owing to the presence and proximity of *M. Everetti*, which grows in the same lake. The spiculation, too, both skeletal and flesh, is almost identical with fresh-water sponge-spicules from alluvial deposits in Bavaria.

Protozoa.

Erythroopsis agilis.‡ — R. Hertwig brings forward a number of facts to show that his lately discovered *E. agilis* cannot, as Vogt thinks, be *Spastostyla sertulariarum*.§ It is nearly three times the size; its tail-like muscular appendage is 3–4 times the length of the

* SB. K. Böhm. Gesell. Wiss., 1884, pp. 55–60 (1 pl.). Ann. and Mag. Nat. Hist., lxxxv. (1885) pp. 13–18.

† Ann. and Mag. Nat. Hist., lxxxv. (1885) pp. 18–20.

‡ Zool. Anzeig., viii. (1885) pp. 108–12.

§ See this Journal, *ante*, p. 77.

long axis of the body, instead of being only about the length of the long axis; it moves by contractions of its appendage, and not as do freed Vorticellines by the anterior circle of cilia; its form is exactly the opposite of that of *Spastostyla*; its body is grooved, and not smooth; it has no peristome, and seems to have no mouth; its protoplasm is not colourless, but reddish brown; it is without symbiotic zooxanthelli. Its pigment body differs from the ocellus of *Lizzia*, which Vogt supposed had been swallowed by being acellular, sharply limited at its edges, and the lens-like body is large, and is partly dissolved by osmic acid. Other points of difference are noted.

Protozoa of the Gulf of Genoa.*—Dr. A. Gruber describes 30 new species of Protozoa, which include the types of seven new genera besides a number of others already known, from the Gulf of Genoa. The new genera he names as follows:—*Craterina mollis*, *Urnulina difflugiaformis*, *Spirostomina lucida*, *Orthodon hamatus*, *Hypocoma parasitica*, *Stylocoma oviformis*, and *Polymastix sol*; all these new genera and species, as well as several others previously known, are described and figured.

Craterina mollis is a peculiar rhizopod; the protoplasm is surrounded by a thick sheath, which does not appear to be chitinous, but merely a thickened portion of the protoplasm itself; one end possesses an aperture leading through the outer sheath in the form of a funnel apparently lined by a continuation of the sheath. No nucleus was discovered.

Urnulina difflugiaformis is a monothalamous rhizopod possessing a somewhat oval shell composed of sand particles and opening by a widish aperture. Only a single specimen was seen alive, and no details can be given as to the condition of the protoplasm, though no nucleus appears to be present.

Spirostomina lucida is a heterotrochous infusorian chiefly remarkable for the presence of two nuclei; either one or a great number are characteristic of the group.

Orthodon hamatus, though differing generically from all other Infusoria, does not seem to present any special features of interest.

Hypocoma parasitica.—This species, which is excessively minute, is found attached to colonies of *Zoothamnium*; the under surface, where the cilia are borne, is sunk below the remainder, and very likely serves as a disk of attachment; they appear to feed upon the *Zoothamnium*.

Stylocoma oviformis.—The body is oval, going to a point behind; in front of the mouth is a kind of collar, projecting in front of the rest of the body; the cilia of the body are arranged in a rather unusual fashion.

Polymastix sol is a flagellate infusorian with radiately arranged flagella—a remarkable feature in the group. Its appearance is strikingly like that of a Heliozoon; but as the flagella are movable they are clearly flagella, and not rigid pseudopodia, like those of a Heliozoon.

* Nova Acta Acad. Leop.-Carol., xlvii. (1884), 67 pp. (5 pls.).

New Fresh-water Infusoria.*—A. C. Stokes describes some new fresh-water Infusoria.

Euglena torta n. sp. bears only the remotest resemblance to any known member of its genus. Its characteristic features are the spiral grooves or keel-like ridges traversing the entire body from anterior extremity to posterior acumination.

Phacus anacelus n. sp. resembles the foregoing in movement, but in little besides.

Vorticella smaragdina n. sp. is in colour a translucent homogeneous emerald green. It has a frequently exercised tendency to a characteristic change of form by retracting the borders of one side of the extended body so as to produce a deep depression, and exhibits a habit of sheathing the distal end of the pedicel in the posterior extremity of the body. The cuticular surface is transversely striated by depressions so fine that they are ordinarily visible only at the lateral borders or after manipulation with the mirror. Minute granules occasionally roughen the surface.

V. macrocaulis n. sp. resembles *V. longifilum* S.K., but is distinguished by its surface striations; whilst the pedicel is ten or twelve times the length of the extended zooid.

V. utriculus n. sp. resembles in form the marine *V. striata* Duj., of which it may be a fresh-water variety. In its habitat it is disposed to be solitary.

V. macrophya n. sp. bears a striking resemblance to *V. cucullus* From., but is distinguished by the presence of cuticular striæ, and the absence of the cushion-like ciliary disk.

All the above forms occur in shallow ponds in Western New York.

Zoothamnium adamsi n. sp. was found attached to *Cladophora glomerata* on the shore of Luna Island in the rapid water of the Niagara river. In external form it resembles Kent's *Z. simplex*; but the cuticular surface, instead of being smooth, is finely and delicately striated transversely. After the colony has been under observation for a prolonged period an action takes place, unrecorded with any member of the genus. "Two neighbouring zooids fold together their ciliary apparatus, and their own private footstalks retract into coils without disturbing the general equanimity of the community. This has been observed repeatedly, the retracted muscular thread being in every instance in apparent connection with that of the remainder of the pedicel. This thread, however, seems to be delicate. For no visible reason it soon separates into scattered fragments within the sheath. In those instances just referred to an inappreciable separation had probably taken place."

A. C. Stokes also describes † the following:—

Opercularia plicatilis n. sp. occurs in colonies of comparatively such immense size that they are visible to the naked eye. In the contracted phase the posterior transverse annulations closely resemble those characteristic of *Epistylis plicatilis* Ehr.

* Amer. Natural., xix. (1885) pp. 18-27 (8 figs.).

† Amer. Mon. Micr. Journ., v. (1884) pp. 226-30 (10 figs.).

Epistylis vaginula n. sp. owes its name to the peculiar formation of a sheath over the end of the footstalk by the extremity of the contracted body, which is characteristic and of diagnostic value.

Euplotes plumipes n. sp. is characterized by the finely fringed extremities of the anal styles. The dorsal surface is often ornamented by longitudinal rows of minute prominences in stellate clusters. Conjugation takes place and reproduction, in which there are some points of unusual interest, by transverse fission.

Cyclidium litomesum n. sp. is distinguished from all other members of the genus by the extreme length of the posterior setæ, and by the unclothed central region of the zooid.

New Choano-Flagellata.*—A. C. Stokes describes new forms of these Infusoria from ponds in Western New York.

Monosiga obovata n. sp.—The body bears a remote resemblance to that of *M. angustata* S.K., but the creature conspicuously differs in being elevated on a long pedicel, in the relative shape of the body, and in its much greater size.

Codosiga utriculus n. sp. has the zooids attached in clusters of four to the summit of a straight rigid footstalk. This arrangement leads the author to discuss Kent's *Codosiga umbellata*, and to state his belief that the typical form of this latter species has the quadripartite pedicel, whilst the bitripartite is the variety.

In *C. magnifica* n. sp. the main stem is considerably longer than that of *C. umbellata*, and bears just twice as many primary branches, each of these being furcated, and each of the secondary branches giving origin to four branchlets, every one of which usually supports two zooids. The entire formation is easily distinguishable under a 1 in. objective.

Salpingæca sphericola n. sp. and *S. lagena* n. sp.—The latter differs from all known pedicellate species in the evenly rounded contour of the lorica base.

Flagellata (Dinobryon) as Members of the Pelagic Fauna of Lakes.†—O. E. Imhof has found two new forms of *Dinobryon*, *D. calyculatum*, and one provisionally named *D. petiolatum*; he considers that the identification, attempted by Kent, of *D. petiolatum* Dujard. with *Poteriodendron petiolatum* Stein is not correct. The form of the chambers of each individual and their arrangement in colonies is entirely different in the two species. He has found species of *Dinobryon* (the descriptions of which are promised) in numerous lakes in Savoy, Upper Italy, Switzerland, the Tyrol, Upper Bavaria, Salzburg, and Styria, and he contemplates shortly publishing his results on the extension of the pelagic fauna, according to his personal researches, over sixty-five lakes in the countries named, as well as the results relating to the deep fauna of a great number of them.

Calcituba polymorpha.‡—This is a new genus and species of imperforate Foraminifera from the Adriatic, discovered by Dr. Zoltau

* Amer. Mon. Micr. Journ., vi. (1885) pp. 8-12 (7 figs.).

† Arch. Sci. Phys. et Nat., xii. (1884) pp. 442-3.

‡ SB. K. Akad. Wiss. Wien, lxxxviii. (1883) pp. 420-32 (1 pl.).

v. Roboz. It occurs fixed on algæ in masses of very variable size, form, and arrangement, occurring in monothalamous, dithalamous, trithalamous (with the broad third chamber communicating externally by two adjacent apertures), and polythalamous forms. Six chambers was the maximum ever observed. The thin, porcellanous, calcareous shell is so transparent as to let the brick-red granular protoplasm be seen beneath. There are numerous pores, and the mouth is always at the free end of the chamber. The protoplasm does not fill the shell, but sends off delicate hyaline threads to the shell-wall. The anastomosing pseudopodia serve exclusively for getting food. Numerous round nuclei were observed in polythalamous forms, but only one in monothalamous forms (cf. Hertwig's observation on young *Miliolidæ*). The classificatory position of *Calcutuba* is among the *Miliolidæ*, of which family it is a primitive example not yet definite in form.

Archerina Boltoni.*—E. Ray Lankester gives an account of a new genus of Protozoa, allied to *Vampyrella*, and remarkable for being chlorophyllogenous; it was discovered by Mr. T. Bolton in ponds in the neighbourhood of Birmingham, associated with desmids and other minute chlorophyll-bearing algæ.

The first growth-phase observed is the Actinophryd-form, in which there is a spherical body $1/2000$ in. in diameter, consisting of a sharply outlined mass of refringent protoplasm, from which radiate a number of very delicate but stiff filaments; these are motionless. Within the body is a large spherical vacuole, and sometimes the whole appears of a bright green colour; when, however, the organism is caused to roll over the green colour is seen to be limited to two masses—a bifid, or in other cases a single chlorophyll-corpuscle; this takes the place of a nucleus, and round it there centre the life and growth of *Archerina*; its division precedes and is invariably followed, sooner or later, by that of the protoplasm of the whole organism. There is no evidence at all that this is a cell-nucleus; no chromatin-substance is to be observed at the time of division, and the process usually results in the formation of four and not of two daughter-bodies.

The author discusses the parasitic nature of chlorophyll-corpuscles in *Hydra*, and urges that the "tetra-schistic corpuscles" of both *Archerina* and *H. viridis* do not resemble any known unicellular green alga, and that there is no reason "for attributing to them a fanciful origin and history differing essentially from that of other coloured corpuscles and such products of the modification of cell-substance."

Stages of encystation and of vegetative growth are next described; and we have then an interesting account of a very curious characteristic. "Groups of ghost-like outlines corresponding to chlorophyll-corpuscles and their radiant filamentous pseudopodia, entirely devoid of any substance," were observed; these are regarded as being undoubtedly skeletal products of the solid protoplasm which has withdrawn from them; they may be compared to the numerous cellulose

* Quart. Journ. Micr. Sci., xxv. (1885) pp. 61-74 (1 pl.).

chambers secreted and abandoned by the protoplasm of Archer's *Chlamydomyxa*; and they are of especial interest as giving the first indication of pseudopodia being capable of secreting a membranous investment. With this may be compared Gruber's statement (see next note) as to the existence of a cuticula-like layer in *Amœbæ*.

Archerina is one of the non-nucleate Gymnomyxa, and in respect of its abundant colony-formation reminds us of *Microgromia socialis*.

Studies on Amœbæ.*—A. Gruber, after descriptions of *Amœba villosa* Leidy and of the new species *A. prima*, *secunda*, *tertia*, *quarta*, *quinta*, *binucleata*, and *lucida*, as well as of *A. verrucosa* and *A. proteus*, finds that the facts here related show that there are a number of separate and exactly definable *Amœbæ* which do not pass into one another; he has convinced himself of this by observing for months and even years forms living in the same locality. The diagnosis of an *Amœba* must be based on its average size, the consistency of the protoplasm, and the movements thereby conditioned, as well as on the characters of its contents, such as vacuoles, granules, crystals; but chiefly on the number, size, and structure of the nuclei. Five of the species described in the present essay are multinuclear, and it is proved how definitely the nuclei are distinguished from one another, and with what certainty one can conclude from external characters on the structure of the nucleus, and *vice versâ*. Thence results the remarkable fact that two very similar species of *Amœbæ* may have very differently formed nuclei, and that in forms which are externally very different the nuclei may be quite similar. In any case the number of the different forms of nuclei is much more important than has hitherto been supposed.

We cannot as yet form any idea of what are the differences in the protoplasm that are of significance; the conditions of existence appear to us to be the same for all *Amœbæ*; many indeed live in the same places and on the same kinds of food. This resemblance is, however, perhaps not real, and we must believe that natural selection has had the same influence in fixing variations among *Amœbæ* as with higher animals. Gruber thinks that Carpenter is in error in excluding the Foraminifera from this influence and in referring the development of the cornuaspire of *Orbitolites* to an internal tendency to variation.

Though we cannot discover any law in the changes of the amœba-body, nor explain the causes of the phenomena of adaptation, it is not right to set them aside. The large number of variations among *Amœbæ* show us that protoplasm is a material which can be moulded into an interminable number of forms, and if here the smallest changes in its constitution are seen to be sufficient to form a new species, we can hardly wonder at the variety of adaptations which are seen when cells are compounded into Metazoa.

Gruber is, further, of opinion that the discrimination of zones of different kinds of protoplasm is due to a misunderstanding; the amœbic body always consists of a single mass of protoplasm in which the various contents lie suspended; where the plasma is fluid the

* Zeitschr. f. Wiss. Zool., xli. (1884) pp. 186-225 (3 pls.).

contents are well distributed, but when it is firmer they do not mix so easily with it; this is the cause of the appearance of a hyaline ectoplasm and a granular endoplasm. The only differentiation in the body of an *Amœba* obtains at the outermost periphery, where the protoplasm—clearly from contact with water—is converted into an invisible cuticula-like layer, which disappears during the outpushing of the pseudopodia and can be re-made.

He is not able to confirm the account of a plexiform structure of the protoplasm, as given by Heitzmann; nor does he allow that the refractive bodies which have been described by Greef in *Pelomyxa palustris* are ever to be found in *Amœba*; he has examined *P. villosa*, where they are certainly absent. The pale filaments found in some *Amœba* appear to be symbiotic fungi; in one species which was remarkable for the constant collection of chlorophyll-containing food they were always present.

The species lately described by Leidy and found by Gruber in Europe confirm the doctrine that the fresh-water Rhizopods are cosmopolitan organisms.

Psorosperm in the Human Pleural Cavity.*—After a lengthy summary of all that is known concerning the Psorosperms, J. Künstler and A. Pitres give a detailed description of a species found in the pus from the human pleural cavity. At the moment of extraction this pus was white, opaque, thick, perfectly homogeneous, and of an oily consistency, without the least disagreeable odour. Examined eighteen hours afterwards without the addition of any reagent it was found to contain *inter alia* some ovoid or fusiform corpuscles, pale and of a hyaline appearance, with sharply cut contour, swimming freely in the fluid or inclosed in variable numbers in hyaline cysts. They varied largely in size, from 18 μ to 100 μ in length, and many appeared to be undergoing fission.

These corpuscles consist of an envelope inclosing a protoplasmic body. The envelope is thin, continuous throughout, and exhibits oblique undulating striæ which form an integral part of the structure of the membrane, and are not due to superficial costæ. The protoplasm is finely granular and completely fills it. It incloses a rounded nucleus. The largest corpuscles, far surpassing the ordinary ones in size, were filled with fusiform corpuscles, the result of endogenous generation. As these fusiform bodies were a little larger than the smallest of the free specimens, it is inferred that the latter are due to fission. No amœboid state nor any trace of intercellular life was observed. In position this parasite is nearest to that division of the Psorosperms known as *Coccidia monospora*, and it seems closely allied to the corpuscles found by Arloing and Tripier in the viscera of the chicken.

New and Little-known Protistæ.†—Prof. Parona describes the following Protistæ from Sardinia:—

Diplodorina Massoni From. (Par.) is fully discussed by the author,

* Journ. de Microgr., viii. (1884) pp. 469-74, 520-6 (2 pls.).

† Atti Soc. Ital. Sci. Nat., xxvi. (1883) pp. 149-59 (1 pl.).

who is led by his investigations of the Sardinian specimens to give an amended diagnosis of the species. *Zigoselmis leucoa* From. According to the author's observations the different forms of development of this species are found as spherical corpuscles of sporiform aspect, different dimensions, and vivid rosy colour. These are sometimes met with in immense quantities in saline waters; and so abundantly as to colour the water itself red, a well-known phenomenon at the salt springs. These sporiform corpuscles have a distinct contour and a well-marked granular internal substance, some appearing colourless. Two new species of *Amœba*, *A. digitata* and *A. velata*; a variety of *Acineta linguifera* C. & L. var. *interrupta*, and a new form of *A. Cattanei* n. sp. Also *Magosphœra Maggii* n. sp., forming a spherical group consisting of unicellular organisms or ciliated spherules, distinctly nucleated and colourless, with flagelliform prolongations directed towards the centre of the sphere and cilia at the opposite extremity pointing outwards. Prof. Parona considers that this represents an organism morphologically antecedent to *M. planula* Hæck.

BOTANY.

A. GENERAL, including the Anatomy and Physiology of the Phanerogamia.

a. Anatomy.*

Structure and Division of the Nucleus.†—In pursuance of his previous researches † on this subject, L. Guignard has continued his examination of the phenomena attending the division of the nucleus, chiefly in the endosperm-cells and mother-cells of the pollen of Endogens. Using appropriate reagents and a No. 12 homogeneous-immersion objective of Verick, with condenser, he found, in the nucleus of the mother-cells of the pollen in several Liliaceæ, that the thread is sometimes formed of two series of chromatic granulations, even before its transverse segmentation. These granulations, placed side by side, appear to result from the doubling of granulations previously larger and placed in a single line. This doubling does not extend to the hyaloplasm, and it is not usually visible until after the transverse segmentation of the filament.

One point in which the indirect division of the nucleus differs in animals and in plants, is the occurrence of the amphiaster in the

* This subdivision contains (1) Cell-structure and Protoplasm (including the Nucleus and Cell-division); (2) Other Cell-contents (including the Cell-sap and Chlorophyll); (3) Secretions; (4) Structure of Tissues; and (5) Structure of Organs.

† Bull. Soc. Bot. France, xxxi. (1884) pp. 324-30.

‡ See this Journal, iii. (1883) p. 864; iv. (1884) p. 915.

former, which has not yet been detected in the latter; and M. Guignard has endeavoured to determine whether this difference really exists. The young embryo-sac of *Lilium* has a large nucleus situated in the centre of a granular protoplasm which forms a sort of narrow-meshed network filling up the cell. The long nuclear spindle is remarkably clear, and at each of its extremities the chromatic threads of which it is composed all converge to the same point. The nuclear plate has the appearance of a star with twelve rays; it is formed of double often straight chromatic segments, with one extremity supported on a chromatic thread, the other turned towards the periphery. At the two poles, suitable reagents, and especially bichloride of mercury, reveal a radial disposition of the protoplasmic granules. The radial arrangement of the protoplasm is also very evident round the nuclei at the time when they are about to divide.

The longitudinal doubling of the chromatic segments of the nuclear plate above described is very evident in all nuclei the size of which is sufficient to permit the observation; as in the mother-cells of the pollen of Liliaceæ, Amaryllideæ, Ranunculaceæ, Magnoliaceæ, &c., in the endosperm after impregnation, and in other vegetable tissues. In some other cases this doubling is difficult, or almost impossible, to determine.

Chromatine in Cell-division.*—A. Brass and Fraisse have investigated the part played by chromatine in the phenomenon of cell-division. It is not constant, being wanting in cells that have been starved for a time. It seems, therefore, to have no other function than that of providing nutriment. Its staining properties are not a proof of physiological importance. On the contrary, the active part in these phenomena devolves upon the protoplasmic filaments which do not take artificial colouring. Professor H. Fol † has been able to establish directly the movements of these achromatic filaments during the segmentation of the eggs of the sea-urchin.

Siliceous Membrane with Properties of the Cell-wall.‡—A. Famintzin has constructed artificially, by the action of concentrated hydrochloric acid on soda-glass, an excessively thin perfectly transparent siliceous membrane having many of the properties of the cell-wall and of starch-grains. These membranes allow osmotic currents to pass freely through them, and their reactions with fuchsin and carmine-solution are the same as those of vegetable membrane; the former they absorb eagerly with very deep staining, while towards the latter they are perfectly indifferent. They also swell up in water to the extent of about 5 per cent.; and this must therefore be regarded, not as a special property of organized structures, but rather as one belonging to all colloidal bodies.

* Arch. Sci. Phys. et Nat., xi. (1884) p. 320.

† Loc. cit.

‡ Bull. Acad. Imp. Sci. St. Petersbourg, xxix. (1884) pp. 414-6.

Chemical Reactions of Chlorophyll.*—A. Tschirch points out in the following table the differences in the reactions of pure chlorophyll and of the green anilin-dyes.

	Chlorophyll.	Green Anilin-dyes.
Hydrochloric acid	Blue.	Yellow.
Ether	Yellow (colourless when xanthophyll is absent).	Colourless.
Spectroscopic examination	Dark band in the red (3 bands from yellow to green).	Inner band in the red.
Fluorescence	Red, even in very dilute solutions.	None.

The chlorophyll-pigment of commerce is a mixture of pure chlorophyll and xanthophyll. These may be separated by a surface layer of benzin, which removes the chlorophyll. Insolation by direct sunlight may also sometimes be used; the sunlight removing the colour from chlorophyll-connyl.

Colouring-matters of Flowers and Fruits.†—A. Hansen asserts that the great variety in the colour of flowers can be referred to a very small number of original pigments. Excluding chlorophyll, the remainder may be divided into three main groups, viz. :—(1) yellow colours; (2) red colours; (3) blue and violet colours. Of these the first group resemble chlorophyll-green in being connected with organized protoplasm-structures, while the members of the two other groups are closely connected with one another, and sharply separated from the yellow pigments, occurring always dissolved in the cell-sap.

The yellow pigment of flowers has the form of an oily compound imbedded in a protoplasmic matrix, whence its insolubility in water. Hansen terms it "lipochrome," from its resemblance to that animal pigment. It crystallizes in needles, insoluble in water, but readily soluble in alcohol, ether, chloroform, petroleum-ether, and bisulphide of carbon. In the solid form it is coloured blue by sulphuric acid, and green by biniodide of potassium. Its spectrum exhibits scarcely any variability; its solutions do not display fluorescence. An orange tint is produced by a dense accumulation of lipochrome in the chromatophores. In a few cases, as the flowers of the dahlia and the rind of citrons, the yellow colour is not produced by lipochrome, but by a yellow pigment dissolved in the cell-sap.

The red colours of flowers may all be referred to a single red

* Vers. Deutsch. Naturf. u. Aerzte Magdeburg, Sept. 23, 1884. See Bot. Centralbl., xx. (1884) p. 122.

† Verh. Phys.-med. Gesell. Würzburg, xviii. (1884) pp. 109-27 (2 pls.).

pigment, seen in the pink pigment of roses, pinks, and peonies. It is soluble in water and alcohol, and can be obtained by evaporation in the solid form. The alcoholic solution is nearly colourless, but is turned red by a drop of hydrochloric acid; ammonia and alkaline carbonates turn it green, caustic alkalies yellow; acids restore the red colour. Its spectrum is characterized by a broad absorption band between D and F. The scarlet colour of such flowers as the poppy is the result of the presence of yellow grains of lipochrome in addition to the red cell-sap; and all intermediate shades are caused by the relative proportion of these substances. The red colours of fruits are due to similar causes.

The blue and violet pigments appear not to be independent, but derivatives of the red. When extracted by alcohol, a drop of acid produces a red colour. The frequent change of colour in flowers from red to violet, as in many Borraginæ, is probably due to acid salts in the sap.

The general conclusion is that while all other vegetable pigments are closely related to one another, chlorophyll-green is a substance *sui generis*.

Red Pigment of Phanerogams.*—H. Pick replies to Wortmann's objections brought against his argument † that the red colouring matter of plants has frequently the object of materially assisting the transport of starch in the plant.

Mechanical Function of Crystals of Calcium Oxalate.‡—P. Baccarini suggests that the sclerenchymatous thickening of cell-walls and the deposition of large quantities of crystals of calcium oxalate, such as occurs in *Viola*, *Colletia*, *Rhipsalis*, *Eryngium*, &c., are alternative processes, both intended to answer the same purpose of furnishing a mechanical strengthening to the tissue, and that, consequently, the two phenomena are very rarely found accompanying one another. Especially does the deposition of masses of crystals in the receptacle and ovary, particularly in the Rosaceæ and Compositæ, form a kind of false tissue.

Starch-meal.§—A. Tschirch points out the necessity of separating the leading forms or types of starch-grains from the secondary forms; it is only from the former that any accurate judgment can be formed. He gives, as an example, the difference between the typical forms of the grains in bean- and pea-meal. The typical for the bean is elongated and bean-shaped, triangular, oval, with large longitudinal fissure and evident lamination. For the pea the type is roundish with cushion-like projections, indistinct lamination, and more often radial striation. The fissure is altogether wanting or very feebly developed. Secondary

* Bot. Ztg., xlii. (1884) pp. 841-3.

† See this Journal, iv. (1884) p. 257.

‡ Ann. Ist. Bot. Roma, i. (1884) 8 pp. (1 pl.). See Oester. Bot. Zeitschr., xxxix. (1884) p. 446.

§ Vers. Deutsch. Naturf. u. Aerzte Magdeburg, Sept. 23, 1884. See Bot. Centralbl., xx. (1884) p. 122.

forms occur in both cases, either resembling the other form or small and roundish. The bean-form occurs in *Faba* and *Dolichos*, viz. small oval grains with longitudinal fissure.

Function of Latex in the Compositæ.*—Mlle. A. Leblois has confirmed, by a special series of experiments, the view of Van Tieghem that the latex is of the nature of a secretion, rather than that of M. Faivre, that it is a reserve food-material. A strong confirmation of this view is that the latex, as for example in *Scorzonera*, is entirely wanting in the embryo.

Influence of Light on the Development of the Assimilating Tissue of Leaves.†—S. Groszlik has examined the structure of the heteromorphic leaves of *Eucalyptus globulus*, and finds that the difference in form corresponds to a difference in anatomical structure. The assimilating tissue of the horizontal leaves is constructed on the dorsiventral type, while in the narrow vertical leaves the two sides are precisely alike. The latter show palisade-parenchyma on both sides, the former on the upper side only, the lower side being provided with spongy parenchyma. The young leaves have always at first a vertical position, from which they pass gradually to the horizontal, their internal structure going through corresponding changes. In the vertical leaves the tissue immediately beneath the large-celled epidermis is composed of similar isodiametric cells, having in its centre a yet feebly developed vascular bundle. It already contains chlorophyll-grains. Groszlik proposes for this tissue the term primary mesophyll. From this primary mesophyll the assimilating palisade-parenchyma is developed at a subsequent stage. It is formed at first beneath the epidermis on both sides of the leaf, and is even more strongly developed on the under side; at one period the mesophyll consists almost entirely of palisade-parenchyma; but as the under side of the leaf passes more and more into the shaded condition, it gradually becomes converted on that side into spongy parenchyma.

In other leaves examined by him the author finds that the formation of true palisade-parenchyma is preceded by that of primary mesophyll, which has been mistaken by Pick ‡ and others for palisade-parenchyma; the differentiation of palisade and spongy parenchyma takes place only at a comparatively late stage.

Cortical Fibrovascular Bundles of Viciææ.§—In the tribe Viciææ of Papilionaceæ the stem is furnished with cortical fibrovascular bundles; and the leaves being distichous, the number of these bundles is reduced to two. In most cases, at each node the cortical bundles completely disappear and are completely replaced; but P. Van Tieghem describes several departures from this normal structure in various species and in the same species at different periods.

* Bull. Soc. Bot. France, xxxi. (1884) pp. 122-4.

† Bot. Centralbl., xx. (1884) pp. 374-8.

‡ See this Journal, iii. (1883) p. 92.

§ Bull. Soc. Bot. France, xxxi. (1884) pp. 133-5.

Formation of Centrifugal Thickenings in the Walls of Hairs and in the Epidermis.*—H. Schenck has carefully investigated the mode of thickening of many epidermal structures, with the view of testing whether it is best explained on the basis of Nägeli's theory of intussusception or Strasburger's of apposition. His general conclusion is that the external projections on cell-walls are sometimes the result of foldings which are afterwards filled up by apposition, sometimes of growth by intussusception, though using the term in a somewhat different sense from that of Nägeli. Among the structures examined were the hooks on the hairs of the fructification of *Marsilea*, the hollow hairs on many plants which subsequently become filled up, the hairs on the nodes of *Coleus*, the epidermis of petals, and many others.

Mechanical Sheaths to Secretion receptacles.†—K. Möbius describes the mechanical protections sometimes found in schizogenous intercellular resin-passages, as in the leaves of *Pinus* and in the adventitious roots of *Philodendron*. They consist of one or more layers of elongated cells with sclerenchymatously thickened walls. The arrangement occurs in several different forms, which are described in detail. Less striking instances occur in the primary cortex of the ivy, the periphery of the leaf-stalk of *Angiopteris*, and elsewhere.

Curvature of Ovules.‡—P. Van Tieghem proposes to define more accurately than has hitherto been done, the exact mode of curvature of anatropous and campylotropous ovules; the terms suggested are taken from those already used in describing the unsymmetrical development of leaves. Van Tieghem proposes to call an anatropous or campylotropous ovule *hyponastic* when the curvature is in an upward direction, *epinastic* when in a downward direction, *exonastic* when the curvature is horizontal towards the median nerve of the side of the upper face of the carpel, *endonastic* when the curvature is horizontal towards the edge of the carpel. These specialities are often characteristic of the whole of large natural orders; sometimes of special tribes or even genera within an order.

Sexual Characters in Zinnia.§—T. Meehan remarks on the change of sexual character which follows the change of a tubular to a ligulate floret in *Zinnia*, *Dahlia*, and he believes all composite flowers. In *Zinnia* a single ligulate floret would often be surrounded by tubular and hermaphrodite ones; but it would have the purely pistillate character of the ray florets. In like manner when in the double *Dahlia* the tubular florets become ligulate, the neutral character of the ray florets follows with them. It is evident that in these cases there is an intimate connection between the form of the floret and its sexual character.

* Schenck, H., 'Unters. über d. Bildung von centrifugalen Wandverdickungen an Pflanzenhaaren u. Epidermen.' Bonn, 1884, 42 pp. (1 pl.). See Bot. Ztg., xlii. (1884) p. 733.

† Vers. Deutsch. Naturf. u. Aerzte Magdeburg, Sept. 20, 1884. See Bot. Centralbl., xx. (1884) p. 62.

‡ Bull. Soc. Bot. France, xxxi. (1884) pp. 67-70.

§ Proc. Acad. Nat. Sci. Philad., 1884, p. 210.

In many Compositæ the growth of the pistil continues for a day or two after the corolla has ceased to grow; in *Zinnia* the growth of the floret is enormous on the last day, often doubling its length.

Elasticity in the Filaments of Helianthus.*—T. Meehan points out that in *Helianthus lenticularis* Douglze, after the corolla tube has reached its full length, the staminal tube commences to grow beyond the mouth of the corolla and ultimately extends to about one-fourth the whole length of the latter. The pollen, forced up by the growth of the pistil within, then commences to emerge through the upper portion of the staminal tube, which, the stamens narrowing, has the apices free, till a large amount has accumulated at the apex of the tube. The following day the arms of the pistil emerge and commence to expand, the staminal tube at once begins to descend, and by the end of the third day has retired entirely within the tube of the corolla, and with the pistil commences to wither. Throughout the whole course the column of united anthers remains entirely of the same length. It is the filaments only which are elastic. These stretch fully one-half their length. The phenomenon is accompanied by a change in the form of the floret. The extension of the staminal tube is, the author considers, evidently mechanical, and is due solely to the upward growth of the stigma, which, partly it seems by the incurved points of the stamens, and partly perhaps by the expansion of the arms of the pistil, is able to carry the tube up with it. This force being removed as soon as the arms emerge, the elastic stamens draw the tube down again to its normal location. The effect of this process is to render the plant strictly a self-fertilizer. *Helianthus hirsutus* exhibits similar features.

Movements of Andrœcium in Sunflowers.†—Alluding to T. Meehan's paper on the elasticity of the filaments of *Helianthus*,‡ Asa Gray says the retraction of the filaments is due to "automatic or irritable shortening," as in the thistle tribe, and not to elasticity; nor is the anther-tube carried up to its full height by the elongation of the style within, as may be readily tested by snipping off the anther-tips with scissors when no retraction follows. Only after the anther-tube has attained its full height is the tip of the style in contact with the anther-tips. He also finds that (contrary to Mr. Meehan's view) sunflowers are largely visited by bees, and by them cross-fertilized.

Haustoria of Parasitic Phanerogams.§—J. Schrenk describes the mode of attachment of the root of several parasitic species of *Gerardia* to that of the foster-plant, *Corylus rostrata*. It is effected by means of haustoria, which make their appearance as small tubercles on the branches of the root, the cells of which are in open communication with those of the foster-root by the disappearance of the separating walls. The merismatic active cells of the haustorium enter the

* Proc. Acad. Nat. Sci. Philad., 1884, pp. 200-1 (2 figs.).

† Ibid., pp. 287-8.

‡ *Supra*.

§ Bull. Torrey Bot. Club, xi. (1884) | p. 103-14 (1 pl.).

vessels of the foster-root bodily after the walls of the latter have been partly absorbed. There is therefore no difficulty in a perfectly free interchange of cell-contents between the foster-plant and the parasite.

Organs of Secretion in Pines and Larches.*—H. Mayr treats in great detail of the mode of formation and distribution, in the families of conifers named, of these organs, which he determines to be invariably of schizogenous and protogenous origin, i. e. to be inter-cellular receptacles for resin.

Distribution of Honey-Glands in Pitchered Insectivorous Plants.†
—J. M. Macfarlane describes the distribution of honey-glands in *Nepenthes*, *Sarracenia*, *Darlingtonia*, and *Cephalotus*. In *Nepenthes Mastersiana* they are found on the outer surface of the pitcher, and exactly resemble those on the inner surface of the lid, except that the gland fossa is deeply hollowed out, and opens externally by a small orifice, while its inner surface is clothed to within a short distance of the orifice by the gland tissue, very much as in sphaeriaceous fungi the cavity of the perithecium is lined by asci. On the outer surface of the lid are a few similar glands; and a like condition is found to occur in all the other species yet examined. Glands are scattered rather sparingly over the upper, but pretty abundantly over the under surface of the lamina. The tendril between the lamina and pitcher also possesses them. On the stem some species have them very sparingly, others in considerable number; but, while resembling those on the leaf externally, they are sunk much deeper in the cellular tissue of the layer, and remind one of a simple animal gland. A complete pavement of glands the same in size and appearance as those on the inner surface of the lid of the pitcher, is spread over the upper epidermis of each sepal. A few large "perithecioid" glands may also be seen on the lower epidermis. In *Nepenthes*, therefore, the same structure which by its secretion attracts insects for aiding in fertilization also lures them to the pitcher, so that their dead bodies may help in the nutrition of the plant.

The other three genera are dealt with, and all four found to agree fundamentally in their morphological arrangements for physiological purposes, though referable to orders so widely separated systematically.

Nectar-Glands of *Apios tuberosa*.‡—A. F. Foerste describes the occurrence of extra floral honey-glands on this plant. The flowers are arranged in dense panicles having the appearance of racemes. The main axis of each bears at short distances the secondary racemes, each of which carries three flowers at the very base of the short stubby axis of the raceme; the top of this axis suddenly becomes truncated, and on the flattened surface are the remaining aborted flowers, which under a low power appear as so many clusters of lanceolate scales. These usually fall off a short time before the

* Bot. Centralbl., xx. (1884) pp. 23-5, 53-6, 86-91, 117-21, 143-53, 183-90, 213-9, 246-53, 278-83, 308-10 (3 pls.).

† Nature, xxxi. (1885) pp. 171-2.

‡ Bull. Torrey Bot. Club, xi. (1884) pp. 123-5 (9 figs.).

flowering of the three lower members of the raceme. Their locality, however, is marked by small rings, slightly raised above the flat surface formed by the end of the axis, and arranged spirally. While the flowers of the lower raceme are in blossom, the first two or three of these rings are exuding a kind of honey; only one or two, however, seem to yield it at the same time. The honey flows freely, and when removed is replaced in less than two or three minutes.

These glands being extra-floral seem to take no part in cross-fertilization, but they are abundantly visited by ants. The plants are free from insects before the period of honey secretion as well as afterwards, whilst any attempting to get at the flowers during their period of blossoming would be effectually "crawled over" by the ants. The ends of the panicle with the raceme belonging to them never mature; a short time before flowering they fall off at a clean-cut joint. The presence of bees is necessary to ensure fertilization.

B. Physiology.*

Fecundation of Ovules in Angiosperms.†—J. Kruttschnitt further develops his novel view that the pollen-tubes as they are found on the stigma lose their separate existence, and discharge their contents amongst the papillæ of the stigma which may be considered the aggregate head of the fibrillæ of the conducting tissue which is found in the style and in the various parts of the ovary, impregnating thus the whole ovary, as an entirety, with the substance of the pollen which has been absorbed by the papillæ of the stigma. He considers that the existence of the nucleus in the pollen-grains is problematic, and its fusion with the oosphere in the embryo-sac not an observed or demonstrable fact. The current view of the fertilization of the plant ovule by "pollen-tubes" should be discarded, as it seems, he thinks, to have been wrongly moulded on the fecundation of the animal ovum.

N. L. Britton combats ‡ these views, and quotes a long list of authorities in support of the accepted theory of fertilization, exhibiting a section of *Monotropa uniflora* with the pollen-tube actually in contact with the embryo-sac.

Embryo of Cycadææ.§—M. Treub supplies a gap in our knowledge of the development of the embryo of *Cycas circinalis*. The corpuscles of this species have, as previously stated by Warming, only two neck-cells, and Treub now shows that there is never any canal-cell. The nucleus always occupies the same position, at the summit of the central cell, close to the neck. If ovules recently fertilized are treated with staining reagents, a crowd of small nuclei is seen in the protoplasm, proceeding from the fertilized nucleus of the oosphere.

* This subdivision contains (1) Reproduction (including the formation of the Embryo and accompanying processes); (2) Germination; (3) Growth; (4) Respiration; (5) Movement; and (6) Chemical processes (including Fermentation).

† Proc. Amer. Soc. Micr. 7th Ann. Meeting, 1884, pp. 93-8.

‡ Journ. New York Micr. Soc., i. (1885) pp. 7-16, 20-1.

§ Ann. Jard. Bot. Buitenzorg, iv. (1884) pp. 1-11 (2 pls.). See Bull. Soc. Bot. France, xxxi. (1884) Rev. Bibl., p. 78.

In a short time all these nuclei place themselves against the cell-wall; the protoplasm around them becomes differentiated, and the pro-embryo (suspensor) is formed. This increases laterally and basally, while the upper part of the cavity does not become filled with new tissue. The summit of the suspensor, continuing to grow, elongates, and pierces the membrane of the corpuscle. Three parts can then be distinguished—the embryo properly so called, the suspensor, and the portion which continues to retain the form of a sac. The following stages resemble those of other Gymnosperms, and one only of the embryos arrives at full development in the seed.

The changes which take place in the ovule of *Cycas circinalis*, in consequence of impregnation closely resemble those in *Ginkgo biloba* (*Salisburia adiantifolia*), indicating an affinity between these two genera.

Embryo of Barringtonia.*—According to M. Treub, the embryo of *Barringtonia Vriesii* produces a certain number of small leaves, before its growth is arrested at the summit, at the time of maturity of the fruit. These leaves remain in the condition of scales, and produce minute buds in their axils. During germination this apical portion elongates into a young stem which produces scales and then normal leaves; when its development is interrupted, one or more of the buds of the embryonal scales develop and replace it. Examined in transverse section, the young embryo shows a thin circular layer of cells which divides the body of the embryo into a cortex and a thick medulla; this layer being the principal cause of the erroneous interpretations to which the embryo of *Barringtonia* has given rise. At the time of germination a formative fibrovascular layer is formed towards the inner portion of the separating layer; and a secondary layer is then produced below the liber, and the primary cortex is exfoliated.

Fertility of Hybrids.†—Recorded and undisputed cases of sterility in hybrid plants are, T. Meehan states, in fact extremely rare. In most cases it has been assumed that the plants were hybrids because there was some difference in appearance from the normal form, or because they were sterile. In his view there is no reason to believe that there is any more sterility attached to hybrids than to ordinary plants.

Germination of Flax and Sweet Almond.‡—A. Jorissen has determined, by chemical tests, that seeds of flax which have germinated for a short time contain a considerably greater quantity of hydrocyanic acid than ungerminated seeds, showing that the substance which yields this acid is one of the products of transformation of the nitrogenous constituents during germination. Amygdalin is formed in the process of germination, even in the dark; and in the sweet almond a substance of similar properties is contained in the plumule and radicle; in smaller quantities in the cotyledons. Another glucoside, solanin, is also formed during germination; and this

* Ann. Jard. Bot. Buitenzorg, iv. (1884) pp. 101-8 (1 pl.). See Bull. Soc. Bot. France, xxxi. (1884) Rev. Bibl., p. 77.

† Amer. Natural., xix. (1885) pp. 73-5.

‡ Bull. Acad. R. Sci. Belg., vii. (1884).

substance is therefore not a reserve-material, as had previously been supposed. These glucosides may be regarded as derivatives of the molecules of albumen, and as stages of transition between the albuminoids and carbohydrates, which circulate through the plant.

Behaviour of Tannin in Germination.*—P. Rulf has examined the part played by tannin in the germination of the seeds of various plants—*Acer platanoides*, *A. pseudoplatanus*, *Fraxinus excelsior*, *Vicia Faba*, and *Cynoglossum officinale*—and finds that it differs according to the species; and that, especially in the early stages, its true function is still obscure.

Laws of Growth of Vegetable Organs: Roots.†—R. v. Wettstein's researches on this subject, of which we have already given a summary,‡ are now published in detail.

Motions of Roots during Growth.§—The researches of J. Wiesner, of which a summary has been given,|| are also now published in detail.

Autumnal Foliage.¶—A. T. Fraser suggests from observations in the extreme north of Scotland, where no forest trees can be got to grow, that leaves fall *in autumn* from trees growing above a certain latitude—about 30°—through loss of vitality in the more or less highly polarized light. "Where the light is polarized, trees are scarce or absent, mown by a swathing light; and in the tropics, where there is little polarization, they are luxuriant and green all the year round." Leaves fall everywhere of course, but in the higher latitudes the fall is *en masse* in the autumn; while more south it is in continuous driblets only.

Respiration of Germinating Seeds.**—G. Bonnier and L. Mangin divide seeds into two classes dependent on the difference of phenomena with respect to respiration during germination:—1. Oleaginous seeds absorb during germination a volume of oxygen greater than that of carbonic acid exhaled; the excess of oxygen absorbed is employed in the oxidation of the fatty reserve-substances during their transformation into starch. There is therefore assimilation of oxygen during this period of the life of the seeds. 2. Amylaceous seeds are characterized physiologically by the constant equality which exists between the volume of oxygen absorbed and that of carbonic acid exhaled. In these cases, therefore, there can be no assimilation of oxygen.

Influence of Gravitation on the Movements of Stamens.††—Dr. J. Dufour points out that in a great number of flowers, the stamens, at first straight, present at the end of some hours a strong curvature, the concavity of which faces upwards. This curvature, which generally coincides with the opening of the anthers, is therefore very

* Zeitschr. f. Naturwiss., lvii. (1884) pp. 40-66. See Bot. Centralbl., xx. (1884) p. 259.

† SB. K.K. Akad. Wiss. Wien, lxxxix. (1884) pp. 59-113.

‡ See this Journal, iv. (1884) p. 772.

§ SB. K.K. Akad. Wiss. Wien, lxxxix. (1884) pp. 223-302.

|| See this Journal, iv. (1884) p. 589.

¶ Nature, xxxi. (1885) pp. 388 and 482.

** Bull. Soc. Bot. France, xxxi. (1884) pp. 306-9. See this Journal, *ante*, pp. 97, 104.

†† Arch. Sci. Phys. et Nat., xii. (1884) pp. 417-8.

apparent in several species of *Funkia* and of *Hemerocallis*, as well as in *Dictamnus Fraxinella*, *Agapanthus umbellatus*, &c.

Experiment shows that the movements are determined by gravitation, and are not purely spontaneous. The summit of the organ tends in reality to turn from the earth. On counteracting the action of gravity, by fixing the flower on a slowly rotating horizontal axis, the curvature is prevented. In the same way, if the flower be turned round, the plane of curvature always remains vertical, and has no morphological relation to the position of the petals. The pistil of *Fraxinella*, moreover, presents the curious property of being first attracted by the earth, then two days afterwards repelled. In *Scrophularia nodosa*, the peculiar curvature of the style towards the close of the period of flowering seems, on the contrary, of a spontaneous nature, as it takes place when gravity is counteracted.

Nyctitropic Movements of Leaves.*—E. Mer gives the following results from observations on the nocturnal position of the leaves in *Robinia pseudacacia*, *Trifolium repens*, *T. pratense*, *Phaseolus vulgaris*, and *Oxalis Acetosella*.

The movements of irritation and the nocturnal position of leaves depend on an antagonism between the upper and under side of the pulvinus of the leaf. This antagonism is due to the unequal tension of the two sides caused by the absorption or loss of water. The nocturnal position is independent of transpiration and of assimilation. Any rapid change in the external conditions causes more or less extensive and rapid movements of the leaf. The nocturnal position appears to be the result of an action of irritation resulting from the alternation of day and night, which has become more regular and certain from hereditary habit and the inductive action of light.

Mechanical Explanation of Spontaneous Nutations.†—J. Wiesner gives further illustrations—taken from the phenomena of growth of the epicotyledonary segment of *Phaseolus multiflorus*—in favour of his theory that the hyponasty and epinasty of many organs are but special cases of undulating nutation. In leaves and stems hyponastic curvature is the result of the unilateral development of the organ. Epinasty, on the other hand, owes its origin to many different causes; in some cases partly or entirely to the greater resistance which the under side of the organ opposes to the effort to bend downwards. Epinasty shares with many other biological phenomena the peculiarity of giving the impression of a simple phenomenon, while its origin may really be very various.

Secondary Geotropic Phenomena.‡—J. Wortmann describes an apparatus by which he has experimented on the effect produced on geotropic curvatures of plant by alterations in the pressure and in the constitution of the atmosphere. In very rarefied air the geotropic curvatures continued, though with diminished intensity. If, on the contrary, the whole of the oxygen is suddenly removed, all sensitive-

* Bull. Soc. Bot. France, xxxi. (1884) pp. 213-23.

† Bot. Ztg., xlii. (1884) pp. 657-64, 673-82, 689-93.

‡ Ibid., pp. 705-13 (1 fig.).

ness ceases, and cannot again be restored. The same is the case if the growing plant is placed for ten minutes in an atmosphere of hydrogen, although this does not entirely destroy the power of growing in length.

Ascent of Water in Plants.*—F. Elfving brings forward arguments against Sachs's view of the ascent of water in plants by imbibition. In the wood of Conifers, as the young wood-cells lose their protoplasm, water, containing air in solution, occupies the cavity, and bubbles of air are formed alternating with drops of water,—in fact, a series of "*chapelets de Jamin*"; only, instead of being simple and in one long tube, each one is complex, and the broken water-columns are confined in closed chambers permeable to water, but not to air, at the bordered pits, and therefore communicating with one another. According to Jamin's researches, these columns of water may be of any height; and the suspension of columns of very great height in lofty trees presents no mechanical difficulty. The molecules of water can pass between the supporting bubbles of air as if they had no weight, since it is only the movement of the masses of water as a whole in a longitudinal direction which is prevented by the capillary forces in the *chapelet de Jamin*. The individual particles of water have perfect freedom of motion, and will of course travel towards the transpiration surfaces. Elfving claims for his theory that it explains many hitherto inexplicable facts in the phenomena of the circulation of fluids in trees.

Formation of Albumen in Green Plants.†—Dr. Emerling has carried on a series of experiments on 1000 plants of *Vicia Faba*, examining them at different stages of their growth, for the purpose of determining whether the amido-acids are formed by synthesis in the assimilating organs, or by the decomposition of albumen already present. His general results favour the former hypothesis. These acids are first used up in the development of the roots and leaves. After the complete development of the leaves they accumulate in the rudimentary fruits, and are used up in their rapid growth; while the pods form receptacles for the non-albuminous substances, which they gradually give up to the seeds during the ripening of the latter. If this hypothesis is correct, the only mode in which albuminoids are formed is by derivation from the amido-acids; while, on the other hand, if the hypothesis is accepted that the amido-acids are derived from albuminoids, the latter must be formed in two different ways, which is improbable, considering their very complicated composition. The very early period at which the amido-acids are formed is also unfavourable to the second hypothesis.

Formation of Hydrochloric Acid in Plants.‡—W. Detmer has convinced himself, by a series of experiments, that organic acids, and especially citric acid, have the power of decomposing the chlorides of

* Act. Soc. Scient. Fenn., xiv. (1884). See Nature, xxx. (1884) p. 561.

† Vers. Deutsch. Naturf. u. Aerzte Magdeburg, Sept. 20, 1884. See Bot. Centrabl., xx. (1884) p. 285.

‡ Bot. Ztg., xlii. (1884) pp. 791-7. See this Journal, iv. (1884) p. 90.

potassium and sodium in the vegetable organism, setting the hydrochloric acid free. The free hydrochloric acid he believes to play an important part in the vital economy, in the formation of starch by means of diastase.

Source of the Nitrogen in Plants.—In the experiments conducted at Rothamsted, Sir J. B. Lawes has paid great attention to the question of the source of the nitrogen contained in the tissues of plants. He confirms the ordinary view that the atmosphere is, if not the sole, at all events the chief source of the carbon in plants, and that the soil is the principal, if not the only source of their nitrogen. The very small amount of nitrogen brought down to the soil from the atmosphere by rain in the form of salts of ammonia is not of itself sufficient to afford the requisite quantity of nitrogen to plants directly; this must be looked for rather in the nitrates present in the soil and in manures. The different results of different modes of treatment on different plants are due to the difference in the nature of the roots as to extent, thickness, &c., and as to their capacity to draw moisture from superficial or from deeper-lying strata of the soil; and to their different capacities to set free the nutrient substances and to assimilate. Although a leguminous crop, like clover, removes a much larger quantity of nitrogen from the soil than a cereal crop, a much better crop of wheat will nevertheless be obtained from the same soil after a crop of clover than after a crop of rye. The clover has obtained the nitrogen from a greater depth in the soil, and the roots and other portions of the clover crop that still remain in the soil, yield to the wheat a much larger quantity of nitrogen than the superficial stratum of soil would do.

Formation of Nitrates in Plants.*—Berthelot and André have investigated the source of the potassium nitrate which is found in large quantities especially in certain plants, as *Borrago* and the *Amaranthaceæ*. It occurs in the largest quantity in the stem, next in the root, to the smallest extent in the secondary roots and flowers, and least of all in the leaves. The percentage and absolute quantity of potassium nitrate in the plant gradually increase from the period of germination, attaining their maximum immediately before the time of flowering. From this time its relative proportion declines, a portion of the nitrogen being used up in the formation of the protein-compounds which are required for the seed, for which purpose a portion of the nitrate is decomposed. To a certain extent there may be considered to be an antagonism between the production of nitrates and the process of assimilation which takes place in the green parts of plants.

With regard to the source of the nitrates, the authors are of opinion that plants do not derive them directly either from the soil, from manures, or from the atmosphere; but that they are formed in the plant itself and especially in the stem. Experiments at Montsouris show that the amount of nitric acid which can be obtained from the atmosphere corresponds to only 4.4 kilogrammes of potassium

* Comptes Rendus, xcix. (1854) p. 683.

nitrate per hectare, which accounts for only one-twentieth part of that contained in the soil; and this may possibly be the source of a very small proportion of the nitrates contained in plants, but by far the larger portion must be formed in the plant itself.

Reducing Properties of Seeds and Formation of Diastase.*—By a series of experiments on the seeds of mustard, flax, lupin, barley, &c., A. Jorissen claims to have determined that the reducing properties of seeds are independent of their vegetative activity, and that there is a relation between this phenomenon of reduction and the production of diastase. It is possible that the presence of bacteria in germinating seeds which contain no starch may bring about the production of a diastatic ferment.

Composition of Mineral Oil in relation to the Plants which have produced it.†—A. Carnol states that the plants preserved in the soil in the state of oil appear to have had very different properties, but a nearly uniform elementary chemical composition. Experiments show that the age of the oil and other circumstances at the period of its formation were not the only factors in determining the properties of the oil; but that when all these circumstances have been identical, different species of forest trees gave rise to oil of sensibly different properties.

B. CRYPTOGRAMIA.

Cryptogamia Vascularia.

Dehiscence of the Sporangia in Vascular Cryptogams.‡—M. Lelerc du Sablon has investigated the mechanism of the dehiscence of the sporangia in ferns and in Equisetaceæ. In the Equisetaceæ the dehiscence is the result of the unequal contraction of the lignified and of the non-lignified parts of the cell-wall, and closely resembles the process of the dehiscence of the anthers of flowering plants. In the Polypodiaceæ, on the contrary, the cause is quite different, and the dehiscence is due to variations in the pressure produced in the cells of which the annulus is composed by the evaporation or absorption of water, and is unconnected with any contraction of the wall itself.

Development of Organs and Growth at the Growing Point of Dorsiventral Ferns.§—L. Klein has examined the apical growth of dorsiventral ferns in fifty species belonging to nineteen genera. In opposition to the prevalent view, he finds, in all the species, notwithstanding a pronounced bilateral structure, a three-edged apical cell. Apparently two- and sometimes also four-edged apical cells occur only temporarily as the result of an abnormally placed segment-wall. In *Pteris aquilina*, on the other hand, the apical cells, which must typically be two-edged, were found to be very frequently three- and even four-edged. These were formed in the way described by Hofmeister, while the three-edged apical cell of other ferns shows no definite origin, but usually has one corner directed upwards. The division of the

* Bull. Acad. R. Sci. Belg., viii. (1884) pp. 521-4, 550-5.

† Comptes Rendus, xcix. (1884) pp. 253-6.

‡ Bull. Soc. Bot. France, xxxi. (1884) pp. 292-5. Cf. *ante*, p. 91.

§ Bot. Ztg., xlii. (1884) pp. 577-87, 593-604, 609-15, 625-35, 641-9 (1 pl.).

segments does not take place so regularly as in the apex of *Equisetum*, so that in good preparations only two circuits, or the six youngest segments, could be followed; these were more often found running to the left than to the right. In *Polypodium vulgare* each internode has the rudiment of a lateral shoot; and in *P. Heracleum*, with the leaves arranged in a single row, the author found sometimes two rudiments, one on the right, the other on the left side of the same internode. But these rudiments do not all develope together; most of them remain in a dormant condition. They originate from a superficial cell at the growing point of the stem, at a great distance from the origin of the leaf, and at a considerable greater angle of divergence as respects the vertical plane of symmetry. There cannot be any genetic connection between the shoot and the leaf; those ferns which were examined could not be brought under the scheme of axillary branching.

In all the species examined the leaves originate from a superficial cell distinguished by a stronger swelling of its outer cell-wall, which divides by two septa curved towards one another in parabolic curves, between which the two-edged apical cell of the leaf is formed. It arises far behind the apical cell of the stem, for it can be recognized only in the fourth or sixth segment; but in *Pteris* sometimes in the third. The author was able to determine that every segment of the two dorsal rows in *Polypodium vulgare* forms a leaf. When from two to six leaves, including rudiments, develope in the year, the apical cell of the stem can divide, during the same time, only from three to nine times; and perhaps not half so often in *Pteris aquilina*; but this could not be absolutely determined, since in this fern each leaf takes four years to develope.

In all ferns the intensity of growth and the rapidity of division of the apical cell of the stem are extremely small; and on these points the following results were obtained. At the growing point, in the first three or four segments, the average absolute growth increases regularly from the apical cell, the relative growth decreases. The change in the intensity of growth varies greatly in the same species during the same time and at the same age of the youngest segment in different individuals. The segments separated from one and the same apical cell in the growing state frequently differ greatly in size; while equal segments behave very variously as respects the intensity of growth in successive sections.

The above facts are stated by the author in two tables. Starting from the superficial view of the growing point, the outlines of the segments were drawn on paper under a magnification of 280 diameters. These drawings were then laid on plastic clay, and successive apical cells and segments cut out and weighed; the proportion of the weights thus obtained giving that of the volumes of the cells.

Prothallium of *Lycopodium*.*—M. Treub gives an exhaustive account of the prothallium of *Lycopodium cernuum* from artificial and

* Ann. Jard. Bot. Buitenzorg, iv. (1884) pp. 107-38 (9 pls.). See Mr. W. T. Thiselton Dyer in 'Nature,' xxxi. (1885) p. 317.

natural cultures. In the former case he did not succeed in carrying the development further than De Bary had done some time ago with *L. inundatum*, but the prothallia which he discovered at Buitenzorg in Java, under spontaneous conditions of development, fitted in exactly where the others stopped.

The adult prothallium is a very singular structure, consisting of a short cylindrical axis, half immersed in the soil at one end, where it is furnished with root-hairs. The upper extremity bears a tuft of small leaf-like lobes. The archegonia and antheridia are found on the upper part of the cylindrical axis, forming a kind of ring or crown near the tuft of lobes. The prothallium therefore presents a type morphologically more differentiated than is met with elsewhere amongst the vascular cryptogams. While this is the case with the sexual generation (oophore), the spore-bearing generation (sporophore) in its embryonic stage is less differentiated than is the case, for example, in the fern. The embryonic root is suppressed, and the whole embryo, which is wholly parenchymatous, approximates in its morphological characters to those of the prothallium.

The prothallium of *Lycopodium** has also been met with again by H. Bruchmann in the case of *L. annotinum*. He describes it as a minute tuber, of a dirty white and felted appearance, and entirely destitute of chlorophyll. The young plants were already from 12 to 20 cm. in length, considerably branched, and probably two years old. The description of the prothallium agrees in the main with that of Fankhauser. The tissue of the vegetative portion may be distinguished into four layers. The layer next to the upper side of the prothallium is completely filled with nutrient substances, protoplasm, oil, and starch. Below this is a row of palisade-like cells, with their longer axis at right angles to the surface; and next to this again a layer of cells of more tabular form. The cells of all three layers contain nuclei and nucleoli. The fourth layer or epidermis is sharply differentiated at the basal part of the prothallium. It is cuticularized on its outer surface, and from it proceed the rhizoids, which are often as long as the prothallium itself. The further growth of the prothallium depends on cell-division at its margin.

The antheridia vary greatly in size and form. The antheridial sacs formed in the centre of the cushion of tissue are the largest; those at the margin are smaller, and apparently abortive. They are oval in form, and lie in large numbers very close to one another. Their walls differ in no respect from those of the other cells of the prothallium, and they are covered outwardly by one or more layers of cells, which become disintegrated when the antheridia discharge their contents. The interior of the antheridium consists of a large number of polyhedral cells, which should, by analogy, be the mother-cells of the antherozoids. But, according to the author, their walls become, when ripe, converted into mucilage, and discharge each, not a single antherozoid, but ten or more small colourless cells, out of which the same number of excessively minute motile bodies, appa-

* Bot. Centralbl., xxi. (1885) pp. 23-8 (1 pl.).

rently antherozoids, escape, pointed at one end, but so minute that their structure could not be clearly made out. If these bodies are really antherozoids, the minute cells from which they escape are the mother-cells of the antherozoids, and the cells of the antheridium the mother-cells of these again. The only other explanation seems to be that these motile bodies do not belong to the *Lycopodium* prothallium at all, but that they are the antherozoids of a parasitic *Chytridium*. The entire antheridium originates from a central cell abundantly filled with nutrient substances, which divides rapidly in all directions. No archegonia were found on any of the prothallia.

South American Isoetes.*—A. Franchet describes a new species of *Isoetes*, *I. Savatieri*, from Patagonia, probably further south than any species previously known. It belongs to the section Amphibiæ, and is distinguished by its great heteromorphism, according as it grows submerged or on dry land.

Development of the Vegetative Organs of *Selaginella spinulosa*.†
—According to H. Bruchmann, the apical growth of the stem and branches in this plant is governed by a group of cells which gives off lateral segments for the widening of the apex by walls placed at right angles to the surface. The formation of the entire tissue of the interior of the stem is referable to the segmentation in a direction parallel to the surface of these segments and of the initial group. The apical growth of *Selaginella spinulosa* resembles therefore that shown by the same author, to occur in *Isoetes lacustris*, *I. Duriaei*, *I. Malinverniana*, *Selaginella Lyallii*, *Lycopodium Selago*, *L. annotinum*, *L. alpinum*, *L. inundatum*, *L. clavatum*, and *L. Chamæcyparissus*. The first branching of the young plant is strictly dichotomous, always at right angles to the cotyledonary plane. It is preceded by an increase in the initial group, by which the energy of growth is transferred from the centre of the apex to its sides, two new apices in divergent directions taking the place of the old one. All the succeeding branchings take place in one plane, at right angles to the plane of dichotomy, and monopodially. *Selaginella spinulosa* has no rhizophore. The roots have their origin at the base of the tigellum, and are constructed out of two initial groups. One of these corresponds to the initial group of the apex of the stem; from it arise the dermatogen, periblem, and plerome of the root. Above this initial group lies that of the calyptrogen. The branchings of the root are always dichotomous; each plane of dichotomy is at right angles to the preceding one.

Muscineæ.

Archegonium and Sporogonium of Muscineæ.‡—L'Abbé Hy has examined the structure of the archegonium and the development of the sporogonium in a large number of species of Muscineæ, belonging especially to the true Mosses. He is led to dissent from the union of the Muscineæ with the Vascular Cryptogams into one class of Arche-

* Bull. Soc. Bot. France, xxxi. (1884) pp. 395-6.

† Zeitschr. f. Naturwiss., 1884, pp. 356-7.

‡ Ann. Sci. Nat. (Bot.), xviii. (1884) pp. 105-206 (6 pls.).

goniatae, which does not correspond to any affinity of structure. The organ known as the archegonium in these two classes has no doubt the same function, and they resemble one another so far that the mother-cell of the oogonium divides into two cells, the lower of which becomes the oosphere; but here the resemblance ceases. The archegonium of Muscineae, to which alone the term ought strictly to be confined, is axial instead of epidermal in its nature, and the paraphyses by which it is surrounded are of a foliar character.

The archegonium of Muscineae always originates from a single primordial mother-cell, which after its separation from a lower cell by a transverse wall, produces, by further divisions, the oosphere, the canal, and their common envelope. These divisions are effected by three longitudinal walls, two anticlinal and one periclinal, separating an axial cell from which spring the oosphere and the canal-cells, and three peripheral cells, the origin of the archegonium-sac. The lowest of these cells, Janczewski's "central cell," never undergoes more than one further division, giving rise to the oosphere or "embryonal cell," and above it to the "ventral canal-cell." The second cell, the "primary canal-initial-cell," produces a row of cells varying in number, but always some multiple of four, by bipartitions in basifugal succession. The successive divisions up to the complete development of the oosphere are always the same in the entire group, and present a great contrast to the corresponding phenomena in Vascular Cryptogams.

The sporogonium which results from the fertilization of the oosphere does not form an alternating generation with the sexual plant in the sense in which the phrase is used with respect to Vascular Cryptogams; the perfect development of both proceed in parallel lines. The sporogonium is composed of the urn (sporangium), the seta, and the foot. The two latter organs differ greatly in their development according to (1) the direction in which it takes place; (2) the time at which it occurs; (3) the result to be attained. The seta is the support of the sporogonium, and supplies it with the nutrient material which it is the sole function of the foot to absorb. The envelope of the sprangium varies in its origin. In the Andreaeaceae it proceeds from the enlargement of the primitive archegonial sac; elsewhere it is due, partially or entirely, to the development of neighbouring organs. The author proposes for this structure the term *epigone*.

The calyptra is an organ of Mosses alone, not occurring in the Hepaticae. The vaginule in Mosses varies greatly in its origin. It sometimes consists of the persistent base of the epigonal sac; sometimes it is formed simply from the growth of the tissues of the mother-plant.

The Muscineae constitute a primary division distinct from Vascular Cryptogams, characterized by the following peculiarities:—(1) The archegonium is altogether different from that of Vascular Cryptogams; (2) they are the only plants which produce a fruit of sexual origin giving rise, by differentiation of their tissues, to spores of endogenous origin. The Muscineae divide themselves naturally into the Musci and

the Hepaticæ. Although the Sphagnaceæ present some characters which mark the transition to the Hepaticæ, they must not be separated from the Musci. The Anthocerotæ, on the other hand, are regarded by the author as constituting a degraded family lower in organization than the Musci and Hepaticæ. Separating these off, the remaining Hepaticæ then present two well-marked orders, the Jungermannioidea and the Marchantioidea; while the Musci are divided into the Musci Anomali (Sphagnaceæ, Andreæaceæ, and Archidiaceæ) and the Musci Veri, again separated into Cleistocarpi and Stegocarpi.

Trochobryum, a new Genus of Seligeriaceæ.*—J. Breidler and G. Beck find on wet calcareous stones and ditches on the Ulrichsberg in Carniola, a new moss which they call *Trochobryum carniolicum*, and regard as the type of a new genus with the following characters: Plantæ humiles, *Seligeriæ* generis speciebus affinitate proximæ. Folia e basi brevi laxe areolata costa procurrente longe subulata. Capsula in seta crassa subsp hærica pachyderma collo brevi indistincto suffulta sicca depressa, deoperculata subdisciformis vel plano-infundibuliformis. Peristomii dentes 16, æquidistantes, hygroscopici, latiusculi, sine linea divisurali. Operculum columellæ adnatum, apiculatum. Calyptra cucullata.

Mosses of France.†—A full account of the mosses (excluding Sphagnaceæ) of France has recently been published by M. Boulay. After a review of the literature of the subject, he states the general character of the class Muscinæ, and of its divisions, the Mosses, Sphagnaceæ, and Hepaticæ; and gives a very full description of the organographic and morphological characters of Mosses, the production of hybrids, and some modes of secondary reproduction. In respect of geographical distribution, the author distinguishes three regions:—the Mediterranean, the forest, and the alpine region.

In classification, commencing with the Hypnaceæ and finishing with the Andreæaceæ, the system of Schimper is followed, though with some deviations. Two new species are described: *Bryum* (*Webera*) *carinatum* and *Grimmia* (*Gümbelia*) *anceps*, both from Mont Blanc, while a considerable number of forms hitherto described as species are degraded to the rank of varieties. The number of species described is 586.

European Sphagnaceæ.‡—C. Warnstoff recapitulates all the additions to our knowledge of the *Sphagnum* forms of Europe since the publication of his 'Europäische Torfmoose' in 1881. The following is his enumeration of the species at present known:—
A. SPHAGNA CYMBIFOLIA. 1. *S. cymbifolium*; 2. *S. papillosum*; 3. *S. medium*; 4. *S. Austini*. B. S. SUBSECUNDA. 5. *S. subsecundum*; 6. *S. contortum*; 7. *S. laricinum*; 8. *S. platyphyllum*; 9. *S. Pylaiei*; 10. *S. tenellum*. C. S. TRUNCATA. 11. *S. Angstrœmii*; 12. *S. rigidum*; 13. *S. molle*. D. S. CUSPIDATA. 14. *S. acutifolium*; 15. *S. acuti-*

* Verh. KK. Zool.-Bot. Gesell. Wien, 1884 (1 pl.). See Bot. Centralbl., xx. (1884) p. 294.

† Boulay, Muscinées de la France. Ptie I. Mousses. Paris, 1884.

‡ Flora, lxvii. (1884) pp. 469-83, 485-500, 501-16, 598-611 (2 pls.).

forme; 16. *S. fimbriatum*; 17. *S. Girgensolmii*; 18. *S. Wulfi*; 19. *S. squarrosum*; 20. *S. teres*; 21. *S. Lindbergii*; 22. *S. recurvum*; 23. *S. riparium*; 24. *S. cuspidatum*. Under many of the species a very large number of forms are enumerated, classified according as they are more or less cæspitose, or of stouter or more delicate growth.

Radula.*—F. Stephani enumerates all the species of *Radula* at present known, and describes a large number of new ones from dried collections from all parts of the world. The organs of fructification being remarkably uniform in the genus, the best characters for classification are obtained from the vegetative organs, and especially from the leaves in relation to their lower lobes. In some species this lobe is quite inconsiderable, while in others it is developed in very characteristic forms. The following are the 12 groups into which Stephani arranges the 110 known species of the genus:—(1) *Acutifoliae*; (2) *Macrolobæ*; lobuli maximi caulem valde superantes. (3) *Ampliatae*; lob. pars libera ampliata supra caulem protracta. (4) *Communes*; lob. subquadrati cauli parum incumbentes. (5) *Javanicæ*; plantæ pro more spectabiles. (6) *Microlobæ*; lob. parvi, subquadrati, cauli parum incumbentes. (7) *Plumulosæ*; lob. parvi, pro more subtransverse adnati, rotundati, ramificatio distincte pinnata. (8) *Saccatilobæ*; plantæ pusillæ, arcte repentes. (9) *Longilobæ*; lob. elongati, axi cauli parallelo. (10) *Tumidæ*; lob. plus minusve inflati, axi carinæ parallelo. (11) *Amentulosæ*. (12) *Cavifoliae*.

The region of tropical America is distinguished by species with strongly developed lower lobes; the Antarctic region by species with large hollow lobes; that of tropical Asia and Oceania by one of the most difficult groups of the genus in consequence of the great similarity of the species belonging to it.

Algæ.

Chlorophyll of Fucaceæ.†—According to A. Hansen the coloured leucites of Fucaceæ contain chlorophyll and xanthophyll in the same proportion as the higher plants, and their physical properties, in *Fucus vesiculosus*, are the same as in flowering plants. The spectrum of the chlorophyll presents four absorption bands in the red, and that of the xanthophyll three in the blue. The brown pigment, or phyco-phæin, the function of which in assimilation is at present unknown, gives one absorption band between Fraunhofer's E and F.

To criticisms in this paper directed against some of the observations of A. Tschirch, the latter replies.‡

New Instance of Symbiosis.§—C. di Marchesetti describes a case of symbiosis between an alga and a sponge from the Gulf of Singapore; the compound organism having been described by Hauk as an alga

* Hedwigia, xxiii. (1884) pp. 113-6, 129-37, 145-59, 161-3.

† SB. Phys.-med. Gesell. Würzburg, 1884, pp. 104-6. See Bot. Ztg., xlii. (1884) p. 649.

‡ Bot. Ztg., xlii. (1884) pp. 817-20.

§ Marchesetti, Carlo di, 'Sur un nuovo caso di Simbiosi.' See Oester. Bot. Zeitschr., xxxiv. (1884) p. 337.

under the name *Marchesettia spongioides*. He regards the sponge (*Reniera fibulata*) here as the parasite, which, from its delicate structure, and the absence of any cartilaginous or calcareous framework, has, for the sake of protection, attached itself to a red alga with stout stem. The close union of the two individuals has completely altered the structure of the alga, so that it resembles another sponge of the genus *Chalina*; and Marchesetti thinks we may possibly have here an instance of protective mimicry.

Vegetative Changes of Form in Chlorosporeæ.*—G. Schaarschmidt finds that changes of form take place in many green algæ, which he compares with those of the Schizomycetes. The following are the series, as he describes them, in the case of *Conferva bombycina*.

In the normal condition (F. 1) the cells are cylindrical, $1\frac{1}{2}$ –2 times as long as broad, and with large chlorophyll-grains. When fresh filaments are about to be formed, the cells undergo their first change in form, become narrow and barrel-shaped (F. 2), and divide when their length has doubled. From this point division proceeds more actively, but the division-walls are, with few exceptions, no longer parallel to one another (F. 3). Some of the cells now lose their contents, and are compressed by the pressure of the adjacent cells. The division now attains its maximum of energy; some of the mother-cells become segmented, by rapidly successive and very thin cell-walls, into sixteen or seventeen daughter-cells (F. 4). In these divisions, the walls of the mother-cells are easily recognized by their H-shaped remains, which bound on either side the row of daughter-cells. A short-celled filament now results from the thickening of the septa (F. 5); but in some exceptional cases, short-celled filaments, 2–3 times as broad as the ordinary ones (F. 6), are found, not dissimilar from those of *Ulothrix*. These are again segmented in the ordinary way (F. 7). After the divisions have been many times repeated (F. 8), 4–8 daughter-cells are developed in the mother-cells of filaments of both kinds (F. 9); and the divisions are now completed. The cells containing the daughter-cells swell up irregularly, the filaments become ribbon-shaped, resembling *Sirosiphon*, curve, and assume forms in which they might readily be mistaken for the microsporiferous filaments of *Ulothrix*. The daughter-cells divide, after their cell-wall has been developed, and become free by the bursting of the mother-cell wall, like *Schizochlamys*. These cells, now free and already segmented (F. 10 a), closely resemble *Chroococcus turgidus*, and form the transition to the *Protococcus*-form (F. 10 b), breaking up into two cells which become free *Protococci* (F. 10 c). The further development of these cells is still unknown; in some cases a quadripartition has been observed, leading to the *Oocystis*-state. Resting-cells were also observed, formed by the thickening of the cell-wall of cells swollen into a spherical form. They are not unfrequently formed, three or four adjacent to one another (F. 11).

A similar series of forms is described in the case of another

* Magyar Növény. Lapok, vii. (1884) pp. 103–13 (1 pl.). See Bot. Centralbl. xx. (1884) p. 354.

unnamed green alga: and the author is of opinion that in the development of the Chlorosporeæ, stages occur which may be compared to the coccus, bacillus, and even to the spiral forms of the Schizophyta; while the formation of zoogloea-colonies is not an uncommon phenomenon. This analogy in the vegetative development is the more interesting, as between the Chlorosporeæ and the Cyanophyceæ there is no such morphological agreement as between the Cyanophyceæ and the Schizomycetes.

Anatomy of *Macrocystis*.*—During the German expedition to South Georgia in 1882-3, H. Will had the opportunity of carefully examining the structure of the thallus of the gigantic seaweed *Macrocystis luxurians*, of which he found stems 70 metres long, and "leaves" 1.6 m. long, with an average diameter of 0.27 m. The branching he found to be of a sympodial and botrychoid character. The lamina of the frond may be divided into three well-marked tissues, the epidermal layer, the cortical parenchyma, and the hyphal tissue; of these the first is the seat of the chlorophyll-grains and of the brown pigment. The air-cavity of the swimming-bladders is formed by the swelling up of the "intercellular substance" in the middle of the hyphal tissue. Within the hyphal bundles of the old stem new elements make their appearance, including sieve-tubes. These have horizontal sieve-plates with very large, polygonal, or roundish sieve-pores, in some cases formed also on the side-walls.

In the examination of a very large number of specimens, consisting of all parts of the plant, and collected at all times of the year, the author was quite unable to detect any organs of reproduction in *Macrocystis*.

Hibernation of *Zygnemaceæ*.†—G. Schaarschmidt has observed that the vegetative filaments of *Zygnemaceæ* (two species of *Mesocarpus* and one of *Spirogyra*) have the power of retaining their vitality through the winter. In the broken lumps of melting ice in a ditch towards the end of March, he detected pale yellow or colourless balls, the contents of the cells having shrivelled up in an irregular manner, and the chlorophores almost lost their colour, as well as their special spiral form in *Spirogyra* and disk-like form in *Mesocarpus*. In the *Spirogyra*-cells were to be seen a few lenticular starch-grains in the chlorophores, as well as pyrenoids. When placed in a warm chamber, these cells showed signs of germination after the lapse of a few hours. In *Mesocarpus* the protoplasm rapidly increased, and became attached to the cell-wall; the chlorophores assumed the form of a rounded square, and the lamellæ increased slightly in length. In *Spirogyra* the chlorophores assumed their characteristic form in the course of a few hours; but their colour was lighter than the normal. *Cladophora glomerata* showed similar phenomena. It is probable that other algeæ, including some of the filiform desmids, are able to hibernate in the same way.

* Bot. Ztg., xlii. (1884) pp. 801-8, 825-30 (1 pl.).

† Magyar Növen. Lapok, viii. (1884) pp. 33-7. See Bot. Centralbl., xx. (1884) p. 257.

Sexuality in the Zygnemaceæ.*—Mr. F. Bates objects to Mr. A. W. Bennett's views † as to the existence of characters whereby the sexual nature of the filaments in the Zygnemaceæ may be determined.

The paper was apparently written in so reprehensible a style, that the President of the Club, Dr. Carpenter, C.B., felt obliged to suggest ‡ that "there should be some modification of the language employed by the author," as "there could be no reason why one scientific man should in this manner impute motives to another. No good ever came of it, and he was quite sure that their Journal would be better without it." The recommendation was apparently received with approval by the meeting, the President stating that "he was glad to find that the feeling of the meeting was with him in expressing himself on this matter."

Parthenogenesis in Spirogyra.§—L. Kolderup Rosenvinge describes a new species of *Spirogyra*, *S. groenlandica*, found among the material collected by Fries in Greenland in 1871, in which parthenogenesis frequently occurs. The parthenospores are sometimes formed in the male cells, and are rather thin, but coloured; occasionally even when a male and female cell unite by lateral conjugation. In these cases the contents of the female pass over into the male cell, a portion sometimes remaining behind in the female cell, which then develops into a parthenospore, while the male cell undergoes no further development. On the other hand, it also occurs that the male cells develop into parthenospores.

Geminella interrupta.||—R. Wollny describes this minute green organism, which he finds abundantly in a ditch. He does not agree with Kützing's reference of it to the Desmidiæ, but considers it more nearly allied to the Palmellaceæ. The phenomenon which Kützing regarded as an indication of conjugation, he looks on rather as the result of rapid cell-division. *Geminella interrupta* shows great resemblance to *Hormospora*, and is probably identical with *H. minor*; but Wollny would retain the former name for the organism, since the genus *Hormospora* is a very ill-defined one, and the species *H. minor* should probably be removed from it. Resting-spores are formed by the breaking-up of the filaments.

Lithoderma fontanum, a New Fresh-water Phæospore.¶—C. Flahault describes a new species of fresh-water alga belonging to the Phæosporeæ found in a small stream near Montpellier. It belongs to Areschoug's genus *Lithoderma*, of which one marine and one fresh-water species are already known, grouped in the family Ralfsiaceæ, and very near in structure to *Ralfsia*. *L. fontanum* is considerably larger in size than the other fresh-water species *L. fluviatile*, forming

* Journ. Quek. Micr. Club, ii. (1885) pp. 104-8.

† See this Journal, iv. (1884) p. 434.

‡ Journ. Quek. Micr. Club, ii. (1885) p. 120.

§ Ofvers. K. Svenska Vetensk. Förhandl., 1883, pp. 37-47 (1 pl.). See Bot. Centralbl., xx. (1884) p. 165.

|| Hedwigia, xxiii. (1884) pp. 137-42 (1 pl.).

¶ Bull. Soc. Bot. France, xxx. (1883) pp. cii.-vi. (1 pl.).

flat disks closely adpressed to stones beneath the surface of the water, 15 cm. in diameter, and with the thallus often as much as 20 cells in thickness. In its mode of growth and cell-division it presents a remarkable resemblance to *Coleochæte*, but the cells are filled with a black-brown endochrome. *Lithoderma* differs from *Ralfsia* in the sporangia being developed directly on the surface of the thallus, instead of being more or less included within it. M. Flahault found in *L. fontanum* only unilocular zoosporangia, and not the two kinds described by Arcschoug in the genus. The zoospores germinate directly, and show no tendency to conjugate.

Structure of the Diatom Valve.*—R. P. H. Durkee, referring to Dr. J. D. Cox's view that each valve consists of two laminae connected by a wall-like structure, in its outline sometimes hexagonal, at others circular, and that each plate is whole or imperforate, says that while engaged in the examination of a preparation of the Nottingham earth he came across a fine specimen of *Heliopelta*. The surface being undulating, the focus so happened to be arranged as to sharply define the highest points. Changing the focus, he became aware of a fine crack beginning at the lower margin of the valve, and extending over the segment and running parallel with one of the points of the star to its hyaline centre, and he found the crack divide and throw out two branches, completely crossing the centre and following out their course over the opposite segments. The centre was perfect in its framework except for the cracks, and the question whether there was a film, and if so, a continuous surface, was answered.

As further evidence of the existence of the two plates, the author says that Dr. Detmers, in examining the specimen, clearly demonstrated that the upper film only was cracked and the lower layer intact; and the paper is accompanied by photographs which have been so arranged as to focus, that they exhibit this point.

Structure of Diatoms.†—G. C. Wallich refers to Flögel's view ‡ that in such genera as *Triceratium* and *Coscinodiscus*, the little hexagonal or cylindrical cavities, though completely closed by a siliceous film on the internal surface of the valve, are not closed by any such membrane on the outer surface of the valve; and to Cox's, who insists § that the cellules are closed by a siliceous film externally as well as internally.

Dr. Wallich considers the objections to the latter view insuperable. If the cellules are closed at both their extremities during the life of the organism, each cellule must be full either of protoplasm or of some other more or less fluid substance, unless, indeed, each contains a gas, or constitutes a perfect vacuum, which is scarcely within the bounds of possibility. If each contains protoplasm, it is obvious that the remains of this, during the mounting of the specimen, would be recognizable amongst the larger species, either by optical or chemical

* Proc. Amer. Soc. Micr., 7th Ann. Meeting, 1884, pp. 105-9 (1 heliotype).

† Engl. Mech., xl. (1885) p. 496.

‡ See this Journal, iv. (1884) p. 665.

§ Ibid., p. 941.

tests. During the boiling in acid, or burning on mica, the fluid contents would burst the films, and in many cases leave behind the evidence of their former condition. In his experience, such evidence has never been forthcoming, and, judging from what is known of cellular structure in organic life generally, there are no examples of truly vacuous cavities, inasmuch as all organic tissues are pervious to dialytic or osmotic action.

It is no doubt true that the organic silica of the diatom, perfectly hyaline as it looks, is in reality a "colloid," and hence, as it contains an infinitesimal percentage of water, just as flint itself does, dialytic action may take place through the film under notice. But even then the perviousness to moisture of the diatom, if it really keeps the chamberlets full of fluid during the vitality of the organism, would not suffice to settle the question; for, if any fluid whatever remained in the cellulules, should the specimens have been but recently taken from their element, it would burst the film on the application of heat, and inevitably burst the walls, whilst traces of the disruption would occasionally be visible under the Microscope. Again, if the chamberlets contained gas of any kind, and in spite of the effects of the boiling in acids, this gas were too minute in quantity to burst the walls, we should certainly be able to detect gas bubbles in some of the chamberlets. But, as is well known, the bubbles so common in mounted specimens are not due to the cellulules having originally contained gaseous material, but to the accidental admission of air during mounting.

The only remaining alternative is that the cellulules cannot be considered closed cavities, and hence that the alleged presence of an external investing and closing film is illusory.

Lagerstedt's Diatom-synonymy.*—In view of the imperfect figures and descriptions in Kützing's *Fresh-water Algæ of Germany*, N. G. W. Lagerstedt has worked out the dried specimens in the museum at Stockholm, in order to determine more exactly the synonymy of the species. Thirty-six species are treated in this publication, and the following are figured:—*Frustulia Ulva*, *Achnanthes intermedia*, *Exilaria Vaucheria*, *Diatoma tenue*, *Frustulia lanceolata*, *F. maculata*, *Fragilaria pectinalis*, and *Brachysira aponina*.

Diatomaceous Deposits in Scotland.†—Prof. W. T. Macadam records the discovery in Scotland of larger diatomaceous deposits than any yet found. The deposit at Black Moss, Aberdeenshire, contains over 800,000 cubic yards. Those of Ordie and Kinnord at least an equal quantity. That at Gress, Lewis, occupies a basin-shaped cavity, not many feet above sea-level, and said to be more than 12 feet deep. The Glen Shira deposit is however likely to prove the largest. The material is generally found forming a bottom layer or stratum underlying peat. Analyses of the various deposits are appended.

* *Ofvers. K. Svenska Vet. Akad. Förhandl.*, 1884, pp. 29-64 (1 pl.). See *Bot. Centralbl.*, xx. (1884) p. 93.

† *Mineral. Mag.*, vi. (1884) pp. 87-9.

Fungi.

Life-history of certain British Heterœcismal Uredineæ.*—C. B. Plowright finds the æcidiospores of both *Uromyces Poæ* and *Puccinia Magnusiana* on *Ranunculus repens*; the two æcidia are not to be distinguished anatomically. The æcidiospores of *U. dactylides* and *P. Magnusiana*, which are similarly indistinguishable, are found on *R. bulbosus*. *Uromyces Poæ* has its æcidiospores on *R. Ficaria* and *R. repens*. The æcidium on *R. acris* belongs to the life-cycle of *P. perplexans*, the teleutospores of which occur on *Alopecurus pratensis*, *Avena elatior* and *Poa* sp. The uredospores of *P. perplexans* are sometimes mixed with capitate paraphyses and sometimes without them. *P. Phragmitis* has its æcidiospores on *Rumex Hydrolapathum*, *R. obtusifolius*, *R. crispus*, *R. conglomeratus*, and *Rheum officinale*. The æcidium on *Rumex acetosa* is connected neither with *P. Magnusiana* nor *P. Phragmitis*. The æcidium on *Senecio Jacobæa* belongs to the cycle of a *Carex* inhabiting *Puccinia*, *P. Schæleriana*.

New Ustilaginea.†—F. Morini describes, under the name *Tolyposporium Cocconii*, a new fungus belonging to the Ustilagineæ which he finds in the neighbourhood of Bologna, on the leaves of *Carex recurva*, causing sterility in the host. The chief interest of the observation lies in the very different development of the fungus under cultivation according as the spores are sown in a decoction of the leaves of the *Carex*, in spring-water containing a large quantity of lime, in distilled water, or in rain-water. Morini was unable to detect any act of sexual reproduction.

Law of Growth of the Fructification of Phycomyces.‡—L. Errera has repeated and confirmed the observations of Carnoy and Brefeld with regard to the remarkable interruption of the growth of the fructification of *Phycomyces nitens* during the period of the formation of the sporangium. This period of growth may be divided into four stages, as follows:—(1) An erect branch, the fertile hypha, springs from the mycelium. This grows in a vertical direction, first with an increasing, then for some time with a constant, finally with a decreasing rapidity, on the whole rather slowly. (2) After this fertile hypha has attained a length varying from 1 to 20 mm., its growth ceases, and its apex begins to swell into the globular bright yellow sporangium, which increases gradually in size. During this period the sporangiophore not only does not increase in length, but may even decrease slightly, the sporangium developing at its expense. (3) Both sporangiophore and sporangium remain for two or three hours absolutely unchanged, at least externally, or at most the sporangium increases to a still further almost imperceptible extent at the expense of the sporangiophore. The former still retains its yellow, the latter its white colour. (4) After this period of rest the

* Quart. Journ. Micr. Sci., xxv. (1885) pp. 151-72.

† Mem. Accad. Sci. Bologna, v. (1884) 2 pls. See Bot. Ztg., xlii. (1884) p. 699.

‡ Bot. Ztg., xlii. (1884) pp. 497-503, 513-22, 529-37, 545-52, 561-6 (1 pl.).

sporangiophore exhibits a new and energetic activity of growth, which rapidly increases in rapidity, attains a maximum which it retains for several hours with slight fluctuations, and then gradually falls to zero. During this fourth period the membrane of the sporangiophore assumes a slate colour, while the yellow sporangium becomes brown and finally black; the columella is formed, and the spores, the formation of which commenced during the third period, arrive at maturity.

Mucor mucedo exhibits similar phenomena to *Phycomyces nitens*, while in *M. stolonifer* the fourth stage is altogether suppressed.

Remarkable Development of *Aspergillus niger*.* — J. B. Schnetzler records the remarkable development of *Aspergillus niger* in water in which there had been a fragment of mucus from the stomach of a mad dog; the fluid contained pepsine and possessed all the properties of gastric juice; it dissolved, for example, small morcels of albumen. Nevertheless the fungus developed a very abundant mycelium; the protoplasm was not attacked by the pepsine, a fresh proof of the fact that a pronounced difference must exist, of a chemical nature, between living protoplasm and ordinary albumen.

Mycelial Conidia of *Polyporus sulfureus*.† — On this species of hymenometeous fungus, which produces the disease known as "caries" in chestnuts in Italy and the Pyrenees, J. de Seynes finds all the three kinds of reproductive cells characteristic of the Basidiomycetes:—(1) conidia or spermatia produced on the mycelium; (2) stylospores or spermatia produced in pycnidia or spermogonia; (3) basidiospores. The mycelial conidia are produced within the tissue of the host, at the extremity of longer or shorter branches of the mycelium.

Monograph of *Polyporus*.‡ — Dr. M. C. Cooke publishes the "præcursores" of a monograph of the genus *Polyporus* Fries. The monograph is intended to include all the scattered descriptions of the species known, with measurements of the pores, &c., and critical notes of the species described by Fries, Berkeley, Leveille, Montague, the author, and others, as derived from authentic specimens.

Development of *Pyronema confluens*.§ — P. Van Tieghem has cultivated this fungus with success, and watched the course of development of the perithecium. The thallus is segmented and anastomoses, and it occasionally produces true conidial fructifications instead of perithecia. The perithecium commences its development by the dichotomous ramification of the enlarged summit of a single erect branch, not of two, as stated by Kihlmann and de Bary: the author describes three different modes of development, dependent on the external conditions.

Van Tieghem differs from the view of these two authorities that the perithecium is an organ in which a process of sexual union takes

* Arch. Sci. Phys. et Nat., xii. (1884) p. 419.

† Bull. Soc. Bot. France, xxxi. (1884) pp. 296-9.

‡ Grevillea, xiii. (1885) pp. 80-7.

§ Bull. Soc. Bot. France, xxxi. (1884) pp. 355-60.

place. He regards the part played by the "neck" and the "club" as purely mechanical in relation to the ascogenous ball. The club is simply a support, and the neck a kind of tendril which coils round this support in order to sustain the ascogenous cell; and the object of the terminal anastomosis is simply to ensure the stability of the support. That this is really the function of these organs is confirmed by the third mode of development described by Van Tieghem. This occurs under conditions of great drought, where the ascogenous ball remains very small; and then, not needing any support, these special organs are not formed, and no anastomosis takes place. Even when there is an anastomosis, there is no passage of protoplasm from the club, the supposed male organ, to the ascogenous ball; on the contrary, the ball empties itself, while the neck and the club remain full of protoplasm. Furthermore the ball develops its ascogenous branches before the terminal anastomosis of the neck, but not before the coiling has been effected which is necessary to its support.

Development of Osteomyelitis-cocci in the Organism.*—M. Ribbert details a series of experiments on the development of this fungus within the organism, and on the pure culture of it. He finds that in the organism the cocci distribute themselves from the part where they are formed to other organs.

Actinomyces in Swine's-flesh.†—H. C. J. Duncker has detected in swine's-flesh roundish calcareous concretions, from 0.1–0.2 mm., in diameter, which he finds to be calcified masses of mycelium of *Actinomyces*. The closely packed, strongly refringent, sharply defined patches of mycelium, and the typical centrifugal arrangement are very characteristic. Cochineal stains both the tufts and the granular masses found in the interior a deep red.

Fungi Parasitic on the Mulberry.‡—G. Passerini attributes the malady which ravaged the mulberry plantations in Tuscany during last spring, &c., to the attacks of a hyphomycetous fungus, *Fusarium urticacearum*, probably genetically connected with *Gibberella moricola*; and a pycnidium-form *Dothiorella Berengeriana*, probably belonging to the cycle of development of *Botryosphaeria Berengeriana*. P. M. Saccardo detects in the diseased leaves, in addition to these fungi, a hitherto undescribed species of *Phoma*, to which he gives the name *P. mororum*. O. Penzig and T. Poggi, on the other hand, attribute the malady rather to unfavourable climatic conditions, regarding the above-named and numerous other fungi which are constantly found in the diseased parts rather as saprophytic than parasitic.

* Vers. Deutsch. Naturf. u. Aerzte Magdeburg, Sept. 20, 1884. See Bot. Centralbl., xx. (1884) p. 312.

† Zeitschr. f. Mikroskopie u. Fleischschau, 1884, No. 3. See Bot. Centralbl., xx. (1884) p. 302.

‡ Passerini, G., "La nebbia dei gelsi," Boll. Comiz. Agrar. Parmense (1884) Nos. 5–6. Saccardo, P. M., "Una nuova crittogama nei gelsi," Boll. mensile di Bacchicoltura, 1884, pp. 53–6. Penzig, O., and Poggi, T., "La malattia dei gelsi," l. c. pp. 56–60. See Bot. Centralbl., xx. (1884) p. 48.

Parasitic Fungus on the Red-currant.*—J. A. Bäumler describes a fungus which brings about great destruction of bushes of *Ribes rubrum*, causing the entire fall of the leaves. He finds the disease to be due to the attacks of *Gloeosporium Ribes* (often accompanied by an *Erysiphe*) identical with that found by Fischer on the gooseberry.

Fungi of the Vine and Willow.†—F. v. Thümen describes a disease of the vine known as "Pilzgrind," which has in recent years been very destructive to the vines in S. Tyrol, Dalmatia, and especially in Roumania. The cause he believes to be the combined action of late frosts, and of a fungus belonging to the genus *Fusisporium*, probably either *F. Biasolettianum* or *F. Zavianum*.

The fungi described as parasitic on willows belong to the Uredineæ, Pyrenomyces, Gymnomyces, and Discomyces.

Monascus, a New Genus of Ascomycetes.‡—P. Van Tieghem describes two species of a new genus of Ascomycetes found upon boiled sections of potato, &c. The septated and much-branched mycelium forms a loose felt on the substratum and on neighbouring substances. Vegetative multiplication takes place by conidiophores, from which are abstricted rows of small roundish conidia. The asci originate as lateral branches of the mycelium which divide by numerous septa. In the uppermost cell of each of these branches is produced a single ascus. It swells up into a spherical form; while from the pedicel-cells beneath the ascus, branches begin to grow upwards which approach one another above the ascus, and, by lateral shoots, form a dense envelope around it. This, however, is not regarded by Van Tieghem as the process of conjugation, but rather as forming a nutritive tissue, as in *Aspergillus* and *Erysiphe*. In one species, *Monascus ruber*, this envelope lies nearly close to the rudiment of the ascus; while in the second species, *M. mucoroides*, there is a considerable space between the two. The ascus contains eight ascospores. The fertile fructification resembles the sporangium of *Mucor*.

Van Tieghem places *Monascus* among the Perisporiaceæ, and the tribe Perisporiæ near to *Apiosporium* and *Cystotheca*.

Relations of Two Cecidomyians to Fungi.§—W. Trelease has observed on the fructifications of several Uredineæ, both on the ædium- and the uredo-generations, minute orange-red insects, which proved to be the larval condition of a *Cecidomyia*. These larvæ feed on the spores of the fungus, are extremely voracious, and seem to perform a useful function in restraining the spreading of the fungus.

In another instance he found that the galls on certain species of *Aster* and *Solidago* were produced only by the concurrent action of an insect, *Cecidomyia carbonifera*, and of fungi, *Rhytisma Solidaginis* and *R. Asteris*, the mycelium of the fungus entering the tissues of the host only after they have been pierced by the insect.

* Oester. Bot. Zeitschr., xxxiv. (1884) pp. 327-8.

† Verlag K.K. Versuchsstation Wein- u. Obstbau zu Klosterneuburg. See Oester. Bot. Zeitschr., xxxiv. (1884) p. 443.

‡ Bull. Soc. Bot. France, xxxi. (1884) pp. 226-30.

§ Psyche, iv. (1884) pp. 195-200.

New Fermenting Fungus.*—E. C. Hansen describes a mould-fungus found on cow-dung, and in fissures of sweet juicy fruits, resembling a *Monilia*, which produces active higher fermentation in saccharine solutions, forming cells altogether similar to those of *Saccharomyces cerevisiæ*. The fermentation caused by it differs, however, from that produced by all other ferments known at present, in that it is wanting in the chemically soluble ferment invertin, and consequently that it can ferment saccharose as such.

Pilobolidæ.†—W. B. Grove gives a detailed account of the various points in the structure of this family of Mucorini, which he divides into the two genera *Pilobolus* and Van Tieghem's *Pilaira*, distinguished by the sporangiophore not being separated from the mycelium by a septum, and the sporangium not being projected. Of the former genus he enumerates and describes seven species as at present known, of the latter three, including one new one. With regard to the genetic relationships of the family, the author considers that the known species form a close series which clusters round two points, *Pilobolus Kleinii* and *Pilaira Cesatii*. He supposes the family to have sprung from a species of *Mucor*, like *M. plasmaticus*, which possesses abundance of interstitial gelatinous substance in its sporangium, and which became provided with an upper indurated cap, and a lower diffuent zone; the sporangium, with its spores, being thus enabled to drop off its stem. *Pilaira* would thus be a stage in the evolution of *Pilobolus*, in which a septum is formed at the base of the sporangiophore, and the rapid swelling of the lower part would cause the well-known projection of the sporangium. *Pilobolus longipes* must be regarded as the highest type to which the evolution of the Mucorini has yet advanced in this direction.

Tetramyxa parasitica.‡—K. Gæbel finds peculiar tuberous structures on the stem, rachis, and leaves of *Ruppia rostellata*, of a yellowish green or white colour, changing to brown in the autumn. They are of parenchymatous structure, with a large dark brown central, and a sharply differentiated cortical portion, the latter appearing white from empty intercellular spaces. In the cells of the inner portion were numerous spores, connected together in fours, with smooth colourless membrane, coloured blue neither by sulphuric acid and iodine, nor by chloriodide of zinc.

In younger stages a plasmodium could be detected in the central cells of these tubers, and in the plasmodium a number of small nuclei, and sometimes also in the peripheral cells; but these latter were replaced afterwards by large starch-grains. On contact with water the plasmodia contracted into spherical balls; currents were not observed in them. The formation of spores was preceded by

* Vers. Deutsch. Naturf. u. Aerzte Magdeburg, Sept. 19th, 1884. See Bot. Centralbl., xx. (1884) p. 56.

† Midland Naturalist, vii. (1884) pp. 131-5, 149-53, 184-7, 214-20, 253-60, 280-4, 304-9, 333-9 (2 pls.).

‡ Flora, lxvii. (1884) pp. 517-21 (1 pl.).

the breaking up of the plasmodium into separate portions, each containing a nucleus, which rounded themselves off and became the mother-cells of the spores. These divided first into two, and then into four portions, each of which became a spore, the four spores from each mother-cell remaining united into a tetrad. Their germination was not observed.

Tetramyxa probably belongs, like *Plasmodiophora*, to the Myxomycetes; but is distinguished from other genera of this group by the formation of the spores by quadripartition. On the germination of the spores, zoospores are probably produced, which penetrate into the tissue of the host and produce hypertrophy. The tubers are about the size of a pea.

Cœnonia, a new genus of Myxomycetes.*—P. Van Tieghem describes a new genus of Myxomycetes, found on rotting beans, and belonging to the family of Acrasiaceæ,† distinguished by their aggregated plasmodium. The chief interest of this organism is in the great differentiation displayed by the fructification, although this fructification is formed of a simple aggregation of cells all alike, and at first free. The very same myxamœbæ may, according to the conditions in which they are found, constitute themselves into any part of the fructification, or into spores from which myxamœbæ again proceed.

Journal of Mycology.—An American journal is announced with the above title, to be issued monthly, and edited by J. B. Ellis (Newfield, N.J.) and W. A. Kellerman (Manhattan, Kansas). Special attention will be devoted to descriptions of North American fungi.

Protophyta.

Structure of Chromatophores.‡—F. Schmitz replies to Klebs's criticisms on his paper on the chromatophores of Algæ.§ With regard to *Euglena*, he asserts that Klebs brings forward no fresh observations in opposition to his own that *E. viridis* has stellate chromatophores. Entering again into the discussion as to the internal structure of the chromatophores and pyrenoids, he admits the possibility of a concentric lamination in certain particular cases named by Klebs, though repeating his opinion that his observation is opposed to it as a general law.

Systematic Position of Saccharomyces.||—M. Reess combats the view advanced by Brefeld ¶ that the yeast-fungi are but special con-

* Bull. Soc. Bot. France, xxxi. (1884) pp. 303-6.

† See this Journal, i. (1881) p. 639.

‡ Bot. Ztg., xlii. (1884) pp. 809-17, 830-41.

§ See this Journal, ante, p. 109.

|| SB. Phys.-med. Soc. Erlangen, May 12, 1884. See Biol. Centralbl., iv. (1884) pp. 481-3.

¶ See this Journal, iii. (1883) p. 877.

ditions of a large number of different fungi of higher organization belonging to the class of moulds; and reaffirms the position previously taken up by himself that the various forms of *Saccharomyces* constitute a distinct and independent group, having its nearest affinity with the lower Ascomycetes. The present state of the question he expresses thus:—That process of development which is termed, where occurring typically in the yeast-fungi, “torulose budding” (*hefeartige Sprossung*), takes place in a large number of higher and lower genera of fungi often but little related to one another. All these genera possess, besides this mode of propagation, also other, usually filiform, organs of vegetation, and are distinguished by their special mode of propagation for each type. The ferment-fungi distinguished as *Saccharomyces* possess, on the other hand, no other organs of vegetative propagation than the bud-cells (*Sprossungszellen*); and as specific organs of reproduction a peculiar mode of spore-formation which is not found in any of the other forms of fungus named. *Saccharomyces* has as little to do with the higher fungi which, under certain conditions, may propagate in the same way, as a filamentous alga with the protonema of a moss. All the evidence we have at present goes to show that *Saccharomyces* must be regarded as a degraded ally of *Exoascus*.

Systematic Independence and Position of *Saccharomyces*.*—

C. Fisch also contests Brefeld's views, and on the same grounds as Reess. He describes a new species of *Ascomyces* (a subgenus of *Exoascus*), under the name *A. endogenus*, parasitic on the alder, and in the epidermal cells, not between these and the cuticle, in which each spore is identical in structure with a *Saccharomyces*-cell, thus confirming the conclusions of Reess † as to the affinities of the latter. The mode of spore-formation in *Saccharomyces* is that of an ascus, as in the lower Ascomycetes, not of a sporangium, as in *Mucor*.

Influence of External Conditions on the Development of *Mycoderma vini*.‡—S. Winogradsky has carried out a series of experiments to determine the action of external influences on the development of the lower fungi, and also to solve the question how far the form of the cell remains constant under varying conditions of nutriment. For this purpose he made use of Geissler's chambers, connected with two glass vessels by caoutchouc-tubes. The culture of *Mycoderma* was all derived from the same mother-cell. In one series of experiments the organic constituents of the nutrient fluid were changed, while the mineral constituents remained constant; in the other series variation occurred only in the latter.

The general result of the first series of experiments was that when the supply of oxygen was abundant, the *Mycoderma* grew by means of ordinary budding, while, under deficiency of oxygen, the growth partook of a mycelial character. As regards the mineral constituents,

* Biol. Centralbl., iv. (1884) pp. 484-8.

† *Supra*, p. 293.

‡ Arbeit. St. Petersb. Naturf. Gesell., xiv. (1884) pp. 132-5 (Russian). See Bot. Centralbl., xx. (1884) p. 165.

marked peculiarities were manifested in the cultures with a zinc salt together with potassium chloride. When these were compared with cultures in which potassium chloride only was used, the influence of the zinc salt was very evident. The habit of the culture with sodium chloride also differed from that with potassium chloride.

With regard to Nägeli's statement that potassium is not absolutely essential to the growth of fungi, but that it may be replaced by rubidium or cesium, the author found this to be true as respects rubidium, while with cesium or lithium not the least trace of development was observed.

A final series of experiments was undertaken with nutrient fluids containing equal quantities of organic substances, phosphoric acid, and potassium chloride, but with different alkaline salts, viz. sulphates of magnesium, calcium, and strontium. Only in the first of these did a good pellicle develop; the rest manifested no development at all. The absence of calcium, so important in the nourishment of green plants, appears to be of no consequence to that of *Mycoderma*.

Origin of Microzymes and Vibrios of Air, Water, and Soil.—

E. Duclaux* has experimented on plants grown in soil free from microbes in order to determine the effect of their presence upon germination. He used peas and Dutch beans, the cotyledons of which uniformly appear, one below the soil, the other above. The soil had been previously sterilized and moistened with sterilized milk. Under these conditions, germination did not take place, and at the end of two months the milk showed no indication of alteration. These experiments tend to prove that the presence in the soil of microbes is necessary to the development and life of plants.

M. Pasteur mentioned when the paper was read that he had proposed to his pupils to examine the effect of feeding an animal from birth with food the elements of which had previously been freed from microbes, and consequently reduced to its nutritive principles, pure and simple. To this he had been led by the idea that in such conditions the maintenance of life and development would be impossible, leading to the important suggestion that the presence of microbes in food is necessary for digestion. The absence of microbes renders impossible the accomplishment of the actions necessary for the elaboration of the matters destined to serve for nutrition. The importance of an exact knowledge of the part played by microbes in digestion cannot be overrated.

A. Béchamp,† after a reference to the previous communication of M. Duclaux, points out that the question at issue may be stated in these terms: Have the microzymes and vibrios of the atmosphere been primitively disseminated in the air, and thence fallen on the ground to penetrate into its depths and waters, as Pasteur thinks; or are not the latter, as the author thinks, the origin of what are found in the atmosphere? M. Béchamp maintains that primitively there were no

* Comptes Rendus, c. (1885) pp. 66-8.

† Ibid., pp. 181-4.

microzymes in the air, but that they have been disseminated by wind from the surface of the earth. He believes that he has proved this completely. He considers that his theory is not the work of the imagination, but is altogether based on experiment, and that it is adequate to explain known facts.

Vitality of Germs of Microbes.*—E. Duclaux has tried to discover whether germs preserved damp would, like those preserved in the dry state and sheltered from solar light, resist for several years the action of temperatures higher than those of the hottest parts of the world. The author has been able to make use of some infusions made by Pasteur in 1875 and 1876 during his experiments on beer, and others which he himself made in 1878 and 1879 when working at cheese. With fifteen specimens of yeast only three cases of the death of the cells occurred, and two of these ought to be attributed to extraneous causes; among the *Tyrothrix* of cheese, after five years, only *T. claviformis* and *T. urocephalum*, which are essentially anaerobic, had died; all the aerobic species have survived in the form of spores. Among micrococci the resistance to death is much less marked, one only among ten having been found alive after three years' preservation. These results agree generally with those obtained by Pasteur in his studies on *Bacillus anthracis*, and the micrococci of chicken cholera.

As ten years were insufficient for the death of the larger number of bacilli, the author was allowed by Pasteur to make observations with some of the infusions prepared by him in 1859 and 1860. All the infusions in which living germs were found had the liquid still slightly alkaline, while those in which they were dead were acid. The alkalinity, however, to be favourable to life, must be slight. Of the sixty-five infusions observed, fifteen contained living germs, and that after a period of twenty to twenty-five years.

Passage of Pathogenous Microbes from the Mother to the Fœtus.†—M. Koubassoff points out that the generally accepted doctrine of Brauell and Davaine that pathogenous microbes do not pass from the mother to the fetus was shaken in 1882, when Arloing, Cornévin, and Thomas showed that the bacteridia of symptomatic anthrax (black-leg, or quarter-evil of cattle) may pass from the mother to the fœtus; in the same year Strauss and Chamberland published two papers, in the first of which they supported the ordinarily received view, but in the second showed it to be erroneous. The author has made five experiments with gravid guinea-pigs inoculated with anthrax; in the seventeen fœtuses examined, all the organs have been found to contain *Bacillus anthracis*.

In one case Pasteur's vaccine was inoculated, and in another a cultivation prepared from the heart of a fetus; in the former the examination of the organs of the fetus resulted in bacilli being found very rarely, while of the cultivations made therefrom some only were

* Comptes Rendus, c. (1885) pp. 184-6.

† Ibid., pp. 373-5.

fertile; in the latter case, where the mother died in three days after inoculation, the liver of the fetus, which was only 0·03 metre long, was found to contain numerous groups of *Bacillus anthracis*.

Development of *Bacillus Amylobacter* in Plants in a Normal Condition of Life.*—P. Van Tieghem points out that this microbe, which produces the butyric fermentation, is a liquid containing a small quantity of nitrogenous and mineral substances, presents quite different phenomena of development, when its spores are introduced into ordinary water in which are immersed portions of living plants which it attacks and speedily destroys. In the first case, if the water is constantly aerated, the development of the bacillus is arrested. In the second case, if a current of air is passed through the water, the *Bacillus* no longer develops in the interior of the fragments of plants, but extends for a short distance around them, and then secretes a large quantity of a gelatinous substance, which unites the separate individuals into a dense limpid and hyaline mass, which is sometimes as much as 2 cm. in thickness. In this condition, where it is protected from contact with the surrounding oxygen, *B. Amylobacter* presents a strong resemblance to *Leuconostoc*.

By experiments on potatoes, beans, and other similar substances, Van Tieghem showed that, when inoculated with spores of *B. Amylobacter*, even when fully exposed to the air, the cellular tissues are in time completely destroyed, and are replaced by a fluid mass containing grains of unaltered starch, albuminoid substances, butyric acid, &c.

Influence of Light on the Vegetation and on the Pathogenous Properties of *Bacillus anthracis*.†—S. Arloing finds that *Bacillus anthracis* grows best in diffused light or in shade; augmentation of the intensity of the light retards the vegetation of the mycelium. Simultaneous cultivations of solutions in darkness and in the presence of red rays seem to the naked eye to be similar; with the aid, however, of the Microscope one sees that the number, distinctness, and refractive power of the spores is much greater in solutions exposed to the coloured rays; red rays have the same advantage over white light. Yellow rays are less advantageous than red. The calorific are more advantageous to growth than actinic rays.

There is no reason for believing that the action of calorific or actinic rays continued through several generations produces any change in the pathogenous activity of bacilli; it remains the same under the influence of calorific rays, and is perhaps rather increased than diminished with actinic rays. The author proposes to study the effect of solar rays.

History of Development and Morphology of *Bacillus anthracis*.‡
—In opposition to the view of Buchner,§ A. Prazmowski main-

* Bull. Soc. Bot. France, xxxi. (1884) pp. 283-7.

† Comptes Rendus, c. (1885) pp. 375-81.

‡ Verh. Akad. Wiss. Krakau, xii. (1884) 1 pl. (Polish). See Bot. Centralbl., xx. (1884) p. 292.

§ See this Journal, ii. (1882) pp. 89, 832.

tains the absolute specific distinctness of *Bacillus anthracis* and *B. subtilis*. The spores of the two bacteria display a difference in the structure of their spore-membranes, and a corresponding different mode of germination. In *B. anthracis* the membrane is of uniform thickness throughout, and, on germinating, bursts at one end of its longitudinal axis. In *B. subtilis* it is thickened at both ends of the elliptical spore, and germination takes place in a direction at right-angles to its longer axis. The morphological characteristics of *B. anthracis*, and also, in the main, its physiological properties, are perpetuated even when it has lost its pathological properties by artificial cultivation. In other respects it only changes its physiological characters by passing over more readily into the swarming condition, and, in consequence, collecting towards the end of its growth, especially on the surface of the nutrient fluid, where it forms thickish dirty white pellicles after the manner of *B. subtilis*; but the two still present points of difference.

Prazmowski's investigations indicate only that, under certain conditions of artificial culture, *B. anthracis* may lose its capacity of multiplying in the animal organism, and producing the cattle-disease. He has observed also in this species a new and peculiar resting condition. The rods exude a thick gelatinous membrane, which soon becomes hard, and then forms a kind of tough and firm envelope round the delicate rod. Under favourable conditions an ordinary rod is then developed from this resting form by the envelope becoming ruptured at a certain point, and the young rod then growing out from this spot as in the germination of the spores.

Diagnostic Value of Tubercular Bacilli.*—Friedrich Müller epitomises the facts at present known with regard to the value of the characters presented by the different bacilli which accompany the various forms of tubercular disease. To these diagnostic characters he attaches great value. The micro-organisms characteristic of tuberculosis and of lepra present great similarity in their forms, mode of formation of the spores, and arrangement in groups; in the latter case, however, they are present in enormous quantities, while in the former their number is comparatively small.

Odour and Poisonous Effects of the Fermentation produced by the Comma Bacillus.†—W. Nicati and Rietsch find that pure cultivations of the "comma" *Bacillus* have a characteristic ethereal odour, quite different from that of putrid substances. This is the odour of the intestinal matter of cholera patients in the early stages, especially if it is kept in a moist atmosphere at 25°–35° for 24 hours. If pure cultivations of this *Bacillus* in Koch's gelatin or in beef-tea, after at least eight days, are freed from *Bacilli* by being passed through a Pasteur's filter, and the clear liquid is injected into the circulatory system of dogs, choleraic symptoms of varying degrees of violence are produced. The same liquid when injected under the skin has no effect. Recent cultivations are also absolutely inactive.

* Verh. Phys.-med. Gesell. Würzburg, xviii. (1884) pp. 1-8.

† Comptes Rendus, xcix. (1881) pp. 928-9.

Relations of Bacteria to Asiatic Cholera.*—E. Klein details the results of an inquiry into the etiology of Asiatic cholera. He finds that the theory of Koch as to the "comma" bacilli (really vibrios) present in the mucous membrane secreting a chemical poison inducing the disease is not correct. Neither the blood nor any other tissue contains the comma bacilli or any other micro-organisms of known character. The behaviour of the comma bacilli in artificial media is not such as to justify their being considered as specific. They grow well in alkaline and neutral media, are not killed by acids, and their mode of growth in gelatin mixtures is not more peculiar than that of other putrefactive bacteria; they show marked differences when grown in different media, but not more so than the ordinary putrefactive bacteria when compared in their growth with one another. Koch overlooked that comma bacilli occur in other intestinal diseases, in the mouths of healthy persons, and, as shown recently, even in some common articles of food.

The experiments performed by Koch and others on animals do not in the least prove that the comma bacilli are capable of producing cholera. The results are easier explained in a manner opposed to that given by Koch. There is direct evidence to show that the water contaminated with choleraic evacuations, and containing of course, the comma bacilli, when used for domestic purposes, including drinking, by a large number of persons, did not produce cholera.

G. M. Sternberg, in a temperately worded summary of the controversy, concludes "that in view of the contradictory testimony now before us, we cannot do otherwise than consider the question still *sub judice*, and wait patiently for detailed reports and additional experimental evidence."†

Microbe of Human Typhoid Fever.‡—M. Tayou has not yet succeeded in conferring immunity from typhoid poisoning on the guinea-pig, rabbit, cat or dog; pigs, on the other hand, are affected by no inoculations, however strong; the author thinks that this is due to the long-acquired filthy habits of the pig, which have gradually conferred on it immunity to poisons found in human excreta.

The infinitely small organism which Tayou has obtained from the blood of a man suffering from typhoid fever has several forms, and seems to pass through several phases. It is rounded at the extremities, has a mean length of 0·00245 mm., and a mean diameter of 0·00049 mm.; in the peritoneum of the guinea-pig or rabbit it gives rise to new individuals which resemble it, but are of a little larger size, 0·00318 mm. by 0·00072 mm.; in the peritoneum of the dog they may become still more elongated, and take on the form of long, very fine filaments, filled with spores. Although typhoid lesions are generally very well marked, the preliminary symptoms vary considerably with different animals.

* Proc. Roy. Soc. (not yet published). See Nature, xxxi. (1885) pp. 354-5.

† Science, v. (1885) pp. 109-11 (2 figs.).

‡ Comptes Rendus, c. (1885) pp. 375-7.

Pneumonia-cocci in Dormitories as a Cause of Pneumonia.*—R. Emmerlich confirms the observations of Kerschesteiner that pneumonia may be caused by micrococci in the sleeping apartments of those attacked by the disease. He obtained material from the dormitories in a hospital where the disease was rife, cultivated it in Koch and Löffler's "Fleischwasser-pepton-gelatine," and injected with it rabbits, porpoises, and mice, which soon died. In their blood and organs he found septic organisms identical with Kerschesteiner's bacillus of pneumonia. These were afterwards identified with the pneumonia-coccus of Friedländer.

"Rauschbrandpilz," a parasitic cattle-disease.†—Neelsen and Ehlers describe a disease known as "Rauschbrandpilz," which is destroying a considerable number of cattle in some parts of northern Europe. It manifests itself in the form of flat painful swellings on the extremities, filled with a dark red frothy fluid, accompanied by a "rushing" noise from the escape of gas. The disease is caused by a Schizomycete, a *Clostridium*, which may penetrate either the muscles or the intestines. It occurs both in the bacillus and in the coccus-form, and produces spores in special individuals which swell up into a lemon- or club-shape. The disease can be propagated by infection in porpoises; but the organism has this peculiarity, which distinguishes it from other allied pathogenous forms, that by no transference from one host to another can its virulence be in the least diminished.

Bacterioidomonas undulans.‡—J. Künstler describes a second species of his lately described new genus, which he found in the intestine of the black rat. The body is elongated, slightly attenuated at either end, and $34\ \mu$ in length; the whole presents slow undulatory movements; in the centre there is a nucleus, and two smaller nuclei are often also to be found, one at each end of the body. Locomotion is rapid, and is effected by the aid of a long and very fine cilium. The reproductive phenomena are very similar to those of *B. sporifera*; they commence with a considerable increase in the refractive power of the body, while the addition of iodine reveals the presence of a quantity of amyloid substance; the protoplasm then becomes concentrated at various points, and gives rise to elongated spores. These are set free by the dehiscence of the walls of the body, undergo several divisions, and taking on a spirillar form gradually grow up into the appearance of the adult. These new organisms resemble the Bacteria in their mode of nutrition by simple imbibition, by being difficult to colour, by the excessive fineness of their flagellum, by their endogenous sporulation, and by the form of the spores. They differ in their size, their constant mobility, their nucleus, and the number of their spores.

* Fortschr. der Medicin, ii. (1884) No. 5. See Bot. Centralbl., xx. (1884) p. 145.

† Neelsen. SB. Naturf. Gesell. Rostock, Jan. 26, 1884. Ehlers, Unters. über d. Rauschbrandpilz, Rostock, 1884. See Biol. Centralbl., iv. (1884) pp. 513-5.

‡ Comptes Rendus, c. (1885) pp. 371-2.

MICROSCOPY.

a. Instruments, Accessories, &c.

Schieck's Bacteria Microscopes.*—F. W. Schieck supplies the instruments shown in figs. 45 and 46, ostensibly for the examination of Bacteria.

They are chiefly remarkable for the strange position of the rack

FIG. 45.

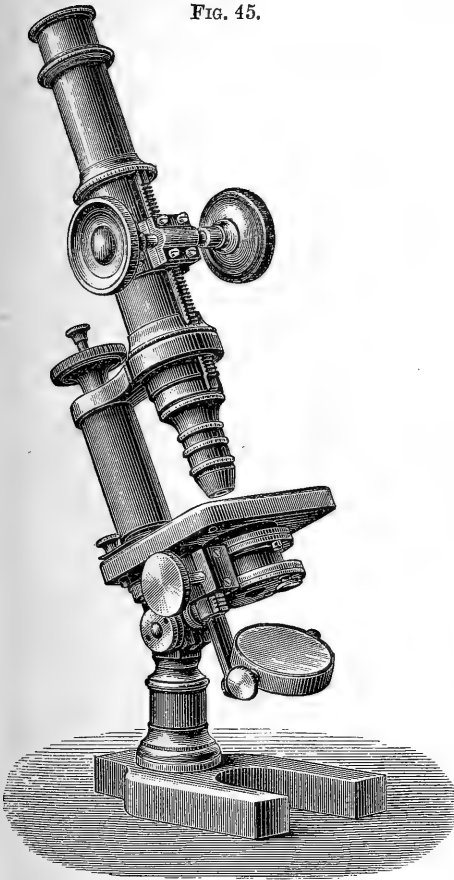
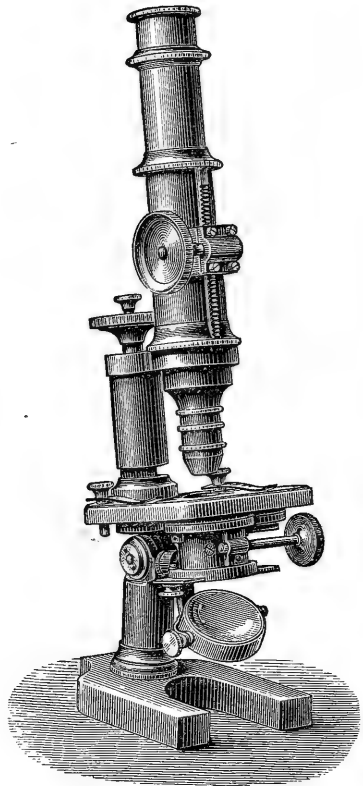

FIG. 46.



and pinion of the coarse adjustment, which is placed in the front of the body-tube instead of behind. It seems to us that this change has nothing to recommend it, and we are at a loss to understand why it has been adopted.

The illuminator is a modified Abbe condenser.

* See Dippel's 'Grundzüge der Allgemeinen Mikroskopie,' 1885, p. 233.

Reichert's No. VII. Microscope.—Herr C. Reichert, referring to fig. 147 of Vol. IV., sends us fig. 47, which represents a Microscope

FIG. 47.



he is in the habit of making, in which the stand is constructed in the same way, the "Jackson" limb being continued to the base. It has, however, the addition of a fine adjustment.

Stein's Microscopes for use with the Electric Light.*—Dr. S. T. Stein has designed the arrangements for applying the incandescent electric light to the Microscope shown in figs. 48 and 49. The

FIG. 48.

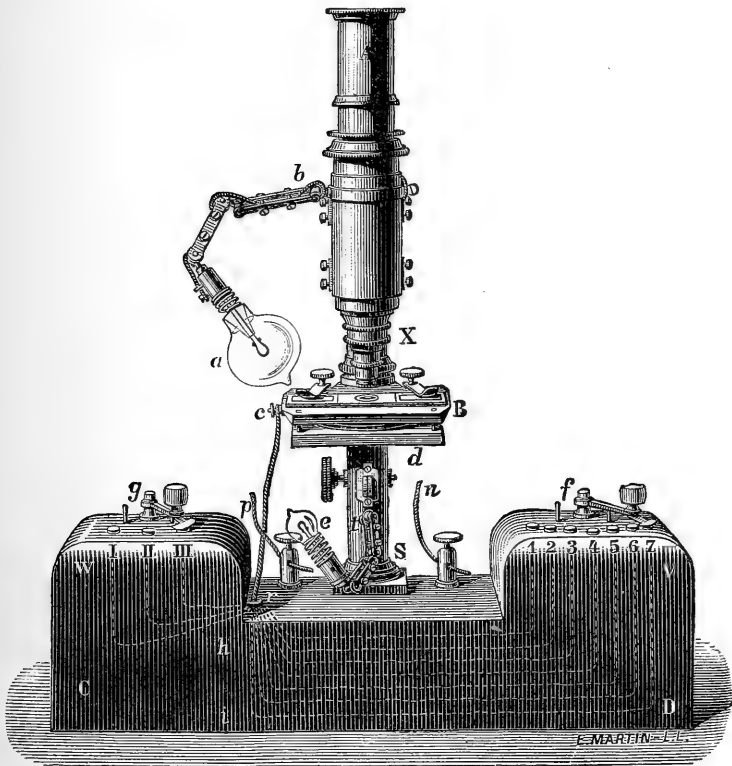

ingenuity which he has displayed is unquestioned, but we cannot help feeling that after all it is in several respects undesirable that the electric apparatus should be permanently connected with the Microscope. It is, we think, preferable to use a lamp on a separate stand as suggested by Mr. Stearn in this Journal,† and by Dr. Stein

* *Zeitschr. f. Wiss. Mikr.*, i. (1884) pp. 161-74 (7 figs.). The clichés with which Dr. Stein has obligingly supplied us met with an accident, which has unfortunately delayed the appearance of this notice, prepared for an earlier issue of the Journal.

† See this Journal, iii. (1883) p. 32.

himself. The expense of a separate Microscope is thus saved as any stand can be used, and the light readily applied above or below the stage.

Dr. Stein's Microscope X (fig. 48) is screwed by its foot S to a wooden base C D, with two raised parts W V similar to the stand of a

FIG. 49.

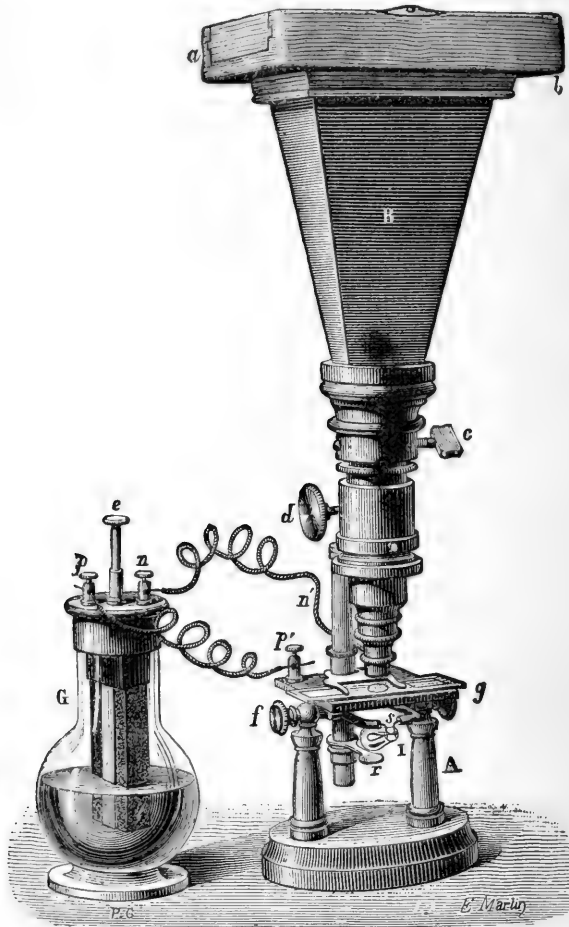

dissecting Microscope. This base contains the wires which convey the current. One lamp *a* is attached to the socket for the body-tube by the jointed arm *b* and serves for the illumination of opaque objects, while a second smaller one *e* is attached to the foot of the stand by a similar arm *t* and is intended for transparent objects. The wires to and

from the battery enter and leave at *p n* respectively. The former is connected, through the arm *f*, with 7 spiral German-silver wires *h i* of different thicknesses, contained in the wooden base, which act as a rheostat to increase or diminish the intensity of the current received by the lamps. By means of the arm *f* the current can be made to pass through any one (1-7) of the wires until the proper degree of illumination is obtained. At the other end the wires are, by the arm *g*, put in connection with any one of the three wires I, II, or III. These are connected with the end of the treble wire *r c*, and from the latter point are led separately either to the large or small lamp or to the stage B, where (at *d*) the current is made use of for heating purposes.* The wire from *n* is in communication with the foot of the Microscope, the latter thus serving as a conductor for the return current.

A simpler form of Microscope is shown in fig. 49 A (with photomicrographic camera B attached). The lamp I is beneath the stage, replacing the mirror, and is put in communication with the battery

FIG. 50.

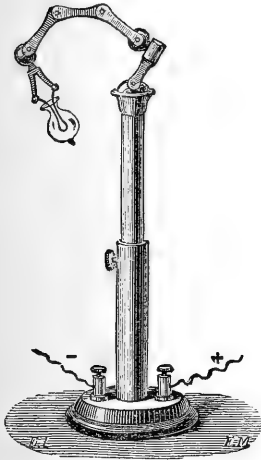

FIG. 51.

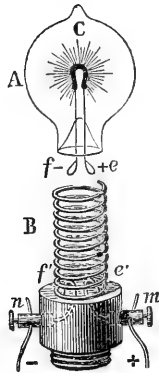
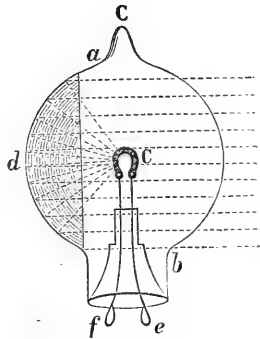

FIG. 52.



G by the wires *p n*, *p' n'* and *s*. The piece *r* is for raising or lowering the lamp without having to touch it when hot; (*d* is the milled head for the coarse adjustment, and *f g* the trunnions on which the body-tube and also the stage are inclined).

For a separate lamp Dr. Stein uses the stand fig. 50, which is practically identical with that of Mr. Stearn.†

The lamps used by Dr. Stein are shown in figs. 51 and 52 and are identical with the Swan lamps in use in this country. A is the small lamp with its spiral socket B, and C the larger lamp. (The connecting

* Dr. Stein's warm-stage arrangement will be described in a subsequent number of the Journal in connection with a summary of the various warm-stages which have been suggested.

† Loc. cit.

wires and hooks are ef , $e'f'$, and mn , and the incandescent carbon at C. For the smaller lamp two, and for the larger three Bunsen or Grove elements (20 cm.) are sufficient. If it is desired to throw a strong light on the object, part of the lamp may be silvered, as at abd , or opal glass may be used if less illumination is required. The great steadiness of the lamps renders them specially serviceable for use with the Vertical Illuminator, and they can obviously be very conveniently applied at the side of the Microscope. If a very intense beam of parallel rays is required to be thrown on the object, an Abbe or other condenser should be used and the lamp placed exactly in the focus.

For photo-micrographic purposes a camera similar to that of B,

FIG. 53.

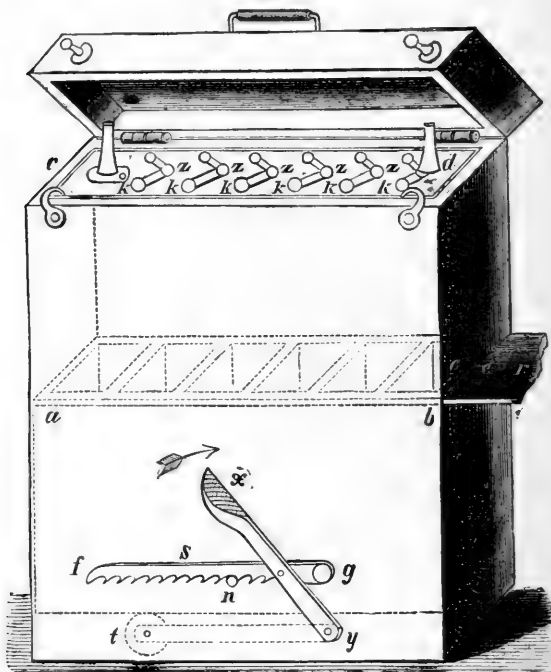
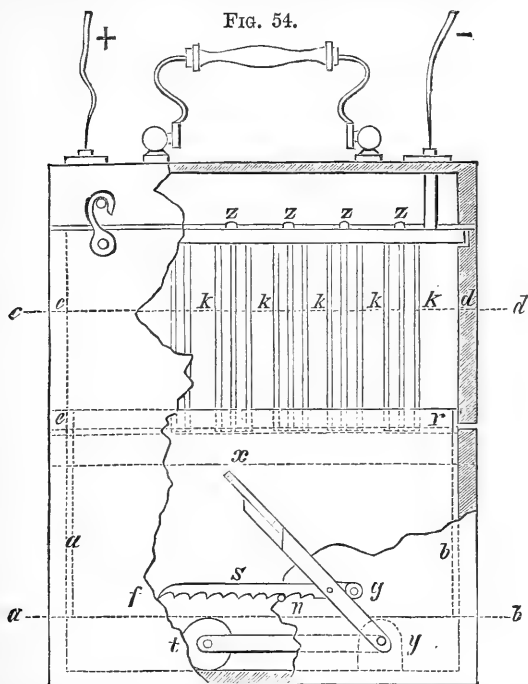

fig. 49, can be used, ab being the box for the plate, and the whole being attached to the body-tube by the screw c . Dr. Stein is somewhat enthusiastic on the use of the electric light for photo-micrography and urges that all microscopists should employ it. He has photographed *Pleurosigma angulatum* $\times 500$ with an exposure of only 70 seconds, and an incandescence lamp of five volts.

Dr. Stein has recently designed the battery figs. 53 and 54 specially for use with the Microscope. Holding 300 gr. of bichromate solution it will actuate for two hours lamps of 2-8 volts and 1-6 candles. The speciality of the battery is the contrivance, $fxsngyt$, for lifting the cells ab up and down to increase or



decrease the light. The higher the cells, and the deeper therefore the immersion of the elements (carbon and zinc *kz*), the greater the illumination. The wires pass out through *cd*. At *er* a cover can be introduced to prevent the fluid spilling when carried. The whole measures 8 in. \times 9 in. \times 3 in.

As we have recently* dealt somewhat fully with the advantages of electrical illumination for microscopical work, it is unnecessary to recapitulate them here, but we may mention that Dr. M. Flesch records† some further experiments both with arc and incandescence lamps, and commends the steadiness of the light and the very perfect manner in which colours are shown, differences of tint hardly appreciable by daylight being readily discriminated with the electric light.

Swifts' Sheep-Scab Microscope.—This (fig. 55) was constructed by Messrs. Swift for a microscopist who desired to examine the scab in sheep without having to approximate his face too closely to the diseased portion of the animal. It would of course be found equally useful in the case of examinations of other contagious or disagreeable diseases.

FIG. 55.



* See this Journal, iv. (1884) p. 966. Cf. also ii. (1882) p. 419.

† Zeitschr. f. Wiss. Mikr., i. (1884) pp. 561-3.

The Microscope consists of two tubes only, the objective being screwed to the outer one and the eye-piece sliding in the inner. A pin on the inner tube works in a slot in the outer, serving as a guide when the former is drawn out. With the eye-piece tube closed, the instrument is $4\frac{1}{8}$ in. long and extended $6\frac{3}{8}$ in. The power varies from 3 (closed) to 12 (extended), with a working distance of from $6\frac{1}{2}$ in. to 3 in. The adjustment for focus is of course made by moving the whole Microscope to and from the object.

Winkel's Demonstration Microscope.—The speciality of this instrument (fig. 56) consists in the arrangement for moving the object. This is effected as represented in fig. 57, which shows the lower part of the Microscope when the upper portion is disconnected. The slide is attached by spring clips to the movable plate, shown in the fig., which has a long slot working on a pin, so that the plate can be moved laterally for rather more

FIG. 56.



FIG. 57.

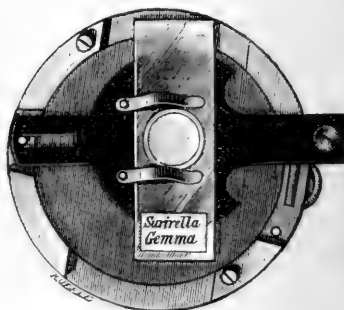

than $\frac{1}{2}$ in. At the same time a motion in arc for about the same distance can be obtained by pivoting the plate on the pin. The combination of these two motions brings all parts of the object into view. Since fig. 56 was drawn,

three feet have been added, forming a tripod support for the instrument when standing on the table. The fine adjustment screw has also been removed from its position at the top of the base and placed below. Its action is to raise or lower the slide-plate at one end slightly. There is a spring clip on the top of the base to receive a card with the name of the object.

Tolles' Clinical Microscope.—This (fig. 58) consists of a principal tube or sheath, into the upper end of which slides the body-tube, with eye-piece and objective, while in the lower end works a third

short tube, with outside screw. In this tube slides the socket to which the stage is attached, and by the action of the screw (on the principal tube being revolved) a fine adjustment is obtained. The screw, though coarse, is of large diameter ($1\frac{1}{8}$ in.), so that the motion is sufficiently slow. A coarse adjustment is made by sliding the body-tube. On removing the stage the end of the Microscope can be closed by a cap, for more conveniently carrying it in the pocket. The total length is $7\frac{3}{4}$ in.

FIG. 58.

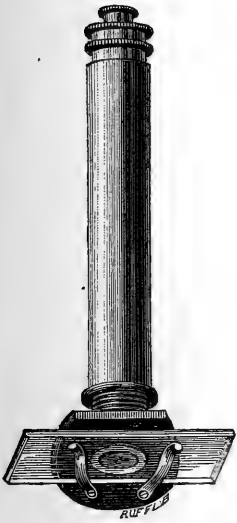

FIG. 59.

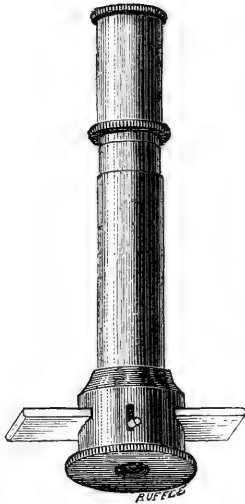
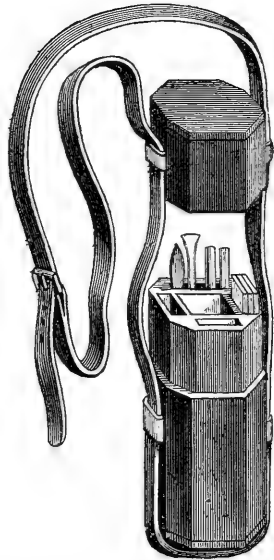

FIG. 60.



Klönne and Müller's Pocket Microscope.—This (fig. 59) is similar in general design to the preceding, but is without any arrangement for fine adjustment. The slide is passed through a transverse opening in the drum which forms the end of the principal tube or sheath, and is kept in position by the action of a spring, the two ends of which move in slits as shown in the fig. There is an aperture in the drum to admit light to the object.

For use in the field the Microscope is carried in the case shown in fig. 60, which contains knives, needles, glass tubes, and slides.

Janney's Simple Solar (or Projection) Microscope.*—This (fig. 61) is a somewhat primitive form of solar Microscope devised by R. Janney, which however, on account of its cheapness and the absence of a heliostat, may be found useful for school demonstrations in countries where there is a fair amount of sunshine. It is claimed

* Scientific American, l. (1884) p. 276 (2 figs.). The fig. is from Zeitschr. f. Instrumentenk., iv. (1884) p. 319, and slightly differs from the original.

that an object (piece of a fly's eye) less than 1/16 in. in diameter can be exhibited clearly and with good definition enlarged to 10 feet, and a bee's sting to 20 feet.

Two mirrors, *a* and *b*, are supported by the arms *l* and *k*, on which they swing. The arm *l* is attached to the ring *h*, which rotates on the

FIG. 61.

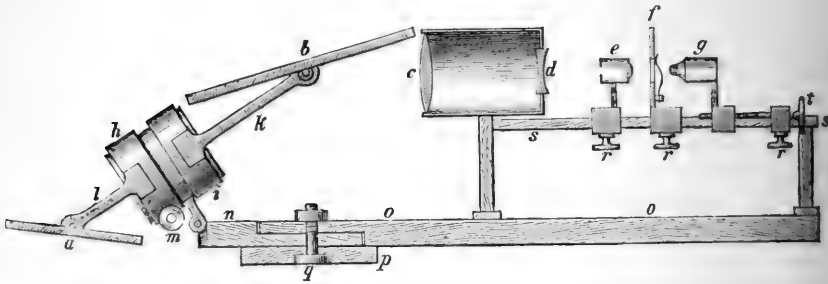

inner cylinder by the milled head *m*. The cylinder being directed to the pole the mirror *a* by the rotation of the ring *h* will be made to follow the sun. The arm *k* is similarly attached to the ring *i*, which rotates by hand, and by which the mirror *b* can be set so that the sunlight is thrown through the condenser. The inner cylinder which is directed to the pole is connected by a hinge joint *n* to the base plate *o o*. The optical part consists of the convex and concave lenses *c d*, small condenser *e*, and the objective *g*. The condenser and objective with the stage *f* slide along two rods *s s*, and are clamped by the screws *r r r*. The fine adjustment is at *t*. The lens *e* can be adjusted vertically or laterally by screws not shown in the fig.

The parts *n o o* are of wood 4 in. by 3/4 in. and 22 in. long. They can be turned about *q*, which is immediately under the centre of the mirror *b*. The piece *p* extends 2 in. beyond either side of *n o*, and is screwed to the window-sill. The three pieces *p n o* all turn independently, and in use *o o* is turned to point to the place where the image is to be shown.

The apparatus can be used with the electric or lime light. Clockwork could be applied to it.

Thompson's Projection Microscope.*—W. G. Thompson describes the following adaptation of a Microscope (designed by himself and Dr. J. W. Roosevelt) "as a sort of magic lantern" for class-room demonstration, which he has found extremely useful, cheap, and practical.

A large common kerosene "duplex" lamp (fig. 62, facsimile of original) is the illuminator. Superfluous light is cut off by a piece of 6-in. stove-pipe, which fits over the lamp-chimney, and rests upon a horizontal collar C, of stove-pipe metal. The collar prevents the pipe from coming down too far upon the lamp, which would cause the

* Science, iv. (1884) pp. 540-1 (1 fig.).

kerosene to become dangerously hot. The lamp is filled at F with a curved glass funnel; and the two flat wicks, $1\frac{1}{2}$ in. broad, are turned by their separate keys outside the pipe. The pipe has two elbows, which conduct heat and smoke away, and completely cut off the light from the top of the flame. These elbows may be rotated into any convenient position. Opposite the lamp-chimney a third short elbow E is inserted, closed by a movable cap. Through this elbow the chimney can be removed, the wicks trimmed, and a concave glass or tin reflector M, $4\frac{1}{2}$ in. in diameter, may be placed behind the flame. The flat of the wicks should be parallel to this mirror. Opposite the mirror, and directly in front of the flame, a plano-convex lens X, 2 in. in diameter, is inserted in a hole in the pipe. The

FIG. 62.

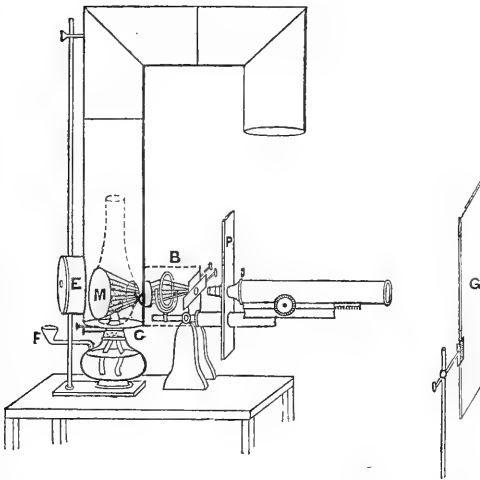

light reflected from the mirror M passes through this lens, and falls upon the mirror of the Microscope, whence it illuminates the object upon the slide in the ordinary way. The object is magnified by a $\frac{1}{5}$ or $\frac{1}{2}$ in. objective; the eye-piece is removed; and the image is projected upon a ground-glass screen G, $1\frac{1}{2}$ ft. square, which is placed from one to four feet in front of the Microscope. The screen is supported by a perpendicular iron rod and cork-lined clamp, such as is in use in every chemical laboratory, to hold glass retorts, tubes, &c. The iron rod rests upon the floor, occupies very little space, and can be moved to any convenient focusing distance. A similar stand supports the horizontal elbow of the stove-pipe. The body-tube should be blackened inside as in photo-micrography.

The great difficulty with the apparatus consists in trying to prevent the reflection of superfluous light. To obviate this, a pasteboard box B, $6 \times 6 \times 8$ in., is readily cut to fit closely over the plano-

convex lens and the back of the stage, thus inclosing the mirror and allowing it room to be focused properly when the lid of the box is removed. It is also advisable to fit a sheet of pasteboard P tightly over the body-tube at right angles to it, in order to cut off the rays which escape around the object illuminated, pass along the axis of vision outside of the tube, and tend to blur the image on the screen.

“Physiological, histological, pathological, and botanical specimens may be clearly shown. A number of students can look on at once. The slides are rapidly changed, and student and instructor may always be sure that they are discussing the same particular cell; which, unfortunately, is not the case when a beginner in the use of the Microscope looks through the instrument alone. The apparatus may readily be constructed by any one for about five dollars; it is easily portable, and always ready for use in any darkened room. . . With some lenses, the use of the eye-piece adds distinctness, but in most cases it cuts out too much light. An Abbe illuminator may be inserted. The image on the screen G is seen most distinctly upon the farther side; and some objects become clearer if the screen be moistened with water, or covered with a thin coat of transparent varnish laid over the ground surface. The image may also be received upon white glazed paper, but this is less clear.

For demonstration on a larger scale, an oxyhydrogen light can of course be used, or some form of electric light. The arc light is not sufficiently steady, and the incandescent light requires a great deal of storage-room for batteries. The light above described shines with thirty-six candle power, is clear and steady, and serves every ordinary purpose: the circulation in the frog's foot, varieties of epithelium, injected lung tissue, tubercle, plant-cells, &c., may all be clearly shown. The colours of stained or injected specimens come out distinctly.

The principle of this apparatus is by no means new; but its application is made so easily within the reach of any one who owns a Microscope, that it is especially recommended to instructors in schools and colleges.”

Apparatus for Botanical Lectures.*—Dr. E. Hallier describes the apparatus which he has found useful in his botanical lectures.

1. *Stand for the Magnifiers and Objects.*—Whilst it is, of course, always required that each student should have in his hand a perfect example of the plant to be described, and that he should dissect it with the knife during the lecture, and then examine each part separately with the magnifier, yet this is not satisfactory with a large number of students, because the teacher cannot superintend the manipulation of each one separately, and cannot be certain that the specimen is dissected and examined as it should be in order to show its essential parts.

Accordingly, Dr. Hallier uses the apparatus shown in fig. 63. A is the stand for the magnifier. To the heavy brass foot *f* the column *s* is screwed, with an arm *a* clamped by the screw *b*, and

* Zeitschr. f. Instrumentenkunde, i. (1881) pp. 393-7 (1 fig.).

movable through *r* to any height. By unscrewing *n* the arm can be removed altogether. The magnifier *l* (a Brücke lens) is connected with *a* by two shorter arms with ball-and-socket joints, *k k*.

FIG. 63.

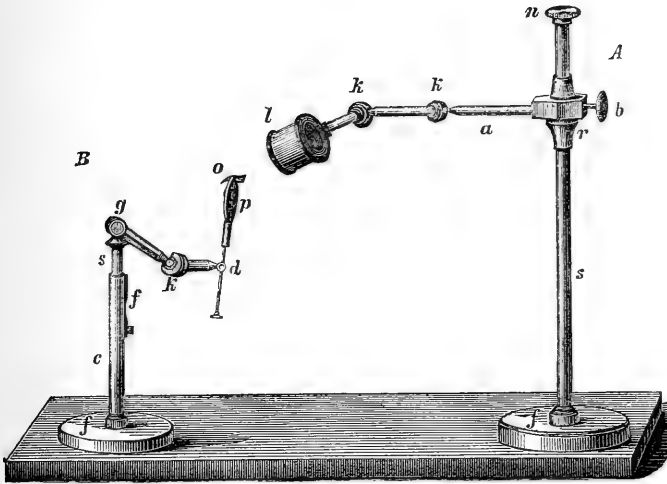

B is the stand for the object. A hollow tube *c*, screwed into *f*, holds a steel rod *s*, which can be removed up or down by the spring *f*; a double arm hinged at *g*, and having a ball-and-socket joint *k*, carries the forceps *p* for holding the object *o*. They can be moved up or down in *d*. The apparatus has the great advantage of being movable in any direction.

In use, the apparatus is placed by the south window of the lecture room, and, to obviate any unsteadiness, it stands upon a piece of felt about an inch in thickness. A large sheet of white cardboard, for which black can be substituted if necessary, is placed on the table as a background for the object. To prevent too strong a light, there are two frames—one having white calico, and the other black cardboard—which fit exactly into the lower part of the window. If the light is required to fall on the object from above, then the black one is used, but the white one if the light is to be dispersed. The specimen being arranged in a good light beforehand, one student after another should examine it; and the Professor has found that, after a short description of the object, the student can dissect the specimen more correctly, and can make a more accurate observation of its parts at his desk than he would otherwise do.

2. *Use of the Sciopticon for Botanical Lectures.*—Every teacher will agree, Professor Hallier says, that there can hardly be too many expedients for demonstrating objects in botanical lectures, the only difficulty seems to lie in the choice of means. To illustrate the teaching of natural science, the preference is always given to the

object itself rather than to a representation of it. A boy who has seen an elephant or a monkey in the Zoological Gardens has a great advantage over his companion who has only seen pictures of these animals. In the same way the anatomical dissection of the human body itself must be thoroughly understood by the medical student, and cannot be replaced by the observation of any artificial model, however skilfully constructed. The same principle applies to botany. Pictorial representations of plants and their parts can in no way replace the necessity for a personal examination by means of the Microscope and the dissecting knife.

One of two methods are usually employed in using the Microscopes, i. e. they are either passed from hand to hand, or are fixed in the lecture room. The first method has the advantage that the explanation is immediately connected with the observation of the object, but it is likewise attended with the great disadvantage, that the larger the audience, the more likely is the position of the instrument to be disturbed, and the object displaced. Besides, while the student is looking at the Microscope, the lecturer has, perhaps, proceeded to another object.

The second method is intended to remove the inconvenience of the former. Several Microscopes are set up, and certain hours fixed for demonstration, and thus the disturbance of the object is avoided. A more serious inconvenience arises however from the fact that it is impossible for the teacher to give an oral explanation, because each student has a different object before him.

Whilst the actual microscopic image is indispensable, it is nevertheless not sufficient by itself, and recourse must often be had during the lecture to diagrams; for this purpose the Sciopticon has been found exceedingly useful. Its advantage lies in its cheapness, and in the very strong light thrown upon the object, consequent upon the arrangement of the lamp and the ventilation. Three kinds of objects can be used with it. First, for a small audience, the microscopic preparation itself; secondly, photographs from the preparations; and, thirdly, photographs from diagrams. Great care in making the photographs of specimens is necessary. For example, sections of wood or bark must be perfectly thin and even, that the photograph may be clear and not perplexing to the beginner by too great a number of unessential parts. Photographs from diagrams have the great advantage of giving the whole development of an organism or an organ in the same diagram, and differently magnified, according to the requirements of each object.

Every object is not, however, suitable for this kind of demonstration; for example, the photograph of a diatom is to be preferred to one made from a drawing of it.

"All objections which teachers formerly made to the Sciopticon have disappeared, after the experience of many years. My audience comprises 60 students, and those at the end of the room can see the images almost as clearly as those in front. Some teachers have expressed the fear that young students would take advantage of the darkness to play mischievous tricks, but it will be found, on the

contrary, that they usually follow this kind of demonstration with the greatest interest. The room, also, need not be entirely dark; gas may be burnt perfectly well at one end, so that the master may control the behaviour of his pupils."

We are inclined to think that the value of the Sciopticon is overrated by Dr. Hallier, at least for natural objects. We recently obtained one from Germany, but were warned by the maker that whilst excellent for showing photographs, it was limited in its operation for ordinary preparations. The image cannot be made more than a half metre in diameter in the latter case, as against 8-9 feet in the former, as there is too little light.* The lime light would of course allow of a larger image and higher objectives, but one of the advantages of the apparatus is then lost.

The instrument in its ordinary form is sufficiently familiar. With

FIG. 64.

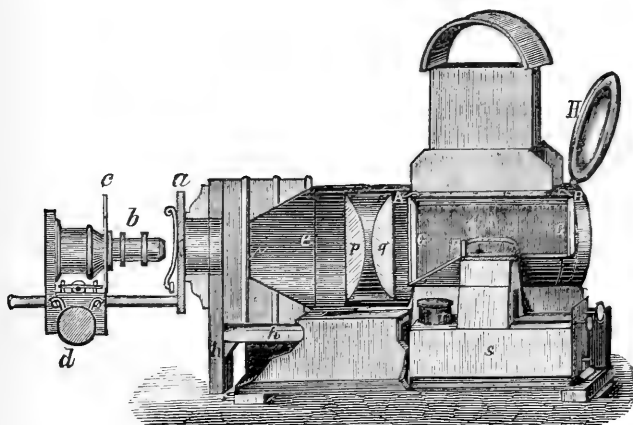

the arrangement for microscopic slides it is shown in fig. 64, in which *a, b, c, d* is the special addition (in place of the usual lenses) necessary for projecting the image on a screen, *a* being the stage, *b* the objective (25-30 mm. focal length), *c* a diaphragm, and *d* the focusing arrangement; *p q* are the condensing lenses, having a blackened cone *e* in front of them. The part *h h* is movable for adjusting the illumination. *s t F* is the lamp, *A B* the case for it, closed by glass at *G G*, *C* the "chimney," and *H* a silvered reflector.

For the lamp is used petroleum in which camphor is dissolved to saturation. A painted white wall is the most suitable for receiving the image. If a transparent image is desired, very white tracing linen is best, instead of wetted linen which is decidedly to be avoided.

* M. Fritz, in 'Das Scioptikon vervollkommneter Projektionsapparat für den Unterricht,' 6th ed., 1881, vi. and 83 pp. (4 figs.), says "The images are quite sharp and bright enough, if not exceeding 50 cm. in diameter, to be seen with all details by eight to ten persons simultaneously."

An improved Sciopticon is announced* by O. Wigand, the principal features of which (for microscopical purposes) are (1) that there is a more perfect combustion of the gases of the petroleum lamp, and therefore a more intense white light, and (2) that none of the reflector is covered up by the frame of the lantern.

L. Edinger,† as noted *ante*, p. 147, uses the sciopticon for readily making drawings of large sections under low powers. The rays are received by a mirror inclined at an angle of 45° , and the image thrown direct on the drawing-paper.

C. J. Taylor‡ finds a valuable screen is made of a sheet of French tracing-paper, of a kind which possesses a remarkably dull, non-reflecting surface. With this screen and only an oil-lamp lantern, it is quite easy to show pictures well to a couple of hundred people in a room fairly well lighted—sufficiently lighted indeed to enable note-taking or reference to books to be accomplished with perfect ease—provided that extraneous lights are not placed behind the screen.

Westien's Universal Lens-holder,§—A. v. Brunn describes H. Westien's lens-holder (fig. 65).

To the standard A is attached the arm B by the "patent junction

FIG. 65.

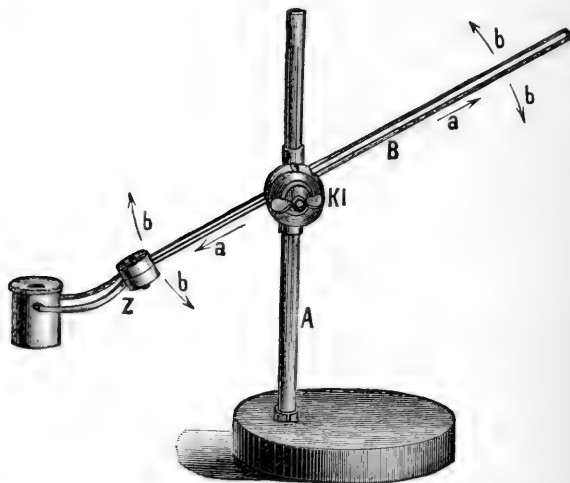

clamp KI." The arm can be moved (1) up and down the standard, (2) round it, (3) backwards and forwards through the clamp in the direction of the arrows *aa*, or (4) round the axis of the clamp, as also shown by the arrows *bb*. These various movements are all controlled

* Central-Ztg. f. Optik u. Mech., iv. (1883) (1 fig.).

† Zeitschr. f. Wiss. Mikr., i. (1884) pp. 250-1.

‡ Nature, xxxi. (1885) pp. 388-9.

§ Arch. f. Mikr. Anat., xxiv. (1884) pp. 470-1 (1 fig.).

by the clamp, so that a turn of the one screw fixes the arm securely in any given position. This is the principal speciality claimed for the instrument. The lens is held by a kind of spring forceps Z, having at the ends of the arms points turned inwards, which pass into shallow holes in the sides of the lens. "A very striking advantage is that any Microscope-objective of low power can be used as the lens, since the necessary holes can be bored in it without damage."

The construction of the clamp is shown * in fig. 66 (viewed from above). It consists of a pin C, two disks E and D, and a thumb-screw

FIG. 66.

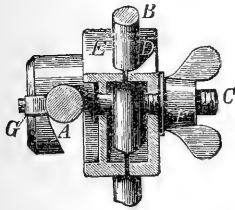

F, the standard being at A and the arm at B. When F is screwed home the two disks close together over the arm B. The disk E is at the same time forced against the standard. To prevent the clamp falling when the screw is loosened to release the arm, two springs are added as shown at G and in fig. 67, which press against the standard.

It is claimed that the clamp has all the advantages of a ball-and-socket joint and none of its disadvantages.

Ward's and Queen's Lens-holders.—R. H. Ward † finds the lens-holders in use are too light to carry large lenses and too short armed for the convenient study of handwriting upon large sheets of paper or mounted herbarium specimens, or else too unstable for use with higher powers, and he has therefore devised the form shown in fig. 68. It consists of a rectangular frame which slips over the pillar of a bull's-eye stand, both it and the bull's-eye being best mounted upon the same stand for the sake of simplifying the apparatus, and because they are often advantageously used in combination. The frame slides smoothly up and down the pillar, being held in any position by an included spring. To an extension of the bottom of the frame is attached a horizontal arm, having first a horizontal pivot joint, and, secondly, a ball-and-socket joint, the tension of these being readily

FIG. 67.

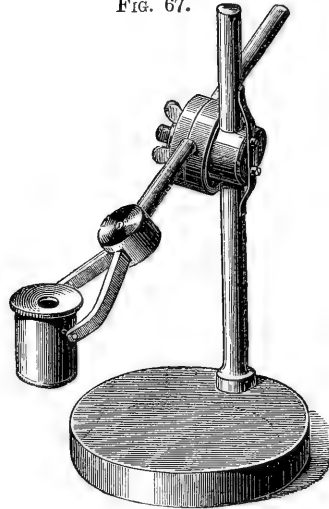

* Zeitschr. f. Instrumentenk., v. (1885) p. 18.

† Proc. Amer. Soc. Micr. 7th Ann. Meeting, 1884, pp. 162-4 (1 fig.).

adjustable by means of a screw with a large milled head. By bending the joints, the lens may be brought near the pillar for use in connection with the bull's-eye; or by attaching the jaws or ring to a longer wire, the total arm-length may be increased at will. At the end of

FIG. 68.

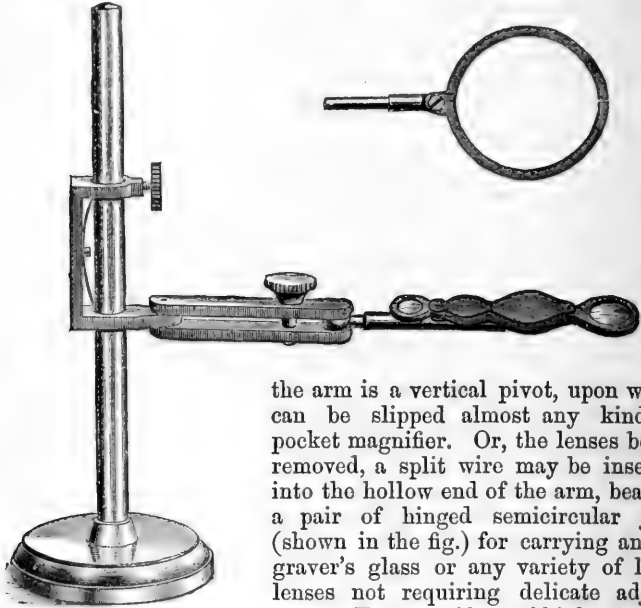

the arm is a vertical pivot, upon which can be slipped almost any kind of pocket magnifier. Or, the lenses being removed, a split wire may be inserted into the hollow end of the arm, bearing a pair of hinged semicircular jaws (shown in the fig.) for carrying an engraver's glass or any variety of large lenses not requiring delicate adjustment. For magnifiers of higher power,

requiring more precise adjustment, a ring is substituted for the jaws.

There is a fine adjustment at the top of the rectangular frame, where a screw with milled head, pressing the pillar against the

FIG. 69.

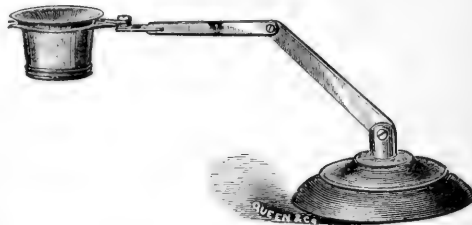

spring, promptly but steadily depresses the lenses to the extent of about four times its own motion.

Simplicity can hardly go further than in J. W. Queen & Co.'s

dissecting stand † (fig. 69). It will take lenses of various sizes and powers. Its stability must be doubtful, especially at the joints of the arms.

Dissecting Microscopes with Brücke Lens.—Dissecting Microscopes are now much in vogue on the Continent in which in place of a

FIG. 70.

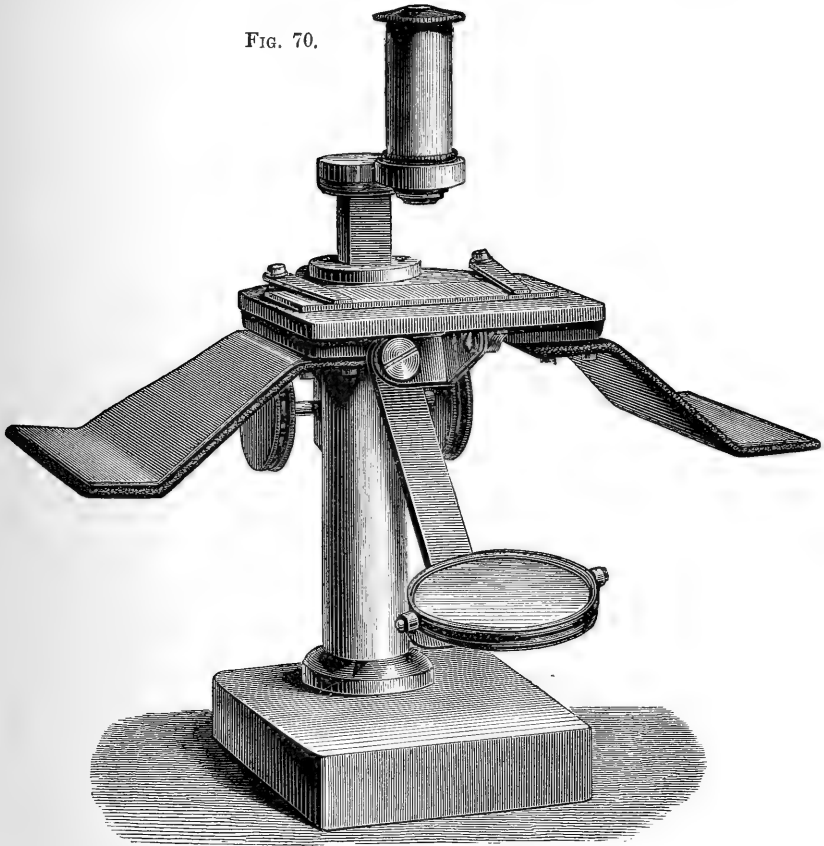

single lens, doublets in the Brücke form are employed. Fig. 70 shows the large dissection Microscope of Dr. Zeiss, the general form of which requires no explanatory description. The optical action is shown in fig. 71, where S_1 is the objective and S_2 the concave ocular. The pencils from the object $O_1 O_2$ which after their passage through the objective converge towards $O_2^* O^* O_1^*$ are intercepted by the ocular and converted into diverging pencils which (prolonged) converge at the distance of distinct vision and there form an erect enlarged image of the object, $O_1^{**} O^{**} O_2^{**}$. The objective is in

† *Micr. Bulletin*, i. (1884) p. 38 (1 fig.).

fact a triple achromatic combination (a triplet and two doublets) and when used without the ocular (also achromatic) the different combinations will give amplifications of 15, 20, or 30 times. When used with the ocular, amplifications of 40, 60, and 100 can be obtained with a working distance of 27, 16, and 9 mm. Mr. E. M. Nelson informs us he has found the power of 100 useful in finding particular specimens on slides, and for the examination of slides such as Cole's series. The field of view visible at one time is small, but by moving the eye over the eyepiece a considerable area can be looked over.



In this form there is no provision for increasing or diminishing the power of the combination as was effected in the original Brücke lens,* by varying the distance of the ocular from the objective, a device anticipated by the "objectif variable" of C. Chevalier,† in which the lenses

FIG. 72.

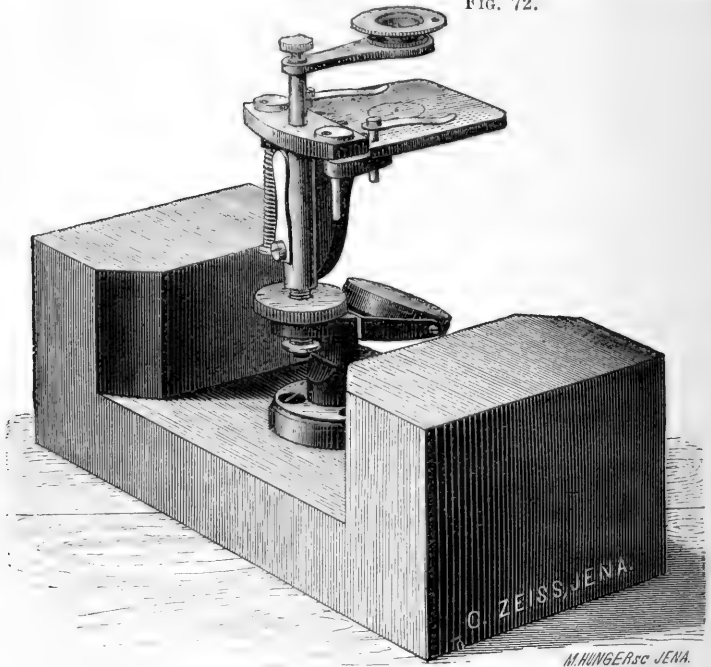

* See this Journal, ii. (1882) p. 101.

† Chevalier, C., 'Des Microscopes et de leur usage,' 1839, p. 156 (2 figs.).

of which the objective is composed are placed in two tubes so that they can be more or less separated, either by sliding or by rack and pinion. This plan was more recently adopted by Dr. Zeiss in the "adjustable objectives," described Vol. III. (1880) p. 524. The fixed

FIG. 73.

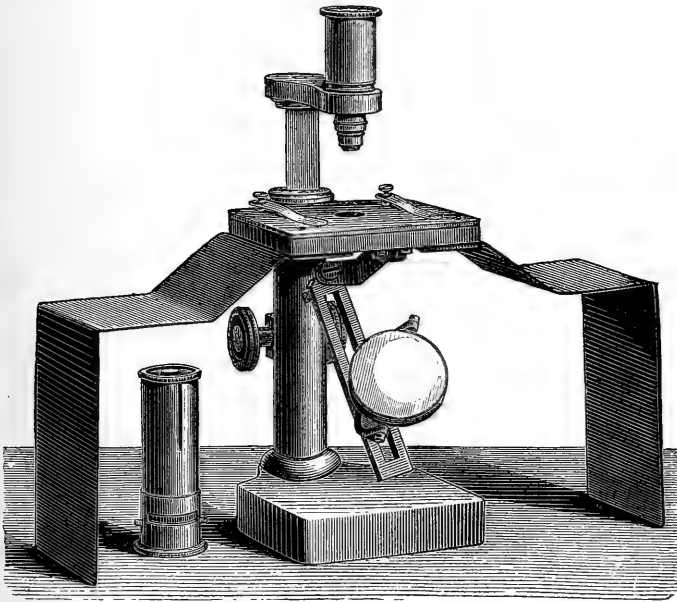

mount enables Dr. Zeiss to use a small diaphragm within the tube which protects the eye from the glare seen with the ordinary Brücke lens.

FIG. 74.

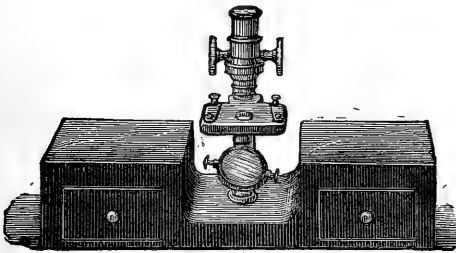

The smaller dissecting Microscope of Dr. Zeiss, with which, by means of an adapter, a Brücke lens can also be used (though not so conveniently as with the former stand, on account of the long working distance of the lens), is shown in fig. 72.

In Klönne and Müller's large dissecting Microscope (fig. 73), with which is also used a Brücke lens, the supports for the hands are

made of two pieces of thin sheet brass bent in the manner shown in the woodcut.

Two other dissecting Microscopes are shown * in fig. 74 (Schieck's) and fig. 75 (Böcker's), in which a Brücke lens in a slightly varied

FIG. 75.

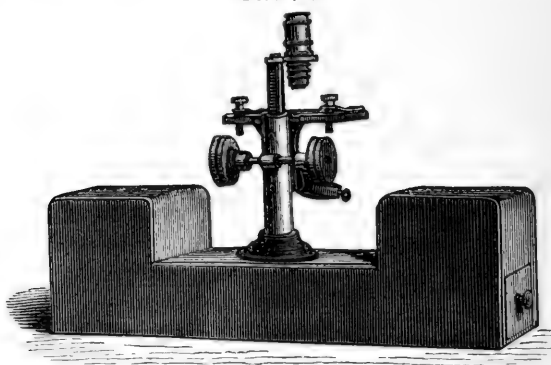

form is employed. None of the English dissecting Microscopes are, so far as we know, provided with other than single lenses or the older form of doublet.

Standard Eye-pieces. — The Committee appointed by the American Society of Microscopists † to report on the nomenclature and sizes of oculars, brought up a further report at the last (Rochester) meeting.‡

The Society adopted the original recommendation of the Committee for 1·25 in. as the standard size of tube (with a preference of 1·00 or 1·35 in. where other sizes are required), and 0·75 in. for cap-tubes (for interchange of camera lucidas, &c.), and 1·50 in. for sub-stage tubes, all outside measure. They also adopted the following resolution on nomenclature, somewhat varied from the Committee's suggestion in their first report.

“Resolved that this Society recommends that oculars be named by the equivalent focal lengths in English inches, representing their actual power in use in the compound Microscope with objectives of not more than 1/4 in. equivalent focus, and with a working tube-length of 10 in. including the mounting of the objective, on the basis of 1-in. focus corresponding to 10 diameters of amplification.”

The Report of the Committee on which the resolution was founded was as follows:—

“*The naming of oculars, like objectives, by their equivalent focal lengths in inches, but estimated in a conventional manner at a somewhat arbitrarily chosen distance. This is an attempt to secure in the case of oculars an approximate and serviceable nomenclature having some-*

* Löwenherz's Bericht u. d. Wiss. Instr. a. d. Berliner Gewerbeausstellung, 1880, p. 295 (1 fig.). Dippel's 'Das Mikroskop,' 2nd ed., 1882, p. 186 (1 fig.).

† See this Journal, iii. (1883) p. 711.

‡ Proc. Amer. Soc. Micr., 7th Ann. Meeting, 1884, pp. 228-33 (1 fig.).

what of the practical convenience of that in use for objectives, which shall imply a reasonable suggestion not claiming to be a precise statement of the power employed. Though not free from criticism, our nomenclature of objectives has been used, and continues to be used, with some satisfaction, and it is conceded to be the best plan yet brought into actual service. It has been already applied to oculars by several makers and by many users, and it is simple and so in accord with present usage and habits as to seem scarcely an innovation, and to be capable of adoption without conscious effort or sacrifice. The only other plan seriously proposed, naming by numbers representing the actual magnifying powers, has long ago been tried and abandoned by most competent authorities. It involves such extreme changes of ideas and habits in thinking and speaking of oculars and objectives, that there is great doubt as to the practicability of securing its early adoption. Nor is it certain to be advantageous if adopted. It lacks the simplicity which in the other case classes the powers in a limited number of familiar groups, and introduces an indefinite number of names marked by larger figures, clumsy to use and difficult to remember, and not so easily suggestive of their practical significance. It also involves the claim for a precision which it does not possess, since the complications of collar adjustment and tube-length, which only somewhat impair the value of the approximate method, seem as yet wholly incompatible with a more precise system. Furthermore, the nomenclature by inches would be so easy a movement in the direction of sensible method, that it might prove to be a step toward, rather than from, any further improvement that might prove desirable.

It is not claimed, and has never been supposed, that the proposed method of measurement would give results exactly corresponding with the optical values of the oculars, as computed by the Cross formula or any other. Nor does it seem certain that persons not opticians can locate the focal planes of their objectives and oculars, with such ease and precision as to secure in each case a tube-length, that would work the various systems exactly at their theoretical power, or that such varying tube-lengths if secured would be within the limits of a convenient working length.

For these reasons it was suggested to establish a conventional nomenclature, representing as nearly as possible the working value in the Microscope as actually employed, without regard to their value under other circumstances. By this plan a 1/2 in. system would be one which, as used in the Microscope, would double the power when substituted for a 1 in., and a 2 in. would be one which would give one-half the power of a 1 in. This is deemed to be an experiment, for the purpose of obtaining at least temporarily approximate results that would be an improvement on the present practice, in the course of which it is assumed that difficulties will be encountered and intelligent work become necessary, especially in applying it to oculars of exceptional construction. The estimate of powers on the ten diameters' rule would evidently cease to be fairly approximate in relation to objectives of very low power, unless a similar nomenclature should be applied to the objectives also. If the proposed method of

measuring the powers of oculars prove impracticable or undesirable, the effort may at least lead to the discussion and adoption in some form of the nomenclature by inches, which is the essential portion of the proposition. It remains for the Society to say whether it is prepared to take the responsibility of trying the experiment or not."

Testing the different Sectors of Objectives.*—Mr. E. M. Nelson finds that all the sectors of an object-glass are not equally good in defining objects. In fig. 76, sectors 1 and 2 may not be as good as 3 and 4. If, however, to test this we rotate the object, the test is not a satisfactory one, as the illuminating conditions are altered, so that when, for instance, a *Podura* scale is being rotated, something must be allowed for the alteration of the illuminating conditions with regard to the position of the exclamation marks, as well as something for the difference in the quality of the sectors.

FIG. 76.



"The importance of separating these variables will be obvious to every one. For this purpose I have designed a revolving nose-piece, which will enable the object-glass to be turned round, and so bring its various sectors into play. By this means it can be easily demonstrated how much of the difference in the pictures is due to the objective, and how much to the illumination. When I practically tried this nose-piece, I was very much astonished at the enormous difference I found in the defining powers of the alternate sectors of an object-glass. To illustrate the difference in the chromatic aberration, let me mention only an example. A very fair water-immersion $1/8$, 1.17 N.A., showed the exclamation marks red in one position, but turned them green when the object-glass was rotated through an angle of about 90° .

"The practical outcome of all this is important. (1) An object-glass which performs well enough when exhibited on the optician's Microscope, may tell a very different tale when tried on the purchaser's instrument, because the objective may not screw up to the same point. (2) It may account for the difference of opinion held by experts as to the quality of any particular objective, for they might have been testing different sectors.

"It would be worth while, in the case of expensive object-glasses, to have the Society's screw portion of them capable of rotation, and provided with jam screws, so that the purchaser might place the better pair of sectors in a line across his own Microscope, then fix it with the jam screws. He would only have to remember to place any exceptionally difficult object in a line with the front and back of his stand."

Mr. Nelson was no doubt not aware when he wrote the foregoing, that the testing of objectives in the way suggested has been practised for many years. All the objectives of Zeiss are thus tested. The matter is referred to by Dr. Dippel, from the suggestions of Prof. Abbe, as follows: †—

To ascertain the faults which arise from defective centering, or which act in a similar way, and may be called want of symmetry in the

* Engl. Mech., xli. (1885) p. 34 (1 fig.).

† See Dippel's 'Das Mikroskop,' 1882, pp. 347-8.

optical action of an objective, it is necessary to be able to rotate the latter on its axis without using the screw. This is accomplished by an adapter, the upper part of which screws into the end of the body-tube, while the lower receives the objective and rotates easily and concentrically on the upper. An object such as the silvered test-plate* is placed on the stage and illuminated by oblique light. The objective is then rotated on its own axis from $1/4$ to $1/4$ or $1/8$ to $1/8$, and to be approved the sharpness of the image and the character of the spherical and chromatic aberrations must be identical in all positions. If this is not so, there are either defects in the centering or local faults in the lenses or in the cement. This test when used on an appropriate object is a very sensitive and valuable one, and is indeed the only one which furnishes a *real* test of the centering of the lenses. The other methods which have been recommended for that object test only the centering of the screws, which in regard to the optical action is quite an unimportant matter.

Cost of Objectives of Large Aperture.—The great increase in the labour necessary to produce an objective of large aperture is but little appreciated by microscopists. Some estimate may, however, be formed from the fact that so low a power as a $1/6$ in. of 1.50 N.A. costs 35*l.* Even at this price there are no signs of any tendency to underselling or competition among opticians. So far as we have been able to form an opinion, the price in question, large as it is, does not represent more than a very moderate return for the skill which the construction of such an objective requires.

Finder.†—P. Francotte describes a finder the designer of which is unknown.

The adapter A (fig. 77), with Society screw, carries a tube B which is kept extended by a spring, but can be pushed back again with very slight pressure. Two screws prevent the tube rotating. To the end of this tube is screwed the conical piece C, the point of which is cut out like a ring punch, so that when smeared with bitumen or ink it will impress a small circle on the slide about $1/50$ in. in diameter.

When the object is in the centre of the field the objective is removed and replaced by the finder, and a circle is impressed on the cover-glass. The spring prevents any damage to the object. With low powers the circle is readily found again. With high powers the procedure is given as follows, though we should have supposed that even with the highest powers it would not be necessary to have recourse to the finder again:—The finder is replaced on the body-tube without any eye-piece. The piece C is removed and the slide placed so that the circle is in the centre of the opening. A small diaphragm will facilitate this operation. The finder is then removed and the objective screwed on.

FIG. 77.

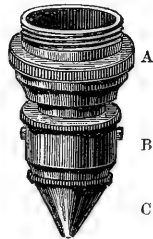

* See this Journal, iii. (1883) p. 125.

† Bull. Soc. Belg. Micr., xi. (1884) pp. 48-50

Ward's Iris Illuminator.*—R. H. Ward, in order to obtain, with oblique illumination, the advantages obtained with the iris diaphragm with axial illumination, has devised the arrangement shown in fig. 78. It consists of any desired lens-system, either dry or

FIG. 78.

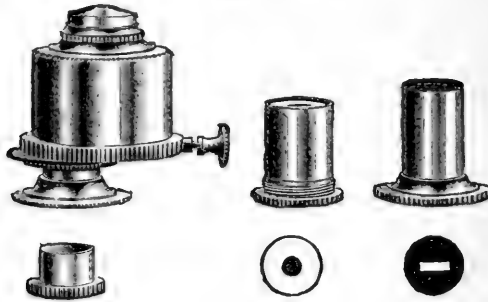

immersion, under and close to which is mounted an iris diaphragm with a decentering adjustment; the diaphragm being set in a sliding plate pushed by a screw or lever, so that it can be moved into any position from the centre to the periphery of the system without altering the position of the latter. Thus not only the obliquity of the light, but the exact amount desired or found advantageous at any chosen obliquity, can be regulated with perfect precision by a touch of the hand to the screw and to the adjusting collar of the diaphragm.

A blue glass disk is fitted to the bottom of the dark well of the diaphragm. A special adapter is also provided for the use, in place of the iris, of central stops for securing dark-field illumination; or of a horizontal slit or pair of horizontally arranged apertures, for the better illuminating of binocular Microscopes, as proposed by the writer in the 'American Naturalist' for December 1870; or of any special stops desired by the user; or of a polarizing prism and selenite plate. The whole apparatus rotates about its own optical axis, which remains coincident with that of the Microscope itself.

It is used to the best advantage with a 4/10 achromatic condenser, or with the thick non-achromatic immersion lenses of the Abbe condenser. It cannot, without outgrowing the limits of the standard $1\frac{1}{2}$ in. substage ring, be applied to the largest lenses now used as condensers, and for this reason, if for no other, it might be unavailable for extreme resolution with objectives of excessive aperture.

By removing the lens from the top of the apparatus, the iris diaphragm, with or without its blue glass disk or the polarizing prism, will be found in position for use by itself.

* Proc. Amer. Soc. Micr., 7th Ann. Meeting, 1884, pp. 160-1 (1 fig.).

Nelson's Simple Condenser.*—E. M. Nelson's object in suggesting this condenser was to provide a very inexpensive, but at the same time efficacious means of illumination for the micro-organisms which are now the subject of so much investigation, and for which purpose it is desirable that the necessary apparatus should involve as little outlay as possible. As exhibited it was attached to a Leitz 3*l.* 12*s.* instrument.

FIG. 79.

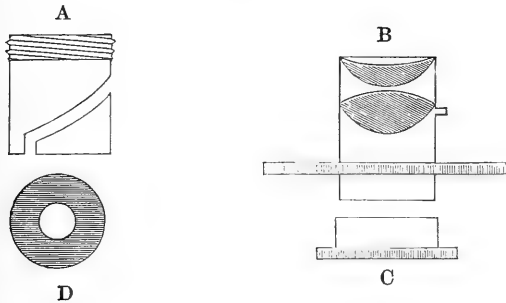

It consists of a socket A, having a spiral slot. This socket screws into the stage, and in it slides a second tube B which has a $1\frac{1}{4}$ in. milled flange for focusing by rotation, and a pin which works up and down in the slot. This tube carries the lenses, which are a meniscus and biconvex. A cap C with large aperture in the centre fits at the end of the tube to hold diaphragms, like that shown at D. The small vertical piece of the slot prevents the condenser being accidentally twisted out. The aperture is 0.5 N.A.

Madan's Method of isolating Blue Rays for Optical Work.—Mr. H. G. Madan finds a combination of ordinary blue glass with a peculiar bluish-green glass, known as "signal-green" glass, much more convenient than the usual glass cell filled with solution of cuprammonium sulphate. Glass coloured with cobalt absorbs most of the rays of medium refrangibility, but transmits besides blue rays a portion of the red rays in the neighbourhood of Fraunhofer's line A.

The "signal-green" glass (so called from its being used for railway signal lamps) is remarkably opaque to red and yellow rays, and hence if a piece of it is superposed on cobalt-blue glass, the only light transmitted by both is that which lies between Fraunhofer's lines F and G, constituting a beam at any rate not less homogeneous than that transmitted by cuprammonium sulphate.

In cases where the double thickness of glass may be an inconvenience, as in disks for stage diaphragms, a plate of "flashed" blue glass may be cemented, flashed side downwards, upon the signal-green glass, and then the whole of the colourless part of the blue glass can be ground away, leaving only the coloured film upon the signal green, and thus forming a plate hardly thicker than the latter alone.

* Engl. Mech., xli. (1885) p. 34 (1 fig.).

Signal-green glass is, so far as the author knows, only made as "pot-metal" and never flashed. The colouring matter is believed to be (di-valent) copper.

Madan's Modification of Foucault's and Ahrens's Polarizing Prisms.*—H. G. Madan suggests that if a film of air (as in Foucault's prism), instead of a film of Canada balsam (as in Ahrens's prism), is placed between the middle spar-prism and the next, the ordinary ray will be totally reflected, while the extraordinary will still emerge and be available as a plane-polarized ray for experiments, as in Foucault's prism.

This extraordinary ray, however, is not only deviated on emergence, but also over-corrected for colour; but both the deviation and the dispersion can be almost entirely corrected by passing the ray through

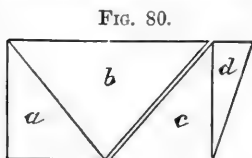

a prism of crown glass combined with a prism of very dense flint glass, as shown in fig. 80 (*a* and *b* calc spar, *c* crown glass, *d* dense flint glass). The combination forms a polarizing prism with an angular field of 28° , about equal to that of an ordinary Nicol's prism, and far greater than that of a Foucault's prism (which is only 8°).

The following points, among others, appear noteworthy in the above prism:—

(1) Its length is scarcely more than twice its breadth, the proportion between the two dimensions being rather greater than in Foucault's prism, about the same as in Ahrens's prism, and much less than in Nicol's prism. (2) Only half the prism is made of Iceland spar, a material which is becoming deplorably scarce and expensive. (3) The combination is not quite free from distortion and chromatic aberration, but this is not serious enough to interfere with its use for many optical purposes, especially as a polarizer. (4) In using it, a diaphragm should be placed in such a position as to limit the entering cone of rays to 28° , since at a greater angle the ordinary rays are not separated by total reflection.

"Ahrens's polarizing prism is certainly," Mr. Madan adds, "a remarkable one. I do not think that a double-image prism has ever been previously constructed in which the extraordinary ray emerges without deviation, while the other ray is deviated to the extent of very nearly 60° ."

Illumination of Microscopes and Balances.†—In measurements and weighings where high scientific accuracy is needed it is sometimes necessary to use artificial means of illumination, and it is found that when reflected light cannot be conveniently introduced, the heat from ordinary lamps causes variations of the temperature of the room, &c., which slightly affect the accuracy of the results to be obtained. By using, however, an incandescent electric lamp fitted inside a glass vessel of water, the light may be even brought near to the Microscope

* Nature, xxxi. (1885) pp. 371-2.

† Ibid., p. 440.

or balance without any appreciable interference with temperature. The glass vessel is provided with a pierced cover or shade, and a little stream of water of a uniform temperature may be kept flowing through the vessel.

By means of a "chromozone" battery, supplied by Mr. O. March, it has been found, at the Standards Office, that a light may be maintained at an insignificant cost for fifty hours without, of course, any attention. During a recent comparison made by Mr. Chaney of two standard kilogram weights it became necessary to use the lamp, but the action of the balance was not interfered with by the proximity of the lamp, the probable error of the result being only ± 0.005 mgr.

Standard Thickness of Glass Slips.*—E. M. Nelson suggests that it would obviate much inconvenience where immersion condensers are used, if a standard thickness was adopted for glass slips. At present there are so many thicknesses in use that it is sometimes very troublesome to adjust the focus properly with high powers, as if too thin the drop will not adhere, and if too thick it gets squeezed out. He proposes that a thickness of $1/20$ in. should be adopted as the best standard, and "if every person would buy slides of that gauge only, the thing might easily be done."

Mr. A. D. Michael said, at the meeting at which this suggestion was made, that he thought he should find a standard gauge for glass slips a great nuisance, especially for such objects as required the use of high powers; while Dr. Carpenter thought it might be well to try to get some uniform slip for use with oil-immersion objectives.

Rabl's Slide for Viewing Objects on both Sides.†—C. Rabl describes a slide (fig. 81) which he found useful in his researches on cell-division. It consists of two pieces of glass *a b* (thick lines),

FIG. 81.

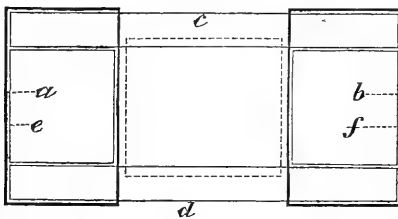

with two strips *c d*, and two square pieces *e f*, cemented on so as to form a frame of glass surrounding a central space. A piece of thin glass (shown by dotted lines) is cemented beneath, on which the object is placed, and when a similar piece is placed over the object it can be examined on either side with the highest powers.

* Journ. Quek. Micr. Club, ii. (1885) pp. 120-1.

† Morphol. Jahrbuch, x. (1884) pp. 218-9 (1 fig.).

Whitney's Life-Box.*—J. E. Whitney reduces the cost of a life-box to a minimum by getting a full set of brass ferules, consisting of about a dozen of graduated sizes, fitting one inside the other. Take any two which fit well together and cement the smaller one, large end down, to the centre of an ordinary glass slide. Cement to the top of the ferule one of the thickest cover-glasses that fits it. Take another thick cover-glass which fits *inside* the large ferule, and cement it to the inside at the top. The box is now complete, and all that remains to be done is to slip the large ferule over the other. Mica can be used instead of the cover-glasses if desired. The set will make an assortment of various sized boxes.

Micrometers mounted in Media of High Refractive Index.—It was suggested some years ago † that a Nobeit test-plate should be mounted in a saturated solution of phosphorus in bisulphide of carbon, with the view of increasing the visibility of the lines. Prof. W. A. Rogers has applied the same method to a stage-micrometer made for the National Museum at Washington. While not better in ruling than others from the same source, it is reported to be of peculiar excellence, owing to the fact that it is mounted in Prof. Hamilton Smith's medium. The fine lines are thereby made far more visible and sharp than on ordinary micrometers, and, as anticipated in the case of Nobeit's plate, "very fine lines, which are scarcely visible otherwise, are readily seen when mounted in the new medium."

Atwood's Apparatus for Photo-micrography.‡—H. F. Atwood describes an "apparatus capable of doing any work in photo-micrography perfectly, and that can be put in the hands of the microscopist

FIG. 82.

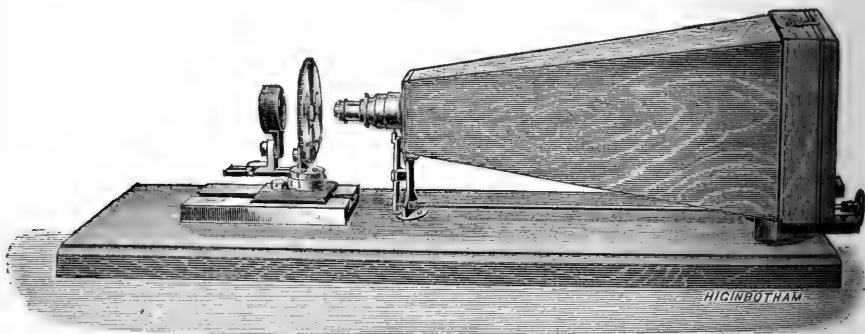

at an expense less than that of ordinary camera attachment for his Microscope." It is shown in fig. 82.

The coarse adjustment is made by sliding the stage and fittings

* Proc. Amer. Soc. Micr., 7th Ann. Meeting, 1884, p. 215.

† In a paper by Mr. J. W. Stephenson. See this Journal, ii. (1882) p. 164.

‡ Amer. Mon. Micr. Journ., v. (1885) p. 38.

§ Proc. Amer. Soc. Micr., 7th Ann. Meeting, 1884, pp. 176-7 (1 fig.).

by hand on the slide on which it rests. On reaching an approximate focus, the stage is secured by a friction-screw. The fine adjustment is controlled by a milled head placed directly under the ground glass focusing-plate, and acts by lever on the nose-piece carrying the objective, and thus tight cords ruining the fine adjustment fixtures are dispensed with. The substage has a fitting to receive any ordinary illuminating apparatus, and by a simple device a condenser can be accurately centered.

Actinic and Visual Foci.—Statements have recently been made that with modern under-corrected microscopic objectives there is no difference between these foci, and that no allowance need therefore be made in focusing. Dr. J. D. Cox, while finding this correct for the generality of objects, remarks that it does not apply when large amplifications are in question. When powers of 1500 and 1600 are used for photo-micrography there is a distinct difference between the two foci, and it is therefore still necessary to give particular attention to the focusing in order to obtain sharp photographs.

Compound Negatives.*—In photo-micrography it frequently occurs that the operator, instead of devoting a negative to each of two or more similar objects for comparison, printing both upon the same print, prefers to have the whole series upon one negative, taking from this a single print. There is often room for two or more images upon the same plate. If the centre of the plate is devoted to one, obviously no more can be accommodated on it, but by placing one at each end, or one on each corner of the plate, both economy of plates and convenience of printing are secured. C. M. Vorce points out that this end may be readily accomplished by "matting" the plate as a negative is matted in printing.

Suppose it be desired to photograph four different species of *Acari* on one plate, the image of each when magnified to the desired extent only covering about one-fourth the exposed area of the plate. First, a mat is prepared of cardboard or thick non-actinic paper, which is adjusted to exactly fill the opening of the plate-holder, lying in front of and close against the plate when exposed, and having one quarter very exactly cut out. A convenient way to fit this mat is to leave projecting lugs on each side at exactly the same distance from the ends, and cut notches in the plate-holder into which the lugs may closely fit. If this work is carefully done, the mat may be reversed both sidewise and endwise, and the lugs will fit the notches; if so, it is ready for use. The object being focused, the camera is raised one-half the vertical dimension of the plate, and displaced to one side half the horizontal dimension, when the image will be found to occupy one quarter of the plate. The mat being placed in the plate-holder, a focusing-glass is inserted in the position the plate will occupy, and final adjustment and focusing made. The plate is then marked on one corner on the film side with a lead pencil, placed in the holder without disturbing the mat, and the exposure made. When the plate is replaced for a second exposure, either the mat is reversed or the

* Amer. Mon. Micr. Journ., vi. (1885) pp. 13-4.

plate turned end for end; but it is best to always place the plate in the holder in the same position, and change the mat to expose successive quarters, but this requires the camera to be moved for each exposure.

Monocular Stereoscopic Vision.*—Prof. Fritsch describes an optical phenomenon observed during the microscopical examination of certain objects, and which he considers is due to monocular stereoscopic vision. Certain images, in particular those of the transverse section of the principal nerves of the electric organ, give the idea of a funnel-shaped depression, such as is otherwise obtained only in binocular stereoscopic vision. He found it especially easy to receive this impression by moving the eye from side to side.

Journal of the New York Microscopical Society.—We are glad to welcome this new microscopical journal. While every addition to the number of new journals adds to the strain which is put upon both space and time so far as we are concerned, it is, we think, clearly to the advantage of the cause of microscopy that there should be a fair number of microscopical journals. Nearly all those published hitherto have at one time or another been the means of adding to our knowledge to no inconsiderable extent.

Strasburger's Practical Botany.†—E. Strasburger supplies an extremely useful handbook for practical botanical students. The smaller work is intended for beginners only. The larger one is printed in two different types. The paragraphs in larger type are adapted for beginners, and those in smaller type for more advanced students, the whole being arranged in thirty-four "lessons" for a six-months' course. The introduction to the larger work deals with Microscopes and all other apparatus, reagents, &c., necessary for workers in the botanical laboratory. In the lessons themselves, plants are in general chosen which are readily accessible; and the mode of treatment is described best calculated to bring out the various important points in their structure. The whole is illustrated by admirable woodcuts.

Microscopical Societies.‡—R. Hitchcock discusses the fact that microscopical societies are "vigorous for a time, then they gradually languish, and sometimes disband. There is scarcely an exception to this rule." He considers the remedy to be to make the meetings of value and interest to the members.

"If the meetings are to be interesting and instructive, somebody must work to make them so. It involves no little labour on the part of the few who undertake to conduct a successful society. Still the time thus spent is not without profit both to the individual and to the members. One need not be thoroughly informed upon microscopical subjects to be an efficient leader. It requires energy, interest, and a willingness to work, more than anything else. Let those who are willing to give their time and work for the benefit of others who do

* Nature, xxxi. (1885) p. 212.

† Strasburger, E., 'Das Botanische Practicum,' xxxvi. and 664 pp. (182 figs.).
'Das Kleine Botanische Practicum für Anfänger,' viii. and 285 pp. (114 figs.).
8vo, Jena, 1884.

‡ Amer. Mon. Micr. Journ., v. (1884) pp. 215-7, 237-8.

little else than attend the meetings to learn what they can, study up and present different subjects of interest in papers, or more informally, and continue in this way. After a while they will find others coming forward, and the society will grow. If the meetings can be made instructive, members will be sure to attend. If they are dull, and if nothing is done to make the time pass profitably as well as pleasantly, so that members will feel that it is worth while to attend, the society might as well disband."

"What is a Microscopist?"*—Some "microscopist" has (we hope unwittingly) given mortal offence to a writer in 'Science,' as it is evident that the following could only have been penned under the severest provocation.

"What is a microscopist? First and last, an amateur who rejoices in the beautiful variety of microscopical specimens; one who treasures slides in the exact centre of which is a ring of cement neatly put on, and holding a cover-glass under which lies some fine test-object,—a delicate diatom, a Podura scale, a bit of tissue the vessels of which are injected with gorgeous red, a polarizing crystal: in short, almost any tiny scrap of the universe, if so it be pretty in the pattern of its shape and colour. These same treasured slides must have neatly bordered labels, and be catalogued and stored by a special system. The microscopist is one who has a formidable and extensive deal of brass stand, which can hold together a cabinet of appliances; and he will display the most admirable patience in getting them in position, until at last he sees the specimen, and is ready to clean and pack away his apparatus. His series of objectives is his glory; and he possesses a fifteenth of Smith and Brown, which will resolve a band of Nobert's not to be resolved by the objectives of any of his friends. His instrument is his pet: about it his interest centres, while the direction of his studies is determined, not by any natural bond between the objects, but by the common quality of minuteness. Is it not curious? Imagine any one deliberately setting out to study whatever he could cut with a knife. We should pity the man who chopped up the sciences according to the instrument he used. We cannot be brought to regard anatomy as a department of cutlery, nor can we seriously admit histology as a department of microscopy.

Scientific men have been very lenient towards the microscopists; and yet the latter, who have long been allowed to march as hanger-on to the regular scientific army, have gradually lagged behind. The army has grown, and divided into many separate corps, traversing the country of the unknown in all directions, and the microscopist knows not whither to follow. If he turns in any direction, he must join with the special work there, and can glean only in one field: he is no longer the universal gatherer. One must be of the army to be with it, and the forces are too scattered for any hanger-on to flit from one division to another. The would-be microscopist has no place among scientific investigators. He must enlist in one company and there remain, or else be content to rank as an amateur, and not as a scientific man."

* Science, v. (1885) p. 164.

It is of course very easy to prove anything if only we are allowed to start with a premiss or definition of our own choosing. If, for instance, a zoologist is held to be a man whose whole delight is to arrange quadrupeds and birds on pieces of nicely polished wood, with every hair of their bodies and every feather in their tails exactly in place, how surely it follows that zoologists ought not to be allowed to "hang-on" to the scientific army. If botanists are people whose only object is to spread plants out flat on pieces of paper of elegant design and with regard only to the prettiness of the arrangement, botanists clearly ought to be shunned by all right-thinking persons. The writer has apparently never heard of a class of men, of whom Dr. Carpenter may be taken as a type, who are truly "microscopists," and yet are not addicted to the vices of the imaginary beings who figure in the above article. Nor does he seem to have ever heard of another class, of whom Prof. Abbe may be taken as an illustration, who are even still more typically "microscopists."

But even if the writer were correct in his definition of a microscopist, he is wholly wrong in the moral he attempts to draw from it.

Why should a person be derided who purchases a Microscope with the intention of using it for the same end as his neighbour uses a stereoscope, viz. as a means of amusement or, as the French say, as a "distraction"? Every one would of course desire that all possessors of a Microscope would devote themselves to working out one or more of the innumerable problems that still remain to be solved, but that furnishes no valid reason for insisting that no one shall use a Microscope who is not pledged to a course of scientific investigation on pain of being denounced as unfit for the society of decent people. It would be just as logical to insist that no one should grow flowers who did not examine them botanically, or that no one should buy or look at pictures who has not mastered the principles of art. Our artists are much too wise in their generation to denounce such persons or to proclaim them "hangers-on," or to suggest that they have had enough of them, that they are nearly at the limit of their patience, or any such absurdities. Scientific societies largely profit by the subscriptions and other support of the so-called "hangers-on," and it is doing no good to science to attempt to shut them out from participating in its pleasures by derision and insult, or by trying to make the possessor of a Microscope feel that he is in the same category as the keeper of an illicit still. *Ceteris paribus*, the man who takes an interest in what the Microscope reveals is likely to be a better man than one who does not, and the greater number of such persons there are the more the ranks of actual workers will be recruited. Moreover, it is in the case of the Microscope *par excellence* that "hangers-on" have secured so great an advantage in the instrument for the benefit not of themselves only, but the world in general. A notable instance of this—the case of objectives—is curiously enough made the subject of (deserved) national glorification in another part of the same paper. The increasing army of observers of micro-organisms are already beginning thoroughly to appreciate how much

they owe to the "amateurs," who alone have been the means of bringing the Microscope objective to its present pitch of perfection.

There is plenty of scope for useful and proper exhortation to microscopists without descending to the caricatures of the writer in question.

American Society of Microscopists, Constitution and Bye-laws of, and List of Members and Officers.

Proc. Amer. Soc. Micr., 7th Ann. Meeting, pp. 283-93 and ii.

ANTHONY, W. A.—See Micrometer.

ATWOOD, H. F.—A new Apparatus for Photo-micrography. [*Supra*, p. 330.]

Proc. Amer. Soc. Micr., 7th Ann. Meeting, 1884, pp. 176-7 (1 fig.).

B.Sc.—Microscope.

[Recommendation to stick to monocular. "The great majority of men who use the Microscope as a tool and not as a plaything look upon the English craze for binoculars and complicated stages and accessories as sheer waste of time."]

Engl. Mech., XL. (1885) p. 457.

" See Short v. Long Body-tubes.

BAUSCH, E.—The Universal Screw for Microscope-objectives.

[Complaint of discrepancies in the standard gauges sent out by the Society, and suggestion for "decisive action on the question of a new Universal Screw. . . . We need a screw which is larger than 0.8 in., but still of such a size that it can be universally applied to instruments as now made."]

Proc. Amer. Soc. Micr., 7th Ann. Meeting, 1884, pp. 153-9.

See also *Science*, V. (1885) p. 179.

" " Considerations in testing Objectives.

[General remarks, dealing principally with adjustment of mirror, thickness of cover-glass, and variations in length of tube.]

The Microscope, V. (1885) pp. 1-5.

BEHRENS, W.—Winkel's Mikrometer-ocular mit vertical beweglichen Mikrometer.

(Winkel's Micrometer eye-piece, with Micrometer moving vertically.) [*Post.*]

Zeitschr. f. Wiss. Mikr., II. (1885) pp. 41-3 (2 figs.).

BOTTERILL, C.—The Theory and Practice of Microscopical Illumination.

[Abstract of Presidential Address to the Liverpool Microscopical Society.]

Sci.-Gossip, 1885, pp. 64-5.

BRADBURY, W.—The Achromatic Object-glass, XLIV.

Engl. Mech., XL. (1885) pp. 489-90 (5 figs.).

BULLOCH, W. H.—The magnifying power of Microscope-objectives and Lenses.

[1. Magnifying power of objectives measured from the posterior focus for parallel rays. (Results of a series of measurements to fix the position of the posterior focus of different objectives and the magnifying powers at 10 in., 12½ in., and 15 in. from the ascertained focus, with table.)

2. The magnifying power of double convex lenses, *post.*

3. The position of the Wollaston camera in measuring objects. "As there is some disagreement among microscopists as to whether it makes any difference in the measurement of objects by means of the Wollaston camera lucida if the distance is the same between the table and the camera and the camera and the object on the stage, he made some measurements (results given in a table) to test the matter, and cannot see that it makes any difference whether the distance between table and camera is changed or with the draw-tube the distance between camera and object."]

Proc. Amer. Soc. Micr., 7th Ann. Meeting, 1884, pp. 183-5, and table.

CARPENTER, W. B.—See Nelson, E. M.

CHEESEMAN, E. L.—A Growing Slide.

[Ordinary slide with cover confined by a light rubber band and immersed in a dish of water.]

Amer. Mon. Micr. Journ., vi. (1885) p. 53.

- COX, J. D.—Photography with High Powers by Lamplight: illustrating structure of diatoms.
[Nearly the same as Vol. IV. (1884) pp. 853-8.]
Proc. Amer. Soc. Micr., 7th Ann. Meeting, 1884, pp. 99-104
(2 pls. of photo-micrographs).
- D. E. T.—Graphic Microscopy. (See in future under Microscopy B.)
- DIPPEL, L.—Einige neue Mikroskop-formen. (Some new forms of Microscopes.)
(Describes stands by Zeiss, Leitz, Seibert, Hartnack, Schieck, Reichert, Wächter, Winkel, and Geneva Co.) [*Post.*]
Zeitschr. f. Wiss. Mikr., II. (1885) pp. 37-40 (1 fig.).
- ERMENGEM, E. VAN.—See Heurck, H. van.
- FELL, G. E.—See Micrometer.
- FRANCOTTE, P.—Description d'instruments construits par M. Reichert de Vienne.
(Description of instruments constructed by Herr Reichert of Vienna.)
[Stands, cf. Vol. IV. (1884) p. 438, and *supra*, p. 302. Microtomes, see *infra*, Microscopy B.]
Bull. Soc. Belg. Micr., XI. (1885) pp. 102-7 (4 pls.).
- " " Exposé succinct de la Théorie de la formation des images
microscopiques, d'après Abbe. (Succinct account of the Abbe theory of the
formation of microscopic images.)
Bull. Soc. Belg. Micr., XI. (1885) pp. 108-27 (1 pl.).
- Frey, Dr. J., death of. *The Microscope*, V. (1885) p. 24.
- FRIEDRICH, K.—Instrument zum Messen und Theilen von Linien. (Instrument
for measuring and dividing lines.)
Title only of German Patent, 1885, Kl. 42, No. 2056.
- " GAMMA SIGMA."—Conical Illumination for Opaque Objects.
[Pointing out the absurdity of "Prismatique's" suggested illuminator,
infra.]
Engl. Mech., XL. (1885) p. 560.
- GRIFFITH, E. H.—The Griffith Nose-piece.
[Cf. Vol. IV. (1884) p. 801.]
Proc. Amer. Soc. Micr., 7th Ann. Meeting, 1884, p. 170 (1 fig.).
- " " The Griffith Eye-piece.
[Cf. Vol. IV. (1884) p. 443.]
Ibid., p. 170 (1 fig.).
- GUNDLACH, E.—An improvement in Objectives. [*Post.*]
Ibid., pp. 148-52.
- HARDY, J. D.—Lantern Illustrations.
[Reply to query, and referring to his direct vision camera enlarged so as to
show images fairly well up to 2 ft. (The camera is an oblong box, 20 in. x
10 in., with a hole at one end to admit the tube of the Microscope
shortened to 2 in. At the other end is a sheet of plate glass, with tissue
or oiled paper to receive the image.)]
Sci.-Gossip, 1885, p. 43.
- HEURCK, H. VAN.—Note sur la photographie des perles de l'*Amphipleura pellucida*.
(Note on a photograph of the "beads" of *A. pellucida*.)
[In part similar to his note *ante*, p. 173, with reply to E. van Ermengem
ante, p. 140. Also rejoinder by E. van Ermengem.]
Bull. Soc. Belg. Micr., XI. (1885) pp. 86-92.
- " " Le Microscope depuis 1878. (The Microscope since 1878.)
I. Montures. Objectifs.
Moniteur du Praticien, I. (1885) *Bull. de la Microgr.*, pp. 14-6.
- [HITCHCOCK, R.]—The New York Microscopical Society.
[Comments on their proposed publication of a monthly journal.]
Amer. Mon. Micr. Journ., VI. (1885) pp. 17-8.
- " " Science True and False.
[Complaint that microscopical literature in America has of late abounded
in insulting personalities; and quotation of remarks by Prof. E. L.
Youmans on the spirit of pure science.]
Ibid., pp. 18-9.

- [HITCHCOCK, R.]—Black-ground Illumination and Polarized Light.
 [Objecting to T. West's condemnation of them, cf. vol. iv. (1884) p. 976.
 "One might as well say, as Mr. E. M. Nelson does, that the use of
 oblique light in microscopy is not desirable."]
Ibid., p. 20.
 " " Beading of *Amphipleura*. [*Infra*, p. 380.] *Ibid.*, p. 32.
 " " Postal Club Boxes.
 "[List of preparations with remarks.] *Ibid.*, pp. 32-4.
 " " Among the Dealers.
 "[Account of a visit to opticians in Philadelphia and New York, and their
 products.] *Ibid.*, pp. 35-6.
 " " I in. American Objective of very wide angle unfavourably
 compared in Paris with a 25 fr. French. Also a 1/10 in. American (hom.
 imm.) favourably compared with a 1/12 in. English. *Ibid.*, pp. 38-9.
 " " Beading of *Amphipleura* and photo-micrography. [*Post.*]
Ibid., pp. 42-5.
 "Homologous Sections, Electric Light, and Molecules.—Mr. Edison has just
 " completed and transmitted to Prof. F. G. Fairfield, of the New York College
 " of Veterinary Surgeons, an electric lamp which has the novelty of being
 " probably the most minute ever constructed. . . . The instrument was made
 " to illuminate a microscopic objective constructed upon the new discovered
 " law of homologous sections. This lens renders it possible to obtain a power
 " of sixty thousand diameters. At such a power only a section of a coloured
 " corpuscle of human blood can be viewed at a time. Computing the molecule
 " of living matter to be about a twenty-millionth of an inch in diameter, Prof.
 " Fairfield believes it possible to project the image of it upon a screen with
 " the help of the lamp, and to take photographs showing the molecular con-
 " stitution of such complex bodies as albumen."
Micr. Bulletin, I. (1884) p. 14. From "a daily paper."
 HUNT, G.—The *Triceratium favus*—to Mr. Nelson.
 [Inquiry as to what he ought to see with a 2/3 in. and dark-ground illumina-
 tion by the achromatic condenser. "Surely not the minute puncta in the
 hexagons arranged in rows converging towards the centre of the triangular
 figure of the diatom."]
Engl. Mech., XL. (1885) p. 539.
 Illumination of Microscopes and Balances. [*Supra*, p. 328.]
Nature, XXXI. (1885) p. 440.
 "INVICTA."—See Short v. Long Body-tubes.
 Journal of the Royal Microscopical Society (1884).
 [Review.] *Journ. of Science*, VII. (1885) pp. 95-6.
 " " " " [Note on.]
Knowledge, VII. (1885) p. 177.
 JAMES, F. L.—The Deposition of Silver on Glass and other non-metallic surfaces.
 [Describes principally the process of Liebig, Draper, Petitjean, and the
 author.]
Proc. Amer. Soc. Micr., 7th Ann. Meeting, 1884, pp. 71-80.
 KÜNKEL D'HERCULAIS, J.—Nouveau valet compresseur pouvant s'adapter au
 Microscope et permettant l'examen de substances molles et opaques. (New
 Compressor adapted to the Microscope and allowing the examination of soft
 and opaque substances.)
 [Exhibition only.] *Bull. Soc. Zool. France*, IX. (1885), *Proc. Verb.*, xxiii.
 Lens, glory of [like that of a man is work].
Journ. New York Micr. Soc., I. (1885) p. 29.
 LÖWIT, M.—Ein heizbarer Objecttisch für starke Vergrösserungen. (A hot stage
 for high powers.) [*Post.*]
Zeitschr. f. Wiss. Mikr., II. (1885) pp. 43-6 (1 fig.).
 M. Q. M. C.—See Short v. Long Body-tubes.
 MADAN, H. G.—On a Modification of Foucault's and Ahrens's Polarizing Prisms.
 [*Supra*, p. 328.] *Nature*, XXXI. (1885) pp. 371-2 (1 fig.).
 Ser. 2.—VOL. V.

- MALLEY, A. C.—Photo-micrography, including a description of the Wet Collodion and gelatino-bromide processes, with the best methods of mounting and preparing microscopic objects for photo-micrography.
2nd ed., vi. and 166 pp. (3 pls. and 28 figs.), 8vo, London, 1885.
- MAYALL, J., Jun.—Nobert's Ruling Machine. [*Infra*, p. 378.]
Times, 6th and 28th March, 1885.
Engl. Mech., XLI. (1885) p. 30.
- MICHAEL, A. D.—See Nelson, E. M.
- Micrometer, Standard, report of Committee on,—with reports of G. E. Fell, W. A. Rogers, and W. A. Anthony.
[Reports "the result of the effort to obtain copies of the Standard."
Proc. Amer. Soc. Micr., 7th Ann. Meeting, 1884, pp. 220-7.
- Microscopist, What is a? [*Supra*, p. 333.] *Science*, V. (1885) p. 164.
- NELSON, E. M.—Microscopic Illumination.
["Right-angled prisms are used in telescopes for the purpose of economizing every particle of light. In the Microscope, however, even with a 1/2 in. wick there is more light than one knows what to do with."
Engl. Mech., XL. (1885) p. 482.
- " " *Triceratium*.
[Reply to query by G. Hunt, *supra*, and further denunciation of the "oblique light and striæ business."
Ibid., p. 560.
- " " Brass and Glass.
[(1) Testing the different sectors of Objectives, *supra*, p. 324. (2) Simple condenser, *supra*, p. 327.]
Ibid., XLI. (1885) p. 34 (2 figs.).
- " " Standard thickness of glass slips, and remarks by A. D. Michael and W. B. Carpenter. [*Supra*, p. 329.]
Journ. Quek. Micr. Club, II. (1885) pp. 120-1.
- Oculars, report of the Committee on, with appendix of extracts from paper by F. Crisp on "Optical tube-length." Vol. III. (1883) p. 816.
Proc. Amer. Soc. Micr., 7th Ann. Meeting, 1884, pp. 228-33 (1 fig.) and 277.
- PHILLIPS, P. A.—*Amphipleura pellucida*—to Dr. Royston-Pigott.
[Inquiry as to how far his experimental proofs (*infra*) go against the Abbe diffraction theory.]
Engl. Mech., XL. (1885) p. 560.
- Photo-micrography at the Health Exhibition.
[A description of the aërosopes, culture-cells, sterilizing and other apparatus, Microscopes, photo-micrographs and apparatus. *Post.*]
Amer. Mon. Micr. Journ., VI. (1885) pp. 28-32,
from *Brit. Journ. of Photography*.
- "PRISMATIQUE."—Conical Illumination for opaque objects.
[Consists of a glass paraboloid in immersion contact with the upper surface of the slide having a cylindrical hole in the centre for the objective to pass through and focus on the object. "Gamma Sigma" points out that none of the rays reflected from the back surface could possibly reach the object unless the cylindrical opening is filled with oil, and not many even then!]
Engl. Mech., XL. (1885) p. 520 (1 fig.).
- QUEEN, J. W.—Note on Centering the Illuminating Beam. [*Post.*]
Micr. Bulletin, II. (1885) p. 1 (4 figs.).
- Rogers' (W. A.) Stage-micrometer. [*Supra*, p. 330.]
Amer. Mon. Micr. Journ., VI. (1885) p. 38.
- " " See also Micrometer.
- Royal Microscopical Society, visit of deputation from, to the American Society of Microscopists. *Proc. Amer. Soc. Micr.*, 7th Ann. Meeting, 1884, pp. 262, 269, 271.
- ROYSTON-PIGOTT, G. W.—*Amphipleura pellucida*.
[Result of examination with the Diatomescope.]
Engl. Mech., XL. (1885) p. 520.

- ROYSTON-PIGOTT, G. W.—*Amphipleura pellucida* and diffraction. I.
 [Reply to P. A. Phillips, *supra*. Also the following, "With proper precautions the limit of angular vision or linear diameter in my experience lies beyond the 1/1,000,000 in. with the best glasses and finest manipulation."]
Ibid., XLI. (1885) pp. 35-6.
- Sachs' (J.) Heating apparatus. [*Post.*]
Micr. Bulletin, II. (1885) p. 6,
 from 'Sachs' Text-book of Botany,' p. 658.
- SCHULTZE, E. A.—Electrical Illumination in Microscopy: Experiments and Views of Dr. H. van Heurck and T. Stein.
 [Principally an abstract of Dr. Stein's paper, *supra*, p. 303.]
Journ. New York Micr. Soc., I. (1885) pp. 1-6 (4 figs.),
 and cf. also pp. 19-20, 22-4.
- Sexton, L. R., Obituary of.
Proc. Amer. Soc. Micr., 7th Ann. Meeting, 1884, pp. 251-3.
- Short v. Long Body-tubes.
 [Further discussion by B.Sc. (better results with a 7 in. or 8 in. than 10 in.), M.Q.M.C. (refers to paper on "Optical tube-length," Vol. III. (1883) p. 816), and *Invicta*.]
Engl. Mech., XL. (1885) p. 457.
- SOUTHALL, G.—Photo-micrography.
 [As to the wide differences between the natural and artificial representations of the same object.]
Knowledge, VII. (1885) p. 181.
- ST. CLAIR, R. W.—A new Electric Lamp.
 [Incandescence lamp; battery with 6 cells and holding 5 oz. of fluid. It has been in use for more than a year. The President referred to it as "the best for brilliancy yet brought before the Society."]
Journ. New York Micr. Soc., I. (1885) p. 42.
- Stearn's (C. H.) Electric Lights for the Microscope.
 [Brief description, with illustrations, of apparatus described Vol. III. (1883) p. 29. Also reference to Stein's, *supra*, p. 303.]
Science, V. (1885) p. 142 (3 figs.), from 'Science et Nature.'
- STEINHEIL, A.—Zur Orientirung über Objektive aus zwei Linsen und ihre Fehler. (On the orientation of Objectives of two lenses and their aberrations).
 [Telescope Objectives.] *Centr.-Ztg. f. Optik u. Mech.*, VI. (1885) pp. 37-40.
- Tolles, R. B., Portrait of.
Proc. Amer. Soc. Micr., 7th Annual Meeting, 1884, Frontispiece.
- VORCE, C. M.—Photographic Methods.
 [I. Formulas for printing solutions (Blue prints. Black prints. Cheap proof solution). II. Compound negatives, *supra*, p. 331.]
Amer. Mon. Micr. Journ., VI. (1885) pp. 13-4.
- WARD, R. H.—The Iris Illuminator. [*Supra*, p. 326.]
Proc. Amer. Soc. Micr., 7th Annual Meeting, 1884, pp. 160-1 (1 fig.).
Amer. Mon. Micr. Journ., VI. (1885) pp. 14-5 (1 fig.).
- " " New Lens-holder. [*Supra*, p. 317.]
Proc. Amer. Soc. Micr., 7th Annual Meeting, 1884, pp. 162-4 (1 fig.).
The Microscope, V. (1885) pp. 32-4 (1 fig.).
- Weisiger, W. R., Obituary of.
Proc. Amer. Soc. Micr., 7th Annual Meeting, 1884, pp. 250-1.
- WESTEN, H.—Mittheilungen aus dem physiologischen Institute der Universität Rostock i. M. 7. Die Patent-Anschlussklemme und ihre Anwendung. (The Patent Junction Clamp and its use.) [*Supra*, p. 316.]
Zeitschr. f. Instrumentenk., V. (1885) pp. 18-9 (3 figs.).
- WHITNEY, J. E.—A cheap and efficient Life-box. [*Supra*, p. 330.]
Proc. Amer. Soc. Micr., 7th Ann. Meeting, 1884, p. 215.
- Woodward, J. J., Obituary of.
Proc. Amer. Soc. Micr., 7th Ann. Meeting, 1884, pp. 253-7.

B. Collecting, Mounting and Examining Objects, &c.

Modified Hardening Process for the Central Nervous System.*—

It is difficult to obtain the human brain in a fresh condition, 36–48 hours generally elapsing after death before it is available for examination. Giacomini proposes the following process to give the preparation greater firmness and elasticity.

After the preparation has been hardened in Müller's fluid, instead of putting it in alcohol it is placed for some days in a 5 per cent. sublimate solution, which is renewed every day until it is no longer coloured. If left in the fluid too long, the preparation becomes black, or if not long enough, small black points will appear. It is very elastic and firm, and very thin sections can be cut, and it stains well with ammonia-carmin.

Preparing Meroblastic Ova.†

The following are C. Kupffer's methods:—

Reptilian Ova.—The ova taken from the oviduct are opened in a dilute solution of 0·1 per cent. osmic acid and the albumen removed as far as possible. The osmic acid is then turned off and a weak 1/3 per cent. solution of chromic acid added for 24 hours. With a fine pair of scissors the germinal area is cut round just outside its margin, and after it has been completely encircled with the incision, floated carefully off from the body of the yolk. The yolk and acid are next removed, and a copious supply of clean water added, which must be several times renewed. It is then put for 3 hours in Calberla's fluid (ā ā glycerin, water, and absolute alcohol in equal parts), hardened in 90 per cent. alcohol, and stained in Böhm's carmine acetate for 24 hours.

Teleostean Ova (T. fario).—Chromic acid (1/3 per cent.), 24 hours. Distilled water for 2 hours. The egg-membrane expands, and may now be easily removed. Wash in distilled water 12 hours. Absolute alcohol, glycerin, and aq. dist. in equal parts for 4 hours. Absolute alcohol. Böhm's carmine acetate (1 to 2 days). Mixture of water and glycerin (equal parts), and 1/2 per cent. hydrochloric acid, for a few minutes. Wash in water (4 to 5 hours). Absolute alcohol (12 hours) preparatory to imbedding in paraffin.

Karyokinetic figures are brought out with great distinctness.

Hydrogen Peroxide as a Bleaching Agent.‡—J. D. Hyatt finds this to be very successful for insects. A flea, for instance, thus bleached shows the heart and all the other internal organs clearly and perfectly and in their proper place. The respiratory system is particularly fine. In the process of decoloration by liquor potassæ, these delicate structures are either partly or quite destroyed.

* 'Fascia dentata del grande ippocampo nel cervello umano.' Torino, 1883, pp. 66–7. Zeitschr. f. Wiss. Mikr., i. (1884) pp. 449–51.

† Arch. f. Anat. u. Physiol. (Anat. Abtheil.) 1882, p. 4. Cf. Amer. Natural., xix. (1885) p. 332, and Lee's Microtommists' Vade Mecum, 1885, p. 316.

‡ Journ. New York Micr. Soc., i. (1885) p. 22.

Biniodide of Mercury and Potassium as a Swelling Agent.*—

L. Dippel finds that a solution of iodide of mercury in iodide of potassium possesses the property of causing the innermost layer of the cell-wall to swell while the other layers remain unchanged. The preparations after carefully washing can be preserved in glycerin or calcium chloride. The degree of concentration of the solution requires to be tested for each object.

The inner layer can be stained without the others. The sections should be placed for some hours in an aqueous solution of fuchsin, and after washing the inner layer will be found at the thinnest points to be stained a pale red. A dilute solution of hæmatoxylin gives a pale violet stain.

Erlicki's Hardening Solution.†—This is a variation of Müller's solution. The latter is composed of bichromate of potash, $2-2\frac{1}{2}$ parts; sulphate of soda, 1 part; and water, 100 parts; the duration of the reaction being about the same as with the simple solutions of chromic salts.

In Erlicki's solution the sulphate of soda is replaced by $1/2$ p. c. sulphate of copper. The hardening properties are superior to those of Müller's solution. It is now very generally employed in Germany.

Böhm's Carmine Acetate.‡—Böhm proposes the following formula:—

Three to four grms. carmine are pulverized in 200 grms. water, and ammonia is added by drops until the solution becomes cherry-red (the carmine should now be fully dissolved). Acetic acid is then slowly added until the colour becomes brick- (or sealing-wax-) red. The addition of acetic acid should be accompanied with stirring, and should cease the moment the change in colour is effected. Then filter until no trace of a precipitate remains.

If the colour is not sufficiently deep, a few drops of ammonia should be added before filtering, and the solution left in an open vessel until the smell of ammonia is not perceptible.

Objects may be left for 24 hours or more in the fluid (or longer if they are more than 1 mm. in thickness). The deep stain should be partially removed by immersion in a mixture of water and glycerin (equal parts), with $1/2$ per cent. hydrochloric acid, for a few minutes.

Staining Method for Karyokinetic Figures.§—P. Baumgarten finds the following an excellent method. Place the sections for 24 hours in a dilute alcoholic solution of fuchsin (8-10 drops of concentrated solution in a watch-glass of water), then rinse in absolute alcohol, then for 4-5 minutes in a concentrated aqueous solution of methyl-blue, dehydrate for 5-10 minutes in absolute alcohol, and lastly place in oil of cloves. The effect of the methyl-blue is to remove the red stain almost entirely from all parts except the nuclei.

* Zeitschr. f. Wiss. Mikr., i. (1884) pp. 251-3.

† Lee's Microtomists' Vade Mecum, 1885, pp. 159 and 403.

‡ Arch. f. Anat. u. Physiol. (Anat. Abtheil.) 1882, p. 4. Amer. Natural., xix. (1885) pp. 332-3. Lee's Microtomists' Vade Mecum, p. 54.

§ Zeitschr. f. Wiss. Mikr., i. (1884) pp. 415-7.

The author's main object was the examination of the cells of tubercle for which the chromic acid process was found unsuitable. If it is desired to examine the bacilli at the same time, the sections should first be placed for 24 hours in a dilute alcoholic solution of methyl-violet and then treated with the fuchsin and methyl-blue. The bacilli are stained blue, and the karyokinetic figures an intense red. It is advisable to leave the sections only 5-10 minutes in the fuchsin and 5-10 seconds in the methyl-blue; if left longer in the fuchsin the bacilli lose their stain.

Ribesin and Eosin.*—Prof. H. Fol, after expressing and throwing away the juice of black currants (*Ribes nigrum*), boils the skins for some hours in 10 per cent. alum solution. The resulting deep violet solution may conveniently be diluted with water, and after the lapse of a day should be filtered, and may then be used for staining.

The stain resembles in its effect that of Boehmer's hæmatoxylin, but is a still more precise nuclear stain. It is a bright, somewhat greenish blue, agreeable, distinct, and permanent. Alcohol objects stain quicker than chromic acid ones, but the most suitable of all are bichromate objects.

A ribesin stain may be followed by eosin-staining, or a double stain may be at once obtained by adding a little eosin to the above ribesin solution and filtering (the filtrate should be cherry red). Wash out with alcohol charged with a little eosin, and clear with clove oil also charged with eosin. The blue of the ribesin remains fixed in the nuclei. In many respects this is a better double stain than Renaut's hæmatoxylic eosin.

Plaut's Staining Process for the Demonstration of Saprogenous and Pathogenous Micro-organisms.†—H. Plaut tabulates the methods of investigation for the various micro-organisms; instructions for the examination, choice, and treatment of the material, the production and treatment of the preparations, the best staining reagents and their action, methods of preservation, &c. In the case of the pathogenous Schizomycetes, the different methods are described, for each species, of the various investigators, Koch, Friedländer, Weigert, &c. The sections are as follows:—A. Saprogenous Schizomycetes: in fluids; in and upon solid substances. B. Pathogenous Schizomycetes: in the blood; in organs; micrococci in *Area Celsi*; *Leptothrix buccalis*; Lepra; bacillus of cattle-disease; pneumonia-cocci; recurrent spirochæte; bacillus of glanders; tubercular bacilli; typhus bacilli. C. *Gregarina*—moulds, &c.: *gregarina*; favus and *Oidium lactis*; *Actinomyces*.

Staining the Spores of Bacillus tuberculosis.‡—A. F. Negri describes a method he has found successful for staining either the spores of *Bacillus tuberculosis* or the organism itself:—

1. Powdered carmine, gr. 0·5; strong ammonia, cc. 1; distilled

* Fol, H., 'Lehrbuch d. vergl. Mikr. Anatomie,' 1884, pp. 183 and 196. See Lee's *Microtomists' Vade Mecum*, 1885, p. 402.

† Plaut, H., 'Färbung's-Methoden zum Nachweis der fäulniss-erregenden u. pathogenen Mikro-organismen.' 2nd ed., 32 pp. 8vo, Leipzig, 1884.

‡ Journ. de Microgr., viii. (1884) pp. 349-51. From 'Lo Sperimentale.'

water, cc. 30. This, protected from dust, is exposed to the air till every trace of ammonia has disappeared, when the clear fluid is poured off and the sediment thrown away.

2. Commercial alcohol, cc. 100 ; pure hydrochloric acid, drops 20.

3. Concentrated solution of picric acid in distilled water.

4. No. 2, cc. 15 ; No. 3, cc. 15.

5. No. 4, with the addition drop by drop of No. 1. Into this a small crystal of thymol is dropped to prevent the growth of mycelium, and the preparation is kept in a stoppered bottle.

6. Methyl violet, gr. 0·7 ; absolute alcohol, cc. 10 ; anilin oil, cc. 4. To this when the colouring matter is completely dissolved is added distilled water, cc. 15.

The sputum is spread in a uniform but not too thin layer on a cover-glass, and then dried in the air and slightly warmed. It is next placed in a watch-glass with the preparation upwards ; some of No. 6 poured on it with an ordinary indiarubber drop-measure, is covered over and left from half an hour to an hour in a temperature of 15° C. It is then washed in water till the excess of colour is dissipated entirely, when it is put into No. 2 until the preparation is cleared, when it is washed in a fresh quantity of the liquid, and whilst still moist some drops of No. 5 are poured on, and it is left to stand for five minutes. The excess of carmine is removed by draining: it is then washed anew in No. 2, and plunged into distilled water, twice renewed, for eight to ten minutes. The preparation is then dried and mounted in pure balsam.

When examined under the Microscope the spores appear of an azure-blue inclosed in the transparent envelope of the bacillus, on a rose-coloured ground.

When it is desired to colour the whole bacillus instead of the spores alone, the preparation is washed, after being subjected to the action of the carmine, in distilled water without being placed in No. 2.

Francotte's Paraffin Filter.*

—P. Francotte suggests the apparatus, fig. 83, for readily freeing paraffin that has been used, from the dirt, fragments of sections, &c., which after a time contaminate it. A B is a double funnel with water between the two casings, the inner one terminating in a bent tube T. Blotting-paper is placed inside the funnel and a spirit-lamp applied at the bottom. An aperture at *u* is for a thermometer and one at *u'* for supplying water.

The apparatus will also enable paraffin to be obtained at any

FIG. 83.

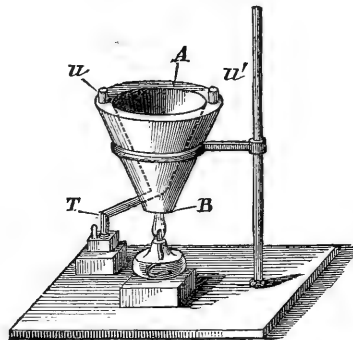

* Bull. Soc. Belg. Micr., xi. (1885) pp. 79-82 (1 pl.).

given point of fusion. Pieces of paraffin are placed in the funnel and heated to the point desired. The liquid which runs out of the funnel is collected, and will be found to melt at the temperature indicated at the moment of filtering.

Dr. Francotte also suggests that the funnel A B may replace the vessel R in his vacuum apparatus, *ante* p. 149, one of the apertures being used for the barometer tube and the other communicating with the vessel with the paraffin. The funnel is cooled by passing water through it.

Parabolic Mirror for Correction of too hard or too soft Paraffin.*
—Prof. H. Fol suggests that if, after the cutting has begun, the paraffin is found to be too hard, it may be softened by the following simple and ingenious expedient:—

A lamp provided with a parabolic reflector is set up near the microtome in such a position that the heat-rays of the flame are thrown by the reflector on to the imbedded object. The right temperature is obtained by adjusting the distance of the lamp. If, on the contrary, the paraffin be found too soft, it may be hardened by exposing it to the cooling influence of a lump of ice placed in the focus of a similar reflector.

Beck's Universal Microtome.—In this microtome (fig. 84) Messrs. Beck have very ingeniously combined in one instrument the means for cutting sections of soft tissues under all the varied conditions required in this class of work:—1stly, for cutting consecutive sections, which are carried off the knife by a continuous ribbon. 2ndly, for cutting sections when frozen by ether. 3rdly, for cutting unimbedded sections. 4thly, for cutting sections with a long diagonal knife. Special arrangements are made for freezing by ice, or for cutting substances under spirits if desired. The Schanze form has been adopted as the basis of the instrument, the main frame consisting of a solid iron base and an upright. The latter carries on one side a carefully planed out V-shaped groove A, on which a heavy brass block B, to which the knife is attached, slides with great accuracy and ease. To this block and behind the knife the apparatus carrying the revolving ribbon C is clamped. This is readily removed when desired.

On the other side of the upright is a vertical slide working in a dovetail, and carrying the mechanism to which the object-holder is attached. The various modes of holding the object are shown at—D when the object is imbedded in paraffin for ribbon cutting; E when the object is frozen by ether; and F when it is clamped in the holder. The socket into which the object-holder fits has rectangular movements controlled by the two thumb-screws, so that the object-holder can be placed in any position. The whole is moved up and down by the lever seen in front of the upright, which brings it in contact with the top of a highly polished steel screw of very delicate construction, upon which it rests. To this screw is attached a large ratchet

* Fol, H., 'Lehrbuch d. vergl. Mikr. Anatomie,' 1884, p. 123. Cf. Lee's *Microtomists' Vade Mecum*, 1885, p. 401.

Fig. 84.

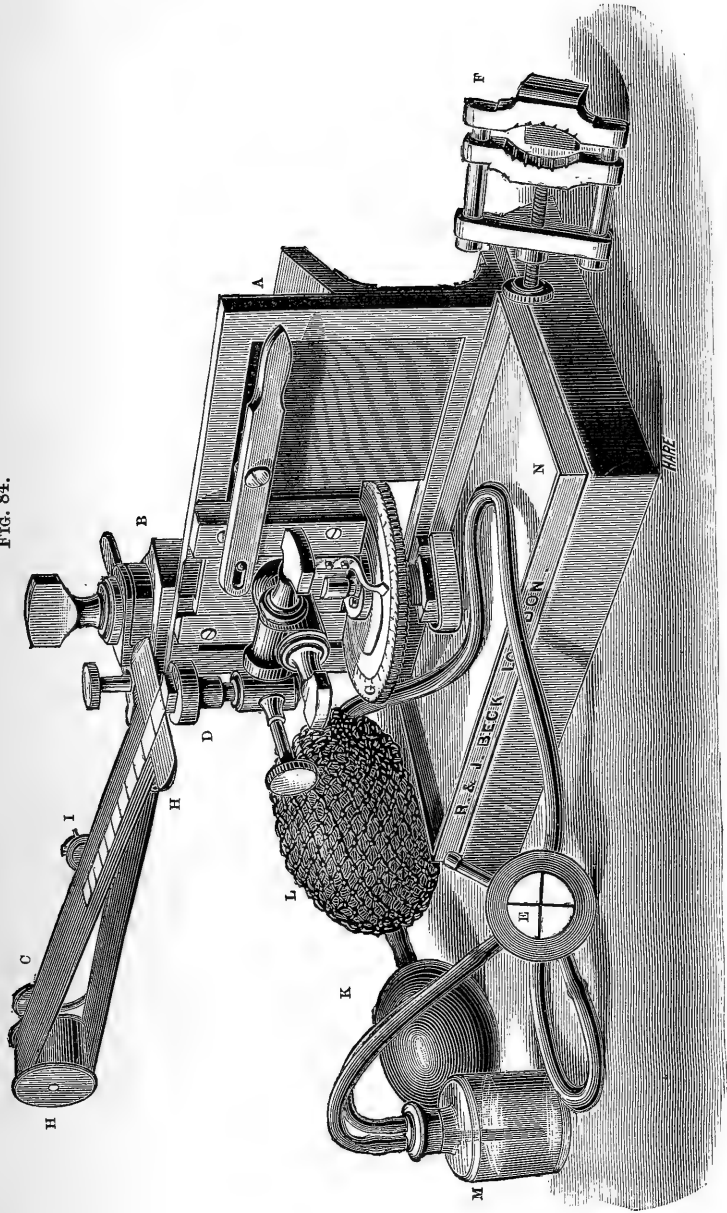

BECK'S UNIVERSAL MICROTOME.

wheel G, which is automatic in its action, being moved forward any distance required at each stroke of the knife. This movement is adjusted by a screw at the side, by which the number of teeth moved forward at each stroke is determined. If the instrument is so adjusted that the wheel moves one tooth at each stroke the thickness of the section will be $1/3600$ in., or 7μ , and so on up to 10 teeth or $1/360$ in. (70μ).

The arrangement for ribbon cutting consists of two drums H H carrying the ribbon C. The distance the ribbon moves is regulated by a small ratchet wheel I, capable of minute adjustment and varying according to the breadth of the section cut.

The ether freezer consists of an indiarubber tube communicating with a chamber E upon the outside of which the object to be frozen is placed; a hand-bellows K, an intermediate regulating bladder L, and a bottle M in which the ether is placed, and into which the two tubes for the ether and drainage are fitted.

The zinc tray N holds any droppings.

If desired a crank movement can also be applied, whereby a continuous motion is given to the knife carrier and to the ribbon apparatus.

The advantage is obvious of having a simple microtome to which a simple ribbon apparatus can be attached when it is desired to cut series of sections, and which does not interfere with the ordinary use of the instrument.

Reichert's Simple Hand-Microtome.—Figs. 85 and 86 show the simple hand-microtome of C. Reichert for objects of 15–25 mm. in diameter.

A metal cylinder has at the lower end a disk *a* with an excentric aperture. One end of a lever *b* within the cylinder passes through

FIG. 85.

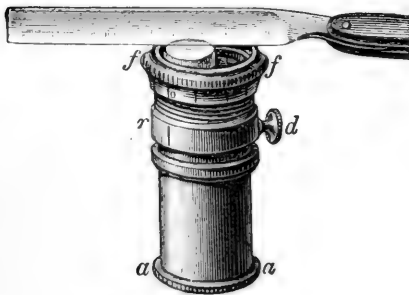
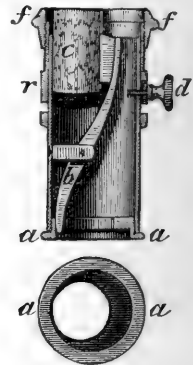

FIG. 86.



the aperture, while the other presses against the piece of pith *c* used for imbedding, and the pressure can be increased or diminished according as *a* is rotated. Over the upper end of the cylinder is fitted a

shorter one, having a fine screw-thread terminating in *r*. The clamp-screw *d* fixes it. A ring *f* with a screw-thread works in that on the short cylinder, its upper edge serving as a guide for the knife. By rotating the ring it is lowered and more of the object to be cut exposed to the knife. The divisions on the ring mark 1/10 mm. in the thickness of the sections.

Reichert's Microtome Object-clamp.—C. Reichert now supplies for use with his microtomes the clamp shown in figs. 87 and 88. The object is fixed between two plates, one of which is movable and is

FIG. 87.

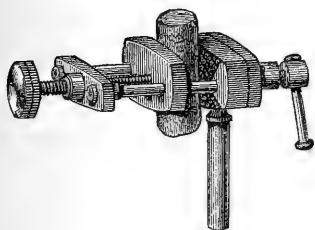
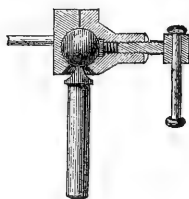

FIG. 88.



controlled by the screw on the left. A universal motion is given to the clamp by a ball-and-socket arrangement shown in section in fig. 88, so that it can be set at all inclinations.

Improvements in Microtomes and Knives.*—P. Francotte suggests attaching to the plate of the Ranvier microtome, on each side of the opening, two pieces of glass, 0.5 cm. broad, and of exactly equal thickness. These will serve as slides for the razor, which, owing to the reduction of friction, will move more regularly, and thus perfectly parallel sections will be obtained which it is otherwise difficult to do.

Another suggestion is to attach two pieces of glass, 1 mm. thick, to the plane face of the razor, a little less in length than the breadth of the blade, so as to leave the edge free. The glass would be better replaced by metal, but that would require a specially constructed knife which it is the object of his suggestions to avoid.

Rogers' Section-Cutter.† — W. A. Rogers describes a form of section-cutter suggested by part of the mechanism employed in the comparator of Princeton College. New tree-ways upon which the Microscope-plate moves are the cores of very long magnets, and it was found that the pulling force required to move the plate under the action of a current developed by four bichromate cells was about 135 lbs.

The apparatus now proposed obviates the uncertainty as to the mechanical indication of the thickness of the sections as well as the uncertainty with reference to its rigidity and the number of parts by

* Bull. Soc. Belg. Micr., xi. (1885) pp. 84-5.

† Proc. Amer. Soc. Micr., 7th Ann. Meeting, 1884, pp. 191-3.

which the increment of motion is given. It consists of (a) A bed-plate of iron about 15 in. long by 6 in. in breadth, having elevated walls on each side and running the entire length. The cores of two or more magnets project through this bed-plate, being fastened beneath. (b) A rectangular plate moving freely between the walls of the bed-plate, and resting directly upon the cores of the magnets. (c) A Microscope-arm attached to the bed-plate in such a way that a ruled metal plate attached to the moving plate can be brought under the objective. (d) A simple means, either by a lever or a screw, of running the rectangular plate over any distance indicated by the scale. (e) The mechanism for holding the object upon the rectangular plate and for moving the knife.

The object being mounted for cutting, each increment of motion is obtained by moving the rectangular plate over a given distance under the Microscope. There can be no mistake about the magnitude of this motion, because it can be at any time verified by reading the scale. In order to fasten the plate, preparatory to making the section, we have only to turn a switch and complete the circuit. By the principle employed there can be no disturbance during this operation, and this fact can be verified by again reading the scale.

Preparing Thin Sections of Shells and Teeth.*—E. Ehrenbaum recommends that before grinding thin sections of teeth, shells of molluscs, foraminifera, &c. (especially small objects), they should be placed in a very fluid and not too warm mixture of 10 parts colophonium (rosin) and 1 part ordinary wax, the latter serving to reduce the brittleness of the former. It is quite transparent, and the object can be oriented in any desired position in the grinding. The objects should be placed in the mixture and after a short time lifted out with the forceps with as much as possible of the mixture hanging to them, and allowed to cool. Or the mixture with the object may be poured in a very small paper box.

The grinding is done on a glass plate with emery powder of various degrees of fineness. When one side is smooth, the section is attached to the slide, and the other side similarly ground down and polished. It is then washed with oil of turpentine and (moistened with the oil) left under a bell glass to clear and render it transparent. The remainder of the imbedding material is best removed with chloroform.

If the section is damaged and likely not to hold together, it can be mounted without dissolving the colophonium, which when pure is little inferior to Canada balsam. In this case the slide should be warmed very gently or some drops of chloroform run over it before the cover-glass is put on.

Rapid Method for Making Bone and Teeth Sections.†—Under this heading E. T. Nealey describes a process which consists of using only perfectly fresh tissue and grinding down first one side and then the other of the tooth or sawn section of bone on a dentist's lathe

* Zeitschr. f. Wiss. Mikr., i. (1884) pp. 414-5.

† Amer. Mon. Micr. Journ., v. (1884) pp. 142-4.

with a set of emery wheels. He uses the palmar surface of the index finger to press the section against the stone. "If a part of the ball of the finger happens to come in contact with a finely polished and well-moistened stone it will have but little if any effect upon the epidermis."

A tooth can thus be made ready to mount in thirty minutes after its removal from the jaw, and the following advantages are claimed for the method over the older ones, viz., "rapidity of preparation, and thereby the specimen retains all of its original tenacity. It does not curl up or become brittle, and thus one is enabled to get a larger and more perfect specimen . . . Perfect longitudinal sections of teeth have been made in this way which were so thin that they would bend under their own weight. This would be simply impossible in a tooth that had become dry during the old process, as they become too brittle to allow of such extreme reduction. The rapidity of reduction and preparation readily admits of staining the protoplasm of bone sections before retrogression sets in, and thereby their value is greatly enhanced."

Staining and Mounting Pollens and Smuts.*—Rev. J. T. Brownell gives the following as an original method:—

"Place a blank slide on the turntable; apply a small drop of the staining fluid to the centre of the slide and place in it the requisite amount of pollen and spread it evenly on the glass by placing the sharp point of a teaser in the centre of the mass, and drawing it gently to one side while the slide is rapidly revolving, washing away the superfluous stain by dropping clean alcohol on the mass of pollen, using for this purpose a sharp-pointed teaser; wipe away the out-flowing fluid by the use of a small piece of clean cloth rolled up neatly and applied to the outer edge of the waste fluid, gradually moving it inward as the slide revolves, until only a small circle is left covered with pollen. Allow a few moments for the alcohol to thoroughly evaporate from this; then apply a minute drop of spirits of turpentine, so that the balsam may permeate the mass without inclosing air-bubbles. Next apply the balsam, *dropping it in a ring around the pollen*, and moving it up to the centre by placing the edge of a small chisel held upright to the surface of the slide, and at an angle such as to gather it (the balsam) together as the slide revolves. Now lay on the cover-glass and settle it well into place, applying pressure (with a tremulous motion of the hand) sufficient to bring all the pollen-grains to a common plane, but yet so as to avoid crushing them. Remove the superfluous balsam, using the small chisel as before, only setting it so as to throw the balsam away from the cover into an outer ring, which operation serves also to accurately centre the cover-glass; and lastly, using a wider chisel, take up this ring of balsam, and the slide, furnished with a temporary label, is laid away to cure."

Practical suggestions are given as to collecting clean pollen, preserving it for future use, avoiding mixing, teasers, chisels, &c.

* Proc. Amer. Soc. Micr., 7th Ann. Meeting, 1884, pp. 212-3.

It is added that "all that has been said applies equally to the mounting of smuts, save that these being dark in colour do not need to be stained, which is also true of many pollens."

Brownell Turntable.*—Rev. J. T. Brownell has constructed a turntable (fig. 89) upon the general plan of that devised some years ago by C. M. Kinne, but with several important improvements.

FIG. 89.

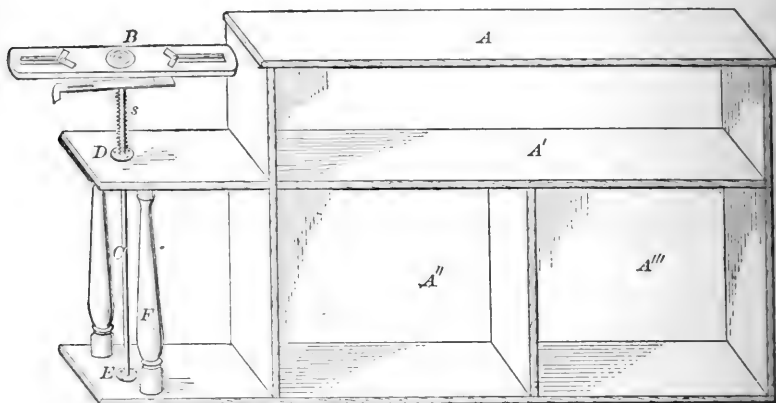

Fig. 89, which is reduced to one-third of full size, represents the table, front view. The stand A is made of wood, with the open chambers A' A'' A''', affording a convenient place for laying the various utensils in use, and also for packing them together with materials, &c., for transportation. The head-block B is of solid brass $4\frac{1}{8} \times 1$ in., and $\frac{1}{4}$ in. thick. It stands on a spindle C 5 in. long, which is supported by the metallic collars D and E. The lower end of the spindle is dressed to a sharp point, and rests on a plate of polished agate underneath the collar E. A couple of inches of the central portion of the spindle are milled, and the instrument is run by the tips of the fingers of the left hand placed against this milled portion, while the hand is steadied by resting the thumb against the pillar F. The revolution of the slide is thus under the complete control of the operator, who can readily keep it in uniform motion, quick or slow, for any desired length of time. Fig. 90 shows the upper side of the head-block, with a glass slip held in place.

The clutches *a* (fig. 90) are set so as to grasp the slip diagonally, bringing it to a true centre, and at the same time leaving one of its corners projecting $\frac{3}{8}$ in. on either side for convenient handling. The clutches are secured in position, being screwed fast to the brass blocks *x* (fig. 91), which move firmly but freely through the grooves cut for them. The lever-bars *y* are attached to these blocks by the

* Proc. Amer. Soc. Micr., 7th Annu. Meeting, 1884, pp. 173-5 (3 figs.).

strong screws *r*, and are connected by the centre bar *z*, which is let into them by a mortice and held by the pins *p*. The clutches are opened for the reception of the glass slip by placing a finger of the

FIG. 90.

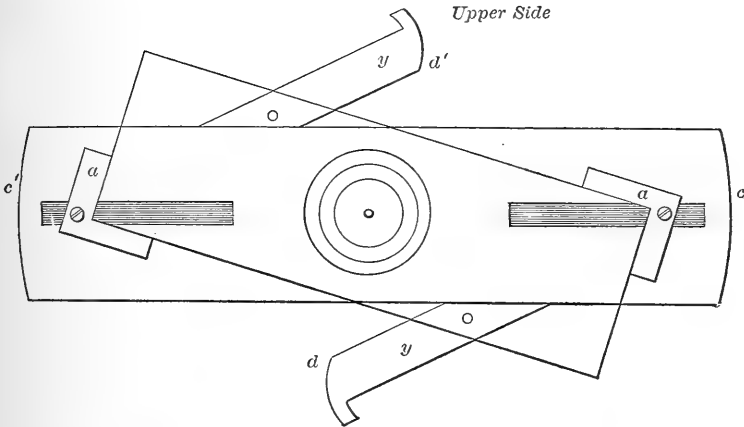

right hand against the milled end of the head-block at *c* (or *c'*), and pressing the end of the lever-bar with the thumb at *d* (or *d'*). The grasping force of the clutches is secured through a spiral spring *s*

FIG. 91.

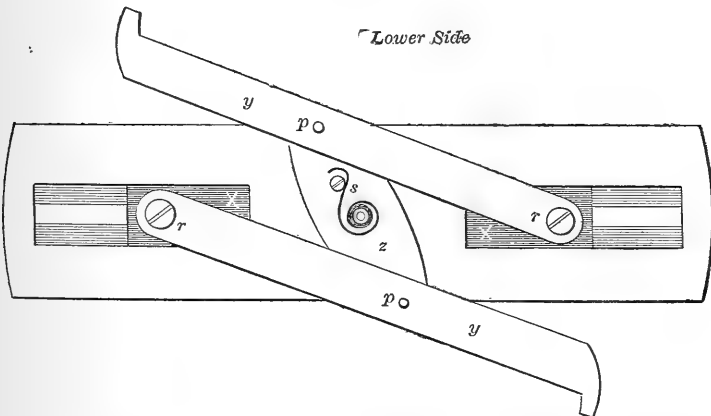

(figs. 89 and 91), coiled around the head of the spindle, as shown in the figures.

The whole rests on disks of rubber, so that it will neither slide about nor mar any surface on which it may be used.

Smith's Mounting Media.*—H. L. Smith describes his colourless medium (1.8 to 2.0 refractive index). It consists of arsenite of antimony (a white powder) dissolved in liquid chloride of arsenic until a somewhat dark-coloured honey-like viscid fluid is obtained, which is used precisely like balsam. Caution is required in the manufacture, which should be done in small quantities and in a homœopathic vial. This should be about one-third filled with the chloride and some of the arsenite, say one-third the bulk of the liquid, added, and the mixture warmed over a spirit-lamp until all is dissolved; then successive portions of the arsenite are added and dissolved until the viscid fluid is obtained. If the ingredients are clean, no filtering will be required. In mounting, the boiling should be prolonged until the large easily-formed bubbles of the excess of chloride disappear; the portion outside will be hard, and require a sharp edge to remove it, care being taken not to disturb the cover. After this the cover and adjacent parts can be washed over with tissue paper moistened with hydrochloric acid; not water or alcohol, as they decompose the medium, causing it to become an opaque white. A wax ring is the best protection for the mount. The medium improves with age, and with further experiments can, it is hoped, be made to give permanent mounts by obviating the tendency to deposit crystals.

The deep-yellow medium (2.4 refractive index) Prof. Smith pronounces to be entirely permanent. Its composition he keeps a secret. It is to be regretted that he should have decided to inaugurate such a departure from the ordinary and very salutary scientific usage in such matters. In the case of dealers this can hardly be legitimately objected to, but we hope that scientific workers in general will not be misled by Prof. Smith's example, to make a mystery of methods and processes which they have hitherto been so ready to make known for the benefit of their fellow-workers.

Balsam of Tolu as a Medium for Mounting.—Mr. F. Kitton writes: "It is stated in the February number of the Journal that this medium is objectionable for mounting purposes, as crystals are apt to form in it sooner or later. I tried it shortly after reading Dr. Kain's recommendation (early in September last), and have now over a hundred preparations in the medium. In February I went through them with some trepidation, but was gratified to find that no symptom of crystallization had appeared. This I should have attributed to the short time that had elapsed since the preparations had been made, had it not been stated that recent preparations (made about the same time as mine) were already full of crystals. I can only account for this by supposing that either tolu is variable in its composition, or that my method of preparing and using it prevents crystallization. Dr. Kain recommends alcohol or chloroform as a solvent; I employ benzole. I remember some years ago inquiries were made as to the cause of crystals sometimes occurring in preparations made with balsam or dammar dissolved in chloroform. As I never found them in my

* Proc. Amer. Soc. Micr., 7th Ann. Meeting, 1884, pp. 186-90.

own preparations made with pure balsam, I attributed them to the chloroform.

Shortly after I began using tolu a correspondent informed me that some of his slides were spoilt by a kind of crystallization, which he described as being like a delicate cobweb. I have noticed a similar appearance in balsamed slides that had been overheated, and in consequence the balsam had become brittle. I have sometimes seen the formation of it when cleaning off the superfluous balsam; a sudden change of temperature, such as the heat of the hand, will produce it. The appearance is caused by innumerable fissures permeating the film of balsam. Tolu if hardened too much will no doubt act in the same manner. Being of slightly higher refractive index than styrax, it is useful for many forms, and I hope that this defect may be remedied either by the use of benzole or by making the tolu less hard."

M. J. Amann also,* as the result of nearly three years' experience, considers tolu superior to Canada balsam and equivalent to styrax. The only drawback is that it has a little more colour than the latter, though, like styrax, it becomes colourless with age and when exposed to the light. On the other hand, it is much simpler to prepare. It is only necessary to dissolve 1 part of the balsam in 2 or 3 parts of chloroform, then filter, and it is ready for use.

Mr. C. Van Brunt, however,† confirming a statement of Mr. E. G. Day, speaks to the crystallization of balsam of tolu, even in slides prepared by an experienced hand.

Glycerin and Balsam Mounts.‡—J. S. Kingsley, referring to the praise recently given to glycerin as a mounting medium, considers that for every-day work it cannot compare with balsam, and that the difficulties connected with the use of balsam have been over-stated. He gives the following comparative statements, the first being the steps required with balsam, and the second with glycerin.

a. Harden with chromic acid. *b.* Dehydrate with alcohol of different grades. *c.* Transfer to chloroform. *d.* Transfer to paraffin. *e.* Cut sections. *f.* Dissolve paraffin with turpentine. *g.* Place on slide in balsam and apply cover.

With glycerin we follow the same steps to *f*, and then we have to add the following:—

g. Get rid of turpentine by alcohol. *h.* Place on slide with glycerin, and apply cover. *i.* Fasten cover.

It seems to him "that some people needlessly take many steps in doing microscopic work which are absolutely needless. For instance, in the time one occupies in finishing a balsam slide he could mount another, and in the experience of the writer all use of cements for fastening the cover in the case of balsam mounts is unnecessary."

Mounting in Phosphorus.§—R. Hitchcock referring to the recommendation to use Walton's glucine or Ray's coaguline as cements,

* Bull. Soc. Belg. Micr., xi. (1885) p. 127.

† Journ. New York Micr. Soc., i. (1885) pp. 41-2.

‡ Science Record, ii. (1884) pp. 269-70.

§ Amer. Mon. Micr. Journ., vi. (1885) p. 7.

suggests a cement which in his opinion will unquestionably serve perfectly well. It is solution of ordinary gelatin in water, coloured slightly with potassic dichromate. A rather thick solution can be used to make a cell, if used warm on a warm slide. When the mount is finished exposure to light for a short time after the gelatin is dry renders it quite insoluble.

Diatoms in Phosphorus.*—L. Dippel finds that all those diatoms which, when mounted dry, show the markings clearly and sharply, act in the same way in the phosphorus solution, while those (especially *Grammatophora*) for which dry mounting is not suitable, are also badly shown in phosphorus. *Amphipleura pellucida*, *Surirella gemma*, species of *Nitzschia* and *Pleurosigma*, *Navicula rhomboides* and *Frustulia saxonica* are best shown in phosphorus; *Grammatophora* in monobromide of naphthaline or biniodide of potassium and mercury.

James' Cover-glass Cleaner.†—F. L. James's device (figs. 92 and 93) is especially convenient for cleaning and polishing extremely thin covers.

FIG. 92.

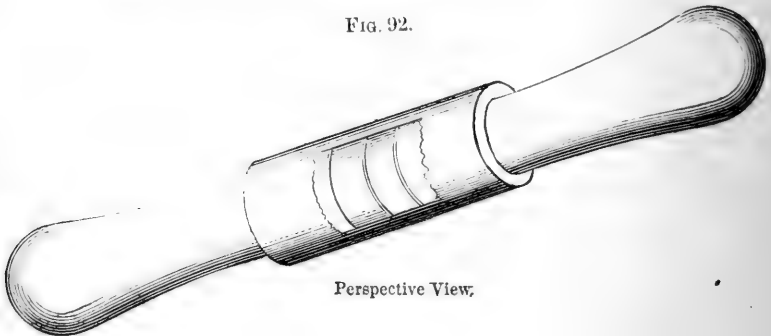

Perspective View.

FIG. 93.

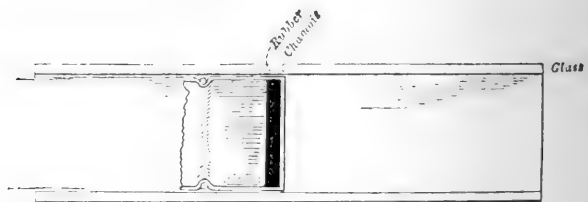

Section.

It consists of three parts: a piece of stout glass tubing, 3 in. to 5 in. long and of sufficient internal diameter ($7/8$ in.) to receive the glass to be cleaned, and two plungers of hard wood long enough to penetrate the tube half-way and leave a good hold for the hands. They

* Zeitschr. f. Wiss. Mikr., i. (1884) pp. 413-4.

† Proc. Amer. Soc. Micr., 7th Ann. Meeting, 1884, pp. 181-2 (2 figs.).

should be a little smaller than the diameter of the tubing. One end of each must be cut very smoothly and exactly at right angles with the axis. From a sheet of indiarubber, which should be at least 1/10 in. in thickness, two disks should be cut of the same size as the end of the plunger, and one attached to the smooth end of each plunger. A piece of chamois large enough to go over the rubber and be fastened to the plunger completes the apparatus. A shoulder should be cut on the end of the plunger to receive the thread or wire used to bind the chamois to its place.

The cover to be cleaned is laid on the end of one of the plungers and inserted into one end of the tube. The other plunger is inserted from the other end of the tube, and friction is made by rotating the plungers. If properly made, the full strength may be exerted on the thinnest cover-glass without breaking it.

Cole's 'Studies in Microscopical Science.'—Mr. Cole's 'Studies' are now resumed. They are divided into four sections: Botanical Histology, Animal Histology, Pathological Histology, and Popular Microscopical Studies. The contents of the first parts of each section are noted *infra*, p. 364. We need only refer to what we have already said as to the great want which these studies are so well calculated to meet, and urge microscopists to support an enterprise which, under the most favourable circumstances, must still leave the editor and publishers with little for their reward beyond the consciousness of having performed a most valuable service to biological students and workers.

Lee's Microtomists' Vade Mecum.*—No literature is more inconveniently scattered than that which deals with histological methods, and Mr. A. B. Lee is deserving of all praise for having accomplished the laborious task of collecting into a handy form for reference all the methods in actual use at the present day, or which have been recommended within recent years.

The book is divided into two parts. The first contains a collection of formulæ under the heads of fixing, staining, hardening, imbedding, cleaning agents, cements, injection-masses, &c. The second part deals with special cases, and is divided into cytological methods, embryological methods, the integument, tactile organs, retina, myelon, tissues, blood, &c., of Vertebrata, with separate chapters for the different divisions of the Invertebrata.

Nearly 700 different methods are described with great conciseness but at the same time completeness; and to make the book useful to beginners as well as advanced anatomists, a general introduction is given, with a series of introductory paragraphs to some of the chapters.

The book will be invaluable to a large class of workers as a ready means of reference, either on matters of detail or otherwise, for which there is a great want. We had to spend some time recently in the endeavour to discover what Erlicki's fluid was, a point which Mr. Lee's book would have cleared up at once.

* Lee, A. B., 'The Microtomists' Vade Mecum: A Handbook of the Methods of Microscopic Anatomy,' xvi. and 424 pp. 8vo, London, 1885.

“Working Session” of American Society of Microscopists.—A leading feature of the last (Annual) meeting of this Society was the “Working Session,” an afternoon of the week of meeting being devoted (under the direction of Mr. E. H. Griffith) to the practical exhibition and explanation of methods of manipulation and investigation, with the view to improvement in technique. Three hours were occupied, the first devoted to preparatory work, the second to finishing work, and the third to questions and discussions. Four pages of the ‘Proceedings’ contain twenty practical questions which were asked, with answers and suggestions.*

Compound Eyes and Multiple Images.†—J. D. Hyatt finds that to show multiple images in compound eyes it is best to cut out with a small punch a circular disk not larger than can be pressed flat without disturbing the facets. The most perfect eye for giving images is that of the cockroach. It is very brittle, and so only a small part of the cornea can be pressed flat in one piece. A piece large enough to fill the field of a 1/2 in. objective and B eye-piece can, however, be cut out, and the many advantages which it possesses more than counterbalance its want of superficial extent. They can be mounted in glycerin, and thus kept quite transparent without losing their properties as lenses.

The eye of a mosquito can be made to show 200 and more pictures of a person in silhouette with great distinctness. The eye of *Limulus* will also give multiple images, a small disk cut from the central part being used. Also the minute globules of water produced by breathing on a slide, and even the transparent parts of any structure which are lenticular or globular.

The fact of the image being erect or inverted may, it is suggested, be of “service in determining the character of minute bodies or structures, such as human blood-corpuscles, all of which show erect images; a proof that they are nucleated or at least lenticular at the centre. The head of the pin-shaped sponge-spicule and the nuclei in certain diatoms produce inverted images.”

Examination of Butter and Fats.‡—T. Taylor (U. S. Department of Agriculture) describes his observations on “artificial butter.” Formerly oleomargarine was easily detected, but latterly the manufacture has been so much improved as to make the task much more difficult.

In the early stages of investigation by the Microscope, it was considered that butter might be distinguished from oleomargarine by a comparison of the oil-globules of each; but it was found that this was an unreliable method. Aware of the fact that all artificial butter was made directly from crystallized fats, he then devised a method by which it could be distinguished by using Nicol prisms. Butter being destitute of free fats, the colours of polarized light would not appear.

* See Proc. Amer. Soc. Micr. 7th Ann. Meeting, 1884, pp. 199-219.

† Journ. New York Micr. Soc., i. (1885) pp. 33-7.

‡ Taylor, T., ‘Microscopic Observations. Internal Parasites in domestic Fowls and Butter and Fats.’ 8vo, Washington, 1884, 7 pp. and 1 pl.

The manufacturers of oleomargarine, however, made further improvements, and it was so free from crystals of fat that the Nicols failed to distinguish them from butter. He therefore introduced a selenite plate, the object of which was to detect fatty bodies in a homogeneous state. Although not so much as a single crystalline form may be present, all the prismatic colours are shown throughout the homogeneous mass, while pure butter exhibits under the same conditions only plain red or green. A non-microscopic test is also given by the author. A coloured plate illustrates the paper.

Polarized Light in Vegetable Histology.*—L. Dippel directs attention to a method of observation by polarized light which has afforded him much assistance in researches into the minute structure of the cell-wall.

Examined with ordinary light, a very thin transverse section of a tissue with thickened cell-walls, cut perpendicularly to its long axis, exhibits the so-called "middle-layer" of Hofmeister, Sachs, and others, in which, beyond the well-known gusset in the angles, no further differentiation is perceptible (fig. 94). Under polarized light, however, and with crossed Nicols, there is a substantial alteration in its appearance (fig. 95). The apparently homogeneous structure is traversed by a fine black line, and is thus divided into three parts.

FIG. 94.

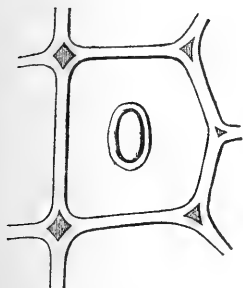
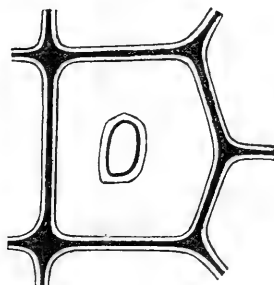

FIG. 95.



Observation with polarized light thus tells us very decisively that the "middle-layer" is not simple, but consists of three laminae, of which the central one is singly refracting, and the two lateral ones doubly refracting. The former is therefore of a different molecular structure, and even chemical constitution, from the other two. Polarized light may also be appealed to to support the results obtained by maceration and reagents, which have been questioned.

On the question of the nature of the first solid secretion-product of the living cell-body, i. e. the first wall-formation to which the "middle-layer" owes its origin, observation with polarized light also affords an explanation if applied to the cell-wall during its

* *Zeitschr. f. Wiss. Mikr.*, i. (1884) pp. 210-7 (5 figs.). Transl. in *Micr. News*, iv. (1884) pp. 291-7 (5 figs.).

development. A transverse section through the cambium-region of a conifer when observed in the darkened field proves that before the primary wall (at once manifesting itself by double-refraction) is formed out of cell-substance, an envelope singly refracting, and consequently not consisting of cell-substance, is secreted out of the protoplasm, which envelope remains during the conversion into wood or bast of the cambium-daughter-cells, and thus becomes the central plate of the "middle-layer."

As to the share to be assigned to the wall-layers in the formation of the pore-canals and the closure of the pores, Dr. Dippel confirms Hartig's view that it is the innermost layer of the cell-wall which is transformed into pore-canals, and that the closure is formed by two adjoining cells here brought together (fig. 96). The fact, as

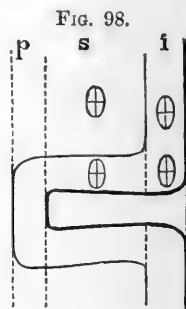
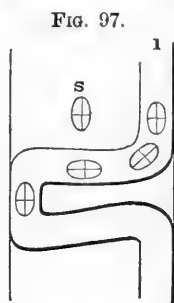
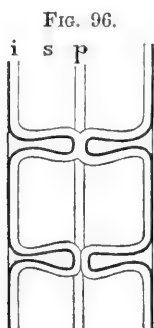

represented in the fig, is admitted by Strasburger, but another interpretation is given to it. According to him the inner layer represents a later differentiation, which arises in consequence of contact with the cell-contents; and the more strongly refracting layer, which only apparently extends from the inner plane uninterruptedly into the pore-canal, represents just such a differentiation of the secondary thickening in the parts adjoining the pore-canal, whilst the closed end of the pore is formed out of the primary walls.

Since the collective layers of the cell-wall possess the form of an ellipsoid of elasticity, which, in the transverse and longitudinal sections appears as a section of an ellipse, in which the smallest axis lies radially or perpendicularly to the stratification, and the greater axis parallel to the stratification (the transverse section yielding the least, and the longitudinal section the greatest axis), observation with polarized light must afford the most trustworthy elucidation of the course of the stratification. If the course of the inner layer is as Hartig maintains, then the sections of the ellipsoids must change in the direction as represented in fig. 97. If, on the contrary, the real structure is in accordance with the view of Strasburger, then such a change cannot take place, and the sections of the ellipsoids will be represented in fig. 98.

In proof that the former view is correct, the author adduces the

phenomena observable when a very thin section of the seed-albumen of *Phytelephas macrocarpa* is viewed by polarized light with a red selenite plate.

Extremely striking results are also given by spectrally-analysed polarized light. With a transverse section of *Pinus sylvestris*, the singly refracted cambium-wall in the parts of the section lying above the dark Müller's band appears most distinctly as a dark streak between the primary walls, which are of a brilliant green, whilst the other parts show the cambium-wall as a coloured streak between the strongly darkened, almost black, primary walls. A longitudinal section through the seed-albumen, examined in a like manner, gives similar striking results, which the author describes and which he considers to prove his theory yet more conclusively.

Direct Observation of the Movement of Water in Plants.*—G. Capus has used the following contrivance for this purpose in the case of plants with hollow stems, or filled only with a very delicate pith, such as the dahlia, artichoke, and a species of *Begonia*. A tangential cut is made on one side of the stem, reaching to the cambium; at a spot exactly opposite a small piece of the woody cylinder is cut out, and the pith carefully removed up to the spiral vessels. In this way, through a Microscope placed horizontally, a sufficiently clear view can be obtained of the vessels and of the air-bubbles contained in them. It may thus be seen that in cloudy weather, or whenever the sun is not shining directly on the plant, the vessels are injected with water; while in direct sunshine numerous air-bubbles make their appearance which gradually become larger.

Microchemical Detection of Nitrates and Nitrites in Plants.† This is possible by the reagent suggested by Wagner, viz. diphenylamin. Molisch uses a one pro mille solution in pure sulphuric acid, applying this to dry sections. If either of the salts above named is present, a deep blue coloration appears, which soon changes to brownish yellow. Brucin in about the same strength is nearly as sensitive a test, producing a transient red or reddish-yellow colour. Molisch employs this method also for approximate determination of the amounts of the salts present, and finds that the percentage decreases from below upward in the plant.

New Method for the Transfer of Sterilized Broths, and the Determination of the number of Living Germs in Water.‡—A new method has been proposed by Dr. H. Fol for preparing, sterilizing, and using nutritive fluids for the cultivation of bacteria, in water and air analyses. The following is a brief abstract of the method adopted. The original is accompanied by figures of the apparatus, and others have been supplied in a private note.

Originally engaged with Professor Dunant in the examination of the potable waters supplied, or that might be supplied to Geneva, Dr. Fol was led to adopt a plan which he considered preferable to

* Comptes Rendus, xviii. (1884) p. 1087.

† Ber. Deutsch. Bot. Gesell., i. (1883) pp. 150-5.

‡ Arch. Sci. Phys. et Nat., xi. (1884) pp. 557-74 (1 pl.).

those in use by others. The principal novelty is the method of transfer. The change that occurs in some nutritive fluids when heated to 110° C. for several hours led to the adoption of repeated heatings for shorter periods, the cold sterilization and filtration, the gelatin plan of Koch, and cultivations on solids, as boiled potatoes, &c. Dr. Fol gives the preference to sterilized beef-broth as used by Dr. Miquel, but instead of sterilizing the flasks and their contents in boiling salt-water bath or concentrated solution of chloride of sodium, or in a Papin's digester charged with water, which he considers has some advantages, he endeavours to get rid of the risks incurred in the superheating and charging of the empty superheated flasks or tubes, and to obtain a less percentage by loss.

Dr. Fol never passes the liquid into a fresh receiving vessel except by a sterilized tube made to perforate the plug closing its mouth. Carded, fine, flexible, silky asbestos is preferred for the plug, as being more easily sterilized and perforated than cotton. The decoction of beef is prepared after Dr. Miquel's formula: 1 kilogramme of lean beef to 4 litres of water, boiled five hours and skimmed from the first boiling, then cooled, the fat removed on the morrow, and the acidity neutralized by caustic soda. Dr. Fol now filters this through a paper filter into a Papin's digester, kept for one hour at 110° C., then cooled and re-filtered to remove the flaky precipitate. It now remains perfectly clear, is returned to the Papin's digester with its special arrangements, and kept at 110° C. from four to six hours, by which time a notable quantity of peptones are formed in the broth. The longer the boiling, the deeper the tint. The cover of the digester is pierced with three openings; one retains a copper tube closed beneath for holding the thermometer, a little oil being placed in the tube; the second corresponds to the valve which is loaded for a temperature between 110° and 112° C.; the third is closed by a pierced cork and screw-nut. Through the cork is pushed a tight-fitting metal tube, twice bent at right angles to form a siphon, the long leg being inside the digester. This tube is flamed before being put in position; the short outside leg is terminated by a thick, short caoutchouc tube, into the open end of which a metallic canula is fitted; this is a trochar tube, into which the steel point of the trochar cut off has been soldered, and just above it an oval aperture is made in the tube. This tube is used to pierce the asbestos plugs and to transfer the broth. The ordinary culture flasks have the neck narrowed at one part to keep the plug in position, and with it are sterilized at 200° C.

The transfer of broth is made by drawing up the long leg of the siphon above described into the vapour space in the digester; a pinch-cock that closed the caoutchouc junction is opened, and the vapour allowed to escape through the canula for ten minutes. The outer surface and point of the canula are now flamed by a Bunsen burner; then the point is placed in sterilized cotton, the pinch-cock closed, and the tube pushed down nearly close to the bottom of the digester. A little broth is now allowed to escape by the canula, and this is then plunged, the pinch-cock being shut, through the plug of

asbestos into a sterilized flask, the pinch-cock opened, and the broth allowed to enter the flask, the canula withdrawn, and other flasks filled. A sterilized cotton plug is placed above the asbestos one in the flasks, and they are set in the stove at 35° C. for proving. No failures are recorded with this plan. These standard flasks hold about $1/4$ litre, and are useful for estimating the number of germs in water by the plan that will be presently described; otherwise small experimental flasks of 10 cc. are filled directly from the digester. The necks of these small flasks are long and narrow, and for necessary precaution the top of the tube-neck is covered with sterilized asbestos, and over it is placed a tube-cap with a plug of cotton in it, the lower edge being rounded off by the flame; this is fitted over the little flask-neck, the space between the neck and cap being closed by the overlying asbestos, some being carried down the sides when the cap is fitted on. Through this top layer of asbestos, after the removal of the cap, the pointed canula can be easily passed without displacing the layer over the top of the neck-tube. When charged they are placed in the stove at 160° C., not more, for some time. This plan has answered well, but control experiments are always made at the same time.

To collect the water for analysis and to estimate the number of germs in a given volume, Dr. Fol takes a tube and places two plugs of asbestos at one end, a little distance apart; the other end is then drawn out, sealed, heated, and the tube bent twice at a right angle, bayonet fashion, the bends being some little distance from each other, like the metal part of a carpenter's drill-stock. To collect the water the plugged end is attached to a caoutchouc tube for aspiration, and the point after due flaming is broken off by sterilized pliers, either before entering or whilst beneath the water, so as not to vitiate the result by the use of another vessel. For taking deep water from the lake, the tubes are sealed at both ends, then heated, and fixed to a metal stem or support also flamed, having a movable branch or arm that can be actuated at some distance by a connected pull-wire, so as to cause rupture of the point, by which the water enters so as to partially fill the tube, then by turning the point upwards a bubble of the sterilized air inside is made to occupy the point, and this is at once sealed. This bayonet curved tube admits of manipulation without wetting the asbestos plugs, which *must be* avoided. For analysis the water is agitated in the tube, the point cut off, a few drops allowed to escape, and the estimation made of the number of germs after the method in use by Dr. Miquel, i. e. by dilution with sterilized water, to be afterwards distributed in prepared culture flasks, but instead of water it is mixed directly with the sterilized broth, and this is distributed into sterilized empty flasks.

For this a burette narrowed at each end is used of 100 cc., divided into tenths of a centimetre, and numbered so that 100 cc. corresponds exactly with the inferior orifice and 0 is at a little distance from the upper end. The burettes are sterilized in a special stove, the orifices closed by asbestos and attached caoutchouc tubes, which are previously washed with oxygenated water. For use, the

burette is fitted to an orifice in the digester and placed in a special wool-lined cradle, so that the lower end may be strongly inclined downwards; the heated vapour is allowed to traverse it for half an hour, a pinch-cock is then applied to the lower caoutchouc tube, and its open orifice closed by a short glass rod, and the upper end similarly closed by a tube plugged with asbestos and having a pinch-cock. It is then fixed to a vertical support, the glass rod at the lower end is replaced by a sterilized canula, and the upper end after removal of the glass tube is closed by sterilized asbestos; the trochar canula is then passed through the asbestos plug after removal of the top cotton plug into one of the proved standard flasks containing the broth. The lower pinch-cock is opened and the fluid runs into the burette and readily fills it; the pinch-cocks are then opened and the fluid allowed to descend to about two-tenths below zero. To charge the burette with the water, the large open end of the collecting bayonet-tube has a small caoutchouc ball fixed to it, whilst the drawn-out narrow end, after due precautions, is passed through the asbestos plug (taking care not to wet the plug), and some of the water allowed to flow out, the pinch-cocks again closed and the fluids mixed, then transferred into the small capped flasks which are then placed in the culture stove for a month. The canula in use must *always* be placed in a sterilized space or covering and *not* be heated during the transfers.

Since the above was published, Dr. Fol has made sundry alterations, such as stoppering the necks of the tubes by pushing the asbestos plug in by a short straight funnel tube, like a very short test-tube with a small hole in the bottom, this little hollow stopper being itself plugged with sterilized cotton, so that the charging by the narrow trochar canula can be more easily accomplished, and the plug remain equally effectual. Reliable results can only be obtained by employing the greatest care in the details.

Discrimination of *Bacillus lepræ* and *B. tuberculosis*.*—P. Baumgarten describes four methods of fuchsin staining by which these *Bacilli*, though nearly identical in form, may be readily distinguished. By all the processes the *B. lepræ* are stained red, while the *B. tuberculosis* are unstained.

Examining Bacteria.†—E. Thurston strongly advocates the examination of bacteria, whenever it is possible, in their natural state, so that their appearances and characteristics may be observed when they have not been subjected to the action of heat or chemical reagents. In many instances species which are undistinguishable from one another microscopically can be easily recognized by their appearance (colour, consistence, &c.) and mode of growth in cultivating media; and for this reason microscopical examination should always be combined with artificial cultivation.

* Zeitschr. f. Wiss. Mikr., i. (1884) pp. 367-71.

† Journ. Quek. Micr. Club, ii. (1885) pp. 121-4.

- ADY, J. E.—The Microscopic Study of Rocks.
 [Three figs., only, relating to previous article, *ante*, p. 161.]
Sci. Monthly, III. (1885) p. 44 (3 figs.).
- ” ” The Microscopic Study of Rocks. II.
 [Crushing rocks for their examination under the Microscope. General remarks.]
Ibid., pp. 67–70 (1 fig.).
- AMANN, J.—Sur l'emploi du Baume de Tolu pour les préparations de Diatomées.
 (On the employment of balsam of Tolu for preparations of diatoms.)
 [Supra, p. 353.] *Bull. Soc. Belg. Micr.*, XI. (1885) p. 127.
- American Society of Microscopists, the “Working Session” at Rochester meeting of. (Programme.) [Supra, p. 356.]
Proc. Amer. Soc. Micr., 7th Ann. Meeting, 1884, pp. 199–202.
 Practical questions, answers, and suggestions
 at “Working Session” of Rochester Meeting of. *Ibid.*, pp. 216–9.
- B.Sc.—A Freezing Microtome.
 [Describes the Williams. Cf. Vol. I. (1881) p. 697.]
Sci.-Gossip, 1885, pp. 37–8 (2 figs.).
- Bacteria, Culture Media for. *Amer. Mon. Micr. Journ.*, VI. (1885) pp. 55–7,
 from *Journ. Amer. Med. Assoc.*
- BEHRENS, W.—Bernsteinlack zum Verschliessen mikroskopischer Präparate.
 (Amber varnish for sealing microscopical preparations.) [Post.]
Zeitschr. f. Wiss. Mikr., II. (1885) pp. 54–7.
- BIENSTOCK, —.
 [Double staining of *Bacillus subtilis*, &c., at period of sporulation—Ehrlich's method for *B. tuberculosis* stains the spores red and the rest of the organism blue.]
Bull. Soc. Belg. Micr., XI. (1885) pp. 92–3.
- Böhm's Carmine Acetate. [Supra, p. 341.] *Amer. Natural.*, XIX. (1885) pp. 332–3,
 from *Arch. f. Anat. u. Physiol. (Anat. Abtheil.)* 1882, p. 4.
- BOOTH, M. A.—White Zinc Cement.
 [Sending slides, for which the cement was used, in proof of his commendation of it. Mr. R. Hitchcock in a note says that every slide arrived smashed to pieces, and he reiterates his objection that it is unreliable. A cement that hardens slowly will not do for many workers. Shellac enables quick and sure work to be done.]
Amer. Mon. Micr. Journ., VI. (1885) p. 39.
- BRAYLEY, E. B. L.—Mounting Insects.
 [Reference to Wilks' cell, Vol. IV. (1884) p. 477. Similar note by W. S.]
Sci.-Gossip, 1885, p. 65.
- BREARLEY, W. H.—See M'Calla, A.
- BROWNELL, J. T.—The Brownell Turn-table. [Supra, p. 350.]
Proc. Amer. Soc. Micr., 7th Ann. Meeting, 1884, pp. 173–5 (3 figs.).
- ” ” Original method of staining and mounting Pollens.
 [Supra, p. 349.] *Ibid.*, p. 212–3.
- ” ” How to make wax cells neat, permanent, and free from
 “sweating.”
 [Sheet wax marked off into 5/8 in. squares. Press a square of white wax on the slide without crushing. Add other coloured squares to the desired height. Turn out the centre with a chisel and turn-table (but leaving the bottom white layer). Turn off the outside. Cover the whole (and fasten on the cover-glass) with a thin coating of shellac varnish, leaving uncovered enough of the bottom to hold the object.]
Ibid., p. 214.
- BRUNT, C. VAN, and E. G. DAY.—Remarks on the tendency of Balsam of Tolu to crystallize. [Supra, p. 353.] *Journ. New York Micr. Soc.*, I. (1885) pp. 41–2.
- Bulloch's (W. H.) Combination Microtome. [Post.]
Amer. Mon. Micr. Journ., VI. (1885) p. 45 (1 fig.).
- Carter's (J. & Co.) Boxes of curious seeds for the Microscope.
 [12, 25, 50, and 100 varieties.]
Mill. Natural., VIII. (1885) p. 56.

COLE, A. C.—Studies in Microscopical Science.

Sec. I. Botanical Histology. Parts 1 and 2, pp. 1-8. The Comparative Morphology of Typical Reproductive Organs in the Vegetable Kingdom. (1) Conjugation. Plate I. *Mesocarpus* in Conjugation \times 200. (2) Formation of Oospores in *Vaucheria*. Plate II. *V. racemosa* \times 300.

Sec. II. Animal Histology. Parts 1-2, pp. 1-8. The Primitive Cell and its Progeny. Plate I. Cornea of Cat. Gold stained. Hor. Sec. \times 250. Plate II. Ovary of Kitten. Tr. section, stained carmine \times 75.

Sec. III. Pathological Histology. Parts 1-2, pp. 1-8. Alveolar Pneumonia. Plate I. 1st stage \times 170. Plate II. 2nd stage \times 170.

Sec. IV. Popular Microscopical Studies. Parts 1-2, pp. 1-8. Plate I. Spinneret of Spider (*Epeira diadema*) \times 70. Plate II. Foot of Garden Spider (*Epeira diadema*) \times 75.

D., E. T.—Graphic Microscopy.

XIV. Toe of Mouse, injected.

[Contains an addendum to No. 13 as to a medium for preserving *Hydrachnæ* without sacrifice of their shapeliness. Distilled water (with a trace of carbolic acid), 8 parts; pure glycerine, 1 part. The characteristic plumpness remains intact, and the ocelli, palpi, &c., are so well preserved and displayed as to bear scrutiny under the highest powers.]

XV. *Polysiphonia elongata*.

[Contains the following:—"A very simple and useful addition to the 'material' of a microscopist are pieces of ordinary glass (not too thick), $3\frac{1}{2}$ in. square; between such plates, specimens capable of being dried and flattened without injury, as portions of fronds of ferns, zoophytes, wings and parts of insects, seaweeds, and many various objects, may be temporarily stored, and thus protected from dust or fracture. The glasses are held together by strips of gummed paper bordering the edges; the advantage being they can be examined on the stage of the Microscope when it is desired to select any part for a permanent mount."]

Sci.-Gossip, 1885, pp. 25 (1 pl.), 49-50 (1 pl.).

DAY, E. G.—See C. van Brunt.

DIENELT, F.—[Advocates an American clothes-pin instead of a bullet for pressing cover down.] *Amer. Mon. Micr. Journ.*, VI. (1885) pp. 59-60.

DUFFIELD, G.—A few hints on hardening, imbedding, cutting, staining, and mounting specimens.

[Hardening by alcohol—Imbedding with celloidin—Cutting with the Schanze Microtome—Staining with picro-carmine or alum-carmine and hæmatoxylin—Mounting in Canada balsam thinned with chloroform.]

Proc. Amer. Soc. Micr., 7th Ann. Meeting, 1884, pp. 209-11.

FIELD, A. G.—Mounting Urinary Deposits.

[Glycerin and distilled water each 4 fluid drachms, chloral hydrate 5 grains, creosote 5 drops, gum camphor 2 grains. Mix, shake thoroughly, and filter. Directions for preparing the casts follow.]

Amer. Mon. Micr. Journ., VI. (1885) pp. 39-40.

FLEMMING, W.—Berichtigung. (Correction.)

[Note that the hæmatoxylin solution for nuclei, described in his "Zell-substanz, &c." as Grenacher's, is probably Prudden's.]

Zeitschr. f. Wiss. Mikr., II. (1885) pp. 57-8.

FRANCOTTE, P.—Inclusion dans la paraffine. (Imbedding in paraffin.)

[A. Apparatus for filtering paraffin, &c., *supra*, p. 343. B. Imbedding boxes (with permanent bottoms). C. Microtome, *supra*, 347.]

Bull. Soc. Belg. Micr., XI. (1885) pp. 79-86 (1 pl.).

" " Description d'instruments construits par M. Reichert de Vienne. (Description of instruments constructed by Herr Reichert of Vienna.)

[Stands, see Microscopy a. Microtomes, Vol. IV. (1884) pp. 823-4, and *supra*, p. 346. New object-clamp, *supra*, p. 347.]

Ibid., pp. 102-7 (4 pls.).

GAGE, S. H.—Serial Sections.

[Directions for making sections, preparing the slides, staining, mounting, and labelling. *Post.*]

Proc. Amer. Soc. Micr., 7th Ann. Meeting, 1884, pp. 202-8 (3 figs.).

GIERKE, H.—Färberei zu mikroskopischen Zwecken (Staining for Microscopic purposes), (continued). [*Post.*]

Zeitschr. f. Wiss. Mikr., II. (1885) pp. 13-36.

GRIFFITH, E. H.—Descriptions of the Griffith Turn-tables. [*Post.*]

Proc. Amer. Soc. Micr., 7th Ann. Meeting, 1884, pp. 165-7 (6 figs.).

The Griffith Microscopist's Working Cabinet.

" [Description of a cabinet resembling "a medium-sized bookcase and intended to be so finished that it may be placed in any room in the house as an ornamental piece of furniture as well as a thing for use." It contains the Microscope, objectives, accessories, and all mounting materials.]

Ibid., pp. 168-70.

HAILES, H. F.—Gum Styrax as a Mounting Medium.

Journ. Quek. Micr. Club, II. (1885) p. 116.

HAMLIN, F. M.—The Ideal Slide. [*Post.*]

Proc. Amer. Soc. Micr., 7th Ann. Meeting, 1884, pp. 179-80 (2 figs.).

HARDY, J. D.—Hardy's Flat Bottle.

[Correction of report of January Meeting of Royal Microscopical Society, and description of the bottle. Cf. Vol. IV. (1884) p. 977, and *ante*, p. 176.]

Engl. Mech., XL. (1885) p. 496 (1 fig.).

HATFIELD, J. J. B.—Description of Rotary Section Cutter. [*Post.*]

Proc. Amer. Soc. Micr., 7th Ann. Meeting, 1884, pp. 171-2 (2 figs.).

HAUSHOFER, K.—Mikroskopische Reactionen. (Microscopical reactions.)

SB. K. Bayer. Akad. Wiss., 1884, pp. 590-604 (3 figs.).

HELLER.—Zur Mikroskopischen Technik. (On Microscopical technics.) [*Post.*]

Zeitschr. f. Wiss. Mikr., II. (1885) pp. 47-8.

Henshalls' (W.) "Fabric" Slides.

" ["Calculated to render assistance in determining by means of the Microscope, the nature and quality of textile fabrics."]

Sci.-Gossip, 1885, p. 64.

[HITCHCOCK, R.]—Preparing Phosphorus Solution and Mounting in it.

[Remarks on A. W. Griffin's paper, Vol. IV. (1884) p. 993, and cf. *supra*, p. 353.]

Amer. Mon. Micr. Journ., VI. (1885) pp. 6-8.

" " The Study of Vegetable Fibres.

" [Gives the method as carried out in the National Museum, for the examination of fibres and for mounting specimens for microscopical study or for reference and comparison.]

Ibid., pp. 22-5.

" " See also Booth, M. A.

HÜPPE, F.—Die Methoden der Bakterien-Forschung. (The methods of investigating Bacteria.)

viii. and 174 pp., 2 pls. 8vo, Wiesbaden, 1885.

HUSSAK, E.—Anleitung zum bestimmen der gesteinbildenden mineralien. (Guide to the determination of the rock-forming minerals.)

iv. and 196 pp. and 103 figs. 8vo, Leipzig, 1885.

HYATT, J. D.—Hydrogen peroxide as a bleaching agent. [*Supra*, p. 340.]

Journ. New York Micr. Soc., I. (1885) p. 22.

" " Compound Eyes and Multiple Images. [*Supra*, p. 356.]

" *Ibid.*, pp. 33-7 (1 fig.). Cf. also p. 52 as to Leeuwenhoek being the earliest observer of the multiple images.

JAMES, F. L.—Cover-glass Cleaner. [*Supra*, p. 354.]

Proc. Amer. Soc. Micr., 7th Ann. Meeting, 1884, pp. 181-2 (2 figs.).

" " Zinc Cement again.

" ["In every instance where zinc cement disappoints its user, it is because the article is improperly made or improperly used, or both."]

The Microscope, V. (1885) pp. 65-6, from 'National Druggist.'

King's (J. D.) Microscopic Sections of the 60 species of Abietinæ of the United States.

[“So prepared by bleaching and double-staining as to show the cross-section and the whole structure of the leaf very perfectly,” .01 to .0012 in. in thickness.]

Science, V. (1885) p. 81.

KUPFFER, C.—The Preparation of Meroblastic Ova. [*Supra*, p. 340.]

Amer. Natural., XIX. (1885) p. 332,

from *Arch. f. Anat. u. Physiol. (Anat. Abtheil.)*, 1882, p. 4.

Kuy's (L.) Method of Studying Algæ.

[Suspend a glass slip in a cylinder of water and allow it to remain until covered with the growths. Cf. also *ante*, p. 146.]

Amer. Mon. Micr. Journ., VI. (1885) p. 38.

LEE, A. B.—The Microtomists' Vade Mecum. A Handbook of the Methods of Microscopic Anatomy. [*Supra*, p. 355.]

[“I desire here to make special acknowledgment of the great assistance rendered me by the Journal of the Royal Microscopical Society—in many respects the best edited periodical known to me.”]

xvi. and 424 pp. 8vo, London, 1885.

LETT, H. W.—Cloudy Mounts.

[Cloudiness arises from moisture in the tissue dispersing through the balsam in bubbles. The remedy is dehydrating in alcohol and oil of cloves. Superfluous oil of cloves is best got rid of by placing the object on note paper (not blotting paper).]

Sci.-Gossip, 1885, p. 43.

LEWIS, W. J.—Hair: Microscopically examined and medico-legally considered.

[*Post.*]

Proc. Amer. Soc. Micr., 7th Ann. Meeting, 1884, pp. 59-70 (2 pls.).

MAXSON, E. R.—The Microscopy of Life and Death.

[Paper read before the Syracuse (U.S.A.) Microscopical Society.]

Syracuse Sunday Herald, February 1st, 1885, p. 2.

McCALLA, A.—The Working Session.

[Claims to be the originator of this feature of the meetings of the American Society of Microscopists; and answers by J. O. Stillson, F. W. Taylor, W. H. Brearley, and C. M. Vorce, maintaining Mr. E. H. Griffith's claim to be the originator.]

The Microscope, V. (1885) pp. 5-7, 42-6.

MERCER, A. C.—The Syracuse Solid Watch-glass.

[Cf. Vol. IV. (1884) p. 983.]

Proc. Amer. Soc. Micr., 7th Ann. Meeting, 1884, p. 178 (1 fig.).

OSBORN, H. F.—Preparing Brains of Urodela. [*Post.*]

Amer. Natural., XIX. (1885) pp. 328-30 (1 fig.),

from *Proc. Nat. Sci. Philad.* 1883, p. 178, and 1884, p. 262, and a letter.

OWEN, D.—Clearing Fluid for Vegetable Tissues.

[When freshly cut put the tissues in alcohol for a few minutes. Then transfer them for 10 minutes to a clearing fluid of absolute alcohol and eucalyptus oil in equal parts. Then in pure eucalyptus oil to remove the alcohol. Mount in glycerin jelly.]

Sci.-Gossip, 1885, p. 43.

PIERSOL, G. A.—Staining Tissues for Photography. [*Post.*]

Amer. Mon. Micr. Journ., VI. (1885) pp. 41-2.

Rabl's (C.) Methods of studying Karyokinetic Figures. [*Supra*, p. 217.]

Amer. Natural., XIX. (1885) pp. 330-2 (1 fig.).

from *Morph. Jahrbuch*, X. (1884) pp. 214-330.

ROGERS, W. A.—On a new form of Section-cutter. [*Supra*, p. 347.]

Proc. Amer. Soc. Micr., 7th Ann. Meeting, 1884, pp. 191-3.

S., W.—See Brayley, E. B. L.

SAHLI, H.—Ueber eine neue Doppelfärbung des centralen Nervensystems. (On a new double stain for the central nervous system.) [*Post.*]

Zeitschr. f. Wiss. Mikr., II. (1885) pp. 1-7 (1 pl.).

- SAHLI, H.—Ueber die Anwendung von Boraxmethyleneblau für die Untersuchung der centralen Nervensystems und für den Nachweis von Mikroorganismen, speciell zur bacteriologischen Untersuchung der nervösen Centralorgane. (On the use of Borax-methyl-blue for the central nervous system and for the detection of micro-organisms, especially for the bacteriological investigation of the central nervous organs.) [*Post.*]
Zeitschr. f. Wiss. Mikr., II. (1885) pp. 49–51.
- Salmon's Culture-tubes.—See Sternberg's.
- SCHIEFFERDECKER, P.—Mittheilung, betreffend das von mir verwandte Aniligrün. (Note on the anilin green used by me.) [*Post.*]
Zeitschr. f. Wiss. Mikr., II. (1885) pp. 51–3.
- SLACK, H. J.—Pleasant Hours with the Microscope.
[“Brief account of the progress lately made in the discovery of diseasegerms and in their modification so as to render them promoters of safety instead of agents of destruction.”]
Knowledge, VII. (1885) pp. 143–4 (9 figs.).
” ” ” ” [Stomata.]
” ” ” ” *Ibid.*, pp. 190–1 (1 fig.).
” ” ” ” [Seeds.]
” ” ” ” *Ibid.*, pp. 232–3 (2 figs.).
- SMITH, H. L.—A new Mounting Medium. [*Supra*, p. 352.]
Proc. Amer. Soc. Micr., 7th Ann. Meeting, 1884, pp. 186–90.
Cf. also *Amer. Mon. Micr. Journ.*, VI. (1885) p. 38.
- SPEE, F.—Leichtes Verfahren zur Erhaltung linear geordneter, lückenloser Schnittserien mit Hülfe von Schnittbändern. (Simple process for obtaining linear, successive series-sections by section-ribbons.) [*Post.*]
Zeitschr. f. Wiss. Mikr., II. (1885) pp. 7–12.
- [Sternberg's & Salmon's] Culture-tubes for Micro-organisms.
[Gives drawings of both, and statement by Dr. Salmon of the advantages of his tube.]
Amer. Mon. Micr. Journ., VI. (1885) pp. 1–2 (2 figs.).
- STIEDA, L.—Ueber die Verwendung des Glycerins zur Anfertigung von anatomischen Dauerpräparaten. (On the use of glycerin for anatomical permanent preparations.)
[Described in its application to macroscopic preparations.]
Arch. f. Anat. u. Physiol. (His and Braune) 1885, pp. 112–9.
- STILLSON, J. O.—See M'Calla, A.
- STOWELL, C. H.—A Microscopic Geissler Tube with Fluorescent Solution.
[By Dr. A. Y. Moore—1/50 in. in diameter by 1/2 in. in length. Platinum wires are soldered into the ends, and the tube contains rarefied air. Around the tube is a fluorescent solution. Mounted in a wooden slide 3 × 1 × 3/8 in. “It is the very latest and handsomest production brought before the Microscope world.”]
The Microscope, V. (1885) p. 41.
See also *Journ. New York Micr. Soc.*, I. (1885) p. 26.
- TAYLOR, F. W.—See M'Calla, A.
- THURSTON, E.—On Bacteria and the methods of staining them.
[First demonstration of the 3rd series. Cf. *supra*, p. 362.]
Journ. Quek. Micr. Club, II. (1885) pp. 121–4.
- VORCE, C. M.—See M'Calla, A.
- WALLER, T. H.—Presidential Address delivered March 4th, 1884.
[“A sketch of some of the subjects relating to geology which have given an interest to the past year . . . confined to points which have a bearing on the chemical and microscopic side of the science.”]
Rep. and Trans. Birm. Nat. Hist. and Micr. Soc. for 1883, pp. i.–xviii.
- WHITNEY, J. E.—Cheap Punches for Sheet Wax.
[“Get a set of brass ferules, and with a round file bevel the large end to a cutting edge, which is easily done, and you will then have a set of punches adapted to making wax rings of sizes corresponding to all the ordinary sizes of cover-glass.”]
Proc. Amer. Soc. Micr., 7th Ann. Meeting, 1884, p. 215.

PROCEEDINGS OF THE SOCIETY.

ANNUAL MEETING OF 11TH FEBRUARY, 1885, AT KING'S COLLEGE,
STRAND, W.C., THE PRESIDENT (THE REV. DR. DALLINGER, F.R.S.)
IN THE CHAIR.

The Minutes of the meeting of 14th January last were read and confirmed, and were signed by the President.

The List of Donations (exclusive of exchanges and reprints) received since the last meeting was submitted, and the thanks of the Society given to the donors.

	From
Stein, S. T.—Das Mikroskop und die mikrographische Technik zum Zwecke photographischer Darstellung. 2nd ed., pp. i.-ix. and 151-322, pls. iii.-vi. and figs. 168-302. 8vo, Halle a. S., 1884	<i>The Author.</i>
Photographs of Diatoms	<i>Dr. J. D. Cox.</i>

Mr. Stephenson exhibited his new Cata-dioptic Illuminator, which gives an aperture within a small percentage of the refractive index of the glass used. It thus represents approximately the maximum aperture obtainable with any form of illuminator. The reading of Mr. Stephenson's paper was deferred to the March meeting (*supra*, p. 207).

Dr. J. D. Cox's further photographs of diatoms were exhibited, and the reading of his accompanying paper ("Structure of the Diatom Shell. Siliceous Films too thin to show a broken edge") was also deferred to the March meeting.

Mr. E. M. Nelson exhibited one of the lowest priced forms of Leitz's Microscopes, to which he had fitted a simple condenser consisting of a meniscus and double-convex lens, which rendered the instrument very complete whilst adding but little to its cost (*supra*, p. 327).

Messrs. Parkes' 1/16 in. glycerin immersion objective of very moderate price was exhibited, and Mr. Crisp remarked upon the use of glycerin for immersion and the superior advantages which were possessed by oil.

Mr. Suffolk exhibited the proboscis from a blow-fly which was preserved in glycerin in 1868. It was now mounted in biniodide of mercury and showed the structure of the pseudo-tracheæ referred to in Dr. Anthony's letter *ante*, p. 174.

Dr. Maddox exhibited some specimens of Dr. Miquel's improved nutritive lichenized paper for the registration and cultivation of

atmospheric and other bacteria (*ante*, p. 111), and gave the following particulars of the method used to colour the organisms after incubation.

The sterilized nutritive paper charged with the lichen jelly is, after use, placed in the incubator for the cultivation of the microbes. It is afterwards put into a saturated solution of alum for five minutes, then washed and placed in a bath of sulphate of indigo (2 grammes to one litre of water) for 30 seconds, again washed and put into a bath of permanganate of potash (2 grammes to 1000 of water) for 30-60 seconds. The paper, now of a rose colour, is washed and immersed for half a minute in a 3 per cent. solution of oxalic acid by which the paper becomes bleached, while the organisms are shown of a very distinctly blue colour.

The Report of the Council was read (*infra*, p. 372).

Dr. Carpenter, C.B., said that he had very great pleasure in moving the adoption of the Report, which could not but be considered by all as most satisfactory from every point of view. As regarded the Journal, their thanks were again due to Mr. Crisp for carrying it on in the way to which allusion had been made, and they would all, he felt sure, be pleased to learn that there was a prospect of it being entirely self-supporting after 1887. The great progress made by the Society, as shown in the Council's Report, must be a source of much congratulation to every Fellow of the Society.

Mr. Cheshire seconded the adoption of the Report.

The President then put the motion to the meeting and declared it to be carried unanimously.

The List of Fellows proposed as the Council for the ensuing year was read as follows:—

President—Rev. W. H. Dallinger, LL.D., F.R.S.

Vice-Presidents—John Anthony, M.D., F.R.C.P.L.; *G. F. Dowdeswell, M.A.; Prof. P. Martin Duncan, M.B., F.R.S.; *Albert D. Michael, F.L.S.

Treasurer—Lionel S. Beale, M.B., F.R.C.P., F.R.S.

Secretaries—Frank Crisp, LL.B., B.A., V.P. and Treas. L.S.; Prof. F. Jeffrey Bell, M.A., F.Z.S.

Twelve other Members of Council—*Joseph Beck, F.R.A.S.; A. W. Bennett, M.B., B.Sc., F.L.S.; Robert Braithwaite, M.D., M.R.C.S., F.L.S.; *James Glaisher, F.R.S., F.R.A.S.; J. William Groves; John Matthews, M.D.; John Mayall, Jun., F.Z.S.; John Millar, L.R.C.P., F.L.S.; Urban Pritchard, M.D.; *Stuart O. Ridley, M.A., F.L.S.; *Prof. Charles Stewart, M.R.C.S., F.L.S.; William Thomas Suffolk.

The President having appointed Mr. Cheshire and Mr. F. H. Ward Scrutineers, the ballot was proceeded with, and the above-named Fellows were declared by the President to be duly elected.

* Have not held during the preceding year the office for which they are nominated.

The Treasurer (Dr. Beale, F.R.S.) read his Statement of the Income and Expenditure of the Society for 1884 (*infra*, p. 373).

Dr. Millar moved, and Mr. Dowdeswell seconded, the adoption of the Statement, which was carried unanimously.

The President then read his Address (*supra*, p. 177), in which he dealt with the life-history of a septic organism hitherto unrecorded. The Address was illustrated by transparencies (thrown on a screen by Messrs. How) and was listened to with marked attention by the largest audience present at an Annual Meeting, at any rate for many years.

Dr. Carpenter, C.B., said that the pleasing duty had been assigned to him of moving a vote of thanks to their excellent and highly esteemed President for the very admirable and interesting address to which they had just listened. He began, as they were aware, by giving them a summary of the doctrines of abiogenesis and biogenesis, but there was one omission in his remarks, due no doubt to his modesty, but which ought not to be omitted, and that was that there was no class of facts which had contributed so much to the settlement of some of these important questions as the researches which their President himself had made. They would no doubt remember that the great supporter of abiogenesis, Dr. Bastian, relied upon the appearance of organisms in flasks which had been exposed to high temperatures, but Dr. Dallinger had shown that though the organisms might be destroyed the spores could still exist under these conditions. He quite agreed that the two sides of the question—pathogenic and morphological—should be studied separately, and that the observations in the latter case should be carried out in the way adopted by the President, by isolating and keeping the object continuously under observation until its whole life-history had been ascertained. But the pathogenic aspect was also of great importance and must be worked out with similar care. Dr. Roberts, of Manchester, who was not only a very careful observer, but also a man of very large experience in diseases, wrote a paper some time ago entirely on Darwinian lines, and he there took some very striking examples—such as the production of the bitter almond from the sweet almond, the one being perfectly wholesome, but the other containing a powerful poison. He had himself always maintained that in the study of species it was necessary to consider the intermediate as well as the complete forms, and had carried this out with great advantage in the case of the *Orbitolites* thirty years ago. Just so he believed the study of the intermediate forms of disease to be necessary. A short time ago he wrote a paper bearing on this subject in the 'Nineteenth Century,' and since then he had received a great number of letters in which many instances had been adduced showing that there were intermediate stages of disease. He desired most heartily to congratulate the Society and also the President upon the admirable and successful work which he had described to them, and upon the completeness of the life-history which he had been able to give them as the results of work, moreover, which

extended over a period of four years. As was well known, he (Dr. Carpenter) had always spoken strongly of the value of thorough and continuous work on one subject. There was a great deal of good microscopical power running to waste, for the simple reason that the owners of the instruments gave themselves up to a kind of dilettante study instead of concentrating their attention. Their President had shown them what was the value of close continuous work, and no better encouragement could be given to the younger members of the Society than was afforded by such an excellent example. He had therefore great pleasure in moving that the best thanks of the Society be given to the President for his admirable address.

Mr. Crisp said he should be glad to be allowed to second the motion, if only to take the opportunity of referring to the way in which Dr. Dallinger had carried out the duties of his presidency during the past year. When his name was first mentioned in connection with the office it was assumed by some that as he lived so far away he would not often attend the meetings. Those who made that assumption did not know Dr. Dallinger. In fact he had attended every meeting since his election, which was more than could be said of any other President within his recollection. The Fellows were not, however, aware at what sacrifice this had been done. The President was accustomed, as on the present occasion, to come up from Sheffield late in the afternoon of the day of meeting, returning the next morning by a train which necessitated his rising shortly after 4 A.M. The President's co-operation had also been available on all other occasions when it had been necessary to refer to him. He was sure they would all agree that in Dr. Dallinger they had a President who was unsurpassed in the zeal which he brought to the performance of the duties of his office.

Dr. Carpenter then put the motion to the meeting, and it was carried by acclamation.

The President said he felt extremely obliged to the Fellows for the attention which they had given to his address, and for the manner in which they had responded to the vote of thanks which had been so kindly proposed and seconded. He could only say that when they elected him to the position he occupied he felt that they did him so much honour that it imposed upon him the obligation of giving the fullest attention to the interests of the Society which lay in his power.

The President proposed a vote of thanks to the Auditors and Scrutineers, which was seconded by Mr. Beck and carried.

The following Instruments, Apparatus, &c., were exhibited:—

Mr. Bolton:—Vorticellidæ and Rotifera.

Dr. J. D. Cox:—Photographs of Diatoms.

Mr. Crisp:—(1) Baumann's Calliper Microscope with fixed Micrometer; (2) Sohcnke's Microscope for observing Newton's Rings.

Dr. Maddox:—Dr. Miquel's improved nutritive lichenized paper.

Mr. E. M. Nelson:—Leitz Microscope with simple condenser.

Messrs. Parkes:—1/16 in. Glycerin Immersion Objective.

Mr. Stephenson:—New Cata-dioptic Illuminator.

Mr. Suffolk:—Proboscis of Blow-fly mounted in biniodide of mercury, showing the structure of the pseudo-tracheæ.

Mr. Tarn:—Swift's Cone Condenser, made in January 1883.

New Fellows:—The following were elected *Ordinary Fellows*:—Messrs. J. Farrow Ballard, F.C.S., A. Swayne Underwood, L.D.S., M.R.C.S., J. Edward Line, D.D.S., and Ernest B. Stuart.

REPORT OF THE COUNCIL FOR 1884.

Fellows.—During the year 52 Ordinary Fellows were elected and 22 died or resigned, making an increase of 30 as against 25 in 1883, and an addition to revenue of 49*l.* 7*s.* per annum. Amongst the elections were those of 4 Lady Fellows, the first elected under the new bye-law, one of them being the joint editor of a microscopical journal well known in America and this country.

The following tabular statement shows the number of Fellows elected in the six years since 1878 and those elected in the preceding six years.

	1873.	1874.	1875.	1876.	1877.	1878.	Total.
Fellows elected	12	17	13	14	20	21	97
	1879.	1880.	1881.	1882.	1883.	1884.	Total.
Fellows elected	58	47	51	40	53	52	301

One Honorary Fellow died during 1884, viz. Dr. J. J. Woodward, whose photo-micrographs obtained such a world-wide reputation. The vacancy was filled by the election of Prof. W. Kitchen Parker, F.R.S., a Past-President of the Society. Since the close of the year biological science has had to deplore the death of Dr. F. Ritter v. Stein, the author of the unfinished 'Organismus der Infusionsthier,' and the Council have approved the nomination as an Honorary Fellow of Dr. J. H. Flögel, some of whose laborious and elaborate researches on the structure of diatoms have recently been published by the Society.

The list of Fellows now includes 581 Ordinary, 50 Honorary, and 83 Ex-officio Fellows, or 714 in all.

Finances.—The Treasurer's accounts continue to show a most satisfactory condition of the Society's finances. 700*l.* 13*s.* 7*d.* was collected during the year for annual subscriptions alone, being 167*l.* 1*s.* 11*d.* in excess of the average of the last six years.

The Council have resolved to make a donation of 100*l.* to the Marine Biological Association of the United Kingdom, believing that in so doing they will be promoting the advancement of a branch of science in which the Society is largely interested, but which has been unfortunately too much neglected in this country.

This sum will be paid out of the invested funds (as was done in the case of the 100*l.* voted to Mr. Reeves), and the Council do not propose to replace it from income, the investments still being considerably in excess of the compositions received from compounding Fellows.

The Council have also voted 5*l.* 5*s.* to the Memorial now being raised in America to the late R. B. Tolles, one of the earliest to appreciate not merely the theoretical but the practical bearing of the immersion system, in allowing of the increase of the aperture of an objective beyond that of a dry objective of 180°, which it was so long supposed to be impossible to exceed.

The revised scale of subscription for Foreign Fellows comes into force at the commencement of 1885, but as some misapprehension seems to exist on the subject, it may be pointed out that it only applies to elections subsequent to the last December meeting, the Society having no power to increase the subscriptions of Foreign Fellows already elected, though it is of course open to any to adopt the revised scale voluntarily. A payment of 1*l.* 11*s.* 6*d.* per annum will still entitle a Foreign Fellow within the Postal Union to receive the publications of the Society post free, representing an equivalent of 32*s.*

Library and Cabinet.—The Council anticipate being able to arrange for the circulation of the books at the commencement of the next session.

The Cabinet of Objects is being thoroughly examined by a committee, consisting of Dr. J. Anthony, Mr. G. F. Dowdeswell, Mr. J. W. Groves, Mr. A. D. Michael, Prof. C. Stewart, and Mr. W. T. Suffolk, who were appointed under the following resolution proposed by Dr. Anthony and accepted by the Council:—

“That a Museum Committee be constituted consisting of six members to examine and report to the Meeting of Council in October next, on the condition of the preparations in the possession of the Society, and as to the best mode of classifying and arranging and making accessible to the Fellows all or such of the preparations as may be worth keeping. And with a view to the future interest and importance of the Cabinet to consider the following proposal:—That while presentations of special slides by the Fellows in illustration of papers, or gifts of choice collections of objects would always be acceptable, preparers of, or dealers in microscopic objects should be invited to forward from time to time to the care of the Librarian, preparations of interest, which can be examined by the Fellows under proper regulations, it being understood that purchases would be made therefrom (and from other home and foreign sources) of such objects as might seem desirable.”

The Committee have not yet been able to complete their report,

but satisfactory progress has been made with the examination of the slides.

Journal.—Mr. Crisp has agreed with the Council to continue his arrangement for the issue of the Journal to the end of the year 1887. As it is known to many of the Fellows that the Journal entails upon Mr. Crisp an annual though progressively decreasing expenditure, the Council think it right to state that it is at his own express desire that the existing arrangement has been continued. The increase in the sales and in the number of Fellows elected (which the Council cannot but regard as due in a great measure to the enlarged activity of the Society since the Journal was commenced), justify the expectation which Mr. Crisp has from the first entertained, that by the end of 1887, when the Journal will have been in existence ten years, it will be wholly supported by the amount contributed by the Society and received through the publishers.

It is constantly urged that changes should be made in the classification of the Summary, but the Council have always considered it undesirable that on this question the Journal should be in advance. A few minor changes have been accepted for the new volume. These comprise in Zoology the subdivision of the Molluscoida into *a.* Tunicata, *β.* Polyzoa, and *γ.* Brachiopoda, and the establishment of a new subdivision of the Arthropoda—Prototracheata—to receive *Peripatus*, hitherto placed with the Myriopoda. In Botany the "General" division has been subdivided into Anatomy and Physiology, and the Bacteria and allied forms have been removed from their position amongst the Fungi to a new division of Protophyta, the position of Algæ and Fungi being also interchanged.

Mr. F. E. Beddard, the Prosector of the Zoological Society, has kindly given the benefit of his services as Associate Editor, as also Mr. B. B. Woodward, of the Natural History Museum. The Council have expressed to Mr. S. O. Ridley their regret at his enforced retirement through ill-health, and their thanks for the assistance he has rendered during the five years he has occupied the position of an Associate Editor.

The number of copies of the Journal printed has been necessarily increased during the year to supply the additional sales, and one of the parts of the 1st Series which has been long out of print is reprinting. To meet the cost of the reprint the Council have decided to offer twenty-five sets of the 1st Series to Fellows at the reduced price of 2*l.* 12*s.* 6*d.* After the first twenty-five applications have been met, the price will be as heretofore 3*l.* 18*s.* 9*d.* to Fellows.

Meetings, &c.—The Ordinary Meetings during the session have been well attended and the subjects brought forward have been varied and interesting. The Council have arranged that abridged reports of the meetings shall appear regularly in the 'Athenæum' and 'Nature,' and it may be noted that the editor of the 'English Mechanic' habitually reports the meetings *in extenso*, so that absent Fellows have an opportunity of ascertaining without delay and at a small cost what has taken place at each meeting.

In addition to the election of Lady Fellows, the other important

event of the past year was the attendance of a deputation at the meeting of the American Society of Microscopists at Rochester, N.Y. The friendly and cordial reception of the deputation was warmly acknowledged by the Society at their October meeting, and leaves nothing to be said here beyond formally placing on record in this Report, the gratification with which all classes of the Fellows have regarded the fraternal greeting given to the Society by their American fellow-workers.

MEETING OF 11TH MARCH, 1885, AT KING'S COLLEGE, STRAND, W.C.,
THE PRESIDENT (THE REV. DR. DALLINGER, F.R.S.) IN THE CHAIR.

The Minutes of the meeting of 11th February last were read and confirmed, and were signed by the President.

The List of Donations (exclusive of exchanges and reprints) received since the last meeting was submitted, and the thanks of the Society given to the donors.

6 Slides :—Head of Honey Bee— <i>A. mellifica</i> (1 slide Queen, 1 Worker, and 1 Drone); Head of Ground Bee— <i>Panurgus</i> <i>Banksianus</i> ; Head of Wild Bee— <i>Andrena fulva</i> ; and Head of Wasp— <i>Vespa vulgaris</i>	From <i>Mr. F. Enock.</i>
3 Slides of Diatoms mounted in Balsam of Tolu	<i>Mr. F. Kitton.</i>
Hardy's Collecting Bottle with Improved Stopper	<i>Mr. Curties.</i>

Mr. Crisp said that, while it was not usual to look too closely at a donation, it was necessary to warn microscopists against the use of Mr. Curties' so-called improvement, which consisted in substituting for the original indiarubber stopper a rectangular one of glass, which was greased in order to make it water-tight. The nuisance in the field of a collecting bottle with a greased stopper was sufficiently obvious.

Mr. Hardy disclaimed any responsibility for the change that had been made.

Mr. Crisp exhibited (1) Winkel's Class Microscope with movable stage, (2) Tolles' Clinical Microscope, (3) Klönne and Müller's Portable Microscope, and (4) Swift's Microscope for Examination of Disease in Skin of Sheep, and having a very long working distance, (5) Griffith's and Bertrand's Objective Adapters, and (6) a new form of "Finder."

Mr. H. G. Madan exhibited some new kinds of glass, having found that a combination of ordinary blue glass with a peculiar bluish-green glass, known as "signal-green" glass, was much more convenient than the usual glass cell filled with solution of cuprammonium sulphate (*supra*, p. 327).

Mr. Baker exhibited some object-boxes in book form for placing on a shelf with books, the objects then lying flat.

Dr. C. V. Zenger's letter was read, describing a new mounting medium, consisting of tribromide of arsenic in bisulphide of carbon, and giving a refractive index of from 1.6696 to 1.7082. An improved slide for viewing the object on both sides was also described.

Mr. C. H. Hughes' description was read of a stage for use with high powers, to prevent the decentering of the condenser, especially when used with immersion contact. Vertical, horizontal, and oblique motions are given to the slide while the stage remains stationary, but can be rotated.

Mr. J. Mayall, jun., described the original ruling machine of the late Herr F. A. Nobert (now the property of Mr. Crisp), which was exhibited to the meeting. He said he should not enter minutely into the details of the construction, as they could hardly be understood without a close inspection of the machine, many portions of which were too delicate and complex to be handed round to the meeting. The foundation of the machine was a dividing engine calculated to produce parallel divisions far finer than could be marked by any ruling point yet discovered. The division-plate had 20 circles of "dots," and these were supplemented by extremely fine graduations on two bands of silver imbedded near the edge, which were viewed by means of two compound Microscopes, each provided with eye-piece screw-micrometers of special construction. The movement of rotation was effected by a fine tangent screw acting upon a worm on the vertical edge of the division-plate. The tangent screw was controlled by a large milled head about 4 in. in diameter, and a graduated drum showed the amount of motion. The method employed by Herr Nobert for obtaining the minute divisions of his test-plates (ranging from 1/1000 to 1/20,000 of a Paris line) was to convert the radius of the division-plate into a lever to move the glass plate on which the rulings were made at right angles to the motion of the ruling point. For this purpose, he attached to the centre of the rotating division-plate a bent arm on which slid a bar of silver, having at one end a finely-polished steel point which could be adjusted by a scale and vernier so as to project more or less beyond the centre of the division-plate or axis of rotation. The radius of the division-plate thus became the long arm of the lever, whilst the radius of the projection of the polished steel point beyond the axis of rotation formed the short arm, the centre of the division-plate being the fulcrum. The motion of the short arm of the lever was communicated by contact with an agate plate to a polished steel cylinder adjusted to slide at right angles to the movement of the ruling point in V-shaped bearings of agate. The steel cylinder carried a circular metal table on which the glass plate to be ruled was fixed by wax and clamps. The motion of the lever arms was, of course, in arc, and hence the divisions would not be strictly equidistant unless compensation were made for the difference in length of the arc and its sine; but since the actual space included between the first and last lines of Herr Nobert's test-

plates hardly exceeded $1/50$ in., this difference would be inappreciable.

The arrangement for carrying the diamond point was, he believed, wholly designed by Herr Nobert, and was a most ingenious combination of mechanism, combining inventiveness and efficiency. The questions to be solved were (1) To provide means to adjust a diamond edge to any angle (within required limits); (2) to balance it truly so that the weight-pressure for ruling might be perfectly controlled; (3) to raise and lower it strictly in one plane—that is to say, mechanically free from lateral play, so that the consecutive divisions of the ruling depended solely on the motion imparted to the glass plate by the dividing engine; (4) to cause the diamond to oscillate freely in one plane; (5) to control the length of the lines to be ruled; (6) to connect the whole with mechanism to ensure an even rate of speed in the ruling movement of the diamond. These matters had been worked out by Herr Nobert with extraordinary perseverance, as evidenced by the elaboration of the adjustments. From the point of view of so accomplished a mechanician as Dr. Hugo Schröder—to whom he (Mr. Mayall) must publicly express his obligations for explanations connected with the machine—the design of this portion of the machine might be much simplified without loss of accuracy or delicacy of action. In particular Dr. Schröder noted that the whole of the movements might be made to act automatically, whereas Herr Nobert went through the process of adjusting the dividing engine and winding up the train of wheels for each line ruled on his test-plates—a labour demanding prodigious patience. It should be observed, however, that Herr Nobert had always to work with very limited means. The success of his efforts must be estimated by those who were familiar with his ruled plates, and who had compared them with others.

For the production of diffraction gratings and ordinary micrometers, where the equidistance of the lines was an essential factor, and where the breadth of space covered by the lines was so large that the lever motion in arc of the dividing engine would have introduced errors in the evenness of the division, Herr Nobert removed the bent arm from the centre of the division-plate and substituted a vertical cylinder, on which he coiled an extremely thin flat steel spring having a hook at the free end; this hook was attached to a stud beneath a straight cylinder of polished steel, which carried the glass plate to be ruled under the diamond, and which took the place of the more delicate arrangement for the test-plates. The rotation of the division-plate caused the vertical cylinder in the centre to rotate, coiling the steel spring, and thus, after the manner of a windlass, hauled along the diffraction-plate carrier at right angles to the ruling motion of the diamond. Presumably Herr Nobert used the stud and “dots” of the division-plate to divide the diffraction plates and micrometers, for the verification of 12,000 consecutive divisions (of which some of his diffraction gratings consisted) by means of the Microscope, would have been too much for even his patience.

Mr. Mayall then referred briefly to the preparation of the glass plates for the rulings, which he said were of specially “mild” composition.

He believed that Herr Nobert's earlier rulings were upon artificially prepared surfaces on the slips themselves, and that later on (about 1860) he came to the conclusion that the melted surface of cover-glass was better for his test-plates. Subsequently Dr. Schröder instructed him in a method of polishing the "mild" glass, which induced him to revert to artificial surfaces again. The later test-plates were probably all ruled on the prepared "mild" glass, thinned down to suit high-power objectives. Mr. Mayall said he must defer his remarks on the diamond points till the next meeting, now mentioning only that the ten diamonds that accompanied the machine presented varieties of preparation. Some had two worked surfaces brought to a knife edge; others one worked surface and one surface of fracture meeting in a knife edge; others had two surfaces of fracture meeting in a knife edge. By reference to Herr Nobert's memorandum book, Mr. Mayall said he hoped to be able to explain the character of the diamonds which were noted as being successful. In conclusion, Mr. Mayall said it was abundantly proved by Herr Nobert's work that the perfection of the mechanical part of the dividing engine was not the only difficulty which he had understood and conquered. There was a still greater difficulty which he had understood, and which he had met with a success that gave him pre-eminence in this department of micro-physics, and that was the preparation of the diamond ruling points.

The President expressed the thanks of the meeting to Mr. Mayall for his description of a machine which exhibited such an immense amount of commendable ingenuity in its construction. He thought it must be a source of gratification to the Society to know that as the machine now belonged to Mr. Crisp, they might hope at some future time to hear more about it, and to see something of its performances.

Mr. Crisp said that Mr. Mayall had kindly undertaken to describe and illustrate the machine in a future number of the Journal.

Mr. Beck said that a paper upon this machine, giving all the details of its construction with illustrations, would be extremely interesting, and he hoped that Mr. Mayall would not only describe its perfections, but would also point out all its weak points, which were sometimes even more interesting and instructive, as showing the manner in which the inventor had been able by practice to overcome them. He remembered that many years ago the micrometer ruling machine by Mr. Jackson produced in his hands some of the best work of its kind that had then been seen; but when after his death it passed into other hands, some of the worst productions resulted. Mr. Jackson had, no doubt, found out all its weak points, and had overcome them by the exercise of his own manipulative skill; and it would be very interesting to know how Nobert had got over all his difficulties, so as to be able to produce bands of lines which stood altogether unrivalled.

Dr. Matthews inquired if there was any provision made for dropping the point upon the plate on commencing a line?

Mr. Mayall said this seemed to be one of the weak points of the machine, for it would be seen, on examination of the test-plates, that there was frequently a small fracture at the beginning of a line, and

that at the end of it there was a slight hook-shaped irregularity. A very delicate arrangement had been devised for causing the point to be lifted automatically; but the shock produced by the sudden arrest of motion was translated on the end of each line by a hook.

Mr. C. Beck exhibited a modification of the "Complete" lamp, fitted with a shallow glass reservoir instead of the original one of metal. It was thought this alteration would tend to prevent condensation or "sweating" of the paraffin upon the surface. He also exhibited a "Vertical Illuminator," with a new form of diaphragm.

Dr. Van Heurck's note was read sending a copy of Prof. Abbe's opinion on the photographs of the "beads" of *Amphipleura pellucida*, in which he stated that he had no reason to doubt the reality of the beads.

Mr. Crisp said that Prof. Hamilton Smith, who had had no little experience on this question, was stated to doubt the reality of any beaded structure in *A. pellucida*, asserting that he can at any time show the beaded appearance, "which is purely an illusion, and is visible even with a 1/4 in. objective," and that the diatoms coated with silver, prepared by Dr. A. Y. Moore, have "failed to show any peculiarity of marking in the hands of other competent observers."* There was also a very curious misapprehension in connection with this diatom discussion. Dr. Flögel, it would be remembered, inveighed somewhat strongly against Prof. Abbe's theory, which he considered to be antagonistic to his researches. The fact was, however, that Prof. Abbe had always considered Dr. Flögel's methods of investigation as the only proper and rational ones in regard to diatom striae, and his own theoretical views strongly confirmed this.

Dr. J. D. Cox's note was read as to actinic and visual foci (*supra*, p. 331).

Mr. Kitton's remarks in commendation of Balsam of Tolu were read (*supra*, p. 352).

Mr. Kitton also recorded the finding by Mr. E. Grove of a species of the beautiful genus *Asteromphalus* (*A. flabellatus*) in the stomach contents of Ascidians collected on the Teignmouth coast. Perfect frustules were frequently observed, which seemed to indicate that the diatom had been recently living in that locality. It was associated with numerous other forms.

The Circular of the Treasurer of the American Society of Microscopists inviting subscriptions to the Tolles Memorial Fund was read. The Circular contained the following paragraph:—

"In this connection it affords me great pleasure to announce to

* See *Amcr. Mon. Micr. Journ.*, vi. (1885) p. 32.

the members of the Society that I have in my possession a communication forwarded to the Secretary, Prof. D. S. Kellicott, from the Royal Microscopical Society, bearing date December 17th, 1884, with an enclosed cheque for five guineas, as the first donation to the Robert B. Tolles Memorial Fund. That this evidence of appreciation of the labours of Mr. Tolles, and of the work in which the American Society is engaged, on the part of the Royal Society, will be keenly appreciated by the members of this Society, and give an impetus to the subscriptions to the funds referred to above, there can be no question."

Mr. G. D. Brown's letter was read as follows:—"In the current number of the Journal, in a review of Mr. Busk's 'Report on the 'Challenger' Polyzoa,' it is stated that the use of the chitinous element as an aid in the classification and descriptive geology of the Polyzoa is entirely due to Mr. Busk. Allow me to call attention to Mr. Busk's first mention of the subject—viz. in the Journal of the Linnean Society, Zoology, vol. xv. (1881) p. 357. In this paper he adopts and develops the facts corroborating the opinion of the importance of these organs in this connection; but he himself states that he is indebted for the suggestion to a paper by Mr. A. W. Waters in the Proceedings of the Literary and Philosophical Association of Manchester, 1878."

Mr. Crisp said that undoubtedly Mr. Waters should have the credit of priority as acknowledged by Mr. Busk. The review in question, however, was written by so eminent an authority (Prof. Allman) that it had been printed without the thought that any correction could be required.

Dr. Ord exhibited and described some objects illustrating the erosion of the surface of glass when exposed to the action of carbonate of lime and a colloid. From experiments made by Mr. George Rainy, it seemed that when lime was deposited upon glass in the presence of a colloid, the globule it formed adhered so firmly as to require removal by means of an acid. After this it was seen that the surface of the glass was dimmed, and microscopical examination showed that this was due to the presence of numerous little pits, which evidently corresponded to the points of adhesion of the globules, although no chemical substance capable of eroding glass had been employed. Further experiments by the speaker were detailed, showing that he had caused lime to be so deposited by mixing carbonate of potash and chloride of lime in solutions of gum, albumen, glycerin, and gelatin, and that in each case, except that of gelatin, the dimming of the glass from the same cause had been observed. Some slips of ivory and mother-o'-pearl were also eroded in the same way by the glycerin solution, and it was inferred from this that the substances mentioned had been eroded by purely molecular action. The observation, it was considered, offered an explanation of the effects of boring sponges upon shell and rock, as well as of the phenomena of the similar removal of shell and bone in the process of their remoulding.

The President thought that Dr. Ord's communication was one of remarkable interest, which appeared to open up a new matter for promising investigation, and which he hoped Dr. Ord himself would develop at greater length in a form for publication.

Mr. T. Charters White mentioned, as bearing upon the subject, the molecular disturbance which took place on the surface of glass in the case of photographic negatives.

Dr. Matthews said there were certain kinds of glass which appeared to undergo spontaneous decomposition; this was particularly noticed in the case of the very old glass found in tombs and causing the iridescence.

Dr. G. D. Brown said that a somewhat similar effect had been observed in the case of old glass in windows; particularly those which faced the south-west.

Prof. Stewart thought that the disintegration of glass which was the cause of the colours referred to, belonged to a different category, as indicated by Sir David Brewster in a paper which he published upon the subject. In examining decomposed glass the primitive surface might often be observed to be broken up into concentric films, frequently following definite lines. When this layer breaks off it leaves the surface pitted with spheroidal depressions. There were, he thought, some difficulties to meet in endeavouring to account for all the phenomena by molecular movement, as, for instance, in the case of *Hydractinia arborescens*, where a film of chitin separated the protoplasm of the organism from the incrustated shell. As regarded the boring powers of certain sponges and the removal of lime, he thought that the suggestion of Dr. Ord was very likely to be correct, and that the movement of the heavy molecules of the colloids might, sledge-hammer-like, increase the motion of the molecules of the body acted upon, and finally produce the observed effects.

Mr. Cheshire thought that there was a curious mathematical side to this question as bearing upon the velocity imparted by the stroke between the heavy molecule of the colloid and the lighter molecule of the lime.

Dr. Ord replied to the remarks that had been made, and exhibited a specimen and also enlarged diagrams of a spheroidal calculus of uric acid, found in the kidney of a patient, surrounded by a layer of a chitinous nature, and showing extensive erosion of the uric-acid nucleus by its colloid investment.

Prof. Stewart mentioned a case of the peculiarly resistant substance of oxalate of lime calculi being similarly eroded.

Mr. J. W. Stephenson read his paper "On a New Cata-dioptric Illuminator," having an aperture exceeding that of any existing objective—or equal to 1.644 N.A. in flint glass, and 1.512 N.A. in crown glass. The subject was illustrated by diagrams and by the exhibition of the apparatus (*supra*, p. 207).

The President thought that all who were in the habit of using high-angled lenses would feel indebted to Mr. Stephenson for giving

his attention to this subject, which was one of great practical interest in these days of extended research on micro-organisms. He regarded as of special practical value the power of obtaining black-ground illumination with objectives of the largest aperture.

Mr. Cheshire and Mr. Cheyne's paper "On the Pathogenic History of a New Bacillus (*B. alvei*)" was introduced by Mr. Cheshire, who said that attention had been called to a very serious disease which had prevailed amongst hive bees, attacking the larvæ to so great an extent that in some instances whole stocks had been exterminated. The disease was known as "foul brood," from the disagreeable smell which came from the affected hives, and from the idea that it was confined to the larval state. On careful investigation, however, it appeared that the disease was due to a bacillus, and that the bees themselves, including the queen, suffered from it. It was very satisfactory to be able to announce that they had discovered that the disease yielded very readily to treatment, which consisted in feeding the larvæ with a syrup containing 1/600 per cent. of phenol.

Mr. Cheyne followed with a detailed explanation of the methods adopted in tracing out the life-history of the *Bacillus*, and exhibited in illustration a series of tubes and bottles in which its propagation had been carried on. It was not possible to rely upon the shape as determining whether the *Bacillus* was a new form or not, but the completion of a series of experiments and observations enabled him to say that this was a new form, and that it was really the cause of the disease. It had been named *Bacillus alvei*.

Mr. Dowdeswell regarded this communication as one of great interest, and especially remarked upon the fact that this was the only instance he had heard of in which the virus of the disease had been taken in with the food instead of being communicated by inoculation. He felt that they were greatly indebted to Mr. Cheyne for so clearly demonstrating the methods employed for the observation of the development of the organism.

Mr. Crisp said that that was not the only claim which Mr. Cheyne had upon their admiration, as it would be remembered that it was he who had organized the Biological Laboratory at the Health Exhibition, which had proved so great a success.

The President expressed his regret that the hour was so late as to preclude the possibility of further discussion on the paper, in which there were many points of exceptional interest.

Mr. Fowke read a paper "On the First Discovery of the Comma-Bacillus of Cholera," illustrating his remarks by photographs and drawings. He showed that the bacillus was known and recognized thirty-five years ago by two Englishmen, Messrs. Brittan and Swayne.

Dr. Maddox pointed out that it was by the breaking up of the rings discovered by the original observers that the so-called "comma" bacilli were formed.

The President announced that the second conversazione would be held on April 22nd.

The following Instruments, Objects, &c., were exhibited:—

Mr. Baker:—Object-boxes in book form and otherwise.

Mr. Beck:—(1) "Complete" Lamp with glass reservoir; (2) Vertical Illuminator with diaphragms.

Mr. Bolton:—Larva of *Spio*.

Mr. Cheshire:—*Bacillus alvei* (1) from juices of diseased bee, (2) showing spores beginning to stain; (3) spores further advanced, (4) in Agar-agar cultivation showing spores.

Mr. Cheyne:—Series of preparations illustrating the propagation of *Bacillus alvei*.

Mr. Crisp:—(1) Nobert's original ruling machine; (2) Winkel's Class Microscope with movable stage; (3) Tolles' Clinical Microscope; (4) Klönne and Müller's Portable Microscope; (5) Swift's Microscope for examination of disease in skin of sheep; (6) Griffith's and Bertrand's Objective Adapters; (7) New form of Finder; (8) Robinson's Focusing glass with spiral adjustment; (9) "Carter's Cabinets of curious seeds for the Microscope," consisting of from 12 to 100 specimens, each in separate wooden "pill-boxes" and named.

Mr. Fowke:—Photographs illustrating his paper on the Comma-Bacillus.

Mr. Kitton:—Three slides of Diatoms mounted in Balsam of Tolu.

Mr. Madan:—"Signal-green" glass, cobalt blue glass, and apparatus for showing the difference in diameter of red and blue interference rings.

Mr. E. M. Nelson:—Drawing of Koch's Comma-Bacillus showing flagella (1/15,000 in. \times 2450. Powell's 1/12 in. Oil-immersion Objective, 1.43 N.A.).

Dr. Ord:—Glass showing erosion of surface by action of carbonate of lime and a colloid.

Mr. Adam Sedgwick:—Slide containing 100 sections through a Polyzoön colony.

Mr. Stephenson:—New Cata-dioptric Illuminator.

New Fellows:—The following were elected *Ordinary* Fellows:—Messrs. C. H. Freeman-Underwood, M.D., J. G. Gibbs, M.D., T. J. Lambert, and G. R. Tweedie.

Dr. J. H. L. Flögel was elected an *Honorary* Fellow.

JOURNAL

OF THE

ROYAL

MICROSCOPICAL SOCIETY;

CONTAINING ITS TRANSACTIONS AND PROCEEDINGS,

AND A SUMMARY OF CURRENT RESEARCHES RELATING TO

ZOOLOGY AND BOTANY

(principally Invertebrata and Cryptogamia),

MICROSCOPY, &c.

Edited by

FRANK CRISP, LL.B., B.A.,

One of the Secretaries of the Society

and a Vice-President and Treasurer of the Linnean Society of London;

WITH THE ASSISTANCE OF THE PUBLICATION COMMITTEE AND

A. W. BENNETT, M.A., B.Sc., F.L.S.,

Lecturer on Botany at St. Thomas's Hospital,

JOHN MAYALL, JUN., F.Z.S.,

F. JEFFREY BELL, M.A., F.Z.S.,

Professor of Comparative Anatomy in King's College,

FRANK E. BEDDARD, M.A., F.Z.S.,

AND

B. B. WOODWARD, F.G.S.,

Librarian, British Museum (Natural History),

FELLOWS OF THE SOCIETY.



WILLIAMS & NORGATE,

LONDON AND EDINBURGH.

CONTENTS.

TRANSACTIONS OF THE SOCIETY—

	PAGE
VIII.—NEW BRITISH ORIBATIDÆ. By A. D. Michael, F.R.M.S., F.L.S., F.Z.S., &c. (Plate VII.)	385
IX.—STRUCTURE OF THE DIATOM SHELL. SILICEOUS FILMS TOO THIN TO SHOW A BROKEN EDGE. By Jacob D. Cox, LL.D., F.R.M.S.	398
X.—ON THE STRUCTURE AND ORIGIN OF CARBONIFEROUS COAL SEAMS. By Edward Wethered, F.R.M.S., F.G.S., F.C.S. (Plates VIII. and IX.)	406

SUMMARY OF CURRENT RESEARCHES.

ZOOLOGY.

A. GENERAL, including Embryology and Histology of the Vertebrata.

LOEW, O.— <i>Protoplasm and its Powers of Resistance</i>	421
HERTWIG, O.— <i>Problem of Fertilization and of the Isotropy of the Ovum</i>	421
RAUBER & SACHSSE— <i>Influence of external conditions on the development of Ova</i>	423
BENEDEN, E. VAN, & C. JULIN.— <i>Fetal Appendages of Mammals</i>	423
SOLGER, B.— <i>Development of the Coelom and Coelomic Epithelium of Amphibia</i>	423
SPENCER, W. B.— <i>Fate of the Blastopore of Rana temporaria</i>	425
HENNEGUY, L. F.— <i>Primitive Streak in Osseous Fishes</i>	425
PERRAVEN, E.— <i>Formation of Egg-shell in Dogfish</i>	425
FOL, H.— <i>Cell-Continuity</i>	426
HERTWIG, O.— <i>Influence of Gravity on Cell-division</i>	426
HÄCKEL, E.— <i>Origin and Development of Animal Tissues</i>	426
ADAMKIEWICZ, A.— <i>Parietal Cells in Nerve-fibres</i>	428
WOOLDRIDGE, L. C.— <i>New Constituent of the Blood and its Physiological Import</i>	428
NIKOLAIDES, R.— <i>Phenomena of Contraction in Striated Muscle</i>	428
LEWIS, W. J.— <i>Hair Microscopically examined and Medico-legally considered</i>	429
MACMUNN, C. A.— <i>New Organic Spectra</i>	429
SHARP, B.— <i>Homologies of the Vertebrate Crystalline Lens</i>	430
BROOKS, W. K.— <i>Recognition by Marine Animals of the Hour of the Day</i>	431
CLAUS' <i>Elementary Text-book of Zoology</i>	431

B. INVERTEBRATA.

NIEMIEC, J.— <i>Morphology of Suckers of Animals</i>	431
VERRILL, A. E.— <i>New Coelenterates and Echinoderms</i>	432
ZACHARIAS, O.— <i>Fauna of the Pieces of Water of the Riesengebirge</i>	433
POTTS, E.— <i>Minute Fauna of Reservoirs</i>	433

Mollusca.

RÖSSLER, R.— <i>Radula of Cephaloporous Molluscs</i>	434
HOYLE, W. E.— <i>New 'Challenger' Cephalopoda</i>	435
NALETA, A.— <i>Intercellular Spaces of Epithelium, and their significance in Pulmonate Mollusca</i>	435
SIMROTH, H.— <i>Cyclostoma and Pomatias</i>	436
HORST, R.— <i>Development of the Viviparous Edible Oyster</i>	436
M'INTOSH, W. C.— <i>Reproduction of Mytilus edulis</i>	437
FLEISCHMANN, A.— <i>Movement of the Foot in Lamellibranchs</i>	437

Molluscoida.

a. Tunicata.

MAURICE, C. H., & SCHULGIN.— <i>Development of Amarœcium proliferum</i>	437
---	-----

β. Polyzoa.

VIGELIUS, W. J.— <i>Morphology of the Bryozoa</i>	438
LEIDY, J.— <i>Urnatella gracilis</i>	439
HINCKS, T.— <i>New Polyzoa</i>	439

γ. Brachiopoda.

BLOCHMANN, F.— <i>Brachiopoda</i>	440
---	-----

Arthropoda.

a. Insecta.

CAMERON'S *British Phytophagous Hymenoptera* 440
TICHOMIROV—*Composition of the Ova of Bombyx* 441
DAVIDSON, J.—*Influence of some Conditions on the Metamorphosis of the Blowfly* .. 441
BARTHÉLEMY, A.—*Head and Mouth of the Larva of Insects* 441
FOREL, A.—*Sensorial Organs of the Antennæ of Ants* 441
POLETAJEW, N.—*Spinning Glands of Saw-flies* 442
BEAUREGARD, H.—*Alimentary Canal of Insects* 442
DIMMOCK, G.—*Scales of Coleoptera* 442
SCHIMKEWITSCH, W.—*Change of Sarcosylla penetrans through Parasitism* 447
" " *New genus of Sarcosyllidæ* 447
OSBORNE, J. A.—*Embryology of Botys hyalinialis* 447
WILLS, L.—*Developmental History and Morphological Value of the Ova of Nepa cinerea and Notonecta glauca* 447
KÖHLER, R.—*Marine Hemipterous Insect, Æpophilus Bonnairei* 448

β. Myriopoda.

SAZEPIN, B.—*Nerve-terminations on the Antennæ of Myriopoda* 448

δ. Arachnida.

BLOCHMANN, F.—*Direct Nuclear Division in the Embryonic Investments of Scorpions* 448
BARBOIS, J.—*Development of Chelifer* 449
HALLER, G.—*Descriptions of New Acarina* 449
LABOULBÈNE, A., & P. MÉGNIN.—*Sphærogyna ventricosa* 449
KELLER, C.—*Spiders in Relation to Forestry* 450

ε. Crustacea.

VIALLANES, H.—*Optic Ganglion of Palinurus vulgaris* 450
WEBER, M.—*Isopoda of the ' Willem Barents' Expedition* 450
HARTOG, M.—*Morphology of Cyclops and Relations of the Copepoda* 452
SMITH, S. I.—*New Decapod Crustacea* 453
HESSE—*New or Rare Crustacea* 453
MURDOCH, J.—*New Crustacea from Arctic Alaska* 453
CHILTON, C.—*New Species of Idotea* 454
CAR, L.—*Copepoda of the Adriatic* 454
POPPE, S. A.—*Copepoda of the North Pacific* 454
DELAGE, YVES—*Evolution of Sacculina* 454

Vermes.

KÜKENTHAL, W.—*Lymphoid Cells of Annelids* 454
FIELDE, A. M.—*Tenacity of Life and Regeneration of Excised Parts in Lumbricus terrestris* 455
NUSBAUM, J.—*Development of the Sexual Organs of Clepsine* 455
ROHDE, E.—*Muscles of Chaetopoda* 456
JOURDAN, E.—*Elytra of some Polynoina* 456
MURDOCH, J.—*New Arenicola from Arctic Alaska* 456
FOETTINGER, A.—*Histriobdella homari* 456
HORST, R.—*Problematical Organ in Chloræmidæ* 457
HASWELL, W. A.—*Segmental Organs of Serpula* 458
BÜTSCHLI, O.—*Origin of the Nervous System of Nematodes* 458
VILLOT, A.—*Host of the Larva of Echinorhynchus clavæceps* 459
NIEMIÉC, J.—*Nervous System of Tæniæ* 459
LOOSS, A.—*Anatomy of the Trematoda* 460
BATESON, W.—*Development of Balanoglossus Kowalevskii, and the Affinities of the Enteropneusta* 461

Echinodermata.

BELL, F. JEFFREY—*Cotton-spinner* 462
WALTER, A.—*Echinodermata of Ceylon* 462

Cœlenterata.

THALLWITZ, J.—*Development of Male Germinal Cells in Hydroids* 462
BEDOT, M.—*Histology of Porpita mediterranea* 463
M'INTOSH, W. C.—*Identity of the two British Species of Cyanea* 464
MACMUNN, C. A.—*Chromatology of Actiniæ* 464

Porifera.

SOLLAS, W. J.—*Structure of the Skeleton in the Anomocladina* 464
MILLS, H.—*New American Fresh-water Sponges* 464
CARTER, H. J.—*New Sponges from South Australia* 465

Protozoa.

WEISMANN, A.— <i>Immortality of Unicellular Organisms</i>	466
GRUBER, A.— <i>Multinucleated Protozoa</i>	467
KLEBS, G.— <i>Peridinia</i>	468
POUCHET, G.— <i>Marine Peridinia</i>	469
ENTZ, G.— <i>Tintinnodes</i>	470
BLANC, H.— <i>Variability and Mode of Reproduction of Ceratium hirundinella</i>	470
KELLCOTT, D. S.— <i>New Infusoria</i>	470
STOKES, A. C.— <i>New Vorticella</i>	470
FOLIN DE— <i>Structure of Reticular Rhizopods</i>	471
FRENZEL, J.— <i>Marine Gregarinidæ</i>	471
WITLACZIL, E.— <i>New Gregarine</i>	471
DANILEWSKY, B.— <i>Hæmatozoa in Cold-blooded Animals</i>	472
NUSSBAUM, M., & A. GRUBER— <i>Artificial Division of Infusoria</i>	472

BOTANY.

A. GENERAL, including the Anatomy and Physiology of the Phanerogamia.

a. Anatomy.

TANGL, E.— <i>Continuity of Protoplasm</i>	473
GUIGNARD, L.— <i>Structure and Division of the Cell-nucleus</i>	474
BERNIMOULIN, E.— <i>Division of the Cell-nucleus in Tradescantia</i>	475
SCHWARZ, F.— <i>Behaviour of the Nucleus after Division</i>	475
TSCHIRCH, A.— <i>Morphology of Chlorophyll-grains</i>	475
WEISS, A.— <i>Soluble Yellow Pigment in the Petals of Papaver</i>	476
" " <i>Spontaneous Movements of Pigment-bodies</i>	476
KRAUS, C.— <i>Excretion of Healing Substances into Wounds</i>	476
SCHWENDENER, S.— <i>Firmness of Tissues</i>	476
ZIMMERMANN, A.— <i>Behaviour of the Optical Axes of Elasticity of Cell-walls under Tension</i>	476
FISCHER, A.— <i>Sieve-tube System of Cucurbitacea</i>	477
FAMINTZIN, A.— <i>Development of the Sclerenchymatous Fibres of the Oleander</i>	478
KRABBE, G.— <i>Growth of the Thickening-ring in Ezogens</i>	478
ROTHROCK, J.— <i>Internal Cambium Ring in Gelsemium sempervirens</i>	478
TSCHIRCH, A.— <i>Penetration of the Mechanical Ring for the Transport of Food-material</i>	479
MÜLLER, C.— <i>Stolons of Sagittaria sagittifolia</i>	479
VUILLEMIN, P.— <i>Anatomical Structure of the Stem of Composite</i>	480
COSTANTIN, J.— <i>Structure of the Stem of Aquatic Plants</i>	480
HILLER, G. H.— <i>Epidermis of Petals</i>	481
STEINBRINCK, C.— <i>Bursting of Ripe Fruits</i>	481
GODFELIN, J.— <i>Comparative Anatomy of the Cotyledons and Endosperm</i>	481
JURANYI, L.— <i>Pollea of Gymnosperms</i>	481
BECCARI, O.— <i>Ant-harbouring Organs of Plants</i>	484
KRASAN, F.— <i>Malformations caused by Insects</i>	484
BOWER & VINES'S <i>Practical Botany</i>	484

b. Physiology.

JOHANNSEN, W.— <i>Development of the Endosperm in Hordeum</i>	485
HELLRIGEL, H.— <i>Influence of Light and Heat on Plant Development</i>	485
" " <i>Evaporative Surfaces of Plants and Influence of Moisture in Soils on Plant Growth</i>	486
KORSCHOLT, P.— <i>Apical Growth of Phanerogams</i>	487
ZIMMERMANN, A.— <i>Causes of Anisotropy of Organic Substances</i>	487
PHIPSON, T. L.— <i>Chemical Phenomena of the Respiration of Plants</i>	488
BONNIER, G., & L. MANGIN.— <i>Respiration of Leaves in Darkness</i>	488
VESQUE, J.— <i>Movement of Ascending Sap</i>	489
GODLEWSKI, E.— <i>Movement of Water in Plants</i>	490
WESTERMAIER, M.— <i>Importance of Dead Tubes and Living Cells for the Conduction of Water in Plants</i>	490
HANSEN, A.— <i>Supply of Air to the Roots and Root-pressure</i>	490
RIMMER, F.— <i>Mutations of Seedlings</i>	490
STAHL, E.— <i>Influence of Light on Geotropism</i>	491
HANSEN, A.— <i>Peptonizing Ferments in Secretions</i>	491

	PAGE
BERTRAND'S Adapter Nose-piece (Fig. 116)	525
RINGS for throwing the Course Adjustment out of Gear (Figs. 117-19)	525
FABRE-DOMERGUE'S Current-Apparatus	526
MOIST CHAMBER	526
MACMUNN, C. A.—Arrangement of the Microspectroscope	527
BOWER, F. O., & S. H. VINES—Examining the Spectrum of Chlorophyll	527
VORCE, C. M., & R. HITCHCOCK—Multiplying Drawings	527
WHITE, T. CHARTERS—Value of Photo-micrographs	528
PUMPHREY, W.—Parallel Rays in Photo-micrography	528
ROUX & H. VAN HEURCK—Small Negatives—Robinson's Miniature Microscopic Camera	528
AMPHIPLEURA PELLUCIDA and the Diffraction Theory	529
BANKS, C. W.—Rimbock's Slides of Arranged Diatoms	530
BRECKENFELD, A. H.—Graduated Glass Modifier	530
FABRE-DOMERGUE, P.—New Movable Stage	530
FOULIS—Oxyhydrogen Light	530
LANCASTER, W. J.—Lengthening Tubes	531
MONOCULAR V. BINOCULAR	532
NOBERT'S Diamonds	574

B. Collecting, Mounting and Examining Objects, &c.

BLANC, H.—Collecting Rhizopods	534
ISRAEL, O.—Cultivation of Actinomyces	534
BRIEFELD, O.—Cultivation Methods for the Investigation of Fungi	534
WALTERS, H. A.—Net for Microscopists	535
OSBORN, H. F.—Preparing Brain of Urodela	536
HARRIS, V. D.—Method of Preparing permanent specimens of Stained Human Blood	537
BAYERL, B.—Demonstrating the Origin of Red Blood-corpuscles in Cartilage at the Margin of Ossification	537
KOESTLER, M.—Preparing the Sympathetic Nervous System of <i>Periplaneta orientalis</i>	538
CAITANEO, L.—Fixing, Staining, and Preserving Infusoria	538
KLEBS, G.—Preparing <i>Euglena</i>	539
LUSTGARTEN, S.—Preparing the Bacillus of Syphilis	539
HICK, T.—Methods for observing Protoplasmic Continuity	540
HOLL, M.—Tolu instead of Chloroform for Imbedding in Paraffin	541
GERLACH, L.—Imbedding Small Objects	541
GOTTSCHAU, M.—Advantages and Disadvantages of Different Forms of Microtome (Figs. 120-129)	541
SCHANZE'S Microtome (Fig. 130)	547
BULLOCK'S Combination Microtome (Fig. 131)	548
CAMBRIDGE Rocking Microtome (Fig. 132)	549
LEE, A. B.—" Ribbon " Section Cutting	552
HÖHNEL, F. V.—Rapid Method of making Sections of hard Organized Substances	553
HOLZNER, G.—Contribution to the History of Staining	553
GIERKE, H.—Staining for Microscopical Purposes	554
FLEMING, W.—Staining Technique	554
EHRLICH—Susceptibility of the Different Tissues to Colouring Matters	554
CYBULSKY, J.—Staining the Nervous System of the Muzzle and Upper Lip of the Ox	555
CERTES, A.—Employment of Colouring Matters in the Study of Living Infusoria	555
SCHAARSCHMIDT, J.—Staining <i>Vaucheria</i> and <i>Chara</i>	557
FRANKEL, B.—Staining of Koch's Bacillus	557
RIBBERT—Staining Bacteria with Dahlia	558
PERGENS'S Picrocarmine	558
FLESCH, M.—Application of the Colouring Matter of Red Cabbage in Histology	558
BRUN, J.—Double Staining	558
PIERSOL, G. A.—Staining Tissues for Photo-micrography	559
BERGONZINI—Collodion and Phenol in Microscopical Technique	559
ROGERS, W. A.—Dry Mounting of Opaque Objects	560
TIEMANN—Examination of Water for the Development of Micro-organisms	560
CARPENTER, H. S., & W. O. NICHOLSON.—Examination of Water for Organisms	560
CHAMBERLAND, C.—Removal of Microbes by Filtering	561
FOL, H., & P. L. DUNANT—Effect of Prolonged Repose and Filtration through Porcelain on the Purity of Water	561
FOL, H.—Determination of the Number of Germs in Air	561
MEYER, A.—Examining Vegetable Powders	562
GAUTIER, A.—Sterilization of Fermentable Liquids in the Cold	562
COLE, A. C.—Mounting Spiders	563
DAVIS J. J.—Simple Cover Compressor	564
KAIN, C. H.—Tolu for Mounting	570
PROCEEDINGS OF THE SOCIETY	568

ROYAL MICROSCOPICAL SOCIETY.

COUNCIL.

ELECTED 11th FEBRUARY, 1885.

PRESIDENT.

REV. W. H. DALLINGER, LL.D., F.R.S.

VICE-PRESIDENTS.

JOHN ANTHONY, Esq., M.D., F.R.C.P.L.

G. F. DOWDESWELL, Esq., M.A.

PROF. P. MARTIN DUNCAN, M.B., F.R.S.

ALBERT D. MICHAEL, Esq., F.L.S.

TREASURER.

LIONEL S. BEALE, Esq., M.B., F.R.C.P., F.R.S.

SECRETARIES.

*FRANK CRISP, Esq., LL.B., B.A., V.P. & TREAS. L.S.

PROF. F. JEFFREY BELL, M.A., F.Z.S.

Twelve other MEMBERS of COUNCIL.

JOSEPH BECK, Esq., F.R.A.S.

A. W. BENNETT, Esq., M.A., B.Sc., F.L.S.

*ROBERT BRAITHWAITE, Esq., M.D., M.R.C.S., F.L.S.

JAMES GLAISHER, Esq., F.R.S., F.R.A.S.

*J. WILLIAM GROVES, Esq.

JOHN MATTHEWS, Esq., M.D.

JOHN MAYALL, Esq., JUN.

*JOHN MILLAR, Esq., L.R.C.P., F.L.S.

URBAN PRITCHARD, Esq., M.D.

STUART O. RIDLEY, Esq., M.A., F.L.S.

*PROF. CHARLES STEWART, M.R.C.S., F.L.S.

WILLIAM THOMAS SUFFOLK, Esq.

LIBRARIAN and ASSISTANT SECRETARY.—MR. JAMES WEST.

* Members of the Publication Committee.

MEETINGS FOR 1885, at 8 p.m.

Wednesday, JANUARY 14	Wednesday, MAY 13
„ FEBRUARY 11	„ JUNE 10
(Annual Meeting for Election of Officers and Council.)	„ OCTOBER 7
„ MARCH 11	„ NOVEMBER 11
„ APRIL 8	„ DECEMBER 9

T. KLÖNNE & G. MÜLLER,

INSTITUTION FOR THE MANUFACTURE OF ACHROMATIC MICROSCOPES AND MICROSCOPICAL PREPARATIONS,

BERLIN, S. PRINZENSTRASSE 71,

Recommend Schizomycetes stained according to the newest methods, the spores red and the bacilli blue; all varieties now known are shown, e.g. Asiatic cholera, Bacillus anthracis in sections and cleaned, Pneumonia, Sarina, Septicæmia, Bact. cyanogenum, Tuberculosis, Typhus, Plant and Animal Parasites, Algæ, Protozoa, Infusoria, Diatomaceæ in varieties not hitherto obtained. Diatom test type-plates, the whole properly arranged, named, and prepared in monobromide of naphthalin or balsam. Diatomaceæ, Earths, Mosses, Woods, Histology of Plants, Echinoderms, Mollusca, Worms, Crustacea, Spiders, Insects, Histology and Anatomy of Man and Animals, Embryology, Crystals, Foods and Adulterations, Webs, Hair, Paper pulp and finished paper, and objects interesting to Brewers and Tanners, all in choice and faultless preparations. Also Achromatic Microscopes of the best workmanship and optical power, with mechanical stages. We are also much commended for our new construction of Bacteria-searcher, calculated for use with high powers with the Abbe Illuminating Apparatus, with which every Schizomycete may be discovered in a preparation; also for our Object-finder, with which the smallest object can always be found without difficulty by a little ring marked upon the cover-glass.

Catalogues gratis.

Agents wanted.

THE BRITISH MOSS FLORA.

By R. BRAITHWAITE, M.D.

PART VIII., TORTULACEÆ, is now ready, price 6s. Subscriptions to Sect. 3 (10s. 6d.) may be sent to the Author.







The previous Parts may be had from the Author, at 303, Clapham Road, London.

ADVERTISEMENTS FOR THE JOURNAL.

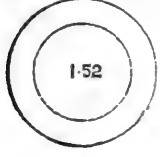
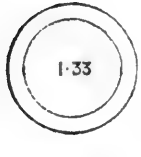
MR. CHARLES BLENCOWE, of 9, BRIDGE STREET, WESTMINSTER, S.W., is the authorized Agent and Collector for Advertising Accounts on behalf of the Society.

I. Numerical Aperture Table.

The "APERTURE" of an optical instrument indicates its greater or less capacity for receiving rays from the object and transmitting them to the image, and the aperture of a Microscope objective is therefore determined by the ratio between its focal length and the diameter of the emergent pencil at the plane of its emergence—that is, the utilizes diameter of a single-lens objective or of the back lens of a compound objective. This ratio is expressed for all media and in all cases by $n \sin u$, n being the refractive index of the medium and u the semi-angle of aperture. The value of $n \sin u$ for any particular case is the "numerical aperture" of the objective.

Diameters of the Back Lenses of various Dry and Immersion Objectives of the same Power (1/4 in.) from 0.50 to 1.52 N. A.	Numerical Aperture. ($n \sin u = a$.)	Angle of Aperture (= 2 u).			Illuminating Power. (a^2 .)	Theoretical Resolving Power, in Lines to an Inch ($\lambda = 0.5269 \mu$ = line λ .)	Penetrating Power ($\frac{1}{a}$)
		Dry Objectives. ($n = 1$.)	Water-Immersion Objectives. ($n = 1.33$.)	Homogeneous-Immersion Objectives. ($n = 1.52$.)			
	1.52	180° 0'	2.310	146,528	.658
	1.50	161° 23'	2.250	141,600	.667
	1.48	153° 39'	2.190	142,672	.676
	1.46	147° 42'	2.132	140,744	.685
	1.44	142° 40'	2.074	138,816	.694
	1.42	138° 12'	2.016	136,888	.704
	1.40	134° 10'	1.960	134,960	.714
	1.38	130° 26'	1.904	133,032	.725
	1.36	126° 57'	1.850	131,104	.735
	1.34	123° 40'	1.796	129,176	.746
	1.33	..	180° 0'	122° 6'	1.770	128,212	.752
	1.32	..	165° 56'	120° 33'	1.742	127,248	.758
	1.30	..	155° 38'	117° 34'	1.690	125,320	.769
	1.28	..	148° 28'	114° 44'	1.638	123,392	.781
	1.26	..	142° 39'	111° 59'	1.588	121,464	.794
	1.24	..	137° 36'	109° 20'	1.538	119,536	.806
	1.22	..	133° 4'	106° 45'	1.488	117,608	.820
	1.20	..	128° 55'	104° 15'	1.440	115,680	.833
	1.18	..	125° 3'	101° 50'	1.392	113,752	.847
	1.16	..	121° 26'	99° 29'	1.346	111,824	.862
	1.14	..	118° 00'	97° 11'	1.300	109,896	.877
	1.12	..	114° 44'	94° 56'	1.254	107,968	.893
	1.10	..	111° 36'	92° 43'	1.210	106,040	.909
	1.08	..	108° 36'	90° 33'	1.166	104,112	.926
	1.06	..	105° 42'	88° 26'	1.124	102,184	.943
	1.04	..	102° 53'	86° 21'	1.082	100,256	.962
	1.02	..	100° 10'	84° 18'	1.040	98,328	.980
	1.00	180° 0'	97° 31'	82° 17'	1.000	96,400	1.000
	0.98	157° 2'	94° 56'	80° 17'	.960	94,472	1.020
	0.96	147° 29'	92° 24'	78° 20'	.922	92,544	1.042
	0.94	140° 6'	89° 56'	76° 24'	.884	90,616	1.064
	0.92	133° 51'	87° 32'	74° 30'	.846	88,688	1.087
	0.90	128° 19'	85° 10'	72° 36'	.810	86,760	1.111
	0.88	123° 17'	82° 51'	70° 44'	.774	84,832	1.136
	0.86	118° 38'	80° 34'	68° 54'	.740	82,904	1.163
	0.84	114° 17'	78° 20'	67° 6'	.706	80,976	1.190
	0.82	110° 10'	76° 8'	65° 18'	.672	79,048	1.220
	0.80	106° 16'	73° 58'	63° 31'	.640	77,120	1.250
	0.78	102° 31'	71° 49'	61° 45'	.608	75,192	1.282
	0.76	98° 56'	69° 42'	60° 0'	.578	73,264	1.316
	0.74	95° 28'	67° 36'	58° 16'	.548	71,336	1.351
	0.72	92° 6'	65° 32'	56° 32'	.518	69,408	1.389
	0.70	88° 51'	63° 31'	54° 50'	.490	67,480	1.429
	0.68	85° 41'	61° 30'	53° 9'	.462	65,552	1.471
	0.66	82° 36'	59° 30'	51° 28'	.436	63,624	1.515
	0.64	79° 35'	57° 31'	49° 48'	.410	61,696	1.562
	0.62	76° 38'	55° 34'	48° 9'	.384	59,768	1.613
	0.60	73° 44'	53° 38'	46° 30'	.360	57,840	1.667
	0.58	70° 51'	51° 42'	44° 51'	.336	55,912	1.724
	0.56	68° 6'	49° 48'	43° 14'	.314	53,984	1.786
	0.54	65° 22'	47° 54'	41° 37'	.292	52,056	1.852
	0.52	62° 40'	46° 2'	40° 0'	.270	50,128	1.923
	0.50	60° 0'	44° 10'	38° 24'	.250	48,200	2.000

EXAMPLE.—The apertures of four objectives, two of which are dry, one water-immersion, and one oil-immersion, would be compared on the angular aperture view as follows:—106° (air), 157° (air), 142° (water), 130° (oil). Their actual apertures are, however, as numerical apertures. .80 .98 1.25 1.39 or their

II. Conversion of British and Metric Measures.

(1.) LINEAL.

Micromillimetres, &c., into Inches, &c.

	μ	ins.	mm.	ins.	mm.	ins.
	1	·000039	1	·039370	51	2·007892
	2	·000079	2	·078741	52	2·047262
	3	·000118	3	·118111	53	2·086633
	4	·000157	4	·157482	54	2·126003
	5	·000197	5	·196852	55	2·165374
	6	·000236	6	·236223	56	2·204744
	7	·000276	7	·275593	57	2·244115
	8	·000315	8	·314963	58	2·283485
	9	·000354	9	·354334	59	2·322855
	10	·000394	10 (1 cm.)	·393704	60 (6 cm.)	2·362226
	11	·000433	11	·433075	61	2·401596
	12	·000472	12	·472445	62	2·440967
	13	·000512	13	·511816	63	2·480337
	14	·000551	14	·551186	64	2·519708
	15	·000591	15	·590556	65	2·559078
	16	·000630	16	·629927	66	2·598449
	17	·000669	17	·669297	67	2·637819
	18	·000709	18	·708668	68	2·677189
	19	·000748	19	·748038	69	2·716560
	20	·000787	20 (2 cm.)	·787409	70 (7 cm.)	2·755930
	21	·000827	21	·826779	71	2·795301
	22	·000866	22	·866150	72	2·834671
	23	·000906	23	·905520	73	2·874042
	24	·000945	24	·944890	74	2·913412
	25	·000984	25	·984261	75	2·952782
	26	·001024	26	1·023631	76	2·992153
	27	·001063	27	1·063002	77	3·031523
	28	·001102	28	1·102372	78	3·070894
	29	·001142	29	1·141743	79	3·110264
	30	·001181	30 (3 cm.)	1·181113	80 (8 cm.)	3·149635
	31	·001220	31	1·220483	81	3·189005
	32	·001260	32	1·259854	82	3·228375
	33	·001299	33	1·299224	83	3·267746
	34	·001339	34	1·338595	84	3·307116
	35	·001378	35	1·377965	85	3·346487
	36	·001417	36	1·417336	86	3·385857
	37	·001457	37	1·456706	87	3·425228
	38	·001496	38	1·496076	88	3·464598
	39	·001535	39	1·535447	89	3·503968
	40	·001575	40 (4 cm.)	1·574817	90 (9 cm.)	3·543339
	41	·001614	41	1·614188	91	3·582709
	42	·001654	42	1·653558	92	3·622080
	43	·001693	43	1·692929	93	3·661450
	44	·001732	44	1·732299	94	3·700820
	45	·001772	45	1·771669	95	3·740191
	46	·001811	46	1·811040	96	3·779561
	47	·001850	47	1·850410	97	3·818932
	48	·001890	48	1·889781	98	3·858302
	49	·001929	49	1·929151	99	3·897673
	50	·001969	50 (5 cm.)	1·968522	100 (10 cm. = 1 decim.)	
	60	·002362				
	70	·002756				
	80	·003150	decim.		ins.	
	90	·003543	1	3·937043		
	100	·003937	2	7·874086		
	200	·007874	3	11·811130		
	300	·011811	4	15·748173		
	400	·015748	5	19·685216		
	500	·019685	6	23·622259		
	600	·023622	7	27·559302		
	700	·027559	8	31·496346		
	800	·031496	9	35·433389		
	900	·035433	10 (1 metre)	39·370432		
	1000 (= 1 mm.)			= 3·280869 ft.		
				= 1·093623 yds.		

Inches, &c., into Micromillimetres,

	ins.	μ
	$\frac{1}{25000}$	1·015991
	$\frac{1}{20000}$	1·269989
	$\frac{1}{15000}$	1·693318
	$\frac{1}{10000}$	2·539977
	$\frac{1}{8000}$	2·822197
	$\frac{1}{6000}$	3·174972
	$\frac{1}{5000}$	3·628539
	$\frac{1}{4000}$	4·233295
	$\frac{1}{3000}$	5·079954
	$\frac{1}{2000}$	6·349943
	$\frac{1}{1500}$	8·466591
	$\frac{1}{1000}$	12·699886
	$\frac{1}{1000}$	25·399772
	mm.	
	$\frac{1}{100}$	·028222
	$\frac{1}{80}$	·031750
	$\frac{1}{60}$	·036285
	$\frac{1}{50}$	·042333
	$\frac{1}{40}$	·050800
	$\frac{1}{30}$	·056444
	$\frac{1}{20}$	·063499
	$\frac{1}{15}$	·072571
	$\frac{1}{10}$	·084666
	$\frac{1}{8}$	·101599
	$\frac{1}{6}$	·126999
	$\frac{1}{5}$	·169332
	$\frac{1}{4}$	·253998
	$\frac{1}{3}$	·507995
	$\frac{1}{2}$	1·015991
	$\frac{1}{20}$	1·269989
	$\frac{1}{16}$	1·587486
	$\frac{1}{12}$	1·693318
	$\frac{1}{10}$	2·116648
	$\frac{1}{8}$	2·539977
	$\frac{1}{6}$	3·174972
	$\frac{1}{5}$	4·233295
	$\frac{1}{4}$	4·762457
	$\frac{1}{3}$	5·079954
	$\frac{1}{2}$	6·349943
	$\frac{1}{16}$	7·937429
	$\frac{1}{8}$	9·524915
	cm.	
	$\frac{1}{16}$	1·111240
	$\frac{1}{8}$	1·269989
	$\frac{1}{4}$	1·428737
	$\frac{1}{2}$	1·587486
	$\frac{1}{16}$	1·746234
	$\frac{1}{8}$	1·904983
	$\frac{1}{4}$	2·063732
	$\frac{1}{2}$	2·222480
	$\frac{1}{16}$	2·381229
	1	2·539977
	2	5·079954
	3	7·619932
	decim.	
	4	1·015991
	5	1·269989
	6	1·523986
	7	1·777984
	8	2·031982
	9	2·285979
	10	2·539977
	11	2·793975
	1 ft.	3·047973
	metres.	
	1 yd. =	·914392



CHARLES COPPOCK,

LATE
PARTNER WITH
R. & J. BECK.

MANUFACTURER
OF
SCIENTIFIC
INSTRUMENTS.

—
PATHOLOGICAL
AND
PHYSIOLOGICAL
PREPARATIONS.

STAINING FLUIDS
AND ALL
ACCESSORIES
FOR STUDENTS'
USE.

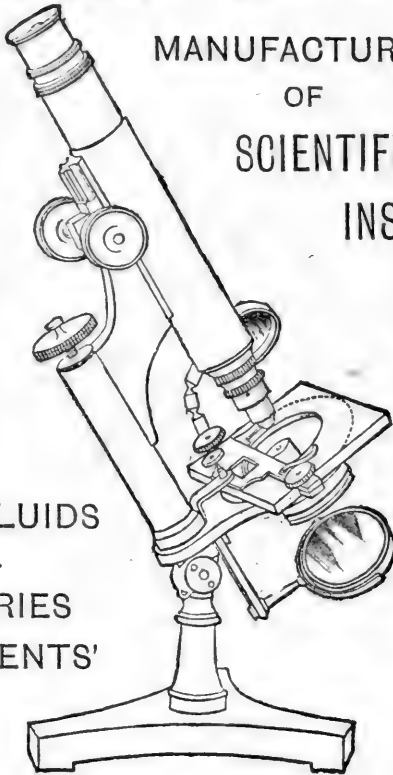

—
Microscopes
for
Students and
Amateurs.

—
ILLUSTRATED
CATALOGUE,
2s.

100, NEW BOND STREET,
LONDON, W.

N.B. SPECTACLES!!

OCULISTS' PRESCRIPTIONS RECEIVE PERSONAL ATTENTION.

AGENT FOR W. H. BULLOCH, CHICAGO, ILLS., U.S.A.
R. H. SPENCER & CO., N.Y., U.S.A.
JAMES L. PEASE, MASS., U.S.A.
M. PRAZMOWSKI, PARIS.
M. A. NACHET, PARIS.

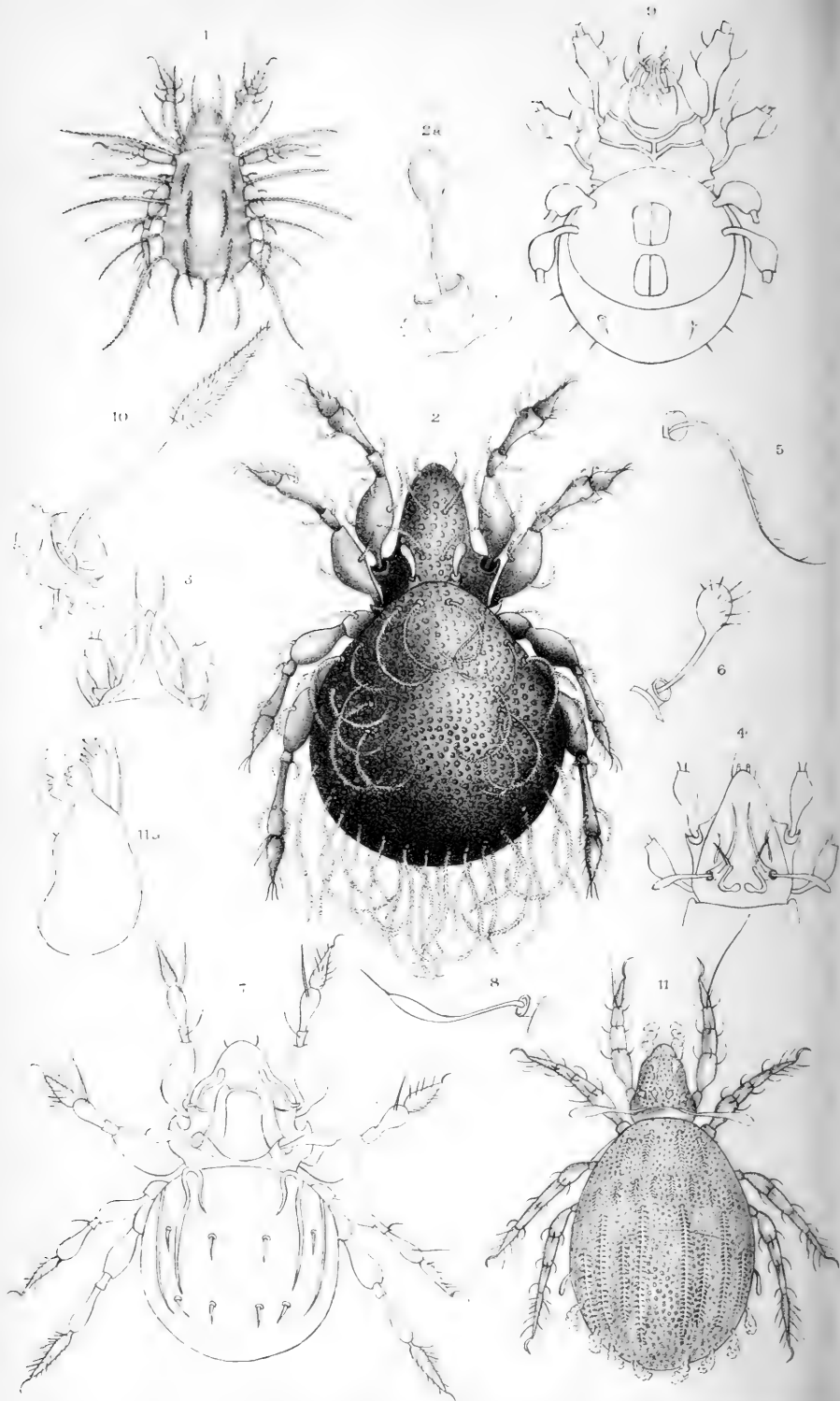

JOURNAL
OF THE
ROYAL MICROSCOPICAL SOCIETY.

JUNE 1885.

TRANSACTIONS OF THE SOCIETY.

VIII.—*New British Oribatidæ.*

By A. D. MICHAEL, F.R.M.S., F.L.S., F.Z.S., &c.

(Read 8th April, 1885.)

PLATE VII.

As this paper is entirely descriptive of new species, and of hitherto unknown stages in the life-histories of other species, the adult forms of which have already been recorded, it is necessarily of a technical character, and does not afford much matter of interest to naturalists generally; a few words may, however, be said as to one or two of the creatures described and the mode of tracing them, which may possibly be acceptable even to those who have not paid special attention to the family of Acarina treated of.

Firstly, as to the nymph of *Cepheus bifidatus*. I have, on more than one occasion, called attention to the bizarre and beautiful forms which the nymphs of some of the Oribatidæ assume, partly consequent on the habit, which so many of them possess, of

EXPLANATION OF PLATE VII.

- Fig. 1.—*Cepheus bifidatus*, larva.
 „ 2.—*Notaspis serrata* n. sp. × 100.
 „ 2a.— „ „ pseudo-stigmatic organ × 300.
 „ 3.— „ „ *juncta* n. sp., outline of cephalothorax × 200.
 „ 4.— „ „ *longilamellata* n. sp., outline of cephalothorax × 145.
 „ 5.— „ „ *pectinata* n. sp., pseudo-stigmatic organ × 250.
 „ 6.— „ „ *clavipectinata* n. sp., pseudo-stigmatic organ × 400.
 „ 7.— „ „ *quadrincarinata* n. sp. × 250.
 „ 8.— „ „ *lanceolata* n. sp., pseudo-stigmatic organ × 275.
 „ 9.—*Damæus sufflexus* n. sp., ventral aspect × 65.
 „ 10.— „ „ *tenuipes* n. sp., pseudo-stigmatic organ × 300.
 „ 11.—*Hypochothinius lanatus* n. sp. × 140.
 „ 11a.— „ „ mandible × 800.

carrying on their backs the notogastral (dorso-abdominal) portions of all their cast skins, which form concentric rings upon the back of the existing creature. The nymphs of *Tegeocranus latus*, *Leiosoma (Cepheus) palmicinctum*, and *Cepheus ocellatus* have been especially noticed as very remarkable creatures, and the present species is not inferior to them in interest and singularity. It is distinctly constructed upon the type of the nymph of *Tegeocranus latus*; it may be remembered that this nymph, which may fairly be considered a typical form, has the abdomen, and each cast abdominal skin, bordered by a series of large, brown, trifid projections, from the central cusp of each of which springs a great serrated spine of clear chitin, doubly curved, so as to form almost a line-of-beauty, directed more or less backward. In the present species the trifid projection is absent, or rather the central cusp alone remains, forming a very large projecting papilla, of which there is a series all round each skin; from each of these springs a spine somewhat of the nature of those borne by *T. latus* but twice or three times as long, far thinner and finer, and with the serrations much further apart, so that it gives the idea that if a spine of *T. latus* were ductile, and could be drawn out to extreme length and tenuity, it would then resemble one of those of *Cepheus bifidatus*. The spines radiate much more than those of *T. latus*, and have the peculiarity, that, while those on the anterior parts of the body are stiff, those bordering the posterior part are more or less flexible. The remarkable length of these spines, their elegant shapes, and the complicated pattern resulting from the curving and crossing of those projecting over the cephalothorax, render the animal as singular a creature as can readily be found.

The mode in which it has been discovered gives it an additional interest in my eyes, as one always has a special liking for what has only been attained by considerable care and trouble. *Cepheus bifidatus* is a rare species, very difficult to obtain; I have not ever found the nymph or larva, and I have traced it solely from the system of preserving the creatures alive in glass cells, and endeavouring to breed from them, which I have adopted in most of my researches on the life-histories of Acarina. Last autumn at Keswick (Cumberland) I came across three or four living adult specimens of the species, and I determined to endeavour to get them to lay eggs and rear them. I carefully isolated them in a cell without other creatures of any sort, and placed them under such hygrometric and food conditions as experience told me would be most likely to keep them in health; after a few weeks I was pleased to find four young larvæ, just hatched, and of a kind new to me, but evidently one of the Oribatidæ; one of these is figured at plate VII. fig. 1. I carefully reared these larvæ until they attained the nymphal stage, and through all the ecdyses of that stage, the whole

process taking over six months, during which they had to be looked to almost every day, until at last they were full grown and became the remarkable creatures I have described. I then killed and preserved two for specimens, retaining the other two alive so as actually to complete the whole cycle of changes. Unfortunately, when one of these was just about to assume the adult condition, by a trifling accident something touched my hand while I was examining the cell, and the creature which I had kept for six months was gone in an instant. I, however, still had one left, and this one I was more fortunate with, and succeeded in rearing it through the final ecdysis; it completed the whole cycle of its existence in my cage and became a perfect *Cepheus bifidatus* on the 30th April, 1885.* I retain it as a specimen with the cast skin from which it emerged.

Another very interesting new species is that referred to below as *Hypothonius lanatus*. The genus *Hypothonius* was instituted by C. L. Koch for two species which he described. Nicolet finding that Koch had established several genera upon immature forms, and seeing that this looked very much like a nymph, positively stated that this genus also consisted of creatures in course of development, and even went so far as to say what it was the early stage of. Dr. G. Haller, some few years since, pointed out that Koch was right and Nicolet in error, as the sexes are well developed and the female is constantly found with ripe eggs. From careful observation of the different species both living and in preparations, I can fully confirm Haller's view; the female lays ripe and fertile eggs in the ordinary way, and neither she nor the male ever undergo any further transformation, while, as I have formerly stated, I have traced the larva and nymph of the species which Nicolet supposed this to be the immature stage of, and they are totally different. The great point of interest, however, is the following. In almost all general works on zoology the Acarina will be found described in words practically of similar purport to the following, which is taken from the English translation of Cohn's Text-book of Zoology (1884). "Acarina, Arachnida with stout body. The abdomen is unsegmented and fused with the thorax;" and further on, "The body of the Acarina is generally small and possesses a stout and unsegmented form. The head, thorax, and abdomen are fused into a common mass." Now this is perfectly true of such extreme forms as the Hydrachnidæ, but in the Oribatidæ, most of the Gamasidæ, the Trombidiidæ, the Tyroglyphidæ, and indeed for the larger part of the Acarina, the abdomen is as distinct from the cephalothorax as that of a beetle is from its thorax. In this genus, however, the matter is carried

* The imago had not emerged at the time this paper was read, but has done so since.

further, for the exo-skeleton of the abdomen is decidedly segmented, and in the species now described the segments are capable of a certain amount of telescopic extension and retraction, and in connection with this it has a power of erecting the spines on its back (which are usually horizontal) as a porcupine does. I am not aware of this power existing in any other species of Oribatidæ.

Another curious new species is that which I propose to call *Damæus tenuipes*. The adult of this creature carries the cast notogastral skins, but they are not, as in *Cepheus bifidatus*, above referred to, extended nearly flat on the back: on the contrary, the abdomen is nearly globular, and the cast notogastral skins retain their hemispherical shape, so that they form a pile on the back, like a diminishing series of dish-covers. These being very thin require some support, and they receive it in an odd way. From the centre of the dorsal shield of the abdomen of the adult arises a chitinous, spine-like process, which is erect, and just touches the lowest cast skin; from exactly above it on that skin arises a similar spine, which supports the second skin, and so on; thus these spines form a supporting column in the centre of the pile. They are never seen except the skin is pulled off or rendered transparent. There is not any spine on the larval skin, which, being the top, has not anything to support.

CEPHEUS BIFIDATUS.

Nymph.

This singular and beautiful creature is decidedly of the type of the nymph of *Tegeocranus latus*, but the spines bordering the abdomen are far longer and more slender, and the processes from which they spring are smaller, and different in form.

Colour very light buff or drab, almost white. Legs and rostrum light pink-brown. Texture granular, rough. Form elliptical, the edge broken by the granulation.

Rostrum blunt-pointed. Cephalothorax small, conical. Pseudo-stigmata dorsal; pseudo-stigmatic organs setiform, serrated spines. Inter-lamellar hairs similar; rostral hairs short and simple. Legs short, of about even thickness throughout, joints rough; tactile hairs on all legs; a whorl of thin curved hairs on each of the central joints of the two front pairs of legs, a few similar hairs on the hind legs.

Abdomen elliptical, notogaster flat, ventral surface arched. Notogaster stands much above cephalothorax. Cast notogastral skins carried flat on the back. The larval skin forms a central shield and the nymphal skins almost concentric rings bordering it, but each skin is usually a trifle in advance of that below it. The larval skin is arched and bordered by about seventeen thin, curved,

sparsely-serrated, colourless spines, the hindermost of which is central. There are three pairs of similar spines on the notogaster. Round the margin of each nymphal skin are about twenty brown, chitinous, more or less conical papillæ; these gradually enlarge in size from anterior to posterior; each carries an excessively long slender spine of clear chitin, sparsely serrated; the anterior are mostly doubly-curved, and stiff, or nearly so, and are of similar form on the two sides of the abdomen; those nearer the posterior extremity are more flexible. Many of the spines are longer than the whole length of the body, and as they stand out radially, and border each cast skin, they give the creature a most extraordinary appearance. Some of the spines which project over the cephalothorax cross and form a series of bilateral figures, all different.

The larva, plate VII. fig. 1.

This is almost colourless, slightly grey; its appearance in other respects may be gathered from the above description of the cast skin.

NOTASPIS SERRATA sp. nov., figs. 2, 2a.

Average length about	:56 mm.
„ breadth „	·37 „
„ length of legs, 1st pair, about	·30 „
„ „ 2nd and 3rd pairs, about	·28 „
„ „ 4th pair, about	·34 „

A species chiefly characterized by the extreme length and serration of the hairs on the notogaster, and by being thickly covered with short processes of the cuticle, which looks like a confervoid growth, and it is often strewn with small particles of lichen, &c.

Colour dull darkish-brown. Texture entirely without polish; coarsely pitted with circular or sub-circular areolations. Shape pyriform, posterior margin very round.

Rostrum narrow, rounded; rostral hairs curved and pectinated. Cephalothorax long, constricted at the juncture with the abdomen. No lamellæ, nor trans-lamellæ; lamellar hairs curved inward and serrated. Pseudo-stigmata near together, strongly projecting. Pseudo-stigmatic organs medium length with fine peduncles and short pyriform, almost globular, heads. Interlamellar hairs long, flexible, pectinated. Legs moderately long. Tarsi almost elliptical, but with long peduncles bearing the claws. Tactile hairs short. A whorl of curved, pectinated hairs on each of the three central joints of each leg, except the tibiæ of the hind pairs.

Abdomen oval, narrow anteriorly, broad posteriorly, where the notogastral plate is bent down so as to form some part of the ventral surface. There is a somewhat irregular row of very long.

flexible, serrated hairs round the margin of the notogaster, and two rows of about three similar hairs nearer the median line. Ventral plate small. Genital and anal apertures large, the former almost square, the latter diamond-shaped.

Nymph.

The usual appearance of the creature is an irregular lump of small pieces of lichen, white powder, and debris, from which springs a forest of long serrated hairs, standing out on every side far beyond the body.

Colour pale-fawn or mouse-colour. Texture rough and leathery. Shape almost oblong.

Cephalothorax distinctly divided into rostrum and hinder part; the latter nearly as wide as the abdomen. Rostral hairs long, serrated, curving inward, and usually crossing. Pseudo-stigmatic organs and interlamellar hairs as in adult. Legs short, fourth pair hardly reaching hind margin, thick. Femora of two front pairs considerably enlarged; whorls of serrated hairs as in adult.

Abdomen not much arched, nearly parallel-sided. Anterior margin slightly rounded, posterior rounded and depressed; sometimes with a slight median indentation. The out-line rough from the texture and shrivelling of the skins and the foreign matter adhering to them. The cast notogastral skins are carried flat and concentrically on the back, but shrivelled, and so hidden by debris that they can often only be noticed from the long serrated hairs which border them. The larval skin shows indications of transverse corrugations. Each skin is bordered by a close row of very long serrated hairs, directed outward and backward, but curving strongly upward and inward at their distal ends. Those on the outer skin are usually far the longest.

I found the species first at Hopwas Wood, Warwickshire; since then I have taken it more abundantly at Ambleside, Westmorland, and Keswick, Cumberland; Mr. E. Bostock has sent me specimens from Stone, Staffordshire, and Colwyn Bay, North Wales. It is usually amongst lichen on walls or rather dry places.

NOTASPIS JUNCTA sp. nov., plate VII. fig. 3.

Average length about	·22 mm.
„ breadth „	·13 „
„ length of legs, 1st pair, about	·12 „
„ „ 2nd and 3rd pairs, about	·11 „
„ „ 4th pair, about	·15 „

A minute species, remarkable for the form of the lamellæ, which meet in the middle of the cephalothorax, and for their long, closely-approximated cusps.

Colour rather light yellow-brown. Texture polished, without punctures (visible with say 200 diameters amplification). Shape short pyriform.

Rostrum pointed; rostral hairs nearly straight. Palpi slightly protruded. Lamellæ thin, slightly undulated, blades on edge; widely separated posteriorly but touching anteriorly at about the centre of the cephalothorax. Cusps very long, starting with a rounded shoulder and twisting over so as to become almost horizontal; they have curved sides and diminish to a blunt point. Lamellar hairs terminal, long, straight, directed forward. Pseudo-stigmatic organs rather short, with slender peduncles extending slightly beyond the pseudo-stigmata, and rather long fusiform heads, which are set at a slight angle with the peduncles. Legs rather short, fourth pair little longer than the abdomen. Femora very broad, thin and rounded, with large blades. Tibiæ much enlarged towards distal ends. Claws monodactyle.

Abdomen a very short ellipse, almost globular, anterior margin slightly truncated; at each antero-lateral angle is a blade-like projection with an undulated lateral and a square posterior edge. There are a few hairs round the hind margin of the abdomen. Genital and anal plates large, roundish, near together.

I have found the species chiefly in moss on trees at Epping Forest. It is not common.

NOTASPIS LONGILAMELLATA sp. nov., plate VII. fig. 4.

Average length about	·33 mm.
„ breadth „	·18 „
„ length of legs, 1st pair, about	·17 „
„ „ 2nd and 3rd pairs, about	·16 „
„ „ 4th pair, about	·18 „

A species chiefly distinguished by the length of its rostrum and lamellæ.

Colour and texture as in *N. juncta*. Shape elongated pyriform. Cephalothorax very long, about five-twelfths of the total length. Rostrum conical, pointed; hind part of cephalothorax almost square. Rostral hairs small, nearly straight; palpi showing, almost at the tip of the rostrum. Lamellæ mere thickened bars, very long, reaching more than half-way along the rostrum; they approach each other for about one-third of their length, commencing posteriorly, then suddenly turn forward and continue parallel until their ends. No cusps nor trans-lamella. Two short paired ridges are situated at the base of the cephalothorax, commencing near the median line, with small, chitinous, almost half-moon-shaped projections, from which thinner ridges run outward and slightly forward, until they nearly touch the pseudo-stigmata; then they turn

inward and forward, and terminate in a short piece bent forward. Pseudo-stigmata large, lateral. Pseudo-stigmatic organs with long filiform peduncles and very short fusiform (pointed) heads. Interlamellar hairs shortish, setiform. Legs rather short, hind pair not reaching posterior margin. Femora without blades; claws monodactyle.

Abdomen truncated anteriorly, rounded posteriorly, antero-lateral angles slightly produced, forming small blunt points. There are two sparse longitudinal rows of fine hairs on the notogaster, and a series of similar hairs round the margin. Genital and anal plates small, pentagonal, far apart.

NOTASPIS PECTINATA sp. nov., plate VII. fig. 5.

Average length about .42 mm.
 „ breadth „ .22 „

A species readily distinguished by the form of the pseudo-stigmatic organs.

Colour rather light yellow-brown; texture smooth but not polished, shape almost fusiform.

Cephalothorax rather small; rostrum pointed; rostral hairs moderate length; palpi not showing. Lamellæ mere ridges, very short, sloping forward and inward but leaving a considerable space between their anterior ends. There is a second pair of more curved ridges at the base of the rostrum. No trans-lamella. Pseudo-stigmata lateral; pseudo-stigmatic organs very long, line-of-beauty shaped; the general direction being backward, upward, and outward. They are slightly thickened in the middle, and have a few distinct widely-separated pectinations upon one side of the middle and some of the anterior portion. Interlamellar hairs much shorter than pseudo-stigmatic organs. Legs moderately long; fourth pair passing hind margin. Femora without blades. Claws monodactyle.

Abdomen acorn-shaped, rounded and slightly truncated anteriorly, pointed posteriorly. Two longitudinal rows of fine hairs on notogaster. Genital and anal plates large, almost pentagonal, near together.

I have only found two or three specimens, all at the Land's End, Cornwall, in moss on the ground.

NOTASPIS CLAVIPECTINATA sp. nov., plate VII. fig. 6.

Average length about	.33 mm.
„ breadth „	.19 „
„ length of legs, 1st pair, about	.21 „
„ „ 2nd and 3rd pairs, about	.18 „
„ „ 4th pair, about	.25 „

A species recognizable by the form of the pseudo-stigmatic organs.

Colour and texture as in *N. juncta*.

Rostrum conical, rounded at tip, cephalothorax behind rostrum would be square were it not for a slight constriction in the middle. Rostral hairs short; palpi projecting. No lamellæ nor trans-lamella. Pseudo-stigmatic organs nearly erect, rather long, with thin, filiform peduncles and short, flat, pyriform heads, from which some stiff bristles, about as long as the heads, radiate. Inter-lamellar hairs shorter than pseudo-stigmatic organs. Legs rather long; fourth pair reaching considerably beyond the hind margin. Femora slim, without blades. Claws monodactyle.

Abdomen elliptical, the breadth of the ellipse varies considerably in different specimens. Two longitudinal rows of fine hairs on notogaster, and a series of similar hairs near the margin. Genital and anal plates far apart, nearly square, the latter much larger than the former.

NOTASPIS QUADRICARINATA sp. nov., plate VII. fig. 7.

Average length about	·2 mm.
" breadth "	·13 "
" length of legs, 1st pair, about	·11 "
" " 2nd " "	·10 "
" " 3rd " "	·12 "
" " 4th " "	·13 "

A thick-set species remarkable for the ridges on the abdomen.

Colour and texture as in *N. juncta*.

Cephalothorax long and large; about five-twelfths of total length, forming a truncated cone. Rostrum blunt, rounded; rostral hairs short. Lamellæ strong, clearly-marked ridges, almost blade-like, short, slightly undulated, without cusps, but ends joined by a very strong trans-lamella. Pseudo-stigmatic organs short, slightly recurved, with thick fusiform heads on short peduncles. A short, doubly curved ridge starts above the insertion of each first leg and terminates a little in front of the lamella. The pseudo-stigmata are joined posteriorly by a transverse ridge. Legs short and thick; femora without blades; claws monodactyle.

Abdomen short and arched, truncated anteriorly. There are four longitudinal ridges on the anterior part of the notogaster; the central pair turn at right angles and run a short distance along the anterior margin and then return and run parallel to their original course, looking like two shorter extra ridges. Four sparse rows of short hairs on notogaster. Genital and anal plates large, near together, almost square.

NOTASPIS LANCEOLATA, sp. nov., plate VII. fig. 8.

Average length about	·33 mm.
„ breadth „	·20 „
„ length of legs, 1st pair, about	·21 „
„ „ 2nd „ „	·19 „
„ „ 3rd „ „	·20 „
„ „ 4th „ „	·24 „

A species most easily known by the short lamellæ meeting anteriorly, and the pseudo-stigmatic organs which have terminal hairs.

Colour and texture as in *N. juncta*. Shape almost fusiform.

Cephalothorax short, conical. Rostrum pointed; rostral hairs rather long, almost straight. Lamellæ short ridges starting from the pseudo-stigmata, and running inward and forward until their ends meet only a short distance from the abdomen. Lamellar hairs long, setiform. Pseudo-stigmatic organs with long thin peduncles, and slender fusiform heads, each terminated by a single bristle. Interlamellar hairs long, setiform, erect. Legs rather long, fourth pair considerably passing the hind margin. Femora slender, without blades; claws monodactyle.

Abdomen a long oval, the larger end forward. Four longitudinal rows of fine hairs on the notogaster and a spine on each antero-lateral margin. Genital and anal plates very large, close together, almost pentagonal.

DAMEUS SUFFLEXUS sp. nov., plate VII. fig. 9.

Average length about	·65 mm.
„ breadth „	·40 „
„ length of legs, 1st pair, about	·62 „
„ „ 2nd „ „	·52 „
„ „ 3rd „ „	·56 „
„ „ 4th „ „	·70 „

A species remarkable for the extent to which the dorsal plate is bent under, on to the ventral surface, and the consequent small size of the ventral plate.

Colour dark hazel-brown. Texture dull; cephalothorax and legs rough.

Rostrum rather long, tip rounded; it has a slight median carination extending about half-way along the cephalothorax. There is a rounded boss on each side beyond the edge of which the first leg is articulated. Behind these bosses is a sharp narrow constriction, then a larger boss on each side beyond which the second leg is articulated, and then follows a second constriction; the last-

named bosses bear the pseudo-stigmata, which are very projecting and nearly upright. Pseudo-stigmatic organs rod-like. Rostral hairs sharply curved, thick; lamellar hairs similar, larger. Legs long and thin, of the typical *Damæus* form, but neither the whole leg nor the peduncles of the individual joints are as long or thin as in *D. clavipes*, *D. tenuipes*, &c. An irregular whorl of thick, sharply-curved hairs on each joint except coxæ and tarsi. Each tarsus has a large spike near its proximal end, in the upper median line.

Abdomen globose, very finely punctured. Dorsal plate very much bent down and under, so as to form part of the ventral surface, especially posteriorly; ventral plate consequently very small. A small projection each side between the third and fourth legs, and a row of brown spike-like hairs round the hind part of the margin.

This creature was discovered by Mr. E. Bostock at Stone, Staffordshire. I have since found a single specimen at Keswick, Cumberland.

DAMÆUS TENUIPES sp. nov., plate VII. fig. 10.

Average length about	·67 mm.
„ breadth „	·45 „
„ length of legs, 1st pair, about	·77 „
„ „ 2nd „ „	·67 „
„ „ 3rd „ „	·84 „
„ „ 4th „ „	1·35 „

A species marked by the form of the pseudo-stigmatic organs and by the long legs.

Colour brown, of medium depth, with a slight purple bloom. Creature usually dusted with white powder. Texture of cephalothorax roughish, of abdomen smooth, but not polished.

Cephalothorax considerably narrower than abdomen; rising to broad elevations opposite the insertions of the first and second legs, leaving a strong depression between. Central part of cephalothorax raised and arched, there is a sharp depression before the abdomen. Rostrum small, pyramidal. Two pairs of rostral hairs. The elevation opposite the first leg has a small projection to which the leg is articulated. There is a much larger projection to the posterior edge of which the second leg is articulated; it is rounded and without any anterior point. There is a smaller projection with a curved anterior point behind the second leg. Pseudo-stigmata much raised, near together. Pseudo-stigmatic organs rather short, with rod-like peduncles of even thickness throughout, heads suddenly increased in thickness and continuing of the increased diameter until near the point; so that the organs have

the appearance of each bearing an elongated cap or pileus, standing outward and slightly forward. Interlamellar hairs short, rough, rod-like. Legs very long and slender. The principal hairs upon them slightly imbricated.

Abdomen almost globular, without markings; it bears two rows of about eight strong, almost straight, black hairs on the notogaster, which diminish in length from the anterior to the posterior; there is also a row of hairs on the hind margin; all these hairs are slightly imbricated. There is a small blunt projection in front of the insertion of each third leg, and a larger one to the anterior angle of which this leg is articulated. The creature sometimes carries its cast skins in a small shrunken lump on the back.

Nymph.

Colour very light grey or straw, almost colourless, legs and rostrum pinkish. Texture polished; semi-transparent.

Rostrum small, rostral hairs curved. Cephalothorax suddenly enlarged behind the rostrum, round and arched. Pseudo-stigmatic organs as in adult. Legs very long and slender.

Abdomen oval, smooth, without markings, anterior margin roundish, posterior with a bifid point, from each division of which springs a long black hair, curved backward and outward. There is a pair of similar hairs on the anterior margin, and two rows on the notogaster. The cast skins are carried in the mode described in the introductory part of this paper.

I have only found the species in the thatch of a roof at the Land's End, Cornwall.

HYPOCTHONIUS LANATUS sp. nov., plate VII. figs. 11, 11a.

Average length about	·33 mm.
" breadth "	·18 "
" length of legs, 1st pair, about	·12 "
" 2nd " "	·10 "
" 3rd " "	·11 "
" 4th " "	·14 "

A species remarkable for its woolly hairs, its power of erecting the spines on the back, and its singular mandible.

Colour light yellow-ochre. Texture dull, reticulated, slightly pulverescent.

Cephalothorax small, irregularly reticulated. Rostrum blunt; lamellæ low rough ridges, extending forward. Rostral, lamellar, and interlamellar hairs, also a pair of hairs at the anterior sides of the pseudo-stigmata, and a pair between these and the lamellar-hairs, all like bunches of white wool. The rostral hairs are the

largest. These woolly hairs under a high amplification are seen to consist of a central stem, with very fine hairs radiating from it like a fox's tail. Pseudo-stigmatic organs long, almost straight, directed backward and outward, they have long rod-like peduncles and fusiform heads, which are woolly like the hairs. Palpi thick, almost conical, slightly projecting. The mandible (fig. 11a) is small but remarkable. The fixed arm of the chela is the shorter and is narrowed to a sort of neck; it has four large teeth; above, and close to it, is a projection from the body of the mandible somewhat in the form of the human hand, being deeply cut into five large teeth or fingers. The movable arm is more normal. Legs rather short; fourth pair not reaching hind margin, gradually diminished in thickness, whorls of short, woolly, curved spines on the three central joints of each leg.

Abdomen pyriform, slightly truncated anteriorly, coarsely reticulated. The division of the notogaster into four segments very conspicuous; each segment is provided with a transverse row of long, colourless, serrated spines, which usually lie horizontally, but can be erected, apparently, at the will of the creature; all are erected together. The spines on the second segment are the shortest, and those on the third the longest. Round the hind margin are about eight short, curved, woolly hairs.

The nymph is very like the adult, but white.

The creature is uncommon; the largest number that I have found were in an old thatched roof near the Land's End, but I have met with single specimens occasionally in old wooden boxes, &c.

IX.—*Structure of the Diatom Shell. Siliceous Films too thin to show a broken edge.* By JACOB D. COX, LL.D., F.R.M.S.

(Read 13th May, 1885.)

IN the current discussion of the structure of the diatom valve, an interesting question has been started regarding the possibility of proving the actual presence of films of siliceous, whose tenuity is so great that they are not visible by ordinary transmitted light. Many observers have questioned, for instance, the existence in *Triceratium favus* of an outer film covering the hexagons on the convex surface of the valve, and others have denied the existence of a similar film covering either the "eye-spots" or the hexagons in *Coscinodiscus oculus-iridis*, &c.

In former papers on this subject, in which I have maintained the presence of such films, I have relied mainly upon what seemed to me the very conclusive evidence obtained from the examination of the diatoms as opaque objects, either with ordinary powers or with high powers aided by the vertical illuminator.* A thin homogeneous film of siliceous of even thickness, so little affects the passing light, that the test of colour alone is hardly sufficient to detect its presence in silicified membranes so extremely delicate as those I have mentioned. In valves broken across the alveoli there is no great difficulty in demonstrating, by photography, the presence of the outer (convex) film in the *Coscinodiscus* and the inner (concave) one in the *Triceratium*.† These are made visible by the dotted markings upon them, and they have, moreover, in the stronger examples, a sufficient thickness to present a visible broken edge, and to make the colour test of value in discriminating the film. But in the case of the outer (convex) film of the *Triceratium*, and that covering the "eye-spots" of the inner (concave) one of the *Coscinodiscus*, whilst I insist that both by colour and by the fractured edge they may sometimes be detected, I fully admit that by the latter test (the discrimination of a fractured margin) their presence cannot commonly be proved.

If the evidence gained from the examination of the frustules as opaque objects shall be recognized as conclusive (as I certainly regard it), the question would be simply, How can we account for the apparent emptiness of the areolæ in nearly all the cases in which these thinnest films are broken across? Three answers may be given: 1st. That so fragile a film may have been destroyed by the force which fractured the valve; 2nd. That the film may have been so imperfectly attached to the hexagon walls (in the case of the *Triceratium*) as that when fractured it floats off or is removed;

* See this Journal, iv. (1884) p. 941.

† Cf. Broken Shell Series, in the Society's Library, Nos. 21-3, 26, 63, 95.

and 3rd. That the film may be of such tenuity that not even its broken edge refracts the light sufficiently to make it visible. The first of these answers will be a satisfactory one in many cases, and does not need to be enforced by much argument. The second is illustrated by the condition in which the finely dotted film of *Heliopelta* is often found. When it is separated from the heavy sub-hexagonal network of the alternate segments of the valve it shows no mark of attachment to these, but is as free from any trace of their outline as if it had never been in contact with them.* It is quite possible that the outer film of *Triceratium* may have a similar loose connection with the hexagons below.

It is, however, to the third of the suggested answers that I wish to call more particular attention; for I have myself been surprised at the conclusiveness of the proof that in microscopical work we have frequently to deal with laminae so thin that our widest-angled glasses entirely fail to detect the outline of a broken margin.

The example which I have selected to illustrate this is *Isthmia nervosa* Kütz. In a former study of this species I noted the fact that the alveoli sometimes show a notched margin where connected with the valve, as if teeth from the thicker part ran down upon the thinner film covering the circular or oval space of the alveoli. I also noted the occasional occurrence in the hoops of this diatom, of a very thin lamina extending beyond the thicker band, as if the suture which usually divides these hoops transversely had been forcibly broken before it was quite ripe, and part of the band had been split off in a very thin wedge-shaped film.† The remembrance of these phenomena has led me to a further investigation in reference to the question of the visibility of these films, as they offer a convenient series of varying thickness.

The hoop of *Isthmia* is a smooth band of siliceous film in which the alveoli are nearly circular, and showing, usually, no evidence of a film covering the apparent opening, except in the increased colour which is so slight as to be of no great weight as proof. The rim of each circlet shows a bright white light which gives the whole an appearance very similar to that of the openings in the reticulated *Polycystinæ*. But occasionally the bright rim of light is broken by four or more pink bars which connect the central portion of the circle with the surrounding lamina of siliceous film at different points in the periphery, and in still more rare examples this central part of the circle is both thickened and mottled till the visibility of the film admits of no dispute.

The alveoli of the valve are of an irregular oval shape, and in

* Cf. Photograph No. 27 in the series before referred to.

† Amer. Journ. of Microscopy, iii. (1878) pp. 97-101, 125-30.

a majority of cases the notching of the edge which I have mentioned, indicates, with the heightened colour of the central parts of the oval, the presence of a film connected with the stronger part of the valve by little teeth which give the rim the notched appearance. But I have found specimens in the fossil deposits of Santa Monica and San Luis Obispo, Cal., and Moron, Spain, in which the vigour of growth has been so great that the film covering the alveoli is strongly marked over its whole surface with a well-defined arabesque pattern. Whenever these shells are broken, it is only in the most robust that the edge of the fractured film within the alveoli can be traced. In by far the greater number the space appears to the eye quite as empty as the "eye-spots" in the *Coscinodisci*, and no care in scrutiny can detect the broken margin after it enters the oval or circular space.* Yet we know that the film is there by the manner in which it is incontestably presented in the stronger specimens of the same kind.

The evidence found in the split film projecting beyond the suture of the hoop of *Isthmia* is more direct, and if possible more conclusive. In this, though the siliceous film is so thin that one hesitates to say that it has given even the faintest tint of pink to the background, the outlines of the alveoli are plainly seen near the suture; but these grow more indistinct until they disappear. Beyond them, no marginal line of the film can by any possibility be traced in those cases in which the split film gradually diminishes to a knife edge. The faint circles of the alveoli are seen in their quincuncial order with nothing apparent to connect them with the more solid parts of the shell, and as if they were the ghosts of small circular diatoms regularly scattered in the field.† In such cases I have exhausted patience in toying with the fine adjustment of the Microscope, trying to find some point in the curved surface at which the margin could be traced, but in vain. In examples in which the split film was broken near the suture and where it had appreciable thickness, its edge was apparent enough; but not in cases where it ran out to its greatest thinness. Yet the curved or thickened margin of the alveoli produces effects of refraction which demonstrate the presence of a lamina of which we should have no knowledge whatever by any other means.

The negative evidence which is found in the apparent emptiness of the circles of broken alveoli is thus demonstrably answered. It is shown that thin films do exist where they cannot be seen of themselves and whose broken edges cannot be traced, in places strictly analogous to those of the "eye-spots" in *Coscinodiscus* and *Triceratium*. The affirmative evidence which is found in the

* Photographs Nos. 101-3, 107, 108.

† Photographs Nos. 102, 103.

examination of these species as opaque objects and with the vertical illuminator is therefore restored to its full force and weight, undiminished by the fact that such films are not always, or even usually, seen in observations by means of transmitted light.

The hoop of *Isthmia* furnishes us with evidence, also, upon another point which has very naturally been the subject of dispute: I mean the permeability of the films covering the alveoli, by the media used in examining and mounting the specimens. It was long since noticed that before the laminae of the *Isthmia* hoop slide upon each other in the growth of the diatom, the areolæ of the dots are concentric, and but one dot will be seen where, as soon as the sliding begins, two are plainly visible. In examples of the more strongly marked sort, I have been able to detect the mottled film which covers the alveolus, in both the outer and the inner laminae. Before the sliding process begins, therefore, we certainly have at least one, if not two, completely inclosed areolæ between the siliceous films. This will be conceded by those who hold that the areolæ in each separate lamina are not completely inclosed, as well as by those who believe that they are; for two pitted surfaces, however applied to each other, would make inclosures of these pits. Yet, when the *Isthmia* is mounted, the dots of the thickest hoop, where no sliding has occurred, are as free from air-bubbles or evidence of vacuum as any other parts of the diatom. It would seem to follow necessarily, therefore, that the medium has penetrated these little cavities, and if in this instance it does so, the supposed difficulty on this score vanishes also in the case of *Coscinodiscus*, of *Triceratium*, and the rest. A majority of observers appear to have been convinced that this permeation of the frustule walls must take place, since whole and unbroken frustules are found to be filled with the mounting medium; but the proof above indicated may be of service in removing doubts in the minds of some who have still remained unconvinced.

Whilst thus presenting examples from *Isthmia nervosa* as demonstrative evidence of the character of the films covering the alveoli in diatoms, I wish to be understood to look upon it as cumulative proof only, and by no means as admitting that the direct examination of valves of *Coscinodiscus oculus-iridis* and *Triceratium favus* is not enough to establish with reasonable certainty the existence of the outer and inner films in those species. The concentric circles of pink colour seen in the "eye-spots" of the largest specimens of *Coscinodiscus* are a distinguishing mark separating these from the homogeneous appearance and even tint of the Polycystinæ openings, and are as real if not as manifest evidence of a film as the elaborate sculpture in the similar film of *Isthmia*. As to that which covers the outer (convex) surface of *Coscinodiscus*, it has now been observed and figured in so many species that although

it has hitherto been disputed, further debate as to its existence can hardly be regarded as tenable. Grunow has figured it in several varieties of *C. asteromphalus* Grun., and in *C. excentricus* and *C. lineatus* Ehr.* Besides verifying it in these, I have observed and noted it in *C. oculus-iridis* Ehr., *C. radiatus* Ehr., *C. perforatus* Ehr., *C. centralis* Ehr., *Systephania diadema* and *S. corona*, Ehr., in *Endyctia oceanica* Ehr., and *Eupodiscus radiatus* Bailey. In some of these cases it is only the marginal circle of dots within the hexagon which can be clearly seen, but after the preceding steps in the proof, these will be regarded as sufficiently conclusive marks of the presence of a covering film. This type of construction is therefore probably common to all the disk forms of the Diatomaceæ having large hexagonal alveoli. It may be well to emphasize the assertion that in these disk forms the "eye-spot" film is invariably that which is upon the inner or concave surface of the valve, and it is the outer which, when thickened, shows the system of dots within the hexagons and to which the hexagonal walls of the alveoli are permanently adherent.† In *Triceratium favus*, on the other hand, it is the inner film which is the heavier and contains the radiating system of dots. It is to this that its hexagonal walls are permanently attached.

It is no uncommon thing to find broken specimens of *T. favus* which give us natural sections as perfectly made as any that could be produced by cutting. The strong marginal band of the valve is very often fimbriated, and the fimbriæ show a tendency to become confluent. This gives an increased breadth to the band, and it now projects almost equally above and below the floor of the valve containing the hexagons. The shell often breaks upon a line parallel to the marginal band and through the row of alveoli nearest to it, giving a perfect section through these hexagons. In a mounted preparation the fragment will adhere to the cover-glass by the broad band which is so transparent that one may easily focus through it upon the walls of the hexagons thus presented in section. In such cases these walls appear as a line thickened into a knob at the top, whilst the dotted floor of the alveoli is shown as a continuous line at right angles to the walls.‡ In most of such examples the thinner outer film cannot be traced. In others it seems to be present; but as in the latter examples there may be doubts whether the section does not include more than one row of alveoli, the evidence from this source cannot be regarded as conclu-

* Van Heurck's 'Synopsis des Diatomées de Belgique,' 1884, pls. 128, 130, 131.

† In his drawings of sections of diatoms Dr. Flögel would seem to make the "eye-spot" film of *Coscinodiscus radiatus* the outer film of the valve. See this Journal, iv. (1884) pl. ix., figs. 23, 24, 26. I have never found it in that situation.

‡ Photographs Nos. 100, 106.

sive. These natural sections also often exhibit the horn or process at the corner of the valve in a very interesting way.

With this paper I send to the Society photographs in continuation of the series formerly sent, and which seem to me to illustrate, and fairly to confirm, the observations which I have detailed above. I will only notice one other point in diatom structure which is shown in a noteworthy manner. In two of the prints of *Pleurosigma formosum* W. Sm., will be found a specimen in which a thread of silex forming part of the mechanism of the raphe or median line is for a considerable distance separated from the half-valve to which it belongs. At the point where it is still connected and where the other half of the broken shell is also in place, the lapping of this second half of the valve over the rod or thread may be traced.* The bright line which is continuous with the line of separation of the rod from the valve indicates the thinness of the connecting film, which is again proved by the fact of the fracture along it. The whole connection of the parts would thus seem to be plainly shown to be a "tongue and groove" joint from the central nodule to the terminal one.

For convenience of reference to the photographs by the Fellows of the Society, I give a list of the additions to the series which I send with this paper. Like the former ones, all have been made with the common lamp, and all but Nos. 69 and 71 with a small beam of strictly central light. The two excepted were made with a stop upon the condenser, having two round holes equidistant in the horizontal diameter of the opening of the condenser, such as was recommended for use with the binocular by Dr. R. H. Ward many years ago,† and which is now furnished with Abbe's binocular eye-piece by Zeiss. Using this on the monocular instrument gave in those cases somewhat oblique cross-lights. Whenever it promised good results, the plates were intensified with bichloride of mercury.

No. 53. *Navicula serians* Kütz. $\times 1565$, exposure 16 minutes. A fragment showing fracture through the dots, and the appearance in H. L. Smith's dense medium (2.4). From H. L. Smith's slide of fossil diatoms from Willington, Conn.

No. 57. *N. serians* Kütz. $\times 1250$, exposure 10 minutes. Whole shell with a segment separated by a crack running through the dots. From Möller's slide of fossil diatoms from Monmouth, Maine, in balsam.

No. 60. *Pleurosigma formosum* W. Sm. $\times 1135$, exposure 10 minutes. Shell broken across, showing separated median line, and fracture through the dots. From Möller's slide of Samoa sea-mud, in balsam.

* Photographs Nos. 60, 79.

† Amer. Naturalist, 1870.

No. 63. *Coscinodiscus oculus-iridis* Ehr. \times 1500, exposure 10 minutes. Showing the outer film covering the hexagons, and its fractured edge. From Möller's slide of Nottingham earth, in balsam.

No. 65. *Navicula humerosa* Breb. \times 1480, exposure 10 minutes. Showing fracture between the costæ and through the dots. From H. L. Smith's slide in very dense medium (2.4).

No. 66. *N. serians* Kütz. \times 1300, exposure 11 minutes. Same shell as No. 57, but with different objective and focusing.

No. 69. *N. rhomboides* Ehr. (*Van Heurckia rhomb.* Breb.) \times 1300, exposure 15 minutes. Showing fractured edge. From Möller's slide of Monmouth earth, in balsam.

No. 70. Same shell, \times 1900, exposure 20 minutes, and afterwards intensified.

No. 71. Same shell, \times 1110, exposure 15 minutes. Taken with a different objective.

No. 79. *Pleurosigma formosum* W. Sm. \times 1100, exposure 13 minutes. Same shell as No. 60, with focus slightly changed to show mechanism of the raphe. From Möller's slide of Samoa sea-mud, in balsam.

No. 82. *P. formosum* W. Sm. \times 1200, exposure 12 minutes. Part of valve on one side of the median line diagonally broken, with the parts still in juxtaposition. From same slide as the last.

No. 83. *P. balticum* W. Sm. \times 1100, exposure 13 minutes. Fragment broken off parallel to midrib. From same slide as the last.

No. 84. *P. balticum* W. Sm. \times 650, exposure $6\frac{1}{2}$ minutes. Fracture across the shell. From same slide as No. 79.

No. 85. Same shell, \times 1050, exposure 10 minutes.

No. 86. *P. formosum* W. Sm. \times 1100, exposure 12 minutes. Same shell as No. 82.

No. 91. *P. balticum* W. Sm. \times 1270, exposure 10 minutes. Fragment from Peticolas' dry slide of diatoms from Long Island Sound.

No. 94. *P. balticum* W. Sm. \times 1300, exposure 13 minutes. Same shell as No. 85.

No. 95. *Triceratium favus* Ehr. \times 1300, exposure $12\frac{1}{2}$ minutes. A specimen with unusually bold marking within the hexagons. From Möller's slide of sea-mud from St. Vincent's, W.I., in balsam.

No. 96. *Stauroneis pulchella* W. Sm. (var.) \times 1100, exposure 10 minutes. A broken shell, showing the elongated hexagons, but without the *stauros*. From same slide as last.

No. 98. *S. pulchella* W. Sm. \times 950, exposure 10 minutes. From Möller's slide of Samoa sea-mud, in balsam.

No. 100. *Triceratium favus* Ehr. \times 1000, exposure 8

minutes. Fimbriated rim with fracture through first row of hexagons showing these in section. From Peticolas' slide of diatoms from Fernandina, Florida, in balsam.

No. 101. *Isthmia nervosa* Kütz. \times 1180, exposure 10 minutes. Fragment of valve, showing dots around margin of alveoli. From my own preparation of recent diatoms from California, in balsam.

No. 102. Same species, \times 1220, exposure 12 minutes. Hoop, showing vanishing film extending beyond the suture. From same slide as last.

No. 103. Same object, \times 740, exposure 6 minutes.

No. 106. *Triceratium favus* Ehr. \times 1150, exposure $12\frac{1}{2}$ minutes. Fragment, focused upon a plane through the process and adjacent hexagons. From Peticolas' slide of diatoms from Fernandina, Florida, in balsam.

No. 107. *Isthmia nervosa* Kütz. \times 1100, exposure 10 minutes. Fragment of valve with unusually strong marking in the alveoli. From Peticolas' slide of San Luis Obispo (California) earth, in balsam.

No. 108. Same object as the last, \times 1100, exposure 10 minutes. Focused upon another part of the curved surface.

X.—On the Structure and Origin of Carboniferous Coal Seams.

By EDWARD WETHERED, F.R.M.S., F.G.S., F.C.S.

(Read 13th May, 1885.)

PLATES VIII and IX.

UP to the publication of the 'Proceedings of the Geological Society of London' for the years 1838–42, there was considerable difference of opinion as to whether coal seams had accumulated from drift vegetation or from vegetation which grew *in situ*. In the 'Proceedings' referred to, however, three papers appeared, which served as powerful arguments in favour of the growth *in situ* theory. The first of these was by Mr. John Hawkshaw*

EXPLANATION OF PLATES.

PLATE VIII.

- Figs. 1 and 2.—Macrospores from the Shallow seam of Cannock Chase, $\times 22$.
 Fig. 3.—Microspores from the same, $\times 262$.
 Fig. 4.—Scalariform tissue from the top of the lower bed of the Welsh "Four Feet Seam," $\times 262$.
 Fig. 5.—Spores from the centre of the same, $\times 262$.
 Fig. 6.—Horizontal section of the same from about the centre of the bed, $\times 160$.
 Fig. 7.—Horizontal section of the same from the top of the bed close under the clay parting, $\times 160$.
 Fig. 8.—Horizontal section of the Better Bed seam of Yorkshire, from the uppermost 3 inches, $\times 12\frac{1}{2}$.
 Fig. 9.—B, Macrospore, $\times 22$, and A, A, microspores, $\times 262$, from the uppermost 3 inches of the Better Bed.
 Fig. 10.—Horizontal section of the Better Bed at 4 inches from the top, $\times 12\frac{1}{2}$.
 Fig. 11.—Macrospores from fig. 10, $\times 50$.
 Fig. 12.—Portion of a macrospore from the same, showing caudate appendages, $\times 50$.
 Fig. 13.—Horizontal section of the Better Bed 10 inches from the top, $\times 12\frac{1}{2}$, shows the coal to be mainly made up of tissue and hydrocarbon.
 Fig. 14.—Portion of decomposed and carbonized cellular tissue from fig. 13, $\times 50$.
 Fig. 15.—Another macrospore from fig. 10, showing caudate appendages, $\times 50$.
 Fig. 16.—A microspore, $\times 262$, from fig. 12.

PLATE IX.

- Fig. 17.—A macrospore from the lowest bed of Splint coal of Whitehill Colliery, near Edinburgh, $\times 22$.
 Fig. 18.—Microspores from the same, $\times 262$.
 Fig. 19.—Another variety of macrospore from the same, $\times 22$.
 Fig. 20.—Another variety of microspore from the same, $\times 262$.
 Figs. 21 and 22.—Other macrospores and microspores from the same, $\times 262$.

* Proc. Geol. Soc., iii. p. 139.

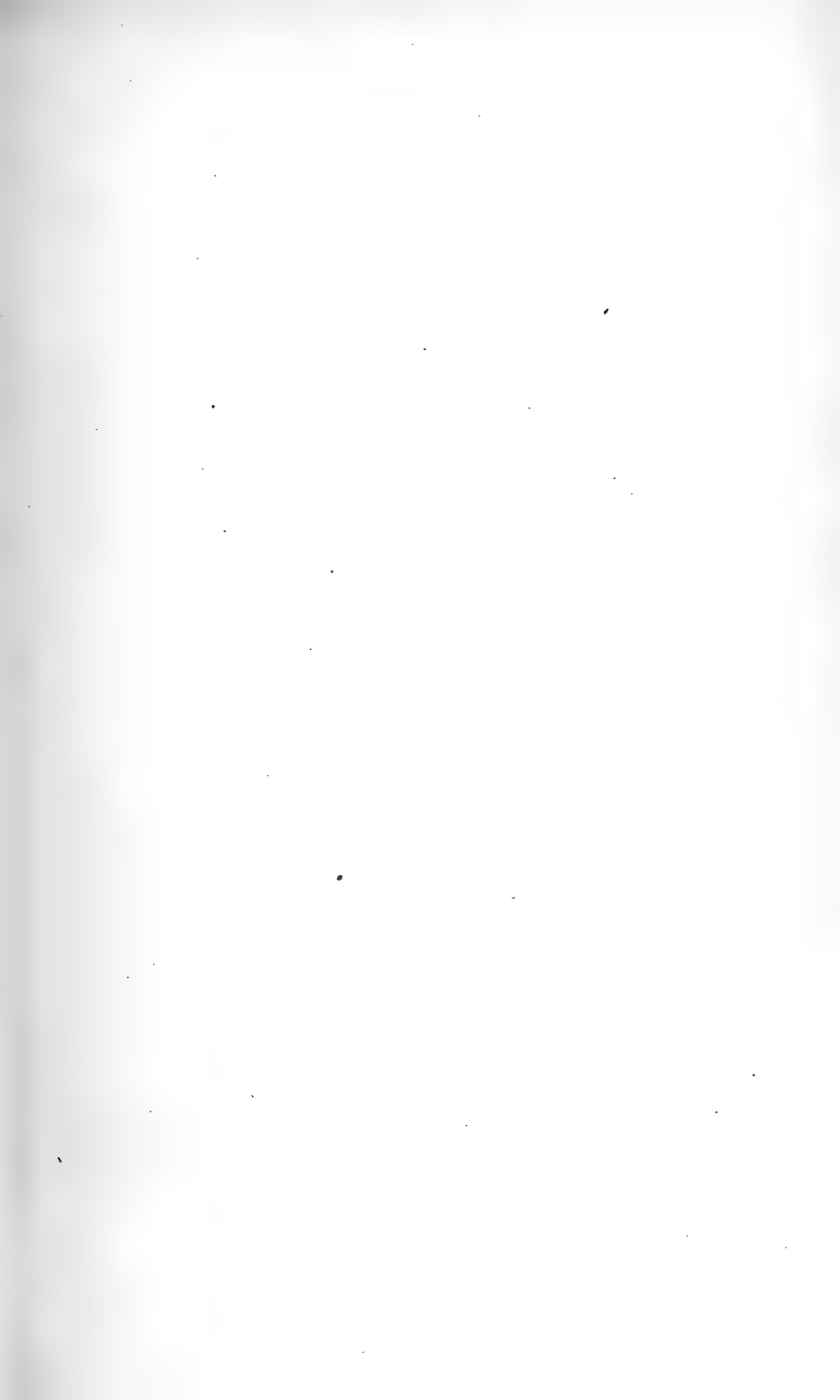

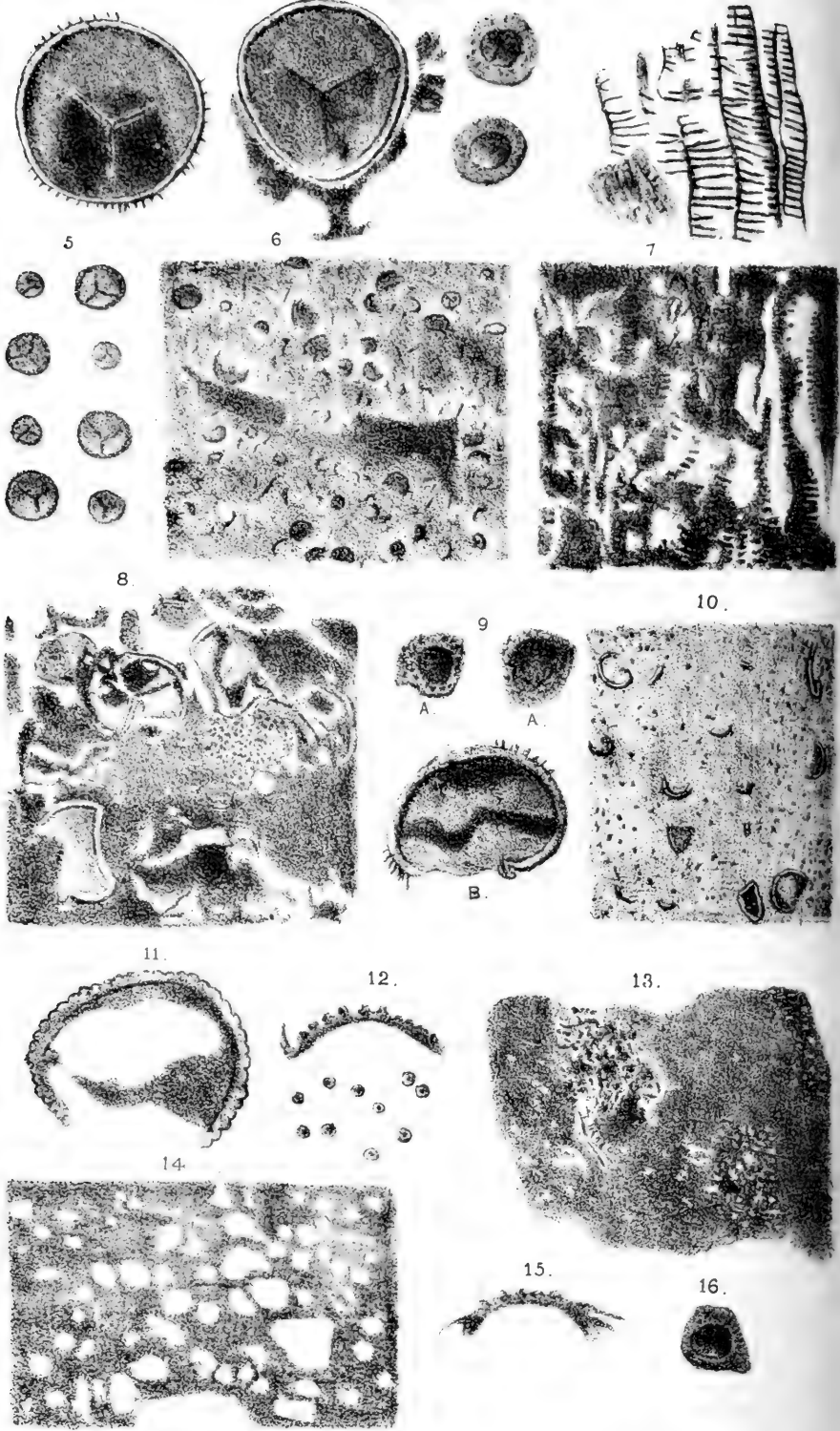



23.

22.

24.

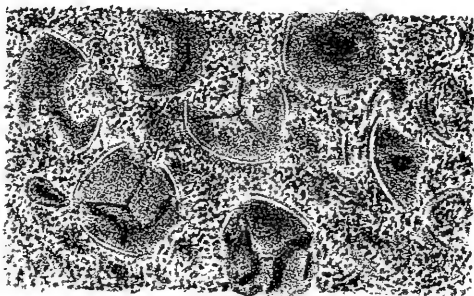
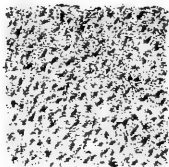

25.

28.



26.

27.

30

29.

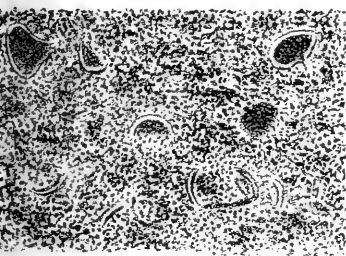

31.

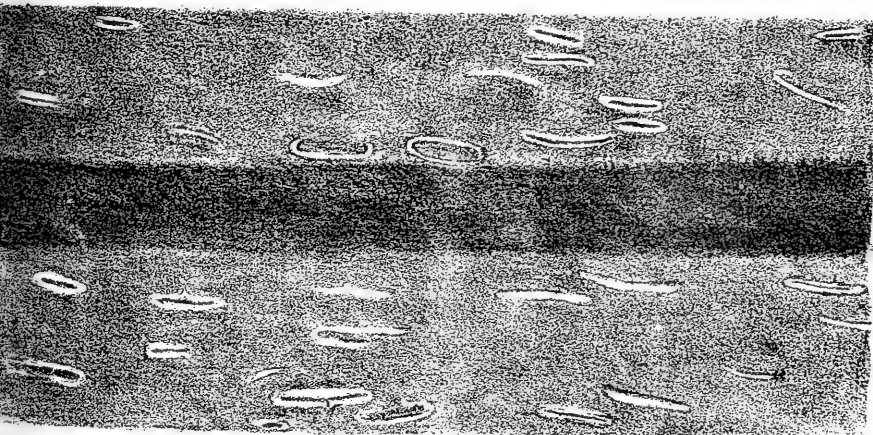

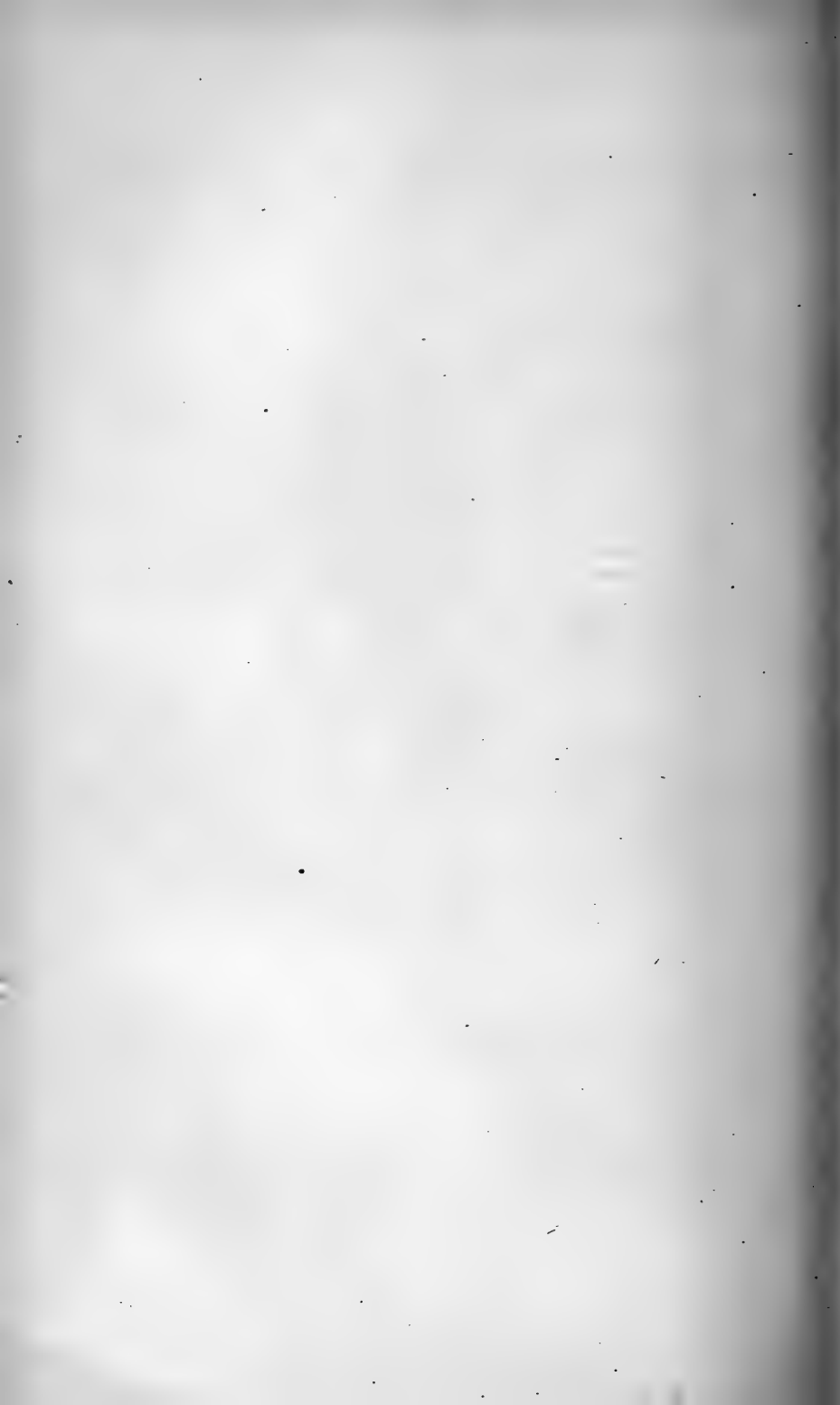

(now Sir John Hawkshaw), in which he describes five trees which had been discovered, standing as they grew, during the excavation of the Manchester and Bolton Railway. "The roots," Mr. Hawkshaw says, "are imbedded in a soft argillaceous shale, and in the same plane with them is a bed of coal 8 or 10 inches thick. Just above the covering of the roots, yet beneath the coal seam, so large a quantity of *Lepidostrobus variabilis* were discovered, inclosed in nodules of hard clay, that more than a bushel was collected around the base of the tree." The trunks were wholly enveloped by a coating of friable coal, varying from $\frac{1}{4}$ to $\frac{3}{4}$ of an inch in thickness, but it crumbled away on removing the matrix. The trees were doubtless *Sigillariæ*, but if they were typical of the vegetation which had formed the seam of coal, it is strange that the layer of coal $\frac{1}{4}$ to $\frac{3}{4}$ of an inch thick, which enveloped the roots, should have been of different material from the coal seam; that it was different is shown by the fact of its crumbling away. It is natural to suppose that the layer which lay at the base of the trees represented their remains, and this is supported by the occurrence of the *Lepidostrobi*, the fruit of the *Sigillariæ*. In a second paper* on the same subject Sir John Hawkshaw refers to the trees as "standing on the same thin stratum of coal as those first discovered." It is, therefore, not quite clear whether they extended through the coal or grew on the top of the seam.

The second paper† was by Mr. John Eddowes Bowman, F.L.S., "On the character of the fossil trees lately discovered near Manchester on the line of the Manchester and Bolton Railway, and on the formation of coal by gradual subsidence." In this paper the author supports the views shadowed forth by Sir John Hawkshaw, namely, that the trees grew where they were found, and had not drifted into the position. He also refers to some discovered towards the close of 1838 in driving the railway tunnel at

Fig. 23.—Portion of fig. 17, showing spine-like projections on the surface, $\times 262$.

Fig. 24.—Horizontal section of the lower bed of the Whitehill Colliery Splint coal, $\times 12\frac{1}{2}$. The spaces between the macrospores are filled with microspores which are slightly more enlarged so as to make them visible.

Figs. 25 and 26.—Macrospores from the middle bed of the Whitehill Colliery Splint coal, $\times 22$.

Fig. 27.—A microspore from the middle bed of the same, $\times 262$.

Fig. 28.—Another spore from the same, $\times 22$.

Fig. 29.—Horizontal section of the middle bed of the Splint coal, $\times 12\frac{1}{2}$.

Fig. 30.—Horizontal section of the top bed of the Splint coal, $\times 12\frac{1}{2}$.

Fig. 31.—Vertical section of the lowest bed of the Splint coal, showing a bright layer between two dull ones, and that the spores are confined to the latter.

* Proc. Geol. Soc., iii. p. 269.

† Ibid., p. 270.

Claycross, five miles south of Chesterfield. In this case it is clear that the base of the trees rested upon a seam of coal 15 inches thick. The stems and upper portion of the roots are described as "standing above the coal," and Mr. Bowman explains this by reference to similar phenomena in peat marshes, in which the base of the trunks of ancient forest trees stand with the roots exposed, owing to the shrinkage of the surrounding peat. But the peat, I must here point out, is not formed by these forest trees, but from the bog-mosses. The inference, then, to be drawn from these trees is, it seems to me, that the seam of coal was formed from bog growth, and that the *Sigillariæ* grew in the bog, as conifers and other trees do at the present time in modern bogs.

The third paper was by Sir William Logan (then Mr. Logan), "On the character of the beds of clay lying immediately below the coal seams of South Wales; and on the occurrence of coal-boulders in the Pennant Grit of that district." This is the well-known paper in which it was pointed out that immediately below every regular seam of coal in South Wales there existed a bed of under-clay in which was always to be found the fossil vegetable *Stigmaria*. This fossil was afterwards proved by Mr. Binney, and others, to be the root of the Lepidodendroid plants generally. The discovery of Sir William Logan, together with the finding of trees growing *in situ* and their remains associated with those of terrestrial growths in the roof shales over seams of coal, led to the belief that coal was the result of the decay of submerged forests. In support of this statement, I may quote Mr. Carruthers, who is a well-known authority on the matter. Mr. Carruthers expressed his opinion in the course of some remarks on a paper which I communicated to the Geological Society.* "Coal seams," he said, "are the remains of forests which grew upon swampy ground, and were subsequently covered by clay."

The first persons to make microscopic sections of coal, so far as I am aware, were Professors J. H. Bennett and J. Quekett, and it is interesting to observe their conclusions. The former published his in a paper † entitled "Investigations into the structure of the Torbanehill mineral," and says, "The various organic appearances found in the sections and ash of coal is wood chemically altered, and for the most part coniferous, or wood allied to it in structure." I shall presently show that Professor Bennett probably mistook microspores for rings seen in coniferous wood. Professor J. Quekett says, ‡ "My investigations, however, lead me to believe that the basis of coal is essentially a peculiar kind of wood, and that when Ferns, *Stigmaria*, and *Lepidodendra*, and

* Quart. Journ. Geol. Soc., xl. p. 59.

† Trans. Roy. Soc. Edinburgh, xxi. (1853-4) p. 173.

‡ Trans. Micr. Soc. Lond., 1854, p. 40.

other plants occur in coal or its neighbourhood, they should be considered foreign to the coal." Professor Huxley seems to have been the next person to draw conclusions as to the origin of coal from microscopic sections made of the "Better Bed" seam of Yorkshire, the sections having been prepared by Mr. E. T. Newton. The conclusions arrived at were stated in the 'Contemporary Review' for 1870; they were that coal was simply the sporangia and spores of certain plants, other parts of which have furnished the carbonized stems and mineral charcoal, or have left their impressions on the surface of the layer. I may here state that Professor Huxley does not claim to be the first to detect spores of plants in coal. The first to discover them was Dr. Fleming, and Professor Morris pointed them out in a note appended to Professor Prestwich's paper on the Geology of Coalbrook Dale.* Later on I shall refer to other observers who have noted the same fact.

Sir William Dawson has also examined coal microscopically, but he does not do so by making sections. The process is described on page 494 of his very valuable work 'Acadian Geology.' Specimens of coal were selected containing the tissue of only a single plant; these were boiled in strong nitric acid, and after the fumes had subsided the residue was washed and submitted to microscopic examination. By this method Sir William Dawson has obtained and figured † tissue of *Sigillariæ*, Calamites, Ferns, and scalariform vessels of *Lepidodendron*. Whether these remains can be considered as typical of the coal-forming vegetation is, I think, doubtful, and for this reason. First, I object to the principle of specially selecting a piece of coal for examination; if we detect a fragment in a seam better preserved, with regard to structure, than the rest of the mass, the very fact should invoke caution, as there may be a cause for the better preservation. It may be due to the fragment being a foreign element (foreign, I mean, so far as the general mass of the coal is concerned), which has resisted decay better than the vegetation which has formed the mass of the coal. Second, when coal is treated with nitric acid dense fumes come off; this implies that something is undergoing destruction, and the importance of the loss is only known when we obtain microscopic sections. Sir William Dawson admits that two difficulties have impeded his investigations, "and have in some degree prevented the attainment of reliable results." One of these, he says, "is the intractable character of the material as a microscopic object; the other the want of sufficient information with regard to the structure of the plants known by impressions of their external forms in the beds of the coal formation."

I will now proceed to give an account of my own investigations,

* Geol. Trans., Second Series, vol. v.

† 'Acadian Geology,' 3rd edition, p. 464.

and will take first the "Shallow Seam" of Cannock Chase, for samples of which I am indebted to Mr. A. H. Barnard, of Chase Town.

SECTION OF THE SHALLOW SEAM.

Description.	Ft. In.	Structure.
"Hardens," or top bed	1 10	The dull lustrous layers largely made up of microspores and macrospores; wood tissue in the bright layers.
"Upper Spire"	0 2	A carbonaceous parting.
"Bright Coal," or middle bed. Bright lustre throughout.	0 9	Brown structureless hydrocarbonaceous material, with occasional microspores and macrospores.
"Lower Spire"	0 2½	Carbonaceous arenaceous parting.
"Best Coal," or bottom bed. Dull and bright lustrous layers.	4 3	Hydrocarbon. Macrospores and microspores, chiefly confined to the dull layers.
Underelay	Argillaceous bed with <i>Stigmaria</i> .

The seam is divided by partings into three distinct beds of coal. In the top one, called "Hardens," two layers could be defined by degrees of lustre, a bright and a dull. In the latter minute specks were detected, somewhat resembling iron rust. By polishing a portion, the specks were distinguished as macrospores, figs. 1 and 2, plate VIII., and a microscopic section shows the spaces around to be filled with microspores (fig. 3). In the bright layer spores were also detected, but they were much less numerous, and there was present, as the chief constituent, a structureless substance to which I have given the name of hydrocarbon. Vegetable tissue was also recognized.

Between the top and middle beds of the seam comes a carbonaceous parting locally termed "spire," and in which was a quantity of pyrites. The middle or bright coal is a cannel. It readily polishes, and when this is done a few macrospores can be made out. The mass of this coal is made up of the substance to which I have referred under the name of hydrocarbon, and before proceeding further it may be as well to say something respecting this substance. It is generally structureless and presents a dark brown appearance, and is an important constituent in the composition of some coals; the so-called bituminous varieties being the richest in the possession of it. I believe it to constitute what has erroneously been termed bitumen. I need, however, hardly say that coal contains no bitumen whatever, and the sooner we strike so misleading a term, as applied to coal, out of our vocabulary the better.

Below the "Bright Coal" is a second parting of "spire," with an arenaceous stratum running through the centre.

Then comes the "Best Coal" or bottom and chief bed of the seam. The lustre throughout is fairly bright, which appears to be due to the numerous thin bright layers. In the dull lustrous portion of the coal macrospores and microspores were numerous, but in the bright portion hydrocarbon was the chief constituent.

The variations in the beds of coal which constitute the "Shallow Seam" illustrate the importance of investigators taking a complete stratagraphical section of each seam of coal to which they turn their attention. The top bed is not freely combustible, but when combustion has fairly commenced, considerable heat is generated. The "Bright Coal" is mainly worked for gas purposes, and the "Best" for gas and household use. A mixture of the "Hardens" and "Best" beds makes a most economical fuel, but require a good draught.

I next take the Welsh "Four Feet" seam celebrated throughout the world for its smokeless properties. For samples of this seam and permission to inspect it underground, I am indebted to the owners (Messrs. Geo. Insol and Son) and to the manager of the Cymmer Colliery near Pontypridd, South Wales. At this colliery the "Four Feet" presents the following sections.

SECTION OF THE FOUR-FEET SEAM, CYMIMER COLLIERY, NEAR PONTYPRIDD, SOUTH WALES.

Description.	Ft. In.	Structure.
Top bed. Coal brittle, with bright lustre.	2 0	Carbonized vegetable tissue, with a little hydrocarbon.
Argillaceous parting	1 0	Miniature underclay. <i>Stigmaria</i> .
Middle bed. Medium lustre ..	4 6	Highly carbonized vegetable tissue.
Argillaceous parting	0 5	Miniature underclay.
Lower bed	2 0	Well-preserved scalariform tissue at the top close under the parting. Beneath spores and spore cases, with other vegetable substances.
Argillaceous parting	0 2	<i>Stigmaria</i> .
Bottom bed	1 6	Inferior coal, not worked.
Underclay	4 0	<i>Stigmaria</i> .

From the fact of this seam being termed the "Four Feet," persons may be led to regard it as constituted by four feet of coal only; that, however, is not the case. The stratagraphical section shows the seam to be made up of four distinct beds of coal separated by clay partings which are miniature underclays; the lowest of these coals I have, unfortunately, not had an opportunity of examining. The top one of all is merely a mass of carbonized vegetable tissue, with a little hydrocarbon. The coal, however, was

so brittle that no very satisfactory slides could be made, though a fair idea of the structure was gained during the process of preparation. The bed 4 feet 6 inches thick, following the last in descending order, is the chief one of the seam; it may be said to be a mass of highly carbonized vegetable tissue, with a small portion of hydrocarbon. Next follows an argillaceous parting 5 inches thick, then comes coal 2 feet thick. The structure of this bed is most interesting and is well preserved; at the top, close under the argillaceous parting, scalariform tissue was detected, fig. 4, but it was not discovered in any quantity below that horizon. Spores occur, and were most numerous about the centre of the bed, fig. 5, and are a distinct variety to those observed in the Shallow seam. The structure of this coal is represented in figs. 6 and 7; the former is drawn from a slide taken from about the centre of the coal, and the latter from the top close under the argillaceous parting; both are magnified 160 diameters.

The next seam of coal to which I shall draw attention is the "Better Bed" of Yorkshire, which has been rendered famous by Professor Huxley, who, as I have stated, made it the subject of an article in the 'Contemporary Review' for 1870. Referring to the structure of this coal, Professor Huxley says: * "Thus, the singular conclusion is forced upon us, that the greater and the smaller sacs of the Better Bed and other coals, in which the primitive structure is well preserved, are simply the sporangia and spore-cases of certain plants, many of which were closely allied to the existing club-mosses." For the specimen which I have examined of the Better Bed I am indebted to Mr. Woodhead, Colliery Manager to the Low Moor Iron Company near Bradford, Yorkshire, who sent me a portion of the seam intact for a thickness of ten inches from the top. I therefore determined to examine it inch by inch. The stratigraphical section of the seam, as sent me by Mr. Woodhead, is as follows.

SECTION OF THE BETTER BED SEAM OF COAL, LOW MOOR IRON COMPANY'S
COLLIERY, NEAR BRADFORD, YORKSHIRE.

	ft.	in.	ft.	in.
Shales				
Coal (laminated)	0	3½	} 1	10
Coal	1	6½		
Seatstone (underclay)	1	0		

The lustre of the first 3½ inches of the above coal was dull, the remainder, with the exception of a layer half an inch thick at four inches from the top, was a medium brightness. In describing my own investigations, I cannot do better than record them as written down at the time.

* Contemp. Rev., xv. (1870) p. 621.

Within the first two inches from the top. Largely made up of macrospores and microspores, fig. 9, very similar to those detected in the "Shallow Seam." Well-preserved scalariform tissue detected. A horizontal section of the coal is represented in fig. 8, magnified $12\frac{1}{2}$ diameters.

Three inches from the top. Spores less numerous, some of the macrospores have caudate appendages attached to the walls. The mass largely made up of hydrocarbon and decomposed vegetable tissue.

Four inches from the top. Spores again numerous, but do not constitute the whole mass. The predominating macrospores are smaller than those above, and are apparently not the same species, figs. 11, 12, 15, $\times 50$ diameters. In fig. 12 microspores are also shown $\times 50$ diameters, and in fig. 16 one is represented $\times 262$ diameters. A horizontal section of the coal is shown by fig. 10, $\times 12\frac{1}{2}$ diameters, which illustrates the difference in the coal compared with the upper portion, fig. 8. Some of the macrospores show caudate appendages and though numerous only fragmentary specimens could be found.

Between four and five inches from the top. Spores less numerous; vegetable tissue occurs generally carbonized. Hydrocarbon contributes largely to the composition of the whole mass.

Between six and seven inches from the top. Spores form but a small portion of the coal; it is mainly made up of tissue and hydrocarbon. A piece of carbonized scalariform tissue was met with, the first time I have noticed it in that state of preservation.

Eight inches from the top. Spores scarce, though they were searched for by horizontal and transverse sections. The coal was mainly made up of tissue in various stages of decomposition. Some of it appeared to yield a resinous material. The structure here exhibited is the first I have noticed of the kind.

Nine inches from the top. A few spores noticed. The coal practically made up of tissue and hydrocarbon, the passage of the former into the latter clearly demonstrated. The resinous-looking material noticed above again present but disappearing.

Ten inches from the top. Spores continue scarce; the coal mainly made up of tissue and hydrocarbon, fig. 13, $\times 12\frac{1}{2}$ diameters. In fig. 14 a portion of carbonized and partially decomposed cellular tissue is magnified 50 diameters.

I am unable to entirely endorse Professor Huxley's statements; undoubtedly the first three inches is very largely made up of macrospores and microspores, and the same may be said of the layer at four inches from the top, though they are mostly of a different species to those above, but below that point spores form but a small proportion of the whole mineral.

The next coal to which I shall draw attention is the "Splint

Coal" seam from Whitehill Colliery, near Edinburgh. For specimens of the seam I am indebted to Mr. James Bennie and to the owners of the colliery. The following is a section of the seam as sent me by Mr. John Begg, to which I have added my notes.

SECTION OF THE SPLINT COAL SEAM, WHITEHILL COLLIERY, NEAR EDINBURGH.

Description.	Ft. In.	Structure.
Splint Coal. Dull lustre, with a few bright layers.	1 10	A mass of macrospores, microspores and fragments of spore-cases.
Rough Coal. Alternation of bright and dull lustrous layers.	0 10	Hydrocarbon in the bright layers; a few spores in the dull, of different variety to those in the "Splint" above and below.
Lower "Splint." Dull lustre, with thin bright layers.	0 4	The dull lustrous portion a mass of macrospores and microspores; the bright layers made up of hydrocarbon, and do not contain spores (Fig. 31).

The Splint coal as worked at Whitehill colliery has three distinct beds, not, however, separated by partings, as is the case with the Four-Foot and Shallow seams. Microscopic sections of the lowest bed showed the dull lustrous portion to be a mass of macrospores and microspores and fragments of spore-cases; a horizontal section is shown in fig. 24, plate IX., and the spores are shown by figs. 17 to 22. No sign of tissue has been, so far, detected. The bright layers were composed of hydrocarbon. In order to test the question as to whether spores do enter into the composition of the bright layer, a vertical section was cut which intersected a bright layer between two dull ones. On placing it under the Microscope, spores were seen to be numerous in the dull portion, but not one was found in the bright layer: a portion of this slide is shown in fig. 31. I do not, however, mean to assert that spores are not to be found in the bright layers of coal, but they seem to me foreign to them.

There appears to be more than one variety of macrospore and microspore represented in this lower bed of Splint coal. The largest variety of macrospore is represented in fig. 17, and measures 0·047 of an inch in diameter. The largest variety of microspores are shown in fig. 18, and measure 0·0015 of an inch in diameter. Both of these seem to be identical with those in the laminated coal of the Better Bed and Shallow Seam. In fig. 19 another variety of macrospore is shown measuring 0·04 of an inch in diameter, and in which the outer edge of the wall is scalloped. In fig. 20 a smaller variety of microspore is shown, and in fig. 21 two

macrospores are seen, measuring about 0·003 of an inch in diameter, and associated with microspores of about ·0005 in diameter. In fig. 22 another of these macrospores is shown, having a triradiate marking. It was while drawing the last figure that I noticed minute spine-like projections on the surface, and on further examination they appeared to pass into the inner surface; this is shown in the figure. Mr. E. T. Newton * noticed the same feature in the spores which occur in Tasmanite and Australian white coal, and I also pointed out the same thing in my paper † “On the Occurrence of Spores of Plants in the Lower Limestone Shales of the Forest of Dean.” Mr. Newton regards them as minute lines (tubes?) passing from the outer to the inner surface. I am, however, inclined to regard them as spines. I have said that it was while drawing fig. 22 that I first noticed these spines (?), and thinking that possibly I had overlooked the feature in the spores previously examined, I again placed them under the Microscope. I had before noticed a granular appearance on the surface of the Macrospores, and dark spots on the microspores; these I now resolved into the same spine-like projections as seen in fig. 22. In fig. 23, I have magnified 262 diameters a portion of the surface of fig. 17, and the spine (?) like projections are clearly shown.

The lowest bed of the “Splint Coal” is replaced abruptly, and without clay parting, by the “Rough Coal” or middle bed of the seam. The transition in the structure of the coal is most striking, and is illustrated in fig. 29, which is magnified $12\frac{1}{2}$ diameters, the same as fig. 24, with which it should be compared. This bed is mainly made up of numerous layers varying in degrees of lustre, and averaging about half an inch thick. A microscopic section of the brightest of these shows only a few spores but plenty of hydrocarbon. In the duller layers, spores were fairly numerous, but for the most part were a distinct variety to those which appear in the bed below; this is shown by figs. 25, 26, 28, which are magnified 50 diameters. The “Rough Coal” is followed, without parting, by the “Upper Splint” bed. The lustre is mostly dull and the greater portion of the coal is simply a mass of macrospores and microspores, some of which are a different species to those which predominate in either of the beds below. The relative size is sufficient to determine that point, and the fact may be seen at a glance by comparing the horizontal section of this bed (fig. 30) with that of the two lower ones, figs. 24 and 29. They are all magnified $12\frac{1}{2}$ diameters, so as to facilitate comparison.

I now come to another important part of my subject, and it is one which is necessarily somewhat speculative; it is the relation and character of the coal-forming vegetation. Among those who have

* Geol. Mag., ii. (1875) p. 339.

† Proc. Cotteswold Club, 1884.

made the matter a special study is Mr. Carruthers, and any words on the subject which fall from him deserve careful consideration. In 1865 he published * a paper "On an undescribed Cone from the Carboniferous Beds of Airdrie, Lancashire," and referring to the occurrence of spores in coal, says (p. 434), "Not only do these bodies exist in quantity in many coals, but some beds even of considerable thickness are almost entirely made up of them. Their relation, however, to any organism that could have produced them was unknown until the discovery of a cone by Mr. James Russell." This cone was submitted to Mr. Carruthers, who described it as a new genus under the name of *Flemingites*, and allied it to the modern family of *Lycopodiæ*. It would therefore appear that Mr. Carruthers included in this genus all the spores discovered in coal up to that time. It seems, however, that all previous observers had fallen into an error in supposing that the coal-forming plant possessed but one kind of spore, namely microspores. Thus Professor J. H. Bennett,† in his paper "An Investigation into the Structure of the Torbanehill Mineral and of various kinds of Coal," refers to what are evidently microspores, microspores as "rings of a transparent yellowish or reddish colour with an opaque centre";‡ and referring to the macrospores, says, "There are also visible, circles or rings of a rich golden yellow matter, much larger, and varying in size from the fiftieth to the sixth of an inch, which have been described by some as seeds or spore-cases." Professor J. H. Balfour, in his paper § "On certain Vegetable Organisms found in Coal from Fordel," mentions the occurrence of seed-like bodies which he considers "to be the sporangia or spore-cases of some plant allied to *Lycopodium*, perhaps *Sigillaria*." Later on, in 1872, Professor Balfour refers || his coal spores and those which had up to that time been detected in the mineral, to Mr. Carruthers's genus *Flemingites*. But what Professor Balfour looked upon as a sporangium (figs. 15, 16, 17, 18, plate II., of his paper) is really not a sporangium but a macrospore. In describing the genus *Flemingites* Mr. Carruthers also fell into the same error, that is to say, he figured it as possessed of but one kind of spore, namely microspores. Like Professor Balfour, the object which Mr. Carruthers took for a sporangium is really a macrospore. Those which I represent in figs. 21, 22, very closely resemble *Flemingites Pedroans*. Mr. Carruthers has himself found out his mistake and withdrawn the genus, which I cannot but regret, as its

* Geol. Mag., ii. (1865) p. 433.

† Trans. Roy. Soc. Edinburgh, xxi. (1853-4) p. 173.

‡ From an examination of Professor Bennett's figures, I should judge that his sections were not made sufficiently transparent to enable him to judge fairly of the spores and the structure of the coal he examined.

§ Proc. Roy. Soc. Edinburgh, xxi. (1854) p. 191.

|| Paleontological Botany—description of plate iii., fig. 1.

re-description, if only as a temporary genus, would have prevented the confusion caused by the withdrawal.

It then becomes a question as to whether the coal spores are still to be allied with the *Lycopodiæ*, and if not, with what. In solving this problem we, unfortunately, have to deal with imperfect and unsatisfactory information. Several *Lepidostrobi* have been figured and described, some of them containing both kinds of spores. There can be but little doubt that the *Lepidostrobi* are the fruit of the Lepidodendroid plants, but there is such a variety of forms included under that head, that it is not likely the known *Lepidostrobi* are the only ones which existed, or that they are even typical of the whole group. There is also uncertainty as to which of the individual *Lepidodendra* they belonged, and in support of this assertion I will quote two authorities. Mr. Carruthers* says a cone is very rarely found connected with its supporting branches, the evidence, therefore, of the connection between a *Lepidodendron* and its *Lepidostrobi* is consequently of a very unsatisfactory nature." Sir William Dawson says, "I cannot pretend that I have found the fruit of *Sigillaria* attached to the parent stem."† Among the cones which have been figured I may mention *Triplosporites*, which was described by Mr. Robert Brown‡ and which Mr. Carruthers looks upon as the Carboniferous representative of *Selaginella*.§ The history of this fruit is, however, very vague. It was brought to this country by a dealer who had obtained it from the collection of a Baron Roget, where it had been for about thirty years. Nothing more seems to be known about the history of the fossil, and it is not mentioned by Sir Joseph Hooker in his "Remarks on the Structure and Affinities of some *Lepidostrobi*" in the second volume of the 'Memoirs of the Geological Survey.' Other fruits have been figured by Brongniart, Lindley and Hutton, Binney, Professor Williamson, of Manchester, and others. The latter pointed out the occurrence of both macrospores and microspores in coal, in a paper read before the Geological Section of the British Association at York, but I am not aware that the paper has been printed except in abstract. In the 'Philosophical Transactions,' Professor Williamson figures a *Calamostachys Binneyana*, which shows two kinds of spores. The microspores measure about 0·0031 and the macrospores occur as large as 0·01. However, the imperfect specimens figured by him in plate 54, figs. 25 and 26 of his Monograph, prevent any reliable comparison, and those figured in the strobilus are not sufficiently magnified to render comparison possible. Professor Williamson has also found some *Lepidostrobi* together with ferns and an articulate

* Geol. Mag., ii. (1865) p. 437.

† 'Acadian Geology,' 3rd edition, 1878, p. 437.

‡ Trans. Linn. Soc., vi. p. 298.

§ Geol. Mag., vi. p. 298.

plant, which he believes to be *Asterophyllites*, and remains of *Lepidodendra* in some remarkable beds in Burntisland, Scotland. He states that the beds appear to have been patches of peat which are now imbedded in masses of volcanic amygdaloid. The general aspect of longitudinal sections of the strobili is that common to *Lepidostrobi*. They usually have a diameter of from less than half an inch to nearly an inch.* The fruit contains both macrospores and microspores, the latter measure about 0·0007 of an inch, and the macrospore figured has a long diameter of 0·027. The triradiate feature of the microspores described by Professor Williamson is common to those in the coal, and is also shown in those figured by Sir Joseph Hooker in the 'Memoirs of the Geological Survey' (vol. ii. part 2). The absence, however, of macrospores in Sir Joseph Hooker's cones renders an alliance out of the question. With Professor Williamson's Burntisland strobili, however, both spores are present. The size of the microspores nearly correspond with the small variety of microspores which I have discovered in the Scotch "Splint" coal, but the macrospores are far too large to correspond with my small variety; they more nearly correspond with my larger forms. Professor Williamson does not mention anything about a triradiate ridge or marking on the surface of these macrospores, which is a conspicuous feature in those from the coal. He states that the characteristic peculiarity of the macrospores from the Burntisland beds "is the projection from every part of their external surface of numerous caudate appendages." This is a feature common to the walls of some of the coal macrospores. In the coal, however, the appendages are not well preserved, and frequently only the roots or base remain, giving to the walls of the spore a tuberculated appearance. The appendages are seen in fig. 1, where a few short ones remain around the wall of the macrospore, and in figs. 12 and 15 they are broken off. Professor Williamson thinks that the strobili referred to are the fruit of *Diploxyylon*, though he does not appear to have found them attached to the stem of that plant. I would call special attention to Professor Williamson's remark that the beds in which the remains occur "appear to have been patches of peat."

I have been told that the coal spores are those of *Triplosporites*. Mr. Carruthers,† in referring to that genus, points out that the microspores occur in triple form, and to show the close alliance with *Selaginella* he figures the triple microspores of *S. spinulosa*. This is a feature, however, which I have never noticed in the coal spores, and had it been common to them I should certainly have detected it. The absence, then, of that

* Phil. Trans., 1872, p. 294.

† Geol. Mag., vi. (1869) p. 298.

characteristic is against an alliance with that genus. Again, the size of the macrospores of *Triplosporites* is given by Mr. Carruthers as 0·0264*: now the largest of the coal macrospores average 0·047; those discovered four inches from the top of the Better Bed 0·01, and the small variety from the Splint coal, fig. 21, plate II., 0·003 of an inch in diameter. The discovery of spines (?), or tubes, penetrating the coal spores, must not be ignored in determining their alliance with others. At the base of the Carboniferous limestone in the State of Ohio occurs the oil-producing shales, known as the "Black Shales." In these Professor Orton,† of Columbo, has discovered vegetable remains which he believes constitute the chief source of the so-called bitumen which these beds contain. In some parts the shale is crowded with minute translucent disks, which turn out to be spores of plants. Professor Orton very kindly sent me specimens of the shale, and informed me that I should find spines on the surface. This I found to be the case, and I have figured them in my paper ‡ to which reference has been made, and in which I have pointed out the occurrence of like bodies in black shales at the base of the Carboniferous limestone in the Forest of Dean. Sir W. Dawson § refers the spores discovered by Professor Orton to his genus *Sporangites*, which he now regards as allied to Rhizocarps. That some forms of *Sporangites* resemble the coal spores is clear from the fact that Sir William Dawson speaks of a Brazilian species as being similar to Mr. Carruthers's genus *Flemingites*, to which, as I have stated, the coal spores were referred previous to the withdrawal of that genus.

Quite recently Professor P. F. Reinsch has figured a number of Carboniferous spores under the name of *Trileteæ*, some of which closely resemble some of mine. In speaking of these he says: || "The *Trileteæ* are spores of Cryptogamic plants more highly developed; and if this supposition be correct, the *Trileteæ* can only be derived from *Lycopodia* and plants much resembling them."

If the coal spores are to be allied, or compared, with modern vegetation, I think due consideration should be made for Professor Williamson's discoveries with regard to vegetable evolution, and it is therefore safer perhaps to say that the coal spores are lycopodiaceous, resembling in appearance the *Ligulataæ*, which includes the *Selaginelleæ* and *Isoeteæ*.

Further investigation will, no doubt, mature our views as to the true nature of the coal vegetation, but one thing seems clear from investigations so far as they have gone, namely, that coal

* Geol. Mag., vi. (1869) p. 154.

† "A Source of the Bituminous Matter of the Black Shales of Ohio," Proc. Amer. Assoc., xxxi. (1882).

‡ Proc. Cotteswold Club, 1884.

§ "On Rhizocarps in the Palæozoic Period," Proc. Amer. Assoc., xxxii. (1883).

|| Micro-Palæo-Phytologiæ, Carboniferous Formation, p. 4, Introduction.

originated not from a variety of vegetation, such as we should expect to find from a submerged forest, but from one class of vegetation. If we are to accept the submerged forest theory, there are one or two difficulties to be removed before it can be conclusive. Professor James Dana * has been at some trouble to ascertain the amount of vegetable matter necessary to form a foot thick of coal; he says, "It would take eight feet in depth of compact vegetable débris to make one foot of bituminous coal, or twelve feet to make one of anthracite." Assuming these calculations to be approximately correct, we have to imagine a four-foot seam of coal formed by an accumulation of forest vegetation to the thickness of 32 feet, and 48 feet for an anthracite seam of the same thickness. How is this mass of vegetable débris to be obtained from a submerged forest? Mr. Carruthers tells us that the "trees grew in the coal itself." † We have to imagine, then, a forest growing on the débris of its own decay, for generations as some people tell us. Now, I would ask any chemist whether such a thing be possible with forest growth exposed to the air: the débris would, of course, be speedily turned into humus by the oxygen of the air. It is not necessary for me to prove that the Carboniferous atmosphere contained oxygen. I do not contend that the coal-forming vegetation was allied to the bog-mosses (*Sphagnacæ*), but I do say that it was of aquatic habit, growing in a manner similar to modern bogs, though of much larger extent.

In conclusion, I beg to return my thanks to Professor Harker, of the Royal Agricultural College, Cirencester, for his kind assistance in looking at my slides, and giving me the benefit of his opinion upon them.

* 'Manual of Geology,' 1st edition, 1866, p. 360.

† Quart. Journ. Geol. Soc., xl. p. 60.

SUMMARY

OF CURRENT RESEARCHES RELATING TO

ZOOLOGY AND BOTANY

(principally Invertebrata and Cryptogamia),

MICROSCOPY, &c.,

INCLUDING ORIGINAL COMMUNICATIONS FROM FELLOWS AND OTHERS.*

ZOOLOGY.

A. GENERAL, including Embryology and Histology of the Vertebrata.

Protoplasm and its Powers of Resistance.†—Dr. O. Loew classes protoplasm as sensitive and resistant, the former readily allowing a breaking-up of the cell-organization and a consequent chemical rearrangement of the molecular albumen, whilst the latter does not immediately show disintegration of layers adjoining that affected by a chemical or other stimulus, and is, in short, harder to kill. *Sphaero-plea* and *Vaucheria* are extreme examples, but all intermediate stages occur.

The chemical characteristics of a cell are closely bound up with the cellular organization. A chemical reaction on living protoplasm can only take place in more or less resistant protoplasm. In sensitive cells the cell is killed before the reaction can take place, e. g. alkaline silver solution kills infusoria at once, but is to some measure reduced by the cells of the frog's kidney, whilst it is energetically reduced by *Spirogyra*. Loew goes on to consider the action of strychnine, ammonia, and other poisons, and is disposed to believe that their action is proportional to the weakness of the solution, the unaffected portions in resistant cells repairing slight damage. A comparative toxicology is thus suggested.

Power of resistance to chemical stimuli is not necessarily equivalent to power of resistance to other stimuli (e. g. heat, drought, &c.), and variations of temperature alter the resistance in like cells, heat making the organism more labile and easy to destroy.

Problem of Fertilization and of the Isotropy of the Ovum.‡—Dr. O. Hertwig discusses the phenomena of heredity. In his first

* The Society are not intended to be denoted by the editorial "we," and they do not hold themselves responsible for the views of the authors of the papers noted, or for any claim to novelty or otherwise made by them. The object of this part of the Journal is to present a summary of the papers as *actually published*, and to describe and illustrate Instruments, Apparatus, &c., which are either new or have not been previously described in this country.

† Arch. f. d. Gesammt. Physiol. (Pflüger), xxxv. (1885) pp. 506-16.

‡ Jenaisch. Zeitschr. f. Naturwiss., xviii. (1885) pp. 276-318.

chapter he deals with the aphorism "The nuclear substance is the fertilizing material, which starts the process of development." Evidence in support of this is to be found in the striking fact that throughout the animal kingdom fertilization is effected in essentially the same way; the direct result of the entrance of the spermatozoon is ordinarily the immediate precursor of embryonic division; this again commences with changes in the germinal nucleus, which are only succeeded by changes in the protoplasm. An analysis of this process shows us conclusively that the entrance of a spermatozoon into the egg is not of itself sufficient for fertilization, but is only the commencement of the process; this is well shown by an observation of Auerbach on *Ascaris nigrovenosa*, where the two nuclei were seen to miss one another, and pass into opposite halves of the cell; shortly afterwards the nuclei died. There is no reason for supposing that the tail of the spermatozoon is anything more than a locomotor organ. Still more instructive are the cases where the spermatozoon enters the egg-cell before it is ripe; here the male cell remains for a time unaltered, for the process of development cannot begin till the ovarian nucleus is formed, which is only after the extrusion of the polar globules. As soon as this is effected there is a fusion of the cells. As Van Beneden has rightly pointed out, we must distinguish between the copulation of the male and female cells, and the fusion of the nuclear parts.

The second chapter is entitled "The fertilizing substance is also the bearer of peculiarities, which have been inherited by descendants from their ancestors." Reference is made to Nägeli's distinction between idioplasm and nutrient protoplasm, and Hertwig tries to show that the nuclei of the sexual products satisfy the requirements of Nägeli's hypothesis. It appears to be a true law of reproduction that normal fertilization, which causes a regular development, is always effected by a single spermatozoon. Nuclein appears to be the substance which not only fertilizes but also inherits peculiarities. It must not be forgotten that fertilization is not merely a chemico-physical process, but is also morphological, inasmuch as the nuclear part of the spermatozoon unites with the nucleus of the egg to form a fresh nucleus. Connecting the results of various observers, Hertwig concludes that the head of the spermatozoon has been shown to be directly derived from the nucleus of the spermatocyte, and that, in fertilization, it directly passes into the sperm-nucleus. The derivation of the ovarian nucleus from the germinal vesicle is much more complicated, and the process is difficult to follow out in detail. At the same time it is clear that the continuity of the nuclear generations is not broken; there are changes, but no new formations. "Omnis nucleus e nucleo."

The discussion is thus summed up: the organization of the mother and father is, in the act of reproduction, conveyed to the child by organized substance of a very complex molecular constitution. In the development of a chain of organisms there are no new formations, there are no breaks; in the successions of individuals there are only changes in organization, whereby force is developed. The nuclei are to be considered as the elements of complicated molecular structure

which convey the peculiarities of the parents. During the development or the maturation of the genital products, as well as in the copulation of the male and female nuclear substances, there is no breaking up, but only change in form. The bearing of polyspermy and of isotropy of the egg on this view is pointed out.

The third chapter of the essay deals with the relations in which nuclear substance and protoplasm stand to one another; the nucleus is regarded as being more highly organized substance, and as representing a special centre of force in the cell.

Influence of external conditions on the development of Ova.*—This has been the subject of a series of observations by Drs. Rauber and Sachsse.

As regards temperature it was found (working with ova of trout, salmon, frog, and fowl) that the maximum, minimum, and optimum vary with different animals. The influence of temperature varies further with duration. The age of ovum and larva made no perceptible difference. An atmospheric pressure of three atmospheres, continued for three days, stopped development, but did not cause death. A constant pressure of eight atmospheres, on the other hand, not only interrupted development, but altered the eventual shape of the embryo, contracting the length and increasing the breadth and height. A pressure of three-quarters of an atmosphere had no effect, but below that, the embryos died. The influence of acid solutions on developing eggs is also recorded, but nothing new was observed of scientific interest, except the action of oxygen in quickening the development of the regions near the gill-slits.

Fœtal Appendages of Mammals.†—The observations by MM. E. van Beneden and C. Julin here recorded were made on rabbits and bats; they find that no amniotic covering is formed at the cephalic end of the embryo of the rabbit; the proamnion or portion formed by the epiblast and hypoblast is temporary, and diminishes as the embryo retires into the true amnion. The formation of a proamnion depends on the anterior edge of the blastoderm remaining diblastic, or not being invaded by mesoblast. The membrana pellucida disappears early and is never villous.

The investigations of Kupffer and Selenka have shown that there is not, as has been supposed, any real reversal in the relative position of the germinal layers of various rodents; the present writers bring the results of other embryological studies into association with their own, and conclude that the determining cause of the formation of the amnion is to be found in the descent of the embryo, due to the weight of the body; the apparent reversal of the layers, and the formation of a proamnion is due to the precocious descent of the embryo.

Development of the Cœlom and Cœlomic Epithelium of Amphibia.‡—Prof. B. Solger is of opinion that the causes of the changes in the cœlomic epithelium are not to be sought for in the blood, but in

* SB. Gesell. Naturf. Freunde Berlin, x. (1884).

† Arch. de Biol., v. (1884) pp. 369-434 (5 pls.).

‡ Morphol. Jahrb., x. (1885) pp. 494-528 (2 pls.).

the grade of development of the organs connected therewith; and especially with that of the enteric canal. He directs especial attention to the fact that, in the *Anura* examined by him, from the earliest appearance of the cœlom in a purely cellular mesoblast until the completion of the metamorphosis, there was not the least indication of the process which His says he has directly observed in the fowl; of course, at a later period, new elements were intercalated among those already present in the epithelium of the cœlom; these cells arise from a deeper mesodermal layer, but they become completely assimilated with the epithelium already developed, and it is impossible to distinguish between younger and older elements.

In giving an account of the formation of the cœlom attention is specially directed to the following points: brown pigment was not confined to the epiblast and its derivative, the central nervous system, but was also found in the endoblastic cells surrounding the primitive enteric cavity, in the notochord, and in the primitive vertebræ. The cavity of the so-called hepatic diverticulum, the base of which is lost by the absorption of the yolk-cells there placed, is bridged over by epiblast in the neighbourhood of the ventral middle line. In *Bufo cinereus* the cœlom first appears in the most anterior dorsal portion of the mesoblast, mesially to the pronephros. In the hinder part of the body, where the mesoblast is still uncleft, there is a linear and, later on, a spindle-shaped cleft which is triangular in form, directed orally, and at first quite symmetrical. Nearer the head the cœlom is asymmetrical, for on the right its transverse diameter is longer than on the left. As long as the cœlom forms a cleft its cellular investment does not differ in form from the other cells of the mesoblast. The flattening out of the cœlomic epithelium is to be ascribed to mere mechanical causes.

The changes in the visceral peritoneal epithelium in the region of the enteric canal were studied in *Pelobates* and *Rana*; as the cells continue to branch the elongation of the enteric canal goes steadily on; when the metamorphosis is complete new elements appear between the now large cells of the cœlom and new elements make their way among them. In *Rana*, after the completion of the metamorphosis, when the enteric canal has reached its last degree of degradation, a new period of growth begins, which has, as may be supposed, some influence on the visceral cœlomic epithelium. This is expressed by the protrusion of processes, and by the appearance of rounded granular elements which take their place in the interspaces of the cell-mosaic; these last appear to arise from a layer deeper than that of the cœlom-epithelium, and to gradually force their way to the surface.

In the third chapter of his essay the author gives examples of changes in the form of cells of the cœlomic epithelium, which are due to an adaptation to subjacent structures, but these can hardly be rendered intelligible without the assistance of figures.

The visceral, pleural, and pericardiac epithelia are next considered, and then the stomata of the mesentery. As the Amphibia appear to have close phylogenetic relations to the Cyclostomata there are some

notes on the coelomic epithelium of *Petromyzon fluviatilis*; in transverse section the cells appear of a low cylindrical or of a cubical form. From the descriptions of Langerhans it would seem that *P. planeri* has retained the primitive form of coelomic epithelium more completely than *P. fluviatilis*; while the latter has a short cylindrical or cubical epithelium still present in the neighbourhood of the parietal peritoneum, in the Amphibia the cells even of this region have become flattened. The epithelium of *P. fluviatilis* varies somewhat with the season of the year.

Fate of the Blastopore of *Rana temporaria*.*—Mr. W. B. Spencer concludes from his observations

1. That the medullary folds grow over and inclose the neural canal, *but not the blastopore which remains open to the exterior*;

2. That the hinder part of the neural canal which opens into the blastopore loses its cavity, and the nervous system in this region becomes solid;

3. That just in front of the blastopore the epi-, meso-, and hypoblast are fused together;

4. That the blastopore never closes, but *becomes transformed into the adult anus*.

Primitive Streak in Osseous Fishes.†—From his recent observations M. L. F. Henneguy has been led to believe with Kupffer that the embryos of Teleosteans possess a primitive streak, but whilst Kupffer regards the longitudinal furrow as representing the streak, Henneguy holds that only the caudal expansion (*bourgeon caudal*) behind Kupffer's vesicle can properly be homologized with that primitive organ. The primitive streak in Teleosteans is rudimentary, and shows a striking analogy to that of reptiles, a class in which Kupffer, disagreeing with Balfour and Stahl, has denied the occurrence of a primitive streak at all.

Formation of Egg-shell in Dogfish.‡—M. E. Perravex has investigated the formation of the egg-shell in *Scyllium canicula* and *S. catulus*; the oviducal gland was supposed by Bruch to be concerned with the production of the egg-shell, and subsequent investigators have assigned its production to a particular layer in this gland. Transverse sections through the egg-shell of a *Scyllium* show that it is made up of a number of layers closely united; the structure of the median portion of the rudimental gland corresponds and is doubtless the seat of origin of the egg-shell; it is composed of a series of layers between which open the glandular cæca whose function it is to secrete the formative matter of the shell. When the ovum is set free from the ovary and falls into the oviduct it receives its albuminous coating in the superior portion of the rudimental gland; during this time the two walls of the median part of the gland, being closely applied to each other, do not allow their

* Zool. Anzeig., viii. (1885) pp. 97-8.

† Ibid., pp. 103-8.

‡ Comptes Rendus, xcix. (1884) pp. 1080-2.

horny secretion to escape, which thus assumes the form of a thread; when the egg reaches this portion of the gland the horny threads become attached to its anterior end; the same process is continued when the ovum has passed through the gland. That the anterior and posterior filaments of the egg-shell are really formed in this way was confirmed by direct experiment.

Cell-Continuity.*—Prof. H. Fol finds that red blood-corpuseles are the only elements which are quite isolated. Everywhere else there is continuity between the prolongations of neighbouring cells, and this is true even of cartilage, the elements of which have been regarded as being inclosed each in a continuous membrane. Of all the fixed tissues the nervous system is perhaps the one of which the cellular elements present the least numerous anastomoses.

Influence of Gravity on Cell-division.†—Dr. O. Hertwig comes to conclusions exactly opposite to those of Pflüger and Rauber; he thinks that, of itself, gravity has no direct influence on the division of cells; the first plane of division, in the equal eggs of Echinids, may have the most various relations to a perpendicular axis; and as Roux has shown, frogs' eggs are not hindered in their development if the localized action of gravity is compensated for by the slow revolution of the egg.

When the substance of the cell is regularly distributed the nucleus seeks to occupy a central position, but if the egg consists of a part which is richer in yolk, and another part which is richer in protoplasm, the nucleus alters its position, and passes into the latter part. We see then that the direction and position of the plane of division is primarily dependent on the organization of the cell itself; the nucleus is the direct cause. But the position of the axis of the nucleus is dependent on the form and differentiation of the protoplasm which surrounds it. In many cases gravity has an indirect influence on the orientation of the planes of cleavage, when there are in the cells substances of various specific gravities, which have become arranged in a heavier and a lighter layer. This is often a consequence of the formation of the polar globules and of fertilization; the egg then gets a definite axis with an animal and a vegetable pole, and this axis must be perpendicular, on account of the action of gravity; here the first plane of division must necessarily be perpendicular.

Origin and Development of Animal Tissues.‡—Prof. E. Häckel sums up the results of his studies in the following theses:—

In all vertebrates the oldest primitive organ is a simple epithelium or blastoderm; this is absolutely preserved in *Amphioxus* only, for in the blastula of craniate vertebrates it is more or less cenogenetically modified. From this primitive organ of the first order two primitive organs of the second order arise by invagination—the two blastophylls or primary germinal layers of the *Gastrula*; these, again, are palingogenetically preserved only in *Amphioxus*; in the Cyclostomata,

* Arch. Sci. Phys. et Nat., xiii. (1885) pp. 256-7.

† Jenaisch. Zeitschr. f. Naturwiss., xviii. (1885) pp. 175-205 (1 pl.).

‡ Ibid., pp. 206-75.

Ganoids, and Amphibia they are slightly, in the Selachii, Teleostei, and Sauropsida greatly, and in the Mammalia most completely altered by cenogeny. The two primary germinal layers are primitively simple epithelia, and are, therefore, to be regarded as primary tissues; all other tissues are secondary, are derived from them, and are apothelial. Thus the mesoblast is, in all vertebrates, a secondary product of the primary endoblast, and is always developed from paired "sacculi celomares"; while the right and left pouches remain separated from one another in the dorsal middle line by the mesentery, they fuse along the ventral middle line, and so give rise to the celom; the parietal mesoblast or somatopleure is re-named the lamina inodermalis, and the visceral or splanchnopleure the lamina inogastralis. There are now four secondary layers, three of which owe their origin to the endoblast. The mesenchym of vertebrates, which is largely used in the formation of blood and connective tissue, may arise from any of the four secondary layers, but does arise chiefly from the mesoderm. The ectoderm is called the methorium parietale, and is stated to consist of part only of the ectoblast, that is, of the epidermis and its appendages; the endoderm is called the methorium viscerales, and is stated to consist of but a small number of endoblasts—the epithelium of the mesodæum and all its glandular appendages, and of two divisions of ectoblasts—the epithelium of the stomodæum and of the proctodæum.

The mesoderm is the general complex of all the other parts, and consists of various tissues which arise directly or indirectly from the two primary germinal layers; these may, according to their origin and their functions, be arranged in five groups.

The epithelial tissues of Vertebrates fall into four essentially different groups: A. Exepithelium or chrotal epithelium; this is the epidermis with its glandular and appendicular products, the epithelium of the stomo- and procto-dæum, the ependyma, the sensory epithelium of the sensory organs (retina, &c.). B. Endepithelium or gastral epithelium; this is the gastrodermis, or epithelium of the enteron and enteric glands. C. Mesepithelium, or celom-epithelium; this is the pleuroperitoneal or pericardiac epithelia, the sexual and renal epithelia. D. Desmepithelium; this is the epithelium of the blood and lymph vessels, of articular cavities and bursæ mucosæ, of serous sacs, with osteoblasts, odontoblasts, &c.

The nervous tissue is completely or largely ectoblastic in origin, and may be divided into cells and fibres; the former are ganglionic or sensory, the latter, medullated or non-medullated. It is very possible that part of this group (e. g. various sympathetic ganglia and plexuses) arises from endoblastic mesenchym-cells, as is the case in many invertebrates; the motor roots of nerves (like the muscles) may arise from mesoblasts.

The muscular tissue is either altogether or largely of endoblastic origin, and derived from the mesoblasts; the greatest part of the transversely striated musculature arises from the somatopleure, and of the unstriated from the splanchnopleure; it is possible, however, that part (e. g. the smooth muscles of the corium and of the blood-

vessels) arises from mesenchymatous cells, as is the case in many invertebrates.

The connective tissue is largely derived from mesenchym, and, moreover, from cells that arose primitively either from ectoblasts or endoblasts: the greater portion probably from mesoblasts of endoblastic origin. It is certain that the development of the connective substances has no necessary or direct causal connection with that of hæmal tissue. The notochord is a connective of purely epithelial origin. The various forms of this tissue are, on the one hand, closely interrelated, and, on the other, are in direct genetic connection with various epithelia.

The hæmal tissue is essentially derived from cells of the mesenchym; and arises chiefly from the visceral mesoblast, or vascular layer. The phylogenetic developmental centre of the blood-vascular system of vertebrates is to be looked for in the two median enteric vessels; the aorta on the dorsal middle line, and the central vein, with its local enlargement, the heart, on the ventral middle line.

The further development of tissues, and their arrangement in various local tissues is the result of histological differentiation; this is due to the laws of heredity and adaptation. The ontogenetic differentiation of tissues can only be understood and explained by being regarded as a recapitulation of the phylogenetic division of labour of groups of cells; and affords a new proof of the validity of the fundamental law of biology.

Parietal Cells in Nerve-fibres.*—After staining with saffranin Prof. A. Adamkiewicz found in transverse sections of nerve-fibres and cords of the spinal marrow, within Schwann's sheaths, yellow to brown coloured crescents which were sections of peculiar fusiform cells and in his opinion represented hitherto unknown parietal cells, lying within the nerve-fibres, distinguished by their saffranin reaction.

New Constituent of the Blood and its Physiological Import † Mr. L. C. Wooldridge describes the following method of obtaining the constituent which he has lately discovered in blood; the plasma of the blood of peptonised dogs having been completely freed from all corpuscular elements by means of the centrifuge, is cooled down to about 0°; the plasma rapidly becomes turbid, and a decided flocculent precipitate is formed. This is the body which gives rise to the fibrin ferment; if examined microscopically the precipitate is found to consist of a number of minute pale transparent bodies which are rounded in shape, much smaller than red blood-corpuscles, and having a great tendency to run together into granular masses. These peculiar microscopical characters may perhaps explain the granules, blood-plates, hæmatoblasts, &c., described by Osler, Bizzozero, Hayem, and others.

Phenomena of Contraction in Striated Muscle. ‡—The most constant and essential bands of the elements of muscle are (1) the

* Nature, xxxi. (1885) p. 548 (Proc. Berlin Physiol. Soc., Feb. 27th, 1885).

† Proc. Roy. Soc., xxxviii. (1884) pp. 69-72.

‡ Arch. f. Anat. u. Physiol., 1885, pp. 150-6 (4 figs.).

finely granular and anisotropic "intermediate disk" (*Zwischen-scheibe*) which is devoid of the terminal membranes ascribed to it by Merkel; and (2) the anisotropic "transverse disk" (*Querscheibe*), which is in two halves. Starting with these views as to muscle at rest, Dr. R. Nikolaides applied a strong induction current to the sartorius of the frog and fixed the muscle by alcohol or osmic acid in the state of maximal tetanic contraction. In a second series of experiments the muscle was fixed at a stage before the maximum of contraction was reached. Microscopic study of preparations so made showed that the phenomena of contraction fell into two series. "First, the transverse disk, which is the essential element, becomes broader and shorter, and at the same time somewhat convex. Next, the shortening of the transverse disks approximates them one to the other, and, in strong contractions, during this approximation, the fluid isotropous substance is forced mechanically into the anisotropic portions, thereby causing the thickening of the latter, and the lateral convexity of the sarcolemma. As for the intermediate and middle disks (*Zwischen-* and *Mittelscheibe*), they have only a passive part to play in the phenomena of contraction. They are the fixed points round which the above phenomena take place.

Hair Microscopically examined and Medico-legally considered.*
—Dr. W. J. Lewis draws attention to the importance in legal cases (when it is often impossible to determine whether certain blood-stains are human or animal) of the evidence to be derived from a microscopic study of the hairs or textile fabrics of one sort or another generally found entangled with the blood-stains on a weapon that has been used in a murderous assault. He illustrates the value of such evidence by reference to actual cases, and points out the differences between human and animal hair, and the distinguishing features of hair from those of the more common filaments which may be mistaken for it, such as the finer fibres of jute, linen, silk, and cotton. The characteristic distinctions which exist between human and animal hair are briefly indicated under four heads, viz. (1) The relative proportions of the cortical and medullary structures. (2) The size, shape, and arrangement of the medullary cells. (3) The size, shape, and arrangement of the superficial cortical cells. (4) The size and shape of the hair-shaft.

New Organic Spectra.†—Dr. C. A. MacMunn describes some new absorption-spectra detected by means of the microspectroscope without the aid of any reagent. Myohæmatin gives three bands. It has been detected in the heart-muscles of every vertebrate animal examined, and in some voluntary muscles of both Vertebrata and Invertebrata. It has been got out of the muscle by digesting in pepsine solution and out of the frozen heart-muscle of rabbits by pressing out the plasma, in which it probably occurs like muscle-hæmoglobin.

Histohæmatin is the name given by Dr. MacMunn to a class of

* Proc. Amer. Soc. Micr. 7th Ann. Meeting, 1884, pp. 59-68 (2 pls.).

† Proc. Physiol. Soc., 1884, No. iv. See Nature, xxxi. (1885) pp. 326-7 (1 fig.).

pigments or modifications of the same pigment, which are widely distributed in the animal kingdom, and to which myohæmatin belongs. The histohæmatins are respiratory pigments, as can be proved by oxidizing and reducing them in the solid organs. Their bands occupy almost the same place as those of myohæmatin. In the suprarenals of man, cat, and some other animals, the medulla gives the spectrum of hæmochromogen, while the cortex shows that of histohæmatin. Hæmochromogen in a vertebrate body is probably excretory and must be so regarded here, hence the function of the adrenals must be (at least in part) to metamorphose effete hæmoglobin or hæmatin into hæmochromogen. An active metabolic process takes place in the adrenals, and the author concludes that they have a large share in the downward metamorphosis of effete colouring matter, and that these observations will help to throw some light on Addison's disease.

Homologies of the Vertebrate Crystalline Lens.*—Dr. B. Sharp traces the stages of the development of the eye from the simple deposit of pigment in an epithelial cell to the highest form, that of the Vertebrata.

The successive steps are as follows:—The first visual organ primarily consisted of a deposit of pigment, centralized at the oral pole. The next step is the formation of invaginated grooves, which gradually form a sphere and protect the organ. The refracting media of separate cells soon coalesce, to produce a cuticular lens. The nerves of general sensibility become specialized and form a distinct (primitive) optic nerve; corresponding stimulation takes place in the brain. Increased activity causes increased development all along the tract from the eye to the seat of vision in the brain. That part of the brain nearest to the eye enlarges, and proceeds by steps toward the eye, the primitive optic nerve still connecting the two. In the next stage, part of the brain closes over the superior part of the eye, being separated by a layer of fibres, which is the much shortened and flattened primitive optic nerve. The pedicle connecting this advanced part of the brain may be looked upon as a ganglion and soon becomes the most important part of the eye and receives the light-waves upon its exterior wall, the primitive eye becoming transparent and later forming the lens. This *ganglion opticum*, as it may be provisionally called, gradually proceeds downwards about the primitive eye, joining below. As development advances the ganglion is hollowed out and later is filled with the *corpus vitreum*, which is included in it.

Thus the lens of the Vertebrata is homologous with a primitive invaginated eye, such as we find to-day in the Gastropoda; the layer of optic fibres of the retina is homologous with the primitive optic nerve. As the retina below has become the sensory part of the eye, the rays must necessarily pass through it to reach a point where nerve-energy is developed. The *nervus opticus* of the eyes of the Vertebrata is, therefore, really a secondary optic nerve.

* Proc. Acad. Nat. Sci. Philad., 1884, pp. 300-10 (4 figs.).

In degeneration the eye proceeds step by step backwards towards the brain, after first losing its accessories, such as the lens, cornea, *sclerotica*, &c.

In *Branchiostoma lanceolatum* brain as well as eye has disappeared. Forms so degenerate as *Branchiostoma* and *Ascidia* should not be taken as a standard on which to base conclusions for the origin of the Vertebrata.

Recognition by Marine Animals of the Hour of the Day.*—The changes produced by the tides are apparently much more important to marine animals than those due to the rotation of the earth; but Mr. W. K. Brooks points out that many important physiological changes are regulated according to the hour of the day, in these organisms as well as in terrestrial animals and plants. In support of this, he cites the regularity with which certain forms deposit their eggs at stated times of the day or night (independently of the influence of temperature, light, &c.), and the regularity with which certain *Actinia* expand. The phenomena, he considers, have been established in each species by natural selection on account of their advantage to the organism.

Claus' Elementary Text-book of Zoology.†—The second half of Mr. A. Sedgwick's edition of Prof. Claus' text-book has been published, so that the English student has now a complete handbook of zoology, which is infinitely better than any which has yet appeared in this country.

B. INVERTEBRATA.

Morphology of Suckers of Animals.‡—M. J. Niemiec gives a list of the very various animals which he has examined in the course of his interesting study. Dealing first with the Echinodermata, he comes to the following conclusions:—the sucker of *Asteriscus* is a terminal enlargement of the ambulacral tube in which the different layers undergo a more or less marked modification; the epithelium has a subcuticular differentiation, a granular mass being formed which increases the resistance of the dermis; the layer of connective tissue gives rise to a ring from which muscular bundles are given off in various directions; the supplying nerve sends off circular branches which unite to form a nerve-ring; a vacuum is effected by the contraction of the longitudinal and perpendicular muscles of the disk; when the sucker is about to be detached the acetabular cavity disappears owing to the contraction of the lateral muscles of the disk, and by the pressure of the liquid in the ambulacral tube.

For the Cestoda, *Tenia cœnurus* as a type was taken, and sections of the scolex, stained with borax-carminé, gave excellent results; their

* Science, iv. (1884) p. 429.

† Claus, C., 'Elementary Text-book of Zoology.' Special Part: Mollusca to Man. Translated and edited by Adam Sedgwick, M.A., with the assistance of F. G. Heathcote, B.A., 352 pp., figs. 492-706. 8vo, London (W. Swan Sonnenschein & Co.) 1885.

‡ Rec. Zool. Suisse, ii. (1885) pp. 1-148 (5 pls.).

muscular system was found to be very well developed; that of the hooks was very complicated; the suckers are principally innervated by branches from the principal lateral and from the secondary ganglia. *T. elliptica* exhibits some differences from *T. cœnurus* in the arrangement of the muscles.

Tristoma molæ, *Hirudo medicinalis*, and *Myzostoma glabrum* are next successively discussed; the subjects among the Mollusca were *Pterotrachæa coronata*, *Pneumodermon mediterraneum*, *Argonauta argo*, and *Sepiola rondeletii*; *Echeneis remora*, *Lepadogaster gouannii*, and the common tadpole complete the series. From this wide survey it results that suckers have very different forms in different animals; simplest in tadpoles, they become powerful and wonderful organs of fixation in the Cephalopoda. As, however, we have to deal with analogues and not with homologues, we cannot draw any conclusions as to the relationships of the animals examined. The fact that, among the Echinodermata, we cannot find points of structure distinguishing the several orders, shows that the suckers are all adapted from a common type; there are here common characters, though not always the same function. The Tæniidæ have suckers which differ in structure from those of the Bothriocephalidæ; and the distinctions are such as to lead us to suppose that these organs had not the same origin. On the other hand, the sucker of *Hirudo* has much in common with the abdominal sucker of the Tristomida; this resemblance does not, in the judgment of the author, justify us in supposing that these two groups have had a common origin; all that it shows is that there has been an adaptation of tissues to a function, which has been everywhere subjected to the same mechanical conditions.

The Mollusca exhibit three distinct types which are seen in the Pteropoda, Heteropoda, and Cephalopoda; there is a great analogy in structure between those of the first two, but the Cephalopoda differ very markedly from them. "Thus the comparison of the organs of suction of the Cephalopoda and Pteropoda does not permit us to advance anything which can speak in favour of the relationship which it has been desired to establish between these two orders." The hooks appear to be derived from the suckers in the Cephalopoda; this question is discussed at some length.

The dorsal disk of *Echeneis* differs from the ventral disk of the *Discoboli* in origin, morphology, and mechanism.

Suckers are grouped into four sets:

1. Suckers without a skeleton (Cestoda, Tristomida, Discophora, Pteropoda, Heteropoda, Amphibia).
2. Suckers with an internal calcareous skeleton (Echinodermata).
3. Suckers with a horny external skeleton (Cephalopoda).
4. Suckers with an osseous skeleton (Fishes).

New Cœlenterates and Echinoderms.*—Prof. A. E. Verrill describes new marine forms obtained by the S.S. 'Albatross' in 1884 from the outer banks off the southern coast of New England. The most

* Amer. Journ. Sci., xxix. (1885) pp. 149-57.

remarkable new species represents a new genus of Pennatulidæ, and is named *Benthoptillum sertum* gen. et sp. nov. It was taken in 991–1073 fath., thus offering a remarkable exception to Kölliker's generalization that only simpler forms occur in deep water, the new genus being a very highly organized and specialized form of large size, with complex lateral groups of very large polyps. As other forms were also dredged at great depths the generalization will probably be found to rest on very insufficient evidence.

A peculiar new species of *Epizoanthus* (*E. abyssorum* V.) was taken in 1555–2033 fath. It usually formed the covering of a hermit-crab (*Parapagurus pilosimanus*). Eight new starfish are also described.

Fauna of the Pieces of Water of the Riesengebirge.*—Dr. O. Zacharias first discusses the fauna of the so-called "Grosser Teich," which lies 1218 metres above the sea, and is 1756 (Paris) feet long by 200 to 560 wide; *Daphnia longispina* was found to be a very common crustacean, and is of special interest, as it is very common in brackish waters. There were thousands of *Polyphemus pediculus*, and contrary to expectation, among these males were discovered; the bluish pigment of this form, which Leydig thought to be placed in the matrix of the cuticle, is rather due to a fluid which is contained in vesicles of connective tissue. The distribution of this species is very carefully detailed. Only one example of the Turbellarian *Stenostomum leucops* was detected, but the author was able to confirm the statement (made by Leuckart in 1854, but since frequently denied) that there is a distinct orifice at the anterior end of the body; further observations on this form are promised in a special essay.

The "Kleiner Teich" is 50 metres lower than the larger piece of water; its entomostracan fauna was found, with the exception of *Polyphemus pediculus*, to be identical with that of the larger lake; but no direct communication between the two pieces of water was to be made out. The rare Turbellarian *Mesostomum viridatum* was found in comparative abundance; *M. rostratum* was also found; this form is remarkable for its tactile proboscis, which is extraordinarily sensitive; its contractile power is due to the possession of five bundles of retractor muscles; its transparency enables the observer to study easily the distribution of its rhabdites; these are arranged in two rows; the red-coloured eyes have a very convexly curved lens.

The author discusses the natural history of these lakes from the geological point of view.

Minute Fauna of Reservoirs.†—Mr. E. Potts, referring to the difficulty of studying deep-water organisms while surrounded by their natural conditions, urges that advantage should be taken of such opportunities as are afforded by the temporary drainage of reservoirs, canals, &c. During a recent drawing off of the water from the Fairmount reservoirs, he availed himself of the opportunity of making such a study.

Of the fresh-water sponges *Spongilla fragilis*, *Meyenia fluviatilis*,

* Zeitschr. f. Wiss. Zool., xli. (1885) pp. 483–516 (1 pl.).

† Proc. Acad. Nat. Sci. Philad., 1884, pp. 217–9.

and *M. Leideyi* were found, while slender waving processes of *S. lacustris*, totally colourless, could be seen reaching up through the mud in little groups upon the bottom. Mr. Potts had always held that it was impossible for sponges to live upon a muddy bottom, and theoretical reasoning would still suggest that probably only this species which can thus hold itself up out of the suffocating silt can survive the constant deposition of siliceous particles.

The commensal habit of many of the lower animals who feed by the creation of ciliary whirlpool currents, has been frequently referred to; the weaker current-makers, such as *Vorticella*, Stentors, and the errant and tubicolous rotifers, planting themselves about the heads of the stronger Bryozoa to supply their own nets with what may have escaped from the others. The same instinctive principle which leads all these to locate themselves most plentifully amongst the stones in the rapids of streams, was particularly noticeable in promoting their aggregation upon and in the neighbourhood of the inlet and outlet gates of the reservoirs. The feeble currents produced by each can only bring within its reach the floating provision from a very limited area; the volume of water poured through these gates brings to them a rich supply, and the numbers and variety of these organisms increase in proportion. Of the fixed forms there were seen amongst the Bryozoa—beside one or more undetermined species of *Plumatella*—*Pectinatella magnifica*, and *Urnatella gracilis* of Leidy, and the newly described *Paludicella erecta*. Attached to these were *Vorticella*, *Epistylis*, and Stentors innumerable; *Pyxicola* and *Acineta*; rotifers of various names, including prominently *Limnias* and other probably undescribed forms among the Melicertidæ. Very abundant among these was the interesting chatobranch annelid *Manayunkia speciosa* Leidy, and the hydroid *Cordylophora lacustris*. This last was particularly abundant around the south-east outlet; its stems forming a complete matting over many yards of surface, commingled with Bryozoa and sponges in intricate confusion.

In a spot where all light was absent was found an incrustation of 3·8 in. in thickness, composed of gemmules and spicules of *Meyenia Leidyi* with stems of *Plumatella*, *Urnatella*, and *Cordylophora*. The fact that these can thus thrive in absolute darkness throws some doubt on the supposed sensitiveness of the forms to the presence or absence of light. The new species *Paludicella erecta* was found in the glare of full sunlight, while *P. Ehrenbergi* is said to seek the darkest corners.

Mollusca.

Radula of Cephaloporous Molluscs.*—Dr. R. Rössler comes to the conclusion that the seat of formation of the radula of all Molluscs is to be sought for in the papilla which traverses the hinder wall of the pharynx on its lower surface and projects by its end into the body-cavity. This radula-pouch is a diverticulum of the oral epithelium, the lumen of which is filled by a mass of connective tissue, which functions as a supporting and nutrient apparatus. The radula

* Zeitschr. f. Wiss. Zool., xli. (1885) pp. 447-82 (2 pls.).

lies between the upper and lower walls of the diverticulum; at its hinder end, or at the base of the follicle, there are a number of specially developed epithelial cells, by the secretion of which the teeth and the basal membrane are formed; the formative cells or "odontoblasts" are of two forms and sizes; we either find that there is a small number of large cells with large nuclei and clear protoplasm, which unite into an almost circular closed groove, as in Pulmonates and Opisthobranchs, or there are a large number of small odontoblasts, which are only occasionally to be distinguished from the surrounding epithelial cells; these unite to form an almost hemispherical prominence in Prosobranchs, Placophora, Heteropoda, and Cephalopoda.

In the Pulmonates and Opisthobranchs, which are distinguished by the uniformity of their teeth, four or five cells take part in forming a tooth, while the subjacent portion of the basal membrane is formed by a single cell, the size of which is in direct relation to the strength of the basal membrane. The odontoblasts are not replaced by new cells after the formation of one tooth, but the group of cells forms all the teeth of one longitudinal row. In the other Mollusca the cushion of odontoblasts breaks up into as many separate divisions as there are teeth in one transverse row of the radula; the striated basal membrane is formed by the lower portions of the epithelial cushion, and the ends of the matrix-cells break up into parallel fibres, which elongate and lie side by side. The forward movement of the radula is to be regarded as a phenomenon of growth.

New 'Challenger' Cephalopoda.*—Mr. W. E. Hoyle gives diagnoses of new species of Cephalopoda collected during the cruise of the 'Challenger.' In this first part the Octopoda are dealt with, comprising eleven new species of *Octopus* (with one new variety); two of *Eledone*; two belonging to a new genus, *Japetella*; three to *Cirroteuthis*; and one to a new genus, *Amphitretus*.

Intercellular Spaces of Epithelium, and their significance in Pulmonate Mollusca.†—Herr A. Nalepa, on examination of the land pulmonates of Austria, finds that fresh tegumentary epithelium, which is best taken from the margins of the foot of small Helicidæ, consists of irregular, many-sided, cylindrical cells, the height of which varies considerably; the separate cells are not closely packed, but have a delicate space between them; this may at some points widen out, and so give rise to the so-called dermal pores. The spaces traverse delicate bridges of substance which connect the cells with one another. The author is of opinion that these are true intercellular spaces, which are connected on the one hand with blood-spaces, and on the other with the surrounding medium; and he thinks that his method of investigation excludes any other explanation. He regards the pores not only as means by which water may enter the hæmo-lymph system, but as having also a relation to the processes of excretion.

* Ann. and Mag. Nat. Hist., xv. (1885) pp. 222-36.

† SB. K. K. Akad. Wiss. Wien, lxxxviii. (1884) pp. 1180-9 (1 pl.).

Cyclostoma and Pomatias.*—Dr. H. Simroth gives a comparative description of the anatomy of these two Neurobranchs, deducing therefrom the conclusion that "*Cyclostoma* and *Pomatias* belong to two quite distinct and widely separated families, which have independently become adapted to crawling on the earth." He notes *passim* that *Pomatias* is the only known snail that in crawling shows an internal movement from the anterior to the posterior border within the "sole." In other cases (where the "locomotory wave" starts posteriorly) the mechanism is muscular, but in *Pomatias* the wave is due to a current of blood swelling the organ.

Development of the Viviparous Edible Oyster.†—In this essay, the text being duplicated in Dutch and French, Dr. R. Horst brings together most of the information of value which has been acquired by his predecessors and contemporaries, and also gives an account of his own investigations, especially those which relate to the development of the shell-gland and gastrula, which he had, however, first published two years ago.

The gastrula is the first to be invaginated; this is followed by the invagination of the shell-gland on nearly the opposite side of the blastula. The mouth is formed at the time of invagination of the gastrula; the anus is formed later, and is broken through at the end of the gastrula pouch of endoblast, which blends with the ectoblast, which also becomes perforated where the two blend. The mantle cavity is formed by the appearance of a space between the posterior margins of the larval valves, lined with ectoblast (mantle), into which the vent opens. The anterior adductor muscle degenerates after fixation, when its function is assumed by the posterior adductor, which develops after the former. The cephalic ganglion originates from an epiblastic thickening situated in the centre of the trochal disk or velum. The larval shell is homogeneous; but at the hinge there are two small teeth separated by an interval from each other.

Dr. Horst's more recent investigations upon the early growth and fixation of the fry or veliger stage of *O. edulis* and its metamorphosis into the "spat" are of great and significant interest. Carrying out more fully a suggestion made by Mr. J. A. Ryder in 1881, Dr. Horst used a wooden frame, into which could be fixed a number of glass slides. This frame, with its slides, some of which were coated with hydraulic cement, was immersed for a period of seventy-two hours in water where free-swimming oyster larvæ were known to exist, at the end of which time spat was found adhering to the slides, measuring 0.24 mm. in height. After fixation the permanent shell is formed or built up by the mantle beyond the margins of the valves of the fry, a homogeneous membrane, subdivided internally into polygonal spaces or areas, being first laid down by the mantle border. In these prismatic areas of the periostracum calcification occurs by the deposit of calcic carbonate, and the shell is thus moulded upon the membranous matrix of conchioline.

* Zool. Anzeig., viii. (1885) pp. 16-9.

† Tijdschr. Ned. Dierk. Vereen. Suppl., 1884, pp. 1-63 (1 pl.). Cf. Amer. Natural., xix. (1885) pp. 317-8.

Attachment and growth of the young edible oyster, according to Horst, is very similar to that of the American species, as described by Mr. J. A. Ryder.* The outgrowth of the first branchiæ as two series of distinct ciliated processes projecting into the mantle cavity of the spat is interesting, as showing that the more primitive condition of the lamellibranchiate gill was much simpler than in the existing adult oyster.

Reproduction of *Mytilus edulis*.†—Prof. W. C. McIntosh describes the reproduction of the mussel (*Mytilus edulis*). The sexes are distinct in the adult form, but in the undeveloped condition the structure of the organs seems to be similar in both sexes. The shape of the valves gives no reliable distinction. The reproductive elements are developed in the mantle: the male presents in January, in the thickened generative region of the mantle, large pale round sperm-sacs filled with minute spermatozoa, which have minute ovoid bodies with finely filamentous tails. They are lively and tenacious of life. Twenty-four hours' exposure, however, seems to be fatal to them. The females have the same region of the mantle crowded with a prodigious number of minute ova. Throughout February the development increases and the whole surface of the mantle becomes speckled in both sexes with the reproductive elements. After full maturity is attained, as in April, the orange mantle is richly marked in an arborescent manner by racemose sperm-sacs and ducts, especially towards the margin. In the female this is not so evident, the ova being grouped in masses and densely packed.

‡ From this time the activity of the spermatozoa and the number of the ova diminish, till in July neither ova nor spermatozoa can be distinguished microscopically.

Movement of the Foot in Lamellibranchs.‡—Herr A. Fleischmann contributes a short addition to the important question whether mussels take in water into the blood system to assist in the movements of the foot. The pores described by Griesbach are asserted to have no existence, and the real cause of the dilatation of the foot is to be sought for in the blood itself, which while the animal is at rest is contained in reservoirs in the mantle; when the foot is extended the beat of the heart is accelerated and the blood is rapidly pumped into the foot; its reflux into the kidney is hindered by the closure of valves.

Molluscoida.

a. Tunicata.

Development of *Amarœcium proliferum*.§—MM. Ch. Maurice and Schulgin find that the embryonic development of *Amarœcium proliferum* much more resembles that of buds, as described by Kowalevsky, than the ordinary development of embryos. Just as in

* Bull. U.S. Fish Commission, ii. (1882) p. 383.

† Ann. and Mag. Nat. Hist., xv. (1885) pp. 148-52 (2 figs.).

‡ Zool. Anzeig., viii. (1885) pp. 193-5.

§ Ann. Sci. Nat.—Zool., xvii. (1884) 46 pp. (2 pls.).

compound Ascidians, there is no segmentation cavity, and the gastrula is formed by epiboly. The first cells of the organs are not all formed by the segmentation of the yolk, but by free cell-formation in its midst. The endoderm in the larva forms the epithelium of the branchial cavity, of the peribranchial cavities, and of the intestine, as well as the notochord. The mesoderm is formed by free cell-formation from the primitive endoderm, and gives rise to the body of the endostyle, among other organs.

The systematic position of *Amarœcium* seems to be between the compound Ascidians with stolons, such as *Perophora*, and the more differentiated colonies which have a common cloaca, like *Botryllus*, and which are the most degraded of all the Ascidians.

B. Polyzoa.

Morphology of the Bryozoa.*—Dr. W. J. Vigelius has examined the Bryozoa material collected during the cruise of the 'Willem Barents,' and has studied the morphology of *Flustra membranaceo-truncata* Smith, and *Barentsia bulbosa* Hincks. The results are now published in one of the most complete monographs that has yet appeared on any division of the Bryozoa.

Much space is devoted to the individual value of the polypide. Grant, Milne-Edwards, and Ehrenberg considered that an individuum was composed of the zoœcium and polypide; but on the other hand, Allman, Smith, Reichert, and Nitsche considered these as separate individuals. This has more recently been disputed by Repiachoff, Hatschek, Salensky, and Kohlwey; and now Dr. Vigelius brings forward a series of arguments to show that the "cystide" and "polypide" should together be considered as an individuum, and the ovicells and radicular appendages he only places as organs, whereas the entire avicularium is an individual corresponding with the zoœcial individual. With Salensky he considers the crown (*Kelch*) of the *Pedicellina* not as the equivalent of a polypide, but as the homologue of a polypo-cystide of which the stalk is an integral part, and he would thus deal with the structure of *Barentsia*. He unites both the endocyst and the endosarc under the name parenchym-tissue, as he holds them both as differentiations of the same tissue. The endosarc he, however, calls "Stranggewebe." Out of this parenchym the muscles take their origin, and, in opposition to the views of Joliet, the parietal muscle is formed after the intestine, and can remain after the absorption of the latter, and this is also the case with the opercular muscles.

The sexual organs can be formed either from the "Stranggewebe" or the parietal layer of the parenchym. The ovarium may be found in very young zoœcia even before the tentacles are formed. Hermaphrodite individuals with both ripe ova and male organs were only very seldom found, and it is very seldom that both sexual products are ripe at the same time.

* *Bijdr. tot de Dierkunde*, xi. (1884) 104 pp. (8 pls.).

As to the function of the "brown body," Dr. Vigelius is not quite in accord with Joliet, but considers its function to be one of nourishment, for in it, so to say, nourishment is preserved which during the absence of an intestine is at least partly assimilated by the animal.

The ovicells which have previously been examined were all external, whereas in this *Flustra* they are internal, but upon examination the difference was not found to be so extreme as at first sight appeared. The cover of the ovicell chamber is closed by two extremely delicate muscles. It is thought that probably the larva-sack in *Alcyonella* is to be compared morphologically with the concealed ovicells of the Chilostomata.

The existence of a nervous system is still an open question, but the author considers that possibly a cluster of round or polygonal cells with large nuclei may be nerve-cells, and as the position is the same as that of the nerve-centre in the Entoprocta, the idea thus receives considerable support.

As the different walls of the zoecium have been variously designated by different naturalists, it would be well if the names proposed by Dr. Vigelius could be generally adopted. The "opercular wall" has been called the front, hæmal side, the "bauchseite," and the upper side; the "neural wall" has been known as the dorsal or lower wall; the others are the distal, proximal, and lateral walls.

Urnatella gracilis.*—Prof. J. Leidy describes some specimens of *Urnatella gracilis*, which nearly all consisted of two stems of unequal length and devoid of terminal polyps. In March the stems had all developed polyps at the distal end. Most were terminated by a single polyp, but a few had also a smaller one on a cylindrical joint springing from the antepenultimate joint of the stem. If portions of the stem are destroyed, the remaining joints are capable of reproducing the polyps. Branches usually spring from the last one or two joints, newly produced from that which immediately supports the terminal polyp. Heads may start laterally from old or mature joints. Thus the latter appear to serve as the statoblasts of other fresh-water polyzoa, but ordinarily they do not become isolated from one another.

New Polyzoa.†—In continuation of his "Contributions towards a general history of the Marine Polyzoa," the Rev. T. Hincks describes some new Cheilostomata from New Zealand and Australia. Of the genus *Diachoris* two new species (and two others) are described, in which the avicularia present remarkable features: there are besides three new species of *Membranipora*, two new forms of *Microporella Malusii* Aud., and *M. diadema* MacGill. Four new species (and two others) of *Schizoporella*; a specimen doubtfully referred to *Hippothoa* which bears a very close resemblance to *H. expansa*, and which exhibits some curious secondary cells (?); also three new species (and one other) of *Lepralia*.

* Proc. Acad. Nat. Sci. Philad., 1884, p. 282.

† Ann. and Mag. Nat. Hist., xv. (1885) pp. 244-57 (3 pls.).

7. Brachiopoda.

Brachiopoda.*—Dr. F. Blochmann's observations on the structure of these animals have corroborated Hancock's views as to the existence of a contractile heart (which contains branching muscle-fibres) and of the dorsal vein over the gut and the genital arteries, which are only spaces within the mesentery. He disagrees, however, with Hancock as to the "afferent brachial canal" of the latter, which is really the supra-oesophageal brachial nerve. Further, the plexus which Hancock describes as circulatory, are really branching and anastomosing connective-tissue-cells. A brachial vessel, sending off vessels to the cirrhi, runs along the whole length of the brachial sinus behind the oesophagus communicating by paired branches with the oesophageal blood-sinus, and so with the heart.

Crania anomala has no heart, but shows numerous enlargements on the "vein." A heart is seen in *Argiope*,—two occurring in *A. neapolitana*.

In *Crania* there are two pairs of straight and three pairs of oblique muscles, together with an unpaired oblique muscle. The mantle-border is smooth, and there is a median and posterior anus.

As regards the nervous system of Brachiopoda, Blochmann agrees generally with Van Bemmelen, except in the histology. In *Crania anomala* there is only a narrow fibrillar commissure in the place of the supra-oesophageal ganglion.

Arthropoda.

a. Insecta.

Cameron's British Phytophagous Hymenoptera.†—In the second volume of his monograph Mr. P. Cameron continues the description of the species of saw-flies (which is to occupy two more volumes), dealing only with the species of a single tribe or sub-family, the Nematina. This group, although not so extensive as that of the Tenthredina, which were treated of in the first volume, is the one which presents the greatest difficulties for the descriptive entomologist, as it includes the great genus *Nematus*, of which Mr. Cameron here records 107 British species, many of which are closely allied—in fact so closely that, as in the case of the Lepidoptera, it seems to be necessary in some cases to rear the species, the larvæ presenting decided differences when those between the perfect insects are obscure. The whole number of British species of the group is only 132.

In an appendix the author indicates certain species to be added to genera treated of in his first volume, and also offers some important remarks upon the subject of parthenogenesis as occurring among the saw-flies, as to which he says, "there seems to be no doubt that the phenomenon is quite common."

* Zool. Anzeig., viii. (1885) pp. 164-7.

† Cameron, P., 'A Monograph of the British Phytophagous Hymenoptera (*Tenthredo*, *Sirex* and *Cynips* L.), vol. ii., 233 pp. and 27 pls., 8vo, Ray Society, 1885. See Ann. and Mag. Nat. Hist., xv. (1885) pp. 416-7.

Composition of the Ova of Bombyx.*—Dr. Tichomirow has examined chemically the ova of *Bombyx*. The weight of the ova was not a constant quantity, 100 ova giving weights ranging from 0·2 to 0·6 gr. The firm membrane of the ova has hitherto been universally regarded as consisting of chitin. The easy solution, however, of this membrane in solution of potash proves the inaccuracy of this assumption. It consists, on the contrary, of a peculiar substance distinguishable from chitin, not only by its ready solubility in potash, but also by a perceptible ingredient of sulphur. Chemically this substance has most relation to keratin, yet it contains less carbon than the latter, and has therefore received a special name, "chorionin." A comparison of the chemical composition of winter ova which had undergone but a partial transformation with the *Bombyx* ova developed into caterpillars showed that in the latter the dry weight had suffered a little diminution, and that the glycogenous contents of the undeveloped eggs had almost entirely disappeared in the process of development, but, on the other hand, that chitin, which was wanting in the ova, was present in perceptible quantities in the caterpillars; while the nitrogenous bases (nuclein probably) were also present in greater quantity in the developed ova than in the undeveloped winter ova.

Influence of some Conditions on the Metamorphosis of the Blow-fly.†—Mr. J. Davidson details six experiments made to ascertain the effect of modifying conditions—heat, light, and darkness—on the metamorphosis of the blow-fly. The result showed that darkness and heat were favourable, and that light, and more especially the blue rays, was unfavourable to the development of the larvæ. Imagines from pupæ that had been kept in darkness were small, almost colourless, and translucent. An attempt to produce a vegetable feeding variety failed. The larvæ instinctively shun light. In conclusion the author offers some observations on the necessity for heat and darkness in development generally, and suggests that this may be an inherited character.

Head and Mouth of the Larva of Insects.‡—M. A. Barthélemy briefly recapitulates the various forms of mouth in the larvæ of different insects, and shows that there exists in insects a general larval form—the caterpillar—whose mouth resembles the appendages of the Nauplius-form and the kindred appendages of the mouth in the lower crustaceans, and that the study of the modifications of these organs in the intermediary forms, nymphæ and chrysalids, must precede that of the same organs in the perfect insects.

Sensorial Organs of the Antennæ of Ants.§—Prof. A. Forel gives a lengthy summary of the myrmecological discoveries in 1884, and describes the organs of sense in the antennæ of ants and some other Hymenoptera, distinguishing three varieties of exterior organs.

* Nature, xxxi. (1885) p. 620. (Proc. Berlin Physiol. Soc., 13th March.)

† Journ. Anat. and Physiol., xix. (1885) pp. 150–65.

‡ Comptes Rendus, c. (1885) pp. 121–4.

§ Bull. Soc. Vaudoise Sci. Nat., xx. (1885) pp. 316–80 (1 pl.).

(1) pointed tactile hairs; (2) sensorial clubs; (3) sensorial hairs, imbedded in a longitudinal depression (at times scarcely visible) and often transformed into ridges or plates. The latter portion of the paper is devoted to a description of new or little known species.

Spinning Glands of Saw-flies.*—These are described by M. N. Poletajew. Each of the two glands (which lie ventrally and mesially in the body-cavity) is made up of a number of small chitinous bodies filled with silk-producing cells. These bodies are more or less aggregated, and their respective ducts unite into a common duct near the labium and then form the spinning apparatus. The common canal is horseshoe-shaped in section, and through its centre issues the *single* thread. In larval Lepidoptera the thread is not single, but composed of *two* twisted threads, and hence Poletajew concludes that Helm and Cornalia are wrong in asserting that union of the two ducts takes place *before* the spinning apparatus is reached.

Alimentary Canal of Insects.†—The researches of M. H. Beauregard deal with the genera *Cantharis*, *Epicanta*, *Lytta*, &c. He distinguishes three regions: (1) œsophagus, (2) stomach, (3) intestine; these are separated from each other by two valves; the structure of the most anterior of these two valves, termed the "cardiac," appears to differ in different genera; the form of the cells is characteristic of the several regions of the gut. The author intends to publish a more detailed description of all these facts.

Scales of Coleoptera.‡—Mr. G. Dimmock describes the scales or scale-like hairs of a number of beetles, and the effects of scales on the coloration of these insects and the modes of coloration of scales themselves. Scale-like hairs of *Cicindela*, *Anthrenus*, *Hoplia*, *Polyphylla*, *Valgus*, *Psiloptera*, *Chalcolepidius*, *Alaus*, an undetermined genus of Elateridæ, *Ptinus*, *Clytus*, and *Entimus* were used. This adds the Elateridæ and Cerambycidæ to the families already recorded as sometimes owing their configuration to a scale covering.

The question of the morphological identity of scales and hairs of insects has been long since settled, so that the question of whether an appendage is a scale or hair has little importance. The extremely minute spines or hairs upon the wings of diptera, hymenoptera, and other insects are simply another form of scales. It is only in insects where certain kinds of brilliant coloration have been developed that one finds scales. This leads to a consideration of how hairs and scales of insects affect coloration. They may simply cover a surface of the same colour as their own; in such cases hairs may, according to the angle in which they stand, their abundance, or their length, give rise to appearances which we designate as pubescent, velvety, pilose, sericeous, &c.; scales under similar circumstances may give rise to similar appearances, but are most often imbricated and usually cause more lustre than hairs. Hairs or scales may be of a different colour from the surface on which they are placed. If they are numerous and

* Zool. Anzeig., viii. (1885) pp. 22-3.

† Comptes Rendus, xcix. (1884) pp. 1083-6.

‡ Psyche, iv. (1883) pp. 3-11, 23-7, 43-7, 63-71 (11 figs.).

opaque they may entirely conceal the surface on which they are inserted, as the white hairs hide the bronze surface of the sides of the thorax in *Cicindela dorsalis*, and as the white scales of *Alaus oculatus* hide the black surface beneath the rings on the thorax; or they may only partly conceal the surface of the insect, giving rise to coarser and finer mixtures and shades of colour. Opaque scales, or hairs, of more than one colour, may cause figuration, whether they imbricate as on the wings of lepidoptera, or are separated as on *Anthrenus scrophulariæ*.

The possibilities of varying effects of colour are many with opaque scales and hairs, but with transparent ones, especially if they are coloured, the effects of colour can be multiplied still further. With hairs the effects are not so remarkable as with scales. The scale, by its form, increases the number of layers of the surface of an insect which are available for coloration purposes. Where the surface of an elytron had previously a cuticular and hypodermal layer, by the addition of a scale of the simplest type there is an addition of two cuticular and, theoretically at least, two hypodermal or sub-cuticular layers; in all six layers, without counting overlappings of imbricated scales. Some of these surfaces may have pigments, striæ, hairs, and other appliances to produce colours, and other surfaces may have other striæ and contrivances to act on the colours produced.

Next to the consideration of how the colour and presence of scales and hairs affect the appearance of surfaces to which they are attached is the not less interesting question of the causes of coloration in scales themselves. But before considering the causes of colour, properly speaking, the author deals with the causes which produce silvery and milk-white appearances in scales and on insects. Leydig was the first, in 1855, to call attention to the presence of air between or beneath their chitin layers as a cause for certain silvery spots and scales on insects. He speaks of air in the finer pore-canal of *Ixodes testudinis* giving these canals a black appearance, but causing the whitish grey colour of the skin. So, too, he mentions silvery scales on a spider, *Salticus*, and glistening hairs on another spider, *Clubione claustraria*, which appendages owe their silvery whiteness to air within them. Again he mentions hairs which contain air on spiders of the genera *Epeira* and *Theridium*.

Leydig accounted for silvery glistening scales and surfaces and for milk-white coloration among insects, but he fails to account for the difference between these two kinds of coloration. Of the white scales of *Pieris rapæ* and the silvery scales on the under side of the posterior wings of *Argynnis idalia*, neither contain any appreciable colouring matter, and both contain air; both, too, are simply milk-white by transmitted light. The difference is that there must be in the silvery scales a polished surface towards the observer. Ground glass does not appear silvery, but what is the surface of the smoothest polished plate of glass but finely ground glass? Ground glass differs from polished glass only in degree: in ground glass the scratches are so coarse and so abundant as to turn most of the light-waves into the glass again, where they are lost. In polished glass the scratches are still present, but have become so small that even the

waves of light are large in proportion to them, and so the light-waves are reflected as if from a theoretically flat surface. But something more than a polished glass is needed to reflect much light, for most of the light passes through the glass; something non-transparent must be behind the glass. In the common mirror it is a mercury amalgam; in the butterfly's silvery scale it is a layer of cavities filled with air. This layer of cavities is not transparent for the same reason that ground glass is not. If we treat the scale with chloroform it has an analogous effect to that of treating the back of a common mirror with nitric acid, thus dissolving off the amalgam. In both cases a non-transparent body is converted into a transparent one, and a mirror, which, whatever be the materials of which it is made, if approximately perfect has a silvery appearance from the amount of reflected light, is reduced to a slightly reflecting surface. But let the scale dry again from its bath, as Fischer apparently did not do, and the mirror will again appear. Both silvery and milk-white colorations are therefore only optical effects produced by reflected light.

Still another kind of appearance is seen in the scales of *Hoplia* and of *Entimus*. These scales are brilliantly coloured, yet their colour is in the one case entirely lost, in the other case greatly changed by wetting with almost any liquid, but when redried the colours reappear with all their previous brilliancy. This coloration also resists all forms of bleaching. It must therefore be produced by some decomposition of light. Whatever acts upon the light must be within the scale, not upon the outside, for all those scales which remain perfectly sealed, so that the liquid does not enter them, retain their colour even when surrounded by liquid. This proves that the colour is not due to external striation, where such exists. The finer striation of the scales of *Entimus* is evidently internal, from its relations to the differently coloured internal cavities of the scales. Besides this striation the interior of the scale is evidently filled with a pith-like substance into which liquids enter with equal readiness in all directions; this pith-like portion apparently has some direct influence upon the production of the coloration, for wherever it is injured or has shrunk away from the basal end of a scale there is no longer coloration in that place. Perhaps it is a necessary filling to cause the striæ to refract the light, the same as air-cavities are necessary as a backing to produce the silvery colour in the scales of Lepidoptera. The striæ themselves are very fine, but whether they are the causes of colour is hard to determine without more accurate instruments of measurement than the author had at his command. As near as he could determine they are 0.0008 to 0.0009 mm. apart. The wave-length of a ray of light from Fraunhofer's A line of the spectrum is, according to Willigen, 0.00076092 mm., and the wave-length at the H₁ line is, according to the same authority, 0.00039713 mm.; the difference being 0.00036379 mm., or the difference of wave-length between violet and red light. To determine the *place* in the spectrum to which the striæ of these scales correspond would require, of course, much finer measurements.

The author adopts Hagen's division of colours into "optical" and

“natural,” of the latter of which he distinguishes two kinds—dermal, where “the pigment is deposited in the form of very small granules in the cell, or in the product of cells in the cuticula,” and hypodermal, where “the pigment is a homogeneous fatty substance, a kind of dye somewhat condensed.” Like organic colours in general, the author found dermal as well as hypodermal colours to be subject to the chlorin bleaching processes, which he first applied in 1875, for the purpose of studying the venation of Lepidoptera, the only difference being this, that dermal colours require to be freed, by long maceration, from their prison in the chitin. Thus a distinction between dermal and hypodermal colours is that the former bleach only by destruction of the parts in which they are enclosed, the latter bleach readily. The following table is given to serve for the separation, under the Microscope, of the different kinds of coloration.

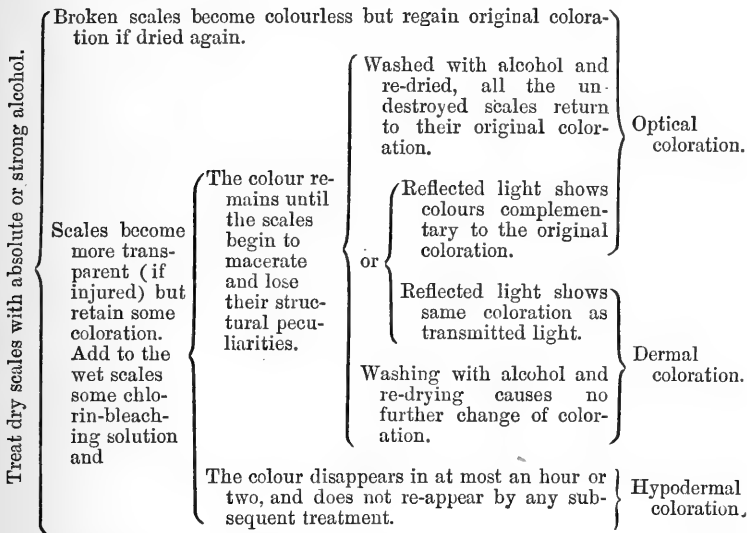

By this and other modes of separation all the scales of Coleoptera which he had at his command have been studied and only optical and dermal (never hypodermal) coloration was found; optical coloration being common. In the case of Lepidoptera, optical coloration, except where concealed or subdued by hypodermal coloration, is somewhat rare, and the author never discovered scales where dermal coloration occurred. This may occur in brilliant gold coloured scales, such as some species of *Plusia* present, but none were at hand to examine.

An interesting object on which to try this mode of colour-separation is the head of a freshly killed larva of *Smerinthus*. Upon the application of strong alcohol, the tubercles lose their milky whiteness from the loss of air, thus proving optical coloration. Chlorin bleaching fluids rapidly destroy the green colour of the fluids of the head, proving

it to be hypodermal, while the outer chitin-shell, or covering of the head, resists all bleaching action, remaining green until it is macerated.

"I cannot yet wholly understand why the scales of Lepidoptera discharge the air contained in them so much more readily, when subjected to treatment with alcohol and chloroform, than do the scales of Coleoptera, while, on the other hand, water will drive out the air from scales of Coleoptera much quicker than from scales of Lepidoptera. There are several things which might cause these phenomena, but I am inclined to the opinion, without having *proved* its correctness, that their cause is the presence of more oil in the scales of Lepidoptera than in those of Coleoptera. This would coincide with the greater lustre of lepidopterous scales, and with other points in their appearance. Perhaps the entrance of the shank of the scale is only closed with an oily mass, for I have never seen the scale of a lepidopteron resist entirely the entrance of fluid, as is often the case with the scales of Coleoptera.

"The striæ upon scales of Lepidoptera have long been a subject of investigation, but, as far as I know, no one, up to 1880, published the fact that their striæ were upon the outside, or upon the side turned away from the wing. In Burgess's paper on *Danaïs** in that year he figures transverse sections of the scales of that butterfly, and calls attention to the fact. Without having seen Burgess's paper, in the following year I noticed that the striæ upon the scales of the proboscis of *Culex* were on the outside, and so figured them in my dissertation † and in 'Psyche.' ‡ By the transverse section of a scale of *Alaus*, figured in this paper, it will be seen that there too the striæ are upon the outer surface. That I have found to be the case with the principal or external striæ, in all beetle-scales which I have examined. It is, briefly expressed, only the development of a mechanical law, which extends to many surfaces which shrink by drying or cooling. It can be easily illustrated by partly filling a bladder with water and allowing it to dry upon a board. The main folds will be, of course, upon the exposed upper side, and the longitudinal ones will be the more prominent.

"Another easy way to prove that the striæ upon the scales of the wings of Lepidoptera are upon the side away from the wing is to take impressions of the scales upon a surface of collodion. These impressions are readily taken by pressing quite lightly a dry butterfly's wing upon a microscope slide, which has been moistened with a solution of collodion in ether. The wing should be removed before the collodion has become thoroughly dry, when beautiful impressions of the outer surface of the scales will remain on the collodion surface, and may be mounted for future study. A very little practice will enable one to remove the wing at the proper moment; if left too long the greater part of the scales will be removed from the wing and adhere to the collodion. In order to take impressions of the under sides of scales, the latter should be transferred by a process described

* Anniv. Mem. Bost. Soc. Nat. Hist., 1880.

† Dissertation, Leipzig University, 1881, pl. 1, figs. 8, 12-15.

‡ Psyche, July-Sept., 1881.

by Berge,* and later by H. Landois,† and others, to a piece of paper, and the impression on collodion then taken from these inverted scales. The process of transferring the scales to paper or other surfaces, first used to get prettily coloured figures of butterflies, consists, leaving out details, in gumming the wing of a butterfly upon paper with gum arabic or glue, and after thorough drying, removing the wing, leaving the scales attached to the paper. From such 'butterfly pictures' impressions of the under surface of the scales can be readily taken.

"By rubbing anilin colours into impressions of the striæ of the scales of insects, I hope later to gain further knowledge of the external configuration of insect scales."

Change of Sarcopsylla penetrans through Parasitism.‡—M. W. Schimkewitsch finds that the females of this animal undergo certain changes when they adopt the parasitic life; the abdomen enlarges and the external stigmata as well as the segmentation disappear; into a cloacal invagination open rectum, sexual organs, and a few stigmata; this "cloaca" is formed by an invagination of the posterior abdominal segments; the muscoli abdominis laterales obliqui connected with the respiratory process disappear and only the dorsal and ventral longitudinal muscles remain; there are also changes in the alimentary tract.

New genus of Sarcopsyllidæ.§—M. W. Schimkewitsch also describes a new genus and species of the family Sarcopsyllidæ, *Vermipsylla Alakurt*, found on cattle in Turkestan, producing great debilitation, or even death, and observed in the greatest abundance during severe frosts. Originally it is nearly black, but when distended it becomes white with variegated bands.

Embryology of Botys hyalinalis.||—Dr. J. A. Osborne describes the development of *Botys hyalinalis*, pointing out more especially that the head of the embryo normally occupies the lower pole of the egg and that the loop form of the embryo is due to a movement of growth, not to change of its position in the egg. The earliest and latest stages were unfortunately not observed.

Developmental History and Morphological Value of the Ova of Nepa cinerea and Notonecta glauca.¶—The most important results of Dr. L. Wills's studies are that the nuclei of the follicular epithelium are provided by the ooblast, the rest of which passes into the definite germinal vesicle; the ova which, as in many groups of animals, are without any follicular epithelium, are homologous with the egg plus the follicular epithelium of higher animals. The ovum of the Hemiptera

* Berge, T., 'Taschenbuch für Käfer- und Schmetterlingssammler,' Stuttgart, 1847, pp. 55-62.

† Landois, H., "Neue Methode Schmetterlinge zu copiren," Zeitschr. f. Wiss. Zool., xvi. (1866) pp. 133-4.

‡ Zool. Anzeig., vii. (1884) pp. 673-6.

§ Ibid., viii. (1885) pp. 75-8. Cf. Ann. and Mag. Nat. Hist., xv. (1885) pp. 270-3.

|| Sci.-Gossip, 1885, pp. 32-6 (10 figs.).

¶ Zeitschr. f. Wiss. Zool., xli. (1885) pp. 311-64 (3 pls.).

is neither a cell nor a cell-complex, but the product of several cells. The homology between the ova of various animals is consequently to be sought for in the fact that the mature ovum always represents a germinal mass, which contains all the elements necessary to future development, and is the product of the activity of those cells which have taken part in its construction.

Marine Hemipterous Insect, *Æpophilus Bonnairei*.* — M. R. Köhler describes the rare marine hemipterous insect, *Æpophilus Bonnairei* Signoret. The presence of eggs in the form described by Signoret as the male, shows that this observer reversed the sexes in his description. The female bears the genital armature on the ventral surface, the male on the dorsal.

β. Myriopoda.

Nerve-terminations on the Antennæ of Myriopoda.† — M. B. Sazepin describes in detail the sensory hairs which are found upon the antennæ of Myriopoda as well as the nervous structures connected with them; they differ more or less in form in the different genera, and the main varieties are depicted in the plates which illustrate the memoir.

δ. Arachnida.

Direct Nuclear Division in the Embryonic Investments of Scorpions.‡ — Dr. F. Blochmann has been enabled to study a gravid scorpion from Brazil, the cells of the coverings of the embryo of which were of colossal size; the nuclei of the cells were large, and the protoplasm was thicker around them than in other parts of the cell; the boundaries of the large cells were remarkable for being fibrillated. In the resting condition the nuclei do not exhibit any remarkable characters; there is a rather coarse nuclear plexus in which one or more irregularly formed nucleoli are to be found; most of the cells contain two nuclei. Some of these may be seen to be elliptical in form, or to present the first signs of division; but in them the contents are not different to those of other cells. Division first becomes apparent when there is a constriction of the nucleus; this is always median, and gradually becomes deeper, without the contents exhibiting any changes. The nuclear plexus has just the same coarse network as in nuclei which have and have not divided. The bridge of substance which connects the two halves of the nuclei becomes gradually thinner and thinner; the filaments finally break, and we have two separate nuclei. No cell-division appears to be associated with this division of the nuclei.

The process here described has a close resemblance to other cases of direct nuclear division; that of leucocytes may especially be cited. Direct division is more common among plants; as, for example, in the Siphonocladaceæ, where there are multinuclear cells, the nuclei of which in the anterior part divide with distinct differentiation of their contents, and in the posterior part by direct constriction; in the

* Comptes Rendus, c. (1885) pp. 126-8.

† Mém. Acad. Imp. St. Petersburg, xxxii. (1884) pp. 1-20 (2 pls.).

‡ Morphol. Jahrb., x. (1885) pp. 480-4 (1 pl.).

Characeæ there is indirect nuclear division at the vegetative point, while the nuclei of the growing internodal cells multiply by direct constriction. In these two, as in many other cases among plants, direct nuclear division is not accompanied by division of the cell, and herein they agree with such cases of direct nuclear division as have been observed in animal cells. The relations of direct to indirect cell-division require much further investigation.

Development of Chelifer.*—M. J. Barrois publishes some observations upon the larval condition of *Chelifer*. The number of limbs is five pairs; all the future limbs exist, but they are incompletely developed and of no functional use; the nutritive yolk is encircled by a layer of exodermic cells, and in front is a suctorial stomach; this latter is an organ peculiar to the larva, and is shed when it attains to maturity; the nervous system consists of two bands, one behind and another in front of the suctorial stomach; when the latter is got rid of they become fused.

Descriptions of New Acarina.†—Dr. G. Haller describes some new American species of the genera *Tyroglyphus*, *Oribata*, and *Eremæus*; from Europe he describes a new species of *Damæus* and of *Cheyletia*, and a remarkable new genus, which he calls *Michaelia* (*M. paradoxa*), dedicating it to Mr. Michael, in recognition of his great services to the Oribatidæ specially, and to Acarinology generally. Standing near *Hoplophora*, it is remarkable for the character of the lamelliform structures found on its appendages, and over the whole surface of the body; in *M. paradoxa* they are generally lancet-shaped; their wide distribution over the body leads to the supposition that they are sensory organs, but time alone will show whether this view as to their function is correct. The only species known is of some size (1 mm. long), of a bright brown colour, and is found rarely among decaying vine-roots in Germany.

Sphærogyna ventricosa.‡—Prof. A. Laboulbène and M. P. Mégnin give an account of this Acarid, which has been placed with *Heteropus* and with *Physogaster*, but for which they institute a new genus.

The female is ovoviviparous, and gives birth to adult males and females, which are fecundated at once; all development is intra-uterine. This is the first example of such a phenomenon among the Arthropods, and perhaps in any zoological group. In the uterus one can distinguish males from females, and there is here no question of parthenogenesis. In the embryonic condition, and immediately after birth, there is a blackish residue in the intestines, but as soon as the Acari begin to suck the juices of their prey, these juices appear to be absorbed completely, and leave no residue. They have a poisonous salivary secretion, which is the chief cause of the death of the insects on which they feed; it is secreted by four pairs of vesicles which are set along the œsophagus, and is emitted immediately after the insertion of the lancet-like mandibles.

* Comptes Rendus, xcix. (1884) pp. 1082-3.

† Arch. f. Naturgesch., l. (1884) pp. 217-36 (2 pls.).

‡ Journ. Anat. et Physiol. (Robin), xxi. (1885) pp. 1-17 (1 pl.).

Spiders in Relation to Forestry.*—M. C. Keller ascribes considerable importance to the influence of spiders on vegetation. The first case taken up is that of their relations to *Lecanium racemosum*, this is succeeded by that of *Chermes coccineus*, where larvæ have great influence in the production of galls; *Chermes viridis*, which appears to the author to be a distinct species, is also affected by spiders. After giving some other instances Keller has a systematic list of the Phalangidæ, and of the true spiders which are important to foresters; here are included *Phalangium parietinum*, *Opilio saxatilis*, *Theridium lineatum*, *irroratum*, and *varians*, *Agelena labyrinthica*, *Thomisus calycinus* and *T. pini*.

e. Crustacea.

Optic Ganglion of *Palinurus vulgaris*.†—M. H. Viallanes describes the optic ganglion as being very complex in structure, and consisting of the layer of post-retinal fibres, the ganglionic layer, the external chiasma, the external medullary mass, the internal chiasma, the internal and the terminal medullary mass.

The ganglionic layer is remarkable for having the large nerve-cells, which are numerous in the crayfish, extremely rare and scattered. Some of the fibres of the chiasma have a peculiar course, and each fibre swells out into a large unipolar cell; united they form a large lobule, which is situated in front of the external medullary mass; this last has such a form that its long axis lies perpendicularly to the long diameter of the other curved parts of the optic apparatus; it is entirely made up of dotted substance. With it there is connected an important ganglionic centre, which, from its form, may be called the ganglionic crown; it is formed of a number of unipolar nerve-cells of various sizes, each of which gives off a process which passes into the midst of the fibres of the chiasma. A bundle of fibres of the internal chiasma divides into two groups, one of which passes into the internal medullary mass, while the other joins and fuses with the optic nerve. The internal medullary mass is invested internally by a ganglionic cortex, which has the same function with regard to it as has the ganglionic crown in relation to the external medullary mass. The terminal medullary mass is the largest and most complicated part of the optic ganglion; it is divided into two parts or balls, into the superior of which the optic nerve enters, and with the dotted substance of which its fibres fuse. This terminal mass is almost entirely covered by a cortex formed of unipolar nerve-cells, divided into a number of lobules. Each of these gives off a number of fibrils which penetrate the mass, and go either to the superior or the inferior ball. The sclerotic is formed by the neurilemma of the optic nerve.

Isopoda of the 'Willem Barents' Expedition.‡—Dr. M. Weber reports on the Isopoda collected in the Arctic Seas by the 'Willem Barents.' In all, fifteen species were collected during the expedition.

* Rec. Zool. Suisse, ii. (1885) pp. 149-88 (1 pl.).

† Ann. Sci. Nat.—Zool., xvii. (1884) Art. No. 3, 74 pp. (5 pls.).

‡ Bijdr. tot de Dierkunde, x. (1884) 39 pp. (3 pls.).

The most important portion of the present report is an account of the *Idothæid* form *Glyptonotus sabini*. The mouth-organs, which are well developed, are described in some detail; the mid- is separated from the hind-gut by a circular constriction which forms a valvular projection into the enteric cavity; the stomach is a bell-shaped tube, only a little wider than the œsophagus, and it is shut off from the intestine by a valve; there are special muscles which compress the stomach from side to side, and the presence within of spines and hairs shows that we have to do with a masticating organ, but with one that is very different from the complicated triturating apparatus of the Oniscidæ; this is to be correlated with the difference of nutriment. In addition to the tubes of the hepatopancreas there are glands of another kind which have not hitherto been detected in the Isopoda; those around the mouth have, under the Microscope, the appearance of spherical or elongated glands, not unlike those seen by Claus in the Phronimidæ, and by P. Mayer in the Caprellidæ. The author is unable to give any definite opinion as to their function, as he is in doubt whether they secrete mucus which aids in the movement of the mandibles, or produce an enzym which acts on the albuminous and starchy bodies that have been cut small by the mandibles.

The ovaries are of the form common among the Amphipoda and Isopoda, and are long tubes, lying laterally above the enteric canal. The genital orifice does not appear to be permanently but only temporarily open; a similar arrangement to this has been detected by Schöbl in the Oniscidæ. Weber enters with some detail into the account of the female organs and the brood lamellæ. The copulatory organs of the male are very similar to those of the terrestrial isopods, the penis being long and stylet-shaped; in some males the penis was seen to be rudimentary, and this appearance is considered to be correlated with an ecdysis; small examples, recognized to be males by the presence of spermatozoa in their testes, had the external appearance of females. The sexual characters are fully described.

The investigation of the nervous system was attended with considerable difficulties, owing to the richly calcareous condition of the carapace preventing the complete preservation of the specimens in spirit. As is well known, the brain of isopods differs a good deal from that of other Crustacea—so far, at least, as we have been able to judge from what is known of the Oniscidæ. In *Glyptonotus* the "optic ganglia" were at first thought to be absent, but treatment of two specimens with osmic acid revealed the fact that they had undergone alteration only; at the point where they are found in the Oniscidæ there was seen a pyriform body, which gave off an extremely fine filament which ended at the point where the eye would have been expected to be, had it been present; this cord is clearly a rudimentary optic nerve. The rest of the brain is not changed in form by the loss of the eyes and the reduction of the optic ganglia. As a compensation for the loss of the eyes the olfactory apparatus is well developed in the male.

Glyptonotus sabini is obviously a common arctic species.

The male of *Murmopsis typica* has, M. Sars has pointed out, the

flagellum longer than has the female; to this Weber adds that it is provided with a large number of extremely long olfactory clubs; as the creature is blind there can be little doubt that the function of these organs is to enable the male to find the female.

Paranthura brachiata is an example of a species that is probably circumpolar in its area of distribution.

Morphology of Cyclops and Relations of the Copepoda.*—Prof. M. M. Hartog gives a full anatomical description of *Cyclops brevicornis* Claus, worked out in great part by the method of sections. The chief new points made out are as follows:—In the skeleton a free entosternite is demonstrated in the maxillary region, and homologized with the tendon of the abductors of the valves of the bivalve Entomostraca. A large postmaxillary apodeme in all Copepoda gives attachment on either side to the great flexors of the trunk. A spring arrangement is shown to relax the flexed male antennule used as a clasper. Pore-canals, cells, or cutaneous glands each receive a nerve-fibre at their proximal end. The hyodermal cells have a polygonal outline.

Under the mesoblastic tissue, Frič's discovery of amœboid cœlomic corpuscles is confirmed. The apparatus of deglutition is fully described, and the author has made out a pair of salivary glands in the epistoma, whose ducts join to open on the back of the labrum by a median pore. In connection with the alimentary canal, the mechanism of circulation and anal respiration is described, the efficiency of the latter being strongly maintained.

The kidney, or "shell-gland," is shown to be a simple, much-coiled tube, with chitinous lining, opening at the base of the outer maxilliped. Incidentally the presence of this organ is noted in several divisions of the marine Copepoda, and the author suggests that it is identical with the "antennary gland" of similar structure of the *Nauplius* larva, which would have shifted its aperture.

A full description of the nervous system follows. The presence of ganglion-cells in the circumœsophageal cords is noted, and used as an argument for regarding the (2nd) antennæ innervated therefrom as oral rather than postoral appendages.

The presence of corneal facets to the lateral ocelli is noted, and an attempt is made to connect what the author has described elsewhere as auditory organs with the unicellular pore-canal glands.

The views of Gruber on the reproductive organs are confirmed. The sexual ducts are described as outgrowths from the sexual glands, themselves derived from a pair of cells of the serosa of the gut of the *Nauplius* as stated by Frič. About thirty-two spermatozoa appear to be formed from each male ovum or spermatospore. The author is inclined to accept Gruber's view that the expulsive bodies of the spermatophore are a second form of spermatozoa.

The author then proceeds to a discussion on the position of the Copepoda. He adduces the following points:—

* Journ. Linn. Soc. Lond. (Zool.) xviii. (1885) pp. 332-3 (Abstract). Complete paper with plates will appear in the Transactions.

1. The plasticity of the eye, derived from the triune inverted eye of the Nauplius, and the absence of paired compound eyes.
2. The biramous condition of the swimming-feet, and the characters of the appendages generally, especially the plasticity of the maxillæ.
3. The slight development of the pleura.
4. The absence of gills, and the functional anal respiration.
5. The plasticity of the fore part of the alimentary canal.
6. The circulation and heart.
7. The general correspondence of the form of the body with that of the Protozoa and Zœa larva.

By converging arguments from these points, it is shown that Copepoda would represent the most primitive Crustacea.

New Decapod Crustacea.*—Mr. S. I. Smith describes some new or little known decapod Crustacea from the east coast of the United States, belonging to the genera *Anamathia* (1), *Munidopsis* (2), *Bythocaris* (2), *Hymenodora* (1), *Acanthephyra* (2), *Ephyrina* nov. gen. (1), *Benthæcetes* (1), and *Benthonectes* nov. gen. (1).

New or Rare Crustacea.†—M. Hesse, in his thirty-fifth and thirty-sixth essays on Crustacea from the French coast, describes two new species of *Porcellana*, *P. navigatrix*, and *P. stenocheles*, and takes the opportunity to refer to a remarkable peculiarity of all the members of the genus, namely the great development of the appendage on either side of the mouth; this is provided along its inner edge with long setæ bent at their free end, and having the function of cirri; just as in Cirripedia they seize on such passing objects as are fit for food.

A description is given of the larva of *Porcellana platycheles*, and it is pointed out that the species, much eaten though it be by fishes, has various means of preserving itself; their small size hides them from their enemies, whilst their large eyes, placed on movable stalks, enable them to look around in all directions; their form is such that they are able to swim with great rapidity, and their enormous rostral appendage serves to cleave the water, while their large flattened abdomen acts as an excellent rudder. The seventeenth species of *Anceus*, *A. danielii*, is described; with rare exceptions, the larval *Ancei* are of wandering habits, and before they take on the adult form they make "dangerous peregrinations" to find the fish on which they are destined to live; the species now described however, lives at the bottom of the water, and among the plants that grow there. The author is unable to explain how it is that the larvæ, whose mouth-organs are of exactly the same form as those of the species which live on the blood of fishes, do not die of inanition.

New Crustacea from Arctic Alaska.‡—Mr. J. Murdoch describes seven new species of Crustacea from Point Barrow, Point Franklin,

* Proc. U.S. Nat. Mus., vii. (1884-5) pp. 493-511.

† Ann. Sci. Nat.—Zool., xvii. (1884) Art. No. 5, 14 pp. and 1 pl.; Art. No. 6, 11 pp. and 1 pl.

‡ Proc. U.S. Nat. Mus., vii. (1885) pp. 518-22.

and Norton Sound, in Arctic Alaska, belonging to the following genera:—*Pandalus* (1), *Mysis* (1), *Acanthozone* (1), *Melita* (2), *Dulichia* (1), and *Poyartemia* (1).

New Species of Idotea.*—Mr. C. Chilton describes a new species of *Idotea* (*I. festiva*) found on the under surface of a boulder at low water at Sumner, Canterbury, N.Z. It comes under Miers' section ii. *a**, but is distinct from the species there described.

Copepoda of the Adriatic.†—Dr. L. Car has found 23 species of Copepods in the Adriatic; he gives the synonymy of the species, and describes three new species, and a young form of *Saphirina*.

Copepoda of the North Pacific.‡—Dr. S. A. Poppe gives an account of the Copepoda collected by the Drs. Krause in the North Pacific and in Behring's Strait; of the four species two are new, and are dedicated to the travellers—*Zaus Aurelii*, and *Scutellidium arthuri*.

Evolution of Sacculina.§—M. Yves Delage has published a lengthy notice of his researches on this parasite, of which we have already given an extended abstract.||

Vermes.

Lymphoid Cells of Annelids.¶—Dr. W. Kükenthal's observations were made on a species of *Tubifex*, apparently *T. bonneti*; the following methods were adopted. The worm was cut into several pieces, and the fluid from the cœlom allowed to pass on to a slide, or treated with a so called physiological fluid, such as $\frac{1}{2}$ per cent. salt solution; in either case the temperature was raised to 16–18°. All attempts at staining the living cells failed. The relations of the lymphoid cells to the general organization of the worm were chiefly studied on young living specimens. In making sections, the worms were killed with Flemming's mixture of osmic, chromic, and acetic acids, or with 1 per cent. chromic acid; borax-carmin and alum-carmin gave the best staining results.

The fluid of the cœlom is not homogeneous, but contains a number of elements of various kinds, among which the rather large rounded cells are the most conspicuous; these are the lymphoid cells, and of them there are two kinds. Some have a more or less finely granular protoplasm, and others contain clear highly refractive granules, which are colourless; others are still larger, and of a yellowish-brown colour. No membrane could be detected in either kind of cell. They exhibit amœboid movements, and were seen to undergo division, which was direct, and preceded by a direct nuclear division. The author's observation confirms, therefore, the statement of Fleming that leucocytes multiply by direct nuclear division.

* Ann. and Mag. Nat. Hist., xv. (1885) pp. 123–4 (3 figs.).

† Arch. f. Naturgesch., l. (1884) pp. 237–56 (1 pl.).

‡ Tom. cit., pp. 281–304 (5 pls.).

§ Arch. Zool. Expér. et Gén., ii. (1884) pp. 417–736 (9 pls.).

|| See this Journal, iv. (1884) pp. 51–3.

¶ Jena. Zitschr. f. Naturwiss., xviii. (1885) pp. 319–64 (2 pls.).

In addition, nuclei divided into four parts, where there was seen to be gemmation, followed by constriction.

After studying the lymphoid cells themselves, Kükenthal passed to their origin, function, and changes. They were found to arise partly from connective-tissue-cells, and partly from cells of the body-wall. The larger rounded cells are derived from cells which clothe the ventral vessel and the nephridia: the smaller from the body-wall. The brown or chloragogenous cells are derived from the lymphoid, and owe their coloured contents to the dorsal vessel. After moving about for some time they break up, and their contents form a blackish detritus, which, as it is abundant in the region of the nephridia, may be supposed to be passed to the exterior by those organs.

After reviewing the work of those anatomists who have busied themselves with annelids, the author comes to the conclusion that what he has observed in *Tubifex* obtains also in other ringed worms, and especially in the Oligochæta. He has been able lately to make some investigations on *Limnodrilus ukedemianus*, and *Lumbricus terrestris*; in the former he has repeated point for point his observations on *Tubifex*. The study of *Lumbricus* was more difficult in consequence of the opacity of the body-wall, but here also the lymphoid cells, which were somewhat larger than in *Tubifex*, exhibited similar phenomena, and in addition to the tetraschistic mode of division occasionally exhibited three, five, or six divisions.

Tenacity of Life and Regeneration of Excised Parts in *Lumbricus terrestris*.*—Miss A. M. Fielde gives an account of experiments on the tenacity of life, and describes the manner of regeneration of excised parts in *Lumbricus terrestris*. She further reports having found a completely regenerated brain, œsophageal collar, and sub-œsophageal ganglion, all of normal size, and in normal site, in earth-worms, which had fifty-eight days previously been decapitated at the fifth segment. Forty days after decapitation the excised segments had been regenerated, and five days after that the blood-vessels were seen ramifying on the completely regenerated pharynx in a normal manner, but no brain was found.

Development of the Sexual Organs of *Clepsine*.†—Herr J. Nussbaum has arrived at the following results from a study of the development of the generative organs in *Clepsine complanata*.

From the eight posterior endoderm-cells are formed by progressive multiplication from before backwards numerous "segment-cells," which are arranged in pairs, one to each segment, on the ventral side of the body. These give rise to seven pairs of spermatoblast masses and two pairs of ovaries, the rest becoming dispersed through the parenchyma of the body; this condition, transitory in *Clepsine*, recalls the permanent structural condition of many platyhelminths. The oviducts and vasa deferentia are developed independently and appear to be modified nephridia; the short transverse

* Proc. Acad. Nat. Sci. Philad., 1885, pp. 20-2.

† Zool. Anzeig., viii. (1885) pp. 181-4.

branches which connect the testes with the vasa deferentia are developed from the mesodermal coating of the testes.

Muscles of Chætopoda.*—Dr. E. Rohde finds that amongst the Oligochæta, the Limicolæ have the simplest musculature, the longitudinal layer consisting of (unstriped) fibres running parallel to each other. Each fibre has a contractile fibrillar periphery and a central cavity. In Terricolæ, on the other hand, the—otherwise similar—fibres are usually united to form bundles with a contractile periphery and an axial cavity. The feather-like arrangement of fibres of which Claparède speaks, was not seen by Rohde in all species of *Lumbricus*. No bundles occur in the circular muscles.

As regards Polychæta, *Serpula* and *Protula* have bundles of longitudinal muscle-fibres, as in the typical Terricolæ. In *Spirographis* the bundle arrangement is only partial, and in all other Polychæta investigated could not be traced at all. In this group the structure of the fibres is as in Oligochæta, and they lie imbedded in a similar multinucleate fibrillar connective tissue.

Elytra of some Polynoïna.†—According to Dr. E. Jourdan, these, like *Aphrodite*, show a cuticle bounding their two surfaces, and a hypoderm beneath either surface connected by fibrillæ. Chitinous disks may be seen in process of formation in the cuticular layer. The irregularities of surface are either "warts" which are large, prickly, and without function, or sensory "papillæ" which are small and circular in optical section, consisting of a chitinous cup (shaped like a wine-glass without a stem) covered by a saucer-like cuticular cap, and containing granular non-nucleate protoplasm into which penetrates a nerve-fibril from the fibrillar layer. Nerve-cells were found beneath the hypoderm surrounding the fibril, and constituting a small racemose ganglion.

Polynoë torquata is phosphorescent, and this phenomenon is not due, according to Jourdan, to the numerous nervous fibrils traversing the elytra, as Panceri maintained. Phosphorescence here occurs in definite regions, and is due to cells of the hypodermis (Jourdan calls it epidermis) of the inferior surface of the elytra, which is locally transformed into phosphorescent mucous cells. As regards the internal fibrillæ, they would appear to be identical with what Claparède variously calls fibrillar hypoderm and stellate connective tissue.

New Arenicola from Arctic Alaska.‡—Mr. J. Murdoch describes *Arenicola glacialis* n. sp. from Arctic Alaska. It is closely allied to *A. marina*, but has only six setigerous segments anterior to the gills, and eleven gill-bearing segments instead of seven and thirteen.

Histriobdella homari.§—M. A. Foettinger renames this worm, which does not appear to be a leech, *Histriodrilus benedeni*. After a short sketch of what has been hitherto known of this form and an account of its external characters, the various organs are dealt with in detail.

* Zool. Anzeig., viii. (1885) pp. 135-8.

† Ibid., pp. 128-34.

‡ Proc. U.S. Nat. Mus., vii. (1885) p. 522.

§ Arch. de Biol., v. (1884) pp. 434-516 (6 pls.).

The nervous system is well developed, and consists of a cerebral mass and a ventral medulla, which is closely associated with the epidermis, and consists of two cords with a ganglionic layer; on the whole, the system is comparable to what is seen in the Archiannelids, save that it is segmented; in every segment the two cords are approximated or fused, and in the middle of the swelling the ganglionic layer is sufficiently well developed to extend on to the dorsal surface; in the constrictions the cords are separated from one another, and the ganglionic cells are small in number, or altogether absent; the swellings correspond to the segments as indicated externally, and to the "segmental organs."

There are several sensory organs; there are five anterior tentacles which seem to have a tactile function, but they are not hollow as are those of *Saccocirrus*, *Polygordius*, or *Protodrilus*; on either side of the dorsal surface of the head is a transverse ciliated pit; each of the hinder appendages have a small dorsal appendage which is ovoid in form and has much the same structure as the cephalic tentacles; there are no eyes.

The muscular system is of the same character as that of the Archiannelids; there are four pairs of locomotor appendages, two anterior and two posterior; they may be moved in all directions, and are swollen at their free ends so as to be able to attach themselves to foreign bodies.

The renal organs are paired, lateral in position, and ciliated internally; they are segmental, but there are nearly twice as many as there are well-developed segments, for in the region of the generative glands there are two pairs in each segment. Notwithstanding a careful search the author was unable to detect any signs of a circulatory apparatus.

The sexes are separate, and the presence of the glands causes a dilatation of the posterior third of the body. There are two symmetrical ovaries, hardly distinguished anteriorly, but more or less fused posteriorly. There are two sexual orifices on the ventral surface. The cœlom is small, is found in the head, and extends into the appendages; it appears to be an enterocœle.

After a reference to the classification of the Annulata suggested by Hatschek, which the author modifies by removing the Hirudinea, which he regards as belonging to the Platyhelminths, and the Gephyrea, the following scheme is propounded:—

Annelida	{	1st order, Archiannelida	{ Polygordida. Histriodrilida.
		2nd order, Chætopoda	{ Saccocirrida (Archichætopoda). Polychæta. Oligochæta.

Problematical Organ in Chloræmidæ.*—This is described by Dr. R. Horst as a dark, tubular organ, lying above the œsophagus, which is narrow anteriorly whilst it broadens posteriorly to meet

* Zool. Anzeig., viii. (1885) pp. 12-5.

the stomach. It is the "second œsophagus" of Otto, but has also been regarded as a gland, and as a diverticulum of the stomach. Horst's observations lead him to consider the organ as circulatory. Posteriorly the stomach and gut form blood-sinuses between their muscular and epithelial layers, but in the anterior regions of the body—here, as in *Enchytraidæ*—the same muscular layer is produced to form a definite blood-vessel. The same arrangement occurs in young *Terebellæ*, but in other Annelida is only transitory during the larval period.

The blood in *Chloræmidæ* is, as the name denotes, green, but the organ now in question is much darker than the blood. This colour is due to a brown cellular fibrillar mass (as shown by sections), which largely fills up the lumen of the organ posteriorly. This mass may correspond to the "corps cardiaque" of many sedentary Annelida, but is by Horst more particularly compared with the coiled mass of vessels described by Vejdovsky in *Enchytræus appendiculatus* as springing from a blood-sinus.

Segmental Organs of *Serpula*.*—Mr. W. A. Haswell, opposing Claparède, asserts that the true segmental organs in this animal "are entirely distinct from the so-called tubiparous, and, though of a simple type, are not unlike those of other Annelids. They are pyriform sacs . . . occurring in pairs in all the segments of the abdomen. They open externally on the sides of the segments by slit-like apertures . . . and, presumably, open also into the body-cavity."

In *Eupomatus* these organs serve not only as efferent ducts for the generative products, but as seats of development for the ova.

Origin of the Nervous System of Nematodes.†—Prof. O. Bütschli finds that the recent works of A. Lang on the nervous system of the Platyhelminths, of Gaffron on *Distomum*, and of Joseph on Nematodes give support to some new ideas as to the origin of the nervous system of the round-worms.

Lang has shown that the nervous system of flat-worms is by no means so simple as has been ordinarily supposed, and that there are more than the two longitudinal ventral trunks which are commonly described; Gaffron has found that from the so-called cerebrum there arises on either side a pair of backwardly directed longitudinal nerves, of which the better developed pair is ventral, and the other dorsal; just at the point of origin of the pairs there is another posterior longitudinal nerve, which extends along the sides of the body, and may be known as the lateral nerve. These six nerves are connected with one another by transverse commissures; and at certain points there are plexiform connections, similar to, though much less numerous than those found by Lang in Turbellarians. Bütschli justly remarks that the arrangements found in the Trematoda seem to lead to the peculiar disposition of the nerve-trunks which is known to obtain in the Nematodes.

The simple cerebral mass of flat-worms may easily be supposed

* Zool. Anzeig., viii. (1885) pp. 96-7.

† Morphol. Jahrb., x. (1885) pp. 486-93 (1 pl.).

to lead to the œsophageal nervous ring of the round-worms, by imagining a gradual approximation of the two ventral cords, until at last they unite to form a single ventral trunk; the single dorsal cord may be supposed to have arisen by a similar fusion of the two dorsal nerves. Attention is directed to the important observation made by Joseph that in young Ascarids there is a distinctly paired ventral cord, and that between the cords there are transverse anastomoses, which may be compared with those found in Platyhelminths.

The lateral nerves appear to be represented by remnants only, and these, which are only evident in the anterior region of the body, pass into the ventral cord.

Although Bütschli thinks that he has been able to bring together evidence as to the general relations which obtain between the nervous system of certain Platyhelminths and that of the Nematohelminths, he wishes it to be distinctly understood that he does not look upon the present flat-worms as being the ancestors of the round-worms, nor does he depart from the phylogenetic views which he expressed nine years ago.

Host of the Larva of *Echinorhyncus clavæceps*.*—This has been found by M. A. Villot in the aquatic larva of *Sialis niger*. The young *Echinorhyncus* lies in a transparent cyst in the fat-body of the insect. It is sub-cylindrical in shape, about 0·56 mm. long, and differs from the adult form only in encystment, size, transparency, and sexual immaturity. There are eighteen hooks on the proboscis, similar to those of the adult, and they are set upon the wall of invagination of the proboscis in three reversed series.

As regards the lemnisci, Villot combats the theory of Mégnin that these organs represent the two intestinal tubes of Distomidæ. "If anything represents a digestive apparatus in the *Echinorhyncus* (larval or adult), it can only be the narrow canal which communicates with the exterior by the terminal orifice of the proboscis, traverses the receptacle and cephalic ganglion, and finally passes into the body-cavity to form the suspensory ligament of the genital organs."

Villot identifies this larva with that figured in 1871 by Ch. Robin as a Nematode parasite of *Nephelis*.

Nervous System of *Tæniæ*.†—The researches of M. J. Niemiec were made on the four following species of *Tænia*, viz. *Cœnurus elliptica*, *serrata*, and *mediocanellata*.

The following differences were noted between *T. cœnurus* and *serrata* :—

1. Filaments, very distinct in the upper part of the scolex, are given off from the nervous ring of *T. serrata*, which, after ramifying, are lost in the muscles of the hooklets.

2. The eight descending branches of the nervous ring have distinct points of departure, while in *T. cœnurus* they are united in pairs at their point of origin.

3. There are no filaments which, issuing from the ring, go directly to the sucker.

* Zool. Anzeig., viii. (1885) pp. 19-22.

† Arch. Sci. Phys. et Nat., xiii. (1885) pp. 249-53.

4. Each sucker receives from the ganglion two lateral nerves, each of which corresponds to a polygonal commissure.

5. Secondary ganglia of the inferior commissure give off distinct branches for the suckers. Each sucker is then innervated by four nerves.

The nervous system of *T. elliptica* is much simpler, but its study is more difficult from the difficulty of preparing sections.

The part of the nervous system of *T. mediocanellata* above the superior polygonal commissure has escaped the author's observation.

From a histological point of view it is to be noted that the nervous fasciuli traverse the parenchyma without being separated from it by a proper envelope. True ganglionic cells have only been found in the scolex. The other nerve-cells differ notably, and possess small oval nuclei.

Anatomy of the Trematoda.*—The contribution of Herr A. Looss to the anatomy of the Trematoda is based on two new species—*Distomum palliatum* and *D. reticulatum*—which were found respectively in the bile-ducts of *Delphinus delphis*, and under the integument and between the muscles of a shad from Costa Rica.

The author strongly recommends the adoption of a number of different staining reagents; he himself made use of picro-carmin, alum-carmin, borax-carmin, hæmatoxylin, and methyl-violet. The value of a number of colours lies in their bringing out differentiations which are never seen when one staining fluid alone is used.

The body-parenchyma of *D. palliatum* is extraordinarily thick, and quite prevents any clearing up of the animal as a whole, and it was for this reason that sections had to be resorted to; the primary mass forms an exceedingly well-developed plexus, the cells of which are of various sizes and have well-marked processes, so that they are closely connected together, and the lacunar spaces are proportionately small; in these last there are to be found the remains of the primitive formative-cells, which consist of an, ordinarily, distinct nucleus, around which is a slight amount of protoplasm. In the region of the organs imbedded in the parenchyma the lacunæ of the connective tissue take on a longitudinal direction which runs parallel to the contours of these organs, and so gives the tissue a fibrous appearance.

In the investigation of the nervous system, which does not differ in arrangement from that which is ordinarily found in Trematodes, dorso-ventral and surface sections are to be preferred to transverse, for in the last the slight diameter of the nerve-ends causes them to be indistinct and hard to distinguish from the surrounding tissue. The generative organs are of great extent in sexually mature specimens; as in *D. hepaticum* and some other species, there is a sinus genitalis; the function of this is discussed, and the conclusion is come to that in Distomes with laterally placed generative pores there is a mode of copulation which may, to put it shortly, be exactly compared to what obtains in snails.

* Zeitschr. f. Wiss. Zool., xli. (1885) pp. 390-446 (1 pl.).

The specimens observed of *D. reticulatum* were seen to be immature, not only from the fact that they were encapsuled, but from the slight development of their generative organs. This species was, however, seen to present many considerable deviations from the ordinary type of *Distomum*; it was of considerable size, being twice that of the comparatively large *D. pulcherrimum* of Weyenbergh. The excretory vessels and the generative organs exhibit a remarkable resemblance to those of Cestoda; for the former have the terminal vesicle greatly reduced, and the system of vessels is greatly branched, while the arrangement of the anterior orifices calls to mind that described by Fraipont in the Tetrarhynchi; the uterus, moreover, is simple and blind, and calls to mind the same organ in the Tæniidæ.

The author foresees that the *Distomata* will have to be broken up into smaller groups, but he does not think (and the neglect of Dujardin's classification supports his view) that any reasonable method of classification is to be found in the number or arrangement of the suckers.

Development of *Balanoglossus Kowalevskii*, and the Affinities of the Enteropneusta.*—Mr. W. Bateson now gives an account of the later stages in the development of *Balanoglossus*; in the species —*B. Kowalevskii*—which he examined there is no *Tornaria*-stage. Shortly after hatching the transverse ring of cilia and the apical tuft disappear; the cilia on the body increase in size, and the tissues, probably from the consumption of the yolk-particles, become more transparent. A temporary organ in the form of a tail arises from the posterior ventral surface, immediately below the anus. It is richly provided with large glands, and serves as a strong sucker; it atrophies soon after the appearance of seven gill-slits, when the body is long enough to be coiled round foreign objects. The mouth is directed anteriorly; in young specimens a rod of hypoblast, solid in front, is gradually constricted off from the hypoblast in the dorsal middle line of the pharynx; the cells of this rod gradually present an appearance precisely comparable to that figured by Scott for the notochord of young lampreys, and by Balgour for that of young Elasmobranchs. The author regards it as comparable to, and henceforward speaks of it as a notochord; "this view of its homology is supported by the presence in the Enteropneusta of many other structures pointing to vertebrate affinities."

The nervous system has a canal and pore; in the mode of origin of the mesoblast, and the fate and asymmetry of the anterior cœlomic pouch, *Balanoglossus* resembles the Chordata, and especially the Cephalochordata; and the same is true of the atria and the excretory funnels; on the whole, the condition is that which would be produced by a partial or arrested development of the corresponding structure in *Amphioxus*. The author regards Metschnikoff's view that the branchial structures of *Balanoglossus* are comparable to the openings from the body-cavity of Echinoderms as untenable; and he comes to the conclusion that the points of similarity with *Amphioxus* are so

* Proc. Roy. Soc., xxxviii. (1884) pp. 23-30.

numerous and so striking that we cannot refuse to place this enigmatical worm with the Chordata, of which he tentatively suggests the following table:—

Chordata—Hemichorda[ta] (Enteropneusta).
 Urochorda[ta] (Ascidians).
 Cephalochorda[ta] (*Amphioxus*).
 Vertebrata.

Echinodermata.

Cotton-spinner.*—In some further notes on *Holothuria nigra* Prof. F. Jeffrey Bell gives a description of fresh specimens, and describes some experiments with the colouring matter, which is dissolved out of their bodies by alcohol; this has the same characters as antedonin, but has no distinctive absorption bands, or has them obscured by another colouring matter which is richly deposited around the attached ends of the Cuvierian tubes. As the ejected tubes owe their difference in thickness merely to the differences in the packing of the threads, it follows that the elongation of the threads is due to the uncoiling of the connective-tissue fibres. The British species appears to be distinguished from the Mediterranean *H. poli* by the absence from its suckers of the characteristic spicules.

Echinodermata of Ceylon.†—Although Dr. A. Walter states that this essay is a "Beitrag" to the paper by Prof. Bell on the same subject, he makes several important additions to the fauna of Ceylon, from the collection made by Hæckel in 1881–2. A specimen of *Luidia maculata* with arms 220 mm. long was collected; specimens of *Toxopneustes pileolus* were, contrary to the statement of A. Agassiz, found to agree remarkably with one another, and fourteen were collected; on the other hand, the fifteen examples of *Hipponoë variegata* varied remarkably. On the whole thirty-two species are known to the author (who, like Bell, failed to enumerate *Antedon reynaudi*, which was long since described by Müller and Troschel as coming from Ceylon), and nine of these are first due to Hæckel and his collectors, though they are not "new species." We may add that there is every reason to believe that the number of known *Holothuria* will be shortly shown to be far more than two; Dr. Ondaatje has lately collected a specimen of *Synapta beseli* measuring 7 feet in length.

Cœlenterata.

Development of Male Germinal Cells in Hydroids.‡—Herr J. Thallwitz comes to conclusions which are not quite the same as those of some of his predecessors. In opposition to Korotneff and Bergh he finds that the heads of the spermatozoa arise from the nuclei of the spermatoblasts, and not independently of them. He cannot agree with de Varenne that the nucleus does not undergo change; on the

* Proc. Zool. Soc. Lond. for 1884 (1885) pp. 563–5.

† Jenaisch. Zeitschr. f. Naturwiss., xviii. (1885) pp. 365–84.

‡ Ibid., pp. 385–444 (3 pls.).

contrary its changes are manifold. Nor, again, are the spermatoblasts multinucleate.

Spermatogenesis in the hydroids examined by the author presented the following history: the primary spermatoblasts, which had been differentiated from the primitive germ-cells, and which were distinguished by their rich supply of protoplasm and sharply contoured nuclei, for a time increased in number, but not in size. When the latter did occur it was at first only gradual; the richness in protoplasm became less well marked, and the nuclei increased in proportionate size, so that a matured testis seemed to be filled with nuclei. Later on a change in the nature of the spermatoblasts was indicated by the difference in effect of staining fluids on the nuclei, the nucleoli of which were now completely hidden; in fact, the nuclei appeared to be quite homogeneous. As the nuclei changed the protoplasm of the germinal cell lost its power of taking up staining fluids. It is possible that these two changes are in causal connection with one another, substances from the protoplasm passing into the nucleus.

The cells next divide into spermatoblasts, the nuclei of which become the head, and the protoplasm the elongated tail of the spermatozoa; the head is ordinarily highly refractive; the head itself varies in form in various species, but in all cases the nuclear division is effected in an indirect manner.

The testicular mass is extraordinarily large in hydroids which have sessile gonophors, and the number of spermatozoa is consequently very large; it is not difficult to correlate this with the fact that the producing mass remains fixed, for a number of spermatozoa must be lost in the water without effecting their function; most hydroid stocks are dioecious, or, in other words, male and female products are by no means in close proximity. The spermatozoa and even the spermatoblasts are definitely arranged, either in chains, bands, or groups. The heads appear most often turned towards the periphery, but in *Sertularella* they are grouped around the meshes of a stroma; this, which is of ectodermal or endodermal origin according to the structure and position of the testis, appears to be widely distributed, though not always so well developed as in *Sertularella*. The presence of stinging cells in the testis of *Clava* is confirmed.

The author expects that studies on spermatogenesis in Medusoid forms will show that the history of development is in them very similar to what he has shown to obtain in hydroid forms.

Histology of *Porpita mediterranea*.*—M. M. Bedot, who has already studied the *Velellidæ*,† finds that, as in them, the *Porpitiidæ* have the organ (central organ) which is ordinarily known as the liver, formed of a number of canals and of a large mass of cnidoblasts; the canals differ in structure in different parts, and are not the same as in the *Velellidæ*, for their cells are closely packed. The prominent bodies which are amorphous in *Velella* are replaced by well-marked granules and by crystals of bright green colour (guanine) in *Porpita*.

* Rec. Zool. Suisse, ii. (1885) pp. 189-94.

† See this Journal, iv. (1884) p. 576.

In the walls of the gastrozoid there is a deep layer of yellowish granulations. The crystals of guanin which were discovered by Kölliker in the white plate come from the canals which traverse the cnidoblast; if, therefore, these elements give indication of a renal organ, we must seat that in the canals of the central organ, and not in the inferior canals or those of the white plate.

Identity of the two British Species of *Cyanea*.*—Prof. W. C. M'Intosh gives reasons for believing that the two British species of *Cyanea*, *C. capillata* Esch. and *C. Lamarekii* Péron and Lesu., are identical, the latter being the young condition of the former.

Chromatology of Actiniæ.† — Mr. C. A. MacMunn finds in *Actinia mesembryanthemum* and other species a colouring matter which is provisionally named actiniohamatin; it is distinguished by its spectral characters and by its chemical reactions as well as by its functions, from actinochrome, for it is respiratory, whereas actinochrome has no such function. A special colouring matter has been found in *Sagartia parasitica*, which likewise exists in different states of oxidation. In the mesoderm and elsewhere in *A. mesembryanthemum* there is a green pigment, which appears to be biliverdin. *Anthea cereus*, *Bunodes ballii*, and *Sagartia bellis* yield a colouring matter resembling chlorofucin; this is derived from the "yellow cells" which are abundant in their tentacles and elsewhere; and it is not identical with any animal or plant chlorophyll. When "yellow cells" are present there appears to be a suppression of those colouring matters which in other species are of respiratory use.

Porifera.

Structure of the Skeleton in the Anomocladina.‡—Prof. W. J. Sollas gives a preliminary description of the structure of the skeleton in the Anomocladina as seen in *Vetulina*.

After boiling in caustic potash the corpuscles of *Vetulina* are found to exhibit the characters which Zittel first assigned to them. By cutting frozen sections, one corpuscle thick, it is seen that there is as a rule but one kind of node, only this is not produced by the union of the ends of the corpuscular rays, but by the centrum of the corpuscles, against which the rays of neighbouring corpuscles abut. About the place of abutment the centrum throws out numerous branched spines, which make interpretation of the structure difficult. In some cases the centrum gives off rays on one side only, and on the other side receives rays only. It then, when isolated, much resembles the stellates of *Holasterella* Carter.

New American Fresh-water Sponges.§—Under the title 'Thoughts on the Spongidæ' Mr. H. Mills gives some account of American sponges of the fresh-water group, and describes some new species. These are as follows:—*Myenia Everetti*, found on Mount Everett,

* Ann. and Mag. Nat. Hist., xv. (1885) pp. 148-9.

† Proc. Roy. Soc., xxxviii. (1884) pp. 85-7.

‡ Ann. and Mag. Nat. Hist., xv. (1885) pp. 236-8 (1 fig.).

§ Proc. Amer. Soc. Micr. 7th Ann. Meet., 1884, pp. 131-47 (3 figs.).

2400 feet above tide-water; *Heteromeyenia longistylis* with the longest shafts to the birotulate spicules known; a variety of *H. Ryderi*; *Pleiomeyenia calumeticus*, *P. Walkeri*, *P. spinifera*, *Meyenia subdivisa*, and *M. Millsii*.

New Sponges from South Australia.*—Mr. H. J. Carter describes some new sponges from the neighbourhood of Port Phillip Heads, South Australia.

Esperia parasitica n. sp. was found growing over the skeletal fibre of a dead Psammonematous sponge; it is chiefly characterized by the free end of the large inequianchorate being furnished with four teeth. *Forcepia colonensis* Carter, provisionally described in 1874, from a flesh-spicule dredged near Colon. *F. crassanchorata* n. sp. very much resembles *Halichondria incrustans* in appearance and structure. In *Halichondria scabida* n. sp. the pore-areas are circumscribed and open, through the subdermal cavities, directly into the large excretory canals, which present circular folds throughout their course. *Suberites Wilsoni* n. sp. has no flesh-spicule, thus differing, among other things, from *Alcyonium purpureum* Lam., in common with which, however, it retains its colour after drying. *Acanthella cactiformis* n. sp. may be a "variety" of the Adriatic species. *Chalina polychotoma* var. *trichotoma* n. v. *Halisarca australiensis* n. sp. is remarkable for the fibro-reticulated structure of the surface. *Luffaria digitata* n. sp. is characterized by the comparative absence of lateral fibre, the smallness of the core compared with the thickness of the keratose wall of the fibre generally, the coarse open fibrous reticulation of the skeleton, and the red fleshy sarcode. *Darwinella australiensis* n. sp. differs from other species of the genus in the prevailing number of the rays being three instead of four or more. *Aplysina levis* n. sp. has a smooth surface and leathery dark dermis, being without conuli and any projecting filaments of the fibro-skeletal structure; it is charged with a large amount of foreign material. *Pseudoceratina durissima* n. sp. is distinguished by its intense wood-like hardness and the fact that when cut into the interior is yellow, but rapidly changes to green and lastly to lead colour or grey. *Pseudoceratina crateriformis* (provisional) is allied in some respects to *Ceratina*, in others to *Halispongia choanoides*.

Mr. Carter revises the order Psammonemata which he subdivides into three families—Bubulida, Hircinida, and Pseudohircinida—comprising 19 groups. *Holopsamma* n. g. is a genus of arenaceous sponges without fibre, whose composition consists of foreign microscopic objects, (sand, &c.), diffused in the flakes of the parenchymatous sarcode. *H. crassa* n. sp. is variable in form and size, and chiefly distinguishable by the coarseness and grittiness of the sand; *H. levis* n. sp. has a comparatively light structure. *H. laminaefavosa* n. sp. is characterized by the globular, elongated, or hemispherical structure radiating laminiferously or in the form of a honeycomb, together with its dark brown colour. *H. fuliginosa* n. sp. is remarkably

* Ann. and Mag. Nat. Hist., xv. (1885) pp. 107-17 (1 pl.), 196-222, and 301-21.

stony, hard, coral-like in form, and of black colour. *H. turbo* n. sp. is chiefly characterized by its shape. *Sarcocornea* n. g. has the same character as *Holopsamma*, but has the sarcode more or less transformed into keratine. *S. nodosa* n. sp. is the sole species described. The genus *Dysidea* Johnston is emended, and four species described, two of which, *D. hirciniformis* and *D. chaliniformis*, are new. The former resembles *D. fragilis*, but is coarser in structure. The genus *Spongelia* is also emended, and one new species, *S. stelladermata*, described, with a new species of *Carteriospongia*, *C. caliciformis*.

The remaining groups of the Hircinida are then dealt with. The family Liochrotida comprises P-ammonematous sponges on which there are no conuli, but in which the keratose fibre is strongly developed and more or less cored with foreign microscopic objects. Of new species we have:—*Stelospongius flabelliformis*. *S. tuberculatus* (provisional) closely resembling *S. levis* in the structure of the sandy incrustation, &c., the general form is like that of a knotted *Chalina*. *Geelongia vasiformis* nov. gen. et sp. affords an instance of the replacement of the natural sarcode by the supposed parasite *Spongio-phaga communis*. Abnormally developed ova were found *in situ* within it. *Dactylia chaliniformis* n. sp. is a distinctly digito-chalina-like sponge. *D. impar* n. sp. is "frosted" white with an incrustation of hyaline grains of quartz. *D. palmata* n. sp. is a flattened variety of *D. chaliniformis*. The family Hircinida comprises Psammonematous sponges which are conulated on the surface. *Hircinia solida* n. sp. is characterized by compactness of structure, prevalence of sandy fibre, soft, fleshy, fibro-reticulated dermis, and dark colour. *H. intertexta* n. sp. is notable for the presence of a microscopic intertextural fibre filling up the interstices of the skeleton. *H. flabellopalmata*, *H. communis*, and *H. pulchra* complete the list of new species for this genus. The family Bibulina comprises Psammonemata having a solid fibre chiefly *without* core of foreign objects. Two new species are added to this family:—*Euspongia anfractuosa* n. sp. resembles the representation of *Spongia cavernosa* (Duch. et Mich.) and Hyatt's photograph of *S. meandriniformis*. *Paraspongia laxa* n. sp. is distinguished for the scantiness of the fibre and its wide reticulation, together with the black colour of the dermis.

The paper concludes with a revision of the subdivisions of the Fam. Pseudohircinida.

Protozoa.

Immortality of Unicellular Organisms.*—Prof. A. Weismann gives a summary of his views on this subject, which have given rise to a considerable amount of discussion. He concludes that

1. The controversy whether it is proper in cases of the fission of Protozoa to pronounce mother and daughter as one and the same individual, or as distinct beings, is purely verbal. It has a deeper

* Biol. Centralbl., iv. (1885) pp. 577-91 and 650-65. See Journ. of Sci., vii. (1885) pp. 204-5.

meaning only when we recognize that in these unicellular beings there is no "individual" in the same sense as in the higher organisms. Indeed, our abstract concepts—such as "generation," "mother," "daughter"—are artificial, and do not correspond to anything in nature.

2. The idea of a "senescence" of unicellular animals is not tenable. Physiologically speaking, there is a profound difference between the uni- and multicellular organisms in the fact that the latter only wear themselves out by living, and proceed to a natural death. The unicellular animals are never so modified by the transformation of matter that life becomes impossible. They have no physiological death; their bodies are immortal.

3. Conjugation in unicellular and fertilization in multicellular organisms are analogous processes.

4. The body of unicellular organisms corresponds to the germinal cells of the Metazoa, and sexual reproduction of the latter may, with certain limitations, be regarded as an alternation of generations. We have first a generation of unicellular organisms—the germinal cells—and next a generation of metazoic individuals, which give rise asexually to a generation of unicellular bodies. We have, in fact, an infinite series of unicellular generations side by side with individuals of a higher order, which alone have a physiological end—a natural death. The unicellular generations—germinal cells—are potentially as immortal as the Protozoa.

Multinucleated Protozoa.*—Dr. A. Gruber commences by referring to the now well-known fact that of closely allied species of the same genus of Protozoa some may be uni- and others multi-nuclear. *Opalina* is very remarkable for the large number of nuclei that are found in one cell. Maupas has lately described a new form, *Holophrya oblonga*, in which there are a number of nuclei; *Lagynus elongatus* is another holotrichous infusorian in which sometimes eight or ten, and in other cases nearly a hundred nuclei are to be observed. Among the hypotrichous forms we find *Holotricha lacazei*, *H. multinucleata*, and *Uroleptus roscovianus*; here, too, the nuclei are small, spherical, and regularly distributed through the body. Nucleoli are sometimes, but not always, present. Gruber, like Maupas, has observed similar phenomena.

The greatest interest about these forms is the relation of the nuclei to the processes of division and conjugation; Maupas thinks that, in division, the nuclei are unaffected, and Bütschli says the same of *Loxodes rostrum*; in *Holotricha scutellum*, however, Gruber observed that, before division, there was fusion of the nuclei, and, as the process is temporary and short, he thinks it probable that there is an error of observation on the part of previous observers.

As has been already reported in this Journal, † Gruber has observed more than one nucleus in various species of *Amœbæ*, and it is quite

* Biol. Centralbl. iv. (1885) pp. 710-7.

† *Ante*, p. 260.

certain that their occurrence is not to be associated with any developmental phenomena.

In a postscript reference is made to the lately published work of Entz,* who denies the accuracy of Gruber's statements; it is pointed out that Gruber's observations were of long duration, whereas conjugation takes but a short time.

The author justly remarks that a new field of difficulty in the investigation of the Protozoa is being opened out to us.

Peridiniæ. †—Dr. G. Klebs has investigated the structure of the pelagic Peridiniæ, driven into the Gulf of Naples by a strong sirocco. Only a few forms are found along the coast among the lower algæ. The marine ally themselves nearly to the fresh-water forms.

The body is usually divided by a transverse furrow into an anterior and a posterior half, the two halves being either equal or unequal, the posterior half usually provided with a longitudinal opening into the transverse furrow. The superficial structure of the membranes which give a cellulose reaction varies greatly. While in the young state the membrane is quite smooth; spines, projections, &c., are formed at a later period, the membrane becoming at the same time brittle, which leads to a breaking up of the shell. This usually takes place very regularly, so that the membrane appears to consist of several plates, the number of which is not always constant, and therefore not of the importance attributed to it by Stein. The cause of the brittleness is not known. From the fact that the structures of the cell-wall are gradually formed, it results that they must not be relied on exclusively for the diagnosis of the species. The author adduces as an instance *Glenodinium trochoideum*.

The peculiar structure of the membrane of species of *Ceratium* is then described in detail. In addition to this, the mode of ciliation is characteristic. Although Stein, Gourret, and Pouchet maintain the existence of a whorl of cilia, Klebs finds, in the marine as in the fresh-water Peridiniæ, only a single cilium in the transverse furrow; this is especially evident in *Amphidinium operculatum*. The cilium is here coiled round the anterior part of the body; the second cilium, directed backwards, has its insertion near the first; it is stretched out at length during movement. The author enumerates the species in which these cilia have been distinctly observed. In regard to the second cilium, he confirms the observations of Claparède, Lachmann, and Pouchet.

The internal organization of the marine and fresh-water Peridiniæ is very similar. There is always a nucleus, and its structure is very characteristic. It contains parallel nuclear threads, which separate into distinct rods when laid in water. No nucleolus could be detected in species of *Ceratium*, nor in *Glenodinium obliquum*. The peculiar structures taken by Stein for germinal globules are widely distributed, but the author is unable to state anything with certainty with regard

* See this Journal, *ante*, p. 80.

† Bot. Ztg., xlii. (1884) pp. 721-33, 737-45 (1 pl.). See this Journal, iv. (1884) p. 68.

to their nature. He considers that they must be either parasitic Peridiniæ or endogenous buddings. There are generally found diatomin-bodies of definite form; but their form and arrangement differ widely in the different species. Pure green Peridiniæ were never seen. Besides these coloured, there are also colourless species or varieties, such as *Peridinium divergens* and *Diplopsalis lenticula*; Gourret describes colourless forms of *Ceratium*. Starch-grains (even in one colourless species) and yellow and red drops of oil, occur in varying quantities; definite eye-spots could not be detected. The so-called contractile vesicles described by Stein are nothing but ordinary vacuoles.

As in the fresh-water forms, the propagation of the marine also takes place by longitudinal division. Usually this occurs when at rest; after the division is completed, the cell-wall bursts, and the products of division escape invested in jelly. This division is more or less oblique, and one of the segments lies therefore higher than the other. The division is sometimes incomplete; and from this result the so-called "copulation conditions" of Stein. The apposition of two individuals, as observed by Pouchet, is no copulation, but a biological phenomenon, an adaptation to pelagic life, which leads, in several forms, to the formation of chains. Another peculiarity of the Peridiniæ is the frequent excoriation, the course of which the author describes; and which takes place especially on any change in the vital conditions, as the result of rapid encysting.

With reference to the classification of the Peridiniæ, the author objects to splitting them up into a number of new genera, as Stein proposes, depending on the comparative structure of the cell-wall; and considers it preferable to retain the old limits of the genus *Peridinium*. He also differs altogether from the suggestion of Stein and Pouchet, of an alliance with the Noctiluca, and maintains his previous view, according to which the Peridiniæ behave as algæ in their structure and history of development, and must be placed in the Thallophytes. Forms like *Exuviaella marina* and *Prorocentrum* present a passage to those algæ which occur as yellow cells in so many Radiolaria and other animals. It cannot, however, be denied that the Peridiniæ exhibit also some relationships to the remarkable middle group of the Flagellata; organisms like *Exuviaella* and *Prorocentrum* presenting resemblances in the form of the body, the attachment of the cilia, and the diatomin, to the Cryptomonads; although Bergh has shown, in the case of *Prorocentrum*, that the relationship is not sufficient to indicate a direct descent of the Peridiniæ from these Flagellata.

Marine Peridiniæ.*—M. G. Pouchet describes a number of marine Peridiniæ, among which *Protoperidinium viride*, *Glenodinium obliquum*, *Gymnodinium pulvisculus*, *crassum*, *teredo*, *pseudonociluca*, and *archimedis* are new. He discusses the systematic position of the group, and points out that they approach plants in having an envelope of cellulose, diatomine, or even chlorophyll, and two flagella, like the

* Journ. Anat. et Physiol. (Robiu), xxi. (1885) pp. 28-88 (3 pls.).

zoospores of algæ. On the other hand, certain forms which it is impossible to separate from the rest have characters which are essentially animal. *Noctiluca* absorb living prey [as do carnivorous plants], others having urticating organs, eyes, a myophanous layer, and so on. Thought till lately to multiply only by fission, they are now known to form cysts or to pass into a fixed stage, in which they live parasitically on animals. It is to be borne in mind that we do not yet know the whole life-cycle of any one form.

Tintinnodea.*—Prof. G. Entz points out that Fol's recent publications of 1883 on this family are in accord with the views put forward in his (Entz's) criticism of 1884 on Fol's earlier works on the same subject, the later contributions of Fol having been unknown to him. As regards the peristome, Entz still agrees with Stein and disagrees with Fol.

Variability and Mode of Reproduction of Ceratium hirundinella.†—Prof. H. Blanc describes at length the variations that *Ceratium hirundinella* O. F. Müller undergoes, and affirms that in all cases reproduction is effected by fission, the nucleolus dividing first, then the nucleus and afterwards the whole animal. The author also shows that *C. reticulatum* Imhof is but a phase in the cycle of variability of *C. hirundinella* Müll.

New Infusoria.‡—Dr. D. S. Kellicott gives the chief results of his study during the previous year of American Infusoria, enumerates the species he has succeeded in identifying, and describes the following new species:—*Scyphidia ovata* n. sp. differs from *S. inclinans* in form, in being of much smaller size, and in taking a nearly globular form when contracted; it differs from *S. fromentellii* in being much smaller, in the character of the ectoplasm, in wanting the longitudinal plications on the attenuate posterior part of the body and smooth surface above. *Epistylis fugitans* n. sp. appears to possess characters in common with both *E. pyriformis* and *E. tubificis* of D'Udekem; but it is much smaller than either and its surface is coarsely striate. *Opercularia elongata* n. sp. should be compared with *O. stentorium* and *O. cylindrata*, from both of which it differs, whilst being of the same size as the former. *O. rugosa* n. sp. is quite distinct in the characters of the zooid and pedicle, as well as in the position of the zooids clustered at the summit of the branches. *Pyxicola striata* n. sp. is considered new mainly because the lorica is anteriorly so clearly striate and the posterior termination of the lorica peculiar. *Stylohedra lenticula* n. g. et sp.; "the single specimen for which the genus is founded might have been referred to *Lagenophrys* by simply emending its formula; it is, however, structurally distinct from that genus."

New Vorticella.§—Dr. A. C. Stokes describes a new *Vorticella* (*V. rhabdophora*) obtained from a vessel of water containing some dead leaves. Its principal characteristic is that the body is clothed by

* Zool. Anzeig., viii. (1885) pp. 163-4.

† Bull. Soc. Vaudoise Sci. Nat., xx. (1885) pp. 305-15 (1 pl.).

‡ Proc. Amer. Soc. Micr. 7th Ann. Meet., 1884, pp. 110-24 (1 pl.).

§ The Microscope, v. (1885) pp. 34-6 (2 figs.).

what seems to be a mucilaginous investment crowded by slightly curved bacilliform rods. This coating is usually much deeper than the width of the spaces between the transverse striations which also ornament the zooid. The bacteriform bodies, $1/12000$ in. in height, are only visible with a power of 500 diameters. They are usually extremely abundant, being scattered, or arranged in irregularly disposed clusters formed of several rods lying parallel to each other.

Structure of Reticular Rhizopods.*—M. de Folin finds that in all Rhizopods the protoplasm has mixed with it foreign corpuscles, mineral or vegetable; by the addition of these the protoplasm becomes "rhizopodic sarcode." The deep-sea explorations have resulted in the discovery of a form for which the author proposes the name of *Bathybiopsis*, which has the power of producing a secretion, and of causing the envelope of the organism to pass through four stages, which are distinguished respectively as submembranous, membranous, subchitinous, and chitinous. These envelopes or tunics appear to be found in all reticular Rhizopods. As we ascend the series we observe more and more well-marked efforts on the part of the animal to defend itself from the dangers which threaten it. If it is naked it hides in some cavity; if it is half-naked it partly covers itself with grains of sand, fragments of spicules and so on; in some cases it presents a completely solid surface. The secretion cements the spicules together, and may be known as the sarcoderm; in all forms the protoplasm is essentially similar, the sarcoderm alone alters in character.

The author distinguishes nine tribes; which he calls the naked, the half-naked, the muddy ("vaseux"), the sticky ("pâteux"), the Globerinaceæ, the Spiculaceæ, Arenaceæ, porcellanous, and vitreous.

Marine Gregarinidæ.†—A full description of new Gregarines found in the Gulf of Naples, is given by Dr. J. Frenzel. They comprise *Callyntrochlamys Phronimæ*, *Gregarina Salpæ*, *G. Dromia*, *G. Clausii*, *G. Nicææ*, *G. Caprellæ*, and *G. conformis*.

New Gregarine.‡—Dr. E. Witzlaczil discovered in the body-cavity and fat-body of male larvæ of *Aphis (Hyalopterus) arundinis* a new Gregarine (*Neozygites Aphidis*). It is small, round, and grey in colour, and has a thin and quite plain cuticle of simple contour, a granular endoplasm, and a scarcely noticeable finely granular exoplasm. Many nucleus-like clear bodies occur in the endoplasm. Copulation takes place as follows: two individuals approach each other and at the point of contact undergo resorption of cuticle, allowing the cell-contents to fuse to an oval mass. The nucleus-like bodies during copulation remain behind in either animal and perhaps eventually disappear. Three concentric cuticles are secreted by the contents of the syzygium. The remnants of the old individuals are then cast off. The process of spore-formation unluckily could not be observed.

* Comptes Rendus, xcix. (1884) pp. 1127-30.

† Arch. f. Mikr. Anat., xxiv. (1885) pp. 545-88 (2 pls.).

‡ Ibid., pp. 599-603 (1 pl.).

Hæmatozoa in Cold-blooded Animals.*—Prof. B. Danilewsky has discovered a new Hæmatozoon, which he calls *Hæmogregarina (cistutinis) Stephanovi*. It is monocellular and worm-like, and is “indisputably an intracellular parasite in the red blood-corpuscles of *Emys lutaria*.” Danilewsky compares the animal with the Cytozoa of Lankester, and has no doubt that the latter’s view as to *Drepanidium*, &c., is correct.

Artificial Division of Infusoria.†—Prof. M. Nussbaum has obtained some interesting results as to the regeneration of unicellular organisms.

He divided an *Oxytricha* into two halves either longitudinally or transversely and found the edges at the point of division were soon surrounded with new cilia. Notwithstanding that sometimes some of the body-substance or even a nucleus was lost during the operation, the two halves became normal animals with four nuclei and the characteristic ciliary apparatus. The anterior portion formed a new hinder-part, and the right half a new left. The complete organisms thus formed again developed by spontaneous division; one *Oxytricha* after being cut in halves, produced ten normal individuals, all of which afterwards became encysted. Even pieces of unequal size grew again, but those without a nucleus appear to have no such vital power; so that a nucleus seems to be essential to the retention of the regenerative power of a cell. Parts with nuclei may, however, not recover if the healing of the injured portion does not take place quickly enough. This was observed in experiments with multinucleated *Opalinæ*, but not with multinucleated vegetable cells.

These experiments, Herr Nussbaum considers, demonstrate that it is possible to divide every cell artificially if the proper conditions for the experiment are discovered. He also says, “That which Fol’s observations first taught us and which was insisted upon by Pflüger and Strasburger, viz. that the egg-cell is potentially a multiple of individuals, is by these experiments still further extended. All the energy developed by the cell is attached to a divisible substratum. The power of division, the potential capacity for increase of the individual cells, is not only present during natural division or the processes that precede it, but is present at all times.”

Simultaneously with Herr Nussbaum’s experiments, Dr. A. Gruber ‡ has artificially divided *Stentor ceruleus*. When divided transversely through the centre the posterior section in twelve hours developed a new peristomial area with the large cilia and oral spiral. The part containing the mouth also added a new posterior portion. A longitudinal division through the peristome was followed by the same regenerative process, two complete peristomes being again formed. Pieces smaller than a half also again formed complete individuals, though it could not be determined whether this occurred in the case of pieces not containing any portion of a nucleus. That even a small remnant of

* Arch. f. Mikr. Anat., xxiv. (1885) pp. 588–98.

† SB. Niederheinisch. Gesell. f. Natur- und Heilkunde, 1884, pp. 259–63.

‡ Biol. Centralbl., iv. (1885) pp. 717–22. See Naturforscher, xviii. (1885) pp. 93–4.

nuclear substance is sufficient for the formation of a complete nucleus is certain; it appears, however, that cell-protoplasm can only produce its like and never nuclear protoplasm.

Dr. Gruber also found that if the divided parts of a *Stentor* were not completely separated, they generally tore themselves apart, sometimes by rotating in opposite directions. If the cut was not very deep, monstrous forms might be produced, as for instance with two complete anterior or two posterior portions. If an incision is made so as to leave a bridge uniting the two parts the same phenomenon is seen as in animals which are about to divide spontaneously, the movements of the anterior and posterior halves being in accord so long as even only a thread of protoplasm unites them.

The *Stentors* are specially suitable for these experiments, on account of their large size, and the clearness with which the synchronous movements of the large peristomial cilia on the divided portions can be observed.

"If," says Dr. Gruber, "a narrow, even thread-like connection is sufficient for the loosely connected pieces to act as one physiological individual, it proves that the nervous conditions are not restricted to definite paths, but that spontaneity governs every protoplasm-element equally. There can be no definite central organ, but each portion of protoplasm is central organ and conductor in one, i. e. the nervous power in the substance of the cell is diffused. It is thus comprehensible that, for instance, a *Volvox*-colony, where the numerous individuals are united by bridges of protoplasm, can behave in their movements as a single individual, swimming backwards or forwards as required, revolving, stopping, and so on. I am convinced that here these bridges serve more for the establishment of a nervous unity than for the mutual nourishment of the separate organisms."

Gruber's experiments on healing agree with and confirm those of Nussbaum; but he cannot accept his conclusions, even though unable to offer any suggestion in their stead.

BOTANY.

A. GENERAL, including the Anatomy and Physiology of the Phanerogamia.

a. Anatomy.*

Continuity of Protoplasm. †—Dr. E. Tangl describes observations on this subject made on the bud-scales of the onion, by preparations in sulphuric acid, using soluble anilin-blue as the staining reagent.

The transverse and lateral walls of the epidermal cells of both outer and inner side of older scales are evidently pitted even when not

* This subdivision contains (1) Cell-structure and Protoplasm (including the Nucleus and Cell-division); (2) Other Cell-contents (including the Cell-sap and Chlorophyll); (3) Secretions; (4) Structure of Tissues; and (5) Structure of Organs.

† SB. K.K. Akad. Wiss. Wien, xc. (1884) pp. 10-38.

artificially swollen. By dilute sulphuric acid and a staining reagent, the closing membrane of the pits is shown to possess a different constitution from that of other parts of the cell-wall. If more concentrated acid is used, the staining then shows that the dark-coloured protoplasmic threads which fill up the pit-canals are united by a lighter-coloured slightly refracting connecting piece. A peculiar appearance of "varicosity" presented by some of these connecting threads the author attributes to their assuming occasionally the form of hollow cylinders. A third mode of combination presents the appearance of a direct communication of the protoplasmic bodies through the open pits after the resorption of the original sieve-like closing membrane. The protoplasm of the entire epidermis is therefore not broken up by the cell-walls, but forms a connected symplasm. In the long narrow cells the nucleus often presents the appearance of a plug filling up the cavity, while in the broader cells it has retreated to the outer cell-wall.

For observing the physiological phenomena, sections made by a sharp knife were laid in moist saw-dust in a closed zinc box, and examined after 12 or 15 hours. The result of median sections was that in the 3-5 layers next the wounded surface, layers of protoplasm formed on the lateral walls next the cut surface, the nucleus passing over into them; while at a greater distance these "traumatropic" collections of protoplasm were only faintly displayed. A gradually decreasing irritation from cell to cell is therefore conveyed by the exposure of the lateral walls; this irritation extending uniformly to a distance of about 0.5 mm. The author considers that this irritation cannot be the result of a molecular or micellar vibration of protoplasm, as supposed by Nägeli and Strasburger; but that it results from the continuity of the protoplasm in the epidermal tissue.

Similar phenomena are presented when transverse and portions of lateral walls are exposed by transverse sections at right angles to the median direction, the protoplasm collecting on the transverse walls and the nucleus passing into it, the extent of the irritation being also nearly the same.

The author thinks that, in normal conditions of the protoplasm, the nucleus is subject to movement in a definite direction independent of the circulation; and that there is no direct connection between the traumatropic change of position of the nucleus and of the protoplasm. No formation of cork takes place on the wounded surfaces, the healing being effected by the excretion of a hyaline substance related chemically to protoplasm.

The continuity of protoplasm is more clearly demonstrated in the parenchymatous tissue; but here the irritation does not result in any change of position of the protoplasm.

Structure and Division of the Cell-nucleus.*—In continuation of previous observations, M. L. Guignard finds, even in very early stages, two rows of microsomes in the nuclear threads; and from this he concludes that the segmentation of the microsomes precedes that of

* Bull. Soc. Bot. Lyon, 1884, 11 pp. See Bot. Centralbl., xxi. (1885) p. 76, and this Journal, *ante*, p. 262.

the protoplasmic matrix of the threads. At the nuclear-plate-stage the microsomes are very indistinctly defined, in consequence of the contraction of the segments and the large amount of nutrition they require during the division of the nucleus; this nutrition being essentially at the expense of the nucleoli, the substance of which passes over during division into that of the threads, and enters at a later period into the daughter-nuclei, where it forms fresh nucleoli.

The microsomes of animal cells show, before division of the nucleus, a rayed arrangement, the amphiaster, at the two poles of the future spindle. The only plant in which a similar phenomenon is known is the snowdrop, where it was observed by Strasburger. As regards the processes which take place in the cytoplasm during the division of the nucleus, the author has observed an evident radial striation round nuclei which were about to divide, and round the poles of the nuclear spindle in the embryo-sac of *Lilium*.

In all cases which have come under his observation the author has detected the longitudinal splitting of the segments of the thread.

Division of the Cell-nucleus in Tradescantia.*—M. E. Bernimoulin gives the following process for examining the division of the nucleus in pollen-mother-cells, staminal hairs, and strips of young epidermis. After killing by immersion for some minutes in concentrated alcohol, the object is coloured by an aqueous solution of methyl-green, then placed in dilute glycerin, and finally in more concentrated glycerin. In the hairs on the filaments of *Tradescantia virginica* he finds the striated condition of the protoplasm in the last stages of the division of the nucleus, which had not been observed before, approaching that found by Strasburger in the division of the nucleus in the mother-cells of the stomata of *Iris pumila*.

Behaviour of the Nucleus after Division.†—Dr. F. Schwarz traces the changes undergone by the cell-nucleus after division, by observing the appearance presented by it in a series of cells gradually at a greater distance from the *punctum vegetationis*. The staining from Beale's carmine becomes, under these circumstances, gradually weaker, the size and amount of the chromatin gradually decreasing. The nucleus also increases in size, changing its globular or ellipsoidal to a discoid or lenticular form, finally again decreasing. The mass of the nucleoli undergoes at the same time similar changes. These changes are explained by the author by a hypothesis of an interchange of nutrient material between the nucleus and the cytoplasm on the one hand, and between the nucleus and the nucleoli on the other hand; the nucleoli being spots in which the nutrient chromatin is reproduced.

Morphology of Chlorophyll-grains.‡—Dr. A. Tschirch gives a brief *résumé* of his previously published conclusions respecting the nature of chlorophyll-grains, and the grounds of his dissent from some of the statements of Schmitz, Meyer, and others.

* Bull. Soc. R. Bot. Belgique, xxiii. (1884) 8 pp. (2 pls.).

† Cohn's Beitr. Biol. Pflanzen, iv. (1884) pp. 79-93.

‡ SB. Gesell. Naturf. Freunde, Berlin, 1884, pp. 72-7. See this Journal, iv. (1884) pp. 415, 920.

Soluble Yellow Pigment in the Petals of Papaver.*—In the yellow cell-sap at the base of the petals of *Papaver pyrenaicum*, Dr. A. Weiss finds that alcohol causes a yellow-green precipitate, consisting partly of amorphous granules, partly of large curved crystalline needles. Similar structures are also precipitated by solutions of iodine, chloride of iron, nitrate of silver, and chloride of platinum. A similar phenomenon is also presented by *P. Burzerii*.

Spontaneous Movements of Pigment-bodies. †—Dr. A. Weiss records peculiar spontaneous amoeboid movements which he has observed in the yellow pigment-bodies of the perianth-leaves of *Iris Kamorensis*, which are separated by narrow colourless intermediate zones. Those pigment-bodies, which lie on the outer walls of the cells, creep about with constant changes of their form and internal structure, putting out protuberances and again retracting them, their substance varying in its homogeneity and in the fineness or coarseness of its granulation. Vacuoles are also constantly making their appearance and again disappearing. Similar striking movements and changes of form were observed in the colouring-matters of the flowers of *Iris Matthioli* and *sordida*, *Tulipa elegans*, and *Trollius europæus*.

Excretion of Healing Substances into Wounds. ‡—Following out the observations of B. Franck, § Dr. C. Kraus observes that the resinous substances which form the duramen in wood are in general derivatives either of starch or of tannin. He states also that in certain circumstances the healing substances which are poured out on wounded surfaces are derived from the vessels themselves, and sometimes in sufficient quantities to be observed without the use of the Microscope.

Firmness of Tissues. ||—Prof. S. Schwendener replies to Detlefsen's objections to his views ¶ on the mechanical principle in the anatomical structure of Monocotyledons, bringing forward in support of these views both practical and theoretical considerations.

Behaviour of the Optical Axes of Elasticity of Cell-walls under Tension.**—Dr. A. Zimmermann has studied the question whether vegetable membranes possess any special elastic properties that are not common to inorganic substances. His general conclusion is that there may possibly be organic membranes which undergo only extremely small changes of their optical properties from pressure and traction; but that there is no universal contrast in optical properties between organic and inorganic substances. The experiments were made on the internodal cells of *Nitella flexilis*, the periderm-cells of *Betula alba* and *Prunus avium*, the epidermis of *Allium Cepa*, and the cortex of the stem of *Feniculum officinale*.

* SB. K.K. Akad. Wiss. Wien, xc. (1884). See Bot. Centralbl., xxi. (1885) p. 101.

† SB. K.K. Akad. Wiss. Wien, xc. (1884) (3 pls.). See *ibid*.

‡ Ber. Deutsch. Bot. Gesell., ii. (1884) pp. liii.-iv.

§ See this Journal, *ante*, p. 88.

|| SB. K. Preuss. Akad. Wiss. Berlin, 1884, pp. 1045-70.

¶ See this Journal, iii. (1883) pp. 383, 679.

** Ber. Deutsch. Bot. Gesell., ii. (1884) pp. xxxv.-xlvi.

Sieve-tube System of Cucurbitaceæ.*—Dr. A. Fischer classifies the sieve-tubes found in the Cucurbitaceæ under four heads:—(1) The vascular-bundle sieve-tubes, found in the sieve-portions of the vascular bundles; (2) hypodermal or ectocyclic, between the epidermis and the stiffening-ring; (3) entocyclic, within the stiffening-ring; (4) commissural, those which serve to combine the other kinds of sieve-tube with one another.

The distribution and mode of formation of the sieve-tubes in the main stem of *Cucurbita* are described at length. Independently of some ectocyclic tubes which are inclosed in the collenchyma, and have become functionless, a number of small sieve-bundles occur in the cortical parenchyma near to the collenchyma, forming a much-branched and extensive system. The stiffening-ring separates this system in the internode completely from that of the vascular bundles. Within the thickening-ring are ten vascular bundles, each with two sieve-portions, and in addition some distinct entocyclic bundles connected with one another by commissural tubes, which also unite the different tubes of each kind with one another. The distribution of the sieve-tubes the author regards as indirectly connected with their function as conductors of albuminous substances, and as determined mainly by the local consumption of albuminoids in the internode.

The author then treats of the facts connected with the sieve-tubes in other parts of the plant of *Cucurbita*; and in particular the gradual change which they undergo in passing from the stem into the root. The ovary possesses an extraordinarily richly developed sieve-tube system, especially in its innermost layer. After impregnation the peripheral layer of the ovary grows most rapidly, and new hypodermal sieve-tubes are formed in it. They are also found in the style close to the central conducting tissue, where they serve, in the opinion of the author, to supply the pollen-tube, during its growth, with albuminoids. He states also that the pollen-tubes branch abundantly, so that one tube can impregnate a number of ovules.

The author examined 28 species of Cucurbitaceæ, belonging to as many different genera; and distinguishes the following six types in reference to the mode of distribution of the sieve-tube system:—(1) *Alsomitra*; (2) *Luffa*; (3) *Bryonia*; (4) *Cyclanthera*; (5) *Lagenaria*; (6) *Cucurbita*. The first type has only collateral bundles without commissures or peripheral sieve-tubes. In the second type there are bicollateral vascular bundles, but only a few rudimentary peripheral sieve-tubes; no radial commissures. The third type has numerous entocyclic, but no ectocyclic or commissural sieve-tubes. In the fourth type the numerous entocyclic tubes have only a few commissures; the ectocyclic are wanting. The fifth type is distinguished from the fourth only by a much more abundantly developed commissural network, and leads to the sixth type, where there are also ectocyclic tubes; and the whole system attains its highest development.

The author states further that it is only the cells of the young

* Fischer, A., 'Unters. üb. d. Siebröhrensyst. der Cucurbitaceen,' 109 pp. (6 pls.) 8vo, Berlin, 1884.

sieve-tubes which can produce albuminous substances, since they still possess a nucleus which is wanting in the mature tubes. He agrees with Strasburger in regarding the nucleus as an important organ in the formation of albuminoids.

Development of the Sclerenchymatous Fibres of the Oleander.*

—M. A. Famintzin has paid attention to the development of these structures, especially with the view of determining whether it is best explained on the theory of development by apposition or by intussusception. In the first two internodes, the membrane of these fibres is thin, and composed only of the primary layer. In the third internode secondary layers are for the first time formed, in some cases two secondary layers, and in subsequent internodes several; the peculiar striation makes its appearance usually only in the fifth internode, in the form of spiral bands, which in the sixth and seventh internodes become split into a large number of very narrow striæ. The general conclusions at which the author has arrived are:—(1) Each thickening layer increases in thickness by apposition, new molecules of cellulose being formed on the inner surface of the layer; (2) the lamellæ are formed by the splitting of the layers; (3) it must still be regarded as undecided whether each secondary layer is formed by the splitting of an older layer, or by apposition.

Growth of the Thickening-ring in Exogens.†—Dr. G. Krabbe maintains that De Vries's experiments on this subject are as easily explained on the theory of a gradual decrease of the pressure of the cambium as on that of an increase of the tension of the bark.

In Coniferæ (*Pinus Strobus*) Krabbe found the radial tension of the bark to be nearly the same in autumn as in spring; while in Angiosperms there is usually a small decrease in the autumn, though not to a greater extent than one-quarter of an atmosphere. The greater part of tangential tension falls on the comparatively thin periderm.

The author describes an experimental method by which he proves the truth of the usual formula for expressing the radial pressure, viz.—

$$\text{Radial pressure} = \frac{\text{tangential tension}}{\text{radius}}$$

In both Conifers and Dicotyledons every radial row of cells in the thickening-ring results from the repeated division of a single initial mother-cell; while in the meristem of the medullary rays the cells immediately derived from this initial cell become, without any previous division, the cells of the medullary rays of the phloëm or xylem. During the development of the annual ring the author distinguishes, in the growing layer of tissue, two zones: that of cell-division or the thickening-ring, and that of cell-elongation or the zone of the young wood-cells.

Internal Cambium Ring in *Gelsemium sempervirens*.‡—Dr. J. T. Rothrock calls attention to the internal cambium-ring in the stem

* Bull. Acad. Imp. Sci. St. Petersburg, xxix. (1884) pp. 416-22 (1 pl.).

† Abh. K. Akad. Wiss. Berlin, June 12, 1884. —See Bot. Centralbl., xxi. (1885) p. 38.

‡ Proc. Acad. Nat. Sci. Philad., 1885, pp. 22-3.

of *Gelsemium sempervirens*. Microscopic examination shows that there are ordinarily four or more points, at which a well-defined swelling curves inward from the circumference of what should be the pith-cavity. These swellings resolve themselves into (1) toward the centre an imperfectly defined membrane, resembling cuticle, which was not always present; (2) one or more rows of large cells like the parenchyma under the epidermal layer; (3) several poorly defined layers of smaller cells, such as often mark the limits of growth in bark; (4) the frequent presence of bast-fibres or of sclerenchyma-cells; and (5) an evident layer of thin-walled, square cells, closely resembling those of the external cambium, and showing signs of division. These facts explain why the pith is constantly encroached upon until it at length almost disappears. The medullary rays dip down through and widen out in this inner cambium *inwardly*, just as they do outwardly in the usual form.

The author also records the presence of considerable quantities of chlorophyll in the pith of *Lycium vulgare*. This is not confined to the smallest stems, but is found also in those of over 1/4 in. in diameter, and where of course a considerable belt of hard wood is found between the pith and the outer zone, where chlorophyll is expected. It was also observed that the chlorophyll was not in the form of bodies but diffused in character, as it is said to be in some infusorians. The cells of the pith show in winter abundance of protoplasm which has the nucleus on one side, and very striking bands extending thence across the cell to the further cell.

Penetration of the Mechanical Ring for the Transport of Food-material.*—Dr. A. Tschirch describes the mode in which the products of assimilation pass from one part of the plant to another through the barrier presented by the “mechanical ring” of hardened impermeable strengthening tissue. This is effected (a good example is afforded by the flat phylloclades of *Mühlenbeckia platyclados*) by the replacement here and there of these strengthening cells by “transmission-cells” (*Durchlasszellen*) which are thin-walled on all sides or at least on one side, and are usually situated near to the vascular bundles. These are generally accompanied by other cells in their immediate neighbourhood, the “collecting-cells” (*Sammelzellen*), roundish cells, containing no chlorophyll, though lying in the midst of green tissue, but densely filled with protoplasm. These cells usually lie in longer or shorter rows leading from above and below to the spots where the mechanical ring is broken through; and the cells of the green tissue often converge towards them like a star; their purpose is to collect the products of assimilation and conduct them to a perforation through the mechanical ring.

Stolons of *Sagittaria sagittæfolia*.†—Dr. C. Müller describes at length the morphology and the anatomical structure of these organs, in relation to the epidermis, the hypodermal layer, the fundamental tissue, the laticiferous canals, and the vascular bundles.

* Ber. Deutsch. Bot. Gesell., ii. (1884) pp. xxvii.—xxxi. (1 pl.).

† SB. Gesell. Naturf. Freunde Berlin, 1884, pp. 165–79.

Anatomical Structure of the Stem of Compositæ.*—M. P. Vuillemin discusses this subject from a systematic point of view. He regards the root, equally with the leaves, as an appendicular organ attached to the stem; and the various component parts of the stem he classifies under the following heads:—Epidermis; cortex, composed of exoderm, endoderm, and autoderm; and central cylinder, composed of pericycle and autocyte. The function of the endoderm is, according to the author, not so much a protecting or isolating one which has acquired for it the term “*gaine protectrice*,” as to furnish resistance to the expansion of the central cylinder, not being developed when the endoderm has become transformed into a hardened ring, but only when it is the seat of active cell-division, especially when it gives rise to adventitious roots.

The course of the fibrovascular bundles in the stem of Compositæ is arranged under five types; while the mode of insertion of the buds in the stem is referable to a single type only, the special variations of which furnish a good anatomical character for indicating the alliance of species.

The development of the roots always takes place at the expense of the pericycle, both in the stem and in the root.

There is not, in the Compositæ, the same relationship between the anatomical structure of the stem and the floral characters as occurs in the Umbelliferae.

Structure of the Stem of Aquatic Plants.†—M. J. Costantin has performed a series of experiments for the purpose of proving how far the placing of a stem in water, air, or soil, modifies its structure; and for this purpose he placed different parts of the same axis in the three media. He finds, on a comparison of the aquatic and aerial regions, that in the former the air-passages are more developed—the vascular system is reduced, and the vessels enlarged; the fibrous tissue and the collenchyma diminish in importance, but persist for a long period in a degraded state; while the endodermic punctations are very visible, even when wanting in the aerial stem. A comparison of aquatic with underground stems shows that in the latter the air-passages are smaller; the vascular system is somewhat less developed; the fibres and the collenchyma disappear almost entirely; the peripheral layers become suberized; and the endoderm is more differentiated. Of the three regions, therefore, the aquatic displays the least development of the vascular system; while the supporting structure is more pronounced.

Amphibious plants partially preserve this aerial structure in the aquatic region, when their lower part only is immersed in water; but, when growing in deep water, the organisation becomes completely degraded. Aquatic plants do not therefore change their structure so completely as terrestrial plants; while transitional states, which are almost entirely wanting in the latter, are much more numerous in the former.

* Vuillemin, P., ‘De la valeur des caractères anatomiques au point de vue de la classification des végétaux,’ 258 pp. and 47 figs., 8vo, Paris, 1884.

† Ann. Sci. Nat.—Bot., xix. (1884) pp. 287–331 (4 pls.).

Epidermis of Petals.*—Herr G. H. Hiller has examined the structure of the epidermis of the petals in a large number of flowers. He calls attention especially to the common occurrence of ribbing in the epidermal cells, where, of two adjacent cells, the wall of one only is strongly thickened in places, forming folds which project into the cell-cavity of the other cell. The statement of some observers that this structure does not occur with brightly coloured flowers is incorrect. It is found especially with petals of delicate texture, and more commonly with dicotyledons than monocotyledons. The degree both of the ribbing and of the waviness of the walls may vary even in different parts of the same petal. The outer surface of the epidermal cells has a strong tendency to develop into papillæ which may vary in shape from segments of spheres to narrow cones. They occur only in the upper part of the petals. The petals very often possess stomata on both sides, which differ in no important respect from those of the leaves; their guard-cells contain abundance of starch. The author noticed in the petals of many plants cells of peculiar shape which appear to be stomata arrested in their development.

Notwithstanding statements to the contrary, intercellular spaces very commonly occur between the epidermal cells of petals, more especially on the under side; they vary greatly in size and form, and are always covered by the cuticle. They almost always result from rib-like foldings of the side-walls.

The main physiological purpose of the epidermis of petals, as of that of leaves, is to protect against excessive transpiration; the papillæ serving as a reservoir of water. The epidermal cells, both on the upper and under side of petals, are very commonly filled with starch, especially when young; it appears to be partially consumed by the rapid growth of the petals.

Bursting of Ripe Fruits.†—Herr C. Steinbrinck, commenting on the paper on this subject by Leclerc du Sablon,‡ objects to his conclusions in some particular instances, while in his general conclusions he charges him with adopting without acknowledgment the results of previous writers. Steinbrinck re-states the general law that in the majority of cases the hygroscopic tensions which cause the bursting of dry fruits do not depend altogether or at all on differences in the capacity for swelling of different portions of tissue, but chiefly or entirely on differences in the shrinking of stretched cells. The actual elements are usually so arranged that—either by themselves or in conjunction with differences in the capacity of swelling of their walls—when they dry up, forces are called out which rupture the pericarp at the point of least resistance, and bring about changes of form serviceable in the dissemination of the seeds.

Comparative Anatomy of the Cotyledons and Endosperm.§—M. J. Godfrin has made a detailed examination, in a great variety of plants belonging to widely separated natural orders, of the develop-

* Pringsheim's Jahrb. f. Wiss. Bot., xv. (1884) pp. 411-51 (2 pls.).

† Ber. Deutsch. Bot. Gesell., ii. (1884) pp. 397-405.

‡ See this Journal, *ante*, p. 276.

§ Ann. Sci. Nat.—Bot., xix. (1884) pp. 5-158 (6 pls.).

Pollen of Gymnosperms.*—In continuation of his previous observations on this subject,† Dr. L. Juranyi now states that the male prothallium of *Ephedra altissima* is formed in precisely the same way as in Cycadeæ, not from the small cells of the pollen-grain which are first separated, but by successive divisions of the larger cell.

Ant-harbouring Organs of Plants.‡—Dr. O. Beccari describes those plants, natives of Malacca and Papua, which possess “extra-floral nectaries,” or receptacles for honey outside the flowers which attract the visits of ants and other insects. He believes that the production of the galleries and other structures in which this secretion takes place, e. g. in *Myrmecodia*, is an acquired hereditary character, resulting in the first place from the irritation caused by the punctures of the tissues by the insect.

Malformations caused by Insects.§—Dr. F. Krasan describes the injuries caused to the oak by the laying of the eggs of *Orchestes Quercus*; their growth is arrested, they curl and roll back, and become thicker and more rigid than the ordinary leaves, giving a very peculiar appearance to the tree. In June these are followed by a second growth of leaves, of very large size, and scarcely resembling the ordinary ones; and later by a third growth of normal leaves. To these phenomena Krasan gives the names megalophyllosis and pachyphyllosis. These distortions may even become hereditary, and cause the appearance of apparently new species; as in the case of *Quercus brachyphylla* Kotschy, probably derived from *Q. pubescens*. Similar malformations occur in several species of *Abies* and in *Thymus serpyllum*.

Bower and Vines's Practical Botany.||—We have here the long needed desideratum of a practical guide for students in laboratory work. After five introductory chapters, viz. (1) Making Preparations; (2) Micro-chemical Reagents; (3) General Structure of the Cell; (4) Micro-chemistry of the Cell; (5) Micro-physics of the Cell, the authors describe the various points of structure which the student has to look for in the different parts of flowering plants, Dicotyledons, Monocotyledons, and Gymnosperms, succeeded by the following types of Vascular Cryptogams:—*Selaginella*, *Lycopodium*, *Aspidium*, and *Equisetum*. The present part is intended to be followed by another comprising the remaining types of the vegetable kingdom. The work is the result of long experience in the practical teaching of botany with the aid of the Microscope; the descriptions are given throughout in clear and terse language, and the work is indispensable to the teacher and of very great value to the learner.

* Magy. Tud. Akad. Ertesitö, 1884 (3 pls.). See Bot. Centralbl., xxi. (1885) p. 76.

† See this Journal, iii. (1883) p. 84.

‡ Beccari, O., ‘Malesia,’ vol. ii. 4to, Genova, 1884, 36 pp.

§ Engler's Jahrb., v. (1884) p. 351. See Naturforscher, xvii. (1884) p. 340.

|| Bower, F. O., and Vines, S. H., ‘A Course of Practical Instruction in Botany.’ With a Preface by W. T. Thiselton Dyer. Part I.—‘Phanerogamæ—Pteridophyta.’ 8vo, London, 1885.

B. Physiology.*

Development of the Endosperm in *Hordeum*.†—In the formation of the endosperm in barley, M. W. Johanssen finds that the connecting fibres between the newly developed daughter-nuclei have not the usual barrel-shaped figure, but run parallel to one another near to the nucleus. He was not able to follow the division of the central nucleus in the embryo-sac.

The so-called "gluten-cells" (*Kleber-zellen*) of the endosperm, which contain oil but no starch, he considers have been unfortunately so called, since they have nothing to do actually with the gluten of the grain. The three outer layers of the endosperm contain protein-grains, with but little power of resistance, lying in a protoplasmic matrix abounding in oil.

The author describes the method by which he prevents the entrance of air into the endosperm in making sections of the grain.

Influence of Light and Heat on Plant Development.‡—Dr. H. Hellriegel finds that the temperature during which plant life proceeds is confined within narrow boundaries, there being a limit for each plant. Near the lowest limit the growth is very slow, but as temperature rises life becomes more energetic, until a certain temperature is reached, when the life is most energetic; this temperature is the "optimum," and does not of necessity coincide with the highest temperature at which life ceases. As a rule the optimum temperature lies between 20° and 40° C.; at 50° life is extinguished. In an analogous manner, light or darkness produces a definite effect; for although germination takes place better in darkness, no plant can thrive without light, the plant is bleached, leaves and stems become abnormal, and the weight of dry matter diminishes. In subdued light, assimilation proceeds but slowly, but is more rapid as the intensity of light increases; the maximum of rapidity, however, is not coincident with the maximum intensity of light. The combination of warmth, light, and moisture forms a very important factor in the fertility of the plant, and in many cases it is of more importance than manuring, &c. The lowest limit of temperature at which the majority of seeds germinate is 4–5° C., but a few can germinate at zero.

Experiments are detailed which were made on various seeds, some in soil kept at different temperatures for 35–60 days.

The results of Hellriegel's further researches § are as follows:—As it was thought impossible that plants growing in glass-houses could obtain light of an intensity equal to that which they would

* This subdivision contains (1) Reproduction (including the formation of the Embryo and accompanying processes); (2) Germination; (3) Growth; (4) Respiration; (5) Movement; and (6) Chemical processes (including Fermentation).

† Meddel. Carlsberg Lab., ii. (1884) (3 pls.). See Bot. Centralbl., xxi. (1885) p. 44.

‡ Bied. Centr., 1884, pp. 123–6. Cf. Journ. Chem. Soc.—Abstr., xlvi. (1884) pp. 855–6.

§ Bied. Centr., 1884, pp. 240–83. Cf. Journ. Chem. Soc.—Abstr., xlvi. (1884) pp. 1206–7.

Pollen of Gymnosperms.*—In continuation of his previous observations on this subject,† Dr. L. Juranyi now states that the male prothallium of *Ephedra altissima* is formed in precisely the same way as in Cycadææ, not from the small cells of the pollen-grain which are first separated, but by successive divisions of the larger cell.

Ant-harbours of Plants.‡—Dr. O. Beccari describes those plants, natives of Malacca and Papua, which possess “extra-floral nectaries,” or receptacles for honey outside the flowers which attract the visits of ants and other insects. He believes that the production of the galleries and other structures in which this secretion takes place, e. g. in *Myrmecodia*, is an acquired hereditary character, resulting in the first place from the irritation caused by the punctures of the tissues by the insect.

Malformations caused by Insects.§—Dr. F. Krasan describes the injuries caused to the oak by the laying of the eggs of *Orchestes Quercus*; their growth is arrested, they curl and roll back, and become thicker and more rigid than the ordinary leaves, giving a very peculiar appearance to the tree. In June these are followed by a second growth of leaves, of very large size, and scarcely resembling the ordinary ones; and later by a third growth of normal leaves. To these phenomena Krasan gives the names megalophyllosis and pachyphyllosis. These distortions may even become hereditary, and cause the appearance of apparently new species; as in the case of *Quercus brachyphylla* Kotschy, probably derived from *Q. pubescens*. Similar malformations occur in several species of *Abies* and in *Thymus serpyllum*.

Bower and Vines's Practical Botany.||—We have here the long needed desideratum of a practical guide for students in laboratory work. After five introductory chapters, viz. (1) Making Preparations; (2) Micro-chemical Reagents; (3) General Structure of the Cell; (4) Micro-chemistry of the Cell; (5) Micro-physics of the Cell, the authors describe the various points of structure which the student has to look for in the different parts of flowering plants, Dicotyledons, Monocotyledons, and Gymnosperms, succeeded by the following types of Vascular Cryptogams:—*Selaginella*, *Lycopodium*, *Aspidium*, and *Equisetum*. The present part is intended to be followed by another comprising the remaining types of the vegetable kingdom. The work is the result of long experience in the practical teaching of botany with the aid of the Microscope; the descriptions are given throughout in clear and terse language, and the work is indispensable to the teacher and of very great value to the learner.

* Magy. Tud. Akad. Ertesitö, 1884 (3 pls.). See Bot. Centralbl., xxi. (1885) p. 76.

† See this Journal, iii. (1883) p. 84.

‡ Beccari, O., ‘Malesia,’ vol. ii. 4to, Genova, 1884, 36 pp.

§ Engler's Jahrb., v. (1884) p. 351. See Naturforscher, xvii. (1884) p. 340.

|| Bower, F. O., and Vines, S. H., ‘A Course of Practical Instruction in Botany.’ With a Preface by W. T. Thiselton Dyer. Part I.—‘Phanerogamæ—Pteridophyta.’ 8vo, London, 1885.

B. Physiology.*

Development of the Endosperm in Hordeum.†—In the formation of the endosperm in barley, M. W. Johannsen finds that the connecting fibres between the newly developed daughter-nuclei have not the usual barrel-shaped figure, but run parallel to one another near to the nucleus. He was not able to follow the division of the central nucleus in the embryo-sac.

The so-called "gluten-cells" (*Kleber-zellen*) of the endosperm, which contain oil but no starch, he considers have been unfortunately so called, since they have nothing to do actually with the gluten of the grain. The three outer layers of the endosperm contain protein-grains, with but little power of resistance, lying in a protoplasmic matrix abounding in oil.

The author describes the method by which he prevents the entrance of air into the endosperm in making sections of the grain.

Influence of Light and Heat on Plant Development.‡—Dr. H. Hellriegel finds that the temperature during which plant life proceeds is confined within narrow boundaries, there being a limit for each plant. Near the lowest limit the growth is very slow, but as temperature rises life becomes more energetic, until a certain temperature is reached, when the life is most energetic; this temperature is the "optimum," and does not of necessity coincide with the highest temperature at which life ceases. As a rule the optimum temperature lies between 20° and 40° C.; at 50° life is extinguished. In an analogous manner, light or darkness produces a definite effect; for although germination takes place better in darkness, no plant can thrive without light, the plant is bleached, leaves and stems become abnormal, and the weight of dry matter diminishes. In subdued light, assimilation proceeds but slowly, but is more rapid as the intensity of light increases; the maximum of rapidity, however, is not coincident with the maximum intensity of light. The combination of warmth, light, and moisture forms a very important factor in the fertility of the plant, and in many cases it is of more importance than manuring, &c. The lowest limit of temperature at which the majority of seeds germinate is 4–5° C., but a few can germinate at zero.

Experiments are detailed which were made on various seeds, some in soil kept at different temperatures for 35–60 days.

The results of Hellriegel's further researches § are as follows:—As it was thought impossible that plants growing in glass-houses could obtain light of an intensity equal to that which they would

* This subdivision contains (1) Reproduction (including the formation of the Embryo and accompanying processes); (2) Germination; (3) Growth; (4) Respiration; (5) Movement; and (6) Chemical processes (including Fermentation).

† Meddel. Carlsberg Lab., ii. (1884) (3 pls.). See Bot. Centralbl., xxi. (1885) p. 44.

‡ Bied. Centr., 1884, pp. 123–6. Cf. Journ. Chem. Soc.—Abstr., xlvi. (1884) pp. 855–6.

§ Bied. Centr., 1884, pp. 240–83. Cf. Journ. Chem. Soc.—Abstr., xlvi. (1884) pp. 1206–7.

receive outside, so that the results of experiments conducted under cover would not be perfectly trustworthy, the author arranged that the plants experimented on should be exposed to the free air in fine weather, but removed under shelter in bad weather. As a proof of the differences produced by the new arrangements, the results of experiments are given which show that not only was the total yield of barley greater, but that the weight also of the grains harvested was greater in free air and direct sunlight than in diffused light. Barley plants were grown under cobalt glass, which allowed of the passage of the red and green rays as well as of the violet, and yellow carbon glass in which the violet and blue were extinguished, with the result, that under the influence of the blue light less ash and more organic matter were produced than under the yellow. The plants under the blue glass grew well, whilst those under the yellow seemed to be retarded in their growth, and when shaded were long in the internodes, and the leaves were thin and delicate. Taking this experiment in conjunction with another somewhat similar one, the author comes to the conclusion that plants are not very sensitive to moderate changes in the composition of the light which falls on them, consequently that the light as altered by the roof and walls of a glass-house cannot have any serious detrimental influence on the plants.

In plants grown under glass shaded by cylinders so that the light could reach them in a vertical direction only, he found that the stems grew lengthy and rapidly, being thin and weak: the lower leaves were pale; those of the pea reddish. Under the influence of lateral shades the growth is somewhat abnormal, and this is the more marked the narrower the shading cylinder. Under all these disadvantages, however, the plants fruited, but under all conditions those plants which were not shaded produced the most fruit, and, as the cylinder narrowed, the yield of grain decreased, while the chaff and the straw (peas excepted) increased. It was also remarked that under the medium-sized shades with the upper opening of the same size as the pots, although the other conditions were so various, the amount of dry matter in the plants was approximately the same.

As regards the warmth necessary for the proper growth and ripening of plants, the experiments are detailed very fully, but it will suffice to state the results obtained. For the growth of four-rowed barley, the average daily temperature during the first half of the period of vegetation should be about 15° C., in the latter half, when the blossom forms, &c., the average must be $17-18^{\circ}$, and the average of the whole season 16° . The average of the mid-day during the first period should be 20° , during the second period about 25° , the average during the whole season about 21° .

Evaporative Surfaces of Plants and Influence of Moisture in Soils on Plant Growth.*--Dr. H. Hellriegel's previous experiments have convinced him that plants so dissimilar as beans and barley have

* Bied. Centr., 1884, pp. 834-49. See Journ. Chem. Soc.—Abstr., *xlvi*ii. (1885) p. 421.

nearly the same extent of evaporative surface, the measurement of which, although difficult, should afford much information as to the effect of moisture in the soil. These effects have been frequently remarked. The author made experiments with barley grown in soils containing 10, 20, 40, and 60 per cent. of water; with the higher percentages, the size of leaf increased proportionally, but when examined under the Microscope the leaves of the plants grown with the lesser quantities of moisture showed far larger numbers of stomata than the others, and in the former the stomata were larger, and the cells more developed. The greater quantity of matter produced by well-watered plants, appears to be due to the quick multiplication and development of the cells; in the less watered plants, the contents of the cells appear to be more concentrated.

Plants do not possess the power of assimilating the moisture existing as vapour in the air; the rainfall is therefore a most important factor in the growth of plants in dry soils; the transpiration from the leaves and the loss of moisture from the soil by evaporation serves to balance the effect of excessive rainfall. The author has observed the fall for fifteen years at one station, but the conclusions drawn are incomplete. Soils possess this power of absorption of moisture from damp air; the author's experiments show that they do not absorb sufficient for plant-life in the absence of other sources of moisture. The diffusion of rain in the soil depends very much on the physical condition of the soil, which, for this purpose, may be looked on as a mass permeated by numerous capillary tubes of smaller or larger dimensions. One important result of the experiments was the great difference in the absorptive capacity of one and the same soil when in loose or close condition, the proportion in good garden soil being in round numbers 2:3, and the author thinks the great advantage of deep cultivation consists as much in improving the power of absorption, as in bringing fresh soil to the surface.

Apical Growth of Phanerogams.*—The examination of the mode of apical growth in a large number of monocotyledons, dicotyledons, and gymnosperms, leads Herr P. Korschelt to the conclusion that there is no variation in essential points. A large more or less distinctly tetrahedral cell can always be distinctly detected in the centre of the growing point from which daughter-cells are detached in regular succession from its three lateral walls. The essential principle of the mode of growth is therefore the same with flowering plants as with cryptogams.

The fact that growth by means of a single apical cell has been established in a very large number of plants belonging to widely-separated natural families, makes it extremely probable that the same mode of growth is characteristic of the entire group of flowering plants.

Causes of Anisotropy of Organic Substances.†—The unequal growth of organic substances has been attributed to two causes:—the

* Pringsheim's *Jahrb. f. Wiss. Bot.*, xv. (1884) pp. 642-74 (1 pl.).

† *Ber. Deutsch. Bot. Gesell.*, ii. (1884) pp. xlvii.-lii.

theory of doubly refractive micellæ, and the theory of crystalline structure. Herr A. Zimmermann contributes a paper towards the solution of this question. He believes that the anisotropy is caused chiefly by the arrangement of the micellæ constituting the substance. It is, however, not improbable—although it cannot be proved by direct observation—that the micellæ possess in themselves a power of double refraction. The theory that crystalline structure of organic substances which produces anisotropy is brought about by tension is not impossible, and is supported by certain facts; but it is not probable that these tensions still remain in the vegetable membrane at a later period.

Chemical Phenomena of the Respiration of Plants.* — Dr. T. L. Phipson in connection with the general idea that the exposure of the green parts of plants to light is sufficient to cause them to breathe, remarks that temperature is quite as important an agent. For example, plants were exposed to light on two days of nearly equal photometric intensity of daylight; but when the temperature was respectively 38° F. and 70° F., in the first case the evolution of gas was *nil*, whilst in the second it was abundant. On another occasion a plant at 45° F. in bright sunlight gave no gas, whereas, after an hour at 59° F. in much less powerful light, gas was evolved.

The plants employed in these observations were unicellular algæ; they have no stomata, it is therefore inferred that these organs are not indispensable for the respiration of plants. A temperature of from 60° F. to 90° F., and exposure to sunlight appear to be the most favourable conditions for the respiration of these plants. Other observations and experiments tend to show that circulation is closely connected with respiration, and, like it, is equally dependent on temperature as well as light. It is stated that the oxygen evolved from the organisms in stagnant water comes from zoospores, and not from infusoria, as is sometimes supposed. It is inferred that the respiration of plants is independent of chlorophyll, but that chlorophyll is formed by the process of respiration, inasmuch as the brown or yellowish *Protococcus pluvialis* emits oxygen, and algæ accidentally bleached by adding a minute quantity of sodium hydroxide to the water in which they were being cultivated, after washing and again exposing to light, gave off oxygen after four hours, and the next day developed green patches. The author's experiments negative the idea that for the cultivation of plants, carbonic anhydride may be replaced by organic acids.

Respiration of Leaves in Darkness.†—The researches on this subject by MM. G. Bonnier and L. Mangin are now published more in detail, with a description of the experiments themselves and of the apparatus employed, together with a number of tables. The relation between the volume of carbon dioxide given off and that of oxygen

* Chem. News, 1. (1884) p. 288. See Journ. Chem. Soc.—Abstr., xlvi. (1885) pp. 420-1.

† Ann. Sci. Nat.—Bot., xix. (1884) pp. 217-55. Cf. this Journal, iv. (1884) p. 591.

absorbed in adult leaves in darkness is a constant quantity for the same species. The increase in the intensity of respiration with a rise of temperature may be represented by a parabolic curve.

Movement of Ascending Sap.*—M. J. Vesque has paid special attention to two points in this question, viz. the influence of external pressure on the absorption of water by the roots; and the part played in this movement by the vessels.

On the first point he comes to the following general conclusions:—In the case of the oleander the absorption of water by the roots depends on the external pressure, and appears to augment in proportion to the difference between this pressure and that of the air contained in the woody substance of the root. The pressure of the internal air depends on transpiration and osmose; the latter force does not appear to be always active; absorption may be arrested by decreasing the atmospheric pressure. Under the conditions employed the pressure of the internal air did not differ greatly from the atmospheric pressure; it was ordinarily somewhat less; in only one case was it observed to be slightly greater. The effect of external pressure on the oleander is sufficiently great for a rapid movement of the barometer to produce a sensible disturbance in the absorption of water by the roots. The bean, and possibly all herbaceous plants, are much less influenced by external pressure than woody plants in reference to the absorption of water. The influence does, however, exist, although usually unperceived by the side of fluctuations induced by variations in transpiration and by other secondary causes. The rapidity of the movement of water in the plant should be greater in proportion to the difference between the pressure of the air imprisoned in the upper and in the lower part of the plant. External pressure, as well as osmose, may increase this difference.

On the second point, the following are the conclusions of the author:—Water is in motion in the young vessels whenever it is possible; i. e. whenever they are not obstructed by accident or by strings of bubbles of air. Whenever either of these is the case, lateral passages are established in consequence of the rapid diminution of the pressure of the air contained in the adjacent woody cells, and the water passes from the vessels into these cells, whence it escapes by the operation of differences of pressure in the woody cells. This lateral passage of water is so rapid that a current is formed in them beneath any obstacle; but this phenomenon does not differ essentially from the normal condition, since the vessels are closed at their extremity. When the open extremity of the vessels of a cut branch or of a leaf taken from a herbaceous or woody plant is stopped, these branches or leaves wither and dry up. When a branch is bruised for a length of some millimetres, so as to close the cavities of the vessels and tracheids, the branch will wither. The author believes that the water placed in movement in the passage from one cell to another is water of imbibition, and considers the term filtration to be improperly used in this connection.

* Ann. Sci. Nat.—Bot., xix. (1884) pp. 159-99.

Movement of Water in Plants.*—M. E. Godlewski accounts for all the phenomena of "bleeding-pressure" by the following explanations:—(1) That in the cells where this pressure originates, periodically recurring splittings and chemical re-formations succeed one another within certain periods; (2) That at the time when the water is expelled from the cell by turgidity in consequence of the diminution of the osmotic attraction of the cell-sap, the protoplasm offers the least resistance to filtration at the spot where the cell is in contact with a fibro-vascular element.

Importance of Dead Tubes and Living Cells for the Conduction of Water in Plants.†—Herr M. Westermaier brings forward practical and theoretical considerations in favour of the following points in the movements of water in plants, viz.:—(1) The anatomical fact of the intimate contact between the parenchymatous and the vascular systems has for its chief purpose the combined action of both systems in facilitating the passage of water through the tissues, rather than the isolated activity of either system; (2) Living parenchyma by itself can only bring about the passage of water from cell to cell by suction through small spaces.

Supply of Air to the Roots and Root-pressure.‡—Dr. A. Hansen shows that an abundant supply of air to the roots is of advantage to plants in two ways; firstly in preventing by oxidation the formation of sulphide of iron, and secondly by preventing the accumulation of algæ about the roots. Dr. Hansen also confirms the statement of Sachs that root-pressure is not a necessary factor in the circulation of fluids through the plant; but that even when the roots are killed, they can absorb from the soil a sufficient amount of water to carry on the process of transpiration and prevent withering; they may even under these circumstances expand their flowers.

Nutations of Seedlings.§—Herr F. Rimmer has experimented, chiefly in the case of *Phaseolus multiflorus*, on the cause of the phenomena of nutation, whether the simple nutation of the hypocotyledonary or of the epicotyledonary portion of the axis, or the undulating nutation resulting from the more rapid growth of one side of the organ in its lower, of the other side in its upper part. The following are the general results attained; the investigation extending also to some other leguminous plants (*Vicia sativa*, *Pisum sativum*), some monocotyledons (*Cynosurus cristatus*, *Hordeum vulgare*, &c.), and some other dicotyledons (*Helianthus annuus*, *Cucurbita Pepo*, &c.):—

1. The simple nutation of the hypocotyledonary segment in *Helianthus*, *Cucurbita*, and *Phaseolus vulgaris*, is partly a spontaneous phenomenon, partly dependent on gravity acting through the cotyledons.

2. The simple nutation of the epicotyledonary segment is purely spontaneous, and is connected with a certain amount of growth.

* Pringsheim's Jahrb. f. Wiss. Bot., xv. (1884) pp. 569-630.

† SB. K. Preuss. Akad. Wiss. Berlin, 1884, pp. 1105-17 (1 pl.).

‡ SB. Phys.-med. Gesell. Würzburg, 1884, pp. 109-12.

§ SB. K.K. Akad. Wiss. Wien, lxxxix. (1884) pp. 393-422.

3. The undulating nutation is promoted by the exclusion of the action of gravity from one side, and the cutting off of light, and passes gradually into circumnutation.

4. The irregular nutations of *Vicia sativa* and *Pisum sativum* are connected with a retardation of the growth in length, and a relative acceleration of the transverse growth.

5. Monocotyledons also possess the power of nutation during germination.

Influence of Light on Geotropism.*—Dr. E. Stahl combats the ordinary statement that light, in itself, has no direct influence on geotropic organs. His observations, made on the rhizomes of *Adoxa Moschatellina* and other plants, have convinced him that light strengthens the geotropism of secondary roots, while on the other hand their growth in length is retarded. He finds that the underground runners or stolons of this plant grow in a horizontal direction in the dark, while under the influence of light they grow vertically or obliquely downwards; and an alternation of light and darkness causes corresponding changes in direction in the same organ.

Peptonizing Ferments in Secretions.†—Dr. A. Hansen has confirmed previous statements with regard to the presence of a peptonizing ferment in the latex of *Ficus Carica*. The effect on fibrin is precisely the same as that of digestion by pepsin; and milk is coagulated by it in the same way. The precipitation of the latex by alcohol produces a white precipitate which assumes a light brown colour in the drying bath, and is of a resinous nature. Triturated with water, it produces a milky fluid which is not so emulgent as the original latex, but coagulates milk in the same way. The latex also produces the diastatic reaction of the conversion of starch and glycogen into sugar. A syrup of dried figs has the same peptonizing property as the latex, as also has the secretion of the pitchers of *Nepenthes*, and the papayotin prepared from *Carica Papaya*; but no similar effect could be obtained from the latex of Euphorbiaceæ, *Papaver somniferum*, *Taraxacum*, *Scorzonera*, or *Chelidonium*.

The cause of the sweetening of potatoes by frost is stated by Hansen to be that a long period of cold prevents the consumption of sugar by respiration, while the activity of the ferment in producing sugar continues. It is not the immediate result of rapid freezing.

B. CRYPTOGAMIA.

Cryptogamia Vascularia.

Apospory in Ferns—Singular Mode of Development in *Athyrium Filix-fœmina*.‡—The discovery of apospory by Mr. C. T. Druery in the varieties of this fern known as *plumosum-divaricatum* and *clarissimum*, is now published in detail. He describes three forms of the phenomenon, termed by the author "proliferation," viz.:—(1) Bulbils of

* Ber. Deutsch. Bot. Gesell., ii. (1884) pp. 383-97.

† SB. Phys.-med. Gesell. Würzburg, 1884, pp. 106-9, 121-2.

‡ Journ. Linn. Soc. (Bot.), xxi. (1885) pp. 354-60, 360-8 (2 pls.). See this Journal, *ante*, p. 99.

the ordinary character developed in the axils and on the superior surface of the pinnæ, and agreeing in character with the ordinary bulbils of *Asplenium*; (2) bulbils formed apparently by transmuted spore-producing energy, and occupying the place of sori, i. e. on the under side of the pinnæ; (3) proliferous prothalli arising from pseudo-bulbils produced by a different transmutation of the reproductive force, and evolving plants only after the prothalli have produced the usual sexual organs common to prothalli resulting from spores.

Prof. F. O. Bower describes more minutely the details of this singular process in *Athyrium Filix-femina* var. *clarissima*. Some of the sporangia in the transmitted sori are of nearly normal structure, with an annulus, and arrested only at a point of development before the formation of the spores; the majority showed more or less the central archspore, together with the cells which would normally form the wall of the sporangium; but there the normal development is suddenly arrested; the archspore has not divided further to form either the tapetum or the mother-cells of the spores. The individual cells are of larger size than ordinary, and contain numerous chlorophyll-grains. Placed under favourable conditions, sporangia of the latter description undergo further development, producing, by a purely vegetative process, outgrowths of very irregular form. Sometimes all the superficial cells of the club-shaped sporangium may take part in the process; sometimes the head is thrown off, while the stalk, which has previously attained an abnormally large size, continues its vegetative growth. The result in either case is the formation of an ordinary prothallium with wedge-shaped apical cell and root-hairs.

Another instance of apospory is yielded by *Polystichum angulare* var. *pulcherrimum*. Here the arrest of development of the sporophore is still more complete, organs of a prothalloid nature being formed by simple vegetative outgrowth of the tips of the pinnules, without any connection with sori or sporangia. In the formation of these prothalloid structures which bear normal antheridia and archegonia, the tip of the pinnule usually forms a flattened expansion, only a single cell in thickness, which ultimately develops, by marginal growth, into a flattened, often heart-shaped, structure, with a thickened cushion similar to that of normal prothalli.

Anatomy of the Vegetative Organs of *Struthiopteris germanica* and *Pteris aquilina*.*—M. P. Terletzki finds the rhizome of *Struthiopteris germanica* to exhibit exceedingly good illustrations of continuity of protoplasm, both in the parenchyma and in the sieve-cells, the protoplasmic threads passing through both the longitudinal and the transverse walls, especially the latter. The intercellular spaces contain protoplasm which is also in the same way in connection with the cell-protoplasm. The arrangement of the vascular bundles is stated by the author to be here, as in almost all other Polypodiaceæ, bicollateral, and not concentric, as stated by De Bary and Sachs. By far the most common form of thickening is the scalariform, accompanied in some cases by spiral and annular; it produces, however,

* Pringsheim's Jahrb. f. Wiss. Bot., xv. (1881) pp. 452-501 (3 pls.).

according to the author, closed conducting cells rather than vessels. The sieve-cells contain, as in all ferns, a clear watery fluid, with a small quantity of fine-grained protoplasm on their walls. The structure of other parts of the sporophore is also described in detail.

Pteris aquilina presents the same phenomena of continuity of protoplasm as *Struthiopteris*; and the contents of the sieve-cells are also similar.

Third Coat in the Spores of the Genus *Onoclea*.*—Mr. D. H. Campbell has detected the presence of a third coat in the spores of the ferns *Onoclea Struthiopteris* and *O. sensibilis*. After the detachment of the exospore the spore is apparently covered only with a thin transparent membrane, which, at the commencement of active growth splits along one side, the true endospore protrudes in the form of a root-hair at one end and the basal cell of the prothallium at the other; the latter becomes again divided, and at this stage with a little care the two lobes of the second covering can be clearly seen. These lobes follow so nearly the lobes of the exospore, in those cases where it remains attached, that it is then impossible to detect them. The accessory covering was not detected in any other genera examined, but as in all cases the exospore adhered so firmly to the spore as to interfere seriously with observations it is not impossible that it does exist.

Fructification of *Sigillaria*.†—M. R. Zeiller describes the structure of the "cones" of several species of fossil *Sigillaria* and *Sigillariostrobus* from the "terrain houillier." He comes to the conclusion that the *Sigillariæ* must be considered as belonging to the Lycopodineæ, and as forming a group intermediate between the *Lepidodendrea* properly so-called and the *Isoëtea*. They present on the one hand an affinity with *Isoëtes* in the disposition of the sporangia, and probably in the mode of dissemination of the spores; on the other hand with *Lepidodendron* in the constitution of the foliar cicatrices, and in the anatomical structure of the stem.

Muscineæ.

Movement of Water in Mosses.‡—Herr F. Oltmanns points out that, in the case of those mosses which have no trace of vascular bundles, as *Hylocomium* and *Dicranum*, the capillary rise of water does not take place in the interior of the stem, although there may be an osmotic current from cell to cell, but in the external capillary apparatus formed by the stem and leaves; there is also a complete absence of transpiration. In *Sphagnum* the same purpose is also answered by the large empty cells. In those mosses, on the other hand, which possess a rudimentary vascular bundle, as *Mnium* and *Polytrichum*, there is a limited amount of conduction of water in the stem itself, as well as a feeble transpiration. It follows that mosses have no power of extracting water from the soil, while they absorb

* Bull. Torrey Bot. Club, xii. (1885) pp. 8-9 (5 figs.).

† Ann. Sci. Nat.—Bot., xix. (1884) pp. 256-80 (2 pls.).

‡ Cohn's Beitr. Biol. Pflanzen, iv. (1884) pp. 1-49 (2 pls.).

water very readily from rain or dew. The course of the rise of water by capillary attraction in such a moss as *Hylacomium loreum* can be very well followed under the Microscope by tinging with anilin-blue.

The effect of a carpet of moss on the soil, whether living or dead, is exactly that of a sponge. Especially when growing on steep declivities, it prevents both the rapid saturation and the rapid drying of the soil. *Sphagna*, on the other hand, which almost invariably grow in wet situations, have a precisely opposite effect in holding a very large proportion of the water which falls as rain, and promoting rapid transpiration, and thus, in a certain sense, assisting in the drying up of bogs. *Sphagna* have also the property of absorbing dew, which other mosses have not.

Algæ.

Batrachospermum.*—M. S. Sirodot publishes a complete monograph of this family of Floridæ, a group subject to extraordinary differences of form, according to the influence of the season, the supply of water, the depth at which they live, and the degree of illumination. When inhabiting deep springs they present all the phenomena of etiolation. According to the external conditions under which they are developed, the Batrachospermæ are found in three different modifications, viz. (1) a primordial condition, or *prothallium*; (2) a non-sexual condition, or *Chantransia*; (3) a sexual condition, or *Batrachospermum*.

The prothallium, which has been hitherto overlooked by observers, is a kind of crustaceous pellicle covering the surface of the stones on which the plant grows. It is composed of irregular filaments, which are sometimes agglomerated into globular masses. This structure is of great importance, since in the perennial species it is the part which renders the plant able to persist. It is capable of growth and reproduction, increasing by the periphery and reproducing itself by sporules. There are, in fact, several species, e. g. *B. sporulans*, in which this is the normal mode of reproduction.

The non-sexual form is composed of broad tufts of filaments, each consisting of a row of cells, ramifying and producing sporules altogether analogous to those of the prothallium. Since this form can reproduce itself through a number of generations, it has long been regarded as a distinct genus under the name *Chantransia*. The fresh-water species of *Chantransia* live on the most shaded walls of wells, developing chiefly in darkness, while the sexual form, on the other hand, seeks the light. Hence the great difficulty in determining a genetic connection between the two, in which, however, M. Sirodot has succeeded in the case of *Chantransia pygmæa*, *chalybea*, and *ramellosa*, which are the non-sexual state of different species of *Batrachospermum*, *C. chalybea* representing several species of the latter genus. It is usually the extremity of a stunted foot of *Chantransia* that is transformed into the sexual form.

* Sirodot, S., 'Les Batrachospermes, organisation, fonctions, développement, classification,' 300 pp. and 50 pls. See Bull. Soc. Bot. France, xxxi. (1884) Rev. Bibl., p. 182.

The sexual generation includes a vegetative structure composed of whorls, primary and secondary fascicles, cortical filaments, and secondary prothallium; but the author finds the primary divisions of the genus on the character of the trichogyne, according as it is pedicellate or sessile; in the latter case it may be ovoid or in the form of a club or truncated cone. In the process of impregnation, the author maintains the actual absorption of the wall of the trichogyne at the point of contact of the pollinidium, the passage of protoplasm from the latter through the orifice thus formed, and the appearance of a septum at the base of the trichogyne which separates the cystocarpic vesicle. The rejuvenescence of the protoplasm at the close of impregnation imparts a great activity to this cell, which then begins to bud and to produce the fertile glomerulus from which proceed the carpospores or oospores.

M. Sirodot describes thirty-three native and exotic species of *Batrachospermum*, which he classifies under six sections, viz.:—*Batrachosperma* Setacea, Moniliformia, Helminthoidea, Turficola, Hybrida, and Viridia.

Stephanosphæra pluvialis.*—Prof. G. Hieronymus has made some further observations on this organism, especially with reference to the conjugation of the microzoospores.

While confirming in the main Cohn and Wichura's observations, the author attributes to the enveloping membrane a high degree of elasticity. It is perforated by two orifices for the two cilia of each primordial cell. These vegetative primordial cells or macrogonidia always possess a red eye-spot, which had not been previously observed. When about to divide, which is usually in the afternoon, these primordial cells retract all their protoplasmic threads by which they were attached to the enveloping membrane, round themselves off, and then divide into microgonidia. Usually all the cells of a vegetative family become transformed into microgonidia at the same time, though there are exceptions to this rule.

The microgonidia, microzoospores, or gametes unite in the ordinary way by conjugation, their anterior ends coalescing in the production of zygotes, zygosporos, or isosporos, which are scarcely larger than the original microgonidia. Those which did not conjugate were found in all cases to perish; the resting-cells are always the result of the conjugation of microgonidia. Germination of the resting-spores was not observed.

Classification of the Lower Algæ.†—Dr. A. Hansgirg proposes a fresh classification of the unicellular fresh-water Algæ, insisting at the same time upon the point that the terms species, genus, &c., must not be understood in the same sense as with the higher plants, it being necessary in the lowest orders of vegetable life to describe and distinguish many forms which are but stages of development of others classified in quite a different group.

* Cohn's Beitr. Biol. Pflanzen, iv. (1884) pp. 51-78 (2 pls.).

† Oester. Bot. Zeitschr., xxxiv. (1884) pp. 313-8, 351-8, 339-94 (1 pl.).

CLASS I. CYANOPHYCEÆ.

Order I. Chroococcoideæ (Coccogonæ Thr.).

Family 1. Chroococcaceæ (Glæogonæ Cohn).

Genus 1. *Chroococcus* Näg.Sect. 1. *Chroococcus a genuina* (Acapsa Näg.).Sect. 2. *Glæocapsa* Näg.Sect. 3. *Aphanocapsa* Näg.Genus 2. *Chroothece* Hansg.Sect. 1. *Chroothece a genuina* (Syncehoccus Näg.).Sect. 2. *Glæothece* Näg.Sect. 3. *Aphanothece* Näg.

CLASS II. CHLOROPHYCEÆ.

Order I. Protococcoideæ (Coccopycæ Rbh.).

Family I. Palmellaceæ (incl. Protococcaceæ).

Genus 1. *Pleurococcus* Menegh.Sect. 1. *Pleurococcus a genuina* Menegh. ex part.Sect. 2. *Glæocystis* Näg.Sect. 3. *Palmella* Näg.Genus 2. *Dactylothece* Lagerh.Sect. 1. *Stichococcus* Näg.Sect. 2. *Dactylothece* Lagerh.Sect. 3. *Inoderma* Ktz.Genus 3. *Rhodococcus* Hansg.Sect. 1. *Rhodococcus a genuinus* Hansg.Sect. 2. *Rhodocapsa* Hansg.Sect. 3. *Porphyridium* Näg.

Order II. Nostocineæ (Nematogenæ Rbh.)

Sub-order 1. Chamæisiphonaceæ (Cystogonæ Bzi.).

Genus 1. *Chamæisiphon* A. Br.Sect. 1. *Sphærogonium* Rfski.Sect. 2. *Brachythrix* A. Br.

Sub-order 2. Isozystæ Bzi.

Sub-order 3. Heterocystæ Hansg. (Hormogonæ Thr.).

Family 1. Lyngbyaceæ (Oscillariaceæ Rbh.).

Genus 1. *Lyngbya* Ag.Sect. 1. *Leptothrix*.Sect. 2. *Oscillaria* (Phormidium Ktz.).Sect. 3. *Microcoleus* Desm.Sect. 4. *Inactis* Ktz.Sect. 5. *Symploca* Ktz.

Family 2. Nostocaceæ.

Genus 1. *Nostoc* Vauch.Sect. 1. *Nostoc genuinus*.Sect. 2. *Anabæna* Bory (incl. *Dolichospermum* Thw.).Sect. 3. *Spermosira* Ktz.Sect. 4. *Cylindrospermum* Ktz.Sect. 5. *Sphærozyga* Ag. (incl. *Aulosira* Koch).

Family 3. Calotrichæ Thr. (Rivulariaceæ Rbh.).

Genus 1. *Calothrix* Ag.Genus 2. *Coleospermum* Koch.

Family 4. Scytonemaceæ.

Genus 1. *Scytonema* Ag.Genus 2. *Mastigocladus* Cohn (Stigonemæ).

The forms included in the genus *Rhodococcus* are distinguished from the analogous forms in the genera *Chroococcus* and *Pleurococcus* by their purple, violet, or brown-red pigment. Many of the forms included under *Chroococcus* arise from the breaking-up of filaments of Cyanophyceæ:—as *C. minor* from various species of *Lyngbya*, *C. coherens* from *L. calcicola*, *C. membraninus* from *L. elegans*, &c. In the same way several species of *Glaucapsa* are formed by the breaking-up of species of *Stigonema*; and *Synechococcus* from *Calothrix salina*.

The author regards most of Kützing's species of *Leptothrix* and Bosc's species of *Oscillaria* as the hormogonia of higher Cyanophyceæ, such as Scytonemæ, Calotrichæ, and Stigonemæ, propagating repeatedly by frequent divisions. These may become invested in a more or less thick gelatinous sheath. Many so-called species of *Lyngbya* are only the young stages of development of those species of *Calothrix* and *Scytonema* to which they are found attached. Although the blue-green algæ, as far as at present known, multiply only non-sexually, they yet display in this a great pleomorphism.

A large number of other genetic connections are also traced by the author.

Class III. PHÆOPHYCÆ.

Order I. Syngeneticæ.

Family 1. Chromophytonæ.

Genus 1. *Chromophyton* Wor.Genus 2. *Synura* Ehrb.

Family 2. Hydrureæ.

Genus 1. *Hydrurus* Ag.

New Freshwater Desmids.*—Mr. F. Wolle describes thirteen new species of Desmids from the United States.

New Diatoms from the "Saugstiefer" of Dubrávica.†—Mr. F. Kitton briefly describes the diatomaceous deposit (*Saugstiefer*) of Dubrávica, and gives a list of the new species and varieties, with figures of three of the most remarkable—*Epithemia cistula*, *Staurorsira Harrisonii* var. *amphitetras*, and *Surirella clementis*. Many of the forms have an old-world look, and exhibit minute differences from those of more recent times. Nearly all the Synedras are distorted, apparently by pressure.

Cell-Division in Melosira.‡—The previous investigations of Dr. O. Müller on the mode of cell-division in *Terpsinoe musica*, led to the

* Bull. Torrey Bot. Club, xii. (1885) pp. 1-6 (1 pl.).

† Sci.-Gossip, 1885, pp. 36-7 (3 figs.).

‡ Ber. Deutsch. Bot. Gesell., i. (1883) pp. 35-44 (1 pl.). Pringsheim's Jahrb. f. Wiss. Bot., xiv. (1883) pp. 232-90 (5 pls.). See Bot. Centralbl., xvi. (1883) p. 194.

similar examination of *Melosira (Orthosira) arenaria*, the main results of which are given.

The two daughter-cells which spring from the spontaneous division of a parent-cell of *Terpsinoe* do not behave alike; the larger one divides earlier than the younger one, triads being produced in this way. This was regarded by O. Müller as a contrivance by means of which the further division of cells which had attained their minimum size, and which could now only multiply by the formation of auxospores, was prevented; and he looked for a further exemplification of the law in the filamentous diatoms which remain connected after cell-division has taken place. In *Melosira arenaria* he found a species which presented all the conditions favourable for such an investigation, in which he was able to determine the relative ages of all the cells in a filament. The investigation was carried on with the aid of drawings prepared by the best homogeneous-immersion systems.

Deep-sea Diatoms.*—Count F. Castracane adds another contribution to our knowledge of deep-sea diatoms, in the examination of the contents of *Holothuria* from depths of 2511–5274 metres, obtained by the 'Challenger' expedition. He finds these to agree substantially with the results previously obtained from the contents of *Echini* from a depth of 2638 metres. In both cases the animals have only a creeping motion, and could feed only on living diatoms growing in the same situations as themselves. The nature of the diatoms and the relation of their specific gravity to that of sea-water, precluded the possibility that they could have sunk to that depth from the surface. One of the *Holothurice* contained enormous quantities of the delicate *Synedra thalassiotrix*, 3–4 mm. in length, and not more than 0·01 mm. in breadth, in a perfect condition, while in sea-mud it is never found in any other than a fragmentary state. In the *Echini* were also many tubes of *Rhizosolenia* with excessively fragile walls, in which state it has never been found by the writer in sea-mud. Another proof that the diatoms were swallowed in a living condition was afforded by the fact that one was found in which the endochrome still retained its yellow colour. These diatoms must therefore have lived at these enormous depths in the sea.

Fossil Diatoms.†—Count F. Castracane describes diatoms belonging to the genera *Cyclotella* and *Epithemia* obtained from a calcareous deposit from Spoleto belonging to the Pliocene formation, and of fresh-water origin. The former of these genera was represented by a single species, probably new, and perhaps the finest hitherto known belonging to the genus.

Structure of the Diatom-valve.‡—Dr. H. Van Heurck, from a study of fragments in highly refracting media, comes to the conclusion that the valve of the Crypto-raphideæ is generally formed of two layers. The lower layer is composed of a single lamina, and has

* Boll. Accad. Pont. de' Nuovi Lincei, xxxviii. (1885); Sess. Decr. 21, 1884, pp. 4–6. See this Journal, iv. (1884) p. 939.

† Boll. Accad. Pont. de' Nuovi Lincei, xxxviii. (1885); Sess. May 15, pp. 8–9.

‡ Heurck, H. van, 'Synopsis des Diatomées de Belgique,' pp. 35–7. See Bull. Soc. Belg. Micr., xi. (1885) pp. 71–3.

more or less delicate punctations on the inner face. It has been impossible to ascertain whether these punctations completely traverse the lower layer of the valve, or only go to a certain depth. In *Triceratium Favus*, of which Dr. Van Heurck succeeded in artificially obtaining transverse fractures of the greatest delicacy, he was not able to see any perforation, although the denticulated form of a membrane found broken in the interior of an alveole seems to be in favour of a real perforation. In certain *Coscinodisci* the valve seems thoroughly perforated below, and this perforation is undoubtedly evident in the fossil forms from Jutland. In *Eupodiscus Argus* there are tolerably large perforations (?) in the lower layer (these are the large granules which are seen in the alveoli); and besides these there are very fine granulations.

The upper layer of the valve exists in all degrees of development. In its most perfect condition, in *Triceratium Favus*, *Coscinodiscus Oculus-Iridis*, &c., it forms the alveoli usually closed from above. In the next condition of lesser development (*Eupodiscus Argus*) the alveoli remain open above. In carrying on researches through the series of genera and species, the upper layer is seen diminishing in strength, and the weakest points, the walls of the alveoli, first disappear, then the intermediary portions between several alveoli diminish, and end by being reduced to the condition of small spines such as are found in so many species of *Biddulphia*. Ultimately these last vestiges of the layer of alveoli disappear in their turn, and there only remains the lower punctated layer of the valve. *Triceratium (Ditylum) intricatum*, for instance, shows this layer reduced to its simplest expression.

The valves of the Pseudo-raphideæ and of the true Raphideæ show the same structure as the Crypto-raphideæ, but the alveoli are very much smaller. By Smith's medium their existence can be shown in numerous species, and particularly in the genera *Raphoneis*, *Nitzschia*, and *Pleurosigma*.

The beads of diatoms are therefore, in reality, formed by alveoli and striæ, and are often formed by the walls of these alveoli. The valve is said to be alveolated or to be of cellular structure when these alveoli are large and appear to be polygonal; they are said to be beaded or punctated when the alveoli are more or less diminutive.

Lichenes.

Development of the Apothecia of Lichens.*—Dr. M. Fünfstück has followed the development of the apothecia in three genera, *Peltigera*, *Peltidea*, and *Nephroma*. In *Peltigera canina* an interval of several years passes between the first formation of an apothecium and the production of the first ripe spores. In *Peltigera* and *Peltidea* there are no spermogonia.

In *Peltigera malacea* the apothecia originate as extremely minute roundish dots on the margin of the thallus, where a few filaments, irregularly coiled into rosettes, the ascogonia, are formed close beneath the cortical layer, on a level with the gonidial zone; they

* Jahrb. K. Bot. Gart. Berlin, iii. (1884) 20 pp. (3 pls.). See Bot. Centralbl., xxi. (1885) p. 69.

are simply portions of the ordinary hyphæ, which increase in length by apical growth, while the ascogonial cells increase at the same time in size by intercalary growth. The cortical fibres and the ascogonial tissue are strongly differentiated from the first. The next period of development commences with the formation of the first paraphyses, commencing in the cortical layer of the apothecium. A mass of young cortical fibres in the middle of this layer displays delicate shoots which develop into the paraphyses. These gradually extend over the entire cortical layer of the apothecium, new ones being formed between the older ones. At the same time the separate ascogonial cells shoot out and form the ascogenous hyphal tissue. The process of disorganization of the ascogonia runs parallel with the formation of this tissue, and finally the asci are formed as bulgings of the ascogenous hyphæ; the outer part of the cortical layer bursts, and thus is formed the "excipulum thalloses" of lichenologists. The formation of the apothecium is not the result of any sexual process, the strong differentiation of the ascogenous hyphæ from those which develop into paraphyses being traced back to the youngest stage. The author regards the process as the same as that in *Podosphaera* among Ascomycetes, apogamy with rudimentary sexual organs.

The processes are nearly the same in *Peltidea aphthosa* and *venosa*, while in *Nephroma tomentosum* and *lævigatum* there are important deviations. In these species the author always found spermogonia, though always in a rudimentary condition. The first apothecial layer is formed beneath a thick close cortical layer on the margin of the thallus by a number of large thin-walled cells arranged in a moniliform manner, and from the analogy of *Peltigera* and *Peltidea*, regarded as ascogonia, developed gradually from ordinary hyphæ of the thallus. The entire structure is enveloped in a dense hyphal tissue, which gradually disappears as the fructification develops; and the apothecia of *Nephroma* are hence described as gymnocarpous. The formation of the ascogonia was not clearly observed. The mode of formation of the paraphyses is similar to that in *Peltigera*, but takes place later. The paraphyses and asci are always formed on the under side of the thallus, so that the young apothecia at first face the substratum; their position is subsequently reversed by a strong curving of the fertile layer.

We have therefore in these lichens similar phenomena of apogamy, and the reduction of sexual organs, to those that have been observed in the Ascomycetes.

Nature of Lichens.*—Prof. M.M. Hartog replies to Rev. J. M. Crombie's paper † on the "Algo-lichen hypothesis." He points out that Mr. Crombie altogether ignores several points which tell strongly in favour of Schwendener's hypothesis, especially Cora and Johow's discovery of the Hymenolichenes, or lichens in which the fungal element is a Hymenomycete. He also states that the "lichenin-reaction" has been observed by De Bary in several undoubted Fungi, and contests Mr. Crombie's statement that fungus-hyphæ are soluble in caustic potash.

* Nature, xxxi. (1885) pp. 376-7.

† See this Journal, *ante*, p. 103.

Fungi.

Development of the Gasteromycetes.*—Dr. E. Fischer has followed out in detail the development of two species of Gasteromycetes, *Sphaerobolus stellatus* and *Mitremyces lutescens* (?); the following are some of the more important points of his observations.

The mycelium of the former species consists of very slender hyphæ, from 1 to 3 μ in diameter, varying greatly in the quantity of protoplasm they contain, and but rarely septated; minute crystals of calcium oxalate are very commonly attached to them externally; the hyphæ are very often connected together into bundles. On the bundles the fructification makes its appearance as a minute globular or lenticular body. As the fructification develops, the outermost part becomes differentiated as a loose web of hyphæ connected together by a mucilaginous substance resulting from disorganization of their outer layers. On its surface it is covered by a kind of cortex consisting of hyphæ with very abundant deposition of calcium oxalate. This external layer passes gradually into the internal portion or nucleus; while at the sides it passes over into the hyphæ of the mycelium. The nucleus becomes subsequently differentiated into the following layers, naming them from without inwards:—the pseudo-parenchymatous layer, the fibrous layer, the collenchymatous layer, and the gleba; and the whole gradually assumes a red tinge. The walls of the collenchymatous layer show the characteristic reaction of epiplasm.† This layer passes insensibly into the wall of the sporangium (gleba) without there being any sharp demarcation between them.

The bursting of the peridium and ejection of the sporangium take place when the air is not too dry, but often in bright sunshine, in the early part of the day. The bursting is preceded by a considerable superficial growth of the collenchymatous layer. This not being accompanied by any corresponding growth of the outer layers of the peridium, the latter burst with a star-shaped opening at the apex. The splitting never, however, descends below the middle of the peridium, in consequence of the resistance of the fibrous layer. The sporangium is finally ejected, usually towards evening, with great force, sometimes to the distance of over a metre, the diameter of the fungus not being above 2–3 cm. After the opening of the peridium and before the ejection, the wall of the sporangium has become converted into mucilage; and the ejection seems to be caused by the further growth of the collenchymatous layer, in consequence of the increase in size of its cells from absorption of water, and not, as Reinke supposes, by the contraction of the outer layers from loss of water.

During the development of the gleba, the basidia have been gradually forming within it, the trama being very feebly developed in comparison to other Gasteromycetes. The basidia are oval or pear-shaped bodies, at the extremity of which the spores are formed, which show when mature a length of 9–11 μ , and a breadth of 6–7 μ . These gradually extract the protoplasmic contents of the basidia.

* Bot. Ztg., xlii. (1884) pp. 433–43, 449–62, 465–75, 485–94 (3 figs. and 1 pl.).

† See this Journal, ii. (1882) p. 824.

Their number varies, the one most commonly observed being seven on a basidium. Before the bursting of the peridium, the gleba also contains crystals of calcium oxalate. In addition to the spores there are also found in it bodies of a different character, of a spherical, elliptical, or pear-shaped form, and considerably larger than the spores. They are probably functionless basidia, analogous to the cystidia of the Hymenomyces. There is still again another kind of body found in the gleba, presenting an external resemblance to germinating basidiospores; these are of the nature of gemmæ, simply detached portions of ordinary hyphæ, which have already begun to germinate while inside the sporangium, and complete this process readily after their escape; while the basidiospores germinate only with great difficulty. The sporangium itself germinates as a whole, playing the part of a single spore with a large number of germinating hyphæ; but the germinating bodies are chiefly the "gemmæ," possibly at the expense of the spores.

With regard to the structure of *Mitremyces*, it shows the greatest analogy to that of *Geaster*, especially of *G. hygrometricus*, in the development of the gleba. There is, as in that species, no well-marked division of the gleba into chambers; hyphæ proceed from the trama which end in basidia, and more or less completely fill up the chambers; but the trama is much more rudimentary. The mode of formation of the spores also presents a great similarity. The collenchymatous layer of the peridium of *Geaster hygrometricus* is represented in *Mitremyces* by a cartilaginous layer. The fructification of *Mitremyces* is distinctly differentiated into three parts: the gleba, surrounded by the inner peridium; the cartilaginous layer and its prolongation, which forms the "foot" of the fructification; and the mycelial envelope, which in the young state envelops the whole. Between these three parts are separating layers. Growth takes place chiefly in the second, resulting in the destruction of the outer envelope, and in many cases the elevation of the inner peridium.

Development of Doassansia.*—According to Herr C. Fisch, the only genera of Ustilaginæ with a true fructification (in De Bary's sense) are *Tubercinia*, *Doassansia*, *Sphacelotheca*, and doubtfully *Graphiola*. Of these the two first genera are distinguished by their masses of spores formed free in the tissue of the host. The genus *Doassansia* was established by Cornu from *D. Farlowii*, found by Farlow on North American *Potamogetons*. Fisch now describes at length the development of *D. Sagittariæ* (*Protomyces Sagittariæ* Fck. in Rabenhorst's *Fungi europæi*) parasitic on *Sagittaria sagittæfolia* and on the American *S. heterophylla*.

This parasite forms circular or less often elliptical or irregular spots on the leaves of the host, at first light yellow, afterwards brown, and from 1 to 2 cm. in diameter, the mycelium filling up all the intercellular spaces. The fructifications are formed only in the spaces beneath the stomata, and at the time of their maturity the mycelium has entirely disappeared in mucilage. The fructification

* Ber. Deutsch. Bot. Gesell., ii. (1884) pp. 405-16 (1 pl.).

then lies in the stoma as an isolated round or irregular mass, resembling some *Synchytria*. It is composed of two different kinds of cells, an outer closely packed "palisade-like" layer of cells somewhat elongated in the radial direction and strongly refringent, and a central mass of closely packed polyhedral spores.

The spores do not possess a distinct endospore. On germinating they put out a germinating filament or promycelium, from the extremity of which are detached very narrow cylindrical sporidia; and from these are developed the secondary mycelia. In very rare cases a conjugation of sporidia was observed by means of a transverse connecting-band. The most suitable nutrient fluids for the germination of the sporidia were found to be solution of grape-sugar, and decoction of plums or dung.

The germinating filaments put out by the sporidia creep over the epidermal cells of the host and become closely attached to them, and reach the intercellular spaces by penetrating the lateral walls of these cells. Here they develop into a dense mycelium, the cells of which are filled with a strongly refractive substance, the glycogen of Errera. In the spaces beneath the stomata the mycelium is especially luxuriant; the filaments becoming interwoven into a dense felted mass. This soon develops into a pseudoparenchyma, which then becomes the fructification by the differentiation of the two kinds of cell already mentioned. The cell-walls of the spores gradually become thicker and browner, the cortical layer of palisade-like cells being formed later. The surrounding mycelium then entirely disappears in mucilage. The formation of the fructification is going on through the whole year and can be observed in all stages at the same time.

Fisch gives the following diagnosis of *Doassansia*:—Fructification multicellular, inclosed in a single cortical layer of sterile cells. Germination of the spores as in *Tilletia* and *Entyloma*, but without copulation of sporidia. Spores without endospore. On the leaves of living plants. The three known species, *D. Alismatis*, *Sagittariæ*, and *Farlowii*, are also described, as well as Farlow's doubtful *D. Epilobii* (on *Epilobium alpinum*), which is more probably a *Synchytrium*.

Reproduction of the Heterœcious Uredinæ.*—Mr. C. B. Plowright points out that when the Heterœcious Uredinæ are reproduced without the intervention of æcidiospores, the resulting uredospores are far more abundant than when they arise from implantation on the host-plant of the æcidiospore. This he states to be the case with *Puccinia graminis*, *P. rubigo-vera*, and *P. obscura*.

Glycogen in the Basidiomycetes.†—In pursuance of his previous observations ‡ on the occurrence of glycogen or animal starch in fungi, Dr. L. Errera has now detected it in a large number of Basidiomycetes, a list of which he gives. Its presence he concludes from observing a whitish substance in the interior of the cells, which is amorphous and refringent, and which is coloured brown-red by iodine,

* Journ. Linn. Soc. (Bot.), xxi. (1885) pp. 368–70.

† Mém. Acad. R. Sci. Belgique, xxxvii. (1885) 50 pp.

‡ See this Journal, ii. (1882) p. 824, iii. (1883) p. 397.

the colour becoming sensibly paler at a temperature of 50–60° C., and reappearing on cooling. The solution of iodine used was as follows:—distilled water 45 gr., crystallized potassium iodide 0·3 gr., crystallized iodine 0·1 gr.

Glycogen is soluble in water, giving a white opalescent milky solution, which is coloured blue by iodine with precisely the same shade as glycogen derived from a dog. Treated with Trommer's reagent it assumes the blue colour of copper hydrate without reducing it on ebullition. Boiled for 20 minutes with very dilute sulphuric acid, the solution loses its property of being coloured by iodine and acquires that of reducing copper oxide. The same action is produced by saliva. The aqueous solution is dextrogyrous.

By tracing the passage of glycogen from one part of the plant to another, the author convinced himself that it plays the same part in the economy as starch in other classes of plants, and that it is the first visible product of the absorption of carbon. It is usually most abundant towards the base of the fungus, in the vicinity of the soil. Its quantity is greatest at early periods of growth of the fungus; after this has attained its full growth it gradually disappears, probably from the effect of respiratory combustion.

With regard to other carbohydrates present along with glycogen, the author found that glucose and diastase are less widely distributed in fungi than in starch-producing plants; while mannite is not less frequent than glycogen, and is often present in considerable quantities. He concludes that mannite is the form in which the carbohydrates pass from one part of the plant to another. He further details several points of analogy between the behaviour of starch and of glycogen, and concludes that their function is the same. In a few species of fungi (as *Scleroderma vulgare*) glycogen appears to be entirely wanting at all periods of their growth.

Spectroscopic Examination of Photogenic Fungi.* — Dr. F. Ludwig finds that for the examination of the spectra of phosphorescing fungi, e. g. *Agaricus melleus*, *Xylaria hypoxylon*, *Micrococcus Phlügeri* (to which he attributes the phosphorescence of sea-fish, &c.), the evening is the best time, as the eye is free from all disturbing influences, which affect it in daylight, and the phosphorescence is more marked. The Sorby-Browning Micro-spectroscope was used for the investigations. The following example will serve to illustrate the line of research.

Trametes pini. Several of the clearest pieces of phosphorescing mycelium were placed under the micro-spectroscope in a quite dark room with closed windows. The spectrum was very faint and without definite colour. At first only a weak bluish shimmer was seen, but after two hours' stay in the dark the outline of the spectrum was distinct. At this time a great number of dark lines were noted, and a broad dark band in the otherwise clear spectrum. By comparing with the spectrum of a lighted candle the commencement of the phosphorescence spectrum was found to be in the clear blue, from which it extended into the ultra-violet. The dark lines were in the clear

* Zeitschr. f. Wiss. Mikr., i. (1884) p. 181.

blue, while the broad band appeared to lie in the ultra-violet. With the naked eye the light was distinctly clear blue, whereas it appeared white when the window was open. A red and violet glass let no light through from the mycelium, and very little light passed through dark-blue glass. An orange glass let light through well, and green glass fairly well. Light passed almost unweakened through clear blue glass.

Structure of *Phallus impudicus*.*—According to M. Feuilleau-bois the dehiscence of this fungus becomes impossible or must be modified when the conditions vary in which the plant is developed. When exposed to the sun either the dehiscence cannot take place, or the peridium is ruptured at the base, and the foot is then covered by a long veil. If the lower part of the fungus is immersed in water the peridial mucus deliquesces, and the whole plant remains inclosed in the peridium.

***Hysterangium rubricatum*, a new *Hymenogaster*.**†—Dr. R. Hesse describes under this name a new species of *Hymenogaster*, distinguished from other species of the genus by the large gleba, being the colour of red clay permeated by bluish veins.

New Entomogenous Fungus.‡—M. H. Gadeau de Kerville has found a new fungus, *Stilbium Kervillei*, growing on the bodies of a dipterous insect, *Leria cæsia*. The only reproductive organs detected consist of a conidiophorous apparatus formed of yellowish heads, 2-7 mm. in diameter.

New Parasitic *Oidium*.§—Signor O. Comes describes, under the name *Oidium Ceratonia*, a parasitic fungus which is very destructive to the Judas-tree, *Ceratonia siliqua*, in Italy. It attacks both leaves and fruit, causing the former to fall off and injuring the quality of the latter.

Dry-rot.||—Dr. R. Hartig gives a detailed account of the mode of detecting the presence of dry-rot, *Merulius lacrymans*, in timber, the life-history of the fungus, the most favourable conditions for its development, and the best methods of preventing its occurrence or of extirpating it. Besides its power of greatly increasing the capacity of wood for absorbing moisture, Hartig states that the fungus itself possesses the faculty of making dry wood moist by itself absorbing water and conveying it to the wood.

Zygosporos of *Mucorini*.¶—M. G. Bainier describes the structure and form of the zygosporos and other organs in a number of species of *Mucorini*.

In *M. spinosus* the sporangia appear completely black, and their wall is furnished with fine needles, which are set at liberty on the

* Rev. Mycol., 1884.

† Pringsheim's Jahrb. f. Wiss. Bot., xv. (1884) pp. 631-641 (1 pl.).

‡ Bull. Soc. Ami des Sci. Nat. Rouen, 1883 (1 pl.). See Bull. Soc. Bot. France, xxxi. (1884) Rev. Bibl., p. 171.

§ Atti R. Istit. d'Incoraggiamento di Napoli, iii. (1884). See Bot. Centralbl., xxi. (1885) p. 53.

|| Bot. Verein München, Nov. 12, 1884. See Bot. Centralbl., xxi. (1885) p. 30.

¶ Ann. Sci. Nat.—Bot., xix. (1884) pp. 200-16 (4 pls.).

disorganization of the wall, and frequently remain adherent to the spores. The zygospores, which had not previously been known, the author obtained from an alcoholic decoction of pears and plums. *M. circinelloides* forms zygospores on horse-dung. It is readily cultivated on a decoction of malt or of plums, but does not appear to produce zygospores under these conditions. They are red, and furnished with long pointed projections. Both these species become transformed, under suitable conditions, into "spheric ferment"; but the presence of this ferment is not necessarily connected with the production of alcohol. Three new species of *Mucor* are also described, *M. erectus*, *fragilis*, and *mollis*, with their zygospores; the first of these produces also azygospores, resembling the zygospores in appearance.

The zygospores of *Chaetocladium Brefeldii* resemble, in all important points, those of *Mucor*. *Thamnidium elegans* is heterosporangeous, producing larger and smaller sporangia. The zygospores are only produced by special cultivation.

Protophyta.

Amœboideæ.*—M. C. Gobi includes as one group under this name all the lowest forms of vegetable life destitute of chlorophyll, which he connects genetically with the more highly developed Hyphomycetes. While in the latter the morphological fundamental element is a hypha, a cell or row of cells provided with a cell-wall, in the former it is a naked protoplasmic body endowed with metabolic movement, which the author terms an amœboid.

The point of departure of the whole series is presented by some protamœba-forms, the lowest organisms as yet known. Among the various forms described by Hæckel, Gobi adopts only four, viz.:—*Protamœba primitiva*, *agilis*, *simplex*, and *Schulzeana*, which he thinks may possibly unite with one another in pairs. The protamœbæ retain their amœboid form during the whole of their life. The next step is furnished by *Vampyrella*, which may be regarded as a cyst-forming protamœba. Here there occurs also a coalescence of amœboids, which the author regards both as a peculiar form of nutrition, and as the simplest form of impregnation. In both respects *Vampyrella* recalls the Myxomycetes. The *Vampyrella*-cysts are analogous to the microcysts or thick-walled cells of the Myxomycetes. An intermediate link is presented by *V. polyplasta* Sorok., since here there is an occasional formation of internal cysts, recalling strongly the formation of spores within the sporangia of the endosporous Myxomycetes. The genera *Monas* Cnk., *Protomyxa* Hæck., and probably *Gobiella* Cnk., may be united with *Vampyrella* into the family *Vampyrelleæ*. All the forms are characterized by the want of internal differentiation and the absence of a cell-nucleus. The amœboid displays at this stage a more or less well marked tendency to assume the form of a zoogonidium.

An internal differentiation into cell-nucleus and pulsating vacuole

* Arbeit. St. Petersb. Natur. Gesell., xv. (1884) pp. 1-36 (Russian). See Bot. Centralbl., xxi. (1885) p. 35.

is first displayed in the Myxomycetes. *Plasmodiophora* must be regarded, notwithstanding the absence of a peridium, as an endosporous Myxomycete. The formation of a peridium seems to be rendered superfluous by its endophytic habit, its place being taken by the cell-wall of the cell which serves as host. The author does not consider the endosporous and exosporous Myxomycetes or Ceratiæ to be derived either from the other; the latter are rather connected with *Vampyrella* through *Bursulla crystallina* Sorok., which may be regarded as a terrestrial *Vampyrella*, its sporangium corresponding, on the other hand, to a spore of the Ceratiæ. The fructification (receptacle) of a *Ceratium* may be regarded as an aggregation of a number of *Bursulle*, with the difference that the "spore"-contents have split up into eight pieces only after their escape from the cell-wall, while in *Bursulla* the same process takes place within the cell-wall. The endogenous Myxomycetes and the Ceratiæ are therefore parallel branches springing from the Vampyrelleæ, and both ending without any genetic connection with any higher organisms.

Another branch of the Amœboideæ is constituted by *Olpidiopsis*, *Rozella*, and *Woronina*, which Gobi combines into the family Myxochytridiæ, with which he considers that *Synchytrium*, united with these genera by Cornu and Fischer, has no near relationship; since it possesses, on one hand, a common sporangial wall, and on the other hand is destitute of an amœboid stage. The course of development of the Myxochytridiæ closely resembles that of *Monas* and the Vampyrelleæ. The ripe cyst gives birth to a number of motile biciliated embryos, which, in search of nourishment, are always transformed into amœboids. The absence of any coalescence of amœboids into plasmodia is due to their endophytic habit. The chief point in which the Myxochytridiæ differs from *Monas*, is that the zoogonidia are not immediately transformed into amœboids, but only after the previous formation of a cell-wall. This phenomenon serves to explain the derivation of the Hyphomycetes, the simplest representative of which is *Chytridium*. If we suppose that the zoogonidium of a Myxochytridia, after it has attached itself to its host and developed a cell-wall, no longer renew its contents in the form of an amœboid, but advances to the stage of endosmotic nutrition, we have a true *Chytridium*. *Myzocyttium*, *Lagenidium*, and *Achlyogeton* differ from *Chytridium* only in their endophytic habit. The first two are nearly related to *Pythium*, and lead to the Peronosporaæ, while the last must be regarded as the simplest form of the Saprolegniæ. *Ancylustes* is also a transitional form between the Amœboideæ and the Hyphomycetes. Through the pedicel-forming *Chytridium laterale* and *C. olla*, we advance to the two-called *Rhizidium*, and then to the typical hyphal forms of the Hyphomycetes. In opposition, therefore, to De Bary and Brefeld, Gobi regards the Chytridiæ not as the result of degeneration, but as a progressive series forming a link between the Vampyrelleæ and the Hyphomycetes. While in the Amœboideæ the amœboid represents the entire vegetative development, in the simple Hyphomycetes it occurs only temporarily in the form of zoogonidium, disappearing entirely in the more highly developed forms.

The author abandons entirely his theory previously published,* that the fungi have originated by degeneration from plants containing chlorophyll.

Beggiatoa roseo-persecina.†—Herr P. Richter has made a study of the various organisms which cause a red or pink colour in water, and refers a large number of them to various stages in the history of development of *Beggiatoa roseo-persecina* Zopf. In its coccus condition it is known as *Protococcus roseus* Meneg., *P. persecinus* Meneg., *P. roseo-persecinus* Ktz., *Pleurococcus roseo-persecinus* Rab., and *Aphanocapsa violacea* Grün. In its bacillus condition it has been described as *Aphanothece purpurascens* A. Br., *Polycystis ichthyoblabe b. purpurascens* A. Br., *P. violacea* Itzig. (not Ktz.), and *Synechococcus roseo-persecinus* and *S. violascens* Grün.; while *Chroococcus rubiginosus* Rab., and probably *Glæocapsa hamatodes* Ktz., consist of encysted cocci of the same species.

Influence of Sunlight on the Vitality of Germs.‡—M. E. Duclaux records the effects produced on germs of *Tyrothrix*, cultivated in milk or in Liebig's extract, when exposed in the dry state to the direct action of the sun's rays in August, as contrasted with those resulting from exposure to an equivalent temperature but protected from the sun. Under the latter condition the germs were never sterilized. Spores derived from a milk cultivation when exposed to the sun were affected as follows:—after fifteen days' exposure, no effect; after one month's exposure, development was slightly retarded; after two months' exposure, two batches out of four remained sterile. With spores from a cultivation of Liebig's extract, the progression was more rapid and sharply defined. In experiments made simultaneously with the preceding, one out of three batches was sterile after fifteen days' exposure, two out of three after a month's exposure, and all three of those submitted to two months' sunlight.

The light of the sun is consequently fifty times as active as its heat, and sunlight is an hygienic agent of great power. Moreover, it follows that germs of the same microbe, identical in appearance, may not possess the same vitality.

Micrococcus in Acute Infectious Osteomyelitis.§—Dr. F. Krause finds in the matter of abscesses which have not yet been in contact with the air, two micrococci, one of which is extraordinarily pathogenic and pyogenous; causing, in rabbits and guinea-pigs, an acute infectious disease soon resulting in death, which is especially localized in the motile organs.

Chemistry of Bacillus subtilis.||—Herr G. Vandevelde has made experiments to ascertain the changes produced by the growth of bacilli in solutions of extract of beef (containing 2.5, 5, and 10 gr. of extract to 500 gr. of water). The solutions were boiled and a few drops of a pure cultivation of *Bacillus subtilis* added. Within 24 hours

* See this Journal, i. (1881) p. 920.

† Hedwigia, xxiii. (1884) pp. 177-80.

‡ Comptes Rendus, c. (1885) pp. 119-21.

§ Fortschr. d. Medicin, ii. (1884). See Bot. Centralbl., xxi. (1885) p. 112.

|| Zeitschr. f. Physiol. Chem., viii. (1884) pp. 367-90. See Journ. Chem. Soc.—Abstr., xlvi. (1885) p. 287.

the solution, originally clear, had become clouded; after a further 40–48 hours this cloudiness had vanished, and a bacillus-film of greyish-white colour had formed on the surface of the liquid. After a while, this film broke up and sank in fragments to the bottom; sometimes one or more additional films formed in succession, but were so thin as to be nearly invisible, whilst bacilli were disseminated throughout the liquid, during these latter stages. The chemical examination of the liquids showed that ammonia and volatile fatty acids were formed at the expense of the creatinine and sarcolactic acid of the flesh extract; the formation of the fatty acids from the latter occurring especially in the latter period of the action, when the bacillus was acting as an anaerobic ferment. In similar solutions to which glycerol and some calcium carbonate were added, the formation of lactic, butyric, and a small quantity of succinic acid was noticed. The gases evolved were carbonic anhydride, hydrogen, and nitrogen. Substituting grape-sugar for the glycerol, the formation of mannite, lactic acid, butyric acid, and (doubtfully) of caproic acid was observed.

Cholera Bacillus.*—Johne in an article on the comma-bacillus,† gives the methods of culture, staining, and preparation of the organism, and emphasizes its differences under cultivation from any of the other bacteria yet compared with it, paying especial attention to the bacillus of Finkler and Prior. To emphasize the difference still more, he gives figures illustrating the different appearances of the cultivations of the two organisms, and the different ways in which they liquefy the culture-material (*Nahr-gelatin*).

Buchner ‡ finds a constant difference between Koch's and Finkler and Prior's organisms under cultivation, and adds his testimony to the effect that confusion of the two should be impossible.

Doyen § gives an account of various forms of bacteria, observed microscopically and under cultivation, in seven cases of cholera. These were found in the liver and kidneys; but as no data are given as to when the post-mortem examinations were made, how soon after death, &c., and as no inoculation experiments are as yet announced, the author is hardly justified, from these observations alone, in heralding "the end of the reign of the comma-bacillus."

Inoculation of Guinea-pigs with Comma-Bacillus.||—Dr. E. Van Ermengem describes the results of inoculation of guinea-pigs with cultivations of comma-bacillus.

An infinitesimally small dose injected into the duodenum produced death in 12–48 hours, a large dose in, sometimes, less than two hours. Post-mortem examination showed the small intestine to be gorged with a rose-coloured sero-fibrinous fluid, sometimes flocculent and whitish. In all cases of slow death the intestinal contents formed an almost pure cultivation of germs, which were also found in other parts of the body. Cultures from which the comma-bacillus had been removed by filtration, or in which they had been destroyed

* Science, v. (1885) pp. 253–4.

† Zeitschr. f. Thiermed., xi. (1885) p. 87.

‡ Münch. Ärtzl. Intell., 1885, p. 549.

§ Soc. Biol., Dec. 13th, 1884.

|| Bull. Soc. Belg. Micr., xi. (1885) pp. 93–4.

by the addition of extremely small quantities of corrosive sublimate, acted fatally on the animals experimented on.

Infectious and Parasitic Pneumonia.*—M. Germain Sée finds that pneumonia may be epidemic, and has endeavoured to see whether such attacks are distinct from ordinary pneumonia; such a view is demonstrated to be erroneous, and it is clear that there is no pneumonia due to cold; whether sporadic or epidemic it is always parasitic in origin. The parasite is in the form of an oval micrococcus $1\ \mu$ to $1.5\ \mu$ long and $0.5\ \mu$ to $1\ \mu$ broad; it may be separate, or as a diplococcus, or in short chains of four. The capsule described by Friedlander, is not regarded by Sée or Talamon as anything else than the result of the method of preparation. Inoculated into animals it produces common pneumonia, such as is seen in man; in many cases the microbe has extended beyond the lungs, and by invading the neighbouring organs given rise to pleurisy and pericarditis of the same nature as the pulmonary inflammation. Pneumonia, then, may be considered as a specific parasitic disease, which may be reproduced in animals, but cannot be brought about by physical or chemical irritations introduced into the lungs. It may be absolutely distinguished from such other forms of acute inflammation as bronchitis, or broncho-pneumonia; for in them microphytes play but a secondary part, and the first cause of them is cold. Parasitic pneumonia has a regular and definite course, just like erysipelas; its duration does not extend over nine days; for about a week there is fever which then suddenly dies down. In fine the course of the disease is cyclical. Sée has found that *antipyrine* is a specific, and that it is well to support the strength of the patient by alcohol.

Action of various Compounds on Tyrothrix.†—M. Chairy has estimated the amount of various solutions (viz. sulphuric acid, chlorine-water, sulphurous acid, hydrogen sulphide, alcohol, phenol, zinc chloride, and alkaloids) required to maintain the transparency of solutions of animal matter when inoculated with various species of *Tyrothrix*, and also the quantities required to kill the spores of these bacteria. He has also examined the action of various gases on the spores, the latter being collected on filter-paper dried by exposure to air, and then subjected to the action of the gas.

The nature of the liquid to which the bacteria are added has very little influence on the quantity of a substance required to prevent the development of the spores or to kill them. The influence of the mass of bacteria present in the liquid is, however, very marked. Those compounds which have a pronounced acid character (e. g. sulphuric acid, chlorine-water, hydrogen sulphide) exert the most destructive action on the bacteria and their spores, whilst substances like alcohol and the alkaloids are efficient only when present in relatively considerable quantity. It is worthy of note, in connection with this result, that the development of the bacteria tends to make the liquid alkaline.

* Comptes Rendus, xcix. (1884) pp. 931-3.

† Ibid., pp. 980-3. See Journ. Chem. Soc.—Abstr., xlviii. (1885) p. 289.

The action of gases on the spores depends on the acid character of the products to which they give rise, and the behaviour of these products towards the envelopes of the spores. Nitrogen peroxide is more active than chlorine, which in its turn is far more active than sulphurous anhydride or hydrogen sulphide. The two latter do not kill the spores, but simply delay their development. Ozonized air, containing 3-4 per cent. of ozone, has no appreciable effect on the spores.

Purity of Air in Alpine Regions. Resistance of Aerial Bacteria to Cold.—Some experiments were conducted by M. de Freudenreich in 1883* to determine the relative purity of the air at different heights in the Swiss Alps and in the plains. The air was aspirated in known quantities through sterilized cotton wool in Miquel's culture tubes. These tubes were duly sealed and returned to Dr. Miquel for distribution in culture fluids. Out of 2700 litres of air taken at heights from 2000 to 4000 metres above the sea they furnished neither bacteria nor mildew spores capable of rejuvenescence in neutralized beef-broth. From 2400 litres taken at the middle of the Lake of Thun there were obtained several mildews and two micrococci. This lake is about 560 metres above the sea. Near the Hotel Bellevue at Thun, from 2400 litres of air taken one metre above a large prairie, resulted five schizophytes. In a room in the hotel from 100 litres of air resulted six bacteria.

Put into another form, the tabulated results would stand for 10 cub. m. of air drawn at different dates in July and August as

1. At an altitude varying from 2000 to 4000 metres	0
2. Upon the Lake of Thun (560 metres) ..	8
3. Near the Hotel Bellevue (560 metres) ..	21
4. In a room of the hotel	600
5. At the Park of Montsouris, Paris	7,600
6. In the Rue Rivoli, Paris	55,000

Thus the air of the lake appeared about three times less charged with germs than that which circulated close to the ground, and this last was purer by 360 times than the air analysed the same days at Montsouris.

To test the resistance of bacteria to cold, ten closed tubes containing several kinds of atmospheric bacteria were experimented on. Six were exposed during thirty-six hours to a slowly decreasing temperature of -10° to -100° C. The sealed tubes remained for more than four hours at the lower temperature. It was found, as in previous experiments, that several kinds of bacteria incapable of resisting for two hours a temperature of 70° C. supported this excessive degree of cold. Some appeared to have aged, that is to say, that when sown afterwards in nutritive broths their rejuvenescence required three days, whilst previously they only needed about twenty-four hours.

Further experiments † in the summer of 1884 by M. de Freudenreich yielded the following results. Out of 2000 litres of air taken

* Semaine Médicale, Oct. 11, 1883.

† Arch. Sci. Phys. et Nat., xii. (1884) pp. 365-87.

at 2900 metres on the Aletsch glacier, a bacillus and micrococcus, a mildew spore and torula were found; omitting these last as not being microbes properly so called, there was an average of 1 per cubic metre. Out of 3000 litres taken at 3340 metres on the Col du Théodule a *Bacterium termo* and a mildew spore were found, or one microbe per 3 cubic metres. On the Niesen out of 600 litres of air taken during rain, snow, and intense fog a minimum of four microbes (without counting mildew spores) was found. In a second trial out of 1725 litres four bacteria were found. The abundance of microbes here is explained by the fact that the observations were taken during hay-making and by the presence of bacteria in the soil.

Experiments made at lower levels were as follows:—Near the Eggischhorn Hotel at 2193 metres above the sea, out of 110 litres a *Penicillium* and three species of *Bacillus* were found, or at least 20 germs per c. m. At Zermatt (1620 metres) 100 litres gave a *Bacillus subtilis* and a mildew spore. A room in the hotel near the summit of the Niesen gave an average of one bacillus to 7 litres of air. At Gurten, near Bern, at an elevation of 323 metres above that town, no germs were obtained: whilst at Bern itself 441 and 250 microbes per cubic metre were taken.

The conclusion drawn from the experiments is that the purity of the air of mountains is much greater than has been supposed, and is only surpassed by sea air. This purity is owing (1) to the progressive disappearance of bacteria-producing centres; at the zone of eternal snow the absence of these centres is complete. 2. To the diminished density of the atmosphere, which becomes less and less capable of sustaining long in suspension the microbes it contains; at the same time the foreign particles are more diluted by the very fact of this decreased density, the space occupied by a given volume of air from the plains augmenting with the altitude.

MICROSCOPY.

a. Instruments, Accessories, &c.*

Beck's "Star" Microscope.—In the construction of this Microscope (fig. 99) Messrs. Beck appear to have reduced the cost of an efficient instrument to its very lowest limits, 3*l.* 3*s.* only being charged for it, including a 1 in. and 1/4 in. objective, which, it is claimed, "are accurately worked, purely achromatic, and thoroughly suited for scientific research."

The Microscope is nickel-plated throughout, with the exception of the base, which is solid in design, and contrived so that the instrument is steady in every position. It is made in two forms, with a sliding or a rack-and-pinion coarse adjustment.

* This subdivision is arranged in the following order:—(1) Stands; (2) Eye-piece and Objective; (3) Illuminating Apparatus; (4) Other Accessories; (5) Photo-micrography; (6) Manipulation; (7) Microscopical Optics, Books, and Miscellaneous matters.

FIG. 99.

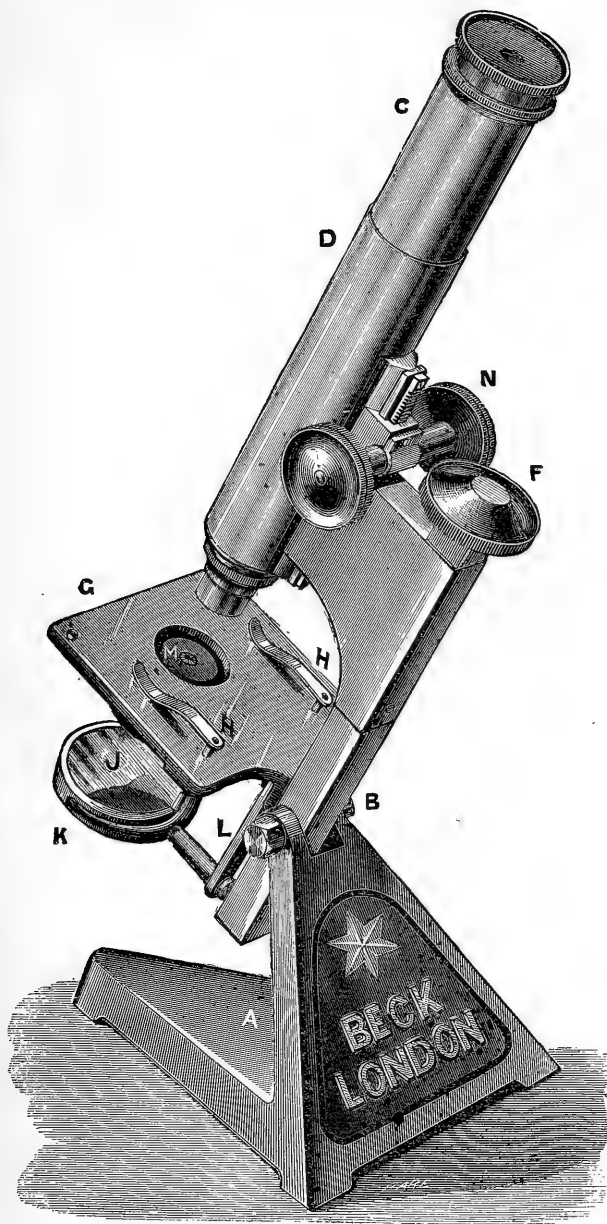

The foundation of the stand is a solid cast-iron base A, having at its top a hinge-joint B, which allows the instrument to be inclined at any angle, and is sufficiently firm to permit of its being placed horizontal for use with Wollaston's camera lucida. The body D has a draw-tube C, with coarse and fine adjustments at N and F. The stage G has two springs H H, the pins attached to which may be inserted in any of the four holes on the stage, and by their pressure (which can be varied by pushing them more or less down) will hold the object under them or allow it to be moved about with the greatest accuracy. The mirror J, besides swinging in the rotating semicircle K, is attached to a bar L, with a joint at each end allowing a lateral movement, so as to throw oblique light on the object. An iris diaphragm M, in which the size of the aperture is varied by revolving it in its fitting, screws into the under surface of the stage, and can be removed when other substage apparatus is required.

FIG. 100.

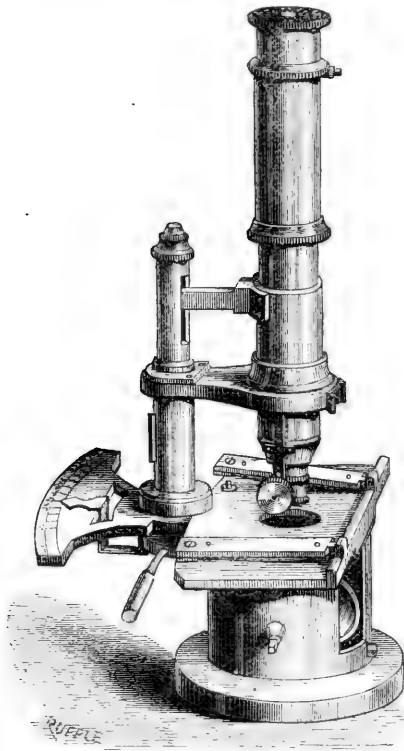

Class Microscopes.—M. Nacet's instrument (fig. 100) is an attempt to cope with the mischievousness of youth, whose eccentricities are liable to invade even the domains of Microscopy.

All the adjustable parts are locked by a removable "key," the large milled head of which is shown near the objective. Thus the eye-piece is fixed so that it cannot be moved; the body-tube can only be raised or lowered by the application of the key to a pin at the top of the pillar (concealed by the ornamental cap, which is unscrewed); the objective is rendered immovable by the same means, the key acting on a screw which passes through the projecting piece, whilst the mirror has no milled heads to the axis, and can only be turned by the key.

The slide is fastened down by two bars, one of which is shown slightly raised in the figure.

The only part left free is the fine adjustment, which is effected by turning the handle seen at the base of the pillar, which slightly raises or lowers the body-tube. An index shows the extent of move-

ment on a graduated arc with ten divisions, which is marked "Vue presbyte," "Vue moyenne," and "Vue myope."

We believe that the Microscope, though perfect as regards the manner in which it carried out the mechanical part of the problem, was not found in the result to accomplish all that was desired. The very fact of such an attempt being made to restrain the practical jokes of the students ("les barbares d'élèves") only served to quicken their determination not to be thus baffled, and improvised "keys" soon left matters in a worse condition than if no such means had been adopted in the first instance.

Messrs. Murray and Heath's Class Microscope (fig. 101) has similar arrangements for locking the parts liable to be disturbed.

FIG. 101.

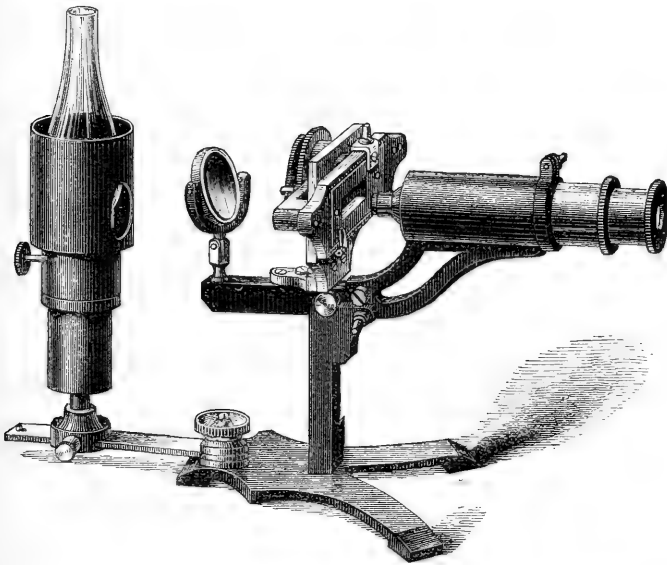

The body-tube is locked by a pin near the top of the socket in which it slides, the fine adjustment being effected by the eye-piece. The slide is placed in a shallow box, which can be locked in the same way. The box, which is movable on the stage, can be fixed when desired by two screws beneath the stage also set fast by the key. A fourth locking arrangement in the limb fixes the Microscope in a horizontal position.

Giacomini's Microscope with large Stage.*—Herr Schieck has already devised a Microscope † with a large stage to meet the wants of observers who have to deal with large sections. The stage is

* Sep. Repr. Giorn. R. Accad. Med. Torino, 1883, fasc. 6, 8 pp. and 2 figs.

† See this Journal, ii. (1882) p. 673.

enlarged to 11 cm. in width, and in addition four arms 4 cm. long can be extended when desired from the sides of the stage.

FIG. 102.

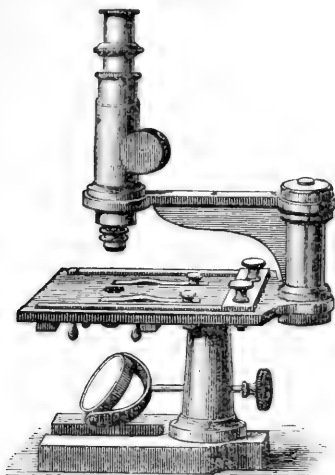

For the purpose of examining sections of the entire human brain Prof. C. Giacomini has constructed the Microscope shown in figs. 102 and 103, which appears to be practically identical with Schieck's. The pillar supporting the stage is in its normal position, and the aperture in the stage is retained at a short distance (4.5 cm.) from the front edge of the stage, so that there is no such obstruction of light as would take place if the aperture (and with it the mirror) were placed further back at the centre of the enlarged stage. The pillar, however, which carries the arm for the body-tube is moved much further backwards, so as to leave a distance of 15.5 cm. between it and the stage aperture. The stage is therefore 20 cm. from back to front, and its width

can be increased so as to take slides up to 34 cm. by attaching to it the two supports shown in fig. 103, on which the ends of the slide rest.

FIG. 103.

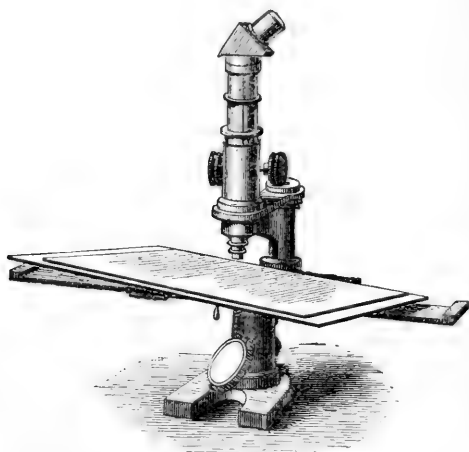

As there is some inconvenience in leaning over the instrument to reach the eye-piece, an Amici prism is used to divert the rays at an angle of 30° .

FIG. 104.

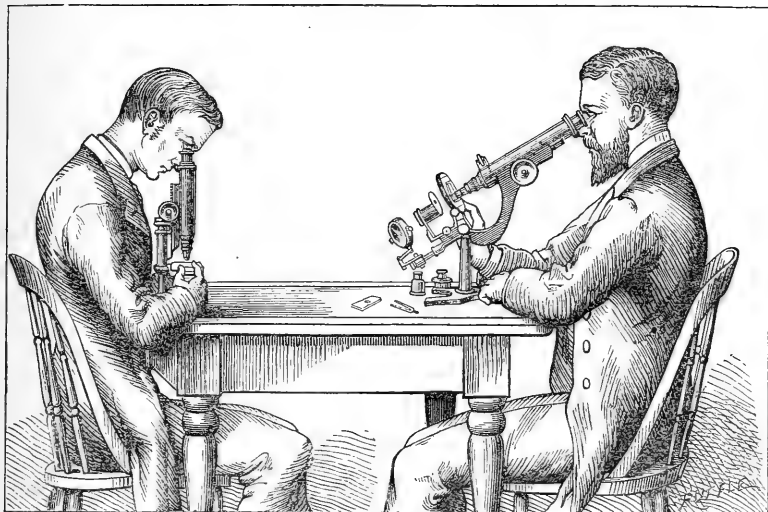

Microscopes with Bent Body-tube.—It is generally admitted that a vertical position of the Microscope is a very inconvenient one for the observer, and that an inclined position is in every way preferable. The late Mr. C. Stodder illustrated this by the drawing reproduced in fig. 104.

On the other hand, there is no doubt that in a large proportion of laboratory researches the conditions of observation with objects in fluid necessitate the stage being maintained in a horizontal position. The two conditions, however, of an oblique body-tube with a horizontal stage can well be reconciled by the plan originally suggested by M. Nachet, of inserting a truncated equilateral prism in the body-tube, as shown in fig. 105. The upper part of the tube above the prism being inclined, the observer is relieved from the discomfort which long obser-

FIG. 105.

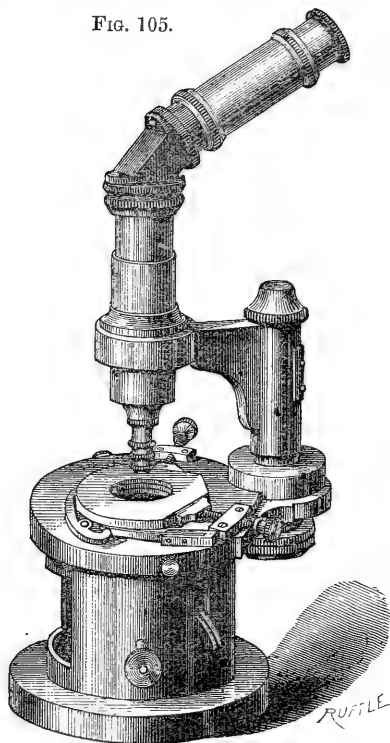

vation with the vertical tube entails upon the muscles of the neck.

The prism, unless badly made, does not interfere with the definition of the objective, even when used upon *Amphipleura pellucida*.

The same prisms were adopted by M. Nacet in his double-bodied Microscope for two observers.

Old Italian Microscope.—In a pamphlet in Italian entitled 'Nvove inventioni di tubi ottici dimostrate nell' Accademia Fisico-matematica Romana l'anno 1686' (19 pp. and 3 pls.), which concludes with the signature of "Carlo di Napoli Dottor nell' vna, e l'altra Legge Prosecretario," several quaint forms of Microscopes and telescopes are described. One of the most curious of the Microscopes is that shown in fig. 106 (reduced from the original fig. to about 2/3 size.)

FIG. 106.

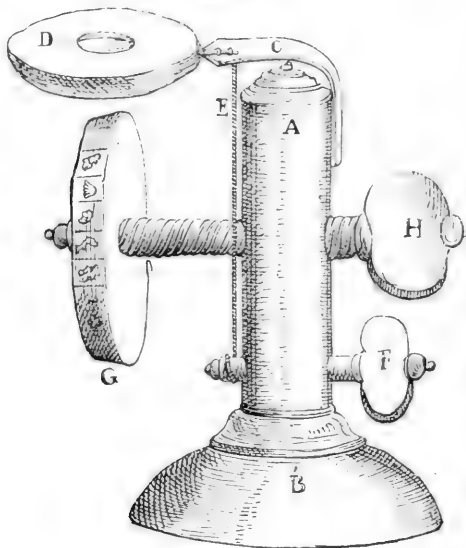

The speciality of the instrument consists in two points. (1) The objects are placed round the circumference of a wheel which has two motions; one on its axis for bringing the different objects under the lens, and a second motion of the whole wheel laterally by rotation of its screwed axis, by which means all parts of the objects can be observed by the lens. (2) The adjustment for focus is effected by the very primitive device of fixing the lens at the end of a spring, to which a cord is also attached. On winding up the cord on a screw peg, the spring is bent and the lens brought closer to the object. On reversing the motion the spring is relaxed again and the lens withdrawn.

The following is a translation of the description as given in the original text:—

“More ingenious still was the next invention shown in figure 5 [fig. 106] in which A B is a stand of wood: C is a bent iron spring, carrying the ring D in which is inserted the lens: E is a thin string, which causes the spring C to move upwards or downwards by means of a small peg F on which it is wound. The objects are placed around the circumference of a disk G which is attached to a screw-peg H, by which the object is adjusted perpendicularly under the lens D.”

The writer of the pamphlet does not give the name of the inventor of the Microscope, but he refers to this and other models in terms which suggest that he had had some experience with them. It is of interest as being the earliest example of a drum-carrier for a number of objects, and therefore in this respect displaces Winter's “Revolver” Microscope described in Vol. IV. (1884) pp. 114–5. In view of the extreme improbability of ever meeting with one of these instruments we have had one constructed closely to the original. If it survives to a later age this notice may serve to prevent its being accepted by posterity as a genuine model, a mistake which the imitative skill of the workman has rendered possible even at this period.

Müller's Insect-catcher with Lens—Insect-cages.—Herr P. Müller has designed* the instrument figs. 107 and 108 to serve the double purpose of catching and observing insects.

It consists essentially of a glass tube having at one end a lens, and inside, close to the focal point, an adjustable mica-plate. A plug is passed up the tube, on which the insect is brought to the focus of the lens. A conical catcher at the opposite end of the tube serves for catching the insect, and can be used as a stand during observation with the lens.

The lens *b* is attached to the glass tube *a*, the inner surface of which is ground as far as $a-\beta$. At *d* is the mica-plate, between the spring rings *c c*, and at *e f* is the catcher.

The following is translated verbatim from the inventor's specification:—

“In use the instrument is taken with two fingers by the ring *f*, and quick as lightning placed over the insect to be caught, whether it is on level ground, on a hedge, or on the side or top of a wall. With skill and the necessary caution the capture is generally successfully effected. It is still more certain if the insect happens to be on an accessible leaf, blade of grass, twig, or flower. In such a case the insect-catcher is held in the way described, and cautiously brought near to the insect. At the same time the open left hand is brought near the insect from the opposite side, and as soon as the capture seems certain the funnel and the hand are brought together over the insect. All the different kinds of flies, gnats, moths, and such others as seek the light will quickly be seen in the illuminated glass tube, from the top of which they will seek to escape. The plug *h* is now

* Specification of German Patent, 6th June, 1883, No. 25,806.

quickly pushed up the tube, as shown at fig. 108, the end of the tube being closed meantime with the thumb. The captured insect by this means can be confined to the field of view, and all its movements can be conveniently observed in all weathers. The size of the insect

FIG. 107.

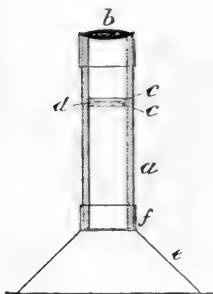
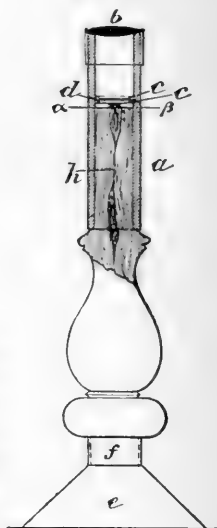

FIG. 108.



can also be determined by a divided scale on the top of *h*. By this process of capture the delicate wings and antennæ, and the fine dust and hairs are not injured, as the captive insect is neither held in the fingers, nor killed, nor pierced through. Shy insects, and those that do not readily escape, as beetles and caterpillars, as well also as spiders, can be knocked from the plant into the funnel by the plug.

It may be here remarked that the roughening of the inside of the tube *a* is intended for those insects which have no hooks on their feet, to crawl up more easily. Should it happen that, in spite of this, these animals will not move up the tube, it must be held with the eye-piece down and the insect shaken into the tube. After the insertion of the plug the funnel is put on the lower end to serve as a foot to the instrument."

The patentee further says that what distinguishes his apparatus from all others is the following contrivance:—"After observing the captive insect in all its parts from above, it can be observed from the under side, by simply turning the apparatus upside down, so that the insect lies on its back on the mica-plate. If the space is increased by withdrawing the plug slightly, and so giving the insect more room for moving, it immediately turns itself over and stands upon its feet. If the plug is again pushed in as far as $a-\beta$, and the apparatus turned with the eye-piece upwards, in a few moments the observer is in a position to examine the insects on the under side. This alternate observation can be repeated at will. If the insect is restless, the mica-plate need only be pressed a little closer, in order to hold it very gently. The space above the plug is adjusted to the size of the insect by moving the ring *c c* up or down. In order to avoid having

to repeat the adjustment of the mica-plate it is advisable to catch a number of large or a number of small insects at a time, which is not difficult to arrange, considering their immense numbers and variety."

An insect-cage supplied to us by Messrs. Beck is shown in fig. 109. It consists of four parts. A is a ring, open at the bottom but closed

FIG. 109.

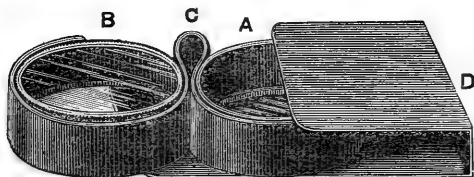

at the top by a glass plate, and having an aperture on one side. B consists of two rings similar to A, one sliding within the other and forming a box. Small insects can pass into the box through apertures in each of the rings, but this can be closed at pleasure by revolving one of the rings on the other. C is a frame into which A and B are placed, and having also a hole through the centre divisions.

A and B being in position in the frame C, and the apertures arranged so that there is a passage from the one box to the other, A is placed over an insect which it is desired to secure for observation. The bent brass plate D is then slipped under it so that A is in darkness and B in the light. The insect will then pass from A to B which can be removed for examination, the aperture being closed by rotating the rings.

If the box B were arranged, as could easily be done, so that the space between the top and bottom could be reduced to suit the size of different insects, we think the apparatus would be decidedly superior to that of P. Müller as it could then be placed on the stage of a compound Microscope and any mode of illumination could be used, transparent as well as opaque.

A somewhat similar contrivance was suggested by Mr. F. N. Tillinghast* to obviate the difficulty of introducing a third or even a second insect into a box without letting one of those already caught escape. It consists of a box divided into two compartments of unequal size by a sliding division, the end of the larger compartment being of glass. The new capture is placed in the smaller compartment and the lid of the box being closed the slide is withdrawn and the insect, observing the light through the glass of the larger compartment, passes into it. On again closing the slide the box is ready to receive further supplies.

Tolles's Centering Stage.—The stage shown in fig. 110 was found among the effects of the late Mr. R. B. Tolles after his death, and is an example of one of the many efforts made by him to improve the mechanism of the Microscope. It was apparently devised to meet

* Amer. Journ. Micr., vi. (1881) pp. 133-4 (2 figs.)

the demand for an inexpensive form of rotating stage with means for centering the motion exactly in the optic axis. The upper plate is fitted to rotate on the lower one, and the latter is attached to the standard or limb by the excentric opening shown. The screws enable it to be adjusted so that the rotation of the upper plate will be concentric with the optic axis.

FIG. 110.

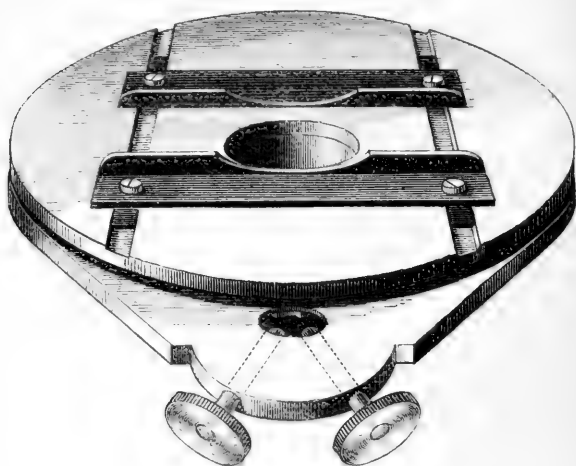

Such a system of centering must, we think, render the attachment of the stage too unstable, which probably accounts for the fact of Mr. Tolles not having further perfected it.

Diaphragms for Beck's Vertical Illuminator.—The diaphragms suggested by Mr. Tighlmann* for the vertical illuminator were found inconvenient in use as the force required to revolve the ring which carried them rendered the apparatus liable to displacement.

FIG. 111.

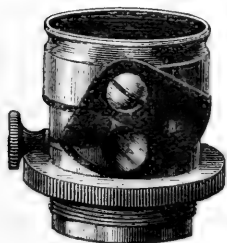

Messrs. Beck now supply the illuminator with the diaphragm shown in fig. 111. There are two apertures, the smaller one being circular and the larger one the shape of a broad crescent. The latter gives many varieties of form when moved laterally in front of the fixed circular opening in the cylinder.

In using the vertical illuminator with such objects as *A. pellucida*, we have obtained the best results by applying a narrow slot diaphragm to one of the small

* See this Journal, i. (1881) p. 941.

openings in the circular disk of apertures supplied by Powell and Lealand with their illuminator.

Stephenson's Immersion Illuminator.—Fig. 112 shows the general appearance of this illuminator, of which a diagram only was given *ante*, p. 208. There are two sets of diaphragms, one on a vertical revolving disk, and the other on a horizontal sliding plate, intended for the higher and lower apertures respectively.

FIG. 112.

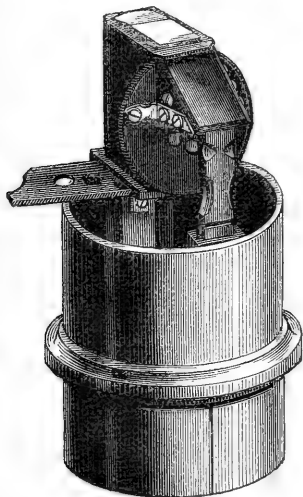
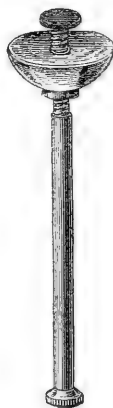

FIG. 113.



West's Adjustable Dark-ground Illuminator.—In the cabinet of the late Mr. F. L. West, optician, of Cockspur-street, W., we found the dark-ground illuminating device shown in fig 113.

It consists of a plano-convex lens through the axis of which a hole is drilled to receive a socket with an internal screw. In the socket is a steel rod carrying a disk of thin metal, which lies over the plane surface of the lens. According to the distance of the disk from the lens more or less of the central rays are shut off. The rod is supported on a pivoted arm similar to that ordinarily used for Darker's wells.

Mirror Diaphragms.—In Dr. J. E. Smith's 'How to see with the Microscope' (p. 53), a reference is made to "slot diaphragms of different widths, covering the whole surface of the mirror, and only allowing light to pass through the slot in such a direction that very sharp shadows by oblique light will be produced." A mirror diaphragm of this kind has been sent us by the Bausch and Lomb Optical Co., and is shown in fig. 114. It is made of ebonite and fits as a cap over the concave mirror, the ebonite being moulded concave

so as to come nearly in contact with the glass surface. It would, we think, be preferable that the ebonite diaphragms should be flat so as to be applied to either side of the mirror.

The suggestion of applying diaphragms to the mirror is a revival of a plan adopted towards the end of the last century by Dellebarre. He made disks of thin metal with circular apertures of different sizes to be applied as caps over the plane or concave surface of the mirror, being held in position by three angle-pins projecting from the periphery.

FIG. 114.

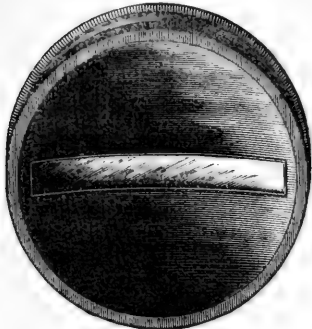

Centering the Illuminating Beam.*—Mr. J. W. Queen points out that it is a practical point of much importance in the use of the Microscope to have strictly central light. To secure this he is accustomed to pursue the following plan:—

Having the object in place and lighted from the mirror, the objective screwed on, and the eye-piece in the tube, first focus. Then remove the eye-piece, and applying the eye centrally to end of the body-tube, notice the spot of light at the back of the objective. It may appear as in A, in which case move the mirror or diaphragm, or both, until the illuminating beam appears central, as in B. If now the lens is a good one, properly adjusted, and the inner circle of B presents an evenly illuminated disk, a good, sharply defined image should be obtained. But there may not be light enough, or there may be too much, in which case a diaphragm of different size should be used, or its distance from the object varied, thus varying the angular size of the illuminating pencil. If the diaphragm be too large or placed too near the object, it ceases to affect the angular size of the illuminating

FIG. 115.

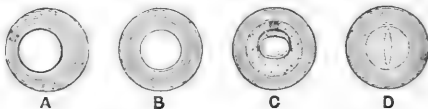

beam (although it may act in another way), and in this case the image of the mirror is seen within the circle of the diaphragm, as at C, if the objective is of sufficient aperture.

If lamplight be used, the image of the flame may be seen within the disk of mirror and diaphragm, as at D. This shows that the beam is not focused upon the object. This may be remedied by the use of a condenser placed near the source of light, making parallel the rays falling on the mirror, or simply by altering the distance of the mirror

* *Micr. Bulletin*, ii. (1885) p. 1 (4 figs.).

from the stage. In some cases, however, the mirror is not of the right focus and the latter course cannot be adopted. The appearance should be like B as nearly as possible.

Many objectives have front lenses much larger than is necessary. This is a real detriment, for light is admitted by the outer zone, which has nothing to do with forming the image; and although it does not reach the eye directly, yet it is reflected again and again from the various lens-surfaces of the objective, forming a haze. Gundlach, in some of his recent objectives, evidently recognizing this fact, turns down the lens-front to the mere size actually used. Where the working distance is sufficient, a diaphragm cap would effect the same purpose. Upon this principle also is the action of a substage diaphragm of suitable size (about the size of the field). Especially is it frequently the case with lenses of large aperture and short working distance that only a small proportion of the front surface is used.

Bertrand's Adapter Nose-piece.—This adapter was devised by M. E. Bertrand, now Secretary of the Académie des Sciences, Paris, to facilitate the rapid change of objectives. It consists of a short tube having an internal thread to screw on the ordinary French nose-piece; the tube extends below in a broad thick flange, on either side of which is a U-shaped spring. The under surface of the flange is cut out slightly in front to permit the entry of a shallow flange-ring, with which each objective is furnished in place of the usual screw. The flange-ring on the objective slides between the adapter and the springs, and to insure correct centering, a short collar on the upper face of the flange is pressed by the springs into a corresponding cylindrical hollow in the adapter.

FIG. 116.

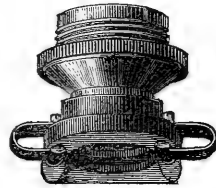

This system of adapter does not appear to have been devised for general use, but only for the series of objectives used with M. Bertrand's Petrological Microscope.*

Rings for throwing the Coarse Adjustment out of gear.—Messrs. Beck now supply the rings shown in fig. 117 for preventing the inadvertent use of the coarse adjustment at soirées, &c., when an object is being shown with a high power. It consists of a cut ring with a screw-thread which is passed over the axis of the milled heads of the coarse adjustment, and a second deeper ring, also with a screw thread, which fits over the milled heads, and to which the cut ring can be screwed. The deep ring has on its outer side a flange which forms with the inner circumference of the cut ring a deep groove rather wider than the milled head. This prevents the ring from being moved laterally, whilst at the same time it fits loosely

FIG. 117.

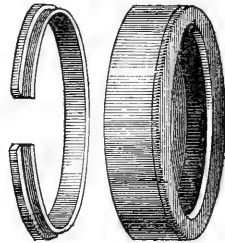

* See this Journal, iii. (1883) p. 413.

over the milled heads, and if the hand is inadvertently applied to it, it revolves freely without acting on the milled head, and the object is thus saved from destruction.

Messrs. Powell and Lealand are the designers of two earlier forms which have been in use some years (figs. 118 and 119). The former is identical in principle with that just described, the only difference being that the cut ring is broad and substantial, which obviates the liability to "spring," unavoidable in the case of a thin ring.

FIG. 118.

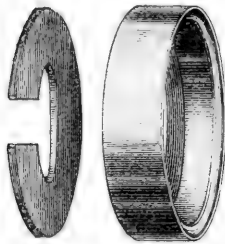
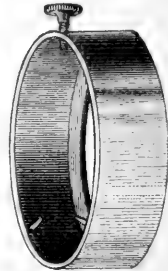

FIG. 119.



Their still older form (fig. 119) has the deep ring only, which has two pins and a screw projecting inwards. When the latter is withdrawn the ring can be slipped over the milled heads, and when screwed home the ring is prevented from slipping off, but revolves freely, as in the other forms.

Fabre-Domergue's Current Apparatus.*—M. P. Fabre-Domergue suggests the following apparatus, as not possessing the inconvenience of monopolizing the Microscope and rendering "all other observation impossible if only one instrument is at our disposition."

A metal plate 4 cm. by 15 cm., with a central aperture, is placed on the stage. One end projects 4 cm. beyond the stage, and supports a small cup of water at the level of the stage. The other end is bent twice at a right angle, and the horizontal portion supports a second cup, about 1 cm. below the stage. Two threads keep up the communication between the cup and the object in the centre. When not under observation the plate can be removed from the stage, and replaced without disturbing the preparation or interrupting the current of water.

Moist Chamber.—A simple moist chamber can be made by cutting a piece of thick rough cardboard to the size of the slide, and punching out a circular hole in the centre of such a size as to be covered by a cover-glass. The piece of cardboard is then soaked in water (or boiled in water when pure cultures of fungi are to be made) so as to saturate it, and placed on the slide. The object is immersed in a drop on a cover-glass, and the latter inverted over the hole in the

* Bull. Soc. d'Hist. Nat. Toulouse, xviii. (1884) pp. 162-3.

cardboard in the usual way. Any loss from the chamber by evaporation is prevented by occasionally wetting the cardboard on the slide.*

Arrangement of the Micro-spectroscope.†—Dr. C. A. MacMunn uses for the researches recorded *supra* p. 429 a binocular Microscope provided with a substage achromatic condenser, to which are fitted two diaphragms. The objectives are so adapted as to enable both fields to be fully illuminated when any power up to 1/8 in. is used. The left-hand tube is used as a "finder," and as a means of getting any required portion of the object into the centre of the field so that its spectrum may be obtained in the spectrum eye-piece of the right-hand tube. In this way the various portions of a very small piece of tissue or organ may be readily differentiated from each other, and their spectra observed. By the use of the iris diaphragm, which is placed below the substage condenser, the marginal part of the field can be readily cut off. A compressorium is indispensable to squeeze out the sections thin enough to allow the spectrum to be observed.

Examining the Spectrum of Chlorophyll.‡—Mr. F. O. Bower and Dr. S. H. Vines recommend the following as a convenient method of examining a solution of chlorophyll spectroscopically.

The tube of the Microscope is withdrawn and replaced by a glass tube, the bottom of which covers the opening of the stage; the sides of the tube being rendered opaque by wrapping round them a sheet of black paper. The solution is then poured into the tube and into the opening of the latter a microspectroscope is introduced. Light is then reflected on to the bottom of the tube by the mirror. The advantage of this method is, it is said, that it enables the observer to vary the thickness of the layer of the solution to be examined.

Multiplying Drawings.§—Mr. C. M. Vorce calls attention to the ferro-prussiate process for this purpose. Let the camera-lucida drawing be made with good black ink directly upon tracing-paper placed over white paper, or it may be drawn on white paper and carefully traced on tracing paper. In either case, when dry, gum the tracing paper on a sheet of clear glass, with the drawing next the glass; it may then be printed from as an ordinary negative, and any lettering will be produced in its proper position. With suitably prepared ferro-prussiate paper in clear sunlight it prints quicker than an ordinary gelatine negative; from 10 to 15 seconds will suffice for well-made drawings on clear paper. The copies are thus made very quickly in any number, and are rinsed in water, and dried much more quickly than an equal number of silver prints could be toned and fixed. Fine details are well reproduced.

As the plan proposed by Mr. Vorce does not dispense with the necessity of camera-lucida drawings, which seems to be a desideratum,

* Bower and Vines's 'Course of Practical Instruction in Botany,' 1885, p. 16.

† Proc. Physiol. Soc., 1884, No. 4. See Nature, xxxi. (1885) pp. 326-7 (1 fig.).

‡ Bower and Vines's 'Course of Practical Instruction in Botany,' 1885, p. 42.

§ Amer. Mon. Mic. Journ., v. (1884) pp. 207-8.

Mr. R. Hitchcock suggests that instead of making a camera-lucida drawing, a negative should be taken from the object, and a blue print made on the ferro-prussiate paper. The drawing may then be traced from that on the tracing-paper, which would doubtless be a better plan for those who cannot use the camera well; but the following plan is even better. Coat very thin and transparent paper with the ferro-prussiate solution, and print from the negative upon that. Then draw the outlines and necessary details on the print with indian ink. Having done this, bleach out the blue picture with very dilute ammonia, which will leave the paper white, with the black ink lines intact. Should there be a yellowish colour left on the paper, a little weak acid will remove it. After the paper is washed and dried, it may be spread on a flat, heated plate—a flat-iron, for example—and paraffin rubbed over it. This will make the paper transparent (like “wax-paper”) and it can then be attached to a glass plate, as suggested by Mr. Vorce.

Value of Photo-micrographs.*—Mr. T. Charters White calls attention to some photographs of young tench in their eggs, as showing that the sensitive film (or “retina of science”) possesses a power of discriminating greater than that possessed by the human retina, a structure quite invisible under the Microscope may become distinctly visible in the photograph. When seen under the Microscope the jelly-like envelopes were of a clear and structureless character. What, however, was clear and gelatinized under the Microscope, was in the photograph shown to be pierced by innumerable tubes which passed through the egg-cases in parallel lines.

Parallel Rays in Photo-micrography.†—Mr. W. Pumphrey calls attention to the great advantage obtained by the use of parallel rays, obtained by causing the light to traverse two apertures, placed $1\frac{1}{2}$ in. from each other, interposed between the lamp and the object. By this means the intervention of a condensing lens is dispensed with, and a much finer definition obtained.

Small Negatives—Robinson's Miniature Microscopic Camera.—Dr. Roux makes negatives about the size of a sixpence, which bear enlarging to the ordinary lantern size of transparencies. These negatives go far to support what is not generally allowed—that better negatives of bacteria and very minute objects can be produced without the eye-piece, by obtaining more perfect small negatives, than by original large direct negatives. There is, of course, the additional trouble of copying and enlarging; but this must not be a hindrance when seeking for the best work.

The plan adopted by Dr. Roux, intended to meet rapid laboratory work, is to fix a small camera or cell to the eye-piece end of the Microscope, containing a little gelatino-bromide plate, the position of the focus and the image having been previously determined by placing a piece of plain glass in the slide, and on its upper surface a

* Photogr. News, xxix. (1885) pp. 179–80 (2 figs.).

† Midl. Natural., viii. (1885) p. 113.

few insect scales. These are brought into focus by a low-power objective used as a focusing-glass, and the image of the object on the stage of the Microscope and the image of the scales are made to coincide. Hence, by withdrawing the little camera and inserting the focusing objective, the focus of any object on the stage can be made to occupy the exact position of the scales on the transparent glass. In other words, the focus of these and the new image are coincident, and, the surface of the plate falling exactly in the same plane, there can be no error through the different thickness of the glass-plate.

The miniature camera of Messrs. Robinson is well suited for taking such negatives as those recommended by Dr. Roux. It is only 3 in. by $2\frac{1}{2}$ in.

Dr. H. Van Heurck* also describes a very small mahogany camera, extremely light, receiving at its posterior part a gelatino-bromide plate of $4\frac{1}{2}$ cm. by $5\frac{1}{2}$ cm. Anteriorly the camera carries a copper tube $5\frac{1}{2}$ cm. in length, terminated by a Zeiss amplifier. The copper tube enters the tube of the Microscope a short distance.

Amphipleura pellucida and the Diffraction Theory.—The photographs of this diatom recently made by Dr. Van Heurck have given rise to some discussion, and some of those who do not admit the reality of the beaded appearance shown by the photographs, claim to rest their view on the Abbe diffraction theory.

This shows that some misconception exists as to the application of the theory, which does not establish, as supposed, that all appearances of minute structure with high powers are wholly illusory and do not correspond to any physical structure. On the contrary, the images shown by the Microscope are all, in fact, caused by real structural peculiarities of the object observed. Thus in the case of the "beads" of *A. pellucida*, the existence of such an image proves that the diatom has not merely a periodic differentiation of structure in one direction, but that such differentiation exists in two directions which cross at right angles.

What the diffraction theory shows is that the *real* form and structure of the beads cannot be determined by the mere inspection through the Microscope of their images. The Microscope leaves wholly undecided the question whether they are elevations, or depressions, or simple centres of thickening in the substance of the valve, resulting, it may be, from the intersection of two siliceous layers, the densities of which vary periodically.

* Amer. Mon. Micr. Journ., vi. (1885) pp. 42-5.

"A BINOCULAR M.D."—See Monocular v. Binocular.

Abbe Condenser.

[Zentmayer's simplified mounting. *Post.*]

Amer. Mon. Micr. Journ., VI. (1885) p. 84 (1 fig.).

ABBE, E.—See Heurck, H. van.

B.S.C.—See Monocular v. Binocular.

BANKS, C. W.—Slides of arranged and isolated Diatoms.

[“By J. C. Rinnbock of Vienna, who probably has no living equal in the production of these marvels of exquisite taste and manipulative skill. With marvellous patience, hundreds of diatoms are arranged on a glass slide in patterns of wonderful beauty. In the slides exhibited Mr. Rinnbock has introduced a novel feature by combining in the same pattern with the diatoms butterfly scales of various hues, and also the plates of *Holothurida*. By a happy combination of these varied forms and by taking advantage of the brilliant chromatic effects produced by many diatoms when viewed with low powers, Mr. Rinnbock has produced slides which, under the Microscope, blaze like a kaleidoscopic arrangement of resplendent gems.”]

Proc. San Francisco Micr. Soc., Feb. 25th, 1885.

BATES, C. P.—Warm Stage. [*Post.*]

Proc. San Francisco Micr. Soc., March 25th, 1885.

BRECKENFELD, A. H.—Graduated Glass Modifier.

[Consists of a disk revolving upon an adapter under the stage. It is “flashed” from clear glass to dark blue, and one-half of its surface being lightly ground, any desired tint of field may be obtained, from white to deep blue, either transparent or translucent, by merely revolving the disk.]

Proc. San Francisco Micr. Soc., March 11th, 1885.

See *Engl. Mech.*, XLI. (1885) p. 187.

COX, C. F.—“What is a Microscopist?”

[Detailed protest against the remarks under this title. *ante* p. 333, “on the ground that instead of keeping to a true estimate of the scientific spirit, they set up narrow and exclusive standards, and are essentially and offensively personal,” and editorial rejoinder.]

Science, V. (1885) pp. 205-6, 209-10.

D'AGEN, F.—See Monocular v. Binocular.

ENAL.—See Monocular v. Binocular.

EXNER, S.—Ein Mikro-Refractometer. (A Micro-refractometer.) [*Post.*]

Arch. f. Mikr. Anat., XXV. (1885) pp. 97-112 (1 pl. and 2 figs.).

FABRE-DOMERGUE, P.—Note sur une nouvelle platine mobile et sur l'emploi de “finders” comparables pour faciliter les relations des micrographes entre eux. (Note on a new movable stage and on the employment of finders to facilitate the intercommunication of microscopists.)

[Describes the Maltwood finder, also suggests the following as a very simple and inexpensive movable stage which is mostly wanting in French Microscopes, and without which the Maltwood finder cannot be used:—Two glass plates 130 mm. by 35 mm. have a central aperture 25 mm. in diameter. Their two ends are cemented to two strips of glass 35 mm. by 5 mm., leaving between them a space equal to the thickness of the strips, about 2 mm. On the left of the top plate is cemented an elbow piece for the slide to butt against. The space between the two plates serves for the springs which by a simple pressure immobilize the apparatus.]

Bull. Soc. D'Hist. Nat. Toulouse, XVIII. (1884) pp. 148-51 (1 fig.).

FOULIS.

[“Demonstration of the circulation in the web of a frog's foot and of some botanical test objects by means of the oxyhydrogen light. The light, transmitted through a powerful condenser, passed through an ordinary Microscope lens, and was thrown upon a large plate of ground glass at a distance of about 25 feet. The image of the object demonstrated could be focused on this plate with great exactitude, the definition even with high powers being excellent, and the general effect strikingly satisfactory.”]

Engl. Mech., XLI. (1885) p. 255.

- GUNDLACH, E.—The Examination of Objectives. (*In part.*)
Micr. Bulletin (Queen's), II. (1885) pp. 14-5,
 from *Amer. Journ. of Micr. for 1877.*
- HEURCK, H. VAN.—Les Perles de l'*Amphipleura pellucida*. (The Beads of *A. pellucida*.)
 [Note read at Meeting of 11th March, *ante*, p. 380. With opinion of Prof. Abbe.]
Journ. de Microgr., IX. (1885) pp. 129-31.
- " " La 'Rétine de la Science.' (The Retina of Science.)
 [Reply to criticisms of M. Van Ermengem on photographs of *Amphipleura*—
 also quotations from S. T. Stein and T. C. White, *supra*, p. 528.]
Journ. de Microgr., IX. (1885) pp. 132-4.
- [HITCHCOCK, R.]—Microscopical Societies.
 [Notice of intention to publish a list of U. S. A. Societies.]
Amer. Mon. Micr. Journ., VI. (1885) pp. 76 and 95.
- " " Microscopical Exhibitions.
 [Suggestions for improvement by showing, not a promiscuous collection, but
 a series of objects in their proper order to illustrate certain subjects.]
Ibid., pp. 77-8.
- " " Postal Club Boxes.
 [List of preparations, with remarks.] *Ibid.*, p. 78.
- " " Objectives for special use. [*Post.*] *Ibid.*, pp. 95-6.
- " " Electric Illumination.
 [General remarks on lamps and batteries.] *Ibid.*, pp. 96-7.
- HOLMES, O. W.—Biography of R. W. Emerson.
 [In the recently-published biography of Ralph Waldo Emerson, by Dr.
 Oliver Wendell Holmes, reference is made to the diary he kept of his first
 visit to Europe, in 1833. The biographer states (p. 63) that Emerson
 'visited Prof. Amici, who showed him his Microscopes magnifying (it
 was said) two thousand diameters. Emerson hardly knew his privilege;
 he may have been the first American to look through an immersion lens
 with the famous Modena philosopher.'"]
Engl. Mech., XL. (1885) p. 493.
- KINNE, C. M.—Presidential Address to the San Francisco Microscopical Society.
Proc. San Francisco Micr. Soc., Feb. 11th, 1885.
- KORISTKA, T.—Norme pratiche per l' uso del Microscopio. (Practical rules for the
 use of the Microscope.)
 8vo, Milano, 1883, 14 pp.
- LANCASTER, W. J.—Microscopic.
 [“By all means have a lengthening tube or a series of lengthening tubes, if
 you want to get out of a lens all that it is possible to get. I have used a
 two-foot tube and have obtained charming definition with some objectives,
 while others break down long before the two foot is reached. You must
 take care that the whole of the tubes are quite perpendicular to the stage,
 and that you have diaphragms about every 9 in. of tube, otherwise you
 will get internal reflection spoiling definition. If you place your Micro-
 scope in a horizontal direction, and have two supports to carry the tube,
 one, say, 10 in. from stage, and another 8 in. further on, then have a
 3/4 in. paraffin wick-lamp as source of illumination, using thin edge of
 flame to stage, and dispensing with mirrors, you will have many a feast
 out of the lengthened body.”]
Engl. Mech., XL. (1885) p. 437.
- LANKESTER, E.—Half Hours with the Microscope.
 16th ed., 142 pp. and pls., 12mo, London, 1885.
- LAURENT, L.—Sur un Appareil destiné à contrôler la courbure des surfaces
 et la réfraction des lentilles. (On an apparatus for checking the curvature
 of surfaces and the refraction of lenses.) [*Post.*]
Comptes Rendus, C. (1885) pp. 903-5 (4 figs.).
 2 M 2

LOMDEL, E.—**Ueber einige optische Methoden und Instrumente.** (On some optical methods and instruments.)

[Contains methods for determining (1) the focal length of a lens, and (2) refractive indices. Also spectroscope with internal slit.

Zeitschr. f. Instrumentenk., V. (1885) pp. 124-6 (3 figs.).

LOUDON, J.—**Geometrical methods chiefly in the theory of thick Lenses.**

Proc. Canadian Institute, III. (1885) pp. 7-17 (1 pl.).

MACMUNN, C. A.—[Arrangement of the Microspectroscope.]

[*Supra*, pp. 429 and 527.]

Proc. Physiol. Soc., 1884, No. 4.

See *Nature*, XXXI. (1885) pp. 326-7 (1 fig.).

MAYALL, J., Jun.—**Robert's Ruling Machine.**

Journ. Soc. Arts, XXXIII. (1885) pp. 707-15.

See also *Engl. Mech.*, XLI. (1885) pp. 101 and 109.

Journ. of Sci., VII. (1885) pp. 243-4.

Knowledge, VII. (1885) p. 433.

Journ. de Microgr., IX. (1885) pp. 176-8.

Monocular v. Binocular.

[Replies in favour of the former by B.Sc., Enal, and E. A. Tindall. Also remarks by R. D. R.]

Engl. Mech., XLI. (1885) pp. 88-9 and 110.

"Comments" on B.Sc.'s letter, *ante*, p. 335, by W. P. Oldham (pointing out the unsoundness of B.Sc.'s advice, insisting that "the binocular is a comfort, a pleasure, and a help," and protesting against the "undesirable practice of sneering at one class of observers because they do not happen to follow the particular line most favoured by another class"), by "A Binocular M.D." (supporting the binocular and the use of the Microscope "as a means to an end, and that end is the pleasure derived from the acquisition of knowledge"), and E. M. Nelson (each is best in its own department. The loss of definition with the binocular is quite inappreciable with the class of objects suitable for it), and F. D'Agen.]

Ibid., p. 132.

"Remarks" by F. D'Agen on R. D. R.'s letter, *supra*. "Many professional readers would be delighted to hear of a cheap Stephenson's erecting binocular with very short tubes (not having too great a slant), and fitted with two powers, one like Zeiss's variable low objective, and the other, say, about 2/3 in. . . . If this ideal Microscope could further have wood supports applied to stage (for hand rests), and be supplied at 5*l.* to 6*l.*, I may safely predict it would have an enormous sale, and would do all that any binocular can for natural history, dissection, &c. With such an instrument, and one other for high powers, the scientific worker would be completely armed. With regard to the high-power instrument, a very short monocular one is best. . . . (The binocular is not of the slightest advantage for high powers. The rest it affords the eye can as suitably be obtained by other plans without its expense and cumbrousness.) For goniometric, polarization, and spectroscopic observations a totally distinct instrument, or rather set of instruments, should be used. . . . If makers would give more of their attention to perfecting a set of instruments to suit the varying requirements of different workers at as low prices as possible, I think a decided improvement would set in. . . . I do not mean to contend that all attempts at combination are impossible, but only that such combination in the main limit, and do not extend, the advantages of the instruments so combined."

Ibid., p. 151.

MOORE, A. Y.—**Homogeneous Immersion Objectives.**

[Remarks in favour of correction collars, and as to the necessity for two fluids (for central and oblique light). Also as to a new Spencer 1/8 in which it is claimed that "the difference in both chromatic and spherical aberrations for the central and peripheral zones of the lenses has been reduced to such a small residuum that there is practically no difference."

The single fluid used with it is one devised by Prof. H. L. Smith, having an index as nearly coincident with that of the front lens as anything yet devised. Thus it will readily be seen that by doing away with one of the fluids and yet not impairing the performance of the objective, its value is greatly increased as a convenient working lens.”]

The Microscope, V. (1885) pp. 73-5.

NELSON, E. M.—Short v. Long Tubes.

[One of the objections to a short tube is that deeper eye-pieces are required to maintain the same magnification, and there is no doubt about the disadvantage of deep eye-pieces.]

Engl. Mech., XLI. (1885) p. 132.

See Monocular v. Binocular.

“NEMO.”—Amateur Microscope Construction.

[A serviceable plain instrument is, he considers, within the power of one who is fairly skilful at lathe and metal work, and he suggests the publication series of articles on the ‘Construction of the Microscope.’]

Engl. Mech., XLI. (1885) p. 127.

OLDHAM, W. P.—See Monocular v. Binocular.

“OS.”—Microscope Construction.

[Reply to query as to making a Microscope. “The glass-work must be purchased, but a really intelligent man who can use his lathe ought to be able to make for 20s. that for which he would pay an optician 10*l.*”]

[“Any decent amateur can construct such an instrument as a Microscope without a special series of papers other than what have appeared in the E. M.”]

Engl. Mech., XLI. (1885) pp. 151 and 193.

PELLETAN, J.—Microscope Mineralogique de M. E. Bertrand. (Mineralogical Microscope of M. E. Bertrand.)

[Same as that described Vol. III. (1883) p. 413.]

Journ. de Microgr., IX. (1885) pp. 163-6 (1 fig.).

PUMPHREY, W.—[Apparatus for photo-micrographs and method of producing them.]

Midl. Natural., VIII. (1885) p. 113.

R., R. D.—See Monocular v. Binocular.

“ROB. CRUS.”—The Micro-objective. I., II.

[Description of a “plan by which the amateur optician may produce a fair combination.” Two plano-convex lenses with foci 2 : 1 placed with planes to object and at a distance apart equal to half the sum of their focal lengths—the shorter focus lens being a thick one. With perfectly central light the definition of thin objects is very little troubled with colour and not at all distorted.]

Engl. Mech., XLI. (1885) pp. 214 (1 fig.), 258 (1 fig.).

SEAMAN, W. H.—Microscopical Societies and Microscopy.

[Abstract of address at the first Annual Soirée of the Washington Microscopical Society.]

Amer. Mon. Micr. Journ., VI. (1885) pp. 87-9, and 98.

Smith, C. Vance, death of.

[“The deceased was noted for his skill in preparing vegetable tissues for the Microscope.”]

Journ. of Sci., VII. (1885) p. 244.

STEINHEIL, A.—Ueber die Bedingungen und Fehler von Objectiven aus zwei Linsen. (On the conditions and aberrations of Objectives of two lenses.)

Zeitschr. f. Instrumentenk., V. (1885) pp. 132-6 (1 fig.)
from *Astron. Nachr.*, No. 2606.

[STOWELL, C. H. and L. R.]—[Beads of *Amphipleura pellicuda*.]

[Americans should bear in mind that the slide from which Dr. van Heurck's photograph was made was prepared by Dr. A. Y. Moore. “We have seen one of these photographs, and the appearance of the beads is unmistakable.”]

The Microscope, V. (1885) p. 91.

TINDALL, E. A.—See Monocular v. Binocular.

TYRRELL, P.—Concerning Angles.

[Statement of his experience as to the superiority, "for histological work or anything else," of wide-angled homogeneous-immersion objectives over water-immersion.]

Amer. Mon. Micr. Journ., VI. (1885) p. 80.

VAN BRUNT, C.—Presidential Address.

[Improvements made in the Microscope—Protoplasm, Schizomyeetes, &c.]

Journ. New York Micr. Soc., I. (1885) pp. 53-9.

VORCE, C. M.—Lantern transparencies. [Post.]

Amer. Mon. Micr. Journ., VI. (1885) pp. 84-5.

WALES.—Observations on resolution of *Amphipteura pellucida*. [Post.]

Journ. New York Micr. Soc., I. (1885) p. 103.

WHITE, T. C.—The Retina of Science.

Photogr. News, XXIX. (1885) pp. 179-80 (2 figs.).

WINTER, W.—Ueber die Darstellung Naturwissenschaftlicher Objekte. (On representing Natural History objects.) [Post.]

Ber. Senckenberg. Naturf. Gesell., 1884, pp. 75-7.

ZIMMERMANN, O. E. R.—Atlas der Pflanzen-Krankheiten welche durch Pilze hervorgerufen werden. Mikrophotographische Lichtdruckabbildungen der phytopathogenen Pilze nebst erläuterndem Texte. (Atlas of plant-diseases produced by fungi. Photo-micrographic illustrations of the phytopathogenic fungi, with explanatory text.) Part I.

16 pp. and 2 pls. of 15 figs. each. Text 8vo, Atlas fol., Halle a. S., 1885.

B. Collecting, Mounting and Examining Objects, &c.

Collecting Rhizopods.*—Prof. H. Blanc describes a method of obtaining material from the deep water of the Lake of Geneva by lowering to the bottom a large St. Andrew's cross, to the four extremities of which are attached pieces of very thick glass. After three or four weeks this is raised to the surface again and the fine mud that has collected on the pieces of glass removed with a brush.

Cultivation of Actinomyces.†—Dr. O. Israel found great difficulty in cultivating Actinomyces from the slow growth of the fungus, as it was crowded out by the growth of other organisms. No result followed attempts at cultivation on fluid nutrient media—beef-bouillon, meat-extract, peptone-solutions, fluid bullock's blood-serum at the temperature of the room and body, or peptone-salt-gelatine-meat solution at 20° C. Only Koch's coagulated bullock's blood-serum proved a suitable nutrient soil, in which it grew very slowly.

The growth appeared as a very thin, velvety, dry looking clump on the bright surface of the coagulum, in which (not for 14 days) small nodules appeared. Cultivation of eight weeks' growth hardly extended more than 1/2 cm. on either side of the point of inoculation. Microscopically the vegetations in the culture corresponded with those which exist in the animal body. With low powers the margin showed a serpiginous border.

Cultivation Methods for the Investigation of Fungi.‡—Dr. O. Brefeld observes that a substratum on which the fungus exists in

* Bull. Soc. Vaudoise Sci. Nat., xx. (1885) pp. 287-8.

† Virchow's Arch. f. Pathol. Anat. u. Physiol., xcv. (1884) p. 140.

‡ Brefeld, O., 'Botanische Untersuchungen über Schimmelpilze,' part iv. pp. 1-35. 4to, Leipzig, 1883.

nature, is in all probability also an appropriate one for the cultivation of the fungus, and one can in many cases make a nutrient solution by cooking the substratum. For example, the dung of herbivora is a very fertile nutrient soil for a variety of fungi, and a decoction of it made clear and freed from fungi by sterilization, is a very good nutrient medium. Nutrient solutions can also be made from sweet fruits, e. g. plums, raisins, &c., of which a watery extract is made, and sterilized by heat. The free acids of the fruit check the development of many fungi. Beer-wort is also a convenient culture-fluid, but is difficult to clarify, and when cooked forms a precipitate. Again, a decoction of yeast, with more or less sugar, or a weak solution of meat-extract, with or without sugar, may be used: or bread, which is not acid, and which has been placed in an air-bath at 150° C. for 24 hours. Lastly, one can use a variety of organic and inorganic compounds. Many fungi flourish in acid solutions, while even a trace of acid prevents the germination of the spores of others.

Brefeld purifies the vessels, &c., used in cultivation experiments, by boiling water, heating, or placing them for some time in 10 per cent. hydrochloric acid, and afterwards scalding them in distilled water. The methods of cultivation and study of spore-formation are entered into, and the means by which impurities from access of air, &c., can be prevented are minutely described.

Net for Microscopists.*—Mr. H. A. Walters first tried a deep conical net, stretched upon a framework of cane, bent (after boiling) somewhat to the shape of an iron hook . Across the open portion, a copper wire, not less than six inches in length, was stretched, which served as a finer cutwater than the cane, and made a strong and effectual "scraper" for such stems as those of the water lily. He found, however, considerable difficulty in turning a net of this shape inside out, and, to overcome this, contrived the following one.

The framework is the same as the first. The muslin bag is so arranged that the point of the cone comes exactly opposite to the centre of its mouth when stretched out behind it, and within this point is inserted a 1/2 in. test-tube having the bottom ground off. The ends of the muslin for 1/2 in. are bound tightly round the head of the tube; the projecting rim of the glass preventing it from being pulled out. Round the whipping is placed a broad band of cork, a wine cork, with the centre burnt out, and the edges bevelled forward to prevent undue resistance to the water, which keeps the tube always behind the muslin, and ready to receive the contents of the net; otherwise, when the net is moving very slowly in the water, the tendency of the tube is to sink below the mouth, thereby causing all animal life to be merely washed in and out again. The tube is closed by placing a square of muslin over the open end, and securing it with a very small band of indiarubber. Duplicates of both muslin square and elastic band are indispensable, these being the two most important parts of all. Care should be taken when cutting the muslin that the piece coming from the wire is quite flat and remains so after being

* Sci.-Gossip, 1885, pp. 78-9.

fixed in its place, for if there is any looseness in the wire, thereby forming a small hollow below the level of the tube head, solid matter, instead of flowing at once into the tube, will "hang" in this hollow.

In constructing the net it is advisable so to arrange the muslin that when travelling in the water the wire may precede the cane; for when skimming, if the shadow of the framework is allowed to pass over the life collected on the surface before the wire with the net attached, is able to follow it up, it is more than likely that many specimens will make good their escape.

When it is required to remove the contents of the net to the collecting bottle, proceed thus:—The net should be raised from the water as rapidly as possible, and the thumb of the right hand pressed tightly against the bottom of the tube so that it may be kept full of water, and it can then be examined. The small diameter of the tube does not prevent the use of a pocket-lens, which is practically useless when the objects are procured in the dipping bottle. If the tube is found to contain anything of value the left thumb is placed on the head of the glass, the latter turned upside down, the square and band removed, and the water gently poured into a bottle.

After using this net for a few minutes the author "has always found more in the glass tube than others have been able to collect in as many hours, while using the favourite bottle and stick; and it is worth remembering that each plunge of the dipping bowl adds seldom less than half-a-pint of water to the total amount that must be carried, perhaps for miles, while the net and tube increases the amount by never more than one tablespoonful."

Preparing Brain of Urodela.*—Prof. H. F. Osborn describes his method of preparation as follows:—Before hardening, the brains were distended with Müller's fluid, so as to preserve the natural proportion of the cavities. After treatment with alcohol, they were placed for a week in dilute carmine. Calberla's egg-mass was employed, the ventricles being injected with the mass before hardening. The delicate parts of the brain-roof were thus retained. It appears now that celloidin may be used for this purpose to equal, if not to greater advantage in results, and with considerable economy of time. The sections were cut in absolute alcohol, were then floated upon a slide in consecutive order, from twenty to fifty at a time, and were covered with a delicate slip of blotting paper during treatment with oil of cloves.

For imbedding, the egg-mass was prepared by shaking the white and yolk of egg together, with three drops of glycerin to each egg, and then filtered through coarse cloth. The bath is then prepared as follows:—There is a large water-pan for boiling with the Bunsen burner, &c. Inside this, supported on rests to prevent jarring, is a covered glass dish, filled to about 1 in. in depth with 85 per cent. alcohol. Within the glass dish is placed a piece of coarse wire netting, which supports the imbedding box, raising it above the alcohol.

* Amer. Natural., xix. (1885) pp. 328-30 (1 fig.), from Proc. Acad. Nat. Sci. Philad., xvii. (1883) p. 178, and xviii. (1884) p. 262, and from a letter.

The box, made of paper in the usual way and one-fourth filled with the imbedding mass, is kept in the bath until the mass is hardened enough to support the brain. The brain is next placed on the hardened stratum and covered with the fresh mass. The second stratum is hardened just enough to hold the brain in place, and then a third is added, filling the box.

The whole mass must now be allowed to harden through and through, requiring about fifteen minutes. The hardening is completed by passing the box through three grades of alcohol—80, 90, and 100 per cent., allowing it to remain twenty-four hours in each. When the mass becomes nearly white and ceases to discolour the alcohol it is ready for cutting.

Method of preparing permanent specimens of Stained Human Blood.—Dr. V. D. Harris writes us as follows :—

Although at first sight a very simple matter, it is found in practice to be anything but easy to prepare specimens of human blood, so that the corpuscles may retain their shape and may be at the same time well stained. After the trial of a large number of different methods I recommend the following as giving the most satisfactory results. The finger is pricked and a large drop of blood is allowed to exude; a perfectly clean cover-glass is lightly drawn upon the top of the drop so that a very thin layer of blood adheres, so thin as hardly to be evident until it is dry. It is then dried in the air or put at once without drying into one of the following solutions, viz. chromic acid 1/12 per cent.; bichromate of potassium 1/2 per cent.; methylated spirit or absolute alcohol for five or ten minutes, washed in water and again dried. The specimen is now ready for staining. The best dye for this purpose will be found a *recently prepared* 1 per cent. solution of Spiller's purple in water to which a few drops of alcohol have been added, or a weak spirit solution of rosein. A few drops of one or other dye having been filtered into a watch-glass, the cover-glass is placed upon the surface of the solution blood downwards, and allowed to remain so for from five to ten minutes. It is then removed, washed for some time in a gentle stream of distilled water, dried thoroughly, and mounted in Canada balsam with or without previous treatment in clove oil for a minute or two. On examination of the specimen the coloured corpuscles should be found of normal shape and coloured purple or red, according to the dye used, and the colourless corpuscles similarly stained. The method with Spiller's purple will be found especially useful when blood is examined in disease conditions in which the existence of micro-organisms is suspected, and is superior to any other of the many anilin dyes (such as methyl-violet) which I have tried.

Demonstrating the Origin of Red Blood-corpuscles in Cartilage at the Margin of Ossification.*—Dr. B. Bayerl, after decalcifying and hardening the specimen in alcohol, imbedding it in paraffin, and cutting, treats the sections with turpentine, soaks in absolute

* Arch. f. Mikr. Anat., xxiii. (1884) pp. 30-45.

alcohol, and places them for fifteen to twenty minutes in a mixture of equal parts of the following solutions:—(a) Carmine, 2; borax, 8; water, 130. (b) Indigo-carmine, 8; borax, 8; water, 130. They are then treated with a saturated solution of oxalic acid, washed, and mounted in balsam.

The ground-substance of the unchanged cartilage is not stained, while at the margin of ossification it is pale red; the cartilage cells are reddish, with dark nuclei; bone and osteoclasts, red; blood-corpuscles, green. The latter stain is a specific property of hæmoglobin, and, of other tissues, only the inner root-sheath of hairs takes on a greenish hue.

Preparing the Sympathetic Nervous System of *Periplaneta orientalis*.*—Dr. M. Koestler recommends the following process:—

The fresh parts of the animal to be examined are held over osmic acid for two to three minutes, washed, and transferred to weak alcohol. They are then stained with picro-carmine for twenty-four hours beneath the bell-jar of an air-pump, and are found to be perfectly hardened. When all traces of alcohol have been removed by washing they are placed in white of egg, freed by filtration from all fibres, &c.

At the end of about two hours the albumen is coagulated, first by weak and then by absolute alcohol, warmed to 40° C., so as to bring about as even a coagulation as possible. The object can then be treated in the usual way with oil of cloves, imbedded in paraffin, and cut with a microtome.

Fixing, Staining, and Preserving Infusoria.†—For fixing Infusoria, Dr. L. Cattaneo employs a watery solution of chloride of palladium, which hardens the organism in a few minutes without modifying its form or blackening it, and allows the granules and cell-nuclei to stand out prominently. Similar effects are produced by double chloride of gold and cadmium, which brings out the cell-nuclei much better than the former. For the study of protoplasmic networks iodide of mercury and potash (1–2 per cent.) is of use, as it stains the granules of the protoplasm black, and brings out clearly the granules of the cell-nuclei. Beautiful preparations can be made with corrosive sublimate, in 5 per cent. solution, which kills the infusorian instantly, and rapidly fixes all the anatomical elements. Further, it gives such consistence to the protoplasm that the most complex staining processes can be carried out.

Specimens treated with osmic acid are dark, and lose their transparency.

Cattaneo places in the second rank as fixing media chromic, picric, and picro-sulphuric acids, and bichromate of potash.

Preparations can be with advantage treated with nitrate of silver (1/2–1 per cent. solution), and afterwards washed with a solution of acid sulphate of soda. As staining reagents, magenta-red and fuchsin give good, and nigrosin and logwood still better results. Both

* Zeitschr. f. Wiss. Zool., xxxix. (1883) pp. 572–95.

† Bolletino Scientifico, 1883, Nos. 3 and 4.

nigrosin and logwood (Kleinenberg's) should be used in weak solutions, and allowed to operate for a long time.

The most preferable staining reagents are considered to be carmine and picro-carmine, which may be used singly or together. As mounting media, Cattaneo recommends glycerin and oil of cloves.

Preparing Euglena.*—Cooked turf, steeped in nutrient salt-solution, is advocated by Dr. G. Klebs as a good substratum for the cultivation of *Euglena* and *Algæ*. Carminic acid is employed for killing the cilia.

The membrane of *Euglena viridis* is almost entirely consumed by pepsin in twenty-four hours; that of *Phacus* is apparently unchanged after days. One ingredient is removed from the membrane of *Euglena* by the pepsin, while another remains behind in the original structure. The first belongs to the group of albuminoids, and the other must be considered as a cellular membrane substance.

Euglena can be kept for many weeks in nigrosin and indigo-carmine without taking up the colouring matter. Living specimens of *E. spirogyra* have been successfully stained with logwood. The whole membrane became dark blue, after first treating it with 0.5 per cent. solution of sodium chloride, to which 1 per cent. chromic acid was afterwards added. After several seconds the *Euglena* was washed and placed in a watery solution of logwood. The membrane can also be stained with carmine, eosin, and anilin-blue. With sulphuric acid it becomes yellow or brown. The whole membrane becomes yellow or nearly black when impregnated with hydrated oxide of iron.

It has not been found possible to separate the cytoplasm from the membrane even when a saturated solution of sodium or calcium chloride is applied. The separation is most easily effected by mechanical pressure, or by alcohol, best when the *Euglena* has been previously killed.

By the application of 10 per cent. sodium chloride the principal vacuole breaks up, and its water is absorbed. Alkaloids produce an enormous dilatation. With sulphate of quinine, only in *Phacus pleuronectes* and *P. pyrum* is a slight increase of the principal vacuole observed; but this is not the rule.

Preparing the Bacillus of Syphilis.†—In sixteen cases of syphilis Dr. S. Lustgarten has found characteristic bacilli in the initial lesion, lymphatic gland, papules, and products of the tertiary stage.

Sections hardened in alcohol are stained in Ehrlich-Weigert's gentian-violet from 12–24 hours at the ordinary temperature, and then for two hours at 104° F. They are then washed in absolute alcohol for several minutes, and transferred on a glass or platinum needle to a watch-glass containing about 3 c.cm. of a 1½ per cent. aqueous solution of permanganate of potash, in which they remain about ten seconds. A brown precipitate forms in the fluid and on the

* Untersuch. aus d. Botan. Institut. zu Tübingen, i. (1883) pp. 233–62.

† Wiener Med. Jahrb., 1885.

surface of the sections. They are then placed in an aqueous solution of chemically pure sulphurous acid, in which they lose the colouring matter in parts. They are next washed in distilled water, and again placed in the permanganate solution for 3-4 seconds, and afterwards in the sulphurous acid. The process is repeated until the sections are colourless, and they are then dehydrated, and mounted in the usual way.

The bacilli of syphilis, leprosy, and tuberculosis are not decolorized by this method; all other bacteria are. The bacilli of syphilis are decolorized by nitric acid. They appear as straight, curved, or irregularly bent rods, $3\frac{1}{2}$ - $4\frac{1}{2}$ μ in length, and under high powers their surface appears undulatory and slightly notched. Each bacillus contains 2-4 oval spores. The bacilli were always inclosed in cells varying from a trifle larger than, to double the size of a white blood-corpuscle, in the midst of the infiltration. The bacilli are found in them singly, in groups of two to nine or more, or in irregular confusion.

Methods for observing Protoplasmic Continuity.*—Mr. T. Hick, in an article on protoplasmic continuity in the Fucaceæ, says that he found the following methods, as a rule, furnished such favourable results, that, for the guidance of those who may wish to verify his statements, he gives them in full.

To obtain a general view of the structure of the thallus of the plant under investigation, thin sections were placed in fresh water for a few minutes and then stained with methyl-green acidulated with acetic acid. After well washing with water or acetic acid, the sections were put for a short time—varying in different cases—into alumcarmine. They were again well washed with water, swollen with strong ammonia, and mounted in glycerin. Sections prepared in this way turn out in a very pretty condition, the protoplasmic structures being coloured green and the framework a pale pink or violet. Before swelling with ammonia the sections must be thoroughly washed, to remove all traces of alum, as otherwise the ammonia will cause a precipitate of aluminic hydrate to be thrown down.

For the determination of more refined details the sections were treated as follows:—Having been washed with fresh water, they were stained with an aqueous solution of saffranin; again washed with water and swollen with strong ammonia; and finally mounted in glycerin. Thus prepared, the sections showed the protoplasts of a pink colour and their envelopes yellow, deepening here and there to brown.

Still more satisfactory results were, however, obtained thus:—Sections were soaked for from 3 to 12 or 20 hours in a mixture of strong sulphuric acid 1 part, and water 3 parts. They were then washed, stained with saffranin as in the preceding process, and mounted in a mixture of glycerin and ammonia. If the ammonia is employed to swell the sections before mounting, they become so much disintegrated that it is then impossible to transfer them to a slide.

* Journ. of Bot., xxiii. (1885) pp. 97-102.

In good sections prepared by either of the first two methods a suspicion of the existence of continuity will be created by the appearance of the cell-contents. A mere suspicion, however, is not sufficient, and to be convinced that it actually exists the ends of the cells must be more closely investigated. For this purpose sections prepared by the third method must be made use of, and even these must be supplemented by others of a still more demonstrative character. The latter may be obtained by slightly modifying the modes of treatment as follows:—

1st. Sections that are to be treated by the second method should be previously placed for a few moments in a weak solution of ordinary bleaching powder.

2nd. Sections that have been treated by the third method should be warmed gently in a mixture of equal parts of glycerin and potash solution, before being mounted in glycerin and ammonia.

Tolu instead of Chloroform for Imbedding in Paraffin.*—Dr. M. Holl finds that objects imbedded in paraffin can be better and more easily cut when they have been previously treated with tolu instead of chloroform. After the object has been hardened in alcohol it is placed directly into the tolu for twenty-four hours (or less for small objects), and transferred from it to the paraffin bath, in which it is also kept for twenty-four hours.

Imbedding Small Objects.†—For imbedding small objects, e. g. embryos or parts of them, Dr. L. Gerlach gives the following receipt:—40 grm. gelatin are added to 200 c.cm. of a saturated solution of arsenious acid, with 120 cc. of glycerin. This fluid is clarified with white of egg, and remains perfectly clear for years in a well-stoppered bottle. Objects hardened in alcohol are most suited for imbedding in this mass. They are, prior to imbedding, placed in weak glycerin (glycerin 1 part, water 2 parts), to which some thymol has been added, for two hours or more, according to their size. So as to remove all traces of alcohol, the fluid is changed from hour to hour.

Advantages and Disadvantages of Different Forms of Microtome.‡—Dr. M. Gottschau has a useful summary of the advantages and disadvantages of different microtomes.

Microtomes are referable to two types. In one (e. g. Oschatz's) the object is raised by a micrometer screw, in the other (e. g. Rivet's) by altering its position on a plane which gradually rises towards the horizontal cutting edge of the knife. In the former a free application of the knife in any direction is feasible; but where the object is slid on a rising rail, the knife must be fastened and guided on a horizontal slide. In the former, again, the preparation must be so firmly clamped or imbedded that it rises without lateral displacement. It is raised by the screw to the fraction of a mm. above the upper opening of the

* Zool. Anzeig., viii. (1885) pp. 223-4.

† Gerlach, L., Beiträge z. Morphol u. Morphogenie. Unters. a. d. Anat. Inst. Erlangen, i., Stuttgart, 1884.

‡ Zeitschr. f. Wiss. Mikr., i. (1884) pp. 327-48.

cylinder, and this projecting part is cut off by the knife. The upper edge of the cylinder is fixed into a metal plate, usually covered with glass, on which the knife is guided by the hand, and a quiet and steady movement of the same obtained.

The possibility of making fine sections does not depend solely on the small and uniform raising of the preparation, but especially on the fixing of the preparation, and the impossibility of lateral displacement from the horizontal. The slightest imperceptible change of direction of the object must produce unevenness of the section.

In cylinder microtomes of older construction the preparation is clamped or imbedded in a glass tube; in others (Ranvier, Gudden, Oschatz) the cylinder is closed below by a plate which is moved by a screw. The hollow cylinder is filled with paraffin, spermaceti, &c., and the preparation imbedded in the mass, so that fine rings of the imbedding mass are removed with the sections. Unless the imbedding mass is quite close to the wall of the cylinder it is not firmly fixed, and even sections cannot possibly be made. But this is impossible if the imbedding mass is to be raised in the cylinder, and, further, all imbedding masses contract on cooling. It is a very difficult matter to make micrometer-screws faultless, i. e. with absolutely regular distances of the threads. Even if it were possible to make a faultless male and female screw, it would entail more trouble and cost than a rail on which a slide is uniformly raised.

Whilst, in preparations raised perpendicularly by a screw precision can hardly be obtained for $1/200$ mm., slide microtomes are now made which raise the object $1/1000$ mm. A further objection to the screw micrometer is the wearing of the screw, whereas a slide microtome, when properly used (i. e. when one does not always use the slide only at one place, but allows it to traverse, when possible, the whole rail), is always better for use, as the slide is always carried symmetrically over the rail.

Attempts have been made to remedy the defects of screw microtomes of older (cylinder) construction. The movability of the object in the cylinder and the difficulty of fixing it satisfactorily have been abolished by a slide, which carries the preparation in place of the cylinder. The preparation is tightly fastened to it by a clamp. This method of fastening and raising offers more advantages than the earlier ones, but one must not overlook the fact that the grooves and edges of the slide must be made to fit as accurately as possible, and that even slight wearing produces a loosening of the slide and an appreciable, if slight, movableness of the object.

In the improved screw microtomes, as also in those which carry the preparation on a slide which is moved in a vertical direction, the screw should, after use, be turned to the end. By use a wearing of the screw as well as of the slide-guide is inevitable, with consequent loosening and inaccuracy of raising.

In all microtomes which are used for fine work the knife is no longer guided by the unaided hand, but by a slide which runs in a horizontal plane, and to which the knife is screwed. The position of the edge is of great importance in the preparation of fine sections.

The knife should pass through the object to be cut in as nearly as possible its whole length. If we make a drawing so as to appreciate the course of the knife better, we obtain (fig. 120) an ideal knife-guidance by hand. In this case the knife *m* runs in a sagittal direction obliquely through the preparation *Pr*, and thus passes through it in its entire length. (The dotted lines show the course of the individual sections of the knife.)

If we alter this drawing only by bringing the knife into the position shown in fig. 121, and cut in the inverse direction from left to right, in which we draw the knife in a "sagittal" direction towards us, we have the course of the knife on the microtome, and the same figure as before, only that, in the latter case, the knife must be a trifle longer, and the position of the preparation to it is more oblique. If we lay, in a special case, particular value on the direction in which the knife glides through the object, we can easily alter the position of the object in such a way that the individual segments of the edge pass through the preparation in precisely the same way as in fig. 120. The dotted line *Pr'* marks the position thus altered.

The longer the knife is in proportion to the preparation to be cut, the less must be the pressure applied in cutting; the shorter the distance over which the knife is used, the greater must be the pressure which is applied with similar size of the object, and the more will the edge crush and chisel. A surface which has been cut through is more smooth and uniform than one which has been pressed on, and the greatest possible use of the edge of the knife offers the best guarantee for perfect sections.

The position of the surface of the knife to the cut surface must also be taken into account. A knife must be applied the more flat the finer the piece to be cut; if the knife is placed in a steep direction, the edge scrapes. The finest and most perfect sections are obtained with a knife when it is in such a position that the side of the knife which is turned towards the cut surface only touches the object at the extreme margin of the edge.

Above all it is necessary to test the edge of the knife, and the shape of the cross-section of the knife. All our ordinary table, bread, or meat knives in their cross-section have the form of a wedge with straight sides, i. e. of an isosceles triangle (fig. 122 *a*). If it is blunt it should have a steel passed over it, applying it not perfectly flat, but at the sharpest possible angle to it; the result of this being that the whole surface is not ground, but only its extreme edge, so that the wedge assumes a pentagonal instead of a triangular form, as is shown on an enlarged scale in fig. 122 *b*. The newly made surfaces do not converge

FIG. 120. FIG. 121.

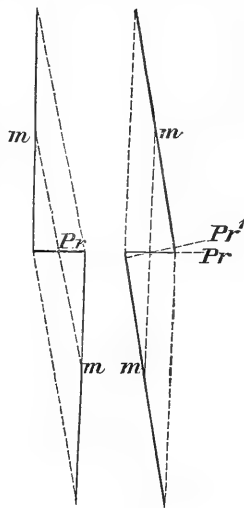

at such a sharp angle as they did originally, and the edge is, in consequence, not so sharp. The harder the object which is to be cut through, the thicker the iron, and the blunter the angle of the edge, the more frequently must the cutting surface be sharpened and ground. In fine knives the transformation of the triangular into a pentagonal wedge must have a very prejudicial influence on the capacity of the edge, but careful grinding of the whole surface takes up much time, so this means has been devised of grinding the knife hollow, as it must always be kept hair-sharp. We distinguish between whole and half-hollow ground knives. It is a great error to lay the hollow ground knife obliquely, and not perfectly flat on the sharpening surface. Half-hollow ground knives should be laid on the strop as shown in fig. 123 in cross-section. In whole-hollow ground razors the

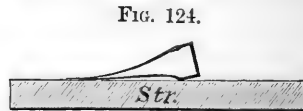
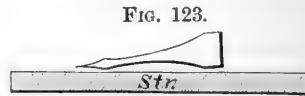

anterior margin of the edge lies flat on the surface of the stone or strop, and the ground surfaces consequently converge at a very acute angle (fig. 124). But this advantage is combined with a serious disadvantage for our purpose, that the edge, which is almost as thin as paper, is very unresisting, and easily bends and gives way before the object to be cut. After all, one should not select such a knife as the latter for a microtome, and it is only useful for quite soft and unresisting preparations. Two forms of knife have proved themselves to be sufficient in practice. The one is only slightly hollow ground, and is used for hard objects; the other, which is the most useful, has the side which is directed upwards whole-hollow ground, and the lower side either quite plane or only slightly hollow. If it is plane a thin wire is placed at the back during sharpening, so that only that part which is next to the edge, and not the whole surface, is sharpened (fig. 125).

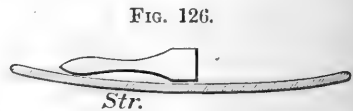
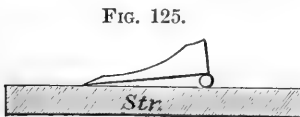

Of all razor strops for knives, those are to be rejected in which two leather straps, which can be stretched tight at pleasure, furnish the rubbing surface. An inflexible knife must, if a fine edge is to be obtained, be moved backwards on a perfectly plane and hard surface. This assertion is best established by reference to fig. 123

in which the shape of the knife is of the well-known form, whereas on a curved leather strop (fig. 126) the surfaces which form the edge are not plane, but convex, and meet in two arcs.

The two figures differ especially in the angle at which the surfaces of the edge meet, and this angle is more blunt with soft strops. It is hardly necessary to mention that the flat-lying knife should not be pressed firmly during sharpening, as by pressure the leather is pressed down and a convexity produced on the edge.

As regards the direction of the under surface of the knife to the cut surface, the knife-slide of several microtomes is provided with an arrangement by which the inclination can be increased or diminished at pleasure. If one is cutting a hard object, e. g. ebony or bone, the knife must be set more steeply than for soft wood. But such an arrangement seems superfluous, as one can by manipulation so adjust the knife for hard substances that when screwed into the slide it has a more slanting direction. A slight difference in the inclination of the knife, as a rule, has little or no effect on the making of fine sections. A sharp-angled knife always does its duty, while a blunt one must be set more steeply, but scrapes rather than cuts.

Uniform hardening and imbedding of the preparation is of primary importance. Every paraffin imbedding-mass is only able to be cut within certain definite limits of temperature, and the recent modifications, which consist of admixture with tallow, spermaceti, oil, and other fats, do not solve the secret of an equally suitable mixture for all temperatures. Experience tells us that a mixture with a low melting point is cut at a temperature of 17° C. rather than at 25° C., and that one generally gives up making sections in series at a temperature of 30° C. and upwards, as the cooling in the water or spirit takes place too quickly.

In recent times too little attention has been paid to the fixing of the knife. In the microtome of Fritsch the author first learned a method by which the free end of the knife can be fixed. A spring screwed into the knife-slide exercises, by means of a screw at its free end, a slight pressure on the end of the knife, and keeps it perfectly firm.

When the earlier slide microtomes (e. g. Long's) are much used their precision fails, and uniformly thin sections cannot be made. Further, in cutting, the knife-slide runs stiffly, so that it has to be constantly taken out and oiled. Thoma constructed a rail in which the slide runs on 5 narrow (2-3 mm.) points, which give great steadiness and easy motion to the slide when this is accurately fitted. In Jung's microtome the knife-slide runs on five, the object-slide on six points. Here too the whole rail should, when possible, be traversed by the slide, as, by unequal usage of the long rail, the knife glides inaccurately.

A preparation slider, which moves the preparation forwards by a screw instead of the hand, is found in Spengel and Jung's microtomes. In the former the screw is of the same length as the instrument, and is attached to the side of the instrument. In the latter the screw is shorter, and possesses a pawl, by which the desired revolution of the

screw is made appreciable to the ear, an advantage which one appreciates when cutting sections in series.

The most certain and suitable method of fastening the preparation is between plates, which can be screwed together or apart at pleasure, so as to obviate loosening by temperature, &c.

The simplest form of such apparatus is the pincer, which is added to most slide and screw microtomes. The author has had constructed

FIG. 127.

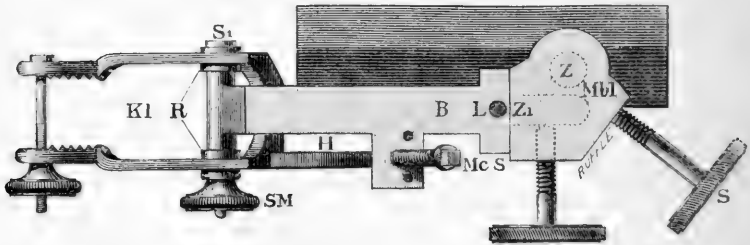

a "clamp for wedge and plane parallel sections," in which the position of the preparation can be changed in three dimensions in a moment, and with which one can make wedge or plane parallel sec-

FIG. 128.

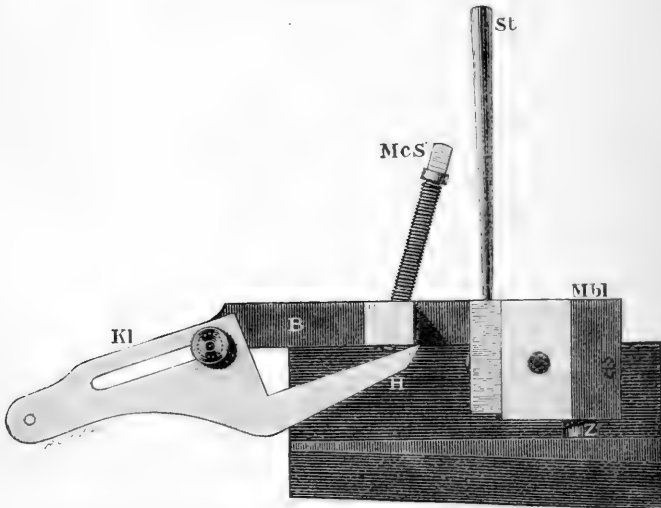

tions of definite thickness. This apparatus as at present made (figs. 127-129) presents the following features:—

The pin Z which carries the whole apparatus, is placed further

back than in Long's microtome. On the pin is a brass block Mbl, which is movable in a horizontal plane and can be fixed by a screw S. In the brass block is a solid beam B, ending in a round pin Z₁. This beam is penetrated at its free end by a steel screw S₁, on which is set a clamp Kl, movable in a backward and forward direction in a slit. This is intended to hold the preparation, and can be pushed 2 cm. forwards or backwards, and is movable on the axis S₁. The clamp is fastened, when it has been brought to the most suitable position, by a female screw SM, which acts on the axes of its two branches and

FIG. 129.

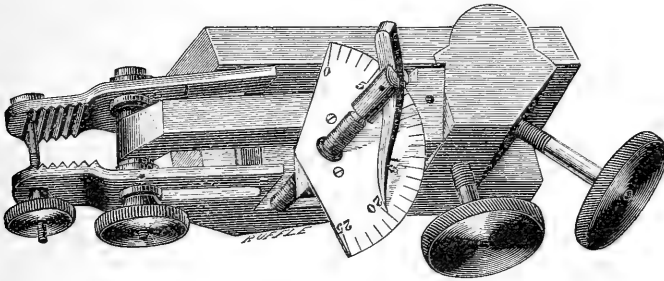

presses them against a metal tube R, so that after fastening displacement is impossible. Below, the clamp communicates with a lever H, which is of the same length as the clamp. A micrometer screw McS presses on the lever and runs in a side-piece of the beam B. By greater or less turning of this screw one can at pleasure make sections of any degree of thickness. In order to be able to move the screw with accuracy, a quadrant divided into 25 parts is placed on the cross-beam, and a small key on the screw carries the pointer. At the end of the beam is a hole, in which a long steel pin St is fixed, with which the movement around the "sagittal" axis is effected.

Schanze's Microtome.—We append fig. 130, showing Herr M. Schanze's microtome,* which is deserving of record as being the original form on which was founded Mr. Bulloch's instrument, as well as that described *ante*, p. 344. Like that of Körting,† it is a combination of the screw and the slide arrangement, the knife being attached to a slide, while the object is raised by a vertical screw S, which is graduated, each division corresponding to a rise of 1/100 mm. This screw works against a plate P, which slides in a dovetail in the vertical plate W and carries the clamp. Two axes at right angles, controlled by thumb-screws, allow of the object-clamp being inclined in any direction. There is a freezing attachment, in addition to a holder for clamping hard specimens and another for objects which have been hardened with any of the usual reagents.

* Cf. Fol's Lehrbuch d. Vergl. Mikr. Anatomie, 1884, pp. 128-9 (1 fig.).

† See this Journal, i. (1881) p. 693.

A special advantage of this arrangement is that the screw is at the side of the object and not directly under it, so that it is not injured by fluid dropping from the object.

FIG. 130.

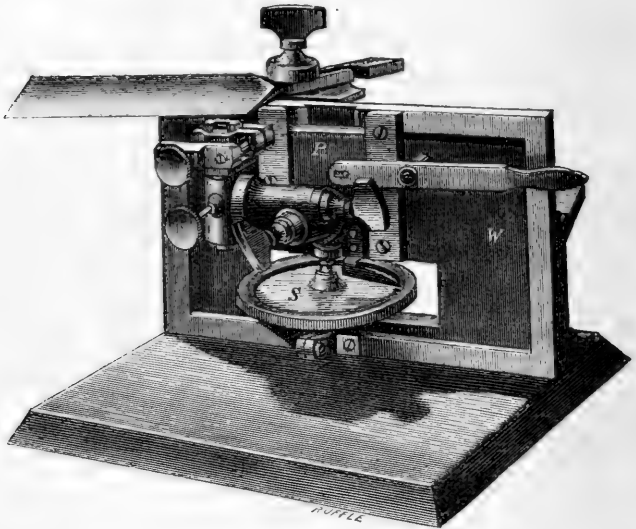

Bulloch's Combination Microtome.*—This microtome which has lately been constructed by Mr. W. H. Bulloch, is claimed to be a combination of the best points of the German and French instruments with some of his own improvements. A general idea of the construction is shown in fig. 131. The main slide for the knife-carrier is $10\frac{1}{2}$ in. long; the height to the cutting edge of the knife $5\frac{1}{2}$ in.; the knife-carrier is made with eight ivory bearings—four on each side—which provide a smooth and easy running surface, which does not require to be lubricated. At each end of the main slide there is a stop with rubber cushions, to prevent the carrier passing over the end. The upper surface of the knife-carrier is made adjustable, so that the knife can be made to cut at whatever inclination is found best. The knife can also be placed at an angle for cutting, or adjusted to cut at right angles for cutting sections into ribbons. The screw for elevating the slide and holder is graduated to $\frac{1}{200}$ mm., and has a spring-click for registering. The spring-click can be turned aside when not required.

The holder for the material to be cut has universal motion, so that the specimen can be adjusted to be cut at any plane. Each movement is independent of the others, and all are so combined that

* Amer. Mon. Micr. Journ., vi. (1885) pp. 45-6 (1 fig.).

the specimen is not raised or lowered in adjusting. For the convenience of using the knife square, or at a right angle to the direction of motion of the knife-carrier, and also for cutting sections in ribbons,

FIG. 131.

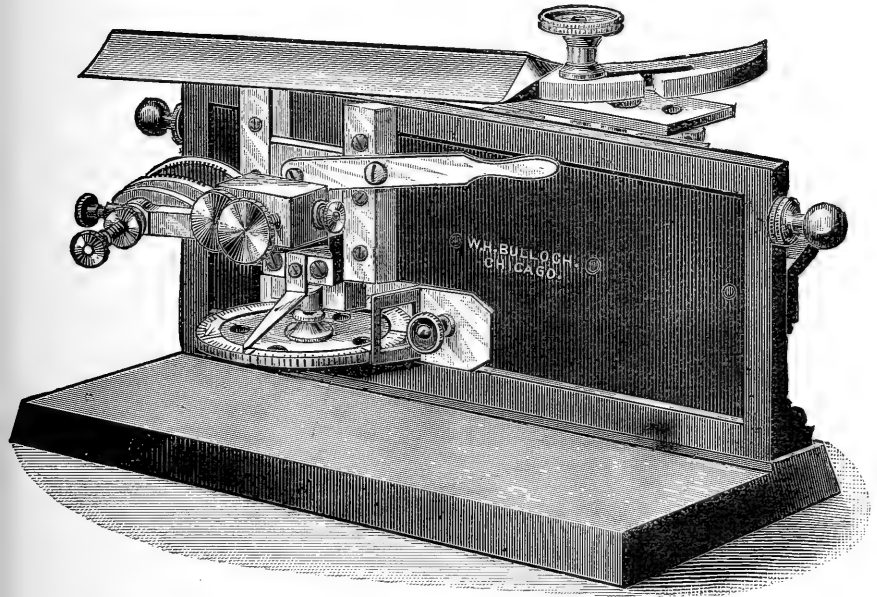

the holder is reversible, in which position the specimen is in about the centre of the slide. There is also the German freezing attachment, with atomizer.

The base and upright are of japanned iron, the other parts of brass, nickel plated. The case is so made that it is not necessary to remove the instrument when operating, as it unfolds, and will lie flat on the table.

Cambridge Rocking Microtome.—The Cambridge Scientific Instrument Company have just introduced an improved and greatly simplified microtome for producing ribbons of sections imbedded in paraffin (fig. 132).

The principle of the simplification is in the employment of a rotary instead of a sliding movement of the parts. The continuous moving silk band which is used in all previous forms is entirely done away with, and the ribbon of sections falls by its own weight direct from the razor on to a sheet of paper or on to the glass slide on which the sections are to be finally mounted.

The construction of the instrument is as follows:—Two uprights are cast on the base-plate, and are provided with slots at the top into which the razor is placed and clamped by two screws with milled

FIG. 132.

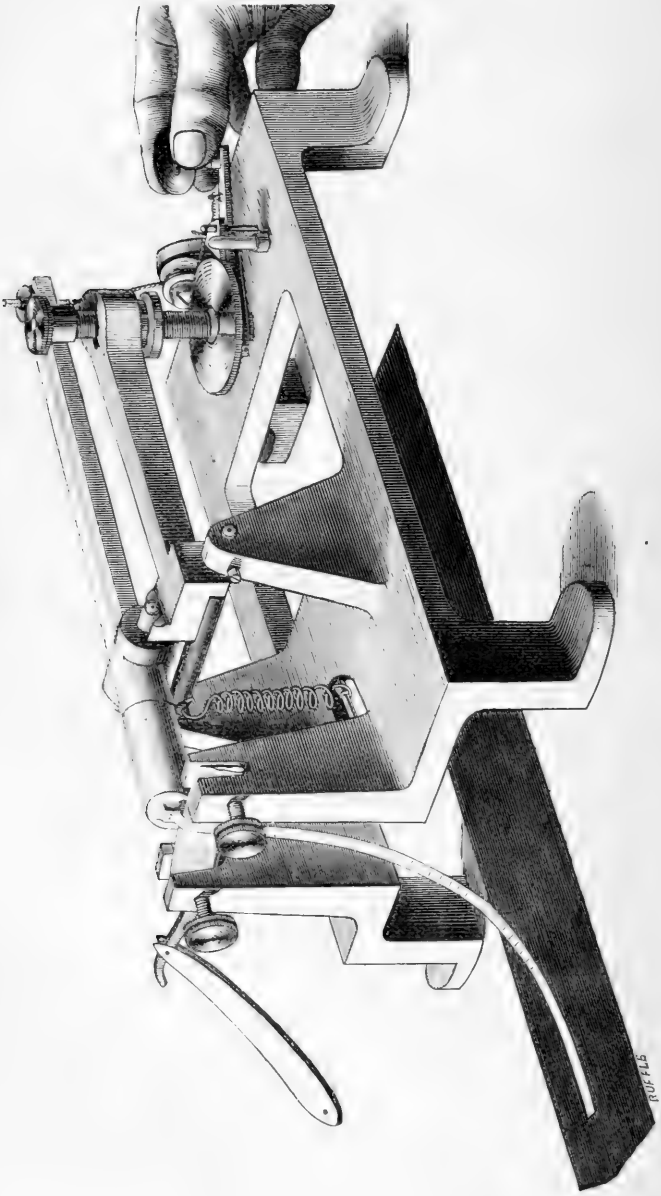

CAMBRIDGE ROCKING MICROTOME.

heads. The inner face of the slot is so made as to give the razor that inclination which has in practice been found most advantageous. The razor is thus clamped between a flat surface and a screw acting in the middle of the blade, and the edge of the razor is consequently in no way injured.

The imbedded object is cemented with paraffin into a brass tube which fits tightly on to the end of a cast-iron lever. This tube can be made to slide backwards or forwards, so as to bring the imbedded object near to the razor ready for adjusting. The cast-iron lever is pivoted at about 3 in. from the end of the tube. To the other end of this lever is attached a cord by which the motion is given, and the object to be cut brought across the edge of the razor. The bearings of the pivot are V-shaped grooves, which themselves form part of another pivoted system.

Immediately under the first pair of V's is another pair of inverted V's, which rest on a rod fixed to two uprights cast on the base-plate. A horizontal arm projects at right angles to the plane of the two sets of V's; the whole being parts of the same casting. On the end of the horizontal arm is a boss with a hole in it, through which a screw passes freely. The bottom of the boss is turned out spherically, and into it fits a spherical nut working on the screw. The nut is prevented from turning by a pin passing loosely through a slot in the boss. The bottom of the screw rests on a pin fixed in the base-plate.

It will be seen that the effect of turning the screw is to raise or lower the end of the horizontal arm, and therefore to move backwards or forwards the upper pair of V's, and with them the lever and object to be cut. The top of the screw is provided with a milled head, which may be used to adjust the object to the cutting distance.

The distance between the centres of the two pivoted systems is 1 in. and the distance of the screw from the fixed rod is $6\frac{1}{4}$ in. The thread of the screw is 25 to the inch; thus, if the screw is turned once round the object to be cut will be moved forward $1/25$ of $1/6\frac{1}{4}$ or $1/156$ in.

The turning of the screw is effected automatically as follows:— A wheel with a milling on the edge is fixed to the bottom of the screw. An arm to which a pawl is attached rotates about the pin which supports the screw. This arm is moved backwards and forwards by hand or by a cord attached to any convenient motor. When the arm is moved forward the pawl engages in the milling and turns the wheel; when the arm is moved back the pawl slips over the milling without turning the wheel. A stop acting against the pawl itself prevents any possibility of the wheel turning, by its own momentum, more than the required amount. The arm is always moved backwards and forwards, between two stops, a definite amount, but the amount the wheel is turned is varied by an adjustable sector, which engages a pin fixed to the pawl and prevents the pawl from engaging the milling on the wheel. By adjusting the position of this sector the feed can be varied from nothing to about $5/32$ of a turn, and hence, since the screw has 25 threads to the inch, the thickness of the sections cut can be varied from a minimum, depend-

ing on the perfection with which the razor is sharpened, to a maximum of $5/32$ of $1/25$ of $1/6\frac{1}{2}$ or $1/1000$ of a turn. The practical minimum thickness obtainable with a good razor is approximately $1/40,000$ in. The value of the teeth on the milled wheel are as follows:—

1 tooth of the milled wheel	=	$1/40,000$ in.	=	$\cdot 000625$ mm.
2 teeth	"	"	=	$1/20,000$ " = $\cdot 001250$ "
4 "	"	"	=	$1/10,000$ " = $\cdot 0025$ "
16 "	"	"	=	$1/2500$ " = $\cdot 01$ "

The movement of the lever which carries the imbedded object is effected by a string attached to one end of the lever. This string passes under a pulley and is fastened to the arm carrying the pawl. Attached to the other end of the lever is a spring pulling downwards.

When the arm is moved forward the feed takes place, the string is pulled, the imbedded object is raised past the razor, and the spring is stretched. When the arm is allowed to move back the spring draws the imbedded object across the edge of the razor, and the section is cut. The string is attached to the lever by a screw which allows the position of the imbedded object to be adjusted so that, at the end of the forward stroke, it is only just past the edge of the razor. This is an important adjustment, as it causes the razor to commence the cut when the object is travelling slowly and produces the most favourable conditions for the sections to adhere to each other.

The following are perhaps the most prominent advantages of this instrument. (1) The price is one-sixth that of the original form. (2) Less skill is required from the operator, for the endless silk band is superseded, and the troublesome and difficult operation of lifting the first sections from the razor on to the silk band is entirely avoided; the ribbon of sections now falls of its own weight direct from the razor on to a piece of paper or glass slide placed to receive them, and by occasionally moving the paper forward any length of ribbon can be obtained. (3) The razor is fixed at what has in practice been found the most advantageous inclination and angle for cutting, and thus an unnecessary adjustment and waste of time is avoided. (4) The imbedded object is with great ease and quickness brought up to or away from the edge of the razor; first for large amounts by sliding backwards or forwards the brass tube on the cast-iron lever, then for smaller amounts by turning round the screw, when the pawl is out of gear, by means of a small milled head placed on the top for this purpose. (5) There are no delicate working parts which can get out of order, and the whole instrument is easily taken apart for packing and is very portable.

"Ribbon" Section Cutting.*—Mr. A. B. Lee gives the following as the factors necessary for the production of a chain of sections:—

First, the paraffin must be at a melting-point having a certain relation to the temperature of the laboratory. Insufficient experiments have yet been made to settle the melting-point of the paraffins that should be used at the different temperatures at which sections

* 'The Microtome's Vade Mecum,' 1885, pp. 400-1.

are usually cut; but at least one point can be indicated with considerable accuracy. *Small* sections can always be made to chain when cut from a good paraffin of 45° C. melting-point in a room in which the thermometer stands at 16° to 17° C. (The temperatures quoted apply to the case of rooms heated by an open fire, and probably would not apply to the case of rooms heated by closed stoves, such as are usual in Germany.) At 15° C. the paraffin will be found a trifle hard. At 22° C., the proper melting-point of the paraffin will probably be found at about 48° C. Second, the knife should be set square. Third, the block of paraffin should be pared down very close to the object, and should be cut so as to present a straight edge parallel to the knife-edge; and the opposite edge should also be parallel to this. The block should in no case be cut so as to present a pointed side, as recommended at the Naples Zoological Station.* Fourth, the sections ought to be cut rapidly, with the swiftest strokes that can be produced. It is evident that this condition can only be conveniently realized by means of a sliding microtome; but it is by no means necessary to have recourse to special mechanical contrivances, as in Caldwell's automatic microtome. The Thoma microtome, well flooded with oil, is sufficient.

Rapid Method of making Sections of hard Organized Substances.†

—Dr. F. v. Höhnel first files the object (e. g. a piece of hard wood) level with an ordinary file, and makes the surface quite even with finer files. A piece (1/2–1 mm. thick) is then split off with a scalpel or cut with a saw from that portion which has been filed smooth. A drop of Canada balsam is then placed on a slide, and on it the piece of wood, with the filed surface below, and the slide warmed till the balsam is melted. The wood is then pressed down firmly with the finger, and the slide set on a cold metal plate till the balsam is cold, a small piece of blotting-paper being laid on the object, which is pressed firmly on the slide with a soft cork. The blotting-paper and superfluous balsam are then removed. The section is next filed, till it is so thin as to be transparent, with a coarse file, and with finer files until it is quite smooth and shining. If the section is to be quite faultless it is rubbed for a short time on a dry Mississippi or Arkansas stone, which should be freed from adherent particles of resin with a cloth damped with alcohol. After the final filing and polishing the slide and edge of the object are cleaned with a towel wetted with alcohol. The object is then mounted in Canada balsam or glycerin. In this way ten to twelve sections can be prepared in a day.

Contribution to the History of Staining.‡—Prof. G. Holzner writes to claim that G. C. Reichel, of Leipzig, was the originator of the process of staining for histological purposes. In his 'De vasis plantarum spiralibus,' 1758, he not only pointed out the different behaviour of the tissues and their elements with a decoction of log-wood, but used the reagent for the discovery of the vessels.

* See this Journal, iii. (1883) p. 917.

† Zeitschr. f. Wiss. Mikr., i. (1884) pp. 231–5.

‡ Ibid., pp. 254–6.

Staining for Microscopical Purposes.*—In continuance of his former articles, Dr. H. Gierke gives a tabular account of (1) the use of anilin dyes for ordinary and bacteriological investigations; (2) the differentiation of tissue-elements by the reduction of silver salts, especially nitrate of silver; (3) impregnation of tissues with chloride of gold, and chloride of gold and potassium; (4) treatment with osmic acid.

Staining Technique.†—For studying cell-division and bringing out nucleoli, Dr. W. Flemming hardens the fresh tissues in the following mixture:—Chromic acid (1 per cent.) 15 parts; osmic acid (2 per cent.) 4 parts; glacial acetic acid 1 part, or less. The pieces remain therein two to three days for complete hardening. They are then washed in water, and, for cutting, further hardened in alcohol, or cut under alcohol, and washed in water. They are then stained in strong saffranin solution and washed in absolute alcohol (with 0·5 per cent. hydrochloric acid).

For staining the inner root-sheath of hairs, the sections are placed for several hours to one day in picrocarmine of medium strength, and then for several hours in Grenacher's logwood,‡ washed in water, and mounted in glycerin or cloves. The fibrillæ of the connective tissue are rose or red; muscles, yellowish red; all cell-bodies, similar; cell-nuclei, dark purple-violet; horny substance of the hair, picric yellow (pale greenish in old chromic preparations); the inner root-sheath, so far as it is horny, of a brilliant light-blue colour.

As a simple method of staining cell-substance and other parts yellow, treatment with an alcoholic solution of picric acid is recommended, after staining with logwood, alum-carminc, or other nuclear stains. This can be applied to specimens hardened in alcohol, bichromate of potash, chromic, picric, or osmic acids.

Susceptibility of the Different Tissues to Colouring Matters.§—Prof. Ehrlich has obtained some physiologically important results from investigations into the susceptibility of the different tissues to colouring matters.

When colouring solutions—in particular methyl-blue—were injected into living animals, and then, with the utmost expedition, particular tissues were examined, interesting reactions of the living tissue under the colouring materials would be perceived, which, in spite of their rapid evanescence, revealed important facts which by other methods were in part wholly unascertainable, in part to be ascertained only with difficulty.

After the injection of methyl-blue, Prof. Ehrlich found in the submucous tissue of the tongue very numerous fibres and fibrous reticula coloured intensely blue, which sent processes to the epithelial formations, and it was easy to determine that these fibres were the

* Zeitschr. f. Wiss. Mikr., i. (1884) pp. 372–408.

† Ibid., pp. 349–61.

‡ Flemming, W., 'Zellsubstanz, Kern- und Zelltheilung,' 1882, p. 383.

§ Nature, xxxi. (1885) pp. 547–8. Report of Proceedings of Berlin Physiological Society, 27th Feb., 1885.

axis cylinders of the sensory nerves. These blue-tinged axis cylinders were found very numerous in the gustatory cuplets, at the bases of which they formed a quite narrow reticular network, whence, single fibres ending in knots proceeded anteriorly to the ciliated cells. Networks of blue fibres were found very copiously and closely in the cornea. The iris likewise showed blue plexuses, particularly on the anterior side; on the posterior side only long cancellated reticula were observed. In the muscles, on the other hand, were found only detached blue fibres, the ending of which in the muscle-fibre could not be established. The axis cylinders of the motor nerves were, according to this experiment, not coloured by methyl-blue during life; it was only the sensory nerves which reacted to the colouring matter. The vessels, arteries, capillaries, and veins were surrounded by blue plexuses. It could not, however, be decided whether the blue fibres proceeded to the smooth muscle-cells. In the retina the nervous layer showed no blue colouring. In the ganglion layer, on the other hand, cells richly charged with blue, and having numerous branching processes, were found, which, too, were in communication with the processes of neighbouring cells. In the mixed nerve-stems and in the roots of the nerves no blue fibres were found. The central ends, on the other hand, showed a decided methyl-blue reaction, as did also the peripheral ends of the sensory nerves. In the brain, blue fibres were found only rarely, but were very abundant in the medulla oblongata, while they were wanting, again, in the spinal marrow, and from these results it appears that the colouring of living organs with methyl-blue is a very important means of observing the endings of sensory nerves in them.

It must, however, be borne in mind, that the examinations had to be prosecuted very rapidly after the colouring process, because, in living tissue, the colouring material was lost by diffusion very quickly—in the course of a few minutes—and the colouring of the axis cylinders disappeared.

Staining the Nervous System of the Muzzle and Upper Lip of the Ox.*—Dr. J. Cybulsky recommends the following method:—

Fresh pieces of the epidermis with a thin layer of the corium are imbedded in elder-pith, and cut with a knife wetted with alcohol and water. The sections are placed for a quarter to three-quarters of an hour in a weak solution of chloride of gold, washed with distilled water and placed in a hermetically sealed vessel in a solution of tartaric acid (saturated or diluted to 1/2). This is placed in water warmed to 50°–60°. Already, in a quarter of an hour, a bright red or bluish striation appears in the sections in consequence of the reduction. The proper degree of staining can only be learnt by experience. If the reduction is continued for a long time the acid must be renewed.

Employment of Colouring Matters in the Study of Living Infusoria.†—M. A. Certes finds that dahlia, chrysoidin, nigrosin, methyl-blue and iodine-green have the property in different degrees of colour-

* Zeitschr. f. Wiss. Zool., xxxix. (1883) pp. 653–82.

† CR. Soc. de Biologie, April 5th, 1885.

ing the nucleus, which, in living infusoria, is not coloured by quino-lein-blue or Bismarck-brown.

Very weak aqueous solutions of dahlia, acid-green, and malachite-green colour the nucleus of a large number of ciliate and flagellate Infusoria. Diphenylamine-blue, on the contrary, even in solution of a deep hue, has no toxic action on Infusoria, which live and develop in it without any coloration being produced, except in the stomachal vacuoles from the ingestion of coloured food.

The solutions of dahlia, acid-green, and malachite-green should be made with the water in which the organisms to be studied are living. The resistance to the toxic action of the staining reagents is not the same in every species. M. Certes has succeeded with solutions of 1/10,000 as a maximum, and 1/100,000 as a minimum.

With dahlia and malachite-green the nucleus behaves differently in species which are closely connected, and in the same species the division of the chromatic material, or the affinity of the nucleus for colouring matters vary according as the infusoria are more or less distant from a period of reproduction by conjugation, e. g. malachite green colours intensely the double nuclei of *Stylonychia mytilus*, various *Oxytriches*, &c., while the simple nucleus of *Paramœcium aurelia* is more faintly stained.

With dahlia, the coloration, more intense in the nucleus, extends, but more faintly, to the rest of the parenchyma. There is often a more coloured zone at the anterior part of the animal, and the sarcod expansions, formed of glycogen, take a feeble tint, which does not seem to occur in Infusoria treated by other colouring materials.

The stomachal vacuoles are always strongly coloured whatever the reagent employed, owing to the vegetable matter or dead animals which are ingested. If a living infusorian is swallowed by a carnivorous infusorian, it only becomes intensely coloured when it has been killed by the action of the gastric juices.

Even deeply coloured solutions of diphenylamine-blue and the blues of Poirrier (B S E and C 3 B) have no toxic action on Infusoria, while they colour and rapidly kill a number of bacteria.

The contractile vacuole is never coloured, except perhaps by dahlia, which faintly stains the sarcod expansions.

Dahlia, acid-green, and malachite-green, &c., bring about in most species slowing of their movements from a kind of paralysis. The contractions of the contractile vacuole first become less frequent, and this morbid phenomenon seems to explain the dropsy which ensues before death.

M. Certes noticed some peculiar phenomena in some Stentors which had been living for several days in a solution of Poirrier blue. The accumulation of the liquid had transformed the individuals into a large soapy bulla, the wall of which contained the nuclei and buccal ciliary apparatus. At a given moment, one of the individuals began to open, and rejected the enormous vacuole inclosed in a special wall and almost as large as itself. It then closed up and swam about apparently unhurt, while the vacuole remained inert at the spot where it was rejected, and became coloured blue.

After the action of malachite-green many organisms die in a state of extension; in *Vorticellas* the contractile peduncle becomes inert, and its central part coloured, before the vibratile cilia lose their movements and the peristoma ceases to contract.

By the simultaneous employment of dahlia and malachite-green the nucleus can be stained green and the protoplasm violet.

Diphenylamine-blue, which colours deeply vegetable débris, dead organisms, and some living microbes, colours neither parenchyma, nucleus, nor contractile vacuole of Infusoria, except the central part of the contractile peduncle of *Vorticellas*.

M. Certes has tried the cultivation of micro-organisms on plates of jelly coloured by diphenylamine-blue. The development of the colonies goes on in the usual way. Some remain uncoloured; others, apparently identical, are coloured. The jelly becomes decolorized whenever it is liquefied by the organisms.

Staining *Vaucheria* and *Chara*.*—Dr. J. Schaarschmidt finds that the granules of *Vaucheria* (*V. sessilis*, and *V. geminata*) which have been treated with osmic acid, glycerin, and alcohol, show different reactions with stains and reagents to those of *Saprolegnia*. The internal spongy part of the younger granules takes up the staining material with avidity, whereas the peripheral part remains colourless or only faintly stained.

They are most strongly stained by nigrosin, rosanilin, eosin, and saffranin; methyl-violet and gentian-violet stain especially the inner part of the granules. They are very resistant to strong chemicals, and in dilute or fairly concentrated sulphuric acid they are hardly altered even after several days. They are only dissolved by quite concentrated sulphuric acid.

Staining of Koch's *Bacillus*.†—Dr. B. Frankel proposes the following formula and methods:—

3 c.cm. anilin oil are dissolved in 7 c.cm. alcohol (or 1.5 c.cm. toluidin in 8.5 c.cm.) and added to 90 c.cm. of distilled water. To 100 parts of this 11 parts of a saturated watery solution of methyl-violet or fuchsin (Weigert). To prepare a solution fresh for use Frankel heats about 5 c.cm. of anilin or toluidin to boiling in a test-tube, and pours it into a watch-glass. To this hot solution the alcoholic solution of the dye is added drop by drop until a deep opalescent colour but no precipitate is obtained. Cover-glass specimens of bacteria floated on this hot solution are stained in two minutes.

The following solutions are used for contrast staining.

1. *Blue*. Alcohol 50, water 30, nitric acid 20; as much methyl-blue as is dissolved by shaking.
2. *Brown*. Alcohol 70, nitric acid 30; as much vesuvin-brown as will dissolve.
3. *Green*. Alcohol 50, water 20, acetic acid 30; as much malachite or methyl-green as will dissolve.

The cover-glasses are stained in these solutions for 1–2 minutes,

* Magyar Növénytani, viii. (1884) pp. 1–13.

† Berl. Klin. Wochenschr., 1884, No. 13.

washed in water or 1 per cent. acetic acid, and then in 50 per cent. alcohol, and dried (firstly between folds of blotting-paper, and then by passing them several times through a flame). In this way one can obtain a perfectly satisfactory double-stained specimen in four minutes.

Staining Bacteria with Dahlia.*—Dr. Ribbert employs for staining the micrococci of pneumonia in sputum a solution of dahlia, which stains the cocci deep blue and the capsules of a lighter hue. Typhoid bacilli in lymphatic glands were better stained by a solution of dahlia in anilin water, according to Gram's method, than by any other process.

Pergens's Picrocarmine.†—This is prepared as follows:—Boil for two hours and a half 500 grms. pulverized cochineal in 30 litres of water. Add 50 grms. potassic nitrate, and, after a moment of boiling, 60 grms. oxalate of potash; boil 15 minutes. On cooling, the carmine precipitates; it is washed several times with distilled water in the course of three or four weeks. Pour a mixture of one volume of ammonia with four volumes of water upon the carmine, taking care that the carmine remains in excess. After two days filter, and leave the filtered solution exposed to the air until a precipitate forms. Filter again, and add a saturated aqueous solution of picric acid; agitate, and then allow it to stand for twenty-four hours. Filter, and add 1 grm. chloral for each litre of the solution. At the end of eight days separate the liquid from the slight precipitate which is formed, and it is ready for use.

This liquid keeps unchanged for at least two years, and is recommended by Carnoy in preference to other picrocarmine solutions.

Application of the Colouring Matter of Red Cabbage in Histology.‡—Dr. M. Flesch concentrates the watery extract of red cabbage by evaporation, mixes with a solution of acetate of lead, and precipitates the latter as insoluble carbonate of lead by carbonic acid, whereby the greater part of the colouring matter is thrown down with the lead precipitate. After washing on a filter, the precipitate is dissolved by acid, the solution carefully neutralized, and treated with sulphuretted hydrogen. The filtrate contains a clear solution of the colouring matter, which is dried and dissolved, one part in water and another part in alcohol. In fresh preparations nuclei are stained green and protoplasm red. Both solutions proved to be good nuclear stains, even in preparations (brain hardened in chromic acid) in which carmine failed.

Double Staining.§—The following solutions are recommended by Dr. J. Brun for animal histology.

a. *Blue.* Soluble prussian blue 1 grm., oxalic acid 0.25 cgrm.

* SB. d. Niederrhein. Gesell. in Bonn, 1884, pp. 244-5.

† Amer. Natural, xix. (1885) p. 428, from Carnoy's 'Biologie Cellulaire,' 1884, p. 92. See also Lee's 'Microtomist's Vade Mecum,' 1885, p. 60-1.

‡ Zeitschr. f. Wiss. Mikr., i. (1884) pp. 253-4.

§ Arch. Sci. Phys. et Nat., xiii. (1885) pp. 257-60.

These are allowed to act for some hours with a small quantity of water, and 100 grms. of pure water are then added. Filter.

b. Red. Dissolve 0·50 cgrm. of alum in 10 grms. of water, and add 0·50 cgrm. of saffranin dissolved in 10 grms. of pure alcohol. Filter.

The objects or sections are washed in distilled water and placed in the blue solution for 5–10 minutes. They are then washed in a large quantity of pure water and placed in the red solution for 5–10 minutes.

Before staining intestinal worms they are rendered transparent by a mixture of acetic acid and glycerin.

Staining Tissues for Photo-micrography.*—Hæmatoxylin stainings in very thin sections, while all that can be desired under the Microscope, are usually very disappointing when photographed; the delicate layer of tissue offers almost no actinic contrast when monochromatic sunlight is obtained by the ammonio-sulphate of copper cell. Since hæmatoxylin is so extensively employed, a ready modification to meet the needs of photography is of advantage, and the following is suggested by Dr. G. A. Piersol. While especially intended for nervous tissues it produces specimens of all organs admirably adapted for photography. No especial formula for hæmatoxylin is needed, using one which is capable of staining deeply and giving standard results. In the usual course of work the sections are stained; a very few thin ones, however, are allowed to remain in the solution, after those for ordinary preparation, until they are of an intense dark purple, when they are transferred, one by one, to a capsule containing a solution of borax 1·0; potassium ferricyanide 2·5; water 100·0. In this they are kept moving until the intense colour is gradually discharged, and the purple tint is replaced by a bronze-yellow, shading to saffron. Before the sections reach the latter colour they should be washed in water; the further usual steps in mounting are then completed.

Sections so stained, and mounted in balsam, will be found to possess all the differentiation given by hæmatoxylin, with a change from the purplish blue colour to the subdued tones of brown—a substitution often most pleasing and grateful to the eye.

Collodion and Phenol in Microscopical Technique.†—Dr. Bergonzini transfers sections which have been made from preparations hardened in alcohol or other reagent, and stained or not, from water into phenol (in which they become transparent) and mounts in a suitable medium. The specimen has not to be dehydrated as in other methods. The action of the phenol can be hastened by gently warming it. Pure phenol is used, to which only as much water is added as will dissolve it. Some recommend the employment of phenol and alcohol in equal parts.

Small animals, e. g. Insecta, can be placed alive in the phenol, which kills and renders them transparent.

* Amer. Mon. Micr. Journ., vi. (1885) p. 41–2.

† Lo Spallanzani, 1883, p. 196.

Dry Mounting of Opaque Objects.*—In the case of opaque objects it frequently happens that the cover-glass becomes covered with a film of oily or watery particles which condense upon its under surface. Prof. W. A. Rogers, whose rulings, as formerly prepared, were frequently injured in appearance by this condensation, has at last, so he believes, entirely obviated this annoyance. He now uses a brass ring for a cell to hold the ruled cover-glasses, but free communication between the air within and without the cell is established through a minute perforation in the side of the cell. Some preparers have been in the habit of maintaining this free communication by leaving a bristle or a thread passing through the wall of the cell until the mount is finished, after which it is withdrawn, thus making a minute perforation.

Examination of Water for the Development of Micro-organisms.†—The following methods are recommended by Dr. Tiemann.

200 cc. of water are placed in vessels carefully purified, disinfected by hot air, and plugged with disinfected cotton wool. The water is drawn up by a pipette, which has been well washed with distilled water. A drop of the water, which has been well shaken, is placed on a cover-glass, which is set with the drop downwards on a glass slide hollowed out in the centre, and magnified 100–500 times. Several such preparations are allowed to dry on the cover-glass, and then stained with methyl-blue, dried, and mounted in Canada balsam. The bacteria are thus stained blue.

To estimate the numbers of the organisms in the water, a certain quantity (1/1000–10 drops) is mixed with nutrient jelly. The quantity is measured in a graduated pipette, which has been previously heated, and washed with distilled water as well as several times with the water under examination. Each sample is added to 10 cc. of liquefied jelly, which is spread on a glass plate previously sterilized by heat. The colonies develop in the jelly, beneath a bell-jar, the air in which is kept damp, at various parts of the plate, and the number per square cm. is counted under a magnification of 30 diameters. The mean of the values thus obtained \times the area of the jelly gives the number of organisms in the sample, and the number of the same per cc. of water can be calculated. For counting, one uses a plate divided into square centimetres, which is placed beneath the test-plate. The estimated is always less than the real number, as some colonies cover each other, and all the micro-organisms do not develop.

Examination of Water for Organisms.‡—If a sample of water contains but few organisms, these may easily escape observation under the Microscope. Mr. H. S. Carpenter and Mr. W. O. Nicholson have, therefore, devised a method by which these organisms may be cultivated, and consequently become so numerous as to be readily recognizable.

* Amer. Mon. Micr. Journ., v. (1884) pp. 210–11.

† Verh. Deutsch. Gesell. f. öffentl. Gesundheitspflege zu Berlin, 1883.

‡ Analyst, ix. (1885) pp. 94–6. See Journ. Chem. Soc.—Abstr., xlviii. (1885) pp. 442–3.

The necessary apparatus consists of:—(1) A short-necked four-ounce flask, fitted with a caoutchouc stopper through which two tubes pass; they are bent at right angles, and have their external ends drawn out; (2) a tube with a bulb (about 25 ccm. capacity) blown on the side, and the ends tapering to fine points; (3) a long combustion-tube 18 in. long, loosely packed for 10 in. with asbestos, which can be connected with a refrigerator. About 50 ccm. of Pasteur's solution are boiled in the flask, the combustion-tube is heated to, and kept at, a red heat, a slow current of air is passed through, the flask is attached, and the tubes are sealed up while the sterilized air is passing and the solution is boiling. A bulb-tube is sealed up at one end, distilled water is introduced and boiled off, and the other end is sealed up while the tube is full of aqueous vapour; one end is now broken off under the surface of the water to be examined, and when the bulb is full the end is immediately sealed up again. The heated combustion-tube is now connected with the refrigerator, and a rapid current of air passed to clear the apparatus; one end of the bulb-tube is connected by means of indiarubber tubing with the refrigerator, which is now cooled; the other by a similar connection with one of the flask-tubes; all the ends are broken by pressing the indiarubber connections, and the water from the bulb-tube rushes into the partially vacuous flask, followed by the cooled sterilized air; the flask-tube is then sealed up and placed in a convenient place for the development of the organisms, and the apparatus disconnected. All requisite precautions are taken to avoid the admission of extraneous organisms.

Removal of Microbes by Filtering.*—M. C. Chamberland finds that a filter composed of porous unglazed porcelain will entirely free any fluid from the microbes which it may contain. It is cleaned with the greatest ease by heating.

Effect of Prolonged Repose and Filtration through Porcelain on the Purity of Water.†—Prof. H. Fol and M. P. L. Dunant describe experiments on this subject. Struck by the small number of germs in the water of the Lake of Geneva compared with that of other drinking waters, and attributing it to the repose of the water, the authors resolved to test this theory. Impure water, estimated to contain not less than 150,000 germs per c.cm., was allowed to stand, and after eight days it was found that it had lost 94 per cent. of the germs, only one in seventeen remaining in suspension. At the end of fifteen days 23 per cent. more had sunk to the bottom, making 95·3 per cent. for the three weeks.

Water that had been passed through Chamberland's unglazed porcelain filters was found to be quite sterile, and the authors consider that not only water, but any liquid sufficiently fluid to pass through the porcelain under a pressure of from two to three atmospheres can thus be sterilized cold.

Determination of the Number of Germs in Air.—Prof. H. Fol writes that he now constantly employs curved tubes closed at one end

* Comptes Rendus, xcix. (1884) pp. 247-8.

† Arch. Sci. Phys. et Nat., xiii. (1885) pp. 110-8.

by the small funnel stopper mentioned *ante*, p. 362. The lower end of the tube, bent somewhat in the shape of a letter S lying down— ω , is attached to the flexible tube of the aspirator, the upper end being closed by the funnel stopper. This is plugged at its lower end by sterilized glass wool, which is covered by a layer of sterilized salt. After the air has been drawn by the aspirator through this double plug, the salt, with the retained germs, is added to the bouillon used for the culture operations.

Examining Vegetable Powders.*—In the microscopical investigation of a vegetable powder as to its purity and its freedom from adulteration, Dr. A. Meyer recommends that it should be examined in water under a power of 50 diameters, and if a foreign element is detected this is magnified 180 diameters, and drawn with a camera lucida. The drawing is then compared with drawings which have been made under a similar magnification of the elements of the suspected adulterating material. Lastly, one compares, under a very high power, the suspected elements with as freshly-prepared specimens as possible of the adulterating material.

An account of the anatomical appearances and structure of the fruits of the buckwheat and maize follows, with a description of the action upon them of reagents: e. g. potash, Schultze's fluid, &c.

Sterilization of Fermentable Liquids in the Cold.†—M. A. Gautier describes a process for sterilization in the cold by means of a filter made of biscuit porcelain or faience rendered vacuous. The filter is placed in the particular liquid and the receiver connected with it. The liquid passes through the porous walls of the filter and thence into the receiver, and in this way solutions of albumen, serum, grape-juice, peptones, milk, &c., can be sterilized without the application of heat.

ADY, J. E.—**The Microscopic Study of Rocks.** III., IV.

[Methods of procuring suitable specimens of rocks and preparing sections from them for microscopical examination, with a description of hammer, and slitting and grinding machine.]

[Petrographist's grinding bench—Mounting rock sections for microscopical examination.]

Ill. Sci. Monthly, III. (1885) pp. 99-103 (4 figs.), 131-3 (2 figs.).

ANDERSON, J., JUN.—**Crystals for the Polariscope.**

[Complaint that such slides are not permanent. Nearly all his slides "show signs of deterioration, and in some the crystals have vanished altogether."]

Sci.-Gossip, 1885, p. 90.

ASSMANN, R.—**Mikroskopische Beobachtung der Wolken-Elemente.** (Microscopical Observation of Cloud-Elements.) [Post.]

Naturforscher, XVIII. (1885) pp. 120-30,
from *Meteorolog. Zeitschr.*, II. (1885) p. 41.

AUBERT, A. B.—**The Gum of Liquidambar styraciflua or American Storax as a Mounting Medium.** [Post.]

Amer. Mon. Micr. Journ., VI. (1885) pp. 86-7.

* *Zeitschr. f. Wiss. Mikr.*, i. (1884) p. 309.

† *Bull. Soc. Chim.*, xlii. pp. 146-50. See *Journ. Chem. Soc.—Abstr.*, xlviii. (1885) pp. 287-8.

- BAYERL, B.—Die Entstehung rother Blutkörperchen im Knospel aus Ossificationsrande. (The origin of red blood-corpuscles in cartilage at the margin of ossification.) [*Supra*, p. 537.]
Arch. f. Mikr. Anat., XXIII. (1884) pp. 30-45.
- BERTHOLD, V.—Ueber die Mikroskopischen Merkmale der wichtigsten Pflanzenfasern. (On the microscopic characteristics of the most important vegetable fibres.)
 [Cf. Vol. IV. (1884) p. 829.]
Beil. d. Zeitschr. f. Landwirthsch. Gewerbe, 1883, Nos. 3-4.
Zeitschr. f. Warenkunde, 1883, pp. 14-5, 17-8 (16 figs.).
- „ „ Ueber den Mikroskopischen Nachweis des Weizenmehls im Roggenmehl. (On the microscopical determination of wheat-meal in rye-meal.)
 [Cf. Vol. III. (1883) p. 604.]
Beil. z. Zeitschr. f. Landwirthsch. Gewerbe, 1883, pp. 1-3 (8 figs.).
- BLOCHMANN.—See Kirchner.
- BONNET, R.—Kurzgefasste Anleitung zur Mikroskopischen Untersuchung thierischer Gewebe. (Brief introduction to the microscopical investigation of animal tissues.)
 8vo, München, 1884.
- BOWER, F. O., VINES, S. H., and DYER, W. T. T.—A Course of Practical Instruction in Botany. Part I. Phanerogamæ—Pteridophyta.
 [Contains:—Introductory Chapters. I. Methods and Reagents: A. Making Preparations; B. Micro-chemical Reagents. II. Structure and Properties of the Cell: A. General Structure; B. Micro-chemistry of the Cell; C. Micro-physics of the Cell, pp. 1-43. Practical Directions for the Study of Types, pp. 44-226; and see *supra*, p. 484.]
 xi. and 226 pp., 8vo, London, 1885.
- BRUN, J.—Procédé de double coloration applicable aux études microscopiques. (Method of double staining for microscopic purposes.) [*Supra*, p. 558.]
Arch. Sci. Phys. et Nat., XIII. (1885) pp. 257-60.
- BÜTSCHLI, O.—See Kirchner.
- CARPENTER, H. S., and W. O. NICHOLSON.—Examination of Water for Organisms. [*Supra*, p. 560.]
Analyst, IX. (1885) pp. 94-6.
- CERTES, A.—De l'emploi des matières colorantes dans l'étude physiologique et histologique des Infusoires vivants. (On the employment of colouring matters in the physiological and histological study of living Infusoria.) [*Supra*, p. 555.]
 Sep. repr. *CR. and Mém. Soc. Biol.*, 1884, 7 pp.
- COLE, A. C.—Studies in Microscopical Science.
 Vol. III. Sec. I. Part 3, pp. 9-12. Formation of Cystocarps in *Batrachospermum*. Plate III. *Batrachospermum* showing Cystocarps. Part 4, pp. 13-16. Structure of the Apothecium in *Solorina*. Plate IV. *Solorina crocea*. V. S. of Thallus and Apothecium.
 Sec. II. Part 3, pp. 9-12. The Primitive Cell and its Progeny (*concluded*). Glands (in part). Plate III. *Anodon*. T. S. of Organ of Bojanus \times 250. Part 4, pp. 13-16. Glands (*concluded*). Plate IV. Liver of Lobster (*Homarus vulgaris*). Tr. Sec. \times 150.
 Sec. III. Part 3, pp. 9-12. Alveolar Pneumonia (*concluded*). Plate III. 3rd stage \times 170. Part 4, pp. 13-5. Broncho-pneumonia. Plate IV. \times 100.
 Sec. IV. Part 3, pp. 9-12. Spiders (*concluded*). Plate III. Jaws of Spider *Epeira diadema*, female, \times 75. (Includes Methods of preparation: (1) Cambridge's process for preserving spiders entire; (2) Method of preparing and mounting dissections.)
 [“The spinneret, leg, and falces having been respectively removed from the spider are placed separately in liq. pot. for 24-36 hours; then soaked in water to remove the potass: then placed in acetic acid (in which such parts of insects, &c., may always be preserved until required for mounting); then again soaked in water; then placed in methylated spirit for a short time; then cleared by means of oil of cloves, and lastly transferred to turpentine, and mounted 'without pressure' in cells. The

tongue of the spider carefully dissected out, forms an interesting preparation. The various parts of the mouth may also be dissected and separately mounted, the skin may be stained with carmine or logwood, and mounted in Canada balsam, whilst the eyes of many spiders, other than the well-known brilliant eyes of the jumping spiders, may be mounted in balsam, in cells as opaque preparations, with the best results."']

Part 4, pp. 13-6. Leeches (in part). Plate IV. Trans. Sec. Medicinal Leech $\times 50$.

Culture Media for Bacteria.

[Directions for preparing flesh-peptone-gelatin, and directions for using the gelatin in plate-cultures and test-tube cultures.]

Amer. Mon. Micr. Journ., VI. (1885) pp. 55-7,
from *Journ. Amer. Med. Assoc.*

CYBULSKY, J. B.—**Das Nervensystems der Schnauze und Oberlippe von Ochsen.** (The nervous system of the muzzle and upper lip of oxen.)

[Contains methods, *supra*, p. 555.]

Zeitschr. f. Wiss. Zool., XXXIX. (1883) pp. 653-82.

D., E. T.—**Graphic Microscopy.**

XVI. Eggs of Vapourer Moth.

XVII. Transverse Section of Spine of *Echinus*.

Sci.-Gossip, 1885, pp. 73-4 (1 pl.) pp. 97-8 (1 pl.).

DAVIS, J. J.—**A simple Cover Compressor.**

[“ Divide a small cork transversely and cut a notch in one end of one of the pieces. Pass an ordinary stationer’s rubber elastic ring over the end of the slide; put the piece of cork under it, the ring resting in the notch; then draw it along until the under side of the ring will rest under the point to which the pressure is to be applied, then lower the cork on the cover. If more pressure is desired a second ring may be placed over the first. Pieces of cork of different lengths give more or less pressure, and those of different diameters apply it over more or less space. The slides can be laid away side by side.”]

The Microscope, V. (1885) p. 36.

DEBES, E.—**Das Reinigen und Präpariren von Diatomaceen-Material.** (Cleaning and preparing diatom material.) [*Post.*]

Hedwigia, XXIV. (1885) pp. 49-66.

DOLLEY, C. S.—**Preservation of Jelly-fishes at the Naples Zoological Stations.**

[Statement of the results obtained by Signor Lo Bianco, but no description of the method.]

Science, V. (1885) p. 272.

DYER, W. T. T.—See Bower, F. O.

EHRLICH.—[Susceptibility of the different tissues to colouring matters.]

[*Supra*, p. 554.]

Nature, XXXI. (1885) pp. 547-8 (Report of Proceedings of Berlin Physiological Society, 27th February, 1885.)

ETTI.—**Verhalten von Tannin und Eichenrindegerbsäure gegen verschiedene Reagentien.** (Behaviour of tannin and quercitannic acid with different reagents.)

Ber. Deutsch. Chem. Gesell., 1884, No. 13.

EWART, J. C., and J. D. MATTHEWS.—**Directions for the examination of *Amœba*, *Paramacium*, *Vorticella*, *Hydra*, *Lumbricus*, *Hirudo*, *Asterias*, and *Echinus*.**

4to, Edinburgh, 1885, 32 pp.

EYFERTH, B.—**Die einfachsten Lebensformen des Thier- u. Pflanzenreiches. Naturgeschichte der Mikroskopischen Süßwasserbewohner.** (The simplest forms of life in the animal and vegetable kingdoms. Natural history of the microscopical inhabitants of fresh water.)

2nd ed., 130 pp. and 7 pls., 4to, Braunschweig, 1885.

FABRE-DOMERGUE, P.—**Note sur les Rhizopodes et les Infusoires des eaux de Toulouse, leur récolte et leur préparation.** (Note on the Rhizopods and Infusoria of Toulouse, their collection and preparation.)

[Describes principally M. Certes’ methods. Also a current apparatus, *supra*, p. 526.]

Bull. Soc. D’Hist. Nat. Toulouse, XVIII. (1885) pp. 152-88.

- FRANCOTTE, P.—Tableaux synoptiques représentant les principales manipulations dans les laboratoires d'histologie et d'anatomie comparée. (Synoptical tables of the principal processes in histological and comparative anatomy laboratories.)
Bull. Soc. Belg. Micr., XI. (1885) pp. 134-42. Extracted from the author's 'Manuel de Technique Microscopique,' in the press.
- Gierke, H.—Staining Tissues in Microscopy. I, II.
 [Transl. by Prof. W. H. Seaman from 'Zeitschr. f. Wiss. Mikr.']
Amer. Mon. Micr. Journ., VI. (1885) pp. 65-8 and 76, 89-94.
- GRANT, F.—Microscopical Staining—Mounting Bacteria.
 [Description of "methods with reference to sputum in particular, but also with reference to bacteria or Schizomycetes generally."] *Engl. Mech.*, XLI. (1885) pp. 212-4.
- HARRISON, W. J.—Simple Methods of making Lantern-slides.
 [Includes "pictures of what one has actually seen . . . through . . . the Microscope."] *Knowledge*, VII. (1885) pp. 284-5, 326.
- HAY, O. P.—Some Anatomical and Histological Methods.
 [1. Modification of Semper's method of making dry preparations. 2. A method of making double injections for dissecting purposes. 3. A method of producing double injections for histological purposes. *Post.*] *Amer. Natural.*, XIX. (1885) pp. 526-9 (1 fig.).
- HOLL, M.—Tolu statt Chloroform bei Paraffineinbettung. (Tolu instead of chloroform in paraffin imbedding.) [*Supra*, p. 541.] *Zool. Anzeig.*, VIII. (1885) pp. 223-4.
- IBIZA, L. é.—[Gelatine-glycerine as a substitute for Canada balsam.] [*Post.*] *An. Soc. Españ. Hist. Nat.*, XIV. (1885) Actas, pp. 12-15.
- JENKINS, A. E.—New methods of Work. (*In part.*)
 [Lavdowsky's 'Myrtillus,' vol. iv. p. 652, and Heidenhain's Hæmatoxylin, *ante*, p. 158.] *The Microscope*, V. (1885) pp. 85-7.
- KAATZER, P.—Die Technik der Sputum-Untersuchung auf Tuberkel-Bacillen. (The technics of the investigation of sputum for tubercle-bacilli.)
 2nd ed., 15 pp., 8vo, Wiesbaden, 1884.
- KIRCHNER, BLOCHMANN, and BÜTSCHLI.—Die Mikroskopische Pflanzen- und Thierwelt des Süßwassers. Theil I. Die Mikroskopische Pflanzenwelt des Süßwassers. (The microscopical vegetable and animal world of fresh-water. I. The microscopical vegetable world of fresh-water.)
 56 pp. (4 pls.), 4to, Braunschweig, 1885.
- KLEIN, E.—Micro-organisms and Disease. An introduction to the study of specific micro-organisms.
 [Contains chapters on "Microscopic examination," "Preparation of culture material," "Vessels and instruments used in cultivation," "Methods of insulation," &c.] 2nd ed., xii. and 201 pp., 116 figs., 8vo, London, 1885.
- KONINCK, L. DE.—Essais microchimiques par voie sèche, procédé de Bunsen. Résumé à l'usage des Laboratoires d'Instruction. (Microchemical assays by the Bunsen dry method. *Résumé* for the use of laboratories.)
 7 pp. and table, 8vo, Liège, 1885.
- MATTHEWS, J. D.—See Ewart, J. C.
- MCCALLA, A.—The Working Session.
 [Remarks on its usefulness—also in reply to the criticisms on his claim to be the originator of it, *ante*, p. 366.] *The Microscope*, V. (1885) pp. 77-81 and 89.
- "MEDICINÆ DOCTOR."—Mounting Bacteria.
 [Comments on F. Grant's note, *supra*.] *Engl. Mech.*, XLI. (1885) p. 238.
- MEYER, A.—Ueber die Mikroskopische Untersuchung von Pflanzenpulvern, speciell über dem Nachweis von Buchweizenmehl in Pfefferpulver und über die Unterscheidung des Maismehles von dem Buchweizenmehle. (On the

- microscopical investigation of vegetable powders, especially with regard to the detection of buckwheat flour in pepper powder, and on the discrimination of maize flour from buckwheat flour.) [*Supra*, p. 562.]
Arch. d. Pharm., CCI. (1883) p. 912.
- MICHELSON, P.—Ueber die Verwerthung der Säure-fuchsinfärbung (nach Weigert) für dermatologische Zwecke. (On the application of Weigert's acid fuchsin staining in dermatology.)
Monatsschr. f. prakt. Dermatol., II., No. 12.
- MOJSISOVICS V. MOJSVÁR, A.—Leitfaden bei zoologisch-zootomischen Präparirübungen. (Guide to zoological-zootomical preparation.)
2nd ed., xii. and 259 pp., 127 figs., 8vo, Leipzig, 1885.
- NELSON, E. M.—Dr. Koch's Comma Bacillus.
[Denial of the suggestion, *ante*, p. 383, that Brittain and Swayne discovered this thirty-five years ago. The art of staining micro-organisms was then unknown, and the "microscopy" of that day could not have been equal to the occasion.]
Engl. Mech., XLI. (1885) p. 82.
- NEVILLE, J. W.—Crystals for the Polariscope.
[Remarks on their instability.] *Sci.-Gossip*, 1885, p. 115.
- NICHOLSON, W. O.—See Carpenter, H. S.
- OTTO, J. G.—Untersuchungen über die Blut-Körperchenzahl und dem Hämoglobin Gehalt des Blutes. (Researches on the number of blood-corpuscles and the amount of hæmoglobin in the blood.)
Arch. f. d. Gesammt. Physiol., XXXVI. (1885) pp. 12-72 (6 figs.).
- PELLETAN, J.—Sur l'emploi du baume de Tolu pour les préparations de Diatomées. (On the employment of balsam of tolu for diatom preparations.)
[Copy of M. Amann's note, *ante*, p. 353, and caution against using Tolu.]
Journ. de Microgr., IX. (1885) pp. 131-2.
- Pergens's Picro-carmin. [*Supra*, p. 558.]
Amer. Natural., XIX. (1885) p. 428,
from Carnoy's *Biologie Cellulaire*, 1884, p. 92.
- QUEEN, J. W.—["Stratena" (glue made fluid by the addition of a small quantity of acetic or nitric acid) recommended for protecting slides against the oil of immersion lenses, and as a cell-substance and finish for objects mounted in various oily media.]
Micr. Bulletin, II. (1885) p. 12.
- RIBBERT.—Ueber Spaltpilzfärbung mit Dahlia. (On staining Schizomycetes with dahlia.) [*Supra*, p. 558.]
Verh. Nat. Ver. Preuss. Rheinl. u. Westfalens, XLI. (1884)—SB. pp. 244-5.
- SALMON, D. E., and T. SMITH.—Koch's method of isolating and cultivating Bacteria, as used in the Laboratory of the Bureau of Animal Industry, Dept. Agriculture.
Amer. Men. Micr. Journ., VI. (1885) pp. 81-4.
- SATTERTHWAITE, T. E.—Manual of Histology and Histological Methods,
2nd ed., 8vo, New York, 1884.
- Seaman, W. H.—See Gierke, H.
- SLACK, H. J.—Pleasant Hours with the Microscope. [Molecular motion.]
[Seeds and Carter's box of seeds for the Microscope.]
Knowledge, VII. (1885) pp. 318-9, 408-410 (2 figs.).
- SMITH, T.—See Salmon, D. E.
- SOLLA, R. F.—Ueber zwei wahrscheinliche Mikrochemische Reactionen auf Schwefelcyanallyl. (On two probable micro-chemical reactions of sulphocyanate of allyl.)
Bot. Centrabl., XX. (1884) pp. 342-5.
- STOWELL, C. H.—The Student's Manual of Histology.
3rd ed., 370 pp., 8vo, Ann Arbor, 1885.
- [STOWELL, C. H., and L. R.]—"Anything to win."
[Polemical remarks on the controversy as to White Zinc cement.]
The Microscope, V. (1885) pp. 88-9.
- TIEMANN.—Untersuchung des Wassers auf entwicklungsfähige Mikroorganismen. (Investigation of Water for Micro-organisms capable of developing.)
[*Supra*, p. 560.]
Verhandl. Deutsch. Gesell. f. öfentl. Gesundheitspflege zu Berlin, 1883.

- TOLDT, C.—*Lehrbuch der Gewebelehre mit vorzugsweiser Berücksichtigung des menschlichen Körpers.* (Text-book of Histology, with special reference to the Human Body.) 2nd ed., xiv. and 679 pp. (195 figs.), 8vo, Stuttgart, 1884.
- VÉTILLART, M.—*Method of Analysis of Fibres, Tissues, &c.*
 [Arrangement in tabular form of the more prominent characteristics which distinguish twenty fibres from each other.]
Amer. Mon. Micr. Journ., VI. (1885) pp. 47-52,
 from *Études sur les Fibres.*
- VINES, S. H.—See Bower, F. O.
- VORCE, C. M.—*The Working Session of the American Society of Microscopists.*
 [Scheme of work for demonstration at the next Session, under twenty-four heads.]
Amer. Mon. Micr. Journ., VI. (1885) pp. 34-5.
The Microscope, V. (1885) pp. 40-1.
- WALTERS, H. A.—*A Net for Microscopists.* [*Supra*, p. 535.]
Sci.-Gossip, 1885, pp. 78-9.
- WHITNEY'S (J. E.) *Preparations of Plant-hairs.*
Amer. Mon. Micr. Journ., VI. (1885) p. 58.
- WIENACK, L.—*Anleitung zur Erkennung organischer und unorganischer Beimengungen im Roggen- und Weizenmehl.* (Introduction to the recognition of organized and unorganized admixtures with rye-flour and wheat-flour.)
 64 pp. and 2 pls., 8vo, Leipzig, 1884.
- WORMLEY, T. G.—*Micro-Chemistry of Poisons*, including their physiological, pathological, and legal relations, with an appendix on the detection and microscopic discrimination of blood, adapted to the use of the medical jurist, physician, and general chemist.
 2nd ed., 784 pp., 17 pls. and 1 table, 8vo, Philadelphia, 1885.
-

PROCEEDINGS OF THE SOCIETY.

MEETING OF 8TH APRIL, 1885, AT KING'S COLLEGE, STRAND, W.C.,
THE PRESIDENT (THE REV. DR. DALLINGER, F.R.S.) IN THE
CHAIR.

The Minutes of the meeting of 11th March last were read and confirmed, and were signed by the President.

The List of Donations (exclusive of exchanges and reprints) received since the last meeting was submitted, and the thanks of the Society given to the donors.

Slides (6) of Diatoms (<i>Stephanodiscus Niagara</i>), showing filamentous projections	From <i>Mr. H. Mills.</i>
Lce, A. B., The Microtomist's Vade-mecum, pp. vii. and 424. Svo, London, 1885	<i>The Author.</i>
Slides (3) of <i>Mentzelia Floridana</i> , <i>Solanum verbascifolium</i> , and a Fungus from an account-book which had been in a fire-proof vault for several years	<i>Mr. H. W. Fuller.</i>

Mr. Crisp referred to Schieck's Revolver Microscope exhibited in December 1883,* in which a drum revolved beneath the objective with the objects arranged on the periphery, so that by turning that drum they were brought successively into view. The novelty of that Microscope was challenged, and one on a similar principle was produced, made nearly sixty years earlier by T. Winter, which was considered to be the earliest of all such forms.† It now appeared, however, that the latter had been anticipated by one made two centuries ago. This was proved by a description and illustration of the instrument which appeared in an old Italian book, without title-page, which, together with a model, was handed round for inspection. The first page commenced, "Nuove Inventioni di tubi ottici dimostrate nell' Accademia Fisico-matematica Romana, l'Anno 1686" (*supra*, p. 518.)

Mr. Beck said that an interesting portion of the instrument was the spring which was used for adjusting the focus of the lens, because that was the subject of a patent which had been taken out about fifteen years ago.

Mr. H. G. Madan exhibited the form of polarizing prism recently suggested by M. Bertrand in the *Comptes Rendus*,‡ and also described in the *Journal*.§ He thought it would interest the Fellows, as it was almost the only one which had yet been seen in this country, added to which it was always more interesting to see a thing in the flesh than merely to read a description of it. The principle of the construction of this prism was known to Jamin as long ago as 1869, and

* See this *Journal*, iv. (1884) p. 112.

† *Ibid.*, p. 115.

‡ *Comptes Rendus*, xcix. (1884) pp. 538-40.

§ Vol. iv. (1884) p. 965.

it had been more lately (1884) described by Feussner; but the credit to which Bertrand was entitled was in the use of a cement which had the high refractive index of 1.66. The great advantage which this prism possessed over the Nicol prism, apart from its cost, was in the larger field which it was possible to obtain. One defect in the prism arose from the great density of the glass, which, being due to the large percentage of lead which it contained, made it very apt to get tarnished. He suggested, as an effectual preventive of this evil, that a piece of thin microscopic glass should be cemented upon each end, which, by keeping off the air, would entirely preserve the surface without impairing the efficiency of the prism in any way.

Mr. Madan also exhibited another form of polarizing prism, which was a modification of Ahrens's double-image prism, made by including a thin film of air.*

The President said the Society was much indebted to Mr. Madan for these details, which showed a great amount of ingenuity.

Mr. Cheshire said it was of course of great value to be able to get such a large field as in Mr. Madan's modification of Ahrens's prism, but it occurred to him that there must be a considerable loss of light in the case of the ordinary ray in passing from the first prism into the air space.

Mr. Madan said no doubt there was a loss of light in this case; but this was a disadvantage which the prism suffered in common with Foucault's and other prisms. Something must necessarily be sacrificed to obtain greater advantages in other directions. He thought that as regarded light Bertrand's was certainly more effective.

Mr. Dowdeswell exhibited some septic microbes from high altitudes, and detailed experiments by M. Freudenreich as to bacterial germs found at various heights, notably upon the Niesen, at an elevation of about 7500 ft. (Cf. *supra*, p. 511.)

The President regarded every addition to their knowledge in this direction as being of the utmost value, and remarked that everything pointed to the necessity of a thorough working out of the correlation of the whole of the specific forms. When that was done they would have gone a long way nearer towards the solution of the problem of their connection with epidemic disease.

Dr. Maddox said he had been in correspondence with M. Freudenreich for some time, from whom he obtained the specimens of the organism, and was glad to learn from Mr. Dowdeswell's careful examination that it was only a septic organism, and not a pathogenic form. Great pains had been taken in carrying out these observations, as would be seen from the fact that all the apparatus had to be carried up high mountains. It was found that the tubes originally provided were difficult to use, and M. Freudenreich had substituted ground caps for the narrow end. He (Dr. Maddox) had suggested to him a form of bottle which he thought would fulfil all the required conditions and be also portable. This bottle had a cap fitting hermetically over the

* Vol. iv. (1884) p. 965.

neck, in which cotton or glass wool was placed, and two tubes were drawn out from the neck, one, also plugged, provided for the purpose of aspiration, the other for removing or supplying the contents for cultivation. The time required for aspirating a large quantity of air was also found to be inconveniently great, so that an apparatus made on the principle of a steam injector was used, which was capable of drawing over 2000 litres of air in an hour if required. By means of a diagram the method of charging the cultivation tubes with the contents of the bottle was explained. Dr. Maddox said he had suggested to Dr. Miquel the use of a small captive balloon for carrying some of his "nutritive paper" for the purpose of obtaining atmospheric germs at definite high altitudes from given localities.

Mr. J. Mayall, jun., reverting to the model of the old Microscope exhibited by Mr. Crisp at an earlier period of the meeting, asked if there was any means of fixing the date when it was made, as he thought it would be very interesting if they could do so with certainty.

Mr. Crisp said there was no difficulty in fixing the exact date. Agreeing in the suggestion of Mr. Madan that it was much better to see a thing in the flesh, he had last month ordered the Microscope to be made, and it was delivered that night. The workman deserved all credit for the skilful manner in which he had manufactured so deceptive a piece of antiquity; even the paper on the drum was 200 years old.

Mr. A. D. Michael gave a summary of his paper on "New British *Oribatidæ*" (*supra*, p. 385).

Mr. Crisp described some very interesting experiments by Dr. Nussbaum and Dr. Gruber on the artificial division of infusoria (*supra*, p. 472).

Mr. C. H. Kain's letter was read as follows:—

"In the report of the last meeting of the Society I notice that a note from Dr. Gray was read, warning members against the use of tolu as a mounting medium on account of its tendency to form crystals. I believe I was the first to call attention to tolu, and therefore it may not be inappropriate for me to say a word. At first I had the same difficulty as Dr. Gray. Indeed, styrax is also likely to produce crystals. There is, however, an easy way of obviating the difficulty in the case of tolu, viz. by dissolving out the cinnamic acid. Tolu is not soluble in benzole, but cinnamic acid is. I have found that by digesting the coarsely powdered gum in benzole for a few days the cinnamic acid is removed. After pouring off all the liquid possible, fresh benzole should be added and allowed to remain a day or two. After pouring off this, the rest of the benzole should be evaporated, and the tolu then dissolved in chloroform and filtered; it is then ready for use. It is best to use heat in mounting, so that, when finished, the medium is nearly or quite hard. The

greatest objection to the use of tolu is its colour. By this mail I send three slides of *Navicula rhomboides* and *Tabellaria fenestrata*, mounted respectively in Canada balsam, styrax, and tolu. That in tolu was mounted October 11th, 1884, and fails to show any signs of crystallization as yet; indeed, I have had no difficulty with crystals since using the process I have mentioned."

Mr. Crisp referred to some of the differences of opinion having arisen from the different meanings which were attached to the term benzolé. What was here understood by that name appeared to be different from the substance so called in America.

Mr. Michael said he had been trying experiments with some of these substances lately, and perhaps could throw a little more light on the matter. He found that there was a great deal of difference in the gums, and that different samples, obtained from perfectly reliable sources, acted very differently under similar conditions. One sample of styrax, for example, would dissolve perfectly in benzole, whilst another would not do so. He thought this might also be the case with some others; but if the tolu was prepared carefully by boiling in distilled water, to get rid of whatever acid it might contain, he believed it might be reduced to a state in which it would give very little trouble afterwards by crystallization.

Mr. Crisp called attention to the alteration of the contents on the wrapper of the Journal, which now contained the names of all the authors. The credit of this was due to Mr. Walter Heape, of Cambridge, and he thought the alteration would be found an obvious improvement in facilitating reference to any paper. He had also taken the opportunity of adding the headings of the classification, and had included all the papers of the bibliography of which any abstract was given, as he found these were often passed over unnoticed. To meet a point which had given not a little trouble with some authors, their names would in future have Mr., M., Herr, &c., prefixed.

Mr. H. Mills's note was read as follows:—

"I send six slides of *Stephanodiscus Niagaræ*, showing filamentous projections on the margin of the diatom.

"During the last ten or twelve years I have given attention to the examination of these organisms, but am still at a loss to determine what they are, or the purpose they serve (if any) in the economy of the diatom. If found attached in the same manner to any of the diatoms that have motion, we might conclude at once that they were for the performance of that function, but occurring as they do on these discoids, which have no motion, it is difficult to suggest anything that is probable. We find many of the diatomaceæ in our water-supply, none, however, having these attachments but *S. Niagaræ*, and perhaps a few *Cyclotella* or other small discoids. The *S. Niagaræ* are found in great abundance during the winter months, and for several years past I have found the filaments most abundant in January, at which time the diatoms can be taken almost free from

foreign matter. The past January has been unusually stormy, and the water consequently roily, while the filaments are not as well developed as in some former years.

"Five of the slides are mounted dry, as the filaments, with rare exceptions, cannot be seen in water. Slide No. 6 contains a drop of water with the diatoms, as caught from a small stream from the faucet in a muslin bag. The extreme tenuity and hyaline character of the filaments are the greatest hindrance to a more perfect examination of them. They are seen to best advantage with a strong light and dark background illumination; sunlight adding much to the effectiveness of the observation. In slide No. 1, using $\frac{2}{3}$ in. or $\frac{3}{4}$ in. objective, may be seen how regularly the filaments arrange themselves on the slide; frequently those of one diatom crossing those of another, all maintaining a radial position with some degree of preciseness. This fact alone would indicate a substance very different in character from the mycelium threads of an ordinary fungus.

"When the diatom is examined edgewise, that is, in front view, the filaments can be seen to proceed from near the line of suture, but whether from the internal contents of the frustule or from the ring of the diatom I am unable to determine. If from the ring, I have thought they might be siliceous, although recent experiments show that they are consumed by the heat of an alcohol lamp. A drop of water containing a few of these diatoms placed on a slide and allowed to evaporate under the Microscope is interesting, and displays a phenomenon not shown by any other diatoms that I am aware of. As the line of evaporation proceeds on the slide, the diatoms frequently disappear instantly; in some cases leaving the filaments attached to the glass, while in other cases, where there is but little foreign matter to interfere, they may be found beyond the extent of the drop, with the filaments spread out as radially as if placed so artificially. If the diatoms stand long enough for the water to become sour, the filaments fall off, and may be seen scattered about the slide, as in No. 2. In some of the slides may be seen a few small discoids without spines, which, when alive in the water, seem to possess power to repel every light body from contact with them, so that a distinct transparent annulus as wide as the diameter of the diatom is presented. A little blueing placed in the water under the cover-glass makes this more noticeable (see Amer. Mon. Micr. Journ., ii. (1882) p. 8). This year I have noticed for the first time that these small diatoms when dry have several small projections which, if in motion, would seem to be sufficient to form the annulus. In some cases the long filaments of *S. Niagara* have the appearance of being branched. My opinion is that it is merely an overlapping."

Mr. Bennett said that having examined Mr. Mills's slides, he thought there was hardly sufficient evidence that the filaments were part of the diatom; they had more the appearance of epiphytic growths.

Mr. Badcock said Mr. Mills's specimens were different from those which he had exhibited on a former occasion as occurring upon *Suriella bifrons* at Keston. These appeared to him to have a distinctly pseudopodal character, having movements very much like an amoeboid elongation and contraction, whereas these now shown very much

resembled the setæ of *Actinophrys*. The question in both cases was whether they represented animal life as being prolongations from the inner protoplasm.

Mr. Hardy was glad to be able to corroborate what Mr. Badcock had stated with reference to the cilia upon *Surirella*, having observed them himself independently on some of the same gathering. He was not able to make out anything like ciliary movement, but should say that they were not of a sarcodic nature.

Dr. Wallich said there was a complete analogy between the specimens now shown and some which he exhibited about twenty years ago, to which he gave the name of *Coscinodiscus Sol.* He found his specimens in the Indian Ocean, and they were described and figured at the time in the Society's Journal.* In the case of the Keston diatoms, he took them to be Epizoa, and thought that Mr. Hudson, writing from Australia, referred to precisely the same forms; but they were also distinctly epizootic. In the case before them, there was no question in his mind about their being a portion of the organism itself, there being distinct apertures round the valves from which they were given off. He was now engaged in going over the slides which he presented to the Society, and found that all these specimens were amongst them still.

Mr. G. C. Karop remarked on an examination he had recently made of the saliva in a case of hydrophobia. The patient, a boy 12

FIG. 133.

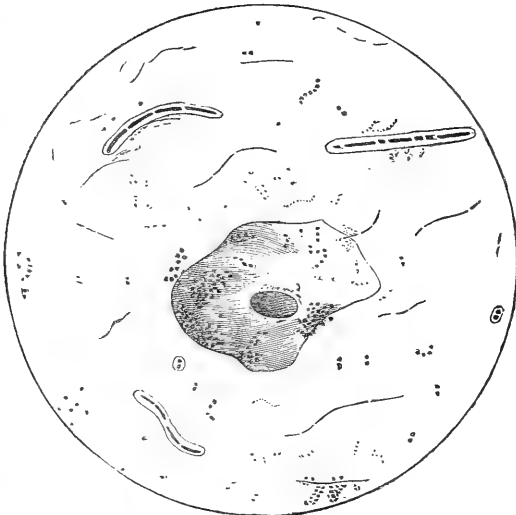

years old, had been bitten two months before any symptoms appeared. He was then brought to the Middlesex Hospital, where he died the

* Trans. Micr. Soc., Lond., 1860, Plate II.

day after admission with all the usual symptoms and agonizing tortures of this horrible disease. An attempt to administer chloroform was made during one of the violent paroxysms towards the end of the case, and about two drachms of saliva collected in a clean tube as it dribbled from the mouth. Some covers were prepared in the usual manner, stained with gentian violet, and mounted in xylol-balsam. The specimens presented the following characters:—Epithelium in large quantities, most of the cells crowded with micrococci; bacilli of various lengths, and very variable in diameter, some being thick and others extremely slender. A few showed evidence of spore formation, and were surrounded by a capsule. Micrococci abundant, in masses; diplococci, and short chaplets. Mr. Karop also exhibited a drawing of the Bacilli (see fig. 133).

Mr. J. Mayall, jun., exhibited the diamonds belonging to the ruling machine of the late F. A. Nobert, a typical one being shown under a Microscope by Mr. Powell. He said that in engaging to report to the Society the results of his examination of the ruling diamonds, he had expected the task would involve at the most a few hours' work with the Microscope, using powers from 20 to 150 diameters. In this expectation he had been mistaken; he had not found it possible to explain the nature of the diamond surfaces by mere inspection with the Microscope. On calling in the testimony of "experts" in diamond cleaving, polishing, &c., the results arrived at had become still more complicated, so that he (Mr. Mayall) had almost despaired of the possibility of bringing before the Society a report to which he could pledge himself. There were ten diamonds with the machine. Two of them were technically termed "points," pyramidal fragments of diamond terminating in points, and all who had examined them agreed that one was a piece of natural crystal, whilst the other had two cleavage faces and one crystalline (natural) face, all three faces untouched by the mill. Regarding these "points," there had been no difficulty in deciding that *none* of the surfaces had been polished. The other eight diamonds each presented the general form of two faces meeting in an "edge"; the difficulty had been to decide whether the faces were in some cases (1) both polished, (2) both cleaved ("cleavage faces" unpolished), or (3) one polished and one cleaved. The opinions of the diamond experts could not be reconciled, for in two instances they were in absolute contradiction; one party affirming that both surfaces were polished, whilst the other party were equally positive that both surfaces were due to cleavage, and were *not* polished.

Under these circumstances it had appeared to him essential to submit the surfaces to the test of the goniometer, with a view to determining whether the angles of the natural cleavage planes had been altered, any such alteration being necessarily due to artificial polishing of one or both surfaces. He had thought it would be most satisfactory to ask the assistance of a professional mineralogist, and had therefore applied to Mr. Lazarus Fletcher, of the Mineralogical Department in the British Museum, who had very kindly undertaken to examine the diamonds and measure the angles with Fuess's goni-

meter. In Mr. Fletcher's opinion, the two "points" were untouched by the mill; diamond No. 4 consisted of two cleavage faces meeting in the edge, and was untouched by the mill; in all the other cases, one of the faces meeting in the edge was an untouched cleavage face; the other had been polished, and in some cases an additional facet or two developed on that side; the alteration of the cleavage-angle he regarded merely as an incident of the polishing. *En résumé*, there were seven diamonds, each having two principal faces meeting in an edge, one face in every case being an untouched (unpolished) cleavage face, whilst the other was polished; one diamond had two cleavage faces meeting in an edge, and both faces were untouched (unpolished); the remaining two were "points," not touched by the mill. The goniometer showed that in the polishing the angles had been altered from the natural cleavage planes by quantities varying from a few minutes up to about 6° , and, as no two were exactly alike, it might be assumed that, as Mr. Fletcher suggested, "the alteration of the angle is merely an incident of the polishing," and not a condition distinctly aimed at by Herr Nobert.

In the face of Mr. Fletcher's opinion, Mr. Mayall said that he must withdraw the statement he had made at the previous meeting that some of the diamonds appeared to have two polished surfaces meeting in one edge. On closer examination in Mr. Fletcher's presence, he found that certain striations on the surfaces, which he had regarded as imperfectly polished, were more probably untouched, and therefore he now gave his adhesion unreservedly to Mr. Fletcher's judgment.

Regarding the mode of preparing the ruling diamonds adopted by Herr Nobert, Mr. Mayall said he had no record save the diamonds themselves. The matter could only be decided by conjecture. After various consultations with diamond experts, he had come to the conclusion that diamonds, exhibiting under the Microscope precisely the character of the seven "edges" to which he had referred, could be prepared from the fragments of gem diamonds met with at any diamond cleaver's. The cleaver would select a fragment which would admit of two faces being cleaved to an edge of about $1/16$ in. or $1/20$ in. in length; one of these faces should be perfectly polished on the mill as near as might be parallel with the cleavage face; the other face should then be cleaved again parallel to its former cleavage, so as to remove the edge, which would probably have been somewhat rounded by the mill, thus furnishing a new and probably sharper edge—a clean fractured surface meeting the flat polished surface; the diamond should then be mounted in a soft metal in a notch at the end of a piece of brass wire by means of a blowpipe. Such fragments of diamonds had but little commercial value. A diamond cleaver in Antwerp had estimated the cost of supplying them complete at less than ten shillings each. After referring to the various notes on the diamonds contained in Herr Nobert's memorandum-book, Mr. Mayall said he had no doubt the publication of the data obtained from the examinations of the diamonds would further the interests of micro-metry. Several ruling machines existed both in Europe and America

capable of dividing spaces as minutely and exactly as Herr Nobert's machine; but most, if not all, of them refused to rule lines at all comparable to Nobert's when the closeness exceeded about 50,000 to the inch, and this was, he believed, mainly, if not wholly, due to imperfection in the diamond, or in the method of regulating its pressure upon the surface to be ruled.

Mr. Hardy exhibited a colony of *Vorticella* having the stalks agglutinated in a bundle, and covered with transparent gelatinous matter. It was found erect on leaves in colonies of 50 to 100, some more erect than others, and coming off the leaf freely. When loose, they appear very like large *Conochilus*, but sink by the weight of stalk. The body was campanulate and very slightly retractile. Height, 2-4 mm.

Mr. Cheshire exhibited a remarkable slide showing conductive nerve-threads escaped from the sheath of the ganglionic chain running through the first three segments of the abdomen of *Vespa vulgaris*.

The following Instruments, Objects, &c., were exhibited:—

Mr. Bolton:—*Volvox globator* (male?).

Mr. Cheshire:—Slide showing conductive nerve-threads from *Vespa vulgaris*.

Mr. Crisp:—Model of an old Italian Microscope.

Mr. Dowdeswell:—Septic microbes from high altitudes.

Mr. Hardy:—Colony of *Vorticellæ*.

Mr. Madan:—Bertrand's polarizing prism, and modification of Ahrens's prism.

Mr. J. Mayall, jun.:—Diamonds belonging to Nobert's ruling machine.

Mr. Michael:—Slides of Oribatidæ in illustration of his paper.

Mr. H. Mills:—Six slides of *Stephanodiscus Niagaraæ*.

New Fellows:—The following were elected *Ordinary Fellows*:—Messrs. McLaughlin Berens, P. H. Emerson, G. M. Giles, M.B., George Norman, Thomas Pray, jun., E. A. Schultze, Edward Wethered, James E. Whitney, and W. G. de Witt, Rev. E. A. Hutton, B.A., and Mrs. Farquharson.

MEETING OF 13TH MAY, 1885, AT KING'S COLLEGE, STRAND, W.C.,
THE PRESIDENT (THE REV. DR. DALLINGER, F.R.S.) IN THE
CHAIR.

The Minutes of the Meeting of 4th April last were read and confirmed, and were signed by the President.

Mr. Beck exhibited the "Star" Microscope (in two forms) which his firm had recently brought out with a view to supply a want which had been felt for an instrument which should be at the same time

very cheap, but yet thoroughly reliable. To explain what he meant by cheapness he mentioned that it was proposed to offer the cheaper of the two forms for 3 guineas, with two objectives (1 in. and 1/4 in.). He believed it would be found that the instruments were suited to all the ordinary requirements of the botanist, the student, or the amateur. He had thought of reading an introductory notice of the instruments which had been prepared for circulation, but instead of doing this he thought it would be better to present an instrument to the Society, so that those who were interested in such matters might have the opportunity of seeing what could be done with it.

The President, in thanking Mr. Beck for his donation, said he was glad to welcome such an instrument, for he was himself constantly realizing the need of a very cheap form of Microscope which was capable of doing work in a reasonably good manner. A large number of boys and youths were prevented from taking up microscopical studies by the expense connected with them, and to be able to have a Microscope of this class with two objectives at the price mentioned would therefore be a great boon.

Mr. Guimaraens exhibited six slides of Pathogenic bacteria prepared by Dr. A. C. Abbott, of Baltimore, U.S.A., from material supplied by Dr. G. M. Sternberg, and mounted according to his directions. He considered *Bacillus tuberculosis* in sputum stained by Frankel's method, and *B. anthracis* in liver of rabbit, deserved especial commendation. There was also an interesting slide of *Micrococcus* of swine plague (pure culture). Dr. Klein maintains the disease is caused by a *Bacillus*, whilst Drs. Salmon and Sternberg consider the form to be a *Micrococcus*.

The President called particular attention to the slides, which he considered were very beautifully mounted, bringing out the *Bacilli* in a most perfect manner.

Mr. Groves exhibited and described one of the new Cambridge Rocking Section-cutters, the principle of which was somewhat new. The razor was firmly fixed at one end of the bed-plate, the imbedded specimen being held in a brass tube fitted upon the end of an iron arm which was mounted upon trunnions after the manner of a gun. There was an ingenious contrivance by means of which the arm was raised clear of the blade, the section being cut as it descended, and dropping directly upon the slide upon which it might be mounted. The machine was capable of cutting the thinnest possible sections. During a recent visit to Cambridge he had found this machine to be the one in general use (*supra*, p. 549).

In reply to questions, Mr. Groves stated that the machine was not adapted for freezing, nor for cutting sections of hard substances, but for soft tissues it worked admirably, and although the sections were not cut in a straight line, they were parallel to each other, and the arc described was so slight that it made no practical difference to the flatness of the section.

Mr. Crisp exhibited a mirror made by the Bausch and Lomb Optical Company, to which was fitted a diaphragm with an oblong slit (*supra*, p. 523).

Mr. J. Mayall, jun., said that the principle of having a diaphragm over the mirror was applied by Dellebarre in the last century, and had been subsequently repeated. He remembered having seen Dr. Charles Robin use similar diaphragms, which he found very useful.

Mr. Crisp mentioned that a short time ago a traveller in Asia gave an account of his discovery of the "wax insects," but stated he had no means of examining them otherwise than with the naked eye. This had led him to look up the account of Gray's water Microscopes, in order to call attention to the very simple means by which magnifying power might be obtained under the circumstances in which this traveller found himself placed. Even a drop of water on a piece of glass would have furnished the power required. Mr. Mayall had constructed a model of Gray's apparatus, which he would describe.

Mr. J. Mayall, jun., said that Gray had described his process very clearly. He employed a plate of metal $1/16$ in. thick with a hole drilled through it about $1/30$ in. in diameter, one side of which was countersunk to $1/8$ in. in diameter, and the other side to about half that extent. A drop of water was then put in each of the countersunk spaces, and it was quite surprising how much magnifying power was obtained, and how clearly the object was shown. Gray suggested that a little cavity should be made in the support in which to put a drop of water containing organisms for examination, but this was not quite so successful. It was not necessary to employ metal for the purpose, a piece of cardboard or wood answered perfectly. Gray's object was to make a simple as well as an effective apparatus, and in this he had been quite successful, and when an observer found himself without a lens he could not do better than follow the suggestion. Gray found it preferable to use a solution of isinglass, which would remain where it was placed better than water.

Mr. Beck said that, some years ago, before the race of street "patterers" became extinct, there used to be a man who went about selling Microscopes made somewhat on this plan, but the lens was made of a drop of Canada balsam.

Mr. Mayall said that, in addition to Canada balsam, there were other substances such as castor oil, and, in fact, many of the highly dispersive oils which would give even better results.

Dr. Maddox read his paper, "An Experiment on Feeding some Insects with the Curved or 'Comma' Bacillus and also with another *Bacillus* (*Bact. subtilis*)," illustrating the subject by preparations exhibited under the Microscope.

Mr. Cheshire said that he must, in the first place, congratulate Dr. Maddox on the time he had been able to keep his bees alive in a state of isolation; they were not at all easy to keep so under ordinary

circumstances. He had tried himself some similar experiments, and thought he had succeeded in infecting *Musca vomitoria*, but it might be well to remark that in one hive bee he had found eight or ten distinct kinds of bacilli, one of which had a distinct curvature. Amongst bee-keepers there used to be an idea that the bees had no diseases, although there was one affecting the larvæ, but directly a careful examination of the bees was made it was found that they were subject to a great many. One kind had the curious effect of causing all the hairs to fall out, and on examining bees which were so affected he found them all to contain large numbers of the short red bacillus. If any one intended to experiment in these matters, it might be useful to know that if the bees were fed with food stained with anilin dyes very curious effects were produced upon the internal organs, differentiation took place within the body, and when they came to dissect them afterwards they would find it a very great help.

Mr. Crisp announced that the Council had decided to place one of Prof. Abbe's Apertometers in the Library for the use of any of the Fellows who might wish to test the apertures of their objectives. Also that it was intended to publish in the Journal in future portraits of the Presidents of the Society. It was also contemplated to publish the portraits of past presidents, but as it would be quite impossible to give whole-page plates of the whole eighteen, it was intended to give one of Prof. Owen as the first President of the Royal Microscopical Society of London, and another of Mr. Glaisher as the first President of the Royal Microscopical Society after the Charter, the others being printed in two groups. To enable this plan to be carried out, they would be glad if any Fellow of the Society who had photographs of either Dr. Lindley, Mr. Jackson, Dr. Lankester, Mr. Farrants, or Mr. Reade, would lend them for the purpose of being copied.

Dr. J. D. Cox's paper, "Structure of the Diatom Shell. Siliceous films too thin to show a broken edge," was read (*supra*, p. 398).

Mr. E. Wethered read his paper "On the Structure and Origin of Carboniferous Coal Seams" (*supra*, p. 406), the subject being illustrated by large diagrams, as well as by numerous preparations exhibited under Microscopes.

The President said he should only be expressing what he was sure would be the feeling of the whole of the Fellows present, in thanking Mr. Wethered for his very interesting paper.

Dr. Hudson's paper "On four new species of the genus *Floscularia*, and five other new species of Rotifers," was read. The paper described *F. mira*, *F. mutabilis*, *F. calva*, *F. edentata*, *Conochilus dossuarius*, *Notommata spicata*, *Stephanops armatus*, *Pompholyx sulcata*, and *Taphrocampa ocellata*.

Mr. J. Mayall, jun., said he wished to correct and supplement certain points in his description of Nobert's ruling machine as reported in the Proceedings of the April meeting. (1) The divisions to 5 minutes in arc on the bands of silver imbedded near the circumference of the division-plate were in all probability made by means of a large circle-divider, and from them the twenty-one (not twenty) rows of "dots" would have been made with great accuracy. The divisions, therefore, should not have been referred to as supplementing the "dots," but as the prime factor of accuracy of the dividing engine. (2) The stud and dots might have been used for cutting toothed wheels, but not for ruling diffraction gratings or interference plates. These latter would require the greatest possible accuracy, and therefore Herr Nobert would assuredly adopt the most certain method, which was to work with the division-plate and the micrometer-Microscopes. The tangent-screw caused the division-plate to rotate with great accuracy, so that Herr Nobert may not have found it necessary to inspect the divisions by the micrometer-Microscopes for each line; he may have tabulated the error of the tangent-screw, and made periodic allowance for it. (3) In order to reduce the motion in arc when ruling test-plates, where the movement of the test-plate represented the sine of the arc motion of the division-plate, Herr Nobert would probably use the arc motion only for the production of the bands of lines, and in moving the test-plate over the blank spaces between the bands would utilize the fine micrometer-screw attached to the agate plate fitted within the hollow steel cylinder carrying the test-plate, by which the latter could be easily moved $1/2000$ in. (the average width of the blank spaces between the bands), or even less. In this way he would reduce the total arc motion to about one-half. To minimize this differential motion Herr Nobert doubtless used the greatest possible excentricity of the short arm of the lever, so as to utilize the smallest motion in arc required for his subdivisions.

The following Instruments, Objects, &c., were exhibited:—

Mr. Beck:—"Star" Microscopes.

Dr. J. D. Cox:—Photographs of broken diatom valves.

Mr. Crisp:—(1) Bausch and Lomb Optical Company's mirror, with diaphragms; (2) Simple Microscope, with "multiplying glass" as the illuminator.

Mr. Groves:—Cambridge Rocking Microtome.

Mr. Guimaraens:—Six slides of Pathogenic Bacteria.

Dr. Maddox:—Slides illustrating his paper.

Mr. J. Mayall, jun.:—Model of Gray's Water Microscope.

Mr. Wethered:—Slides illustrating his paper.

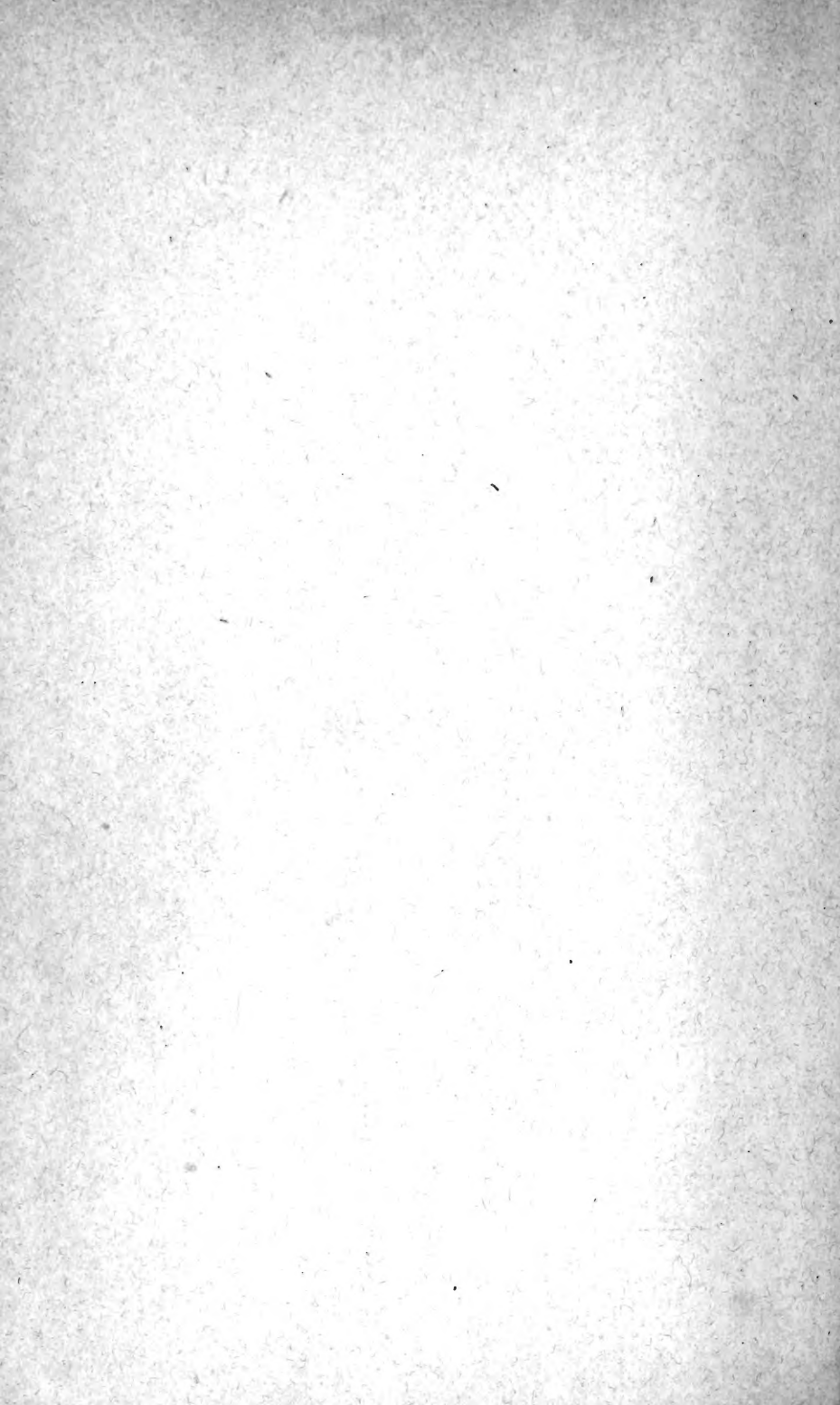



3 5185 00266 7721

