

B. E. STECHBART

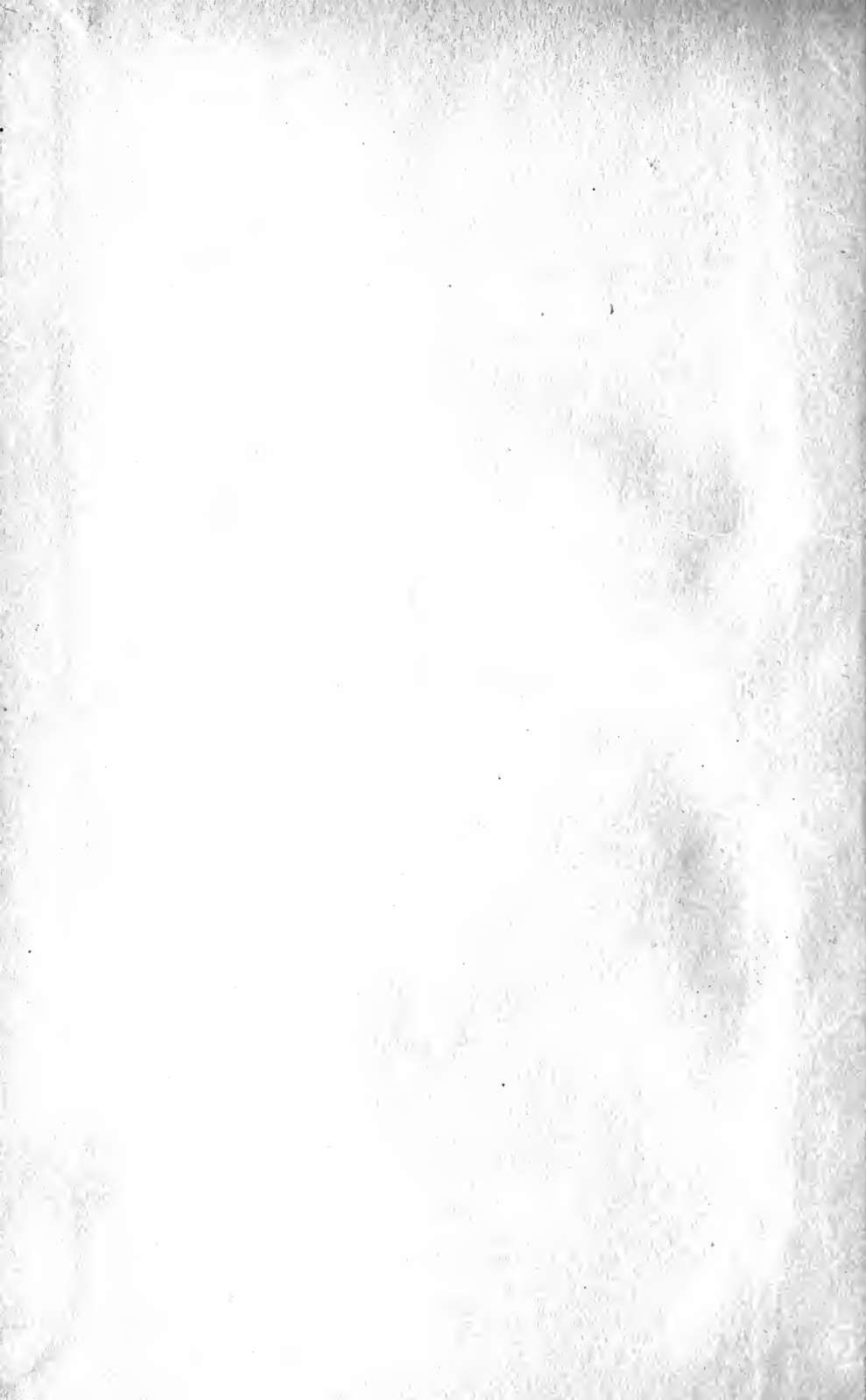

Digitized by the Internet Archive
in 2007 with funding from
Microsoft Corporation



VOL. XXII

NO. 1

JOURNAL
OF THE SOCIETY OF
MOTION PICTURE ENGINEERS

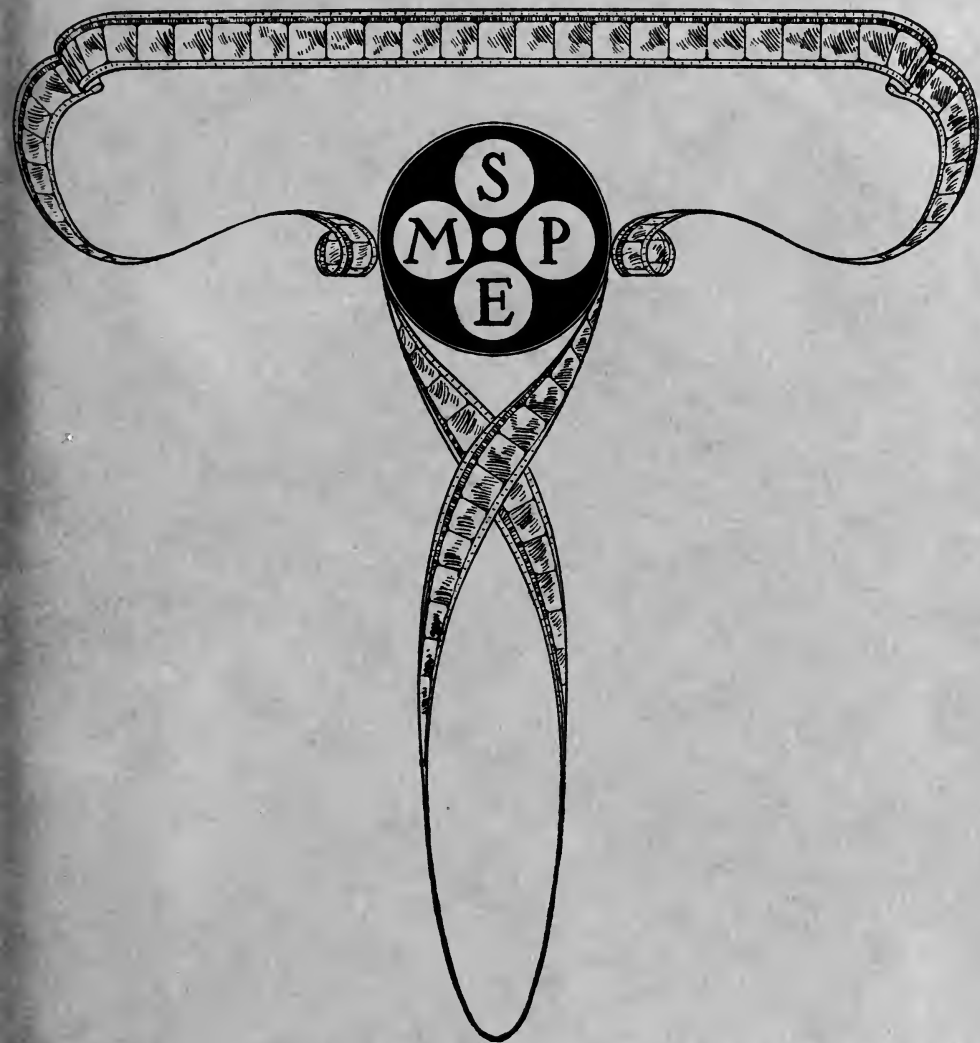

JANUARY, 1934

PUBLISHED MONTHLY BY THE
SOCIETY OF MOTION PICTURE ENGINEERS

The Society of Motion Picture Engineers

Its Aims and Accomplishments

The Society was founded in 1916, its purpose as expressed in its constitution being the "advancement in the theory and practice of motion picture engineering and the allied arts and sciences, the standardization of the mechanisms and practices employed therein, and the maintenance of a high professional standing among its members."

The membership of the Society is composed of the best technical experts in the various research laboratories and other engineering branches of the industry in the country, as well as executives in the manufacturing and producing branches.

The Society holds two conventions a year, spring and fall, at various places and generally lasting four days. At these meetings papers dealing with all phases of the industry—theoretical, technical, and practical—are presented and discussed and equipment and methods are often demonstrated. A wide range of subjects is covered, many of the authors being the highest authorities in their particular lines of endeavor.

Papers presented at conventions, together with contributed articles, translations and reprints, abstracts and abridgments, and other material of interest to the motion picture engineer are published monthly in the *JOURNAL* of the Society. The publications of the Society constitute the most complete existing technical library of the motion picture industry.

JOURNAL

OF THE SOCIETY OF

MOTION PICTURE ENGINEERS

Volume XXII

JANUARY, 1934

Number 1

CONTENTS

	<i>Page</i>
Report of the Committee on Laboratory and Exchange Practice	3
Report of the Projection Practice Committee.....	11
Report of the Historical and Museum Committee.....	13
Report of the Committee on Standards and Nomenclature.....	17
Sprocket Dimensions for 35-Mm. Visual and Sound Projection Equipment..... H. GRIFFIN	20
Direct-Current High-Intensity Arcs with Non-Rotating Positive Carbons..... D. B. JOY AND A. C. DOWNES	42
A New Development in Carbon Arc Lighting..... P. MOLE	51
A New White Flame Carbon for Photographic Light..... D. B. JOY, F. T. BOWDITCH, AND A. C. DOWNES	58
The Use of the Talking Picture as an Additional Educational Tool at the University of Chicago..... H. B. LEMON	62
A New 35-Mm. Portable Sound Projector..... H. GRIFFIN	70
Society Announcements.....	78

JOURNAL OF THE SOCIETY OF MOTION PICTURE ENGINEERS

SYLVAN HARRIS, EDITOR

Board of Editors

J. I. CRABTREE, *Chairman*

O. M. GLUNT

A. C. HARDY

F. F. RENWICK

Subscription to non-members, \$8.00 per annum; to members, \$5.00 per annum, included in their annual membership dues; single copies, \$1.00. A discount on subscriptions or single copies of 15 per cent is allowed to accredited agencies. Order from the Society of Motion Picture Engineers, Inc., 20th and Northampton Sts., Easton, Pa., or 33 W. 42nd St., New York, N. Y.

Published monthly at Easton, Pa., by the Society of Motion Picture Engineers.

Publication Office, 20th & Northampton Sts., Easton, Pa.

General and Editorial Office, 33 West 42nd St., New York, N. Y.

Entered as second class matter January 15, 1930, at the Post Office at Easton, Pa., under the Act of March 3, 1879. Copyrighted, 1934, by the Society of Motion Picture Engineers, Inc.

Papers appearing in this Journal may be reprinted, abstracted, or abridged provided credit is given to the Journal of the Society of Motion Picture Engineers and to the author, or authors, of the papers in question. The Society is not responsible for statements made by authors.

Officers of the Society

President: A. N. GOLDSMITH, 444 Madison Ave., New York, N. Y.

Past President: J. I. CRABTREE, Kodak Park, Rochester, N. Y.

Vice-President: W. C. KUNZMANN, Box 400, Cleveland, Ohio.

Vice-President: O. M. GLUNT, 463 West St., New York, N. Y.

Secretary: J. H. KURLANDER, 2 Clearfield Ave., Bloomfield, N. J.

Treasurer: T. E. SHEA, 463 West St., New York, N. Y.

Governors

E. COUR, 1029 S. Wabash Ave., Chicago, Ill.

H. T. COWLING, 7510 N. Ashland Ave., Chicago, Ill.

R. E. FARNHAM, Nela Park, Cleveland, Ohio.

H. GRIFFIN, 90 Gold St., New York, N. Y.

E. HUSE, 6706 Santa Monica Blvd., Hollywood, Calif.

W. B. RAYTON, Rochester, N. Y.

H. G. TASKER, 41-39 38th St., Long Island City, N. Y.

REPORT OF THE COMMITTEE ON LABORATORY AND EXCHANGE PRACTICE*

The first report of this Committee discussed laboratory procedure in general. The discussion is continued in this report, but now is restricted to the development of the film, which is divided into three phases, *viz.*, (1) the preparation of a negative developing solution, (2) the preparation of a positive developing solution, and (3) means of development control. The material has been selected from the accompanying bibliography supplemented by information collected by the members of the Committee.

NEGATIVE DEVELOPER

The *D-76* borax developer for motion picture negative film was first used for developing duplicate negatives. The excessive graininess of duplicate prints led to the substitution of this fine-grain developer for the old sodium carbonate developer. As the results attained with the new developer were very satisfactory, it was soon tried also for developing regular negatives. Several papers were published describing the characteristics of the borax developer, and the film manufacturing companies began to recommend its use by the motion picture laboratories. Today it is used, variously modified, in practically every motion picture laboratory.

The original borax formula was prepared for rack-and-tank development. In most instances it proved to be too strong a solution to be used in developing machines, where the high speed of the film and the forced circulation of the developer caused a decided increase in the degree of agitation.

Due to the lack of standardization, very little uniformity obtains in the construction and operation of the developing machines installed in the various laboratories. Each machine must be operated in a particular specified manner if it is to be operated efficiently and the cost of developing a unit length of film be maintained at a minimum. This necessitates the most careful use of the developer to limit the cost of the chemicals, and the operation of the developing

* Presented at the Fall, 1933, Meeting at Chicago, Ill.

machine at the maximum safe speed to limit the cost of labor and equipment. Therefore, it has been necessary to prepare a different formula in almost every laboratory, in order that the desired contrast and density might be obtained under each peculiar set of operating conditions. It may be added that these desired results are not yet completely standardized, as good photographic quality is still a subject of personal judgment.

With the assistance of the photographic chemists, the laboratory technicians have been readily able to modify the standard borax formula, and prepare solutions suitable for the special operating conditions. Two methods are available for finding the proper formula: the standard solution can be diluted, or the relative quantities of the constituents can be varied. Considerable danger is incurred if dilution is carried too far. Negatives of poor quality may result from a change in the characteristic curve of the developer; or the efficiency of the solution may be decreased, with an accompanying increase in the cost of chemicals.

For these reasons a developer of the proper characteristics is usually found by varying the constituents of the standard developer. A solution of the standard formula is first put into the machine, and the contrast and density are checked with the machine operating under the desired conditions. Additional chemicals in solution are then added until the desired contrast and density are attained. If it is necessary to vary the standard formula to such an extent that the efficiency of the developer has been appreciably decreased, it may be necessary to vary the operation of the machine or to alter its design. Such changes, of course, would be necessary only in the case of machines designed and constructed in the early days of machine developing, when little was known of their operating speeds and capacity.

This method of varying the constituents of the borax developer so as to achieve certain desired characteristics has been discussed in several papers presented to the Society. In particular, the paper entitled "Some Properties of Fine Grain Developers for Motion Picture Film," by Carlton and Crabtree,* has proved extremely helpful to the laboratory technicians in preparing satisfactory negative developing solutions. It demonstrates in detail the numerous changes that occur in the characteristics of the solution when the

* See appended bibliography, under *Developing Solutions*.

quantities of the chemicals are changed, as well as the effect of adding other chemicals.

In general practice the same formula is used for the negative replenisher as for the original solution. In some laboratories, however, the negative replenisher is much more concentrated than the developing solution. The necessary rate of flow of additional solution to maintain the bath at constant strength is readily determined by sensitometric tests.

POSITIVE DEVELOPER

The *D-16* developer for motion picture positive film was recommended to the laboratories many years prior to the era of machine development. It still serves today as a very satisfactory positive solution for preliminary testing in selecting a positive solution suitable for a particular developing machine. Just as when preparing the negative developer, preliminary tests are made with the standard developer, and the quantities of the constituents are varied until the desired results are attained. Equal percentage variations of the metol or monomethylparaminophenol sulfate, hydroquinone, and sodium carbonate may be made over a wide range, with no appreciable decrease in the efficiency of the developer or change in its characteristic curve. In general, a change in the quantity of metol will cause a greater change in the density than the corresponding change in the contrast. Similarly, a change in the quantity of hydroquinone will cause a greater variation in the contrast than in the density. As has been mentioned, the density produced by the positive bath for a standard exposure must remain constant if prints are to be made from old negatives using the original timing cards.

The laboratories on the West Coast favor a special formula for the positive replenishing solution. In the eastern section of the country the formula of the replenisher is the same as that of the original solution, except that the potassium bromide is omitted. Both seem to produce satisfactory results. The problem of properly selecting a positive replenishing solution has been ably discussed by Crabtree and Ives in a paper entitled "A Replenishing Solution for a Motion Picture Positive Film Developer."*

* See appended bibliography, under *Developing Solutions*.

DEVELOPMENT CONTROL

More progress has been made in development control during the past several years than in any other phase of laboratory work. To a great extent this is due to improvements that have been made in sensitometric equipment, and the consulting service on sensitometry now available to the laboratories. The Eastman type *Iib* sensitometer and the Eastman densitometer, which have been described in the JOURNAL,* have proved very satisfactory for laboratory control work.

The methods used by the Hollywood laboratories in applying these instruments were described to the Society by Mr. E. Huse in his paper "Sensitometric Control in the Processing of Motion Picture Film in Hollywood."* The Committee has found that the same methods, with very little variation, are used in all other sections of the country also.

R. F. NICHOLSON, *Chairman*

J. CRABTREE	A. HIATT	J. S. MACLEOD
J. I. CRABTREE	E. HUSE	R. F. MITCHELL
A. S. DICKINSON	D. E. HYNDMAN	H. RUBIN
G. C. EDWARDS	E. D. LEISHMAN	W. SCHMIDT
R. M. EVANS	C. L. LOOTENS	V. B. SEASE
T. FAULKNER	K. MACILVAIN	J. H. SPRAY
	D. MACKENZIE	

BIBLIOGRAPHY

Developing Machines and Associated Equipment

"Erbograph Machine," R. C. Hubbard, *Trans. Soc. Mot. Pict. Eng.*, VII (1923), No. 17, p. 163.

"Straight Line Developing Machine," R. C. Hubbard, *Trans. Soc. Mot. Pict. Eng.*, VIII (1924), No. 18, p. 73.

"Machine Developing of Negative and Positive Motion Picture Film," A. B. Hitchins, *Trans. Soc. Mot. Pict. Eng.*, IX (1925), No. 22, p. 46.

"A Negative Developing Machine," C. R. Hunter, *Trans. Soc. Mot. Pict. Eng.*, XII (1928), No. 33, p. 195.

"A Horizontal Tray Type of Continuous Processing Machine," H. T. Jamieson, *Trans. Soc. Mot. Pict. Eng.*, XII (1928), No. 36, p. 1093.

"A Method of Quantity Developing of Motion Picture Film," C. R. Hunter and R. M. Pierce, *J. Soc. Mot. Pict. Eng.*, XVII (Dec., 1931), No. 6, p. 954.

"Rust Proof Steel Tanks for Developers," *Lichtbild* (June, 1932), No. 11, p. 237.

"Syphons and Measuring Devices for Photographic Solutions," K. C. D. Hickman, *Trans. Soc. Mot. Pict. Eng.*, X (1926), No. 26, p. 37.

* See appended bibliography, under *Development Control*.

"Rack Marks and Airbell Markings on Motion Picture Film," J. I. Crabtree and C. E. Ives, *Trans. Soc. Mot. Pict. Eng.*, **IX** (1925), No. 24, p. 95.

"The Handling of Motion Picture Film under Various Climatic Conditions," R. J. Flaherty, *Trans. Soc. Mot. Pict. Eng.*, **X** (1926), No. 26, p. 85.

"The Examination of Film by Projection for a Continuous Processing Machine," W. V. D. Kelley, *Trans. Soc. Mot. Pict. Eng.*, **XI** (1927), No. 30, p. 224.

"Handling of Motion Picture Film at High Temperatures," J. I. Crabtree, *Trans. Soc. Mot. Pict. Eng.*, **VIII** (1924), No. 19, p. 39.

"Directional Effects in Continuous Film Processing," J. Crabtree, *J. Soc. Mot. Pict. Eng.*, **XVIII** (Feb., 1932), No. 2, p. 207; *J. Soc. Mot. Pict. Eng.*, **XXI** (Nov., 1933), No. 5, p. 351.

"A Modern Laboratory for the Study of Sound Picture Problems," T. E. Shea, *J. Soc. Mot. Pict. Eng.*, **XV** (March, 1931), No. 3, p. 277.

"Materials for the Construction of Motion Picture Processing Apparatus," J. I. Crabtree, G. E. Matthews, and J. F. Ross, *J. Soc. Mot. Pict. Eng.*, **XVI** (March, 1931), No. 3, p. 330.

"Movement in Film Tanks," *Brit. J. Phot.*, **LXXIX** (July 8, 1932), No. 3766, p. 405.

"Individual or Multiple Film Development," C. Emmerman, *Photofreund*, **XII** (March, 1932), No. 5, p. 86.

Developing Solutions

"A Preliminary Note on the Development of Motion Picture Film," F. F. Renwick, *Trans. Soc. Mot. Pict. Eng.*, **VII** (1923), No. 16, p. 159.

"The Development of Motion Picture Films by the Reel and Tank System," J. I. Crabtree, *Trans. Soc. Mot. Pict. Eng.*, **VII** (1923), No. 16, p. 163.

"Investigation on Photographic Developers," J. I. Crabtree and M. L. Dundon, *Trans. Soc. Mot. Pict. Eng.*, **VIII** (1924), No. 19, p. 28.

"Behavior of Gelatin in the Processing of Motion Picture Film," S. E. Shepard, *Trans. Soc. Mot. Pict. Eng.*, **XI** (1927), No. 32, p. 707.

"Motion Picture Photomicrographs of the Progress of Development of a Photographic Image," C. Tuttle and A. P. H. Trivelli, *Trans. Soc. Mot. Pict. Eng.*, **XII** (1928), No. 33, p. 157.

"The Fogging Properties of Developers," M. L. Dundon and J. I. Crabtree, *Trans. Soc. Mot. Pict. Eng.*, **XII** (1928), No. 36, p. 1096.

"Some Properties of Fine Grain Developers for Motion Picture Film," H. C. Carlton and J. I. Crabtree, *Trans. Soc. Mot. Pict. Eng.*, **XIII** (1929), No. 38, p. 406.

"Borax Developer Characteristics," H. W. Moyse and D. R. White, *Trans. Soc. Mot. Pict. Eng.*, **XIII** (1929), No. 38, p. 445.

"A Quick Test for Determining the Degree of Exhaustion of Developers," M. L. Dundon, G. H. Brown, and J. G. Capstaff, *J. Soc. Mot. Pict. Eng.*, **XIV** (April, 1930), No. 4, p. 389.

"A Replenishing Solution for a Motion Picture Positive Film Developer," J. I. Crabtree and C. E. Ives, *J. Soc. Mot. Pict. Eng.*, **XV** (Nov., 1930), No. 5, p. 627.

"Variation of Photographic Sensitivity with Development Time," R. Davis and G. K. Neeland, *J. Soc. Mot. Pict. Eng.*, **XVIII** (June, 1932), No. 6, p. 742.

"A Method for the Correct and Most Economical Concentration of Elon and Hydroquinone in a Borax Developer," A. M. Gundelfinger, *J. Soc. Mot. Pict. Eng.*, **XX** (April, 1933), No. 4, p. 343.

"Some Properties of Two Bath Developers for Motion Picture Film," J. I. Crabtree, H. Parker, Jr., and H. D. Russell, *J. Soc. Mot. Pict. Eng.*, **XI** (July, 1933), No. 1, p. 21.

"The Deterioration of Sulfite Hydroquinone Solutions and the Mode of Activity of Old Solutions," J. Pinnow, *Z. Wiss. Phot.*, **27** (Nov., 1930), No. 11/12, p. 344.

"The Role of Sulfite in Photographic Developers," J. Rzymkowski, *Camera* (Luzern), **9** (1930), No. 5, p. 128; No. 6, p. 164.

"Metol Developer," A. Kachelmann, *Reproduktion*, **3** (May, 1932), No. 5, p. 66.

"Metol-Quinol Developers for Negatives and Prints," G. W. Pritchard, *Brit. J. Phot.*, **LXXIX** (April 22, 1932), No. 3755, p. 240.

"Advantages of Compensating Developing," A. Lux, *Photofreund*, **XII** (Sept. 20, 1932), No. 18, p. 340; (Oct. 5, 1932), No. 19, p. 357; (Oct. 20, 1932), No. 20, p. 377.

"Practice of Fine Grain Development," K. Brandt, *Filmtechnik*, **VII** (Nov. 14, 1931), p. 7.

"Deterioration of Amidol Developers," P. J. Cammidge, *Amat. Phot.*, **LXXIV** (Aug. 17, 1932), No. 2284, p. 154.

"Keeping Properties of Developing Solutions," H. W. Bennett, *Brit. J. Phot.*, **LXXIX** (Sept. 23, 1932), No. 3777, p. 375.

"Obtaining Sediment Free Developers," E. Van Beugen, *Focus*, **XIX** (June 25, 1932), No. 13, p. 399.

"Pyrocatechol Developers with Little or No Sulfite," P. Hanneke, *Phot. Chronik.*, **XXXIX** (Oct. 25, 1932), No. 28, p. 209.

"Motion Picture Developer Formulas," *Amer. Cinemat.*, **XIII** (Aug., 1932), No. 4, p. 42.

"Reducing Grain in Negative," S. Moir, *Amer. Phot.*, **XXVI** (Oct., 1932), No. 10, p. 584.

"The Grain of the Negative," C. Emmerman, *Atelier*, **XXXIX** (Oct., 1932), No. 10, p. 82.

"Perpetual Life Film Tank Developer," W. G. Barker, *Brit. J. Phot.*, **LXXX** (Jan. 13, 1933), No. 3793, p. 16.

"Fog Formation by Chemical Reactions," E. Fuchs, *Z. Wiss. Phot.*, **XXXII** (1933), No. 1, p. 2.

"Grain vs. Exposure: Paraphenylenediamine Developer," *Brit. J. Phot.*, **LXXX** (Feb. 10, 1933), No. 3797, p. 69.

"Keeping Quality of Developers," H. W. Bennett, *Brit. J. Phot.*, **LXXIX** (Dec. 9, 1932), No. 3788, p. 751.

"Too Little Known Developer," W. Mernsinger-Beat, *Camera* (Luzern), **10** (Feb., 1932), No. 8, p. 266.

"Knapp System of Development," A. Knapp, *Brit. J. Phot.*, LXXX (April, 7, 1933), No. 3805, p. 191.

Development Control

"Actinic Measurements on the Exposing and Printing of Motion Picture Film," W. E. Story, Jr., *Trans. Soc. Mot. Pict. Eng.*, XVII (1921), No. 13, p. 106.

"A New Sensitometer for the Determination of Exposure in Positive Printing," L. A. Jones and J. I. Crabtree, *Trans. Soc. Mot. Pict. Eng.*, VI (1922), No. 15, p. 89.

"A Motion Picture Densitometer," J. G. Capstaff and N. B. Green, *Trans. Soc. Mot. Pict. Eng.*, VII (1923), No. 17, p. 154.

"An Improved Sector Wheel for Hurter and Driffield Sensitometry," M. Breifer, *Trans. Soc. Mot. Pict. Eng.*, IX (1925), No. 21, p. 85.

"A Compact Motion Picture Densitometer," J. G. Capstaff and R. A. Purdy, *Trans. Soc. Mot. Pict. Eng.*, XI (1927), No. 31, p. 607.

"A Trial and Error Method of Preparing a Motion Picture Sensitometer Tablet," J. I. Crabtree and C. E. Ives, *Trans. Soc. Mot. Pict. Eng.*, XI (1927), No. 32, p. 740.

"Artificial Sunlight for Photographic Sensitometry," R. Davis and K. S. Gibson, *Trans. Soc. Mot. Pict. Eng.*, XII (1928), No. 33, p. 225.

"The Measurement of Density in Variable Density Sound Film," C. Tuttle and J. W. McFarlane, *J. Soc. Mot. Pict. Eng.*, XV (Sept., 1930), No. 3, p. 345.

"Two Special Sensitometers," D. R. White, *J. Soc. Mot. Pict. Eng.*, XVII (March, 1932), No. 3, p. 279.

"Gamma by Least Squares," D. R. White, *J. Soc. Mot. Pict. Eng.*, XVIII (May, 1932), No. 5, p. 584.

"The Relation between Diffuse and Specular Density," C. Tuttle, *J. Soc. Mot. Pict. Eng.*, XX (March, 1933), No. 3, p. 228.

"Photographic Sensitometry," L. A. Jones, *J. Soc. Mot. Pict. Eng.*, Part I: XVII (Oct., 1931), No. 4, p. 491; Part II: XVII (Nov., 1931), No. 5, p. 695; Part III: XVIII (Jan., 1932), No. 1, p. 54; Part IV: XVIII (March, 1932), No. 3, p. 324.

"Time and Temperature vs. Test System for Development of Motion Picture Negative," W. Leahy, *J. Soc. Mot. Pict. Eng.*, XVIII (May, 1931), No. 5, p. 649.

"Sensitometric Control in the Processing of Motion Picture Film in Hollywood," E. Huse, *J. Soc. Mot. Pict. Eng.*, XXI (July, 1933), No. 1, p. 54.

"The Eastman Type 2B Sensitometer as a Control Instrument in the Processing of Motion Picture Film," G. A. Chambers and I. D. Wratten, *J. Soc. Mot. Pict. Eng.*, XXI (Sept., 1933), No. 3, p. 218.

"The Processing of Variable Density Sound Records," R. F. Nicholson, *J. Soc. Mot. Pict. Eng.*, XV (Dec., 1930), No. 6, p. 374.

"A Motion Picture Laboratory Sensitometer," L. A. Jones, *J. Soc. Mot. Pict. Eng.*, XVII (Oct., 1931), No. 4, p. 536.

"Sound Film Developing and Processing," *Kinemat. Weekly*, 152 (Nov. 7, 1929), No. 1177, p. 52.

"Making Sound Films (III) Sensitometric Tests," T. T. Baker, *Kinemat. Weekly*, 155 (Jan. 16, 1930), No. 1187, p. 67.

"Review of American Film Technique," W. Geyer, *Kinotechnik*, II (Dec. 5, 1929), No. 23, p. 623.

"Sensitometric Control in the Development of Sound Films," A. Kuster and R. Schmidt *Kinotechnik*, XIII (April 5, 1931), No. 7, p. 123.

"Temperature Control During Film Development," T. T. Baker, *Kinemat. Weekly Supp.*, 721 (June 18, 1931), No. 1261, p. 41.

"Saving Underexposures," K. Reitz, *Brit J. Phot.*, LXXIX (Nov. 4, 1932), No. 3783, p. 670.

"After-Treatment of Negatives (IV)," O. Mente, *Reproduktion* 3 (Nov., 1932), No. 11, p. 164.

DISCUSSION

PRESIDENT GOLDSMITH: I desire again to stress the need that this Committee should give consideration to the new problems that are arising in connection with the suitable development and proper maintenance of film for use in extended frequency systems.

MR. CRABTREE: The smaller laboratories are often in a quandary as to what kind of developing machine to purchase on the market. I wonder whether the Committee could make a survey of the available machines and describe them in the report.

MR. HYNDMAN: The Committee did what Mr. Crabtree suggested; but unfortunately, the patent litigation on developing machines has prevented our making such suggestions. Furthermore, it is the custom for practically all laboratories that use continuous machines to build their own; and though the general principles are always the same, many of the adjuncts are designed by the members of the particular laboratories. In view of these facts, we did not feel that it was advisable for the Committee to recommend what machines should be purchased until the litigation will have been completely settled.

MR. CRABTREE: I don't see that the Committee would have to assume any responsibility. It is simply a matter of abstracting the manufacturer's literature.

PRESIDENT GOLDSMITH: There is no just reason why the publication by the Society of descriptions of the various machines that are freely offered for sale by their manufacturers would be construed as a violation of legal or ethical rights. The buyer may require patent advice if there is litigation in process; but that is no reason why the Society should not describe the machines.

MR. NICHOLSON: I should like to add to Mr. Hyndman's remarks. With another member of the Committee I listed the names of all companies that had manufactured developing machines, and the types of machines that were being used in the various major laboratories, for inclusion in the report. At one of the meetings of the Committee, several members objected to including such data, so they were omitted.

MR. CRABTREE: I understand that small machines are manufactured by Debrie in France, Geyer in Germany, and Vinten in England.

REPORT OF THE PROJECTION PRACTICE COMMITTEE*

The Projection Practice Committee presented its latest detailed report at the Spring, 1933, Convention at New York, N. Y.¹ The meetings that have been held since that time have been devoted to formulating the plans for its next detailed report, to be presented at the Spring, 1934, Convention. Some of the topics to be included in that report, according to the present plans, are as follows:

- (1) The presentation of the electrical, optical, and mechanical principles involved in projection, from the point of view of the practical projectionist.
- (2) Projection room routine and maintenance.
- (3) Precautions to prevent breakdowns or imperfections of projection.

Some of these subjects have already been given considerable attention by the Committee; however, in view of their great importance, and in view of the changes of technic that are continually occurring, it is advisable that the previous analyses be considerably extended and brought up to date.

Another matter of great importance, to which the Committee has already devoted much time and effort, relates to the preparation of data dealing with the clearances, tolerances, and amount of wear of projection and sound equipment in the theater; and the design and use of tools for determining, rapidly and accurately, the condition of the equipment of the projection room, and of determining the need for replacement of worn parts. The Committee believes that the availability of data, tools, and testing methods appropriate to the projection room will constitute a contribution of major value to the art of projection.

In concluding this brief report, the Committee wishes again to emphasize a statement made in its previous report: "He (the projectionist) should be stationed constantly at the projector while it is in operation. . . ." The Committee is of the opinion that a proper factor of safety in operation, as well as the avoidance of imperfect operation of the projection equipment or unjustified interruptions of service, can be attained only by having an adequate personnel,

* Presented at the Fall, 1933, Meeting at Chicago, Ill.

as mentioned above, in the projection room. The Committee purposes further to study this aspect of projection practice, from the point of view of technical requirements; and plans to report in full on the subject on a later occasion.

H. RUBIN, *Chairman*

J. O. BAKER
T. C. BARROWS
G. C. EDWARDS
J. J. FINN
C. FLANNAGAN
S. GLAUBER
C. GREENE

H. GRIFFIN
J. HOPKINS
W. C. KUNZMANN
R. H. McCULLOUGH
P. A. McGUIRE
R. MIEHLING
F. H. RICHARDSON

V. A. WELMAN

REFERENCE

¹ Report of the Projection Practice Committee, *J. Soc. Mot. Pict. Eng.*, **XXI** (Aug., 1933), No. 2, p. 89.

DISCUSSION

MR. CRABTREE: Can the Committee make any recommendations for preventing the screens from going dark in the theaters other than by having the projectionist keep his eyes glued to the screen, or to the projector?

MR. GRIFFIN: There are only two reasons for stoppage in a theater, and they are film breakage and equipment failure. Unfortunately, these will occur sometimes when least expected, but if the projection room is equipped with sufficient and proper personnel, there is little excuse for it.

MR. RICHARDSON: The place for the projectionist is beside the projector every minute of the time it is running. If he is not there, there is likelihood that fire may occur. Furthermore, the manager says to himself, "Well! The motor is running the show. Why should I pay that fellow \$50 a week?" If the men stay where they belong and attend to their business, and are given the proper coöperation by the management, there is no excuse for a stop.

PRESIDENT GOLDSMITH: The Committee has not unduly stressed that point. One might imagine what might happen if a locomotive engineer should open the throttle wide and then retire to the tender to read a novel. It is true that a motion picture projector may operate as long as current is supplied to it. But that procedure is not in accord with the art of practical projection. This Committee of the Society, being a *practical* projection Committee, is of the belief that there should be adequately trained and interested personnel in the projection room. The Committee is interested only in the idea of satisfactorily continuing the show, and of the factor of safety for the audience that is required to ensure confidence.

REPORT OF THE HISTORICAL AND MUSEUM COMMITTEE*

This Committee in the past few months has been occupied with bringing together biographical records of many of the pioneers of the motion picture. These records, which are authenticated by early documentary evidence, patents, and contemporary accounts, are to be published when complete in the JOURNAL. It is the hope of the Committee to create a complete record of the beginnings of the motion picture for the JOURNAL so that future students who endeavor to establish and to investigate the origins of the industry can find an authoritative account in the JOURNAL. The Committee will appreciate any suggestions regarding memoirs, documents, or other information that will throw light on the early developments.

Besides this activity of creating written records, the Committee has been bringing many accessions to the Los Angeles Museum Collection of our Society. To enumerate them all would require too much space; however, a few of the larger additions will be itemized.

At last the animated cartoon exhibit has been completed and is on display. This exhibit traces the history of the animated cartoon, and includes examples of the series of drawings, three feet in length, that were used in the *Wheel of the Devil* in 1834 by William George Horner, as well as copies of three-color cartoons made in 1932-33. Examples of the cartoons that initiated the cartoon vogue in 1913-15 may also be seen. There is a complete display of the Disney "Mickey Mouse" cartoon covering the process in its various departments by photographs. There are examples of the double sound and picture manuscript used in cartoon making because the picture and sound are recorded separately. There are also examples of the camera exposure sheets, which show the necessary series of drawings required for the action. Stages in the making of the drawing are shown, from the rough character drawing layout, to the final opaqued cartoon characters. Included are examples of the various types of background drawings, original drawings from the first two-color cartoon made by Ted Eshbaugh as well as the first three-color "Silly Symphony," *Flowers and Trees*, made by Disney.

* Presented at the Fall, 1833, Meeting at Chicago, Ill.

An exhibit of the various lamps used in the studios has also been put on display. In this collection, which was made available by the General Electric Co. and Mr. John Winchester of the Metro-Goldwyn-Mayer Studios, are a representative group of lamps used in the studios today including the smallest globe made, the 1½-volt "grain of wheat" lamp used in miniatures, and the largest lamp, the 10-kilowatt, occasionally used for set illumination. Besides miniature lamps and studio set lamps, there are examples of the photoelectric recording and reproducing cells, projection lamps, heat lamps, *etc.* As a background of this display, there are some historic lamps. One of these is a model of the first Edison lamp of 1879, and another is a crude globe made by Sawyer in 1879. This last named type was developed by many experimenters in electric illumination before Edison conceived of the necessity of high resistance for efficient illumination. There are two coiled platinum wire filaments in the Sawyer lamp about 1/8 inch thick. This collection, however, is far from complete. It is required that any one having exhibits either of a historic nature or new types of lamps should send examples to the Committee for display. They should be forwarded to the Chairman of this Committee, care of the Los Angeles Museum, Motion Picture Division, Los Angeles, Calif. Besides an official acknowledgment from the Museum, credit will be given the donor on the accompanying museum label.

Mr. L. B. Mayer has presented a collection of pre-sound arc lighting equipment. In this accession are representative examples of the "overhead dome," "scoop," "flood banks," "rifle arcs," and "broad lights" of the "hard light" period of motion pictures. This collection supplements the one loaned some time ago by Mr. O. K. Oleson. It is hoped that it will be possible to build a full size set of a historical nature showing this lighting equipment, with cameras and other paraphernalia, when sufficient space may be allotted to do so. Models of the Aristo and early Kleig lights are wanted and any information that will lead to the whereabouts of such equipment will be appreciated.

Mr. W. Clendenin has added a group of early equipment catalogues to his already extensive donation. Mr. C. Blackstone has donated a Lubin Camera and Mr. A. J. Fitzpatrick, a model 5 Prestwich Camera. There are now in the collection, ten examples of cameras that were used during the period of about 1900 to 1915. Mr. Louis Lumière has sent a Cinematographe dating before 1900, which has ar-

rived but at present is going through the United States Customs routine required for historical pieces. This camera is one of the more notable of the early cameras. It served as a printer and projector, as well as a camera. It is about the size of a cigar-box, while the cameras of its time were as large as trunks. Such cameras as the Lubin, Pathé, Selig-Shustek, and others patterned their intermittent movement after the Lumière camera, which was first made early in 1895. It is very important that an old Biograph camera be located before they are all destroyed.

Mr. Cecile B. DeMille has added a number of props used in filming the *Sign of the Cross*. Among them is a replica of the Arena Roll that served as programs for the Roman Gladiatorial contests. There is a model of a Roman Arena also, as well as other items used by the Romans. Mr. L. B. Mayer recently loaned the collection a five-foot copper model of a Roman Fighting Galley, which was used in filming the naval battle in *Ben Hur*.

Three of the proposed set models showing the making of pictures today and the historical set have been put on display. These include the making of a glass matte shot, a sound set in operation, and a model of the first motion picture studio, the Edison "Black Maria," made from specifications furnished by Mr. W. K. L. Dickson who supervised its construction and made pictures in it for Edison in 1892-95.

Some additional documents from old magazines and books have been located. Where the original was not available, photostats have been made. Assistance in locating this material and in photostating it is being given by Mr. L. G. Young. The compilation of early references to the industry for posterity and for the use of students today is important and is not being overlooked. Anything located should be sent to the museum for display and for preservation. Booklets and other literature sent out by manufacturers or those developing new types of equipment are being filed, and your Committee would appreciate anyone's forwarding such data to the museum as it also is of value in preserving the history of the industry. Besides the memoirs of the past, everything pertaining to the present era is being preserved. Handbills, technical information, or new apparatus announcements are being classified. The importance of this work will be recognized by those who have found it necessary to investigate the details of almost any activity of the past.

Electrical Research Products, Inc., has assured the Committee of cooperation in bringing together a collection of sound recording

equipment for the exhibit. Some of this material in the form of recording lamps has been placed with the museum. It is their plan to display recording slits, microphones, illustrations, and other items that will show the sound recording process.

One of the largest accessions received recently consisted of about 10,000 old motion picture announcement, lecture, advertisement, and song slides, donated by Mr. H. Ross. These slides date back to the inception of the use of slides in connection with the motion picture. Besides the usual announcements of new pictures and neighborhood advertisements, of the time before the trailers on film, there is a wide collection of slides exhorting the members of the audience to "Please refrain from spitting on the floor," "Ladies, please remove your hats," "Those desiring to smoke, please sit on the right side of the house," "Leave the dogs at home," "One minute for repairs," "Good night," *etc.* This collection vividly portrays the boisterous movie audience of that day. A representative group has been put on display, shown to advantage by back lighting. As a contrast to these slides, specimens of the present film trailers may be seen.

Coöperation is invited and any one knowing of the whereabouts of relics or memoirs of the motion picture should get in touch with the Chairman of this Committee, care of the Los Angeles Museum, Los Angeles, Calif.

The assistance and help so generously given by Dr. Lee de Forest, Robert G. Linderman, Harry Tucker, Willis O'Brien, Carrol Shepp-herd, Dr. E. M. Honan, G. R. Lilly, Edward T. Estabrook, Silas Snyder, Walt Disney, Ted Eshbaugh, Walt Lantz, John Winchester, Louis B. Mayer, and others has been appreciated.

E. THEISEN, *Chairman*

G. A. CHAMBERS
W. CLARK
B. W. DEPUE
O. B. DEPUE

C. F. JENKINS
W. V. D. KELLEY
G. E. MATTHEWS
O. NELSON

T. RAMSAY
A. REEVES
F. H. RICHARDSON
A. F. VICTOR

REPORT OF THE COMMITTEE ON STANDARDS AND NOMENCLATURE*

The last report of the work of this Committee was presented to the Society at the New York meeting in April.¹ The present report, therefore, is a résumé of the subjects discussed and the resulting action since the April Convention.

Howell and Dubray², in the April, 1932, *JOURNAL*, proposed a new perforation to replace the existing 35-mm. positive and negative film perforations. The Standards Committee has discussed at great length the question of adopting a single standard perforation for both positive and negative film. Briefly, the conclusions are as follows: An entirely new perforation would involve new perforating equipment, and would not be satisfactory in existing projection equipment. The present positive perforation results in longer life of the negatives, due to the better clearance when the film is run on commercial sprockets. Tests made on sound track prints show an advantage in using the present positive perforation for both positive and negative film. The advantages are better definition of the high frequencies and more accurate location of the sound track. It is also possible to print the picture with less side-weave if suitable equipment is provided for printing.

The Standards Committee has unanimously approved the following proposal:

RESOLVED, that a single perforation be adopted for all 35-mm. film and that this perforation be the present standard positive perforation, to be known hereafter as the Standard S. M. P. E. Perforation.

It appears that the only equipment that will require a change in order to standardize the positive perforation for negative film completely will be the registering pins on cameras or printers. Undoubtedly, considerably longer life of negatives will result from using the positive type of perforation.

The Sub-Committee on Sensitometry has agreed upon a standard unit of photographic intensity; and the Standards Committee has unanimously approved the following resolution.

* Presented at the Fall, 1933, Meeting at Chicago, Ill.

RESOLVED, that the unit of photographic intensity adopted for negative materials by the International Congress of Photography, and the principle of non-intermittency in making sensitometric measurements, be adopted as recommended practice.

The revision of the standards booklet is nearing completion. The booklet will contain new drawings for 35-mm. sound film negatives and positives, showing minor changes in the dimensions and the values of the tolerances where desirable. The 35-mm. sprocket drawings are being revised. The positive type of perforation will be shown on the layout for the negative film. The booklet will contain the 16-mm. sound-on-film layouts that have been approved. New dimensions will be shown for the camera and projector apertures, in accordance with the present practice and previous reports published by the Committee and by the Academy of Motion Picture Arts and Sciences. The revised booklet will be submitted to the American Standards Association after being approved in its final form by the Standards Committee, and subsequently published in the JOURNAL and finally approved by the Board of Governors.

The Committee has, in reviewing the standards booklet, given consideration to comments contained in an article by H. Pander³ of Berlin, entitled "The New German Standards," in which the author compares the German standards with those published in the Standards Booklet approved by the American Standards Association in September, 1930.

A letter has been received from the British Kinematograph Society, stating that at a meeting of the Standards Committee of that body held on July 14, 1933, it was agreed that the positive perforation dimensions should be the universal standard for all 35-mm. film. The opinion of the S. M. P. E. Standards Committee was also requested as to a suitable date for making the change in the negative perforation. The date July 1, 1934, was suggested. In the same letter, the Chairman of the Standards Committee of the British Kinematograph Society stated that it had been agreed to recommend a universal core for all 35-mm. raw stock, according to drawings transmitted with the letter. This suggestion has been discussed by the S. M. P. E. Standards Committee and, while no definite action has been taken, it is the feeling of the majority of the members of the Committee that the suggestion is worthy of further consideration. The British Committee also has recommended that a triangular sign be placed between film perforations in order to distinguish safety film from nitrate film.

The reason for such a recommendation is that edge printing as now applied to sound film frequently obliterates the present marks along the edge of the film. Although the Standards Committee is considering this suggestion at the present time, no action has yet been taken.

The design of a suitable reel for 35-mm. film has been discussed by the Standards Committee on several occasions. At the present time, the Sub-Committee on Exchange Practice is studying the problems involved in connection with reels, and it is expected that this Sub-Committee will present a definite recommendation to the Standards Committee for a satisfactory reel.

M. C. BATSEL, *Chairman*

W. H. CARSON
L. E. CLARK
J. A. DUBRAY
P. H. EVANS
R. M. EVANS
R. E. FARNHAM
C. L. FARRAND

H. GRIFFIN
A. C. HARDY
R. C. HUBBARD
L. A. JONES
D. MACKENZIE
G. F. RACKETT
W. B. RAYTON
C. N. REIFSTECK

H. RUBIN
H. B. SANTEE
V. B. SEASE
T. E. SHEA
J. L. SPENCE
E. I. SPONABLE
S. K. WOLF

REFERENCES

¹ Report of the Committee on Standards and Nomenclature, *J. Soc. Mot. Pict. Eng.*, **XX** (June, 1933), No. 6, p. 505.

² HOWELL, A. S., AND DUBRAY, J. A.: "Proposed Change in the Present Standards of 35-Mm. Film Perforations," *J. Soc. Mot. Pict. Eng.*, **XVIII** (April, 1933), No. 4, p. 503.

³ PANDER, H.: "The New German Standards," *Filmtechnik*, **IX** (May, 1933), No. 8, p. 121.

ERRATUM

THE APERTURE ALIGNMENT EFFECT

E. D. COOK

On page 395 of the November, 1933, issue of the JOURNAL, the equation immediately below Fig. 4 should read

$$\mathcal{Y}_m = (Y_{m1} + Y_{m2})$$

and Eq. 6, on the same page, should read

$$Y_{m1} = G \left[\begin{array}{l} \{ (1 - m) + a_0 m \} + m \left\{ \begin{array}{l} b_1 \sin \omega + b_2 \sin 2\omega \\ + \dots \end{array} \right\} \\ + m \{ c_1 \cos \omega + c_2 \cos 2\omega + \dots \} \end{array} \right] \quad (6)$$

SPROCKET DIMENSIONS FOR 35-MM. VISUAL AND SOUND PROJECTION EQUIPMENT*

H. GRIFFIN**

Summary.—A résumé of the existing situation with respect to sprockets for 35-mm. sound and projection equipment is first presented, followed by a discussion of the interference between the film and the sprockets that transport the film, for sprockets of various dimensions. As a result of the study, sets of dimensions are proposed for the feed- and hold-back sprockets and for the sound sprocket, submitted for the consideration of the Standards Committee of the Society.

The purpose of this paper is to present to the Society a résumé of the existing situation, and a proposed change in standards, as regards 35-mm. sprocket dimensions.

In the Society's standards booklet, *ASA-Z22-1930*, charts 6 and 7, respectively, set forth the standards for feed and hold-back sprockets. These standards have frequently been the subject of discussion in the Society, and the author personally has never agreed that the dimensions shown are satisfactory. Since the publication of the standards booklet, many new standards have come into existence, and a revision of the entire booklet by the Committee on Standards and Nomenclature has become necessary; and as the subject of sprocket dimensions has again come to the front, the author was requested to prepare for the Standards Committee a set of sprocket dimensions that would fulfill the requirements for shrunk and unshrunk film, without damaging the film, and would present a minimum amount of interference between the film and the sprockets in projection and sound reproducing equipment.

All film used in projection and sound reproducing equipment is definitely guided at the sound track edge, and sprockets should be constructed according to the above requirements with that fact clearly in mind. The present standard for feed sprockets as it

* Presented at the Fall, 1933, Meeting at Chicago, Ill.

** International Projector Corp., New York, N. Y.

appears in the standards booklet is shown in Fig. 1. It will be noted that the transverse tooth gauge is 1.107 inches, the width of the sprocket tooth 0.065 inch, the thickness of the tooth 0.050 inch, the base diameter 0.9452 inch, and the tooth radius 0.075 inch. It will also be noted that the corners of the teeth are shown rounded to an approximate radius of 0.010 inch. I wish to point out that if sprock-

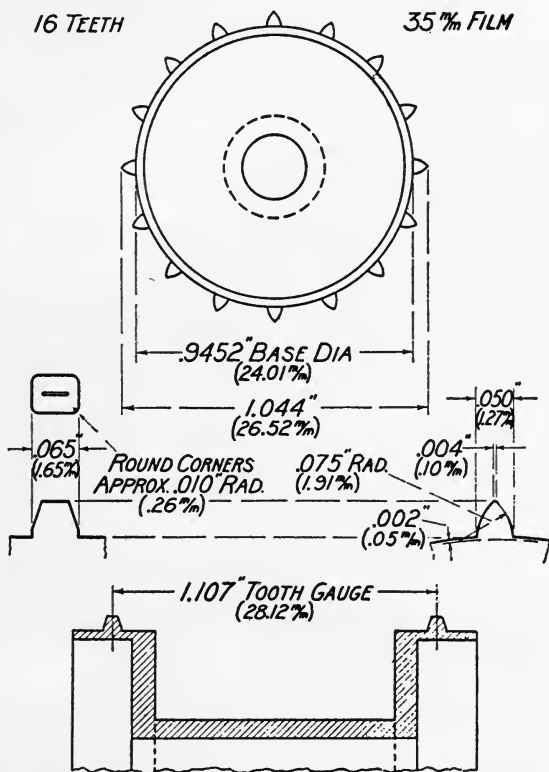

FIG. 1. Present S. M. P. E. standard feed sprocket.

ets were manufactured in accordance with those dimensions it would be impossible to accommodate standard 35-mm. film properly, when using the sound track edge of the film as a fixed guide, without seriously damaging the film and sadly marring the quality of the reproduced sound.

The proper design of sprockets, particularly for sound reproduction, requires absolute freedom from obstruction between the tooth

and the sprocket hole on both sides of the film; and for mechanical reasons, the circumferential thickness of the tooth should be as great as possible without causing interference between the film and the teeth in contact.

Fig. 2 shows the condition obtained with 35-mm. standard unshrunk film, guided at the edge, and a sprocket having the dimensions of the Society's present standard, as shown in Fig. 1. For reasons that will be explained later, no radius has been shown on the corners of the sprocket teeth; and it will be noted that with such a condition, adequate clearance obtains in both sprocket holes.

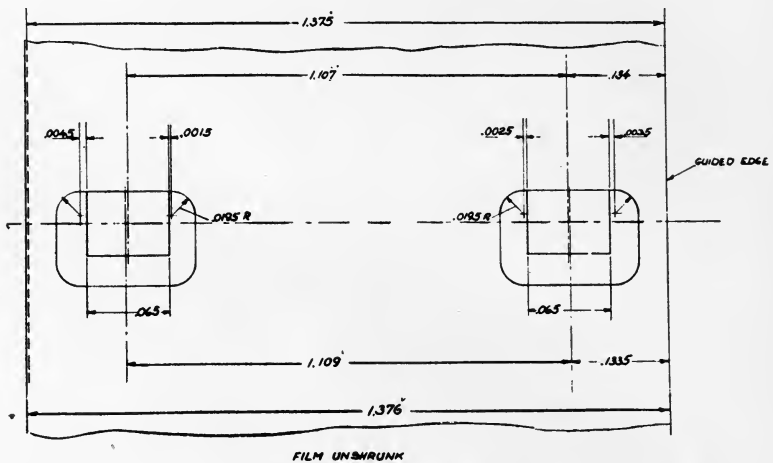

FIG. 2. Relation between sprocket teeth and film perforations: present S. M. P. E. standard sprocket (Fig. 1), and standard 35-mm., unshrunk, edge-guided film.

Fig. 3, however, illustrates the condition that exists when using the same sprocket and the same guided edge, when the film, has shrunk 1.5 per cent. The sprocket tooth at the picture side of the film interferes with the film by 0.0146 inch, and the entire strain of moving the film is placed at one corner of this sprocket hole, the film being prevented from contacting properly with the driving surface of the tooth to the extent of 0.0067 inch.

Fig. 4 illustrates the situation more forcibly, and shows exactly what must occur when the film-driving surface of the sprocket tooth is forced into its driving position against the film at the edge of the perforation. It is evident that the corner of the sprocket hole must

come an intricate problem, indeed, and the cost would be far greater than the cost of sprockets as manufactured today.

The radius is entirely unnecessary in any case, as will be shown, and satisfactory sprockets can be manufactured in which the film bearing surface is considerably greater than that possible with sprockets made according to the Society's present standards. What happens to the film when it removes the radius from the sprocket tooth of our Society's present standard has been shown in Fig. 4.

For reasons already mentioned, sprockets constructed according to the present standards have, so far as the author has ascertained,

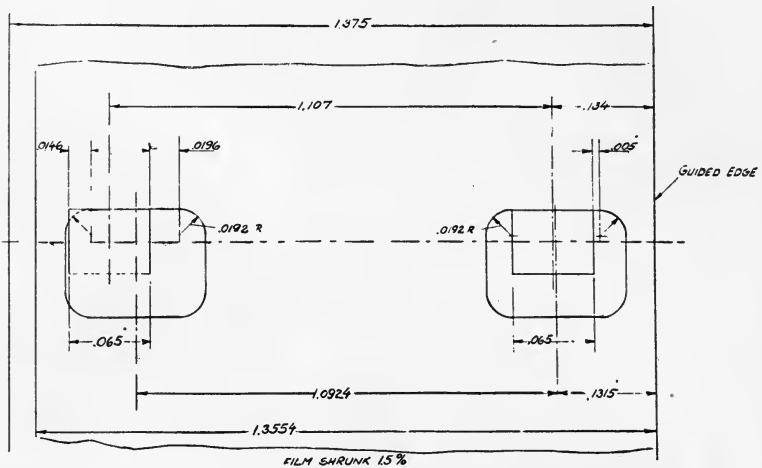

FIG. 4. Same as Fig. 2; redrawn to show forcing of film at corner of perforation.

never been made commercially, and certainly not for use on projection and sound reproducing equipment. The International Projector Corp. has made hundreds of thousands of sprockets for its own use and for the use of other organizations. Feed sprockets manufactured until quite recently had a transverse gauge of 1.102 inches (instead of 1.107), a transverse width of tooth of 0.060 inch (instead of 0.065), a circumferential thickness of tooth of 0.060 inch (instead of 0.050), and a tooth radius of approximately 0.085 inch (instead of 0.075). More recently, however, the dimensions were changed to those shown in Fig. 5. It will be noted in this that the standard base diameter of feed sprockets (0.945) was retained, that the transverse

pitch of the sprocket teeth is again 1.102, the transverse thickness of tooth again 0.060, and the circumferential thickness of tooth now 0.055. The tooth radius, approximately 0.077, will be explained later.

Since the Standards Committee began its work of revision, a thorough study has been made of the sprocket situation; and it is a fact that with a tooth thickness of 0.060 inch there is no circumferential interference with either 1.5 per cent shrunk or unshrunk film,

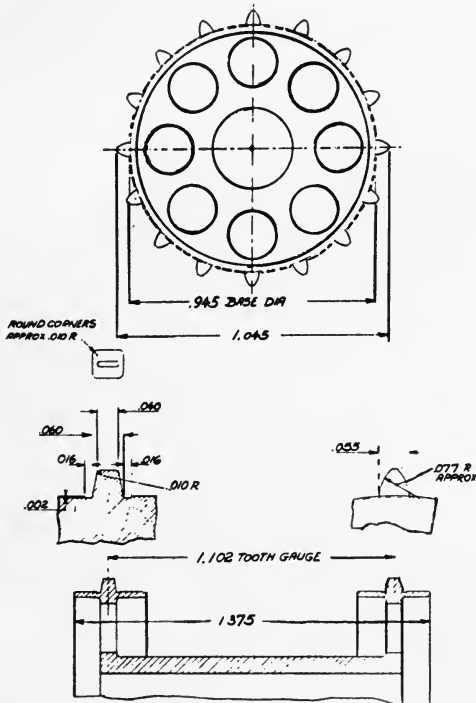

FIG. 5. Present commercial sprocket.

when not more than five teeth are engaged. But there is interference in the case of upper feed-sprockets, where the number of teeth engaged is eight or nine. Therefore, the circumferential thickness should be changed to 0.055 inch for the teeth of all projection and sound sprockets. Such a dimension allows satisfactory clearance between all sprocket teeth and sprocket holes up to nine in contact, with a base diameter of 0.945 inch, and strengthens the tooth by 0.005 inch, or 10 per cent, when compared with the 0.050 tooth

no serious evidence of damaged perforations. However, it is not a desirable condition by any means, particularly with regard to sound sprockets. Note that no radii are shown at the corners of the sprocket teeth; the reasons for that have already been mentioned. If the radius were present, however, the interference would be a clearance of 0.0003 inch.

During discussions of the subject by members of the Standards Committee, it was suggested that it would be generally undesirable to change a standard of long standing, and drawings were submitted

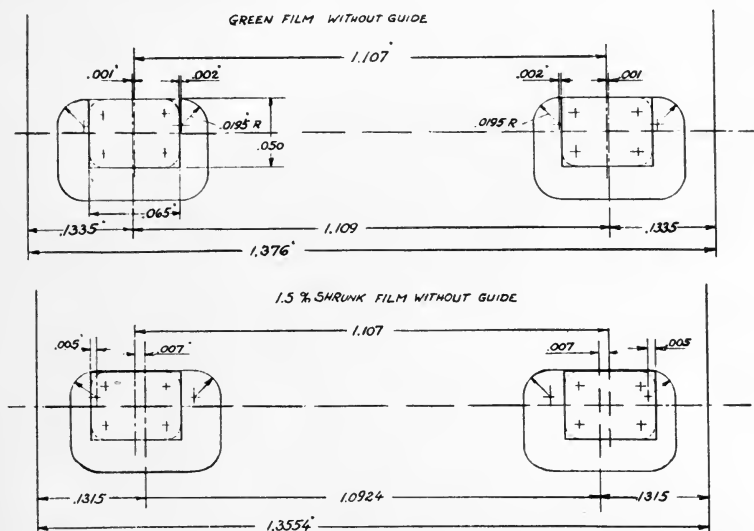

FIG. 7. Relation between sprocket teeth and film perforations: present S. M. P. E. standard sprocket (Fig. 1), and standard 35-mm., unshrunk and shrunk (1.5 per cent), unguided film.

for the purpose of showing under what conditions the sprocket shown in Fig. 1 could be used satisfactorily. Fig. 7 shows this layout for shrunk and unshrunk film, with the Society's present standard sprocket drawn in. Note that in this case the film has been shown unguided, whereas in practice all film is guided in both the projector and the sound reproducer by the edge of the film nearest the sound track. If it were possible to manufacture sprockets such as shown in this drawing, and unguided film could be used, it would be possible to use sprockets such as that which would function satisfactorily within the shrinkage limits shown. The drawing shows a radius of

film as a guide. The sprocket teeth are moved over on the sprocket a distance of 0.0115 inch ($= 0.1340-0.1225$) toward the guided edge of the film, which immediately removes it from the category of present standards, as shown in Fig. 1. Even were it practicable from a manufacturing standpoint (considering again the 128 radii) such a sprocket would be impractical from a commercial standpoint because it would be impossible to reverse it on the shaft to take advantage of the driving surfaces on both sides of the teeth. It is

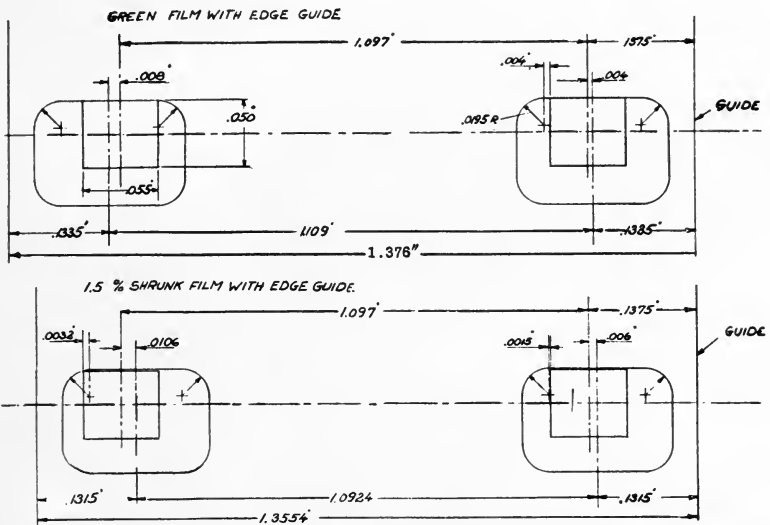

FIG. 9. Relation between sprocket teeth and film perforations: proposed transverse pitch and tooth width, but with teeth moved toward the guided edge by 0.0015 inch.

the practice of many projectionists to turn sprockets around, thus obtaining a 100 per cent increase in the life of the sprocket.

Referring again to Fig. 8, it will be seen that with green film and such a sprocket, if the tooth radius were omitted, the interference with the perforation near the guided edge would be 0.008 inch. It would be a clearance of 0.002 inch if the radius shown in dotted lines were really present. On the picture side, without the tooth radius, the interference would be 0.010 inch. With film shrunk 1.5 per cent, and without the tooth radius, the interference of 0.0065 shown at the guided side would become a clearance of 0.0035 with the

is that if it were reversed, and it surely would be, the clearance of 0.0015 inch for shrunk film shown for the perforation at the guided edge would become an interference of 0.0015 inch, and the interference shown for the perforation at the picture edge of 0.0032 would become an interference of 0.0062, which is a little worse condition than can be obtained with film of the same shrinkage and proposed standard sprocket, which could be reversed and thus permit the same results to be obtained either way.

We now come to the proposed standard dimensions for 35-mm., 16-tooth sprockets, which are shown in Figs. 10, 11, and 12. It

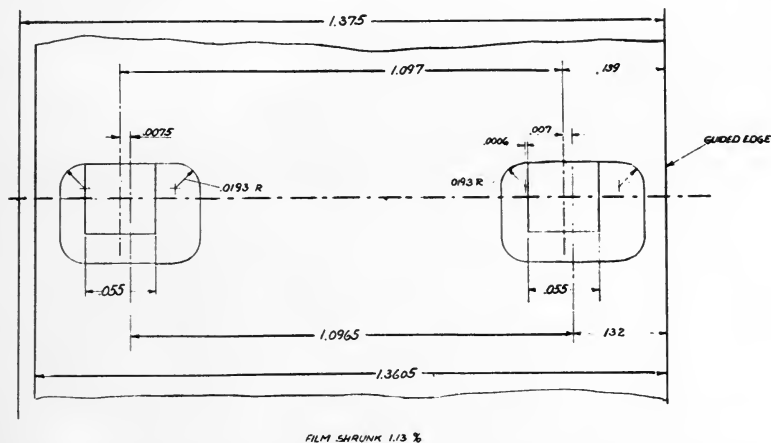

FIG. 11. Relation between sprocket teeth and film perforations: proposed 35-mm., 16-tooth sprocket, and standard 35-mm., shrunk (1.13 per cent), edge-guided film.

is recommended that the transverse pitch of the sprocket teeth be made 1.097 inches, the transverse thickness of the teeth be 0.055 inch with the burrs completely removed from the corners, a circumferential thickness of tooth of 0.055 inch be adopted for all sprockets, the center line of the sprocket tooth be 0.139 from either end of the sprocket, and that the 0.139 dimension be maintained between the center line of the sprocket tooth and the guided edge of the film. The tooth radius for the proposed standard is arbitrarily established as 0.077 inch, which dimension holds, however, only with respect to the upper portion of the tooth; the lower portion is not a true radius, but is rather an involute curve developed by the action of

as great as 1.5 per cent in some of the older product, so Fig. 12 has been drawn to show the proposed sprocket operating with film shrunk to that extent. It will be noted that there is an interference of 0.0046 inch at the picture edge sprocket hole, which in effect holds

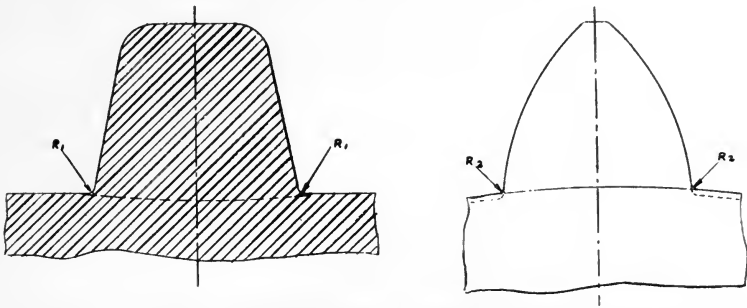

FIG. 13. Contour of teeth showing points at which interfering radii or fillets occur due to inability of cutting tools to cut absolutely sharp corners. At the right is shown the manner of sinking the tooth cutter so as to obviate this difficulty; unfortunately, however, burrs and irregular surfaces are produced.

the film away from the working surface of the tooth by 0.0006 inch, as compared with an interference of 0.0146 inch between the sprocket hole and the sprocket in the case of the Society's present standard when the tooth corner radius is omitted.

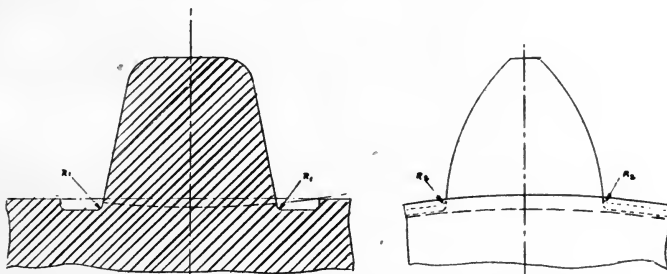

FIG. 14. Solution of the difficulties of Fig. 13; the teeth rise out of a relieved section, bringing all burrs or fillets below the base diameter of the sprocket.

In former methods of manufacture it has been extremely difficult, almost impossible, to avoid a small radius or fillet at the base of the tooth where it meets the body of the sprocket because the cutting tools can not have absolutely sharp corners (Fig. 13). As that is

the working point of the sprocket, interference frequently occurs, which prevents the film from seating itself perfectly on the base diameter. Such a condition may be partially obviated by sinking the tooth cutter slightly below the base diameter of the sprocket, which practice, however, unfortunately introduces other evils, principally an irregular surface for the film to ride on, with burrs which can be completely eliminated only with difficulty. An ex-

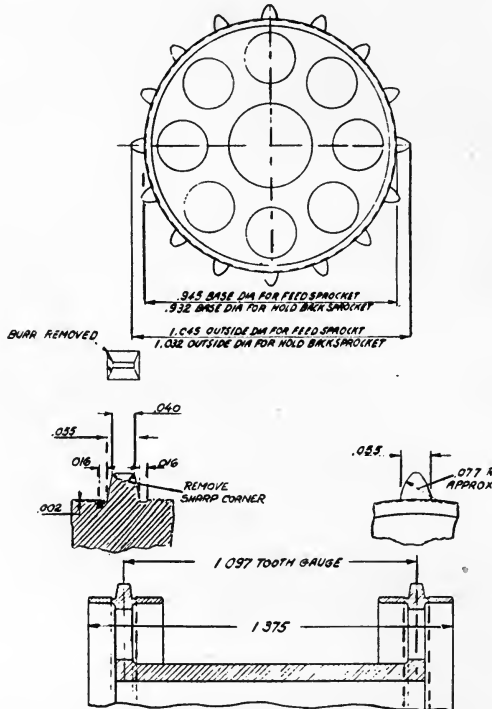

FIG. 15. Drawing of feed and hold-back sprockets proposed for standardization.

cellent solution of this problem is found in Fig. 14, where the teeth rise out of a relieved section, thus bringing all burrs or fillets below the base diameter of the sprocket, maintaining a smooth even surface for the film to ride on. There is nothing on this tooth that might cause interference with the perforation, and the film seats itself on the base diameter as it should.

All the foregoing material has dealt entirely with feed-sprockets

for projection equipment and hold-back sprockets for projection and sound equipment, and a composite dimensional chart of such sprockets is shown in Fig. 15. It is quite evident that the proposed

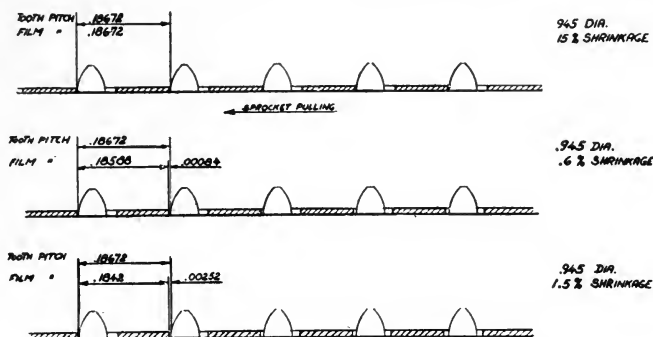

FIG. 16. Relation between sprocket teeth and film perforations: sprocket of Fig. 15 used as sound sprocket; base diameter 0.945 inch, and standard 35-mm. film shrunk 0.15, 0.60, and 1.5 per cent.

standard feed-sprocket can be readily used as a sound sprocket also, but the problem of correct design for sound reproducer sprockets becomes slightly different in so far as the base diameter of the sprocket

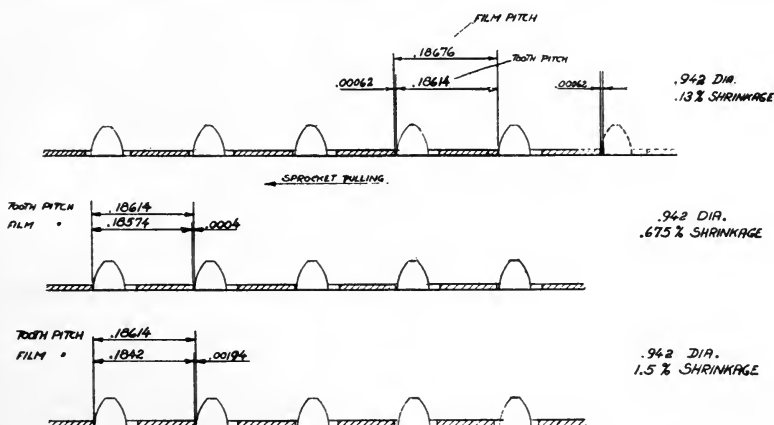

FIG. 17. Same as Fig. 16, except that the base diameter has been decreased to 0.942 inch.

is concerned. The reason is that it is extremely desirable that the sound sprocket transport the film past the scanning beam at as constant a velocity as possible; and, therefore, with a minimum

amount of slippage from tooth to tooth. A sprocket for that purpose having a base diameter of 0.945 will perform as shown in Fig. 16, in which it will be seen that for a shrinkage of 0.15 per cent all teeth are engaged; that with a shrinkage of 0.6 per cent the left-hand tooth shown in the drawing does all the work of moving the film; and that there is a slippage from tooth to tooth of 0.00084 inch. With a shrinkage of 1.5 per cent the left-hand tooth is still doing all the work of moving the film, and there is slippage from tooth to tooth in this case of 0.0025 inch.

PER CENT SHRINK- AGE	SPROCKET DIA. IN INCHES.					
	.945	.944	.943	.942	.941	.940
0.0	.00028	.00047	.00066	.00086	.00106	.00126
0.13	.00004	.00023	.00042	.00062	.00082	.00102
0.15	.00000	.00019	.00038	.00058	.00078	.00098
0.2	.00003	.00010	.00029	.00049	.00069	.00089
0.3	.00028	.00009	.00010	.00030	.00050	.00070
0.4	.00047	.00028	.00009	.00011	.00031	.00051
0.5	.00065	.00048	.00029	.00007	.00013	.00033
0.6	.00084	.00065	.00046	.00026	.00006	.00014
0.675	.00098	.00079	.00060	.00040	.00020	.00000
1.5	.00252	.00233	.00214	.00194	.00174	.00154

FIG. 18. Chart showing interference and slippage in relation to base diameter of feed sprocket, and shrinkage of film. Figures above heavy line indicate interference in inches between edge of perforation and entering tooth. Figures below heavy line indicate slippage in inches from leaving to entering tooth.

Recent investigation indicates that the average shrinkage of film as received for a first showing is between 0.2 and 0.3 per cent, and that during the life of the print as a first run subject the shrinkage rapidly increases to about 0.5 to 0.7 per cent, and more slowly thereafter. Theoretically, then, it might be expected that better results could be obtained, as regards uniformity of film propulsion, with a sprocket having a tooth pitch more closely registering with film in this shrinkage range; and that, therefore, a sprocket having a base diameter of 0.942 inch would be better for the purpose. Such a

sprocket is shown in Fig. 17. It will be noted that with film shrinkage somewhere between 0.5 and 0.6 per cent all teeth are in contact with the film perforations, which is an ideal state of affairs. It is true that when prints are first released the shrinkage is not so high, and is of the order of 0.2 to 0.3 per cent, or even lower. The upper drawing in Fig. 17 shows the conditions under which the film and

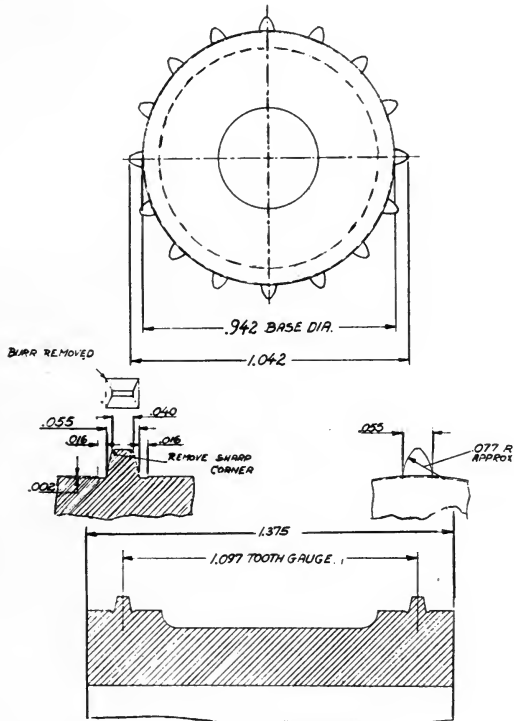

FIG. 19. Drawing of sound sprocket proposed for standardization.

the sprocket are then working. One tooth is doing the work of moving the film, but the following or oncoming tooth is subjected to an interference of 0.00062 inch for a shrinkage of 0.13 per cent; or, instead of having a slippage from tooth to tooth, the oncoming tooth is pushed slightly, this action continuing, in a diminishing degree, until a value of shrinkage between 0.5 and 0.6 per cent is attained, when all teeth are in contact. As shrinkage increases, a gradual

increase of slippage from tooth to tooth occurs until, at 1.5 per cent shrinkage, the slippage is of the order of 0.0019 inch. In this connection the sprocket shown in Fig. 17 is superior to a sprocket having a base diameter of 0.945 inch.

Therefore, the proposed standard base diameter for sound sprockets is 0.942 inch. This will provide a sprocket that will give excellent results under average conditions and satisfactory results with film shrinkages between 0.6 and 1.5 per cent. The slight interference with the oncoming tooth, as shown in Fig. 18, for shrinkages below 0.6 per cent is practically negligible. A careful study of Fig. 18 will support this recommendation, notwithstanding the fact that the chart also discloses the fact that a sprocket having a base diameter of 0.940 provides the best condition for film shrunk 0.675 per cent. By adopting a sprocket having a base diameter of 0.942 we would have a sprocket that more satisfactorily accommodates shrinkages from 0.15 to 0.675 per cent than does a sprocket having a base diameter of 0.940 inch, inasmuch as the slip at 0.6 per cent with the 0.942-inch sprocket is only two and one-half ten-thousandths of an inch, and the interference at 0.15 per cent, which is rarely encountered outside the studio and laboratory, is less than six ten-thousandths of an inch; whereas, with a 0.940-inch sprocket there is an interference of one and one-half ten-thousandths at 0.6 per cent and an interference of nearly one thousandth of an inch at 0.15 per cent shrinkage. The dimensions of the proposed standard sound sprocket are shown in Fig. 19. It should be evident from a study of the drawings shown in this paper that sprockets of the dimensions proposed as a standard offer a satisfactory solution of the sprocket dimension problem; it is hoped that they will meet with the approval of the Society.

DISCUSSION

MR. JONES: How long, under usual conditions, do the sprockets last before they are reversed?

MR. GRIFFIN: That is very difficult to answer, because a projectionist usually uses his own judgment. If the sprocket is designed properly and is of the proper material, the tooth will wear uniformly from the base to the top of the tooth, and as long as there is no under-cutting the sprocket is all right. If under-cutting occurs, the sprocket should be changed immediately. Even a very little under-cutting is disastrous. It is very hard to say when they should be reversed, because that depends on how the tooth performs.

MR. RICHARDSON: Referring to Fig. 6, at the time of its adoption by the Standards Committee, there was much discussion as to whether the corners

should be rounded or not. It was finally decided that the rounded sprocket hole was necessary, in order to increase the strength and to prevent splitting at the corners. Projectionists were greatly troubled with split sprocket hole corners. Tension in the projector is tremendously variable; many projectors used to have, and to a certain extent yet have, excessive tension. If the tension is correct and the film is green, a deposit of emulsion accumulates on the aperture plate: the tension is immediately greatly increased. Removing the rounded corner of the perforation will decrease the resistance of the corner against the strain of which I am speaking. Split sprocket holes are bad because they cause unsteadiness of the picture on the screen.

MR. GRIFFIN: The only bad condition that exists (referring to Fig. 6) is that the film has shrunk 1.5 per cent; such great shrinkage is not encountered in the film that is being manufactured today, but was prevalent in the film that was used three or four years ago.

The sprocket tooth is held away from the film a little more than 0.0026 inch, and inasmuch as we have had far greater interference in the past and, as stated in the paper, there has been no apparent damage to film, I don't think that is a serious thing today. Fig. 4, with the present standard, shows an interference of 0.0146 inch. In Fig. 11, of the proposed studies, we have a shrinkage of over 1 per cent, which is considered to be excessive today. Even in that condition, you see, there is a clearance over both teeth and both sprocket holes.

MR. CARVER: The chief argument for the reduction in transverse pitch is very closely related to edge-guiding. Now, the edge on all the drawings is assumed to be 0.139 inch from the center of the sprocket teeth. In actual practice, at least until two years ago, the edge guiding has been a very haphazard thing. All the edge-guiding in the picture gate was done by the two little rollers at the top. Although these may have been adjusted correctly at the factory, in practically every case the projectionist himself changed their position so that the edge-guiding on no two machines would be exactly alike. That means that there would be interference in some of the machines on one side, and in other machines on the other side. The adjustment would be changed only when the picture on the screen was seen to lift up in one corner. Then it would be moved over a bit to avoid this trouble. For these projectors the transverse pitch of the sprocket ought to be the same as that of most of the film that is being run. Film of which the average transverse pitch has shrunk, say, 0.5 per cent, will have a better chance of not causing interference on these machines that are out of adjustment if the sprockets have the same transverse pitch as the film, than if the transverse pitch of the sprockets were as short as is indicated on the drawings, *i. e.*, to correspond to a shrinkage of about 1 per cent. The real reason why I believe it is probably necessary, at least for the International Projector Corp., to make sprockets as outlined is that for the last two years a certain number of projectors have been put out with definite edge-guiding in the picture gate. That edge distance is, as you have shown, 0.139 inch.

This brings up the question as to whether we should adopt a standard that is correct for one projector and perhaps satisfactory, but theoretically somewhat incorrect, for projectors that have been designed a little differently. We hope that our standards will be adopted and in agreement with the German and the International standards. It seems a bit ridiculous to show, as in Fig. 10,

edge-guiding in which the center of the sprocket on the right-hand side is actually nearer the center by 0.0055 inch than the center of the hole. The tolerance for shrinkage is reduced just by that amount. If it were moved farther to the right there would be much more tolerance. There would be used, in that case, a greater transverse pitch, which would be more satisfactory for most of the Simplex machines on the market now, in which the edge-guiding is a rather haphazard arrangement, the adjustment being made solely by the projectionist. From Mr. Griffin's point of view and the point of view of the International Projector Corp., I don't see what else can be done. I think probably the thing for them to do is to make the sprockets as described. It is quite another thing, however, for the Society to sanction a standard that really is illogical. It is probably satisfactory, but should we officially adopt such a standard?

In regard to the rounded corners, Mr. Griffin has presented his point very strongly and very clearly against the rounded corners. I must admit that he has convinced me. The film manufacturer looks at such things somewhat differently from the projectionist. He hates to see all the film that he has so carefully made subjected to sharp corners of any sort. We have made some tests with the square-cornered type and the rounded-cornered type, and as you all probably would predict, found the film to have a life three times as long with the rounded corners as with the squared corners. Mr. Griffin's argument that the rounded corners don't last, that most of the time the corners are sharp because the sprockets are worn, is certainly of great weight; but it seems to me that in an official standard, at least, the corners should be rounded a little.

In regard to the increased bearing surface, a year or so ago, when wide film was being discussed, we measured the resistance of the film to the impact of teeth having different bearing surfaces, and found that the resistance increased linearly as the bearing surface was increased, until it reached a value of about 0.0045 inch. After that it didn't matter very much whether the bearing surface was increased or not. Of course, a narrow bearing surface such as a knife would cut right through. As the bearing surface is increased, the knife becomes duller and duller; but after a while a certain point is reached beyond which further increase in bearing surface, or dullness, causes no further increase in resistance.

MR. GRIFFIN: I stated before that the edge-guiding may be adjusted by the projectionist. I should have stated that the adjustment is made on the unguided side. The guided side is fixed in the film trap. The adjustment for the tension is on the other side, so that we have definite edge-guiding even in the old projectors. The new ones, as I explained, have runways to guide the film definitely. I am quite sure that sprockets of the design I have indicated wouldn't cause any hardship on the old equipment, no matter how old it is.

MR. CARVER: I mentioned the fixing of the edge-guiding so that the sprocket was at the inside of the hole rather than the outside.

MR. GRIFFIN: The illustration to which you referred was for unshrunk film; unshrunk film is unknown, particularly when it is projected in a theater, and the condition improves as it shrinks.

MR. CARVER: No, it gets worse as it shrinks.

MR. GRIFFIN: Yes, it moves to the right. I get your point, but there is a clearance of only 0.0015 inch with unshrunk film.

MR. CARVER: I admit it is a minor detail. I think this sprocket is much

better than the old sprocket actually manufactured. I don't know that it is better than the old standard, although I think it probably is.

MR. GRIFFIN: I will say this: the old standard was perfect, without edge-guiding. The drawings prove that.

MR. CARVER: This sprocket is so much better than the sprocket now manufactured that perhaps wear and tear troubles will vanish. The change of diameter alone should increase the life of the film five times at least.

MR. JONES: Why was the value 0.139 chosen? That is the distance between the edge of the guide and the center line of the adjacent tooth. From an inspection of the illustration, I believe that if the dimension had been made somewhat less the shrinkage range would have been considerably greater before the beginning of interference on the other side where it does occur. Why did you choose 0.139 rather than a slightly smaller dimension?

MR. GRIFFIN: There is only one real reason, and it isn't a hard and fast rule: 0.139 happens to be the distance from the center line of the sprocket tooth to the end of the sprocket on both sides, giving a sprocket of 1.375 inches wide; it is barely possible that equipment might be manufactured in which the guiding edge is the edge of the sprocket itself. Under such circumstances that dimension would be necessary. The sprocket is placed on the shaft, and the bearings in which the sprocket shafts run are milled to an accurate dimension, the width of the sprocket definitely placing them at a fixed point with relation to all the other sprockets in the projector. We started out with a 1.375-inch sprocket some years ago, and that dimension must be retained for the sake of interchangeability.

MR. JONES: As a matter of fact, the way edge-guiding is practiced today, there is no reason why the 0.139 dimension couldn't be decreased to give you the additional shrinkage range.

MR. GRIFFIN: A study of Figs. 10 and 11 shows that it would be possible to move the teeth over only 0.0015 inch, and then only considering that the sprocket may not be reversed on its shaft. If it were reversed, and it surely would be, interference would occur at a shrinkage of 1.13 per cent. It would not be good practice at this late date to begin making sprockets that could not be placed on the shafts without regard to which end was placed on first. To move the film itself the one and one-half thousandths would require operations on all projectors in use. After all, 0.0015 inch is not a serious matter. I doubt whether the film path in many projectors would be as accurate as that.

DIRECT-CURRENT HIGH-INTENSITY ARCS WITH NON-ROTATING POSITIVE CARBONS*

D. B. JOY AND A. C. DOWNES**

Summary.—A d-c., high-intensity arc for low currents is described. It differs from the ordinary high-intensity arc used for projection in that the positive carbon is not rotated and is copper coated so that it can be held some distance from the crater end. The current, voltage, and burning characteristics are given for the size carbons available at this time.

The possible utilization of this type of arc for projection is discussed, and it is pointed out that because of the comparatively simple lamp mechanism required, it will take its place with the new a-c., high-intensity arc described in a previous paper in supplying the need for more light in the small and medium size theaters.

In a previous paper¹ the authors have shown that projection lamps and carbons may be classified in definite types, depending upon the kind of arc, the current, and the optical system used. These types are as follows:

- (1) The high-intensity condenser type, with rotating positive, high-intensity, d-c. carbons burning at 85 to 150 amperes. These lamps consume approximately 15 per cent of the carbons used for motion picture projection.
- (2) The high-intensity mirror type, with rotating, positive carbons burning at 60 to 85 amperes. These lamps consume about 18 per cent of the carbons used for motion picture projection.
- (3) The low-intensity mirror type, with non-rotating, positive, low-intensity, d-c. carbons burning at 16 to 42 amperes. These lamps consume about 60 per cent of the carbons used in motion picture projection.

It was also shown that a rather large interval existed between the screen illuminations practicable with the low-intensity reflecting arcs and the lowest screen illumination obtained with the high-intensity reflecting arc. There is also a marked difference in the color of the light from these two types of arc. The low-intensity arc gives a yellowish white light, whereas the high-intensity arc gives a snow white light which is generally considered more desirable for the projection of motion pictures.

* Presented at the Fall, 1933, Meeting at Chicago, Ill.

** Research Laboratories, National Carbon Co., Cleveland, Ohio.

There was also described a fourth type, utilizing a high-intensity, a-c. arc preferably operated on the secondary of a specially designed transformer, without the usual motor-generator set and ballast resistance. This high-intensity, a-c. arc gives screen illuminations higher than the low-intensity arcs, therefore bridging, in part, the wide gap between the screen illuminations produced by the low-intensity and the d-c., high-intensity reflecting arcs, and makes

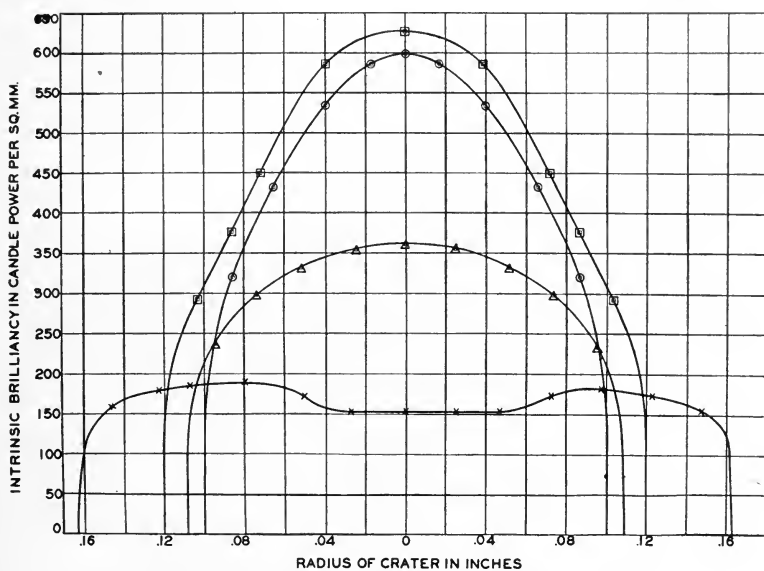

FIG. 1. Intrinsic brilliancy across crater face.

Positive Carbons		Negative	Amps.	Volts
×	12-Mm. S.R.A.	8-Mm. S.R.A.	30	55
○	6-Mm. H.I. cc.	5-Mm. cc.	40	31
□	7-Mm. H.I. cc.	6-Mm. cc.	50	33
△	8-Mm. a-c. cc.	a-c.	80	25

available to the smaller theaters a white light very similar to that obtained from the d-c., high-intensity arcs.

In this paper will be described another type of light source, which may take its place with the a-c. arc in bridging this gap between the low-intensity and present high-intensity arcs.

It is for use on direct current, and employs a series of high-intensity carbons smaller in diameter and lower in current-carrying capacity than have hitherto been used for projection work. The carbons

have been designed so that with a few simple precautions the positive carbon does not need to be rotated and the negative carbon can be coaxial with the positive. The carbons are protected from oxidation, and their electrical resistance is reduced by a copper coat that makes it practicable to hold the carbons any convenient distance from the arc.

The carbons are at present available in the sizes and current ranges given in Table I. Although they are copper coated, smaller in size, and of lower current capacity than the 9-mm. to 16-mm. high-intensity carbons used for motion picture projection, these carbons have the same crater appearance and formation, high current density, and give the same brilliant snow-white light on the screen as the larger uncoated, high-intensity, d-c. carbons. The rate of carbon consumption is essentially the same as that for the larger sizes of high-intensity carbons.

Table II gives the average intrinsic brilliancy of these arcs and other light sources used for projection, and Fig. 1 shows the distribution of intrinsic brilliancy of the new light sources. The method of making these measurements is the same as that employed by Benford and ourselves, and has been described in the literature.^{2,3}

While Table II shows that the intrinsic brilliancies of the 6-mm. and 7-mm. carbons at the specified currents are approximately the same, it should be noted that the crater area of the 7-mm. carbon at 50 amperes is greater than the crater area of the 6-mm. at 40 amperes, and that the 7-mm. carbon gives 44 per cent more light than the 6-mm. size at the respective currents.

It is evident from Fig. 1 and Table II that the crater diameters of these non-rotating, high-intensity carbons are considerably smaller than those of the 12-mm. mirror arc carbons used in a majority of the low-intensity mirror arc applications. This difference in crater size will require an optical system of higher magnification when using a 7-mm., high-intensity, d-c., positive carbon than one for use with the 12-mm. mirror arc carbon to give the same size spot on the aperture plate.

Fig. 1 shows very marked differences in the distribution of light intensity across the faces of the various light sources. The crater face of the low-intensity, positive, mirror arc carbon is comparatively flat. The light comes entirely from the incandescent crater, and is therefore fairly uniform across the crater face.

The crater of the new, non-rotating, d-c., high-intensity, positive

TABLE I

Carbons for D-C., High-Intensity Arcs, Positive Carbon Non-Rotating

Positive Carbon	Negative Carbon	Current-Carrying Capacity (Amperes)	Consumption in Inches per Hour (Pos.)	Consumption in Inches per Hour (Neg.)	Amperes per Square Inch of Cross Section of Positive Carbon
6-mm. H. I. cc.	5-mm. H. I. cc.	35-40	9-15	2.9-3.8	800-920
7-mm. H. I. cc.	6-mm. H. I. cc.	45-50	9-15	2.9-3.8	760-850
Reg. H. I. 9-mm. to 16-mm.	$5/16''$ to $1/2''$ Orotip	60-150	8-20	2.0-3.8	450-900
8-mm. a-c.		75-80		4-5.5	970-1040

TABLE II

Average Intrinsic Brilliancy of the New Arcs and Other Light Sources

Light Source	Candle Power per Sq. Mm.	Crater Depth (Inches)	Crater Diameter (Inches)	Source of Data
Tungsten filament 40-watt vacuum type. clear blub incandescent lamp.	20.6			Int. Critical Tables
Tungsten filament 900-watt gas-filled. clear bulb incandescent lamp.	26.6			Int. Critical Tables
Positive crater of cored d-c. low-intensity carbon. 12-mm. carbon at 30 amperes, 55 volts.	165	0	0.32	J. Soc. Mot. Pict. Eng.
Crater of high-intensity a-c. white flame carbon. 8-mm. carbon at 80 amperes, 25 volts.	280	0	0.22	N. C. Co. Laboratories
Positive crater of non-rotating high-intensity d-c. white flame carbon.				
6-mm. carbon at 40 amperes, 31 volts.	380	0.08	0.20	N. C. Co. Laboratories
7-mm. carbon at 50 amperes, 33 volts.	380	0.10	0.24	N. C. Co. Laboratories
Positive crater of high-intensity d-c. positive carbon.				J. Soc. Mot. Pict. Eng. and N. C. Co.
9-mm. to 16-mm.	400-800	0.10-0.27	0.25-0.53	Laboratories

carbon is cup-shaped, and is essentially the same as that of the large, d-c., high-intensity carbons. The light intensity is considerably higher at the center of the crater than at the sides as in all d-c., high-intensity arcs, due to the crater shape and the presence of the highly luminous gases in the crater. It is essentially the same in form, although lower in value, as that found by Benford³ for the 150-ampere, high-intensity carbon.

The a-c., high-intensity carbon has a comparatively flat face, and also the highly luminous gases similar to those found in the crater of the high-intensity, d-c. carbon. The shape of the distribution curve of intrinsic brilliancy is, therefore, intermediate between those

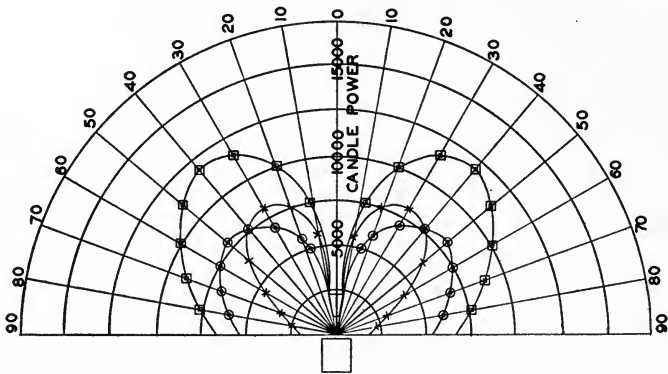

FIG. 2. Light distribution from arc in horizontal plane.

Positive Carbons		Negative	Amps.	Volts	Arc Length (Inch)
×	12-Mm. S.R.A.	8-Mm. S.R.A.	30	55	11/32
○	6-Mm. H.I. cc.	5-Mm. H.I. cc.	40	31	5/32
□	7-Mm. H.I. cc.	6-Mm. H.I. cc.	50	34	7/32

of the low-intensity mirror arc and the d-c., high-intensity carbon arc. These differences in distribution of the light intensity of these light sources must be taken into consideration in designing optical systems to give the uniformity of screen light required by good projection practice.

The light emitted by the 12-mm., low-intensity arc and the non-rotating, d-c., high-intensity, arcs, in a plane through the axis of the carbons, is given in Fig. 2. The dip at 0 degrees, or directly in front of the positive carbon, is due to the interference of the negative carbon and negative holder. The light cut off by the negative carbon

TABLE III
Characteristics of Various Types of Arcs

	Positive Carbon 12-mm. S.R.A. Mirror Arc	Negative Carbon 8-mm. S.R.A. Mirror Arc	Current	Voltage	Watts at the Arc	Line Watts		Screen Light in Arbitrary Units
						^A 50 Volt Motor- Generator*	^B 80 Volt Motor- Generator*	
	8-mm. a-c.		30	55	1650	3530	3530	100
	6-mm. H.I.cc.		80	25	2000	2220**	2220**	140
	6-mm. H.I.cc.	5-mm. H.I.cc.	35	30	1050	2570	4120	145
	7-mm. H.I.cc.	5-mm. H.I.cc.	40	34	1360	2940	4700	180
	7-mm. H.I.cc.	6-mm. H.I.cc.	45	31	1400	3310	5280	170
	7-mm. H.I.cc.	6-mm. H.I.cc.	50	35	1750	3680	5880	220

* 68 per cent efficient.

** 90 per cent efficiency for a reactance transformer.

and holder is in reality only a small percentage of the useful light from the arc.

The non-rotating, d-c., high-intensity arcs are operated at a comparatively low voltage and short arc length, as shown in the figure. The light at 90 degrees, or at right angles to the trim, is much higher for the high-intensity arc than for the low-intensity arc. Part of this light is usable since it includes at least a portion of the focusable light directly in front of the crater. These distribution curves may be valuable in determining the proper angle of light pick-up for the mirrors to be used with these carbons. The mirror size will also be governed by the speed of the projection lens, the physical limitations of the lamp, and the cost of the mirror.

When the positive and negative carbons of the non-rotating, high-intensity arc are on the same axis, there is no strong directional force guiding the tail flame from the arc. It may be desirable to use a magnet to attract the tail flame in one direction, although it has been found that when a comparatively short arc length such as given in Fig. 2 is used, the arc gives steady operation and light without superimposing any external force.

Operation of this non-rotating, d-c. arc with this short arc length and low voltage will need a motor-generator set of a rating not greater than 50 to 55 volts, and it may be possible to design generators of such characteristics that no resistance will be required in series with the arc. It should be emphasized that freedom from stray magnetic fields and the proper alignment of the negative with respect to the positive are essential for uniform light and steadiness.

Table III gives the current, arc voltage, line power, and relative light on the screen through the same optical system for the 12-mm., S.R.A., low-intensity mirror arc, the 8-mm., high-intensity, a-c. arc, and the new non-rotating, high-intensity, d-c. arc.

These data on comparative light on the screen were obtained on a laboratory set-up and, while comparable among themselves, are not indicative of what may be obtained with any other set-up of optical system and screen. In order to compensate partially for this condition the measurements are made with the same distribution of light on the screen for all the carbons.

While Table III shows that at the particular wattages given, the non-rotating, d-c., high-intensity arcs give a higher screen illumination than the a-c., high-intensity arc of equivalent wattage, it should be recognized that the exact order in which these will come in practice

will be dependent upon the design of the optical systems. These optical systems must take into consideration the differences in diameter, and the shapes of the intrinsic brilliancy curves of the light sources if they are to give the same uniformity of screen illumination and the same latitude of operation.

These measurements do not illustrate the difference in the color of the light from these types of carbons. The light from the low-intensity arc is a brilliant white light, although it appears to be yellowish white when compared on a screen with the snow-white light given by the a.-c., high-intensity arc or that from any of the d.-c., high-intensity arcs. This is best illustrated by throwing the light from a 12-mm. S.R.A. carbon and the new d.-c., non-rotating, high-intensity carbon on the screen through a suitable optical system.

It is apparent, from the data presented here, that the conventional light sources, with the addition of the a.-c., high-intensity arc and the new non-rotating, d.-c., high-intensity arc, provide a series of light sources which with suitable optical systems will give light on the screen ranging from that desired by the smallest theaters to that demanded by the largest theaters.

REFERENCES

¹ JOY, D. B., AND DOWNES, A. C.: "A New Alternating-Current Projection Arc," *J. Soc. Mot. Pict. Eng.*, **XXI** (Aug., 1933), No. 2, p. 116.

² JOY, D. B., AND DOWNES, A. C.: "Properties of Low-Intensity Reflecting Arc Projector Carbons," *J. Soc. Mot. Pict. Eng.*, **XVI** (June, 1931), No. 6, p. 684.

³ BENFORD, F.: "The High-Intensity Arc," *Trans. Soc. Mot. Pict. Eng.*, **IX** (1925), No. 24, p. 71.

⁴ JOY, D. B., AND DOWNES, A. C.: "Characteristics of High-Intensity Arcs," *J. Soc. Mot. Pict. Eng.*, **XIV** (March, 1930), No. 3, p. 291.

DISCUSSION

MR. GREENE: Where, in this scale of light units, would the 75-ampere, rotating, high-intensity arc fall?

MR. DOWNES: Just above the 9-mm. mirror reflecting high-intensity and below the 11-mm. at 90 amperes.

MR. GREENE: How does the amount of light delivered to the screen by the arc in its mounting compare with that delivered by a mirror as used in theaters? What value would you assign for the column headed "Screen Light in Arbitrary Units" (Table III)?

MR. DOWNES: I assume that you mean a high-intensity arc with a condensing lens system, as compared with the reflecting, high-intensity arc. Since the high-intensity arcs used with condensing lenses are all burned at higher currents than those used with the reflecting mirrors, they would give more light on the screen

than any of the arcs described in the paper, assuming the optical systems to be the same. It should be recognized that differences in optical systems—carbon trimming, *etc.*—sometimes even in the same theater, cause a great deal of trouble in attempts to compare screen illuminations from different carbons.

MR. MACOMBER: Were the optical systems used here designed primarily for the smaller light sources or for larger ones?

MR. DOWNES: The same optical system was used in all these tests, adjusting the distribution of the light on the screen so that it was the same in each case. Optical systems particularly adapted to each of the light sources described in the paper were not available.

The paper carefully points out that when practical lamps and optical systems are available, these several light sources may not fall into the exact order shown in Table III.

MR. MACOMBER: Any given optical system would be more favorable to one carbon size than to another; it is probable, then, that these were a compromise.

MR. MARR: What is the effect of these new carbons on colored film? I have the impression that the very white light would make colored pictures appear somewhat hard and cold, and possibly less pleasing than would a somewhat softer light of the same intensity. Will this new development be extended to the high-powered carbons for searchlight work?

MR. DOWNES: Spectral energy distribution curves for high-intensity arcs at various currents and for several carbon sizes have been previously published by the authors in the JOURNAL.⁴ We have not as yet made energy distribution curves on these new d-c. carbons, but from our work on various types of arcs we know quite well that the form of the spectral energy distribution curves will be the same as those shown in the article cited, but at a lower level. The effect of these light sources with colored film would therefore be similar to that of the high-intensity arc.

In regard to searchlight applications, we have operated for a long time high-intensity searchlight carbons that have been in regular use at various currents up to 150 amperes. Experimentally we have made carbons, called super-high-intensity carbons, for currents up to 250 amperes. A few such carbons are being used regularly at 180 to 200 amperes. Tests on super-high-intensity carbons show that the light on a screen located 2700 feet from the searchlight is about 60 per cent more at 180–190 amperes, and about 100 per cent more at 250 amperes than that from a regular 150-ampere carbon.

A NEW DEVELOPMENT IN CARBON ARC LIGHTING*

P. MOLE**

Summary.—A new motion picture arc lamp designed for use as a general lighting unit is described, in which the new 8-mm., copper-coated, cored carbons are used. Two special mechanisms feed the two carbons of the unit independently of each other, the rate of feed of each being controlled by the voltage drop in each arc. Each control circuit includes a voltage coil and a current coil, acting in magnetic opposition, which arrangement avoids variations of light intensity, flickering, and blinking. The lamps operate under a voltage of 115, drawing a current of 40 amperes, d-c.

During the past five years the development of carbon arc lighting equipment for use in motion picture production was retarded by several factors. The introduction of panchromatic film, and its almost universal acceptance as negative raw stock, provided a photographic medium that was well adapted to photographing with incandescent filament lamps. The introduction of sound recording in connection with motion picture photography prohibited the use of any type of lighting equipment that was not quiet in operation. However, all through this period 150-ampere Sun arcs and Rotary Spots have been used to a large extent in combination with incandescent lighting.

By making mechanical improvements in the mechanism of Sun Arcs and Rotary Spots, quietness of operation was obtained which overcame the objections of the sound technicians. The old type of broadside lighting units, used extensively in the days of silent pictures, has been practically abandoned in modern picture production, because its design inherently prevented silent operation.

Early this spring, one of the leading producers of colored motion pictures requested Mole-Richardson, Inc., to investigate the possibility of developing a motion picture arc lamp for use as a general lighting unit. This firm was developing a new process of color photography, and it seemed that arc illumination would provide the most satisfactory means of lighting the sets to be photographed.

* Presented at the Fall, 1933, Meeting at Chicago, Ill.

** Mole-Richardson, Inc., Hollywood, Calif.

The specifications were as follows:

- (1) The lamp should produce an illumination level of 200 foot-candles, as measured at fifteen feet with a standard Weston photometer.
- (2) It must have a comparatively flat distribution curve over a projection angle of sixty degrees or more, and the field of illumination should be devoid of any hot spots, *i. e.*, areas of illumination that are photographically objectionable.
- (3) The feeding mechanism of the lamp should be so designed as to provide a reasonably uniform level of light intensity during its period of operation, and the spectrum of the light emitted should not show any alteration of its characteristics during the period of operation.
- (4) It should be silent in operation, so that it may be satisfactorily operated in conjunction with modern sound recording apparatus.
- (5) It should take such a form, and be so mounted, that it will be convenient for placement, and be of such weight as to be easily handled on the set.
- (6) It should be economical in operation with regard to attendance, the consumption of current, and carbon electrodes.

First experiments were made with half-inch white flame carbons, which had previously been used in practically all arc broadside lighting units. By improving the reflecting surfaces, it was found possible to boost the light flux of the old type of broadside units from 60 foot-candles, measured at fifteen feet with a standard Weston photometer, to about 90 foot-candles.

We quickly realized, however, that even though we overhauled and installed new reflectors in our old side arcs, it would be impracticable to attain the 200 foot-candle requirement desired by our client.

We communicated with the National Carbon Company to ascertain what new developments had been brought forth in arc carbons, which would be suitable for use in equipment of the broadside type, and as a result obtained samples of several types of carbons that were thought to fulfill the requirements. After numerous experiments, we decided that probably the 8-mm., special, copper-coated, cored carbons that were recommended would best suit the purpose.

An old type broadside unit was adapted to operate with the carbons and was supplied with chromium-plated metal reflectors. With the 8-mm. carbons in both the upper and the lower carbon holders a marked improvement in light intensity was attained. Utilizing practically the same current, 40 amperes, the light intensity was raised from 90 foot-candles, measured at fifteen feet, to 120 foot-candles.

An inherent fault of the old type of broadside arc lighting unit was its inability to maintain a uniform level of illumination. When first energized, the old type lamps would consume from 40 to 45 amperes,

and produced their maximum lighting intensity; by the time the feed mechanism came into operation, the current in most cases dropped to approximately 32 amperes, and the lighting level dropped about 40 per cent. The specifications set forth demanded a much more accurate control of the lighting intensity.

Knowing the limitations of the old style carbon control mechanism of the various lamps that had been previously designed, it was decided to experiment with a lamp in which each pair of carbon electrodes would be separately controlled. An experimental model was built, and after a number of modifications a mechanism was developed that reduced the fluctuations in light intensity during the feeding cycle of the lamp to within 10 per cent.

In previously designed broadside lamps it had been attempted to control the feeding of the carbon by means of a single current coil in series with the arcs, and by utilizing various means for equalizing the feeding of the upper carbons toward the lower carbons. As far as we have been able to observe, mechanisms operated on such a principle fail to provide good operating conditions, due to the fact that the tolerances in the diameters of the carbon electrodes must of necessity be rather large; and if it happens that a carbon with a minus tolerance be placed in one side of the twin arc mechanism, and a carbon with a plus tolerance be placed in the other side, the carbon having the small diameter will inevitably feed more rapidly than that having a larger diameter. It is most difficult to devise a mechanism operating with a single control coil that would overcome the difficulty without greatly complicating the structural characteristics of the feeding device.

The mechanism developed for the *M-R* Type 29 twin arc broadside controls each pair of carbon electrodes, independently maintaining the voltage drop across each pair of electrodes at 35 to 40 volts, and the feed of each pair of electrodes is independent of the other and controlled by the voltage drop in the arc that the mechanism controls.

Fig. 1 is a schematic diagram showing the method by which this is accomplished. Each carbon arc has its lower carbon electrode in a fixed position. The upper carbon electrode is movable; and when no current flows, the lamp is in contact with the lower carbon. When the lamp is connected to the line, the circuit is closed with only the ballast resistance to impede the flow of current.

The current coils of each mechanism are in series with each other

and with the two arcs. The current from the positive side of the line passes through the ballast resistance, 1, into the base of the lamp, through the switch to the control coil of mechanism No. 1, and on to the upper carbon; thence to the lower carbon, into the current coil of mechanism No. 2 through the coil to the other upper carbon, then to the lower carbon, and back to the line through the ballast resistance, 2. The energizing of the circuit actuates the solenoid armatures, which, through their connecting linkages, elevate the upper carbons in each arc system, striking both arcs.

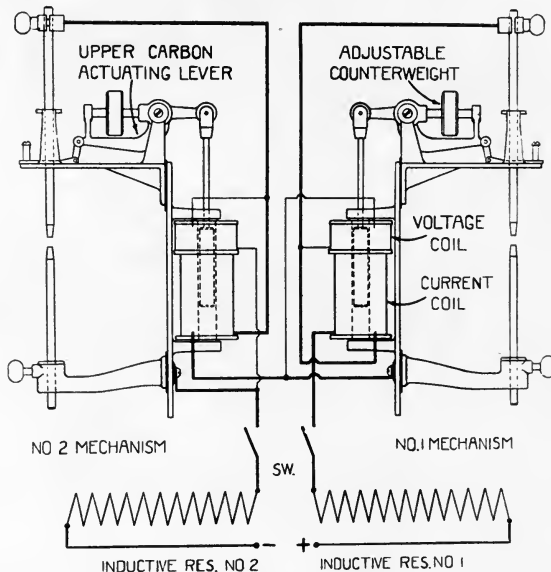

FIG. 1. Schematic diagram of arc regulating mechanism.

Above each current coil, and surrounding each armature, is a coil wound with fine wire and a large number of turns, connected across the arc controlled by it. These coils are wound counter to their respective current coils, and the instant the arc is struck a small current flows through each coil. Since they are shunted across the arcs, the energy introduced into them increases as the voltage drop of each arc increases, the magnetic flux of each voltage coil opposing that of its corresponding current coil. By properly proportioning the number of turns in the current and voltage coils, and proportioning and spacing their respective armatures, it is possible by this method to

control the opening of the arc and to maintain quite accurately a uniform voltage drop across the arcs. Ball-bearings were introduced at the fulcrum of the upper carbon actuating levers, so as to make the mechanism sensitive to the changes of voltage of the arc. Simple, plate-type carbon clutches have proved entirely adequate.

Since maximum efficiency with the carbon electrodes used was attained by using a $\frac{5}{8}$ -inch arc gap, it was necessary to take precautions to prevent magnetic "blowing" of the arcs. This was accomplished by connecting the current coils of each mechanism so that they formed



FIG. 2. Broadside Twin Arc Lamp
M-R type 29.

a closed magnetic circuit, and by placing a steel magnetic baffle plate between the coils and the arc.

The entire mechanism is relatively simple, and may be economically manufactured, because, except for connections in the wiring, each unit of the mechanism is an exact duplicate of the other. To adjust each mechanism so that it will operate in harmony with its adjacent unit, it was desirable that a simple adjusting means be provided. This adjusting means is the movable counterweight mounted on the arc actuating lever. As the lamps leave the factory they are adjusted for

operation on 115 volts, 40 amperes d-c., voltage readings being taken across each arc and the counterweights adjusted for balanced operation.

Under practical and test conditions it has been found that with this mechanism flickering has been totally eliminated. Even though the line voltage be greatly disturbed, as it often is on motion picture stages when operating under heavy loads, the mechanism is so responsive

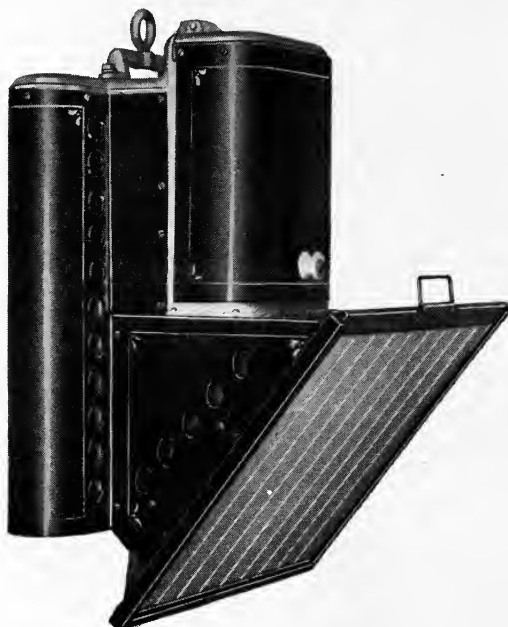

FIG. 3. Twin Arc Scoop Lamp *M-R* type 27.

that such disturbances are compensated without the "blinking" that was often experienced with the old type twin arc lamps.

The mechanism has been built into two types of lamp heads: the *M-R* type 29 Twin Broadside Arc and the *M-R* type 27 Twin Arc Scoop. The Broadside Lamp, designed for floor use, is mounted on a pedestal having two telescoping sections, and may be elevated from a height of four feet one inch, to eight feet eight inches from the floor. The housing of the *M-R* type 29 has been constructed of duralumin sheet metal and aluminum castings (Fig. 2). The mechanism may be tilted from the vertical position thirty degrees forward or backward without disturbing the operating characteristics. Chromium plated

reflectors, which have proved to be entirely satisfactory in this type of equipment, increase the light flux of the lamp in excess of the specification requirements.

The scoop is illustrated in Fig. 3. Its housing, in addition to carrying the mechanism, also carries the resistance units. To facilitate the dissipation of the added heat of the resistance, the head has been amply ventilated with louvers. The aperture of the lamp has been set at an angle to deflect the light downward, as the scoop is primarily designed for overhead use. To assist in carrying off the fumes from the arc coring, both types of lamps are provided with a chimney midway between the twin arcs. This ventilation contributes to the cleanliness of operation of the equipment, a large portion of the white condensate from the arcs passing off through the chimney.

Both types of lamps are intended to be used with glass diffusers. A prismatic glass, sand-blasted on one side, has proved best for the purpose, its high lead content inhibiting the transmission of ultra-violet radiation. No complaints have been received from actors working under the lamps in regard to injury of their eyes.

While it is not anticipated that this new equipment will revolutionize motion picture stage lighting, there are many types of photography and many special effects for which this equipment is peculiarly adapted.

DISCUSSION

MR. JOY: Any one who has seen Mr. Mcle's lamp in operation realizes that he has made a very material contribution to the art of illuminating motion picture sets. The feeding of the carbons is uniform and regular, as the feeding solenoid of each arc is controlled by the current and voltage of that arc, resulting in a steady light from the unit. Tests have shown that within an angle of 60 degrees in front of the lamp, the decrease in light from the center to the outside is only about 15 per cent. Such a small change over such a wide angle should be particularly advantageous in photographic and motion picture work.

MEMBER: What is the bulk or weight of the equipment? To what extent does it add to or detract from the regular incandescent equipment?

MR. MOLE: It would not add to the bulk or the number of units. Experience has shown that the number of units used on the set depends entirely on the set, regardless of whether arcs or incandescents are used. As many units are used as the size of the set demands, so that the entire set will be covered.

MR. COUR: What is the comparison in wattage?

MR. MOLE: That is very difficult to answer. One cameraman on a 15 by 15 set would use 600 amperes and another would use 1200 amperes, so there is no way of determining the saving. More lumens per watt are radiated by an arc than by incandescents, but whether a man is working on a low level or high level, we don't know.

A NEW WHITE FLAME CARBON FOR PHOTOGRAPHIC LIGHT*

D. B. JOY, F. T. BOWDITCH, AND A. C. DOWNES**

Summary.—A new type of white flame arc for use in photography is described and its distribution of energy and the composite effect of this energy distribution on the transmission of the lenses and the sensitivity of supersensitive panchromatic film are shown. Of the total radiant energy almost 37 per cent is in the visible portion of the spectrum, and the new carbon shows a very considerable increase in light emitted over former carbons at the same current and voltage.

Carbon arcs were the first artificial light sources used for photography of various kinds where light was required for more than a very few seconds. The first arcs used were d-c. plain carbon arcs in which the source of light was the incandescent crater of the positive carbon. These plain carbon arcs were relatively inefficient from the standpoint of photographic power per watt of electrical energy, since only about 17 per cent of the radiant energy was in the visible spectrum and the photographically effective ultra-violet.

About 1910, the white flame carbon arc was introduced to the photographic industries largely as a result of the work of one of the early members of this Society, William Roy Mott, of this laboratory. The source of light in this arc is the brilliant flame between the electrodes, which themselves give very little light. The visible and photographically effective light from this arc is from 30 to 35 per cent of its total radiant energy. In addition to white, the flame arc can be made to produce light of other colors which have been useful for certain types of photographic work.

The effectiveness of a light source in photography is dependent upon the distribution of its radiant energy throughout the spectrum, the spectral sensitivity of the photographic emulsions, and the transmission factors of the lenses used in the camera.¹

In a previous paper² the spectral energy distributions of the regular white flame photographic carbons and the panchromatic O

* Presented at the Fall, 1933, Meeting at Chicago, Ill.

** Research Laboratories, National Carbon Company, Inc., Cleveland, Ohio.

carbons at 35 amperes and $37\frac{1}{2}$ volts on direct current with the upper carbons positive were presented, together with the efficiencies in lumens per watt of those and several other flame arcs. There were also presented the photographic effects of the use of these carbons upon the panchromatic film in use at the time. Subsequently, the supersensitive panchromatic film was introduced to the motion picture industry and the effects of various light sources upon the proper rendition of colors were given in an article by Finn,³ in which it was shown that the white flame arc with this supersensitive panchromatic film gave better definition and better rendition of colors than other light sources.

An improved white flame photographic carbon has been developed in the laboratories of the National Carbon Company known as the

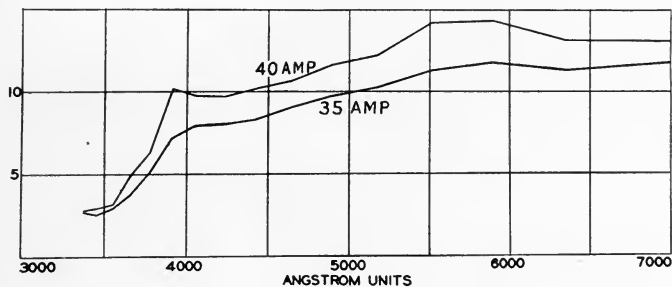

FIG. 1. Spectral energy distribution of 8-mm., copper-coated, motion picture studio carbons: 35 and 40 amperes, 37.5 volts, d. c.; each rectangle represents 10 microwatts per sq. cm. at one-meter distance.

“National copper-coated M.P. studio carbon.” This new carbon is 8 millimeters in diameter and 12 inches long, with a core of suitable size for flaming arcs filled with a composition of rare earth chemicals of the cerium group. The cross-sectional area of this new carbon is only about 38 per cent of that of the well known 13-mm. \times 12-inch white flame photographic carbons. Since the small carbons carry the same or greater current, it is necessary to coat them with copper. This, however, does not impair the steadiness of the arc, which is always better with small carbons when compared with larger sizes at the same current. Fig. 1 gives the spectral energy distributions at $37\frac{1}{2}$ volts and 35 and 40 amperes on direct current with the upper carbon positive.

The comparison of these spectral energy distribution curves with

that for the 13-mm. white flame photographic carbons given in Fig. 1 of the previous paper² shows that while the radiant energy in the near ultra-violet is essentially the same, the radiant energy of the new carbon in the visual portion of the spectrum is at a considerably higher level and shows a peak in the region where the supersensitive panchromatic film is least sensitive, which should make for desirable photographic results.

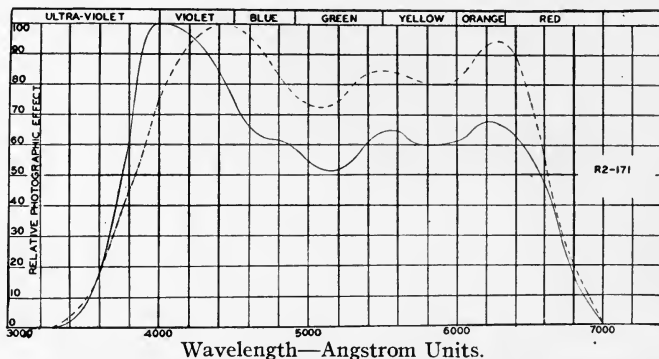

FIG. 2. Photographic effect *vs.* wavelength, for supersensitive panchromatic film: broken curve, sunlight; solid curve, 8-mm., copper-coated motion picture studio carbons: 40 amperes, 37.5 volts; ordinates represent the product of transmission of glass lens, relative sensitivity of film, and spectral distribution of light source values, adjusted to maximum of 100.

Table I shows the percentage distribution of radiant energy from these carbons at 40 amperes and 37½ volts, with the upper carbon positive.

TABLE I
8-Mm., National Copper-Coated, M.P. Studio Carbons
Relative Energy in Several Spectral Bands

	Per Cent
Visible light, 4000–7000 Å.	36.6
Photographically effective, 3400–7000 Å.	40.2
Infra-red (heat), 7000–50,000 Å.	58.4
Total radiant energy of wavelengths less than 50,000 Å.	100.0

From this table it is seen that only 58.4 per cent of the radiant energy from this new M.P. studio flame arc is heat. These (8-mm., copper-coated, M.P. studio) carbons at 40 amperes and 37.5 volts give about 9330 candle-power in the horizontal direction, and are consumed at an average rate of 3.6 inches per hour.

A twin arc (two arcs in series) without reflectors will give approximately 200,000 total lumens at the same current and voltage compared with 158,000 total lumens for the older 13-mm. white flame carbons under the same conditions. Such a twin arc burning the new 8-mm. carbons gives an efficiency of approximately 40–46 lumens per watt on a 115-volt line as compared with 34–38 lumens per watt with the 13-mm. carbons in the older studio twin arc lamps without reflectors.

Fig. 2 shows the photographic effect in relation to wavelength for supersensitive panchromatic film with sunlight and the copper-coated M.P studio carbons at 40 amperes and $37\frac{1}{2}$ volts.

These curves of photographic effect take into account the spectral sensitivity of the supersensitive panchromatic film, the transmission of the glass camera lenses, and the spectral energy distribution of the light source. The calculations were made by the method described by Jones.¹

Fig. 2 shows very clearly that the photographic effect of the light from the new studio carbon arc follows the form of the photographic effect of sunlight very closely indeed. We believe that the energy distribution curve and the curve of photographic effect of the radiant energy from these studio carbons show that they should be a very desirable source of illumination for all kinds of photography.

REFERENCES

¹ JONES, L. A.: "The Use of Artificial Illuminants in Motion Picture Studios," *Trans. Soc. Mot. Pict. Eng.*, V (1921), No. 13, p. 74.

² JOY, D. B., AND DOWNES, A. C.: "Characteristics of Flame Arcs for Studio Lighting," *Trans. Soc. Mot. Pict. Eng.*, XII (1928), No. 34, p. 502.

³ FINN, J. J.: "Soft and Hard Lighting with Supersensitive Panchromatic Film," *Internat. Proj.*, 2 (March, 1932), No. 1, p. 33.

THE USE OF THE TALKING PICTURE AS AN ADDITIONAL EDUCATIONAL TOOL AT THE UNIVERSITY OF CHICAGO*

H. B. LEMON**

Summary.—Committed to a policy of undergraduate education of a general type during the first two college years, the College was faced with the problem of presenting the natural sciences to the entire undergraduate body by means of lectures only. Absence of effective laboratory work seemed to doom the enterprise to failure. Demonstration lectures have serious limitations with large groups. The talking motion picture is a perfect medium to use in support of the demonstration lecture in these two ways: close-ups of delicate apparatus can be projected on gigantic scale; natural large-scale phenomena out of doors, and industrial processes may also be brought vividly into the classroom by this means.

The University of Chicago is engaged in producing a series of films designed specifically for the four Introductory General Courses of the University, viz., the humanities, and the social, biological, and physical sciences. Completed and already used with excellent success are films on the molecular theory of matter, oxidation and reduction, energy and its transformations, and electrostatics. In production to be ready for use this year are two reels on wave motion and sound, magnetism and electromagnetism, one reel each. Films on the velocity of chemical reaction, chemical equilibrium, atomic and molecular structure, spectra, interference of light, the velocity of light, carbon and its compounds, the atmosphere, the solar system, the changing surface of the earth, weather and forecasting, time and the calendar, and volcanic phenomena and earthquakes are among those planned for in the physical sciences.

This changing world of politics, industry, and economics that we have been going through has had its counterpart in a changing world of education. In the year 1892 about 200,000 students were enrolled in the high schools of this country. Forty years later, in 1932, over 4,000,000 students were enrolled in the high schools of this country. The percentage of our population of high-school age who went to high school was 10 per cent thirty years ago, and is now over 50 per cent. While these figures relate to high schools, the situation in the colleges, while not involving nearly such large numbers of students, has been closely parallel, and those of us who have been in

* Presented at the Fall, 1933, Meeting at Chicago, Ill.

** Professor of Physics, University of Chicago.

touch with undergraduate and graduate education in our universities in the last ten or fifteen years, have been aware of serious problems.

The business of going to college had become, up to two or three years ago, very largely a social matter, whereas going to college in the days of our parents was solely a matter of acquiring a very special training preparatory to entering one of the learned professions. In recent times, going to college has seemed to be something in the nature of having four years more of fun before having to go to work, and many of us have felt in all seriousness that a very large number of our college men and women were learning, in the four years of college, chiefly bad habits. I don't mean by that anything involving actual deeds of moral turpitude, but very bad habits in preparation for life—such bad habits, as never to do anything thoroughly well, or developing a chief interest in social activities. While I would never advise any young person to let his studies totally interfere with his college education, it seemed to us that there was not at all the proper motivation on the part of many of these young people. Of course, we never blamed the young people for that; we blamed the parents, we blamed ourselves. It may be that one of the silver linings of this very dark cloud under which we were passing is going to be a very marked change of attitude in the future toward this business of going to college.

As a result of that and other things, the University of Chicago two years ago adopted a new plan of college education, a plan that very frankly avoided the training of specialists in the first two years of college. We are not attempting to train specialists in physics or chemistry or mathematics, hardly even starting that training at the University of Chicago in the first two years. We are devoting the first two years to what we call general education. There is a danger in such a procedure. There has been some tendency in recent years to teach students more and more about less and less. General education—survey courses, as they are sometimes called—have a tendency to do just that sort of thing. We wanted our curriculum to have depth, as well as the utmost breadth.

Consequently, in the first two years at the University, every student is required to take, out of a total of eight courses in the two years, four general courses—one in the physical sciences, one in the biological sciences, one in the humanities, and one in social studies—each of which require a full year. That makes four of the eight. In addition, two full-year, second-year courses in two of those

four fields are required. So our undergraduate body in the first two years will have covered by intensive study during two years, one-half the entire field of university activities, and all of it in one-year courses. That takes six out of the eight courses to do that and it leaves them two courses available for continuation of interests in high-school—English, special courses, modern languages—that they may need.

These changes, of course, involved an entirely different problem for our teaching force, an entirely new curriculum, and very largely an entirely new staff, a staff which now, instead of being largely in the hands, as in the old curriculum, of relatively young and inexperienced men, required the drafting of a personnel that had more experience, and in so far as possible represented distinguished work, both in research and in teaching.

Coming now to the very definite problem of the physical sciences we were offering a new course in addition to all the old courses we already had, in which the numbers of students involved is enormously greater than ever before. Students going to the University under the old curriculum interested in social sciences and humanities, students in general, avoided physics—for the very good reason that our whole courses in physics were designed for the training of specialists. Now they all have to take not only physics, but chemistry, astronomy, geology, and mathematics, in this survey course.

One of the problems to be faced was the question of how to present our source material in the physical sciences. One would not know how, I believe, to teach students something about the interpretation of literature, or how to project a study of literature before a group of students who had never read any books. As books are the source material for literature, so are phenomena the source material for science. The conventional laboratory was out of the question. The freshman and sophomore students—a vast majority of them—had never been inside a laboratory. Even if they had, the problem of administering elementary laboratory work to a class of 750 students was impossible. It is in the laboratory, in conventional courses in physics and chemistry, that students acquire most of their first-hand knowledge of the phenomena.

We knew perfectly well from former experience that we could not contemplate giving a "talkie on science"—getting up and talking *about* science. The words go into one ear and out the other, and leave no impression. We already had the technic of demonstration

lectures where you demonstrate the phenomena on the lecture table. Statistics show that in the last thirty years the use of the demonstration lecture has greatly increased.

Experiments on the lecture table would probably be clearly visible to an audience of this size, under the best conditions, about half-way back in the room. Those at the rear could not see ordinary apparatus, so at once we were limited to showing on the lecture table things that could be shown with fairly large-scale apparatus; and, of course, physical laboratories whose main business has been research all these years, have no such equipment. There are notable laboratories in Europe where demonstration lectures can be made to audiences as large as 400 or 500 persons, and the audience can see everything that is going on because the apparatus is all built on a large scale, very brilliantly illuminated. This, obviously, was one way of presenting source material.

Another method is to use the permanently set up demonstrations in very elaborate museums of science. The sort of thing you have been seeing in the Hall of Science at the World's Fair can be done on a smaller and less ambitious scale locally, and devices operated by the students, on which they press a button and an experiment takes place, resets itself, and is repeated as often as the button is pressed, are very effective means of presenting phenomena of science.

We have such museums—one very elaborate one in physics, one less ambitious which we hope to develop further for chemistry. The Adler Planetarium serves as our astronomy museum, where our classes meet at certain stated periods. We have a museum of geology in which are shown many of the things seen in the geology exhibits at the Fair. Indeed, not a few of those exhibits have taken form from what we have been doing at the University, and have been rebuilt for the Hall of Science. But there are many things that can not be done by any of those methods; but, as a matter of fact, the demonstration lecture table can be greatly assisted by the talking motion picture. We are not speaking academically or from theory. We know it can because we have done it.

There were no films available that were suitable for our courses. Not being professional motion picture producers, we were not competent to make such films. We knew what we wanted, but how to get it was another matter. Electrical Research Products, Inc., having already studied the technic of educational motion pictures, assisted in the production. We, the faculty, familiar with the university

activities and the nature of the general courses, had already worked out a comprehensive plan from the point of view of the desirable content of the pictures. We have tried only to produce pictures that were exactly what we wanted to use in our classes. The films that were produced may find a wide usefulness in other state and privately endowed universities. They will be equally useful in small colleges and ultimately, if our plans go ahead and the reels expand somewhat, they will have an enormous usefulness in the secondary schools. We have already used four films in our courses and have four more in production that we expect to finish in time for use this year.

We have only one set of data, one year's class; but from those data we are firmly convinced that we can cover more ground in less time with a class, and make the information stick very much better. That, of course, is the ultimate aim of the teacher, always. As the knowledge increases we are continually faced with the need for covering more ground and, of course, we always want to make it stick better.

Let me tell you something of the manner in which we use our films in the class. Imagine that you were in a class, and that you had never heard anything about the molecular theory of matter. You would first be presented with a synopsis of the entire subject covered in the film. At the first meeting, in the first ten minutes, you would watch the film and listen to it. The lecture would be fifty minutes long. Forty minutes would remain in which we should arrange supporting apparatus for additional demonstration on the table; so that after you had seen the film, we would show you some experiments that would not be duplicates of those in the film, but things that could be done effectively on the table. On the next day we would talk to you for forty or fifty minutes again. Day after that the subject would still be on the boards, and we would probably begin the performance by running the film silently and talking to you about it, pointing out many things that had escaped your attention at first. The rest of the hour would be consumed by talk on our part, questions on yours. When the subject had been fairly well concluded, in the last ten minutes of the last hour you would see the talking picture once more, with the sound audible, as a review.

We give these details partly because the general feeling on the part of teachers is that when the teacher advocates talking motion pictures for use in classes, he is organizing himself out of a job.

These films that we are making are utterly *useless without a teacher*. They constitute nothing more in our curriculum than an additional and a very effective tool, which, together with the museum, together with the demonstration lecture, together with the quizzes, the recitations, and all the old tools that we had, enable us to do a better and much more comprehensive job, in very much less time.

DISCUSSION

MR. FRITTS: What is the relative value of 16-mm. *vs.* 35-mm? Also, assuming that in due time we shall have, in addition to black-and-white, natural color and three dimensions, of what value would they be?

MR. LEMON: With respect to your first query, we use at the University 16-mm. sound-on-disk, Western Electric equipment, in my own lecture room. We have available for use, also, for larger groups, 35-mm. sound-on-film. So far as my two years of experience goes, I see no choice. The 16-mm. film is probably not capable of projection on quite as large a scale; but for audiences the size of our classes—100 to 250 persons—the 16-mm. equipment is perfectly effective in our own lecture rooms, which is acoustically treated.

With respect to color, my reaction would be, speaking academically and in advance of experience, that the more realistic the picture on the screen can be made, the better it will be. However, we felt, before trying these pictures, that photographed experiments would not go across to a class as well as actual experiments on the table. However, when the film is used in conjunction with demonstration experiments, we find that the students are apparently quite unconscious of the difference. The black-and-white seems to go across quite as well as the actual experiment on the table.

I want to emphasize that we have as yet only one set of data, on one year's course. Any conclusions that I may draw now, since this is frankly an experiment in education, are subject to revision as data accrue. I see no present need for color; there is much to be done before that, in any event.

MR. FRITTS: At one time it was suggested that a teaching projector should be capable of being stopped at any particular point for further elucidation by the lecturer.

MR. LEMON: That is very desirable; when we show silent film we do stop it occasionally. However, it is rather disastrous to the film, for the heat filter is not quite adequate. We can't stop too long, so I always have my assistant at the machine to stop it long enough for me to point out everything I want to point out.

It is very difficult to talk to one of these pictures. No one who hasn't actually done it can appreciate the enormous amount of time and effort that go into the selection of every particular word, and the problem of synchronization. To have the correct phase of the picture meet the eye just as the corresponding content strikes the ear—that is *when the context is appreciated*—is an extremely difficult thing.

For the sake of some schools, and because of the present financial situation

of most educational institutions, we have to cover the temporary emergency with a study guide, which contains a certain amount of instruction about use, and so on, and suggestions for the teacher, but the most important part of which is the full-scored script of the film. Consequently, a school without sound equipment at the present time, wanting to use these films, will find it relatively easy to have the instructor simply read from the study guide while the film is being run silently, and he can synchronize fairly well.

MR. RICHARDSON: Do I understand that the University of Chicago has been convinced of the fact that in the future the school or college that attains the highest proficiency in education must have special talking films for certain classes?

MR. LEMON: One hesitates to make predictions. The basic assumption that we are entertaining in these new general courses is that in the future probably not nearly as many students will go to college for four years. We are rather expecting that large numbers of our students will leave the University, at least for some period of years, at the end of their sophomore year. They will then have been trained in no specialty; they will have received no technical training at all, but will have been exposed for two years to the entire scope of University activities. However, they will be in a much better position than many of the four-year graduates now are, who find that the classical curriculum has not given them even a background for solving the problems they have to face in life.

We expose our students for two years to the whole scope of our activities, and for an additional year to half the scope. In order that a respectable number of our students do creditable work on comprehensive examinations on these subjects, at the end of a year's time, we have resorted to the talking motion picture as an additional tool in our educational problem. Otherwise, we should never have discovered how effective the pictures can be.

MR. MATTHEWS: As I viewed the two demonstration films, it seemed as though the tempo of the second film was more suitable, as far as receptivity was concerned, than that of the first. I thought that the speed of the former was too great: one idea followed another so rapidly that in listening it was difficult to absorb the idea that was intended to be conveyed before another idea was presented.

MR. GREENE: One of the great advantages of film methods of presentation is that the viewing distance can be shortened to any extent desired. The instructor can, in effect, bring his class right down beside him, instead of having them view the operations from a remote point at the rear of the lecture hall.

As to the matter of three-dimensional pictures, the difficulty attending the use of supplementary apparatus can easily be obviated in the classroom, whereas it is very detrimental in the theaters. The instructor can easily instruct his class on how to handle the auxiliary apparatus, and since his audience consists always of the same persons, at least during a given term, there should be no difficulty in doing so.

As to the matter of holding the film stationary at any point, would it not be practicable, where the pictures are repeated term after term, to provide lantern slides for those frames? If not, a light source of higher temperature might be used in the projector; if the installations are permanent, a high-temperature arc

might be used instead of a Mazda lamp. It would be a bit more difficult to control, but would furnish a light that is much cooler.

MR. HOLSLAG: I believe that the use of color would benefit such a film considerably, because color could be used, in animation, to differentiate between two important curves or points, such as is sometimes done in the case of graphs. The color and sound would be supplementary, and would convey the ideas more forcibly than they could be conveyed by color or sound alone.

Speaking of stopping the film, or slowing it down, it seems to me that an unfortunate psychological effect would be produced upon the class: we are all familiar with the queer sound that is produced when the sound track is slowed down. A much better method would be simply to duplicate the desired frame a number of times on a special printer. This would produce the same effect as a slide without the attendant difficulties of stopping the film and of bringing another projector into action. The instructor could determine beforehand what particular frame to duplicate, and it might be made to cover three to five feet, or whatever length might be necessary.

NEW MOTION PICTURE APPARATUS

A NEW 35-MM. PORTABLE SOUND PROJECTOR*

H. GRIFFIN**

The use of motion pictures in the non-theatrical field, such as in schools, colleges, churches, commercial organizations, steamship lines, hotels, hospitals, *etc.*, was well established for many years before synchronized sound found its place in the motion picture industry. This field was well supplied with various types of portable motion picture projectors, among which was one known as the Acme S.V.E.

Projectors for silent film, however, are no longer saleable; for that reason the International Projector Corp. has developed a portable 35-mm., sound-on-film equipment that admirably takes the place of its predecessor. The object of this paper is to describe briefly the design and construction of this new equipment. It is assembled completely in two carrying cases (Fig. 1), in one of which are the projector and sound reproducing mechanism. The amplifier, loud speaker and cable, and the upper magazine of the projector are carried in the second case. The front of the case is used as a baffle for the loud speaker.

Considerable effort has been expended in order to combine high-quality equipment with its correspondingly accurate assemblies, with acceptable portability. The entire projector mechanism, lamp house, take-up magazine, motor, and sound head are enclosed in a substantially built carrying case 22½ inches long, 24 inches high, and 10½ inches wide, and the equipment is so constructed that no parts or adjusting mechanisms project beyond the confines of the case. This feature eliminates the possibility of damaging the apparatus during shipment or when carried from place to place.

The projector is of the straight feed type, similar to standard professional equipment, and the case door is provided with two glass observation ports in order that the film may be observed while in transit through the equipment. The door is provided with a lock and key to prevent unauthorized persons from tampering with the equipment. The film magazines satisfactorily accommodate 1000 feet of standard 35-mm. film, and are constructed from one piece of metal with no soldered joints.

The conventional fire valves are provided on both the upper and lower magazines, and the magazine doors are substantially supported by heavy hinges. A spring latch is provided to hold the magazine doors closed. The upper magazine is attached to the top of the mechanism case by means of two thumb screws, and

* Presented at the Fall, 1933, Meeting at Chicago, Ill.

** International Projector Corp., New York, N. Y.

is readily removed for packing in the amplifier case. Professional practice is followed in the construction of the upper magazine; it is equipped with a revolving spindle having a key and toggle latch for holding the reel, and an adequate hold-back tension device to prevent the film from over-running during projection.

Provision has been made for holding both the lower magazine door and the projector case door open while threading, regardless of the projection angle of the projector; and the take-up magazine door is positively closed and latched with the closing of the door of the projector case.

The projector (Fig. 2), sound mechanism, and take-up unit are entirely gear driven. No belts or chains of any kind are used in any part of the equipment. Bearings of all drive-shafts other than the intermittent movement are of a bronze, oil-absorbing composition, and oil fed to the outer surface of these bearings seeps through the bearings to the spindles, thus providing adequate lubrication at all



FIG. 1. *Right:* case containing projector and sound mechanism; *left:* case containing amplifier, loud speaker and cable, and upper magazine of the projector.

times. Oil is fed to these lubrication channels by means of conspicuously located oil tubes and oil holes in the several parts of the apparatus, and these lubrication points are shown in a threading and oiling chart permanently attached to the door of the projector.

The revolving cut-off shutter is placed between the lamp house and the projection aperture and is a little larger than 8 inches in diameter. The shutter is enclosed by a guard so as to protect the projectionist from injury. Provision is made for setting the shutter without removing any part of the equipment other than the guard. This construction offers the same advantage and protection, in so far as heat reduction at the aperture is concerned, as is gained by rear shutter equipment on professional apparatus.

The fire shutter is of the centrifugally operated type, which opens automatically when the projector has reached a safe operating speed, and closes automatically

when the projector is stopped. No friction operated devices are used in this connection, and the unit is to all intents and purposes the same as is used on the Simplex projector.

An automatic safety trip is provided for the fire shutter (Fig. 3). Should the film for any reason stop at the aperture plate while the projector is in operation, the fire shutter is instantly released, thus preventing the film from taking fire at that point. This safety trip is of the automatic resetting type so that all its component parts are automatically restored to their operating positions when the projector comes to rest and the reason for the stoppage has been removed.

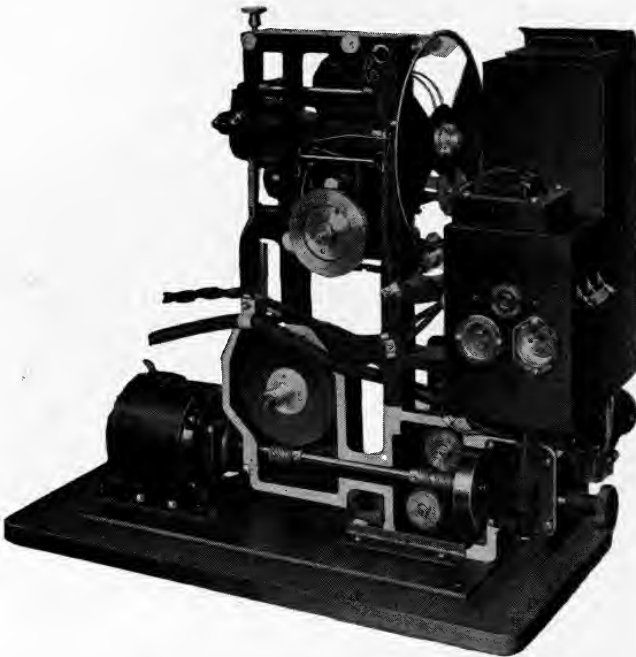

FIG. 2. View showing gearing of projector sound mechanism and take-up unit, filter flywheel, and switches.

The intermittent movement is of the conventional Geneva type, except that the star-wheel, cam, and the cam pin are hardened and ground on all operating surfaces, and the assembly operates in a fluid oil bath. The housing for the intermittent assembly contains also the driving units for the upper feed sprocket and the shutter shaft, all of which are lubricated by the splash system of the intermittent movement assembly. An observation port is provided in the casing so that the oil level may be easily determined at all times.

The picture is framed from outside the projector case by moving the entire intermittent mechanism laterally with respect to the aperture plate, allowing for the framing of one full picture. A framing and threading lamp is provided in such

a position that the picture may be properly framed at the aperture when threading the projector. This lamp gives sufficient illumination for threading the projector in a darkened auditorium or projection room, and it is possible to turn the projector over manually in order to position the intermittent movement properly for threading. The projected picture is exceptionally steady, due to the special construction of the film trap and gate assembly, which are also designed to project

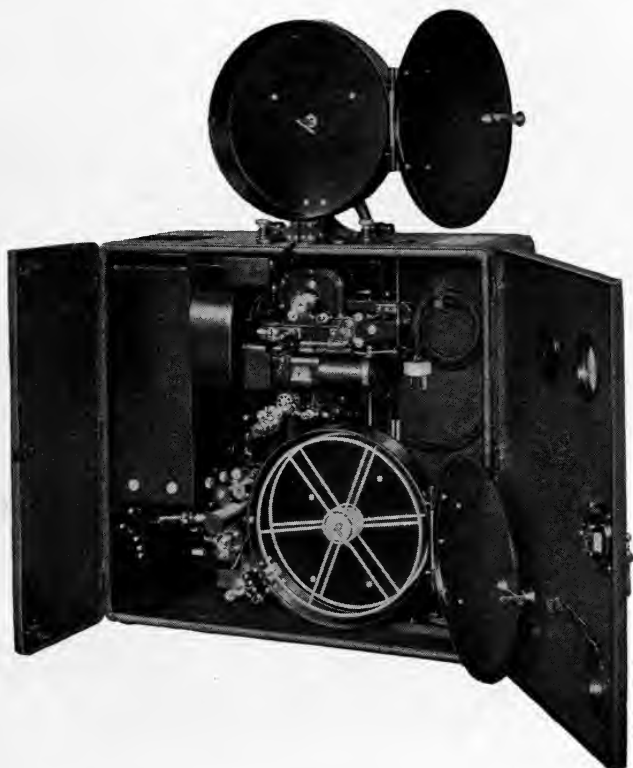

FIG. 3. View showing assembly in case. The automatic safety trip is shown immediately to the left of the upper feed sprocket; to the left of the trip is the fire shutter guard mounted adjacent to the lamp house.

buckled film with a minimum of optical disturbance. The lens is focused conveniently from outside the projector case.

The lamp house (Fig. 4) is of the double-walled type with a ventilating space between the walls, and a gear-driven fan is provided in the top of the lamp house, which directs the ventilating draft and at the same time prevents stray light from leaving the lamp house. The latter is provided with a standard pre-focus Mogul socket, which will accommodate any standard *T-20* pre-focus lamp, and

an adequately supported spherical mirror. Socket and mirror are rigidly held in their correct optical positions by means of adjusting mechanisms that may be securely locked after the various units have been correctly aligned.

Switches of ample carrying capacity are provided for the projection lamp, motor, and exciter lamp, respectively (Fig. 2). The projection lamp and exciter lamp switches are mechanically coupled in such a manner that the lamps may not be operated separately for threading and running-out purposes, so that the

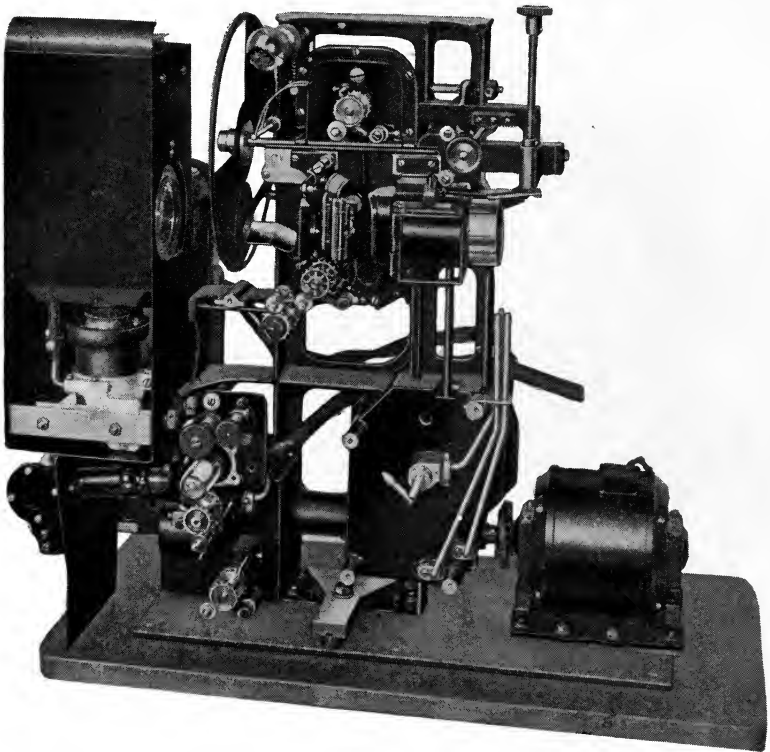

FIG. 4. View showing lamp house, framing and threading lamp, automatic safety trip, and exciter lamp system.

switch assembly provides a satisfactory means for making change-overs when two projectors are used. The usual amplifier change-over is avoided by this means, the actual change-over of the sound reproducing equipment being effected through the exciter lamps.

A separate input receptacle is provided for the projection lamp, and an additional input receptacle is provided for the motor and exciter lamp circuits. The exciter lamp is heated by alternating current through a step-down transformer mounted in the equipment. An output receptacle is also provided, connected in parallel

to the motor and the exciter lamp receptacle, this receptacle being used to supply alternating current to the amplifier.

The driving motor is of the 115-volt, 60-cycle, split-phase induction type, and is mechanically connected to the mechanism through a flexible coupling. The motor is resiliently mounted in such a manner that its mechanical vibrations are effectively prevented from reaching the driven mechanism.

The sound reproducing system (Fig. 4) is operated entirely by alternating current. The exciter lamp operates on 10 volts a-c., drawing $7\frac{1}{2}$ amperes. The sound optical system (Fig. 4), when properly adjusted, projects a scanning beam



FIG. 5. Amplifier, loud speaker, cable, and upper magazine; the loud speaker operates through an opening in the front of the case (Fig. 1), the front of the case acting as baffle.

0.008 mil high by 0.084 mil wide. Means are provided for properly focusing the objective with relation to the sound track on the film without affecting the angular adjustment of the unit.

The sound aperture plate is of the curved type, without tension shoes or gate, the tension on the film being supplied by a sprocket under tension mounted on the intermittent movement assembly. By this means the film is maintained in the correct optical plane with respect to the scanning beam. Means are also provided for the instantaneous lateral adjustment of the film at this point. This adjustment may be made with the projector in operation, and when the standard S. M. P. E. sound test film is used for the purpose, the correct positioning of the sound track becomes a very simple matter indeed.

A radical departure from conventional filtering methods has been made in this equipment (Fig. 2). The sound filter flywheel, instead of operating at 360 rpm., is operated at 1725 rpm. through an accurately machined pair of gears, the gear and flywheel floating within certain limits on the projector drive shaft. No flywheel forms part of the sound sprocket shaft assembly proper. This unit is therefore very simple to manufacture and performs very creditably. Great accuracy, of course, is necessary in this assembly, and all manufacturing tolerances in this connection have been reduced to an absolute minimum.

The sound sprocket operates in a free loop of film except for the tension sprocket referred to above (Fig. 3), and a hold-back sprocket is provided between the

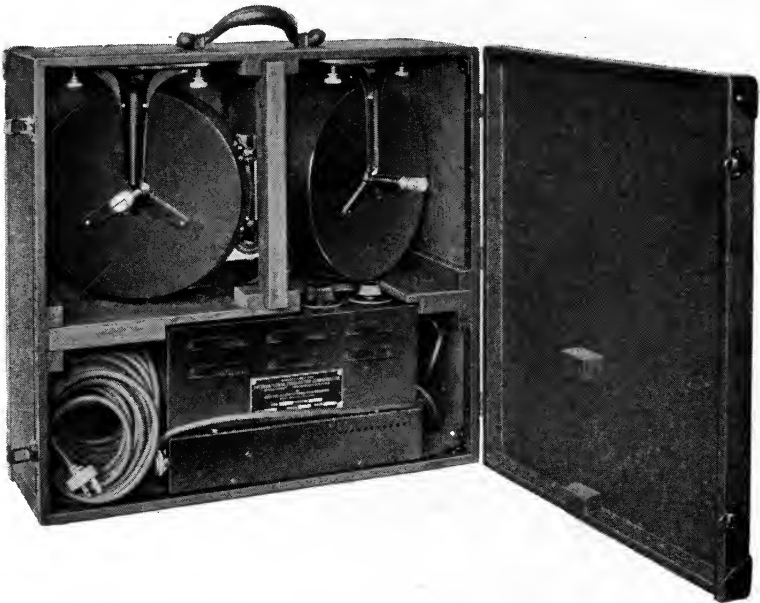

FIG. 6. Speaker carrying case equipped for double-unit installation.

sound sprocket and the take-up, effectively preventing any variation due to the transmission of take-up tension to the sound system.

The photoelectric cell, of the conventional type, is coupled to the amplifier by means of a low-capacity cable with an unbroken continuous shield from the socket of the cell to the amplifier input receptacle.

The amplifier is of class *A* construction, and operates on 115 volts, 50 to 60 cycles (Fig. 5). It has a maximum undistorted output of 5 watts (the harmonic distortion not exceeding 5 per cent), and is capable of reproducing all frequencies up to 9000 cycles. It is equipped with a special input jack for phonograph, a receptacle for two-button microphone, a low-frequency cut-off switch, a tone control for eliminating needle-scratch in phonograph disk reproduction, a high-

and low-voltage switch, a-c. *on* and *off* switch, volume control, input receptacles for two projectors, monitor speaker receptacle, and auditorium speaker receptacle; and all tubes are enclosed in a substantial perforated grille.

The auditorium speaker is of the electrodynamic type, and is mounted in the speaker carrying case, the front of which acts as a baffle. The speaker opening in the case is provided with a removable cover to prevent damage during shipment. The speaker is provided with a 50-ft. length of cable.

The speaker carrying case (Fig. 6) for a double-unit installation is slightly larger than that used for a single unit, for the reason that space is provided for carrying two upper projector magazines. This construction makes possible a transportable unit for a double projector installation consisting of only three cases. In all other respects the double- and single-unit speaker cases are identical. An entirely metal, rigid, collapsible stand with telescoping legs is available for this equipment, which, when collapsed for shipment, is approximately 24 inches long, 10 inches wide, and $2\frac{3}{4}$ inches high.

The equipment is manufactured in three types: one for operation on 60 cycles, 115 volts a-c., the second for operation on 50-cycles, 115 volts a-c., and the third for operation on either alternating current from 40 to 60 cycles, 115 volts a-c., or 115 volts d-c. The motor in the latter is electrically governed, is designed to operate at a fixed speed of 90 feet per minute for sound film reproduction, and provision is made through control equipment for reducing the speed so as to allow satisfactory projection of old silent film productions at the correct projection speed.

SOCIETY ANNOUNCEMENTS

BOARD OF GOVERNORS

A meeting of the Board of Governors is scheduled for January 19th at New York, at which time the results of the balloting on the amendments of the Constitution and By-Laws proposed at the Chicago Convention will be announced. Among various other items on the agenda are the nominations of the new officers, provided the amendments are approved, the preparation of the 1934 budget, the launching of a vigorous membership campaign, and the formulation of plans for the Spring, 1934, Convention, which the Board voted at its last meeting is to be held at Atlantic City, N. J.

PACIFIC COAST SECTION

The first meeting of the 1933-34 season was held in Los Angeles at the Maryland Inn and was convened at 7:00 P.M. at dinner. The meeting was attended by fifty-one members and guests, all of whom displayed marked enthusiasm and contributed valuable suggestions to the proposed agenda for the ensuing year. Chairman Emery Huse called the meeting to order, and appointed Messrs. Silent and Handley to tally the sealed ballots of the annual election for Section officers. Following their count, Mr. Silent announced that Mr. Huse had been reelected Chairman of the Section, Mr. Harcus had been elected Manager for the ensuing two years, and Mr. Rackett had been reelected Secretary-Treasurer. These officers were installed with appropriate declarations of policy.

The Chairman then invited Mr. Mole to express some thoughts that he had regarding the activities of the Section. Mr. Mole outlined the functions that the Section had performed since its formation, and stated that he felt that the general situation in Hollywood warranted greater activity on the part of the group, with particular reference to the important link occupied by the Society between the research laboratories of the equipment manufacturers and the studio technicians, who should be kept in close touch with new developments and recommended features which will make them more practical under conditions of production. This general thesis was concurred in and amplified by Messrs. Kunzman, Dubray, and Rackett.

The topic of desirable subjects for meetings was then opened for general discussion by the Chairman. The following items were recommended:

A description of the advances in and current status of television, as it is being developed by the local Don Lee station.

A historical review of the development of the motion picture art at a meeting to be held at the Motion Picture Exhibit in the Los Angeles Museum, where Mr. E. Theisen, a member of the Society, is Honorary Curator.

A demonstration and explanation of the projection test reel developed by the Projection Practice Committee.

The developments in 16-mm. sound-on-film projection equipment.
Technicolor's three-color process.

The speaker of the evening, Mr. William Hartman of the Carl Zeiss organization, was then introduced by the Chairman. Mr. Hartman responded with an excellent dissertation on the planetarium now being constructed in Los Angeles on Hollywood Mountain, accompanying his descriptions with appropriate lantern slides. Mr. Hartman's talk was followed by an open forum of questions and discussion which covered many phases of the optics and mechanics of the planetarium instrument, as well as some of the general facts of astronomy.

The meeting was adjourned by the Chairman at 10:15 P.M.

NEW YORK SECTION

The first monthly meeting of the Section was held at the studio of RCA Photophone, Inc., New York, N. Y., on December 13th. First on the program was the presentation of a short motion picture, followed by a talk and demonstration by F. C. Barton, of the RCA Victor Company, on "High-Fidelity Lateral-Cut Disk Records." After the discussion of the presentation, another short subject was shown, which was then followed by an open forum discussion on the subject "Should Studio Recording Equipment Compensate for Theater Reproducing Characteristics?"

CHICAGO SECTION

At a meeting held on December 14th at the studios of Burton Holmes Lectures, Inc., Chicago, Ill., demonstrations and talks on the subject of laboratory practice were presented, as follows:

"Airplane Racks," by T. L. Gibson, J. E. Brulatour, Inc.

"Chemical Fades," by R. Tavenier, Mutual Film Laboratory.

"Developer Exhaustion Tests," by H. Anders, Jam Handy Pictures Service, Inc.

"Bloop Punch," by V. M. Bowers, Action Film Co.

"Tight Winders," by R. F. Mitchell, Bell & Howell Co.

"Moviola Sound Editing," by W. and H. Lignell, Burton Holmes Films, Inc.

"Film Kinks," by V. Blakeley, Chicago Film Laboratory.

"Filing Film," by E. Cour, Jeencour Productions.

STANDARDS COMMITTEE

At a meeting held on December 6th at the General Office of the Society, the final form of the Revised Standards Booklet was decided upon, and final drawings are being made for publication in the JOURNAL in the near future. The Committee is also studying the practicability of establishing new dimensional standards for reel hubs. The Standard S.M.P.E. film perforation was adopted by the British Kinematograph Society, subject to acceptance as a Deutsche Industrie Normen. Proposals have also been submitted by the B. K. S. concerning a universal film core for all 35-mm. raw stock, which is now being considered by the Committee.

A Question

ANSWERED

WHAT big picture today does *not* include backgrounds that call for composite photography? The answer is obvious. . . . The really vital point is: What medium to use in photographing these important backgrounds? . . . Eastman has answered that question. Eastman Background Negative, with its remarkably fine grain, its surprising speed, and its excellent processing characteristics, completely solves the film problem of the composite shot. Eastman Kodak Company, Rochester, N. Y. (J. E. Brulatour, Inc., Distributors, New York, Chicago, Hollywood.)

EASTMAN

Background Negative

JOURNAL

OF THE SOCIETY OF

MOTION PICTURE ENGINEERS

Volume XXII

FEBRUARY, 1934

Number 2

CONTENTS

	<i>Page</i>
Further Investigation of Ground Noise in Photographic Sound Records O. SANDVIK, V. C. HALL, AND W. K. GRIMWOOD	83
Sound Film Printing—II. J. CRABTREE	98
Recent Improvements in the Bell & Howell Fully Automatic Printer A. S. HOWELL AND R. F. MITCHELL	115
The Economics of Projector Lamps for Advertising Purposes E. W. BEGGS	127
Sixteen-Mm. Sound-on-Film J. O. BAKER	139
Color for Industrial and Business Films R. H. RAY AND H. W. CRESS	144
Some Practical Applications of Acoustics in Theaters G. W. BAKER AND M. A. SMITH	148
Society Announcements	153

JOURNAL OF THE SOCIETY OF MOTION PICTURE ENGINEERS

SYLVAN HARRIS, EDITOR

Board of Editors

J. I. CRABTREE, *Chairman*

O. M. GLUNT

A. C. HARDY

F. F. RENWICK

Subscription to non-members, \$8.00 per annum; to members, \$5.00 per annum, included in their annual membership dues; single copies, \$1.00. A discount on subscriptions or single copies of 15 per cent is allowed to accredited agencies. Order from the Society of Motion Picture Engineers, Inc., 20th and Northampton Sts., Easton, Pa., or 33 W. 42nd St., New York, N. Y.

Published monthly at Easton, Pa., by the Society of Motion Picture Engineers.

Publication Office, 20th & Northampton Sts., Easton, Pa.

General and Editorial Office, 33 West 42nd St., New York, N. Y.

Entered as second class matter January 15, 1930, at the Post Office at Easton, Pa., under the Act of March 3, 1879. Copyrighted, 1934, by the Society of Motion Picture Engineers, Inc.

Papers appearing in this Journal may be reprinted, abstracted, or abridged provided credit is given to the Journal of the Society of Motion Picture Engineers and to the author, or authors, of the papers in question. The Society is not responsible for statements made by authors.

Officers of the Society

President: ALFRED N. GOLDSMITH, 444 Madison Ave., New York, N. Y.

Past President: JOHN I. CRABTREE, Kodak Park, Rochester, N. Y.

Vice-President: WILLIAM C. KUNZMANN, Box 400, Cleveland, Ohio.

Vice-President: OMER M. GLUNT, 463 West St., New York, N. Y.

Secretary: JOHN H. KURLANDER, 2 Clearfield Ave., Bloomfield, N. J.

Treasurer: TIMOTHY E. SHEA, 463 West St., New York, N. Y.

Governors

EUGENE COUR, 1029 S. Wabash Ave., Chicago, Ill.

HERFORD T. COWLING, 7510 N. Ashland Ave., Chicago, Ill.

RALPH E. FARNHAM, Nela Park, Cleveland, Ohio.

HERBERT GRIFFIN, 90 Gold St., New York, N. Y.

EMERY HUSE, 6706 Santa Monica Blvd., Hollywood, Calif.

WILBUR B. RAYTON, 635 St. Paul St., Rochester, N. Y.

HOMER G. TASKER, 41-39 38th St., Long Island City, N. Y.

FURTHER INVESTIGATION OF GROUND NOISE IN PHOTOGRAPHIC SOUND RECORDS*

O. SANDVIK, V. C. HALL, AND W. K. GRIMWOOD**

Summary.—This paper presents an investigation of the growth of the ground noise during the successive stages of the processes involved, from the time of manufacturing the base support until the sound is reproduced in the theater.

A study is made of the relation between emulsion grain size and the level of ground noise. When the processing and handling were done with the utmost care, the ground noise was found to decrease continuously as the emulsion grain size decreased.

Finally, a study was made of the character of the noise from the standpoint of the relation between its r.m.s. value and its average and peak values, as well as a determination of the noise as a function of frequency.

In two earlier papers¹ on this subject, the origin of ground noise was investigated, and attempts were made to reduce it by certain types of surface treatments. The aim of the present paper is to determine the growth of the noise level during the successive stages of the processes involved from the time of manufacturing the base support until the sound is reproduced in the theater, and to study its character in terms of its r.m.s. value, its peak values, and the distribution of its energy as a function of the frequency.

In the first paper on the subject, data of a rather qualitative nature were published, showing the growth of the noise during the various manufacturing and processing stages into the finished sound and picture. It was concluded at that time that the level of what might be called the inherent ground noise in the film was of a lower order than the level of the ground noise which was encountered in practice, that is, in the theater. The origin or cause of this high noise level was assigned to various kinds of surface damages, such as scratches, dirt, dust, finger-prints, and oil spots. It was also found that the noise continued to grow in a uniform and continuous manner with the number of times that the film was run through a projector.

* Presented at the Fall, 1933, Meeting at Chicago, Ill. Communication No. 525 from the Kodak Research Laboratories.

** Eastman Kodak Co., Rochester, N. Y.

These measurements have now been made with greater care and better facilities, and the results check our earlier conclusions in that the level of the noise encountered in practice, in general, is higher than the inherent or irreducible level of film noise present upon careful processing, and that it grows very rapidly as the film is run repeatedly through a projector.

In view of these facts, it appears that the ground noise as encountered in motion picture practice can not be lowered materially by decreasing what has been referred to as the inherent film noise.

TABLE I
Growth of Ground Noise with Successive Stages of Manufacturing and Processing

Material	Treatment	Noise Level in Db. with Audibility Network	Noise Level in Db. without Audibility Network
Film Base	None	-43	-39
Film Base Gelatin-Coated	None	-40 ¹ / ₂	-37
Positive Film	Fixed, washed, and dried	-40	-36
Positive Film	Developed, fixed, washed, and dried	-37	-32
Positive Film	Run through printer once, developed, fixed, washed, and dried	-37	-32
Positive Film	Run through printer once with sound negative, developed, fixed, washed, and dried	-37	-33
Positive Film	Run through sound recorder once, developed, fixed, washed, and dried	-35	-29

However, because of the tremendously important bearing which this question has on any sound recording process, it appears worth while to inquire what determines its irreducible limit.

Accordingly, measurements were made to determine the actual noise level in the film at each successive stage of manufacture and processing. The results of these measurements are given in Table I. Columns 1 and 2 give the material and its treatment, respectively, while columns 3 and 4 show the noise level of the several materials and treatments, with and without the audibility network, respectively.

Before discussing these data it might be well to describe briefly the method of measurement and the function and characteristics of the audibility network. The measurements were made by running the film through a slightly modified sound head of a motion picture projector with a scanning beam whose dimensions were 0.0008 by 0.084 inch on the film. The modifications of the sound head were for the purpose of insuring low microphonic and system noises. Their sum, with maximum illumination on the photoelectric cell and the operating gain of the amplifier as described below, was 63 db. to 64 db. below the level of the standard frequency record used. The combined over-

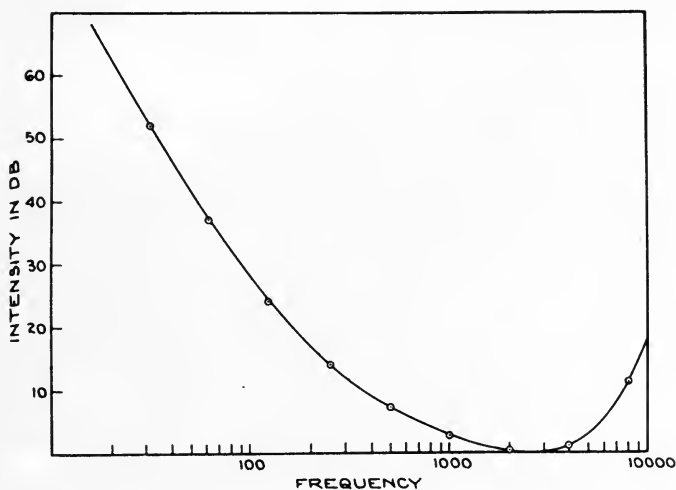

FIG. 1. Curve showing the sensitivity of the ear as a function of the frequency at a loudness level of 30 db.; also the attenuation in db. of the audibility network.

all response of the photoelectric cell, the amplifier, and the measuring device was uniform over the frequency range of 50 to 10,000 cycles per second, and measured exactly the r.m.s. values of the current. The operating gain of the amplifier in all cases was adjusted by the aid of a variable width 1000-cycle record of about 80 per cent modulation. The gain was adjusted so that the output level of this record was $+6\frac{1}{2}$ db. and all subsequent data were obtained using this as the reference level. The frequency characteristics of the system were checked frequently by the aid of a multiple frequency record set aside for that purpose.

The sensitivity of the ear is not constant over the frequency range indicated, but varies with the frequency in some particular manner, which is different for different loudness levels. Therefore, in order that the physical measurements should correspond approximately to audition tests, it is necessary to be able to change the frequency response of the measuring system to conform to that of the ear at the loudness level in question, which was chosen as 30 db. above the audibility threshold. The change in the sensitivity of the ear with frequency at that loudness level is shown in Fig. 1, where the ordinates under the curve represent the increase in intensity in db. required at different frequencies for equal sensations.

In order to change the frequency characteristic of the amplifier to conform to that of the ear, it was therefore necessary to insert a network, called an audibility network, which attenuated the current at the different frequencies by an amount equal to the ordinates under the curve in Fig. 1.

Returning now to Table I, it is found that plain film base has a noise level of -43 db. and -39 db. (below the output of the 1000-cycle standard record), with and without the audibility network, respectively. This is the lowest one in the entire series. Film base gelatin-coated is next, and although there is little choice between film base gelatin-coated motion picture positive film after the silver halide is fixed out and the remaining gelatin-coated base is washed and dried. However, when positive film was subjected to the action of *D-16* developer for 6 minutes before fixing, the noise increased materially.

In order to find the effect of printing, a sample of positive film was run through a printer once, a second sample was run through the printer once in contact with the sound negative, and a third sample was run through once in contact with the sound negative and a second time in contact with the picture negative. Each of these samples was then processed, that is, developed for 6 minutes in *D-16* and fixed, washed, and dried. None of these three samples was found to be noisier than a sample of positive film taken directly from the original wrapper and processed. It is interesting to note, however, that a sample of positive film run once through the recorder and then processed was found to be materially noisier than the sample run through the printer. This can be accounted for only by the fact that in the former case the sample was exposed to unfiltered, unconditioned air, while in the latter case the operation was carried out in a printing

room where the air was filtered and conditioned. This serves to emphasize the extreme care with which film should be handled.

The most pronounced increase in the noise during any one of the above steps occurs when the film is developed. This might be due to the development of a certain number of silver halide grains, that is, fog grains, which modulate the photoelectric cell illumination and,

TABLE II
Growth of Ground Noise with Processing Treatment of Gelatin-Coated Film Base

Material	Treatment	Noise Level in Db. with Audibility Network	Noise Level in Db. without Audibility Network
Film Base			
Gelatin-Coated	None	-41 $\frac{1}{2}$	-37
Gelatin-Coated	Washed and dried	-39 $\frac{1}{2}$	-35
Gelatin-Coated	Fixed, washed, and dried	-40	-35 $\frac{1}{2}$
Gelatin-Coated	Developed, fixed, washed, and dried	-38 $\frac{1}{2}$	-33 $\frac{1}{2}$

therefore, give rise to noise. It might also be due to suspended particles in the developer which are deposited on the surfaces and within the emulsion layer.

In an attempt to determine which of these two suppositions is the correct one, tests were made on gelatin-coated base by subjecting it to the successive stages of processing. The results of these tests

TABLE III
Growth of Ground Noise with Time of Development of Gelatin-Coated Film Base

Time of Development in Minutes in <i>D-16</i>	Noise Level in Db. with Audibility Network	Noise Level in Db. without Audibility Network
2 $\frac{1}{2}$	-40 $\frac{1}{2}$	-37
3 $\frac{1}{2}$	-40 $\frac{1}{2}$	-37
5	-40	-35
7	-39	-34
10	-39 $\frac{1}{2}$	-34

(Table II) show some difference in the noise at the successive stages, particularly when developed. It is not sufficiently great, however, to account for the increase in noise found in Table I. Further measurements were made on gelatin-coated base subjected to the action of *D-16* developer for different lengths of time, as shown in Table III. These results indicate a gradual growth in noise with de-

velopment time. However, with the audibility network particularly, this growth is not well defined; further data, which will be presented below, show that the growth is due to a change in the grain characteristic with development.

If the structure of a uniformly flashed image were optically homogeneous, as the density of the deposit increases, thereby decreasing the photo-cell illumination, the noise level should decrease correspondingly. If the latter is not the case, then the microscopic structure

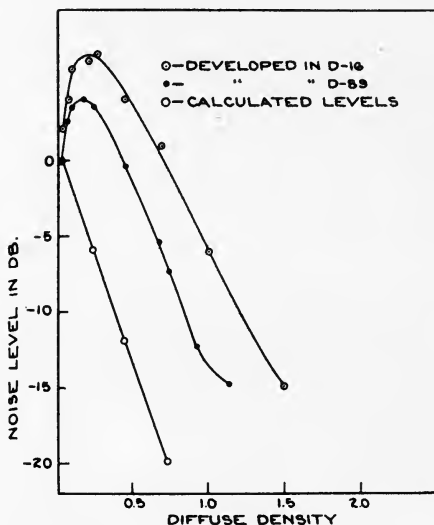

FIG. 2. The two upper curves show the relation between ground noise and density of positive film developed in *D-16* and *D-89* developers, respectively. The lowest curve shows the same relation calculated on the basis that the photographic deposit is optically homogeneous and the illumination on the film constant.

of the image, that is, the size and distribution of grains and grain aggregates, must be such as to modulate the photo-cell illumination. In order to determine whether the noise of a series of uniformly flashed and developed sound track densities decreased in the ratios of the corresponding decrease in the photo-cell illumination, samples of positive film were exposed to different amounts of light and developed for $3\frac{1}{4}$ minutes in *D-89* developer, giving a gamma of about 0.6. A similar series of samples was prepared and developed for 6

minutes in *D-16* developer, that is, to a gamma of about 2.0. These samples were measured, and the results are shown in Table IV and Fig. 2. The relation between ground noise and density is more readily seen by reference to the figure. It is seen that for both sets of samples the noise actually increased with the density up to a diffuse density of 0.17, whence it decreased as the density increased. It should also be noticed that the noise level is higher on the samples developed in *D-16* developer than it is for the corresponding densities on samples developed in *D-89*.

It is evident from these data that the structure of the silver deposit itself has a very important bearing on the question of surface noise. This raises several questions: First, do the two developers mentioned

TABLE IV
Ground Noise as a Function of Density of Positive Film Developed in D-16 and D-89 Developers; Illumination on Film Constant

Density	Noise Level in Db. with Audibility Network		Noise Level in Db. without Audibility Network	
	Developed 6 Min. in <i>D-16</i>	Developed 3 ¹ / ₄ Min. in <i>D-89</i>	Developed 6 Min. in <i>D-16</i>	Developed 3 ¹ / ₄ Min. in <i>D-89</i>
0.03	-39	-41	-33	-34
0.07	-36	-38 ¹ / ₂	-32	-34
0.10	-35	-37 ¹ / ₂	-30 ¹ / ₂	-32
0.18	-33 ¹ / ₂	-37	-29 ¹ / ₂	-31 ¹ / ₂
0.25	-33 ¹ / ₂	-37 ¹ / ₂	-29 ¹ / ₂	-32 ¹ / ₂
0.45	-37	-41 ¹ / ₂	-33	-35 ¹ / ₂
0.68	-40	-46 ¹ / ₂	-36	-39
0.92	-44	-53 ¹ / ₂	-40	-44
1.14	-49	-56	-45	-47
1.50	-55	..	-50	..

above produce images of fundamentally different microscopic structures, or does the difference lie only in the different degrees of development? Second, in the case of the variable density type of records particularly, what combination of negative and print densities and gammas gives the greatest ratio of signal to noise? Finally, would there be any advantage from the standpoint of noise in using an emulsion of materially different grain characteristics?

To investigate the relationship between the ground noise and the degree of development, a series of flashed and developed samples was prepared on positive film. The series of flashed exposures was timed so as to produce equal densities for the different lengths of time of development. The results of the measurements of these samples are

shown in Table V and Fig. 3. It is seen that the growth of noise with time of development in this case is much more pronounced than it was in the case of a similar series of tests on gelatin-coated film base developed for various lengths of time, the results of which were shown in Table III.

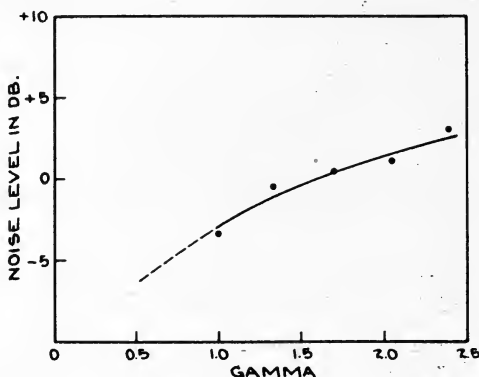

FIG. 3. Variation of ground noise with gamma of positive film developed in *D-16* developer.

This growth of the noise is due apparently to the granularity of the silver deposit. Also, the differences in the values in columns 2 and 3 or 4 and 5 in this table are evidently due primarily, if not entirely, to the difference in the degree of development. Unfortunately, no data were obtained on the noise from flashed exposures developed to equal

TABLE V

Ground Noise as a Function of Gamma of Positive Film Developed in D-16

Time of Development in <i>D-16</i> (Min.)	Gamma	Density	Noise Level in Db. with Audibility Network	Noise Level in Db. without Audibility Network
2 $\frac{1}{2}$	1.01	0.63	-43 $\frac{1}{2}$	-38 $\frac{1}{2}$
3 $\frac{1}{2}$	1.33	0.62	-40 $\frac{1}{2}$	-35
5	1.72	0.63	-39 $\frac{1}{2}$	-35
7	2.05	0.64	-41	-34
10	2.40	0.65	-37	-32

gammas in the two developers. The extrapolated curve in Fig. 2, however, should give a rough approximation of the noise at a gamma of 0.6 in *D-16*. This procedure indicates a noise level of about -7 db., as compared to the observed value of -6 $\frac{1}{2}$ db., at the same density and gamma, for the sample developed in *D-89*.

Now, the second question, namely, which combination of negative and print density and gamma results in the greatest ratio of signal to surface noise, is a question which can not be properly treated without due consideration of the percentage modulation and other factors which affect harmonic distortion. Therefore, the few measurements which have been made bearing on that phase of the problem will not be included in this paper.

The last question of the relation of the emulsion grain size and ground noise has been investigated at some length, and the results

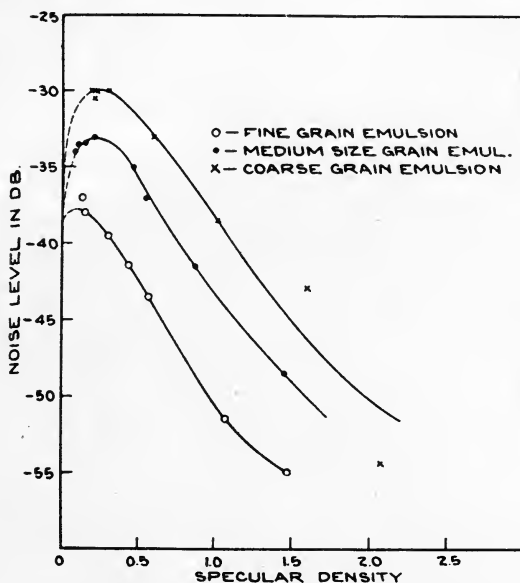

FIG. 4. Curves showing the relative noise levels of three classes of emulsions, at different densities.

which were obtained are quite encouraging. It is, of course, evident that as the discrete silver particles, which make up the developed image, are made smaller and smaller, the structure of the image should become more and more nearly optically homogeneous; until, in the limit, when the state of division is atomic, the structure would be continuous to the scanning beam. The granularity or the size of the grain aggregates in general is less in the photographic image developed from a fine-grain emulsion than it is from a coarse-grain emulsion. Therefore, if the size of the silver halide grains could be sufficiently reduced, the developed silver deposit should approach

optical homogeneity. Whether or not this atomic state of division can be attained, it lies quite beyond the realm of practicability, owing to the important consideration of emulsion sensitivity. However, in order to get some idea of the relation between noise and grain size, samples were prepared from film coated with three classes of emulsions, one with coarse grains, a second with medium sized grains,

TABLE VI
Comparison of Ground Noise as a Function of Density, of Three Classes of Emulsions; Measurements Made with Constant Illumination on Films

Emulsion	Specular Density	Gamma	Noise Level in Db. with Audibility Network	Noise Level in Db. without Audibility Network
Fine-Grain Emulsion	0.13	3.8	-37	-33
	0.15	3.8	-38	-33 ¹ / ₂
	0.30	3.8	-39 ¹ / ₂	-35
	0.44	3.8	-41 ¹ / ₂	-36
	0.57	3.8	-43 ¹ / ₂	-37
	1.07	3.8	-51 ¹ / ₂	-41
	1.47	3.8	-55	-46
Medium Size-Grain Emulsion	0.08	2.0	-34	-30 ¹ / ₂
	0.10	2.0	-33 ¹ / ₂	-30
	0.15	2.0	-33 ¹ / ₂	-29
	0.20	2.0	-33	-29 ¹ / ₂
	0.47	2.0	-35	-31
	0.55	2.0	-37	-32 ¹ / ₂
	0.88	2.0	-41 ¹ / ₂	-37
Coarse-Grain Emulsion	1.46	2.0	-48 ¹ / ₂	-43 ¹ / ₂
	0.21	1.5	-30 ¹ / ₂	-26
	0.19	1.5	-30	-26
	0.21	1.5	-30	-26
	0.30	1.5	-30	-26
	0.60	1.5	-33	-29
	1.02	1.5	-38 ¹ / ₂	-34 ¹ / ₂
1.60	1.5	-43	-47 ¹ / ₂	
2.07	1.5	-54 ¹ / ₂	-49 ¹ / ₂	

and a third with very fine grains. A series of uniformly flashed exposures was made in each class and developed in *D-16* developer to gammas of 1.5, 2.0, and 3.8, respectively. The reason for not developing all three to equal gammas was that the maximum gamma of the coarse-grain emulsion was not much above 1.5, while the time of development for a gamma of 1.5 on the fine-grain emulsions was so short that it would have been difficult to develop it uniformly.

The r.m.s. value of the total noise of these samples was determined as before, and the results are shown in Table VI and Fig. 4. The noise levels in each case are again expressed in terms of a level of $+6\frac{1}{2}$ db. for the standard 1000-cycle record. These data can be more readily compared by referring to Fig. 4, which shows the relative noise level of the three classes of emulsions for a series of specularly measured densities. The three curves are extrapolated to converge at the point represented by zero density and a level of $-38\frac{1}{2}$ db., which point represents the noise level for developed clear film. The data show that the noise level decreases very decidedly with the grain size, the difference between the levels of the coarse-grain and the fine-grain ones at a specular density of 0.6 being nearly 12 db. This is encouraging, since when and as the processing and handling conditions improve so as to warrant it, finer and finer grained sound recording emulsions can be employed. Inasmuch as a decrease in the grain size is accompanied by a corresponding sacrifice in the emulsion sensitivity, and since the adoption of sound recording emulsions with materially finer grains than the present sound recording emulsions would probably also necessitate considerable change in the processing, it is the opinion of the authors that, so far as the motion picture theater field is concerned at present, such a change is not advisable; particularly since the size of the grain, and, therefore, the granularity of the photographic image, contributes only a small fraction of the noise levels which obtain in practice.

Some additional data were obtained which deal more particularly with the character of the noise, from the standpoint of types and their origin. That part of the investigation consisted in determining the number of voltage peaks lying above successively increasing levels, and in determining the distribution of noise as a function of the frequency.

The description of the apparatus used for these analyses will be omitted, except to state that the apparatus for determining the number of peak voltages consisted of a number of recording peak reading voltmeters. The recording was accomplished by means of Central Scientific Co. impulse counters. These counters were calibrated so as to trip on voltage peaks corresponding to r.m.s. values of +24, +28, and +32 db., respectively. The peak voltmeters used were of the full-wave type and, therefore, operated the counter on voltage impulses caused by either a sudden increase or a sudden decrease in the opacity. By means of the volume indicator the gain was adjusted to

approximately equal levels for all densities. The volume indicator used reads very nearly average values.

Its readings are given in the fourth column of Table VII, while the r.m.s. values are shown in the third column, and the number of voltage peaks, corresponding to r.m.s. values of +24, +28, and +32 db., are shown in columns 5, 6, and 7, respectively. Each counter was capable of recording peaks at the rate of 450 per minute. Thus, a

TABLE VII
Distribution of Noise in Terms of Number of Peak Voltages above Given R.M.S. Levels

Sample	Specular Density	R.M.S. Values	Volume Indicator	Noise Level in Db. without Audibility Network		
				Number of Peaks per Min. above +24	above +28	above +32
Plain Film Base	..	19.6	18.0	448	150	60
Gelatin-Coated Film Base	..	20.7	18.0	450	125	40
Fine-Grain Emulsion	0.13	19.4	17.0	425	220	21
	0.30	19.8	18.0	420	128	12
	0.44	18.6	17.5	290	65	7
	0.57	17.8	16.0	226	80	7
	1.07	15.5	13.0
Medium Size-Grain Emulsion	0.08	18.7	18.0	420	210	14
	0.10	20.2	18.0	450	215	21
	0.15	19.3	18.0	375	120	12
	0.20	19.8	18.5	380	250	14
	0.47	20.4	19.0	420	100	8
	0.55	18.6	17.5	145	25	5
	0.88	18.6	18.0	166	17	1
	1.46	15.8	14.0	7	15	1
Coarse-Grain Emulsion	0.19	21.0	19.5	460	58	0
	0.21	19.4	18.5	188	27	0
	0.30	21.0	20.0	465	24	0
	0.60	18.3	17.5	8	4	0
	1.02	18.4	18.0	47	0	0
	1.60	15.4	14.5	1	1	1

value in excess of 440 indicates at least one voltage pulse of the indicated height every $\frac{1}{8}$ second.

It should be remembered that in this case the gain of the amplifier was not adjusted by means of the standard record; that is, the levels in Table VII have no particular relation to the level of $+6\frac{1}{2}$ db. for the standard record, although the relation could, of course, be obtained from the record kept of the gains which were used. The pur-

pose was to get some idea of the distribution of the voltage peaks with respect to some average value which was chosen arbitrarily to read at approximately +18 db.

Two facts are readily observed from this table. First, the number of peaks above a given value fall off as the density increases. Second, the number of peaks at the highest level, particularly, are relatively fewer in number as the average value or the r.m.s. value of the so-called inherent noise increases. These facts, although not conclusive, indicate rather definitely that the noise which contributes the bulk of the energy, that is, determines the r.m.s. value, has a different

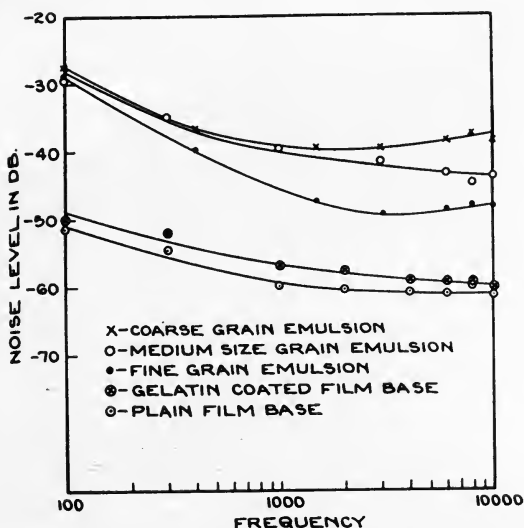

FIG. 5. Ground noise as a function of frequency, for different samples of film.

origin from that which gives rise to large peaks indicated by loud bangs and crackles in the loud speaker. These latter are very probably due to the surface conditions, that is, to dirt, dust, scratches, *etc.* It should, of course, be borne in mind that the amplifier gain for a level of +18 db. on the fine-grain emulsion is much greater than the gain for the same level at the same density on the coarse-grain emulsion.

Fig. 5 shows the distribution of the noise as a function of the frequency from 100 to 10,000 cycles per second, for the three classes of emulsions at a specular density of 0.6 and gammas the same as shown

in Table VI, and also for plain film base and gelatin-coated film base. The relative levels of the last two samples have been adjusted to equal illumination on the photo-cell with respect to the others. The relative levels among samples are, however, not particularly reliable nor of any particular importance. The distribution of noise in any one sample shows no striking departure from the distribution of any other sample. The most marked difference perhaps is the gradual divergence of the curves for the three emulsions with frequency. One interpretation of this, which may or may not be correct, is that the high-frequency noise, in excess of that due to the film base, in general, is due to the grain structure, that is, the granularity of the photographic image.

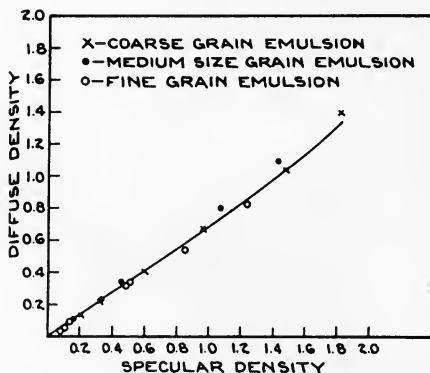

FIG. 6. Relation between specular (photoelectric cell) density and diffuse density for the three classes of emulsions.

Fig. 6 is included to give the relation of diffuse to specular densities as used in this paper. The term "specular density" has been used for convenience—it is actually photoelectric cell density as determined in the sound head.

REFERENCES

¹ CRABTREE, J. I., SANDVIK, O., AND IVES, C. E.: "The Surface Treatment of Sound Film," *J. Soc. Mot. Pict. Eng.*, XIV (March, 1930), No. 3, p. 275; *Kino-technik* XII (1930), p. 390, 420.

² SANDVIK, O.: "A Study of Ground Noise in the Reproduction of Sound by Photographic Methods," *Trans. Soc. Mot. Pict. Eng.*, XII (1928), No. 35, p. 790.

DISCUSSION

MR. CRABTREE: It is interesting that the noise level-gamma curve at a constant density corresponds very closely to the graininess gamma curve at a constant density.

In connection with the relatively large increase of the noise level as development progresses in certain developers, especially those containing a high concentration of sulfite, the sulfite dissolves some of the emulsion which, in turn, is reduced to silver which tends to deposit on the film surface. If film that has been developed in such a solution is wiped with cotton, the cotton will remove a certain amount of this colloidal silver and rapidly become dirty. Also, developers of this type deposit a sludge of silver in the bottom of the tank and, if the developer is agitated, the sludge becomes suspended again and tends to deposit on the film. The matter of developer filtration is, therefore, of some importance in this connection.

Have measurements been made on the effect of pure oil on the film? Some films are badly spattered with oil, and I should like to know whether that oil has any effect on the ground noise. I don't mean oil mixed with dirt; I mean pure clean oil on the film.

MR. SANDVIK: If the oil is uniformly distributed over the surface of the film, it usually decreases the ground noise, particularly after the film has been run through the projector a number of times. If it is patchy, then it causes a certain amount of low-frequency noise, due to the large patches, but not very much. It amounts to only about 2 db.

MR. CARVER: Has the noise that is measured any relation at all to the noise we actually hear? What I hear in a film is a scratching that can't possibly have anything to do with a very fine deposit of colloidal silver. Occasionally there will be a little clicking noise. This is what I believe every one hears when ordinary film is projected too loud. It seems to me that the colloidal silver would produce a uniform hissing noise which I probably couldn't hear at all. Is that possible?

MR. SANDVIK: If you listen to a film with a uniform density, which has been processed and handled very carefully so as to have no large scratches or large dust particles on it, I think that you will find that the noise is more a hissing noise than anything else. But, of course, after the film has been run through the projector once or a dozen times, it suffers considerable surface damage, which causes what you probably describe as scratches or bangs and booms. Those constitute an annoyance factor to the ear which can not be evaluated by physical measurements alone.

MR. CARVER: Those are really the noises that matter, aren't they?

MR. SANDVIK: The other, that is, the continuous hiss, is important too; although at the present time it is probably not of great importance from the standpoint of the theater because the surface damage raises the noise level to an extent such that what I call the inherent ground noise in a film is inherently small.

There is another thing that has to be taken into account, and that is that even though the distribution of the noise is fairly uniform and slopes up somewhat at the low frequencies, the sensitivity of the ear decreases so tremendously at the lower end that you aren't conscious of as great a disturbance at those frequencies.

MR. CRABTREE: What is the magnitude of the ground noise of cellulose acetate records as compared with that of good film records?

MR. WILLIS: Possibly 10 db. lower in the best cases.

SOUND FILM PRINTING—II*

J. CRABTREE**

Summary.—The production of sound-film prints from variable density negatives by the Model D Bell & Howell printer has been studied from the point of view of high-frequency response and uniformity of product. The account of this study, begun in Part I¹, is continued here, with particular reference to the degree of influence of slippage on the high-frequency response, occasioned particularly by non-conformity of the perforation pitch of the negative and positive films. It is found that to improve printing conditions in practice, it is first necessary to achieve consistency in the pitch of the processed negative and positive materials and to make the pitch of the processed negative 0.0004 inch less than that of the positive raw stock.

In an earlier paper¹ the author referred to the small values of shrinkage that result from processing present-day motion picture film. In the sound picture laboratory of the Bell Telephone Laboratories, where processing machines representative of those used in commercial laboratories are employed, the average value of shrinkage resulting from processing is about 0.025 per cent.

The Bell & Howell Model D continuous printer is widely used in sound film printing. Printing is effected in this device at the periphery of a sprocket of such curvature as to accommodate, without slippage, a negative that is 0.368 per cent below standard pitch and positive raw stock that is 0.079 per cent below the standard pitch of 0.187 inch. The following discussion is based upon studies made with that printer.

Assuming that the negative and positive raw stocks are full pitch, the negative, if printed soon after processing, will be approximately 0.3 per cent oversize for the sprocket, and slippage of that amount between negative and positive will occur at the printing aperture. If the pitch of the negative raw stock is above standard, as occasionally occurs, or, if the positive raw stock is undersize, which we have found to be usually the case, the amount of slippage is increased by the extent of oversize or undersize, as the case may be. The effect of slippage between negative and positive during the printed exposure is

* Presented at the Fall, 1933, Meeting at Chicago, Ill.

** Bell Telephone Laboratories, New York, N. Y.

to cause a blurring of the printing image, which results in a reduction of amplitude of the recorded signal to an extent depending upon the recorded frequency, being negligible at low frequencies but very appreciable at high frequencies.

The manner and degree of this degradation of print definition depends upon the height of the printing aperture and to some extent on the sprocket tooth contour.

Some idea of the degree of the influence of slippage on high-frequency response can be obtained theoretically by calculation if certain assumptions are made. Such a calculation has been made on the

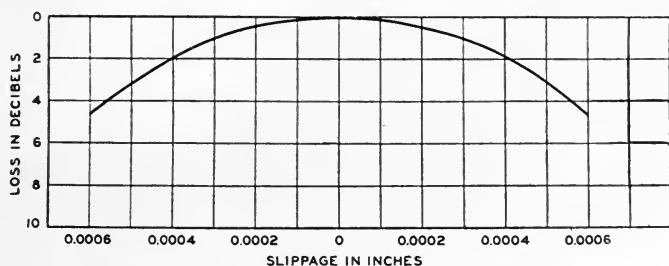

FIG. 1. Calculated printing loss at 9000 cycles due to slippage between negative and positive.

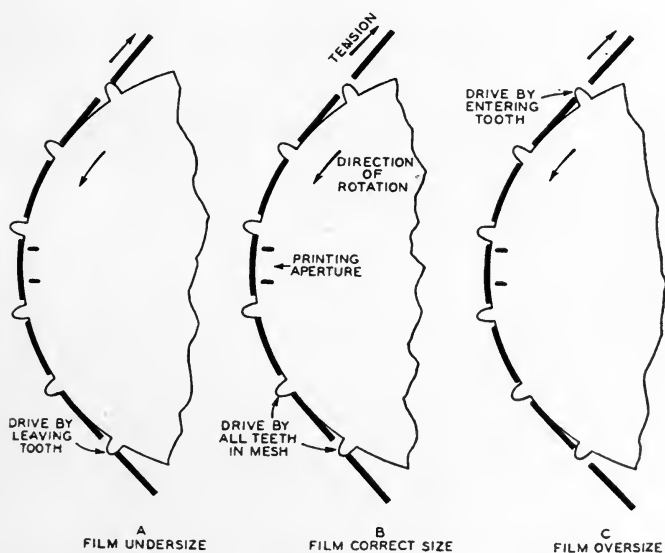

FIG. 2. Influence of film pitch dimensions on manner of propulsion by sprocket.

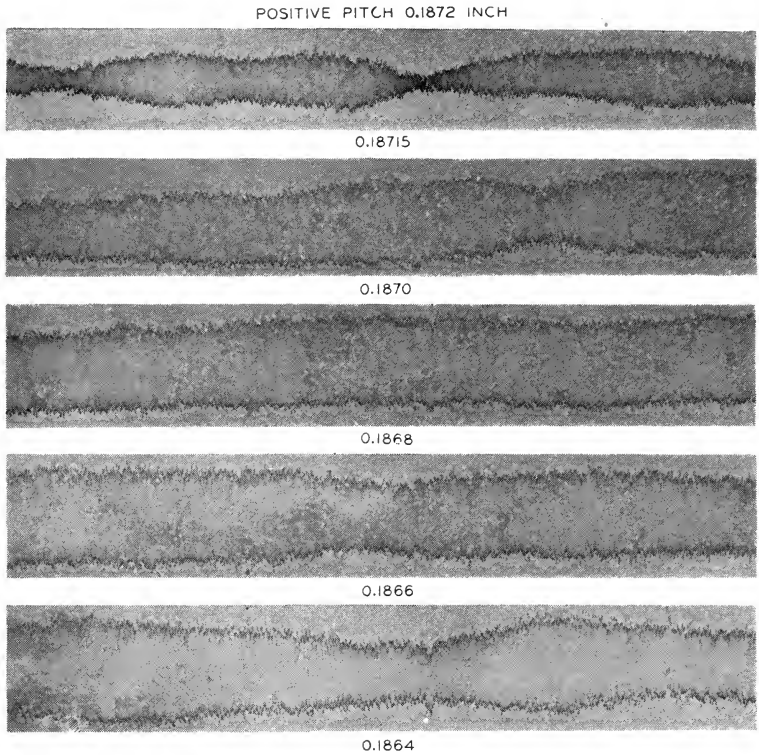

FIG. 3(A). Effect of pitch measurement of negative on print uniformity; 9000 cycles: printed on positive stock of pitch 0.1872 in.

basis of two such assumptions: first, the use of an aperture height equal to twice the perforation pitch ($\frac{3}{8}$ inch) and, second, that slippage, when it occurs, is practically instantaneous. Under such conditions the resulting print may be regarded as approximately equal to that of two sine waves of transmission which are out of phase by an amount equal to the degree of slippage as the load is transferred from tooth to tooth. Computation of the amplitude loss at a frequency of 9000 cycles resulting from different values of slippage produces the curve shown in Fig. 1. On the left-hand side of the peak, the negative is oversized; on the right-hand side, undersized. Conditions have been encountered in normal printing practice where slippage of 0.0006 inch or more has occurred. The computed loss from such a condition is shown to be nearly 5 db. at 9000 cycles. It was thought

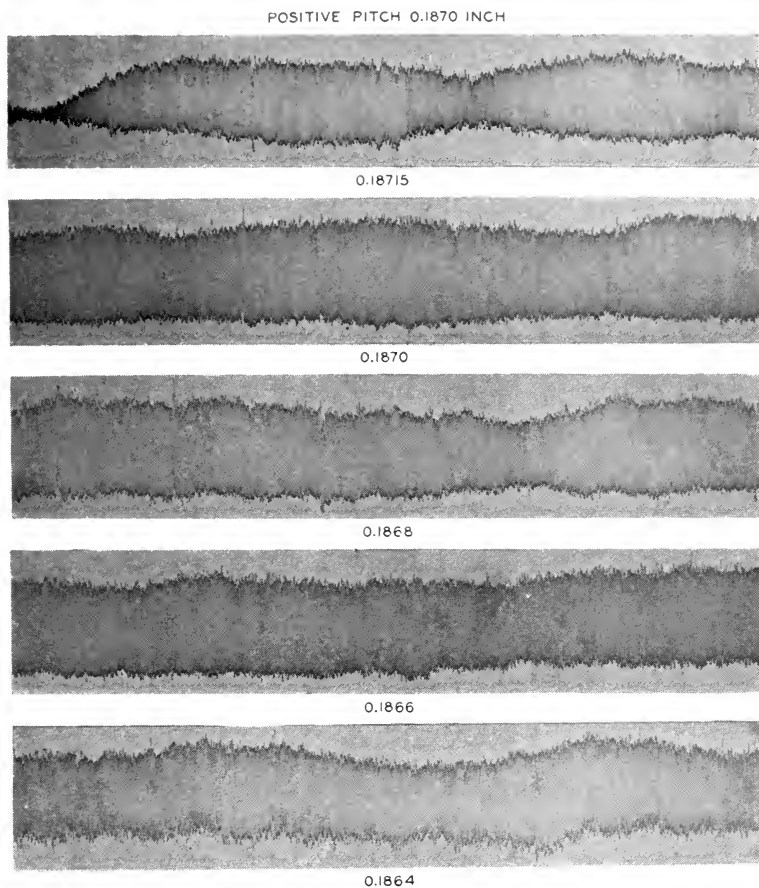

FIG. 3(B). Same as Fig. 3(A): pitch of positive stock 0.1870 in.

important to determine experimentally the magnitude of the losses resulting from mismatching the films and sprocket since, it should be noted, slippage is not the only undesirable factor resulting from pitch errors.

It is well known that when a film is oversize for the sprocket, it is driven by the pair of entering teeth, as shown in Fig. 2(C). In the case of the printer under discussion, the entering teeth precede the printing aperture, so that the film is no longer under tension at the printer gate but is being pushed downward between the aperture plate and the shoe. The tendency of a film driven by the entering teeth

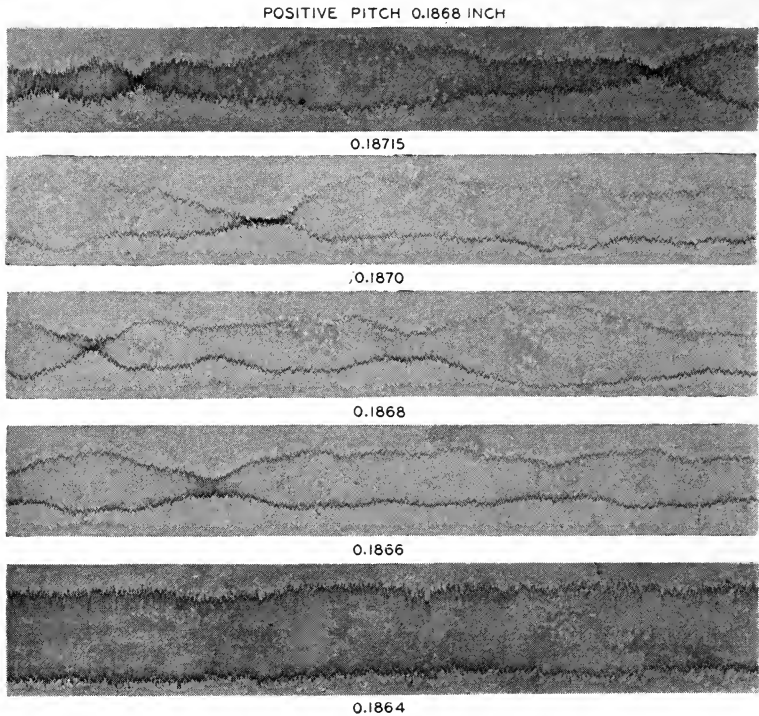

FIG. 3(C).

FIG. 3(C). Same as Fig. 3(A): pitch of positive stock 0.1868 in.

is to ride up on the face of the tooth away from the shoulder of the sprocket. This tendency will probably be increased by friction in the gate, and opportunity for a loss of contact between the negative and the positive results. Examination of microdensitometric traces of high-frequency envelopes printed in this manner indicates that such conditions occur.

In Figs. 3(A), 3(B), 3(C), and 3(D) are shown traces of sections, three frames in length, of 9000-cycle records printed from negatives having different pitches on positive raw stocks of different pitches. Constrictions in the wave envelopes indicate losses of modulation due to the loss of contact between the negative and the positive during printing. It will be seen that such losses are greatest when the negative approximates full pitch, but that the losses decrease and finally disappear as the negative shrinkage attains a certain value. It should also be

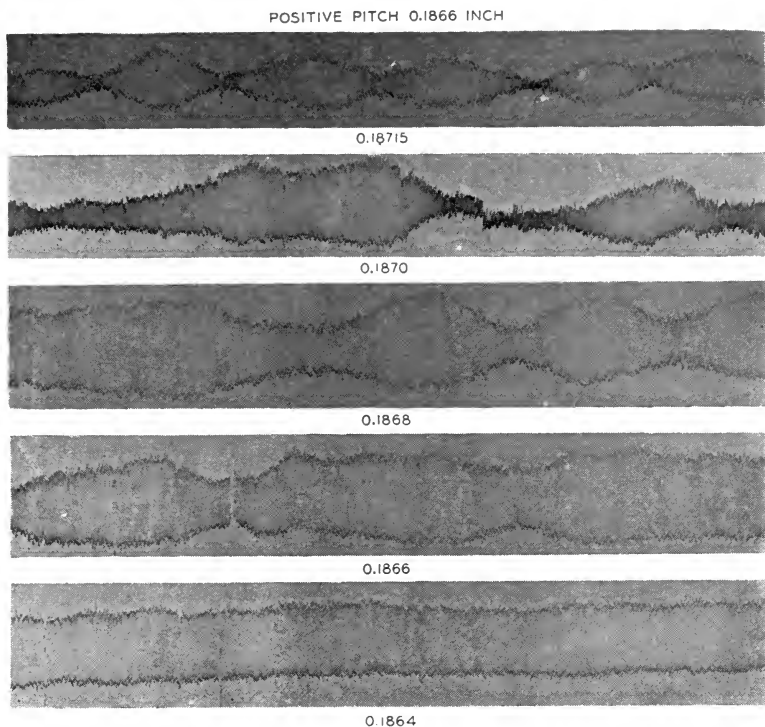

FIG. 3(D). Same as Fig. 3(A): pitch of positive stock 0.1866 in.

noted where the negative is oversize, that the unevenness of the envelope is less when printed on full-pitch or oversize positive than when the print is made on undersize positive. That is, the worst condition for contact losses occurs when the negative is oversize and the positive undersize, a condition common in practice.

When both the negative and the positive are oversize, and, therefore, not under tension at the aperture, they ride in and out on the teeth more or less in contact; whereas, if the positive is shorter, or undersize, and, therefore, under tension, the underlying oversize negative can not ride out on the teeth: it therefore buckles, causing a loss of contact and the consequent loss of amplitude, as shown.

The study of a large number of microdensitometric traces of prints made under different conditions suggested that in the case of printing with oversize raw stock the irregularities tend to be less when the perforations are similar in both the negative and the positive than

NEGATIVE ON POSITIVE

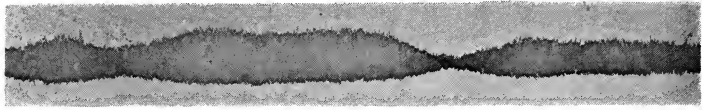

0.1870

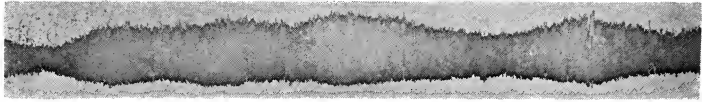

0.1868

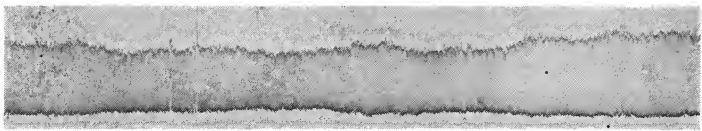

0.1866

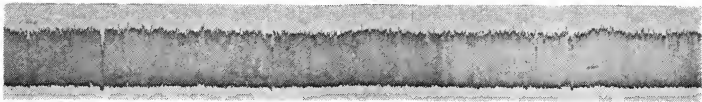

0.1865

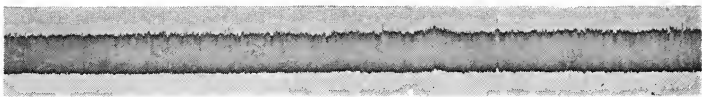

0.1864

FIG. 4. Effect of perforation shape on print uniformity; 9000 cycles.

when they are dissimilar, as is the case in commercial practice (Fig. 4). This appears to be reasonable, since the dimensions of the perforation probably determine the behavior of the oversize film in relation to the sprocket teeth. The difference in size and shape of the two types of perforations now in use (Fig. 5) is apparently sufficient to cause a difference in the behavior of the films as they pass through the printer.

It was further observed, on comparing the prints made by a printer using the original printing sprocket with those made by a printer using the more recent sprocket which is made to closer manufacturing tolerances, that the matching of the pitch of the negative to that of the sprocket is of greater importance than is the presence of slight errors in the sprocket (Fig. 6), while still recognizing the fact that

POSITIVE ON POSITIVE

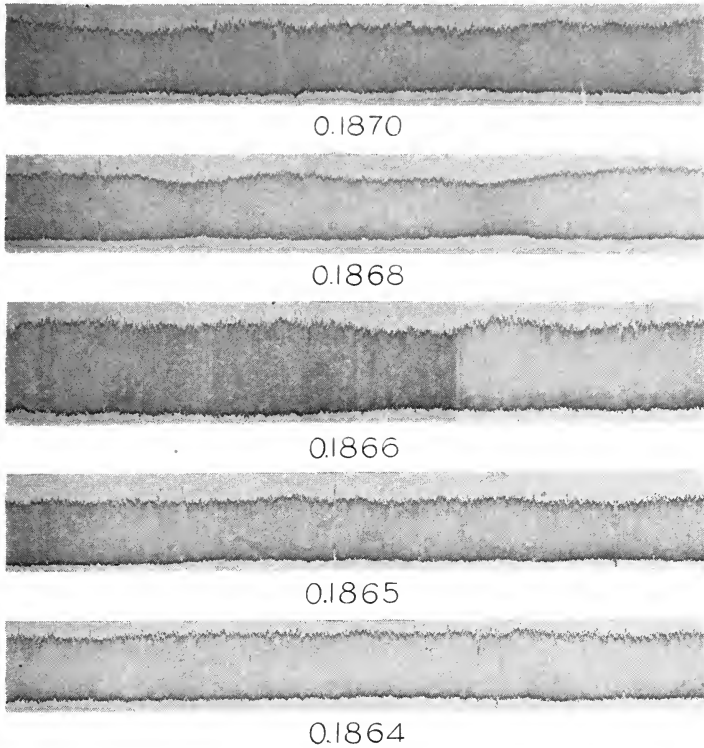

FIG. 4. (Cont.)

sprocket errors are probably the cause of the irregular separation of the films. This latter fact is evident from Fig. 7, which shows the traces of a 9000-cycle print representing the same twenty teeth of a sprocket for three successive revolutions. The periodicity of the constrictions of the envelope with rotation of the sprocket shows that the print defects result from sprocket error.

We have, then, the following conditions affecting printing loss and uniformity:

(1) Slippage between films, resulting from mismatching of negative and positive pitches, and causing loss of modulation by phase displacement of the overlapping printed images.

(2) Loss of contact between films due to buckling consequent on mismatching of negative or positive, or both, with the printing sprocket. This causes a loss of definition of the printed images at the points of buckle, resulting, in the print, in an irregular amplitude loss and non-uniformity of wave envelope.

To obtain a measure of the sum of these losses, negatives were recorded on films covering a relatively wide range of pitch dimensions and having both types of perforation, and were printed on positive film, also covering a relatively wide range of pitch dimensions and of both types of perforation. The reason for examining the various combinations of the two types of perforation was, of course, to establish a preference for a given combination if a physical basis for such preference should be found to exist.

The negatives used were made in two ways:

(1) Constant frequency records were made on a sufficient length of full-pitch material. After processing, a section of the negative was removed and

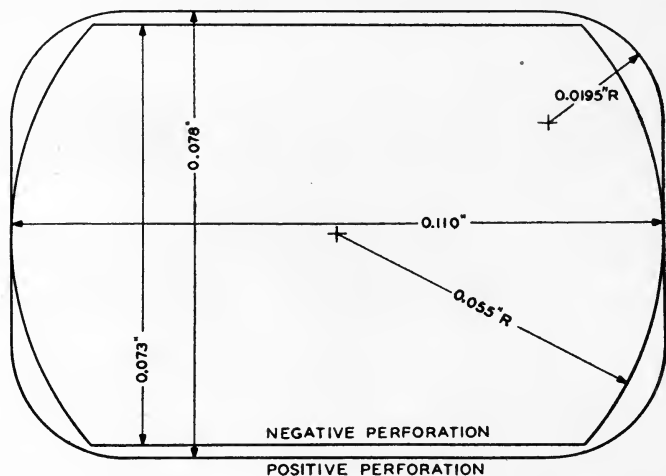

FIG. 5. Showing differences in dimensions of negative and positive perforations.

kept in a small sealed container while the remainder was left in the drying cabinets of the processing machines, where it was subjected to a current of air at a temperature of about 100°F . Pitch measurements were made each day, and as the desired degrees of shrinkage were attained, sections were removed and stored. When the extreme degree of shrinkage desired had been attained, the various sections were assembled, and after storing the assembly for a few days to permit the whole to assume a uniform moisture content, the assembled negative was used for printing.

(2) From a series of emulsions of raw film stock purchased over a period of two years it was possible to obtain a range of pitch values from 0.18715 to 0.1862

inch in the same type of perforation. Sections of the various stocks were spliced together, and 9000 cycles recorded and the film processed as one unit. The frequency response of the various sections of the negative was measured to insure that no differences in recorded amplitude existed; any sections showing such differences were excluded from the experiment.

Of the stocks used for making the prints, some were selected from new consignments of film as received, six items were specially ordered for specific values of pitch, and the lowest pitch values were obtained from our older emulsions referred to above. Measurements of resolving power of each emulsion were made—by static printing in a printing frame from a closely spaced line grating test object and measuring the amplitude of the resulting wave envelope—to insure uniformity in this respect.

The assembled negatives were then printed in the usual manner in the printer on each raw stock in turn. The pitch of each section of negative was measured before and after each printing, while the raw stock on which the print was made was measured at the beginning and end of the print. A length of about one hundred feet was discarded from the outside of each roll to avoid any possible error from drying out of the outer turns.

Pitch measurements were made by laying the film on a flat surface and measuring the length of one hundred perforations with a high-quality steel rule graduated in hundredths of an inch.

The prints were processed in a continuous machine to an over-all sensitometric gamma of 1.0. The response of the prints was measured on a Western Electric re-recording machine, using equalization. The frequencies were 9000 cycles and 2000 cycles, recorded on opposite sides of the negative. The loss of 2000-cycle output due to slippage was assumed to be negligible, the difference between the 9000-cycle and 2000-cycle levels being taken as the 9000-cycle loss. The volume indicator was a vacuum tube voltmeter with a damped meter circuit measuring the r. m. s. output. Its readings checked those made with a thermocouple.

The 9000-cycle loss was plotted against the pitch of the negative for each positive that was printed. The curve so obtained gave the 9000-cycle loss as a function of the negative pitch for a particular positive pitch and type of perforation. Several prints were made on different occasions and the results averaged, so that each curve is derived from a considerable number of measurements. All curves in a given combination of perforation types are assembled on one

OLD SPROCKET

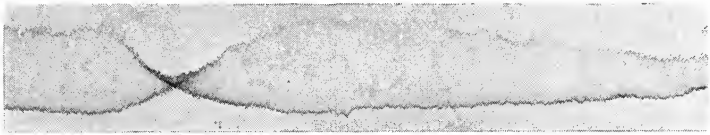

0.1870

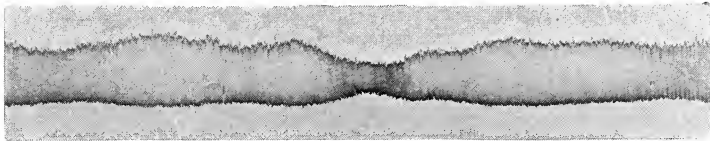

0.1869

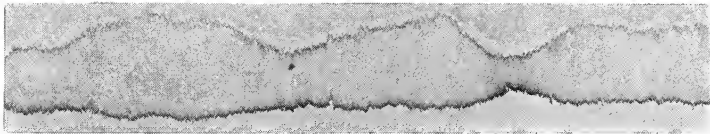

0.1868

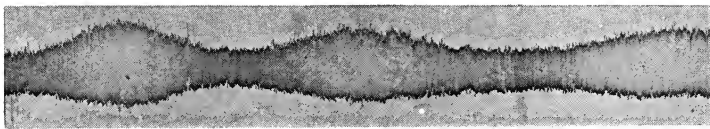

0.1866

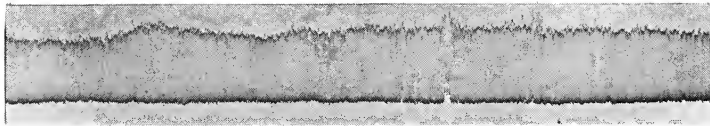

0.1865

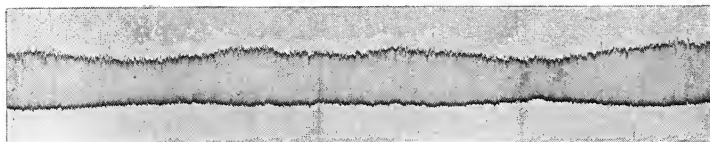

0.1864

FIG. 6. Effect of film pitch dimensions and sprocket accuracy on print uniformity; 9000 cycles.

NEW SPROCKET

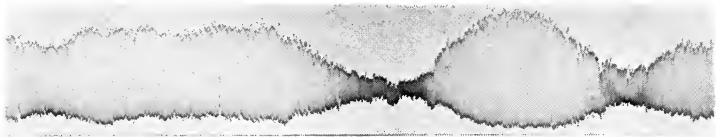

0.1870

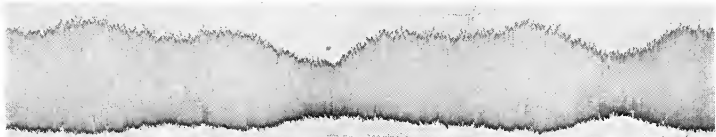

0.1869

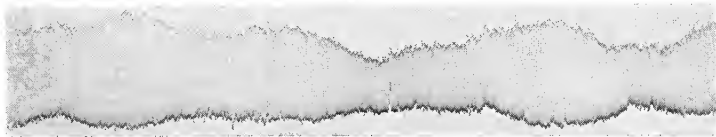

0.1868

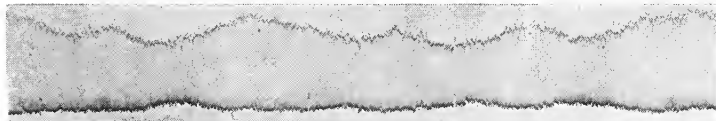

0.1866

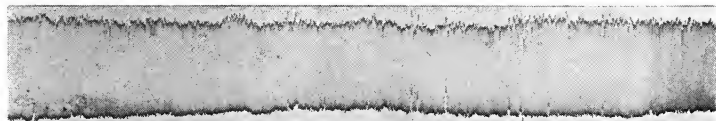

0.1865

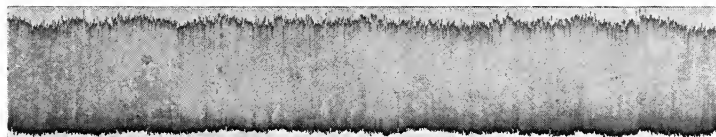

0.1864

FIG. 6. (Cont.)

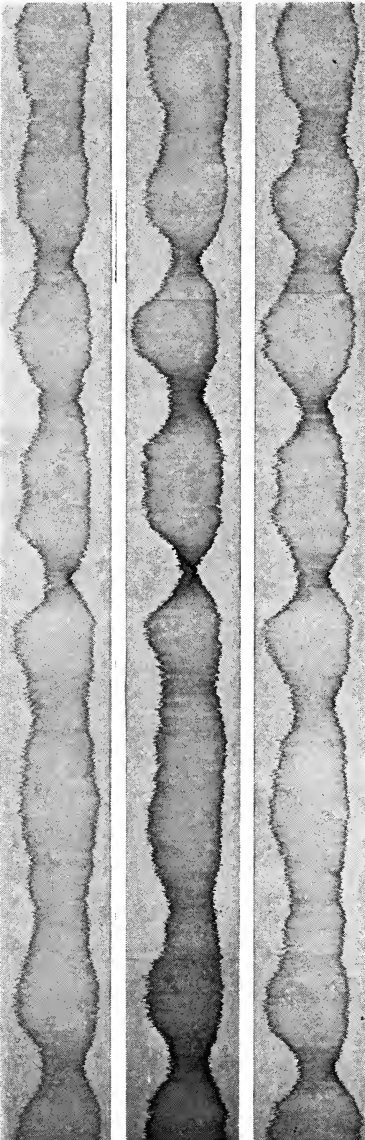

FIG. 7. Envelope of 9000-cycle print, showing periodicity of variations with sprocket rotation.

diagram in order to show the effect of the positive pitch as well as the negative for that combination. The combinations are:

Fig. 8: negative perforations printed on negative perforations.

Fig. 9: negative perforations printed on positive perforations.

Fig. 10: positive perforations printed on negative perforations.

Fig. 11: positive perforations printed on positive perforations.

It is obvious from the figures that for any positive material there is an optimal value of pitch for the negative for which the 9000-cycle loss is least, and that it is less than that of the positive by an amount that is fairly constant. In Figs. 12 to 15 the curves are replotted, showing the 9000-cycle loss as a function of the difference between the negative and the positive pitch. These curves show that within the error of experiment the optimal difference between the negative and the positive is the same, at least from the range of positive pitch likely to be encountered in practice.

In Fig. 16, each group is merged into one curve, enabling a comparison of the four group averages to be made. These, in turn, are reduced to an average curve in Fig. 17. The latter curve shows that the averaged optimal difference of pitch between the negative and the positive as determined from these experiments is 0.000425, or 0.23 per cent of the standard pitch value. The theoretical value derived from the

determined from these experiments is 0.000425, or 0.23 per cent of the standard pitch value. The theoretical value derived from the

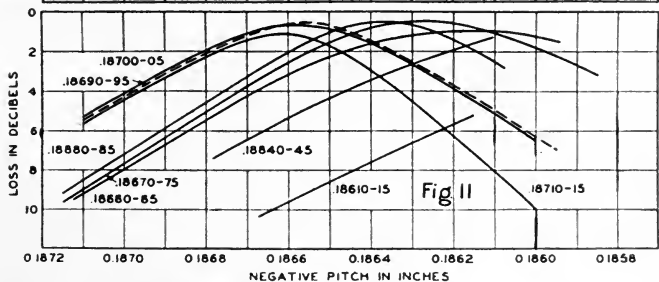
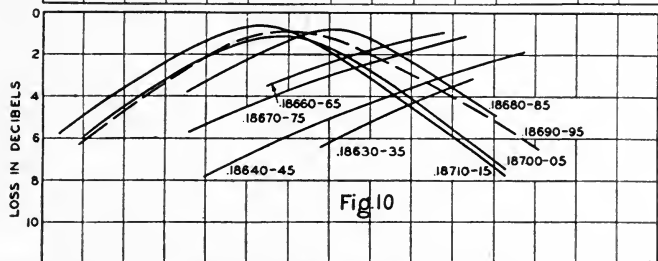
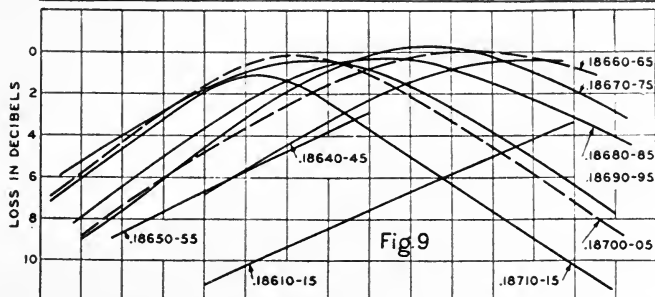
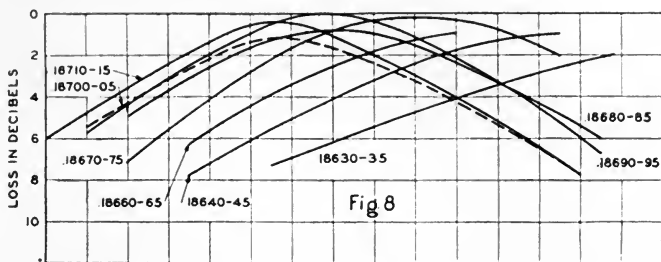

FIG. 8. Printing loss (at 9000 cycles) as a function of negative pitch, for positives of pitch dimensions as shown: negative with negative perforations; positive with negative perforations.

FIG. 9. Same as Fig. 8: negative with negative perforations; positive with positive perforations.

FIG. 10. Same as Fig. 8: negative with positive perforations; positive with negative perforations.

FIG. 11. Same as Fig. 8: negative with positive perforations; positive with positive perforations.

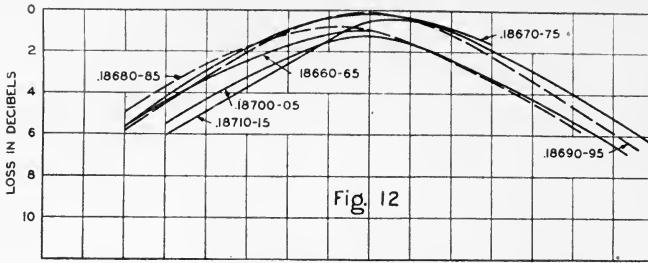

Fig. 12

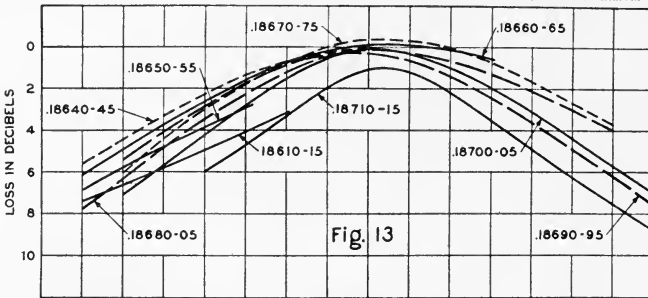

Fig. 13

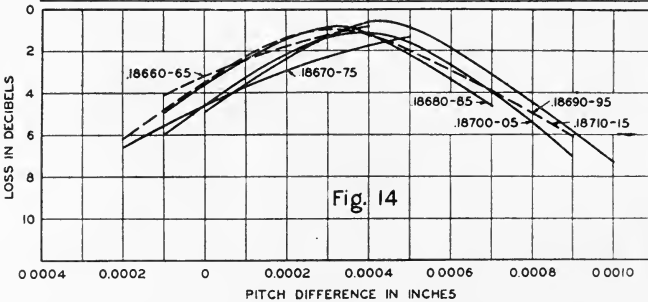

Fig. 14

FIG. 12. Printing loss (at 9000 cycles) as a function of difference in pitch between negative and positive, for positives of pitch dimensions as shown: negative with negative perforations; positive with negative perforations.

FIG. 13. Same as Fig. 12: negative with negative perforations; positive with positive perforations.

FIG. 14. Same as Fig. 12: negative with positive perforations; positive with negative perforations.

measurement of sprocket diameter and the film thickness is 0.00054 or 0.29 per cent of the standard pitch value. No explanation is advanced at this time for the discrepancy, which is small compared with the pitch variations occurring in film.

It will be seen from the final average curve that the slopes on either side of the peak are approximately the same; that is, the loss for a

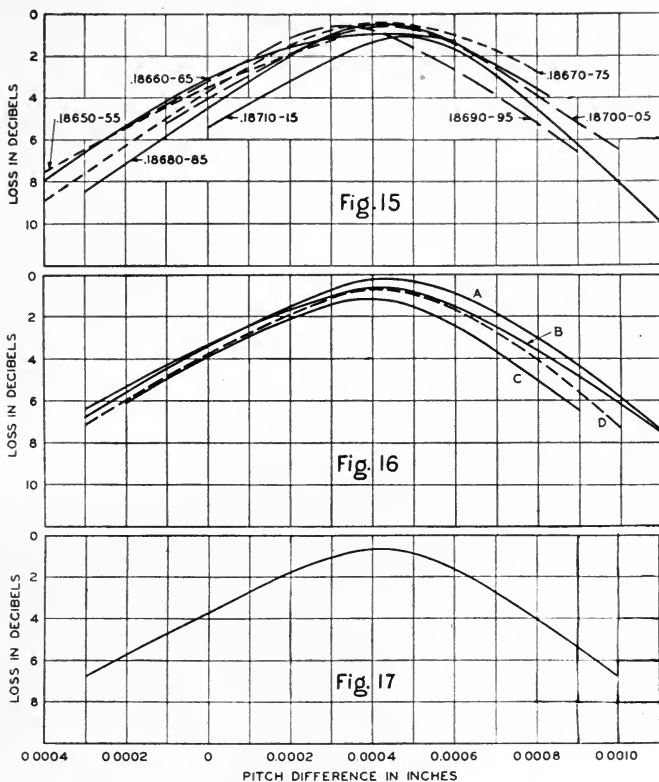

FIG. 15. Same as Fig. 12: negative with positive perforations; positive with positive perforations.

FIG. 16. Printing loss (at 9000 cycles) as a function of difference in pitch between negative and positive; averages from Figs. 12 to 15, inclusive.

	Negative	Positive
(A)	neg.	neg.
(B)	neg.	pos.
(C)	pos.	neg.
(D)	pos.	pos.

FIG. 17. Printing loss (at 9000 cycles) as a function of difference in pitch between negative and positive; average over-all curve.

given slippage between the negative and the positive is the same whether the slippage is plus or minus, although microdensitometric records show that on the oversize side of the optimum, the print envelopes are not uniform, whereas on the undersize side, the envelopes are smooth.

The group averages as in Fig. 16 show an apparent but slight preference for negatives with Bell & Howell perforations. That is, however, not entirely in accord with the observations on envelope uniformity on page 103.

The connection between these results and commercial practice is of considerable significance. The results show that under the conditions of processing employed in this laboratory, which are regarded as representative of commercial practice, the use of negative and positive raw stocks of standard pitch will result in a printing loss of at least 3 db. at 9000 cycles when printing is performed soon after the negative is developed. With positive stocks below the standard pitch, the loss mentioned above is increased by amounts that can be deduced from the curve in Fig. 16, and the non-uniformity of the wave envelope is aggravated.

To improve printing conditions in practice, it is first necessary to achieve consistency in the pitch of the positive and negative materials. Next, the pitch of the processed negative should be approximately 0.0004 inch less than that of the positive raw stock. If a survey of commercial processing conditions shows that the average negative development does not reduce the negative pitch to that value, sub-standard perforation of the negative raw stock should be resorted to. Similarity in the types of perforation of the negative and the positive may insure some improvement in print uniformity where oversized film is printed, and the pitch values of the negative and positive must match that of the sprocket.

REFERENCE

¹ CRABTREE, J.: "Sound Film Printing—I" *J. Soc. Mot. Pict. Eng.*, **XXI** (Oct., 1933), No. 4, p. 294.

RECENT IMPROVEMENTS IN THE BELL & HOWELL FULLY AUTOMATIC PRINTER*

A. S. HOWELL AND R. F. MITCHELL**

Summary.—The results of a year of experience with the engineering model of this printer in actual production printing are outlined. The actual constructional changes that have been made in the printer are described and illustrated, and new developments that enable prompt and accurate sensitometric control to be maintained under production conditions are outlined briefly.

The engineering model of the fully automatic sound and picture printer described previously¹ has been in continuous use at the M-G-M laboratory at Culver City, Calif., for more than a year. During that time complete and exhaustive tests were made that amply demonstrated the success of the design. It was operated on an average of twenty or more hours a day so successfully that a battery of printers was ordered. This battery, just completed, is shown in Fig. 1. Furthermore, experience with the new printer has enabled the M-G-M laboratory to utilize many refinements of sensitometric control of processing developed by the Bell & Howell Co.

PERFORMANCE

Some idea of the performance of the printer may be gathered from the experience of the M-G-M laboratory. One of the early tests involved printing a six- or seven-reel picture. One reel was printed on the new printer while the remaining reels were printed in the usual way. After quite a few prints had been made it was found that the new printer afforded such superior "snap" to the picture and quality to the sound that the one reel contrasted boldly in comparison with the rest. As a result, the remainder of the picture was printed on the new printer. The rush of work that followed showed what the machine could do in an emergency.

Recently, an *NRA* subject had to be printed in a hurry. One thousand prints were made without removing the negative for cleaning; at the end of the run the negative and matte films were in

* Presented at the Fall, 1933, Meeting at Chicago, Ill.

** Bell & Howell Co., Chicago, Ill.

perfect condition and fit to make another run. The outstanding nature of this performance is obvious when it is realized that in ordinary practice the negatives must be removed after every few prints in order to be cleaned. Not only did the machine avoid the delays of cleaning, but the resultant wear and tear on the negative, as well. Furthermore, there was no waste due to breakage, mislights, asynchronism, *etc.* The machine was operated 24 hours a day until the complete release was finished. All the operator had to do was to feed positive stock into it.

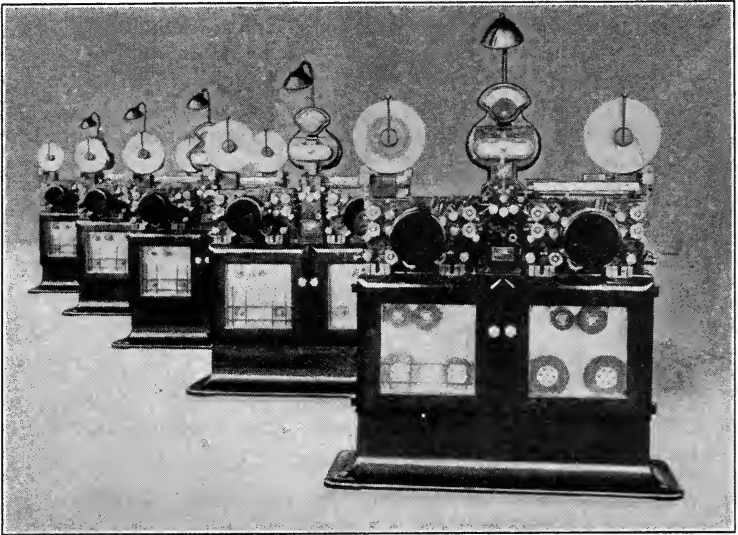

FIG. 1. Battery of new fully automatic printers ready for operation.
(Note rheostat unit just below voltmeter.)

Such examples are typical, and indicate the accomplishments possible with the new instrument. It is obvious that a year's test, involving every contingency and difficulty that could be imagined, has indicated a number of valuable refinements in the original design. Following is a brief outline of the various changes effected in the final model.

REFINEMENTS IN DESIGN

The new machine is noticeably thinner and appears more compact because of its smoother outline. Refinements in gear cutting have made its operation even quieter than before.

Main Sprocket.—A change of major importance involves the shape of the sprocket teeth and the angle of the arc of contact of the films at the aperture. The shape of the tooth departs slightly more than that of the model *D* tooth from the true involute curve, and is designed to provide a straight-line wedge action so that the film, within the range of shrinkages now encountered, is transferred smoothly from one tooth to the next without jerking.

It was found necessary to go to extremes in making the main printing sprockets of the required accuracy. A special hobbing machine, fitted with specially made hobs, is used exclusively for generating the main printing control sprockets. Each tooth is individually finished, and then the tooth contour is checked in a contour projector and the pitch is checked on an optical dividing head. The sprockets are now made from stainless steel, thus assuring a permanently clean, smooth tooth surface. As a result, the controlling dimensions of tooth radius, pitch, and other critical factors are held to a tolerance of ± 0.0002 inch.

Because of the smoother operation of the machine and of using a printing aperture considerably smaller than that of the model *D* printer, the angle of contact of the films at the aperture has been reduced from approximately 41 to 24 degrees for the negative, and from approximately 32 to 19 degrees for the positive. This still brings the positive and negative films to perfect coincidence just before they reach the aperture, and allows the films to be stripped off the sprocket immediately after the films pass the aperture. This, in conjunction with the air pressure on both sides of the film at the aperture, reduces wear and abrasion of the films, an important factor in achieving a long life of the negative.

All the factors which were investigated in this connection will not be discussed; suffice it to say that the combination of the new tooth shape, precision of construction, and the change of the arc of contact of the films at the aperture combine to produce the kind of work mentioned above. Incidentally, due to the ability of the machine to operate in both directions, the wearing of the sprocket teeth is equalized, and twice the ordinary effective life is attained as compared with the usual case where the machines operate only in one direction.

Changing Parts.—Another important improvement is the arrangement that allows important parts to be changed quickly.

(a) The aperture plate. This can be removed in a few seconds

for cleaning, polishing, or replacement by another type (for example, for $17\frac{1}{2}$ -mm. sound negative). It is necessary only to loosen one locking screw.

(b) The main sprocket. The complete flywheel unit is removable by unscrewing the six bolts that hold it to the main frame. This exposes the outer side of the sprocket, as in Fig. 2. The aperture plate

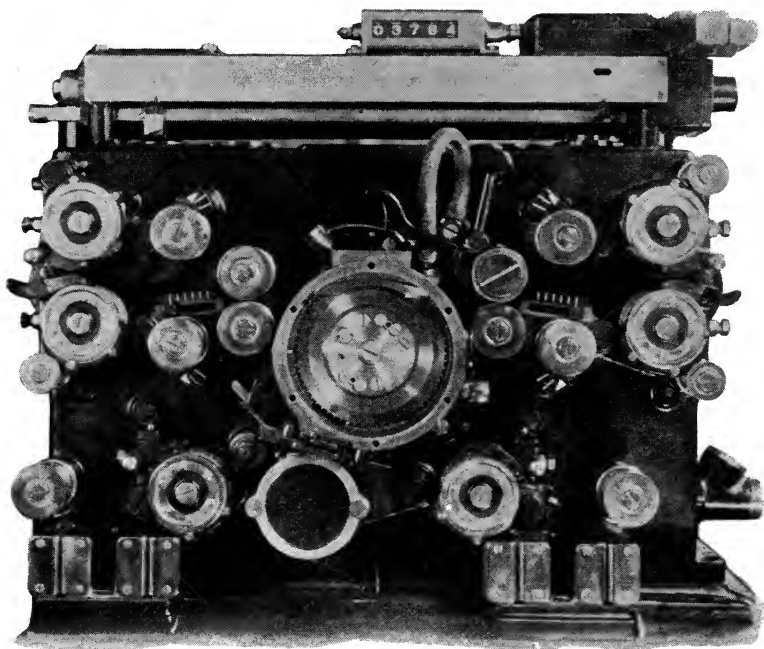

FIG. 2. Close-up of right-hand head, with mechanical filter removed to show lower part of interchangeable aperture plate and ease of removing sprocket; also the method of adjusting the tension of the tension rollers by moving along the slide the set screw holding the roller. The white pointers are set between the two index marks when threading to place the correct tension on the films.

is removed, and then the sprocket and the light trap ring can be removed. This construction permits the main sprocket to be replaced at any time by the laboratory mechanic, with the assurance of retaining perfect alignment.

(c) Roller assemblies. The rollers are made with self-contained ball bearings permanently retained in position by an expansion of the ends of the inner bearing tube. This allows rollers to be changed

instantly without danger of losing the balls and bearings, and yet with assurance of maintaining perfect concentricity.

Optics.—The optical system has been improved in several respects. First, the reflector was eliminated, as it was found to introduce complications: if the lamp were moved for any reason, the reflector had to be reset, with the possibility of affecting the exposure value of the light. By re-designing the condensers and other optical parts the effective even light of the former arrangement was more than doubled, despite the removal of the reflector. Furthermore, the exposure is comparatively unaffected by slight changes in the posi-

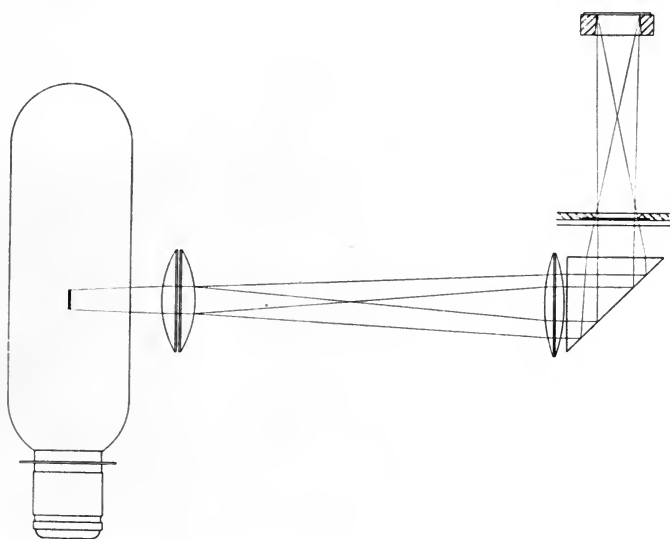

FIG. 3. Diagram of the improved optical system giving greatly increased but very even illumination.

tion of the lamp due to imperfect seating in the holder, *etc.*, yet the illumination over the entire printing aperture is exceptionally uniform. For instance, a fog test made on the machine can be drawn past the eye without showing evidence of unevenness. Such a test is decidedly more sensitive than any measurement of the variation of density on any densitometer in regular use.

The optical system has been arranged to provide a moderate degree of diffusion of the light. Extensive tests showed conclusive evidence that purely specular illumination introduced too many complications, reproducing minute scratches on the celluloid side of the picture and

sound negatives, whereas a moderate degree of diffusion eliminated them for all practical purposes. The evenness of the illumination, and the narrow printing aperture and perfect smoothness of film travel past the aperture, were the factors of principal importance

Evenness of Operation.—It is evident that the fog test is also quite critical with respect to indicating slight variations of the speed of the printer. This is especially so considering that the picture printing aperture has been reduced from $\frac{5}{16}$ to $\frac{3}{16}$ inch, and the sound print-



FIG. 4. Close-up of rear of rheostat unit, showing rheostat handle interlocked with the water supply, and motor reversing switch on the starting handle.

ing aperture from $\frac{5}{16}$ to $\frac{3}{32}$ inch. This reduction has been made possible by the improvements of the optical system and by the accurate speed regulation achieved by the combination of synchronous motor, precision gears, flywheel, and mechanical filter for operating the printer sprocket. The smaller the printing aperture the higher the sound frequency that can be printed, the "crisper" the print, and the more difficult it is to make a printer that will function perfectly.

Rheostat Control.—In place of the master control matte originally

fitted, the printer is now furnished with an alternative rheostat control as illustrated in Figs. 4 and 5. The rheostat is divided into three units.

The main rheostat is operated from the rear (Fig. 4). Its purpose is to reduce the initial shock of switching 1000 watts directly on the same line that feeds the other printer lamps, and to avoid surges that might affect the other printers on the line. Separate combination rheostats in front are employed to adjust the voltages of the two printer lamps very precisely. Each of the two setting dials is comprised of an inner and outer unit, each of which is calibrated in twenty

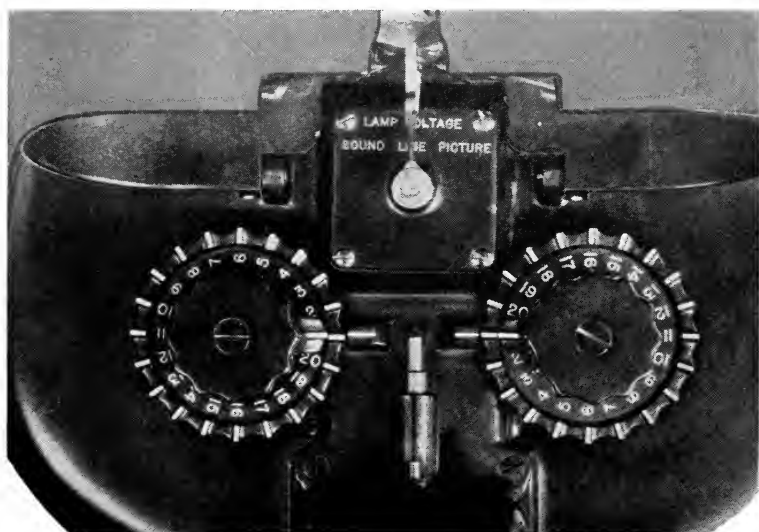

FIG. 5 (a). The front of the rheostat with cover open, showing double dials and trip plunger. The outer part of each dial has voltage steps of 2 volts, the inner of 0.2 volt.

steps, the outer dials in steps of 2 volts, and the inner dials in steps of $\frac{2}{10}$ volt (Fig. 5(a)).

This arrangement allows minute adjustments of the printing lamp voltages to be made with precision, to follow the variations of the speeds of different emulsions. When the control rheostats are adjusted for a given emulsion and given developing conditions, the voltages are marked on the cards on the rheostat cover (Fig. 5(b)). The set-up man then locks the cover and, therefore, has sole responsibility for the printer light setting. The arrangement allows the

operator to start the machine at any time by turning on the main rheostat at the rear.

The main rheostat lever is interlocked with the water supply so that the water is automatically turned on when the lamps are turned on. The rheostat coils are immersed in transformer oil; the entire unit has a water jacket for cooling.

Printing Lamps.—Improvement has been effected in the printing illumination by utilizing special 115-volt, 500-watt lamps of the on-course Beacon type, of the *T-20* bulb size with standard mogul prefocused bases. Normally the lamps are operated at about 85 to

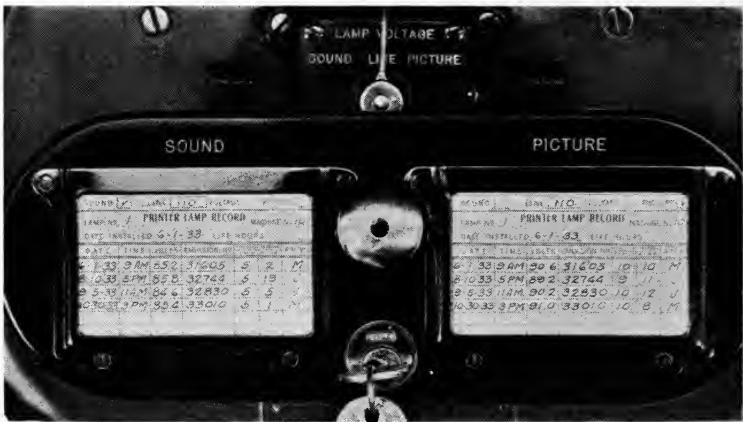

FIG. 5 (b). The front of the rheostat with cover closed and locked. The cards are for lamp voltage records. Between the cards is the emergency trip (electrical). Above is the voltmeter switch for reading the voltage on the sound head, line, and picture head, respectively.

95 volts, so that they will last a year or two. The main advantage of operating at such a low level is that the danger of destroying the filament is practically eliminated and the illumination is maintained practically constant.

The decrease of illumination due to bulb blackening is so slight that it is not noticeable in operation; the rheostat settings are changed often enough to take care of other variations, so that the slight decrease due to that cause is compensated for automatically.

Mattes.—The control of the printer depends to a large extent on the control in making the mattes. It was found that unless the density of the opaque parts of the matte were kept above a certain

value, enough light was passed to affect the efficiency of the narrower mattes. Increasing the exposure and development time to achieve the requisite density introduced the complications of the Eberhard effect: there was enough "burn over" into the clear portion of the matte to reduce its effective transmission value, apart from the fact that it was difficult to keep the base fog down to a minimum.

The problem was solved by using a special experimental high-contrast emulsion, and maintaining the density of the dark part of the matte negative at a value of 1.65-1.90 and of the positive matte 2.0-2.2. No determination of gamma is made, as the development

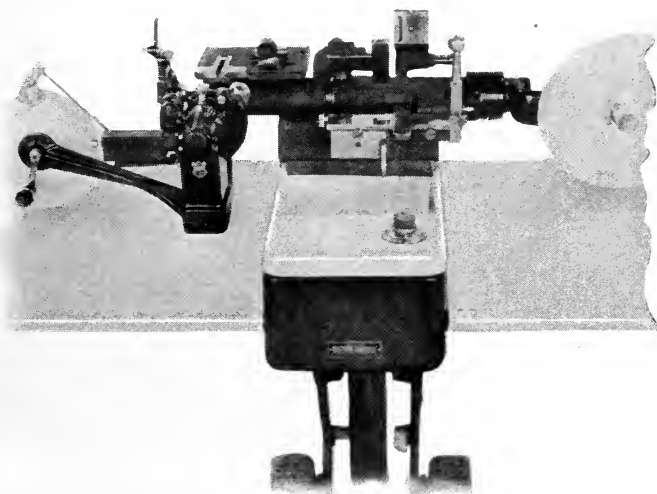

FIG. 6. New matte film matching unit installed on regular B&H splicing machine.

occurs in the usual positive developer under conditions that afford a normal gamma of 2.0 with regular positive stock.

The widths of the various matte openings were revised to provide an even geometric progression of exposure at the aperture, using mattes of the above-mentioned transmission characteristics in conjunction with the improved optical system. The changes in the mattes required only that a new set of matte slides be made.¹ However, a more convenient method of matching the mattes to the negatives has been devised. The original method involved running the negative on the splicer at the same time as the mattes were being spliced. In the present method, a careful record of the scene lengths of the negative, correct to the frame, is made.

An attachment that can be fitted in a few minutes to any splicer is used to measure the matte film to the corresponding lengths (Fig. 6). Inasmuch as the matte length is one quarter that of the negative, the splicing attachment is geared accordingly, but the footage dial and frame counter register as feet and frames of negative. An integral punch permits locating the exact perforation at which the mattes are to be spliced, so that the complete matte can be made up without touching the negative.

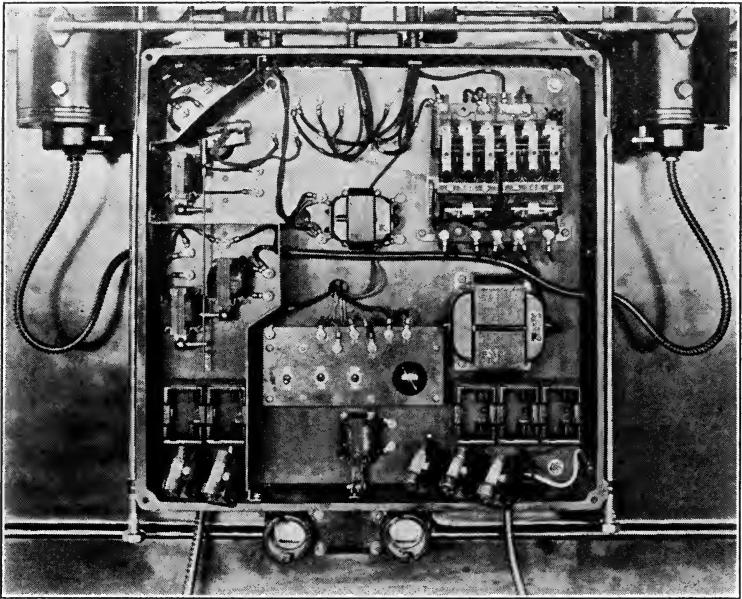

FIG. 7. Switchboard unit with cover removed. Note valves on air inlets operated by solenoid at bottom center. The three tumbler switches immediately above operate the three edge-printing lamps.

MISCELLANEOUS IMPROVEMENTS

Air Valve.—An air valve has been arranged to interlock with the regular tripping mechanism so that the machine will stop if the air supply fails. Valves have also been located at the main air inlet, which open when the machine is started and close when it is stopped. These can be seen clearly in Fig. 7.

Electrical.—The machine is operated by a 220-volt, three-phase synchronous motor. One transformer provides 110 volts for the

ruby lamps, and another provides 40 volts for operating the edge-printing lamps in series with a trip coil. The main printing lamps are operated on 115 volts d-c. A simplified switchboard arrangement has been developed in which a metal partition separates the a-c. from the d-c. circuit (Fig. 7), and a similar partition is provided also on the inner side of the board, thus conforming to the most stringent underwriters' requirements. Normally, the switchbox cover is bolted on. The cover is provided with a door that allows access to the fuses and edge-printing lamp switches only.

Dual Printing.—The machine includes provisions for future installation of an additional take-up unit on each head for dual printing.

IMMEDIATE PRECISION SENSITOMETRIC CONTROL

A simplification of the sensitometric control matte system outlined in the previous paper has been effected. Gamma can be determined with sufficient accuracy for efficient control by taking readings of any *two* separated positions on the straight-line portion of the H&D curve. In order to provide such a check, and to avoid the possibility of using the wrong mattes, *etc.*, two slots of the exact widths are cut in a piece of opaque stock with a very precise special punch. Corresponding slots are cut in a piece of opaque stock spliced into the negative leader. This arrangement provides two controlled exposure spots in the finished print. The densities are read and entered on a suitable form. It is sufficient to know beforehand what the densities should be, so that, if any discrepancy is noted, a check can be made to locate the source of the trouble.

This method does not supplant the usual sensitometric tests, but avoids the necessity of making the sensitometric strips so frequently. At the same time, it avoids also the one- or two-hour delay that now occurs between the time a film is developed and the time the final sensitometric strip is measured and charted.

To reduce this delay still further, a special form of flicker comparator, or *gamometer*, has been developed, which allows the "working gamma" to be determined in one or two minutes after the film has been developed. To facilitate making a continual check on the reduction rate of the developer another instrument called a *potentiometer* has been developed.

The gamometer and potentiometer check each other, as well as the printer light setting and the functioning of the developer. They

allow quick check readings to be made on each roll that is developed, and a constant graphical indication of the trend of any variations that may occur may be gained by charting the readings. This, in turn, admits of quicker action than the present method of reading the gamma every two hours or so. These instruments are the equivalent of "tolerance gauges" in mechanical work and, of course, should be compared with the standard sensitometer and the H&D curves at intervals.

REFERENCE

¹ HOWELL, A. S., STECHBART, B. E., AND MITCHELL, R. F.: "The Bell & Howell Fully Automatic Sound and Picture Production Printer," *J. Soc. Mot. Pict. Eng.*, XIX (Oct., 1932), No. 4, p. 305.

DISCUSSION

MR. CRABTREE: Is the diameter of the printing sprocket the same as that of the model *D* printer?

MR. MITCHELL: Yes. The shape of the tooth has been changed slightly to provide a little more even slippage characteristic, if I may so express it. The diameter is the same, but the arc of contact, that is, the angle of approach and release, is different.

MR. CRABTREE: Is there any reason why this printer will provide better contact and less slippage than the model *D* printer?

MR. MITCHELL: Yes. Apart from the other factors of tooth shape and the like, the two films are pressed together by air, as well as by the tension applied by the tension rollers. The evenness of travel also helps to eliminate the possibility of slight slippage.

MR. CRABTREE: Suppose you flash the film, that is, put a piece of film through without a negative, develop it, and then project it; do you notice any variation in density?

MR. MITCHELL: We have made a great number of what are referred to in this paper as "fog" tests. Passed in front of the eye, they provide a very sensitive test. We also placed such a fog test on a sound projector, the idea being that if any variations occurred due to any cause whatsoever, they would show up as changes of pitch.

MR. CARVER: Did I understand that the film is pulled through the machine by the tension roller, so that the printer sprocket does not pull the film?

MR. MITCHELL: The printer sprocket pulls the film, but the film is under a certain adjustable tension.

MR. JONES: Are both films under tension in the same direction at one time?

MR. MITCHELL: Yes.

MR. JONES: How many teeth are in engagement at the aperture, as compared with the model *D* printer?

MR. MITCHELL: In the new printer seven teeth, and in the old printer nine teeth—exclusive of the one tooth entering and the one tooth leaving the perforations.

THE ECONOMICS OF PROJECTOR LAMPS FOR ADVERTISING PURPOSES*

E. W. BEGGS**

Summary.—Although the trend in projection lamp development has been toward high-intensity, short-life lamps, the need for a lamp that can be operated for long periods of time, such as in advertising projectors, has arisen. The design and operating characteristics of such a lamp are described, together with the influence of airway beacon practice, the problem of existing projectors, projector lens limitations, and the effect of voltage change.

The average home projector is operated only a few hours each month. Compared with the investment in the machine and the films, the cost of the lamps and the current represents only a relatively small part of the annual cost of the outfit. For such equipment, therefore, the operator will, in order to project a picture of adequate brightness, make use of high-intensity, short-life lamps. Similarly, an industrial operator exhibiting a motion picture at a convention or a sales meeting, or a commercial projectionist exhibiting pictures before a paying audience, may find it desirable and necessary to use the 25-hour projection lamps. Furthermore, he often chooses to overload the lamps in order to produce the most brilliant picture possible.

While the trend in projection lamp development in recent years has been rightly toward the very maximum in illumination by means of high-intensity, short-life lamps, a need has slowly grown for an entirely different sort. These lamps are needed for projectors that are operated long hours, often 8 and occasionally 24 hours each day. They are for the most part burned in automatic lantern-slide machines operating with a short throw. In machines of this type the requisite picture brightness can be obtained rather easily, and the only unfilled need seems to be a means for reducing the cost of operation. Such projectors are operated in railway stations, restaurants, store windows, drug stores, showrooms, and even on building roofs and along highways. For the most part, they are employed in advertising work.

* Presented at the Fall, 1933, Meeting at Chicago, Ill.

** Westinghouse Lamp Co., Bloomfield, N. J.

In the case of an advertising projector, therefore, a special situation is encountered. The size of the audience varies and is often small, and the daily operating period is long; so that the success or failure of an installation depends largely upon the hourly cost of operation. Consequently, the life of the projection lamp is an important matter, since that is what largely determines the operating cost. The problem, then, is to determine over what period a lamp can be operated most economically with little or, if possible, no loss of picture brightness. Such a length of time can then be used in designing lamps wherein the cost of operation is the most important

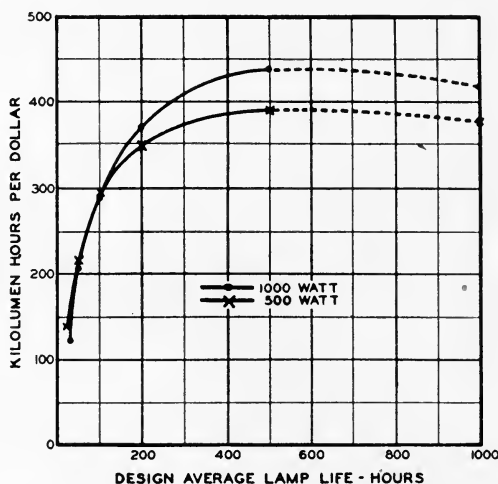

FIG. 1. Relation between life and operating cost of advertising projector lamps.

consideration. Where the brightness is of greatest importance obviously short-life, high-intensity lamps will be used, as at present.

THE IDEAL LAMP LIFE

The ideal advertising projector lamp should produce the greatest possible screen illumination for the least possible operating cost. The items of operating cost in an advertising projector that must be considered are the cost of the lamp and the cost of the current. Prolonging the life of the lamp naturally reduces the lamp cost per hour. At the same time, however, the lumen output per watt decreases, and, consequently, the cost of the current per lumen-hour increases. A point is reached where the increase in the cost of the current offsets

the saving on lamp cost. That point determines the most economical operating period for the lamp in question. If such an operating period is practicable from the standpoint of the fixture also, it can be established for the service.

In order to determine the proper operating period for advertising projector lamps, the change in operating cost has been calculated for a series of lamps. The results of such calculations are plotted in the curves of Fig. 1. In computing the data, certain assumptions were made regarding the lens system, the wattage capacity of the projector, the cost of the lamps, and the cost of current.

First, it was assumed that the lens system could fully accommodate any light source that might be chosen; that is, that the design of the filament of the ideal advertising projector lamp would be suitable if the optical parts were designed to conform to it. In extreme cases, of course, that would be impossible, since, when the life becomes very long, the source becomes too large; but in the series investigated the size of the light source was always fairly small, and hence the assumption was reasonably safe.

Second, it was assumed that the projector housing could accommodate the higher wattages made necessary by the longer life of the lamp. Any cooling of the lamp bulb that might be required should be done by natural means in order to minimize the operating cost. In most cases the assumption will be justifiable because the range of bulb size will not greatly exceed the sizes now in common use, particularly when the lamp life is not excessive.

Third, certain lamp costs must be assumed. For the purpose of this analysis, the lamp prices determined are, in most cases, already established. Where no prices have been established for the hypothetical lamps discussed, they were estimated, which means that the costs assumed are very nearly correct, although not necessarily exact. In the computations, the net lamp cost was assumed on the basis of the discount on lamps such as obtains with a small commercial Mazda lamp contract.

Fourth, the cost of electric power varies, depending upon the part of the country in which the device is operated and upon the power contract according to which the power will be purchased. Assuming that the device will ordinarily be operated in a small commercial establishment, the average cost of power in the United States during 1932 for that type of installation may be used with safety. That figure, according to the reports of the electrical industry, was \$0.0409

per kw-hr., and in the computations 4 cents per kw-hr. was the figure used.

Determined on the basis of the maximum number of lumen-hours per dollar, an operating period of 500 hours is most economical for the two lamps represented in Fig. 1. The sizes of the source and the bulb, for lamps of this size, type, and operating period have been proved practicable by five years of service as U. S. airway beacons. Advertising projector lamps of the wattages cited, therefore, should in general be designed for such an operating period, and advertising projector apparatus should be designed to accommodate such lamps and light sources. Lamps of smaller wattage for advertising projector service for the present should be designed for somewhat shorter

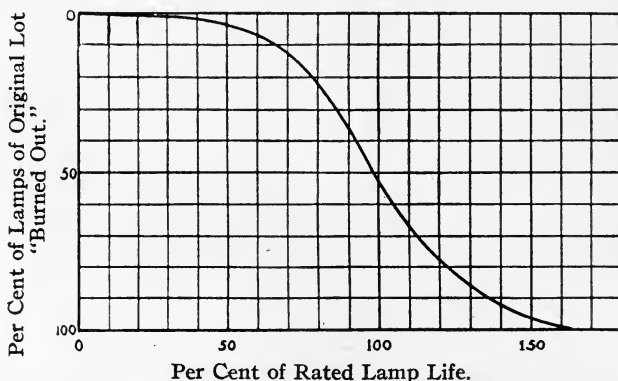

FIG. 2. "Mortality" curve of 500- and 1000-watt lamps, indicating the importance of relamping.

lives so as to maintain the illumination values above the useful minimum.

INFLUENCE OF AIRWAY BEACON PRACTICE

While many advertising projectors have successfully used airway beacon lamps, few if any have fully utilized the facilities made available by beacon equipment. It is standard practice in the United States to equip each rotating airway beacon projector with an automatic lamp changer, which introduces a spare lamp into the circuit when the active lamp burns out. The lamp changers have functioned with little or no trouble for more than five years in more than one thousand projectors, and their characteristics are such as could well be utilized in advertising lantern slide machines and the like. Such

an application would reduce the cost of maintenance and would improve the continuity of the service.

At the same time a second feature should be introduced to assure the best possible performance of the lamps: the lamps should be replaced according to a fixed schedule, so timed that, in general, the lamps would be renewed before they fail in service. Such a process would be based on the "mortality" curve of Fig. 2, which shows diagrammatically the sort of actuarial data available on Mazda lamps. It shows that some lamps fail before and some after the average or nominal operating life has been attained. The U. S. Department of Commerce arranges matters so that in practically every case beacon lamps are renewed before the beacon becomes dark. The visits to each station for re-lamping are timed so that considerably less than 1000 hours elapses between visits. Having two 500-hour lamps in each unit, such service makes possible the high degree of dependability now achieved in airway lighting. It would seem desirable to apply similar devices and maintenance procedure to advertising projectors for the advantages they offer. Projection lamps will function very suitably in the lamp changers, and the mortality data may be used also to calculate the best renewal periods.

The new bipost base, 1000-watt, T-20, bulb, airway beacon lamp is shown in Fig. 3. This lamp is also available with the mogul screw and mogul prefocus type of base.



FIG. 3. The new 1000-watt beacon lamp with the bipost base; automatic lamp changers are available for this and also the mogul prefocus bases.

THE PROBLEM OF EXISTING PROJECTORS

Projectors now in use, however, must be provided with economical lamps. In many cases they are using standard 50-hour projection lamps providing excellent illumination, but with, in some cases, a prohibitive operating cost. Those projectors could more profitably employ higher-wattage, longer-lived lamps, but the substitution of such lamps does not necessarily produce the results desired because of optical and, also, mechanical limitations. An analysis of each case

can be made, requiring certain data to establish definitely the possibilities offered in each case.

To choose a suitable lamp for a given projector, the following information is required:

- (1) Size of light source that the lens system will accommodate.
- (2) Filament dimensions of lamps now available.
- (3) Lumen output, prices, and operating life of the lamps.
- (4) Mechanical clearances and cooling requirements of the lamps available.
- (5) Effect of operating voltage on screen illumination, lamp life, and wattage.
- (6) Screen lumen ratios for monoplane and biplane filaments where a change of filament structure is to be made.

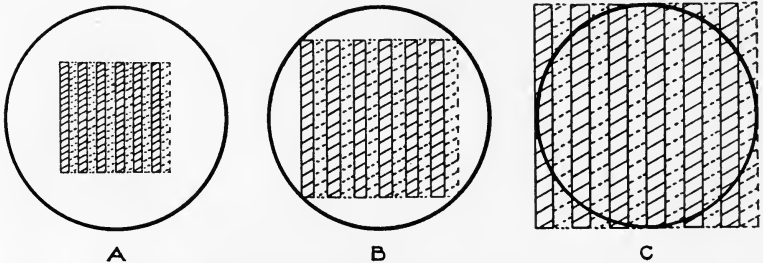

FIG. 4. Illustrating the dependence of available illumination upon the size of the light source: (A) This condition permits a large increase in the size of the source; (B) a good condition for efficient utilization of light, and intense screen brightness; (C) lens filled: condition for maximum screen illumination.

Having all that information, a designer or an operator may determine for himself the most suitable lamp for his purpose. Each requirement will be discussed in some detail below.

PROJECTOR LENS LIMITATIONS

Any stereotype projector now equipped with a projection lamp falls into one of three classifications as to lens limitations. Assuming that the optical system is arranged to focus the image of the filament in the objective lens, the source of light, together with the image from the reflector may partly fill, completely fill, or it may over-fill the objective lens. If the lens is incompletely filled, changes can be made quite freely, whereas, if the lens is full or over-filled, the problem is more difficult. Visual inspection of the projector during operation will show what are the conditions involved. By looking through a dark glass into the objective lens toward the lamp filament, the lens-filling conditions can be roughly determined as described below.

Fig. 4 shows three lens-filling conditions for monoplane filaments and reflected images. *A* is a condition that is common with 500-watt, 50-hour projection lamps when used in lantern slide projectors of the standard types now on the market. In this case, a large light source can be accommodated, and the illumination of the screen will increase approximately in proportion to the light flux emitted by the light source until the lens becomes filled.

When the image of the source is just inscribed in the circle of the objective lens as shown in Fig. 4(B), a condition of maximum

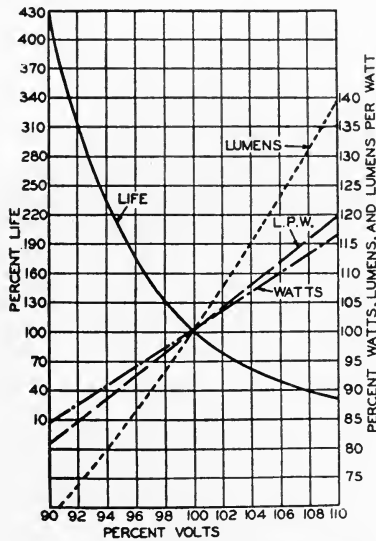

FIG. 5. Lamp performance curves, in relation to the applied voltage; showing light output, power consumption, and life.

illumination with little waste is attained. Increasing the size of the source will increase the illumination somewhat, but some of the light will fail to pass through the lens to the screen.

In advertising projectors an over-filled lens represents waste in the form of initial lamp cost and operating current. In certain instances, according to requirements, such a condition may be justified, but ordinarily such over-filling should be avoided.

Fig. 4(C) shows the circle of the lens just circumscribed by the image of the filament. This is the condition that provides maximum screen

illumination, but it obviously results in appreciable waste: about 22 per cent of the total flux fails to pass through the objective lens to the screen. Increasing the size of the source beyond that shown in Fig. 4(C) will fail to increase the brightness of the screen. To increase the brightness under such a circumstance will require either a brighter shorter-lived filament or a filament of biplane construction.

LAMP DATA

The filament dimensions, luminous output, recommended operating period, list price, and other useful data on various lamps now available are given in Table I. When applying these data the following general relations among the various types of lamps will be useful in computing the results achieved by changes in lamps.

(1) By doubling the electrical rating of a monoplane filament the projected area of the light source will be approximately doubled.

(2) The output in lumens of a 500-hour lamp is approximately 25 per cent less than that of a 50-hour lamp of equal electrical rating.

TABLE I

Lamps for 100, 105, 110, 115, or 120 Volts

Watts	Bulb	Service	Life	Filament	Lumens	Maximum Fila. Dim.		Relative Price††
						Width Mm.	Height Mm.	
50	T-8	Proj.	50	CC-13	790	6	4.5	1.50
100	T-8	Proj.	50	CC-13	1,870	7.5	6	2.00
200	T-10	Proj.	50	CC-13	4,000	8.5	9	2.20
300*	T-10	Proj.	25	C-13	7,500	10	10	2.90
500*	T-10	Proj.	25	C-13D	12,500	9	9	6.25
500	T-20	Proj.	50	C-13	13,150	14.5	13	3.00
500†	T-20	Adv. Proj.	500	C-13	9,700**	15	14	3.95
500†	T-20	Beacon	800	C-13B	8,800	23	11.5	3.90
750*	T-12	Proj.	25	C-13D	19,500	11	11	7.75
750*	T-20 Short	Proj.	25	C-13D	19,500	11	11	8.00
1000*	T-20 Short	Proj.	25	C-13D	27,600	12.5	12	9.25
1000	T-20	Proj.	25	C-13D	27,600	12.5	12	9.25
1000	T-20	Proj.	50	C-13	27,000	15	15	6.50
1000	T-20	Beacon	500	C-13	20,500	17.5	18.5	6.50
2000†	T-32	Beacon	500	C-13D	42,600**	19	19	17.25

* Require forced draft cooling.

** Preliminary Data.

† Special lamps.

†† Subject to change.

C-13 designates the monoplane, while *C-13D* designates the biplane filament construction. *C-13B* filaments are monoplane, wider than they are high.

(3) The projected area of a biplane filament will be a little more than half that of a monoplane filament of equal electrical rating and equal operating period.

(4) The projected area of the 500-hour light source will be approximately 25 per cent greater than that of an otherwise equivalent 50-hour light source.

Diagram of Optical System

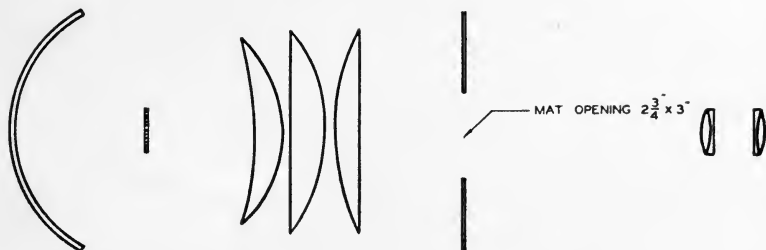

Screen Illumination Values

Watts	Lamp		Design Lumens	Screen Lumens		Operating Cost in Cents per Hour		
	Fila.	Design Life Hours		Mirror	No Mirror	Lamp	Current at 4¢ per Kw-hr.	Total
500	C-13	50	13,150	915	539	6.0	2.0	8.0
500*	C-13	500	9,700**	674	397	0.75	2.0	2.75
1000	C-13	50	27,600	1613	962	13.0	4.0	17.0
1000	C-13	500	20,500	1240	729	1.3	4.0	5.3
2000**	C-13	500	44,700†	1357	860	3.00††	8.0	11.00
2000*	C-13D	500	42,600†	1763	1400	3.05	8.0	11.05

* Special lamp.

** Experimental lamp.

† Preliminary data.

†† Estimated.

Image of Filament at the Objective Lens

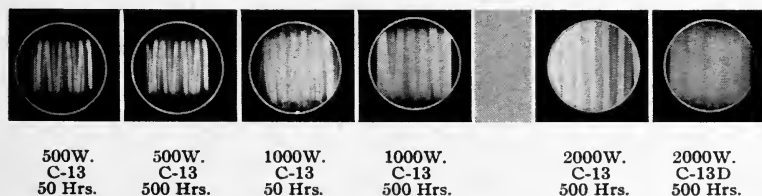

FIG. 6. Reference table for various lamps used with a given optical system.

The clearances required for the various lamps referred to in Table I can be calculated from the bulb designations given. In Mazda lamps, the bulb is designated first by a letter that defines the contour of the bulb. A *T*-bulb is a tubular bulb. The number following the designating letter defines the maximum diameter of the bulb in $\frac{1}{8}$ ths of an inch. The maximum diameter of a *T-20* bulb, for example, is $\frac{20}{8}$ or $2\frac{1}{2}$ inches.

The lamps marked with an asterisk require forced ventilation. All others listed can be adequately cooled by natural draft. The 300-watt *T-10* and 750-watt *T-20* lamps require only a moderately strong draft of cooling air on the bulb.

EFFECT OF VOLTAGE

In the past, it has been fairly common practice to subject a projection lamp to a voltage either greater or less than its normal rating. This effects lamp performance as shown in the curves of Fig. 5, from which can be calculated the expected average life, luminous output, and wattage of any lamp for which the data are required.

ILLUSTRATIVE EXAMPLES

Substitution of Long Life Lamp.—A practical example of the application of the principles discussed here would be to select a lamp suitable for replacing a 500-watt, 50-hour projection lamp in a typical lantern-slide projector used for advertising. In this case, the extent to which the lens is filled will be assumed to be as shown in Fig. 4(A). It is apparent that the size of the source can be increased without waste.

Assuming that it is desirable to maintain or improve the illumination, the 1000-watt beacon lamp will be selected, and its operating costs and illumination data will be determined.

Fig. 4(B) illustrates approximately the condition attained by using such a source. As it is fully accommodated by the particular objective lens that is used, the brightness of the screen will be increased in proportion to the luminous output of the two lamps. The increase of screen illumination can be calculated by means of the following formula, where I_{1000} is the new value and I_{500} the original value for screen lumens:

$$I_{1000} = I_{500} \times \frac{20,500}{13,150} = 156\% \text{ of } I_{500}$$

This shows that theoretically an increase in illumination can be achieved under the conditions assumed. A series of tests conducted

on a typical commercial projector afforded the data on illumination and operating cost given in Fig. 6.

In these tests the objective lens was filled with light to the extent shown in the photographs. The over-filling of the lens by the 1000-watt beacon lamp produced an illumination somewhat less than the theoretical value calculated by the formula given above. The data are exact enough, however, to confirm the theory of the formula.

Use of Biplane Filament.— The use of the biplane filament would be appropriate where the screen illumination is to be increased over what is possible with the monoplane filament. The data in Fig. 6 show the effectiveness of such a lamp of 2000 watts in a lens system for which the 2000-watt monoplane source is altogether too large and, therefore, relatively ineffective.

Effect of Undervoltage.— To show the effect of undervoltage an example can be computed from the data given in Fig. 5. Assuming that it is desired to double the life of the lamp, and that a reduction in illumination will not seriously affect the results, the final operating conditions can be computed from the curves which indicate a life of 200 per cent of the normal at a voltage of 95 per cent of the rated value. Let I_{100} represent the illumination when the lamp is operating at the rated voltage, or 100 per cent. Let I_{95} be the illumination when the lamp is operated at 95 per cent of its normal voltage, which would be the case if a 115-volt lamp were operated at 109.3 volts. The resulting illumination will be:

$$I_{95} = I_{100} \times 0.83 = 83\% \text{ of } I_{100}$$

Therefore, in this instance, the illumination would be reduced 17 per cent. Similarly, the wattage will be reduced from 100 to $92\frac{1}{2}$ per cent, and the life increased from 100 to slightly over 200 per cent. Assuming a 1000-watt *T-20* lamp, the operating cost would therefore be reduced approximately 16 per cent, with a reduction in picture brightness of 17 per cent.

CONCLUSION

High-intensity, short-life incandescent light sources are needed for projecting pictures before audiences who demand the maximum screen brilliance. The lamps that have been developed during the past year or two have filled that need, which was most urgent for motion picture work. Lantern-slide machines, particularly of the automatic type with which the requisite screen brightness is relatively easy to

attain, and when the lamps burn long periods each day, present a radically different problem. Here the application of lamps of higher wattages with filaments designed for longer lives seems to be the solution.

Higher wattages and larger light sources and bulbs will present new problems as regards lens and fixture design. In general, monoplane filaments will be applied for economy; but on occasion, when the very maximum of illumination is needed, the biplane type of source may be used. Lamp changers of the airway beacon type, together with periodic lamp replacement schedules, are recommended for reducing the maintenance costs and to increase the continuity of service to a maximum.

SIXTEEN-MM. SOUND-ON-FILM*

J. O. BAKER**

Summary.—Improvements that have been made in the production and reproduction of sound on 16-mm. film are briefly described, together with some of the problems that have been encountered. The two methods of obtaining sound-on-film, namely, recording and optical reduction printing, are discussed. It is now possible to reduce optically frequencies as high as 9000 cycles on 16-mm. film. Using a practical design of 16-mm. reproducing equipment it is possible to obtain sound from the 16-mm. film of as good quality as the sound that was formerly obtained from the average 35-mm. theater equipment.

The purpose of this paper is to describe briefly the improvements that have been made in the production and reproduction of sound on 16-mm. film and some of the problems that have been encountered. The task of overcoming those problems has led not only to methods of producing high frequencies on 16-mm. film, but incidentally has also assisted in the production of better 35-mm. sound. A comparison of the two and their relative frequency ranges will serve to give an idea of the improvements that have been made and the quality of reproduction that can be obtained from 16-mm. film.

In the past it has been the commercial practice to limit the high-frequency response on 16-mm. film to approximately 4000 cycles, and on 35-mm. film to approximately 6000 cycles. General improvements that have been made in 35-mm. recording, processing, and reproducing have extended the frequency range to 9000 and 10,000 cycles. Similar improvements in the 16-mm. processing have extended the 16-mm. frequency range to 6000 cycles without serious attenuation, while frequencies as high as 9000 cycles can be placed on the film and reproduced on high-fidelity reproducing equipment. As pointed out in a previous paper¹ there are two methods of obtaining sound on 16-mm. film from 35-mm. recordings: namely, by re-recording and by optical reduction printing.

Re-recording has the advantage that the frequency characteristic

* Presented at the Fall, 1933, Meeting of Chicago, Ill.

** RCA Victor Co., Camden, N. J.

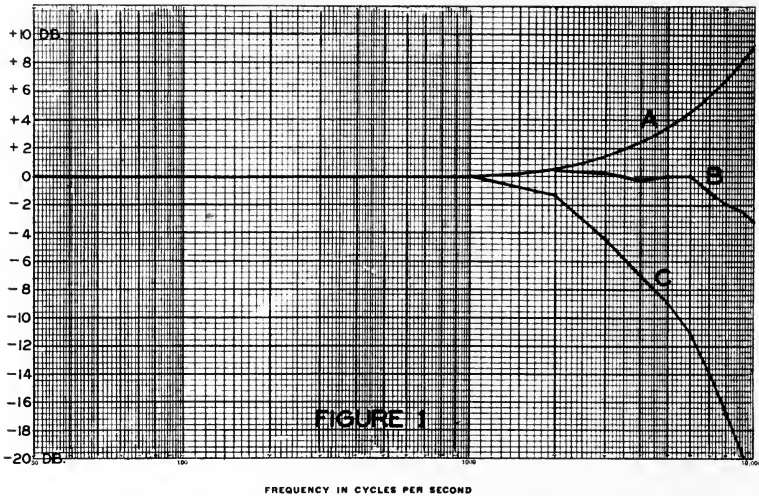
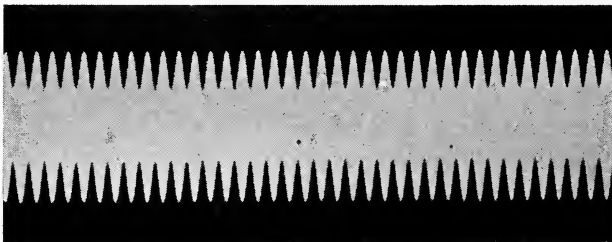
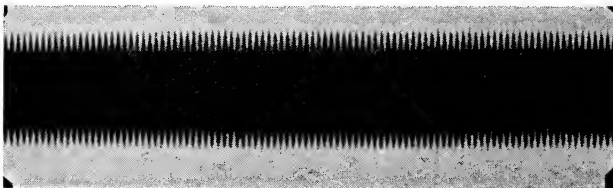

FIG. 1. Comparison of frequency characteristics, using S. M. P. E. standard sound test film: (A) measured galvanometer deflection; 35-mm. recording; (B) measured film output; 35-mm., 0.5-mil reproducer slit; (C) measured film output; 16-mm., 0.5-mil reproducer slit.



35-mm. negative



16-mm. optical reduction print

FIG. 2. 4000-cycle sound tracks: 35-mm. negative and 16-mm. optical reduction print.

can be altered by compensation if found necessary or desirable. However, it has a disadvantage in that losses are introduced, which are somewhat difficult, but not impossible, to overcome. These losses are due to two causes: irradiation within the emulsion, and the finite width of the recording slit.

Optical reduction of the sound track has two distinct advantages. One is that no additional slit losses are introduced. The other is the reduction of irradiation losses, which is due to the specular form

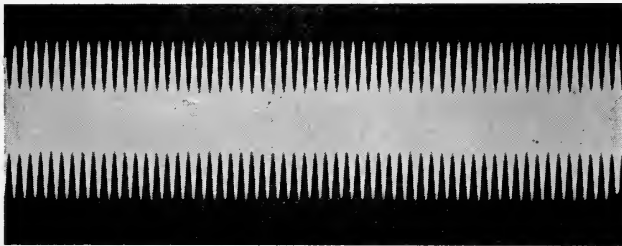

35-mm. negative

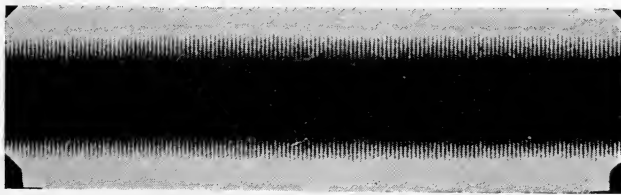

16-mm. optical reduction print

FIG. 3. 6000-cycle sound tracks: 35-mm. negative and 16-mm. optical reduction print.

of the printing light. In other words, the printing light enters the film more nearly parallel than in the case of contact printing where diffused transmission of light is utilized.

The curves of Fig. 1 are intended to show a comparison between the frequency characteristics of the 35-mm. and the 16-mm. reproduced sound. These curves were made with the Standard S. M. P. E. Sound Test Film. Curve *A* is the measured galvanometer deflection of the 35-mm. recorder having a $\frac{1}{2}$ -mil recording slit. From this curve it can be seen that the compensation required in the recording to

produce a flat frequency response when the film is reproduced in a no-loss reproducer is 4.7 db. at 6000 cycles and 9.5 db. at 10,000 cycles.

Curve *B* is the measured output from the 35-mm. negative, using a $\frac{1}{2}$ -mil reproducer scanning slit. If this curve is corrected for the reproducer slit loss the characteristic will be substantially flat.

Curve *C* is the measured output from a 16-mm. print, optically reduced from the 35-mm. negative and reproduced on a reproducer having a $\frac{1}{2}$ -mil scanning slit. It should be noticed that the film and reproducer loss is 11 db. at 6000 cycles and 20 db. at 9000 cycles.



35-mm. negative



16-mm. optical reduction print

FIG. 4. 9000-cycle sound tracks: 35-mm. negative and 16-mm. optical reduction print.

Since the loss due to the 16-mm. reproducer scanning slit is approximately 3 db. at 6000 cycles and 6 db. at 9000 cycles, the film loss is reduced to only 8 db. at 6000 cycles and 14 db. at 9000 cycles.

Figs. 2, 3, and 4 are photographs of the 4000-cycle, 6000-cycle, and 9000-cycle sound tracks, respectively, of both the 35-mm. negative and the 16-mm. optical reduction positive films. The filling-in of the valleys of the 16-mm. sound tracks is due to irradiation of the 16-mm. emulsion. These photographs were magnified 28.5 to 1.

By this method the sound printed on the 16-mm. positive will be free from distortion, except to the extent that it may be present in the 35-mm. negative and introduced due to improper processing of the film. It is possible, therefore, to produce a high-fidelity 16-mm. sound track which may be reproduced on suitable reproducing equipment. The 16-mm. reproductions that have been made demonstrate the practicability and uniformity with which acceptable 16-mm. sound can be obtained from film.

REFERENCE

¹ BATSEL, C. N., AND BAKER, J. O.: "Sound Recording and Reproducing Using 16-Mm. Film," *J. Soc. Mot. Pict. Eng.*, **XXI** (Aug., 1933), No. 2, p. 161.

COLOR FOR INDUSTRIAL AND BUSINESS FILMS*

R. H. RAY AND H. W. CRESS**

Summary.—*The economics and practical application of color cinematography, its problems in production, and its laboratory requirements in the industrial field are briefly reviewed.*

Many users of the motion picture in the advertising and the selling fields find a definite need for color in their productions. Several years ago, it was realized that the sale of business films might be stimulated if some practicable and economical color process were available for commercial use.

In surveying the possibilities of color photography in the industrial field it was necessary to consider the following points due to vast differences in production set-up between theatrical and non-theatrical production:

- (1) The design and mobility of cameras and equipment.
- (2) Developing and printing facilities.
- (3) Print costs.
- (4) Projection equipment.

After a thorough review of the field and after many tests were made, it was decided that 16-mm. color films, such as were available, could not be considered practicable in this field because of the following limitations:

- (1) Restriction in duplicate prints.
- (2) Size of picture.
- (3) Limitation to non-theatrical field.

It was found also that the Technicolor process, using Technicolor cameras, prints, and service, would not fall within the requisite non-theatrical production costs and the necessity for prompt print delivery in small quantities.

It was decided, therefore, to adopt the bi-pack process for making

* Presented at the Fall, 1933, Meeting at Chicago, Ill.

** Ray-Bell Films, Inc., St. Paul, Minn.

industrial films in color. Through the assistance of W. T. Crespinel and his laboratory (then Multicolor) this company produced its first industrial color film aboard a transcontinental train in May, 1930. Since that date some all-color releases and some part-color releases have been produced with considerable success and satisfaction. As long as laboratories equipped to process color prints are able to deliver a good standard of prints it is quite probable that color will continue to be used in industrial films, and that an increase in color footage in that field will be seen before long.

Why the bi-pack process has proved to be the most adaptable to the industrial field will be understood from the following account.

Camera Equipment.—The regular black-and-white Bell & Howell or Mitchell cameras with certain minor changes in the pressure adjustment of the aperture plate may be used in a bi-pack process, therefore making unnecessary any great outlay of money for new camera equipment. Magazines for the double bi-pack negatives are not expensive, and do not add any particularly cumbersome apparatus to the cinematographer's equipment.

Developing and Printing Facilities.—After exposure of bi-pack negatives it is possible to develop both the panchromatic and the red-dyed or orthochromatic negatives in a manner very similar to that for ordinary black-and-white negatives. It is quite necessary, of course, to make sufficient tests in order that a proper balance between the two negatives is maintained in order to achieve a correct balance of color in the print. No added equipment is necessary for this process other than a tank of hydrosulfite bleach for clearing the dye from the front negative.

Print Costs.—Industrial film users buy relatively few prints, but always insist on buying most economically; it was found that both nitrate and safety stock color prints could be furnished at about twice the cost of black-and-white prints. Good service from the laboratories in Hollywood has been maintained, and prints can be delivered within twelve days after the negative has been shipped from the laboratory.

Projection Equipment.—Many industrial film users have 35-mm. projectors, and in using the bi-pack process no change of any kind is necessary in the projection equipment. It is also possible to use the films in theaters.

There are numerous other advantages of such a color process. It is impossible to use large crews in shooting industrial films, and a camera-

man, assistant cameraman, and director can easily handle a silent scenic job in color, using this system. It is often necessary to pack the equipment and travel over mountain trails, often to places where the motion picture camera has never been before and, under such circumstances the less equipment and personnel needed, the easier it is to obtain such contracts. The cameramen, when shooting color pictures, have followed a few rules that have aided them in obtaining good color results with the bi-pack process during the past several years. These rules will, no doubt, be helpful to those contemplating bi-pack color photography.

In making scenic exterior shots it is quite necessary that the atmosphere be clear and the sunlight brilliant. It is a good plan to nick the film at the scene change and make careful tests when there is any decided change in the type of scenes made on the same roll of negative. Care should be taken with relatively short ends left in magazines for any length of time as this will tend toward "breathing" trouble. In making interiors particular care should be taken to light up the floor, especially if a dark rug or dark upholstered furniture is used on the set. Finally, the cameraman should be particularly careful as to the particular colors that are attempted. It is well to adhere to the reds, orange, blue-greens, blues, and browns. With these thoughts in mind good results should be obtained and every one satisfied with the production.

DISCUSSION

MR. CRABTREE: You said something about the reproduction of yellows in the prints made by Cinecolor. Can you tell us more about it?

MR. RAY: It is very new. We have been trying some experiments with titles using the Eastman background negative. Two filters were recommended, but I haven't the data with me.

MR. CRABTREE: Is it the final print that shows the yellows, as well as the reds and blues and greens? How are the blues?

MR. RAY: They are blue-greens.

MR. CRABTREE: And the reds?

MR. RAY: The reds are orange. I am sure you know the limitations of two-color processes.

MR. CRABTREE: Yes, but I was just wondering how you get the yellows.

MR. RAY: Yellow is an over-all dye that is put on the film.

MR. CRABTREE: Probably imbibed on the film?

MR. RAY: Yes; and in clear whites it will come through yellow.

MR. CRABTREE: But how do you determine where to put the yellow? Is it used only in connection with titles?

MR. RAY: Titles and cartoons.

MR. FARNHAM: What form of lighting equipment was used for the interior scenes?

MR. RAY: Incandescent.

MR. CRABTREE: Perhaps Mr. Farnham is wondering whether you used the overvolted lamps.

MR. RAY: No; we haven't tried those yet, but we hope to do so very soon. That should improve the color efficiency considerably.

MR. CRABTREE: It is of historical interest that Dr. P. G. Nutting and Mr. J. G. Capstaff used overvolted tungsten lamps for color photography in the Eastman Research Laboratories in 1914. A small stage about 15 feet square was equipped with special 1000-watt lamps supplied by the General Electric Co. and, of course, they were considerably overvolted. In front of the lamps window-glass with chicken netting embedded in it was fitted so as to protect the actors in case the lamps should burst. A stream of cold air was blown over the lamps to keep them cool. The life of the lamps was relatively short, but that of the modern lamps is surprisingly long.

How much more can you charge for such colored pictures than you can for black-and-white?

MR. RAY: So far we have found it necessary to increase our costs about 50 per cent for color over black-and-white.

MR. CRABTREE: You certainly can't make much profit at that rate when you have to use twice the footage of negative.

MR. RAY: In the additional prints that are used there is a little more profit in the sale of color prints than in black-and-white.

MR. CRABTREE: Why is it that people are willing to pay for the color in this class of work, and yet the producer of photoplays is not interested?

MR. RAY: Color is particularly adaptable to selling things in which color is dominant. It provides an additional sales advantage.

MR. CRABTREE: But the producer is often interested in selling sex appeal, and I think color would add to that.

MR. RAY: That is the point. In the industrial field color isn't always applicable to every subject, but when it can be used advantageously we are able to sell our customer on the idea of the additional expense of color over black-and-white.

MR. MURRAY: Has there been any demand for 16-mm. color in the industrial field?

MR. RAY: Yes. I had a sample the other day from Hollywood, made by a 16-mm, two-color process.

SOME PRACTICAL APPLICATIONS OF ACOUSTICS IN THEATERS *

G. W. BAKER AND M. A. SMITH**

Summary.—Some of the more common acoustical defects of theaters, such as the transmission of extraneous noises into the auditorium, the emanation of sounds from vibrating or rotating machinery, the reflection effects of curved surfaces, and reverberation, are discussed. The manner of treating auditoriums for obviating such effects is described briefly.

In presenting this paper the authors have borne in mind numerous theaters that are constructed and that have, or have not, been treated acoustically for the purpose of affording the critical patron the degree of satisfaction to which he is entitled. The average theater owner, manager, or projectionist knows very little about how the reproduction sounds in the house; just as long as the projection room monitor is loud enough and the projectionist can hear distinctly, everybody is satisfied.

The degree of satisfaction that the patron derives from a motion picture theatre presentation depends on many factors, *viz.*, the acoustic properties of the house, the projection, the sound equipment, heating and ventilation, seating comfort, *etc.* Most theater managers are acquainted with the projection, ventilation, seating, *etc.*; yet, in spite of all the money that is involved in such factors in the class *A* houses, and the high degree of perfection attained in those directions, the manager does not always find that his patrons are satisfied to the extent he would like them to be. It often happens that many of the audience have to strain their ears to hear the sound, or are wondering when the level of the sound is going to be reduced to a more comfortable volume. Again others may not be able to distinguish what is being said.

Cases have come to our attention wherein managers and owners have spent large sums in improving the sound equipment, only still

*Presented at the Fall, 1933, Meeting at Chicago, Ill.

**United States Gypsum Co., Chicago, Ill.

to be confronted with defective sound. Had the managers given their problem a little thought, and had their knowledge of the acoustics of the house been enlarged, those sums might not have been spent. Poor quality of sound will tend to create dissatisfaction much more rapidly than any other kind of defect. It is trying on one's nerves not to be able to understand all that is being said.

It is the purpose of this paper to acquaint the theater manager and the projectionist with some practical knowledge of where to look for acoustical defects and how to remedy them. When planning to build a theater, it seems logical that the owner should engage a reputable acoustical engineer to check the design of the intended auditorium so that it will be acoustically correct. The location, size, and shape of the interior surfaces, the placement of vibrating machinery, the ventilating system, and numerous other factors that will be shown to be important, should be considered very carefully and thoughtfully. Once a house has been built, acoustical correction is very often more costly than it would be if the acoustical factors were taken into consideration in the original design. Very often the house that has been corrected is not as good acoustically as it might have been had it been built properly, from the acoustical point of view.

There are four major points to be considered: first, extraneous noise. Motion picture theaters are always built where the largest possible number of persons pass their doors; on streets where there is adequate transportation; in most cases at the crossing of busy thoroughfares. Acoustically, such locations are not the best. But since potential box-office receipts always govern the location, outside noises must be excluded by proper sound insulation if the house is to be profitable.

Noises coming through the front doors are much easier to exclude than those coming through the ground, up through the floor, and into the house. Noises coming through the front foyer doors may be reduced almost to inaudibility by means of entrance doors on the street end of the lobby. If that does not suffice, and additional reduction is needed, the ceiling and part of the side walls of the lobby may be covered with absorbent material. The foyer should be heavily carpeted, and thick plush drapes should be used for decorating it.

When a house has fire doors that open to a noisy street or alley, with small vestibules leading to them, the vestibules should be laid

with padded carpet, and absorbing material should be added to the ceilings and walls. Drapes should be hung over the opening between the house and the vestibules.

The ducts of the ventilating systems should be lined with absorbent material. There are sectional absorbents on the market that can be conveniently adapted to almost any kind of ventilating duct. Windows should be made with double or triple panes, spaced apart and floated in felt.

Noises from the ground coming through the floor usually require considerable, expensive treatment, and should be studied by a capable engineer. In most cases the noise may be reduced to inaudibility by placing a floor mounted on a resilient structure over the old floor. Such resilient constructions absorb the vibrations, and prevent them from entering the house. Noises that are transmitted through the house walls may be reduced by placing resiliently mounted faces on the walls, for the purpose of damping the vibrations.

The second major factor to be considered is the noise emanating from unbalanced or vibrating machinery. When a machine is placed on a floor or wall the noise that it creates is amplified because of the larger vibrating surface. The larger the area the louder the noise. Projection arc generators are frequent causes of such trouble. When they are located on the projection room floor, the sound is transmitted by the floor into the house. When located in the basement the noise travels upward through the columns that support the floor, and thence into the auditorium. Usually the projectionist will place a pad beneath the generator, expecting the pad to eliminate the noise. Sometimes such a plan works, but usually the loading of the pad is incorrect, and the low-pitched noise still remains audible.

When placing resilient pads beneath generators, motors, pumps, blowers, *etc.*, correct loading and flexibility may be attained by trial and error; but much money will be saved by seeking advice from reputable concerns that manufacture such resilient bases. Where there are pipe connections to a machine mounted on a resilient base, an effort should be made to connect the pipes resiliently, because otherwise they may transmit the offending vibrations to the walls and into the house.

Exhaust fans placed in the walls leading to the outside are constant sources of noise. In the summer months most of the fans are useless, because they are too noisy, and mask the sound. By properly de-

signing the fan blades and guards, and properly balancing the rotating parts, the vibrations, and hence the noise, may be reduced; but generally, with all the care that is taken, there is sufficient vibration to be objectionable. If the fan is placed in an opening in a wall the noise is amplified. Resilient constructions placed between the fan mounts and the wall will remedy the defect. Here again proper proportioning of loading and flexibility must be given consideration.

The third factor to be considered is one in which surgical treatment is usually necessary. Objectionable reflecting surfaces, which have been discussed extensively in the literature, are present to a more or less degree in every house.

The worst kind of surface is the curved surface, which acts toward sound just as a curved mirror acts toward light: If convex, the sound is dispersed; if concave, it is concentrated to a focal point. In the theater there are curved ceilings, curved balconies, curved rear walls, domes, and barrel-shaped surfaces. Curved ceilings with the center of curvature at the floor line, in the audience, or slightly above, present a very difficult problem. When such a condition exists the auditors at the focal point of the reflecting surface hear the sound at a very high level of volume. Those outside the focal area will hear less than the normal volume. Such a defect should have been avoided in the original design. If such a troublesome surface exists in a house already built, it may be partly corrected by deep coffering. Sometimes it is advantageous to line the surface with an effective absorbent. A new ceiling of proper shape, constructed below the offending surface, will remedy the defect. Curved surfaces that have their centers of curvature below the floor line or high above the audience generally present little difficulty.

Curved rear walls and balconies offer the same objections, and are dealt with in the same manner. Objectionable concentration of sound by curved panels may be obviated by breaking up the panel into divergent reflecting surfaces.

One way of determining whether there are any troublesome surfaces is to walk slowly about the auditorium while listening to a person on the stage speaking in a normal tone of voice. If there are any areas where the sound is unusually loud they should be noted. By standing in such areas one can usually determine where the offending surfaces are located by noting the general direction of the sound. The observer can not determine the location of the reflecting

surfaces by clapping his hands, as the source of the sounds should be located on the stage, and not in the audience.

Sometimes echoes will be heard; the auditor will hear the sound coming directly from the stage, and an instant later will hear the same sound reflected from some surface. Echoes can be detected only when the difference between the length of the direct path and that of the reflected path is eighty feet or more.

The fourth major factor to be considered is that of reverberation. This might have been mentioned first, since many engineers regard it to be the only factor of importance. However, the acoustical qualities of an auditorium depend upon the others as well.

Reverberation is the continuance of a sound for such a length of time that it interferes with a sound made subsequently. The longer it takes for sound to become reduced to inaudibility, the more difficult it is to hear clearly. The time of reverberation (the time required for a sound of a definite intensity to become inaudible) can be calculated and measured. Knowing the time, one can install absorbing material over a sufficient area to reduce it to the proper limit. Excessive reverberation is bad in any case.

After the proper amount of absorption required for acoustical correction has been determined, the choice of the surfaces to be so treated should be made. The usual practice is to place the material on the ceiling of the house proper, under the balcony, on the rear wall, and the rear portion of the side walls. The best practice is to distribute over almost the entire surface of the walls and ceiling a material of only fair absorbing power.

When material of great absorbing power is placed under the balcony, the hearing becomes poor in the rear seats as the house fills with people. The absorption of the audience, plus that of the treated balcony ceiling, causes the sound level to be lower under the balcony than in the main body of the house. Patrons sitting beneath the balcony complain, and the usher causes the sound level to be raised. Those under the balcony are satisfied, but those in the first few rows near the stage complain that the sound is too loud.

The stage and the front portion of the side walls should not be covered with absorbing material, and the absorbing power of the auditorium should be maintained as constant as possible. The use of seats, the absorbing power of which is about equal to that of an auditor, is advisable. The acoustical absorption of the patron's clothing is substituted for that of the seat he occupies.

Society Announcements

NEW YORK SECTION

The regular monthly meeting of the New York Section was held on January 10th, at the Eastern Service Studios, Inc., Long Island City, N. Y. Mr. T. Keith Glennan, Vice-President and General Manager, and Mr. R. O. Strock, Chief Sound Engineer, delivered talks on "The Studio and Its Operation." After the talks, the main stage, the lower floor, the power and recording rooms, and the carpenter shop were opened for inspection. Examples of the work done by the studio were projected for the entertainment of the members, including a new feature picture, *His Double Life*.

Through the courtesy of Dr. Harvey Fletcher and the Bell Telephone Laboratories a demonstration of the "Transmission and Reproduction of Speech and Music in Auditory Perspective" was held in the auditorium of the Engineering Societies Building at New York, N. Y., on January 30th, to which the members of the New York Section were invited. Full details of the demonstration will be given in the March issue of the JOURNAL.

CHICAGO SECTION

The regular monthly meeting of the Chicago Section was held on January 11th, at the Electrical Association, Chicago, Ill. The subject of the presentation was "Microphone Technic in Recording," a discussion of the practical applications of microphones to motion picture film recording, supplemented by an exhibition of microphones of various types, such as condenser, crystal, moving-coil, and velocity. Messrs. J. E. Jenkins, of Jenkins & Adair, Inc., and W. Hotz, of Burton Holmes Lectures, Inc., assisted in the presentations, and microphone concentrators were exhibited through the courtesy of the National Broadcasting Company.

PROJECTION PRACTICE COMMITTEE

The regular monthly meeting of the Projection Practice Committee was held on January 24th, at the Paramount Building, New York, N. Y., at which time further progress was made in the preparation of the report of the Committee to be presented at the Spring Convention. The major portion of the evening was devoted to a discussion of the a-c. carbon arc, which the Committee is investigating from the standpoint of practical projection.

Coming: A Fourth Year of
ACHIEVEMENT

SINCE Eastman Super-sensitive Panchromatic Negative was introduced early in 1931, its revolutionary qualities have fulfilled every hope and prediction of its sponsors. It has helped cameramen and producers so tremendously . . . it has affected the motion picture art so profoundly . . . it has contributed to so many cinematic triumphs, that a further prediction can now be made: In its fourth year, as heretofore, this Eastman film will be an important factor in the most conspicuous motion picture achievements. Eastman Kodak Company. (J. E. Brulatour, Inc., Distributors, New York, Chicago, Hollywood.)

EASTMAN *Super-sensitive*
Panchromatic Negative

JOURNAL

OF THE SOCIETY OF

MOTION PICTURE ENGINEERS

Volume XXII

MARCH, 1934

Number 3

CONTENTS

	<i>Page</i>
Equipment for Recording and Reproducing Sound with Photo-Film.....A. F. CHORINE	157
Standard S. M. P. E. Visual and Sound Test Reels.....	173
High-Fidelity Lateral-Cut Disk Records.....F. C. BARTON	179
Open Forum: Should Studio Recording Equipment Compensate for Theater Reproducing Characteristics?.....	183
An Automatic Change-Over Device.....A. PRITCHARD	186
The Control Frequency Principle.....J. E. JENKINS AND S. E. ADAIR	193
The Rotambulator—A New Motion Picture Camera Stand...J. A. DUBRAY	200
Book Reviews.....	206
Society Announcements.....	208

JOURNAL OF THE SOCIETY OF MOTION PICTURE ENGINEERS

SYLVAN HARRIS, EDITOR

Board of Editors

J. I. CRABTREE, *Chairman*

O. M. GLUNT

A. C. HARDY

F. F. RENWICK

Subscription to non-members, \$8.00 per annum; to members, \$5.00 per annum, included in their annual membership dues; single copies, \$1.00. A discount on subscriptions or single copies of 15 per cent is allowed to accredited agencies. Order from the Society of Motion Picture Engineers, Inc., 20th and Northampton Sts., Easton, Pa., or 33 W. 42nd St., New York, N. Y.

Published monthly at Easton, Pa., by the Society of Motion Picture Engineers.

Publication Office, 20th & Northampton Sts., Easton, Pa.

General and Editorial Office, 33 West 42nd St., New York, N. Y.

Entered as second class matter January 15, 1930, at the Post Office at Easton, Pa., under the Act of March 3, 1879. Copyrighted, 1934, by the Society of Motion Picture Engineers, Inc.

Papers appearing in this Journal may be reprinted, abstracted, or abridged provided credit is given to the Journal of the Society of Motion Picture Engineers and to the author, or authors, of the papers in question. The Society is not responsible for statements made by authors.

Officers of the Society

President: ALFRED N. GOLDSMITH, 444 Madison Ave., New York, N. Y.

Past President: JOHN I. CRABTREE, Kodak Park, Rochester, N. Y.

Vice-President: WILLIAM C. KUNZMANN, Box 400, Cleveland, Ohio.

Vice-President: OMER M. GLUNT, 463 West St., New York, N. Y.

Secretary: JOHN H. KURLANDER, 2 Clearfield Ave., Bloomfield, N. J.

Treasurer: TIMOTHY E. SHEA, 463 West St., New York, N. Y.

Governors

EUGENE COUR, 1029 S. Wabash Ave., Chicago, Ill.

HERFORD T. COWLING, 7510 N. Ashland Ave., Chicago, Ill.

RALPH E. FARNHAM, Nela Park, Cleveland, Ohio.

HERBERT GRIFFIN, 90 Gold St., New York, N. Y.

EMERY HUSE, 6706 Santa Monica Blvd., Hollywood, Calif.

WILBUR B. RAYTON, 635 St. Paul St., Rochester, N. Y.

HOMER G. TASKER, 41-39 38th St., Long Island City, N. Y.

EQUIPMENT FOR RECORDING AND REPRODUCING SOUND WITH PHOTO-FILM*

A. F. CHORINE**

Summary.—The work of the Central Laboratory of the All-Union Electrical Trust, Leningrad, U. S. S. R., under the direction of the author, in connection with the study, design, and manufacture of motion picture recording and reproducing apparatus, is described. The present installment of the article deals with the research on light modulators, variable width and variable density; ordinary and noiseless recording systems; various forms of recording light sources; and the relative characteristics of the different kinds of modulator, viz., Western Electric, RCA, the author's, Kerr's cell, and the flashing lamp. The article will be concluded in the April, 1934, issue of the Journal.

In 1926 the study of problems of the sound picture was begun in this laboratory, and since that time work has been conducted both on the theoretical aspects of the problems and on the design and construction of equipment for recording and reproducing sound. At the outset, light modulators for film recording constituted the chief problem. Their design was subject to such wide controversy that it was necessary to undertake extensive experiments with existing modulators in order to determine their relative excellence. Indeed, on recording and reproducing systems in general, much of the data previously accumulated seemed to be of questionable accuracy; and since it was impossible to acquire elsewhere the equipment with which to check the data, we had to develop our own methods and equipment for the purpose. Some of the methods were not only original but were devised to deal with problems of major importance, and it is such methods, and the equipment designed by us for practical use, that are described in this paper.

LIGHT MODULATORS

The first light modulator that was developed is shown schematically in Fig. 1 and more concretely from the top and side in Fig. 2. A

* Received October 2, 1933. Limitations of space have necessitated abbreviation of the original paper.

** Director, Central Laboratory, All-Union Electrical Trust, Leningrad, U. S. S. R.

bronze or aluminum ribbon is fixed in the field of a magnet, so that when sound currents pass through the ribbon, it vibrates perpendicularly to the lines of magnetic flux. An optical system, consisting of a light source *A*, objectives *B* and *C*, and a cylindrical lens *D*, records these vibrations on the film *F*. The first objective focuses an image of the slit *M*₁ (Fig. 2) in the plane of the ribbon. The second objective produces an image of the ribbon on the film, and the cylindrical lens (*OB*) produces an image of the slit *M*₂ reduced to 0.02

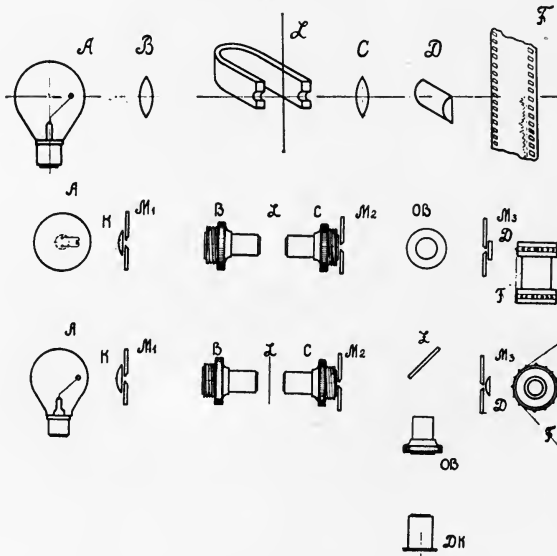

FIG. 1. (Upper) Schematic arrangements of first light modulator developed in the author's laboratory.

FIG. 2. (Lower) Details of modulator illustrated in Fig. 1.

mm. Thus there falls upon the film a thin strip of light whose length is determined by the position of the ribbon. When the ribbon vibrates and the film moves, an oscillogram of the sound-current actuating the ribbon is produced. In order to darken half the track a ribbon 0.25 mm. wide would be necessary, and since the ribbon is only 0.17 mm. wide, a small plate 0.30 mm. wide is attached to it.

By simply turning the ribbon and the magnet ninety degrees, so that the ribbon is parallel to the axis of the cylindrical lens, the system can be changed from a variable width to a variable density

recording system. The vibration of the ribbon when so placed varies the amount of light falling upon the film over the whole width of the track. The latter use of the system offers a number of advantages, due to the fact that the maximum displacement of the ribbon needs be only 0.05 mm., instead of the 0.12 mm. required for variable width recording. Hence the small plate may be discarded, and weaker currents can be employed, tending less to change the vibrational characteristics of the ribbon due to heating.

The first model was completed by the author in 1927, with the assistance of his close associates, Litvinsky and Smirenin, and the senior laboratory worker, Padkovsky. The modulator is shown in Fig. 3, in position to be tested by the photoelectric cell shown in the

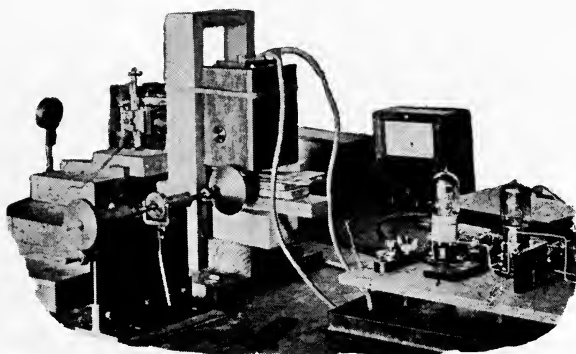

FIG. 3. First model of light modulator, in position to be tested by the photoelectric cell in the foreground.

foreground. It was soon apparent that improvements in details could be effected in this simple form of apparatus. In the first place the frequency characteristic showed a peak ascribable to the tendency of the ribbon to vibrate at its natural frequency. Second, it appeared that many advantages might be gained by further magnifying in some way the effects of the vibrations of the ribbon on the amount of light falling on the film.

Theory indicated that the frequency characteristic would be improved by making the natural frequency of the ribbon as high as possible and by damping its vibration. For a given length of ribbon, the former can be accomplished by decreasing the mass and increasing the tension as much as possible, and to this end duralumin was used. Experience showed that immersing the ribbon in petroleum oil of

carefully chosen properties was a satisfactory method of damping its vibrations. So damped, the response of even a bronze ribbon with an attached plate varied not more than 3 db. at frequencies up to 7000 cycles per second.

Experiments were also conducted in which the ribbon was left undamped and an electrical filter was used to compensate for the resonance of the ribbon. That procedure had the disadvantages of requiring exact adjustment of the filter frequency to the ribbon frequency, constant control of the latter at a fixed value, and exact similarity of all ribbons so that they could be interchanged. A simpler method of using an undamped ribbon was to increase its tension so as to raise its natural frequency to 10,000 or 11,000 cycles

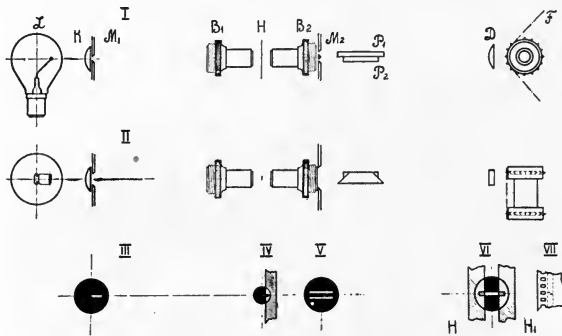

FIG. 4. System for producing two images of the one ribbon: the prisms P_1 and P_2 have been added to the system of Fig. 2 between the second objective and the cylindrical lens, and two slits are used at M_2 instead of one.

per second. While for the most part satisfactory, it was found that, on sudden transitions between silence and loud sounds, faint traces of resonance would color the reproduced sounds in an indistinct but characteristic way.

Both in the laboratory and in practice damping was attempted by placing a drop of "tavote" or oil at the points of attachment of the ribbon to its mounting. Such damping required extreme care, and the results were far from uniform. Important changes in the frequency characteristic resulted from small changes in the temperature of the ribbon and in the amount of oil used. The use of this method of damping in the Leningrad studios of Soyuzkino, however, has shown that the failure to eliminate the resonance peak completely merely

colors certain speech consonants in a way that does not spoil the quality appreciably.

It is also important that the deflection of the ribbon be proportional to the strength of the actuating current for all current strengths. Calculation shows that a change in this proportionality is possible only at current densities great enough to lengthen the ribbon by heating it and stretching it. Such changes in length are avoided by fixing the ribbon to its mounting through a spring. The measured amplitude characteristic that results is entirely satisfactory.

Any way by which a given value of current can be made to produce a larger effect on the film obviously will improve the modulator, particularly by permitting the use of smaller currents and thus avoiding overheating, straining, or breaking the ribbon. Such an increase

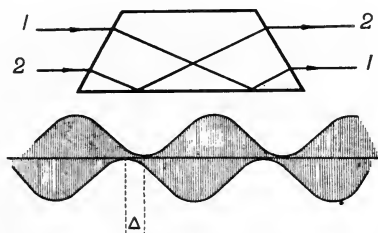

FIG. 5. (Upper) Path of the light beam through the trapezoidal prism P_1 of Fig. 4.

FIG. 6. (Lower) The two sound tracks recorded by the system of Fig. 4.

can be obtained either by adding a second ribbon, actually or optically, or by achieving further enlargement in the optical system. The addition of a second material ribbon was tried and rejected because of the precision required in mounting the two ribbons to insure that they were exactly spaced and that their images were precisely focused on the film. Furthermore, overmodulation caused clashing and short-circuiting.

It was therefore decided to obtain optically two images of the one ribbon. A duplicator for that purpose was devised by adding two prisms to the system shown in Fig. 2, between the second objective and the cylindrical lens, using two slits instead of one in M_2 , as shown in Fig. 4. Rays passing through one of the slits pass through the trapezoidal prism P_1 , as shown in Fig. 5, and produce an inverted

image on the film. Rays from the other slit, passing through the rectangular prism P_2 , produce an uninverted image, this prism serving merely as a compensator so that both bundles of rays receive the same optical treatment except for the inversion of the one.

In use, such a system produces two sound tracks on the film, as shown in Fig. 6. Since the system brings the two images to a focus one above the other on the film, one sound track appears to lag with respect to the other by an amount equal to the width of the slit image, 0.02 mm. By changing the forms of the prisms the two images, direct and inverted, can be placed side by side at the same height, but such prisms are inconvenient and complicated to construct. The same result can be accomplished more simply by constructing the cylindrical lens so that to either the upper or the lower half of

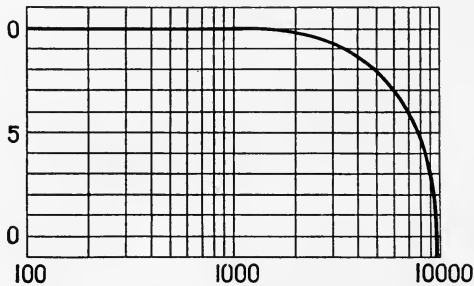

FIG. 7. Variation of amplitude of reproduction of a pure frequency recorded by two images of the same ribbon, and reproduced by a device using a single ribbon.

its flat side is effectively added a thin prism through which the rays from one of the slits pass and are thus deflected to the same height on the film as the rays from the other slit.

It can be shown that if a pure frequency is recorded by two images of the same ribbon, one lagging with respect to the other, and the record is reproduced by a device using a single slit, the resulting sound will have the same frequency as the original, but will differ from the latter in amplitude and phase. The extent of the differences will depend upon the frequency of the sound and the relative deviation of the two tracks. In the case of a recorder in which the lag is 0.02 mm. and the velocity of the film is 450 mm. per second, the reproduced amplitude falls off with the frequency, as shown in Fig. 7.

To eliminate this relative deviation and its effects entirely, the

optical duplicator diagrammed in Fig. 8 was designed. The duplicator proper, L_2 , is composed of two prisms, I and II , whose surfaces are in optical contact over the section back of the line AB , but are separated by an air space in front of the line. Thus, rays passing the ribbon N and proceeding through the objective L_1 and the slit P are divided in two parts, 1 and 2, at the dividing line AB . Part 1 passes through the cemented section and is reflected downward by prism II to form the image N_1'' . Part 2 is reflected upward by the surface of I , which is separated by air from II , and subsequent

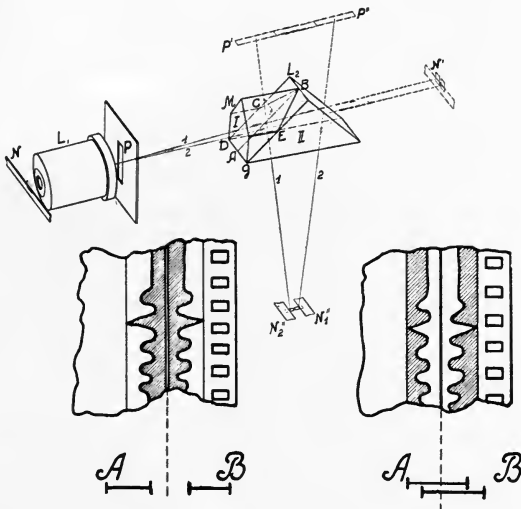

FIG. 8. (Upper) Optical duplicator for eliminating the lag illustrated in Fig. 6.

FIG. 9. (Lower) The two types of record produced with the optical duplicator of Fig. 8.

reflection from the two top surfaces of I sends the rays downward to form the image N_2'' , the inverse of N_1'' . It is evident from the construction of the prism system that the two images will be precisely aligned. Furthermore, the quality of the images will be impaired no more than they would be if the rays had passed through a flat glass plate having parallel surfaces perpendicular to the direction of the rays, since all the rays pass through the same amount of glass, and enter and leave the glass at the same angles in the case of the prisms as they would in the case of the plate.

According to which end of the slit the ribbon is opposite, its two images on the film will either always overlap or always remain separate, producing the two types of record shown in Fig. 9. When the direct image *A* and the reversed image *B* overlap, they produce a record somewhat like what would be produced by a ribbon that became thicker and thinner in accordance with the sound current actuating it.

The efficiency of the recorder was still further increased by using new objectives designed for greater magnification. Special immersion objectives designed by us for use with a ribbon damped by petroleum oil were manufactured by *VOOMP*.* The general scheme

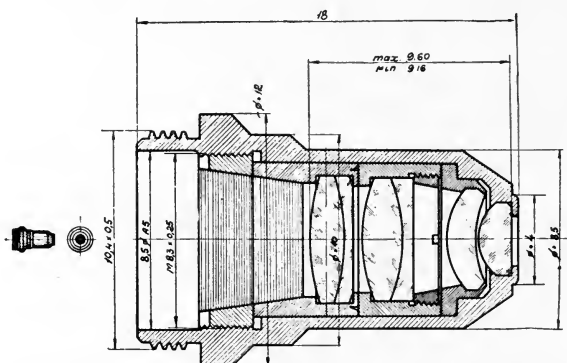

FIG. 10. Special immersion objective designed for use with a petroleum-damped ribbon.

of such an objective, 18 mm. long and 11 mm. in diameter, is shown in Fig. 10. Not only is its magnification double that of the old objective (20x instead of 10x) but it is improved in regard to spherical and chromatic aberration and satisfactorily meets the sine condition. Taking all matters into account, the objective appears to produce images of good quality in a field of 12 mm., and hence within an object field of 0.6 mm.

• The next improvement was a combination of a 20x objective, immersional or non-immersional, with the duplicator first described. In this combination the slit M_2 was moved from in front of the duplicating prisms to a position behind them, and thus its construction could be simplified to provide only one slit instead of two. The

* All-Russian United Optico-Mechanical Industries.

optical systems for use with oil and with air objectives differ only in the dimensions of their parts.

With the additional magnification thus attained it is possible to reduce the amplitude of vibration of the ribbon, and hence in turn to reduce the current actuating it to about a quarter of its former value. Furthermore, the reduction of the required amplitude permits the use of a ribbon only one-fourth as wide, and thus its tension can be reduced to effect a still further reduction of current.

The use of highly magnifying objectives complicated considerably the problem of designing the pole pieces of the magnet in which the objectives must be mounted. In the previous 10x optical system the distance between the outer lens and the ribbon was about 11 mm., readily permitting a satisfactory construction for the pole pieces. With a 20x air objective, the distance between the outer lens and the ribbon must be only 0.7 mm., and to accommodate the objective in this position the pole pieces must be given a peculiar form such that the whole flux passes through a very narrow strip of material. The immersional objective already described, therefore, was so designed as to make the distance between the ribbon and the first lens as great as practicable. The separation of 1.5 mm. actually achieved makes possible a far better magnetic circuit.

Finally, the use of an achromatic lens to double the transmitted light, and the modification of the objective so as to double the distance between the cylindrical lens and the ribbon, increased the enlargement even more, while still retaining a sufficient intensity of light in the image to permit satisfactory recording on positive film. The combined use of the 20x objective, the additional doubling lens, and the doubled distance provide a total magnification of 80-fold. With such magnification the current actuating the ribbon needs not be larger than 20 or 30 milliamperes, allowing greater freedom in the placement of microphones and permitting the use of recording amplifiers of considerably lower gain and lower power output potentialities.

It is generally appreciated that in order to attain the best artistic effect in reproducing sound, background noise must be eliminated, and that such noise is produced by the undarkened portion of variable-width sound tracks and by portions of low density on variable-density sound tracks. The noise can be reduced by darkening those sections in proportion to the envelope of the recorded vibrations. To that end two methods, one wholly electrical and another partly mechanical, were developed.

In the former the sound currents are divided (Fig. 11), one portion passing through a stopping condenser in series with the ribbon, and the other through a copper-oxide rectifier and simple low-pass filter to the ribbon. The condenser in the first circuit has a capacitance of about 1000 micromicrofarads, and the circuit freely passes currents of frequencies higher than 40 or 50 cycles per second. Hence the

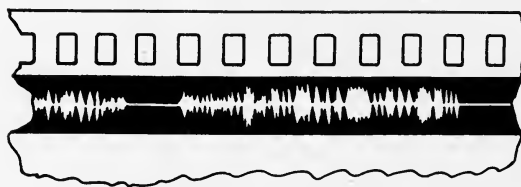
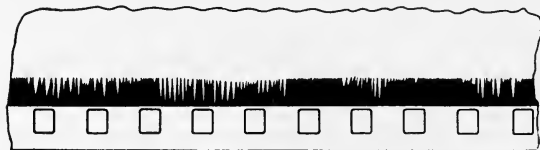
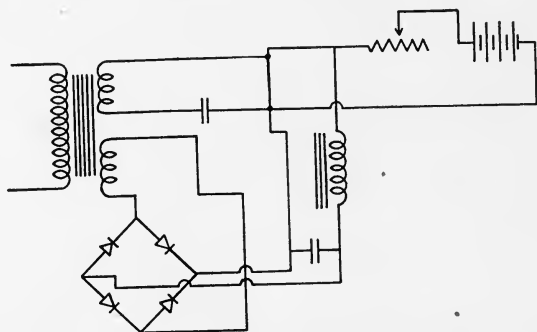

FIG. 11. (Upper) Divided electrical circuit for noise suppression.

FIG. 12. (Center) Negative record produced with the electrical noise suppressing system of Fig. 11.

FIG. 13. (Lower) Noiseless recording produced with the optical duplicator.

ribbon vibrates not only in accordance with the sound currents supplied by the first circuit, but at the same time shifts its position in accordance with the envelope of those currents supplied by the second circuit. When no current is passing, the image of the ribbon is near the edge of the sound track, almost completely covering it, and when the current is small most of the sound track is darkened, producing a

negative print such as that shown in Fig. 12. When a larger current passes, the image of the ribbon shifts farther from the edge of the track and exposes more of the film.

By such an arrangement, the ribbon is obliged to conduct twice the current that it would otherwise be required to carry, a disadvantage when the current is large. To avoid it, the ribbon is mounted so that one edge of its image normally falls at the center of the sound track, and biasing current is supplied by a battery through a variable resistance such that the current is sufficient to deflect the ribbon so that its image falls at the edge of the sound track as before. By then permitting the current from the rectifier to oppose the biasing current, neutralizing it when the sound current reaches a maximum, the ribbon is required to carry no more current than in normal recording during loud passages.

The fact that the sound track is modulated only at the extreme edge by currents of small amplitude is a disadvantage, for in poorly serviced theaters, where the optical system of the reproducer is improperly placed laterally with respect to the film, or incorrectly focused, distortion of the weak sounds may result. This disadvantage is obviated by the use of the duplicator, which requires no change in the noiseless recording system, and which centers the modulated portion of the sound track regardless of the current strength, as shown in Fig. 13.

In the other method of noiseless recording the voice currents are divided between the ribbon and a small galvanometer (Fig. 14). A small vane is attached to the needle of the galvanometer, the motion of the needle being damped by a wire attached to it immersed in glycerine. The vane is thus moved from side to side in accordance with the average strength of the sound current, after a delay due to the damping. By focusing an image of the vane on the film at such a distance from the image of the ribbon as to allow for the delay of response of the vane, and adjusting the amplitude of its motion by means of a resistance in series with the galvanometer, the device can be made to produce a positive in which the envelope of the modulated sound track is darkened. The galvanometer requires at the most one-tenth of the total current for its operation. One embodiment of this device is shown in Fig. 15.

We have been no exception to the general rule that every one who works on the problems of the sound film must suffer and recover from the children's disease of experimenting with Kerr's cell. We did not

experiment long with the system, nor intend it for general use, because of its well-known basic faults: small light intensity, large harmonic output when inaccurately controlled, the necessity of high voltages, expensive optical systems and the use of nitrobenzol, and the danger of freezing at low temperatures. The system has been extensively used in Germany, where those shortcomings have been overcome by indirect methods not available to us, such as the use of large prisms, and film of very fine grain and high sensitivity.

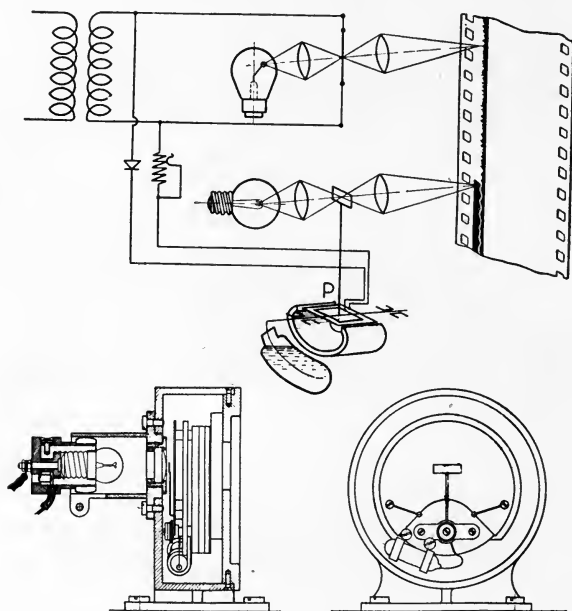

FIG. 14. (Upper) Electromechanical system of noise suppression.

FIG. 15. (Lower) One embodiment of the electromechanical system of noise suppression of Fig. 14.

Work with a flashing lamp was also undertaken, in the hope of achieving a simpler and more compact form of recording apparatus than was possible with other means. It was found possible to use such a lamp for recording on negative film, but the lamp could not be made bright enough to record the necessary densities on positive film. It was difficult to produce a sufficiently large glowing surface that would radiate over a wide enough angle to permit proper employment of the necessary optical systems.

We investigated the dependence of the brightness of the lamp on the voltage supplied to it by exposing negative film to the lamp while the voltage was varied. Previous measurements of the relation between the density of the film and its exposure then enabled us to determine the variation of the lamp brightness with the voltage. The intensity of the light radiated from the central portion of the light source was also measured photographically (Fig. 16). The source was imaged by an objective on the entrance opening of a second objective, a diaphragm of which occluded all but the central portion of the image. The second objective imaged the exit opening of the

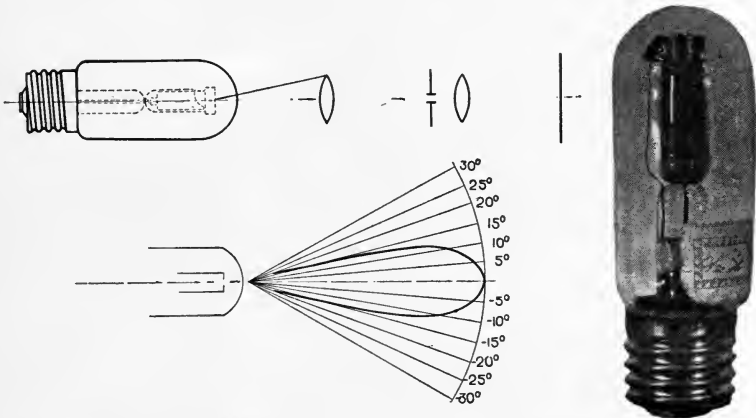

FIG. 16. (Upper) Measurement of intensity of radiation from central portion of flashing lamp.

FIG. 17. (Lower) Intensity of radiation of central portion of flashing lamp at various angles.

FIG. 18. (Right) The flashing lamp used in the experiments.

first objective on a negative film. Thus measurements of the distribution of density of the developed negative could be used to determine the radiation of the central portion of the source at various angles (Fig. 17). The flashing lamp constructed in this laboratory was of the type shown in Fig. 18, and was employed in conjunction with the optical system diagrammed in Fig. 19.

These experiments with various types of modulators, and examination of the available literature on the subject, have convinced the author that the best sound recording systems are those in which mechanical vibrations are used to modulate the light beams, since such systems provide the most intense illumination and are generally

the most compact. The author hopes he may be pardoned for daring, with some excusable partiality, to compare from his standpoint the merits of the various light modulator systems that have recommended themselves. In this comparison it is assumed (a) that the recording is on regular positive motion picture film, (b) that all frequencies from 50 to 10,000 cycles per second are recorded, and (c) the image of the slit on the film measures 0.02 mm. by 3 mm.

Table I roughly rates the extent to which the most important requirements are met by five different modulators: Western Electric (*W*), RCA (*R*), the author's (*Ch*), Kerr's cell (*K*), and the flashing lamp (*L*). Where a requirement is completely fulfilled, the sign + is entered; where not, the sign -; and where a modulator fulfills the requirement poorly in comparison with other modulators, the sign \pm .

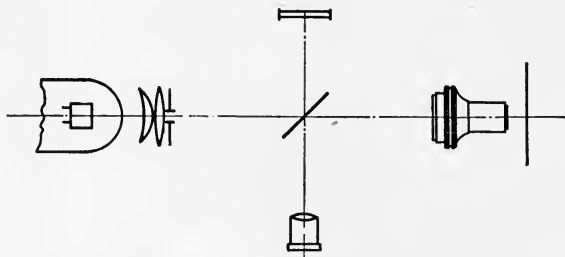

FIG. 19. Optical system employed with the flashing lamp of Fig. 18.

(1) The luminous intensities of modulators *W*, *R*, and *Ch* are sufficient for positive film; Kerr's cell only barely supplies enough light when supplemented with large Nicol prisms, special preparations of nitrobenzol, *etc.*, as by Klangfilm Tobis. Flashing lamps can not be made to supply enough light and at the same time fulfill the other requirements for positive film.

(2) All the modulators possess the requisite frequency characteristics except the flashing lamp, the characteristic of which is inconsistent and indicates the presence of hysteresis.

(3) In the first three modulators the amplitude of response is proportional to the amplitude of the actuating signal, within the required range. In the last two that is true only under very special conditions of battery voltage and the like.

(4) All the modulators require that the current supplied to them be amplified. Differences in the degree of amplification required are

TABLE I

Characteristics of Five Different Types of Modulator

	<i>W</i>	<i>R</i>	<i>Ch</i>	<i>K</i>	<i>L</i>
(1) Light Intensity	+	+	+	≠	-
(2) Frequency Characteristic	+	+	+	+	≠
(3) Amplitude Characteristic	+	+	+	≠	≠
(4) Amplification Required	+	+	+	+	+
(5) Working Voltages	+	+	+	-	-
(6) Type of Record Produced	-	+	+	-	-
(7) Distortion on Overmodulation	-	+	+	-	≠
(8) Influence of Temperature	+	+	+	-	+
(9) Complexity	+	+	+	-	+
(10) Noiseless Recording	-	+	+	-	-
(11) Extent of Modulation	-	+	+	-	-

of no great importance in practice, requiring merely different numbers or kinds of vacuum tubes and different amplifier circuits. Apparently the Western Electric System requires the least energy for actuating the ribbon.

(5) The first three modulators use very low voltages throughout. Kerr's cell and the flashing lamp require the use of inconveniently high voltages close to the modulator.

(6) Only the RCA and the author's modulators produce variable-width records, the photographic manipulation of which is much simpler than that of variable-density records. As already described, the author's system can be used for either method of recording without change of construction.

(7) In spite of the argument that records can be made without overmodulating them, the danger of doing so can not be disregarded. In the Western Electric System overmodulation produces a short-circuit. In the RCA and the author's systems overmodulation causes the movements of the ribbon image to exceed the limits of the sound track, and hence the reproduced sounds are distorted. The distortion takes the form of added higher harmonics, however, which do

not entirely spoil the sound. In Kerr's cell overmodulation changes the direction of the current, greatly distorting the record, and can be detected and avoided only by special devices. In the flashing lamp, distortion due to overmodulation varies with the characteristic of the lamp.

(8) All the modulators work well at all temperatures except those employing Kerr's cell, which will not operate at low temperatures without special arrangements for controlling the temperature with a thermostat.

(9) As so far developed, most modulators are not unduly complicated, except again Kerr's cell in any form that provides enough light for recording on positive film. For simplicity the Western Electric modulator has not been surpassed.

(10) The RCA and the author's systems seem to be those in which noiseless recording methods can be most satisfactorily applied, but since the last word has not yet been said in the matter, the ratings given here must be regarded as open to question. Noiseless recording with the variable-density systems always distorts the reproduction because the amount of light transmitted by any portion of the positive sound track, when the sounds are reproduced, is not proportional to the amount of light required to record that portion of the sound track, over the range of density that is encompassed.

(11) It can be said, in general, that the extent of modulation is greater with variable-width than with variable-density systems.

A glance at the table now shows that, from the standpoints adopted, the systems employing Kerr's cell and the flashing lamp are the least satisfactory, and the RCA and the author's systems are the most. The comparison, of course, affords only a rough idea of the situation today, and different points of view might lead to different conclusions.

It is interesting to notice that this work, undertaken primarily to develop apparatus for sound picture use, has borne fruit in an instrument useful not only in that field but as a tool for scientific investigation. The light modulator constitutes an ideal oscillograph. Only modulators producing variable-width records can properly be considered as microscopic oscillographs, as variable-density records can be used as oscillograms only with difficulty.

(To be concluded in the April issue of the Journal)

STANDARD S. M. P. E.

VISUAL AND SOUND TEST REELS

Prepared under the Supervision of the
PROJECTION PRACTICE COMMITTEE
(1933)

Summary.—The Visual and Sound Test Reels, developed under the supervision of the Projection Practice Committee, were described fully in the August, 1933, issue of the Journal. The reels are now available, and consist of two sections, each approximately 500 feet long. They are designed to be used as precision instruments in theaters, review rooms, exchanges, laboratories, and the like, for testing the performance of projectors. Either or both sections may be obtained on order accompanied by a remittance of \$37.50 for each section, from the General Office of the Society, at 33 West 42nd Street, New York, N. Y.

INSTRUCTIONS

The test reel consists of two separate sections of standard 35-mm. film, each section being approximately 500 feet long: (1) picture, and (2) sound. The two portions can, and preferably should, be used separately.

PURPOSE OF REEL

To enable the projectionist to check his equipment for optical and sound defects within the limited time usually available prior to the opening of performance; and to aid in eliminating such defects, thereby helping him to maintain a high standard of projection.

PICTURE SECTION

The picture section consists of various test targets,* each preceded by a title stating the purpose for which it is intended, arranged in the following order:

(a) Small diamonds and vertical bars arranged alternately in rows for checking travel-ghost.

(b) Small squares arranged diagonally across the frame, for checking picture jump and picture "weave."

* Illustrated in the August, 1933, JOURNAL, p. 90-94.

- (c) Fine vertical lines closely spaced, for checking marginal and radial aberration (imperfection) of objective (projection) lens.
- (d) Fine horizontal lines closely spaced, for checking marginal and radial aberration (imperfection) of objective (projection) lens.
- (e) Small squares for checking best focal position of objective lens.

(a) *To Check for Travel-Ghost.*—Set the shutter adjusting knob to its central position. Set the shutter approximately to the correct position. This permits advancing or retarding the shutter while the projector is running. White streaks appearing on the screen above or below the white objects indicate the presence of travel-ghost, which should be removed by manipulating the adjusting knob: streaks above indicate that the shutter should be advanced; streaks below indicate that the shutter should be retarded. Intermittent streaks indicate insufficient tension of shutter-cam spring, excessively worn gears, or worn bearings. If the projection distance is great, an observer should be stationed near the screen, so as to detect faint travel-ghost that might be invisible from the projection room, and to signal to the projectionist whether the streaks are “up” or “down” and when they are entirely eliminated.

(b) *To Check for Picture Jump and Picture Weave.*—The picture jump is measured by placing a ruler against the screen and measuring the amount of movement of one of the squares in a *vertical* direction.

If the projector is in first-class condition, and the intermittent movement and the picture gate are properly adjusted, the picture jump should not exceed the values given in the following table (one-third of one per cent of the picture height):

<i>Vertical Movement</i> (inch)	<i>Height of Picture</i> (feet)
$\frac{1}{8}$	3
$\frac{1}{4}$	6
$\frac{3}{8}$	9
$\frac{1}{2}$	12
$\frac{5}{8}$	15
$\frac{3}{4}$	18
$\frac{7}{8}$	21

An excessive amount of picture jump may be due to one or more of several causes, namely:

- (1) Insufficient or excessive gate tension.
- (2) Worn intermittent sprocket teeth.
- (3) Intermittent sprocket of incorrect dimensions.

- (4) Dirt accumulated upon face of sprocket.
- (5) Improper adjustment of intermittent movement.
- (6) Vibrations transmitted by projector motor.
- (7) Bent shutter shaft or unbalanced shutter.
- (8) Insecure foundation for projectors.
- (9) Loose lens holder or lens elements.
- (10) Improper fitting of intermittent sprocket on shaft.
- (11) Worn or damaged test-reel sprocket holes.

The picture *weave* is measured by placing a ruler against the screen and measuring the amount of movement of one of the squares in a *horizontal* direction. If the projector is in first class condition, the weave should not exceed one-third of one per cent of the picture width. The table provided above for picture jump may be used, substituting "horizontal" for "vertical" in the first column, and "width" for "height" in the second column. Excessive picture weave may be caused by:

- (1) Insufficient tension on lateral guide rollers.
- (2) Misadjustment, sticking or cut lateral guide rollers.
- (3) Improper adjustment of intermittent sprocket.
- (4) Improper fitting of intermittent sprocket on shaft.
- (5) Worn or damaged test-reel sprocket holes.

(c, d) *To Check for Lens Aberration.*—All commercial projection lenses have defects called aberrations, which are corrected to a greater or lesser degree depending upon the type of lens and the quality of the workmanship and materials used in its manufacture. Blurring of any portion of the targets indicates that the lens has not been fully corrected. No adjustment can be made by the projectionist to correct such a condition; but the targets should be used to make comparisons between lenses, especially before purchasing new ones.

(e) *To Check Best Focal Position of Lens.*—The focal adjustment of the lens is best when the greatest possible number of squares is sharply and clearly defined on the screen. The rows of squares are numbered vertically and horizontally for the purpose of locating defects and for comparing different optical systems.

SOUND SECTION

The sound section of the test reel consists of an assortment of sound recordings to be used for detecting faults in the reproduced sound and for checking the performance of the projectors and the associated sound equipment. Two sound tracks, each approximately 500 feet

long, are printed near the left and the right margins of the film, with the starting points at the opposite ends of the film. Such an arrangement permits the two sound tracks to be used without rewinding the film. In order to use the second sound track, the reel may be removed from the lower magazine, turned so as to present the emulsion side to the light source, placed in the upper magazine, and threaded in the usual manner. The sound recordings are as follows:

(a) Buzz track (a track that is practically the reduced image of the rungs of a ladder) for checking the position of the scanning beam relative to the sound track.

(b) 6000-Cycle and 9000-cycle note for checking the focus and rotational adjustment of the sound optical system.

(c) Selected frequencies, including 50, 100, 200, 300, 500, 1000, 2000, 3000, 4000, 5000, 6000, 7000, 8000, 9000, and 10,000 cycles for ascertaining the over-all output characteristics of sound heads and amplifiers. This track was recorded at a constant level in order to avoid voltage calibration when a volume indicator is used (*i. e.*, the volume indicator should always indicate the same reading). In listening, the 1000-cycle note will sound louder than the others, because the normal ear is more responsive to notes of that frequency than to higher or lower notes. This track may be used to check the range of frequency covered by the equipment.

(d) Vocal recording for checking intelligibility of speech and theater reverberation.

(e) Piano recording of sustained notes for checking "flutter" and "wows."

(f) Orchestral recording for checking naturalness of reproduction.

(Tracks *a*, *b*, and *c* are on one margin of the film. Tracks *d*, *e*, and *f* are on the opposite margin.)

(a) *Buzz Track*.—For checking correct alignment of film with the sound gate.

(i) Be prepared with proper tool to make adjustment of lateral guide rollers of sound gate, if necessary.

(ii) Project film with amplifiers in operation and fader up.

(iii) When the 1100-cycle (higher) note is heard, the film is passing the scanning beam too closely to the sprocket hole margin.

(iv) When the 300-cycle (lower) note is heard, the film is passing the scanning beam too closely to the picture margin.

(v) When both notes have been eliminated by properly adjusting the lateral guide roller (or by adjusting the optical system, where such adjustment is intended), correct film travel may be assumed. Adjustment of the optical system should not be undertaken unless the system has been designed to be adjusted and suitable tools are available. When one or both notes are heard intermittently, the film weave is

excessive, or the optical system improperly focused or not standard. Incorrect relative alignment of the projector head and the sound head may also cause film weave.

(b) *6000-Cycle and 9000-Cycle Constant-Frequency Tracks*.—These are for the purpose of focusing and checking the rotational position of the scanning beam. The 9000-cycle track consists of parallel lines 1 mil wide and spaced 1 mil apart, facilitating the very closest adjustment. The 6000-cycle note is provided for use when a volume indicator is not available and when the 9000-cycle note is inaudible because of the limited frequency range either of the reproducing equipment or of the ear of the listener.

When maximum volume is attained at both frequencies by carefully adjusting the focus, it may be assumed that the optical system is correctly positioned for best results; that is, that the scanning beam is sharply focused and is at right angles to the direction of film travel. Adjustment of the optical system should not be undertaken unless the system has been designed to be adjusted and suitable tools are available. The type of optical system having the light slit fixed with reference to the machined base of the optical unit will not permit rotational adjustments to be made.

(c) *Selected Frequencies*.—This is used for checking the over-all output characteristics of the sound head and the amplifier (using a volume indicator), and for listening tests to determine the range of frequency covered by the reproducing equipment. This track is also useful for locating the causes of rattling or buzzing of loud speakers. Among the various frequencies there may be one that will correspond to the natural frequency of the loose wire or part, causing it to vibrate and thus enabling it to be located.

(d) *Vocal Recording*.—This provides a good test for frequencies in the middle of the range, which exert the greatest influence on the intelligibility and clarity of speech.

(e) *Piano Recording*.—This is intended for checking and determining orally the extent of "wows" or "flutter," which are more easily detected in the sustained notes. Any factors that cause a variation in the speed at which the film passes the scanning beam, such as worn sound sprocket teeth, off-center sound sprocket, accumulation of dirt or wax on the sound sprocket, improper sound gate tension pad, or uneven tension on take-up, will cause "wows" or "flutter." A loose exciting lamp or machine vibration may also cause "flutter."

(f) *Orchestral Recording*.—This is to provide a test of the natural-

ness of reproduction, which will depend on the range of frequency covered by the reproducing equipment. This recording contains notes ranging from those of the lowest tuba and double-bass up to the very high overtones of the brass instruments. The metallic quality of certain instruments, such as the wire brushes, should be particularly noticeable.

CARE OF FILM

The test reels are *instruments of precision*, and should be handled with the special care befitting such devices. Accordingly, before threading the films into the projector, the entire track through which the film is to pass should be carefully cleaned and examined to avoid any likelihood of film damage. It is recommended that between showings of the test reel, it be wound tightly on a metal reel having a large hub, and stored in a metal reel-can which should be made as air-tight as possible (for example, by using adhesive tape).

HIGH-FIDELITY LATERAL-CUT DISK RECORDS*

F. C. BARTON**

At a meeting of the New York Section of the Society, held at New York on December 13th, the following address was delivered by Mr. Barton through the medium of a disk record of Victrolac¹ recorded through a high-fidelity recording system and reproduced through a properly compensated high-fidelity reproducing system. Following the reproduction of the record, the meeting was opened to a general discussion of the system.

Mr. Chairman and Gentlemen:

It is our privilege to demonstrate some experimental records which have been made through a high-fidelity recording system, reproducing them through a properly compensated high-fidelity reproducing system. The records are of the conventional lateral-cut variety; that is, the vibrations representing the sound waves pass from side to side in a horizontal plane.

I do not intend to present a technical paper on the subject of high-fidelity lateral recordings, or burden you with the presentation of curves analyzing the various parts of the system. Suffice it to say that the over-all system, from the original sound entering the microphone to the reproduced sound leaving the loud speaker, is substantially flat. Certain units in the system have characteristics that are anything but flat. However, for each variation that occurs in one part of the system there is a compensating variation in the opposite sense in some other part of the system; and these when algebraically added will produce a substantially flat over-all system. An example may be found in the recorder, which at 100 cycles may be down approximately 12 db. To off-set this the reproducing amplifier will be approximately 12 db. up at 100 cycles.

The records to be played are short extracts made during regular recording dates, which will account for the fact that in most cases they are incomplete, at least in so far as the beginnings and the ends of the selections are concerned.

* Demonstrated before the New York Section, December 13, 1933.

** RCA Victor Company, Camden, N. J.

These records, while not presented as indicating that perfection has been achieved, do indicate that a degree of fidelity far in advance of that normally attained is possible with the lateral recording system. Advances in technic of considerable magnitude have been achieved even since these records were made, and it is hoped that sometime in the not too distant future another demonstration of a more finished nature may be made.

REFERENCE

¹ BARTON, F. C.: "Victrolac Motion Picture Records," *J. Soc. Mot. Pict. Eng.* XVIII (April, 1932), No. 4, p. 452.

DISCUSSION

MR. EVANS: What is the material of the record?

MR. BARTON: Victrolac. It is a new synthetic resin, which has been found adaptable to the manufacture of high-grade records. The motion picture records were dyed black.

MR. EVANS: What is the range of volume between ground noise and maximum?

MR. BARTON: Some improvements have recently been made that have decreased the background noise considerably. I must revise my figures before making definite statements.

MR. HUNT: The records were started without any noise whatsoever; but it seemed that after the start a certain amount of surface noise could be heard.

MR. BARTON: Because of the abrupt start of the music, in most cases the pick-up was put on the record and the sound faded in. The background noise of some of the records was rather considerable. Improvements have been made, as I said when speaking from the record. The surface noise has been dropped 12 db., so that it is now quite in the background.

MR. MARMON: Is the reduction in surface noise due entirely to the material of which the record was made, or other contributing factors?

MR. BARTON: There are many factors, principal among them being the processing of the wax.

MR. EVANS: What are the speed, pitch (the number of grooves to the inch), the depth of the cut, the width of the cut? What is the commercial status of the records? Is the development directed toward home entertainment or for use in connection with pictures as well?

MR. BARTON: The pitch is approximately 100 grooves per inch, which is the normal commercial pitch. The speed is 78 rpm., the records having been cut on a standard recording machine. The groove is narrower than the standard groove by a couple of thousandths of an inch. The development is directed primarily at this time toward home use; it will probably branch out. It is felt that the record for home consumption has stood still for quite a long time, and that it is time something were done about it.

MR. EVANS: Is a special reproducer required for playing in the home, or can one play the records with the present reproducing equipment?

MR. BARTON: A special reproducer is required.

MR. EVANS: Have you an instrument for playing back from the wax?

MR. BARTON: Yes.

MR. YAGER: How does the volume range of the records compare with that of the ordinary record?

MR. BARTON: Volume range is entirely a matter of surface noise to signal ratio. In the records of the Philadelphia Orchestra, the surface noise was down far enough to take advantage of the increased range. The records were not monitored. If you know the volume range of the Philadelphia Orchestra, then that is the range of the records.

MR. TASKER: By monitoring I suppose you mean the adjustment of gain during recording?

MR. BARTON: Yes.

MR. YAGER: Is the deflection of the record truly lateral or at an angle?

MR. BARTON: It is truly lateral. The chief difference between these records and the commercial records as they are sold now is that the recording systems are flat to 9500 cycles and the groove is of different size. The recorders are up to 90 per cent of normal at 10 kc. The low-frequency attenuation of the recorders is somewhat different from that of ordinary commercial recorders, but that merely indicates that the reproducer amplifier characteristics should be the inverse of the recorder low-frequency attenuation.

MR. EVANS: Are the high frequencies compensated for as well as the low?

MR. BARTON: Yes. The high-frequency response is up about 4 db. in recording, and is correspondingly attenuated in reproduction.

MR. POPOVICI: What is the maximum level that can be impressed on the recorder without cutting over?

MR. BARTON: Do you mean in thousandths of an inch?

MR. POPOVICI: No, in decibels.

MR. BARTON: I would rather avoid the question of levels. If you would like the answer in terms of physical measurements, we can swing the recorder stylus a maximum of about 4 mils; that is, 2 mils on either side of the center.

MR. TASKER: I suppose you refer to the amplitude at relatively low frequencies.

MR. BARTON: Relatively low frequencies. The recording system has practically constant amplitude characteristics from about 800 cycles down, and constant velocity characteristics from 800 cycles up.

MR. ROSS: Does the tone-arm follow the groove freely or is it screw driven?

MR. BARTON: It is free; but no trouble is experienced from jumping the groove.

MR. TASKER: We can all agree to the last statement, having heard the tremendous range of the records without any jumping of grooves.

MR. MANHEIMER: Is there a counterbalancing arrangement on the reproducer arm?

MR. BARTON: Yes, although the pick-up is very light in itself.

MR. DIAMOND: Is an ordinary needle used for the reproducer?

MR. BARTON: We use a diamond. With the very light pick-up the weight of the set-screw for clamping the needle would alone be entirely out of the question; in fact, the whole moving system in the pick-up probably weighs less than a steel needle—considerably.

MR. ROSS: What other equipment contributes to the quality, aside from the recording process?

MR. BARTON: The standard high-fidelity RCA Photophone film reproducing system is used. At the input of the system is a small amplifier, which has the necessary compensation to differentiate between films and disk; in other words, it has the necessary characteristics to bring the disk recording out flat when coupled to this Photophone reproducer.

MR. MANHEIMER: Is there only one speaker back of the screen?

MR. BARTON: Yes, a single speaker.

MR. DROSATTI: How many times can you play the records?

MR. BARTON: I don't know; a great many times. Some day when I have the time I shall cut some that stay in the same groove, and play them to death. It would take a long time to play a complete record enough times.

MR. ROSS: I should like to hear the recorded speech again, and afterward hear you repeat part of the speech in the same tone. Your voice seemed somewhat more formal through the microphone. (Mr. Barton did as Mr. Ross requested.)

MR. EVANS: How far did you stand from the microphone when the record was made?

MR. BARTON: About 2 $\frac{1}{2}$ feet.

MR. KELLOGG: The record sounded to me as though you were in a much more resonant room than this when you made the speech over the record. Also you have been standing about 10 or 12 feet nearer us than the loud speaker. This increases the contrast between your natural and recorded voice. If you had stood farther back in carrying out the test requested by Mr. Ross the naturalness would have been increased.

MR. BARTON: I say there have been advances since the record was made. You see, I am supposed to be talking. The advance took place just prior to the time this particular speech record was made.

MR. KELLOGG: Then the words "these records" in your recorded speech refer only to the musical records?

MR. BARTON: Yes.

SHOULD STUDIO RECORDING EQUIPMENT COMPENSATE FOR THEATER REPRODUCING CHARACTERISTICS?

At a meeting of the New York Section of the Society, held at New York on December 13th, an open forum discussion of the subject of compensation was held. The discussion follows:

MR. TASKER: We have heard a number of examples this evening of sound that was produced through recording and reproducing systems that were engineered to cooperate in some manner or other. The meeting is now open for remarks on the manner of engineering the two systems with respect to each other.

MR. EVANS: Quite a long time ago, two or three years at least, it was suggested that the recording system be made to compensate for the theater characteristics. I advocated rather strongly to the Sound Committee that that be done, but the majority of the Committee seemed to feel otherwise. My reason for advocating it at that time was that the reproducing equipment of those days was rather deficient in both high and low frequencies, and it seemed as though some of the deficiency might be compensated for in the recording system. The majority of the Committee felt, however, that nothing of that sort should be advocated because it would not be long before the reproducing equipment would be improved, and then anything that had been so recorded as to sound well on existing equipment would not sound so well on the improved equipment. The discussion continued for a couple of years, but the recommendation was finally made that the recording system should be so designed as to produce a flat characteristic on the print, and that the reproducing equipment provide a flat characteristic from the print through the loud speaker. I do not know whether the Standards Committee has acted in the matter.

MR. BATSEL: It has not been presented to the Standards Committee.

MR. EVANS: It has, however, been formally adopted by the Sound Committee. At about the time it was adopted the new reproducing equipment was becoming available. RCA was bringing out the high-fidelity system and Western Electric its wide-range reproducing equipment. Strangely enough, at about the same time some of the studios on the West Coast acquired the idea of compensating for the reproducing equipment during the recording; and in the spring we began to notice that some of the pictures coming from the Coast had been so compensated, with the result that we are now faced with a rather difficult situation. According to recent figures, about 1000 theaters are now equipped with high-fidelity or wide-range systems—mostly class A houses, I believe—and it is very confusing at the present time to have some of the pictures compensated during recording for the older equipment: when these are played on the newer equipment they do not sound as well as when reproduced on the older type of equipment. In July Dr. Goldsmith asked the Sound Committee to consider the subject of standardizing the frequency characteristic and to try to induce the

various studios to adhere to such a standard, so that the recordings made by all the studios would sound alike on the same equipment. This problem will be one of the most important before the new Committee this coming year, and I hope some progress will be made in solving it.

MR. KELLOGG: Did the compensation take the form of accentuating the bass or accentuating the high frequencies?

MR. EVANS: More particularly the high frequencies.

MR. MCNAIR: It seems to me that the recommendation of the Sound Committee that the recording of itself be flat, and the theater equipment also of itself be flat, is a sound point of view. It might be well to ask, though, whether any one knows the reasons why certain producers were led to make films that were not in accordance with that principle. (No answer.)

MR. TASKER: It is true that compensation that raises the high frequencies above the normal level during recording, and decompensates to the same extent in reproducing, provides inherently a lower noise level than can be attained with the so-called ideally flat characteristics?

MR. EVANS: I believe that that statement is true only for a limited amount of upward compensation of high frequencies during recording, with appropriate downward compensation, or decompensation, during reproduction. If we plot the curve of acoustic energy produced by the ideally flat reproducer through unmodulated film we should expect a noise-energy curve that would continuously rise toward the higher frequencies. If this curve were then multiplied by the relative sensitivity of the ear for each frequency a new curve would result that would be a figure of merit for this system. If, then, the recording system is compensated upward to correspond to this latter curve, and the reproducing system decompensated downward to an equal extent, we should attain the lowest noise level that is possible.

MR. YAGER: By increasing the high-frequency response in order to allow for the loss in compensation, the noise level of the entire system increases with the gain of the recording amplifier; and nothing is gained unless the noise level is entirely within the range of compensation.

MR. EVANS: We must bear in mind when considering noise level, that the film is probably at the present time the controlling element. I do not believe that the system noise is as great as the film noise after the film has been run through the projector a few times. The noise level increases considerably after a few trips through the projector.

MR. BATSEL: Our experience indicates that the point Mr. Evans and Mr. Yager have made is essentially correct. If it is necessary to compensate or equalize for losses in reproducers, the recording system would probably have to be peaked so much for frequencies as high as 9000 cycles that the swing for full modulation would be taken up by those frequencies instead of frequencies in the range contributing most to the loudness of the speech or music. The gain required for reproduction would be increased to such an extent as to result in perhaps more noise than is produced by a flat system. In reproducing, there is a certain amount of extremely high-frequency hiss that would be lost by attenuating the high frequencies, but much can be accomplished in limiting noise by having a reproducing system free of peaks. The noise is much less, as pronounced peaks at some frequencies may increase the noise without having much effect on apparent

loudness. If the system is smooth, some of the hiss due to the film grain is eliminated by attenuating the highs. By carrying compensation to extremes the noise will be increased.

MR. RICKER: In the average theater, or even in class *A* theaters, to what extent can a loud speaker reproduce film grain noise?

MR. TASKER: Do you mean with respect to the frequency?

MR. RICKER: The point I wish to make is this: that the loud speakers are not able to reproduce frequencies such as would be represented by the film grains that I find and measure under the microscope. I believe that many of you engineers charge ground noise against film grain when it should be charged to some other factor.

MR. TASKER: I believe it is a fact that noise from film does extend over the whole frequency range; but it is obvious that any 500-cycle components, for example, could scarcely arise from film grain or even grain clumps, but must be due to irregularities of the base or variations of the sensitivity of the emulsion, or something of that sort.

MR. RICKER: A careful examination of film after it has been used a few times and dried out would show reason enough for ground noise. There will be found scratches and translucencies that come into the base as well as in the emulsion; enough to be responsible for the increased noise. If the base is examined by reflected light under a microscope, or by transmitted light, it will be found that the most perfect base is anything but constant in its refractive effect. In other words, the piece of film base, when magnified, looks like a piece of corrugated glass instead of a piece of flat glass. Nitrate base is more perfect than acetate base; but either, when stripped of emulsion, will provide plenty of ground noise if run through a sound head.

[Note: Measurements of the ground noise of film base are given in the article by O. Sandvik, V. C. Hall, and W. K. Grimwood, on p. 83 of the February, 1934, issue of the *JOURNAL—Ed.*]

AN AUTOMATIC CHANGE-OVER DEVICE*

A. PRITCHARD**

Summary.—A device proposed for use in all theaters as a standard method of changing from one projector to the other is described. The device is controlled by a constant frequency photographically recorded on the edge of the film a given distance from the end of the picture portion of a reel of film. Its purpose is to eliminate individual cueing and improve the presentation of talking motion pictures by enabling the projectionist to make change-overs more exactly without visible marks on the screen, and to avoid to a large degree the film mutilation and increased fire hazard that results from the practice of individual cueing.

The primary purpose of this paper is to outline the principles and methods of operation of an automatic sound and picture change-over device, intended for use in theater projection rooms and all other places where 35-mm. film is projected, using two or more projectors in sequence.

The purpose of the device is to improve the presentation of motion pictures in enabling the projectionist to make change-overs more exactly and to eliminate the visual cues and individual cueing that result in the mutilation of film. It is controlled by a record, similar in appearance to a portion of a constant frequency sound track, recorded on the prints photographically between the row of perforations and the edge of the film at a certain distance from the end of the picture portion of the reel.

Cueing Methods.—Until about three years ago the entire problem of cueing for change-overs was a matter for the projectionist to solve to the best of his ability. That was a very undesirable situation, since practically every projectionist had his own way of cueing. Some scratched lines in the emulsion, some scratched crosses; some punched holes of a particular shape so as to distinguish theirs from the other holes previously punched by other projectionists. Others preferred to use click splices, and in order to distinguish theirs from the others, they used a certain color or shape or placed them in certain positions on the frame. Others wrapped a strip of tinfoil around the edge of the film, and in many cases an adhesive was employed which

* Presented at the Fall, 1933, Meeting at Chicago, Ill.

** Coronado, Calif.

caused the film to crack, requiring that portion of the film to be removed. Others trimmed the edge of the film close to the sprocket holes, thereby weakening the film which also resulted in the later removal of that portion of the film. Others who had a little respect for their profession and the producers, chose to use china-marking pencils of their preferred colors, so that the cue might be erased and not permanently mutilate the film.

In the interest of improving change-overs and conserving the prints, the standard release print, which was made effective Nov. 1, 1930, provided standard cue dots photographically recorded in the picture portion of the film for eliminating the individual cueing and improving the presentation of the picture. It is now definitely proved that the standard dots were not the remedy for the situation. The majority of the projectionists have returned to their old methods of cueing, apparently paying no attention whatever to the standard dots except when they are so conspicuous that they could not possibly be missed, and even then sometimes they apply their own cues.

An increasing number of projectionists are at the present time using a method of cueing that adds very greatly to the fire hazard. That is the use of tinfoil, or painting the edge of the film with a conductive paint. In one scheme, one of the rollers of the lower sprocket is insulated from the projector head. One wire of a 110-volt supply leads to the projector head; another from the insulated roller leads to a lamp; thence to the other side of the 110-volt supply. The tinfoil or conductive paint completes the circuit from the one roller to the other, thus causing the lamp to light. Under normal conditions a very small current flows through the circuit. But, suppose the lamp were injured or something happened that would short-circuit the lamp as the conductive strip passed through. There would be a flash, and then a fire. True, there are regulations against such things, but they do not seem sufficient to stop the practice. However, there are ways of stopping people from doing things, and usually the best way is to show them something better. A few examples of the fore-mentioned methods of individual cueing, now in general use, are illustrated in the accompanying photographs of pieces of film (Figs. 1 and 2) cut from prints received from exchanges.

Requirements of a Satisfactory Change-Over Method.—In order that a change-over may be perfect several precautions must be observed: (1) the film in the oncoming projector must be threaded at the proper distance from the first picture; (2) the motor switch and

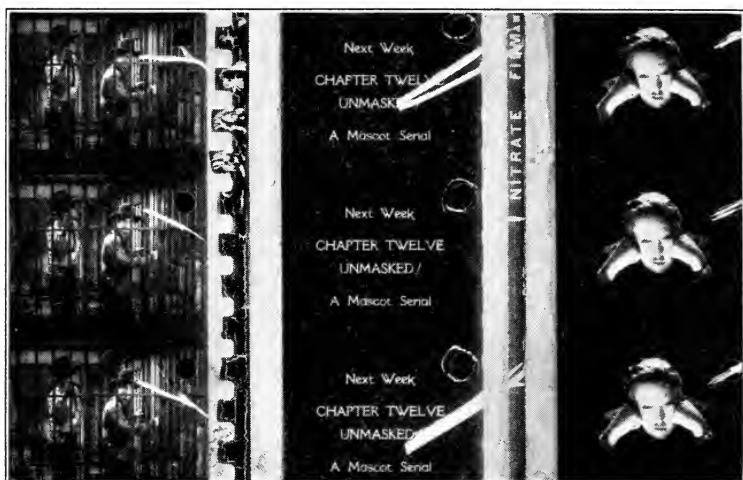

A

B

C

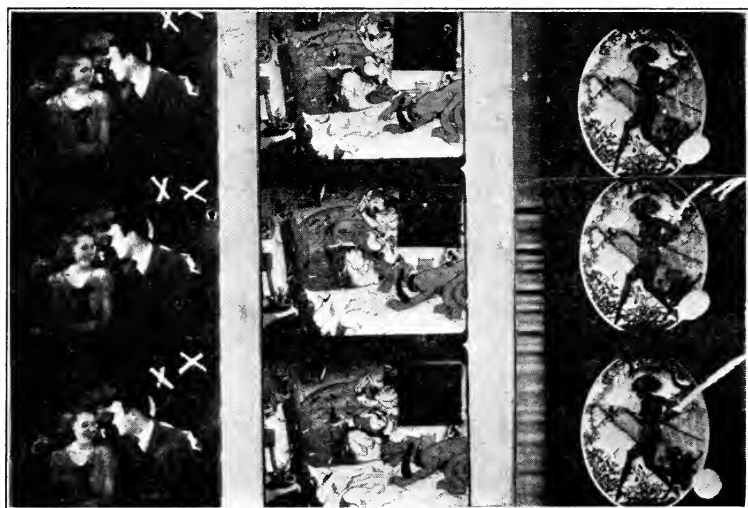

D

E

F

FIG. 1. (*A, B, C*) Illustrating complete disregard for the standard dots. The edge of sample *A* has been painted with a conductive paint.

(*D*) Since the crosses on the left are more upright than those on the right, the indication is that they were put on the film in different theaters.

(*E*) The black squares represent pieces of black film cemented to the print. As a result, the film was made very stiff and tended to break more easily.

(*F*) The presence of the round hole at the bottom as compared with the oval holes above would indicate that the holes were punched in different theaters. The scratches in this color print extended nearly to the center of the frame, and showed red on the screen.

douser switch must be closed at the proper time; and (3) the sound must be changed from one machine to the other at the proper time.

The first operation can with a little care on the part of the projectionist be done correctly. However, as to the others, the most alert and conscientious projectionist can not repeat them at the same intervals every time, and variations in the performance of those operations result in imperfect change-overs. From such facts it is apparent that change-overs can not be made perfectly

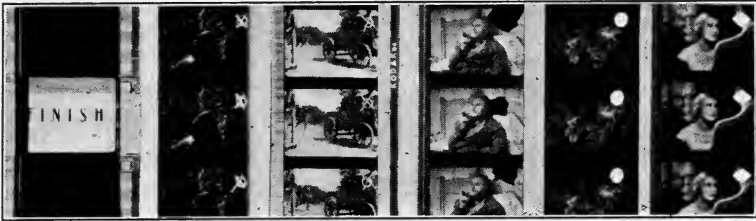

FIG. 2. Miscellaneous examples of "cues" clipped from current films.

every time by manual means: they must be accomplished by automatic means. It is the writer's opinion that the apparatus described herein fulfills the requirements for a means for making a perfect automatic change-over every time in any theater.

In any remedy for the appalling situation that now exists several facts must be borne in mind:

- (1) If individual visual cueing is to be eliminated, all visual cues must be eliminated.
- (2) The method must be amenable to standardization, and adapted to the needs and requirements of all theaters.
- (3) Cues or means of control of an automatic change-over system have no place in the picture portion of the film.
- (4) The cue or control of the device must be impossible of duplication by the projectionist.
- (5) The cue or control must be positive in operation and impossible of accidental duplication.
- (6) The cue or control must be photographically recorded on the film, and not controlled by trimming or notching the edge of the film.

The constant frequency area will fulfill all these requirements; a portion of a film thus prepared is illustrated in Fig. 3.

The Change-Over Control.—Following the trend of many modern electrical developments, the change-over device depends upon a beam of light and the photoelectric cell for its operation. Referring to Fig. 4, the optical assembly collects light from the exciting lamp

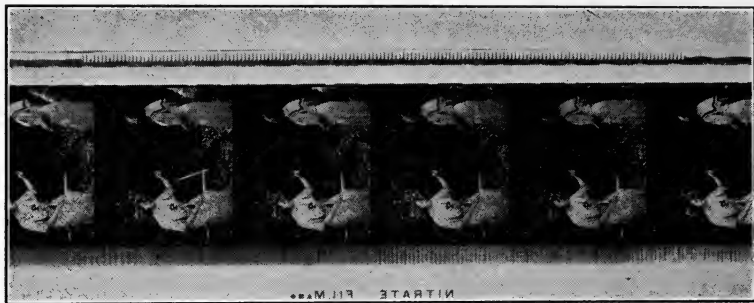

FIG. 3. A portion of film bearing the constant frequency record on its edge.

and projects a line of light upon the film. Due to the fact that the frequency recorded on the film will not be high, it will be apparent that a rather inferior optical system, compared with that used for sound-on-film, may be used.

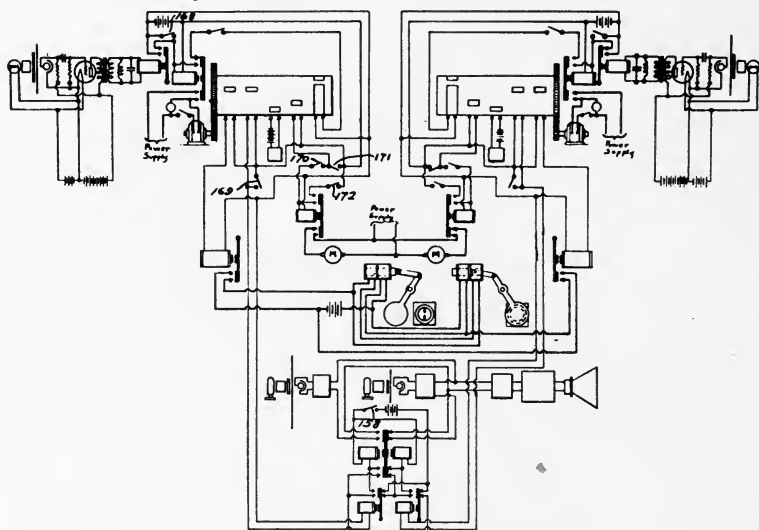

FIG. 4. Wiring diagram, illustrating how the various circuits are controlled in sequence by the revolving drum.

The photoelectric cell is coupled to the amplifier in the conventional manner. Current fluctuations in the cell cause fluctuations in the voltage drop across the resistor, which are transmitted through the coupling condenser to the grid of an amplifier tube. The transformer in the output circuit of the tube is coupled to a tuned relay, which is tuned to the frequency recorded on the film.

We shall assume that the tuned relay has just been actuated by the passage of the constant frequency area through the light beam. Being a momentary contact relay, it closes a circuit to an interlocking relay. The latter closes a circuit to the motor, which is geared to a revolving drum in such a manner as to cause the drum to revolve slowly and at a predetermined speed. On the drum are means for closing various circuits in sequence and with a predetermined interval of time, depending upon the adjustments of the circuit-closing means.

The drum, now revolving, first closes the circuit of a bell or other warning signal, which calls the projectionist's attention to the fact that the reel is nearing conclusion and that it is time for him to light the lamp of the oncoming projector and make any other adjustments that may be necessary. The next circuit to close is that of the projector motor, which is completed through several switches, the purpose of which will be explained later. Next, the douser control relay and the sound control relay operate simultaneously. The douser relay closes a circuit from a source of electric

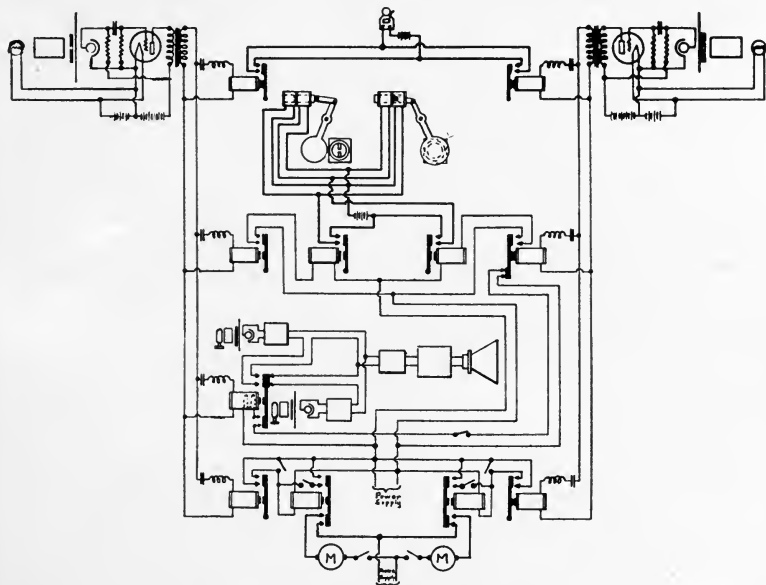

FIG. 5. Wiring diagram, illustrating how the various circuits may be controlled by separate areas of different frequencies.

supply to the coils of the doussers (the battery shown as the source of supply was included as a matter of convenience in illustration only). The sound control relay is a momentary contact relay. Its function

is to break the interlock of one of the coils of the double-coil interlocking relay, which breaks the sound circuit and closes the circuit of the opposite coil of that relay, thus causing the sound circuit to be closed for the other machine. The change-over has thus been made; the revolving drum continues to run until the circuit of the interlocking relay controlling the motor is broken by the drum. The outgoing machine is then stopped by manually operating switch 172 (Fig. 4), which breaks the interlocking circuit of the projector motor relay. Due to the fact that there is no particular advantage in stopping the outgoing projector automatically, means have not been included on the drum for doing so. It will be understood, however, that any operation associated with change-overs, such as the control of title curtains or lighting effects, wherein the desired effect depends upon executing the operations at the proper instant, can be controlled by the drum. The drum can be made in sections, so that any number of sections may be used; and each section may be so adjusted in relation to the others so as to conform to the individual requirements of each theater.

Should it be desired to change over the sound from one machine to the other manually, switch 169 (Fig. 4) may be used. Switch 158 is provided for stopping the sound reproduction of either machine. Switch 168 is used for closing the circuit of the drum motor relay manually when starting the first projector at the beginning of a show, thus insuring that everything is operating properly and that the douser is not opened until the film has reached the proper position, eliminating the chance of showing leader footage marks on the screen. Switch 170 may be used when shutting down after the last reel of a performance, thus preventing the projector motor from starting. Switch 171 is used for starting the projector motor alone, for "warming up" or testing, or for playing musical disk selections on certain types of equipment.

Fig. 5 illustrates a slight variation of the system shown in Fig. 4. Here it is intended that separate constant-frequency areas, of different frequencies, located on the film in their respective positions, will actuate the different relays controlling the several circuits in the proper order and at the proper time by varying the inductance and the capacitance of the separate resonance units. However, in the opinion of the author the revolving drum method is by far the most practicable, because it can be adjusted to conform to any requirements of each theater.

THE CONTROL FREQUENCY PRINCIPLE*

J. E. JENKINS AND S. E. ADAIR**

Summary.—The control frequency principle, consisting in the impression of a supra- or infra-audible frequency on a disk record for the purpose of actuating relays and local circuits in order to change views projected by a stereopticon or other means, is described. Two forms of apparatus are presented, the Phonopticon and the Controlophone.

We realized some time ago that it might be desirable to synchronize certain mechanical and electrical actions with recorded sound, if such an accomplishment could be achieved by fairly simple and not too expensive equipment; and believed that it might be done by superimposing at the proper point on the record some frequency, preferably outside the audible range, and arranging the circuits so that this frequency would operate a relay while the remainder of the recorded sound operated loud speakers in the usual manner. The frequency might be supra- or infra-audible, but the latter was chosen. We planned to use ordinary lateral-cut records for the commercial equipment, on which it would be difficult to impress a high frequency, and from which it would be as difficult to reproduce it. Furthermore, the high-frequency impressions wear off more rapidly than the low.

We therefore decided to use a low control frequency, keeping in mind the danger of overcutting, the poor response of the average commercial pick-up, and the possibility of interference by the very low notes of musical instruments. After considerable investigation, we found that a 48-cycle note, if recorded and reproduced as nearly as possible in sinusoidal form, was practically inaudible to the average person. This frequency was also within the other limitations, and has been found in practice to be very satisfactory. It is the frequency of G_3 in the musical scale. While several instruments go below G_3 , the impression of the fundamental is not sufficient to operate the control relays.

We were forced to develop the *Controlophone* from standard com-

* Presented at the Fall, 1933, Meeting at Chicago, Ill.

** Jenkins & Adair, Inc., Chicago, Ill.

mercial parts, for the reason that it was necessary to make the sale price as low as possible. It was not possible to use special pick-ups, turntables, or tubes, and we were limited to the regular lateral-cut record. Outside of special transformers and retards, which are part of our business, all parts had to be purchased on the open market. This fact did not in any way simplify matters.

While the apparatus was still in an early stage of design, we encountered an interesting problem in connection with the 48-cycle oscillator for putting the impulses into the recordings. These impressions became known as "bloops," and the device was therefore

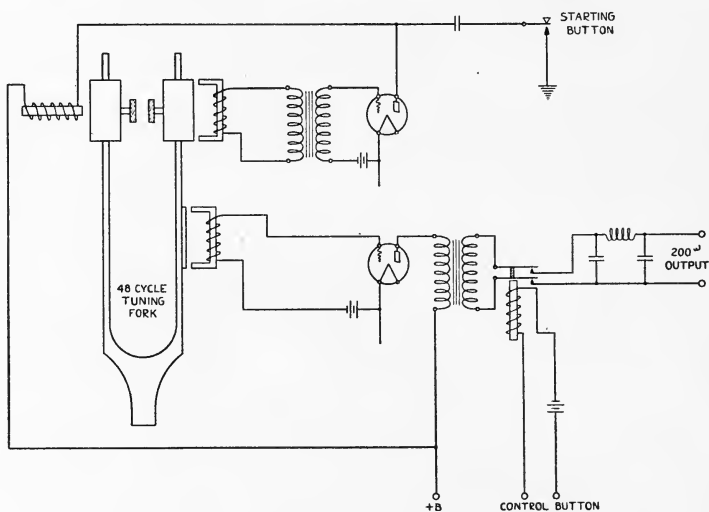

FIG. 1. Schematic circuit of apparatus generating 48-cycle control frequency, used in producing Controlophone records.

the "blooper." It had to be portable, self-contained, produce a really sinusoidal current of constant amplitude, connect into a microphone mixing position, and impress in the wax a bloop that was free from a most annoying click at its beginning and end. The final device (Fig. 1) consisted of a good tuning fork, one of its tines driven by a vacuum tube with grid and plate magnetically coupled, and the other tine affecting a simple magnetic pick-up, which was followed by a one-stage amplifier having a 200-ohm output. A remotely controlled relay was included in the circuit, as well as a section of low-pass filter. The purpose of the filter was to annul the objectionable click caused by transients that occurred when the relay happened to close the out-

put circuit at the instant of maximum amplitude of the 48-cycle current. For reasons that will be noted later, constant frequency was not a requirement. A variation of 3 per cent would do no harm; hence, thermal control and like complications were unnecessary.

The *Phonopticon* and *Controlophone* circuits are basically identical (Fig 2). The Phonopticon was designed to work in conjunction with the Bausch & Lomb *Balopticon*, a continuous automatic slide projector, motor-driven. It may be equipped with a limit switch, which will stop the motor after a new slide has been moved into position. This limit switch is simply a cam-operated contact in series with the

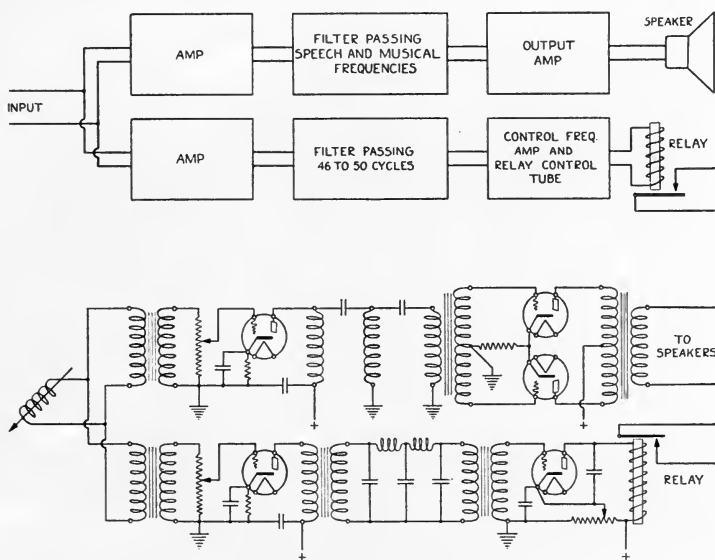

FIG. 2. Schematic circuit of Phonopticon.

motor circuit. The function of the Phonopticon is to short-circuit the switch when the pulse on the record closes a simple relay. The pulse on these records has a duration of $1\frac{1}{2}$ seconds. The new slide comes up about half a second after the start of the pulse. The Balopticon mechanism cycles once, and awaits the next pulse. The result is an inanimate automatic lecturer, which delivers a talk on a given subject and turns up its own slides at exactly the right moment. The turntable is of the automatic repeating type, so that the machine may be run continuously. If desired, the turntable is equipped with a limit switch, so that the Phonopticon will tell its story once, and

then wait until the starting button is pressed again. The length of the record, when concerned with sales talk, should never exceed three or four minutes. Lectures, of course, may be of any length. In one instance, we had to supply a turntable with a record changer, to provide a performance lasting 40 minutes, and using 80 slides. This is not desirable.

While up to the present time our installations have included a Balopticon, the device is applicable to any automatic picture-changing mechanism. It is now being arranged for use with a slide-film projector in which the film will be moved by a solenoid, this latter being operated by the pulses on the record.

The applications of the Controlophone are far more difficult to describe, as they have assumed such a number of different forms. As

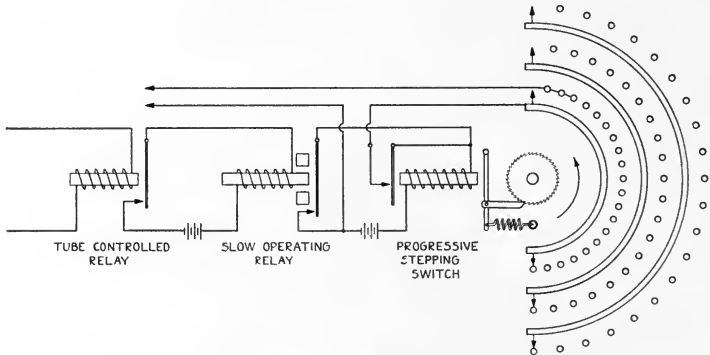

FIG. 3. Relay and switching circuits of Controlophone.

has been said, the basic set-up is the same, as shown in Fig. 3. Following the sensitive d-c. relay in the plate circuit of the control output tubes is a time-delay relay. It is set to delay about $\frac{2}{5}$ of a second, the purpose being to prevent its acting on brief impulses from scratches or imperfections in the record and thus throwing the system out of synchronization. The contacts of the time-delay relay close the motor circuit of a standard rotary selector switch, which in turn controls the lights, motors, *etc.*, which go to complete the Controlophone display. Between the selector and these devices are interposed suitable external relays, the size and type of which are governed by the loads involved.

The selector switch is wired so that it returns to its starting position at the end of each performance. Instead of depending upon the

pulses in the record to do this, we decided on a definite mechanical control, and built into the repeating turntables a contactor that operates only during the repeating action. The circuit established through this contact restores the switch, and re-synchronizes the system, if it be necessary to do so.

A brief description of some Controlophone installations should be of interest, and I have selected three which are very different in character.

A simple application is found in an installation demonstrating a mayonnaise mixing machine. The record runs $3\frac{1}{2}$ minutes, during

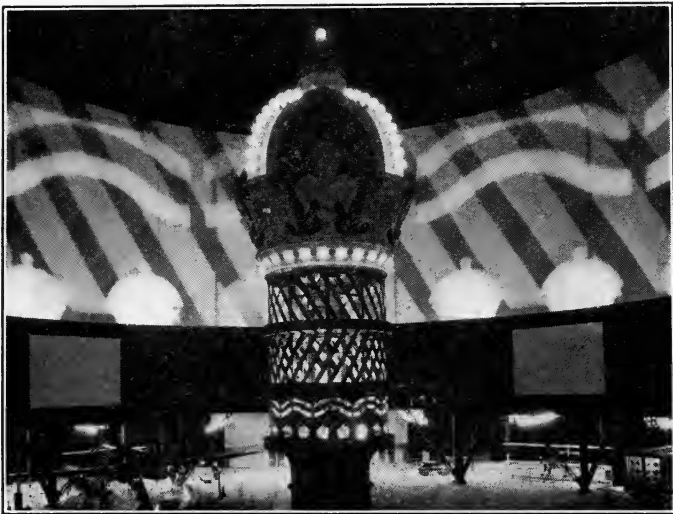

FIG. 4. Standard Oil Co. of Indiana display in operation.

which time the announcer describes the mixing machine. As he mentions the various important parts, the attention of the audience is at once directed to them by neon tube arrows, suspended over them and pointing to them.

As another example, part of the Union Carbon & Carbide exhibit in the Hall of Science,* is actually a large 12-foot turn-table supporting four dioramas pertaining to various products, entirely housed in, and having three apertures through which three of the dioramas may be seen. Four different records are required, and four voice channels.

* Century of Progress World's Fair, Chicago, Ill.

Only one of these is a Controlophone, which supplies the oral description and operates dimmers and various lights on the acetylene diorama. The other three dioramas do not require synchronous effects, but their three records are started by the Controlophone simultaneously with its own record. All four records are of the same duration, and when their speeches have ended, the Controlophone rotates the whole 12-foot turntable one-quarter of a revolution, after which it starts all four shows over again. People grouped around the structure may see the four shows in succession without changing their positions. The four records contain 2½-minute talks.

The largest and most complex installation is for the Standard Oil Co. of Indiana, in the huge rotunda of the Travel and Transport



FIG. 5. Standard Oil Co. of Indiana control room.

Building* (Fig. 4). The 32-ton steel structure in the center of the rotunda is about 90 feet high. The three lower stages house silhouette machinery, with three 15-kw. lamps centrally located. The ring above these supports 24 moving-coil loud speakers. The crown contains four silent 35-mm. projectors and operators.

The show begins with a 6-minute introduction, during which a musical prelude, composed for the purpose is reproduced. Pulses on

* Century of Progress World's Fair, Chicago, Ill.

the record control the silhouette machines in synchronism with the changes in mode and tempo of the musical score, slowly building the lighting and sound up to a very startling climax. At that point, the projectors are started, and the Controlophone continues to supply suitable background music for the moving pictures until their conclusion, some 20 minutes later. The show is started by a time-clock, hourly on the half-hour. The only manual operation is the reloading of the projectors by the operators.

The control room, shown in Fig. 5, contains, from left to right, generators for the projector arcs and for the Controlophone, which is seen mounted on three tall racks; then the complicated relay panels, and under them the generators for the silhouette lamps; and finally the program drum, the rotation of which is handled directly from the rotary switch of the Controlophone.

NEW MOTION PICTURE APPARATUS

THE ROTAMBULATOR—A NEW MOTION PICTURE CAMERA STAND *

J. A. DUBRAY**

Modern Motion Picture production has developed an interesting technic which, though not entirely new, is now applied to such an extent that it has required the development of new apparatus to assure perfection of execution and rapidity of manipulation. In 1910 or 1911, the Italian producer of *Cabiria*

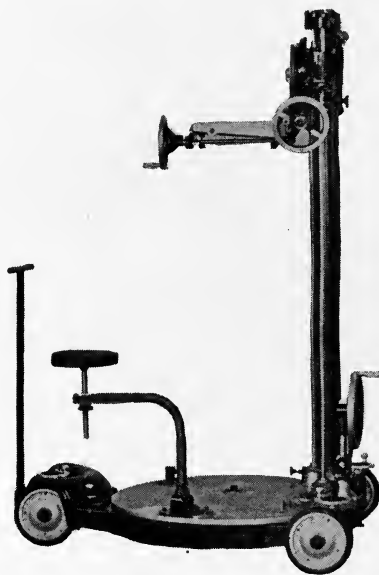

FIG. 1. The Rotambulator, showing highest position.

conceived the idea of replacing the stereotyped system of cutting from long shots to close-ups with the perambulating of the camera toward the action that was to be emphasized.

All who saw the picture marveled at it then, and still remember today the

* Presented at the Fall, 1933, Meeting at Chicago, Ill.

** Bell & Howell Co., Hollywood, Calif.

theretofore unknown sense of continuity of action that resulted and the sense of intimacy that was conveyed by that relatively simple trick. It was only around 1926 that German producers revived the idea and elaborated it with such astounding results that American producers fell in line and the camera began to travel about the sets, at times, perhaps, with exaggeration, but most of the time maintaining a very effective continuity of action and a sustained interest in the story.

At the time that recorded speech became an essential part of motion pictures, the new technic proved invaluable as a means of sustaining the tempo of the action which the spoken word had a tendency to slacken. Expedients were resorted to and the camera was set on rude perambulating platforms improvised

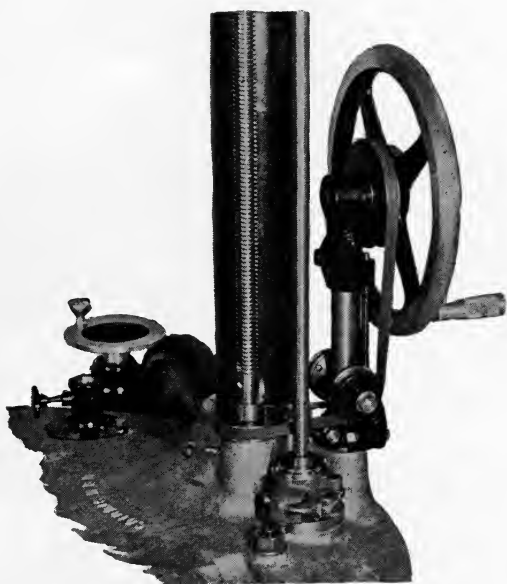

FIG. 2. The elevating mechanism.

according to the needs of each individual scene. Little by little, with the designing of more efficient rolling tripods, the perambulating camera had to evolve means for controlling the technic involved in its motion, with the result that special "follow focus" devices and special self-adjusting finders were added to it. The increasing complexity of camera motion brought forth the building of cranes, some of them mastodonic, some of less bulk and more easily manipulated.

At that time the Bell & Howell Company considered the advisability of constructing a camera stand for practical every-day use—one that would permit with ease the simultaneous use of the four elements of camera motion. These are, disregarding any attempt of having the camera perform acrobatic tricks: perambulating, panning, tilting, and elevating or lowering. Such a piece of equip-

ment was considered highly desirable also because the bulk and weight of the camera "blimps," now in use, made every camera "set-up" a matter of brawn rather than brain unless facilities were given the cinematographer to set his camera easily and quickly at the proper distance and height.

The *Rotambulator*, illustrated in Figs. 1 and 5, consists of a three-wheeled undercarriage on which rests a rotating platform. A strong upright holds the camera platform and the elevating and tilting devices. Both panning and tilting are accomplished by the cameraman from a seat which is an integral part of the panning platform, so that his position in relation to the camera is always the same irrespective of panning and perambulating.



FIG. 3. The base, showing the large pulley for the panning drive and the large ball race.

Fig. 1 shows the general appearance of the apparatus with the camera platform at its highest level. The main dimensions are as follows:

Over-all height	90 in. (7 ft. 6 in.)
Over-all length	62 ³ / ₄ in. (5 ft. 2 ³ / ₄ in.)
Over-all width	46 ³ / ₄ in. (3 ft. 10 ³ / ₄ in.)
Max. height of camera table	71 ³ / ₄ in. (5 ft. 11 ³ / ₄ in.)
Min. height of camera table with panning wheel attached	16 in. (1 ft. 4 in.)
Min. height of camera table with panning wheel removed	12 ³ / ₄ in. (1 ft. ³ / ₄ in.)
Diameter of rotary platform	42 in. (3 ft. 6 in.)
Size of camera table	13 ¹ / ₄ in. × 13 ⁷ / ₈ in.
Max. height of seat	39 ³ / ₄ in. (3 ft. 3 ³ / ₄ in.)
Min. height of seat	31 ³ / ₄ in. (2 ft. 7 ³ / ₄ in.)
Height of standing platform	21 in. (1 ft. 9 in.)
Net weight	700 pounds

When the camera is set at such height that it is difficult for the operator to follow the action through the finder, the seat is replaced by a lower platform on which he can stand, bringing his eyes to the level of the finder.

The elevating mechanism is illustrated in Fig. 2. Through a crank and pulleys

linked by a belt, the elevating screw is made to rotate at a ratio of five turns for three complete turns of the crank. The screw acts upon a nut in the camera platform housing, raising, or lowering it one foot for every 36 turns of the crank.

A great deal of thought has been given to determining the elevating speed, experience having taught that it would be mostly used for rapidly setting the camera at the proper height and seldom for the purpose of achieving the effect of changing elevation while the camera is operating. That can, however, be done, and again experience has proved that a greater or lesser elevating or descending speed would not be conducive to any better results.

The panning crank is in easy reach of the operator at the left of the camera platform. It operates through two beveled gears which rotate an upright and a

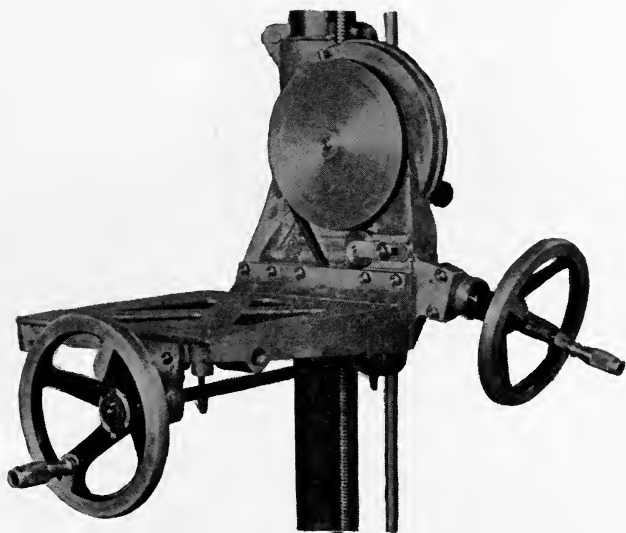

FIG. 4. The camera platform and the panning and tilting controls.

pulley located within the base which is in turn linked by a belt to another pulley, shown in Fig. 3. The smoothness of the panning operation is attained through proper tension of the belt and the possibility of adjusting it, and through a large ball race as shown in Fig. 3.

The tilting mechanism is easily controlled by the right hand of the operator, and consists of a worm and worm gear which control the motion of a system of pulleys and an adjustable belt shown in Fig. 4. Ball races of generous diameter assure smoothness of motion and a good balance against the considerable weight of a camera enclosed in a blimp (from 300 to 500 pounds). The camera platform is a separate unit solidly anchored to the tilting system. Its design can be altered to accommodate blimps of any design.

Both the panning and tilting devices can be disengaged; the first by releasing a clutch; the second by opening a lock, thus idling the gears so that the apparatus

can be used in the same manner as a "free tripod head," in which case, however, the operator must work from the floor and sacrifice the convenience of the seat.

The undercarriage forms a solid triangular base of such width and length as to assure rigidity of the apparatus even when the camera is at the maximum height. The carriage is mounted on four rubber rimmed wheels mounted on ball bearings and perfectly aligned to insure smoothness of running. An operator perambulates the apparatus by means of a tongue handle, the two wheels at the apex of the triangle being mounted on a swivel carriage. Three jacks permit

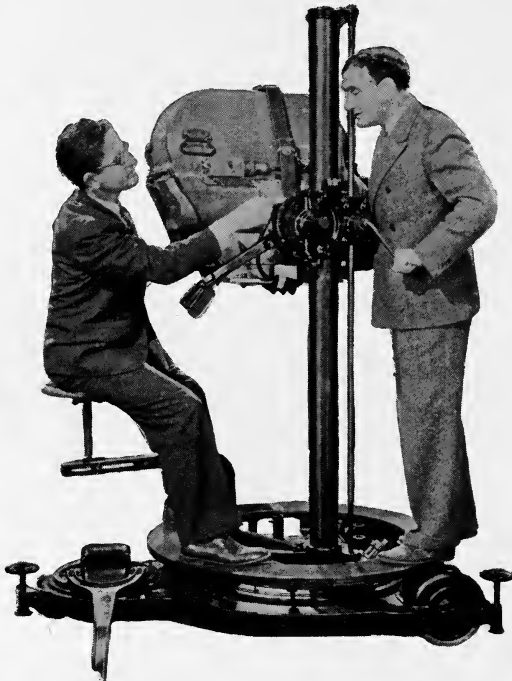

FIG. 5. The Rotambulator in use at the M-G-M Studio.

stabilization of the machine for stationary "shots" and also leveling in case of slight unevenness of the floor.

Among the details of construction, the following are worthy of mention: the camera platform is so located that in the panning operation the axis of revolution is as close as possible to the photographic lens, depending upon the design of the blimp. The cameraman's seat is adjustable so that the operator can place it in the most comfortable position. Sockets are made part of the rotating platform so that additional seats or lighting equipment can be fastened to the apparatus.

The other type of *Rotambulator* is illustrated in Fig. 5, where it is shown with the camera blimp in position, and cameraman William Daniels and Director

Edgar Selwyn at the controls. The principal difference between this design and the one described above consists in the method of controlling the tilting and panning arrangements. Gears, pulleys, and belts are eliminated, smoothness of operation being attained by controlling the mechanism through oil feeds. The tilting handle is simply moved up or down according to the requirements, and a slight pressure on a trigger which is integral part of the handle releases a stout brake which otherwise holds the tilting device locked in position.

The panning arrangement is novel in that it is operated by a slight pressure of the operator's foot on a stationary circular platform independent of the rotating platform on which the camera standard is mounted. This method offers the advantage of freeing the left hand of the operator.

BOOK REVIEWS

Commercial Cinematography. G. H. SEWELL. *H. Greenwood & Co.*, London, 1933.

There has been a need for a book of this type which would give the industrial firms definite practical information concerning the making of 16-mm. pictures. As the author states, "The making of films consists of one part photography and nine parts picture making." Too often in his experience business firms have overemphasized the photographic aspect and have given too little thought to the idea of producing an interest-compelling picture. Equipment is described for taking, editing, and projecting 16-mm. and 9.5-mm. films. Data are included on stop-motion and cartoon work, and a brief concluding chapter deals with amateur sound films.

G. E. MATTHEWS

Amateur Talking Pictures and Recording. BERNARD BROWN. *Isaac Pitman & Sons*, London and New York, 1933. 225 pp. 91 figures.

The author states in his preface, "The ordinary gramophone is out of date, radio is almost commonplace, and television is somewhat in the future. The home talking picture might well fill the gap." This terse statement describes clearly the reason for writing the book; and this little volume provides the amateur with an excellent summary of the available equipment for small-scale sound recording as well as working details for actually doing it. Sound-on-disk and sound-on-film methods are described. The book does not aim to include every type of amateur sound equipment available but is intended to cover those that differ essentially in fundamental design. The illustrations are well chosen, and the drawings assist materially in clarifying the text.

G. E. MATTHEWS

The Sound Motion Picture in Science Teaching. PHILLIP J. RULON. *Harvard Univ. Press*, Cambridge, Mass., 1933. 236 pp.

There has been considerable divergence of opinion relative to the value of motion pictures as a visual aid in educational work. In the introduction, the author states "... only a small percentage of the literature appearing during the last decade has concerned itself with experimental evidence on the effectiveness of such aids." There are so many easily overlooked factors that exert an important influence on the results of such work that the author feels that even in those cases where experimental investigation has been attempted, "... the motion picture as an instructional device is yet to be evaluated."

This book represents a report of "... an attempt to evaluate numerically the educational effectiveness of the sound motion picture in the teaching of a school subject." The ninth grade (first year high school) was used, and the subject chosen was General Science, particularly Physiography and Biology. A textbook was prepared that was designed to be typical of those in the fields of general science, and films were specially produced to parallel the text. Of two groups

of pupils, one used the text-book only; the other the text and films. A third group, serving as a second control group, did not study the experimental instructional material. The children were drawn from three suburbs of Boston. The school year was divided into three parts: (1) a pre-instructional period, (2) the experimental instructional period, and (3) a retention period when the regular general science work was taken up again. Tests were given at the end of each period.

The general conclusions of the results of the work were (1) the general pupil-achievement increase ascribable to the use of the film exceeded 20 per cent; (2) those facts and relations specifically dealt with in the film resulted in a 35 per cent increase in pupil achievement; and (3) neither of the gains mentioned under (1) and (2) were made "...at the expense of more important but less definable educational values, such as good habits of thinking."

The first half of the book reviews the details of the experiment, and the latter portion contains a bibliography, a census of occupational listings, scripts for experimental films, bulletins, teachers' guides, and data used in the tests.

G. E. Matthews

SOCIETY ANNOUNCEMENTS

BOARD OF GOVERNORS

NEW OFFICERS

At the last meeting of the Board of Governors, held on January 19th at New York, final steps were taken to put into effect the amendments of the Constitution and By-Laws proposed at Chicago, October 16th, and approved by letter ballot of the Active membership of the Society January 15, 1934. The Constitution and By-Laws now in effect are as embodied in the brochure mailed with the voting ballots to the Active membership the latter part of October.

The system now in effect is, in brief, as follows: the Board of Governors consists of the President, the Past-President, five Vice-Presidents, the Secretary, the Treasurer, five elective governors, and the three section chairmen. The nominations made by the Board of Governors were as follows:

Executive Vice-President, H. C. Silent
Engineering Vice-President, L. A. Jones
Editorial Vice-President, J. I. Crabtree
Financial Vice-President, O. M. Glunt
Convention Vice-President, W. C. Kunzmann
Governor, A. S. Dickinson

Under the new plan the various Committees of the Society will be under the direction of the several Vice-Presidents, *viz.*, Engineering Vice-President: all the technical Committees; Editorial Vice-President: the Board of Editors, Historical Committee, Progress Committee, and Papers Committee; Financial Vice-President: the Ways and Means Committee and the Membership Committee; Convention Vice-President: the Convention Arrangements Committee and the Publicity Committee.

Ballots for voting on the nominations have been mailed to the Active membership, and will be counted on April 19th, whereupon the elected nominees will immediately assume office. The remainder of the Board of Governors, with the exception of the two incumbent Vice-Presidents, will be as presented on the reverse of the contents page of this issue of the JOURNAL.

NEW MEMBERSHIP DUES

At the same meeting of the Board, final steps were taken to put into effect the new annual dues rates, and to establish the new three grades of membership that will replace the existing two grades. The new grades and rates are in the table on the next page.

The fiscal year of the Society will now coincide with the calendar year, beginning January 1st, instead of October 1st. On that account, an adjustment of the dues of the current year was necessary in order to encompass the year and

a quarter from October 1, 1933, to January 1, 1934. Accordingly, all members were billed for the last quarter of 1933 at the old rates (*i. e.*, \$5 for Actives, \$2.50 for Associates) to which were added the normal annual rates given in the table below. Thus, the dues of Active members for the year and a quarter were \$15, and for Associate members, \$8.50. Those members who paid their dues in full according to the old rates (Active, \$20, Associate \$10) will be credited with the excess against their dues for 1935; *i. e.*, Active members will be credited \$5, and Associate members \$1.50.

Grade	Min. Age	Years of M. P. Work	No. of References*	Admission Fee	Annual Dues**
Fellow	30	3	3 Fellows	\$10	\$20
Active	25	3	3 Fellows or Actives	\$ 5	\$10
Associate	18	..	1 Fellow or Active	...	\$ 6

*References should be named who have personal knowledge of the applicant's experience. It is suggested that applicants furnish more than the requisite number of references and a full record of experience.

**First year's dues prorated monthly from date of admission; dues of succeeding years payable January 1st.

RECLASSIFICATION OF MEMBERSHIP

A Committee was appointed by the Board of Governors for the purpose of reclassifying the membership of the Society into the three new grades. Invitations to apply for transfer to an upper grade are being extended by the Committee to those members whose records on file indicate their fitness for the grades in question. All members, of course, are entitled to apply for transfer voluntarily, if they so wish: the approval of their application will depend, in the usual manner, upon their ability to comply with the qualifications and requirements specified in the By-Laws (By-Law I, Sec. 1). The Committee is composed of the following members:

T. E. SHEA, *Chairman*

H. GRIFFIN

J. H. KURLANDER

R. E. FARNHAM

H. G. TASKER

1934 BUDGET

Two budgets were approved by the Board of Governors: one to terminate the accounts of the Society on January 1, 1934, in order to advance the date of commencement of the fiscal year; and another to encompass the calendar year 1934, which henceforth will be identical with the fiscal year. Under the new arrangements the Society will operate within its income; and, if the campaign for new members proves as successful as is anticipated, may be able to broaden its activities and improve its JOURNAL considerably.

NAMES OF S. M. P. E. SECTIONS

The Board of Governors ruled that the names of the three local sections of the Society, now known as the New York Section, the Chicago Section, and the Pacific Coast Section, shall hereafter be the "Atlantic Coast Section," the "Mid-West Section," and the "Pacific Coast Section," respectively.

SPRING CONVENTION

CHALFONTE-HADDON HALL, ATLANTIC CITY, N. J.
APRIL 23rd TO 26th, INCLUSIVE

CONVENTION ARRANGEMENTS COMMITTEE

W. C. KUNZMANN, *Chairman*

J. H. KURLANDER

H. GRIFFIN

M. W. PALMER

LOCAL ARRANGEMENTS COMMITTEE

H. BLUMBERG, *Chairman*

J. FRANK, JR.

M. L. SWAAB

B. BLUMBERG

H. WALTERS

W. R. BAKER

J. O. BAKER

M. C. BATSEL

C. TREEN

PROJECTION COMMITTEE

H. GRIFFIN, *Chairman*

J. FRANK, JR.

C. TREEN

H. BLUMBERG

Officer and Members of Atlantic City Local No. 310, I. A. T. S. E.

LADIES' COMMITTEE

MRS. M. C. BATSEL, *Hostess*

Assisted by

MRS. J. FRANK, JR.

MRS. C. N. REIFSTECK

MISS E. BATSEL

MRS. J. O. BAKER

OPENING OF CONVENTION

The Convention will convene at 10:00 A.M., Monday, April 23rd, at the Chalfonte-Haddon Hall, in the Viking Room on the thirteenth floor of the Haddon Hall section. At noon of the opening day there will be an informal get-together luncheon, during which the members of the Society will be addressed by several prominent speakers. The morning preceding the luncheon will be devoted to registration, reports of officers, and other Society business, as well as the reports of technical committees.

SESSIONS

All technical sessions and film exhibitions will be held in the Viking Room, where also will be located the registration headquarters. Technical sessions will be held on Monday, Tuesday, and Thursday afternoons, and on Tuesday, 210

Wednesday, and Thursday mornings. Monday morning will be devoted to Society business and committee reports; Wednesday afternoon, preceding the semi-annual banquet in the evening, will be left free for recreation. The film programs of recently produced outstanding features and shorts will be held on Monday and Tuesday evenings, and will be booked by Mr. J. Greenburg, of the Philadelphia Film Board of Trade, and Mr. H. Blumberg, chairman of the Local Arrangements Committee.

BANQUET AND DANCE

The S. M. P. E. Semi-Annual Banquet and Dance will be held in the Vernon Room of the Chalfonte-Haddon Hall on Wednesday, April 25th, at 7:30 P.M.—an evening of dancing, movies, and entertainment; no banquet speeches. Banquet tickets should be obtained at the registration headquarters: tables reserved for six or eight persons.

SPECIAL RATES

Excellent accommodations are assured by the management of the hotel, and minimum rates are guaranteed. Room reservation cards mailed to the membership of the Society should be returned immediately to the Chalfonte-Haddon Hall in order to be assured of satisfactory reservations.

EUROPEAN PLAN

Room with bath, ocean view, <i>single</i>	\$4.00
Room with bath, ocean view, <i>double</i>	\$6.00
Room with bath, city view, <i>single</i>	\$3.00
Room with bath, city view, <i>double</i>	\$5.00

LADIES' HEADQUARTERS

A reception suite will be provided for the use of the ladies attending the Convention, and an attractive program for their entertainment is being prepared by the Ladies' Committee.

EXHIBIT OF MOTION PICTURE APPARATUS

Arrangements are being made to hold an exhibit of newly developed motion picture apparatus, in order to acquaint the members of the Society with the newly devised tools of the industry. The exhibit will not be of the same nature as the usual trade exhibit; there will be no booths, but each exhibitor will be allotted definite space and all exhibits will be arranged in a single large room. Requests for space should be directed to the General Office of the Society, 33 West 42nd Street, New York, N. Y., stating the number and nature of the items to be exhibited. Regulations concerning the exhibit are given in the tip-on in this issue of the JOURNAL. The charges for space will be as follows: up to 20 sq. ft., \$10; every additional 10 sq. ft., \$5.

PROJECTION PRACTICE COMMITTEE

The last meeting of the Projection Practice Committee, held at New York on January 24th, was perhaps the most outstanding meeting of the Committee since its organization. Twenty-one representatives of the major theater circuits attended, as also representatives of the National Carbon Company, for the purpose of discussing and analyzing the various problems attendant upon the new a-c. carbon arc projector lamp. The Committee plans to include, as part of its semi-annual report, a full presentation of the operating features of the lamp from the projectionist's point of view. The next meeting of the Committee will be held on February 28th.

**DEMONSTRATION OF TRANSMISSION AND REPRODUCTION IN
AUDITORY PERSPECTIVE**

On January 30th, the members of the Atlantic Coast Section were the recipients of a kind invitation of the Bell Telephone Laboratories to attend a demonstration of transmission and reproduction in auditory perspective by Dr. Harvey Fletcher, at the Engineering Societies Building, New York, N. Y. Full details of the demonstration are being prepared by Dr. Fletcher, and will be published in the JOURNAL in the near future. The meeting was attended by approximately 700 members of the S. M. P. E. and the Acoustical Society of America.

The next meeting of the Atlantic Coast Section will be held on April 28th, at New York, N. Y.

JOURNAL

OF THE SOCIETY OF

MOTION PICTURE ENGINEERS

Volume XXII

APRIL, 1934

Number 4

CONTENTS

	<i>Page</i>
Equipment for Recording and Reproducing Sound with Photo-Film (<i>Concluded</i>).....A. F. CHORINE	215
Acoustical Requirements for Wide-Range Reproduction of Sound.....S. K. WOLF	242
Wide-Range Recording.....F. L. HOPPER	253
The "Selenophon" Sound Recording and Reproducing System.. G. E. ROTH	260
Society Announcements.....	270
Spring Convention: Atlantic City, N. J., April 23-26, 1934....	273

JOURNAL OF THE SOCIETY OF MOTION PICTURE ENGINEERS

SYLVAN HARRIS, EDITOR

Board of Editors

J. I. CRABTREE, *Chairman*

O. M. GLUNT

A. C. HARDY

L. A. JONES

J. O. BAKER

Subscription to non-members, \$8.00 per annum; to members, \$5.00 per annum, included in their annual membership dues; single copies, \$1.00. A discount on subscriptions or single copies of 15 per cent is allowed to accredited agencies. Order from the Society of Motion Picture Engineers, Inc., 20th and Northampton Sts., Easton, Pa., or 33 W. 42nd St., New York, N. Y.

Published monthly at Easton, Pa., by the Society of Motion Picture Engineers.

Publication Office, 20th & Northampton Sts., Easton, Pa.

General and Editorial Office, 33 West 42nd St., New York, N. Y.

Entered as second class matter January 15, 1930, at the Post Office at Easton, Pa., under the Act of March 3, 1879. Copyrighted, 1934, by the Society of Motion Picture Engineers, Inc.

Papers appearing in this Journal may be reprinted, abstracted, or abridged provided credit is given to the Journal of the Society of Motion Picture Engineers and to the author, or authors, of the papers in question. The Society is not responsible for statements made by authors.

Officers of the Society

President: ALFRED N. GOLDSMITH, 444 Madison Ave., New York, N. Y.

Executive Vice-President: HAROLD C. SILENT, 7046 Hollywood Blvd., Los Angeles, Calif.

Engineering Vice-President: LOYD A. JONES, Kodak Park, Rochester, N. Y.

Editorial Vice-President: JOHN I. CRABTREE, Kodak Park, Rochester, N. Y.

Financial Vice-President: OMER M. GLUNT, 463 West St., New York, N. Y.

Convention Vice-President: WILLIAM C. KUNZMANN, Box 400, Cleveland, Ohio.

Secretary: JOHN H. KURLANDER, 2 Clearfield Ave., Bloomfield, N. J.

Treasurer: TIMOTHY E. SHEA, 463 West St., New York, N. Y.

Governors

EUGENE COUR, 1029 S. Wabash Ave., Chicago, Ill.

HERFORD T. COWLING, 7510 N. Ashland Ave., Chicago, Ill.

ARTHUR S. DICKINSON, 28 W. 44th St., New York, N. Y.

RALPH E. FARNHAM, Nela Park, Cleveland, Ohio.

HERBERT GRIFFIN, 90 Gold St., New York, N. Y.

EMERY HUSE, 6706 Santa Monica Blvd., Hollywood, Calif.

WILBUR B. RAYTON, 635 St. Paul St., Rochester, N. Y.

HOMER G. TASKER, 41-39 38th St., Long Island City, N. Y.

EQUIPMENT FOR RECORDING AND REPRODUCING SOUND WITH PHOTO-FILM*

(Concluded from page 172 of the March Journal)

A. F. CHORINE**

Summary.—The work of the Central Laboratory of the All-Union Electrical Trust, Leningrad, U. S. S. R., under the direction of the author, in connection with the study, design, and manufacture of motion picture recording and reproducing apparatus is described. The present installment of the article deals with the research on light modulators, variable width and variable density; ordinary and noiseless recording systems; various forms of recording light sources; and the relative characteristics of the different kinds of modulators, viz., Western Electric, RCA, the author's, Kerr's cell, and flashing lamp.

SOUND RECORDING EQUIPMENT

In our work it was necessary to produce equipment of the simplest construction possible, so that repairs could be made at the existing technical shops of the picture studios themselves. The apparatus delivered for practical use can be classed according to the following categories:

- (1) Stationary apparatus for studio use, recording sound on a positive film separately from the picture.
- (2) Light, portable apparatus for field use, recording sound and picture on the same negative film.
- (3) Light apparatus for newsreel recording on a single film.
- (4) Universal apparatus that can be used in either the studio or the field.
- (5) Stationary apparatus for recording sound on 300-meter lengths of film.

The author's modulator has been used in all such apparatus except in apparatus of the third class, where recording was done by a flashing lamp.

Fig. 20 shows the earliest model of light modulator, and camera for 120 meters of film, actually delivered for use. The magnet is of

* Received October 2, 1933. Limitations of space have necessitated abbreviation of the original paper.

**Director, Central Laboratory, All-Union Electrical Trust, Leningrad, U. S. S. R.

horseshoe type, with magnetizing coils wound cylindrically around it, and the axis of the optical system has a bend between the lamp and the magnetic system. With this model it was not possible to make variable-width and variable-density records alternatively. In all succeeding models the axis of the ribbon could be given any direction in the vertical plane by turning the entire system about the horizontal axis, which is the optical axis of the rays passing through the pole pieces of the electromagnet.

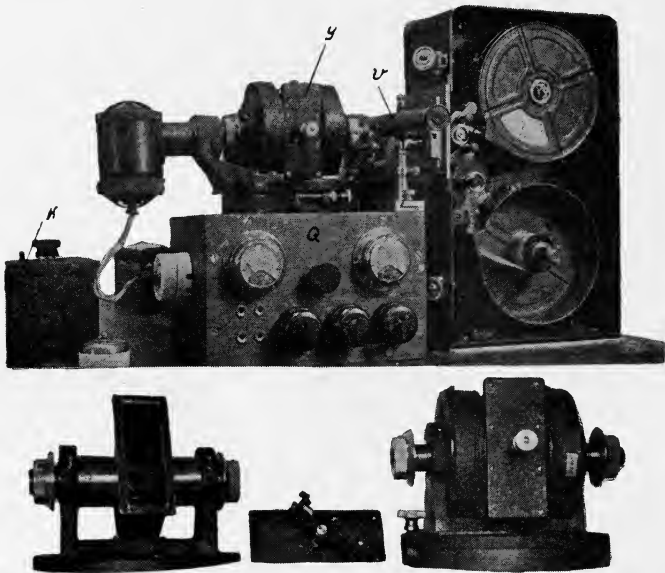

FIG. 20. (Upper) Earliest model of the light modulator.

FIG. 21. (Lower) Second model of the modulator, which could be used alternatively for variable-width or variable-density recording.

Such an arrangement was achieved in the second model of the modulator (Fig. 21), by mounting the magnetic system on roller bearings on vertical columns, so that the electromagnet, the oil container soldered to it, and the frame with the stretched ribbon could be turned to any angle. The ribbon can be precisely adjusted in relation to the optical axis by the screw on the top of the oil container.

In both models normal microscopic ten-fold anachromatic objectives, with aperture $f/0.30$, were used. These greatly simplified

the focusing of the optical system and made it possible to obtain a strong magnetic field of about 22,000 gauss in the interpolar space. With a 20x air objective, the best possible construction of the pole pieces lowered the magnetic intensity somewhat, but with the 20x oil-immersion objective the full field strength was restored. The duplicator is contained in a brass tube mounted in the opening in the pole piece that contains the recording objective. The shorter working distance of the 20x objectives necessitated a change in the construction of the inner part of the pole pieces. Bringing the objective nearer

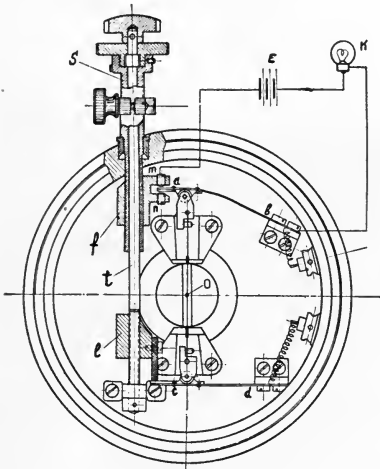

FIG. 22. (Left) The fourth model of the modulator: *ab* and *cd* are springs that stretch the ribbon; the brass box serves both as oil container and as ribbon mount.

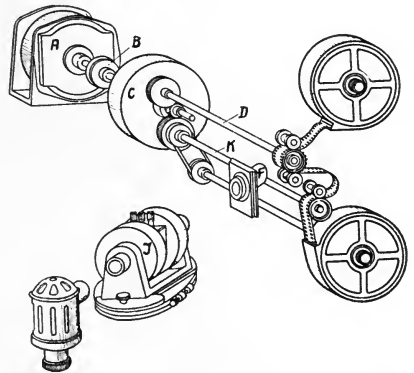

FIG. 23. (Right) Schematic arrangement of recording mechanism.

the ribbon reduced by some 25 per cent the strength of the magnetic field in the space between the poles.

An integral part of the light modulator is the observing microscope, which visually assists in focusing the objective and controlling the amplitude of the vibrating ribbon. In the system described, it is mounted perpendicularly to the direction of the light rays, between the projecting microscopic objective and the cylindrical lens, and consists of a flat reflecting mirror, a 1.5x objective, and a 10x ocular placed in a metallic tube mounted on a vertical support. The tube can be placed in any position in relation to the optical axis.

The operator is thus enabled to watch the amplitude of the ribbon during recording and regulate it by adjusting the amplifier.

Because of its short focusing distance, the cylindrical lens must always be placed near the film and be focused very exactly. Consequently, in all modulators of this type the cylindrical lens is installed on the same mounting as the mechanism holding the film as it passes the cylindrical lens. Since the image can not be exactly focused on the film visually, even with the aid of a microscope, exact focus is achieved by placing the cylindrical lens in several different positions in relation to the film, making an instantaneous exposure

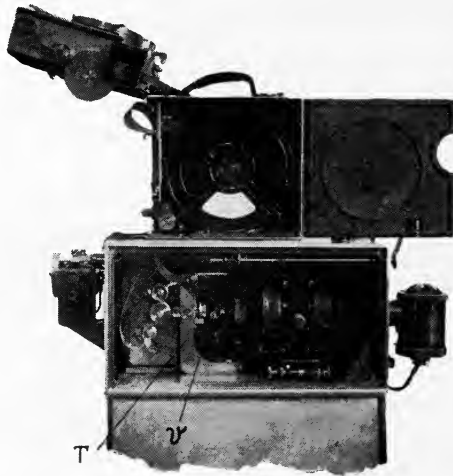

FIG. 24. Portable sound recorder.

in each position, and computing the proper position from measurements made on the developed film.

Usually the cylindrical lens is placed, together with its diaphragm, in a special fixture installed in the short tube. In systems in which the light modulator is placed within the camera, this tube is mounted either on the wall of the camera, or on a special fixture holding the film carrying mechanism.

As a source of light the standard incandescent lamp "GOZ" (12 volts, 3 amperes) is used. Its support is designed to permit its adjustment to the correct position. The whole optical system of the modulator, except the cylindrical lens, is assembled on one block, and can thus be focused in advance by removing it from the recorder.

When reinserted, it must merely be placed correctly in relation to the cylindrical lens.

The fourth model is quite different in construction from the foregoing. The ribbon is mounted and stretched not on a separate frame but in a shallow round brass box that serves both as oil container and ribbon frame, with a removable round cover that seals the box when bolted on. The ribbon is stretched by two flat springs ab and cd (Fig. 22) whose tension is controlled by the screw f with two contacts, m and n . The amount of tension can be read from the graduated head of screw S . Screw t , passing through screw S , stretches the ribbon until the spring ab touches the contacts m and n , and so extinguishes the control lamp. Since only the heads of screws S and t are outside the box, the ribbon can be stretched to the proper tension without opening the box. The pole pieces of the magnet, of the same form as in previous models, are soldered to the top and bottom of the box. When the ribbon is installed, its position in relation to the pole pieces and the opening O , through which the light passes, can easily be seen and adjusted.

To change the ribbon, it is necessary only to substitute a second reserve box in which the ribbon has already been properly stretched. This scheme eliminated many of the disadvantages of the former systems, although the objectives may have to be refocused. The system can be used either with or without the damping oil. In the former case the openings O at the bottom and the top of the box are sealed by flat-parallel glass plates preventing seepage of the oil from the box and into the objectives.

The magnetic system is cylindrical in form, and consists of two removable parts, each having a winding and a pole piece carrying an objective. The entire modulator can be turned to make possible either variable-width or variable-density recording.

Stationary models of sound recording equipment were assembled either on massive tables or on rolling platforms, along with the amplifier and all necessary sources of current for the amplifier and the light modulator. In these models there was no difficulty in using sufficiently powerful motors to drive the film, either of the synchronous or the interlocking type. The necessary synchronizing power of the motor, not less than 75–100 watts, made it possible to use a simple flywheel directly on the motor shaft, rotating at 1440 rpm., in order to suppress irregularities of rotation. The shaft of the sprocket that drives the film is geared to the motor shaft by 1:4 gears.

With only the flywheel to serve as filter, the uniformity of motion of the film has proved quite satisfactory. The use of so simple a filter was possible, however, only in mechanisms that have a constant or a slowly and smoothly varying load, and when the flywheels are very well made. To avoid sudden irregularities of load due to friction in the winding bobbin, the bobbin is driven through a round rubber belt, which smoothes out the effects of bumping on the motor shaft. Recording on the film as it passes over the sprocket causes no serious distortion if the drum is made with sufficient exactitude and if an additional drum is interposed between it and the winding bobbin so that tension from the latter does not reach the former.

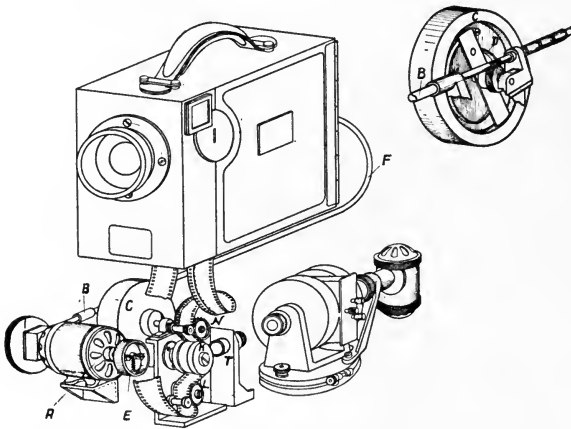

FIG. 25. Driving mechanism of portable sound recorder shown in Fig. 26.

The scheme of the entire installation, including the film driving mechanism, is shown in Fig. 23. *A* is the synchronous motor, *B* a coupling, *C* the flywheel, *D* the shaft of the sprocket on which the recording is done, *K* the shaft of the interposed drum, *F* the tube with the cylindrical lens, and *I* the light modulator.

Portable sound recording units, usually fixed on tripods, are too light to permit the use of sufficiently powerful driving motors, and since sound and picture are usually recorded simultaneously on the same film, the load on the motor driving both the camera and the film driving mechanism varies quite widely. This makes it rather difficult to move the film sufficiently smoothly. A portable model

that has given good results in the field under varying conditions is shown in Fig. 24 and Fig. 25 shows its film driving mechanism. The d-c. motor *A*, consuming 30 to 35 watts at 24 volts and turning at 3000 rpm., turns the shaft *B* at 1440 rpm., which rotates the mechanical filter *C* with the spiral spring *D* at 360 rpm. The rotation of the motor is stabilized by the electric regulator *E*.

The shaft *B* rotates also the mechanism of the picture camera through an elastic spindle 6 mm. in diameter, housed in the bent tube *F*. Tube and spindle can be readily removed and replaced.

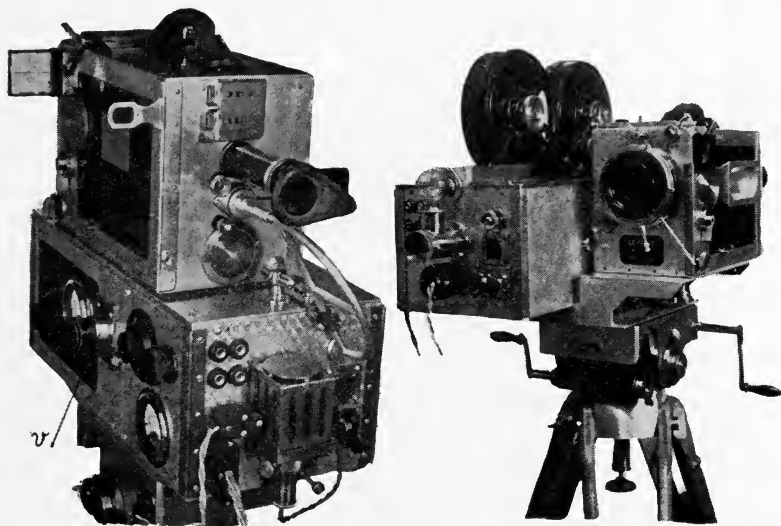

FIG. 26. (Left) Universal recorder for single-film system.

FIG. 27. (Right) Original model of universal recorder adapted to double-film recording

The elastic spindle greatly reduces the unevenness of load due to the operation of the "pull-down" of the camera. Through a slot at the bottom of the camera, the film passes to the take-up mechanism.

The sound is recorded on the film as it passes over the smooth massive drum *K*, which rotates freely on its shaft and is driven by the film itself. The cylinder *L* stretches the film over the recording drum, and its escape over this drum is controlled by the sprocket *N* mounted directly on the same shaft as the mechanical filter. The filter is undamped. The tube with the cylindrical lens and the focusing screws are mounted on the support *T*. Measuring and directing

instruments and the observing microscope are assembled on the side covers of the apparatus, as shown in Fig. 24.

Sound recording with such equipment is satisfactory, but the uniformity of motion of the film is insufficiently assured because of the small power of the motor and the relatively light weight of the filter, which has a natural frequency of 3 cycles per second.

The universal equipment for recording sound and picture either together on a single film or separately on two films is similar in construction to the portable equipment, because it is necessary to use tripods and to be able to move the equipment about. Fig. 26 shows the adaptation of the apparatus for recording sound and picture on the

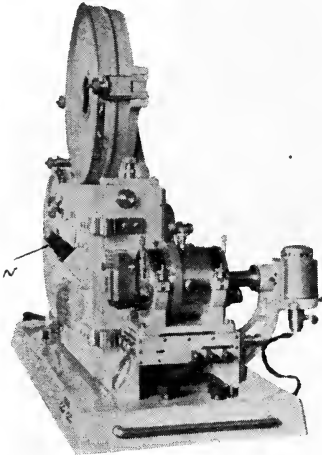

FIG. 28. Stationary model of portable recorder.

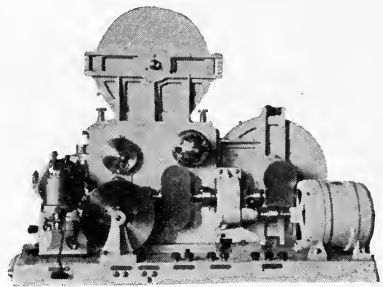

FIG. 29. Another view of Fig. 28.

same film. The motor is so mounted that it can be easily replaced by an arrangement permitting the apparatus to be connected to the interlocked motor necessary when the sound is recorded on a separate film. In the latter case the apparatus is removed from the tripod and installed on a base plate on which the interlocked motor is mounted. The camera is removed and replaced by a light-tight box of the same dimensions, containing small cases of film and the winding mechanism. About thirty minutes are required to change from the one form of equipment to the other. The reliability and quality of the results when sound is recorded on a separate film are of course higher than when sound and picture are recorded together. The use of a light

modulator with special immersional objectives permits great simplification of the entire installation and a record whose quality is the equal of that obtained with the heavy stationary systems.

The original model of this type of equipment (Fig. 27) differed from that described in so far as the camera was driven inelastically through friction rolls and the apparatus mounted on a tripod even while recording on two separate films, to eliminate the necessity of interlocked motors and thus make possible the use of the camera motor exclusively. This model has not been generally used because of its inconvenience and certain defects of construction.

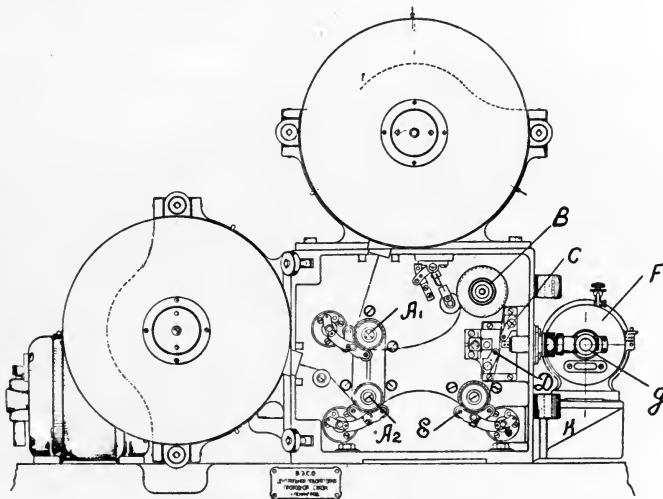

FIG. 30. Schematic arrangement of Figs. 28 and 29.

The stationary model of a portable set shown in Figs. 28, 29, and 30 is one of our most recent designs of sound recording equipment, in which all the parts are compactly mounted on a common baseplate. Recording is made on the film, not while it is passing over the sprocket, but while it is passing freely between two cylinders. Such an arrangement greatly facilitates focusing the image on the film and observing the amplitude of vibration of the ribbon, which can be watched through the film by means of an observation microscope mounted in the top of the camera. To enable still more convenient control of the amplitude, a system has been used in which the form of a section of the sound wave is made continuously visible by means of

total internal reflections in prisms rotating immediately behind the film. Thus, not only the amplitude trend, but also an oscillogram of the sound can be seen in the microscope.

How the film is threaded through the machine can be seen in Fig. 30 where A_1 and A_2 are pull-down and hold-back sprockets, B is the cylinder stretching the film by friction between two cylinders, C and D , and directing the film to the point at which the sound is recorded, and E is the sprocket that drives the film, mounted on the shaft of the flywheel of the mechanical filter. The light modulator F is mounted on the base K of the camera: The modulator contains a rotating prism g of total internal reflection, permitting the

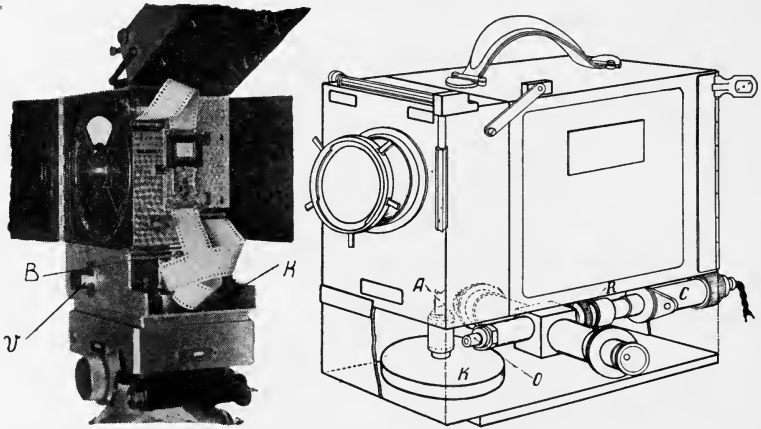

FIG. 31. (Left) Newsreel recorder.

FIG. 32. (Right) Schematic arrangement of camera of Fig. 31.

rays of light to be excluded from the recorder and the modulator to be refocused without moving it from its place. The mechanical filter contains a cylindrical spiral spring and is air-damped; its natural frequency is only a quarter cycle per second. Every possible shock and vibration from the synchronous motor is absorbed by this filter. The ready removal of the upper case and the base-plate permits the apparatus to be compactly and conveniently packed in a trunk. All instruments for measurement and control are mounted on the base-plate.

Fig. 31 shows the model of a newsreel recorder in which the film driving mechanism, in order to reduce weight, is directly connected

with the picture camera, and the mechanical filter, consisting of a spiral spring and a flywheel, rotates on the vertical shaft *A* (Fig. 32). Fig. 32 shows the camera. Sound recording is done by a flashing lamp, in the housing *C* outside the film-drive housing, which illuminates the drum *B* (Fig. 31) mounted on the shaft of the flywheel *K* of the filter. For use in focusing the image and installing the lamp an observing microscope is provided, with two oculars, one on each side of the camera. The objective *O* is focused by the screw *R*.

When sound is recorded for reproduction without a picture on the radio or in the theater, a large portion of the film is not used, and both this film and the chemicals used to develop it are wasted. Various methods have been developed for avoiding this waste by condensing the record on the film, which can be accomplished either by manifold

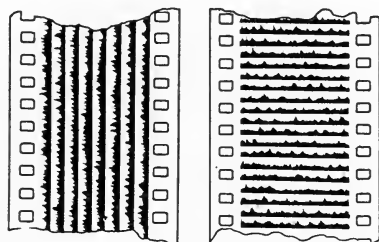

FIG. 33. Multiple-track methods for conserving film and chemicals.

recording along the film or across it (Fig. 33). Both methods have been used with rather good results.

One method of multiple recording along the film is to record on one edge of the film while it is moving in one direction, then reverse the camera and record on the adjacent strip, *etc.* Another method is to make a record in the form of a spiral on a closed loop of film. The first method can be accomplished very simply with an ordinary camera by reversing the light modulator and the direction of the film, but this does not produce an uninterrupted record.

The second method, producing an uninterrupted record, can be accomplished by using a box permitting continuous movement of the film, as illustrated in Fig. 34. Through the flywheel the motor drives the cylinders of the box which rotate the ring of film. Fig. 35 shows schematically the arrangement of such a box, in which a radial system of cylinders and rollers is driven through conical gears 2 by the central conical gear 3.

In the center of the box are placed sprocket 4 (see also Fig. 34) and similar sprockets at the edge of the box, both geared to the rollers. The diameters and angular velocities of rollers 1 and sprockets are identical. The rollers serve both to support and rotate the film roll. A crown resting on the rollers fixes the inner diameter of the film roll. The device is shown in Figs. 36 and 37. A special electro-frictional arrangement (2 in Fig. 36) shifts the drum that guides the film past the recording point just enough to prevent the successive sound tracks from overlapping. Metallic connections at

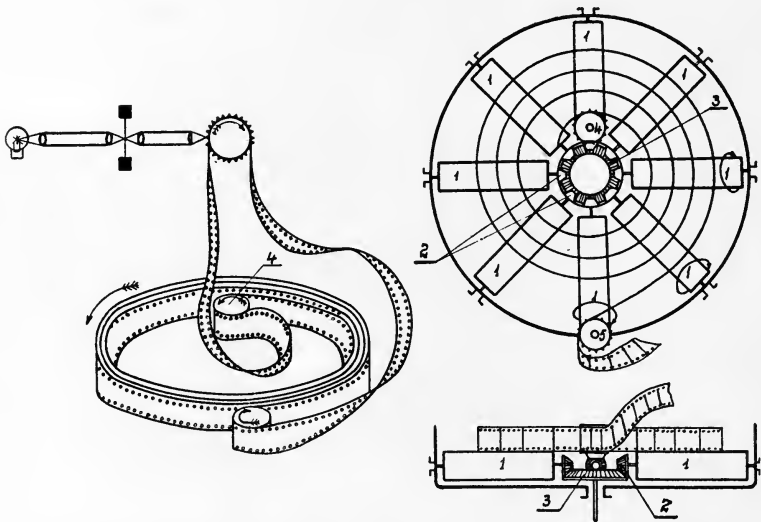

FIG. 34. (Left) Scheme for producing an uninterrupted multiple-track recording, with continuous movement of the film.

FIG. 35. (Right) Arrangement of the mechanism embodying the scheme of Fig. 34.

the beginning and the end of the film loop control the action of the device, and disconnect the entire apparatus when all the space on the film has been used. The manufactured set can accommodate loops of from 2 to 1000 meters of film, and since eight tracks can be placed side by side, as much as six hours of uninterrupted sound can be recorded.

In the first model that was designed, it was intended to provide a similar box for uninterrupted reproduction. Furthermore, it was expected that an optical system for sound reproduction could be

included in the recorder. Experience showed that such a system was too clumsy, and accordingly a special arrangement (Fig. 38) was designed for reproducing from a manifold record. We have used this unit as an electro-stenographer for recording meetings, operas, concerts, *etc.* Any portion of a record made by such a unit can be copied in a form suitable for insertion into any picture.

The solution of the problem of manifold recording across the film would open tremendous possibilities in sound pictures, radio, telegraphy, telephony, and stenography, but the problem presents great difficulties. A special recording and reproducing arrangement is necessary. We work with systems of the type diagrammed in Fig. 39.

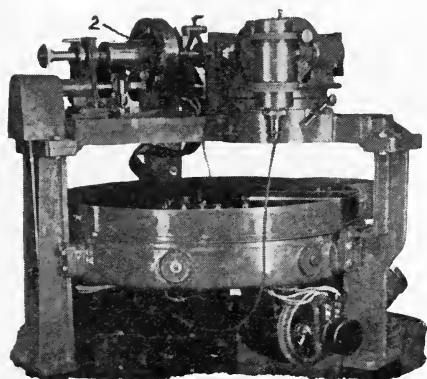

FIG. 36. Photograph of multiple-track recorder of Figs. 34 and 35.

Here the optical system produces on the film the image of a rectangular slit in the form of a thin line 2 to 2.3 mm. long and 0.02 to 0.03 mm. wide parallel to the edge of the film. Ribbon *N* is also imaged on the film, covering half the length of the line when at rest. The rays forming the images reach the film by reflection from one or another of the 42 mirrors on the rotating drum *L*₄. When *L*₄ is given $\frac{1}{42}$ of a complete revolution, the rays reflected to it from one of the mirrors will move across the film from one edge to another (Fig. 40). On further rotation of the drum the rays will be reflected from the next mirror and will sweep through the same path. By properly adjusting the speeds of the film and the drum the successive sweeps of the rays will trace adjacent parallel paths across the

film. Thus the mirror drum must rotate with a constant angular velocity that bears a fixed relation to the angular velocity of all sprockets driving the film.

Fig. 41 shows the exterior of the apparatus for such recording. After being withdrawn from box 1 by the sprocket 2 the film forms a loop, and then is passed by the drum through frame 4 where the record is made. After forming another loop, it passes over drum 5 against which it is held frictionally by the bobbin, and finally is wound on the reel 8. To assure that the rotation of the mirror drum will be as

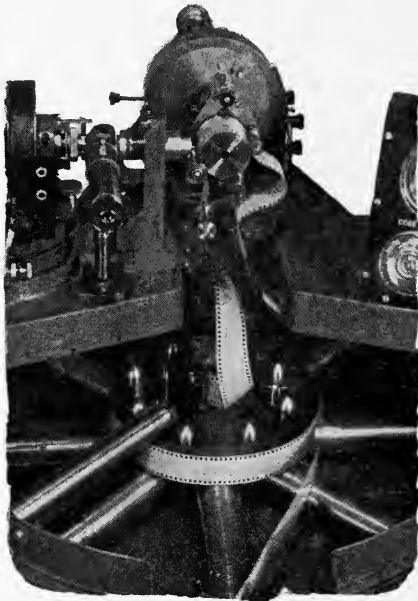

FIG. 37. Another view of Fig. 36.

uniform as possible, it is made of solid brass and carries a heavy fly-wheel on each side.

The record can be conveniently reproduced by the same apparatus when the light modulator is replaced by a suitable optical system such as that shown in Fig. 42. This system projects on the film an image of the rectangular slit P in the form of a thin line 0.02 to 0.03 mm. wide and 2 to 2.1 mm. long. The light transmitted through the film F enters the photoelectric cell.

In the operation of the system it may happen that before one mirror

has completed reading its line, the next mirror begins to read the following line. To avoid this the mirrors in both recording and reproducing equipment must be very accurately mounted on the drum. Experience has shown that an error of $\frac{1}{4}$ angular minute in mounting a mirror will produce on the film an error of 0.012 mm. in the position where two consecutive lines begin.

As the time for recording one line is $\frac{1}{20}$ second, the passage from one line to the other can introduce an unwanted signal with a fundamental frequency of 20 cycles per second. The usual amplifier does not pass such a frequency, but it will pass all the harmonics in-

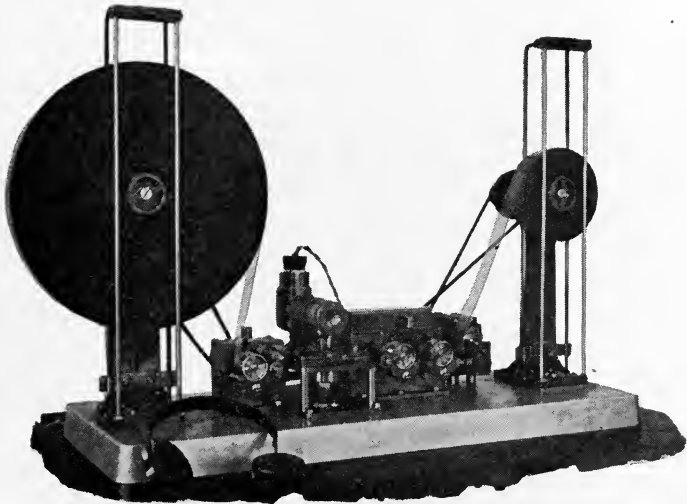

FIG. 38. Special arrangement of multiple-track recorder, used as an electro-stenographer for recording meetings, *etc.*

cluding the second. The signal is of such form (Fig. 43) that these harmonics may be of considerable magnitude. The amplitudes of the first four harmonics, as the starting point of a line S_1 deviates from its proper position S , have been calculated (Fig. 44) and show that it is difficult to avoid the production of harmonics. In general, the mirrors are mounted with an accuracy of 0.25 angular minute.

Another remedy is used to eliminate the undesired frequencies in the reproducer. An additional lens L_5 (Fig. 42) is placed between the film and the photoelectric cell. Its focal distance is such that the distance between it and the film is sufficiently large to permit the rays that have passed through the film to diverge (Fig. 45). Near

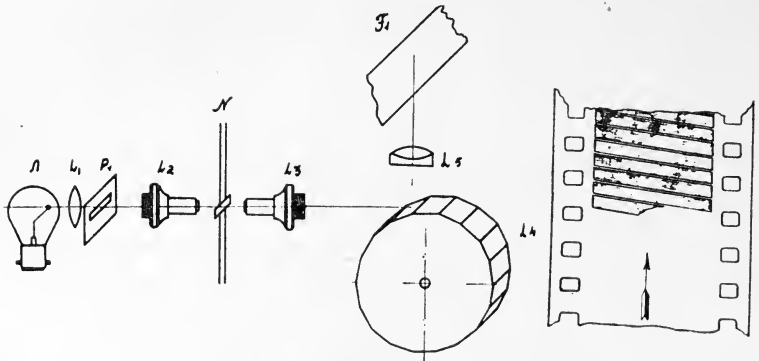

FIG. 39. (Left) Experimental system for multiple recording across the film.

FIG. 40. (Right) Illustrating the disposition of the sound tracks on the film.

the lens an adjustable rectangular slit is placed. When the strip of light moves along the film from one edge to the other, the slit is slid in front of the lens L_5 . When the strips of light from two successive mirrors reach the slit, it cuts off portions of both strips in such a way that the light entering the photoelectric cell remains constant.

By these two means—the accurate mounting of mirrors and the diaphragming of the rays—undesired noise due to the transition from one line to the next is considerably reduced. The largest volume of unwanted frequencies occurs during the silent portions of the record. Here the application of noiseless recording effects a further reduction. From Fig. 43 it can be seen that C_1/C equals 2, while with noiseless recording C_1/C is reduced to $5/3$; the amplitude of the harmonics is

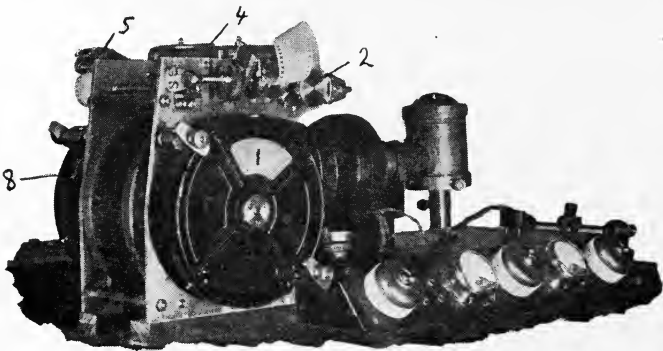

FIG. 41. Exterior view of apparatus for multiple recording across the film.

reduced by an even greater amount. Further development of this multiple recording system is being directed toward achieving an arrangement giving greater light intensity. The automatic developing and drying of cross-recorded film make the system extremely handy. Its only disadvantage is the high precision required in manufacture. If further development can solve this difficulty, the system should find wide practical use.

In order to produce a good sound record, the motion of the film during recording must be smooth. Our experiments to this end

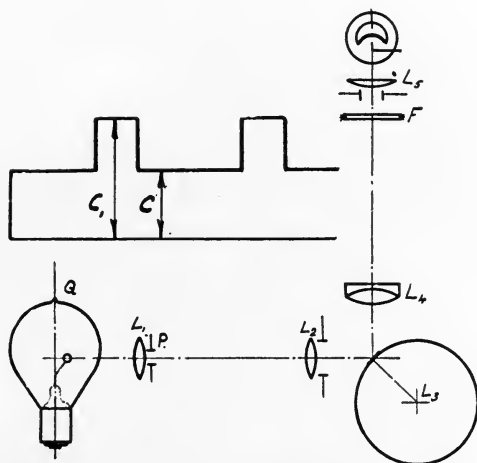

FIG. 42. (Lower) Arrangement for reproducing the multiple-track records across the film, recorded by the system of Figs. 39 to 41.

FIG. 43. (Upper left) Form of signal wave produced when passing from one line of a transverse recording to another.

differed somewhat from the methods followed in other laboratories. A familiar cause of distortion is the inaccurate cutting of the teeth in gears, worms, *etc.* We used the apparatus illustrated in Fig. 46 to measure inaccuracies in a gear train containing any number of gears from two up to those of an entire driving mechanism.

The driving gear A is placed on a shaft whose turning angle can be measured with an accuracy of 4 angular seconds. On the shaft of the final gear B of the train is the mirror C_1 from which a beam from the light source O is reflected to the rigidly fixed mirror C_2 and thence to

the scale P . Turning the driving gear A turns the gear B , and shifts the position of the ray on the scale. After each turn, the mirror C_1 is returned to its original position by an electromagnetic arrangement, so that it needs not be touched with the hands, and thus the ray on the scale returns approximately to its original position.

On conducting a test, the starting point of the ray is first noted on the scale. The driving gear is then turned through the chosen angle

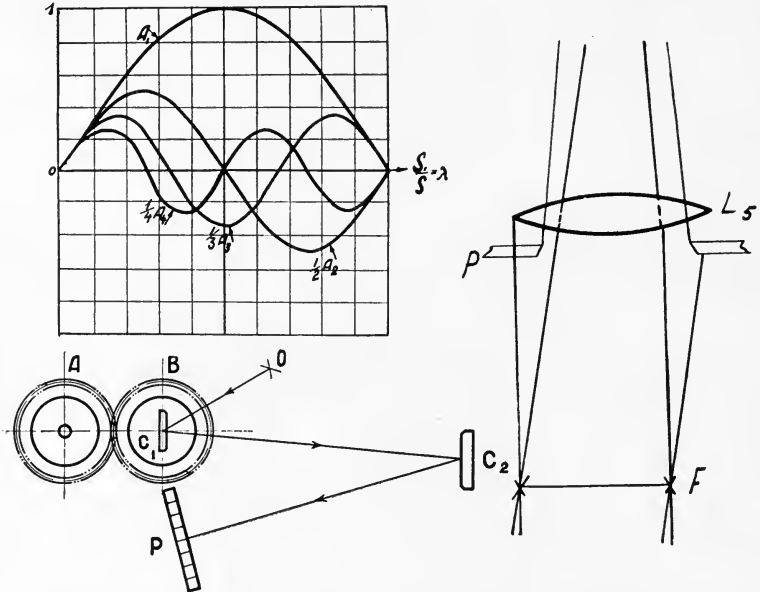

FIG. 44. (Upper left) Amplitudes of the first four harmonics as the starting point of one transverse line of recording deviates from its proper position.

FIG. 45. (Right) Path of rays through lens L_5 of Fig. 42.

FIG. 46. (Lower left) Method of checking inaccuracies in gear trains.

and the new position of the ray noted on the scale. The mirror is now returned to its original position and the new zero point noted. Again the driving gear is turned through the same angle, and again the position of the ray is read. These operations are repeated to cover a complete cycle of the gear train. The angle through which B is turned can be read from the scale with an accuracy of 5 to 6 angular seconds. From the data the average angle through which B was turned, and the deviation of each turn from the average, can be cal-

culated. Hence the percentage deviations and cumulative error, plotted in Figs. 47 and 48, respectively, can be obtained for a pair of ordinary cylindrical gears, and in Figs. 49 and 50 for cylindrical gears with oblique teeth.

It is interesting to notice from the curves that the gears with the oblique teeth are the worst. This is easily explained by the conditions of their manufacture. The simpler the part, the more easily it can be made. Even the most inefficient worker could make the

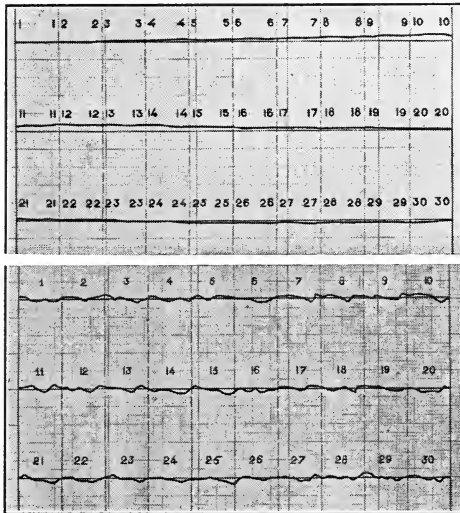

FIG. 47. (Upper) Graph of percentage deviations of a pair of ordinary cylindrical gears.

FIG. 48. (Lower) Graph of cumulative error in a pair of ordinary cylindrical gears.

ordinary gear sufficiently well, while the more complicated type of gear could be well made only by a highly trained mechanic. We have tested by this method all commonly used gear trains, and the results have always substantiated this practical rule.

Another method used for measuring the uniformity of movement of such mechanisms employed a regulating microphotometer, and was used for testing cameras already assembled. Uneven motion of the recording sprocket (in early models a sprocket with 16 teeth was generally used) was caused by incorrectly cut teeth and incorrect

profile and marking of the sprocket driving the film. In these tests the film was wound around the driving sprocket and fixed with rubber bands, while the image of the slit, 0.02×3.0 mm., was focused on the film. The sprocket was rotated at normal speed, and a special diaphragm exposed the sprocket to the image during exactly one revolution. By repeating the experiment with the film in the same position on the sprocket we could find out the periodic defect

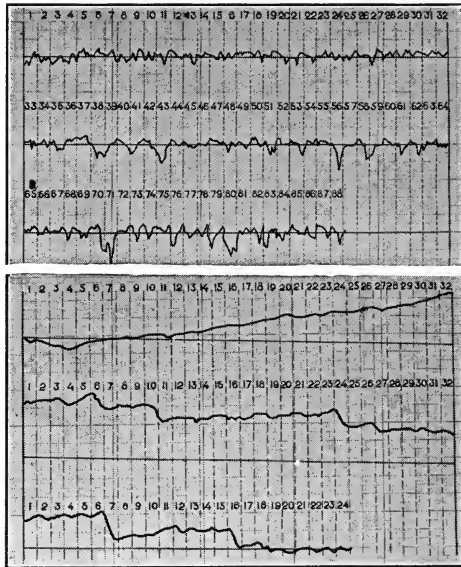

FIG. 49. (Upper) Graph of percentage deviation of a pair of cylindrical gears with oblique teeth.

FIG. 50. (Lower) Graph of cumulative error of a pair of cylindrical gears with oblique teeth.

in the cut of the drum, and by passing the developed film in front of the illuminated opening in the camera, we could visually analyze the movement of the mechanism. By ascertaining the gamma of development, and measuring the developed densities by Koch's microphotometer, we were able to obtain a quantitative curve of variations in the drum speed.

Figs. 51 and 52 are two typical records of the deflection of the ribbon in the electrometer of the measuring device when the track de-

veloped after such a test is microphotometered. Along the horizontal axis of the record 10 mm. is equivalent to 0.5 mm. on the film, or 0.001 second. These particular records were made to test one of the first cameras manufactured for sound recording, which had just left the studio. It is apparent that inexact tooth shapes and poorly adjusted details have produced many small speed deviations.

SOUND REPRODUCING EQUIPMENT

One of the problems in providing sound reproducing equipment for motion picture theaters was the design of a sound attachment that could be easily installed on the existing and most generally used silent picture projector of the "Tomp No. 4" type. The construction

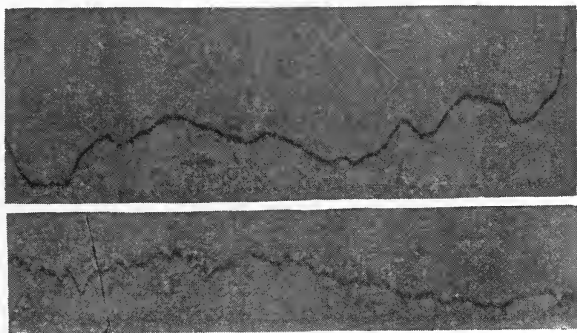

FIG. 51. (Upper) Typical record obtained with registering microphotometer for determining variations of rotation.

FIG. 52. (Lower) Similar to Fig. 51.

adopted is shown in Figs. 53 and 54, where *D* is the housing of the sound attachment, which can be readily mounted under the table of the picture projector. The lower reel is attached to the lower wall of the housing, and inside is the mechanical filter consisting of a fly-wheel, flat spiral spring, and damping friction. The tube *S*, on the face, contains the optical system diagrammed in Fig. 55. To correct for the curvature of the image field produced by the objective, the slit *G* (0.23×21 mm.) has a curvature in the line perpendicular to the figure. A polished flat-parallel glass plate *N*, rotatable to ninety degrees, and an observing microscope *O* assist in focusing the image of the slit on the ribbon, and in checking the installation of the lamp with the aid of the opal glass *C*. The photoelectric cell and the pre-

liminary amplifier tube are housed in a separate shielded container.

The sprocket *Y* (Fig. 54) loops the film to prevent the transmission of shocks to the sprocket *T* from the lower reel. The reverse side of the housing has a removable cover on which is mounted a gear meshing with gear *X* on the vertical shaft which thus connects the sound attachment with the top of the picture projector and drives the lower reel through a belt. The whole projector is driven by a single-phase synchronous motor, or by a d-c. motor with an electrical governor.

This sound attachment was placed in use early. Many efforts

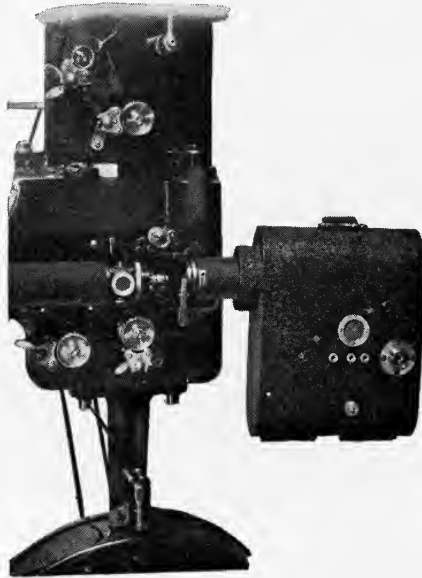

FIG. 53. Sound attachment for existing silent projectors.

have since been made to simplify the system, in order to reduce the cost in mass production, by eliminating the filter and simplifying the optical scheme, but so far without success.

When sound films are reproduced in motion picture theaters, a gain control is often operated by some one in the auditorium in order to achieve a greater range of volume than can be reproduced directly from the film. Such manual control has, however, a number of defects: it depends upon the musical training of the man handling it, his attentiveness, and his familiarity with the picture; and it is diffi-

cult to adjust the control for sounds of short duration, such as gun shots and other sudden noises. It is much more satisfactory to control the gain automatically so that, when certain portions of the film pass through the apparatus, predetermined sections of a sound potentiometer are connected to the amplifier.

To attain such control a special punch is used to press into the film spherical embossings about 3 mm. in diameter and 0.75 to 1 mm. high. As many as five such embossings can be placed across the film, between frames so that they can not be seen in the picture projected on the screen. Mounted on the projector, somewhat above the pro-

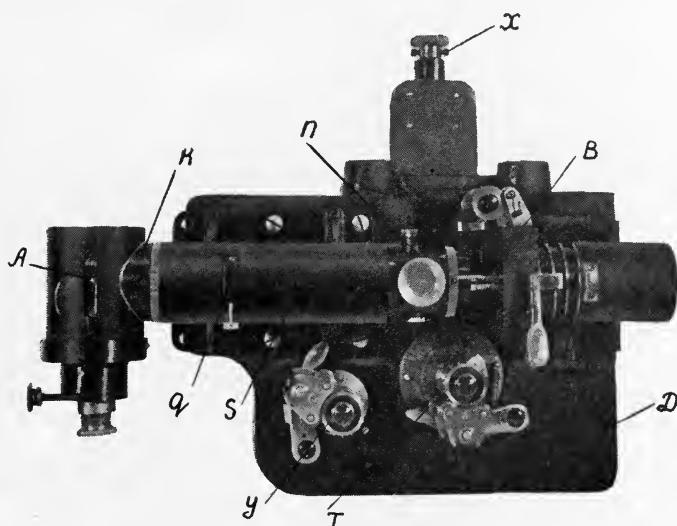

FIG. 54. Close-up of sound projector of Fig. 53.

jection window, are five small levers 0.2 mm. from the film. When the film passes through the projector (Fig. 56) an embossing *O* moves its corresponding lever *K*, and so through a pair of spring contacts *M* and a relay in box *L* connects the corresponding section of the potentiometer to the amplifier. This section remains connected until another embossing acts. By mounting the levers so that the embossings act while the frame is stopped during projection, the duration of the current pulses operating the relays is made 0.035 to 0.037 second, which is quite sufficient for reliable relay work.

In the first model of the volume control unit, four groups of contacts were used, providing complete silence by switching off the

sound, and three values of sound intensity. The fifth contact group was added to switch the sound from one group of loud speakers near the screen to another group located elsewhere in the auditorium. Thus, for instance, a conversation can be reproduced between an actor on the screen and a supposed partner somewhere in the auditorium and the sound of a falling object apparently thrown out from the screen can be made to emanate from the auditorium. With the same five pairs of contacts and a more complicated relay system, some thirty different operations can be performed by various combinations of operated and unoperated contacts. In such a way the lights in the auditorium can be turned off, operation can be switched to another projector, *etc.*

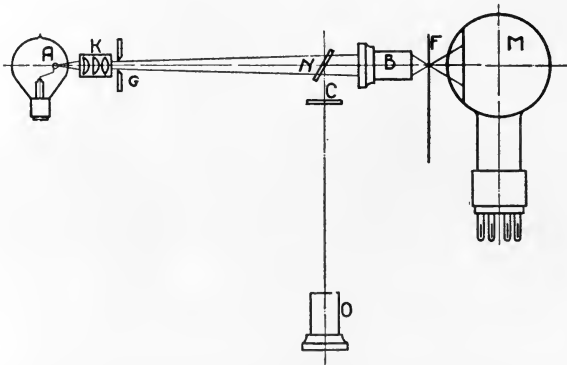

FIG. 55. Optical system contained in tube *S* of Fig. 54.

AMPLIFYING EQUIPMENT

The work already described, on optico-mechanical apparatus for recording and reproducing sound, has been accompanied by the development of amplifying equipment, beginning with simple battery-operated amplifiers similar to those used in radio, and ending with equipment fulfilling the requirements specifically demanded by the sound picture. Since the recording of sound and its transmission to the amplifying equipment are subject to various requirements that can not be satisfied by one universal equipment, separate units have been designed for recording and for reproduction.

Amplifying equipment for sound recording on film consists of the following parts: mixer equipment for three microphones with pre-

liminary amplifier; final amplifier for the recording; equipment for diminishing the noise of the film, and the monitoring amplifier.

The mixer equipment is designed to accommodate three microphones of the condenser or moving-coil type. It includes three potentiometers, for varying the volume of each microphone through a 24-db. range in steps of 1.5 db.; a three-stage preliminary amplifier with a gain of 40 db.; a regulator for varying the output volume through a range of 32 db. in steps of 2 db.; and power control instruments and a volume indicator. This equipment is fed from the same battery that feeds the microphone amplifiers, and is screened to reduce interference from outside power sources. The outputs of the

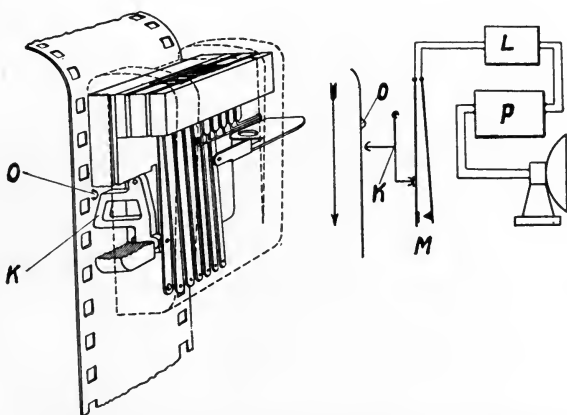

FIG. 56. Automatic volume control system, operating by means of embossings on the film which actuate spring contacts and relays.

microphones are connected to the potentiometers without the use of coupling transformers to guard still further against the interference that might be picked up by a non-toroidal retard coil or transformer. The mixer equipment is placed close to the scene being photographed, so that the operator may watch the scene and at the same time monitor the sound through a telephone.

Other parts of the recording amplifier are placed on a standard rack. They are fed entirely by alternating current, through rectifiers mounted on the same rack. Normally all this is placed in a separate room. When necessary, each part can be removed from the rack, packed in a separate box, and used on location either separately or in combination with any other part.

The complete recording amplifier not only increases the volume to a degree sufficient to operate the light modulator, but also, by a special network, corrects the distortions of frequency characteristics that result from the finite width of the slits in the recorder and reproducer, and from the limited resolving power of the film. The former can be calculated; the latter varies somewhat with the chemical treatment of the film. Therefore, when the corrective network was designed it was given a frequency characteristic that would compensate for the effect of the slits and the average effect of the film; this characteristic has been maintained with an exactitude of 1.5 db.

The equipment for reducing the film noise consists of a two-stage amplifier, a copper-oxide rectifier, and a filter that passes only the d-c. component brought to the ribbon of the recording modulator and which changes the position of the ribbon in accordance with the amplitude of the signal.

The complete amplifier and the silencer are fed from a common rectifier, because normally both are in operation at the same time. When necessary, as, for instance, on location, batteries can be used. The monitoring amplifier amplifies a portion of the signal output of the complete amplifier, enabling the recorded sound to be heard as it should be when reproduced. This amplifier is also operated on alternating current, and has its own rectifier.

All the amplifiers described, except the distortion-correcting stage, have frequency characteristics that are flat within 1 db. between 50 and 10,000 cycles per second. Distortion is corrected at frequencies up to 7000 cycles per second, above which the distortion varies too greatly with the way the film is manufactured to make correction possible.

Since the correction of distortion originating anywhere between the microphone and the loud speaker is accomplished in the recording amplifier, the reproducing amplifier is given a frequency characteristic that is flat within ± 1.5 db. between 50 and 10,000 cycles per second. All operating potentials, including that for the photoelectric cell, are obtained from 50-cycle a-c. sources. To reduce the noise from the sources the rectified anode potential is carefully filtered, and compensations for the noise are introduced. The noise is thus reduced to less than 0.1 per cent, and actually is imperceptible.

The equipment consists of four parts: a photoelectric cell placed on the picture projector; a preliminary single-stage amplifier with a gain of 27 db., placed beside the picture projector on the wall of the camera;

an amplifier with a 79-db. gain and maximum undistorted power output of 2.5 watts; and an amplifier with a 20-db. gain and maximum undistorted power output of 30 watts. In small theaters the fourth element is omitted and the total gain is restricted to 106 db. The photoelectric cell and the preliminary amplifier are fed from a 2.5-watt amplifier. When the 30-watt amplifier is used, the 2.5-watt amplifier works into the power amplifier and the control loud speaker, and the total gain is of the order of 126 db.

To simplify operation, the amplifier is transferred from one projector to another by means of relays operated by pressing buttons placed near each projector and on the amplifier itself. Pressing a button also lights pilot lamps indicating the projector with which the amplifier is connected. Since in vacuum tubes of the heater type the plate potential must not be applied until the cathodes have been sufficiently heated, the power supply circuit includes a relay that automatically delays the application of the plate potential for the necessary interval of 40 to 60 seconds.

On the remainder of the apparatus used in sound recording and reproduction, we have done little development work. We have used many types of microphones, both of our own and foreign construction and have found their differences perceptible but not of conclusive importance. For loud speakers we have used the normal electrodynamic type. Horn loud speakers have not yet been distributed in great numbers, although we have at our disposal both our own and certain foreign types. In practical use we have generally employed photoelectric cells of the potassium type, gas-filled, but we have experimented with various types of caesium and rubidium elements both gas-filled and vacuum.

In concluding this brief review, the author wishes to express his appreciation and gratitude to his close associates for their enthusiasm and assistance, past and present. Professors Litvinsky, Smerinin, Kulikoff, Yakhontoff, and Nikolsky, and Engineer Podkovsky have been associated with the work from the outset; Engineers Borissoff, Vorobioff, Lessnikoff, Moshonkin, Obukhoff, Polansky, Stepanoff, Salier, Timartzeff, Ussikoff, and Chibissoff joined it later; and Engineers Volkoff, Mukhatchoff, Shtzo, Kumitz, and V. V. Petroff have been of great help in the practical work in the studios, theaters, radio centers and the workshops of Soyuzkino.

ACOUSTICAL REQUIREMENTS FOR WIDE-RANGE REPRODUCTION OF SOUND*

S. K. WOLF**

Summary.—The extension of the frequency and volume ranges in recording and reproducing sound has aroused a greater and more critical consciousness of the importance of theater acoustics. It follows that higher fidelity in reproduction excites greater intolerance of the needless distortion caused by poor acoustics of the theater. To cope with the new situation, engineers have developed new instruments for acoustical analysis, which provide greater precision and facility in detecting defects and in determining the necessary corrections.

In addition to instrumental developments there have been concurrent advances in acoustical theory and practice. The result is that the more stringent requirements imposed on the acoustics of the theater by the enlarged frequency and volume ranges can be fulfilled adequately and practically. The paper discusses the requirements and describes some of the available methods for complying with them.

The extension of the frequency and volume ranges in recording¹ and reproducing² sound has brought about a greater and more critical consciousness of the importance of quality as a factor in sound pictures. It may well be said that, as one result, sound pictures have come into their majority and achieved their birthright; they are now a medium of entertainment free from the necessity of leaning on their novelty as an apology for their deficiencies.

It follows naturally that greater fidelity of reproduction excites greater intolerance of the needless distortion of quality caused by poor acoustics in the theater. With every other link in the chain from the recording set to the theater made as nearly perfect as modern engineering can make it, it would appear a perverse blow indeed if, through either negligence or ignorance, the character of the reproduction were degraded by improper acoustical conditions.

The extension of the frequency and volume ranges has, of course, imposed additional requirements on the acoustics of the theater; but fortunately concurrent advances have been accomplished in acoustical theory and practice, as well as new developments in instruments

* Presented at the Fall, 1933, Meeting at Chicago, Ill.

** Electrical Research Products, Inc., New York, N. Y.

for making analyses. The result is that both the old and the new requirements can be met adequately and practically and at the same time with greater precision and speed than in the past. This paper discusses the new situation and describes some of the available methods of coping with it.

FREQUENCY RANGE EXTENSION

The work done by Sivian, Dunn, and White³ and by W. B. Snow⁴ on the spectra of musical instruments, and that done by Fletcher on speech spectra, indicate the importance of the higher and lower frequencies in the reproduction of music and speech. It follows that, if these additions to the frequency bands are worth reproducing, they are worth reproducing correctly. It is, therefore, necessary to include an analysis of the acoustics of the theater relative to those added frequencies when making acoustical corrections.

One of the most important factors in auditorium acoustics is reverberation. As is generally known, reverberation is determined by the acoustical absorption present in an auditorium and the cubical content of the auditorium. Through the work of W. C. Sabine,⁵ Lifschitz,⁶ and MacNair,⁷ we know that there are optimal conditions for reverberation which vary with frequency. Reverberation times in excess of the optimal lead to excessive "liveness," as the sounds are prolonged beyond the proper length of time. Reverberation times less than the optimal lead to a characteristically "dead" and "flat" quality. It has been found that there is a median band of reverberation times within which good conditions obtain.

In Fig. 1 are shown optimal reverberation times as a function of the frequency, for an auditorium of 300,000 cubic feet. The cross-hatched sections at the two ends represent the extensions involved in wide-range reproduction. It will be seen that more reverberation is acceptable at low frequencies, due to the fact that the human ear is less sensitive to low-frequency sounds. Theaters that were acoustically satisfactory prior to wide-range reproduction may require additional treatment in order to avoid the confusing and hollow quality deriving from excessive low-frequency reverberation.

Acoustical correction at such low frequencies is complicated by the fact that in most cases the absorption of acoustical materials has not been tested at frequencies below 128 cycles, due to the lack of adequate testing facilities in the past. It is not always possible, therefore, to determine the conditions existing in a theater merely by com-

puting the reverberation times, as has been the general practice. It is safer to make actual measurements in the theater to ascertain the true picture and thus arrive at the proper recommendations for correction.

Fig. 1 indicates that frequencies above 4000 cycles should also be included in making a thorough acoustical analysis. We know, from an analysis of vocal and musical spectra, that such frequencies are of great importance in imparting brilliance and character to the reproduction. Here, also, correction of a theater is complicated by the fact that absorbing materials have usually not been tested above 4096

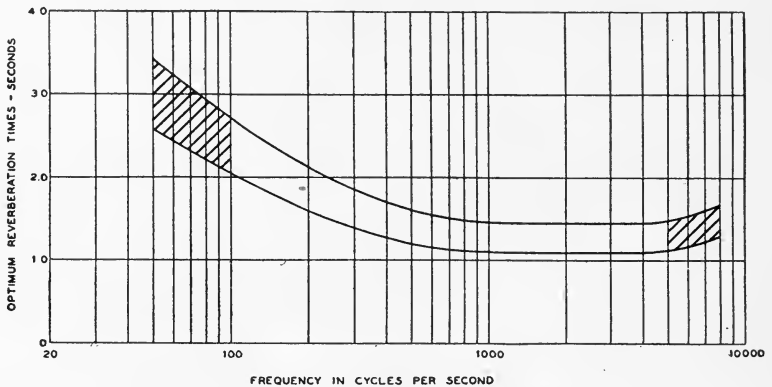

FIG. 1. Optimum reverberation times for 300,000 cu. ft. theater.

cycles; and, what is worse, that at the present time they are not being tested above 2048 cycles by most manufacturers. Another complication is introduced by the absorption of the air as the sounds travel through it. Air absorption is very appreciable at high frequencies, and becomes more so as the frequency is increased. It depends upon various conditions such as temperature and humidity, which constitute a source of uncertainty (excepting in air-conditioned rooms) in making corrections. However, experience has enabled us to make thoroughly reasonable allowances for the possible variation of atmospheric conditions.

The reverberation times shown for the high frequencies in Fig. 1 were determined on the basis of MacNair's work. Their attainment in the theater on the basis of computation alone is uncertain; and, again, for a higher degree of accuracy direct measurements must be made. However, in a great many instances, measurement is im-

practicable for commercial reasons and, therefore, compromise solutions must be adopted.

In Fig. 2 are shown reverberation times measured in two auditoriums, indicating the extremes that may exist. One is far too "live" at high frequencies, the other at low frequencies, the over-all characteristics indicating intolerably bad situations. It is true that they represent extreme cases; but, at the same time, they indicate what may happen when no precautions are taken to achieve suitable and proper acoustical conditions.

The extension of the low-frequency range has accentuated another factor which occasionally gave trouble in the past: resonance. Room resonance, usually at comparatively low frequencies, causes a pro-

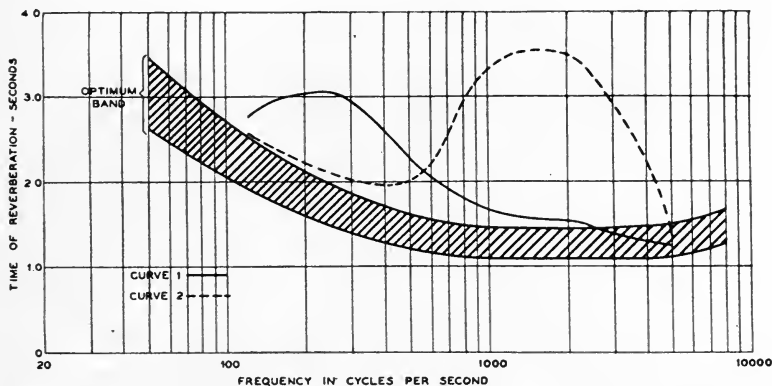

FIG. 2. Reverberation frequency characteristics: two theaters of 300,000 cu. ft., compared with optimum time band.

nounced "boomy" quality, with disagreeable emphasis and prolongation of certain tones beyond their normal values. A loud speaker that has a comparatively good frequency response characteristic when measured in a "dead" room may exhibit a humped and jagged characteristic when installed in a theater. Resonance may exist between the rear wall of the stage and the speaker baffle if their planes are nearly parallel. In the present era of large baffles, such a situation can be serious, and in a considerable number of instances has required correction. However, the condition can easily be remedied by installing absorbing materials on the surfaces that cause the trouble. Sometimes satisfactory results can be attained by re-aligning the loud speaker baffle. Cases of mechanical resonance would require

special consideration and treatment. Tests of one installation showed resonance at 80 cycles. By treating the surfaces surrounding the loud speaker with 2-inch rock wool, the sound intensity behind the baffle was reduced by as much as 8 decibels at a point adjacent to the baffle and 23 inches from the speaker unit.

Such resonance should not be confused with excessive low-frequency reverberation, which is similar in some respects. Resonance causes an accentuation of a few discrete frequencies, and is the more troublesome owing to the fact that any sort of impulsive tone will lead to the appearance of those frequencies. Accordingly, the reproduction of speech or music may be marred by the intermittent accompaniment of such resonances. Low-frequency reverberation, on the other hand, affects all frequencies within the band, and will appear as a rolling prolongation of the low-pitched sounds actually present in the passage being reproduced. Its correction involves the installation of absorbing material in the proper amounts on surfaces throughout the theater and not total suppression as in the case of resonance.

Because of the fact that multiple sets of loud speakers are required to embrace the extended frequency range, the problem of achieving a uniform distribution of acoustical power at all frequencies may be regarded as somewhat simplified. The loud speaker units and their associated circuits at present divide the frequency range among themselves into either two or three bands. Since each unit serves a relatively narrow band width, the directive properties of the combination are more nearly uniform throughout the range, and thus better distribution is achieved. However, because of the over-all improved quality, smaller irregularities become more prominent, so that even with a more amenable system, a great deal of care is still necessary. Further discussion of this phase of the acoustic problem is beyond the scope of this paper.

INTENSITY RANGE EXTENSION

Extension of the recorded and reproduced intensity range is not so recent a development but, nevertheless, it may fittingly be treated here. The recorded range has been increased by about 8 decibels to an amount more nearly capable of accommodating the intensity variation encountered in the original production of speech and music. This increase, brought about by "noiseless recording," is accomplished entirely at the low-intensity end of the range, the maximum values being untouched. Accordingly, it is now possible to hear

relatively faint sounds that would formerly have been submerged in a welter of surface noise. In order to foster and protect this gain, it is necessary to guard against excessive ambient theater noises.

The effect of noise⁹ in reducing the benefits of wide volume range recording is shown in Figs. 3(a) and 3(b), which were obtained with

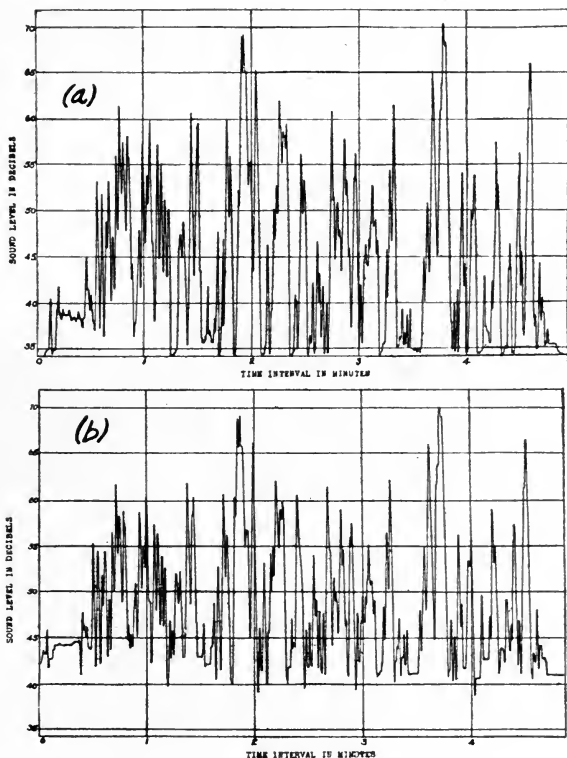

FIG. 3. (a), Variation of reproduced sound level of a wide-range recording under quiet acoustic conditions; (b), same as (a) but reproduced in the presence of acoustic noise of 41.5 db.

an automatic level recorder, developed by the Bell Telephone Laboratories. Fig. 3(a) is an intensity level chart of a recording having a wide volume range with no external noise present. It will be seen that all low-intensity sounds are clearly defined, and that the full volume range could be enjoyed by an auditor without requiring close aural attention. Fig. 3(b) is a chart of the same recording under ex-

actly the same conditions, with the same upper intensity level, but reproduced in the presence of noise. It is apparent that the effectiveness of the low-intensity range has been seriously impaired by the presence of the noise, with a resultant loss of intelligibility and enjoyment. Of course, even in the presence of the noise, the average auditor could still distinguish and interpret speech and music, but only with difficulty and with closer attention. For such reasons it is as much the duty of the exhibitor to provide good hearing conditions for the aural comfort of his patrons as it is to provide good ventilation and seating for their physical comfort.

The maximum permissible limit of noise in the theater is determined by the noise produced by the audience. It is possible to treat other noise sources but the audience is a source over which our control is meager. From a series of observations in a number of theaters, it has been found that the noise level that may be considered to be representative of a comparatively quiet audience is approximately 35–40 decibels above the threshold of audibility. It is to be appreciated that greater levels may occur momentarily, and that during tense dramatic moments they may be much lower. It is apparent, then, that the audience noise is the controlling factor for the maximum permissible noise level and that every effort should be made to reduce all theater noises to levels lower than it. That does not imply that the noise sources will not be heard, but rather that their effects will have been overcome from a practical standpoint.

Theater noises may be divided into two general classes: those produced externally of the theater, and those within the theater and incidental to its operation. Primarily among the noises produced externally are those emanating from street traffic, industrial establishments, and railway or other forms of transportation. Observations conducted in New York City have shown that the average street noise level due to traffic is approximately 70–80 decibels, depending upon the nature and density of, and proximity to, the traffic. Momentary peaks, of varying duration, of 90–95 decibels may be encountered, and in a few isolated cases levels of street noise as high as 105 decibels have been measured. It is apparent, therefore, that in order to remain below the maximum internal noise level, the transmission-reduction factor of the theater structure should lie between 35 and 45 decibels to overcome average traffic noise for satisfactory conditions; and, in very severe situations, between 60 and 70 decibels. In suburban locations the average street noise level may be consider-

ably less than the values here presented, but the momentary peak values stated will probably be still representative.

NEW INSTRUMENTS AND METHODS

To supplement and augment their theoretical information, engineers have had to seek the aid of instruments. As has been the case with most work in acoustics, recent or otherwise, and because the field is a comparatively unexploited one, instruments have had to be developed especially for the purpose. One of the devices that has just become available is the high-speed level recorder,¹⁰ which has

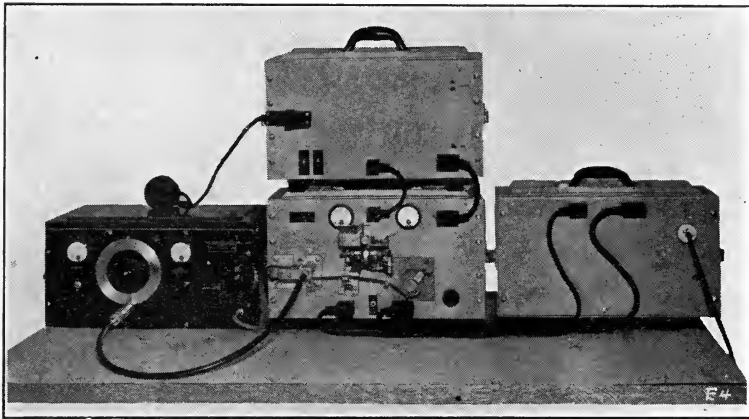

FIG. 4. High-speed level recorder.

already proved its value in conducting measurements of reverberation time and frequency response. Its name suggests its purpose: it automatically records sound intensity levels as they fluctuate at a point. The curves in Fig. 3 were obtained by means of one type of such a level recorder.

Fig. 4 is a photograph of the meter, designed by the Bell Telephone Laboratories, set up for synchronous operation with a beat-frequency oscillator. Excluding the oscillator, there are three separate units: the recording unit proper, its associated amplifier, and a battery box. The record is impressed on a moving waxed paper strip by a stylus which follows the changes of the sound intensity. The speed of the paper may be varied in three steps from $\frac{3}{64}$ inch per second to 3 inches per second. The stylus also may be adjusted to follow changes

of intensity from 45 decibels per second to as much as 360 decibels per second. By driving the paper and the oscillator frequency control synchronously, the horizontal axis may be made proportional to the frequency instead of to the time.

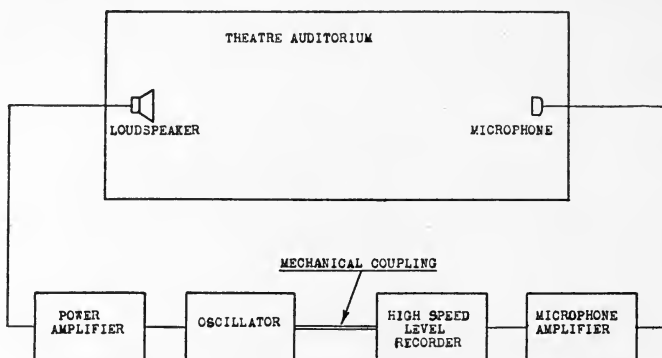

FIG. 5. Acoustic response measuring equipment.

Fig. 5 is a schematic drawing of the recorder as it is used for determinations of loud speaker response in auditoriums. It is obvious that by means of such an arrangement measurements can be made expeditiously and automatically and that, therefore, very complete information concerning the performance of a loud speaker in a given auditorium can readily be obtained. Fig. 6 is an example of such a

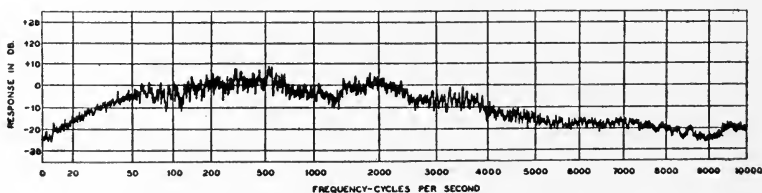

FIG. 6. Typical frequency response characteristic.

study. The sound intensity level at a point in a theater is given as a function of the frequency from 0 to 10,000 cycles. It will be noted that the response falls off above 4000 cycles. In this particular instance, the loud speaker input circuits were adjusted to produce such an effect in order to avoid accentuation of the (high-frequency) surface noise very prominent in the older recordings. By conducting

several such tests at representative points in a theater, valuable information concerning the distribution of sound energy, the over-all response of the system, resonances, and peculiarities of the auditorium may be ascertained.

The level recorder is useful also for measuring the rate of growth and decay of the sound energy. At its most sensitive setting it can record reverberation times as short as 0.028 second, which is shorter than is usually attained even in "dead" rooms. In Fig. 7 are four

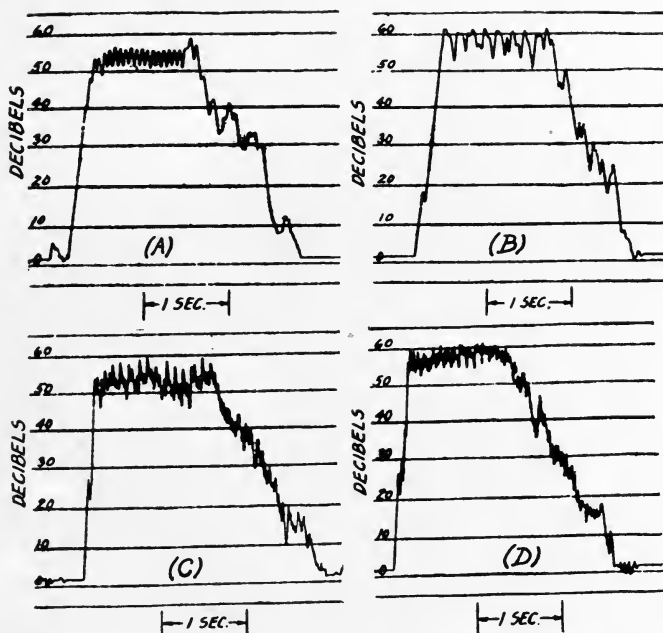

FIG. 7. Sound energy growth and decay curves: (A) 160 cycles per second; (B) 500 cycles; (C) 1000 cycles; (D) 2250 cycles.

examples of growth and decay curves. It will be observed that the sound intensity does not decay uniformly but, rather, rises and falls at about an average rate. In extreme cases this fact may be substantiated by direct aural tests, but usually instrumental observations are necessary to demonstrate the existence of such peculiarities.

Because the scope of this paper is limited, only brief mention will be made of other instruments. The sound meter used by us for studying noise levels has been described before.^{8,9} It is of great value

in arriving at recommendations for treating troublesome noise sources in theaters and on recording stages. Refinements in design have enabled us to produce such a meter consisting of only one comparatively light case containing all the needed equipment. Another instrument has also become available: a precision analyzer, also designed by the Bell Telephone Laboratories. This device is useful in analyzing many different types of noise, testing the linearity of response of amplifiers and loud speakers, and supplementing other instruments when it is necessary to isolate given frequency bands.

REFERENCES

¹ HOPPER, F. L.: "Wide-Range Recording," *J. Soc. Mot. Pict. Eng.*, **XXII** (April, 1934), No. 4, p. 253.

² WARD, J. S., AND WILLIS, F. C.: "Wide-Range Sound Reproduction," presented at the Fall, 1933, Meeting of the Soc. Mot. Pict. Eng.

³ SIVIAN, J. L., DUNN, H. K., AND WHITE, S. D.: "Absolute Amplitudes and Spectra of Certain Musical Instruments and Orchestras," *J. Acoust. Soc. of Amer.*, **II** (Jan., 1931), No. 3, p. 330.

⁴ SNOW, W. B.: "Audible Frequency Ranges of Music, Speech, and Noise," *J. Acoust. Soc. of Amer.*, **III** (July, 1931), No. 1 (part 1), p. 155.

⁵ SABINE, W. C.: "Collected Papers on Acoustics," *Harvard Univ. Press*, Cambridge, Mass., 1927.

⁶ LIFSCHITZ, S.: "Mean Intensity of Sound in an Auditorium and Optimum Reverberation," *Phys. Rev.*, **27** (May, 1926), No. 5, p. 618.

⁷ MACNAIR, W. A.: "Optimum Reverberation Time for Auditoriums," *J. Acoust. Soc. Amer.*, **I** (Jan., 1930), No. 2, p. 242.

⁸ KNUDSEN, V. O.: "Measurement and Calculation of Sound Insulation," *J. Acoust. Soc. Amer.*, **II** (July, 1930), No. 1, p. 129.

⁹ WOLF, S. K., AND TWEEDALE, J. E.: "Theater Noise Problems," *J. Soc. Mot. Pict. Eng.*, **XIX** (Dec., 1932), No. 6, p. 499.

¹⁰ WENTE, E. C., BEDELL, E. H., AND SWARTZEL, K. D.: "A High-Speed Level Recorder for Acoustical Measurement," presented at the May, 1933, Meeting of the Acoust. Soc. of Amer.

WIDE-RANGE RECORDING*

F. L. HOPPER**

Summary.—The recent improvements in sound quality resulting from the extension of the frequency and intensity ranges are the results of coordinated activity in recording equipment and processes, reproducing equipment, and theater acoustics. This paper discusses the recording phase of the process. A wide-range recording channel consists essentially of the moving-coil microphone, suitable amplifiers, a new recording lens, and certain electrical networks.

The characteristics of such a system, from the microphone to and including the processed film, are shown. Other factors fundamentally associated with wide-range recording, such as monitoring, film processing, the selection of takes in the review room, and re-recording, are also discussed. The changes brought about by this system of recording result, first, in a greater freedom of expression and action on the part of the actor; and, second, a much greater degree of naturalness and fidelity than has been previously achieved.

Since the advent of sound in the motion picture industry, the sound engineer has steadily endeavored to make the reproduced sound more natural and pleasing. While there has been continuous effort to accomplish such improvements, the results have been apparent to the public only intermittently, as in the case of noiseless recording, and in the more recent improvement in sound quality known as "wide range." The latter step, which is basically an extension of the range of frequency,¹ both in recording and reproduction, has been achieved by coordinated activity in three fields: that of recording equipment and processes, that of reproducing equipment, and that of theater acoustics. The improvements in the latter two fields are described elsewhere,^{2,3} and this discussion will therefore be confined to the changes made in the recording channel to attain this most desirable end.

As the basis of coordinated design, it has been agreed that the overall characteristic of film recording and reproducing equipment should be essentially uniform at all frequencies. However, due to conditions affecting the sound previously to pick-up, and other conditions

* Presented at the Fall, 1933, Meeting at Chicago, Ill.

** Electrical Research Products, Inc., New York, N. Y.

affecting it subsequently to its leaving its reproducing apparatus, the characteristic may, at times, have to be slightly modified in order to achieve the most pleasing effect.

The changes made in equipment and their result on the circuit and on the sound will be discussed in the order of their occurrence in the recording channel, beginning with the pick-up. The moving-coil microphone, which appears to be the most suitable pick-up instrument, has been described in detail elsewhere.⁴ Its use results in a much truer reproduction of the original sound than was attained with other microphones used in the past. Practically, its use for dialog has resulted in a greater freedom of dramatic action, making it possible to produce takes that would have been unsatisfactory with mi-

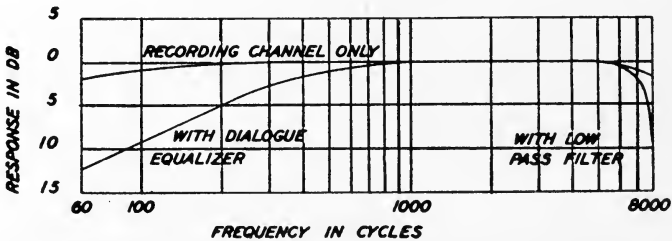

FIG. 1. Recording channel characteristics.

crophones of the older types. Probably a part of this additional freedom is due to the better high-frequency response of the moving-coil microphone, resulting in good articulation even though the actor move freely about the set.

While the frequency response of the amplifier system is uniform over the recording range, modification of the characteristic is frequently necessary to achieve the most pleasing effect. These modifications are effected by a "dialog equalizer," which is introduced into the recording system during the process of recording the dialog. Its purpose is to attenuate the low-frequency speech currents gradually so as to reduce the "chesty" and "panel resonance" effects that become distinctly so noticeable on extending the low-frequency range. The attenuation required is not definitely fixed, since it is frequently desirable to alter it to suit varying conditions on the set. Its purposes are:

(1) To diminish excessive low-frequency reverberation or resonance, frequently encountered in sets.

(2) To compensate for an apparent increase in the low-frequency response when the speech is reproduced at a greater volume than that obtaining during the recording.

(3) To effect psychological compensation in scenes that would obviously be incompatible with their appearance in a large theater; as with an intimate close-up in a large auditorium, with the source of sound at some distance from the audience, in which case the desired feeling of intimacy can not be easily aroused.

From this it is apparent that the dialog equalizer is not necessary for musical recordings, and may not be required for certain kinds of speech, such as those that are declamatory.⁵ In addition to the dialog equalizer, a high-pass filter is sometimes required to exclude extraneous low-frequency sounds occurring on the set.

The characteristic of the recording channel as affected by a dialog equalizer is shown in Fig. 1. This particular equalizer droops more at the low frequencies than most equalizers now in use. On the same figure is shown also the effect of the low-pass filter used to adjust the final characteristic for the upper frequencies. This is perhaps better shown in Fig. 2.

The light-valve used with the system is tuned to 9500 cycles, and its rising characteristic in the region immediately below resonance serves the useful purpose of offsetting the film loss and the loss due to the ribbon velocity effect.⁶ Heretofore the characteristics of light valves did not rise sufficiently to accomplish such a purpose, and a film compensating network has in some cases been used to balance the residual recording losses. However, the new valve characteristic, assisted by an improvement in the design of the recording lenses, is now sufficient to compensate for all recording losses, and the film compensating network becomes unnecessary. Returning to Fig. 2, the film characteristic shown is the one obtained with standard positive film, using the improved lens system. This figure shows also the com-

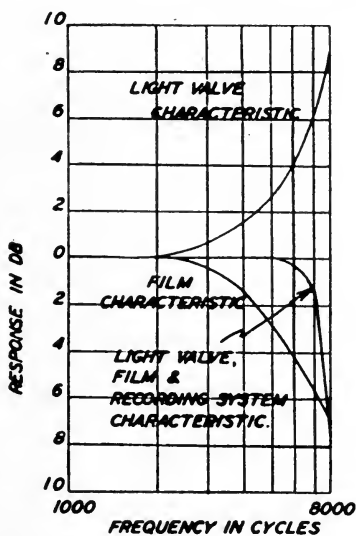

FIG. 2. Light-value, film, and recording system characteristics.

posite curve representing the net effect on the light-valve characteristic, the film loss, and the characteristic of the recording system, including the low-pass filter. In order to obtain such a characteristic it is essential that the film be processed carefully and that no appreciable slippage shall occur in printing. With the development of new film emulsions, better resolving power will probably result, so that a film recorded with this valve might have a rising frequency characteristic. This will permit the light-valve to be tuned to a higher frequency, and thus allow a further extension of the frequency range; or it would permit using the present recording system with some attenuation of the high frequencies in reproduction, thus effecting a reduction of the relative noise level. Combining the final characteristic with that of the recording channel, shown in Fig. 1, we have Fig. 3, which is the over-all characteristic of the wide-range recording system

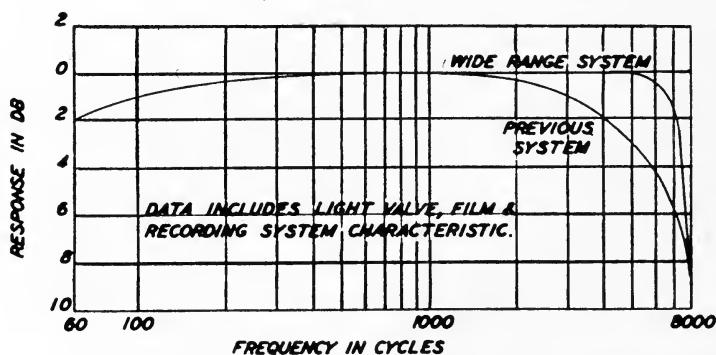

FIG. 3. Combination of characteristics of Figs. 1 and 2.

as viewed by the photoelectric cell in the reproducing equipment. This characteristic includes the recording amplifiers, low-pass filter, light-valve, and all film losses. For purposes of comparison, a similar characteristic is shown of the recording system as previously used.

However, that is not the complete story, as it neglects the effect of the microphone. Fig. 4 shows the final result for both systems. The characteristic of the wide-range system includes that of the moving-coil microphone, while that of the previous system includes that of the condenser microphone which was used with the older type of recording channel. It will be seen that the wide-range system is much more uniform in frequency response over a wider band of frequencies than the previous system.

The new system may be said to have its upper cut-off at a frequency of about 8000 cycles. The low-frequency cut-off is not fixed, having been made, as already explained, purposely indeterminate in order that it may be changed to suit varying conditions. In music, for example, the cut-off is placed below the lowest frequency that the reproducing system is expected to reproduce, while for speech the lower frequency cut-off or droop is so placed that the most pleasing final effect is obtained.

Under the former conditions of recording there existed a deficiency in frequency components above 5000 cycles. This lack of high frequencies was partially compensated by the accentuation of frequencies in the region of 3500 cycles by the condenser microphone. This accentuation resulted in a decided harshness and a nasal quality that are absent in wide-range recordings.

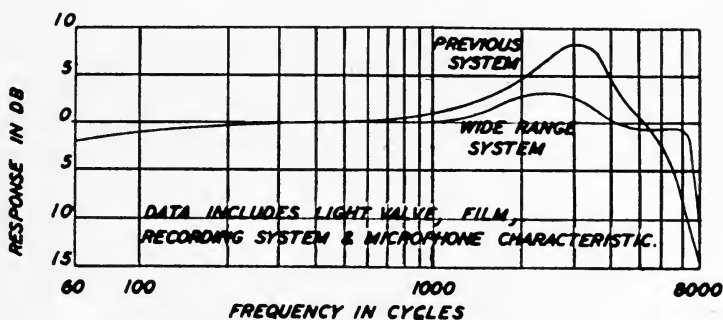

FIG. 4. Final characteristics including microphone.

Further extension of the frequency range in recording will probably require higher tuning of the light-valve and an improvement in film characteristic. Valves having tuning points well above 12,000 cycles have already been used, and certain special test emulsions having the necessary extended response have been produced. The limitation of valve tuning follows from the presence of components whose frequency is such as to cause valve overload. The low-frequency response is limited by the loud speaker system and certain peculiarities of noise reduction. Improvements in the noise reduction system may, in the future, off-set this to some extent. Improvements in film emulsions, resulting in a greater signal-to-noise ratio are, of course, most desirable.

The use of the moving-coil microphone has made it necessary

to make further modifications in the noise reduction system, particularly for the higher frequencies. These changes do not affect the over-all frequency response of the system, but do add materially to its effectiveness of operation.

Monitoring facilities for wide-range recording assume added importance, since the mixer must be provided with equipment enabling him to hear all the sounds being recorded that will subsequently be reproduced in the theater. The electrical characteristics required for the monitoring system are equivalent to those of the recording channel as to fidelity; and, in addition, improved loud speakers have been provided for monitoring. If the older monitoring facilities were to be used with a wide-range system, many sounds or extraneous noises might be recorded on the film that had not been heard by the mixer, thus making retakes necessary. Such improved facilities are particularly desirable when recording music, since judgment as to orchestral balance and instruments employed may be different when using a monitoring system whose frequency range is limited.

That a satisfactory original record of the sound be made is not sufficient; three other steps remain: the selection of "takes" in the review room, the re-recording (when done), and the proper processing of the release print. The importance of the proper review room and associated equipment is even greater than the importance of adequate monitoring. The system should, of course, reproduce the entire range of frequency that has been recorded, and the acoustics must be so adjusted that the effect created in the review room is as nearly representative as possible of the effect that will be obtained in the better theaters. As it is impossible for a small review room to have the same acoustic properties as a theater, final judgment as to the reproduced sound must be formed by playing the film in a theater that is satisfactory for wide-range reproduction, as discussed in the papers previously mentioned.

As in most studios the "dailies" are either partially or wholly re-recorded before the release prints are made, a re-recording channel must be provided. Such a system must be capable of producing so close a copy of the original that the copy will be indistinguishable from the original when both films are reproduced on identical equipment in the theater. The re-recording channel includes equalizing amplifiers and the necessary mixers. The latter are needed where additional sounds and speech effects are combined with the original pick-up recorded on the wide-range recording channel.

Film processing assumes a rôle of even greater importance than heretofore since any degradation of quality produced by it is quite apparent in the impairment of naturalness or sound quality in the reproduced film. From this discussion it will be seen that the equipment for wide-range recording differs from that previously used principally in the use of the moving-coil microphone, the introduction of the new recording lens, the use of a low-pass filter, and the insertion of a dialog equalizer when required. Improved monitoring facilities are, of course, essential to its satisfactory use.

As is usually the case when several such closely interrelated changes are to be made in an electrical or mechanical system, the attainment of a satisfactory over-all result requires that all the necessary modifications be properly coördinated and combined, so that the system is converted as a unit and not on a partial or piecemeal basis.

In conclusion, it may be said that the conversion of a recording system to wide range results, first, in greater freedom of expression and action on the part of the actor and, second, in a much greater degree of naturalness and fidelity than has heretofore been achieved. This improvement is not only very apparent when wide-range recordings are reproduced in studio review rooms, but will also be readily appreciated by the layman in the theater.

REFERENCES

- ¹ SNOW, W. B.: "Audible Frequency Ranges of Music, Speech, and Noise," *J. Acoust. Soc. Amer.*, III (July, 1931), No. 1 (part 1), p. 155.
- ² WARD, J. S., AND WILLIS, F. C.: "Wide-Range Sound Reproduction," presented at the Fall, 1933, Meeting of the Soc. Mot. Pict. Eng.
- ³ WOLF, S. K.: "Acoustical Requirements for Wide-Range Reproduction," *J. Soc. Mot. Pict. Eng.*, XXII (April, 1934), No. 4, p. 242.
- ⁴ JONES, W. C., AND GILES, L. W.: "A Moving-Coil Microphone for High-Quality Reproduction," *J. Soc. Mot. Pict. Eng.*, XVII (Dec., 1931), No. 6, p. 977.
- ⁵ SIVIAN, L. J.: "Speech Power and Its Measurement," *Bell Syst. Tech. J.*, VIII (Oct., 1929), No. 4, p. 646.
- ⁶ SHEA, T. E., HERRIOT, W., AND GOEHNER, W. R.: "The Principles of the Light Valve," *J. Soc. Mot. Pict. Eng.*, XVIII (June, 1932), No. 6, p. 697.

THE "SELENOPHON" SOUND RECORDING AND REPRODUCING SYSTEM

G. E. ROTH*

Summary.—This paper provides further details of the Selenophon system described previously in the *Journal*,¹ and an account of recent developments of the system. Records can be made by either the variable-width or the variable-density method; the latter being used almost exclusively for film recording, and the former for recording on paper. The paper records were produced in order to provide a means of recording sound in the home and for other "stenographic" purposes at small cost.

The "Selenophon" system was developed as the result of many years of collaboration by the Director of the Institute of Theoretical Physics at the University of Vienna, Prof. Dr. Hans Thirring, the Director General of the Austrian Radio Broadcasting Company, Oscar Czeizja, and the late Scientific Director of the Austrian Radio Broadcasting Company, Prof. Leopold Richtera. Schrott¹ has published a brief description of the process, and this paper provides further details concerning recent developments. Although the Selenophon system is of interest from the point of view of its recording process, the chief interest lies in the portability of the apparatus developed in recent years.

THE RECORDING PROCESS

For recording sound, the Selenophon process employs a string oscillograph, the optical arrangement of which is shown in Fig. 1. The light of a 50-watt incandescent lamp L , after passing through the condenser K and the slit-diaphragm B , passes through the reducing micro-objective O to a fine metal wire S , about 0.1 mm. in diameter and 20 mm. in length, which is so stretched that its natural frequency lies above the highest frequency to be recorded. The metal wire S is located in an air space 0.6 mm. wide between the poles of an electromagnet; and is so arranged that, in its position of rest, it covers one-half the image of the slit B formed by O . If, now, the microphone

* Engineer, Tulpengasse 5, Vienna VIII, Austria.

current flows through the wire, the wire is moved out of its position of rest and thus governs the intensity of the light passing the slit in correspondence with the sound vibrations to be recorded. Beyond the wire S is located a lens A , which images both the image of the slit and that of the wire together upon the film F , where the line of light has a breadth of 0.010 to 0.012 mm. The sound record and the focus on the film are observed by means of the focusing microscope composed of the objective O_m and ocular A_m .

The maximum current impulses in the wire attain the value of

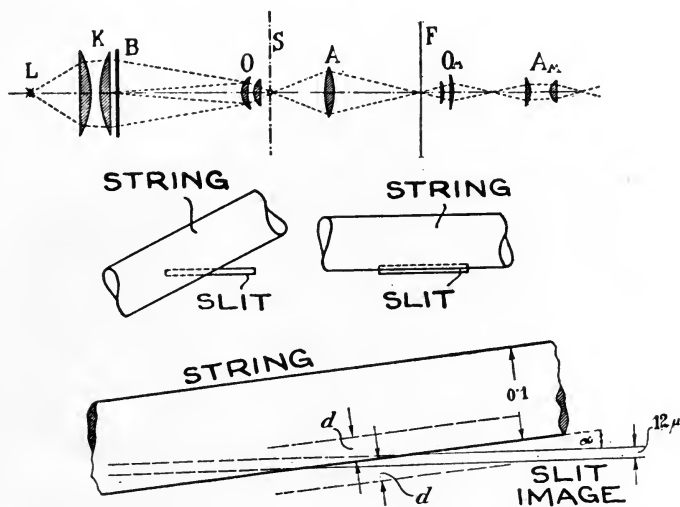

FIG. 1. (Upper) Optical arrangement of the string oscillograph.

FIG. 2. (Center) The relative positions of string and slit: (left) for the variable-width process; (right) for the variable-density process.

FIG. 3. (Lower) The relative positions of string and slit: recording by the variable-width process.

about 1 ampere; the resistance of the wire to alternating current amounts to about 0.5 ohm; the maximum power momentarily expended upon the wire accordingly attains values of 0.5 to 1 watt. In practice, a 4- to 5-watt microphone amplifier is used, in order to afford a reserve of output. The output transformer, which feeds into the oscillograph string and whose primary impedance is adapted to the output resistance of the terminal amplifier tube, possesses a conversion ratio of about 60 to 1, and has a secondary winding, in relation

to the current, of ample dimensions. The natural frequency of the string is 14,000 cycles per second. The use of oil for damping the string is avoided, since the oil bath absorbs the actinic rays and disturbances easily occur in the path of the rays as a result of eddy currents and occluded air bubbles caused by the rapid vibration of the string. A special damping method was developed, however, and is now employed; but it can not yet be described on account of the patent situation. The light source *L* and the electromagnet are energized by a 12-volt battery, and together require about 6 amperes.



FIG. 4. View of recording apparatus. The driving motors are mounted on a base adjacent to the apparatus proper. Above is the speed indicator for the synchronous motor. The operator observes the recording through the focusing microscope. His left hand rests on the lever that disengages the coupling between the motor and the camera.

The recording can be done by either the variable-density or the variable-width method. The positions of the string with reference to the slit, corresponding to the two processes, are shown in Fig. 2.

In recording on films, the Selenophon company uses at present the variable-density method almost exclusively; whereas for the paper records to be discussed later, recording is done only by the variable width-method, which is much less critical as to the average

recording illumination and the developing and printing processes. Fig. 3 (which is not drawn to scale) shows that the string is placed at a relatively small angle to the image of the slit. Such an arrangement has the advantage that a greater portion of the image is covered or uncovered by a small movement, d , of the string. In the recording apparatus, which is represented in Figs. 4, 5, and 6, the film is moved in a horizontal track which lies perpendicular to the optical axis of the image-forming system. Fig. 4 gives a general view of the apparatus, showing the sources of current and the driving motors. Fig. 5 is a view of the string galvanometer from the front, and Fig. 6 shows the driving mechanism diagrammatically from above. The

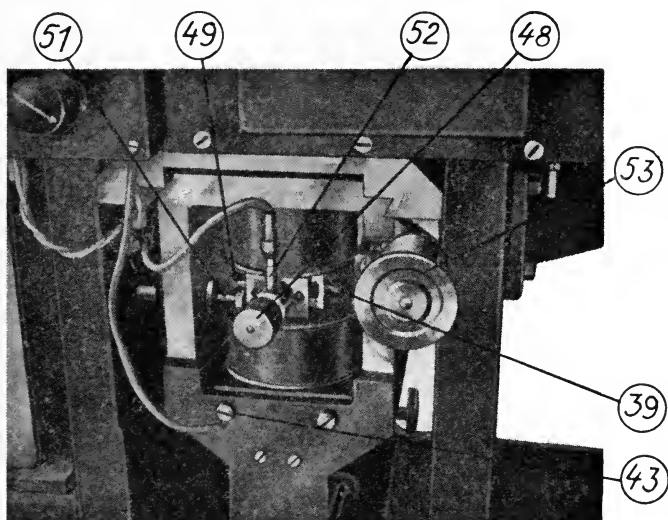

FIG. 5. String galvanometer, showing adjusting handles, connections, and magnet field coils.

driving is done through a shaft that extends parallel to the housing. This covers the supply sprocket V , the sound aperture where the exposure takes place, and the take-up sprocket N . V is driven by a pair of spiral gears Z_1 , while N is driven from the same axis through the pairs of spiral gears Z_3 and Z_4 . The sprocket T is driven from the main shaft through the spiral gears Z_2 , while the fly wheel S , which is rigidly joined to T , is rotated along with it by means of an elastic coupling. The film coming from the feed magazine K_1 , after passing over the supply sprocket V , the sound gate F , the driving sprocket

T , and the take-up sprocket N , is taken up in the magazine K_2 , for which a separate motor M with a worm drive Z_5 is used.

The sound recorder camera is driven by a d-c. motor of 250 to 300 watts, held to a speed of 1440 rpm. by means of a small, four-pole synchronous motor (3-phase, 48 cycles). (Motors of similar type are used also for driving the picture cameras.) Since the main shaft of the sound camera should rotate at 180 rpm., a reduction gear unit having a ratio of 8:1 is used between the motor and the sound camera. This unit employs precision worm gears, and offers the advantage of permitting the motors to be mounted at right angles to the driving shaft. The transmission of vibrations from the separately mounted motors to the sound camera is thus largely avoided. A separable friction clutch is inserted between the drive and the sound camera, by means of which it is possible to run the motors up to their full speed

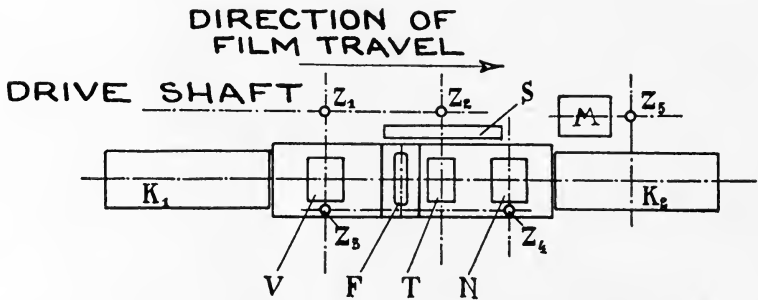

FIG. 6. The film propelling mechanism of the sound recording apparatus.

and then, by slowly letting in the clutch, start the film in the sound camera gradually, avoiding the strain on the mechanism caused by sudden starting. Fig. 7 is a sectional view of the sound camera, the external appearance of which was shown in Fig. 5, through the optical system. The most important details are as follows:

The recording lamp is at 15, in the lamp house 16. The foot 31 of the lamp house can be adjusted in the clamping device 32 by loosening the screw 33, while the guides 34 and 35 permit a movement at right angles to the axis. The slit diaphragm 20 can be moved out of the path of the rays by the knurled head 21 fastened to the pin 22. Correct focusing of the point of light of the recording lamp in the optical axis of the condenser lens 19 is achieved by moving the parts 17 and 18. The mounting of the lamp is designated by 30, while the

part 50 serves to adjust the slit diaphragm in a position exactly perpendicular to the axis of the film. The light rays, reflected perpendicularly upward by the prism 23, pass through the hollow core 24 of the string oscillograph 1, through the lens 25, through the hole 26 in the magnet poles, and through the lens 27, and thus reach the

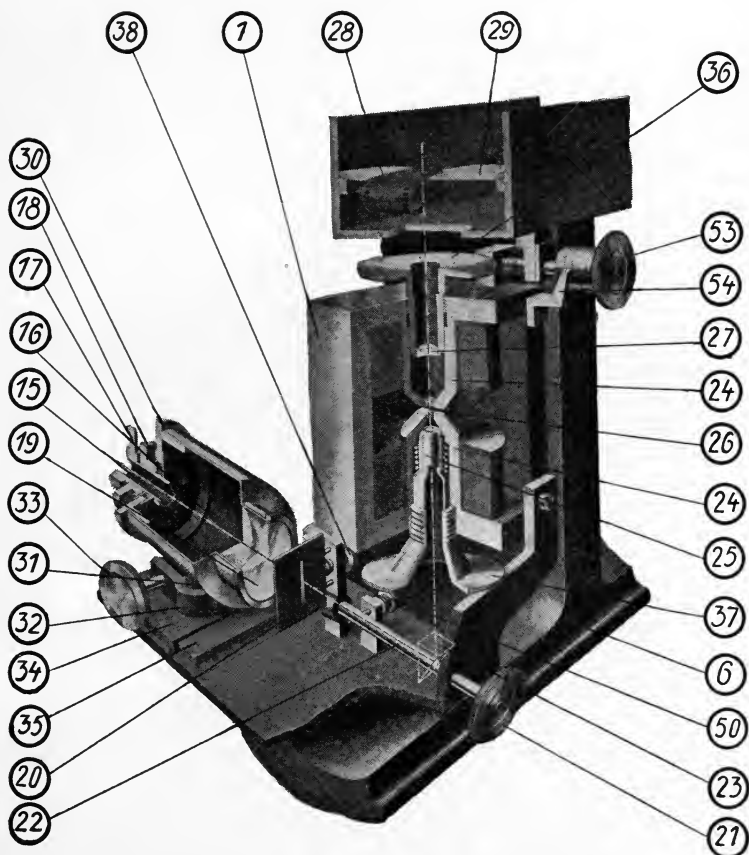

FIG. 7. Diagrammatic cross-section through the sound recording camera, without the oscillograph string and its mounting.

film 28, which is in the sound aperture 29. In Fig. 1, *K* corresponds to the condenser 19, *B* to the slit diaphragm 20, *O* to the lens 25, and *A* to the lens 27. The lens 27 is focused by means of the disk 36 with a milled edge; and the lens 25, by means of the disk 37. The parallel adjustment of the slit is accomplished by means of 38.

By means of the adjusting screw 53, the perpendicular optical axis of the string oscillograph can be displaced at right angles to the film width, the indicator 54 showing its position at any time. By such means, it is possible to make eight adjacent sound records, each 3 mm. wide, on a 35-mm. film, with adjacent records running in opposite directions. The arrangement of the string between the magnets is visible in Fig. 5. The string holder with its mounting can be turned about the principal axis of the oscillograph, this movement being governed by the projection 51 (Fig. 5). The output transformer of the amplifier is connected, on the one side, to the post 52, and is grounded to the apparatus on the other side at 43.

A SMALL APPARATUS

A special opportunity of the Selenophon company lies in the construction of apparatus solely for sound film recording and repro-



FIG. 8. Paper strip reproducing apparatus ready for use.

ducing, to be used, like the phonograph, independently of motion pictures. The development of the small machines has already progressed so far that they are used in regular broadcasting by all the Austrian stations, for international broadcasting (League of Nations' Session, September, 1931) and even by European and American stations. Two types have been developed: a small paper strip apparatus, which reproduces only sound records made on paper (Fig. 8) and a universal apparatus (*U-7*), shown in Figs. 9 and 10.

Before going more into detail regarding these two very interesting

pieces of apparatus, something must be said about the use of "paper films." The Selenophon Company began with the proposition that the use of the usual celluloid film as a support for sound records in home apparatus could not be considered on account of the expense. There were two possibilities in the use of paper as a support: the prints can be made either by contact on photographic paper or by one of the known mechanical printing processes. Both possibilities have been developed to such an extent that they already fill high qualitative demands, so much so that the ground noise of the recording is substantially reduced in reproducing from paper by the construction of the illuminating system, and that the playing time of records on paper films is materially longer than that of disk phonograph records. The 300-meter reels, 6 mm. wide, carry two records each 2.5 mm.



FIG. 9. The *U-7* apparatus, closed, ready for recording.

wide, and have a playing time of about 11 minutes per record; hence 22 min. in all. The sound range of the paper films printed on a rotary press corresponds to that of commercial disk records; their life is much longer, since the paper is subjected to no mechanical wear.

The small reproducing apparatus, shown in Fig. 10, is designed for 6-mm. paper films and is sold as a suit-case model. It contains a built-in asynchronous driving motor, and a pre-amplifier that operates on either 110 or 220 volts. The alternating current delivered by the pre-amplifier corresponds to the power from a good pick-up, and therefore operates satisfactorily radio receivers such as are found in any home. In Fig. 8, the path of the paper film is seen

clearly in the apparatus ready for operation; and, at the center, toward the back, the photocell is seen enclosed in a small cylindrical housing.

The universal apparatus *U-7* permits both the recording and the reproduction of paper and celluloid films 6 mm. wide with two records. It was developed to comply with all the requirements of the radio broadcasting companies, which have, in the *U-7*, an ideal sound recording apparatus that is relatively cheap (800 dollars). The sound is recorded directly on narrow film or light-sensitive paper strips without perforations. The records so produced are developed, fixed, washed, and dried in the usual manner, and can then be used again immediately for reproducing in the same apparatus. The

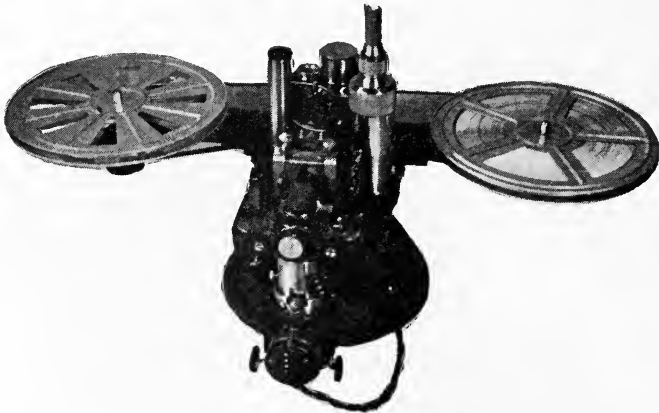

FIG. 10. The *U-7* apparatus arranged for reproduction of paper strip sound records.

entire weight of the apparatus amounts to about 44 pounds. For transportation, a case of about 20 inches long, 20 inches high, and 12 inches wide will serve. For operating the apparatus, only a two-tube amplifier is necessary, such as is found in radio receivers. Fig. 9 shows the *U-7* during recording. As will be seen, both the actual recording parts and the magazines are inclosed light-tight. The recording can be controlled optically and acoustically. The optical control is effected through a viewing microscope visible in the left-center of Fig. 9, while the acoustical control takes place through the photocell. In Fig. 9, the photocell housing is seen in the right-center with the shielded cable attached. At the base of the apparatus,

in the foreground, the lamp house and a part of the optical system for recording are visible. The *U-7* as a reproducing apparatus is shown in Fig. 10. In this case, the paper or celluloid strips are led through the same guide rolls as in the recording. Now, however, the sound lamp with its optical system serves as a light source for scanning the sound records. The photocell receives the light beam, which varies in its intensity after transmission or reflection, through the reproducing optical system.

REFERENCE

¹ SCHROTT, P. VON: "The Selenophon Sound Recording System," *J. Soc. Mot. Pict. Eng.*, **XVIII** (May, 1932), No. 5, p. 622.

SOCIETY ANNOUNCEMENTS

FUNCTIONAL AND ADMINISTRATIVE ORGANIZATION OF THE SOCIETY

In the amendments of the Constitutions and By-Laws proposed at the Chicago convention last October, provision was made for five vice-presidents instead of the then existing two, and for an additional elective member of the Board of Governors. The functions of the new officers were to direct the various agencies of the Society as indicated by the names assigned to the offices, indicated below.

The following is a complete list of the officers and governors of the Society, in which the newly elected officers and governor are indicated by asterisks.

President: Alfred N. Goldsmith

**Executive Vice-President:* H. C. Silent

**Engineering Vice-President:* L. A. Jones

Technical Committees

Sound

Projection Theory

Standards

Projection Practice

Studio Lighting

Projection Screens

Color

Laboratory and Exchange Practice

Non-Theatrical Equipment

**Editorial Vice-President:* J. I. Crabtree

Board of Editors

Papers Committee

Progress Committee

Historical Committee

**Financial Vice-President:* O. M. Glunt

Membership Committee

Ways and Means Committee

Advertising Committee

**Convention Vice-President:* W. C. Kunzmann

Convention Arrangements

Apparatus Exhibit Committee

Publicity Committee

Treasurer: T. E. Shea

Secretary: J. H. Kurlander

Governors: H. T. Cowling

*A. S. Dickinson

R. E. Farnham

H. Griffin

W. B. Rayton

Chairmen of Local Section:

Atlantic Coast Section: H. G. Tasker

Mid-West Section: E. Cour

Pacific Coast Section: E. Huse

The Editorial and Convention Vice-Presidents were elected to serve for one year; the Engineering and Financial Vice-Presidents for two years. Future alternate elections of these officers will be for two-year terms. Of the Governors, the terms of Messrs. Cowling and Farnham expire January 1, 1935; those of Messrs. Dickinson, Griffin, and Rayton, January 1, 1936. The terms of the President, Executive Vice-President, Secretary, and Treasurer expire January 1, 1935; those of the Section Chairmen, January 1, 1935.

PACIFIC COAST SECTION

The second meeting of 1934 was convened at the General Service Studios, at Hollywood, February 21st, as a general session on "sound." The meeting was attended by 55 members and guests, whose interest in the papers was indicated by the spirited discussion following the presentations.

Opening the meeting, Chairman E. Huse expressed the appreciation of the Section to the management of the General Service Studios for the use of their review room and wide-range reproducing equipment, and for the preparations and the courtesies extended to the Section. Following the reading and approval of the minutes of the previous meeting, Mr. H. C. Silent, Executive Vice-President of the Society, assumed the chair after words of appreciation by Mr. Huse for Mr. Silent's part in arranging for the two interesting papers presented by members of the Hollywood laboratory of Electrical Research Products, Inc.

Mr. F. L. Hopper next presented a paper on "Wide-Range Recording on Film." Mr. Hopper's interesting and clear elucidation of the subject, accompanied by graphical and pictorial lantern slides illustrating the equipment and its characteristics, was followed by demonstration recordings and samples of production bearing upon important points of the discussion.

Mr. D. T. Loye next presented a paper on the "Acoustics of Wide-Range Reproduction." Characteristics of existing theaters and review rooms were contrasted with those most desirable for the extended frequency range to attain the full benefit of the extension. The methods followed in making the acoustical measurements were explained, and a sound analyzing equipment was demonstrated in order to illustrate the important advances being made by equipment manufacturers in that field.

After the presentations Mr. Huse resumed the chair. The members were then entertained by viewing one of the latest of the *Silly Symphonies* in color, which had been loaned for the occasion through the courtesy of the Walt Disney Studios; that it was greatly appreciated and well received need hardly be said.

At the request of Mr. Huse, Mr. G. A. Chambers then proceeded to describe the composition and uses of the S. M. P. E. Standard Test Reels, after which the reels were reviewed on the screen. A lively and interested discussion of the various presentations and related subjects terminated the meeting.

MID-WEST SECTION

Members of the Society from eight cities of the Middle West met at Detroit, Mich., on March 3rd, to signalize the change of designation of the Section from "Chicago" to "Mid-West." The meeting convened at an afternoon session in the

new studio of the Metropolitan Motion Picture Company, Mr. Maurice J. Caplan of that company kindly acting as host to the visiting members.

After a brief summary of the aims of the S. M. P. E. by Mr. E. Cour, Chairman of the Section, Mr. H. L. Shippy of the Bausch & Lomb Optical Company presented a paper on the "Problems of Slide Film Projection." The remainder of the program of that session consisted of the following presentations:

"The Slide Film *vs.* the Industrial Film," by Mr. John Strickler, of the Jam Handy Picture Service, Inc.

"Little Smoke Screens," a 16-mm., optically reduced, sound-on-film Jam Handy production, projected by Mr. P. M. Albrecht, Davenport, Ia., with the new Victor 16-mm. sound projector, and followed by a technical description of the new projector.

"The Talking Slide Film," a demonstration by Mr. George Jarrett, of the Metropolitan Motion Picture Company.

"Magnifying Time," by Mr. W. H. Strafford, a demonstration of the use of slow motion in engineering research at taking speeds of 400-1200 pictures per second.

Steel and the Pierce-Arrow, a screening of two Metropolitan productions.

At the conclusion of these presentations, the meeting adjourned for a visit through the interesting new plant of the Metropolitan Motion Picture Company, and after that, to dinner at the famous 2626. An interesting visit was then made to the plant of Wilding Picture Productions, Inc., where Mr. R. Biddy acted as host. The new wide-range recording equipment in process of being installed in the Wilding Studio was very thoroughly explained to the members by Mr. E. A. Dickinson.

The evening session was held in the studios of Jam Handy Picture Service, Inc. Mr. Tex Rickard demonstrated the ERPI sound recording equipment, after which the members were conducted on a tour of inspection through the three large plants of the Jam Handy Company by Messrs. G. Knapp and J. F. Strickler. The tour ended in the projection room, where *Love Apples* and *Men and Work* were screened, after which the session adjourned.

SPRING CONVENTION

CHALFONTE-HADDON HALL, ATLANTIC CITY, N. J.

APRIL 23rd TO 26th, INCLUSIVE

CONVENTION ARRANGEMENTS COMMITTEE

W. C. KUNZMANN, *Chairman*

J. H. KURLANDER

H. GRIFFIN

M. W. PALMER

LOCAL ARRANGEMENTS COMMITTEE

H. BLUMBERG, *Chairman*

J. FRANK, JR.

M. L. SWAAB

B. BLUMBERG

H. WALTERS

W. R. BAKER

J. O. BAKER

M. C. BATSEL

C. TREEN

PROJECTION COMMITTEE

H. GRIFFIN, *Chairman*

J. FRANK, JR.

C. TREEN

H. BLUMBERG

Officer and Members of Atlantic City Local No. 310, I. A. T. S. E.

LADIES' COMMITTEE

MRS. M. C. BATSEL, *Hostess*

Assisted by

MRS. J. FRANK, JR.

MRS. C. N. REIFSTECK

MISS E. BATSEL

MRS. J. O. BAKER

OPENING OF CONVENTION

The Convention will convene at 10:00 A.M., Monday, April 23rd, at the Chalfonte-Haddon Hall, in the Viking Room on the thirteenth floor of the Haddon Hall section. At noon of the opening day there will be an informal get-together luncheon, during which the members of the Society will be addressed by several prominent speakers. The morning preceding the luncheon will be devoted to registration, reports of officers, and other Society business, as well as the reports of technical committees.

SESSIONS

All technical sessions and film exhibitions will be held in the Viking Room, where also will be located the registration headquarters. Technical sessions will be held on Monday, Tuesday, and Thursday afternoons, and on Tuesday,

Wednesday, and Thursday mornings. Monday morning will be devoted to Society business and committee reports; Wednesday afternoon, preceding the semi-annual banquet in the evening, will be left free for recreation. The film programs of recently produced outstanding features and shorts will be held on Monday and Tuesday evenings, and will be booked by Mr. J. Greenburg, of the Philadelphia Film Board of Trade, and Mr. H. Blumberg, chairman of the Local Arrangements Committee.

BANQUET AND DANCE

The S. M. P. E. Semi-Annual Banquet and Dance will be held in the Rutland Room of the Chalfonte-Haddon Hall on Wednesday, April 25th, at 7:30 P.M.—an evening of dancing, movies, and entertainment; no banquet speeches. Banquet tickets should be obtained at the registration headquarters; tables reserved for six or eight persons.

SPECIAL RATES

Excellent accommodations are assured by the management of the hotel, and minimum rates are guaranteed. Room reservation cards mailed to the membership of the Society should be returned immediately to the Chalfonte-Haddon Hall in order to be assured of satisfactory reservations.

EUROPEAN PLAN

Room with bath, ocean view, <i>single</i>	\$4.00
Room with bath, ocean view, <i>double</i>	\$6.00
Room with bath, city view, <i>single</i>	\$3.00
Room with bath, city view, <i>double</i>	\$5.00

LADIES' HEADQUARTERS

A reception suite will be provided for the use of the ladies attending the Convention, and an attractive program for their entertainment is being prepared by the Ladies' Committee.

EXHIBIT OF MOTION PICTURE APPARATUS

Arrangements are being made to hold an exhibit of newly developed motion picture apparatus, in order to acquaint the members of the Society with the newly devised tools of the industry. The exhibit will not be of the same nature as the usual trade exhibit; there will be no booths, but each exhibitor will be allotted definite space and all exhibits will be arranged in a single large room. Requests for space should be directed to the General Office of the Society, 33 West 42nd Street, New York, N. Y., stating the number and nature of the items to be exhibited. The charges for space will be as follows: up to 20 sq. ft., \$10; every additional 10 sq. ft., \$5.

TENTATIVE PROGRAM

Monday, April 23rd

- 9:00 A.M. *Viking Room*
Registration
Society Business
Reports of Officers
Reports of Committees
- 12:30 P.M. *Benjamin West Room*
Informal get-together luncheon for members and guests; short addresses by prominent speakers
- 2:00 P.M. *Viking Room*
Program of Technical Papers
- 8:00 P.M. *Viking Room*
Presentation of recent outstanding motion pictures

Tuesday, April 24th

- 10:00 A.M. *Viking Room*
Program of Technical Papers
- 2:00 P.M. *Viking Room*
Program of Technical Papers
- 8:00 P.M. *Viking Room*
Presentation of recent outstanding motion pictures

Wednesday, April 25th

- 10:00 A.M. *Viking Room*
Program of Technical Papers
- 2:00 P.M. Afternoon open for recreation
- 7:30 P.M. *Rulland Room*
Semi-Annual Banquet of the S. M. P. E.; an evening of music, dancing, entertainment, and motion pictures

Thursday, April 26th

- 10:00 A.M. *Viking Room*
Program of Technical Papers
- 2:00 P.M. *Viking Room*
Program of Technical Papers
- 5:00 P.M. Adjournment of Convention

STANDARD S. M. P. E.
VISUAL AND SOUND TEST REELS

Prepared under the Supervision
OF THE
PROJECTION PRACTICE COMMITTEE
OF THE
SOCIETY OF MOTION PICTURE ENGINEERS



Two reels, each approximately 500 feet long, of specially prepared film, designed to be used as a precision instrument in theaters, review rooms, exchanges, laboratories, and the like for testing the performance of projectors. The visual section includes special targets with the aid of which travel-ghost, lens aberration, definition, and film weave may be detected and corrected. The sound section includes recordings of various kinds of music and voice, in addition to constant frequency, constant amplitude recordings which may be used for testing the quality of reproduction, the frequency range of the reproducer, the presence of flutter and 60-cycle or 96-cycle modulation, and the adjustment of the sound track.

PRICE \$37.50 FOR EACH SECTION,
INCLUDING INSTRUCTIONS

(Shipped to any point in the United States)

Address the

SOCIETY OF MOTION PICTURE ENGINEERS
33 WEST 42ND STREET
NEW YORK, N. Y.

JOURNAL

OF THE SOCIETY OF

MOTION PICTURE ENGINEERS

Volume XXII

MAY, 1934

Number 5

CONTENTS

	<i>Page</i>
Two New Photographic Recording Instruments, the Sensitograph and the Gammagraph. . H. BRANDES AND R. SCHMIDT	279
A Study of Television Image Characteristics. . E. W. ENGSTROM	290
Transmission and Reproduction of Speech and Music in Auditory Perspective. H. FLETCHER	314
Book Reviews.	330
Society Announcements.	331
Atlantic City, N. J., Convention; April 23-26, inclusive.	334

JOURNAL OF THE SOCIETY OF MOTION PICTURE ENGINEERS

SYLVAN HARRIS, EDITOR

Board of Editors

J. I. CRABTREE, *Chairman*

O. M. GLUNT

A. C. HARDY

L. A. JONES

J. O. BAKER

Subscription to non-members, \$8.00 per annum; to members, \$5.00 per annum, included in their annual membership dues; single copies, \$1.00. A discount on subscriptions or single copies of 15 per cent is allowed to accredited agencies. Order from the Society of Motion Picture Engineers, Inc., 20th and Northampton Sts., Easton, Pa., or Hotel Pennsylvania, New York, N. Y.

Published monthly at Easton, Pa., by the Society of Motion Picture Engineers.

Publication Office, 20th & Northampton Sts., Easton, Pa.

General and Editorial Office, Hotel Pennsylvania, New York, N. Y.

Entered as second class matter January 15, 1930, at the Post Office at Easton, Pa., under the Act of March 3, 1879. Copyrighted, 1934, by the Society of Motion Picture Engineers, Inc.

Papers appearing in this Journal may be reprinted, abstracted, or abridged provided credit is given to the Journal of the Society of Motion Picture Engineers and to the author, or authors, of the papers in question. Exact reference as to the volume, number, and page of the Journal must be given. The Society is not responsible for statements made by authors.

Officers of the Society

President: ALFRED N. GOLDSMITH, 444 Madison Ave., New York, N. Y.

Executive Vice-President: HAROLD C. SILENT, 7046 Hollywood Blvd., Los Angeles, Calif.

Engineering Vice-President: LOYD A. JONES, Kodak Park, Rochester, N. Y.

Editorial Vice-President: JOHN I. CRABTREE, Kodak Park, Rochester, N. Y.

Financial Vice-President: OMER M. GLUNT, 463 West St., New York, N. Y.

Convention Vice-President: WILLIAM C. KUNZMANN, Box 400, Cleveland, Ohio.

Secretary: JOHN H. KURLANDER, 2 Clearfield Ave., Bloomfield, N. J.

Treasurer: TIMOTHY E. SHEA, 463 West St., New York, N. Y.

Governors

EUGENE COUR, 1029 S. Wabash Ave., Chicago, Ill.

HERFORD T. COWLING, 7510 N. Ashland Ave., Chicago, Ill.

ARTHUR S. DICKINSON, 28 W. 44th St., New York, N. Y.

RALPH E. FARNHAM, Nela Park, Cleveland, Ohio.

HERBERT GRIFFIN, 90 Gold St., New York, N. Y.

EMERY HUSE, 6706 Santa Monica Blvd., Hollywood, Calif.

WILBUR B. RAYTON, 635 St. Paul St., Rochester, N. Y.

HOMER G. TASKER, 41-39 38th St., Long Island City, N. Y.

TWO NEW PHOTOGRAPHIC RECORDING INSTRUMENTS, THE SENSITOGRAPH AND THE GAMMAGRAPH*

H. BRANDES AND R. SCHMIDT

I. INTRODUCTION

Summary.—Two pieces of apparatus for evaluating sensitometric strips are described: the sensitograph for objective measurement of complete sensitometric strips and automatic recording of the density curve, and the gammagraph for use in continuous control of constancy of the gamma value of short strips.

A photographic density curve is a curve which represents the relation between exposure (plotted logarithmically) and the density produced by it. To produce the curve, strips of the test material are so exposed in a sensitometer that the amount of light falling on consecutive steps of the layer increases in geometric progression. The strips are developed and then measured step by step in a suitable densitometer, and the results are plotted graphically. The measuring and the plotting done at the present time wherever large numbers of plant tests have to be made, as in photographic factories, require considerable time.

Moreover, there is the disadvantage of subjective error with measuring instruments, so liable to occur in a long continued series of measurements, because the observer's eye quickly tires, and errors of measurement result. A certain saving of time can be produced by combining the measuring and the drawing in one operation (as in the Goldberg densograph of Zeiss Ikon) but the saving of time is not very great and, in addition, the measurements are made with the eye, and are subject to the error discussed above. Our aim, therefore, was to develop a device that would make the measurements objectively, and reduce as far as possible the time required for measuring the sensitometric strips.

For that purpose two instruments were developed which combine the following advantages: (1) objective measurement of the den-

* Translated from Agfa Veröffentlichungen des wissenschaftlichen Zentral-Laboratoriums, der Photographischen Abteilung, Band III, 106-114.

sities, by using a photoelectric cell instead of the eye; (2) substantial saving of time by making the measuring and plotting process completely automatic. The range of application of the two instruments is adjusted to fit the particular problem: the *sensitograph* is used for evaluating the entire sensitometric strip; that is, for plotting the whole density curve, while in those cases in which only the maintenance of constancy is concerned, *e. g.*, the developing conditions in processing stations, the use of a shortened sensitometric strip and its evaluation by the *gamma graph* is in order.

II. THE SENSITOGRAPH

(A) *Principles.*—A density wedge is arranged between a light source and a photoelectric cell which can be moved by means of a

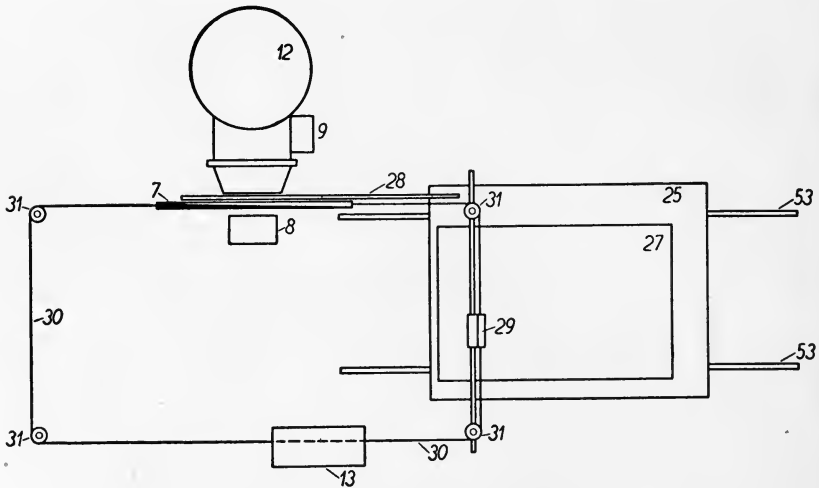

FIG. 1. Principle of the sensitograph.

driving arrangement in the sense of increasing the illumination falling upon the photoelectric cell. When the intensity of the illumination attains a certain value, the clutch between the drive and the density wedge is disengaged, and the wedge remains stationary (null point). When a density strip to be measured is introduced into the path of the rays, then the wedge is shifted until the sum of the density of the wedge and the field being measured is equal to the density of the wedge at the null point (measuring process). The position of the wedge when a balance is attained is thus a direct measure of the

density of the field. In order to render the fluctuations of the light source ineffective, a second photoelectric cell (compensating cell), which receives its light from the same incandescent lamp as the measuring cell, is used in place of the usual high resistance in the measuring cell circuit.

The method of plotting the results is shown schematically in Fig. 1 in which we see the light source (12), the measuring cell (8), and the compensating cell (9). The sensitometric strip and the measuring wedge (7), fastened to the carrier (28), lie in the path of light to the photoelectric cell (8). The wedge is driven through the clutch (13)

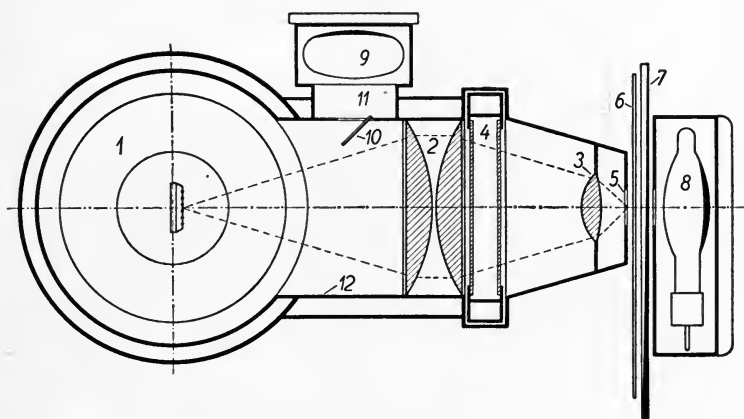

FIG. 2. Optical arrangement of the sensitograph.

and the steel tape (30) to which the recording point (29) is attached. With increasing density of the sample the measuring wedge is moved farther and farther to the left and the pen is moved toward the top of the graph paper, increasing correspondingly the ordinates of the points to be registered. The form itself is fastened to a carriage (25), which runs on the rails (53), and also carries the sensitometric strip holder (28). This carriage is moved to the left step by step in such a way that each area to be measured is brought into position when its corresponding abscissa value is brought under the pen. In this way the density curve is plotted by combining the movement of the carriage and the recording point, which operate perpendicularly to each other.

(B) *Optical Arrangement.*—Fig. 2 shows the lamp house (12) with the photoelectric cells (8 and 9), as well as the sensitometric strip

(6) and the wedge (7), on a larger scale. A 500-watt motion picture projection lamp (1), with the condensers (2 and 3) and the filter cell containing copper sulfate solution (4) used to prevent heating, provides the illumination. The diaphragm (5) reduces the beam to the width of the sensitometric field. The compensation cell (9) receives its light by reflection from the white screen (10). There is provision for inserting a density at (11) for setting the zero point. The housing and trough are provided with a water jacket.

(C) *Electrical Arrangement.*—As soon as the illumination of the photoelectric cell (8), or, more accurately, the relation of the illumi-

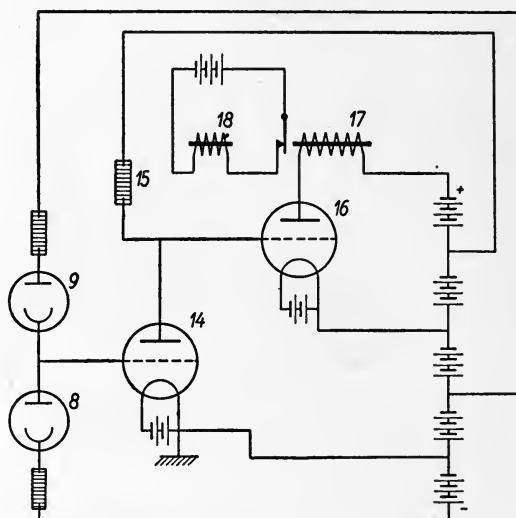

FIG. 3. Circuit diagram of the sensitograph.

nation of the cell (8) to the illumination of cell (9), falls below a certain value, the clutch (13), which controls the gray wedge (7), is engaged; and then, upon the restoration of that value, is disengaged. The electrical circuit, shown in Fig. 3, serves this purpose. If, with constant light illumination of the photoelectric cell (9), the illumination of the photoelectric cell (8) decreases, then obviously the anode current of the tube (14) increases, with a consequent increase in the potential across the resistance (15), and the anode current of tube (16) is diminished. Thus, with less than the standard illumination, the relay (17) is released, closing the circuit that serves the magnet (18).

Since the current strengths at disposal for controlling the grid potential of the first tube are extremely low (of the order of 10^{-8} ampere) on account of the low level of illumination of the photoelectric cell, extensive protective precautions are necessary to minimize leakage. They consist of grounding the cathode of the first tube so that there is essentially no potential difference across the insulation between the grid and ground. The only leakage currents still to be feared would be on the part of the cathode lead of the

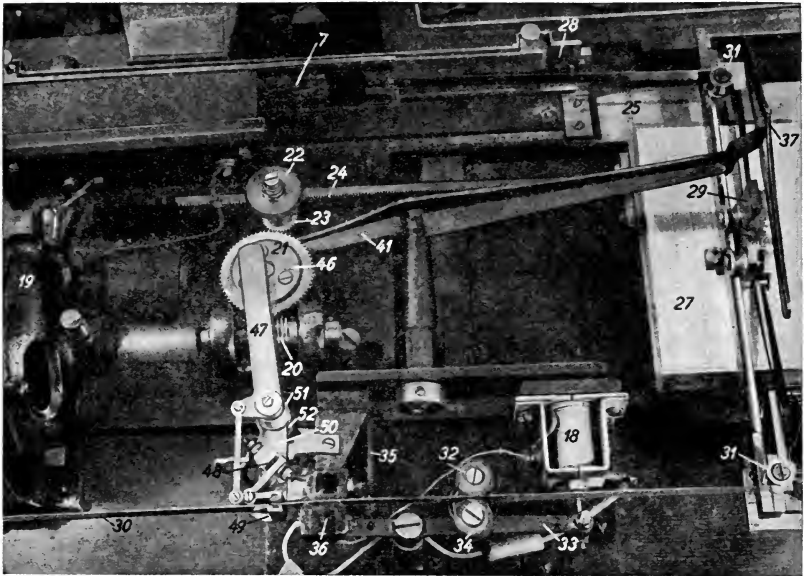

FIG. 4. Mechanical arrangement of the sensitograph.

cell (8), the anode lead of the cell (9), and the amplifier tubes. The leads of the photoelectric cells in question were insulated by leading them through a grounded brass ring, which makes contact with the hard rubber mounting plate of the cell and provides a path to ground for leakage currents coming from the cell leads to the ground. Grounded wire rings, wound around the cells at suitable places, screen off disturbing potentials. The anode lead at the base of the amplifier tube (14) is screened by means of a grounded tinfoil ring. The pin connected to the grid at the foot of the tube was not, as customarily, plugged into the socket, but after removal of the corre-

sponding socket part wired directly. A degree of insulation was attained by these precautions which made it possible to record densities reliably up to $D = 3.5$, using the illumination intensity mentioned.

(D) *Mechanical Arrangement.*—The mechanical arrangement (Figs. 4 and 5) fulfills the following functions:

- (1) To move the strip to be measured forward step by step.
- (2) To move forward, simultaneously, the record sheet under the pen, in steps corresponding to the single steps of the strip.
- (3) To bring about the movement of the control for the gray wedge and the recording point through the action of the magnet (18).
- (4) To operate the recording point.

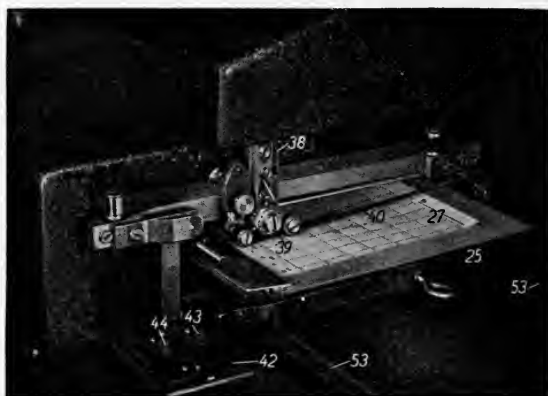

FIG. 5. The recording device.

A 65-watt motor (19) is used as the source of power for all purposes. The screw (20) drives the shaft (21), which in turn actuates the various elements in the machine.

For (1) and (2) above: the shaft (21) drives the shaft (22) by means of a six-sectioned Maltese cross driving gear. The pinion (23) on this same shaft drives the rack (24), which is attached to the carriage (25). The carriage is thus moved once for every rotation of (21). It propels both the graph paper (27) and the carrier (28), to which the sensitometric strip is attached.

For 3: the gray wedge (7) and the pen (29) are both fastened to the endless steel band which is carried over the four rollers (31) and passes in front of friction roller (32) which is driven from shaft (21)

by bevel gears. As soon as the magnet (18) is energized it presses the steel band against the driving roller by means of the lever (33) and the idle roller (34). The steel band, together with the gray wedge and the recording point, are moved until the correct standard illumination of the photoelectric cell (8) is attained, and the magnet (18) is cut out. At once the spring (35) retracts the lever (33), and the steel band is no longer moved but is held fast by the brake block (36). In this way the adjustment of the recording point is completed.

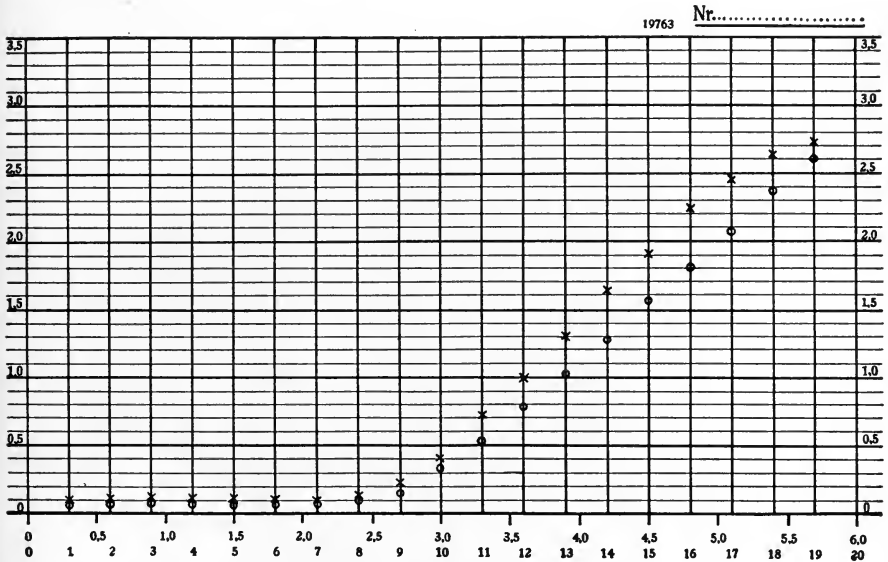

FIG. 6. Curve sheet with plotted points.

The location of the pen is established by the point at which the coupling is switched out. There is the danger that with very small increases in density from step to step on the sensitometric strip, such as occur in the neighborhood of the threshold, the darkening of the photoelectric cell that occurs is not sufficient to actuate the relay for engaging the clutch. In order to avoid this, an arrangement is provided that draws the density wedge and the recording point backward whenever any advancement of the carriage takes place that is sufficient to cause the relay to act. The measuring device is thus set anew for each field, even when no increase in density over the preceding field occurs. The arrangement provided for the

purpose consists of a dog (46), which is fastened to the disk (21) and moves the lever (47) to the right with every rotation of the disk, in such a way as to allow it to go back again quickly. When the lever is drawn back first the contact (48) which breaks the circuit of the magnet (18), and then the claws (49) grasping the carrying band (30) close. With further movement of the lever (47) the entire lever (50), together with the claw (49) and the steel band (30), is moved to the left until the dog (46) releases the lever (47), whereupon all quickly return to the rest position under pressure of the

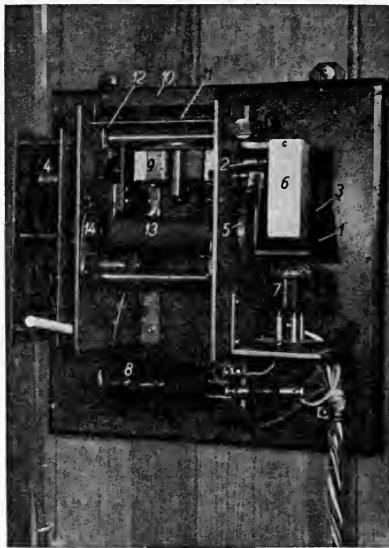

FIG. 7. Interior view of the gamma-graph

springs (51 and 52). The steel band nevertheless remains displaced about 4 mm.

For 4: the recording stroke occurs when the bar (37) is lowered. This is brought about by a cam on the shaft (21) acting upon a roller affixed to the end of a lever (41), which causes the bar to be raised and then dropped shortly before the next advancement of the carriage. The bar (37) thrusts the spring-supported marker (38, Fig. 5) toward the graph paper, and the marking is done by means of the typewriter ribbon (40). The marker is a rotatable hexagon which carries

six different kinds of type (cross, point, circle, *etc.*) so that several curves can be recorded differently on the same graph paper for purposes of comparison.

The single phases of measurement take place in the following order: advancement of the density step and the graph paper; adjustment of the recording point; recording; advancement, *etc.* With the last advancement the carriage cuts out the switches (43) and (44), that is, the motor and the lamps, by means of the trip (42).

The steps of the sensitometric strips are 10 mm. wide. Accord-

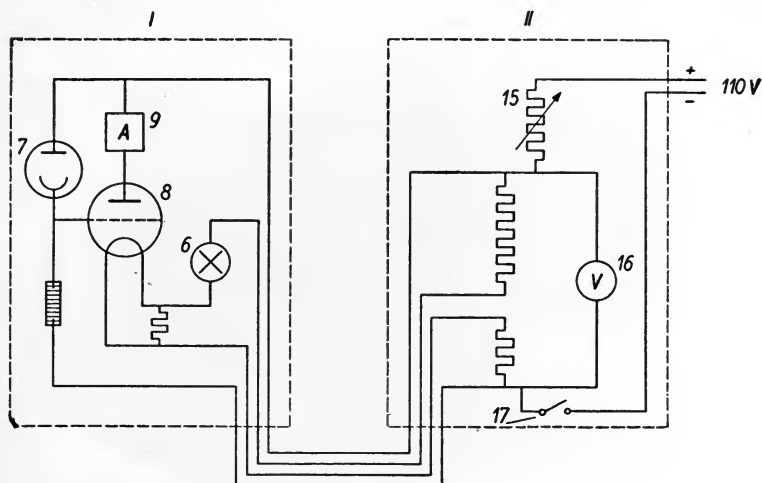

FIG. 8. Circuit diagram of the gammagraph.

ingly, the advancement of the carriage with the recording paper must be adjusted to 10 mm. per step, which requires the constant of the gray wedge to be 0.3 per cm. A curve sheet with two curves is shown in Fig. 6.

III. GAMMAGRAPH

The gammagraph had its origin in the development of the Agfa gammameter. The latter consists of a printing sensitometer in which a five-step sensitometric strip is exposed, and a reading desk on which one can obtain the gamma value of the finished developed strips. The gammagraph, which draws the results as a series of points on a recording strip, takes the place of the reading desk. In this case, the problem is limited for most purposes to indicating

whether the gamma value of the strip to be tested is correct, or lies too high or too low in comparison with a desired value.

For this purpose the test strip is laid on a comparison strip of the desired gamma, and is tested photoelectrically as to whether the total transmission is the same in all five fields or whether it increases or decreases from step to step.

Fig. 7 shows a cylindrical sector (1) rotatable about the axis (2) which contains the comparison strip and is arranged for taking the test strip. It carries also a comparison field (3) with the help of which the absolute value of the density of the gammameter strips can be compared. During the rotation of the sector by means of the clock



FIG. 9. The gammagraph ready for use.

work (4) all six fields are moved through the functioning of the cam (5), one after the other, in front of the window of the lamp house (6). The light passing through the gammameter strip and the comparison strip falls on the photoelectric cell (7) which, through the agency of the amplifier tube (8), actuates the galvanometer (9). The position of the galvanometer indicator for each area is marked on a recording tape running over the roller (12) by the dropping of the frame (10) and the typewriter ribbon (11). The drive for the recording paper comes from the rubber roll (13) and the pressure roller (14), and is usually actuated by clockwork, as is also the control of the dropping frame.

The circuit diagram of the apparatus is shown in Fig. 8, where *I* is the measuring apparatus, and *II* an auxiliary instrument that

serves to connect the main part with a 110-volt source of continuous current. The method of working is shown without going any further into the explanation of the circuit. The figures correspond to those in the photograph. The regulating resistance (15) serves to maintain the working potential, read at the voltmeter (16), constant when the supply voltage varies. The switch (17) controls the entire apparatus. Fig. 9 shows the gammagraph hung up ready for use. The sample strip is inserted in the cylinder (1) through the opening (18), and the current is turned on by means of the switch (17). Then the button (19) is pressed, setting the clockwork in action. The apparatus automatically takes care of five measuring fields and the comparison field, indicates the results on the recording paper, and after the measurement is done automatically cuts out the clockwork again.

A STUDY OF TELEVISIGN IMAGE CHARACTERISTICS*

E. W. ENGSTROM**

Summary.—An investigation was carried out to obtain quantitative information on the several characteristics of television images, particularly those relating to image detail. The tests were conducted largely through the use of equivalents so as to provide sufficient range of measurement. Such data are of value in establishing operating standards, determining satisfactory performance, and in guiding development work. It was found possible to define satisfactory television image characteristics for those items studied. The results are given in such form as to be readily applicable to practical conditions.

INTRODUCTION

Because of the lack of quantitative measures of performance, expression of the degree of satisfaction provided by a television image has been bounded on one hand by the optimism or conservatism of the observer, and on the other hand by the practical limitations which prevent for the moment an increase of picture detail, picture steadiness, picture illumination, picture contrast, and frame repetition frequency. It is the purpose of this paper to describe investigations made regarding some of these picture properties.

Picture detail is determined by the quantity of information that the entire system can handle in a given time. Also, the communication band is proportional to the frame repetition frequency. (Frame repetition frequency determines steadiness of action and picture flicker.) Optical, sensitivity, and transformation problems are present in the pick-up gear and become apparent as attempts are made to go beyond present practical limits. Somewhat similar problems are present in the reproducing elements. These limits are contingent upon the particular state of the art, and, therefore, are constantly receding and yielding to development.

Since the frequency band required is proportional to the quantity of information to be transmitted, the limitations of the electrical channels must be considered. These problems include the ability to handle wide frequency bands and to provide space in the radio spec-

* Reprinted from *Proc. I. R. E.*, 21 (Dec., 1933), No. 12, p. 1631.

** RCA Victor Co., Camden, N. J.

trum for television channels. This may be illustrated by the following table for certain conditions which are stated.

Aspect Ratio 1.33 (4/3).

Frame Repetition Frequency 24 per second.

Picture Frequency

It is assumed that the picture resolution along the scanning line is approximately the same as the width of the scanning line (square picture elements) and that each picture element (of maximum resolution) requires one-half cycle for transmission in elemental form. The maximum picture frequency, therefore, determines the steepness of wave front or change in contrast along the scanning line.

It is also assumed that pictures will be transmitted for ninety per cent of the total time, the remaining ten per cent being necessary for control functions.

Scanning Lines	Picture Elements	Maximum Picture Frequency	Maximum Picture Communication Band
60	4,798	63,970	127,900
120	19,200	256,000	512,000
180	43,190	576,000	1,152,000
240	76,780	1,024,000	2,048,000
360	172,800	2,302,000	4,604,000
480	307,100	4,094,000	8,188,000

The limitations present in the electrical circuit are also determined by the state of the art at any particular time, and, therefore, are subject to advances as a result of development. It is probable that the ultimate limit may be the space available for television channels in the radio spectrum.

GENERAL CONSIDERATION OF IMAGE CHARACTERISTICS

Determination of satisfactory picture quality in television images is difficult because of the inadequacy of present television apparatus for such a study and because the reactions involved are largely psychological and physiological. During the growth of television detail, as the development work has progressed, improvement of picture quality has been noted, for example, through stages of a , $2a$, $3a$, and $4a$ scanning lines, where $4a$ represents the present practical limits. We are not in a position to work with and study $5a$, $6a$, etc., scanning lines in such a determination. Therefore, in studies of picture detail, picture size, and viewing distance, many subterfuges have been used.

Because of the wealth of detail, extreme ranges of brightness, and contrast in nature, the eye tends to demand image resolution up to the

acuity and perception limits of the eye. We have, however, become accustomed to certain compromises in these image characteristics through long association with paintings, photographs, projected transparencies, and other forms of reproduction, because of the limitations of these agencies of reproduction.

The perception of form or acuity of the eye is usually defined as the minimum angular separation which permits resolution of two point objects. For the average normal eye this approximates one minute of arc for that portion of the field which falls on the fovea of the retina. Other measures include minimum dimensions for seeing a point, line,

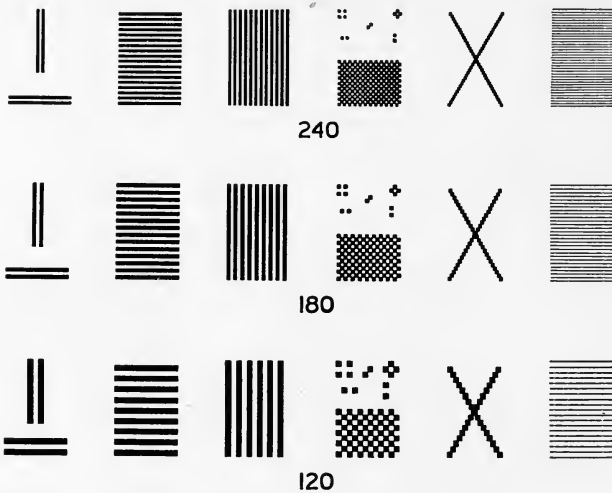

FIG. 1. Patterns for visual acuity tests.

or separation between two lines or groups of lines, change of contour, *etc.* Some of these become rather indefinite if the object is self-luminous. Other eye characteristics of interest in such a study include perception of movement, perception of contrast, color vision, color sensitivity, perception of light, and effects of flicker.

Elementary studies of some properties of vision may be made through the use of the chart indicated by Fig. 1. This chart includes a group of patterns which may be obtained from the scanning system used in television. The numbers under each group indicate the total number of scanning lines for the height of the chart. This chart assumes equal horizontal and vertical resolution for the groups of five

figures to the left of the chart. It also assumes that the scanning lines will coincide with the detail structure (of same width as scanning line) of the chart scanned, so as to provide the greatest possible detail in the chart reproduced for a given number of scanning lines. The fine grating to the right of the chart indicates the scanning line paths. No particular attempt was made to avoid optical illusions, but it is believed that the figures are sufficiently free to avoid mistakes in judgment.

Relationship of picture size, picture detail, and viewing distance is of interest in studying television images. This relationship may be approached from theoretical considerations of providing sufficient detail to satisfy the acuity of the eye. We may start with the definition of acuity for the average normal eye (one minute of arc for that portion of the field which falls on the fovea of the retina). This is justified even though the image may be so large as not to be included within the relatively small field of most acute vision, since the eye naturally tends to explore the entire image, and the image is, therefore, subjected in all its parts to the finest resolution of the eye.

Since the resolving properties of the eye are so definitely tied up with the type of detail to be analyzed, we shall choose for this theoretical consideration a very specific definition of acuity. For this example we shall use two black lines separated by a white space equivalent to the width of one of the lines, such as the pairs of lines in the groups to the left of the chart. If such lines, for a particular viewing point, are separated so that the distance between them subtends an angle to the eye of one minute, then the average eye will be able to see them as two lines. At greater viewing distances the two lines will blur into one. In order to keep our discussion in terms of scanning lines, the curve to follow will be plotted in terms of scanning lines against viewing distances. For the two horizontal lines it is necessary to have one scanning line for each line and one scanning line for the space be-

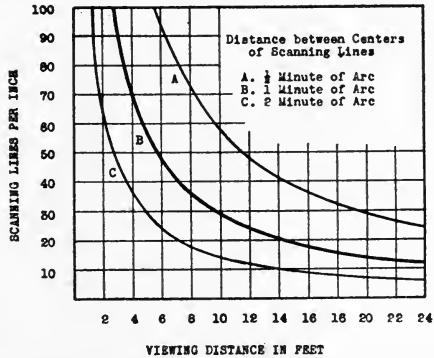

FIG. 2. Scanning lines per inch required for subtending various angles at the eye for various viewing distances.

tween lines. Since, by definition, the space between lines must subtend an angle of one minute, then the width of each scanning line or, in other words, the distance between centers of scanning lines, also subtends an angle of one minute. Fig. 2 includes a calculated curve indicating for various viewing distances the number of scanning lines per inch required for a one minute of arc separation between centers of scanning lines. For later reference, curves are also shown for one-half-minute and two-minute arc distances between centers of scanning lines.

In using these curves it is necessary to understand the span or variation of eye acuity for different people. For the type of detail we are considering, this span is probably from approximately one-half minute

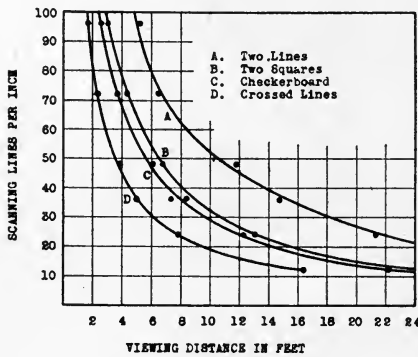

FIG. 3. Observational curves obtained for several patterns.

to approximately one and one-half minutes—one minute being used as the average. This is pointed out specifically because of this wide variation and the difficulty of dealing with a definite average value.

By inspection of this curve (the one-minute curve) we are able to determine (within the scope of our definition) the amount of detail in terms of scanning lines for still images at various viewing distances

for the "average eye." If, for viewing distance X , the curve indicates that Y scanning lines should be provided, then the eye will be satisfied at this viewing distance for a detail of Y scanning lines. For closer viewing distances and Y scanning lines, the eye will not be satisfied since the picture structure will be pronounced, resulting in "lack of detail." For greater viewing distances and Y scanning lines, the eye will be satisfied from the standpoint of detail, but more detail is available than required by eye acuity.

In order to make some practical tests, a number of observations were made using charts of the type shown in Fig. 1. Three charts were used—one two and one-half inches high, the second five inches high, and the third twenty inches high—so as to provide an effective range of scanning lines of from 60 to 480. Tests were made by three

people having good vision and having no known eye defects. The tests were conducted by placing the charts on a wall at eye level in a room having uniform daylight illumination (mainly sky light since the sun did not strike the windows). The illumination at the chart was between 20 and 40 foot-candles. The contrast on the charts was the maximum possible in a normal photographic print.

The pairs of lines to the left of the chart were used to obtain data for the first curve. For each degree of "scanning line detail" a viewing distance was chosen at which the two lines could just be resolved; at greater distances the two lines blurred into one. At this same viewing distance the group of horizontal and the group of vertical lines (the second and the third groups of figures from the left) could just be resolved into lines; at greater distances they blurred into a uniform gray. The curve plotted in Fig. 3 is the average for the three observers. A curve was plotted for resolving the two squares, a part of the fourth group from the left (the two squares at the left, just above the checkerboard pattern). A curve was plotted for resolving the checkerboard pattern, in the lower half of the fourth figure from the left. A curve was also plotted for the crossed lines, the fifth figure from the left. In this case the viewing distance chosen was the point at which the line structure could just be seen; at greater viewing distances the line structure was missing, and the cross appeared to be made up of two straight lines of constant width. All of the curves were plotted using the average viewing distance for the three observers. An interesting point noted from the observations was the consistency of the viewing distances chosen. Two of the observers picked viewing distances very nearly the same. The third observer picked viewing distances slightly greater (10 to 20 per cent). In the case of the third observer, this difference was consistent for all of the tests. These curves indicate the range of satisfactory viewing distances for the types of detail chosen. In general, the detail types probably do not cover the extremes, but do cover at least the average range encountered in scanned television images. Some interesting deductions may be made by comparing these data with the theoretical curves for one-half, one, and two minutes of arc separations between center lines of scanning paths. For convenience these curves are shown in Fig. 4, superimposed. The data from the observations are indicated by a dark band including the span between the test for the two lines and the test for the crossed lines of the previous curves. The one-half-, one-, and two-minute arc curves are

shown as solid lines. The data presented in Fig. 4 indicate that the types of detail on which the tests were made require, for any chosen viewing distance, a range of from a little over one-half minute to a little less than two minutes of arc separation between centers of scanning lines. It is also indicated that the average acuity of the three observers is above that of the "average eye"—near the upper limit of acuity. From the standpoint of these tests and the tests to follow, this is a safe condition because, for any viewing distance, detail satisfactory to this group of three observers will certainly be satisfactory to the average observer.

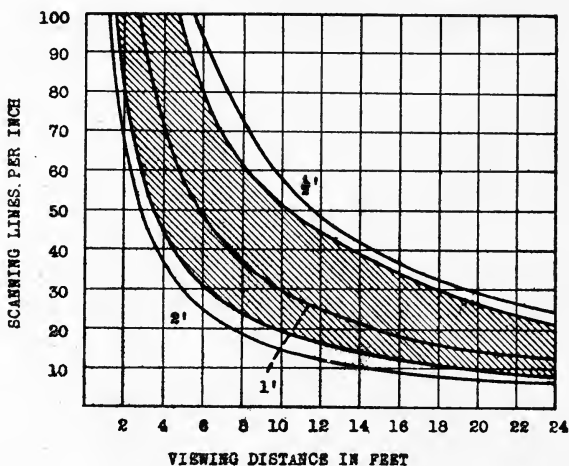

FIG. 4. Comparison of observational data and curves of Fig. 2.

In viewing reproductions the observer tends to position himself so that he is satisfied regarding the information and the effect he wishes to obtain. (The position or viewing distance for greatest resolution is about eight to ten inches for the average person.) Because of habit and experience we have learned to temper our acuity demands. The following generalizations are of interest, and are given in terms of general experience rather than technical knowledge. When viewing a painting we rather unconsciously choose a position where the brush stroke detail becomes unnoticeable, and where we obtain the effect the artist wished to convey. We have learned that a newspaper illustration contains only a certain amount of detail, and that such illustrations will not bear close inspection. We also know in general what

to expect from motion pictures of the theater and home types. We, further, know that good photographs go beyond the acuity limits of the eye, and that the field may be optically enlarged to improve the resolution. Other examples could be given, but the above are sufficient to illustrate the effect of experience on the average person.

The value of the above curves is to indicate the maximum useful detail from the standpoint of eye acuity, assuming favorable conditions for all other related factors. For a particular viewing distance, the amount of detail required in a reproduction (still image) is dependent upon the type of information to be conveyed by the picture. Since this varies, it is safe to assume that, for limiting conditions, detail corresponding to that indicated by the curves should be provided. For average conditions and for general use it is also safe to assume that sufficient satisfaction can be provided by considerably less detail than that indicated. This is verified by the various types of printed reproductions.

DETERMINATION OF SCANNING LINES, PICTURE SIZE, AND VIEWING DISTANCE FOR TELEVISION IMAGES

It is difficult to interpret television image quality in terms of the relationships discussed. The first reason for this is that television images are the result of scanning at the pick-up end which introduces an aperture effect, and at the reproducing end the aperture effect is introduced for the second time. This results in a definite and peculiar line and detail structure. Detail along each line is dependent upon the ability of the system to reproduce changes in contrast. The second reason is that television images are made up of rapidly superimposed, individual pictures much the same as motion pictures. The third reason is that television images usually include motion having certain continuity. The effects of motion will be taken up more in detail later in the paper.

Photographs have been made which consist of scanned reproductions of an ordinary photograph or scene. These, therefore, have picture structures which correspond to television images and are useful in studies of the character outlined by this paper. Such scanned reproductions are usually limited in the number of scanning lines possible by much the same reasons that a television system is limited in the number of scanning lines unless elaborate apparatus is specially constructed. Other forms of reproductions have been used to simulate television picture structures. Such methods of compari-

son are, naturally, limited to inspection of one picture frame and, as such, a still image.

In television we are concerned with moving images and with a succession of movements or scenes which have certain continuity. Also, the vision is aided by sound accompanying the picture. Because of the wide gap between a still picture of certain detail and a television reproduction having the same equivalent detail, it is difficult to draw any definite information regarding the number of scanning lines desired for a particular condition from any of the methods of study which have been discussed. These methods are helpful in preliminary studies, but fall short when an attempt is made to draw general conclusions.

Motion in a picture directs the observer's interest to the object or objects in motion. Under these conditions the eye requires less detail than for a still picture, assuming that the detail is sufficient so that the purpose of the movements may be understood. Proper use of this may be made in television in the choice of "story action" and choice of background for the action. Also, in an image which is the result of scanning at the pick-up end, motion of the objects being scanned positions these objects for particular frames in favorable relation to be analyzed and reproduced when these objects are small and approach in at least one dimension the size of the scanning beam.

For a more complete study of television image, it seems necessary to have available the ability to produce image reproductions which have picture structures equivalent to television, controllable illumination, controllable size, flicker frequency equivalent to television, and capacities for subjects which will be used in television. It is also desirable to cover a range of picture detail equivalent to television images of 60, 120, 180, 240, and even larger numbers of scanning lines. These equivalents should be so made that they represent nearly perfect picture structures for the detail included. This seems desirable so as to avoid mistakes in judgment. Also, it will permit study with images equivalent to the more advanced stages of television which will later be attained as a result of continued development. Such an experimental set-up will allow reasonable determination of several related picture properties—picture detail, picture size, and viewing distance.

As has been pointed out, it is impracticable to make use of television systems for this study. This is because of limitations in our ability at present to produce television images with sufficient detail, illumina-

tion, and size for this investigation and to have these characteristics variable. We must, therefore, resort to suitable equivalents. A motion picture film having a picture structure equivalent to a television image provides a very flexible means for carrying out this work. Such a method was chosen, and the procedure used will be described. There are numerous ways in which such a film may be made, but the method used for this investigation is flexible and presents only a reasonable amount of preparatory work.

In the system of television that we are considering, the scanning paths are horizontal and the beam progresses from left to right (when facing the object or reproduction) and from top to bottom. The scanning beam is usually round or square in cross-section. Since the scanning beam has width in the direction of the scanning path, a certain form of distortion is introduced. This is known as aperture distortion, and has been adequately treated in the general television literature. This much has been indicated about the image characteristics because we shall later make comparisons between the structure of a television image and the motion picture equivalents we are to use.

The equipment used in making 16-mm. motion pictures with detail structure equivalent to television images consisted essentially of a 35-mm. to 16-mm. optical reduction printer. A system of optics was interposed between the two picture gates for the purpose of breaking up the picture image into small areas, each of which was uniformly illuminated, and which transmitted the same total quantity of light as a corresponding area in the picture image. A diagram of the optical system is shown in Fig. 5. The filament of an incandescent lamp *1* is focused by means of condenser lenses *2* upon a corrected lens *4*. Lens *4* in turn forms an image of the 35-mm. picture aperture *3* on the plane surface of condenser lens *7*. The equivalent of thousands of tiny spherical lenses *6* are placed directly in front of lens *7*. Each of the tiny lenses forms an image of aperture *5*. The plane containing the many images of aperture *5* is brought to focus upon the 16-mm. aperture *9* by means of a corrected lens *8*. Condenser lens *7* makes it possible for lens *8* to collect an equal quantity of light from each of the images formed by lenses *6*. The horizontal dimension of the rectangular aperture *5* is such that the sides of the images formed by lenses *6* just touch, thereby forming continuous bands of light in the horizontal direction. The dimension of aperture *5* in the vertical direction is narrower, thereby producing narrow dark spaces be-

tween the horizontal lines formed. This was done to simulate television image lines. The image at aperture 9 of a motion picture film at aperture 3 is broken up by this optical system into as many elementary areas as there are lenses or equivalent lenses in 6, each of which contains no detail within itself. By adjusting the reduction ratios of lenses 4 and 8, and by having sufficient equivalent lenses at 6, it is possible to vary the number of picture elements.

Since it would have been quite difficult actually to obtain the thousands of minute spherical lenses, an approximate but more practical

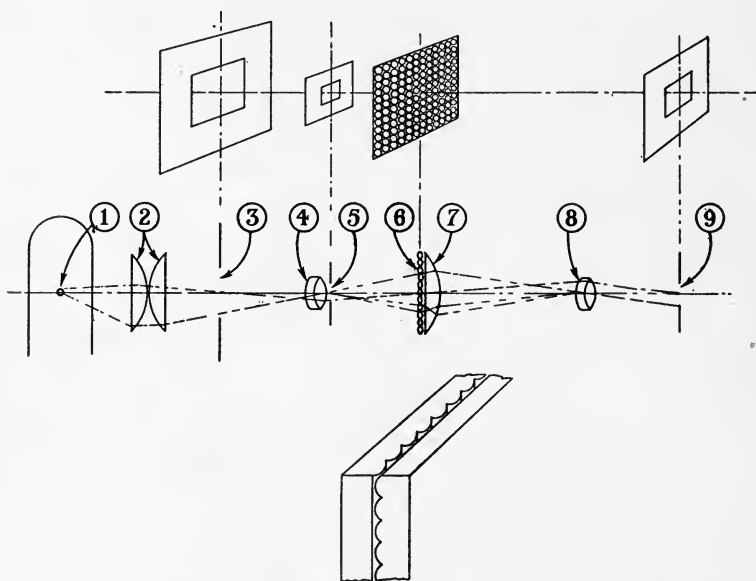

FIG. 5. Diagram of the optical system used in making the motion pictures.

scheme was resorted to. It is known that two crossed cylindrical lenses are very nearly equivalent to a single spherical lens. Thus, it would be quite possible to approximate the required condition by crossing two layers of fine glass rods, the rods being in actual contact with each other. Fortunately, an even simpler solution was found. Kodacolor film is embossed with minute cylindrical lenses having focal lengths of about 6 mils. By crossing two pieces of Kodacolor film with the embossed surfaces in contact, very satisfactory results were obtained. The focal lengths of the equivalent spherical lenses formed by crossed Kodacolor film were so short that the size of aper-

ture 5 would have had to be larger than the diameter of lens 4. This condition was corrected by forming a cell made up of two pieces of Kodacolor film crossed, and filling the space between the embossings with a transparent solution having an index of refraction greater than air and less than the index of the film base. By varying the index of refraction of this transparent solution, it is possible to make the lenses have any desired focal length from 6 mils to infinity.

The Kodacolor cell and lenses 4 and 8 were arranged in a suitable mounting and mounted on the reduction printer between the 35-mm. aperture and the 16-mm. aperture. Arrangements were provided for adjustment of these various lenses. The subject matter was taken from a 35-mm. positive print. The first printing operation gave a 16-mm. negative having the desired picture structure. A 16-mm. positive was then made by printing from the negative in a 16-mm. contact printer. The sound was transferred in the usual manner.

Films were made up for a variety of scenes and subjects. These, in general, included:

- Head and shoulders of girls modeling hats,
- Close-up, medium, and distant shots of a baseball game,
- Medium and semiclose-up shots of a scene in a zoo,
- Medium and distant shots of a football game,
- Animated cartoons,
- Titles.

These were assembled for one group with all scenes of the same detail (line structure) on the same run of film. For another group these were assembled with each scene progressing from 60- to 240-line structure. The pictures made included:

- 60-line structure,
- 120-line structure,
- 180-line structure,
- 240-line structure,
- Normal projection print.

It was planned at the start to produce pictures having detail structures greater than 240 lines, but it was found that limitations, mainly in film resolution, prevented this. The resolution of the 16-mm. film used was naturally considerably greater than a 360-line structure, but, with the averaging process used in producing each small section of the picture, the resolution was not sufficient to prevent merging of one section into the next. Later determinations made from viewing these films indicated that the 240-line structure

pictures were sufficient for the purposes of the investigation since the results were of such a nature that the relationship could be extended to higher numbers of scanning lines.

Samples of three picture frames are given as Figs. 6, 7, and 8. These are all enlargements from the 16-mm. negatives and include structures of 60, 120, 180, and 240 lines and, also, a normal photographic enlargement. It is interesting to note how near the 240-line structure approaches the normal enlargement in picture quality.

An RCA Photophone 16-mm. sound projector equipment was used in projecting these films. The light cutter in the projector was modified so as to interrupt the light only during the time that the film was being moved from one frame to the next by the intermittent movement. This modification consisted in removing one blade from the light cutter. The light was, therefore, cut off once per frame, giving for these tests a flicker frequency of 24 per second. The films were shown to several groups of people, using projected picture sizes 6, 12, and 24 inches high. The major reaction from these showings was the expression of satisfaction obtained from viewing pictures 12 inches high and larger in comparison to smaller pictures.

It will be of interest at this point to record some of the reactions on how well these films form equivalents of television images. These reactions were formed as a result of observations and tests made with the films. The horizontal-line structure was so clearly equivalent that we may pass by this without comment. The changes of contrast along the horizontal "scanning" lines for the 60-line structures appeared somewhat "mosaic" in arrangement. This was because the boundaries of the individual picture arrangements were determined by the multiple lens arrangement used to produce the image. This effect was not noticed in 120-line structure or in those of higher detail. The 120-, 180-, and 240-line structures, and also the 60-line structure, except for the effect explained above, were well suited for study of image detail. In general, a particular line structure on the film was considerably better than a television image (as we are at present able to produce them) of the same number of scanning lines. This is a desirable condition because the results of the tests will then be in terms of television of an advanced stage rather than in terms of present capabilities.

In order to obtain some quantitative information, a number of practical viewing tests were made. These tests were made by the same three observers who made the tests covered earlier in this paper.



60 Scanning Lines
(a)

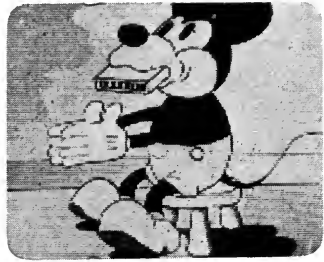

120 Scanning Lines
(b)

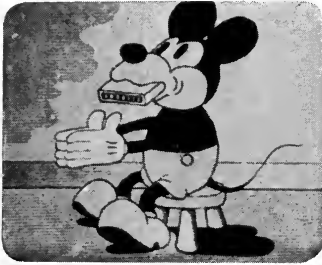

180 Scanning Lines
(c)

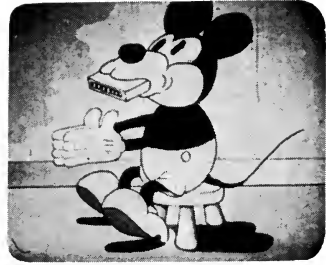

240 Scanning Lines
(d)

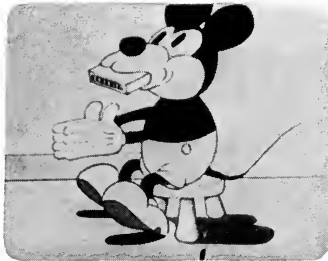

Enlargement
(e)

FIG. 6. Sample of picture frame.



60 Scanning Lines
(a)



120 Scanning Lines
(b)



180 Scanning Lines
(c)



240 Scanning Lines
(d)



Enlargement
(e)

FIG. 7. Sample of picture frame.



60 Scanning Lines
(a)



120 Scanning Lines
(b)



180 Scanning Lines
(c)



240 Scanning Lines
(d)

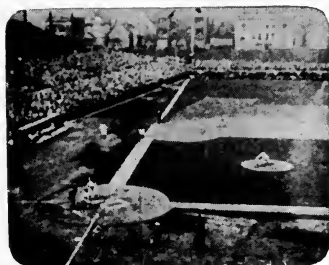

Enlargement
(e)

FIG. 8. Sample of picture frame.

For these observations the same projector equipment as described in a paragraph above was used (one light interruption per frame). The projection lamp was operated at rated voltage (normal brilliancy) and the projection lens was stopped down to give the desired screen illumination. A screen illumination of five to six foot-candles was chosen. This was measured at the screen, looking toward the projection lens, and with the projector running, but without film in the picture aperture. This value of screen illumination, though less than for theater or home movies, was chosen because it gives a fairly bright picture and because it falls within a range to be reasonably expected for television. For the pictures of various sizes the foot-candles of

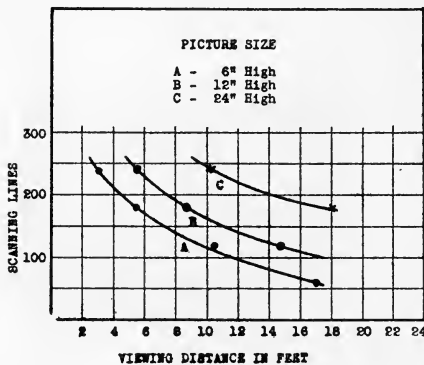

FIG. 9. Viewing tests with pictures of various heights.

illumination (surface density) was kept the same, varying the total luminous flux in proportion. The stray room illumination was of the general order of one-tenth foot-candle.

Viewing tests were made with projected pictures of various heights, using the film subjects listed earlier. For pictures of given height and line structure, observations were made for each type of subject matter on the film.

These data were averaged, and the information used in the curves to be plotted includes this in terms of an over-all average for the three observers. In taking the observations, viewing distances were chosen at which the lines and detail structure became noticeable. At closer viewing distances the picture structure became increasingly objectionable. At the viewing distances chosen the picture detail was just satisfactory. At greater viewing distances the picture detail was, naturally, sufficient. It was noted that the type of picture subject did not influence the viewing distance chosen by more than ten per cent. This is explainable on the basis that we are determining minimum conditions in terms of line and detail structure. Data were taken for pictures 6, 12, and 24 inches high, and for picture structures of 60, 120, 180, and 240 lines, and also for a normal projection print. This information is given in curve form in Fig. 9.

In order to present these observed data in more general form, the above curves are shown, in Fig. 10, replotted in terms of scanning lines per inch. The curve drawn through the observed points is the two minutes of arc curve from Fig. 2. This, as explained earlier in the paper, is a curve between scanning lines per inch and viewing distance where the dimension between centers of scanning lines subtends an angle to the eye of two minutes. Because of the correspondence between the plotted points and the two minutes of arc curve, we shall use this two minutes of arc curve in our discussion as representing the average results (for the three observers) for practical viewing conditions.

It is of interest to compare these observed results from viewing the films of several detail structures with the observed results of viewing the chart, Fig. 1, the curves of which are shown in Fig. 4. In the case of the still chart observations, the average falls on the one minute of arc curve; in the case of the observed motion picture television equivalents, the average falls on the two minutes of arc curve.

In order to indicate the relative viewing distances for a normal projection print, the data taken are shown in another graphical form.

The plotted points for picture structures of 60, 120, 180, and 240 lines are the same as for the curves in Fig. 9. The plotted points for a normal projection print were taken in the same manner as for the other films. In this instance the viewing distance chosen was where the picture just began to show loss of detail. Thus Fig. 11 indicates in a general measure the relative merits of the several picture structures. It also shows how near the 240-line structure approaches a normal 16-mm. projection print. In inspecting this chart it will be noted that the observed data do not entirely check the theoretical acuity conditions. This is also to be noted by the variation of the points from the theoretical curve in Fig. 10. An example of this for the chart, Fig. 11, is that curve *D* for 240 lines should indicate viewing distances one-half that for curve *B* of 120 lines. Curve *B*

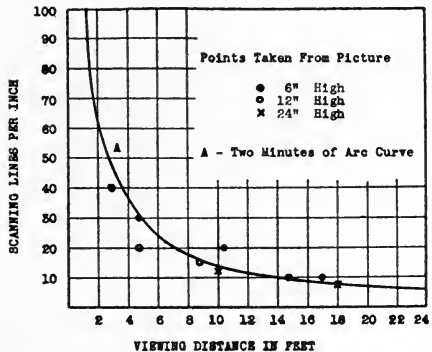

FIG. 10. Data of Fig. 9 replotted.

for 120 lines and curve *A* for 60 lines show the proper one-to-two relationship for viewing distances. It is probable that for the higher number of lines the observed data err on the side of being too "good."

With a screen illumination of the order used in these tests (5 to 6 foot-candles) an increase in apparent detail can be obtained with higher values of illumination, thereby providing a greater range of contrast. To determine the general order of this increase, several tests were made with a screen illumination of 20 foot-candles. With this value the apparent picture detail was improved, but also the picture structure was more pronounced, requiring a choice of viewing distance from thirty to forty per cent greater than for an illumination

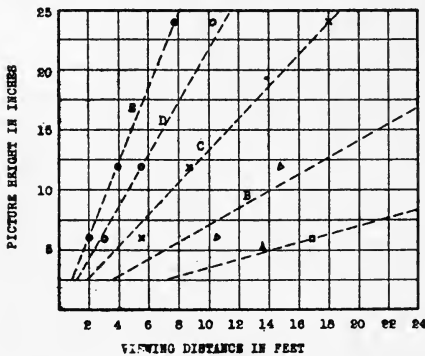

FIG. 11. Chart showing the relative merits of the several picture structures: *A*, 60 scanning lines; *B*, 120 scanning lines; *C*, 180 scanning lines; *D*, 240 scanning lines; *E*, projection print.

of 5 to 6 foot-candles. Since 5 to 6 foot-candles are more in keeping with television possibilities for the next several years, and since the difference in apparent detail and viewing distance is within the accuracy tolerances of the generalizations to be drawn, this particular condition will not be taken into account.

Some interesting data were obtained from direct comparisons of these projected television equivalents with the same subjects having "perfect detail." Two similar projectors were set up so that the projected images were side by side on the screen and the illumination of each the same. One projector was used to project the film having television line structure; and the other projector, the same film subjects but a normal projection print. Observations were made using pictures of several heights and using the films having picture structures of 120, 180, and 240 lines. Viewing distances were chosen at which the two screen images had the same apparent detail. At these viewing distances the image from the normal projection print had a detail structure beyond eye acuity in fineness, and in this sense "perfect." These viewing distances might, therefore, be termed "ideal viewing distances" from the standpoint of picture detail and structure for the television

equivalents. The data taken indicate that this "ideal viewing distance" is approximately fifty per cent greater than the "minimum viewing distances" shown by the curves in Figs. 9 and 10. This information is shown in graphical form by Fig. 12.

We have determined from these observations two viewing distances in terms of picture detail and structure. The first is a minimum viewing distance, and the second an ideal viewing distance. If the total picture size were limited, we would, in viewing this picture, tend to approach it until the picture detail and structure became unsatisfactory. We would for this condition choose the minimum viewing distance referred to above.

If the total picture size were ample, we would tend to position ourselves so that we would view it at the ideal viewing distance. This relationship will be covered more fully later in the paper.

The tests we have made on picture detail are rigorous. We have set as standards the ability of the eye to see the elements of detail and picture structure. Another less exacting standard would be

the "ability" of images having various degrees of detail to "tell the desired story." In this case the detail required is dependent upon the kind of story and information to be presented. The detail requirements would increase as the scenes became more intricate. During the early stages of development such a standard is useful, but, for obvious reasons, it is not of a lasting type since it is the eye and the reactions of vision that must be satisfied. The standards we have used are definite and of a character which will not become obsolete as the development of television progresses.

If we qualify and limit "the ability to tell a desired story" to specific conditions, the experience we have had with television and these tests allows us to make some interesting approximate generalizations. If we take as a standard the information and entertainment capabilities of 16-mm. home movie film and equipment, we may estimate the television images in comparison.

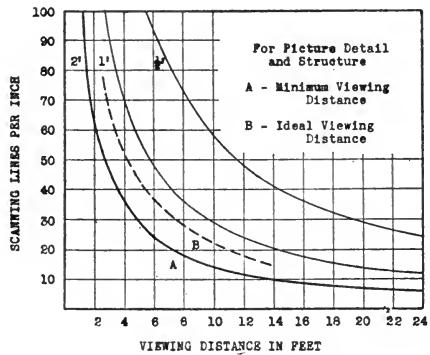

FIG. 12. Comparison of projected television equivalent with same subjects having "perfect detail."

60 scanning lines	entirely inadequate
120 scanning lines	hardly passable
180 scanning lines	minimum acceptable
240 scanning lines	satisfactory
360 scanning lines	excellent
480 scanning lines	equivalent for practical conditions

This comparison assumes advanced stages of development for each of the line structures. It relates to the ability of observers to understand and follow the action and story. It does not relate to the ability to reproduce titles and small objects.

We stated earlier in this paper that motion in a picture has an effect on the apparent detail. There are several reasons for this. The observer's interest is directed to the object or objects in motion. The eye then does not tend to explore the picture step by step, examining each section critically. Under these conditions the eye requires less detail than for a still picture, assuming that the detail is sufficient so that the purpose of the movements may be understood. Objects made up of too few picture elements to recognize while still, may be recognizable and realistic while in motion. A portion of this improvement is due to experience on the part of the observer in associating the motion with things and processes he understands. A portion of the improvement is due to more favorable conditions for scanning while the object is in motion. Another portion of the improvement, as already stated, is due to concentration of interest around the motion. This effect is very important in dealing with crude television images, but becomes minor in images having sufficient detail to satisfy eye acuity. An image made up of 30 scanning lines, though inadequate for almost any subject, provides much more satisfactory results for objects in motion than for still scenes. On the other extreme, a normal 16-mm. projected image of a scene including motion is not, in any large measure, superior to a scene containing no motion. There is, of course, a decided difference in the center or centers of interest.

Reference to Figs. 6, 7, and 8 will illustrate this. In particular, in the 60-line print of the baseball scene, the players are about five picture elements high, and considerable imagination must be used to locate them. With the same scene in motion the observers can pick out the players, roughly determine their action, and, in a general sense, follow the game. In other words, the condition has changed from a reproduction of a scene containing no motion, and which gives prac-

tically no information except that it is a baseball field, to a reproduction of the same scene in which the players move, and which in general allows the observers to follow the action roughly. It is apparent from examining the other prints, particularly as the amount of detail increases, that reproductions with motion would naturally improve the satisfaction obtained, but the difference would not be as great and would decrease as the picture detail improved. Summarizing the effects of motion in a television image, we may conclude that the major improvement is that of observer interest. This is true because, to be generally satisfactory, the image must contain sufficient detail to satisfy eye acuity. This same condition holds in the case of motion pictures. We are, therefore, justified (and safe, from the standpoint of results) in discounting the effects of motion in the generalizations to be drawn from this analysis.

Thus far in our investigation we have considered picture detail and structure and have arrived at certain relationships between number of scanning lines and viewing distances. We have not taken into consideration the picture size. By reference to the curve in Fig. 10, and by knowing the total number of scanning lines available for the system we are considering, we may readily determine the size of the picture in terms of height. This does not, however, tell us, at the viewing distance we have chosen, that the picture will be of a size pleasant to view. If the picture is too small it will be unsatisfactory because too fixed an attention will be required for viewing. If the picture is too large it will be unsatisfactory because too large movements of eyes or head will be required for viewing. In television, because of the practical limitations in detail (scanning lines), we are confronted in general with too small rather than too large pictures.

In television we use the same ratios of picture width to picture height (aspect ratio) as in motion pictures (6 to 5, or 4 to 3). In moderately large theaters the distance from the back row of the orchestra section to the screen does not usually exceed six to seven times the screen height. The front row of seats may be as close as one and one-half to two times the screen height. The choice position is probably at four times the screen height from the screen. In home movies (where less detail is available because of the smaller size film) the desired viewing distances cover a span of from four to eight times the picture height. Since television, of the type we are considering, is for home entertainment, we shall in this consideration of television picture size use the accepted ratio of picture height to viewing

distance for home movies (span of one to four—one to eight) in our comparisons. To make this more specific we shall follow through an example. For this illustration we shall use a picture one foot high. The desired viewing range is from four to eight feet. Going beyond eight feet, viewing conditions become decreasingly satisfactory and at twelve feet and beyond become quite unsatisfactory. This is based on the assumption that the same general run of subject matter will be used as for motion pictures.

We have now accumulated data which allow preparing a chart including relationships between scanning lines, picture size, viewing distance, and desired ratios

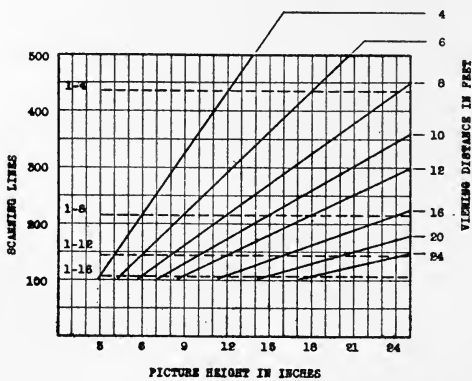

FIG. 13. Relationship between scanning lines and picture size for several viewing distances. Broken lines indicate picture height to viewing distance ratios.

of picture height to viewing distance. The information on this chart, which is given as Fig. 13, is based on the observed data recorded in curve form in Fig. 10. Using this "minimum viewing distance" relation between scanning lines per inch and viewing distance, the chart in Fig. 13 shows for a number of viewing distances the picture size—total scanning line relationship. Superimposed on this are horizontal broken lines for picture height to viewing distance ratios of one to four, one to eight, one to twelve, and one to sixteen. In using this chart we must take into consideration the fact that between the one-to-four and one-to-eight picture height to viewing distance lines, the viewing conditions will be satisfactory. As we drop below the one-to-eight ratio line the viewing conditions become less satisfactory, and below the one-to-twelve ratio line, generally unsatisfactory.

This chart (Fig. 13) includes all the necessary information to determine scanning lines required if viewing distance and picture height have been decided upon; or picture size, if a certain number of scanning lines are possible and a certain viewing distance is desired. The chart also provides a guide for the desired picture sizes for general

of picture height to viewing distance. The information on this chart, which is given as Fig. 13, is based on the observed data recorded in curve form in Fig. 10. Using this "minimum viewing distance" relation between scanning lines per inch and viewing distance, the chart in Fig. 13 shows for a number of viewing distances the picture size—total scanning line relationship.

viewing conditions. To illustrate, we might decide that we wish to view a television image at eight feet. Starting down the eight-foot viewing distance line, we find that with 360 scanning lines we may have a picture twenty inches high. We also learn that the picture height to viewing distance ratio is a very desirable one. With 240 scanning lines we find that we may have a picture thirteen and one-half inches high. Here the picture height to viewing distance is above the one-to-eight ratio line and, therefore, satisfactory. With 180 scanning lines we may have a picture ten inches high. We note that we have dropped below the one-to-eight ratio line, a less desirable viewing condition. At this point the picture will, in general, be satisfactory for viewing but probably the minimum desirable for an eight-foot viewing distance.

The viewing distance lines on this chart mean that, at this particular distance and for the number of scanning lines and picture height indicated at any point along the line, this is the minimum viewing distance for a picture of this number of scanning lines and height. Since this information is based on tests made by three observers who have, as previously pointed out, acuity above average, this is a safe condition for average use. Suppose, as in the above illustration, we have chosen an eight-foot viewing distance and, with 240 scanning lines available, a picture height of thirteen and one-half inches. The nearest an observer should view this image is, then, at eight feet. To determine if the general viewing conditions at more distant points are satisfactory because of the picture size, we may start at the eight-foot viewing distance line and the thirteen and one-half inch picture size and drop down along the thirteen and one-half inch ordinate. At a ten-foot viewing distance we are just a little under the one-to-eight ratio. At a twelve-foot viewing distance we are nearing the one-to-twelve ratio and approaching unsatisfactory viewing conditions. Therefore, a picture of 240 scanning lines and thirteen and one-half inches high may be viewed from eight feet to about twelve feet.

ACKNOWLEDGMENT

The author expresses appreciation for the assistance of Messrs. W. L. Carlson and T. V. DeHaven who together with the author were the three observers referred to in the paper, for the assistance of Mr. T. V. DeHaven in preparing some of the test set-ups, and for the assistance of Mr. G. L. Dimmick in preparing the films having the special detail structures.

TRANSMISSION AND REPRODUCTION OF SPEECH AND MUSIC IN AUDITORY PERSPECTIVE*

HARVEY FLETCHER**

Summary.—On January 30, 1934, a demonstration of the transmission and reproduction of speech and music in auditory perspective was held in the auditorium of the Engineering Societies Building, New York, N. Y., to which the members of the Society of Motion Picture Engineers and the Acoustical Society of America were invited. The following are Dr. Fletcher's remarks in explanation of the various features of the demonstration.

We have met tonight to listen to some demonstrations of sound in "auditory perspective." There is nothing mysterious about the word, although it might seem like mixing sight and sound. Perhaps even that is permissible, particularly before a motion picture engineer's society. What we mean when we use that term is a system that will project sound into an auditorium in such a way that you are able to recognize the direction from which the sound is coming, that is, to be able to locate the sources of sound on the stage. Probably as you have already noticed, if you listened critically to the piece just rendered, the music was coming from all parts of the stage rather than from a single point, as would be the case if a single loud speaker were used for reproducing. This characteristic of auditory perspective is not the only one that we think is important in this system. No new principles have been suddenly discovered and incorporated into this system, for the principles necessary for building such a system were worked out some time ago. It was only after considerable research, however, that we were able to embody them into concrete physical apparatus to the degree that was desired, so as to fulfill all the requirements for reproducing any sort of sound, though it might contain frequencies from the lowest to the highest that are audible, and intensities from the lowest that you can hear

* Presented at the Engineering Societies Building, New York, N. Y., January 30, 1934.

** Bell Telephone Laboratories, New York, N. Y.

to the highest that you can tolerate. This system was originally designed for reproducing symphonic music.

The requirements for reproducing any sort of sound, you might think, would depend upon the character of the sound. That is true to a certain extent. For example, if you wanted only to reproduce a sound that contained no components except within a limited range of frequency, say, from 500 to 2000 vibrations per second, it is evident that the system would be required to reproduce only that range. However, if you wished to reproduce even such common sounds as the clapping of the hands, or any sound that is started suddenly or stopped suddenly, we know from theoretical consideration that it would be necessary to reproduce an infinite range of frequency to reproduce it correctly. Consequently, impact sounds such as the clinking of keys or the ringing of bells, theoretically, require an infinite range of frequency. Inasmuch as such sounds form a large class the requirement imposed upon the system is not determined by the source of the sound but by the limits of hearing. If there are components in the sound that we can not hear, it is not necessary to reproduce them. If we desire to design a system that will reproduce any sort of sound that we can hear, then we must design the system so that it will be able to reproduce all frequencies from 20 to 20,000 cycles per second, inasmuch as that is the range of hearing.

For symphonic music, however, it is not necessary to reproduce such a wide range. We determined by actual hearing tests, that is, by listening to an orchestra with a very wide-range system and then limiting the range by means of filters, that if we eliminate frequencies beyond 15,000 cycles per second, or below 40 cycles per second, there is no detectable difference in the reproduced music. The system that is being demonstrated tonight was designed from that viewpoint, for reproducing symphonic music, and consequently reproduces faithfully all frequencies from 40 cycles per second up to 15,000 cycles per second. For the same reasons that the hearing limits the range of pitch, it also limits the range of intensity. If we reproduce the orchestra merely as it is played, it will require a range of about 60 to 70 decibels. This range does not use the entire audible range.

Measurements of hearing indicate that, when the intensity level reaches 120 decibels, the "feeling point" is reached, for most of the frequency range, corresponding to an intensity of 10^{-4} watts per square centimeter of the wave-front. Although the entire upper

part of that range can be used the lower part is limited, because there is always some noise in the hall where the sound is reproduced. For example, if I asked you to remain as quiet as humanly possible, there would still be enough noise, due to breathing and shifting of clothing, *etc.*, so that you would not be able to hear a sound of as low an intensity as you would if you were shut up in a sound-proof room where there were no such noises. So it is difficult to use the first 20 decibels above the threshold.

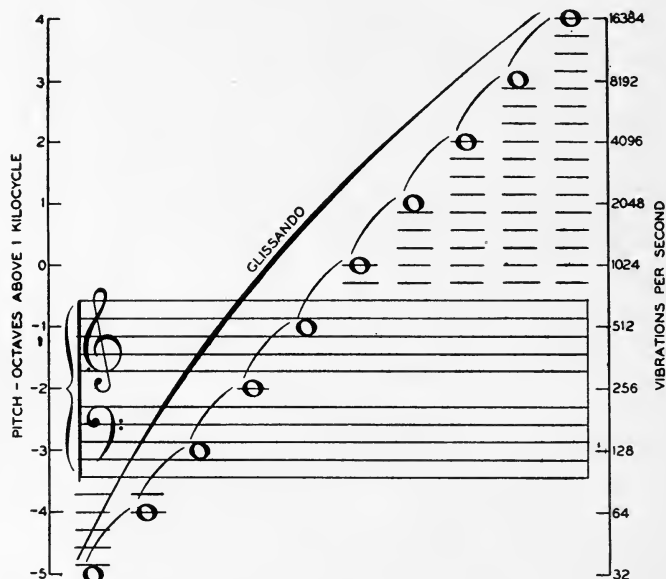

FIG. 1. Chart showing relation between frequency, octaves above and below middle C, and musical notation.

A range of approximately 100 decibels, or a range of 10^{10} in intensity ratio, is the useful range of hearing. That is a very large range compared with that of a good many reproducing systems in use today. Phonographs and radio sets have a range of something like 10^4 .

The first experiments to be performed will show you what we mean by auditory perspective, and how a sound source may be apparently projected on to the stage and moved about. We shall then demonstrate the second characteristic, namely, the ability to reproduce sound through the entire audible pitch range from the lowest that you can

hear to the highest that you can hear. Next, we shall perform some other experiments that will show that this system can utilize the entire range of useful hearing from sounds as soft as you can hear to sounds as loud as you can tolerate. Finally, we shall demonstrate some effects achieved by using the electrical controls during the reproduction of the sound.

As most of you know, our transmission system is composed of microphones to pick up the sound, of amplifiers, and of loud speakers or sound projectors to reproduce it. The microphones are located on the fifth floor of this building where we have a miniature stage on which the action takes place, and also another small stage on which an orchestra of 25 pieces will play. By means of wires the microphones are connected to loud speakers on the stage before us; and all the sound that you hear coming from behind the curtains is reproduced electrically. Let me make that statement emphatic, because, in spite of repeating it over and over again, we have found by experience that people go away from our demonstration thinking that someone was behind the curtain.

In the first demonstration we have an act that illustrates the property, auditory perspective. Certain noises and sounds will be produced on the miniature stage, the main object of the demonstration being to enable you to determine the position of their sources. There is also the other object of showing you that the system will actually reproduce faithfully sounds that you do not hear reproduced faithfully by any other transmission system. They are the impulsive sounds that I mentioned; I am sure you will be able to recognize them as the experiment progresses.

[Then followed the reproduction of a man hammering a nail into a board, and sawing wood; the sources of the sounds assumed various positions on the unseen stage, and the reproduction of the sound by the system produced an auditory effect corresponding to the positions of the sources—Ed.]

In the next demonstration we shall have two trumpeters: one here as you see before us, and one on the miniature stage. One of the trumpeters will play here, and then the one upstairs, or *vice versa*; and then they will move about the stage. The trumpeter here, you will see move; but try to determine where the other man is moving and determine, if you can, which one is playing.

[The demonstration described was very effectively performed—Ed.]

That demonstrates what we mean when we say "auditory per-

spective;" you had no difficulty in locating the position of the trumpeter on the miniature stage on the fifth floor.

As I said before, the sounds most difficult to reproduce naturally are the impact sounds, such as the sound of a bell or any sound that is caused by percussion. In the next demonstration we shall use two such sounds, one from the tambourine, which, as you know, is

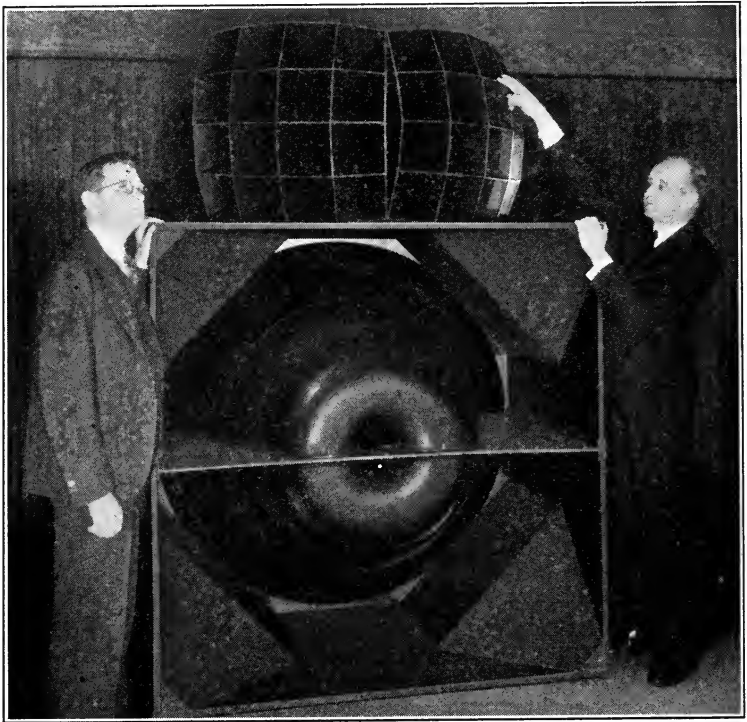

FIG. 2. One of the reproducer units used in the demonstration.

produced by striking a stretched skin and by the rattling of the little clappers on the side, and one from the tinkle of a bell. Inasmuch as they require such a large range of pitch to make them sound natural they are very directional, because high frequencies are much more directional, than the low frequencies, so I hope in this demonstration you will be able to follow without difficulty the locations of the sources. [*Demonstration*]

I neglected to say that you get the sense not only of right and left, but also of forward and backward. Of course, when you are a great distance from the stage the forward and backward motions are difficult to detect, even when the sound sources are on an actual stage before you. Those in the front part of the house will have no difficulty in locating the sound as back stage or front, as well as to the right and to the left.

In the next demonstration we shall again use an impact sound. It is what we call the illusion of a tap dancer. One of the tap dancers will perform here and one upstairs. See whether you can tell by the sound which one is dancing. [*Demonstration*]

There are many possibilities of producing rather peculiar and amusing effects by operating the electrical controls. For example, by sliding the dial backward and forward, you can emphasize the rhythm of the tap and also make it any loudness you desire, as we shall now demonstrate. [*Demonstration*]

Another possibility of the system is that of reproducing the voice of a singer at various positions on the stage. It therefore opens some possibilities for opera. If desired, one might have some pantomime actors on a stage going through the action, and the singers off the stage producing the music. In this particular demonstration the singer is moving about on the miniature stage in the corresponding positions which you will recognize here on this stage. [*Demonstration*]

Those of you who were at the meeting of the Acoustical Society a little over a year ago, remember that Dr. Stokowski gave a talk in which he said that in the future he expected to see opera put on in pantomime and that he would have the good singers back stage and the good looking performers on the stage doing the pantomime. This demonstration, I think, shows the possibility of doing so if desirable.

In the next demonstration we wish to show the possibilities for drama, as well as for opera. I think that there are a number of possibilities for the system in legitimate drama or in sound pictures. Just how it might be worked out I do not know, but in the next demonstration we shall present a brief dramatic sketch in which the actors speak from various positions on the distant stage. There is some quick action at the end of the act but I want you to notice particularly the fidelity of the pistol shot that ends the act.

[*Demonstration: The voices emanating from the loud speakers apparently followed the actors about in their movements on the unseen stage—Ed.*]

Those of you who have had some experience in trying to reproduce the sound of a pistol by electrical transmission know that it is very difficult to do, and I assure you that what you heard is a rather faithful reproduction. It is against the law to use firearms in which an actual bullet is used. This gun uses a blank cartridge. We had it down here on the stage and it sounded like what you heard. In the next demonstration also we shall have a pistol shot, but one of our own make rather than with a real pistol. We call it a pistol



FIG. 3. The control station in the balcony of the auditorium.

shot, but it is something to illustrate how we can make the sound travel across the stage. You will hear something that sounds like a report of a gun, the bullet will come out leisurely, go across the stage and strike the target. This will be repeated, then the bullet will come out of the target and return to the gun.

[*Demonstration: The sound of the shot came from one side of the stage, and that of the shot striking the target from the other. A whistling sound seemed to follow the "bullet" across the stage—Ed.*]

I might explain how the act was done. A man on one side of the miniature stage on the fifth floor clapped two boards together, an-

other ran across the stage, blowing a whistle; the man on the other side then struck a metal circular saw that was handy; and you heard the result. We used that particular stunt, for it is just a stunt, because it shows rather vividly what we mean by auditory perspective.

Now if we have only a single source of sound on the stage, that is, a single source at a time, it is very easy to produce the illusion of motion without having any motion on the miniature stage at all, by simply manipulating the electrical controls. The apparent position of a source of sound on the stage is dependent upon the relative loudness of the sound that reaches your ears. When more sound comes into your right ear, you localize the sound as on the right. When more sound comes into your left ear, you place it on the left; for that reason we can easily manipulate the dials controlling the amplifiers connected to the loud speakers, so as to make the sound move either right or left. The possibility of making it move backward, however, is a little more difficult, for in that case it is necessary not only to decrease the sound intensity but also to add reverberation to it. In the demonstration only transverse motion took place. We shall now put on the same demonstration by manipulating the controls. Remember this time that the sounds, clapping of the boards, the blowing of the whistle, and the striking of the circular saw, all occur before a single microphone, and all the apparent motion is produced by manipulating the dials. [*Demonstration*]

It is evident that the apparent location of the voice of a singer can also be controlled by means of the dials. Our artist will next sing the same song she sang a few minutes ago, but this time will remain stationary in front of the microphone; the apparent movement will be produced by manipulating the dials on the control.

[*Demonstration: The voice of the singer was made apparently to move from one point to another on the stage—Ed.*]

In these demonstrations we have emphasized the property that we call "auditory perspective," but, of course, we have used a system that has other characteristics that must be practically perfect or you would not realize the effects that you have heard. In the next demonstration, we shall use the full orchestra. We shall use the wide band system, reproducing all the frequencies in the orchestra uniformly, and we shall use the controls so as to emphasize the contrasts in the music and do it as artistically as we know how. A musician will manipulate the dials, so that the result that you will hear will be due to the composer first, then to the players in the or-

chestra, then to the director's interpretation, and finally to the interpretation of the person manipulating the dials. The selection will be Shubert's *Unfinished Symphony*. In the first part the music comes from the full stage, and you will be able to localize the instruments if you try. [*Demonstration*]

You will all agree that for an orchestra of only 25 pieces, with only four first violins, the music sounds considerably like that of a large orchestra. That demonstrates the possibilities of using the controls. Even with a large orchestra such as a symphony orchestra, this system could be used, we think, to improve the music. I think a large number of musicians at our Washington demonstration agreed with this conclusion although some disagreed. But just what use would be made of this stereophonic system in music, must be determined by the musicians after they have a chance to use it and to compose their music with it in view.

For the benefit of those who are interested in the engineering aspects of this demonstration, the controls are in the balcony. Mr. Snow, who is at the controls, can hear everything that is going on in the room, and controls the volume and the quality of the sound. The loud speakers are behind the screen here on the stage. The amplifiers are off-stage at the right, and there is a control man located here. Then, of course, there are the controls on the fifth floor, where the miniature stage is located; and, finally, there is another group of men in the projection room for performing some further experiments, which you will see later. All these various places are tied together by means of telephone lines. I have a microphone here on the speaker's stand so that all the groups are hearing what I say, and in that way the demonstrations are synchronized.

Next, let us turn our attention to the second characteristic of the system, which we feel is worthy of notice: namely, that it will reproduce with almost uniform efficiency frequencies from those so low that you can scarcely hear them to those above the audible range. As I told you at the beginning, to produce such sound as we have been producing here requires a range from 40 to 15,000 cycles. In order to convince you that the system will actually reproduce such a range, we are going to reproduce single frequencies, or pure tones, beginning with the lowest pitch and ascending to the highest audible pitch. To aid you in following the experiment, we shall use a chart, which you now see on the screen. In the projection room is a heterodyne oscillator, which will generate currents of 40 to 15,000

cycles. The tuning condenser of the oscillator is geared to the indicator that you see projected across the chart, the position of the latter on the chart indicating the frequency of the oscillator. The heterodyne oscillator is connected to the amplifier controlling the loud speakers.

We shall first reproduce the sounds starting at the lower limit of 40 cycles and then proceed to the highest, 15,000 cycles. At various pitches as the frequency rises a number of you will be unable to hear the sound. In any audience of this size there will be persons whose hearing begins to be defective anywhere from 2000 cycles up to 15,000 cycles. This is not only a test of the system, but it will also be a test of your hearing. [*Demonstration*] All right, we'll start.

On the left-hand side of the chart you see a pitch scale, which indicates the number of octaves above or below a thousand cycles per second. That reference frequency corresponds approximately to high *C* on the musical scale. At the center of the chart is a musical scale from which you can read the pitch. The frequency is indicated by the right-hand scale. The tones that you just heard were produced with practically the same intensity. When listening to the low tones you probably thought there were peaks in the system, but that was due to the room, the reflections of which build up intensity maxima in certain spots, and as you change the pitch those spots switch around the room. You probably noticed also that some low frequencies caused rattling from somewhere in the room. I assure you it was not from the stage. It was from the window panes and various panels in the room which were resonant to the frequency we were producing. If we make that frequency loud, you will notice that it will shake the panels very vigorously. For fear of bringing some of them down, we shall not hold the tone at one particular frequency very long, but I should like you to hear what intense sounds can be produced. We shall go so rapidly through the pitch range that there will be little danger of any resonance being too strong. If you watch the indicator you can see the range of variation. [*Demonstration*]

This would be a good test for locating bad resonances in auditoriums. I am sure that in a good many halls such bad resonances exist without their being detected. They probably produce bad effects on the music if it is very loud. But I think in the future when this reproducing system it to be used with such great intensity an exploration for locating such bad resonances must be made, and

the offending member rectified before you can expect to have a room of very good acoustics.

There are other ways of showing the pitch range of the system. In the last experiment, we produced a single tone and made its pitch go through the whole range. Another way that might show the same effect is to produce a sound that has all the frequencies present, such as any of the impact sounds of which I spoke, and then limit the range by means of electrical filters. One can introduce into the transmission circuit electrical filters that will eliminate all frequencies above a certain value, or all below a certain value. In the next two experiments we shall do that, using the chart as before. The chart has been changed somewhat; at the bottom is the vibration number and the corresponding note on the musical scale. For example, high *C* and 1024 correspond. The blackened portion which you see there represents the part that is eliminated by the filters in our transmission system. First you will hear the sound reproduced naturally, that is, with the complete range. Then the filter will eliminate the frequencies represented by the blackened portion of the chart, and you can compare it with the original sound. The first source of sound that we shall use will be an impact instrument. It will be the snare drum, one of the most difficult instruments to reproduce, accompanied by a fife. The players will first march across the stage as they play, to show you how naturally such instruments can be reproduced. Then they will stand in the center while we perform filtering operations on the sound. [*Demonstration*]

You can judge from what you have heard what range is necessary to reproduce the snare drum and the fife. If your judgments were all written down and compared you would find that observers differ because the range depends on hearing ability. If you can hear frequencies above 8000 cycles you can readily detect the introduction of the 8000-cycle low-pass filter; but if you can not hear frequencies above 8000 cycles, you can not detect its introduction.

In the next experiment the full orchestra will be used, and similar filtering operations will be performed. In this case, as I told you before, for a large orchestra at least, a range from 40 to 15,000 cycles is required to make all the instruments sound natural. You can judge for yourself whether this orchestra requires the full range or not. We shall filter out the top frequencies and then the bottom. When the chart on the screen is completely white the system is reproducing uniformly from 40 to 15,000 cycles. When part of it is

blackened, the frequency band corresponding to the blackened portion of the chart is being filtered out. [*Demonstration*]

Experiments of this sort are a little unsatisfactory before a general audience, particularly when you have to depend upon someone else to throw the filters, because some of you may feel they are changing at the wrong time. Everybody has his own notion as to when he would like to have the filters switched. It was through a series of experiments of just this type, using a jury of 15 or 20 experienced listeners, some of them musicians of national repute, listening to the Philadelphia Orchestra under the direction of Dr. Stokowski, that we were able to come to the conclusion that eliminating frequencies below 40 cycles or above 15,000 cycles did not produce a change that could be detected. But at 13,000 cycles, for example, there was a very definite majority opinion that something had been changed in the music.

In the next series of demonstrations we wish to illustrate the third property of which I spoke, namely, the wide intensity range that this system is capable of reproducing. I said that to take advantage of the entire range of hearing would require a range of 120 decibels on the intensity level scale. Now those of you who are familiar with the theory of room acoustics know that there is a definite relationship between the intensity of a source of sound in a room, the volume of the room, and the absorption in the room. As you can readily see, if the absorption is greater it will require more power to build up a certain intensity in the room. Also, if the room is large, it requires a greater power. Those relationships have been worked out mathematically and, if we put into the resulting equations the threshold intensity for feeling, then we arrive at a relation that gives the intensity of sound that the loud speakers must produce in terms of the volume of the hall and its reverberation time. That relationship was given in one of the papers presented before the American Institute of Electrical Engineers. Using that relationship, it turns out that for a hall like the Academy of Music in Philadelphia, the power that the loud speakers must produce at their peak is about half a kilowatt, 400 watts to be more exact. That, then, is the maximum power that the loud speakers will ever be required to deliver in a hall of that size. As a matter of fact, if there is any greater capacity than that there is danger of impairing somebody's hearing. The loud speakers we are using will produce about that amount of acoustic power. The electrical power put into them by

the amplifiers is, of course, greater than that. The approximate efficiency for musical sounds is about 50 per cent. In the loud speakers handling the low range it is as great as 75 per cent, so that the electrical power required for the loud speakers is approximately 1 kilowatt for producing this maximum sound intensity.

The meaning of such an intensity range will be illustrated by a few experiments. To follow the experiments we shall use a chart that has an intensity scale rather than a pitch scale; the intensity level scale is expressed in decibels, from the threshold of hearing to the threshold of feeling, which is approximately 120 decibels. Near the intensity levels corresponding to the top of the scale you begin to feel the sounds and, of course, you can not get much lower than 20 decibels before you begin to be troubled by the noises in the room. The little pointer at the side of the chart, which indicates the level that is being produced, is geared directly to a level recorder, so that the sound intensity level in the room can be read directly on the scale. By means of a microphone just beneath the balcony at the rear, the sound is picked up and then put through an amplifier, from which it goes to the level recorder, and the indicator moves up and down as the intensity of sound changes. It reads the intensity level in front of the microphone. That is not the same as in other parts of the room, although it will give you a rough indication of the intensity of the sound where you are sitting. In any room, no matter what kind of sound you produce, due to the reflections from the walls there are certain places of maximum and others of minimum sound. I notice that you are already trying to assure yourself that the indicator will respond to sounds that you make as well as to the sounds of my voice. This level indicator has a range slightly greater than 90 decibels. Consequently we must choose the range that we wish to cover. Since that is the upper range, its resting point is somewhere between 20 and 30 on the scale. Usually there is enough sound in the room to keep it up to that level anyway.

The scale is the one that the Acoustical Society of America has adopted recently and the American Standards Association is now considering for adoption. It has a zero that corresponds to an intensity of 10^{-16} watts per square centimeter and a scale in decibels. As I am talking now the actual intensity level, if I sustain my voice like this: "Ah," should be between 40 and 50. That is about the level of the voice of a speaker from the platform into a large room of this sort. Remember these levels are the levels produced out in

front of the microphone. On the chart, ordinary conversational volume refers to, of course, the intensity level that would be received by a listener two or three feet away from the speaker. Above that is the singing intensity level of a loud soprano in a concert hall, which you can check when the singer sings. If we desire, by using the electrical controls we can raise the intensity of the singing voice much above that level.

In the first demonstration, we shall use a sound source to check the scale. As you see, aeroplane noise should be about 110 decibels. Let us listen to it at about its natural intensity if it came close to us. The measurement indicated on the chart was made in the cockpit of the aeroplane. Now we shall see if we can reproduce the aeroplane noise at the intensity level indicated on this chart. [*Demonstration*] As you probably recognized, that was a phonograph record. The intensity to which it reached was about the intensity you would experience if you were near an aeroplane.

We shall show you the possibilities of this system for utilizing the full intensity range. A good musical selection to show it is a march. The music will first be reproduced so softly that you will just be able to hear it—near the threshold of hearing. Then the loudness will be increased through the entire intensity range of the system, and you will notice what range the extreme intensity level attains. The entire orchestra will be used. [*Demonstration*]

In the next demonstration we shall use a steady source of sound, so that you may note the indicator reading of the intensity level and have time in which to compare it with the sound heard. The music, of course, varies in its intensity. The sound now will vary gradually, increasing in intensity to its maximum and then decreasing again. The sound is that of an electrical buzzer. When it is at its low intensity level you will recognize it. When it gets up to high intensity it will sound like something you have never heard before. I believe these few experiments will help you to realize what we mean by a wide intensity range. The march music probably illustrated it better than anything else.

Now let us illustrate the fourth property that I mentioned: namely, that of controlling the sound while it is being produced as music. As most of you engineers know, at the present time the music that is sent out from broadcasting stations is controlled, in order to keep the intensity within the range that the system will transmit without distortion. The high-intensity sounds are lowered somewhat and

the low sounds raised somewhat, in order to keep them within the working range. To show what we mean by such statements, we shall reproduce part of a musical selection under such control. The first time it will be reproduced just as the orchestra plays it; that is, with the same intensity. The second time we shall reproduce the same piece, but shall manipulate the controls so that the reproduction is kept within the very limited range of 30 decibels. The third time it will be played, the controls will be manipulated so that the contrasts will be very greatly emphasized, as you will notice on the chart. It will probably be magnified more than might be necessary for best musical taste. [*Demonstration*]

Now, of course, it is difficult to judge by such a short musical selection, but I believe that it illustrates what we mean by electrical control of the music. In order to find out whether the enhanced volume range is worth anything musically, we should have to have a concert here and listen to some of the masterpieces played by a large symphony orchestra, and then have some musical critics listen to it while it is reproduced in these three different ways. I am sure there would be no uncertainty as to what the verdict would be, judging from the verdicts we have had in the past.

In the next number we will use all the characteristics we have described, and all the artistry that we possess. Our soprano will sing again, with the orchestra. The orchestra will be reproduced through the two side channels, and the voice through the center channel. Also, it is arranged that the intensity of either center or sides can be placed at any desired level. [*Demonstration*]

I see by the intensity level of the applause that you liked that about 80 decibels worth. Now, of course, there may be musicians here who would say that no human voice can sing that loud and consequently that it is unnatural. That may be true, but the question is, did you like it?

This really is the end of our program, but I am wondering if you wouldn't like to hear one more selection from the orchestra, using the three channels, that is, if you wish to stay. We shall now end the program with a rendition of the William Tell Overture, and this time again all three channels will be used. [*Demonstration*]

I think that you will agree that we have demonstrated that the system is new in the following respects: It has auditory perspective, that is, it will reproduce the sound as though it were on the stage and coming from all positions on the stage; it reproduces a wider

range of pitch than most other systems; it reproduces a wider intensity range than previous systems; and, of course, it has the novel feature, which may not be considered entirely new, of permitting the volume and the quality of the reproduced sound to be controlled.

The loud speakers behind the screen reproduced all the sound that you heard. The lower part of each loud speaker reproduced the low frequencies, up to 300 cycles. The two loud speakers on the top of each unit reproduced the frequencies from 300 up to 15,000 cycles. The low frequencies spread out all over the audience, as they have very little directional properties; but the high frequencies, as I have emphasized several times, are very directive. Therefore, they must be brought out of the loud speakers in such a way as to cover the entire hall; and that is why the horns have peculiar shapes. There is a section that points to each one of you from each of these units; and they are so arranged that a spherical wave comes out of the front, and consequently there are no directional effects such as occur with most loud speakers.

BOOK REVIEWS

Filmcraft. A. Brunel. *Geo. Newnes, Ltd.*, London, 1933; 238 pp.

Comparatively few books have been written on the technic of film production by experienced professional workers. This book should be welcomed, therefore, by the amateur ciné enthusiast because it represents an outline of film production technic written by a well-known British director. Helpful information is included on all phases of the subject from the selection and preparation of the scenario to the final editing of the picture. The working staff is planned along lines similar to those of a professional studio. The text contains several examples of actual scenarios and working scripts. An abbreviated glossary of technical terms used in film production is included. The hand-book closes with a number of short articles on various phases of film production written by experts at several of the British studios. Typical subjects treated are "Commercial Cutting," "Film Writing," "Lighting and Its Application," "Notes on Art Direction," and "Notes on Direction." This little book should prove a useful addition to any library on film production, either amateur or professional.

G. E. MATTHEWS

Film Technique. V. I. Pudovkin. Translated by I. Montagu. *Geo. Newnes, Ltd.*, London, 2nd Edit., 1933; 204 pp.

The author of this work on motion picture production technic is one of a school of Russian directors who have grown up within the past decade, and whose reputation has been based on their ability to make pictures that contain a flowing composition or rhythm. Editing or "montage" is considered the essence of film art, for by its subtle use scenes may be welded together smoothly and the tempo changed more or less at will. The first half of the book is divided into three essays, the first of which is a clear introduction to the other two. In the second part the principles of scenario construction are soundly treated in simple, understandable terms, with illustrative examples. The third part is a philosophical analysis of the process of motion picture production. The director must dominate the making of a picture and should follow through the cutting. Praise is repeatedly given the work of certain American directors, such as D. W. Griffith, but most American pictures are not considered representative of the author's ideas.

Three new chapters have been added in the second edition, dealing respectively with "Close-ups in Time," "Asynchronism as a Principle of Sound Film," and "Rhythmic Problems in My First Sound Film." In the first of these the author describes his method of utilizing scenes or bits of scenes made with the ultra-rapid camera to incorporate "... various degrees of retarded speed of movement integrally in the construction of a given editing phase." To be most effective, sound must be edited into a film rather than recorded solely at the same time that the picture is taken. Several illustrations of this principle are given in connection with the Russian sound picture *Deserter*, directed by the author in 1933. A glossary of notes contains many useful comments.

G. E. MATTHEWS

SOCIETY ANNOUNCEMENTS

MID-WEST SECTION

At the regular meeting held at the Mid-West Film Company, at Chicago, April 12th, a symposium on sensitometry was held, as follows:

"Sensitometry and the Laboratory Man," H. Anders, Jam Handy Picture Service, Inc., Chicago, Ill.

"Sensitometry and the Sound Man," J. Elliot Jenkins, Jenkins & Adair, Chicago, Ill.

"Sensitometry and the Cameraman," E. J. Cour, Jeencour Productions, Chicago, Ill.

A sensitometer built according to Eastman specifications was demonstrated. The meeting was well attended and great interest was shown in the proceedings, the subject of sensitometry having been chosen because of the many demands by members of the Section for a review of the practical applications of sensitometry.

ATLANTIC COAST SECTION

At the meeting held at the Hotel Pennsylvania on April 11th, members of the Amateur Cinema League and the Metropolitan Motion Picture Club were invited as guests of the section, to participate in a meeting that was devoted entirely to the interests of amateur cinematography. Despite the inclement weather, 110 persons attended the meeting, and evidenced their great interest in the proceedings by the enthusiasm shown toward the outstanding presentations by prominent amateur "filmmers," as follows:

Screening: *Century of Progress, 1933*, in Kodacolor, by H. H. Johnson, New York, N. Y.

Slow Motion Diving Studies in Color, by E. Zacher, Hartford, Conn.

A Christmas Story, in Kodacolor, by E. M. Barnard, Arkansas City, Kan.

Chartres Cathedral and Venice, in Kodacolor, by J. V. Hansen, Washington, D. C.

Cinecoles Review, by R. Coles and C. Coles, Brooklyn, N. Y.

Under the Maple Leaf, with special disk-sound accompaniment, by H. H. Jones, Buffalo, N. Y.

Papers: "The Broader Aspects of Kodacolor," by F. A. Beach, Technical Consultant, Amateur Cinema League.

"Development of 16-Mm. Projection in the Home," by R. C. Holslag, *Movie Makers Magazine*, New York, N. Y.

Century of Progress (1933), *Chartres Cathedral and Venice (1932)*, and *Under the Maple Leaf (1932)* were listed by *Movie Makers magazine* among the ten best

amateur films of the years indicated. *Slow Motion Diving in Color* was given honorable mention in 1933.

All those who participated in the program were members of the Amateur Cinema League.

SUB-COMMITTEE ON EXCHANGE PRACTICE

Two meetings were recently held by the Sub-Committee on Exchange Practice specifically for the purpose of studying the recently proposed 1700-foot reel length. Both meetings were held at the Great Northern Hotel, in New York, N. Y., the first on March 26th, and the second on April 2nd, and were well attended by not only the members of the Committee, but representatives of the various important exchanges.

As a result of the study made of the advantages and disadvantages of the 1700-foot length, the general consensus of opinion indicated disapproval of the 1700-foot length, in view of its not being able to accomplish the objective desired in establishing that length; namely, the elimination of doubling of reels by the projectionist, and the consequent waste of material and mutilation of the film.

The Committee and exchange representatives were generally in favor of continuing to use the 1000-foot reel length unless economic considerations should favor a 2000-foot length. In any event, lengths between 1000 and 2000 feet were objected to.

A tentative report for presentation at the Spring Convention at Atlantic City was prepared, and was submitted on April 4th to the Projection Practice Committee for its consideration.

PROJECTION PRACTICE COMMITTEE

At a meeting held at the Paramount Building, New York, N. Y., on April 4th, the tentative report of the Sub-Committee on Exchange Practice dealing with the proposed 1700-foot reel length was carefully considered from the point of view of projection practice, with the result that the two Committees concurred in their general conclusions although they arrived at them from different considerations.

The original proposal was to establish the length of 1700 feet as a maximum. As the film capacity of reels in common use in projection rooms is 3450 feet, the establishment of a 1700-foot maximum would not prevent doubling, particularly as it is common practice among projectionists to transfer the film to their own reels, which are generally in better condition than the reels supplied by the exchanges.

In order to prevent doubling, it would be necessary for the *minimum* length of film to be somewhat greater than half the capacity of the reel, which means that 1750 feet should be the minimum, and about 2000 feet the average or nominal length. Such a length would make doubling impossible, and the objectives desired from making such a change would be accomplished.

The Committee, although disfavoring the 1700-foot length, or any length between 1000 and 2000 feet for the reasons stated above, expressed its willingness to agree to whichever of the two latter lengths economic considerations might prove to favor.

The report of the Committee was presented at the Spring Convention, at Atlantic City, and will be published shortly in the JOURNAL.

STANDARDS COMMITTEE

At a meeting held at the General Office of the Society on April 6th, the revision of the Standards Booklet was carried to the point of preparing printer's proofs for the final inspection of all the members of the Committee before publication in the JOURNAL. Seventeen new charts have been added to the original fifteen, some of the latter being superseded by the new ones. Tolerances have been added throughout, both in the English and the metric systems, both composite and break-down drawings have been provided for film layouts, *etc.*, and in many other respects the booklet has been made very complete and up-to-date.

The final report of the Committee will be presented at the Spring Convention, Atlantic City, April 23-26, 1934.

MEMBERSHIP COMMITTEE

Results of the membership campaign thus far have been gratifying. Although the campaign did not begin until January 15th, at which time the reduction of dues and other fees went into effect, 170 new members have been added to the roll since October 1st. The number of delinquent members this year is considerably smaller than the number last year, probably due also to the reduction of the fees, although many members have taken advantage of the reductions to apply for transfer to the higher grades.

The special committee appointed by the Board of Governors to re-grade the membership will announce the results of its work at the Spring Convention. Members of the Society are urged to assist in continuing the campaign for new members as vigorously as it has started.

PETER A. SNELL

The Society regrets to announce the death of Dr. Peter A. Snell, last year the holder of the S. M. P. E. Fellowship established through the generosity of the late George Eastman. Dr. Snell, 27, died March 14th, at Baltimore. He was a graduate of Hill Preparatory School and Princeton University, and received the degree of doctor of medicine from the University of Rochester, in 1933. While studying at Rochester he specialized in the physiology of vision, and pursued the investigations on visual fatigue that formed the subject of his S. M. P. E. Fellowship. His report was presented before the Society at the Fall, 1932, Meeting at New York, N. Y.

SPRING CONVENTION

ATLANTIC CITY, N. J., APRIL 23-26, 1934
CHALFONTE-HADDON HALL

Approximately two hundred members and guests of the Society attended the various sessions of the Spring Convention at Atlantic City. The Convention opened on Monday morning with a general session, including reports of Committees and a special meeting for Atlantic City projectionists, exhibitors, and managers. At the latter meeting short addresses were made by President Goldsmith, Mr. F. H. Richardson, and Mr. William Reed, who is perhaps the oldest projectionist in America, in point of length of service.

At noon of the opening day, an informal luncheon was held for the members and guests. A short address of welcome was given by President Goldsmith, followed by addresses by Mr. Thomas Huselton, Secretary of the Atlantic City Chamber of Commerce, and Major William Casey, City Commissioner.

The program of papers and presentations, as actually followed at the sessions, is presented herewith. At the semi-annual banquet, held on Wednesday evening, the members were addressed briefly by Mr. G. D. Lal, a member from India, and by Mr. Strickland Gilliland, humorist and author, of Washington, D. C. The principal address of the evening was presented by Mr. Sol A. Rosenblatt, Divisional Administrator, National Recovery Administration, who spoke on the various aspects of the motion picture code. Mr. Rosenblatt was appropriately introduced by President Goldsmith.

Credit for the success of the Convention is largely due to the efforts of Mr. W. C. Kunzmann, Convention Vice-President, and Mr. J. O. Baker, Chairman of the Papers Committee. Others to whom credit is due were Mr. Harry Blumberg, Chairman of the Local Arrangements Committee; Mr. W. Whitmore, Chairman of the Publicity Committee; Mr. J. Frank, Jr., Chairman of the Apparatus Exhibit Committee; Mr. H. Griffin, in charge of projection; the officers and members of Atlantic City Local No. 310; Mrs. M. C. Batsel, Hostess; and Mr. J. Greenberg, Secretary of the Philadelphia Film Board of Trade.

The sound and projection equipment used in the meetings and at the banquet was supplied and installed by the RCA Victor Company, the International Projector Corporation, the Bausch & Lomb Optical Company, the National Carbon Company, and the National Theater Supply Company.

Monday and Tuesday evenings were devoted to film programs as follows: A hand-synchronized 16-mm. travelogue, by Mr. Hamilton Jones, of Buffalo, N. Y.; *Paramount News, Let's You and Him Fight*, Paramount Pictures Corp.; *Maid in Hollywood*, Metro-Goldwyn-Mayer; *Stand Up and Cheer*, Fox Film Corp.; *Twenty Million Sweethearts*, Warner Bros. First National Pictures; *Sisters under the Skin*, Columbia Pictures Corp.; *Beauty and the Beast*, Vitagraph Corp.; *The China Shop* and *Three Little Pigs*, United Artists.

The last two pictures were projected at the banquet; in addition, the banquet entertainment included a Hawaiian orchestra, through the courtesy of Mr. Richard Endicott, of the Steel Pier Theater, Atlantic City. The proceedings of the banquet, between 10:30 and 11:00 P.M., including the introductory remarks by President Goldsmith and the address by Mr. Sol A. Rosenblatt, were broadcast over the red network of the National Broadcasting Company. Passes to the various theaters of Atlantic City were kindly provided for the members by Mr. Coplan, Seashore Theaters, Inc.; Mr. Endicott, Steel Pier Theater; and Mr. H. Walters, Ventner Realty and Leasing Company.

HIGHLIGHTS OF THE MEETING

An interesting demonstration on Monday which aroused numerous comments was that given by C. E. Lane on the properties of wave filters. A series of pendulums attached to a beam were interconnected by metal spring bands. At certain frequencies the amplitude of the wave imparted mechanically to the first pendulum was gradually filtered out so that the last pendulum was motionless.

The papers on 16-mm. equipment on Monday afternoon stimulated much discussion. This session proved to be one of the most interesting of the entire convention. Many favorable comments were heard relative to the improved sound quality on the 16-mm. films, particularly the quality of the reduction prints from 35-mm. feature pictures. The quality of the sound on the 16-mm. Kodacolor was also of a high order.

One of the most interesting demonstrations of amateur equipment was that given by H. Jones, who hand-synchronized over 50 different phonograph records with a travel picture on 16-mm. film.

The combined reports of the Projection Practice and Exchange Practice Committees, presented Tuesday afternoon, indicated that a decided stand would be taken opposing the adoption of a reel of 1700 feet length and favoring a 1000- or a 2000-foot reel. Much evidence was advanced to show the fallacy of the intermediate size of reel.

Dimmick and Belar's demonstration of the new twin triangular diaphragm sound track for noiseless recording represented, probably, the finest sound reproduction of the Convention. The demonstration was given twice on Wednesday in order that those attending the Lighting Session could have the opportunity of listening to it.

One of the liveliest discussions of the meeting occurred after B. Schlanger opened the forum Wednesday morning, on "What Is Wrong with the Shape of the Motion Picture?" The suggestions raised by Mr. Schlanger indicated much constructive thought on his part and his claim that the present picture includes only a small portion of the area covered by natural vision elicited many comments. It was evident from the resulting discussion that the wide-film pictures shown in 1930-31 approached more nearly Mr. Schlanger's ideal shape and were more realistic than present-day films.

The use of the piezoelectric properties of quartz, tourmaline, and other crystalline substances to construct extremely accurate "time clocks" for use in radio broadcasting stations and sound studios was explained in a paper by F. R. Lack, of

the Bell Telephone Laboratories, on Thursday morning. A practical application of the use of piezoelectric crystals was given during the apparatus symposium by A. L. Williams who demonstrated a microphone which utilized a crystal of Rochelle salt.

Originals and duplicates made by the British Dufaycolor process on 35-mm. and 16-mm. films were shown by W. H. Carson. This is a three-color additive process using a line screen which is coated on the film. Generally favorable comment was heard on the beauty of the colors, which were of pleasing pastel shades.

PROGRAM

MONDAY, APRIL 23RD

Morning: General Session

"Technical Committees—Their Organization and Policies," L. A. Jones, *Engineering Vice-President*.

Report of the Progress Committee, J. G. Frayne, *Chairman*.

Report of the Committee on Standards and Nomenclature, M. C. Batsel, *Chairman*.

"Some Early Experiments in Photographic and Motion Picture Work," F. E. Ives, Philadelphia, Pa.

"Oscilloscope," H. F. Mallina, Bell Telephone Laboratories, New York, N. Y.

"History of Sound Pictures," W. E. Theisen, *Honorary Curator*, Los Angeles Museum, Motion Picture Division, Los Angeles, Calif.

Afternoon: Amateur and 16-Mm. Session

"A Demonstration of the Properties of Wave Filters," C. E. Lane, Bell Telephone Laboratories, New York, N. Y.

"A Sixteen-Millimeter Sound Camera," G. L. Dimmick, C. N. Batsel, and L. T. Sachtleben, RCA Victor Company, Camden, N. J.

"Sixteen-Millimeter Sound Motion Pictures in Color," C. N. Batsel and L. T. Sachtleben, RCA Victor Company, Camden, N. J.

"Recent Examples of 16-Mm. Sound Pictures on Double Sprocket Hole Film," A. W. Carpenter, H. J. Hasbrouck, J. F. Nielsen, and E. R. Ross, United Research Corporation, Long Island City, N. Y.

Report of the Committee on Non-Theatrical Equipment, R. F. Mitchell, *Chairman*.

"Problems of the Amateur Motion Picture Maker," R. C. Holslag, Amateur Cinema League, New York, N. Y.

TUESDAY, APRIL 24TH

Morning: Projection Session

"Factors Covering the Design of Projection Lamps, and Their Application to Equipments," F. E. Carlson, General Electric Company, Cleveland, Ohio.

"Operating Characteristics of the High-Intensity A-C Arc for Motion Picture

Projection," D. B. Joy and E. R. Geib, National Carbon Company, Cleveland, Ohio.

"The Relationship of the High-Intensity A-C Arc to the Light on the Projection Screen," D. B. Joy and E. R. Geib, National Carbon Company, Cleveland, Ohio.

"A-C Adapters for Low-Intensity Reflecting Arc Lamps," R. Michling, New York, N. Y.

"Effect of Aperture Lenses on the Illumination of Motion Picture Screens," W. B. Rayton, Bausch & Lomb Optical Company, Rochester, N. Y.

Afternoon: Exchange and Theater Session

"Simple Theory of Three-Element Vacuum Tubes," H. A. Pidgeon, Bell Telephone Laboratories, New York, N. Y.

Report of the Sub-Committee on Exchange Practice, T. Faulkner, *Chairman*.

Report of the Projection Practice Committee, H. Rubin, *Chairman*.

"Reel Problems in Exchange Practice," T. Faulkner, S. M. Chemical Company, New York, N. Y.

"Technical Aspects of Theater Operation," R. M. Wilcox and L. W. Conrow, Electrical Research Products, Inc., New York, N. Y.

"Cheapness Does Not Always Pay," F. H. Richardson, New York, N. Y.

"The Motion Picture Theater Auditorium," B. Schlanger, New York, N. Y.

WEDNESDAY, APRIL 25TH

Morning: Sound Session

"Some Recent Improvements in Equipment and Technic in the Production of Motion Pictures," E. A. Wolcott, RKO Studios, Hollywood, Calif.

"Some Considerations in the Design of Sound Reproducing Equipment," F. Marion and G. Friedl, Electrical Research Products, Inc., New York, N. Y.

"On the Realistic Reproduction of Sound, with Particular Reference to Sound Motion Pictures," H. F. Olson and F. Massa, RCA Victor Company, Camden, N. J.

Report of the Sound Committee, L. W. Davee, *Chairman*.

"An Improved Sound System for Noiseless Recording," G. L. Dimmick and H. Belar, RCA Victor Company, Camden, N. J.

"Recent Optical Improvements in Western Electric Sound Film Recording Equipment," W. Herriott and L. B. Foster, Bell Telephone Laboratories, New York, N. Y.

"Care and Operation of Theater Sound Systems," J. S. Ward and P. T. Sheridan, Electrical Products, Inc., New York, N. Y.

Morning: Lighting Session

"Studio Lighting," S. W. Woodside, Westinghouse Lamp Company, Bloomfield, N. J.

"The Application of the Bi-Plane Filament Light Source to Spotlighting Service," G. T. Mili, Westinghouse Lamp Company, Bloomfield, N. J.

Open Forum: "What Is Wrong with the Shape of the Motion Picture?" "How Can the S. M. P. E. Be of Better Service to the Industry?"

- "Developments in Spotlighting," H. Kliegl, Kliegl Bros. Stagelighting Company, New York, N. Y.
- "Thyratrons and Their Application," E. H. Alexander, General Electric Company, Cleveland, Ohio.
- "Stroboscopic Light High-Speed Photography," H. E. Edgerton and H. Germeshausen, Massachusetts Institute of Technology, Cambridge, Mass.

THURSDAY, APRIL 26TH

Morning: Laboratory Session

- "Continuous Optical Reduction Printing," A. F. Victor, New York, N. Y.
- "A Non-Slip Sound Printer," C. N. Batsel, RCA Victor Company, Camden, N. J.
- "An Optical Reduction Sound Printer," C. N. Batsel and L. T. Sachtleben, RCA Victor Company, Camden, N. J.
- "Properties of Piezoelectric Crystals," F. R. Lack, Bell Telephone Laboratories, New York, N. Y.
- "The English Dufaycolor Film Process," W. H. Carson, New York, N. Y.
- Open Forum: "Suggestions for Improvements in Motion Picture Laboratory Practice," "Possible Motion Picture Applications of the Principle of Auditory Perspective."
- "A Small Developing Machine," H. R. Kossman, Andre Debrie, Inc., New York, N. Y.

Afternoon: Photographic Session

- "Piezoelectric Microphones," A. L. Williams, Brush Development Company, New York, N. Y.
- "Equipment for the Hard-of-Hearing," D. D. Halpin, Sonotone Corp., New York, N. Y.
- "Some Properties of New Agfa 35-Mm. Film," P. Arnold, Agfa Ansco Corporation, Binghamton, N. Y.
- "The Failure of the Reciprocity Law in Photographic Exposure," L. A. Jones and J. H. Webb, Eastman Kodak Company, Rochester, N. Y.
- "A Year's Practical Experience with a High-Speed Timing Camera," H. T. Day, Electrical Research Products, Inc., New York, N. Y., and F. Tuttle, Eastman Kodak Company, Rochester, N. Y.
- "The Microdensitometer as a Laboratory Measuring Tool," W. R. Goehner, Bell Telephone Laboratories, New York, N. Y.
- "A Sweep Oscillator Method of Securing Wide Band Frequency Response Spectra on Short Lengths of Motion Picture Film," J. Crabtree, Bell Telephone Laboratories, New York, N. Y.

JOURNAL

OF THE SOCIETY OF

MOTION PICTURE ENGINEERS

Volume XXII

JUNE, 1934

Number 6

CONTENTS

	<i>Page</i>
Progress in the Motion Picture Industry: Report of the Progress Committee.....	341
Report of the Projection Practice Committee.....	379
Report of the Sub-Committee on Exchange Practice.....	386
Society Announcements.....	391
Author Index, Volume XXII (January to June, 1934).....	393
Classified Index, Volume XXII (January to June, 1934).....	395

JOURNAL OF THE SOCIETY OF MOTION PICTURE ENGINEERS

SYLVAN HARRIS, EDITOR

Board of Editors

J. I. CRABTREE, *Chairman*

O. M. GLUNT

A. C. HARDY

L. A. JONES

J. O. BAKER

Subscription to non-members, \$8.00 per annum; to members, \$5.00 per annum, included in their annual membership dues; single copies, \$1.00. A discount on subscriptions or single copies of 15 per cent is allowed to accredited agencies. Order from the Society of Motion Picture Engineers, Inc., 20th and Northampton Sts., Easton, Pa., or Hotel Pennsylvania, New York, N. Y.

Published monthly at Easton, Pa., by the Society of Motion Picture Engineers.

Publication Office, 20th & Northampton Sts., Easton, Pa.

General and Editorial Office, Hotel Pennsylvania, New York, N. Y.

Entered as second class matter January 15, 1930, at the Post Office at Easton, Pa., under the Act of March 3, 1879. Copyrighted, 1934, by the Society of Motion Picture Engineers, Inc.

Papers appearing in this Journal may be reprinted, abstracted, or abridged provided credit is given to the Journal of the Society of Motion Picture Engineers and to the author, or authors, of the papers in question. Exact reference as to the volume, number, and page of the Journal must be given. The Society is not responsible for statements made by authors.

Officers of the Society

President: ALFRED N. GOLDSMITH, 444 Madison Ave., New York, N. Y.

Executive Vice-President: HAROLD C. SILENT, 7046 Hollywood Blvd., Los Angeles, Calif.

Engineering Vice-President: LOYD A. JONES, Kodak Park, Rochester, N. Y.

Editorial Vice-President: JOHN I. CRABTREE, Kodak Park, Rochester, N. Y.

Financial Vice-President: OMER M. GLUNT, 463 West St., New York, N. Y.

Convention Vice-President: WILLIAM C. KUNZMANN, Box 400, Cleveland, Ohio.

Secretary: JOHN H. KURLANDER, 2 Clearfield Ave., Bloomfield, N. J.

Treasurer: TIMOTHY E. SHEA, 463 West St., New York, N. Y.

Governors

EUGENE COUR, 1029 S. Wabash Ave., Chicago, Ill.

HERFORD T. COWLING, 7510 N. Ashland Ave., Chicago, Ill.

ARTHUR S. DICKINSON, 28 W. 44th St., New York, N. Y.

RALPH E. FARNHAM, Nela Park, Cleveland, Ohio.

HERBERT GRIFFIN, 90 Gold St., New York, N. Y.

EMERY HUSE, 6706 Santa Monica Blvd., Hollywood, Calif.

WILBUR B. RAYTON, 635 St. Paul St., Rochester, N. Y.

HOMER G. TASKER, 41-39 38th St., Long Island City, N. Y.

PROGRESS IN THE MOTION PICTURE INDUSTRY

REPORT OF THE PROGRESS COMMITTEE*

Summary.—This report of the Progress Committee covers the period June, 1933, to April, 1934. The advances in the cinematographic art are classified as follows: (I) Cinematography, (II) Sound Recording, (III) Sound and Picture Reproduction, (IV) Film Laboratory Practice, (V) Applications of Motion Pictures, (VI) Publications and New Books, (VII) Appendix.

In preparing the report on progress in the motion picture industry for the year 1933, the Committee appeared about to undertake what might be termed a very disheartening task. The members of the Committee who have been in close touch with the producing phase of the industry took the rather pessimistic point of view that little, if any, progress could be reported for the past year. The economic difficulties in which most of the major producers found themselves during the past year, coupled with the bank holiday and an acute labor crisis during the summer, prevented the studios from giving as much attention to technical improvements and advances as they might otherwise have done.

In view of this situation it was a matter of much gratification to the Committee to find considerable evidence of progress in new equipment in the various reports submitted for consideration. It is true that there is little to report in the way of new films and emulsions either for photographic or sound recording purposes—a situation that can undoubtedly be attributed to the fact that during the preceding years great advances had been made in that branch of the industry.

There is little to report in the way of new professional cameras and accessories during the year, but there are many items of interest connected with improvements in studio illumination. Of particular interest is the new type of mirror coating employing aluminum, which has received considerable publicity during the past year.

In the field of color there has been little to report, except that the public appears to be evincing more interest in colored cartoons

* Presented at the Spring, 1934, Meeting at Atlantic City, N. J.

and the stage appears to be set for an impressive revival of color in important feature pictures.

There are many more new developments in amateur cinematography than in the professional field. Many new cameras have been presented to the public by manufacturers in this country as well as in Germany and Great Britain.

In the field of sound recording there are many evidences of progress. The wide-range and high-fidelity systems are gradually replacing the older recording systems in studios. One of the major electrical corporations, during the past year, has announced a device for making the recording valve used by it more nearly perfect in its operation. Announcements have also been made by the electrical corporations of extremely portable light-weight, single-film recording systems; and while they are primarily intended for use in newsreel work, there is some possibility of introducing the corresponding recording technic into the studios in place of the standard dual systems now commonly used.

A number of new sound recording accessories are reported, among which are wave analyzers for facilitating measurements of harmonic distortion in audio-frequency circuits, as well as noise meters, which have a very timely application in sound recording and in measuring camera noise on sets. The report this year mentions a new item not heretofore reported: namely, a complete equipment for recording sound on 16-mm. film, using an amateur camera. It will be interesting to follow the reception that will be accorded by the public to this equipment.

In the field of sound and picture production is an announcement from Germany of several new types of projectors having many novel features. In the United States there have not been many items offered in this field, but it has been reported to the Committee that a considerable number of theaters in the country are bringing their sound reproducing equipments up to date.

There is little to report on film laboratory practice, but there are evidences here and there of general improvement in the film developing situation. The quality of release prints still remains questionable, and the Committee regrets that it has nothing definite to report in the matter of improvement in that vital field.

As to the applications of motion pictures, considerable progress appears to have been made in the practical application of a small light-weight, high-speed camera capable of taking 2000 frames per

second on the standard 16-mm. film. This camera is associated with a timing device, which should make it an important tool in all kinds of accurate time analyses.

In the Appendix of the report is listed an account of progress in motion pictures in Great Britain and Japan. It is of interest to note that the motion picture industry in Great Britain has made considerable progress during the past year, as evidenced by the excellent reception given in this country to sound pictures made there.

The Committee wishes to thank the following firms for supplying photographs for use in this report: Bell & Howell Company; General Radio Company; Eastman Kodak Company; Electrical Research Products, Inc.; Paramount Productions, Inc.; RCA Victor Company; Victor Animatograph Co.; and Western Electric Company, Ltd.

J. G. FRAYNE, *Chairman*

W. P. BIELICKE
L. BUSCH
A. A. COOK
R. N. CORBIN

J. A. DUBRAY
R. E. FARNHAM
W. C. HARCUS

G. E. MATTHEWS
H. MEYER
G. F. RACKETT
S. S. A. WATKINS

SUBJECT CLASSIFICATION

I. CINEMATOGRAPHY

A. *Professional*

1. Films and Emulsions
2. Cameras and Accessories
3. Studio Illumination
4. Color

B. *Amateur Cinematography*

1. General
2. Cameras
3. Projectors
4. Color

II. SOUND RECORDING

A. *Professional*

1. General
2. Recording Equipment (Dual System)
3. Recording Equipment (Single System)
4. Accessories

B. *Amateur*

III. SOUND AND PICTURE REPRODUCTION

1. Sound Equipment
2. Projectors and Accessories
3. 16-Mm. Sound-on-Film

IV. FILM LABORATORY PRACTICE

1. Film Development
2. Laboratory Equipment

V. APPLICATIONS OF MOTION PICTURES

1. Education
2. Timing Devices
3. Miscellaneous

VI. PUBLICATIONS AND NEW BOOKS**VII. APPENDIX**

- A. General Field of Progress of the Motion Picture Industry in Great Britain
- B. Progress in the Motion Picture Industry in Japan

I. CINEMATOGRAPHY*A. Professional*

1. *Films and Emulsions*.—A review of the literature for the past year reveals very little new information concerning motion picture film emulsions. Extensive use has been made, however, of the fast panchromatic materials since their introduction three years ago. Several additions were made to the list of film emulsions available to the still cameraman. Panchromatic roll films of high speed and color-sensitiveness combined with fine grain were introduced. One of these films was somewhat similar in speed, color-sensitiveness, and grain characteristics to the motion picture background negative film introduced in 1932.¹

In the sound recording emulsion field the Agfa Ansco Corporation has announced the *TF III* 35-mm. motion picture film for sound recording with the variable density method. Its speed, about five times greater than that of positive, the long straight-line density curve, the low gamma infinity, and its great resolving power are stated to qualify this film as a high-class dependable recording material.

This corporation announces also the *TF IV* 35-mm. motion picture film for the variable width recording method. It is claimed to be superior in contrast and resolving power to positive film, and about 2 to 3 times the speed of the latter.

In the realm of theory, a number of interesting papers have ap-

peared that deal with emulsion research. Methods of testing gelatins for photographic use were described by Fuchs² who stated that the emulsion maker's experience and intuition still are important factors in governing the selection of gelatins. Heyne³ reviewed the history of gelatin and pointed out that we still have not attained the ideal position of being able to produce a particular emulsion from an absolutely inactive gelatin by predetermined additions of one or more sensitizers. Some factors in the preparation of photographic emulsions were discussed by Charriou,⁴ such as the concentration of gelatin during precipitation, the rate of precipitation, the effect of temperature and concentration of silver nitrate during preparation.

The interesting research on photographic emulsions by Carroll and his co-workers at the U. S. Bureau of Standards was extended. In conjunction with Hubbard,⁵ data were published dealing with the mechanism of hypersensitization and with sensitization by sodium sulfite.

Russian chemists published a group of papers dealing with several aspects of photographic emulsion manufacture.⁶ The emulsion ripening process and also the chemical sensitizing of the finished emulsion showed a displacement of spectral sensitivity toward the longer wavelengths in confirmation of Sheppard's theory of sensitizing nuclei. It was observed that the crystals of Russian emulsions were more cubical in form than crystals of emulsions made elsewhere.

Patent protection was granted several applicants for methods of halation prevention.⁷ Capstaff⁸ would obtain a tinted film with a clear sound track area by tinting the entire support surface and then removing the layer containing the dyes along the sound track. Crouch⁹ described a method of preventing buckling of the film along the sound track by treating it with water and a solvent above normal temperatures.

The usual large number of patents were issued to various persons on the subject of improvements in cellulose compositions, which indicated that research has been going forward in that important field. The reclamation of nitrate and acetate supports is a subject of fundamental interest, and two methods for such recovery were disclosed.¹⁰

Two unusual patents proposed the incorporation of magnetic particles in an adhesive material coated on a film strip, the purpose being to permit the recording of sound on the magnetic particles.¹¹ Several methods were disclosed for producing non-inflammable

motion picture film; one type comprising a layer of insoluble gelatin coated on each side with successive layers of rubber and a protective varnish.¹²

2. *Cameras and Accessories.*—The year 1933 has offered little in new emulsions and cameras in the professional field. Announcements of more compact and silent cameras in the report of last year have not been followed by commercial production or by the introduction of this type of camera into general studio use. In the United States, at least, the standard 35-mm. camera in a blimp housing continues to be used in the great majority of cases. Improved silent cameras are undoubtedly on the way, but are not yet a reality so far as adoption by the industry is concerned.

In the line of accessories, the Bell & Howell Company has announced a sunshade of conventional design, but adapted for lenses of very short focal length (241). Provision is made for using filters, diffusing disks, *etc.*¹³

An account is given in the *American Cinematographer* of a camera carriage with a crane arm adjustable for any camera height from 26 inches to 6½ feet, equipped with conventional panoram and tilt head and carried on four rubber-tired wheels.¹⁴

An interesting hydraulic camera dolly has three wheels, electric motor drive, and automatic cable reels.¹⁵ The hydraulic elevating column has an elevation range from 18 to 66 inches.

A number of new ultra-rapid lenses have been announced during the past year. Zeiss has produced an $f/0.85$ objective especially designed for x-ray cinematography.¹⁶ The Astro-Gesellschaft offer $f/0.95$ lenses in focal lengths of 52 mm. and 75 mm. for standard film, and a 35-mm. outfit for amateur use.¹⁷ The Pantar objective, with an aperture ratio of $f/1.0$, has also been described,¹⁸ and there have been an unusual number of patents relating to the details of objective construction.¹⁹

The German Askania Works have completed during the year the development of a telephoto lens that is new in its application to cinematography. This objective is described by H. Acht and F. Beck²⁰ in an article containing excellent illustrations of the construction of the lens and the results that can be obtained with it. It employs reflectors instead of refracting elements, like an astronomical telescope, and this type of construction appears to have many advantages when extremely long focal lengths are required.

H. Naumann has published a paper on the history and characteris-

tics of variable focus lenses now used on motion picture cameras.²¹ There is a growing interest in the type of photography that employs light at the infrared end of the spectrum, as shown by the number of published articles on the subject.²² A motion picture was made by infra-red radiation of subjects in complete darkness on Oct. 9, 1933, at the Gaumont-British Theater, London, England^{22a} (Fig. 1).

A series of articles has just been published by W. Taylor²³ describing the methods and machinery used in the optical shop of an English manufacturer; the author seems to consider his methods as the most modern ones. There have appeared a few articles on the depth-of-field of camera objectives, one by A. A. DeBois²⁴ and one by J. F.



FIG. 1. Motion picture made with infra-red radiation. Radiation supplied by two 2000-watt spotlights covered with infra-red filters. Vinten camera with $f/1.9$ lens used. Pictures exposed 16 per second. Hypersensitized infra-red film. (*Illustrated London News*)

Westerberg, which was published in the *JOURNAL*.²⁵ Westerberg has also published in the *International Photographer*²⁶ a series of tables that seem to cover all the optical and photographic data that could ever be required by a cameraman.

3. *Studio Illumination*.—About the time of the 1933 Spring Meeting the two major lamp companies introduced a complete line of projection lamps, including lamps suitable for the recently introduced 8-mm. film projectors as well as the more familiar 16- and 35-mm. portable equipments. An interesting feature of the newer lamps is the adoption of a 25-hour life in order to gain higher screen brilliance; and the increase in wattage without proportionate increase of bulb volume, thus necessitating a high degree of forced

ventilation with equipments employing them. Brief mention is made of these lamps in the report of the Non-Theatrical Equipment Committee presented at the April, 1933, Meeting.

At this same time one of the well-known equipment manufacturers made available a new type of cored carbon especially applicable to a-c. power supply. This carbon operates at the unusually low voltage of from 27 to 30 volts, and produces a bluish white light characteristic of the high-intensity flame carbons. This carbon should find its greatest application in the smaller theaters now using the low-power reflector arcs.

The past year has witnessed the quite general adoption of what is now known as the *No. 20* Photoflash lamp by many professional and amateur photographers. This lamp is of interest to the motion picture industry because of its general use by the still photographers employed by the producers, and its frequent use in movies bringing in the newspaper theme. In addition, two new lamps have been introduced; one known as the *No. 10*, of one-half the light output of the *No. 20*. This lamp is intended for amateur use and sells for a lower price. The second new lamp, known as the *No. 75*, has more than three times the light output of the *No. 20* and is intended for newspaper photography covering large areas as well as for color photography.

Of special interest to motion picture cameramen has been the new *Movieflood* lamp, designed especially for motion picture photography in color. This lamp is rated at 2000 watts, and is photographically equivalent to about four and one-half 1000-watt general service lamps. It operates at a very high efficiency, which makes its light much richer in blue and violet radiation than the more familiar lamps. It is supplied in the *PS-52* bulb, and has a life of 15 hours. A more detailed account of it and its uses was presented before the Pacific Coast Section of the S. M. P. E. and published in the July, 1933, issue of the *JOURNAL*.

On March 1, 1934, there was introduced a new larger sized Photoflood lamp having four times the light output of the original Photoflood lamp. This new lamp is known as Photoflood *No. 4*, and the smaller original one as Photoflood *No. 1*. It has a consumption of about 1000 watts, and provides approximately $2\frac{1}{2}$ times as much light as any other lamp of equal wattage. It is of particular interest to motion picture cameramen for close-up work as well as to the commercial photographer.

Of unusual interest to the manufacturers of motion picture lighting equipment has been the announcement by one of the large aluminum producers of a method of treating aluminum to obtain very high reflection efficiency. Ordinary aluminum surfaces, matte or polished, have a reflection efficiency of 65 to 70 per cent, whereas the new surface ranges from 85 to 90 per cent. Aluminum surfaces ranging from highly specular to totally diffuse are obtainable by this treatment, and are especially resistant to atmospheric corrosion.

An account of the use of aluminum in reflectors was presented before the Cleveland Section of the Illumination Engineering Society in January, 1934. It was explained by R. B. Mason, of the Aluminum Research Laboratories, that a new type of anodic treatment known as "electrolytic brightening" gives the aluminum its brightened surface. By this process, it is claimed, an aluminum polished surface having a total reflectivity of 74 per cent had a reflectivity of 87 per cent after being subjected to the anodic treatment. It was further pointed out that after the electrolytic brightening operation a substantial oxide coating could be produced by anodic processes without any substantial loss of reflectivity. As a final step in producing the finished reflector, known as the *Alray*, the oxide coated surface is sealed to make it impervious to corrosive influences.

Another type of reflecting surface involving aluminum received considerable publicity in the scientific press last year. Aluminum metal is evaporated *in vacuo* on to the metal or glass mirror, producing thereon a reflecting surface of high efficiency, which is claimed to be free from any staining due to exposure or handling. This method has been described by Strong²⁷ and Edwards,²⁸ and is now being used for coating astronomical mirrors. It has not yet made its appearance in commercial studio equipment although several studios are experimenting with it.

Kliegl Bros., of New York, have recently introduced a new type of incandescent lamp spotlight which employs a rhodium plated elliptical reflector. This reflector, in conjunction with a suitable projecting lens, allows an accurate control of the light over a wide angle. A spotlight involving this principle has produced more than three times the amount of illumination as compared with the more usual lens spots. In addition, it provides a very uniform, sharply defined spot.

The General Electric Vapor Lamp Company reports that a new

type of high-efficiency, limited-pressure mercury arc is well along in development. This arc has an efficiency of about 40 lumens per watt, and is quite compact, a 425-watt unit being contained in a tubular lamp bulb 2 inches in diameter and 13 inches in over-all length. The light source itself is 6 inches long and about $\frac{1}{2}$ inch in diameter. The arc can be used for any of the studio applications for which the older type of low-pressure mercury arc has been used, and has the advantage of possible use with reflectors in broad-beam general lighting units. The color quality of the light is considerably whiter than that of the older low-pressure form of the mercury arc, there being additional red and green light of value in panchromatic work.

4. *Color Cinematography*.—The interest in the use of color in professional cinematography noted in the previous progress report has been carried forward into the current year. The strengthened competition, with which the motion picture industry finds itself faced, as a consequence of advanced technic in radio presentation, the rehabilitation of the dramatic stage, and various other amusement facilities, has made it necessary for the industry to seek additional appeal for its productions. That one of those appeals should be color is a natural conclusion; that advances in the development of a satisfactory three-color process were available to supply that appeal was not coincidence, but the result of far-sighted planning by organizations such as Technicolor.

The outstanding development during the current year has been the veritable craze for color cartoons, the outstanding example of which was Disney's *Three Little Pigs*, photographed in Technicolor's three-color process, establishing a new technic, and breaking records on every front. This successful excursion was followed by notable dramatic sequences M-G-M's *The Cat and the Fiddle* and 20th Century's *The House of Rothschild*. Cinecolor has also contributed to the cartoon field with several successful numbers. A bi-pack process was introduced by a British firm which utilized a double-coated film for printing.^{28a}

A large number of patents were issued covering improvements in 35-mm. lenticulated films, particularly methods of printing such color records, but no extensive commercial use was known to have been made of these films except their application to small still cameras such as the Leica and Contax. Records made with these cameras would presumably be projected similarly to slide films.^{28b}

A German patent has been issued describing the making of a line-

screen for color photography by using several spinneret tubes to form the lines in uniform succession on the carrier base.²⁹ A method of producing multicolored pictures was patented, consisting in the use of an impregnated support composed of esters of leuco compounds of a vat dye. This support was recommended to be exposed behind a color-separation negative to yield the positive, from which the unchanged leuco ester was to be washed out.³⁰ Several additional patents were noted which dealt with various improvements in the additive color process using lenticulated film.³¹

B. Amateur Cinematography

1. *General.*—The past year has been marked by improvements of existing apparatus, materials, and processes, rather than by development of any new principles. Many reversible emulsions have been introduced in both the United States and Europe. These aim mostly at progress in speed, freedom from halation, good color-sensitivity, and fine grain.^{32, 33}

2. *Cameras.*—Several new amateur cameras have been either introduced or improved during the past year. Features of the *Ciné-Kodak Special* include a dissolve shutter, a turret carrying any two of a series of interchangeable lenses, a reflex focusing finder, and a spring motor with long uniform run characteristics. The speed is controlled from 8 to 64 frames per second, and interchangeable film chambers are provided having capacities of 100 and 200 feet. Other features included are a single-exposure trip, single-frame per turn and eight-frame per turn hand-crank or motor-drive shafts, and masks for double exposure and effect photography.

The Bell & Howell Company has announced a model 70 *E Filmo* 16-mm. camera. It is similar to the *Filmo 70 D* model with the exception that the three-lens turret has been eliminated. However, interchangeability with all types of lenses mounted for the *Filmo 70 D* is possible. The 70 *E* model can be operated at speeds from 8 to 64 picture frames per second, and can be used for black-and-white or Kodacolor pictures (Fig. 2).

The Bell & Howell Company also has announced a new model 16-mm. camera of extreme compactness. There are two finders, one a direct sight and the other a waist level type. It can be operated at a speed of either 16 or 24 picture frames per second. The shutter is of a unique type with oscillating body action akin to that of a focal plane shutter. Its film capacity is 50 feet to the cartridge—magazine

type, greatly simplifying the loading. A variety of lenses of various focal lengths and apertures is available, and the camera can be used for black-and-white as well as for Kodacolor pictures (Fig. 2). Of interest to amateurs is the 1934 model 3 *Victor* camera which has five operating speeds. Other features include duplex twin mounted spring motor, attached winding crank, built-in exposure guide, multiple view finder, *etc.*(Fig. 2).

In Germany the Siemens A. G. have completed their entire 16-mm. program by producing the Siemens *Kino-Kameras C* and *D*. In

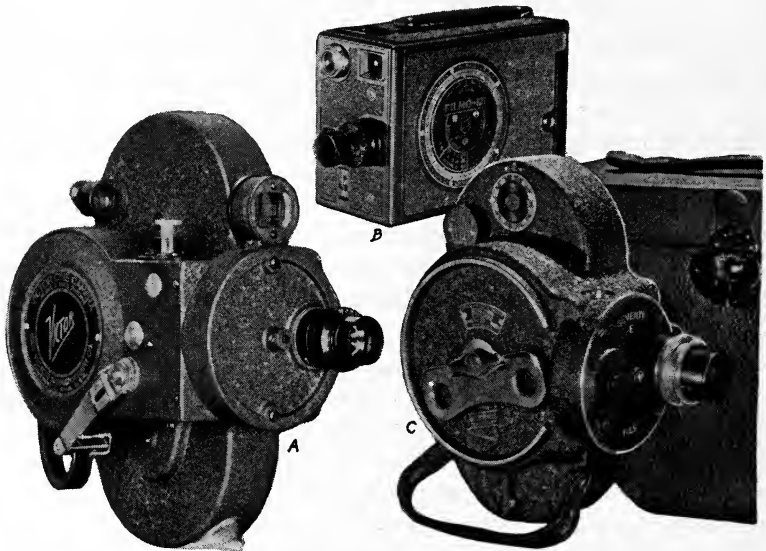

FIG. 2. (A) 16-Mm. camera (model 3, *Victor Animatograph Corp.*); (B) 16-mm. camera (model 121, *Bell & Howell Co.*); (C) 16-mm. camera (model 70-E, *Bell & Howell Co.*).

general the type *D* Siemens corresponds with the Siemens *Kino-Kamera C*,³⁴ with the exception that the latter has only one $f/1.5$ lens; whereas the model *D* is fitted with three lenses on a vertical slide, with apertures ranging from $f/1.5$ to $f/4.5$ in different focal lengths.

In the course of the past year, the firm of E. Leitz, at Wetzlar, Germany, produced several new lenses especially suitable for sub-standard film. In view of the improvements that have been made in the fine-grain emulsions, all their lenses were newly calculated. This is particularly true with two Leitz lenses, the *Dygon* $f/2.8$ and $f/3.5$,

both of which have a focal length of 20 mm., and even more so with the four *Hektor* lenses $f/1.4/25$ -mm., $f/2.5/35$ -mm., $f/1.9/50$ -mm., and $f/2.5/50$ -mm., as well as with the Tele-Lens *Telyt*, which has a focal length of 75 mm. and a relative aperture of $f/4$. All these lenses are obtainable in focusing mounting, and the *Dygon* $f/3.5/20$ -mm. can also be had in *Fixfocus* mounting.

The firm of Jos. Schneider & Co., Kreuznach, has also been very active. Their *Xenon* $f/1.3, 1.5$ lens can be used in conjunction with a special lens, and is also particularly suitable for lenticulated film, such as Kodacolor and Agfacolor. With this lens a careful correction of the coma is effected. Schneider states that the Gauss type of lens is particularly suitable for such correction, as it makes this possible without affecting the elimination of other lens defects.

3. *Projectors*.—Continued improvement in 16-mm. projectors is evidenced by the announcements of the manufacturers. From Germany comes the announcement that the *Grossraum* projector has an unusual brilliancy, as it is equipped with a 75-volt, 375-watt lamp, and is therefore suitable for use in large auditoriums. It is provided with a new type beater movement. The advertising projector is fitted with a relay which effects the rewinding of the film at regular intervals. Consequently, the projection is not continuous, but repeated.

During 1933 the firm of Zeiss Ikon produced a portable 16-mm. projector of great efficiency, the so-called *Schmalfilm-Kinox*.³⁵ This apparatus is suitable for large projection and is built in the form of a suitcase. It is also said to be adapted to sound film projection.

The firm of Lytax in Germany has produced a new projector called the *Piccolo*, with which either a 33-volt, 100-watt lamp, or a 100-volt, 400-watt biplane lamp can be used, and thus very brilliant pictures can be projected. This apparatus incorporates a new movement constructed on the same lines as the Geneva cross. With this it has been possible to achieve a correct movement of the film within 60 degrees of the rotary shutter. It is claimed that, due to the fact that the sprockets of the intermittent wheel are always in contact with several perforation holes, the durability and steadiness of the projected pictures are both improved, and that by this method the apparatus is rendered suitable for *Ozaphan* film as well as for the usual safety film.

4. *Color*.—A new type of prism for exposing two images on a single frame of 16-mm. film was demonstrated at a meeting of the

British Physical Society in February. The prism is said to split the beam from a single lens without loss of light or definition. The prism holder and the twin-lens mount can be interchanged with the ordinary lens in a few minutes. A projector fitted with a double-lens system is used to show the prints.^{35a}

II. SOUND RECORDING

A. Professional

1. *General*.—There has been no outstanding alteration of recording technics in studios this past year. Compromise has been effected between extended high-frequency range and film background noise, with the result that an upper cut-off at about 8000 cycles per-second is generally attempted. The use of microphones of the dynamic type continues to expand although the condenser microphone is still used for dialog recording in many studios.

2. *New Recording Equipment (Dual System)*.—Several innovations in the methods of light-valve recording were announced by Electrical Research Products, Inc. Changes have been made in the input circuit of the light valve so as to compensate for the time shift of the effective exposure produced by the light-valve ribbons, which is equal to the time required for the film to travel from the neutral position of the image of one ribbon. With a constant film speed of 90 feet per minute and a ribbon spacing of one mil, the loss in effective exposure is dependent upon the frequency of the input current, amounting to approximately 3 db. at 9000 cycles. Compensation for this loss is accomplished by splitting the input circuit to the light valve and inserting a delay in the part of the circuit that feeds the upper ribbon. The delay is adjusted so that maximum response occurs at 8000 cycles. With this adjustment it so happens that the ribbons are approximately 180 degrees out of phase at 9500 cycles, the frequency at which they are tuned. This out-of-phase relation allows a greater input to the light valve at the higher frequencies with less danger of light-valve clash.

Amplitude adjustment relative to the frequency is introduced so as to utilize the maximum volume range available in the film material and in the recording system with phase-adjusted light valve as above described. The energy distribution of orchestral music or of speech is such that it is feasible to record with a rising characteristic while still maintaining constant probability of valve-ribbon clash at all frequencies. Since most of the annoyance caused by background

noise is due to the high-frequency components of the noise, subsequent amplitude adjustment in the reproducing system to compensate for the amplitude adjustment introduced during recording reduces the reproduced noise level and increases the signal-to-noise ratio considerably.

A study of recording conditions attainable with the phase-adjusted light valve and amplitude adjustment has resulted in the design of a recording system in which the 8000-cycle response is increased about 28 db. The total harmonic content is reduced about 12 db. relative to that in previous systems.

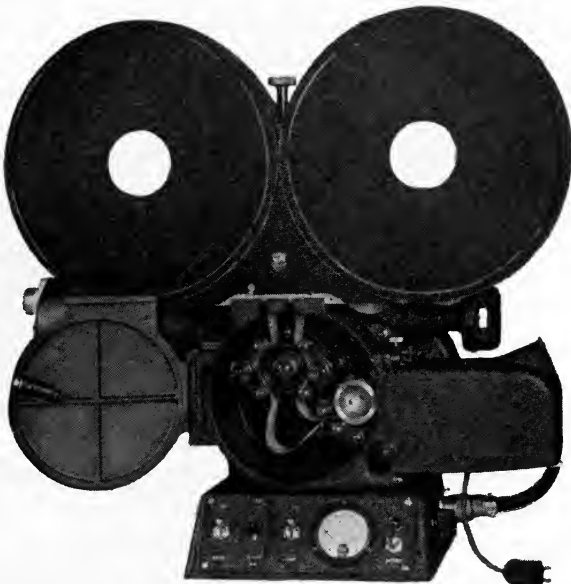

FIG. 3. Portable recorder showing the film path (*RCA Victor Co.*).

The use of toe recording up to the point of preparing the master negative by re-recording further improves quality by eliminating a printing operation and its consequent losses and distortions.

The RCA Victor Company announces a light-weight dual film recording equipment. This recorder combines portability and light weight with the merit of the rotary stabilizer type of drive, which effects uniform motion of the film at the exposure point. The necessary controls are built into the base of the recorder (Fig. 3). The

optical system produces the symmetrical type of sound track obtained with standard studio equipment. The standard galvanometer is used. This has integral provision for noise reduction, if a small noise reduction amplifier is added to the main amplifier described above.

A-c., d-c. interlock camera motors equipped with the regular ciné type mountings are used. These motors operate on 115 volts d-c., derived from a set of three 45-volt *B*-batteries. For studio operation, 110-volt, d-c. mains may be plugged in.

To reduce the weight further no tripod is supplied for the recorder, and the latter is designed to operate standing on the side or end of the carrying case. Provision has been made to fasten a plate to the base to act as an adapter to any kind of tripod, if desired by the user.

3. *New Recording Equipment (Single System)*.—During the past year the RCA Victor Co. has introduced a portable single-film recording system, meant chiefly as a portable newsreel recording equipment for use with an Akeley audio camera. The equipment is noted for its simplicity, ruggedness, and light weight. Inductor type pressure-operated microphones are used, and provisions are made so that the outputs of two of these microphones may be mixed simultaneously. The microphones are of the permanent-magnet type, compact, unusually rugged, free from noise due to shock excitation, and are little affected by wind. Since it is a relatively high-level, low-impedance device, it does not need an amplifier closely associated with it, but can utilize a transmission line to the amplifier.

Because of the points mentioned above, pre-mixing is effected in the main amplifier, and no separate microphone amplifiers are used. This results in a saving of bulk, battery consumption, and amplifier stages. A selector key is provided so that when only one microphone is used, the mixer control for the other is automatically eliminated from the circuit, thereby increasing the available gain. This system provides the maximum signal-to-hiss ratio under all conditions.

The amplifier itself is quite compact, uses non-microphonic radio-trons, and has an output in excess of the normal requirements for a standard studio type of galvanometer. The standard studio type of galvanometer is employed in the small optical system that fits the Akeley audio camera.

Electrical Research Products, Inc., has announced the Western Electric *Type G* single-film portable recording system, which is primarily intended for use in newsreel work where lightness, ease of

operation, reliability, and high-quality results are the controlling factors. The normal sound recording part of the system consists of a microphone and tripod, an amplifier assembly, a motor battery case, a monitoring head-set, a modulator unit, and the necessary connecting cords. This equipment has a total weight of less than one hundred pounds, and is relatively convenient to transport as personal baggage by automobile or train, even when the camera and its tripod and the motor battery are added.

This light-weight recording system was made possible by the



FIG. 4. Wave analyzer (*General Radio Co.*).

development of the moving-coil microphone, which does not require a transmitter amplifier, light-weight speech transformers, which are used in the compact high-gain amplifier, and the permanent-magnet light valve, which is used in the modulator unit. Although this is an exceptionally portable and compact recording system, the reliability of operation and quality of recording are in no way impaired.

4. *Accessories.*—The General Radio Company has announced the *Type 653* Volume Control. These mixer controls have been developed in order to reduce to its lowest possible value electrical noise introduced into the sound system. They are of the step-by-step design, having contact points and switches of approximately the same

alloy, so that electrical contact potential is reduced to zero. The switch is of the four-blade construction, and is so cut as to provide a sidewise wiping contact on the switches to prevent cutting and to keep them clear of dirt. The windings are on bakelite posts molded into the switch contact structure. This reduces the possibility of breaking the resistance wire due to mechanical strain. A ladder circuit is used, which has a continuously variable attenuator of about $1\frac{1}{2}$ db. per step over the first thirty steps, the last three steps being in larger increments to the cut-off or infinity attenuation position.

The same company announces the *Type 636-A* wave analyzer, which is a precision instrument to facilitate measurements of harmonic distortion in the audio-frequency circuits (Fig. 4.) The instrument operates on the heterodyne principle, in which the fre-

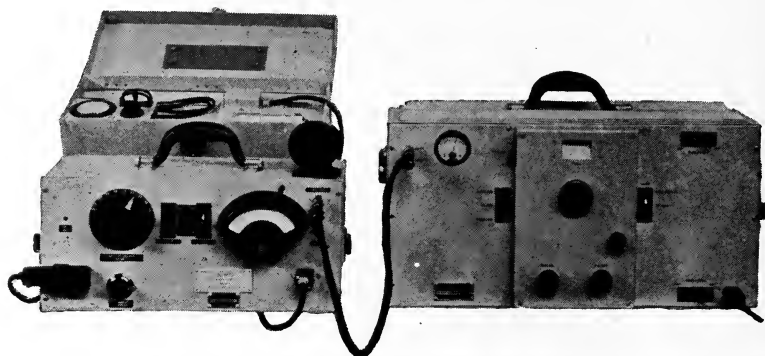

FIG. 5. Sound meter and frequency analyzer (*Electrical Research Products, Inc.*).

quency under analysis, which may be anywhere in the range from 5 to 15,000 cycles, is heterodyned by means of a local oscillator to a frequency of 50,000 cycles. The 50,000 cycles is passed through a very highly selective amplifier, which is tuned interstage by means of quartz crystals. Two quartz crystal tuning stages are used. The amplitude of each harmonic present in the voice-wave can be isolated and measured on the output vacuum-tube voltmeter. Push-pull detection is used, and particular care has been exercised in the design of the detector so that it, of itself, introduces little if any distortion. The selectivity is very high, the discrimination to frequencies only 2 cycles off resonance being 6 db. At 100 cycles off resonance, the discrimination is over 60 db. This means that 60

cycles and the harmonics thereof can be measured with ease; and the tenth and eleventh harmonic, for example, can be separated by more than 50 db. The analyzer is entirely self-contained, and requires no outside equipment of any sort except a 6-volt storage battery for filament supply.

The new Western Electric crystal-controlled sound frequency analyzer is shown in Fig. 5. It is essentially a band-pass filter of fixed width, which is continuously variable throughout the audible frequency range: namely, 40 to 10,500 cycles per second. Either of two band widths: namely, 20 cycles per second or 200 cycles per second, may be selected by operating a pair of keys. The general circuit arrangement, while new in application, is not unusual in principle except as to the use of quartz crystals to obtain stability and high discrimination. In the analyzer unit, the incoming signal is heterodyned by a variable high-frequency oscillator, and the modulation produced passed through the crystal filter. Another portion of the tuned oscillator output is used to demodulate the output of the crystal filter. The output of the demodulator is fed into the final amplifier in audio-frequency form, and may be monitored and measured in the sound meter or recorded in a high-speed level recorder.

The excellence of this analyzer is claimed to be due to the exceptionally high suppression attained outside the band of frequencies passed by the crystal filters. Taking into consideration harmonic generation in the tubes and other limiting factors, a suppression of 50 db. is actually obtained at 45 cycles either side of the center of the 20-cycle band. The use of this instrument in conjunction with a sound meter or high-speed level recorder permits the rapid solution of a large number of different types of problems, such as the analysis of the sound spectra of various types of noise or of musical instruments, the location of resonance effects in auditoriums, and the measurement of harmonics in sound systems.

The high-speed level recorder referred to above is a development of the Bell Telephone Laboratories. It will record rapid changes in audio-frequency currents directly on a moving strip of waxed paper by means of a stylus. A 60-db. range of intensity can be covered, during which range the deflection of the stylus is proportional to the input in decibels. It will follow changes of intensity at adjustable rates up to 360 db. per second. Various fixed paper speeds may be selected.

The equipment consists of three units: namely, an amplifier, a

recorder, and a power-supply unit, each provided with an aluminum carrying case for field use or arranged for rack mounting for laboratory use.

This instrument is extremely useful for a wide variety of acoustical measurements. It has all the advantages of any direct recording meter in that there is no time-consuming developing process as with photographic recorders. The record is instantly available and observable during the recording. A partial list of its uses includes: reverberation time measurements and studies of the pattern of sound decay in auditoriums under various conditions; high-speed recording in conjunction with sound frequency analyzers; noise measurement where the records of changing conditions of noise are desired; studies of the intensity of singing and speaking voices; and loud speaker calibration when synchronized with a variable-frequency oscillator.

A device has been made available by Electrical Research Products, Inc., for automatically altering the volume or frequency spectrum of the signal in a particular circuit under the control of a signal in another part of the circuit. A typical application of this function is found when two or more sound records are re-recorded and combined, or when original sound is recorded in combination with sound already recorded. One particular application, for instance, would be in the case of a picture showing a couple dancing to a fairly loud orchestra and conversing in an ordinary tone of voice. As normally recorded, the speech under such conditions would be practically unintelligible if the music were mixed at a satisfactory uncontrolled volume. However, if the background sound of the orchestra can be reduced appreciably in the presence of the speech, the latter becomes easily intelligible and a very satisfactory effect of loud background music is obtained. It is obviously impossible for the mixer operator manually to control the musical background to produce the effect satisfactorily. By means of the voice-operated switching device, the musical background is suppressed only during the speaking. Under these conditions the volume changes of the music are scarcely noticeable and the over-all effect is as required.

B. *Amateur*

The RCA Victor Company has announced a new 16-mm. sound camera and associated recording equipment. There are two types of this camera: namely, the *Autophone Type*, by which only the speech of the operator can be recorded, and the *Microphone Type*, by which

the sound of the photographed subject may be recorded. Two speeds of operation, 24 or 16 frames per second, are provided. In addition to the camera the following equipment is supplied with the *Microphone Type*: a two-stage amplifier with cable, a microphone with cable, a battery box, a belt assembly, a connecting cable from camera to amplifier, and one monitoring phone.

The amplifier is a high-gain, battery-operated type using one *RCA 232* and one *RCA 233* tube. Special features are its manual volume control and visual recording level indicator, the latter consisting of three neon tubes, each lighting at a different sound level.

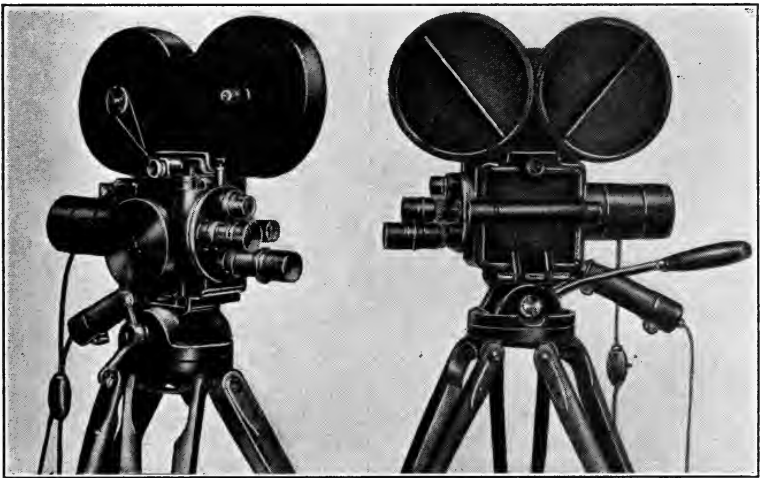

FIG. 6. British 16-mm. sound-on-film camera (*Movies and House Talkies*, London).

The first announcement of a British 16-mm. sound-on-film camera appeared in the April, 1934, issue of *Home Movies and Home Talkies*. Variable-density recording is used, the recording lamp being quickly removable for shipment or replacement. A four-lens turret is fitted and direct focusing is employed. Film retorts of 400-ft. capacity are supplied. Single-perforation S. M. P. E. standard film is utilized^{35b} (Fig. 6).

III. SOUND AND PICTURE REPRODUCTION

1. *New Sound Equipment.*—Little has been offered in the way of new sound equipment by the manufacturers in the last year. The

high-fidelity reproducing system is being installed in an increasingly large number of theaters, and up to March 3, 1934, 717 theaters had been equipped with wide-range projection equipment.

Of interest to studios and theaters showing double-film previews is an announcement of a new type of double-film attachment that permits running the picture and the sound print in synchronism over one projection machine (Fig. 7).

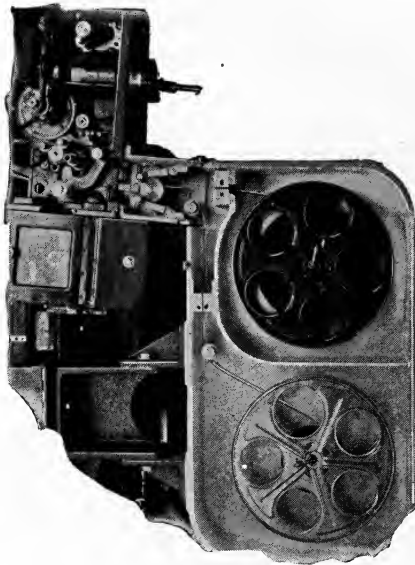

FIG. 7. Double-film attachment for preview projection (*Electrical Research Products, Inc.*).

2. *New Projectors and Accessories.*—From Germany comes the announcement that the firm of Zeiss Ikon produced in 1933 a new type of theater projector called *Ernemann V*, its special feature being a water circulating scheme for preventing the film gate from becoming hot, as well as certain arrangements which, in case of the advent of wide film, would make it possible to adapt the 35-mm. film track for films of larger sizes. The water flows mainly through such parts as are heated by the projection lamps, especially the film track and gate, as well as the parts to be oiled and the transport mechanism. The projector is provided with a rotary shutter between the light and the film. Descriptions of *Ernemann V* and *Ernon LV* will be found in *Filmtechnik*.³⁶

Zeiss Ikon have also improved their projection lamps and their well-known *Artisol* lamps with the carbon points set at an obtuse angle, and a reflecting mirror with condenser. This involves a special correction of the reflecting mirror which permits very uniform illumination of the gate and does not require an additional condenser. The *Kinesol* lamp can be used with a maximum current of 35 amperes, and the *Artisol* lamps have recently been delivered for amperages up to 80.

During the past year, the firm of Eugene Bauer, Stuttgart, Germany, which was amalgamated with the Kinoton Company in Germany, has produced three new projectors, two of which have not yet been completely described in the literature.

The three new projector models are called *Standard 5*, *Standard 7*, and *Super 7*. The *Standard 7* is described in *Kinotechnik*.³⁷ It might be mentioned that *Standard 5* is intended for use in medium-sized theaters, and is provided with a rotary shutter between the film and the lamp, as well as a completely enclosed casing with an automatic circulating lubricator. It can be used with a lens of 62.5-mm. focus. In view of its particular suitability for smaller cinemas, this apparatus is provided with take-up spools for 1300 meters of film, thus enabling a long uninterrupted projection. Bauer points out that an important novelty of this projector is the framing device, according to which the film gate moves together with the Geneva cross, whereas the picture gate remains in a fixed position. This arrangement permits framing even if the projector is not in operation.

An important feature of the *Standard 7* projector is the incorporated sound pick-up, which is rigidly connected to the projector. The construction of the sound pick-up is similar to that of the *LT* type put out by the firm of Bauer. The *Standard 7* projector, however, can be used also in conjunction with any other sound pick-up without having to make alterations. It is driven by means of a shaft that makes 1440 rpm. on practically the same principle as that of the *Standard 5* projector.

The *Super 7* projector, like the *Standard 7*, is suitable for use in the largest theaters, and a particularly interesting feature of the former is the completely enclosed film track. The projector can be fitted with lenses up to 104-mm. focus, and is equipped with a new lamp casing which is large enough even for lamps with a mirror of 300 mm.

The firm of Bauer has also improved its *Bauer-Kohlennachschieb N 2*.³⁸ A special wiring system in this arc lamp provides an auto-

matic control of the carbons. Other mirror lamps are described in *Filmtechnik*,³⁹ especially one produced by the firm of Erko, which employs a mirror of 250-mm. focal length constructed by the firm of Busch, the carbon points of which are axially arranged.

In the United States, C. Tuttle has published in the *JOURNAL*⁴⁰ an analysis of distortion in theater projection, concluding with the opinion that the amount of distortion tolerable from the view-point of the observer is greater than ordinarily supposed. Distortion from the cameraman's view-point, with particular reference to the keystone effect in theaters, is the subject of a paper by R. F. Mitchell.⁴¹

Two new projector arcs for the new a-c. carbon arrangement have been announced, and both are equipped with elliptical reflectors.⁴²

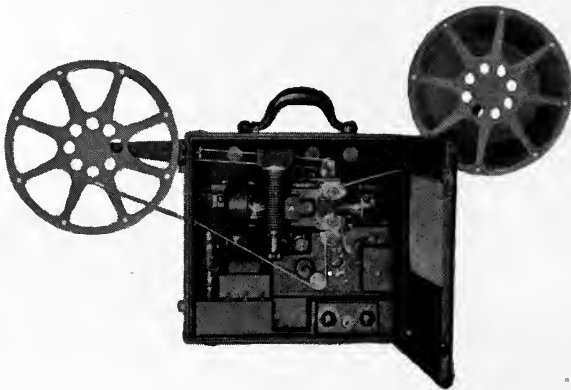

FIG. 8. Sound projector for 16-mm. film (*Bell & Howell Co.*).

A water-cooled metal reflector, for which claims of unusual durability are made, has been developed in England.⁴³ Some work leading toward the development of new reflecting surfaces on glass, particularly of aluminum and magnesium, has also been reported during the past year.⁴⁴

Another process of stereoscopic projection, invented by G. Jellinek, has been described in the literature.⁴⁵ C. R. Haupt has also published a comprehensive discussion of the question.⁴⁶ The usual number of patents on stereoscopic projection have been noted.⁴⁷ There have been a few patents also on non-intermittent projection.⁴⁸

Two articles have been published on optical systems for transparency projection in the studio,⁴⁹ which suggest means for lessening

the "hot-spot" effect on the translucent screen used as the background. Opinions seem to agree that no cure has yet been found for this defect, and the subject appears to need further investigation.

3. *16-Mm. Sound-on-Film Projection.*—The adoption of 16-mm. sound-on-film by the public appears to be taking place gradually, and new equipment continues to be introduced every few months. The Bell & Howell Company has announced the *Filmosound* projector (Fig. 8). This is a 16-mm. projector and sound reproducer, embodying a 500- or a 750-watt lamp, a sound reproducing head, and

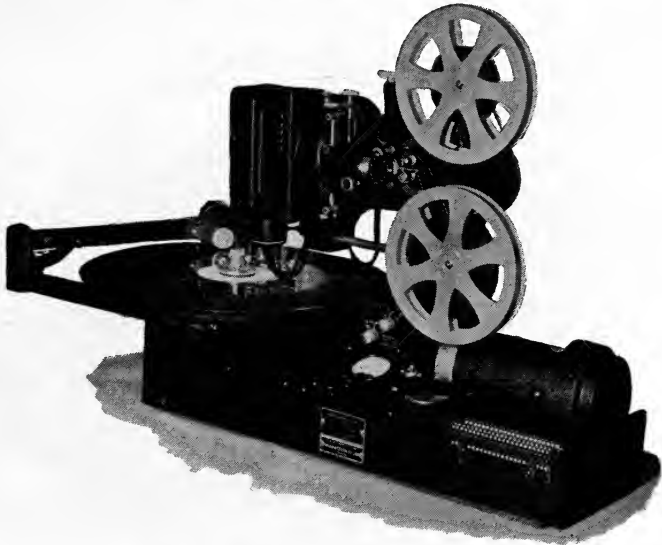

FIG. 9. Disk reproducer for 16-mm. film projector (*Western Electric Co. of London*).

amplifier system in one case; and loud speaker in a separate case, which can also house all cables necessary for operation, as well as spare accessories. Features of the apparatus are an "optical slit," which is obtained through a system of cylindrical lenses so arranged as to produce an image of the exciter filament reduced in size approximately 10 to 1 in the vertical plane, and an oscillatory circuit supplying a high-frequency alternating current for the exciter lamp and incorporating a single 145 triad to eliminate hum due to a-c. supply. The volume is controlled by simultaneously varying the photo-cell and exciter lamp voltages with a single control.

From England we are advised that the Western Electric Company,

Ltd., is manufacturing 16-mm. sound-on-disk apparatus (Fig. 9). Some of the features of the equipment are: a double projector system for change-over purposes, thus allowing a continuous program to be given; a gear-changing device to enable the projector to run at either 16 or 24 frames per second; and a gear-changing device to allow the turntable to run at either $33\frac{1}{3}$ rpm. for sound pictures, or 78 rpm. for incidental music.

A sound-on-film projector for 17.5-mm. film and using one square perforation per picture was introduced abroad last winter by the Pathé Company. A gate mask is used to prevent the perforation holes from showing on the screen. One of the most interesting

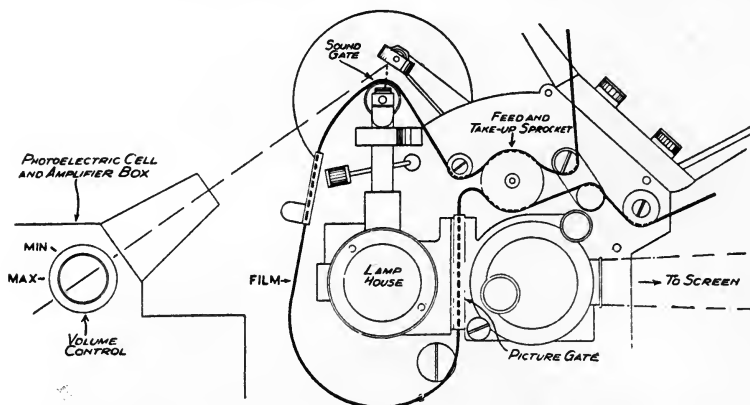

FIG. 10. Pathé 17.5-mm. sound-on-film projector (*Movie and Home Talkies*, London).

features is that the same lamp is used both for projection and illumination of the sound track. After the light passes through the sound track, it is reflected by a mirror into the photo-cell in the sound-head. Volume control is secured by a rotatable shutter in the light path before the photo-cell⁵⁰ (Fig. 10).

Early in 1934, the German firm of E. Bauer introduced a portable 16-mm. sound-on-film projector. The sound-head permits reproduction to 6000 cycles. The projector is operated with an *Asynchron* motor and the apparatus weighs about 60 pounds.

IV. FILM LABORATORY PRACTICE

1. *Film Development*.—There is little new to report as to the adoption of new practices related to the development of 35-mm.

sound or picture film. Some properties of two-bath developers for film have been discussed in the JOURNAL.⁵¹ Three types of two-bath developers have been investigated as follows: (1) bath A containing all the developing agents plus sodium sulfite; bath B, all the alkali plus the balance of the sulfite; (2) both baths containing developing agents; (3) both baths of identical composition, the first bath being replaced by the second as it becomes exhausted. The results of the investigation showed that the type (1) is the most satisfactory developer combination, and with this method it is possible to obtain an almost constant gamma with only a slight loss of emulsion speed

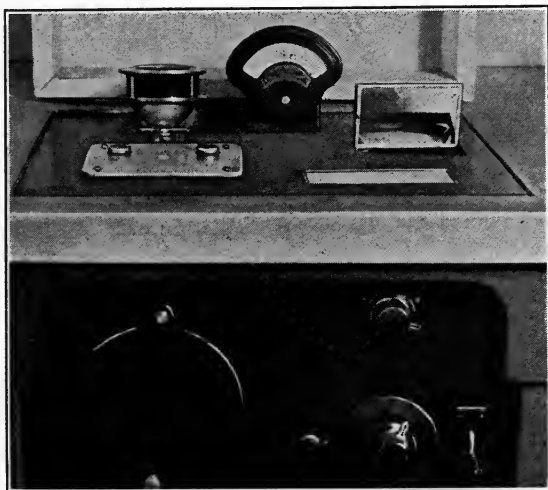

FIG. 11. Densitometer employing photronic cell (*Paramount Productions*).

over a fairly wide range of time of development. A formula is also suggested for the development of variable density sound negatives. The application of two-bath developers to machine and rack-and-tank systems is described.

2. *Laboratory Equipment.*—There is little to report in the way of new laboratory equipment during the past year. From the Paramount Laboratory in Hollywood comes an announcement of a new type of visual densitometer (Fig. 11). Its essential elements consist of a light source, a Weston Photronic cell, and a microammeter. The density range of the densitometer is 0 to 1.00 density diffuse. It is claimed to be extremely accurate and stable, and very simple to

operate. One major advantage over the eye-balance system is that it obviates all personal error caused by eye fatigue.

Extensive studies of printing problems have been made at the Bell Telephone Laboratories during the past year, reports of which have been published in the *JOURNAL*.⁵² It has been definitely established by this investigation that deterioration in sound printing in standard printers can be attributed to improper sprocket hole dimensions of the negative and positive films, which are in contact. The report showed that a certain fixed differential in pitch amounting to 3.6 thousandths of an inch should exist between the negative and the print stock if serious distortion of the sound wave envelope is to be avoided. The negative film being adjacent to the curved sprocket wheel should, of course, be of lesser pitch than the positive which is on the outside with a larger radius of curvature.

These studies have created a new interest in film pitch dimensions in the studios and film laboratories. The possibility of introducing a negative sound film having a sub-standard pitch of 0.1866 inch as compared with the standard value of 0.1870 inch, has been presented, and this may be a solution of the problem of obtaining correct sprocket hole pitch relations between negative and positive films.

V. APPLICATIONS OF MOTION PICTURES

1. *Education*.—A sound film project initiated by the University of Chicago in 1932 for the purpose of presenting the subject of natural science to the entire student body by means of lectures only was reported to be successful in a paper by Lemon read last fall at the Chicago meeting. Plans were being made to extend the work to cover social, biological, and physical sciences.⁵³ Two interesting books on the subject of the use of sound pictures in education are listed in the Bibliography section of this report.

At the Century of Progress Exposition in Chicago in 1933, motion pictures were reported to have been used effectively in a great many of the concessions and educational exhibits.⁵⁴

2. *Timing Devices*.—The Western Electric timing system mentioned in last year's report has been further developed through co-operation of the Eastman Kodak Company and the Bell Telephone Laboratories (Fig. 12). It is primarily intended for use in accurately timing any sequence of events that can be photographed. Examples of particular applications are: the timing of foot races, airplane races, and other sporting events; the time analysis of

movements made in playing games or in performing various kinds of work; industrial applications, such as the study of processes and reactions in such fields as physics, chemistry, biology, and psychology;



FIG. 12. Timing system, attached to Eastman high-speed camera (*Western Electric Co. and Eastman Kodak Co.*).



FIG. 13. Records made with Eastman high-speed camera and Western Electric timer: ignition of Mazda photoflash lamp connected to electric circuit, which in turn ignites successively two other lamps with their glass surfaces in contact. Total time interval 0.16 sec. (*Western Electric Co.*).

as an acceleration microscope to obtain data for plotting time against displacement or deflection; and various specialized applications in widely varied lines. Fig. 13 shows the time lapse occurring during the

ignition of three photoflash lamps, one of which was fired electrically.

The system consists fundamentally of two main elements: namely, a special 16-mm., high-speed, non-intermittent motion picture camera and an electrical equipment for registering time. The camera has two lens systems, so arranged that when the camera is used to photograph any event, the moving dials of the time register are also simultaneously photographed on one-eighth of each frame of film beside the picture. Upon viewing or projecting the film so made, the instant at which any portion of the event occurred can thus be read immediately from the direct time record in the picture.

The camera is available in two models: namely, a high-speed model known as *Type No. 1*, taking from 30 to 250 frames per second, and an ultra high-speed model, known as *Type No. 2*, taking from 300 to 2000 frames per second.

For athletic events, or other events occupying time intervals not exceeding five minutes, the accuracy of the timing system justifies reading the time register to the nearest scale division: namely, $\frac{1}{100}$ of a second. For longer intervals, and provided it is possible to operate the system in locations where the temperature is between 40° and 90° F., the frequency generator which supplies power to the time register is accurate to 1 part in 100,000. For engineering use a time register is available with dials graduated in seconds and $\frac{1}{500}$ of a second, for use with the ultra high-speed *No. 2* camera. When using this time register and camera, it is feasible, by interpolation, to determine elapsed time to an accuracy of $\frac{1}{2000}$ of a second. If desired, the time register can be used alone without the camera, after the manner of using a stop-watch, or with two or more cameras operating in synchronism.

3. *Miscellaneous.*—An interesting development is reported in *Editor & Publisher*. A method has been developed that permits a bit more than eight full-sized newspaper pages to be recorded on a strip of film measuring $1\frac{3}{8}$ by 12 inches. Despite the extreme reduction of the page size, the clarity of the image on the film is so great that by means of a viewing device any part of the original page can be projected to 150 per cent of its original size. It is claimed that all the pages of a month's file of a 50-page newspaper could be recorded on a film that would occupy storage space $3\frac{5}{8}$ by $3\frac{5}{8}$ by $1\frac{1}{2}$ inches. A photograph of the viewing device for examination of the 35-mm. film image of the newspaper library is shown in Fig. 14. One month's file is shown on the small reel.

VI. PUBLICATIONS AND NEW BOOKS

Possible duplication of published information will be avoided in future as a result of the joining of the *Motion Picture Projectionist* (New York) with the *International Projectionist* (New York). This trend is a favorable one and was begun several years ago when the *Motion Picture World* combined with the *Exhibitors Herald*. A new amateur publication, *Personal Movies* (Canton, Ohio), which was issued first in 1932, has been continued. Those who desire to do

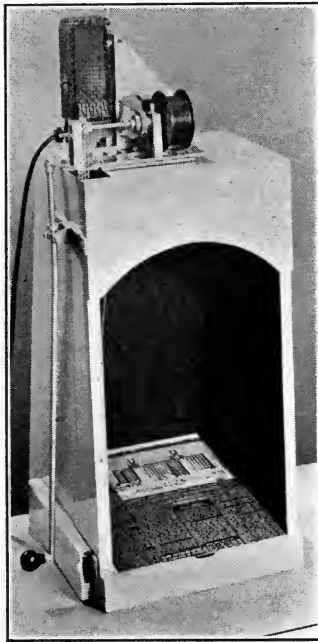

FIG. 14. Viewing device for examining 35-mm. film image of newspaper library (Eastman Kodak Co.).

reference reading will welcome the news that a ten-year index appeared in 1933 for Vols. 1 to 10 of the Royal Photographic Society's *Journal, Photographic Abstracts*. A list of the principal books that have been published since the last report of the Committee (April, 1933) follows:

1. *Year Book of Motion Pictures—1934*, 16th Edition; Film Daily, New York.

2. *Motion Picture Almanac—1933*; Quigley Publishing Co., New York.
3. *Kinematograph Year Book—1934*; Kinematograph Publications, Ltd., London.
4. *Yearbook of Photography, Cinematography, and Reproduction Processes for the years 1928–1929 (Jahrbuch für Photographie, Kine-matographie, und Reproduktionsverfahren für die Jahre 1928–1929)*, Vol. 31, Pt. 2, edited by J. M. Eder, E. Kuchinka, and C. Emmermann; W. Knappe (Halle).
5. *Yearbook of the Cine-Amateur—1934 (Jahrbuch des Kino-Amateur—1934)*, edited by W. Frerk; Photokino-Verlag, Berlin.
6. *The Film and Its World (Der Film und seine Welt)*, German film Almanac, edited by F. Henseleit; Photokino-Verlag, Berlin.
7. *Studies from the Emulsion and Colloid Laboratory* (in Russian) Vol. 1, 1932; Kinophoto Institute, Moscow.
8. *Pictorial Composition in Photography*, by A. Hammond; American Photographic Publishing Co., Boston, Mass.
9. *Commercial Cinematography*, by G. H. Sewell; Pitman & Sons, London.
10. *Sound Picture Recording and Projection*, by K. M. MacIlvain; International Text Book Co., Scranton, Pa.
11. *Talking Pictures*, 2nd Edition, by B. Brown; Pitman & Sons, London.
12. *Illumination for Motion Picture Projection (La Lumière dans la Projection Cinématographique)*, by J. Marrette; Gauthier-Villars, Paris.
13. *Motion Picture Projection and Sound Pictures*, by J. R. Cameron and others; Cameron Publishing Co., Woodmont, Conn.
14. *Theatre and Motion Pictures*, several articles by various authors; Encyclopedia Britannica, New York, N. Y.
15. *The Visual Fatigue of Motion Pictures*, by A. E. Singer; Amusement Age Publishing Co., New York.
16. *Amateur Talking Pictures and Recording*, by B. Brown; I. Pitman & Sons, London.
17. *Movie Making Made Easy*, by W. J. Shannon; Moorfield & Shannon, Nutley, N. J.
18. *The Sound Motion Picture in Science Teaching*, by A. J. Rulon; Harvard University Press, Cambridge, Mass.
19. *The Educational Talking Picture*, by F. L. Devereaux; Univ. of Chicago Press, Chicago, Ill.

20. *Film Tricks and Trick Films (Filmtricks und Trickfilme)*, by A. Stuler; W. Knapp (Halle).

21. *Infrared Photography*, by S. O. Rawling; Blackie & Sons, London.

22. *The Photography of Colored Objects*, 12th Edition, Revised; Eastman Kodak Co., Rochester, N. Y.

23. *The Complete Projectionist*, by R. H. Cricks; Kinematograph Publications, Ltd., London.

24. *The Projectionist's Handbook*, by R. Pitchford and F. Coombs; Kinematograph Publications, Ltd., London.

VII. APPENDIX

A. *General Field of Progress of the Motion Picture Industry in Great Britain*

Résumé.—The year 1933 has been a successful one, in general, for the British industry. On the production side the technical standard has improved considerably, resulting in pictures of a better class than have previously been made in this country. In the theater field conditions have generally improved, but some of the smaller exhibitors experienced trying times owing to the fact that so many large cinemas are now being built. The year has shown a marked increase in the number of British films shown in cinemas in this country. Of the 685 pictures shown to the trade, 456 were of American origin, 196 British, and 33 from other parts of the world.

16-Mm. Development.—The principal technical activities in this field have been in connection with the development of sub-standard equipment. Several such equipments have appeared on the market employing both sound-on-disk and sound-on-film in the 16-mm. size. Considerable lack of standardization is at present evident with regard to the latter. Equipments have been designed so as to be adaptable to a considerable range of voltage, and to operate at both silent and talking picture speeds.

The use of films for advertising has developed rapidly along the lines of improved technic of production and the production of films suitable for non-theatrical exhibition, by means of sub-standard equipment or daylight trucks. The principal enterprise in this direction has been shown by the tobacco companies, automobile manufacturers, and manufacturing confectioners. Little progress has been made in connection with the educational use of films on account of lack of Government funds.

Studio Production.—The progress in the studios was greater during 1933 than at any time in the history of motion pictures in this country, and 33 more feature productions were registered than in 1932.

The standard of technic definitely improved and productions became more polished than previously, as shown by the success in America of some of the features made here. Undoubtedly the arrangement between a leading American company and some producing companies over here, whereby the American company guarantees a release in the United States for first-class British productions, appears to be partly responsible for the producers' attempts to make films of high quality. The leading companies are spending from 50,000 to 80,000£ on a production, in order to produce material comparable with American feature productions, while fewer shorts are being made.

Technically, there has been considerable improvement in studio products due in part to improved lighting equipment, better use of incandescent lighting, more expert photography, general improvement in sound, more elaborate and better designed sets, and improved laboratory work.

Studio Expansion.—The majority of studios are working at full capacity, and some are increasing their facilities in order to fulfill the demands for studio space. Two new studios were built, one at Hammersmith for P.D.C. having two stages, and the other at Shepperton, while other studios are considering new buildings, and one is being converted for sound.

Most of the larger studios have now installed the latest type of camera cranes; and a new camera which is giving excellent results has been put on the market by the British firm of Messrs. Vinten, Ltd.

Back projection is now commonly used, although a satisfactory medium to take the place of the glass screen has not yet been found. Oiled paper, chemically treated linen, and cotton fabrics have been tried without much success.

Theater Progress.—In the main, 1933 has been a poor year for exhibitors, for, although business conditions generally have improved, this has been offset by the fact that during the year the weather was extraordinarily good, as a result of which people preferred other forms of entertainment. The smaller cinemas, in particular, are finding conditions difficult, one reason for which is the entertainment tax, which imposes a burden they find difficult to carry. In spite of this

the total seating capacity in this country is about the same, for fewer but larger cinemas have been built. Some 75 new theaters were erected, and the number in the course of construction at the moment is 83, with an average seating capacity of 1335.

There is little or no indication that the general public is tiring of talking pictures, but they are showing considerable discrimination in choosing films they wish to see and, because of the luxurious cinemas now being built, are becoming educated to a degree of comfort that hitherto they have not expected.

One of the problems that has to be met is that of over-seating; for, with the growth of the suburbs surrounding the larger towns, it is quite a common occurrence to find two or three cinemas with fairly large seating capacities catering to a population that is not large enough to patronize all the attractions offered. The Cinematograph Exhibitors' Association is concerned with this problem, and the general feeling is that the more modern theaters will gradually cause the small, independent, and out-of-date theaters to disappear.

B. Progress in the Motion Picture Industry in Japan

In looking at the activities and progress of the motion picture industry in Japan one must consider the local market for motion pictures. Simply to compare the progress made in production in Japan with that in the United States does not give the complete story. The price of admission to a "movie" in the cities of Japan begins at five sen and goes to thirty or forty sen; in the smaller towns five and ten sen are the usual prices. The average number of release prints is seven to ten to a picture. All this means that the cost of the average first-class picture must not exceed 30,000 or 35,000 yen. All cameras, printers, film, and even developing agents, must be imported and paid for in pounds, francs, marks, or dollars, all of which come high in yen. The waste in film can not be very high: 50 per cent of the negative footage is the average in first-class studios. This leaves very little room for retakes or attempts to improve by experiment. Nor does it leave much money for development work or for buying the latest equipment.

Thus, when sound came along it was hardly feasible for Japanese producers to buy equipment priced for United States consumption and with royalty payments required that were suited to a 200-400 print release per picture. As a result, development of sound in Japan was delayed, and attempts were made to develop sound ap-

paratus locally. Developments were naturally rather slow, and it was not until 1932 that any of this apparatus was in condition to be exploited. During 1932, Shochiku Studios produced several pictures in sound on equipment developed and assembled in their studios by the Tsuchichashi Bros. Also by 1932, both RCA Victor and Western Electric had brought in recording equipment. In 1932, Western Electric turned out one test picture.

In local parlance a sound picture is one with scored music or sound effects, whereas a "talkie" is a picture to which the sound is synchronized. During 1933 Shochiku produced "sound pictures" and "talkies" regularly in their two studios at Kamata and Kyoto, although the big percentage of their releases were still silent. Also, Western Electric signed up Nikkatsu as a licensee during 1933, and they proceeded to turn out one "talkie" a month, which is equivalent to one-fourth their total production. One or two equipments were bought from independent dealers in sound equipment in the United States, and several pictures were turned out on these. Besides, there have been a number of locally assembled equipments used for a few pictures by smaller independent studios.

There have been several sound stages built during 1932 and 1933, and more are under construction. The talkies are drawing the biggest share of the patronage and the industry will doubtless be forced to turn "all talkie" during 1934. At the end of 1933 a studio devoted to trick effects was established in Kyoto. This is the first of its kind. In the studios some attempts at process work have been made, but there has been little success to date, chiefly for lack of equipment. Two companies have been formed for the production of animated cartoons but there have not been many releases.

By the first of 1933 there were two independent laboratories equipped with continuous developing machinery and apparatus necessary for handling sound negative and positive. One of these has a sound stage, as well, and has produced several pictures. The bulk of the film, both negative and positive, is developed by rack and tank. During 1933, 431 pictures were made and released in Japan, of which 159 were sound pictures, including several shorts and newsreels. The end of 1934 will undoubtedly see the percentage of sound pictures much higher.

REFERENCES

¹ *Internat. Phot.*, 5 (Aug., 1933), p. 31.

² *Phot. Ind.*, 31 (March 8, 1933), p. 254; *Ibid.*, 31 (June 7, 1933).

- ³ *Phot. Korr.*, **69** (March, 1933), p. 41.
⁴ *Sci. Ind. Phot.*, **4** (June, 1933), p. 177.
⁵ *Bur. Stand. J. Research*, **10** (Feb., 1933), p. 211; *Ibid.*, **11** (Dec., 1933), p. 743.
⁶ *Kinophoto Inst.*, **1** (1932), p. 70; *Ibid.*, **1** (1932), p. 128; *Ibid.*, **2** (1933), p. 127.
 Also *Trans. Opt. Inst.*, Leningrad, **9** (1933), No. 88, p. 3.
⁷ U. S. Pats. 1,884,035; 1,923,495; Brit. Pat. 396,646.
⁸ U. S. Pat. 1,912,758.
⁹ U. S. Pat. 1,897,838.
¹⁰ U. S. Pat. 1,897,878; *Phot. Ind.*, **30** (Sept. 21, 1932), p. 955.
¹¹ U. S. Pat. 1,883,559; 1,883,562.
¹² Brit. Pat. 378,394; Ger. Pat. 565,378; Fr. Pat. 721,911.
¹³ *Am. Cinem.*, **13** (Sept., 1933), p. 174.
¹⁴ *Am. Cinem.*, **14** (May, 1933), p. 835.
¹⁵ *Int. Phot.*, **5** (May, 1933), p. 20.
¹⁶ *Brit. J. Phot.*, **80** (March 10, 1933), p. 125.
¹⁷ *Amer. Cinem.*, **13** (April, 1933), p. 18.
¹⁸ *Film für Alle*, **7** (March, 1933), p. 73.
¹⁹ U. S. Pats. Brit. Pats.
 1,882,530 359,474
 1,888,156 376,044
 1,892,162 377,036
 1,897,262 377,537
 1,897,896
 1,899,069
 1,899,934
 1,910,115
 1,910,492
 1,913,389
 1,921,918
 1,922,537
 1,924,527
²⁰ *Kinotechnik*, **15** (March, 1933), p. 75.
²¹ *Kinotechnik*, **15** (Oct., 1933), p. 307.
²² *Amer. Cinem.*, **13** (Sept., 1933), p. 166: Capt. F. M. Williams.
 Phot. Ind., **31** (Sept., 1933), p. 166: W. Dieterle.
 Photofreund, **12** (May 5, 1932), p. 161: A. Buchholz.
 Phot. Korr., **68** (Nov., 1932), p. 198: J. Plotnikow.
 Brit. J. Phot., **80** (Jan. 13, 1933), p. 15: B. Alfieri.
^{22^a} *Brit. J. Phot.*, **80** (Oct. 13, 1933), p. 611.
²³ *Amer. Cinem.*, **13** (Oct., Nov., and Dec., 1933).
²⁴ *Amer. Annual Phot.* **47** (1933), p. 242.
²⁵ *J. Soc. Mot. Pict. Eng.*, **XVIII** (May, 1932), No. 5, p. 655.
²⁶ *Inter. Phot.*, **5** (May-Dec., 1933).
²⁷ *Phys. Rev.*, (March, 1933).
²⁸ *Rev. Sci. Instr.*, **4** (Aug., 1933), No. 8, p. 449.
^{28^a} *Kinemat. Weekly*, **199** (Sept. 21, 1933), p. 3.
^{28^b} *Phot. Ind.*, **31** (1933), p. 926.
²⁹ Ger. Pat. 559,029.

- ³⁰ U. S. Pat. 1,918,623.
- ³¹ Fr. Pats. 708,330; 739,461; 738,353.
Ger. Pat. 558,365.
Brit. Pat. 393,901.
- ³² *Kinotechnik*, 14 (1933), p. 237.
- ³³ *Bull. Soc. Franc. Phot. Cinem.*, 3, p. 20; 75 (July, 1933), p. 151.
- ³⁴ *Kinotechnik*, 15 (1933), p. 85.
- ³⁵ *Kinotechnik*, 15 (1933), p. 348.
- ^{35a} *Brit. J. Color Supp.*, 28 (March 2, 1934), p. 12.
- ^{35b} *Home Movies and Home Talkies*, 2 (April, 1934), p. 433.
- ³⁶ *Filmtechnik*, (1933), pp. 127 and 240.
- ³⁷ *Kinotechnik*, 15 (1933), p. 34.
- ³⁸ *Kinotechnik*, 15 (1933), p. 333.
- ³⁹ *Filmtechnik*, (1933), p. 187; p. 241; p. 251; p. 304.
- ⁴⁰ *J. Soc. Mot. Pict. Eng.*, XXI (Sept., 1933), No. 3, p. 198.
- ⁴¹ *Amer. Cinem.*, 13 (Jan., 1933), p. 45.
- ⁴² *Internat. Proj.*, 6 (Dec., 1933), No. 3, pp. 12 and 24.
- ⁴³ *Kinemat. Weekly*, 194 (April 9, 1933), p. 42.
- ⁴⁴ *Phys. Rev.*, 43 (Feb., 1933), p. 205.
- ⁴⁵ *Kinotechnik*, 15 (Feb. 15, 1933), p. 45; 15 (March 20, 1933), p. 106.
- ⁴⁶ *Internat. Phot.*, 5 (May, 1933), p. 4.
- ⁴⁷ U. S. Pats.
- | | |
|-----------|-----------|
| 1,882,424 | 1,905,469 |
| 1,882,646 | 1,905,716 |
| 1,882,648 | 1,916,320 |
| 1,883,290 | 1,917,246 |
| 1,883,291 | 1,919,115 |
| 1,899,139 | 1,927,925 |
- Brit. Pat. 376,421,
- ⁴⁸ U. S. Pats. 1,918,788; 1,928,255; Brit. Pat. 346,851.
- ⁴⁹ *Amer. Cinem.*, 14 (Jan., 1934), p. 353; *Ibid.*, 14 (Aug., 1933), p. 134.
- ⁵⁰ *Home Movies and Home Talkies*, 2 (April, 1934), p. 423.
- ⁵¹ *J. Soc. Mot. Pict. Eng.*, XXI (July, 1933), No. 1, p. 21.
- ⁵² *J. Soc. Mot. Pict. Eng.*, XXI (Oct., 1933), No. 4, p. 294.
- ⁵³ *J. Soc. Mot. Pict. Eng.*, XXII (Jan., 1934), No. 1, p. 62.
- ⁵⁴ *Film Topics*, 9 (1933), No. 2, p. 1.

REPORT OF THE PROJECTION PRACTICE COMMITTEE*

There is much current activity within the industry looking toward the establishment of a new standard of reel length for multiple reel subjects (commonly termed feature pictures). Any change in reel length would directly affect three important branches of the industry—production, exchange practice, and, in particular, projection—and it was with this thought in mind that the Projection Practice Committee investigated thoroughly the proposed changes.

The standard that has been most favorably regarded to date outside the projection field would establish a reel length of 1700 feet maximum, and adopt as standard a reel length of 13½ inches outer diameter. The reasons advanced in support of this proposal are:

(1) It would eliminate the practice of "doubling," or joining present single reels, which in many instances involves extensive cutting both before and after projection, resulting in a serious loss of footage and in print mutilation;

(2) Fewer reels would be required for each feature, resulting in: (a) a reduction in the number of film leaders and tail pieces, (b) fewer change-overs, thus assuring a smoother show and less film damage, which is greatest at the beginnings and endings of reels.

In the opinion of this Committee the increase of reel footage to a maximum of 1700 feet (which probably would result in a minimum footage of 1500 feet, or less) is unsuitable for the general needs of the industry and undesirable from the standpoint of the practical projectionist. It is quite apparent, as will be demonstrated subsequently, that this proposal decidedly would neither eliminate the practice of "doubling," nor offer advantages of sufficient import to justify a change in the present reel length standard.

The outstanding claimed advantage of a 1700-foot reel length is the elimination of "doubling." Investigation by the Projection Practice Committee discloses the fact that no such result would ensue, for the following reason:

The standard projector magazine, used in all theaters, is 18 inches in diameter and has a film-carrying capacity of 3450 feet. The proposed new reel standard is based on a maximum length of 1700 feet

* Presented at the Spring, 1934, Meeting at Atlantic City, N. J.

of film, with the minimum length likely to approximate 1500 feet, or less. Obviously, even if the great majority of reel lengths should attain the maximum length of 1700 feet—and it is very unlikely that they would—it still would be possible to “double” two such reels and remain within the capacity of present standard magazines. Thus is vacated the major advantage claimed of the proposed new standard.

The Projection Practice Committee believes that if it be found desirable to establish a new standard of reel length, the maximum length should be fixed at 2000 feet, with the minimum length in no instance less than 1750 feet. Obviously, it would be impossible to “double” any two reels that conformed to this recommendation.

Another advantage claimed for the 1700-foot reel is the reduction in the number of reels necessary for mounting and shipping feature pictures, and in the number of change-overs required for projection—the latter reason being advanced in the interest of a smoother show than at present. Here again the weight of evidence favors the longer reel length, as may be seen from the following comparative table:

TABLE I

Comparison between Number of Reels for Features of Various Lengths, for Reel Lengths of 1700 and 2000 Feet.

Feature Length	Cutting Division	No. of Reels
6000 Feet	3 × 1700 plus 1 × 900	4
	3 × 2000	3
6500 Feet	3 × 1700 plus 1 × 1400	4
	3 × 1800 plus 1 × 1100	4
7000 Feet	4 × 1500 plus 1 × 1000	5
	3 × 1900 plus 1 × 1300	4
8000 Feet	5 × 1600	5
	4 × 2000	4
9000 Feet	5 × 1600 plus 1 × 1000	6
	4 × 1900 plus 1 × 1400	5
12,000 Feet (Special)	7 × 1600 plus 1 × 800	8
	6 × 2000	6

The conclusions to be drawn from Table I, in every instance representing the most advantageous basis for each standard, are as follows:

- (a) In no case are more 2000-foot reels required than 1700-foot reels.
- (b) In the majority of cases fewer 2000-foot reels are required than 1700-foot reels.
- (c) Flexibility in cutting point is pronounced in favor of 2000-foot reels.

(d) Advantages of the 2000-foot reels on longer features are particularly outstanding.

The following additional reasons are offered by this Committee in support of its recommendation for the longer, or 2000-foot, length, as against the 1700-foot length:

(1) Present standard reels, retained by the theater, are 15 inches in diameter and will accommodate 2300 feet of film.

(2) Present standard rewinders will accommodate the 15-inch reel.

(3) Present standard projector magazines and take-ups will require no change.

(4) None of these equipment items will occasion any additional expense to theaters.

It is apparent that, over-all, the recommendations of this Committee in favor of the longer reel length would: (1) be advantageous in shipping and handling film, (2) reduce the number of change-overs, (3) reduce the number of film leaders and tail pieces required, and (4) reduce the amount of film wear. Briefly stated, the longer, or 2000-foot, reel length retains and even exceeds the advantages expected to be realized through the adoption of the 1700-foot length, without being subject to any of the latter's disadvantages.

The opinion of this Committee relative to a change in the present reel length standard may be summarized as follows:

(1) The Committee is not opposed to the present standard of 1000-foot reel length, if the exchanges and the theaters regard this length as a practical solution of the film reel problem.

(2) The Committee emphatically is opposed to the proposed standard of a 1700-foot maximum reel length, which, for the reasons previously cited, it does not regard as an appropriate solution to the problem.

(3) If at any time in the future reel lengths exceeding 1000 feet are to be used, the Committee expresses its preference for, and endorsement of, the 2000-foot maximum and 1750-foot minimum lengths.

STANDARD TEST REEL

The S. M. P. E. Standard Test Reel prepared by the Projection Practice Committee in coöperation with RCA-Victor Company is now available for general distribution. This reel, described in detail in the JOURNAL,¹ has been brought to the attention of the industry through the kind coöperation of Society members and industry trade publications, for which aid the Committee expresses its appreciation.

The response to the announcement of the availability of this reel has been gratifying, with reports from studios, theaters, and individuals indicating general satisfaction concerning its use. The Com-

mittee invites comment and suggestions relative to the content and applicability of the reel, particularly with respect to any possible improvement.

PROJECTION ROOM PRACTICE AND MAINTENANCE ROUTINE

Work has been initiated and is progressing satisfactorily on a valuable compendium of projection room practice and maintenance. Participation in this work is not limited to Committee members, and all contributions of data or suggestions will be appreciated.

NEW ARC TYPES

The Committee is engaged at present in an intensive study of new projection arc types, including the new a-c. arc. Papers embodying the results of this work will, it is hoped, be ready in the near future for presentation to the Society through the JOURNAL.

H. RUBIN, *Chairman*

J. O. BAKER

E. R. GEIB

R. H. McCULLOUGH

T. C. BARROWS

S. GLAUBER

P. A. McGUIRE

G. C. EDWARDS

C. GREENE

R. MIEHLING

J. K. ELDERKIN

H. GRIFFIN

F. H. RICHARDSON

J. J. FINN

J. J. HOPKINS

V. A. WELMAN

W. C. KUNZMANN

REFERENCES

¹ Report of the Projection Practice Committee, *J. Soc. Mot. Pict. Eng.*, **XXI** (Aug., 1933), No. 2, p. 89.

Standard S. M. P. E. Visual and Sound Test Reels, *J. Soc. Mot. Pict. Eng.*, **XXII** (March, 1934), No. 3, p. 173.

DISCUSSION

MR. FINN: Some members may have gathered the impression that the Projection Practice Committee has definitely committed itself to the a-c. arc or other arc types. That is not so; the Chairman of the Committee wishes to emphasize the fact that the Projection Practice Committee has not yet rendered any report on any new arcs.

MR. FAULKNER: The rewind that is used in exchanges measures about $15\frac{1}{4}$ inches from the spindle to the table. The 15-inch reel allows about $\frac{1}{4}$ inch clearance. It would be possible to mount the rewind $\frac{1}{4}$ or $\frac{1}{2}$ inch higher, on a block for the necessary clearance, but there would still be the gear ratio of 4 to 1 in the drive. The inspectress turns the handle of the rewind once, and the reel revolves four times. With 2000 feet of film on the take-up reel, or say, 1500 feet on the take-up reel and 500 on the feed reel, in order to detect the damaged places on the film she must exert so much pressure with her hand that the drag on the film

becomes too great for her to turn the take-up with her right hand. Regardless of the size or the height of the rewind, the gear ratio is too great. Besides, the latter footage of the reel would be travelling so fast that she would not be able to detect the damage no matter how hard she tried.

MR. QUINN: Film should not be examined at such a speed. That is, to examine film properly (which is not the way it is done at the present time) the girl should stop at each splice, look at it, and see whether it has been made properly, and see whether the cement on the splice is holding. Allowing ten minutes for examining each 1000 feet of film, there should be no danger of her cutting her hand on any kind of reel that she might use, and the gear ratio of the rewind would not enter into consideration.

MR. FAULKNER: The film is always inspected from the tail of the reel to the head, so that when the inspection is finished, the head of the reel is out; therefore, the most important part of the film to be in good condition is the first 50 or 100 feet. If 1500 to 2000 feet of film have been taken up on the right-hand reel, starting with the tail of the reel, and 150, 100, or 50 feet remain on the left-hand reel, even though the speed of inspection is reduced considerably, the latter footage of the reel will be travelling too fast.

The human factor must be considered. If everything were done as it should be we probably shouldn't need these discussions. The average distributing company has from 250 to 300 inspectors who run the film through faster than they should. Again, in many instances much more work is demanded of them than they can properly do. If the exchange manager wants 50 reels a day, on the average, the inspectors must inspect that number; some exchanges 55, some 60. Whether that is right or wrong is their problem.

MR. QUINN: To provide new rewinds, changing the gear ratio to 3 to 1, or 1 to 1, would cost only \$3 at the most, if bought in quantity. The largest major company, Metro, for instance, has not more than 300 throughout the country. The rewinds would cost only \$900; and they would not all have to be purchased at one time.

MR. FAULKNER: Each inspector has two rewinds. That would be 600.

MR. QUINN: Six hundred rewinds would not be very costly, in comparison with the good that would result from a 2000-ft. reel for the theater patrons; and after all, they are the ones who pay all our salaries and enable the industry to continue and prosper, yet they are the ones who are not considered.

MR. FAULKNER: The rewind represents only a small item among the many presented.

MR. ROBIN: What consideration has been given to the load on the lamp, the carbon waste, the load on the rectifier or generating apparatus, in connection with the change in the reel length?

MR. RUBIN: If the industry demands a change, if a change is necessary from the point of view of economy, as has been brought out, the Projection Practice Committee feels that the lamps, the rectifiers, the generators, and carbons will accommodate the 2000- as well as the 1000-ft. length. At the present time I do not know of any lamp that will not burn twenty minutes. I do not know of any generator or any rectifier that will not withstand twenty minutes of burning. Regarding the carbon waste, if such a standard is adopted, I am sure that the carbon companies will make their carbons conform to that standard.

MR. GRIFFIN: All this controversy about the length of reels and the change in dimension of the reel came about through the fact that it is common practice throughout the country to double reels today. If that is true and doubling reels is common practice, the question raised by Mr. Robin can not enter into it. The equipment now is running for twenty or twenty-two minutes, and is standing up under the load.

MR. QUINN: More than 90 per cent of the projectionists double the reels and run satisfactory shows. The National Carbon Company recently lengthened the 13.6-mm. carbon from 20 to 22 inches, because of the fact that with double reels there was a waste of 2 inches. By adding 2 inches more it became possible to project an additional reel with each carbon.

MR. CRABTREE: What is the real objection to the 1000-ft. reel? Is it that the projectionists waste too much film in splicing?

MR. EDWARDS: Many reels are 400 feet or shorter. Now, while 400 feet of film is running it is obviously difficult, sometimes impossible, to retrim, rethread, and rewind; and those things have to be done right away. There are many theaters throughout the country in which there is only one projectionist, and he is kept extremely busy trying to keep the show running on 1000-ft. reels. The trouble is that there are rarely 1000 feet of film on a reel; we can put on the show all right with 700 feet; but with less there is difficulty.

Another reason for doubling up is to provide a smoother performance. When you consider the length of time that the change-over dots appear on the screen, that is, the start-machine and the change-over dots, you only have to wink an eye, and they will be missed. There is always the possibility of a blank, which we always want to avoid. The 2000-ft. reel would reduce by 50 per cent the possibility of such errors.

MR. CRABTREE: I am not objecting to the 2000 feet. Sometimes the projectionist receives 1000-ft. reels and splices them up into 2000-ft. reels. What is the difference between his doing that and the exchange's supplying him with 2000-ft. reels? Is it merely the time involved in splicing the reels and breaking them down when he returns them to the exchange? Does he spoil a lot of film in the process or does he not have sufficient time between receiving the film and putting it on the screen to do it properly?

MR. EDWARDS: The objection to doubling is that every time that a cut is made, four frames are lost from every two reels—two frames per reel—that is, if the projectionist is careful. Unfortunately, the human factor enters, and some are not as careful as others. We are trying to evolve a scheme by which the man who has to project a film after 30 or 40 showings in different theaters will not lack the closing scenes entirely.

MR. CRABTREE: How long is it before the film goes back to the exchange? Does it go through several theaters before it is returned to the exchange?

MR. EDWARDS: Sometimes; sometimes there is a change every day.

MR. CRABTREE: Why doesn't the exchange repair the damage?

MR. EDWARDS: I can not answer that question.

MR. HOLLANDER: It must be remembered that the several systems, such as the RCA and the Western Electric, operate at different speeds, pick-ups, starting points, and change-overs. To join part one to part two, and to cut two frames off, as Mr. Edwards said, will cause the loss of the change-over dots, which are

only 15 frames from the end of the reel; and it takes only 7 theaters to cut off the change-over mark. The eighth projectionist who gets the print then makes his own change-over marks. He has a three-ft. pick-up; so he makes a 13-ft. mark instead of leaving the 10-ft. mark. If the film contained 2000 ft., and had a standard leader and a standard change-over, cutting the film would not be necessary.

MR. CRABTREE: But why do the exchanges allow the film to be clipped by seven persons before it is returned to them?

MR. HOLLANDER: They can't prevent it.

MR. FAULKNER: The change-over does not, of course, bother the projectionists in the first-run houses. But by the time the film arrives at houses 30 to 60 days later, the change-over cues are of little value. Each projectionist removes the head and tail pieces of the particular reels he wishes to double.

Now, if a print goes out in seven reels, depending upon the program, one man might double a newsreel and reel No. 1. At the next theater the projectionist might double reel No. 1 and reel No. 2. Due to machine pick-ups, each projectionist makes his own change-over cues, and it often happens that in doubling reels he might wish to put a reel and a half on one reel and a reel and a half on the next. Then the cut occurs at the middle of the reel, and in order to change over, the projectionist would have to place his cue marks at that point.

It is not a matter of what the exchange can do about it, nor is it the fault of the projectionist. Any condition under which the exchange handles its units in one length and the theaters in another is quite absurd.

MR. RUBIN: Doubling reels was practiced in the days of the silent picture, when the standard length was 2000 feet. At the introduction of sound we had disks. The industry had to standardize on 1000-ft. reels as the disks were made to conform to only 1000 feet of film. Then came sound-on-film. The projectionist returned to his old length of 2000 feet, despite the fact that the standard for the change-over marks was 1000 feet.

It is my understanding the producers or distributors feel that if the projectionist wants 2000 feet on the reel, and is determined to double, why not send out 2000-ft. reels, for the reasons stated by Mr. Edwards. However, the producers recommend rather a 1700-ft. reel, which means that on the average a theater will find it to be anywhere from 1200 feet to 1700 feet, and in most cases it will be 1200 feet.

To cite an example: *Bottoms Up*, a recent picture, contained 7400 feet on 10 reels—you would not get 1700 feet, but much less. The reels are now averaging 700 feet or less. If the standard is made 1700 feet the purpose of the new standard will be defeated because the projectionist is supplied with equipment that will still permit doubling. For that reason the Committee recommended that if a change is to be made, it should be to 2000 feet, with a minimum of 1750, and thus prevent doubling with his present equipment.

REPORT OF THE SUB-COMMITTEE ON EXCHANGE PRACTICE*

The problem of recommending a design for a metal reel for mounting and maintaining release prints that might be standardized for use in the exchanges and would be acceptable to the projectionist for use in projection machines has been before the Committee. With the coöperation of representatives of the exchange operation departments of the various distributing companies and members of the Projection Practice Committee, the matter of footage capacity of the reel was given the greatest consideration.

The 1000-ft. reel, for which the present laboratory and exchange machines are geared, was compared with reels having greater footage capacity, as follows:

ADVANTAGES OF REEL CAPACITY GREATER THAN 1000 FEET

(1) *Saving of Film because of Fewer Change-Overs.*—The average print of seven reels mounted in 1000-ft. units necessitates "head and end" titles 8 feet long on each end of the reel, plus a change-over footage of 16 feet on each end, totalling 24 feet of film. To mount the print on reels having a capacity of 2000 feet, three such change-overs and 48 feet of film would be eliminated, or 144 feet of film to each print of seven reels. Based on an estimate of 500 releases by all companies annually, and 175 prints of each release, the footage saved would amount to 12,600,000 feet; or, on an estimated laboratory charge of 1½ cents per foot, \$189,000.

(2) *Prevention of Doubling of Reels by the Projectionist.*—A print edited and cut to 2000-ft. lengths would prevent the projectionist from doubling the reels, as the capacity of the projector magazines is not sufficient to accommodate the footage of two reels of film of that length.

(3) *Cost of Shipments.*—The possible reduction of the cost of shipping was discussed, but it was generally agreed that the total weight of a shipment comprising four 2000-ft. reels of film would be as great as one of seven reels of 1000-ft. capacity.

* Presented at the Spring, 1934, Meeting at Atlantic City, N. J.

Any capacity between 1000 feet and 2000 feet was unanimously disapproved, as a reel of 1500 feet or 1700 feet, as has been suggested at various times, would still offer the opportunity of doubling, as the projector magazine has a capacity of 3500 feet.

DISADVANTAGES OF REEL CAPACITIES GREATER THAN 1000 FEET

(1) Short subjects of 1000 feet or less would either have to be mounted on large reels, or two sizes of reels and shipping cases be maintained for use in the exchange. It is estimated that more than 50 per cent of the number of shipments made by all exchanges are individual shipments of 1000-ft. lengths or under.

(2) *Cost of Adapting Exchanges and Equipment for 2000-Ft. Reels.*—

(a) *Vault Racks.*—Few film vault racks could accommodate shipping cases of the size required to store a 2000-ft. reel without expensive alterations.

(b) *Cost of Reels.*—Present reels of 1000-ft. capacity cost in the neighborhood of 12 cents each. A satisfactory 2000-ft. reel could probably be furnished, in quantity production, for 50 cents each. The 1000-ft. reels now in use would be discarded when final disposition of the film mounted on them was made.

(c) *Shipping Cases.*—No noticeable difference in the cost of shipping cases is in favor or against 2000-ft. capacity. The saving in units about compensates for the cost of the additional strengthening required because of less compactness. The 1000-ft. shipping cases, discarded when the film they now hold is junked, would be a total loss.

(d) *Rewinds.*—Present rewinds for 1000-ft. reels would be inadequate for use with 2000-ft. reels as they are not sufficiently high for the larger reel. The gear ratio of 4 to 1 is too great to make it an easily operated unit for the average inspectress.

(e) *Film Bands.*—New film bands would have to be provided for the 2000-ft. reels. The only cost involved would be in discarding any stock of 1000-ft. bands on hand.

(f) *Vault Containers.*—Those companies using *I.C.C.* shipping cases for vault containers would not be affected; but where laboratory tins are used for vault containers for 1000-ft. reels, the adoption of the 2000-ft. reels would require purchasing new or larger containers.

(3) *Inspection of Films.*—The use of 2000-ft. reels would present greater hazards, as regards injuring the inspectresses because of the

greater weight. The outer rim of the metal reel would be travelling at a much greater speed when rewinding the latter footage of the reel and would, therefore, be harder to stop.

Due to the higher rate of film travel, when inspecting the latter footage of the 2000-ft. reel, and remembering that the damaged parts are located by touch, it would be necessary that closer supervision be given to inspection to reduce the possibility of damaged portions of the film passing through the inspectors' fingers unnoticed.

(4) *Film Damage*.—A large proportion of film damage occurs in the projector. When such damage begins, usually the portion of the reel that follows is likewise damaged. The projectionist is not always aware that the damage is being done, and often when he is aware of it he can not afford to interrupt the show and, consequently, will not stop his machine. Where 2000-ft. reels are used, the damage done to the film throughout the remaining footage may be increased considerably if the damage begins somewhere in the first 1000 feet.

Regardless of the size or capacity of the reel, the projectionist usually has his own personal 12 or 15 reels bought at a price far in excess of what the exchange can afford to pay for them. Because of the projectionist's confidence in the condition of his own reels, and his lack of confidence in the exchange's reels, the usual practice is to use the projection room reels regardless of the type or condition of the exchange reel. Therefore, the size or type or condition of the exchange reel has meaning only for the exchanges (inspection and shipping), except when lack of time makes it necessary for the projectionist to run his first show "from the can."

This practice in projection restricts the question of metal reels solely to exchange operation, but the matter of footage is of importance to both projectionists and exchanges. The industry operates with the idea of delivering to its customers, through the medium of the screen, the ultimate in beautiful photography and continuity of sound and action. Therefore, the matter of reel footage is of more immediate concern to all of us than is the question of metal reels.

From the view-point of what is best for the exchange, the latter would prefer the present 1000-ft. reels. But the projectionist has his rights in the matter; and after all, he is the medium through which the industry's efforts are delivered. For instance, one of the most popular releases of the past season was delivered to the projection room mounted on 14 reels—14 thread-ups and 13 change-overs. The total footage of the subject was such that the pro-

jectionist could mount it on four large reels. Due to the doubling of reels in the theaters during the early runs of the subject and their consequent mutilation, when they finally reached the one- and two-day theaters a series of change-over cues was scattered throughout, and so much footage lost at the original beginnings and ends of the reels that the screen result was anything but favorable. This, then, makes film footage of reels an item for exchange practice consideration.

One of two things should be done. Either the projectionist should use the present 1000-ft. lengths in projection and not double the reels, or the film should be served to the theaters in lengths that will provide the best screen results, not only for the first-run theaters but for subsequent-run theaters, as well.

To change over the studio editing and cutting departments so as to enable them to supply film to the exchanges in 2000-ft. lengths would:

(1) Benefit the industry by saving an estimated footage of 12,600,000 feet annually.

(2) Eliminate the doubling of reels in projection, thus avoiding the consequent damage and loss of footage.

To offset these benefits:

(1) A different size of reel and shipping case would be required to handle subjects of 1000 feet or under.

(2) Alterations in the vault racks would be required to accommodate the larger storage can or shipping case.

(3) The cost of reels for mounting new prints would be increased.

(4) The loss of reels and shipping cases discarded when the 1000-ft. units are retired would be entailed.

(5) New vault containers would have to be purchased.

(6) New rewinds would have to be purchased.

(7) The danger of personal injury to the inspectresses would be increased.

(8) The efficiency of the inspectresses would be reduced.

At this time, it is the belief of the Committee that the 1000-ft. reel now used in exchange practice is best suited for present exchange routines, as any metal reels furnished by the exchanges are rarely used by the projectionists.

The economics of standardizing on the length of 2000 feet, or twice the footage of the present average reel, should be studied in all its phases. The efforts of the exchanges to maintain their prints properly and the efforts of the projectionists to screen their pictures

properly are apparently in opposition, each undoing what the other has done. If a cure for this condition exists it lies with the 2000-ft. reel, and not with the 1700-ft. reel with an average film footage on it of 1400 or 1500 feet, or any size reel that would permit doubling.

T. FAULKNER, *Chairman*

A. S. DICKINSON

J. S. MACLEOD

H. RUBIN

G. C. EDWARDS

N. F. OAKLEY

J. H. SPRAY

A. HIATT

L. L. STEELE

(This report was discussed jointly with that of the Projection Practice Committee, at the Spring, 1934, Meeting. The reader is therefore referred to p. 382 of this issue of the JOURNAL.)

SOCIETY ANNOUNCEMENTS

ATLANTIC COAST SECTION

The regular monthly meeting, held in the *Salle Moderne* of the Hotel Pennsylvania, New York, on May 23rd, was attended by approximately 140 members and guests. Prior to the meeting, about 30 of the members met at an informal dinner in the Café of the hotel. It is planned next season to make this dinner preceding the meeting, to which all members and friends of the Section are cordially invited, a regular feature of the monthly meetings of the Section.

The principal speaker of the evening was Mr. J. A. Norling, who presented a paper on "Methods of Process and Trick Cinematography," illustrated by a reel portraying many of the various fades, turn-overs, wipe-outs, *etc.*, used in animation and trick work.

Following Mr. Norling's presentation, Mr. H. R. Kossman presented a reel of trick shots made in France and printed on a new Debie automatic trick printer.

Further illustrations of animation and trick photography were illustrated in *Brave Tin Soldier* and *Jack and the Beanstalk*, colored cartoons supplied through the courtesy of Liberty Productions, Inc., and *Popeye the Sailor*, by Paramount Pictures Dist. Corp.

The Section expresses its appreciation to Messrs. Griffin, Heidegger, and Knapp, of the International Projector Corp., for installing the projection equipment; and to the Raven Screen Corp. for presenting to the Society the screen used at the meeting.

MID-WEST SECTION

The regular monthly meeting of the Section was held on May 17th in Eckhart Hall, University of Chicago. Professor H. B. Lemon presented an interesting paper on "The Use of Sound Motion Pictures in Educational Work." Two new reels of sound pictures selected from the Physics Lectures of the University were presented: *Sound Waves and Their Sources* and *Fundamentals of Acoustics*. The meeting was well attended, and an interesting discussion followed.

PACIFIC COAST SECTION

The regular monthly meeting of the Section was held on May 22nd, at the Don Lee Building, Hollywood, the subject being "Radio Television of Motion Pictures."

Starting at 8:00 P.M., the members were conducted on a tour of inspection, in groups, through the Don Lee studios and television transmitting stations *W6XS* and *W6XAO*, in operation.

Convening again at 8:30 P.M., Mr. Harry R. Lubeke, director of television of the Don Lee Broadcasting System, described the equipment and commented on the relation of television to the motion picture art. The meeting terminated with a lively open-forum discussion of the subject by the members.

NOMINATIONS OF OFFICERS FOR 1935

On or about June 1st, the customary ballots will be mailed to the Honorary, Fellow, and Active members for nominations for officers of the Society for 1935. The Officers and Governors whose terms expire December 31, 1934, are as follows:

- *President: Alfred N. Goldsmith
- *Executive Vice-President: Harold C. Silent
- Editorial Vice-President: John I. Crabtree
- Convention Vice-President: William C. Kunzmann
- *Secretary: John H. Kurlander
- *Treasurer: Timothy E. Shea
- Governor: Herford T. Cowling
- Governor: Ralph E. Farnham

(Asterisks indicate one-year terms; the remainder two-year terms.)

At the next meeting of the Board of Governors, July 16th, the nominations returned by the members will be used in constructing the voting ballot to be mailed to the voting members about September 19th. The ballots will be counted at the Fall Convention, to be held in the Hotel Pennsylvania at New York, October 29th–November 1st, and the results will be announced. The newly elected officers will assume their duties January 1, 1935.

AUTHOR INDEX, VOLUME XXII

JANUARY TO JUNE, 1934

<i>Author</i>		<i>Issue Page</i>
ADAIR, S. E. (and JENKINS, J. E.)	The Control Frequency Principle	Mar. 193
BAKER, G. W. (and SMITH, M. A.)	Some Practical Applications of Acoustics in Theaters	Feb. 148
BAKER, J. O.	Sixteen-Mm. Sound-on-Film	Feb. 139
BARTON, F. C.	High-Fidelity Lateral-Cut Disk Records	Mar. 179
BEGGS, E. W.	The Economics of Projector Lamps for Advertising Purposes	Feb. 127
BOWDITCH, F. T. (and JOY, D. B., and DOWNES, A. C.)	A New White Flame Carbon for Photo- graphic Light	Jan. 58
BRANDES, H. (and SCHMIDT, R.)	Two New Photographic Recording In- struments, the Sensitograph and the Gammagraph	May 279
CHORINE, A. F.	Equipment for Recording and Reproduc- ing Sound with Photofilm	Mar. 157 Apr. 215
CRABTREE, J.	Sound Film Printing—II	Feb. 98
CRESS, H. W. (and RAY, R. H.)	Color for Industrial and Business Films	Feb. 144
DOWNES, A. C. (and JOY, D. B.)	Direct-Current High-Intensity Arcs with Non-Rotating Positive Carbons	Jan. 42
DOWNES, A. C. (and JOY, D. B., and BOWDITCH, F. T.)	A New White Flame Carbon for Photo- graphic Light	Jan. 58
DUBRAY, J. A.	The Rotambulator—A New Motion Picture Camera Stand	Mar. 200
ENGSTROM, E. W.	A Study of Television Image Character- istics	May 290
FLETCHER, H.	Transmission and Reproduction of Speech and Music in Auditory Perspective	May 314
GRIFFIN, H.	Sprocket Dimensions for 35-Mm. Visual and Sound Projection Equipment	Jan. 20 Jan. 70
GRIFFIN, H.	A New 35-Mm. Portable Sound Projector	
GRIMWOOD, W. K. (and SANDVIK, O., and HALL, V. C.)	Further Investigation of Ground Noise in Photographic Sound Records	Feb. 83
HALL, V. C. (and SANDVIK, O., and GRIMWOOD, W. K.)	Further Investigation of Ground Noise in Photographic Sound Records	Feb. 83

<i>Author</i>		<i>Issue Page</i>
HOPPER, F. L.	Wide-Range Recording	Apr. 253
HOWELL, A. S. (and MITCHELL, R. F.)	Recent Improvements in the Bell & Howell Fully Automatic Printer	Feb. 115
JENKINS, J. E. (and ADAIR, S. E.)	The Control Frequency Principle	Mar. 193
JOY, D. B. (and DOWNES, A. C.)	Direct-Current High-Intensity Arcs with Non-Rotating Positive Carbons	Jan. 42
JOY, D. B. (and BOWDITCH, F. T., and DOWNES, A. C.)	A New White Flame Carbon for Photo- graphic Light	Jan. 58
LEMON, H. B.	The Use of the Talking Picture as an Additional Educational Tool at the University of Chicago	Jan. 62
MITCHELL, R. F. (and HOWELL, A. S.)	Recent Improvements in the Bell & Howell Fully Automatic Printer	Feb. 115
MOLE, P.	A New Development in Carbon Arc Lighting	Jan. 51
PRITCHARD, A.	An Automatic Change-Over Device	Mar. 186
RAY, R. H. (and CRESS, H. W.)	Color for Industrial and Business Films	Feb. 144
ROTH, G. E.	The "Selenophon" Sound Recording and Reproducing System	Apr. 260
SANDVIK, O. (and HALL, V. C., and GRIMWOOD, W. K.)	Further Investigation of Ground Noise in Photographic Sound Records	Feb. 83
SCHMIDT, R. (and BRANDES, H.)	Two New Photographic Recording In- struments, the Sensitograph and the Gammagraph	May 279
SMITH, M. A. (and BAKER, G. W.)	Some Practical Applications of Acoustics in Theaters	Feb. 148
WOLF, S. K.	Acoustical Requirements for Wide-Range Reproduction of Sound	Apr. 242

CLASSIFIED INDEX, VOLUME XXII

JANUARY TO JUNE, 1934

Acoustics

Some Practical Applications of Acoustics in Theaters, G. W. Baker and M. A. Smith, No. 2 (Feb.), p. 148.

Acoustical Requirements for Wide-Range Reproduction of Sound, S. K. Wolf, No. 4 (April), p. 242.

Advertising Equipment

The Economics of Projector Lamps for Advertising Purposes, E. W. Beggs, No. 2 (Feb.), p. 127.

The Control Frequency Principle, J. E. Jenkins and S. E. Adair, No. 3 (March), p. 193.

Apparatus

A New Development in Carbon Arc Lighting, P. Mole, No. 1 (Jan.), p. 51.

Recent Improvements in the Bell & Howell Fully Automatic Printer, A. S. Howell and R. F. Mitchell, No. 2 (Feb.), p. 115.

Standard S. M. P. E. Visual and Sound Test Reels, No. 3 (March), p. 173.

An Automatic Change-Over Device, A. Pritchard, No. 3 (March), p. 186.

The Rotambulator—A New Motion Picture Camera Stand, J. A. Dubray, No. 3 (March), p. 200.

A New 35-Mm. Portable Sound Projector, H. Griffin, No. 1 (Jan.), p. 70.

Two New Photographic Recording Instruments, the Sensitograph and the Gammagraph, H. Brandes and R. Schmidt, No. 5 (May), p. 279.

Arcs, Projection

Direct-Current High-Intensity Arcs with Non-Rotating Positive Carbons, D. B. Joy and A. C. Downes, No. 1 (Jan.), p. 42.

Auditory Perspective

Transmission and Reproduction of Speech and Music in Auditory Perspective, H. Fletcher, No. 5 (May), p. 314.

Change-Overs

An Automatic Change-Over Device, A. Pritchard, No. 3 (March), p. 186.

Color Cinematography

Color for Industrial and Business Films, R. H. Ray and H. W. Cress, No. 2 (Feb.), p. 144.

Committee Reports

Report of the Committee on Laboratory and Exchange Practice, No. 1 (Jan.), p. 3; No. 5 (May), p. 332.

Report of the Sub-Committee on Exchange Practice, No. 6 (June), p. 386.

Report of the Projection Practice Committee, No. 1 (Jan.), p. 11; No. 2 (Feb.), p. 153; No. 3 (March), p. 212; No. 5 (May), p. 332; No. 6 (June), p. 379.

Report of the Historical and Museum Committee, No. 1 (Jan.), p. 13.

Report of the Committee on Standards and Nomenclature, No. 1 (Jan.), p. 17; No. 1 (Jan.), p. 79; No. 5 (May), p. 333.

Progress in the Motion Picture Industry: Report of the Progress Committee, No. 6 (June), p. 341.

Membership Committee, No. 5 (May), p. 333.

Disk Recording

High-Fidelity Lateral-Cut Disk Records, F. C. Barton, No. 3 (March), p. 179.

Educational Cinematography

The Use of the Talking Picture as an Additional Educational Tool at the University of Chicago, H. B. Lemon, No. 1 (Jan.), p. 62.

Exchange Practice

Report of the Committee on Laboratory and Exchange Practice, No. 1 (Jan.), p. 3; No. 6 (June), p. 386.

Gammagraph

Two New Photographic Recording Instruments, the Sensitograph and the Gammagraph, H. Brandes and R. Schmidt, No. 5 (May), p. 279.

General

The Use of the Talking Picture as an Additional Educational Tool at the University of Chicago, H. B. Lemon, No. 1 (Jan.), p. 62.

The Economics of Projector Lamps for Advertising Purposes, E. W. Beggs, No. 2 (Feb.), p. 127.

Equipment for Recording and Reproducing Sound with Photofilm, A. F. Chorine, No. 3 (March), p. 157; No. 4 (April), p. 215.

The Control Frequency Principle, J. E. Jenkins and S. E. Adair, No. 3 (March), p. 193.

Transmission and Reproduction of Speech and Music in Auditory Perspective, H. Fletcher, No. 5 (May), p. 314.

Ground Noise

Further Investigation of Ground Noise in Photographic Sound Records, O. Sandvik, V. C. Hall, and W. K. Grimwood, No. 2 (Feb.), p. 83.

Historical

Report of the Historical and Museum Committee, No. 1 (Jan.), p. 13.

Illumination in Photography

A New Development in Carbon Arc Lighting, P. Mole, No. 1 (Jan.), p. 51.

A New White Flame Carbon for Photographic Light, D. B. Joy, F. T. Bowditch, and A. C. Downes, No. 1 (Jan.), p. 58.

Incandescent Lamps

The Economics of Projector Lamps for Advertising Purposes, E. W. Beggs, No. 2 (Feb.), p. 127.

Index

Author Index, Vol. XXII, Jan. to June, 1934; No. 6 (June), p. 393.

Classified Index, Vol. XXII, Jan. to June, 1934; No. 6 (June), p. 395.

Industrial Cinematography

Color for Industrial and Business Films, R. H. Ray and H. W. Cress, No. 2 (Feb.), p. 144.

Instruments, Measuring

Standard S. M. P. E. Visual and Sound Test Reels, No. 3 (March), p. 173.
Two New Photographic Recording Instruments, the Sensitograph and the Gammagraph, H. Brandes and R. Schmidt, No. 5 (May), p. 279.

Laboratory Practice

Report of the Committee on Laboratory and Exchange Practice, No. 1 (Jan.), p. 3.

Lamps

The Economics of Projector Lamps for Advertising Purposes, E. W. Beggs, No. 2 (Feb.), p. 127.

Lighting

A New Development in Carbon Arc Lighting, P. Mole, No. 1 (Jan.), p. 51.
A New White Flame Carbon for Photographic Light, D. B. Joy, F. T. Bowditch, and A. C. Downes, No. 1 (Jan.), p. 58.

Local Sections

Atlantic Coast Section, No. 1 (Jan.), p. 79; No. 2 (Feb.), p. 153; No. 3 (March), p. 212; No. 5 (May), p. 331; No. 6 (June), p. 391.
Mid-West Section, No. 1 (Jan.), p. 79; No. 2 (Feb.), p. 153; No. 4 (April), p. 271; No. 5 (May), p. 331; No. 6 (June), p. 391.
Pacific Coast Section, No. 1 (Jan.), p. 78; No. 4 (April), p. 271; No. 6 (June), p. 391.

Membership

Reclassification of S. M. P. E. Membership, No. 3 (March), p. 209.

Museum

Report of the Historical and Museum Committee, No. 1 (Jan.), p. 13.

Obituary

Peter A. Snell, No. 5 (May), p. 333.

Open Forum

Should Studio Recording Equipment Compensate for Theater Reproducing Characteristics? No. 3 (March), p. 183.

Organization of the Society

Functional and Administrative Organization of the S. M. P. E., No. 4 (April), p. 270.

Portable Equipment

A New 35-Mm. Portable Sound Projector, H. Griffin, No. 1 (Jan.), p. 70.
Sixteen-Millimeter Sound-on-Film, J. O. Baker, No. 2 (Feb.), p. 139.

Printing

Sound Film Printing—II, J. Crabtree, No. 2 (Feb.), p. 98.
Recent Improvements in the Bell & Howell Fully Automatic Printer, A. S. Howell and R. F. Mitchell, No. 2 (Feb.), p. 115.

Processing, Control of

Two New Photographic Recording Instruments, the Sensitograph and the Gammagraph, H. Brandes and R. Schmidt, No. 5 (May), p. 279.

Progress

Progress in the Motion Picture Industry: Report of the Progress Committee, No. 6 (June), p. 341.

Projection, General Information

Sprocket Dimensions for 35-Mm. Visual and Sound Projection Equipment, H. Griffin, No. 1 (Jan.), p. 20.

Direct-Current High-Intensity Arcs with Non-Rotating Positive Carbons, D. B. Joy and A. C. Downes, No. 1 (Jan.), p. 42.

A New 35-Mm. Portable Sound Projector, H. Griffin, No. 1 (Jan.), p. 70.

Report of the Projection Practice Committee, No. 1 (Jan.), p. 11; No. 6 (June), p. 379.

Standard S. M. P. E. Visual and Sound Test Reels, No. 3 (March), p. 173.

An Automatic Change-Over Device, A. Pritchard, No. 3 (March), p. 186.

Projection Practice

Report of the Projection Practice Committee, No. 1 (Jan.), p. 11; No. 6 (June), p. 379.

Standard S. M. P. E. Visual and Sound Test Reels, No. 3 (March), p. 173.

Selenophon

The "Selenophon" Sound Recording and Reproducing System, G. E. Roth, No. 4 (April), p. 260.

Sensitograph

Two New Photographic Recording Instruments, the Sensitograph and the Gammagraph, H. Brandes and R. Schmidt, No. 5 (May), p. 279.

Sixteen-Millimeter Equipment

Sixteen-Mm. Sound-on-Film, J. O. Baker, No. 2 (Feb.), p. 139.

Sound Recording

Further Investigation of Ground Noise in Photographic Sound Records, O. Sandvik, V. C. Hall, and W. K. Grimwood, No. 2 (Feb.), p. 83.

Equipment for Recording and Reproducing Sound with Photofilm, A. F. Chorine, No. 3 (March), p. 157; No. 4 (April), p. 215.

High-Fidelity Lateral-Cut Disk Records, F. C. Barton, No. 3 (March), p. 179.

Open Forum: Should Studio Recording Equipment Compensate for Theater Reproducing Characteristics? No. 3 (March), p. 183.

Wide-Range Recording, F. L. Hopper, No. 4 (April), p. 253.

The "Selenophon" Sound Recording and Reproducing System, G. E. Roth, No. 4 (April), p. 260.

Two New Photographic Recording Instruments, the Sensitograph and the Gammagraph, H. Brandes and R. Schmidt, No. 5 (May), p. 279.

Sound Reproduction

Equipment for Recording and Reproducing Sound with Photofilm, A. F. Chorine, No. 3 (March), p. 157; No. 4 (April), p. 215.

Open Forum: Should Studio Recording Equipment Compensate for Theater Reproducing Characteristics? No. 3 (March), p. 183.

Acoustical Requirements for Wide-Range Reproduction of Sound, S. K. Wolf, No. 4 (April), p. 242.

The "Selenophon" Sound Recording and Reproducing System, G. E. Roth, No. 4 (April), p. 260.

Transmission and Reproduction of Speech and Music in Auditory Perspective, H. Fletcher, No. 5 (May), p. 314.

Sprockets

Sprocket Dimensions for 35-Mm. Visual and Sound Projection Equipment, H. Griffin, No. 1 (Jan.), p. 20.

Standards

Report of the Committee on Standards and Nomenclature, No. 1 (Jan.), p. 17.

Sprocket Dimensions for 35-Mm. Visual and Sound Projection Equipment, H. Griffin, No. 1 (Jan.), p. 20.

Standard S. M. P. E. Visual and Sound Test Reels, No. 3 (March), p. 173.

Studio Equipment

A New Development in Carbon Arc Lighting, P. Mole, No. 1 (Jan.), p. 51.

A New White Flame Carbon for Photographic Light, D. B. Joy, F. T. Bowditch, and A. C. Downes, No. 1 (Jan.), p. 58.

The Rotambulator—A New Motion Picture Camera Stand, J. A. Dubray, No. 3 (March), p. 200.

Television

A Study of Television Image Characteristics, E. W. Engstrom, No. 5 (May), p. 290.

Test Reel

Standard S. M. P. E. Visual and Sound Test Reels, No. 3 (March), p. 173.

Theater Characteristics

Some Practical Applications of Acoustics in Theaters, G. W. Baker and M. A. Smith, No. 2 (Feb.), p. 148.

Open Forum: Should Studio Recording Equipment Compensate for Theater Reproducing Characteristics? No. 3 (March), p. 183.

Acoustical Requirements for Wide-Range Reproduction of Sound, S. K. Wolf, No. 4 (April), p. 242.

Transmission of Sound

Transmission and Reproduction of Speech and Music in Auditory Perspective, H. Fletcher, No. 5 (May), p. 314.

STANDARD S. M. P. E.
VISUAL AND SOUND TEST REELS

Prepared under the Supervision
OF THE
PROJECTION PRACTICE COMMITTEE
OF THE
SOCIETY OF MOTION PICTURE ENGINEERS



Two reels, each approximately 500 feet long, of specially prepared film, designed to be used as a precision instrument in theaters, review rooms, exchanges, laboratories, and the like for testing the performance of projectors. The visual section includes special targets with the aid of which travel-ghost, lens aberration, definition, and film weave may be detected and corrected. The sound section includes recordings of various kinds of music and voice, in addition to constant frequency, constant amplitude recordings which may be used for testing the quality of reproduction, the frequency range of the reproducer, the presence of flutter and 60-cycle or 96-cycle modulation, and the adjustment of the sound track. Reels sold complete only (no short sections).

PRICE \$37.50 FOR EACH SECTION,
INCLUDING INSTRUCTIONS

(Shipped to any point in the United States)

Address the

SOCIETY OF MOTION PICTURE ENGINEERS
HOTEL PENNSYLVANIA
NEW YORK, N. Y.

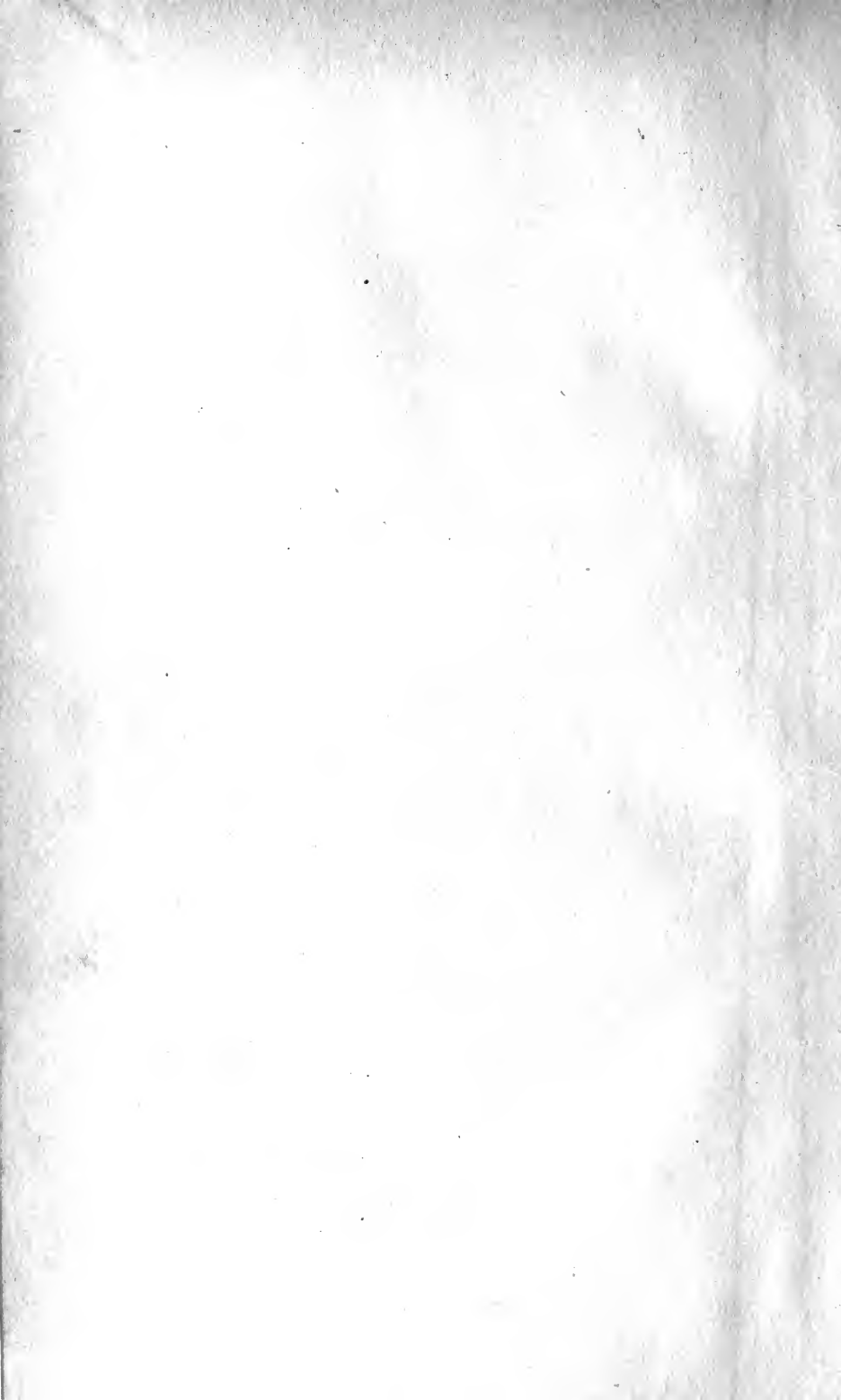





BRABANDT & VALTERS
BOUND
SEP 5 1934
CHICAGO, ILL.

