

B. E. STECHBART

From the collection of the

o P^{z n m}re^aL^vibrary^{t p}

San Francisco, California
2007

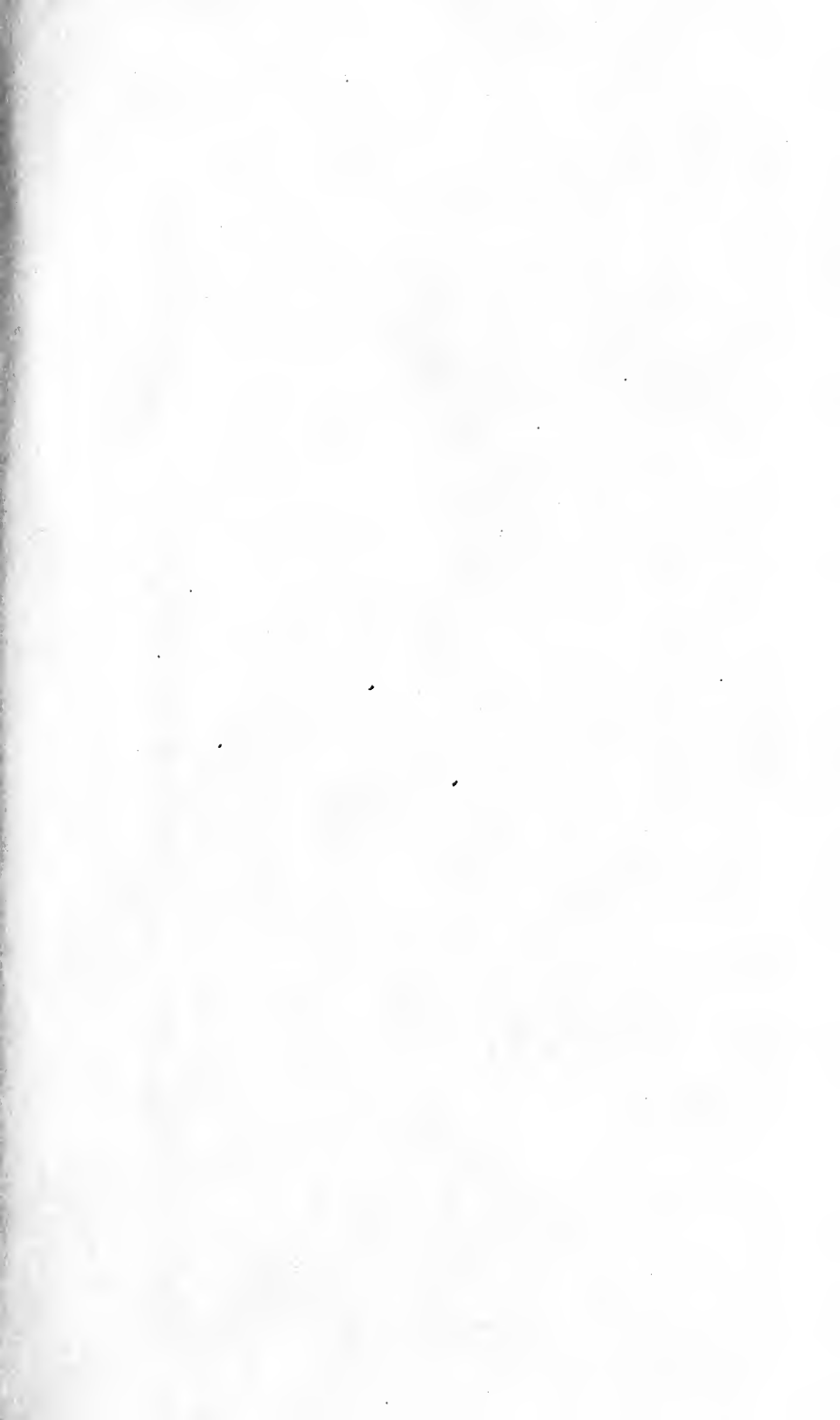

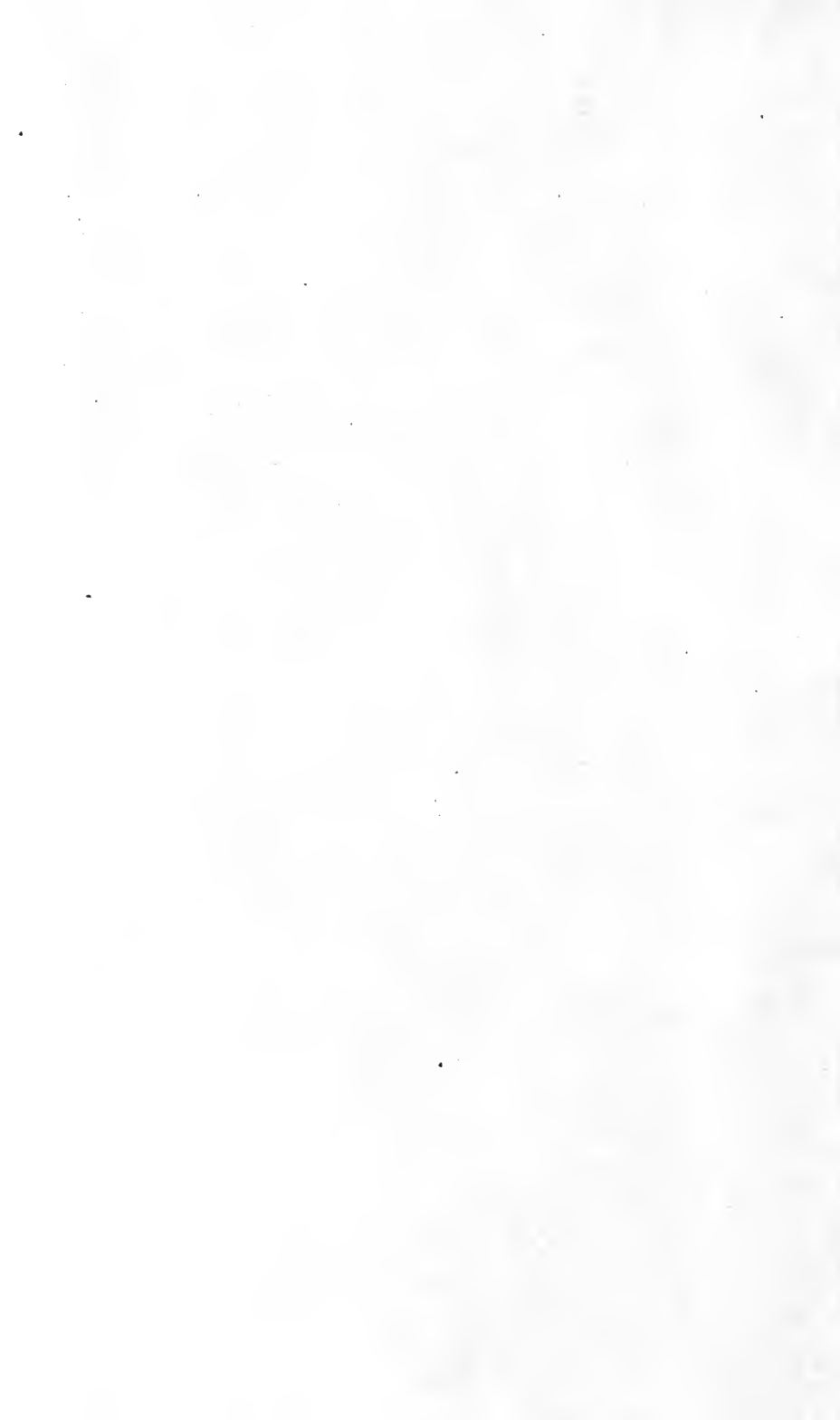

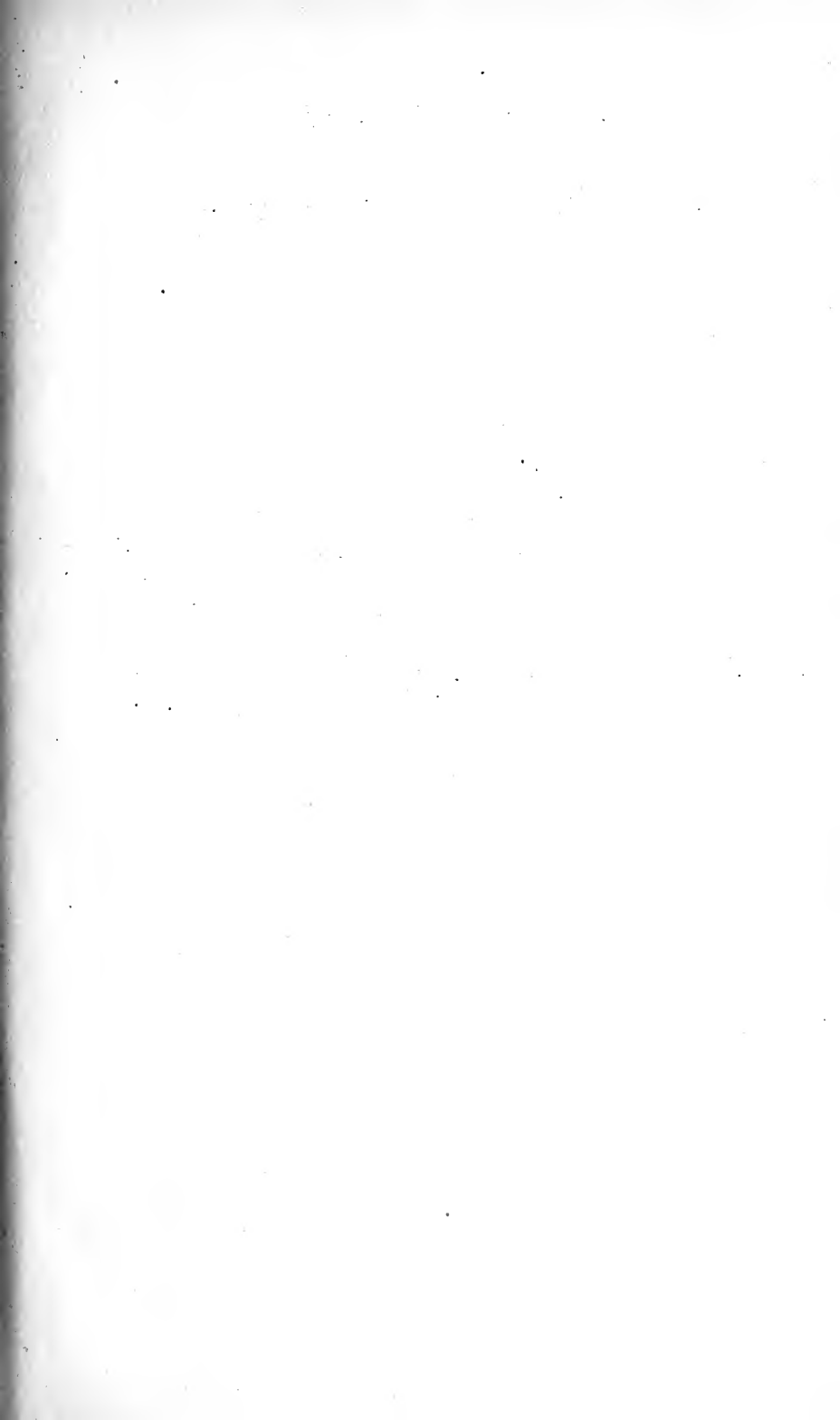

Digitized by the Internet Archive
in 2007 with funding from
Microsoft Corporation

Journal of the Society of Motion Picture and Television Engineers

VOLUME 55

JULY 1950

4271

NUMBER 1

Simplification of Motion Picture Processing Methods.....	C. E. IVES and C. J. KUNZ	3
A 16-Mm Rapid Film Processor.....	J. S. HALL, A. MAYER and G. MASLACH	27
A Method of Measuring Electrification of Motion Picture Film Applied to Cleaning Operations.....	H. W. CLEVELAND	37
Variable-Area Sound Track Requirements for Reduction Printing Onto Koda- chrome.....	ROBERT V. MCKIE	45
The Pressurized Ballistics Range at the Naval Ordnance Laboratory.....	L. P. GIESELER	53
An Experimental Electronic Background Television Projection System....	WAYNE R. JOHNSON	60
Effects of Incorrect Color Temperature on Motion Picture Production....	FRANK F. CRANDELL, KARL FREUND and LARS MOEN	67
The Stroboscope as a Light Source for Motion Pictures.....	ROBERT S. CARLSON and HAROLD E. EDGERTON	88
Study of Sealed Beam Lamps for Motion Picture Set Lighting.....	WAYNE BLACKBURN	101
Color Committee Report.....	HERMAN H. DUERR	113
NEW AMERICAN STANDARDS.....		117
Scanning-Beam Uniformity Test Film for 16-Mm Sound Reproducers (Laboratory Type), Z22.80-1950; Scanning-Beam Test Film for 16- Mm Sound Reproducers (Service Type), Z22.81-1950; Sound Trans- mission of Theater Projection Screens, Z22.82.		
68th Semiannual Convention.....		121
High-Speed Photography Question Box.....		122
Engineering Committees Activities.....		123
Society Announcements.....		123
New Members.....		124
LETTER TO THE EDITOR.....	By Joseph H. Spray	125
BOOK REVIEW: <i>Handbook of Basic Motion-Picture Techniques</i> by Emil E. Brodbeck.....	Reviewed by James W. Moore	126
New Products.....		127
Employment Service.....		128

ARTHUR C. DOWNES
Chairman
Board of Editors

VICTOR H. ALLEN
Editor

NORWOOD L. SIMMONS
Chairman
Papers Committee

Subscription to nonmembers, \$12.50 per annum; to members, \$6.25 per annum, included in their annual membership dues; single copies, \$1.50. Order from the Society's General Office. A discount of ten per cent is allowed to accredited agencies on orders for subscriptions and single copies. Published monthly at Easton, Pa., by the Society of Motion Picture and Television Engineers, Inc. Publication Office, 20th & Northampton Sts., Easton, Pa. General and Editorial Office, 342 Madison Ave., New York 17, N.Y. Entered as second-class matter January 15, 1930, at the Post Office at Easton, Pa., under the Act of March 3, 1879.

Copyright, 1950, by the Society of Motion Picture and Television Engineers, Inc. Permission to republish material from the JOURNAL must be obtained in writing from the General Office of the Society. Copyright under International Copyright Convention and Pan-American Convention. The Society is not responsible for statements of authors or contributors.

Society of Motion Picture and Television Engineers

342 MADISON AVENUE, NEW YORK 17, N.Y., TEL. MU 2-2185
BOYCE NEMEC, EXECUTIVE SECRETARY

OFFICERS

1949-1950

PRESIDENT
Earl I. Sponable
460 W. 54 St.
New York 19, N.Y.

PAST-PRESIDENT
Loren L. Ryder
5451 Marathon St.
Hollywood 38, Calif.

SECRETARY
Robert M. Corbin
343 State St.
Rochester 4, N.Y.

EXECUTIVE
VICE-PRESIDENT
Peter Mole
941 N. Sycamore Ave.
Hollywood 38, Calif.

EDITORIAL
VICE-PRESIDENT
Clyde R. Keith
120 Broadway
New York 5, N.Y.

CONVENTION
VICE-PRESIDENT
William C. Kunzmann
Box 6087
Cleveland 1, Ohio

1950-1951

ENGINEERING
VICE-PRESIDENT
Fred T. Bowditch
Box 6087
Cleveland 1, Ohio

TREASURER
Frank E. Cahill, Jr.
321 W. 44 St.
New York 18, N.Y.

FINANCIAL
VICE-PRESIDENT
Ralph B. Austrian
25 W. 54 St.
New York 19, N.Y.

Governors

1949-1950

Herbert Barnett
Manville Lane
Pleasantville, N.Y.

Charles R. Daily
113 N. Laurel Ave.
Los Angeles 36, Calif.

Lorin D. Grignon
1427 Warnall Ave.
Los Angeles 24, Calif.

Kenneth F. Morgan
6601 Romaine St.
Los Angeles 38, Calif.

John P. Livadary
4034 Cromwell Ave.
Los Angeles, Calif.

Paul J. Larsen
6906 S. Bradley Blvd.
Bradley Hills
Bethesda, Md.

Norwood L. Simmons
6706 Santa Monica Blvd.
Hollywood 38, Calif.

William B. Lodge
485 Madison Ave.
New York 22, N.Y.

William H. Rivers
342 Madison Ave.
New York 17, N.Y.

1950

F. E. Carlson
Nela Park
Cleveland 12, Ohio

Edward Schmidt
304 E. 44 St.
New York 17, N.Y.

Edward S. Seeley
161 Sixth Ave.
New York 13, N.Y.

George W. Colburn
164 N. Wacker Dr.
Chicago 6, Ill.

Malcolm G. Townsley
7100 McCormick Rd.
Chicago 45, Ill.

R. T. Van Niman
4501 Washington St.
Chicago 24, Ill.

Simplification of Motion Picture Processing Methods

By C. E. IVES AND C. J. KUNZ

EASTMAN KODAK CO., ROCHESTER, N.Y.

SUMMARY: The chemical bath formulas and treating methods used in present-day continuous motion picture processing machines were adopted without essential modification from the earlier manually operated rack-and-tank process, to which the long times of treatment were well suited. In continuous processing at high running speed, these long times of treatment require the use of large-size machines of considerable complexity which are costly to build and difficult to operate and maintain. Recent work on rapid processing methods has shown that, with highly active baths and spray application, the times of treatment can be reduced by a factor of 25 to 50, so that equipment can be made smaller and simpler as well as easier to operate and maintain.

With such types of film as can be strongly hardened in manufacture, elevated temperatures are used to accelerate the reactions further and to simplify temperature control without refrigeration. In this case, processing is complete in a minute or less. Even with films which are not hardened to such a degree in manufacture, the total time for processing can usually be reduced to a few minutes by making use of active baths applied by spraying and impingement warm-air drying. The latter films sometimes are hardened in a preliminary bath to gain time by the use of vigorous baths and elevated temperatures if the process comprises a number of successive bathing operations.

The design of equipment to suit the needs of these processing methods is described with reference to the conditions which are met in television work, in the motion picture laboratory and in the field.

AMONG ALL the types of photography, motion picture work stands out as that in which the degree of mechanization and the completeness of technical control during the processing operations are greatest. The present high level of quality and uniformity of results bear evidence of the effectiveness of the effort which has been made to improve materials and equipment over the years. While quality has undergone continuous improvement during the last three decades, the running speed of processing machines has increased by a factor of several times, with a corresponding gain in productive capacity.

The chemical processes around which the continuous machine is built, however, have not changed significantly from the day of the hand-manipulated rack-and-tank method for which they were de-

PRESENTED: October 14, 1949, at the SMPE Convention in Hollywood.
Communication No. 1317 from the Kodak Research Laboratories.

vised. It is probably fair to say that the chemical process has not been adapted in any way to take advantage of the capabilities of automatic machinery for rapid, precise operation, and that no recognizable trend in machine design has demanded any important modification of the process. Consequently, the present fast-running machine, with its hundreds of transport rollers along a film path thousands of feet in length, is so large and complex that it requires much skill for operation and maintenance and the use of a large amount of associated equipment. Nevertheless, existing equipment of this type is meeting the requirements of the large laboratories, with respect to both the quality and quantity produced, and probably will do so for some time to come. On the other hand, this type of equipment is too bulky and inflexible for use in certain special applications. The present work is concerned primarily with the latter cases in which requirements are unusual, but the results obtained are significant in many respects for general processing practice as well.

Although some simplification in the operation of processing equipment could be achieved by redesigning individual elements and introducing more elaborate control instruments, much more might be accomplished if the time of treatment in the various steps of the process could be shortened by a factor of ten times or more. Even in cases where a reduction of the time of processing is not in itself of paramount importance, shortening of the film path and diminution in the volume of the baths would permit radical changes in design and in methods to provide more automatic operation.

About twenty years ago it appeared that a photographic film intermediate step would be required in television for the sake of the additional sensitivity it offered in the pickup from original subjects and in some cases for light amplification and image storage at the receiving point. In response to these needs, considerable work was done on rapid, highly automatic processing methods,¹⁻³ some of which have found application in other types of photography^{4,5} and appear to offer promise in present-day motion picture work. More recently, the requirements of military use have led to the development of stepwise processing methods^{6,7} in which the time of treatment was shortened by a factor of 25 to 50 times, compared to that of ordinary practice, by the use of highly active baths, elevated temperatures, forceful application of the baths and, to a limited extent, special photographic films.

The strenuous treatment employed to obtain the most rapid processing in some of the cases cited would cause serious softening of the emulsion gelatin unless it was hardened either in manufacturing or at

a suitable stage in the processing. At the time when further study of applications of these methods to motion picture work was undertaken, the hardening of some of the lower-speed printing and sound-recording films had been increased sufficiently in manufacture and effective methods were available for hardening other films in processing. Preliminary studies of washing and drying techniques had indicated that great acceleration of the process was possible by adoption of forceful jet impingement methods in place of the low velocities and slow renewal characteristic of current practice.

EXPERIMENTAL EQUIPMENT

Work on rapid processing published up to the present time has revealed little as to the uniformity and image quality attainable for motion picture use. Since temperatures would often be well above ambient and short times of treatment would prevail with the methods considered, automatic equipment with thermostatic control would be needed for the investigation. Also, in due course, practical equipment would be required for studies of the techniques for applying treating baths and drying air.

Two major units of continuous processing equipment were therefore built and used in this work, although supplementary tests were carried out on a variety of other equipment. The first machine was a highly compact, semiportable unit occupying about 2 cu ft of space, and the second was intended for operation at the rate of 90 fpm and was proportionately larger. Based on preliminary tests, the design in both cases provided for the complete processing of the highly hardened Eastman Fine Grain Release Positive Film in a minute or less.

Semiportable 16-Mm Machine

The first continuous machine used in the present work was designed to give about 5-sec immersion treatment in developer, rinse, fixing and washing tanks, respectively, at a running speed of 8 fpm. It was intended to be highly compact, easy to thread, and simple in construction. Figure 1 shows the machine with tanks removed, revealing the film in normal running position. Threading is accomplished by drawing the film from the supply box at the lower left across the upper rollers standing between the several tank compartments into which loops are formed when the rack assembly carrying the lower rollers is slid down into position. Upon leaving the last tank at the right, the film passes through the squeegee rollers and then around the two large heated drive drums on which drying is effected

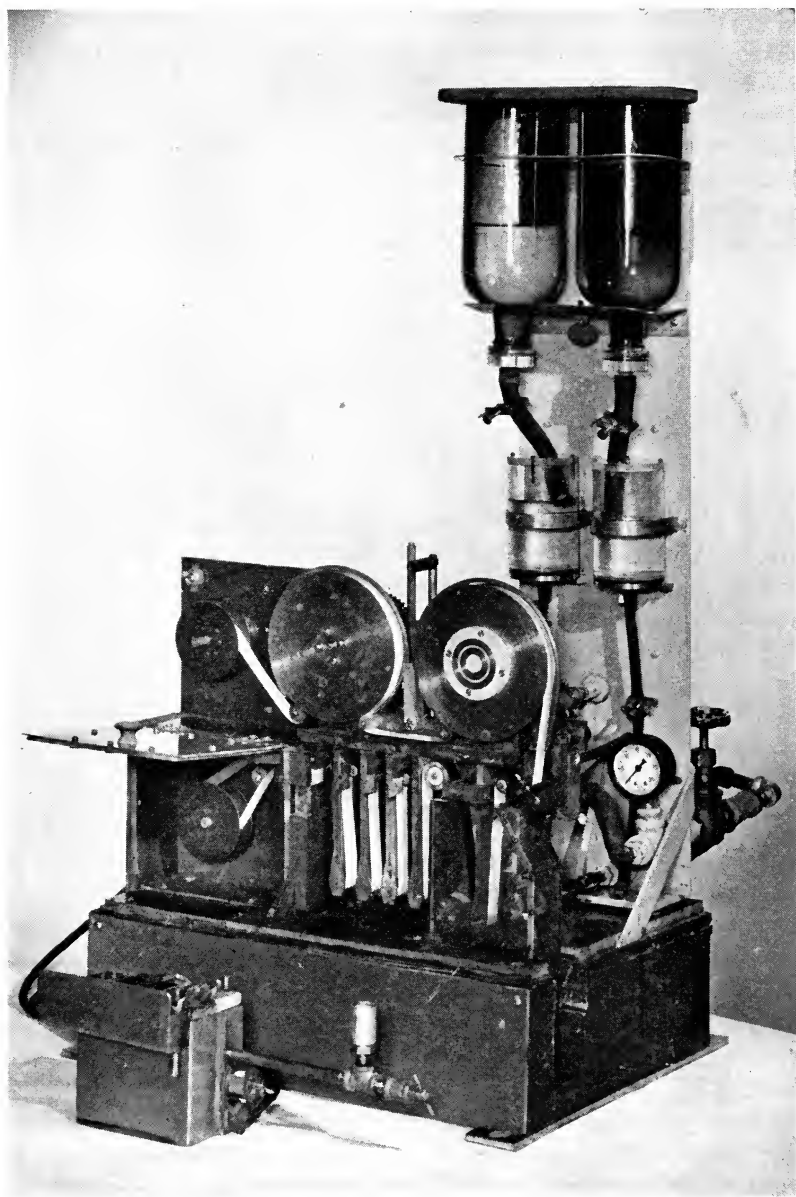

Fig. 1. 16-Mm continuous rapid processing machine, with tank section removed to show film path.

with the help of compressed air discharged against the emulsion surface through orifices in the arcuate distributing pipes. The dried film is wound up on the reel at the top left. When the rack frame is lowered to form the loops, the drive is automatically connected by radial engagement of a spur gear on the shaft of one of the interlinked drums. One ounce of processing bath is then run into each tank and brought to working temperature by a thermostatically controlled heating element immersed in the water jacket, which can be seen with the tank assembly in Fig. 2. When the working temperature is



Fig. 2. Tank section for 16-mm rapid processing machine; heat-exchanger jacket at left, and four processing tanks with preheating coils at right.

reached, as evidenced by a heater pilot lamp bull's-eye, wash water and compressed air are turned on and the drive is started. Developer and fixing-bath replenishers flow continuously under control of throttle valves from the constant-level chambers above at the back and reach the work tanks after passing through tempering coils (Fig. 2) in the water jacket. Just below the drying drum at the right (Fig. 1) is a transparent box enclosing an additional film loop and two water spray nozzles which can be used when thorough washing is desired or by-passed if a minimum processing time is required.

At a film speed of 8 fpm, a 4.8-sec time of treatment is provided in each bath, which is sufficient for normal processing at 125 F (degrees Fahrenheit) when Kodak D-8 Developer and the Kodak Rapid Liquid Fixer (with Hardener) are used with Eastman Fine Grain Release Positive Film, Type 7302. Except in the spray wash section, the baths are neither agitated nor circulated except as a result of film motion.

While the rate of reaction in the chemical baths was not affected significantly by the lack of agitation, development uniformity and tone reproduction were not always up to commercial standards for continuous-tone work. Hot-drum drying, while efficient from the viewpoint of heat transfer, was prone to cause mottle pattern because of the practically unavoidable nonuniformity of contact.

Nevertheless, this apparatus has served its purpose well in a great variety of experimental work involving a wide range of temperatures, chemical treating methods, and film types. The machine was sufficiently light-tight for daylight operation and could be loaded without the use of a magazine if the film had removable opaque backing. The high-*pH* developers were effective in removal of the backing material with the aid of a light frictioning in the bath.

With the addition of a small air-compressing pump and a pressure tank for the water supply, this equipment required only a source of electric current for installation almost anywhere. Therefore, it has been sent out frequently for use in tests involving other less portable equipment,⁸ for processing in an airplane, and for lecture-hall demonstrations, and has given regular service in laboratory work.

A 90-fpm Machine

In order to evaluate rapid processing for such applications as theater television and motion picture laboratory work where highest standards of quality and uniformity would have to be met, a faster machine with more effective means for bath agitation and for drying was needed. A 90-fpm speed was decided upon with intense spray application of chemical solutions and wash water to secure the rapid and uniform renewal at the film surface which would be requisite with the short times of treatment.

Provision was made for times of treatment as short as 5 sec in each bath, with the possibility of increase to 10 or 15. The film was supported on a cylindrical drum during the 5-sec drying treatment so that forcible air jets could be applied. Longer times would be attainable by reducing the running speed. Unless the film splicing and roll changing could be made fast and entirely automatic, the usual

type of elevator and splicer sections would be disproportionately large in comparison with the rest of the machine. These elements were, therefore, omitted entirely, inasmuch as a machine with such a short processing time and film path could be stopped at the end of each roll, at least in experimental work.

Arrangement of Parts

In the front elevation of the machine in operating condition (Fig. 3) starting from the left are seen the supply roll, the developer cabinet,

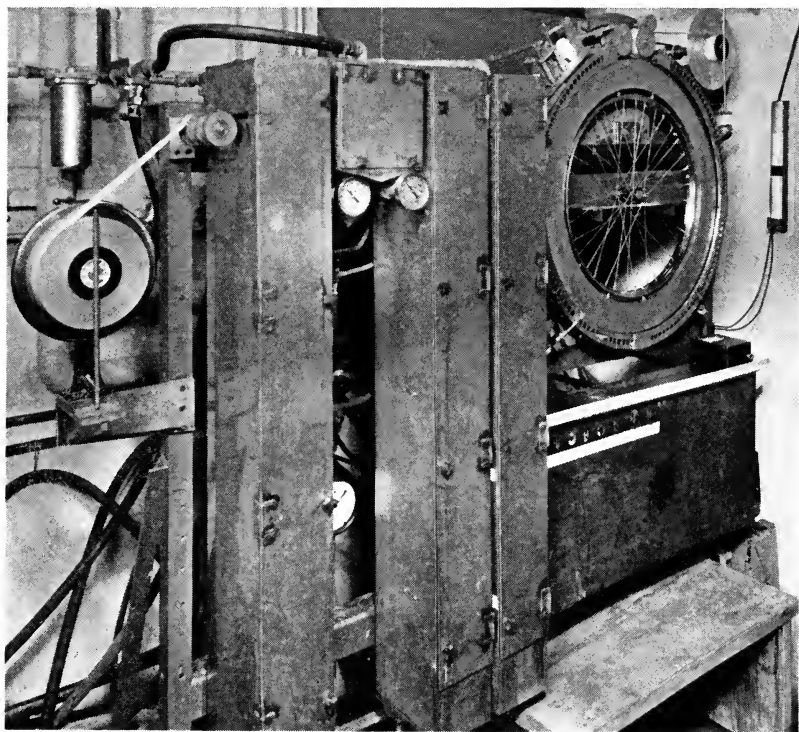

Fig. 3. 90-Fpm 35- and 16-mm rapid processing machine.

a short section for rinsing, the fixing and washing cabinets, the pneumatic squeegee, the drying drum, and at the top right, the film-drive roller and the windup. Figure 4 is a closer view of the bathing section with the doors opened as for threading to show the arrangement of the film loops and spray nozzles. These figures are essentially the same as those shown at the SMPE Chicago Convention in the spring

of 1947, when the method was discussed in a preliminary way. This machine is about 6 ft long, 7 ft high, and 2 ft deep.

In the three larger cabinets, the film traverses the familiar flattened helical path over free-running rollers supported by the parallel upper and lower shafts on 42-in. vertical centers. The lower shaft is fixed in position and does not rotate, while the upper shaft is mechanically driven at a speed somewhat greater than that at which the rollers are turning with the moving film. With the upper shaft somewhat larger than the lower, this overdrive of a few percent largely neutralizes the frictional drag and relieves film tension. The film moves through the small rinse cabinet in a straight line so as to provide a time of about one-half second.

Figure 5 shows the circulatory path of the developer and fixer. From the sump at the bottom of the rectangular tank at the upper left, the developer goes through the pump, a heater and a filter, past the thermostatic switch and thermometer to the spray nozzle system. In order to simplify piping while obtaining complete spray coverage of the film, the nozzles were located inside the film loops and directed upward and transversely to the film at an angle of about 30° to the vertical. It had been determined in advance that films which are as strongly hardened in manufacture as Eastman Fine Grain Release Positive Film, Type 5302 (or 7302), could safely be run with the emulsion in contact with a reasonable number of smooth rollers, as long as the film surface was kept completely wet and proper principles were adhered to in design and maintenance. Stainless-steel construction and piping were used, where necessary, with commercially available spray nozzles of the same material.

The pneumatic squeegee used was of a type employed on many conventional processing machines and consisted of a hollow box with roller-guarded slotted openings at opposite ends.⁹

While a considerable variety of drying schemes were of interest, the basic equipment on this machine consisted of distribution piping for the drying-air jets and a radiant-heating ribbon of Nichrome surrounding the drum and concentric with it and at a distance of about one-half inch from the film. In some of the work, a cabinet dryer located above the drum was used instead.

Applications of Spray-Type Machine

Although the ability of this type of equipment to do good work had been demonstrated prior to the preliminary report presented in the spring of 1947, much remained to be learned both as regards features of the equipment design and as to the application of a rapid

processing technique to films of widely varying properties. Because of the lack of automatic equipment for preliminary study on a test-tube scale and the need for information on processing-machine design, the experimental work was carried out mainly with the continuous machines under conditions of practical use and will, therefore, be discussed on the same basis.

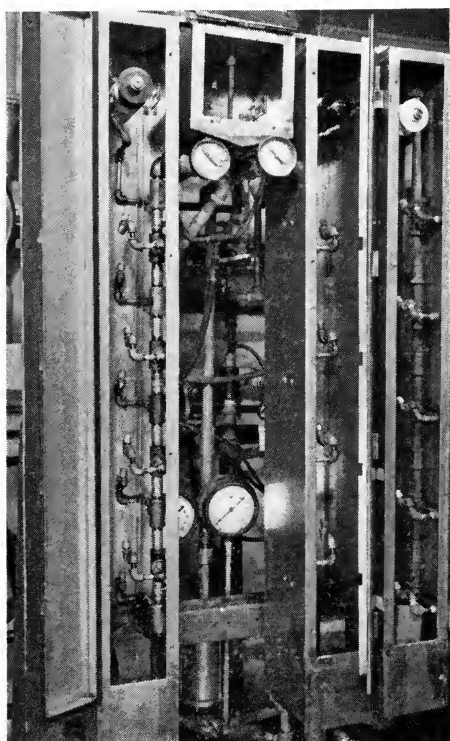

Fig. 4. Spray processing chambers of 90-fpm machine, with doors opened to show position of nozzles.

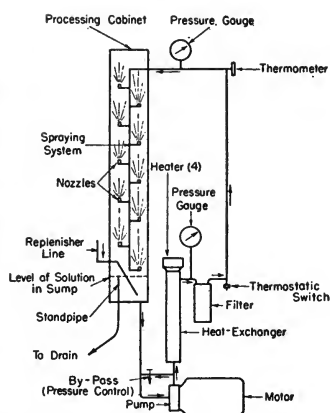

Fig. 5. Circulation system in 90-fpm rapid processing machine.

THEATER TELEVISION; FINE GRAIN RELEASE POSITIVE FILM

In the processing of Eastman Fine Grain Release Positive Film in theater television use, both compactness of equipment and extreme curtailment of the processing time were required. A study was made, therefore, of processing methods for use in the 90-fpm spray-type machine, with the object of arriving at a $\frac{1}{2}$ -min total time for processing, including drying.

The 40-fold reduction in developing time from $3\frac{1}{2}$ min to 5 sec was achieved by the combined effect of a very active developer, such as Kodak SD-27 (formula below), and an elevation of temperature from 70 to 120 F.

Kodak Rapid Developer SD-27

Water, about 90 F (32 C).....	750.0 ml
Kodak Elon Developing Agent.....	5.0 g
Kodak Hydroquinone.....	45.0 g
Kodak Sodium Sulfitc, desiccated.....	90.0 g
Kodak Sodium Hydroxide (Caustic Soda).....	40.0 g
Kodak Potassium Bromide.....	10.0 g
Kodak Anti-Fog No. 1 (Benzotriazole).....	1.0 g
Water to make.....	1.0 l

Some difficulty was experienced with nonuniformity of density until it was realized that complete wetting of the film must be attained in the first one-half second which, of course, constituted 10% of the total developing time. The use of a wetting agent, such as "Tergitol" Penetrant 08 (Manufactured by Carbide & Carbon Chemicals Div., Union Carbide & Carbon Corp., New York, N.Y.) at a concentration of 0.1% in the developer was helpful but insufficient except in combination with proper application of the bath at the start. The practice finally adopted consisted in momentary immersion in developer contained in a small vestibular trough at the cabinet entrance followed immediately by a strong spray blast. The wetting agent was retained for its effect in preventing a type of marking caused by small scattered airbells. Developer from the first nozzle maintained sufficient depth in the trough to insure wetting of the entering film and sealing of the opening against the entry of air. Additional pressure of developer at the nozzles above the minimum of 30 psi required to produce the full spray pattern had no effect on the quality of results.

Rinsing

Adequate rinsing was obtained in the 9-in.-long straight pass through the next small cabinet, which was equipped with two spray nozzles directed upward toward the emulsion surface and one downward toward the film support. All three were supplied with tempered water. Any deficiency in rinsing tended to cause the typical yellowish fog which is formed when residues of a vigorous developer are present in film as it enters a fixing bath. Soft-rubber wringer rollers located at the entrance and exit openings of each cabinet are helpful in minimizing carry-over and leakage.

Fixing

Complete fixation of the Eastman Fine Grain Release Positive Film in 10 sec at 120 F, was attained by the use of an ammonium thio-sulfate bath, such as Kodak Rapid Liquid Fixer (with Hardener), at a dilution of one part of the commercially supplied concentrate to three parts of water. While there is no need to harden the film in question for the sake of toughening it, inclusion of the hardening constituent in the bath has been found desirable to make drying easier.

Washing

The spray system for applying wash water was essentially similar to that used in the developing and fixing tanks and used water at a rate of about 1.5 gpm. At a wash-water temperature of 120 F with the film in question, hypo and silver residues reached the level sometimes referred to as "commercial" in 5 sec and as "archival" in 10 sec or less.

Squeegeeing

When rapid drying is to follow, loose water must be removed more uniformly and completely than in normal processing. Spots and streaks produced in drying when squeegeeing is inadequate cannot be prevented by the liberal use of an efficient wetting agent in the wash water, presumably because the rate of redistribution is too slow to keep up with the needs in the two or three critical seconds of the drying process. Of necessity, reliance was placed, therefore, on the liberal use of compressed air. About 30 cfm (atmospheric) were used at 15 psi.

Drying

Measurements of the water content of Eastman Fine Grain Release Positive Film processed in the manner described here have shown that the water absorption is ordinarily less than in conventional processing and that almost all of it is by the emulsion layer.

The drying equipment used in this work is designed to hasten the evaporation of water mainly from the emulsion surface while the film support lies in contact with the smooth chromium-plated drum shielded from air circulation. No provision is made for application of heat except from the emulsion side. In the first experimental work, drying air at room temperature was supplied in forceful cross streams from orifices of 0.040 in. in diameter near the edge of the film

at intervals of one-half inch on either side. Considerable dependence was placed upon the supplementary effect of radiant heat provided by the near-by fluted Nichrome ribbon which was operated near the glow point, i.e., about 1000 F. With this open radiator, the machine was suited only for use with safety film.

Previous studies had shown that for proper use of radiant heat the flow of air over the film surface should be sufficient to prevent any large elevation of the temperature of the film if severe physical effects were to be avoided. In the present work, therefore, an ample air stream was used to hasten the drying so that the condition of the film was good except for a small and unimportant increase in brittleness. Nevertheless, the proximity to the threshold of physical change was indicated by a tendency to increased glossiness of the emulsion surface. Any substantial increase in air flow was impractical because of the loss in total efficiency of the system caused by the cooling of the bare radiant ribbon by the air deflected back against it from the film and the air distribution piping.

More intensive air impingement with a new distributor was then tried with success. In place of the original cross-flow system, a ladderlike structure of tubing was installed at a distance of about one-half inch from the film. The four 0.040-in. orifices in each rung were staggered relative to the width of the film. With 40 rungs along the 7.5-ft film length, for example, 40 cu ft of air at about 160 to 170 F and at 10 lb manifold pressure were required for the Fine Grain Release Positive Film. In general, lower temperatures are preferred, with a greater number of rungs delivering a proportionately increased volume of air. An improved design is now being built for the systematic study of temperature, pressure, orifice diameter and spacing. Preliminary data indicate that groups of orifices of the type mentioned here, located at intervals of 1 in. or less and delivering a total of 100 cu ft of air at 90 F, will be sufficient.

Cabinet Dryer

When, for any reason, the drying path is increased beyond 10 ft, the drum-type dryer is too cumbersome and will be replaced by a cabinet dryer in which less forcible air streams will be applied over a proportionately greater length of less firmly supported film. A cabinet dryer of this type is illustrated in Fig. 6.

In the dryer, the film travels, emulsion side outward, in the usual helical path around upper and lower rollers of the rack. Drying air is delivered perpendicularly to the emulsion surface from the supply plenum through a very large number of staggered small orifices or

through numerous narrow slits, each covering the width of the film strand. Pressure is maintained in the plenum by a blower which takes air from the vicinity of the film strands and fresh air from a dampered intake pipe. Air leaving the blower flows through the thermostatically controlled heater and then enters the several sections of the plenum.

The slits or groups of orifices should be spaced in such a way that the film in each strand passes them at a rate of 15 or more a second. Air velocities should be upward of 100 fps. The dimensions of the openings will depend upon the supply pressure. The total volume of air necessary for drying Eastman Fine Grain Positive Film at 120 F will be of the order of 75 to 100 cfm, measured at atmospheric pressure.

The essential feature of the cabinet as well as of the drum design is the frequent sweeping of the emulsion surface by forcible streams of unsaturated warm air. During the 5 sec the film is in the drum dryer, the force of the air blast is so great that the film must be supported rigidly at all times.

When 10 to 20 sec of time are available, sufficient support may be provided by a few backing rollers or by balancing air jets applied to the film support.

By the use of the methods and equipment discussed here, the requirements of theater television and the like for simplified, automatic processing of Fine Grain Release Positive Film in a restricted space can be met. Depending upon the requirements for quality and permanence in a given case, the time of processing, including drying, may be reduced below the 25 to 40 sec employed in the practice described here.

USE IN MOTION PICTURE LABORATORY

At present, rapid processing equipment might be adopted in commercial laboratory work because it requires less space and entails smaller capital outlay than conventional equipment. Justification

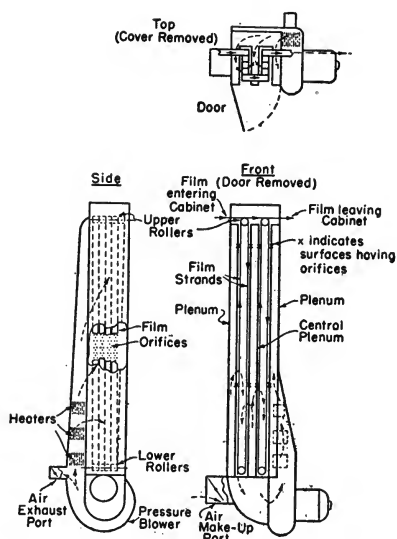

Fig. 6. Cabinet-type rapid film-dryer employing numerous jets of high-velocity, heated air.

might be on this basis where additional equipment is needed for a specific task during a limited period of time. In special situations the simplified temperature control requiring no refrigeration, which is enjoyed when the processing temperature is well above ambient, will be of importance. Occasionally, equipment and a method of this type will be valuable because the delay in processing before a short length of film is available for subsequent use is reduced.

In many of these cases, reduction of the processing time below 2 or 3 min would not be necessary and greater running speed even with proportionately larger size might be desirable. A longer film path could be adopted for a motion picture laboratory machine in which highest quality of results is of prime importance and to permit the use of more dilute baths, possibly in a cascade flow through two tanks for economy. With more time for washing, savings could be effected by heating water only to 70 F.

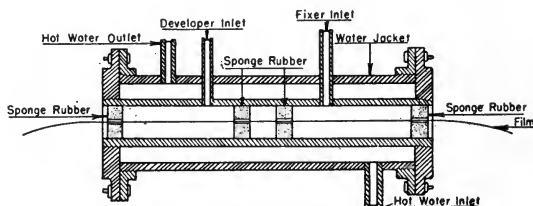

Fig. 7. Straight-line tube equipment for ultrarapid processing.

SPECIAL APPLICATIONS

An extreme case is that in which the exposed film, in a continuous length, must be made to produce a visible image at the earliest moment after leaving the exposing station. For this purpose, in which the film can be used directly without washing or drying, a straight-line machine of the type illustrated in Fig. 7 was devised by one of the authors about 1937. It consisted of a jacketed tube 2 ft long separated into three compartments by means of sponge-rubber plugs held in place by friction with the tube wall. The device was assembled with the leader film passing in a straight line from one compartment to the next through knife cuts in the sponge-rubber plugs. The end compartments about 8 to 9 in. long were filled with developer and fixing bath, respectively, while the smaller space in the middle was empty. The exposed film was attached to the leader and drawn through the baths at the rate of about 100 fpm so as to provide about one-half second in each bath. The highly hardened, low-speed

Kodalith Type film was used with the strongly alkaline Kodak Developer D-9 and an ammonium thiocyanate fixing bath at about 150 F. The latter was made up in the proportion of 15 g of the salt to 5 ml of water and solidified at room temperature. Equipment of this type is, of course, very limited in application but it gives some indication of the possibilities when the rapid processing methods and equipment are properly chosen for a special purpose.

ADAPTATION TO PROPERTIES OF FILM

Up to this point the practice of rapid processing has been treated mainly for the case in which the film to be used is so highly hardened in manufacture that it can be subjected to severe chemical treatment at high temperature without causing much swelling or softening of the gelatin emulsion layer. Among the motion picture films regularly supplied only certain of the lower-speed types are hardened to this degree during manufacture. In addition, a few special photographic films have been made for applications where certain limitations in properties and restrictions in handling can be accepted. At the present time it is not possible to make commercially satisfactory high-speed negative emulsions hardened to this degree, although progress is being made.

In order to extend the benefits of the rapid processing procedure to the emulsion types which are not available fully hardened, modified techniques have been studied in which supplementary hardening is given at the start of processing or in which the severity of the treatment is moderated with some concession in length of treating time.

Method with Prehardener

The use of a prehardening bath, such as Kodak Prehardener SH-5, is satisfactory with most types of high-speed negative films and permits subsequent development at temperatures up to 125 F, but consumes from 1 to 4 min in various cases. However, this treatment¹⁰ removes all obstacles to the use of the strenuous rapid processing treatment without causing any significant loss of emulsion speed or image quality.

From the prehardener the film can go directly to a vigorous developer, such as Kodak Rapid Developer SD-26. This is followed by rapid fixing, washing and drying procedures of the type discussed in the preceding sections. Times of treatment for the higher-speed negative materials must be appropriate for the combination of film type and processing baths chosen but will usually be several times as long as for Fine Grain Release Positive Film.

When it is imperative that the time of prehardening be reduced, the temperature in this prebathing can be elevated to 125 F if the SH-5 is modified by the addition of 100 g of anhydrous sodium sulfate, and 45 ml of formalin per liter. High-speed negative films can be fully hardened in this bath in 30 sec to 1 min, but when so treated will yield only about one half the normal emulsion speed. The anti-foggant concentration may require adjustment for optimum emulsion speed with a given combination of film type and developer.

Intermediate Method

A preferable scheme of handling the less hardened films including the high-speed negatives is to employ all the features of the rapid processing technique such as the use of rapidly acting baths, the spray bathing and washing, and impingement warm-air drying, avoiding only the use of high temperatures. In this way, the high-speed negative films can be processed completely at 70 F to give good-quality images in 4 min, that is, in one tenth the usual time, by the use of Kodak Rapid Developer SD-26 (formula below), Kodak Rapid Liquid Fixer (with Hardener), spray washing, and impingement warm-air drying, each for 1 min. A 2-sec spray rinse with water is sufficient between developing and fixing.

Kodak Rapid Developer SD-26

Water, about 90 F (32 C).....	750.0 ml
Kodak Elon Developing Agent.....	20.0 g
Kodak Sodium Sulfit, desiccated.....	60.0 g
Kodak Hydroquinone.....	20.0 g
Kodak Sodium Hydroxide (Caustic Soda).....	20.0 g
Kodak Potassium Bromide.....	10.0 g
Cold water to make.....	1.0 l

With the drying air moving at high velocity over all parts of the film, the temperature of the wet emulsion approaches the wet-bulb temperature which is below 80 F for a dry bulb of 120 F, even when the air is taken into the system at 70 F and 70% relative humidity. A further margin of safety against softening of the emulsion can be obtained where required by an increase of 1 min in the time of treatment in the hardening fixing bath, which should be obtained preferably by the addition of a second fixing-bath cabinet, into which the replenisher bath is fed in a two-stage counterflow system.

Composition of Processing Baths

The formulas given here have been found useful in practical applications but will require modification to suit the needs of individual

film types, the limitations and peculiarities of equipment, and to meet the chemical and economic requirements of replenishment and silver recovery. Additional information on the chemistry of rapidly acting baths will be found in a series of papers by J. I. Crabtree and his associates¹¹⁻¹⁴ on rapid processing and on low- and high-temperature processing.

Because of the short times and intense agitation used in practice, preliminary tests with hand manipulation are of limited assistance in selection of chemical bath formulas, and should be followed by tests on a typical element of the machine design under consideration before final decisions are made. For example: the characteristic curve may show a drooping shoulder with quiet immersion development; high fog may be caused by excessively slow transfer from developer to rinse, insufficiently rapid renewal of rinse water, or lack of agitation in rinsing; yellow stain which may be difficult to eliminate in hand tests without use of an acid stop bath is easily overcome in the machine by forceful spray rinsing with water.

An unusual characteristic of the current variable-density sound-recording film was observed when high-activity hydroquinone or Elon-hydroquinone developers were adopted for rapid processing. When development in these baths was carried to the point where the normal low-contrast curve was obtained with low-intensity exposures, a contrasty continuously upcurving characteristic was found with high-intensity short time exposures such as are used in sound-recording or in kinescope photography. The effect was observed at 70 F as well as at higher temperature. Normal curve shape was obtained by the addition of 10 g of sodium thiosulfate per liter to the rapid developer. The effect of exposure intensity level on curve shape with normal developers is very small.

It has been supposed that excessive consumption of developer might occur with spray application of warm developer. In practice, this is not a serious problem since the air in a small developer cabinet is insufficient to oxidize any large amount of sulfite, and renewal of air can be kept small by the use of the tight seals which are required for other reasons. Nevertheless, troublesome aerial fog was encountered in one case, even when extra precautions were taken to reduce the amount of air leakage. This difficulty was eliminated when the developer alkalinity was lowered a few tenths of a *pH* unit below the critical point for aerial fog propensity—near 12.0—found by H. D. Russell and M. D. Little, of these Laboratories (private communication).

In connection with the increasing use of spray application of de-

velopers, the relation between features of design of a chemical recirculation system affecting aeration, and the economics of the developing agent and sulfite consumption have been studied by G. I. P. Levenson.¹⁵ He concludes that serious losses can occur when air is introduced into a developer by spraying or other means, especially if the volume of developer in a recirculation system is large. His findings indicate the desirability of extremely small circulatory systems relative to the rate of film handling, as exemplified by the spray developing unit described in the present paper.

Effect of Temperature Elevation

As stated by Crabtree,¹³ the rate of development generally increases by a factor of about 2 for each 15 F rise in temperature. The acceleration of fixing by elevation of temperature is much less. Washing of film can be speeded up greatly by rapid renewal of water at the film surface but the influence of temperature elevation, while favorable, requires further study. Unnecessarily high temperature of the wash water should be avoided, both to prevent swelling and softening of the gelatin emulsion and to economize power in water heating. The effect of temperature variation in rapid processing has proved to be about the same per degree as in conventional 70 F processing.

Quality of Rapidly Developed Images

Up to the present time, no systematic study has been made of the effect of rapid processing on the structure of the developed silver image to discover the effect on resolution, graininess, etc. However, observation on images developed, fixed, washed and dried in times of 5 to 10 sec, respectively, by projection and in photomicrographs has shown little that is unusual. In certain cases, evidence has been obtained of incompleteness of treatment near the bottom of the emulsion layer with a development time of 5 sec even though the emulsion speed and quality were about normal. This deficiency has been found to increase when the treating time was reduced to 1 second, for example, especially if the compensatory adjustments in developer activity and temperature were not sufficient to assure normal completeness of development. The use of elevated temperatures appears to offer no promise of a significant increase in emulsion speed nor of improvement in graininess. Anyone contemplating the use of high-temperature processing with the softer types of emulsion should make sure that the supplementary hardening in processing is always ample so that graininess will not be produced as a result of incipient reticulation.

Mechanical Condition of Processed Film

A marked embrittlement of a type which is not removed by equilibration with an atmosphere of 70% relative humidity is observed occasionally when radiant heat is used improperly in drying. The condition appears to be caused when the film reaches an excessively high temperature in the course of drying and can be largely corrected by rewetting the film and drying it under more favorable conditions. It is not a direct consequence of rapid drying but rather of overheating during drying.

Almost all of the heat which goes into the drying process is accounted for as the latent heat of evaporation of the water so that, unless evaporation is retarded by the accumulation of moisture vapor above the film surface as a result of insufficiently high velocity of the drying air, a high rate of heat input produces only a moderate rise in temperature of the film. Therefore, a first concern in designing a drying system is to have proper velocity and distribution of the air. Only when this is assured is it safe to introduce the large amount of heat which will be required for rapid evaporation of water.

Effect of Rapid Processing on the Film Support

Up to the present time, no detrimental effects of rapid processing on the film support have been observed when temperatures and physical handling were reasonable. As the temperature actually attained by the film is raised above 125 F, additional care is required to limit the tension applied because the film becomes more susceptible to plastic deformation.

ADVANTAGES IN USE OF RAPID PROCESSING

Some of the advantages obtained by the use of the rapid processing technique are as follows:

1. Elimination of delay in obtaining completed film.
2. Simplification of equipment design, which affects construction, maintenance and use.
3. Reduction of volume of baths, especially if spray application is used, thereby reducing the amount of space required and simplifying chemical control.

Some of the disadvantages of the methods considered are:

1. Increased chemical consumption in certain cases where concentrated baths are replenished rapidly.
2. Increased power consumption when certain extreme requirements as to operating characteristics or size are imposed.

CHOICE OF TYPE OF EQUIPMENT

It is apparent that when the operations in processing are shortened by a factor of 10 to 50 times or more, attractive possibilities are offered. However, there is no universally best design for equipment to be used with rapid processing methods. Instead, the design must be chosen in any particular case according to whether the emphasis is to be on compactness, curtailment of the time of processing, simplification of operation, etc. General comments on design of equipment are given in Appendix I and details in regard to components in Appendix II.

ACKNOWLEDGMENTS

The authors are glad to acknowledge the valuable contributions made to this work by Norman A. Exley, of these Laboratories, particularly in the work on the "intermediate method" by which the softer high-speed negative films can be processed rapidly without the use of a prehardening bath. They also desire to express their thanks for the generous assistance in problems of equipment design given them by the engineering personnel of the Eastman Kodak Co.

Rochester 4, N.Y.
September 28, 1949.

APPENDIX I. COMMENTS ON DESIGN OF EQUIPMENT

1. *Film Path.* In applications where unskilled operators will use the equipment, threading should be extremely simple, or else fully automatic. However, unless an ultrarapid process is employed, the longer film-path length of fast-running machines must be sinusoidal or helical for the sake of compactness. In order to cut down the horizontal length of the machine and the number of film-transport rollers, the film loops could be lengthened, but when the span between supporting rollers exceeds about 5 ft it becomes increasingly difficult to keep the film in position under the action of forceful jets. The use of drums is limited practically by their bulk, even if the film makes more than one turn around them.

2. *General Arrangement.* With equipment such as the 90-fpm unit, a turn-around path could be used to place the start and finish, side by side. The machine could then be located in an alcove on a roll-away truck.

3. *Number of Stages.* As stated previously, the provision of more than a single stage in the bathing treatments where space restrictions are not extreme gives desirable latitude in formulating baths and makes possible more economical operation.

4. By the use of stepped-roller shoulders and the interposition at suitable points of fully supporting soft-rubber rollers, 16- and 35-mm film can be run alternately without pause.

5. To avoid excessive carry-over or dilution of the concentrated solutions which would otherwise occur in the necessarily very short cross-over paths, soft-rubber wringer rollers or other squeegee devices must be used.

6. *Film Drive.* In the equipment described, the film receives positive drive at a single roller near the wind-up. This is made possible by the shortness of the film paths and by the reduction in film-dimensional change in the shortened processing times. As the length of the film path and the number of rollers is increased to provide for additional stages of treatment, it is to be expected that provision for relief of accumulated film tension will be required.

7. *Spray Application.* Forceful application of an over-all fine spray appears most practical for vertical film strands. A flooding-type low-pressure nozzle has the advantage of operating at low pressures and does not clog easily. However, it is usually applicable only to horizontal film paths. Widely spaced solid stream jets are usually not suitable.

8. *Splicing and Roll Handling.* Suitable rapid automatic splicing is needed with fast machines to eliminate the need for bulky film-reservoir elevators. Developments in heat splicers show promise. In low-speed machines, threading can be made so simple that leaders can be dispensed with. The machine can be stopped momentarily for rethreading after the tail end of the preceding roll has been allowed to run through.

9. *Power Consumption.* It should be possible to increase the efficiency of squeegeeing immensely by improvement of the pneumatic method or by introduction of another. Likewise, with the use of air recirculation and with low-pressure fans in place of compressors, power consumption during drying can be minimized. Machines designed for greater economy of power and water consumption with provision for removal of hypo from water¹⁶ and for daylight operation should prove useful for military and other uses in which portability is required.

APPENDIX II. SELECTION OF COMPONENTS

1. *Thermometers.* When the solutions are rapidly circulated, the temperature can be measured accurately by means of an industrial-type thermometer properly located in the spray-nozzle feed lines. Examples are the Weston Dial Thermometer Model 221-D, Range

0-200 F, and the Rochester Manufacturing Co. Model No. 1758, Range 0-200 F.

2. *Thermostats for Liquid Solutions.* In the circulatory systems described, the simplest types of on-off thermostats have been used successfully when located immediately downstream of low-lag type heaters. Industrial-type thermostats with thin stainless-steel protective wells, such as the Fenwal Thermoswitch A-7100 (well extra), can be used. In differently arranged systems or in case equipment is to be operated with both refrigeration and heating elements or for long periods without checking, it is likely that more elaborate controls will be required. Tempered water can be obtained most conveniently by the use of thermostatic mixers, such as the "HE" series furnished by Powers Regulator Co.

3. *Solution Heater.* Highly responsive electric resistance heaters sheathed in stainless steel and fitted for insertion in threaded pipe are well suited to use in the small recirculating systems. For example, in the 90-fpm machine, a 4,000-w multiple-connection Screw-In Immersion Heater, Model No. 3-887, supplied by the American Instrument Co. with U-shaped heating coils, provides for rapid heating in the warm-up period and then operation with lower wattage when the 120 F level has been reached. At an ambient temperature of 70 F and with 70 F replenisher flowing in at the rate of 300 ml a minute, a 1000-w heater must operate almost continuously to maintain temperature at 120 F in the 90-fpm machine described. The switching relay can be made to rearrange the load connections automatically in proper sequence.

4. *Solution Heat Exchanger.* The heat exchanger can be assembled from standard stainless-steel pipe and fittings chosen to suit the length of the heating coils and to assure full velocity of the circulated liquid.

5. *Solution Filters.* All spray systems should be equipped with strainers of 50- to 100-mesh wire screen just upstream of the distributing manifold to prevent clogging of nozzles. Stainless-steel cloth is available for this use in any degree of fineness needed. A coarser screen should be installed in the outlet from the sump to protect the pump. A filter, such as the Fulflo (Commercial Filters Corp.) Model ABR-8, but specified in stainless steel instead of the usual brass, can be used with the disposable 8-in. filter cell, 1541 KCOSS-1, which consists of cotton fiber wound on a stainless-steel wire-mesh core. However, the need for a filter should be established relative to the type of use because the rapid purging in these small systems minimizes sludge accumulation.

6. *Spray Nozzles.* The forceful solid-cone spray required for washing and usually for solution application can be obtained by the use of commercially available nozzles, such as the stainless-steel $\frac{1}{8}$ GGSS-1 supplied by Spraying Systems Co. At 30 psi, this nozzle is rated to deliver 0.17 gpm. A diversity of nozzle types are available from several manufacturers and can be obtained in various other materials, such as Monel metal, and hard rubber. In the 90-fpm machine, nine nozzles were sufficient to cover the film in two loops totaling 15 ft in length, while five additional nozzles were needed for an additional loop.

7. *Pumps.* Several types of pump suitable for supplying the 2 gpm at 30 psi required in the case of the 90-fpm machine are available. Corrosion resistance equivalent to that of "18-8 molybdenum" (American Iron and Steel Institute), Type 316 or 317, is desirable, especially with fixing baths, while Type 304 is suitable for developer. Other highly resistant metal, glass, or plastic materials may be required for use with more corrosive baths, such as bleaches, toning baths, etc.

8. *Drying Air Temperature Control.* Drying systems in which the air is recirculated present the usual problems of regulation and may require hygrometers as well as thermostats. In contrast, once-through systems which take low-temperature room air and raise its dry-bulb temperature 30 F require only a thermometer and means for manually setting the power input to the heaters if the quality of the supply air is constant. Problems of regulation as well as operation are entailed if the air distribution system has a large thermal capacity or sluggish heaters. Rapidly responding electrical heaters are generally most suitable and should be placed close to the discharge orifices.

9. *Air Heaters.* A wide variety of electrical heaters are available in forms suitable for the space in which they must be installed.

10. *Rollers.* Because they were readily available, molded rollers of "non-fogging" Bakelite were used in the 90-fpm machine, even though they were eroded rather rapidly by the hot high-pH developer. Rollers were turned from other more resistant plastics or even from stainless steel for some of the other machines.

11. *Corrosion-Resistant Construction.* In some cases, it will be impractical to solve the problem of corrosion resistance by specifying construction with certain materials. It may then be necessary to plan to renew certain parts from time to time. Considerable assistance can be obtained from the recently published *Corrosion Handbook*¹⁷ and from the booklet, "Materials for the Construction of Photographic Processing Apparatus."¹⁸

REFERENCES

1. E. Goldberg, "Anwendung der Fernschmethoden in der photographischen Technik," *Kinotechnik*, vol. 14, pp. 401-402, 1932.
2. G. Schuberg, W. Dillenburger, and H. Zschau, "Das Zwischenfilmverfahren," *Fernseh G.m.b.H.* vol. 1, pp. 201-210, Dec. 1939.
3. A. G. D. West, "Television in the cinema," *To-Day's Cinema*, pp. 5-9, June 27, 1935.
4. F. E. Tuttle and C. H. Green, "Photographic race timing equipment," *Jour. SMPE*, vol. 27, pp. 529-536, Nov. 1936.
5. A. R. Burkin, "Ultra-rapid processing of photographic materials," *Phot. Jour.*, vol. 87B, pp. 108-111, Sept.-Oct. 1947.
6. R. J. Hercock, "The photographic recording of cathode-ray tube screen traces; the choice of emulsions and developers," *Phot. Jour.*, vol. 86B, pp. 138-142, 1946.
7. F. Brown, L. L. Blackmer, and C. J. Kunz, "A system for rapid production of photographic records," *J. Frank. Inst.*, vol. 242, pp. 203-212, Sept. 1946.
8. B. K. Thorne, "Air Force 'Brass' Gets 'At Ease' Sky," *New York Times*, June 27, 1949.
9. D. S. Bond and V. J. Duke, "Ultrafax," *R.C.A. Review*, vol. 10, pp. 99-115, Mar. 1949.
10. J. G. Capstaff, Eastman Kodak Co. U.S. Patent No. 2,289,753, 1942.
11. H. A. Miller, J. I. Crabtree and H. D. Russell, "A prehardening bath for high-temperature processing," *J. Phot. Soc. Amer.*, vol. 10, pp. 397-404, Sept. 1944; vol. 10, pp. 453-458, Oct. 1944.
12. H. Parker and J. I. Crabtree, "Rapid processing methods," *Jour. SMPE*, vol. 26, pp. 406-426, Apr. 1936.
13. J. I. Crabtree and H. D. Russell, "Rapid processing of photographic materials," *J. Phot. Soc. Amer.*, vol. 10, pp. 541-551, Nov. 1944.
14. R. W. Henn and J. I. Crabtree, "Photographic processing at low and sub-zero temperatures," *J. Phot. Soc. Amer.*, vol. 12, pp. 445-451, Oct. 1946.
15. J. I. Crabtree, "Rapid processing of films and papers," *J. Phot. Soc. Amer.*, vol. 15, pp. 130-136, Feb. 1949.
16. G. I. P. Levenson, "The chemical economics of spray processing," *Brit. Kinemat.*, vol. 14, pp. 65-81, Mar. 1949; also G. I. P. Levenson, *Jour. SMPE*, vol. 53, pp. 665-690, Dec. 1949.
17. H. P. Gregor and N. N. Sherman, "Demineralization of photographic wash water by ion exchange," *Jour. SMPE*, vol. 53, pp. 183-192, Aug. 1949.
18. *Corrosion Handbook*, H. H. Uhlig, Editor, J. Wiley & Sons, New York, 1948.
19. J. I. Crabtree, G. E. Matthews, and L. E. Muehler, *Materials for the Construction of Photographic Processing Apparatus*, Eastman Kodak Co., Rochester 4, N.Y.

A 16-Mm Rapid Film Processor

BY J. S. HALL AND A. MAYER

GENERAL PRECISION LABORATORY INC., PLEASANTVILLE, N.Y.

AND G. MASLACH

UNIVERSITY OF CALIFORNIA, BERKELEY, CALIF.

SUMMARY: The proven practicability of spray processing, coupled with the availability of acetate film bases which will withstand fairly high processing temperatures, enables construction of compact continuous processing equipment for operation at synchronous speed of cameras and projectors. The theory and construction of an experimental equipment are described. Significant performance features are studio print quality, continuous automatic operation and convenient control of process variables. Auxiliary equipment permits reel-to-reel, camera-to-projector or camera-to-reel processing. Possible applications are television network service in connection with video recording, motion picture theaters, laboratory processing of small film batches, and motion picture studio monitoring of critical takes.

ALTHOUGH PRODUCTION of release prints in 16-mm size has increased considerably in the past few years, very few users of 16-mm film have been able to maintain complete processing facilities for preparing their own prints immediately after photography. Recent developments in film bases and emulsions now enable construction of compact high-temperature, continuous processing equipment for this purpose.

Continuous film processors operate on fundamentally the same principle, regardless of their size or their speed of operation. The film travels at a steady rate through a series of processing chambers, where it is developed, rinsed, fixed, washed and dried in accordance with a definite time cycle. Time allotments in the wet stages of the cycle are determined largely by solution strengths and temperatures. In the drying stage, the time allotment is determined by the film water content and by the effectiveness of the drying method. The sum of the separate time allotments is the total processing time. The internal film path is sufficiently long to allow completion of the processing cycle while the film travels through the machine at a predetermined rate.

The physical form of a processor is, however, subject to wide variations, depending on the operating condition for which the particular processor is designed. Commercial bulk film processors are designed for high production quotas, involving film travel rates of at least

PRESENTED: April 25, 1950, at the SMPTE Convention in Chicago.

150 fpm. These machines have long internal film paths and use large quantities of developer and fix solutions. They are therefore quite large, requiring one or more rooms for complete installation. Threading is a lengthy operation. The travel time from one end of the machine to the other may be as long as 30 min.

Television film processing introduces a new operating condition, calling for a different type of processor. In this case, the processor

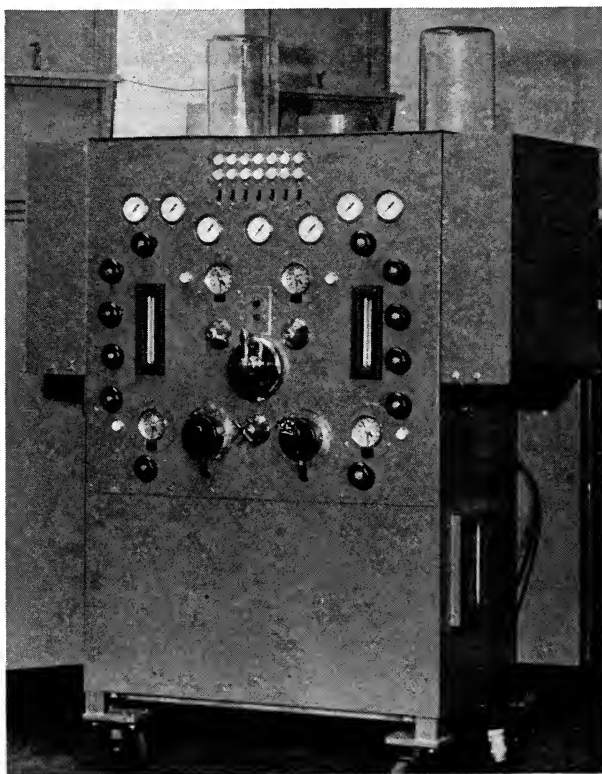

Fig. 1. Rapid film processor, front view.

receives film directly from the camera, and the prime requirement is that the film should be ready for projection in as short a time as possible. The machine developed for this purpose is called a Rapid Film Processor. It differs from a bulk film processor in several respects. The film travel rate is only 36 fpm, which corresponds to the average rate of 16-mm film, exposed at 24 frames/sec. Since the rate is much lower than that required in a bulk film processor, the

internal film path can be much shorter, threading can be simpler, and construction can be much more compact. Solution quantities are correspondingly smaller, and hence there need be no major loss of time and chemicals when starting and stopping the processor. Special measures are, however, required to shorten the processing time in both the wet and dry stages.

The introduction of hardened emulsion type film (Eastman Fine

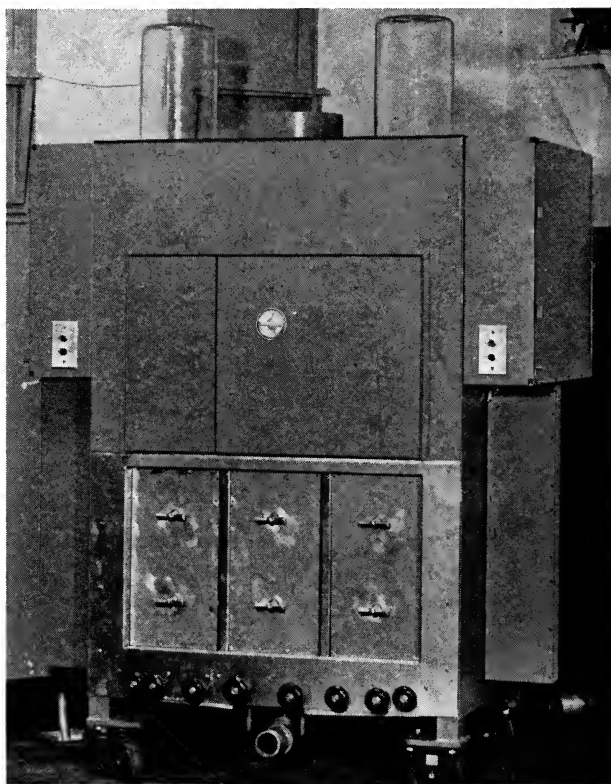

Fig. 2. Rapid film processor, rear view with covers closed.

Grain Release Positive, Type 7302) permits rapid processing at elevated temperatures. A rule-of-thumb formula indicates that processing time is cut in half for each 15 F (degrees Fahrenheit) temperature increase.

The film stock is intended for positive prints, but can be used as a negative material in noncritical applications. It is low in cost and has the added advantage of a fine grain emulsion.

The rapid film processor which will be described is an experimental model. It was constructed primarily for evaluation of space requirements, control features, and film receiving and discharge methods. The flow rates, pressures and temperatures employed in this unit are based on those used in a 35-mm pilot unit which was built by Eastman Kodak Co., under the direction of C. E. Ives and C. J. Kunz (see pp. 3-26 of this issue of the JOURNAL). Controls, indicators and measuring devices have been planned to permit further experimental studies. Simplification of controls will be necessary and desirable for commercial production.

The experimental processor stands 5 ft high, 2½ ft deep, and 3 ft wide, exclusive of side film storage compartments. It produces finished film, ready for projection, in 40 sec from the start of processing. Print quality is comparable to that obtained in larger machines operating on a much longer processing cycle. The film is thoroughly washed and fixed, and has a sufficiently low hypo content for long-term or archival storage.

GENERAL DESCRIPTION

Front and rear views of the processor are shown in Figs. 1 and 2. The film is carried on reels in storage compartments in the side covers. Exposed film from the right storage compartment is processed as it passes through the console, and is taken up as finished film on a take-up reel in the left storage compartment. With different film routing through the storage compartments, film can be received from a camera film tunnel, or can be delivered directly to a projector. Switches are provided to control a camera and projector, starting or stopping them simultaneously with the processor film drive.

The film travels on spools through the three processing tanks shown in Fig. 3. Spray processing is used in all three tanks to avoid directional effects encountered in dip processing. These effects are caused by diffusion of development products from exposed film areas onto adjacent film areas that have had different exposure. With spray processing, a uniform solution concentration is delivered to all film areas, and development products are continuously removed. The solution penetrates deeply into the film emulsion. The exposed film passes first through the developing tank, then through the rinse and wash tank to the fix tank. The film then returns to the rinse and wash tank, from where it travels upward through the air squeegee into the drying chamber.

The air squeegee, in effect, scrubs the film with a stream of pre-heated air, bodily removing surface water. The film leaving the air

squeegee requires further drying, but has no surface droplets to spot the base or the emulsion. The film then passes through a drying chamber where infrared lamps and circulating air complete the drying process. After drying, the film is ready for waxing and projection.

The processing solutions, and the rinse and wash water, are used at a normal temperature of 120 F. The rinse and wash water is discarded after a single pass through the processor. The processing solutions are conserved through recirculation, and are replenished at a constant rate to maintain working strength. The spent solution residues mix with the rinse and wash water in the sump of the processor, where they neutralize each other almost completely and become sufficiently diluted for disposal in a sewage system.

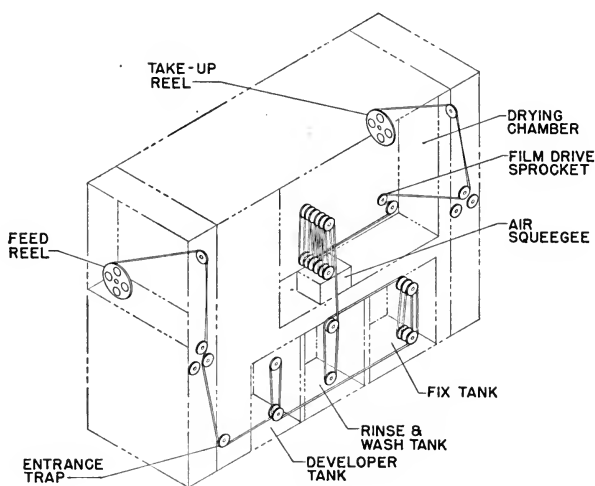

Fig. 3. Interior arrangement.

High solution temperatures and effective drying techniques reduce the total film processing time to 40 sec between the input and output ends of the processor. This time is divided as follows: develop, 5 sec; rinse, 2 sec; fix, 10 sec; wash, 5 sec; dry, 15 sec; and inter-process film transport, 3 sec.

The film drive sprocket (Fig. 3) is the only point in the processor where film is positively driven. The synchronous motor which drives the sprocket also drives the spindles which carry the upper film spools in the tanks and drying chamber. The spindles rotate at a higher rate than the film travel rate, and the resultant drag between the spindles and the spools assists the film in its travel through the

processor. This aided drive limits the film tension to less than 8 oz at any point.

In the tanks and drying chamber, the film travels in helical closed loops, with emulsion side out. Multiple loops stack compactly, so that a single group of wide angle sprays covers all the loops within a tank. The tanks are large enough for convenient film threading.

Intertank traps prevent spray transfer between tanks. The traps are plastic boxes with bottom drain holes, containing upper and lower rollers between which the film passes. The upper roller, being gravity loaded, rests on the film and confines the spray. An entrance trap seals the film tunnel against developer spray and wets the film uniformly at the start of development.

Controls for the developer system are grouped on the right side of the front panel, and are matched symmetrically by corresponding fix controls on the left side. The developer bottle, which holds $2\frac{1}{2}$ gal of developer, is inverted into a stainless-steel reservoir at the top of the processor. An air trap bottle closure of the type used in chicken feeders maintains constant fluid level in the reservoir and seals the bottle against liquid spillage during insertion and removal. From the reservoir, the developer flows by gravity through a needle valve, which controls the replenisher flow rate, and through a flow-meter to the pump input line. The pump delivers filtered and heated developer to the spray nozzles in the developing tank. The spray, after impinging on the film loops, falls into the sump, where an overflow pipe maintains a constant level and continuously drains a portion of the spent solution. The remainder of the spent solution returns to the pump input, where it is replenished with fresh developer from the developer bottle and recirculated.

Two thermostatically controlled heaters maintain solution working temperature within a tolerance of $\frac{1}{2}$ a degree. The first heater, a coarse heater with a high rating, functions on starting and cuts out at 5 F below the operating temperature. The second heater, a fine heater with a lower rating, cuts out when the solution reaches operating temperature.

The controls for the fix system are the same as those for the developer system. Normal replenisher flow rate for each system is 60 to 70 ml/min, or approximately 1 gal/hr. Two gallons are required for initial priming of each system. Approximately 0.9 gal/min are sprayed through each set of nozzles during operation.

The controls for the rinse and wash system are grouped in the center of the front panel. Operation of the system is entirely automatic. A thermostatic mixer, mounted on the front panel, maintains accurate

water temperature as long as the incoming hot water supply is hotter than the operating temperature. A panel thermometer indicates the hot water supply temperature and lights a warning light if necessary to indicate *Subnormal Water Supply*. The combined flow of hot and cold water supplies is $1\frac{1}{2}$ gal/min.

The air squeegee housing contains two orifice-blocks which direct air streams onto opposite sides of the film. The film enters the housing through a lower pair of rollers, spaced 0.008 in. apart, and leaves the housing through an upper pair of rollers, spaced 0.006 in. apart. Since the upper rollers provide no film clearance, the air stream is confined to the 0.001-in. clearance space under each lower roller. As a result, the air stream is in close contact with both sides of the film. The air stream bodily removes surface moisture from the film and carries it downward toward the sump. Each pair of rollers is spring loaded so that it yields to permit passage of a film splice, but does not deflect under normal air flow pressure. The housing may be opened for film threading.

Two 500-w infrared lamps heat the film in the drying chamber, driving moisture out of the film emulsion. An exhaust blower at the top of the drying chamber carries away moisture-laden air. Clean, dry air enters the console through filter panels in the side covers.

DELIVERY OF FINISHED FILM

Before the film leaves the drying chamber, it passes through a dip bath containing a solution of carnauba wax in carbon tetrachloride. It is generally recognized that films which have been waxed in this manner are more durable than unwaxed films. The film dries completely before it leaves the chamber, and the fumes are carried away by the exhaust blower. The film is then ready for projection.

As the finished film discharges from the processor it is either delivered to a projector or taken up on a storage reel within the side cover. One experimental type of side cover carries fittings for both methods of delivery. In addition to a take-up-reel spindle, it has a film storage elevator containing an isolating film loop. The maximum footage which can be stored in the loop is equivalent to 10 sec of running time. The main purpose of the loop is to permit simultaneous starting or stopping of processor and projector, allowing for a difference between the separate machine rates during the transition period.

A large-capacity film storage elevator is available which will permit as much as a 3-min delay between processor and projector. By use of this elevator, film can be monitored and edited prior to pro-

jection. The unit can be equipped with a commercial viewer, such as a Craig viewer, which has been found very useful for continuous monitoring.

PERFORMANCE RESULTS

A series of test runs has been made at different operating temperatures. The results of three of these runs are shown in Fig. 4, in the form of H & D curves. All runs were made with Eastman Fine Grain Release Positive Film Type 7302, processed in D-8 developer. At a temperature of 120 F, the temperature at which the required increase in processing rate was obtained, a density of 3 is attained within the linear portion of the curve.

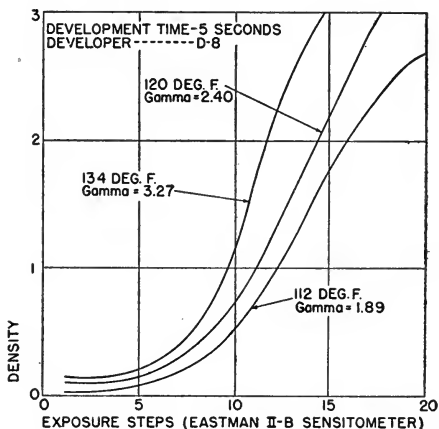

Fig. 4. Density vs. exposure at different temperatures.

It may be noted that the upper temperature limit of the series of runs exceeds the allowable processing temperature of the film. The purpose of these runs, however, was to determine the range of gamma variation in processing at different temperatures. The curve reproduced in Fig. 5 shows a very linear variation with temperature, demonstrating the practicability of gamma control through temperature setting.

The residual hypo content of film processed at normal temperature (120 F) was tested by the mercuric chloride method described in American Standard Specifications Z38.3.2-1945 "Films for Permanent Records." The film samples for test were taken at random from several film batches, and were split into two groups. The samples of one group were washed thoroughly in carbon tetrachloride to re-

move the lubricating coating or carnauba wax; the samples in the other group were untreated. All samples in both groups showed a sufficiently low hypo content to be well within the acceptable limit. On the basis of hypo content, the film qualifies satisfactorily for use in permanent records.

APPLICATIONS

The fact that finished film can be reviewed within a minute after the event has been photographed is possibly the most valuable single characteristic of the processor.

In motion picture studio practice, special sets must often be retained intact until the film has been processed and reviewed. The

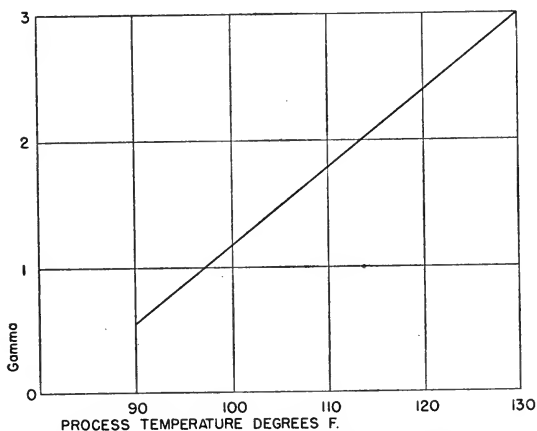

Fig. 5. Gamma variation with temperature.

necessity for checking unusual lighting effects may keep actors and stage hands on location for a much longer time than required for photography alone. Delays of this nature can be minimized by using an auxiliary 16-mm camera in conjunction with a rapid film processor.

Motion picture theaters may now photograph and process their own 16-mm film. This opens a potentially tremendous new field of application, the possibilities of which have not been fully explored. A 16-mm arc lamp projector is available for theater exhibition of films which have been prepared in this manner.

The processor is expected to become a useful tool for industrial laboratories. Machinery studies are often recorded photographically on motion picture film, but the results are not available until the film has been processed. The delay entailed in commercial processing

extends the time of a test program and increases the cost. The rapid film processor, on the other hand, can be used to make permanently recorded results almost immediately available. No major loss of time and chemicals is involved in starting and stopping the machine, and since threading is a relatively simple operation, small discontinuous film batches are readily handled. The processor is therefore well suited for laboratory operation. It is believed that use of the processor will enable sizeable economies to be effected during the course of a test program.

Films which are prepared for television broadcast by the medium of video recording require very close control in all phases of preparation. The contrast and density of the finished print are of utmost importance. When the station equipment includes a rapid film processor the studio crew can control all phases of photography, including the recording, processing, and reproduction of the film. Factors affecting either contrast or density can be partially or completely corrected within the studio, before the film enters the projector.

CONCLUSION

The rapid film processor is sufficiently compact for general use in projection booths. It provides continuous automatic operation and enables convenient control of process variables. As indicated by the performance results, it produces film of adequate contrast, density and permanence to meet critical studio requirements.

ACKNOWLEDGMENT

A development of this nature represents the combined work of many individuals. The authors wish to express to the following their appreciation for technical engineering data: H. E. White and E. Warnecke of Eastman Kodak Co. and J. G. Stott, formerly of Eastman Kodak Co. and now of Du-Art Film Laboratories.

A Method of Measuring Electrification Of Motion Picture Film Applied to Cleaning Operations

BY H. W. CLEVELAND

EASTMAN KODAK Co., ROCHESTER, N.Y.

SUMMARY: A dielectric, such as photographic film, becomes electrified when rubbed or passed over rollers. The electrostatic charges which are generated attract dust and dirt particles to the film. Since dirt is objectionable to both the manufacturer and the user of film, means are sought to reduce electrification. This paper describes a method that has been devised to evaluate roller-film combinations electrostatically. Film is brought to a given potential, either positive or negative, and the change in potential measured as it passes over a test roller. Typical data for a variety of rollers are presented. The work was extended to test the effect of rubbing film with cleaning pads of velvet and mouton fur. Measurements were also made with solvents applied to a velvet cleaning pad.

A DIELECTRIC MATERIAL, such as photographic film base, becomes electrified when rubbed against almost any object, or when it passes over a roller, either of dielectric or of metallic composition. One of the effects of this electrification, and one which causes a great deal of trouble, is the electrostatic attraction of dust particles to the film. An attempt to clean the film by brushing or rubbing usually results in higher charges which further increase the difficulty of removing the dust. This problem is serious to the manufacturer of the support who seeks to produce a dust-free film, and to the laboratory technician who handles processed films, particularly when there is dust on negative film in the printing process. If emulsion-coated films become electrified beyond a critical value, discharges occur and fog and other markings are produced.

In the handling of photographic products, one aim is to select materials and to design equipment which will produce a minimum amount of electrification. Naturally, some means of evaluating these materials in contact with different types of photographic films is necessary. This is true also in the selection of the cleaning materials and the methods of their use. The purpose of this paper is to describe a method for determining the electrification properties of roller-film combinations. In addition, it will be shown how the method can be

PRESENTED: April 28, 1950, at the SMPTE Convention in Chicago.
Communication No. 1345 from the Kodak Research Laboratories.

adapted to measure the charging and discharging characteristics of cleaning pads and the influence of cleaning solutions applied to these pads.

TESTING PROCEDURE

The schematic arrangement of equipment used in comparing various roller-film combinations is shown in Fig. 1. A loop of film, about 30 ft in length, is driven over the various rollers ($r_1, r_2, r_3, r_4, r_5, r_6, r_7$) and the test roller, in the direction shown by the arrows. Rollers r_1 and r_2 are insulated to reduce conduction of charge in the film from the test roller to the ground. The film is driven at a constant velocity by a synchronous motor connected to roller r_5 . The film is kept under constant tension by attaching a weight, W , to a floating roller, r_7 .

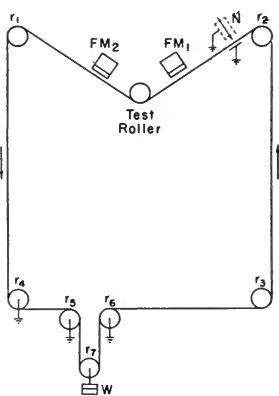

Fig. 1. Schematic diagram of testing apparatus.

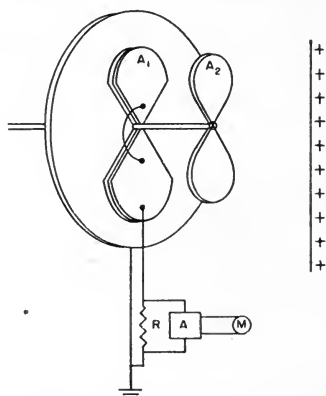

Fig. 2. Schematic diagram of field meter.

This insures a uniform pressure of the film against the test roller. The film is first brought into equilibrium with a given humidity and temperature, and then tested in this same atmosphere. The angle of wrap of the film at the test roller is normally kept at 60 deg.

After leaving roller r_2 , the film passes between an insulated needle, N , and a grounded plate. By raising the needle to high potentials, either positive or negative, charges of either polarity may be sprayed onto the film. This is similar to the scheme that is used in charging the belt in the Van der Graaf type of electrostatic generator. A 20-kv, d-c power supply, in which either the positive or the negative terminal may be grounded, is used to supply the needle potential. The grounded plate concentrates the field and increases the efficiency of this charging process. A shield is placed around the needle to prevent stray fields from affecting near-by electronic equipment.

An electric field-meter, FM_1 (Fig. 1), is placed just ahead of the test roller and a similar unit, FM_2 , just following it. These instruments are of the type described by Gunn¹ and Waddel.² A drawing of the detecting unit of this instrument is shown in Fig. 2. A grounded two-bladed sector, A_2 , rotates in front of an insulated stationary sector, A_1 ; A_1 is alternately exposed to, and shielded from, the electrified plane at the right of the figure, which, in this case, is shown to be charged positively. The insulated sector is connected to ground through a high resistance, R . When exposed to the field, a charge is induced on A_1 ; when A_1 is shielded from the field, the induced charge flows back to ground through R . Rotation of the sector, A_2 , repeats this process

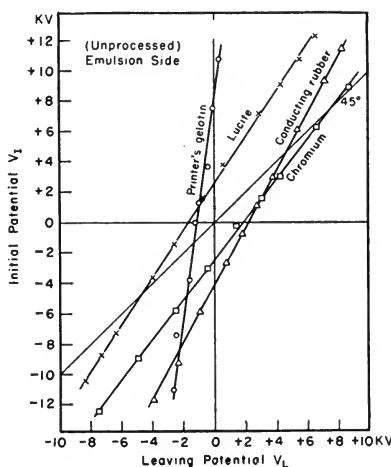

Fig. 3. Curves showing electrification of different film-roller combinations.

whereby an alternating potential is developed across R . This potential is amplified by the amplifier, A , and read on the output meter, M .

In practice, a 10-bladed sector is rotated at a speed of 1,800 rpm. This produces a 300-cycle signal. With an amplifier which is peaked for this frequency, 60-cycle disturbances are sufficiently excluded so that an electronic rectifier can be substituted for the mechanical rectifier system which has been more commonly used.³ With this instrument, the electric field, due to the charges on the film, can be read. The field meters are calibrated in terms of volts on a uniformly charged plate placed in the same position as the film to be measured. By using two of these instruments, the potentials which a given area of film assumes before and after passage over the test roller can be read di-

rectly. The relation between these two sets of values can be used to specify the electrostatic characteristic of a given roller-film combination.

The data are plotted on a 4-quadrant type of graph, with the leaving potential, V_L , as a function of the initial potential, V_I . The film is brought to any initial potential, V_I , with the necessary needle potential. The initial potentials, V_I , are plotted as ordinates, with the zero level in the center of the chart—positive potentials above the zero line, and the negative potentials below. The leaving potentials, V_L , are plotted as abscissae in a similar manner, with positive potentials to the right, and negative to the left of the zero line. If the data fall on the 45-deg line drawn diagonally through two of the quadrants (Fig. 3), the original voltage level of the film has not been altered in passing over the test roller. In the upper right-hand quadrant, if the curve falls to the left of the 45-deg line, the film is being discharged; if to the right, it is being charged. Similarly, in the lower left-hand quadrant, film will be discharged if the curve is to the right of the 45-deg line, and charged if at the left of this line.

ROLLER DATA

Examples of running unprocessed Eastman Fine-Grain Release Positive Film over four types of rollers are shown in Fig. 3. The emulsion side of the film contacted the rollers. A chromium-plated metal roller or a conducting rubber roller will reduce negative potentials on the film, but will add potential to the film if it is at low positive potential. The resulting value for subsequent passages may be found by applying V_L for one passage to V_I of a subsequent passage. By this procedure, it may be seen that the film must ultimately come to the potential which corresponds to the intersection point of the curve and the 45-deg line, e.g., for the metal roller this value is +7.5 kv and for the conducting rubber roller +4.5 kv.

An example will illustrate. Referring to the conducting rubber roller curve, if we start with an initial potential, V_I , equal to about -4 kv, the charges will be completely removed, and the leaving potential, $V_L = 0$. Now, taking zero on the V_I axis, the V_L value on the conducting rubber curve is +2.2 kv. Repeating this, if we apply $V_I = +2.2$ kv to the conducting rubber curve, we get $V_L = +3.0$ kv. Continuing this process, subsequent values are, in turn, +3.5 kv, +3.8 kv, etc., and finally the curve intersects the 45-deg line at about +4.5 kv. No further change in potential will take place. The film now leaves the test roller at the same potential it had when it reached the

test roller. This process corresponds to the passage of the film over a number of rollers of this same material.

Examination of the Lucite roller curve shows that for the film used in this case, a high positive potential, V_I , is always reduced by passage over the roller until the incoming potential, V_I , becomes about +2.5 kv. In the next passage over this roller or a duplicate roller, negative charges are added and the film leaves with a potential of -1.5 kv. Continuing the step-by-step process, the film reaches a stable potential level of approximately -4.5 kv, again the point of intersection with the 45-deg line. In the case of the printer's gelatin roller, if film, charged either positively or negatively, contacts this roller, it will be brought to a level of about -1 kv. This occurs in a very few roller passages because of the steepness of the curve. Numerous types of curves are found with different roller-film combinations and, in many cases, quite different data are found on the support side from those on the emulsion side.

CLEANING PADS AND SOLUTIONS

In order to test the effect of rubbing film with a cleaning pad, a 2-in.-diameter roller was covered with the test material, and the film passed over the material on the roller with a 60-deg wrap, the roller being held stationary. The same technique of measurement as described above was used.

It is found that ordinary velvet produces very little electrical charging when rubbed against either the emulsion or the support side of Eastman Plus-X Panchromatic Negative (processed) Film. The curves lie very close to the 45-deg line (Fig. 4), showing that this film may pass across the velvet at any potential and its potential level will not be altered. This may, therefore, be termed a "neutral" combination.

Mouton fur, on the other hand, alters considerably the potential level of processed motion picture negative film (see Fig. 5). In contact with the emulsion side, mouton fur discharges the film when it is charged to either positive or negative values, with the exception of positive potentials under 2 kv. With this exception, the film will always leave the fur at a lower potential than it possessed upon reaching the fur. Low positive potentials will be increased but will not exceed a 2-kv level. This corresponds to the point of intersection with the 45-deg line. The mouton fur will discharge the support side very rapidly when charged positively. Between +4.5 kv and zero, the polarity is reversed by the fur, and for all approaching negative potentials, still higher negative values result. Successive passages

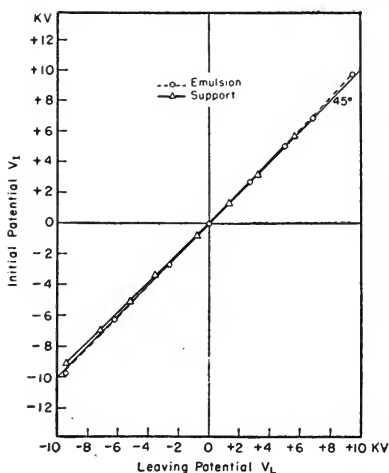

Fig. 4. Electrification curves of dry velvet and processed motion picture negative film.

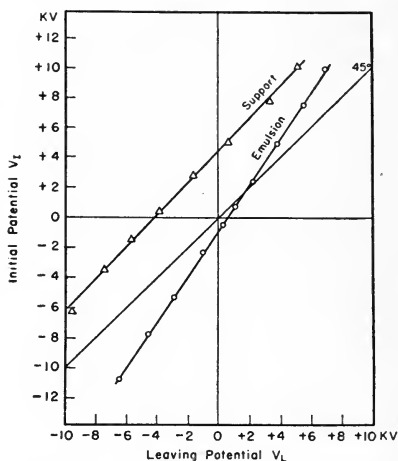

Fig. 5. Electrification curves of mouton fur and processed motion picture negative film.

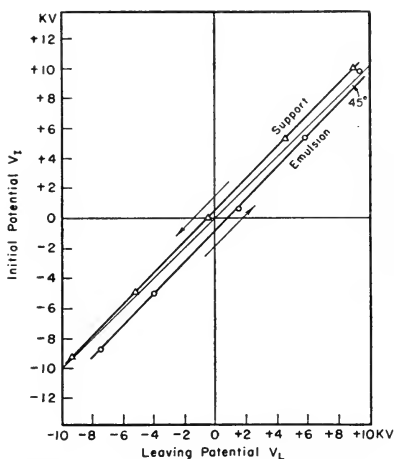

Fig. 6. Electrification curves of velvet plus petroleum ether and processed motion picture negative film.

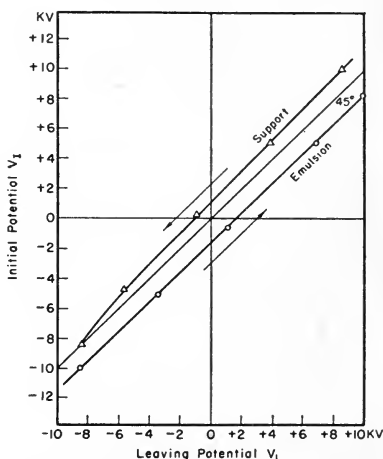

Fig. 7. Electrification curves of velvet plus Skelly Light Solvent and processed motion picture negative film.

will, therefore, build up very high potentials, since the curve does not intersect the 45-deg line, at least up to -6 kv, the limit used here. The point corresponding to $V_I = 0$ is of significance since it predicts the resulting potential with uncharged film, i.e., at zero level. A low

positive charge equivalent to 0.5 kv will be imparted to the emulsion side, and a negative charge equivalent to 4 kv to the support side.

If the velvet is wetted with petroleum ether and rubbed against the emulsion side of processed motion picture negative film, it will decrease the potential of negatively charged film but will raise the potential of positively charged film (see Fig. 6). On the support side, the reverse is true, viz., positive potentials are reduced, and negative potentials increased. These may be termed "positive" and "negative" combinations, respectively, since on the emulsion side, potentials move in the direction of positive values, and on the support in the negative direction, as shown by the arrows in Fig. 6.

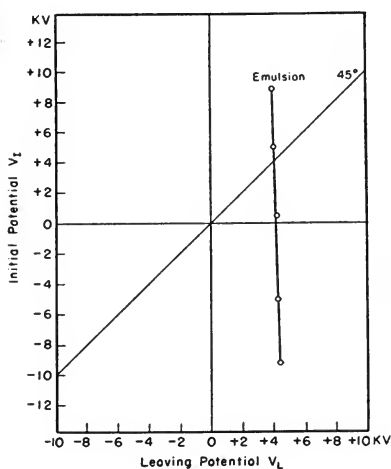

Fig. 8. Electrification curve of velvet plus carbon tetrachloride and the emulsion side of processed motion picture negative film.

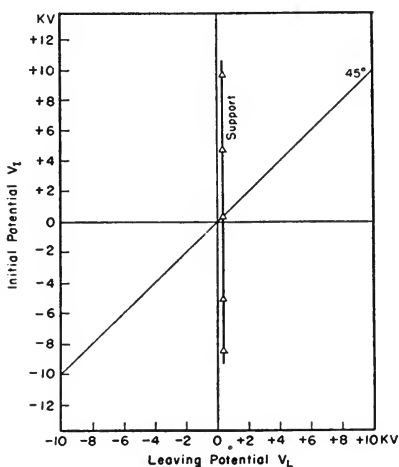

Fig. 9. Electrification curve of velvet plus carbon tetrachloride and the support side of processed motion picture negative film.

Velvet wetted with Skelly Light Solvent (a petroleum ether product manufactured by the Skelly Oil Co.) gives practically the same results on both the emulsion and support sides as described above for velvet and petroleum ether (see Fig. 7). If velvet saturated with carbon tetrachloride rubs the emulsion side, it will maintain the potential of the film at a constant value of +4.5 kv, regardless of the initial magnitude or polarity of the film potential. This is shown by the vertical lines in Fig. 8. It might be termed a "positive regulator."

A similar phenomenon occurs when the support side is rubbed with velvet saturated with carbon tetrachloride (see Fig. 9). The regu-

lated potential is also positive but has a much lower value, +0.4 kv. This represents the closest to the ideal found in any of the combinations tested, in that nearly complete de-electrification of the film is accomplished. If film can be kept at low potentials of this order of magnitude, there should be little tendency for it to collect or hold dirt because of electrostatic charges.

CONCLUSIONS

The electrification behavior of film, when passed over a roller or rubbed with a cleaning pad, can be satisfactorily evaluated by bringing the film to given potentials, either positive or negative, and noting the change in the potential level after passing the test material. Most rollers of the more common materials which are suitable for use with motion picture films add charge to film rather than dissipate any existing charge.

Dry velvet does not appreciably change the potential of processed Eastman Plus-X Negative Film when rubbing either the emulsion or the support side. If velvet can be kept wetted with carbon tetrachloride, it will hold this film at about +4.5 kv when rubbed against the emulsion side, or it will almost completely discharge the film when rubbed against the support side.

ACKNOWLEDGMENTS

The author is greatly indebted to R. Hubbard and T. Whitmore, for their assistance in this work, and to Dr. J. H. Webb, under whose direction this work was carried out.

REFERENCES

1. R. Gunn, "Principles of a new portable electrometer," *Phys. Rev.*, vol. 40, pp. 307-312, Apr. 1932.
2. R. C. Waddel, "An electric field-meter for use on airplanes," *Rev. Sci. Instr.*, vol. 19, pp. 31-35, Jan. 1948.
3. *Ibid.*, see the bibliography.

Variable-Area Sound Track Requirements for Reduction Printing Onto Kodachrome

By ROBERT V. MCKIE

RADIO CORPORATION OF AMERICA, RCA VICTOR DIV.,
HOLLYWOOD, CALIF.

SUMMARY: This paper presents a plan for establishing the processing control of variable-area sound tracks printed on Kodachrome. Data are presented for two methods starting with the 35-mm master or dubbing print and following through the intermediate steps to the final Kodachrome prints.

THE INCREASED ACTIVITY in the Kodachrome field has made it necessary to establish commercial processing tolerances. The processing control of variable-area tracks in general has been successfully established by the cross modulation method, and this same method was adopted to establish the processing tolerances for variable-area tracks on Kodachrome. There have been published a number of articles¹⁻⁴ on the processing control of variable-area sound tracks. All of these deal with the fundamental problem of controlling the image spread in the final print so that its average transmission will be constant regardless of the amplitude or frequency recorded on the track, provided that noise reduction is not considered. In the negative print process for black-and-white tracks this becomes a simple process of producing enough image spread in the negative to balance or cancel out the image spread in the print. It is understood, of course, that the print density is maintained high enough to give a good output level and signal-to-noise ratio. Kodachrome is a reversal process and this introduces other problems. The Kodachrome sound track must be printed from a positive rather than a negative and the finished sound track is a silver sulfide rather than a metallic silver track. The exposed Kodachrome duplicates are developed in a normal black-and-white developer and the exposed silver bromide area is converted to metallic silver. The unexposed silver bromide is unaffected during this process. The sound track is then treated in a sulfide solution which converts the unexposed silver

A CONTRIBUTION: Submitted June 8, 1949.

bromide to silver sulfide. In the final processing step the metallic silver is removed and the portion of the Kodachrome track exposed in the printer becomes the transparent area of the Kodachrome print. The sound track remains as a positive image of silver sulfide. To prevent a serious loss of level, there must be sufficient exposure during the printing operation to maintain the clear area portion of the completed Kodachrome print relatively transparent. As shown in the following data this area becomes the controlling density. It is also necessary to control the image spread of the black-and-white printing master so as to cancel the image spread resulting from the Kodachrome printing operation.

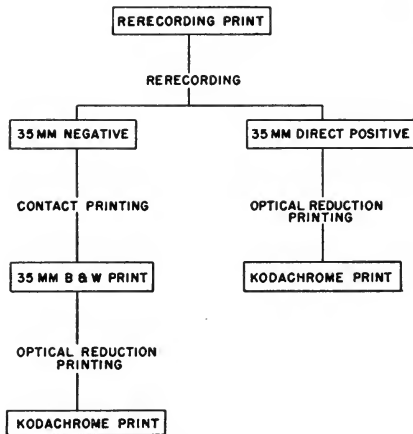

Fig. 1. Methods for making Kodachrome sound tracks.

A series of tests was planned to determine a practical method of establishing the processing control of printing variable-area tracks on Kodachrome. The following data are presented as examples of this control. Standard printers and developers were used in making this series of tests. The negatives and prints were processed according to the routine practice of the commercial laboratories printing Kodachrome duplicates.

TEST PROCEDURES

Figure 1 shows the two methods most generally used for producing Kodachrome variable-area sound tracks by optical reduction printing. These methods will be discussed in the order shown.

Method A

A 35-mm cross modulation test negative was recorded at 80% amplitude. This test consisted of: (1) 400 cycles for reference level; (2) 4000 cycles for measuring high-frequency loss; and (3) 4000 cycles modulated in amplitude at a 400-cycle rate for cross modulation measurements.

Using Eastman fine grain sound recording film, Type 1372, the cross modulation test was exposed with a 3-mm 597 filter for a density of 2.70. This negative density value was determined from previous cross modulation tests for black-and-white printing. The negative was then developed in a high contrast variable-area negative developer at a gamma of 3.50. Previous tests had indicated that no advantages could be gained by varying the density of the original negative.

From the 35-mm negative a family of contact prints was exposed with unfiltered light onto Eastman fine grain release positive, Type 1302. The black-and-white prints were developed in a print type developer at a normal release print gamma of 2.50. Print densities ranging from 1.28 to 2.25 were obtained.

Figure 2 shows the cross modulation curve of the black-and-white prints that were used for making the Kodachrome duplicates. A normal release print at balance density (1.28), a balance density being the maximum cancellation point, and four other prints with increasing degrees of image spread as indicated by this cross modulation curve, were selected for making the Kodachrome prints. A lighter than balance density offered no advantages for Kodachrome printing.

A family of black-and-white prints developed in a variable-area high contrast negative developer indicated that extremely high black-and-white positive densities on the order of 3.5 would be required for Kodachrome printing. As these high densities were often difficult to obtain and control under existing commercial printing conditions, only a print type developer was used for the final tests.

Families of Kodachrome duplicates were then made by optical reduction printing from these 35-mm black-and-white prints. The Kodachrome film was processed at the Eastman Kodak Cine Processing Plant in Hollywood in the normal manner for sound duplicates.

The densities of the negatives, black-and-white positives, and Kodachrome prints were measured with the Western Electric RA1100B densitometer using the visual filter. The Kodachrome prints covered a clear-area density range from 0.55 to 0.90. The Kodachrome prints are designated by the clear-area density rather than the sound track density. Due to the characteristics of the duplicating film, we have

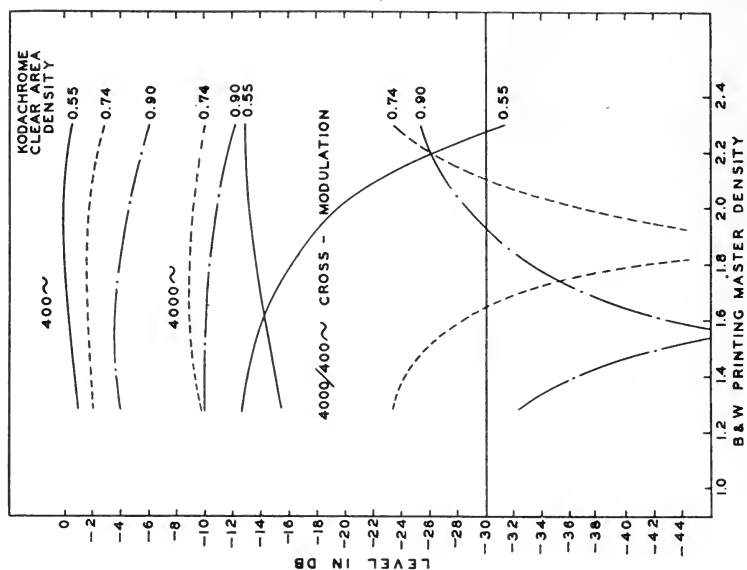

Fig. 3. Kodachrome processing characteristics.

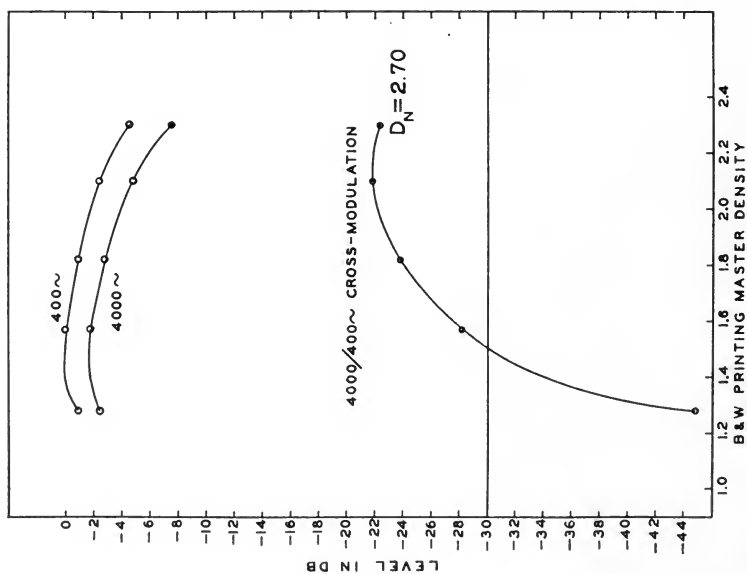

Fig. 2. Characteristics of black-and-white printing masters.

found that the clear-area density is the best index of the image spread present in the Kodachrome sound track and therefore the most accurate means of measuring density for control purposes.

The cross modulation tests were run on an RCA 200 16-mm reproducer through a calibrated reproducing system. The reproducer was calibrated with the SMPE multi-frequency 16-mm test film Series 555.

Figure 3 shows cross modulation curves plotted against the black-and-white print density.

It has been established by numerous tests that -30 -db cancellation of the 400-cycle component in the cross modulation test is satisfactory for all types of material; therefore density tolerances have been established at this cancellation value.

From these curves it is evident that satisfactory cancellation may be obtained from black-and-white sound tracks having a wide range of densities. However, volume level, as shown by the 400-cycle curve, and high-frequency attenuation, as shown by the 4000-cycle curve, must also be considered. Therefore, the Kodachrome prints which most closely satisfy all the conditions of volume output, high-frequency response and cancellation would be a clear area density of 0.74 printed from a black-and-white positive having a density of 1.85. A lighter Kodachrome print density would require a darker printing master for sufficient cancellation with a resulting loss in high frequencies, as shown by the 4000-cycle curve of the 0.55 print density. A darker Kodachrome print density would result in loss of level as shown by the 400-cycle curve of the 0.90 print density.

Method B

Using Eastman fine grain sound recording film, Type 1372, a direct positive cross modulation test was exposed with a 3-mm 597 filter over a density range from 1.60 to 2.30. The direct positive was developed in a print-type developer at a normal release print gamma of 2.50.

Figure 4 shows the cross modulation curve of the EK 1372 direct positive that was used for printing a family of Kodachrome duplicates.

Kodachrome prints covering a density range from 0.59 to 0.90 were made by optical reduction printing from the 35-mm direct positives. The Kodachrome film was processed at the Eastman Kodak Cine Processing Plant in Hollywood in the normal manner for sound duplicates.

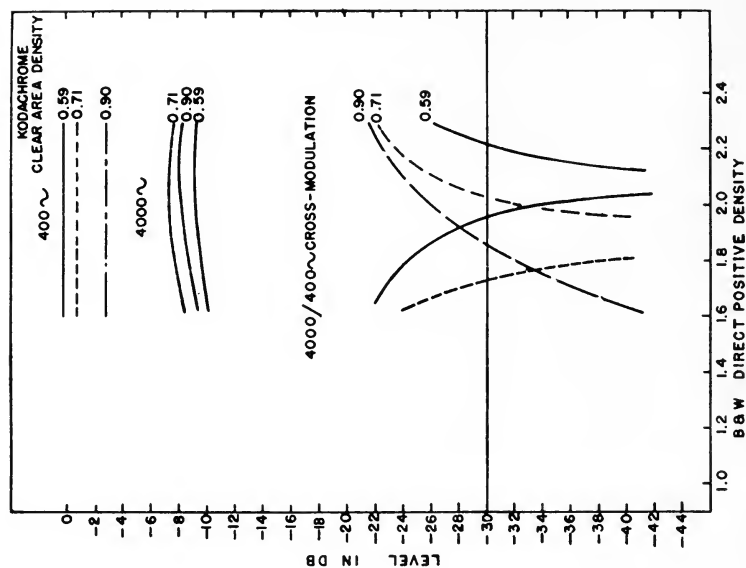

Fig. 5. Kodachrome processing characteristics.

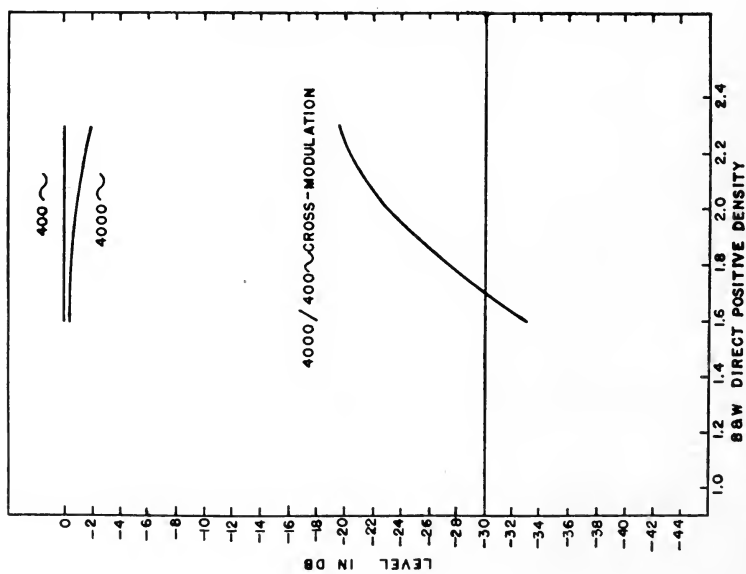

Fig. 4. Characteristics of black-and-white direct positives.

These prints were measured in the same manner as the Kodachrome duplicates made under Method A.

Figure 5 shows the cross modulation curves plotted against the direct positive density.

The Kodachrome print which most closely satisfies the conditions of volume output, high-frequency response and cancellation would be a clear area density of 0.71 printed from a direct positive having a density of 1.88. The cross modulation test processed under these conditions also indicates that a lighter Kodachrome print density would require a darker direct positive density for sufficient cancellation with a resulting loss in high frequencies as shown by the 4000-curve of the 0.59 print density. A darker Kodachrome print would result in a loss of level as shown by the 400-cycle curve of the 0.90 Kodachrome print density.

For those studios not equipped to make cross modulation measurements, the proper combination of black-and-white and Kodachrome print densities can be determined by listening tests. If Method A is to be used, a short section of sibilant dialog should be recorded and developed to a normal negative density. A series of black-and-white prints made from this negative and covering a wide density range can be used for printing a family of Kodachrome duplicates. The Kodachrome prints should then be run on a good reproducer to determine which combination of negative and print density gives the best quality. Improper density combinations will cause the sibilants to be distorted or rough. Therefore, the print which is free of sibilant distortion, which has the best volume output and high-frequency response together with low surface noise, will determine the proper combination of black-and-white and Kodachrome print density to be used.

When printing from a direct positive the same procedure should be followed. The direct positive sibilant tests should be exposed over a wide density range and developed at a normal release print gamma. A family of Kodachrome prints made from the direct positives can then be run on a good reproducer to determine which combination of direct positive density and Kodachrome print density gives the best quality.

CONCLUSION

From the above tests it is evident that satisfactory sound quality on variable area Kodachrome prints may be obtained by selecting that printing exposure which will produce a clear area density giving satisfactory volume level and high-frequency response and by using a

black-and-white with sufficient image spread to cancel the image spread which will be produced in the Kodachrome printing operation.

From these tests the following values were found to produce the best sound quality for 16-mm duplicates made by optical reduction printing:

For Method A

- (1) Negative exposed for a density of 2.70 and developed in a high contrast negative developer.
- (2) 35-mm black-and-white print exposed for a density of 1.85 and developed in a print-type developer at a normal release print gamma.
- (3) Kodachrome prints exposed for a clear area density of 0.74.

For Method B

- (1) 35-mm direct positive exposed for a density of 1.88 and developed in a print-type developer at a normal release print gamma.
- (2) Kodachrome print exposed for a clear area density of 0.71.

Due to variations in printers and developers, it is impossible to give absolute densities for the black-and-white printing masters to be used for making Kodachrome sound tracks. Therefore, data in this paper will apply to only one particular set of printing and processing conditions and can serve merely as a guide in helping to establish density tolerances for other printing or developing conditions that will be used.

REFERENCES

1. J. O. Baker and D. H. Robinson, "Modulated high-frequency recording as a means of determining conditions for optimal processing," *Jour. SMPE*, vol. 30, pp. 3-17, Jan. 1938.
2. A. C. Blaney and G. M. Best, "Latest developments in variable-area processing," *Jour. SMPE*, vol. 32, pp. 237-245, Mar. 1939.
3. Dorothy O'Dea, "Comparison of variable-area sound recording films," *Jour. SMPE*, vol. 45, pp. 1-9, July 1945.
4. G. L. Dimmick, "High-frequency response from variable-width records as affected by exposure and development," *Jour. SMPE*, vol. 17, pp. 766-777 Nov. 1931.

The Pressurized Ballistics Range At the Naval Ordnance Laboratory

By L. P. GIESELER

NAVAL ORDNANCE LABORATORY, WHITE OAK, SILVER SPRING, MD.

SUMMARY: A description is given of the ballistics range at the Naval Ordnance Laboratory, White Oak, Md. Details of the 25 photographic stations with their electronic controls are included.

A BALLISTICS RANGE is a piece of equipment used for determining the characteristics of a missile in flight. In its operation it is very similar to a classic experiment done by Leland Stanford and Edward Muybridge in 1872. Stanford, a wealthy sportsman, was interested in finding out information about the various gaits of the horse. He engaged Muybridge to set up a group of 30 cameras in a row, in a special building about 50 ft long. The shutters of the cameras were controlled electrically by wires stretched transversely from the cameras to a white wall on the opposite side. A horse galloping by touched the wires, and a series of pictures of the action were thus obtained. A chronograph measured the time intervals between successive pictures.

If we use high-speed flash photography for the cameras, and substitute electronic methods for the shutter mechanism, we will have a modern ballistics range.

Figures 1 and 2 show the physical layout of the pressurized range at the Naval Ordnance Laboratory. The range is located in a steel tube 3 ft in diameter and over 300 ft long. Pressures up to five atmospheres and down to one-hundredth of an atmosphere can be obtained inside the tube. A standard 20-mm gun located in one end shoots the projectiles down the length of the tube into an 8-ft long barrier of sand. Smaller caliber guns can also be used. Twenty-five photographic stations are located along the tube.

Figure 3 is a close-up of one of the photographic stations. When the missile passes between the source of light at A and a photocell located in B, a chain of events is initiated which ultimately causes the micro-second spark source, C, to flash. A shadow of the missile is thus thrown on the vertical photographic plate, D, and also by reflection from a mirror, E, to the horizontal plate, F. A set of

PRESENTED: October 13, 1949, at the SMPE Convention in Hollywood.

accurately located grooves from which the exact position of the missile can be determined is also photographed.

Figure 4 shows the components required for one photographic station. These components will be briefly described in the following paragraphs.

Light-Screen Source

This is a type T12-1 lamp manufactured for this purpose by the General Electric Co. The filament is approximately 28 in. long and is equipped with a spring tension device which holds it taut and straight at all times. The lamp is enclosed in a housing containing a slot covered with Eastman ruby safelight material. This reduces to a low value any fogging of the photographic plates caused by the light-screen source.

Photocell Amplifier

The photocell amplifier is made up of a photocell, a three-stage amplifier, a thyratron and a power supply. The photocell is of the



Fig. 1. Pressurized range, as seen from the gun end,

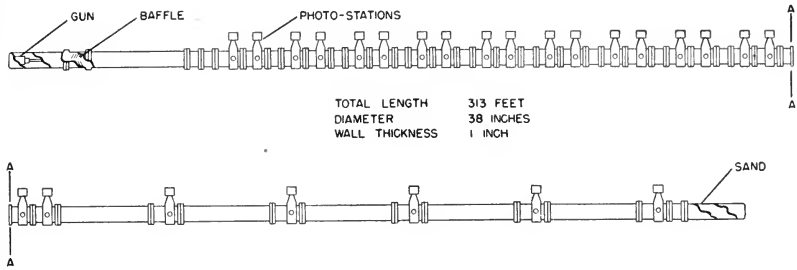

Fig. 2. Pressurized ballistics range.

high vacuum type with a red-sensitive photosurface. Light from the light-screen source is focused on this surface by a plastic cylindrical lens, which also serves to reduce the effect on the photocell of extraneous light coming from other directions. A gain control applies selective negative feedback to the amplifier and makes it possible to adjust the gain to the size of missile to be photographed. Because of the conditions of vacuum and pressure under which the apparatus is to be used, the paper condensers are of the hermetically sealed type, and no electrolytic condensers are used at all.

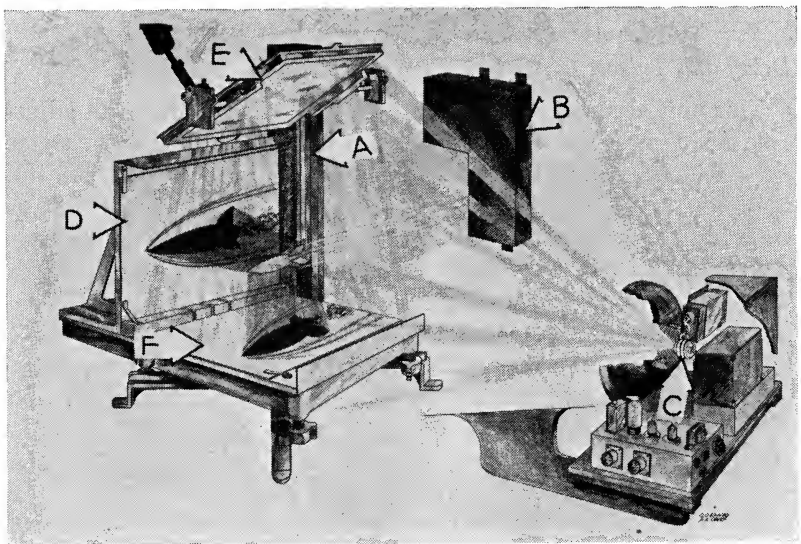

Fig. 3. Perspective view of one photographic station.

- | | | |
|------------------------|-------------------|---------------------|
| A, light-screen source | C, spark | E, mirror |
| B, photocell amplifier | D, vertical plate | F, horizontal plate |

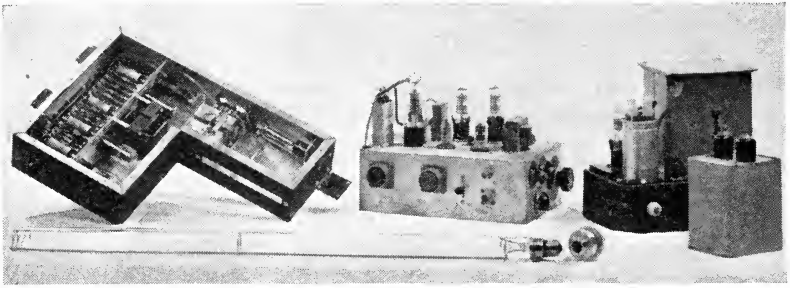

Fig. 4. Components required for one photographic station: foreground, General Electric Co. Type T12-1 Lamp and microsecond spark; background (from left to right), photocell amplifier, delay and trigger unit, high-voltage power supply and main discharge condenser.

With 70 volts applied to the light-screen source, the photocell current will be constant at approximately 0.5 microamperes, and no signal will be transmitted through the input condenser to the amplifier. A rapid change in light intensity such as is caused by a missile passing between the light-screen source and the photocell will originate a signal which ultimately fires the thyatron. An output pulse of about 50 v magnitude will result, and this value is independent of the magnitude of the initial optical signal.

Delay and Trigger Circuit

This unit accomplishes the dual purpose of introducing an adjustable delay in the sequence of events, and producing a 12,000-v trigger pulse which initiates the spark discharge. It consists of a 6J6 tube used in a "one-shot" multi-vibrator circuit, a 2D21 "booster" thyatron, a 3C45 output thyatron, and an output step-up transformer. The output of the first tube consists of a single negative rectangular wave whose duration can be varied from 70 to approximately 10,000 μ sec. The coupling network to the 2D21 thyatron produces a differentiating action, which changes the above signal to an initial negative pulse, followed after an adjustable interval by a positive one. The positive pulse fires the thyatron, which in turn fires the 3C45 thyatron. A 0.5- μ f condenser, which is initially charged to 1200 v, discharges through both thyatron and the primary of the output transformer, producing an output of approximately 12,000 v.

Spark and Discharge Circuits

The output pulse of the delay unit is applied between a trigger electrode and one of the main electrodes of the spark. The ions

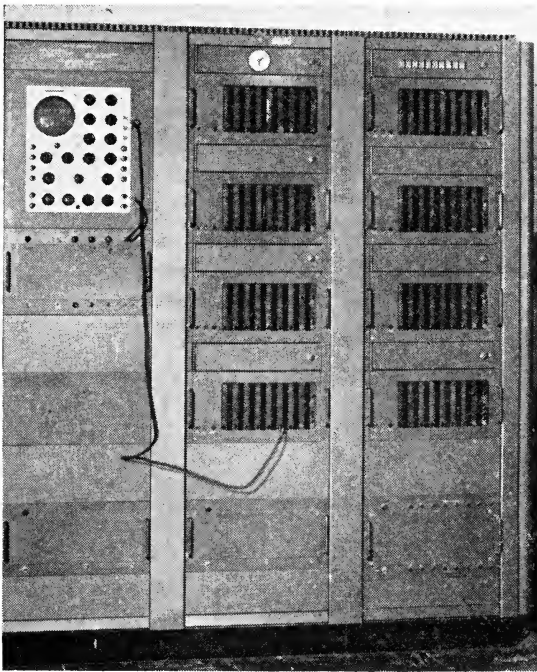

Fig. 5. Electronic chronograph; seven standard counters and one test counter are available; the oscilloscope is used for trouble shooting.

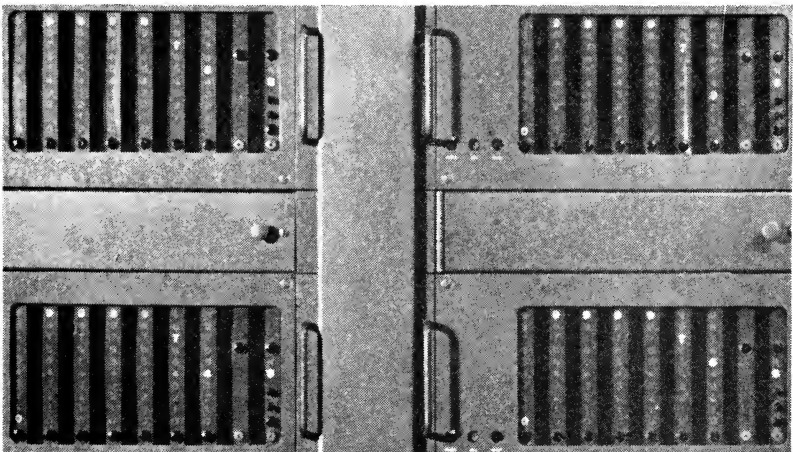

Fig. 6. Close-up of four of the counters; an interval of approximately 0.1 sec has just been measured by the counters connected in parallel.

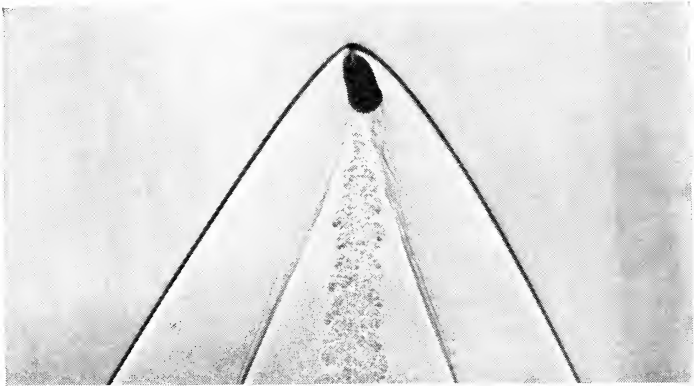

Fig. 9. 30-Caliber bullet at 75-psi pressure.

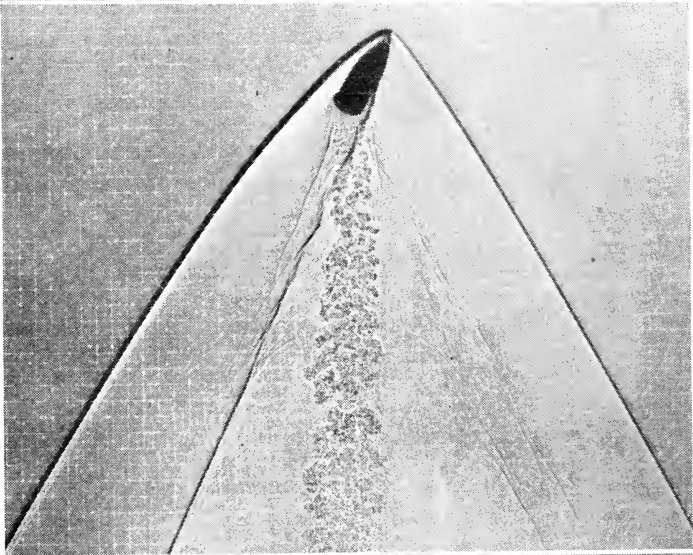

Fig. 8. 30-Caliber bullet at 50-psi pressure.

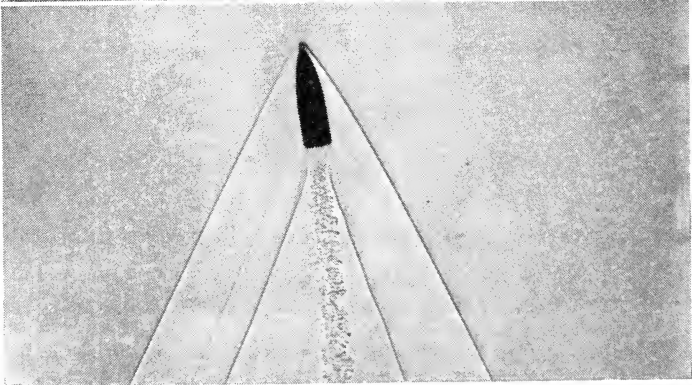

Fig. 7. 30-Caliber bullet at 25-psi pressure.

formed cause the breakdown of the main gap, thereby discharging a 0.4- μ f main discharge condenser, and producing a short brilliant flash of small diameter. The effective duration is approximately 0.5 μ sec, and the intensity is sufficient to give pictures of good contrast at a distance of 72 in. At the instant that the spark flashes, a pulse is produced which actuates the chronograph.

Further Considerations

Lantern slide plates are used rather than film or paper to eliminate errors in missile position that might be caused by shrinkage. They may be either 11 \times 14 in. or 14 \times 17 in. in size. The large size is convenient for showing a large part of the shock wave and the turbulent wake. The developing is done in 80-gal stainless-steel tanks that will accommodate up to 48 plates at one time. Figure 5 is a photograph of the electronic chronograph used to measure the time required for the missile to pass from a reference station to any other station. Intervals up to 1 sec may be obtained to a measuring accuracy of 0.0000001 sec. The absolute accuracy is somewhat less, being determined by a quartz-crystal oscillator which drives all seven counters. Figure 6 shows how four of the counters look after they have measured an interval of approximately 0.1 sec produced by the test counter. The four determinations of the interval read 0.0999975, 0.0999973, 0.0999974, and 0.0999975 sec. Figures 7-9 are actual photographs of a 30-caliber bullet at various pressures.

To explain the value of the pressurized feature of the range, it is necessary to discuss briefly some aerodynamic considerations. Most ranges and wind tunnels obtain information on small models rather than on the full-scale missile. For subsonic work, it is essential that the Reynolds numbers be the same for the two cases. The Reynolds number is equal to dVL/u , where d is the density, V the velocity, L a dimension on the model and u is the viscosity. For testing models in a supersonic flow, the important constant is the Mach number, which is the ratio of the velocity of the missile to the velocity of sound. The Reynolds number is, however, also important. With the pressurized range it will be possible to vary the density of the gas inside the tube and thus to study the aerodynamic characteristics of missiles at the same Mach number but different Reynolds numbers. This will lead to a better correlation between model and full-scale data.

An Experimental Electronic Background TV Projection System

By WAYNE R. JOHNSON

EARLE C. ANTHONY, INC., KFI-TV, LOS ANGELES, CALIF.

SUMMARY: The system is an electronic version of the process screen now used in motion pictures and television. Two television cameras may be mixed without superimposition. A contrasting white background screen in back of the foreground subject, which is always brighter than the subject, provides contrasting information. This information keys the two cameras on or off through an electronic switch. Details of the signal selection, modification of the keying signals and the use of delay lines are discussed.

BEFORE PROCEEDING we shall review a few basic principles of television in order more fully to understand the electronic process. Television is basically a scanning system; that is, the picture is divided into lines, and the transmitted signal is formed from a dot portion of a line which dot portion moves progressively from one end of the line to the other, retraces quickly back, and starts on another line. It takes 525 lines to make up one complete television frame and there are 30 frames in one second. Figure 1, trace A, shows an example of the electric signal corresponding to one horizontal line. The polarity of the signal as shown is white in the upward direction and black in the downward direction. The signal at each end of the line is the pedestal or blanking pulse which is black and which occurs during the retrace time of the scanning beam. It blanks out the retrace lines so that they will not show.

In order to superpose the television signals from a foreground subject and a background without securing a double exposure effect, a switching system is used to switch the output from the foreground to the background and back, as the scanning spot crosses the desired boundaries. This switch has to operate at a very fast rate—in the order of $1/10$ μ sec (microsecond) or quicker. To select the desired boundaries a switching signal is used, and to derive the switching signal a contrasting signal is needed from the studio camera which is taking the foreground subject. The contrasting signal can be white or black; we prefer a white backdrop with the foreground subject

PRESENTED: February 16, 1950, at the Pacific Coast Section Meeting in Los Angeles; and on April 25, 1950, at the SMPTE Convention in Chicago.

performing in front of it. No part of the subject can contain any portion appearing as white as the backdrop, otherwise wrong switching will occur in that region.

The light intensity radiated from the white backdrop is 150 foot-Lamberts. This is about the right amount for the type 5820 camera tubes. The stop opening is adjusted for the saturation point, that is,

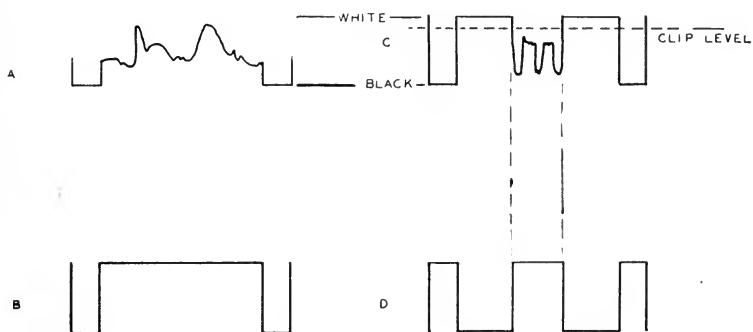

Figure 1.

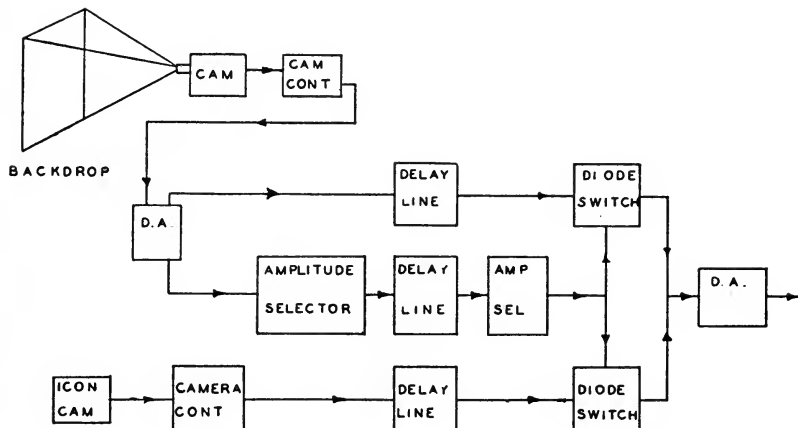

Fig. 2. Block diagram of the system.

at about $f/16$. Trace B in Fig. 1 shows the camera video signal with only the white backdrop present. Trace C shows the camera video signal with the white backdrop and with a foreground object between the backdrop and the camera.

As seen in the third trace, the white backdrop provides the contrasting information. To satisfy the need for a means of electroni-

cally isolating the white backdrop signal from the foreground object, an amplitude selection method is used, that is, a portion of the video signal is selected by the grid cutoff characteristics of electron tubes. The upper trace, C, shows the video signal at the grid of a tube; the dotted line marked "clip level" shows the grid cutoff point. The portion of the signal between this and the clear white level yields the resultant plate current, in the lower trace, D, which is in a form that could be used directly as a switching signal to switch between the foreground camera and the background information that it is desired to mix with the foreground subject.

Figure 2 shows a block diagram of the system. The foreground camera is in the upper left portion of the diagram. The white backdrop is in front of this camera and between the two is the foreground

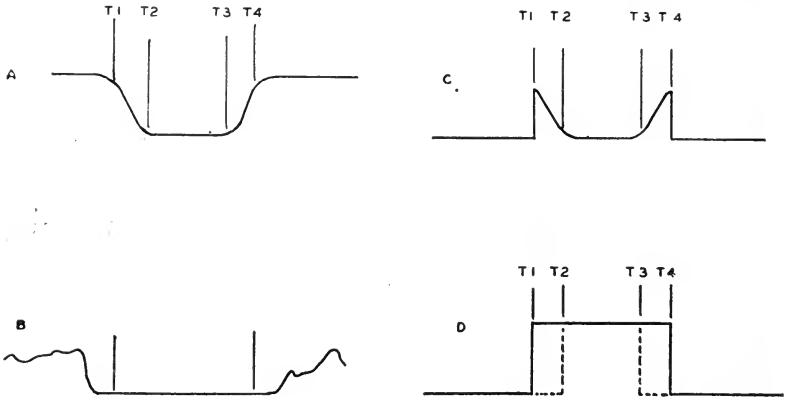

Figure 3.

subject. The video information from this camera then goes to a distribution amplifier which bridges the line and sends the video signal to the amplitude selection amplifier. This video signal also goes through a separate branch to form the pictorial signal when the foreground subject is switched in. Delay lines are used in both branches so that the times of transition in the foreground and switching signals match exactly at the final switching point. The output of the amplitude selection amplifier goes through a pulse narrowing system which will be referred to later. The switching signal from the latter system then operates a diode switch which has connected to one side of it the foreground video signal from the delay line. The background video signal from a camera or from a motion picture or slide projector is connected through an identical delay line to the other side

of the diode switch. The switching diodes are connected in opposite polarity so that, when one is on, the other is off. The common output of the diode switch is bridged by a distribution amplifier which changes the output impedance to 72 ohms and sends the composite mixture of foreground and background picture to the studio switching system.

Figure 3 shows in trace A an expanded view of a horizontal line from the foreground camera. The camera output at time T-1 is at white level and it is going to black level which is the foreground subject. Prior to time T-1 this camera was looking at the white backdrop and its output did not appear in the composite mixture, but was replaced by the background information. Television cameras do not have infinite detail so the transition from white to black requires a finite time. The speed of transition varies from $0.06 \mu\text{sec}$ for 600-line definition to $0.12 \mu\text{sec}$ for 300-line definition. It is this limitation

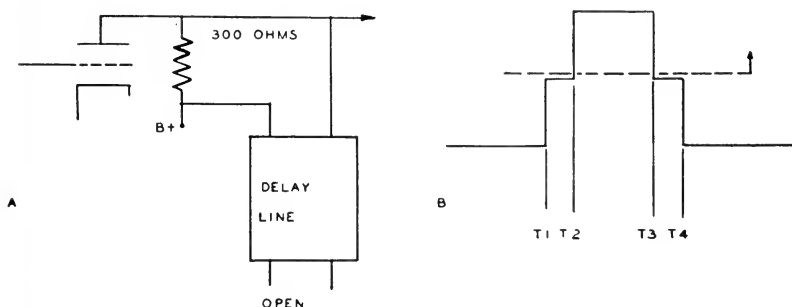

Figure 4.

that makes necessary a pulse narrowing device. Suppose the amplitude selector selects the signal at time T-1 and develops a switching signal at the same time—if the background information at this time is dark as shown in trace B it will, unfortunately, be turned off too early. Trace C shows the resultant video signal when this occurs. As the figure shows, a short white pip from the backdrop around the foreground subject will be obtained. The net result of successive horizontal lines is to produce a white ring around the foreground subject which is called halo. The same thing happens in reverse order when the switch turns the foreground subject off and the background subject on, that is, during the time from T-3 to T-4.

In order to correct for this limitation it is necessary to delay the switching signal from T-1 to T-2 and in reverse order advance the switching signal from T-4 to T-3, as shown in trace D of Fig. 3. Of course, there are no advance lines being manufactured at this time



Fig. 5A. The background scene.



Fig. 5B. The foreground actor, with white backdrop.

and a different scheme is used involving the narrowing of the switching signal by means of a delay line. Figure 4 shows in the upper portion a delay line connected to the output of the amplitude selection amplifier. A 300-ohm line is used with the far end left open. The trace at the bottom of Fig. 4 shows the switching wave form as it is modified by the delay line. At time T-1 the voltage is one-half of normal because the driving impedance is in parallel with the characteristic impedance of the delay line. When the switching voltage returns $\frac{1}{10}$ μ sec later from being reflected at the open end of the delay line it adds to the original signal at time T-2. At T-3 the switching voltage from the amplitude selector goes to zero, but the reflected signal from the open end of the delay line continues for an additional $\frac{1}{10}$ μ sec. The modified switching signal is clipped by another amplitude selector which selects the narrowed portion of the pulse giving a switching signal that is $\frac{1}{10}$ μ sec narrower. In the process of narrowing the switching pulse, an additional delay of 0.05 μ sec has been incurred. This delay is compensated for by the video delay lines before the video signal arrives at the switcher. The timing has to be held to 0.01- μ sec accuracy in order to prevent any trace of halo. So much for the electrical features of the electronic background projection equipment.

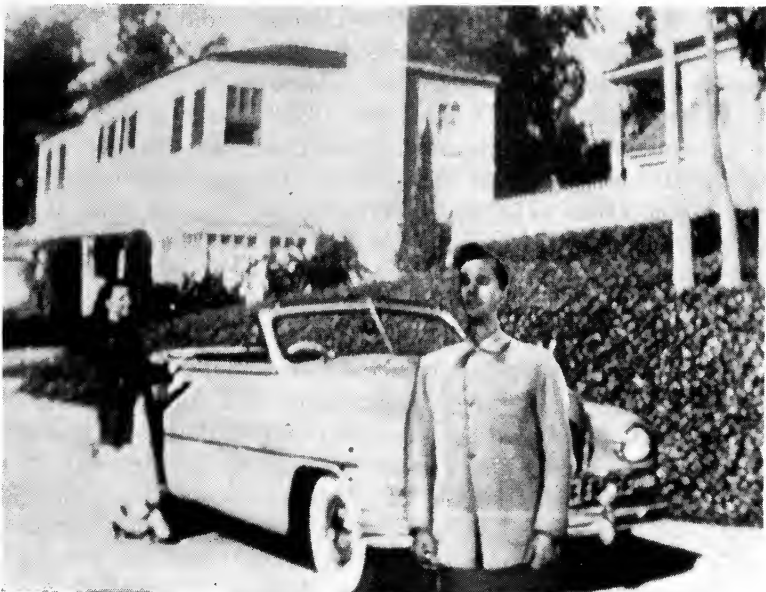

Fig. 5C. The composite picture.

Some of the characteristics of the composite mixture are of interest. For instance, the relation of the foreground picture to the background picture during the process of dolly shots and panning presents some problems and also offers some possibilities for unusual effects. The dolly shots are very realistic when the background picture is of an outdoor scene. The background picture remains stationary if it is a still, while the foreground picture is changing, that is, if the camera starts to dolly at a distance the actor first appears small, and then as the camera moves in the actor fills up more and more of the screen. At the same time, however, the background does not change. This gives the illusion that the background is at a considerable distance. If, on the other hand, the foreground camera is panning, some strange things appear to happen. The background remains stationary while the actor moves left or right as the foreground camera is panned. This gives the appearance that the actor has been moved by an invisible hand; there is no body action to indicate movement. If this effect is not desired the camera should be locked in azimuth and elevation. In normal shots this is not an insurmountable difficulty, and ways and means are being developed to eliminate it.

The nature of the system depends upon amplitude selection and this, therefore, places a limitation on the type of clothing that can be worn by the foreground performers and the type of lighting to be used in the working area. No white clothing should be worn since none of the high lights in the foreground subject should be greater than the reflection from the illuminated backdrop. The desired type of clothing would be in the gray region. Black clothing does not give too satisfactory a picture when image orthicon tubes are used in the camera. Large white areas on the image orthicon target cause some secondary electrons to be emitted into the darker areas of the target and causes the black areas to become lighter than they should. While normal type of makeup can be used in most cases, it has been found in some instances that a heavier type of makeup helps to subdue spectral reflections. Makeup on the hands has to be used for the same reason. The area in which the foreground subject performs needs to be lighted somewhat differently from the normal shots. A constant intensity of lighting is needed in the working area and this means that the light sources should be located farther away than usual. We have been using the long slim-line floor fluorescent lamps.

Figure 5A shows the background scene, and Fig. 5B the foreground actor with the white backdrop. In Fig. 5C is illustrated the composite picture obtained from the processed signal.

Effects of Incorrect Color Temperature On Motion Picture Production

BY FRANK F. CRANDELL, KARL FREUND AND LARS MOEN

PHOTO RESEARCH CORP., BURBANK, CALIF.

SUMMARY: Past efforts to systematize control of film production (and especially color) have been partially defeated by inability to detect variations of color temperature of daylight and artificial light sources. Effects of such variations on tone or color of makeup, costumes and sets are cited. Steps necessary to complete control, and the part which color temperature of illuminants plays in each are indicated. A new instrument is described which makes the practical determination of color temperature a simple step. A more accurate method is proposed for the description of illuminants, color film and filters.

THE TIME HAS PASSED when it is necessary to explain to a body of engineers what we mean by the "color temperature" of an illuminant. The concept of a black-body radiator and its Kelvin temperature is generally understood by illuminating engineers, studio technicians and workers in the field of color photography.

If the illuminants in general use were true black-body radiators, and if their color temperature were a factor of high constancy, there would be no problem in the application of such light sources to color photography and cinematography. Unfortunately, we are becoming increasingly aware that practical light sources represent only approximations, and often poor ones, of black-body radiators. It has, of course, long been realized that practical light sources vary constantly in their spectral distribution of energy, with serious results upon the exposure balance of color materials. In the earliest literature of color photography, there are frequent references to the instability of filter factors caused by the fluctuating color balance of light sources, and especially daylight. On the whole, in reading these early statements, one is struck by the fact that the subject was less complicated and easier to understand before the concept of equivalent color temperature was introduced.

In the following paper, we shall sometimes use the term "color temperature" for lack of a generally accepted term which would be more descriptive. We shall also, however, set forth the first results of a series of studies in the measurement of the color balance of practical illuminants, and make certain proposals concerning a more simple

PRESENTED: October 11, 1949, at the SMPE Convention in Hollywood.

and informative method of designating this property of a light source.

Until fairly recently, color temperature might be said to have been the "hidden factor" in color film production and color photography. We knew about it, but because there was no available means of taking it into account, there was a natural tendency to ignore it. The color balance of a scene sometimes turned out correctly, and often did not, and when it did not the blame was usually placed on the manufacturer or the laboratory. The manufacturer, harassed by the difficulties of making color film with reasonably constant over-all speed, went on the simplifying assumption that the color temperature problem could be solved by the user of color materials. The processing laboratory, busy with the complexities of maintaining unstable baths at constant energy, likewise assumed that the color temperature of the taking illuminant could be ignored.

This simplification was undoubtedly justified as a practical measure during the period in question. Today, however, it is neither justified nor necessary. Now, that incident light measurement has been generally accepted as a means of exposure determination, the ASA Exposure Index¹ takes on real meaning, and the recent announcement of Eastman Kodak that professional color film materials will be packaged with a slip bearing the individual exposure index of that particular batch will mean that exposure determination will take on an increased degree of precision.

Improvements in laboratory procedure and the use of color densitometry now make it possible to hold the color balance of monopack or integral tripack materials to tolerances comparable with those in handling separation negatives on black-and-white film. Therefore, it would be fair to assume that results should now be perfect, but, as every practical worker knows, they are not. There must be another serious factor at work, affecting color balance—and this factor, of course, is the color balance, or temperature, of the taking light.

We believe, therefore, that the time has come to bring color temperature out into the open, to recognize it, and to try to solve the problems which it creates, just as these other problems have been solved. In addition to intensity of illumination, brightness range and contrast, we must now measure the color of the illuminant.

Even in black-and-white work, this hidden factor of color temperature has had an important effect on tone reproduction of different hues. Every cameraman has had the experience of being unable to duplicate the results of an earlier test, even when film bearing the same emulsion number was used. All the conditions seemed the same, but the fact

that he may have been given old lamps for the test and new lamps on the set, or may have used "nets" instead of dimmers, may have been enough to shift the spectral distribution of the illuminant, and with it the spectral sensitivity of the film.

Even now, this question would be purely academic if no instruments were available for the measurement of color temperature. Such instruments are available, however, and their use will undoubtedly become an integral part of professional procedure. The professional worker knows that if certain factors are to be measured and controlled, then all factors should be similarly measured and controlled, or the final result may be worse rather than better.

Nor should it be felt that this complete application of measurement restricts the freedom of the artist. The cameraman, as artist, will still be free to deviate from the norm in any direction which he desires, with the added benefit of the assurance that the results will be what he wishes.

Before dealing further with the applications of color temperature measurement in motion picture production, we shall describe briefly the problems of designing an instrument for this measurement, and give one solution of the problem.

Awareness of the effects of incorrect color temperature on color balance is not new. When Wall wrote his *Practical Color Photography*² in 1922, he said: "Theoretically, one ought to determine the filter ratios before each exposure, as the color composition of daylight varies considerably, being much richer in red and green in sunlight than in shadow or in cloudy weather. But if the filter ratios have been determined, one may ignore this factor, at any rate at first." Considerably earlier references may be found in von Hubl, Koenig, and others.

Despite this awareness, surprisingly few efforts have been made in the past to provide the photographer with a means of measurement and control. Two visual instruments have been placed on the market. The first was based on the visual match of a yellow filter and an additive mixture from red and green filters. The second relies on a "dichroic" filter which appears pink under one type of illuminant and bluish under another. Such meters have undoubtedly been of considerable assistance when used correctly, but are unavoidably affected by the adaptation and condition of the observer's vision.

For this reason, it was felt worth while to develop an instrument which would not involve judgment, or any subjective factors, despite the many design problems involved.

The term "color temperature" has three meanings at the present

time: a particular spectral distribution of energy, a visual appearance which matches a particular spectral distribution, or (in photographic literature only) a certain ratio of photicities in three broad zones of the spectrum.

The instrument in question has been designed with a full awareness of this triple nature of color temperature, and to a high degree, the instrument is suitable for the measurement of all three.

If radiation is close to the true spectral distribution of black-body radiation, then the ratio of the measurement at any two points in the spectrum will be characteristic of one color temperature only, and if the instrument is properly calibrated it will be possible to measure the color temperature of true black-body radiation accurately over the desired range. This can be done with an accuracy well within the range of least perceptible differences.

Any two points in the spectrum might serve, but for maximum precision it is desirable to have the distance between the two points great enough so that filters with no overlap may be selected.

In the case of visual color temperatures, the instrument becomes in effect a photoelectric colorimeter, and the visual sensitivity curves used in standard colorimetry must be taken into account. Any two of these might be used, but since it has already been decided that there shall be no overlap, the best choice would seem to be the blue and the major portion of the red. The fact that the secondary maximum of the red sensitivity curve (in the blue) is not present in the red filter becomes without significance in this case, since the secondary maximum would alter the blue-red ratio by a constant factor, and this cancels out in the calibration of the instrument.

Thus, in the case of light sources with continuous spectra, the instrument will give the color temperature of the black-body radiation for which the illuminant in question is a visual match.

In the third case, that of photographic color balance, the problem is simple and straightforward. We are interested in measuring the amount of red and blue, and sometimes green, in three relatively broad zones with well defined maxima. While different color processes vary somewhat in the boundaries of these zones and in the precise location of the maxima, the similarities are far greater than the differences, and the agreement is close enough to make it entirely feasible to select reference points for measurement which will be valid for all present processes with precision well within the permissible tolerances.

The same red and blue filters which were selected to meet the second condition also serve for the third purpose, that of measuring photo-

graphic color balance. When departure from the correct amount of green is suspected, this can be checked by the use of the third filter, green, with which the new professional model of the instrument is equipped. If the amount of green is not that for which the red-blue ratio would call, in accordance with black-body standards, the meter will at once indicate it, and corrective measures may be applied.

The curves shown in Fig. 1 represent the effective sensitivities resulting from the combined effect of filters and barrier type cell.

How this is accomplished will immediately be clear from the following description. The body of the instrument consists of a circular housing, about 4 in. in diameter, with a pistol-type grip on the bottom for convenience in aiming the instrument at a light source. The body has a gray crackle finish. On the front of the circular housing is the opening through which light enters the instrument, surrounded by a knurled ring which is coupled to the diaphragm over the light cell. This diaphragm consists of two overlapping sectors with serrated

Fig. 1. Comparison of the standard blue and red visual sensitivity curves (dotted curve and dashed curve) with the sensitivity of barrier cell plus blue and red filters in a commercial color temperature meter.

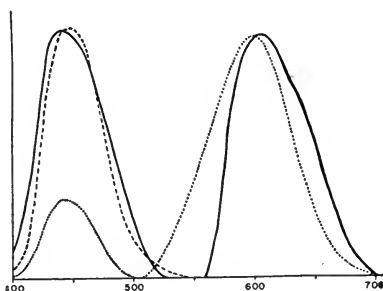

edges. Behind this diaphragm is a red filter, through which the light passes before reaching the barrier-type cell.

On the back side of the circular housing, set at an angle for easy visibility, is the needle and scale of the millimeter. On this scale is a red mark. The user points the instrument at a light source and adjusts the diaphragm ring until the needle coincides with the red mark. All that remains is to pull the trigger set in the front of the pistol grip. This replaces the red filter with a blue filter, and the scale reading then gives directly the color temperature of the light source, or the deviation from a standard temperature and the correction filter to use to bring the illuminant to that standard, depending on the scale in which the instrument has been calibrated.

One accessory to the instrument should be mentioned. This is a frosted glass hemisphere, completely neutral in color, which may be fitted over the front of the meter. This is for use when the prevail-

ing illumination is not all of one color, and it is desired to obtain a practical average value.

When measurement of the green is desired as well, for illuminants which are not a good approximation of a black-body radiator, it is a simple matter to add a green filter and a second trigger position. This is now being done on a new professional model which will be ready shortly. The significance of this green measurement, and the relation of readings to the use of corrective filters, will become clearer in a later section of this paper, in the discussion of a proposal for an improved method of specifying the color balance of an illuminant. We will first consider some of the possible applications of color temperature measurement to actual studio procedure.

When we speak of color temperature today in the motion picture industry, as already mentioned, we may mean any one of three quite different things: (1) We may mean true black-body radiation, or a close approximation thereof. (2) We may mean a light source which is a visual match for such black-body radiation, even though its spectral distribution is vastly different (and such a light source corresponds to the meaning of the adopted American nomenclature). (3) In purely photographic and cinematographic terminology, by color temperature we may mean merely the proportions of red, green and blue radiation in a light source, which balance the sensitivities of a particular type of color film—a light which may be neither black-body radiation nor a visual match for such radiation.

This third usage of the term is not met with in the scientific literature, properly speaking, but is the common usage in motion picture practice, and as such is worthy of a little more consideration than has as yet been given to this subject. In motion pictures, and in color photography generally, we are not concerned with the conformity of a light source to a particular black-body distribution of radiation. What we are interested in is a continuous spectrum in the three broad bands or zones of the spectrum which will be recorded on the film, and it is desirable that the general curve of spectral energy distribution be reasonably smooth, so that it will not show any unpleasant surprises in connection with colors having narrow absorption or reflectance bands. With this qualification it is only necessary that the energy which falls in the band of the blue filter or sensitization, the green filter or sensitization, and the red filter or sensitization have a proper ratio to the total of the three or to each other, since this will ensure color balance. Actually, it would be more accurate and correct, and more easily intelligible, to the average nonspecialist in colorimetry if we were to use the term "color balance" of the illumi-

nant rather than color temperature, since it is color balance that is actually meant.

In setting up a color process, whether it be one which uses three separate negatives, like Technicolor, or an integral tripack coated on a single base, such as Kodachrome and Ansco Color, the maker balances the film for a particular color ratio in the taking light source. So far as we are aware, very little information has been released by Eastman Kodak and Ansco on the procedures involved in this and the standards used, and it might eventually become an important contribution to a better standardization and simplification of nomenclature in this field if the manufacturers were disposed to co-operate in setting up specified procedures. It must not be forgotten that the illuminant under which color motion pictures are taken is not an end in itself but solely a means to an end, that end being a positive color film which the ultimate beholder will find agreeable and acceptably realistic.

Color temperature, in motion picture production, is not an academic question. Given a particular color process and a particular batch of film, what is desired is to make a balanced set of negatives on that film, using whatever light may be necessary for that purpose regardless of what this light may be called or how it may be classified. The basic conditions to be satisfied in this direction were laid down many years ago, when the practice of color photography was in an almost purely empirical state, in terms of what is known as "the first gray condition" and "the second gray condition." The first gray condition specified that a neutral gray, photographed through the three taking filters, shall produce equal densities in all three negatives, and the second gray condition specifies that equal densities in the three negatives shall produce a neutral gray, or a good approximation thereof, in the finished positive. Today, we should probably modify that a little bit, recognizing that in such processes as color development and some other means of forming colored images, equal silver densities do not necessarily yield equal dye densities. Therefore, the "first and second gray conditions" could probably be more accurately reworded to say that "a neutral gray object, photographed through the three filters, shall produce *correctly balanced* densities in the three negatives, and that correctly balanced densities in the three negatives shall be those densities which produce dye densities in the positive giving the best neutral gray of which the process is capable."

The simple statement of the problem in this way holds the whole basic question of photographic color temperature, and helps to point up the fact that what we are interested in is not color temperature *per se*, but a certain specific and definite ratio of silver densities in the

negative image and a certain ratio of dye densities in the finished positive.

Nothing will emphasize the absurdity of the present color temperature nomenclature in relation to photography and cinematography more than the necessity of explaining the matter to someone previously quite ignorant of it. At the present time, one is first obliged to explain the concept of a black-body radiator, an abstraction not too easily grasped by the nontechnical mind, then the complex mathematics of determining the distribution of energy in the radiation from a black body at different temperatures, the character of light emitted at the different temperatures, and so on. After this somewhat lengthy beginning, it is then necessary to confuse completely the person to whom the explanation is being given by explaining that what we have just told him is color temperature, but that what we are talking about is not that but something quite different. Then, it is necessary to go into the explanation of equivalent color temperature and light sources which are a visual match for a particular color temperature, after which we must again explain that that is not what we mean either, but that color temperature in relation to photography actually means the balance of red, green and blue in certain important sections of the spectrum, such balance to be similar to the balance of those same zones in a black-body radiator.

"Color balance of the illuminant" is probably too clear and simple a term to find favor as a new nomenclature, but there assuredly is a drastic need for a simple term which will make it clear that we are concerned with the balance of three specific zones and not with black-body radiation or a visual match for it. If, as we believe to be wise, a new term is sought, it would seem desirable at the same time to adopt a more rational system of numerical evaluation than that employed in the color temperature system. Judd³ pointed out 14 years ago that the use of the reciprocals of Kelvin temperatures would give rise to a scale in which the least perceptible difference in color temperature to the observer would remain more or less constant, whereas on the Kelvin scale it differs sharply from zone to zone. At 3200 K (degrees Kelvin) for example a difference of slightly less than 50 K is a perceptible difference, whereas at 6500 K, the least perceptible difference is in excess of 200 K. On the other hand, if these are expressed in terms of Micro-Reciprocal Degrees or Mireds (obtained by dividing the Kelvin temperatures into 1,000,000) we find that the least perceptible difference represents about the same number of Mireds over the entire portion of the scale in which we are interested. A temperature of 3200 K becomes 312 Mireds, and 6500

K becomes 154 Mireds, and in both cases the least perceptible difference would be approximately 5 Mireds. This least perceptible difference is not a constant throughout the whole of the Kelvin scale, but as Judd³ has pointed out, it is substantially constant from 1,800 to 11,000 K, which fully covers the range in which we are interested.

There would seem, therefore, to be every practical advantage in specifying light sources in terms of Mireds rather than degrees Kelvin, when we are discussing their visual appearance. However, the Mired, as a unit, still fails to convey directly the information in which we are interested for photographic purposes, and we shall propose a further standard later in this paper, though we shall relate it to the Mired.

One field which calls for definite investigation is the establishment of tolerances which will specify the permissible variation in color of the taking light. We know about what this should be when we are dealing with direct visual perception, but we do not know what difference in the color of the illuminant will produce a just perceptible difference in a color photograph taken by that illuminant.

Presumably, since the color photograph is of lower saturation, the tolerance is somewhat greater. Presumably, also, the better the subtractive primaries the more critical the balance, the poorer the primaries, the greater the tolerance. We know, for example, that when a letterpress printer has difficulty in controlling the balance of a three-color job, he deliberately "grays" the process inks by contaminating them with each other, so that the balance will be less critical.

We may assume that in an ideal process of color photography, the photographic tolerances would be the same as the visual tolerances, or about 5 Mireds. As to actual processes, we have little data. Dr. Spencer, in an investigation made in England before the war, found that a density variation in a Carbro separation positive of about 5% represented the permissible limit. This is roughly equivalent to 10 Mireds illuminant color difference, or two visual steps. Eastman Kodak recommends a tolerance of about the same amount for Kodachrome.

So, while we should not infer too much from these unrelated observations, as good a guess as any at the present time would be that on current processes the photographic tolerance is about twice the visual tolerance.

However, it is not suggested that the use of this doubled tolerance in the exposure of color film would be good practice, for two reasons: first, because as processes improve, the photographic tolerance will approach the smaller visual tolerance, and second, because if we utilize

the full tolerance of imbalance at the time of shooting, no tolerance is left for the manufacture or processing of the film.

A practical and sound tolerance, then, which we believe should be recommended at this time, is ± 5 Mireds. At tungsten temperatures, this represents about ± 50 degrees K, and at daylight temperatures, ± 200 degrees.

Permissible variation in directions away from the black-body locus remains to be investigated.

Before going farther, we shall consider the steps involved in complete color control in the studio, after which we shall take up a proposed means of systematizing such control. The major steps which affect the validity of color reproduction in a motion picture are the following:

1. Selection of correct subject matter.
2. Use of illuminants of correct color balance while shooting.
3. Correct color balance of film sensitivities and filter transmissions.
4. Use of a camera objective which is reasonably nonselective.
5. Balanced negative processing.
6. Balanced printing of the positive.
7. Balanced positive processing.
8. Projection with light of uniform color, both in distribution and duration (and preferably as white as possible), and with a minimum of stray light reaching the screen.
9. A screen which is reasonably nonselective.
10. An observer with normal vision.

With slight exceptions, these steps apply with equal force to all processes in use at the present time, and we shall briefly consider the part which the color balance of illuminants plays in several of these steps.

1. Selection of Subject Matter. This involves the choice of fabrics for costumes, pigments for set decoration, cosmetics for makeup, and many other items. Some of this choice is done by visual color matching, some by practical tests shot in advance. In the case of visual matching, it seems to us particularly unfortunate that there is a general tendency in the studios to do this under fluorescent lighting. As Nickerson,⁴ Evans, and others have recently pointed out, the presence of strong blue and orange monochromatic bands in these illuminaires leads to considerable distortion of colors with fairly abrupt absorptions and reflectances. The use of properly filtered tungsten sources would lead to more consistent and reliable color matching and selection, particularly in the makeup department. Such sources should be checked frequently for proper color with a

suitable meter. With standardized color matching sources of this type, makeup colors could be standardized, ending the present chaos. Different studios, using the same Technicolor process, employ sharply differing basic makeup colors. Which are correct? Which are better? It would seem that this might well be a matter for the attention of the Research Council of the Academy of Motion Picture Arts and Sciences, rather than the individual manufacturer of cosmetics. As regards camera tests of makeups, fabrics and the like, it goes without saying that the color of the illuminant should be rigorously controlled, so that it may be duplicated during production.

2. *Taking Illuminant.* The causes of variation in the color of the prevailing illumination on the set or on location are so numerous that an entire paper could easily be devoted to them. In the studio, the type and age of lamps, the line voltage, silks which grow yellow, filters which fade, arcs which smoke—these and a score of other factors—make the color of set illumination problematical. In the open air, there are comparable variations due to meteorological and geographical conditions. We know that reasonable errors in balance can be corrected later, provided the error is fairly constant over the entire frame. Nothing can be done, however, if it is a single face, or a single portion of the set. Control by means of suitable instruments will reduce the need for laboratory correction to a minimum, and should virtually eliminate scenes which cannot be corrected.

3. *Film and Filter Balance.* We know that there is some unavoidable variation in manufacture, in the age of the film, and so on. However, if we hold our tolerances closely on the color of the taking illuminant, the requirements of a particular emulsion number can be determined accurately and closely met. Naturally, we must be sure there is no serious image regression through too long storage after exposure and before development, since this affects balance very adversely.

4. *Nonselective Objective.* This is a minor item, but yellowed balsam in an old lens can affect blue transmission perceptibly, and low-reflectance coatings which are all of the purple type can drop red and blue transmission as much as 6%. All blue or all yellow coatings give an even worse result. The remedy, of course, is to discard old and yellowed objectives, and to have low-reflectance coatings applied with a suitable mixture of purple and brown surfaces.

5. *Negative Processing.* This has been so adequately dealt with in other papers before the Society that there would be no point in repetition here; however, better standardization of illuminant, film and filter relationships will obviously make it easier to obtain uniform laboratory results.

6. *Balanced Printing.* This again calls for accurate control of the color of the illuminant (especially in the case of multi-layer materials). Tolerances should be held as closely as on the set, which means photoelectric measurement.

7. *Positive Processing.* This has also been covered. If previous steps have been held within desirable tolerances, this step should offer less difficulty than at present.

8. *Projection Light.* The light reaching the screen should be reasonably white, uniform in color over the screen, and uniform in color when making a change-over.

9. *Projection Screen.* Should be reasonably nonselective. Photoelectric control is useful to check the combined performance of light source and screen.

10. *Normal Observer.* If the observer is color blind, there is nothing we can do about it. We can, however, be reasonably sure that the responsible personnel working with color have normal color vision, since the unsuspected presence of an individual with some form of color blindness can cause much waste and confusion.

So much for the steps in production at which control may be exercised. We have purposely curtailed this section somewhat, because we feel that more importance attaches to a proposal which we shall make for a new system of measuring and specifying the color balance of illuminants instead of the Kelvin color temperature scale. After all, an adequate system of measurement and description is the essential first step toward better control, so all of this is extremely pertinent to the general subject of the paper.

Dissatisfaction with the term "color temperature" and all that it stands for is not precisely new, but it has recently become insistent. Nickerson⁴ said, in a paper at the last meeting of the Society:

"The specification of the color of sources in terms of color temperature without an understanding of the limited meaning of the term has caused much confusion in color thinking as it concerns the illuminant... For any real understanding of color processes, whether visual or photographic, it is necessary to take into consideration the more exacting specification of spectral distribution. Thus, while illuminants in this report are often referred to in terms of the color-temperature scale, it should be remembered that it is not their color but only their spectral characteristics that will tell whether they are suitable for use with a given film, or to produce a specified result."

Evans⁵ says, in his invaluable book: "The usage of the term is exceedingly confusing and it appears inevitable that sooner or later a new terminology will appear."

Moon⁶ says, in the report of the Optical Society of America Committee on Colorimetry: "...the concept of color temperature...still serves as a rough engineering specification. However, one may expect it to decline gradually, to be replaced by the much more satisfactory spectrophotometric curve and by the colorimetric methods of Chapter XIII."

To this, Jones and Condit⁷ add the following comment in a recent paper before the Optical Society of America: "Our feelings are somewhat stronger than those of Moon concerning the discontinuance of the usage of the term 'color temperature,' particularly in the field of photography. We should like to recast the last sentence of the above quotation to read as follows: 'However, we hope its use in the field of photography will decline rapidly or cease abruptly and be replaced by...etc.'"

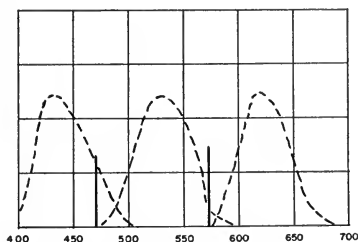

Fig. 2. Two monochromatic lines, at 470 and 573.1, visually match Illuminant C but would photograph as pronouncedly blue, as shown by dotted trichromatic filter curves.

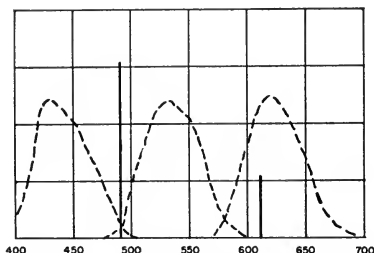

Fig. 3. Two monochromatic lines, at 490.4 and 610, visually match Illuminant C but would photograph as red.

Our own work in the field of illuminant color measurement has made us extremely conscious of the shortcomings of Kelvin temperature, which has led us to seek something more descriptive.

The inadequacy of visual-match color-temperature as a standard for color photography can be best shown by taking a few extreme cases. In Fig. 2 is shown the spectral distribution of a light source which emits two monochromatic lines, as shown. Colorimetrically, this is a visual match for Illuminant C, the artificial daylight of colorimetry. Photographically, as shown by the three filter transmissions indicated in dotted lines, this illuminant would photograph as a bright blue. The source shown in Fig. 3 would photograph as bright red, yet visually it matches Illuminant C. Lastly, that shown in Fig. 4 also matches Illuminant C, and would scarcely record on normal color film at all.

These are extreme cases, but it would be a mistake to assume that they are irrelevant. The rising popularity of lamps with strong monochromatic lines, even though these be superimposed on a continuous spectrum, makes it necessary to stress as strongly as may be that their use as illuminants for color photography leads to many unpleasant surprises, and may be misleading in the selection of fabrics, makeup, pigments and the like.

The need for a direct adequate method of specifying the red, green and blue energy content of an illuminant makes it worth while to review a proposal put forward a few years ago in connection with the spectral sensitivity of photographic materials. Dr. D. R. White,⁸ as a member of the Subcommittee on Sensitivity to Radiant Energy of the American Standards Assn., put forward a proposal which is extremely pertinent in this connection. Although his proposal was

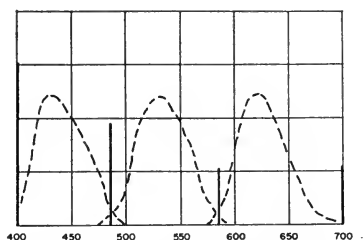

Fig. 4. Four monochromatic lines, at 400, 485, 585 and 700, visually match Illuminant C but would scarcely record at all on color film at ordinary exposure levels.

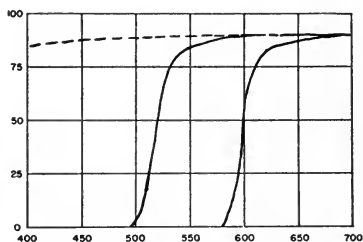

Fig. 5. Transmission curves of standard Wratten filters proposed for division of spectrum into appropriate zones: dotted line, No. 0 filter; center No. 12; right, No. 25.

limited to monochrome reproduction and to a single illuminant, we should like to point out a way in which it could be extended to cover color film and color processes, the color balance of light sources, and the calibration of correction and compensation filters.

Since Dr. White's proposal is available in the literature, there is no need here for more than a brief summary. Basically, what he proposed was a simple means of measuring the relative percentages of the total sensitivity of an emulsion to Illuminant C, in the red, in the green and in the blue, and a simple index number in which three values would completely characterize that sensitivity.

This simple and direct approach involved only the determination of filter factors. Thus, if the material required ten times the intensity of Illuminant C through a No. 25 red filter to produce a suitable standard density that was required with no filter (a filter factor of 10)

it was evident that the sensitivity in the red was one-tenth of the total sensitivity. Similar filter factor determinations in the green and blue would assign values for all three zones. However, since the notorious inefficiency of green and blue filters would make special correction factors necessary, Dr. White adopted the artifice used years before by Dr. Eder and used a red, a yellow and a colorless filter, of substantially equal efficiency. The unfiltered value minus yellow filtered value then gave a total blue reading, and yellow minus red gave the full green sensitivity.

The resulting percentages were expressed in a system of indices which it would be pointless to reproduce here, since the steps were too great for the differences which are significant in color photography. Let us see what happens, however, when we extend the system to light sources, color film and corrective filters.

Dr. White's proposal was to rate the sensitivity of black-and-white materials in relation to Illuminant C, which was a logical simplification. Color processes, however, introduce a completely new relationship between illuminant and sensitized material—a reciprocal relationship between the spectral distribution of energy in the light source and the spectral distribution of sensitivity in the film, so that an illuminant of the correct color will record balanced densities in the film.

Since the color of the light source becomes the most important variable, in this case, and since it is to the illuminant that corrective measures will be applied, it has seemed to us logical to take the illuminant as the point of departure for the entire system.

What we have done is, first, to evolve a numerical index which accurately describes the spectral distribution of energy in the light source, in terms of those attributes which have a bearing on color photography. The color film or process is then rated in terms of the index of the illuminant which will produce the most nearly neutral image of a neutral object. Corrective filters are rated in terms of the change which they introduce into the illuminant before it reaches the film. Thus, illuminant, filters and film are rated in identical units, all derived objectively from easily obtained data.

The first problem, then, is to find an index which will express the relative amounts of energy in three bands of the spectrum, suitably measured. For the isolation of these bands, the filters proposed by Dr. White seemed eminently suitable, with one modification. He proposed to use the Wratten Filter No. 25 for the red, the Wratten No. 12 for the yellow, and no filter for the white light exposure, a suitable correction factor being applied to the white light data to simulate the filter losses by surface reflection in the yellow and red light expo-

tures. To eliminate this additional step in computation, it has seemed to us more convenient to make the white light measurement through a Wratten No. 0 plain gelatin filter. All the data to be presented are based on this set of filters, Nos. 25, 12 and 0. It should be pointed out in passing that glass filters have been made with very similar transmissions, and if it is felt that complete stability of the primaries is more important than general availability, a closely matching set of glass filters could be produced. Curves of the three gelatin filters used are shown in Fig. 5; and in Fig. 6 are shown the effective red, green and blue transmissions which result after the subtraction of red from yellow and yellow from colorless. As will be seen, the fictitious filters which result from this artifice are considerably better than actual green and blue filters. The transmission maxima are all high,

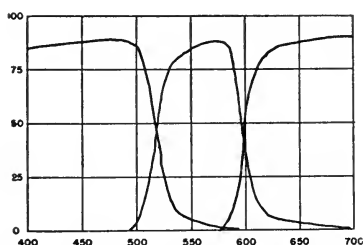

Fig. 6. Fictitious filter curves which result when transmission of No. 12 is subtracted from that of No. 0 (left); when No. 25 is subtracted from No. 12 (center); and real curve of No. 25.

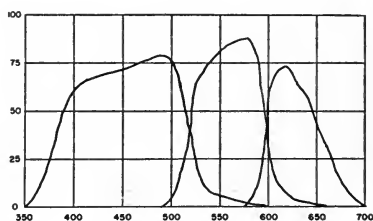

Fig. 7. Curves of Fig. 6 combined with spectral sensitivity of a typical barrier cell. This gives the proposed cutoffs at the long and short-wave limits.

and the cutoffs are steep. Furthermore, they show a good degree of similarity to the curves of leading color processes.

A special word needs to be said at this point about the boundaries of the red, green and blue zones. The boundary between blue and green lies at 518, and that between green and red at 598. This leaves the question of the long and short wave limits to be fixed. It is our belief that the blue zone should extend to 350, at which point it should approach zero, and that the red zone should reach a negligible value at 700. These limits are in good agreement with available data on color film sensitivities, which we are not at liberty to make public. Furthermore, the proposed set of filters, 25, 12 and 0 gives this sort of over-all response when used in conjunction with a suitable barrier-type cell, as shown in Fig. 7, where filter transmissions are applied to the sensitivity of a particular cell used for colorimetric purposes.

This means that photoelectric measurements may be taken which can be expected to show a high degree of similarity to the behavior of color film under the same conditions.

However, all of the computational results presented in this paper were obtained with an arbitrary set of primaries which cut off the blue at 400 and the red at 675. This was necessary because complete and accurate data were not yet available on the band from 350 to 400. However, such trials as have been made have shown that this extension of the boundaries will not affect the principal results in any material way, with the possible exception of one or two arc sources which are entirely incidental at this point.

To summarize, then, the data on which this paper is based are derived from an arbitrary set of primaries:

Blue. A Wratten Filter No. 0 minus a No. 12, with a cut-off at 400.

Green. A No. 12 minus a No. 25.

Red. A No. 25, with a cutoff at 675.

The first step was to compute the energy transmitted by these filters for a whole series of black-body radiators, from 2,000 to 12,000 K, or from 500 to 83 Mireds. Values were computed at 2,000, 3,000, 3,200, 3,250, 3,400, 4,000, 5,000, 5,900, 6,100, 7,000, 10,000 and 12,000 degrees.

For each illuminant, the energy was integrated for all three filters. For example, at 164 Mireds (6100 K) the totals were: blue, 1105; green, 720; and red, 586. Reducing these to percentages gave: blue, 45.8%; green, 29.9%; and red, 24.3%.

The first intention was to use these percentages as an index, but a few trials showed that three digits would have to be used for each color to distinguish illuminants with just perceptible color differences, so this was abandoned as impractical.

The system proposed by Dr. White—to multiply the percentages by 20, then take the logarithm—was tried also, but likewise failed to distinguish between small steps with a small number of digits in the index.

It then occurred to the writers that a ready-made system existed, with which a vast number of studio technicians and other engineers were already familiar: the decibel system. The decibel is, of course, derived by finding the log of a ratio, then multiplying it by 10 if referring to a power ratio, or, by 20 if referring to a voltage ratio. For the light energy ratios used as example in this article, a ratio multiplier of 20 was used. Each color was considered as the ratio of its energy to the total energy in the three zones, and this ratio was converted to decibels. In the example already given, the percentages

worked out as follows: 45.8%, 13.22 db; 29.9%, 9.51 db; and 24.3%, 7.71 db.

Since we are interested only in ratios, and not in absolute energy levels, and since the three always add up to 100% or unity, it was obvious that two of the values would be enough to describe the light source. The red value was, therefore, subtracted from all three decibel values, reducing red to zero and the others to proper relative levels. Numerous trials had shown that the second figure after the decimal point could be dropped without loss of the specified accuracy, so the adjusted values became: blue, 5.5; and green, 1.8; with "red 0.0" implied. This was expressed as an index in the form 5.5/1.8, which immediately tells us that in comparison with red, blue is "up" 5.5 db and green is "up" 1.8 db. In other cases, of course, either or both may be "down" as compared to red, in which case the db values are preceded by a minus sign. For want of a better name, we call this Spectral Distribution Index, or SDI.

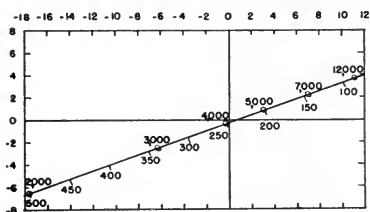

Fig. 8. Straight-line locus which results when decibel values of blue-red ratio (horizontal axis) and green-red ratio (vertical axis) are plotted against each other, 2,000 to 12,000 degrees Kelvin. Mired values (below the locus) are spaced linearly for the limits within which Wien's law is valid.

However, as an example of the results obtained with one set of primaries, the graph is shown in its entirety in Fig. 8 and with certain areas on a larger scale in Figs. 9 and 10.

As regards the Spectral Sensitivity Index, or SSI, to be applied to the film, it seems to us that the simplest procedure is to describe the film in terms of light to which it is balanced. Thus, a color film balanced to an illuminant with an SDI of $-4.9/-2.0$ would have the same figures as its SSI. Actually, of course, the sensitivities are reciprocal, but we are not interested in sensitivities per se, but only in their equilibrium with a certain spectral energy distribution.

Calibration of correction filters is greatly simplified by the use of the decibel concept. A filter is rated in terms of the decibel reduction which it effects in each zone, and this figure is arrived at by multiplying the filter density in the blue, the green and the red by 20. Since this density may be measured on a color densitometer, or computed from an accurate spectral curve, calibration becomes an extremely simple matter.

We would suggest, however, that the Spectral Absorption Index, or SAI of the filter, should retain all three values rather than be reduced to a form which eliminates the red. In this form, the gray content, or density common to all three colors, will be evident, and the index will show both the change in color of the light and the exposure increase, if any.

If, for example, a filter with an SAI of 1.0/0.5/0.5 is used with an illuminant of index 6.0/1.8, we should make the following simple computation:

6.0	1.8	0.0
1.0	0.5	0.5
5.0	1.3	-0.5

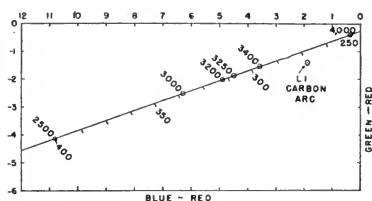

Fig. 9. Enlarged section of the db locus, taking in commonly used incandescent lamp Kelvin temperatures; as might be expected, the point representing the light from a low-intensity carbon arc is off the black-body locus.

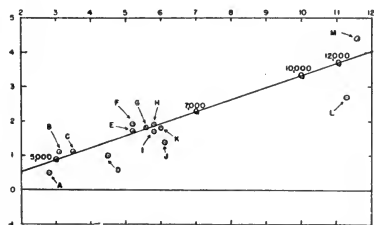

Fig. 10. Enlarged section of db locus, taking in sources of higher temperature: A, studio broadside; B, 170 M-R with Y-1 filter; C, average noon sunlight; D, Technicolor unit with Whitelite 6300 filter; E, daylight falling on horizontal plane, fairly clear; F, same on a clear day; G, sun outside earth's atmosphere; H, Graf A. C. high-intensity arc; I, complete overcast; J, Technicolor unit with Whitelite 7100 filter; K, Illuminant C; L, sunshine white flame arc; M, north sky light on a clear day.

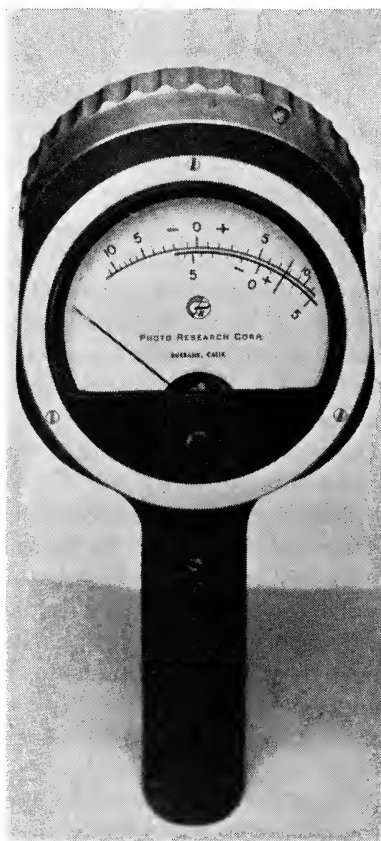

Fig. 11. Spectra Color Temperature Meter fitted with the proposed new decibel scales indicating the blue-red and green-red ratios.

Adding 0.5 to all three, to bring red back to its zero level, we have:

5.0	1.3	-0.5
0.5	0.5	0.5
5.5	1.8	0.0

This reckoning, which would usually be carried out mentally, tells us that the illuminant has been reduced to an SDI of 5.5/1.8, or, in other words, Illuminant C has been reduced to 6100 K. The total energy loss is $1.0 + 0.5 + 0.5$, or 2 db, which must be made up by a suitable exposure increase, 6 db corresponding to one full stop.

For purposes of quick comparison, and to illustrate the concise manner in which information is conveyed, it may be mentioned that while 6100 K is 5.5/1.8, Illuminant C is 6.0/1.8, which tells us at once that, in the latter, blue is up another half a db and that green is identical.

Having derived the index values for the selected series of black-body radiators, the next step was to plot them on a graph. This was carried out, with green db values along one axis and blue values along the other.

When this had been completed, a very interesting and useful property of the index emerged: the locus connecting all of the points was a straight line, with a completely linear scale of Mired values. This meant, of course, that least perceptible color differences were a substantially constant linear amount from 500 to 91 Mireds, or 2,000 to 11,000 K. The linear scale and the perfect straightness of the locus make it both easy and safe to interpolate values, and probably to extrapolate as well. Two computations serve to establish the locus, and a third to verify it.

Nonblack-body radiators will, in general, fall at points off the line. Those which fall on the line may be considered, for photographic purposes, as black-body radiators.

There would be little point, at this time, in publishing the decibel values for all of the illuminants studied, since this work will be repeated in the near future with a corrected set of primaries. This may affect the gradient of the locus, and the reference level, but there is no reason to anticipate any change in the over-all relationships which have been established.

All of the foregoing can be applied by the manufacturer, who could mark the film and filters with appropriate values, but even without this there would be little difficulty in the application of the system by a single user. The foregoing procedures can easily be correlated with standard color densitometric procedures. The laboratory could

advise the cameraman as to the best illuminant for a particular emulsion, and if the cameraman, under the pressure of production were obliged to shoot scenes with an incorrect illuminant, a single dot on a graph would tell the laboratory the nature and amount of the deviation to be expected.

An instrument incorporating the logarithmic scales described here for the blue-red and green-red values is shown in Fig. 11.

Much work remains to be and will be done on the system herein described. In the meantime, it has seemed to us that the results are sufficiently promising and interesting to warrant publication and availability for discussion at this time.

REFERENCES

1. ASA Z38.21 (1947), "American standard method for determining photographic speed and exposure index," American Standards Association, 70 E. 45 St., New York.
2. E. J. Wall, *Practical Color Photography*, Amer. Phot. Publishing Co., p. 59, Boston, 1928.
3. "A Maxwell Triangle Yielding Uniform Chromaticity Scales," Research Paper RP756, Bureau of Standards, p. 52.
4. Norman Macbeth and Dorothy Nickerson, "Spectral characteristics of light sources," *Jour. SMPE*, vol. 52, pp. 157-183, Feb. 1949.
5. R. M. Evans, *An Introduction to Color*, pp. 213-14, John Wiley, New York, 1948.
6. Committee on Colorimetry, "Physical Concepts; radiant energy and its measurement," *J. Opt. Soc. Amer.*, vol. 34, pp. 183-218, Apr. 1944.
7. L. A. Jones and H. R. Condit, "Sunlight and skylight as determinants of photographic exposure, Part II, Scene structure, directional index, photographic efficiency of daylight, safety factors and evaluation of camera exposure," *J. Opt. Soc. Amer.*, vol. 39, pp. 94-135 (p. 123), Feb. 1949.
8. "A Spectral Sensitivity Index for photographic emulsions and calculations based thereon," *Jour. PSA*, vol. 9, No. 8, p. 386, October, 1943; and No. 9, p. 585, December, 1943.

The Stroboscope as a Light Source For Motion Pictures

BY ROBERT S. CARLSON

UNIVERSITY OF MISSISSIPPI, OXFORD, MISS.

AND HAROLD E. EDGERTON

MASSACHUSETTS INSTITUTE OF TECHNOLOGY, CAMBRIDGE, MASS.

SUMMARY: The stroboscope has long been proposed as a source of illumination for ordinary motion pictures because of several attractive technical features; however, as has been pointed out clearly by F. E. Carlson¹ recently, there are serious disadvantages that must be overcome before the flashtube finds widespread practical use for everyday motion picture studio photography. This study reports additional experiences with flashtubes especially at large power input as would be needed in picture taking. One object was to find the upper power limitations of existing commercial flashtubes. A further object was to study the design and performance of a three-phase efficient power supply.

MOTION PICTURE studio lighting has been a challenging problem for electrical engineers especially since the advent of sound and color photography. There is still need for improved light sources and it is this urge which has prompted the effort reported in this paper.

The theory of flashtubes and circuits has been described in several articles given in the bibliography²⁻⁴ and therefore will not be repeated here.

First, it is in order to discuss briefly the advantages that are inherent in the stroboscopic system of illumination:

1. The flashes of light occur only while the camera shutter is open, resulting in 100% utilization of the light. A conventional camera with continuous light uses only about 50% of the light. Thus a doubling of efficiency is possible.

2. The light-producing efficiency of Xenon-filled electronic flashtubes is higher than tungsten lamps.

3. The effective color temperature of Xenon tubes is almost the same as for daylight. Therefore the same camera and film equipment can be used for outdoor and studio photography.

The main disadvantages of the stroboscopic system are:

PRESENTED: October 11, 1949, at the SMPE Convention in Hollywood. This is a condensation from a Master's thesis at the Massachusetts Institute of Technology, Electrical Engineering Dept., by R. S. Carlson.

1. The flicker of the light at 24 cycles (one flash per frame) is unbearable by the actors. It has been proposed that multiple flashes be used to avoid this difficulty. Another possible solution is to use a combination of continuous and flashing lights.

2. The short flash of the stroboscopic source produces a clear sharp photograph of a rapidly moving subject instead of the desired blurred image.

3. There is a certain amount of noise associated with a powerful stroboscopic source that may be objectionable on sound stages. Acoustical treatment will be necessary for the tubes.

This paper is concerned with the design of powerful 24-cycle stroboscopic sources using existing tubes with the thought that the advantages of the system will make the system useful, regardless of the disadvantages, for special applications.

FLASHTUBES FOR STROBOSCOPIC SOURCES

The practical upper power limit for a flashtube operated as a stroboscope is considerably different than when operated for single-flash photography. Some of the important factors influencing tube design and use are discussed in the following.

Flashtubes when used for single flashes at remote intervals of time are not concerned with the over-all temperature of the tube. The inner surface of the tube is influenced by the transient temperature pulse but the average temperature does not rise to a point where performance is influenced. One of the upper limits of energy that can be put into a flashtube in a single flash depends upon the surface temperature conditions. With a glass tube, an overload will result in a crazed surface consisting of a network of surface cracks. With a quartz tube, the overload will be several times greater for the same internal dimensions and will produce a cloudy appearance which is apparently caused by condensed quartz vapor that has been evaporated by the energy from the flash. Experiments show that the light output is not materially reduced for both glass and quartz tubes even after serious crazing or cloudiness; however, the life of such tubes may be greatly reduced.

It is very important in single-flash work to load the flashtube as high as possible in order to enjoy the resulting high efficiency; therefore an effort is made to load single-flash tubes to a maximum.

For continuous stroboscopic use, it is not possible to load the tubes since the average temperature of the tube walls will become excessive. A glass tube exhibits wall conduction when it becomes hot. The trigger electrode potential in some cases will cause a puncture of

the hot glass wall allowing the entrance of air and thereby ruining the tube. In other cases the conduction by the hot glass effectively short circuits the spark excitation, resulting in flash missing. The quartz tubes exhibit similar characteristics except the failures exhibit themselves at a much higher temperature. Puncture of a quartz tube by the excitation is a rather rare event compared to skipping, while with a glass tube the opposite is the general case. A skipping quartz tube

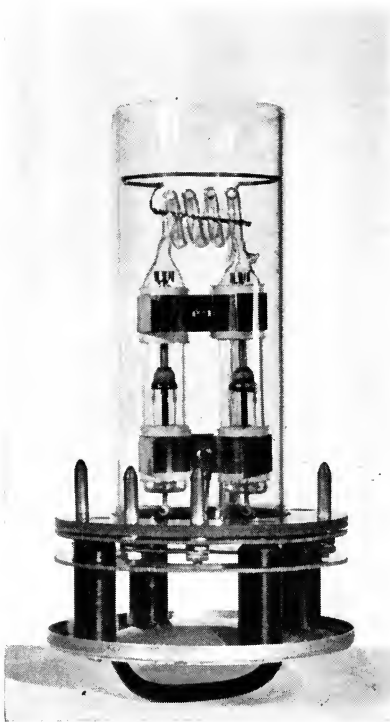

Fig. 1. General Electric quartz flashtube No. FT-417.

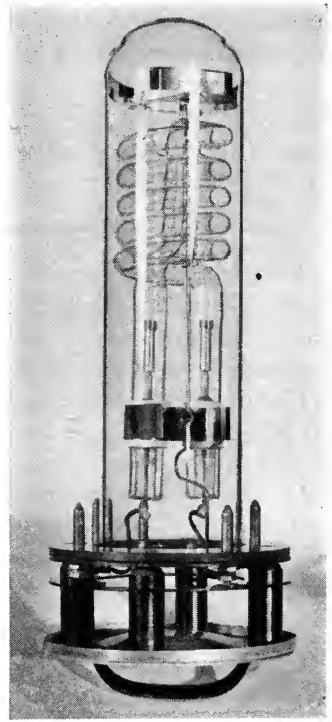

Fig. 2. General Electric quartz flashtube No. FT-623.

is usually not damaged. It can be made to operate satisfactorily by reducing the power input or by artificial cooling with air or water.

Another limiting factor for stroboscopic tubes is electrode temperature. For single-flash applications the electrodes can be small; however, for stroboscopic use, the area must be increased to radiate the continuous electrode losses.

Flashtubes such as the FT-503 and FT-524 (General Electric Co.) have a quartz spiral but small electrodes limit the input to about

700 w since with that input the electrodes reach a yellow heat. Additional continuous input will result in excessive electrode evaporation and other objectionable characteristics. A flow of air is required also for 700-w input to cool the quartz spiral and the FT-524 tube is especially designed for this with an open end so that a draft of air can be forced directly through the tube. These tubes were not studied since their output was so small.

Two quartz flashtubes are available which have a larger electrode assembly which is capable of handling greater power. These tubes are the FT-617 and the FT-417 (Fig. 1), both General Electric Co. products. Flashtube No. FT-617 is the same as No. FT-623 (Fig. 2) except that the glass envelope is open to facilitate cooling. An uncoiled version of the FT-417 is also available from General Electric Co. and is identified as the FT-427. Approximate dimensions of the helical tubes follow:

	Helix diameter, in.	Helix length, in.	Number of turns	Tubing, outside diameter	Gas
FT-417	$1\frac{1}{8}$	$1\frac{3}{8}$	4	$\frac{1}{4}$	Xenon
FT-617	$2\frac{1}{16}$	3	5	$\frac{1}{2}$	Xenon

The electrodes of both tubes consist of a sintered pellet of tungsten, nickel and barium, welded to a $\frac{1}{4}$ -in. solid iron post about 1 in. in length.

The actual tubes used in our tests were an earlier variation of the FT-617 and had a spiral of six turns instead of five. Likewise the FT-417 tube used here was an early experimental type which may be slightly different from production tubes. However it is thought that the results from these tubes will be comparable to the tubes currently available. No experiments have been made to determine the life under the conditions reported here. Our results should be

Table I. Efficiency Data

Tube	V, volts	C, microfarads	Energy, watt-sec	Light, lumen-sec	Efficiency, lumen-sec/ watt/sec
FT-214 Std.	2150	101.17	235	7550	32.1
FT-417	2150	130	300	8800	29.3
	2150	101.17	235	6650	28.3
	2150	50.7	117	2870	24.5
FT-617	2150	130	300	5750	19.2
	2150	101.7	235	4500	19.2
	2150	50.7	117	2250	19.3

considered to be preliminary and should be checked with production tubes.

The efficiency data for the two tubes under conditions as used in stroboscopic circuits are shown in Table I.

It has been found that each given type of tube can be operated at some experimentally determined maximum power input for given cooling conditions. In terms of the circuit this power is approximately

$$P = \frac{CE^2}{2} f \text{ watts input}$$

where C = capacitance in farads,

E = voltage to which the capacitance is charged prior to the flash in volts, and

f = the frequency of flashing in flashes per second.

Once the maximum power is known and the frequency selected, then the watt-seconds loading $CE^2/2$ is fixed. Likewise the efficiency is determined as given by the characteristics of the flashtube.

An important conclusion from the above that bothers the designer of a stroboscope is the decrease of possible efficiency with an increase of frequency when the power is constant. The importance of the use of quartz and forced cooling is apparent since both permit a higher power input and therefore the tube operates at a higher efficiency.

Without forced cooling, both the FT-617 and the FT-417 are limited in continuous stroboscopic operation by the heating of the quartz tubing. The FT-617 with its large-area coil structure is easy to cool with a blast of air through the tube. The FT-417 does not cool so easily since the air flow is not uniform around its small coil. Hot spots tend to develop on the opposite side of the tube from where the air is blown. These can be seen since the quartz reaches a red heat.

The FT-617 tube cannot be operated with a power input greater than 4 kw even with an unlimited air blast since the electrodes reach a temperature where holdover tendencies are in evidence. Furthermore the electrodes tend to evaporate and discolor the tube.

The FT-417 is likewise limited to 4 kw because of the electrode structure. Cooling of the quartz spiral on the FT-417 is more of a problem than on the FT-617 because of difficulty of getting adequate heat transfer. A few experiments were made with the FT-417 coil immersed in water. The operation was satisfactory even with 10-kw input for short bursts with electrode heating again being the limiting factor.

Intermittent use of a stroboscope can be accomplished at higher power inputs than when used continuously. For example an earlier version of the FT-617 tube discussed later which operated continuously at 4-kw input could be run for 30 sec with 10 kw before the electrodes reached an excessive temperature.

POWER SUPPLY DESIGN AND TUBE PERFORMANCE

The design of a power supply to operate a stroboscope tube with an input of 4 to 10 kw requires some special considerations. For example, if a single-phase a-c circuit is used, the power supply would need to have filter capacitors to smooth out the ripples which might cause nonuniformity of the light flashes.

The preferred method of supplying power from an a-c distribution system for power values over about a kilowatt is the use of the conventional three-phase system. This type of system was used for a

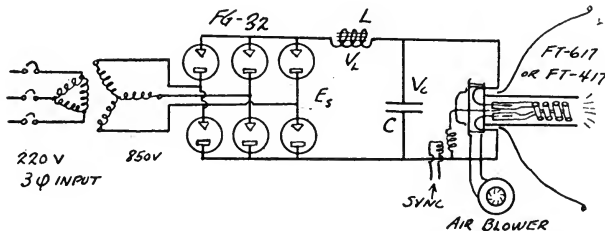

Fig. 3. Three-phase power supply to operate a flashtube at 10-kw input.

power source here with a six-phase rectifying system which has a rather small ripple. In fact with the choke charging system shown, there is no need for a capacitor filter.

Figure 3 shows the diagram of the power supply which was used. This 1000-v supply can deliver 10 kw to a stroboscope lamp at 2000 v.

Power can be purchased from the power company at the proper voltage (about 850 v) to supply the rectifiers and flashtube. In this way the cost of transformers is eliminated from the power supply equipment at a considerable saving in expense and weight.

The six-phase rectifier system reported here shows mercury vapor rectifiers, General Electric Co. type FG-32. Serious consideration should be given to selenium rectifiers for this service since the filament-heating delay complications would be eliminated. At present the selenium system would cost more than tubes but would have operational advantages that might justify the extra investment.

The size and thereby the cost of the charging inductor is deter-

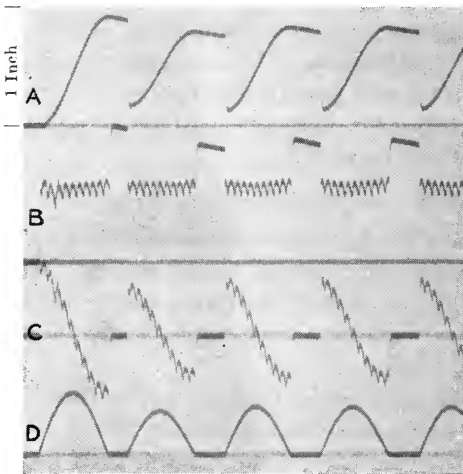

Fig. 4. Voltages and current in charging circuit during flashtube operation at 24 flashes/sec. $L = 1.62$ h; $C = 46 \mu\text{f}$.

KEY to Figs. 4, 5 and 6:

Time scale: 1 in. = 0.08 sec. (See legend beside Fig. 4 above.)

A. $V_c(t)$, storage capacitor and flashtube voltage, 1 in. = 3,780 v.

B. $E_s(t)$, rectifier output voltage, 1 in. = 3,000 v.

C. $V_i(t)$, charging inductor voltage, 1 in. = 3,220 v.

D. $i(t)$, charging current, 1 in. = 19 amp.

mined by the transient watt-second storage capacity. As will be shown later this energy is one-fourth that of the discharge capacitor. In our preliminary design investigations, we found that the inductor might weigh more than the capacitor. A further engineering study is required to arrive at the best design of the inductance.

The power transformer, if used, can be built with leakage reactance that can supply all or part of the inductive component of the circuit.

The flashtube energy storage capacitor C (Fig. 3) is charged to approximately twice the rectifier output voltage, through the charging inductor L . The capacitor holds the voltage because the rectifiers prevent a current reversal until the flashtube is triggered. When the flashtube is ionized, it breaks down and discharges the capacitor to the relatively low voltage at which the flashtube becomes non-conducting. The capacitor then recharges through the inductor, completing the cycle.

Figure 4 shows oscillographic records of the current and voltage relations in the charging circuit during repetitive operation at 24 flashes/sec, with a storage capacitor of $46 \mu\text{f}$ (microfarads) and a charging inductor of 1.62 h (henries). The rectifier output voltage has a ripple with six times the frequency of the supply voltage, caused

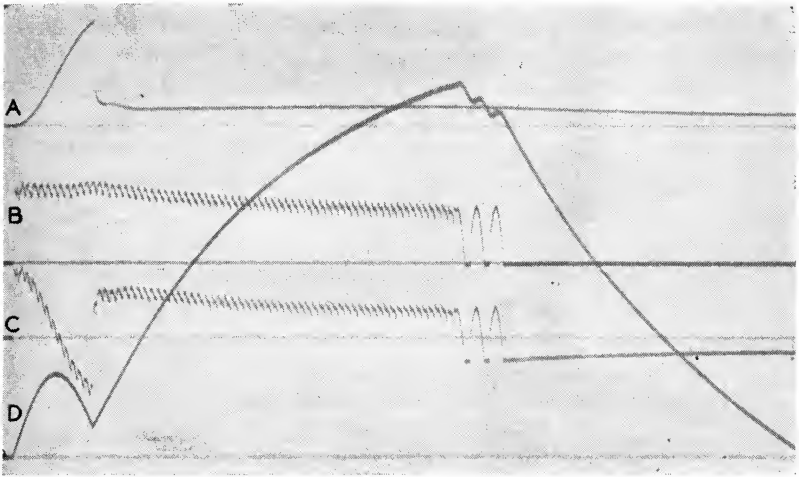

Fig. 5. Voltages and current in charging circuit, showing flashtube hold-over during first pulse of charging current. $L = 1.62$ h; $C = 94 \mu\text{f}$.

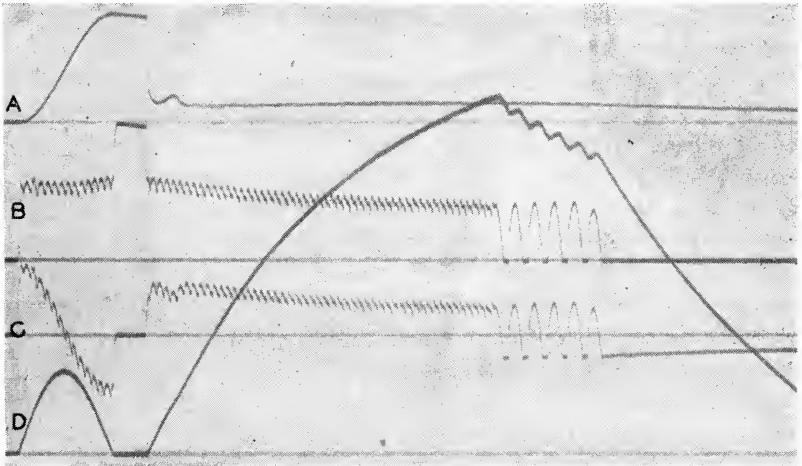

Fig. 6. Voltages and current in charging circuit, showing flashtube hold-over during second pulse of charging current. $L = 1.62$ h; $C = 94 \mu\text{f}$.

by the full-wave, three-phase rectification. The first pulses of current and voltage are larger than succeeding pulses, because the first charging cycle starts with the capacitor initially uncharged. The slight drop in the capacitor voltage after it reaches a maximum is caused by the drain of the oscillograph element and multiplier.

A mathematical analysis of the charging circuit yields the expressions given below, in which the resistance of the charging circuit has been considered negligible. For a general analysis of d-c charging, see *Pulse Generators*.⁵

$$i(t) = \frac{E_s - V_c(0)}{\sqrt{L/C}} \sin \sqrt{1/LC} \ t \quad (1)$$

and

$$V_c(t) = E_s + [V_c(0) - E_s] \cos \sqrt{1/LC} \ t \quad (2)$$

where

$i(t)$ is the charging current as a function time, t ,
 $V_c(t)$ is the storage capacitor voltage,
 E_s is the rectifier output voltage during charging,
 $V_c(0)$ is the capacitor voltage at the beginning of a charging cycle,
 L is the charging inductance in henries,
 C is the energy-storage capacitance in farads, and
 $t = 0$ is the beginning of a charging pulse.

Equations (1) and (2) are valid only between $0 \leq t \leq \pi\sqrt{LC}$; that is, the equations are valid for the duration of the charging-current pulse, or while the charging current is positive. When the charging current is zero, the drop across the inductor is zero and the rectifier voltage becomes equal to the capacitor voltage, which is about twice E_s , and Eq. (1) and (2) no longer hold. If the current has not become zero by the time the flashtube is fired, it is likely that continuous conduction of the flashtube will result, with current being supplied directly from the power supply to the flashtube. To assure that the current will be zero at the time of the flashtube firing, $\pi\sqrt{LC}$ should be less than the period between successive flashes. However, making the charging period very short means higher instantaneous charging current, which makes the duty harder on the rectifier tubes and other parts of the power supply. The waveform of the input alternating current also becomes poorer as the charging time becomes a smaller fraction of the period between flashes.

From Eq. (1) and (2), it is noted that the maximum value of charging current is

$$I_{\max} = \frac{E_s - V_c(0)}{\sqrt{L/C}} \quad (3)$$

and the maximum capacitor voltage is

$$V_{c \max} = 2 E_s - V_c(0) \quad (4)$$

Equations (3) and (4) are useful in predicting two quantities of primary concern in the design of the power supply: maximum charging current and maximum or final capacitor voltage.

From Eq. (3) it is obvious that the maximum current should vary inversely as the square root of the charging inductance. Equation (4) indicates that the maximum capacitor voltage is not affected by changes in charging inductance. A change in the storage capacitance affects the maximum current the inverse of the way a change in charging inductance does; that is, the maximum charging current increases directly as the square root of the storage capacitance.

In the charging circuit, the inductor must be capable of storing the energy $LI^2_{\max}/2$. Changing the size of the inductance will not alter the required energy-storage capacity of the inductor, since I_{\max} increases inversely as the square root of L . The required energy-storage capacity of the inductor is

$$LI^2_{\max}/2 = \left[\frac{E_s - V_c(0)}{2E_s - V_c(0)} \right]^2 \frac{CV^2_{c \max}}{2} \quad (5)$$

From Eq. (5) it is seen that on the initial charging pulse, since $V_c(0)$ is zero, the peak energy storage in the inductor is one-fourth of the final energy storage in the capacitor, but is less than one-fourth on succeeding pulses, when $V_c(0)$ is not zero.

To summarize the requirements of a charging inductor:

1. The peak energy-storage capacity of the inductor must be at least one-fourth the final energy storage of the capacitor.
2. For a given amount of capacitance, the inductance should not be so large that $\pi\sqrt{LC}$ exceeds the period between flashes.
3. The inductance should not be so small that the charging time is too short in comparison with the period between flashes. Low inductance, besides increasing the severity of the duty on circuit elements, is less effective in isolating the flashtube from the power supply immediately following the flash.

Besides the above considerations, an economical inductor design must take into account the proper balance of copper, iron, air gap and insulation. Of course, if one inductor is to be used over a range of flashing rates or capacitances, optimum design over the whole range is not possible, and some compromises must be made.

The oscillograms of Figs. 5 and 6 illustrate two conditions that lead to holdover, or failure of the flashtube to stop conducting. In Fig. 5, the flashtube was flashed before maximum voltage and zero charging current occurred. Since there was a current flowing in the inductor at the time of flashing, it continued to flow through the flash-

tube, being limited only by the charging inductance, until finally the circuit breakers opened.

In Fig. 6, the current had gone to zero, following the charging of the capacitor to full voltage. The flashtube was flashed, and the normal build-up of current and capacitor voltage had begun when apparently the flashtube "broke down" again, and a holdover similar to the one in Fig. 5 occurred. The breakdown of the flashtube was probably caused by failure of the inductor to provide isolation from the power supply long enough for complete deionization of the flashtube to take place. With the FT-617A, it was impossible to prevent holdover by increasing the size of the inductance when the input was above about 4 kw at 24 flashes/sec, with flashtube voltage at 2,000. The inductance was increased to the limit at which $\pi\sqrt{LC}$ was just below the period between flashes, and holdover still occurred occasionally.

With the FT-417, no trouble was experienced with holdover even when loaded to 10 kw. This is attributed largely to the fact that the smaller tube had a much shorter deionization time than the FT-617A. Deionization after conduction is the result of ion and electron recombination mainly on the inner surface. Since the ratio of surface area to volume increases when diameter decreases, the smaller tube should become deionized more readily.

Two related problems that are of considerable importance are those of flashtube cooling and flashtube starting, or triggering. When the flashtube becomes too hot, the insulating property of quartz becomes very poor, and the starting pulse—instead of ionizing the gas—is shunted around the gas by the quartz tubing, and the flashtube fails to fire. With the FT-617, this is easily remedied by using a small air blower for forced air-cooling. Whereas the flashtube could be operated without cooling at a power input of $1\frac{1}{2}$ kw for 1 min, or at 4 kw for 30 sec, with forced air-cooling it could be operated continuously with an input of 5 kw, except for the holdover problem at this input.

The smaller FT-417 heated up more rapidly and would not operate for more than about 20 sec at 5-kw input, even with very strong forced air-cooling.

An interesting experiment in water-cooling was performed with the FT-417. It ran smoothly with an input of 10 kw while the whole flashtube, except for the main electrode lead-in wires, was submerged in water. The flashtube would apparently fire regularly for as long as desired. However, the electrodes became white-hot in about 30 sec at this input. After a total flashing time of about 2 min at this input, the flashtube showed several signs of hard use. The electrodes

were blackened and pitted, and some of the metal had sputtered to the adjacent quartz tubing. The inside of the quartz tubing was clouded considerably, presumably caused by a melting or vaporization of the quartz on the inside of the tubing. This experiment indicates the possible practicability of using a water-cooled flashtube, though of course there would be numerous problems connected with the design of such a flashtube.

THE FLICKER PROBLEM

A major problem with the use of stroboscopic sources when people are illuminated is the flicker effect. Intermittent 24-cycle light is very disturbing.

A brief investigation was made to determine the possibility of relieving the flicker effect by supplementing the stroboscopic light with some continuous light. It was found that the ratio of continuous light from a tungsten lamp to stroboscopic light, for almost complete elimination of the flicker effect, was about 10 to 1. For a basis of comparison, the light output in lumens for the stroboscopic source was taken as 24 times the lumen-seconds per flash. With this ratio of continuous to stroboscopic light of 10 to 1, the usually observed stroboscopic effects—such as the apparent change in speed or direction of rotation of wheels, jerkiness of movements, and flickering of light—were hardly detectable. However, at ratios of about 8 to 1 and lower, the stroboscopic and flicker effects were only slightly less than when only the stroboscopic source was used.

The problems of flashtube noise and the excess blue of the flashtube light output will also have to be met in using flashtubes in movie work. Some noise reduction may be obtained by tube design and by using an inductance in series with the flashtube. For color correction for daylight-type Kodachrome film, a CCl3 or CCl5 filter is recommended. It may be that a proper mixture of stroboscopic lighting and continuous lighting would make the use of filters unnecessary.

Another method of reducing flicker is to increase the flashing rate. To do this reduces the efficiency as has been pointed out before.

CONCLUSIONS

The upper limit of power input to a flashtube is determined by the thermal capacity of the flashtube. If the quartz tubing becomes too hot, the flashtube fails to fire and the tubing may be damaged; if the electrodes become too hot, they may be damaged and the flashtube tends to hold over more readily. Which of the factors is the limiting

one depends upon the tube and electrode design, the circuit design, the method of cooling, and the length of time that operation is desired.

Once the maximum power input is determined for a given tube, circuit and cooling, it will be essentially constant regardless of frequency. Then, since power input is a function of input per flash and flashes per second, the permissible input to the flashtube for each flash will depend upon maximum power input and the rate of flashing, or $CV^2/2 = P_{\max}/f$ watt-seconds per flash.

The stroboscopic flashtube unit described here when operated with the FT-617, with a storage capacitance of 74 μf charged to 2,000 v, will operate continuously at a flashing rate of 24 flashes/sec, with forced air-cooling from a 35-w, 8,400-rpm blower; operation for about 30 sec is possible with no forced air-cooling. The power input to the system is about 3.6 kw, and the energy per flash is about 150 w-sec.

The light output is 2,600 lm-sec/flash, since the efficiency is about 17 lm/w. If the flashtube is placed in a reflector with an efficiency of 10, it produces 104 lm/sec/sq ft at a distance of 5 ft. This amount of light is sufficient for photography with daylight-type Kodachrome film at $f/3.5$, and considerable coverage could be obtained with several such flashtubes. However, it is obvious that increasing the flashing rate means cutting the watt-seconds per flash in order to stay within the power rating of the flashtube. For example, if the flashing rate in the above case were increased to 48 flashes/sec, the energy input per flash would have to be cut in half, or to 75 w-sec/flash. The light output would be cut by more than half, since the efficiency would be lowered.

Thus it seems that in order to get a flashtube source more useful for movie photography, it will be necessary to increase the thermal capacity of flashtubes so that they can be operated repetitively at higher loadings and higher efficiencies. One possibility is a water-cooled flashtube. Another is a tube with large electrodes.

REFERENCES

1. F. E. Carlson, "Flashtubes: a potential illuminant for motion picture photography?" *Jour. SMPE*, vol. 48, pp. 395-406; May, 1947.
2. H. E. Edgerton, "Photographic use of electrical discharge flashtubes," *J. Opt. Soc. Amer.*, vol. 36, p. 390; July, 1946.
3. F. E. Carlson and D. A. Pritchard, "The characteristics and applications of flashtubes," *Illum. Eng.*, vol. 42, p. 235; February, 1947.
4. H. M. Lester, "Electronic flashtube illumination for specialized motion picture photography," *Jour. SMPE*, vol. 50, pp. 208-232; March, 1948.
5. G. N. Glasoe and Jean V. Lebacqz, MIT Radiation Laboratory Series, No. 5, *Pulse Generators*, 728 pp., McGraw-Hill, New York, 1948.

Study of Sealed Beam Lamps For Motion Picture Set Lighting

By WAYNE BLACKBURN

MOTION PICTURE RESEARCH COUNCIL, INC., HOLLYWOOD, CALIF.

SUMMARY: Limitations and advantages of sealed beam lamps for motion picture set lighting are disclosed. Comparisons of light output and distribution vs. regular studio spot lamps are made; also, lamp efficiency, life and weight of equipment are discussed. Lamp requirements for motion picture set lighting are presented and the methods followed by the Motion Picture Research Council to determine possible usage of sealed beam lamps are described.

FOR SOME TIME, many people associated with motion picture set lighting have thought the incandescent lighting equipment now being used appeared heavier and more bulky than necessary. The recent strict budgets have accelerated the exploration for a simple light source and flexible lighting equipment. Attention was drawn to the sealed beam type of lamp having a built-in reflector. This type of lamp is presently being used primarily for fill light on locations and was used for television studio lighting as early as July, 1939.¹

The amount of illumination obtained from this type of lamp, such as the reflector photoflood (RFL-2) and reflector spot (RSP-2) (see Fig. 1), is very impressive. Such lamps have an average life of 6 hr and dissipate 500 w. This lamp construction and operation will supply more light per watt to the studio set than present spot lamps, but the fixed focus design sacrifices the ability to spot or flood the light beam.

The Colortran Converter Co., Hollywood, Calif., supplies to the industry portable kits in which long-life industrial lamps are used. These lamps are operated at an elevated voltage by transformer action. So operated, these industrial lamps have a light output, color temperature and life comparable to photofloods. Such tactics increase lamp efficiency since light output increases approximately twice as fast as the wattage when the melting point of the tungsten filament is approached (see Fig. 2).

This Colortran equipment is very popular with the studios, especially for location work where close shooting quarters, power consump-

¹ William C. Eddy, "Television lighting," *Jour. SMPE*, vol. 33, pp. 41-53, July 1939.

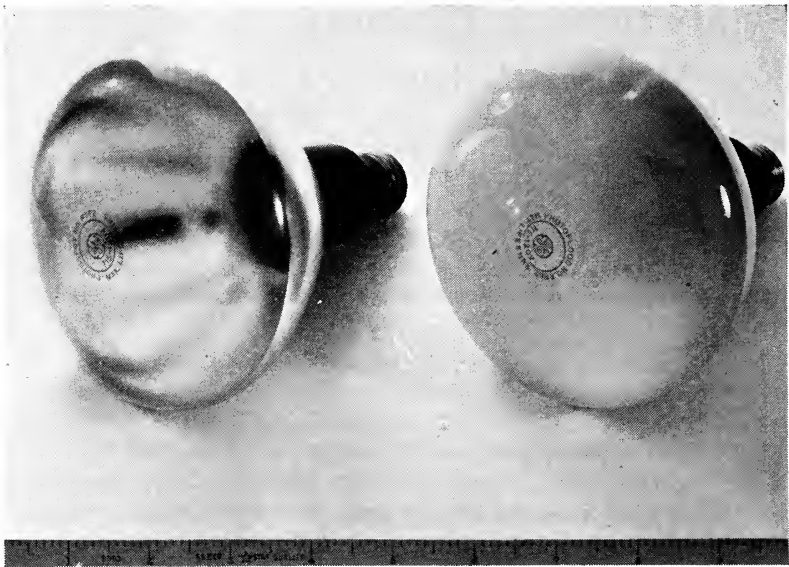

Fig. 1. Reflector Spot (RSP-2) and Reflector Flood (RFL-2); 500-w, 6-hr life.

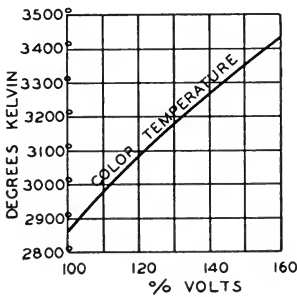
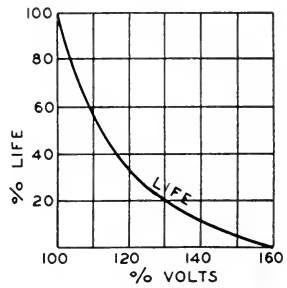
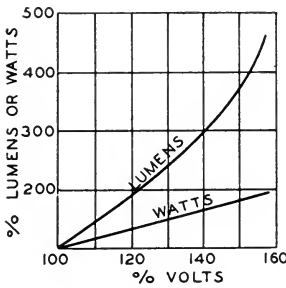

Fig. 2. Characteristic curves of standard 120-v, 1,000-hr life, incandescent lamps when operated at other than the rated voltage.

tion and portability are important considerations. The industrial 150-w PAR-38 flood (Fig. 3) appears to be the most suitable lamp for this equipment.

Due to the interest shown in reflector-type lamps, the Motion Picture Research Council studied the characteristics of such lamps to see if over-all advantages existed which would make them more economical for studio use. Existing built-in reflector lamps were measured and compared with present equipment (see Table I). Light measurements were made at the center, edge and 6 deg outside a circle $8\frac{1}{2}$ ft in diameter, located 20 ft from the light source.

It is interesting to compare the 500-w reflector flood (RFL-2) operating at 120 v with the PAR-38 flood operating at 185 v. Under these operating conditions, the lamps have comparable life. Inside the circle, the PAR-38 delivers twice as much light as the RFL-2. The RFL-2 has a more uniform field of illumination, but the fall-off of the PAR-38 is not considered too serious. Outside the circle, the RFL-2 delivers considerably more light. In general, however, this outside illumination is undesirable and will be masked off with barndoors* or gobos† unless the lamp is being used to supply fill light.

Photographic tests were made at Paramount Studios to determine whether acceptable black-and-white picture quality could be obtained using only reflector-type lamps. Colortran transformers were used for over-voltage operation. Identical long shots and close-ups with the same light key and at the same lens stop were taken; first with standard lighting equipment and then repeated using sealed beam reflector-type lamps only (Fig. 4). Well-known cinematographers, professional players, a dressed set and the recording of sound were used. Equivalent and highly satisfactory photography was obtained using barndoors, scrims and gobos, in spite of the fact that sealed beam lamps are diffused light sources. The sealed beam lamps required approximately one-third the wattage of that of standard lighting. Less time was required to make setups using the sealed beam lamps. However, a fair comparison cannot be made because the studio lamps were set up first and lamp placement had already been determined when the sealed beam lamps were set up. Individual dimming was supplied to each sealed beam lamp through a small variable resistor. The sealed beam lamps had a higher color temperature, although the foot-candle reading was kept the same for both types

* Black, movable extension doors hinged on lamp housing to restrict light from reaching certain areas.

† Normally, cloth masks of various sizes, mounted separately from lamp housings, used to block light from certain areas.

TABLE I. Test Results of Light Output

Description	Volts	Watts	Life Hours	Light Distribution*			
				Color Temp., °Kelvin	Center foot- candle	Edge foot- candle	2 Ft † outside circle
<i>From Commercial Sealed Beam Lamps</i>							
RFL-2.....	120	500	6	3400	20	17	16
RSP-2.....	120	500	6	3400	130	60	23
150 PAR-38/FL.	120	150	1000	2800	11	8	6
150 PAR-38/FL.	155	225	63	3100	22	18	13
150 PAR-38/FL.	185	292	6	3340	46	33	23
150 PAR-38/SP.	120	150	1000	2800	29	7	3
150 PAR-38/SP.	175	267	7	3260	100	25	11
150 R-40/FL....	120	150	1000	2800	3	1	½
150 R-40/FL....	175	267	7	3260	12	9	7
150 R-40/SP....	120	150	1000	2800	14	8	2
150 R-40/SP....	175	267	7	3260	53	12	7
300 R-40/FL....	120	300	1000	2800	6	5	3
300 R-40/FL....	175	535	7	3260	22	18	14
300 R-40/SP....	120	300	1000	2800	40	13	5
300 R-40/SP....	185	585	3	3340	160	45	13
4560†.....	28	600	25	3300	1260	72‡	—
750 R-40.....	120	750	6	3400	165	37	20
500 R-40.....	120	500	750	2800	15	12	10
(Frosted)							
500 R-40.....	165	810	7	3175	41	32	26
(Frosted)							
500 R-40.....	120	500	750	2800	21	27	20
(Clear)							
1000 R-80.....	120	1000	750	2800	17	10	16
(Clear)							
1000 R-80.....	120	1000	750	2800	17	17	16
(Frosted)							
1000 R-80.....	155	1500	37	3090	38	38	37
(Frosted)							
<i>Present Studio Lamps, for comparison</i>							
500 MP.....	120	500	35	3200	31	24	12
500 MP.....	135	600	8	3325	43	34	16
500 CP.....	120	500	8	3350	32	24	12
750 MP.....	120	750	30	3200	45	37	18
750 MP.....	135	900	7	3325	63	52	26
750 CP.....	120	750	12	3350	48	39	20
1000 MP.....	120	1000	35	3200	60	50	22
1000 MP.....	145	1340	6	3410	108	87	30
2000 MP.....	120	2000	100	3250	118	94	32
2000 MP.....	145	2680	8	3460	210	165	95
2000 CP.....	120	2000	25	3350	125	100	41

See notes on following page.

of lighting. This increase of energy in the blue region of the spectrum increased the actinic value so that a negative of higher density was obtained with the sealed beam lamps. Thus, to match print density from the two negatives, it was necessary to print two light steps higher with the negative using sealed beam lamps. Rigging and striking time was reduced because the lamp housings weighed only a fraction of the weight of standard equipment.

With evidence that satisfactory photography could be obtained with sealed beam lamps, the lamp manufacturers were requested to provide special lamps for experimental work. Special filaments in existing bulbs of various sizes were supplied. These lamps were life tested and the rate of aging was measured for different filament orientations.

Of these experimental lamps, the PAR-38 flood bulb with a 115-v, 500-w, CC-6 filament seemed the most desirable for our application. Life tests indicated that an average life of 6 hr could be expected. Damage of the reflector was observed directly about the filament during life tests, but had no serious effect. The lamp delivered over three times the amount of light of a 500-w RFL-2 in the 8½-ft-diameter circle and approximately 75% of the light of a 2,000-w studio Junior spot lamp.

To realize fully the possible advantages of sealed beam lamps for studio use, the Research Council designed housings, associated equipment and scaffolds to accommodate PAR-38 or R-40 bulbs. Figure 5 shows the lamp housing and the adjustable scissor bracket in the retracted position. Figure 6 is a multiple exposure showing possible positions of the scissors. Figure 7 is a small set rigged with this special lamp equipment. Figure 8 shows the type of scaffold used, which is supported entirely by the set walls.

Individual electrical dimming of the lamps can be done either from a master control board located on the stage floor, or with a rheostat located on each housing and operated at the lamp. Remote control on a master board affords quick lamp adjustments for the gaffer (chief set electrician), but entails the numbering of each lamp and the running of cables from the lamps to correspondingly numbered controls

NOTE: Underlined figures of *life* and *color temperature* are calculated for an average lamp and subject to considerable variation for an individual lamp.

* Measurements made in standard studio lamp housings flooded to 20% reduction in lamp beam candlepower at edge of circle 8½ ft in diameter, 20 ft from lamp; this is to simplify comparison with reflector lamps.

† Airplane landing lamp.

‡ 6° from center.



Fig. 3. PAR-38 Flood; 150-w, 1,000-hr life.



Fig. 4. Master long shot using sealed beam lamps.

at the master board. Having a rheostat on each lamp housing provides a much simpler wiring setup, but requires manual dimming at the lamp by the operator. Choice between these two methods will be determined largely by operating experience.

Sealed beam lamps are not capable of producing the sharpness of shadows obtained with regular studio lamps. This has been cited as a handicap by the cinematographers, although as shown by our Paramount tests, it is not a requisite for pleasing photography. The cameramen claim the difficulty lies in obtaining an apparent pictorial separation of the subject from the background by producing a brightness

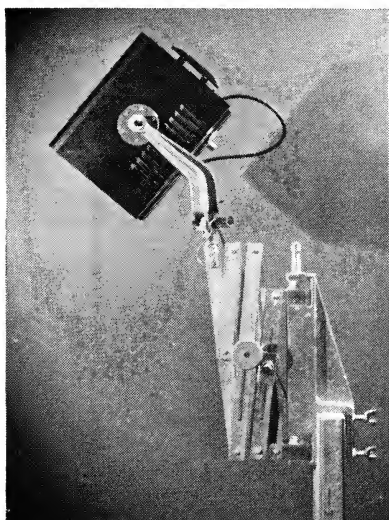

Fig. 5. Lamp housing and the adjustable scissor bracket in the retracted position.

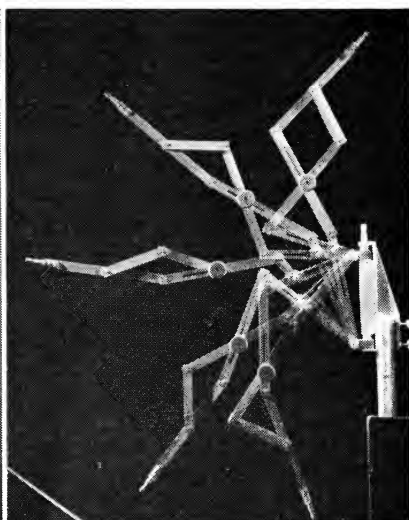

Fig. 6. Multiple exposure photograph showing movement of the scissors.

difference. This decrease in shadow sharpness is due to the increase in apparent light source size. For example, the entire area of the lamp face of the popular photoflood (RFL-2) is the apparent light source. Therefore, when half of the lamp face is covered, no shadow is produced on the corresponding side of the set, but only a general reduction in total illumination results. Each section of the face of a regular studio lamp supplies light to a different area in the set; that is, the top portion of the lens face supplies light to only the top area of the set and therefore can be conveniently masked near the lamp. This permits an actor to be properly illuminated, and then by masking

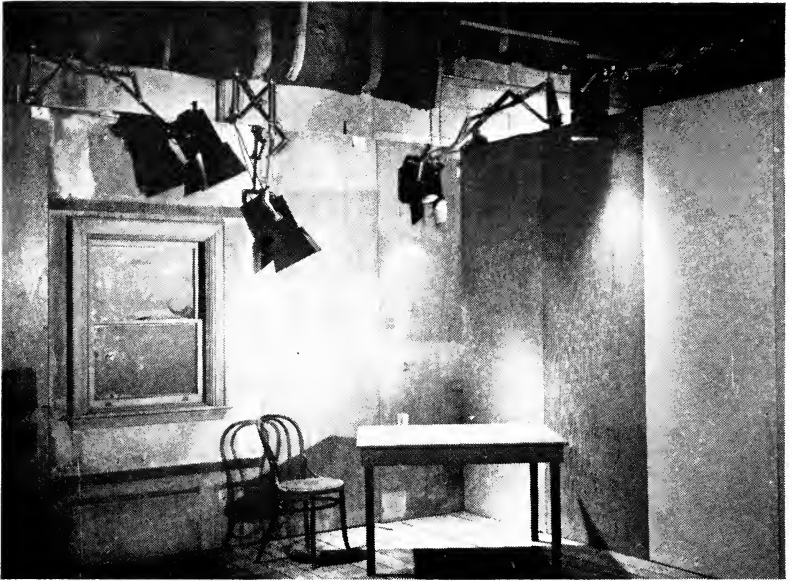

Fig. 7. Small set rigged with housings and scissors.

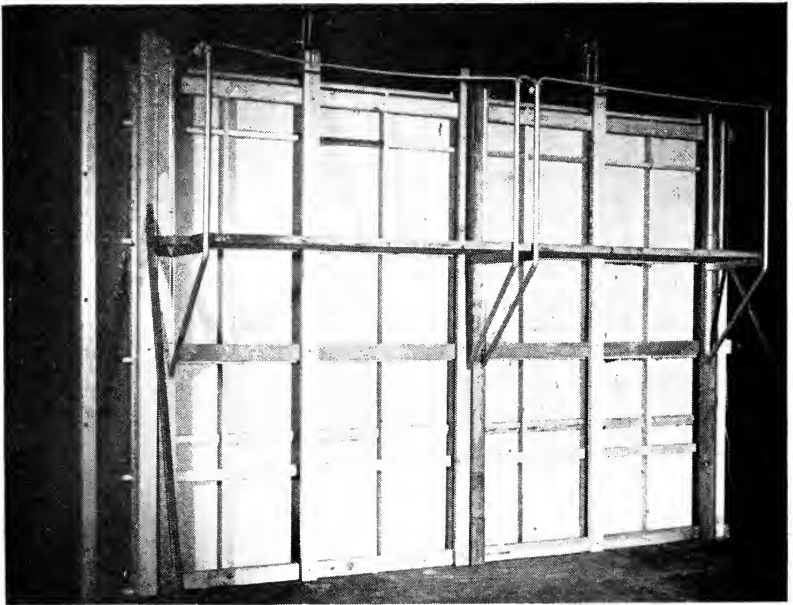

Fig. 8. Scaffold hangers supported by set walls.

the outer portion of the lamp face, casts a corresponding shadow close to the actor without affecting the amount of illumination on the subject.

Tests were made to determine in what way and to what extent sealed beam lamps deviate from a point source. This was done by masking off the face, except for a hole 1 cm in diameter (0.4 in.). The 1-cm hole was permitted to transmit light at various points located from the center out to the edge of the lamp. The plots of a typical reflector lamp and a regular studio lamp are shown in Figs. 9A and 9B.

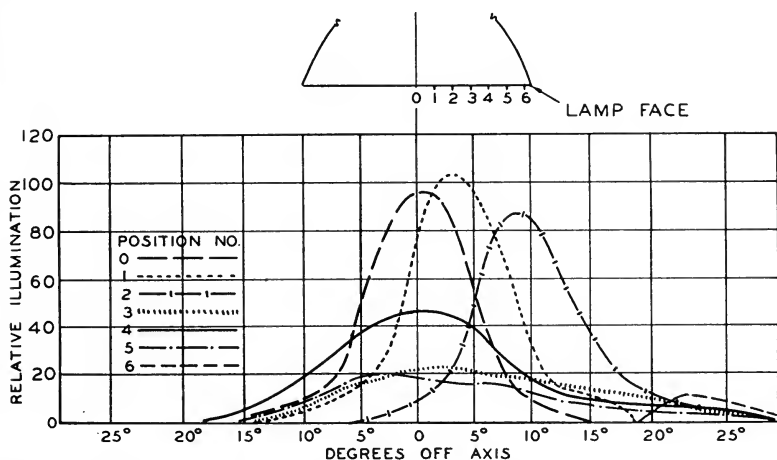

Fig. 9A. Distribution of light from small circular areas (1-cm diam.) of lamp face of PAR-38 Flood.

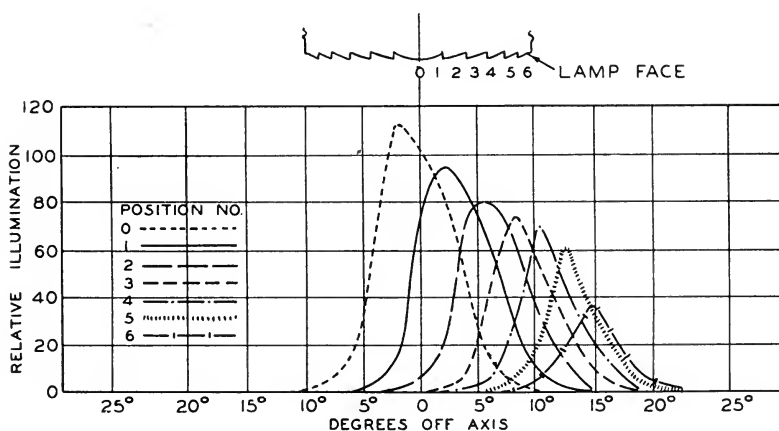

Fig. 9B. Distribution of light from small areas of Baby Junior lamp face (full flood position).



Fig. 10A. Taken with Studio Baby Junior;
lamp placed 6 ft from subject.

Note that with the reflector lamp, any point in the field sees the entire large source area, while with the regular studio lamp the outer portions of the lens-face supply light to only the outer areas of the field and not the entire field area, thus meeting the requirements for a sharp shadow. This effect is pictorially shown in Figs. 10A and 10B. The facial shadows and the shadows from the door molding and door blind are comparable using either the studio baby Junior spot or the PAR-38 flood. But where object and shadow are widely spaced, such as head to shadow on the door blind, the baby Junior casts a sharper shadow. Note that the shadow break above the door, produced with barndoors on housings, is much sharper with the baby Junior than with the PAR-38 flood. This indicates that if an improvement in shadow sharpness



Fig. 10B. Taken with PAR-38 Flood in Research Council housing;
lamp 6 ft from subject.

is to be obtained with sealed beam lamps, the face of the lamp must be masked to reduce the apparent source size.

Various types of louvers were tried in front of the lamp face to reduce the apparent source size. In general, the light distribution was badly distorted or confined, with loss in light output. An open rectangular slit kept parallel to the barndoors was found to be the best compromise, but the loss of light output makes the use of louvers questionable.

It should be stated that from a practical standpoint the apparent source size of a sealed beam lamp cannot be reduced by the use of a lens face, such as a Fresnel. This is due to the fact that the filament

size and focal length of the reflector are the determining factors of source size. Light output and size make it impractical to change the lamp design.

Sealed beam lamps should be given serious consideration for use in set lighting. Although, as outlined above, sealed beam lamps are different in many respects than present studio incandescent lamps, they have distinct advantages.

To summarize, sealed beam lamps supply light at a high efficiency and are small and lightweight. For example, a 500-w, PAR-38, 6-hr lamp with a Research Council housing weighs 7 lb and delivers 75% of the light of the 2,000-w Studio Junior weighing 39 lb. Such features make the lamps practical for location work in existing homes and buildings where transportation, close shooting quarters and power consumption are extremely important considerations.

Use of sealed beam lamps for stage work will save production time if the present technique of "painting" with light is changed. Present practice must be modified as it calls for a given number of individual light sources, each of which lights an assigned portion of the scene; each is adjusted, scrimmed and masked to do its job. Sealed beam lamps have no unique value if so applied. However, production time can be substantially reduced by the efficient use of sealed beam lamps. By efficient use is meant reducing considerably the use of light controlling devices, such as gobos, scrims and barndoors.

In general, our tests, coupled with current studio experience, demonstrate that sealed beam lamps can be successfully used on both location and stage sets with good photographic quality and a saving in production time.

Color Committee Report

BY HERMAN H. DUERR, COMMITTEE CHAIRMAN

ANSCO, BINGHAMTON, N.Y.

IT IS THE PRACTICE to report to the membership from time to time about the work which is being carried on in the different technical committees. Due to the excellent support which the chairman has received from the members of the Color Committee and its subcommittees, it has been possible to make considerable progress on some of the projects the committee has undertaken. This report outlines briefly the present organization, the scope of its activities, what has been done so far, and what is being planned for the immediate future.

There is no scarcity of problems which could or should be tackled by the Color Committee. It is rather a question of doing first things first and giving priority to those problems which are of greatest concern to the industry. Any suggestions from the members will be very much appreciated.

The eighteen members of the Color Committee represent all major organizations actively engaged or involved in the production of color motion pictures.

The objectives of the Color Committee are to make recommendations and prepare specifications for the operation, maintenance and servicing of color motion picture processes, accessory equipment, studio lighting and projection light sources for color, selection of studio set colors, color cameras, color motion picture films, and general aspects of color photography. This is a big order and future chairmen will not have to be afraid of running out of projects in the next five or ten years.

It was agreed at the first meeting of the present committee that it could best serve the Society by working on a progressive program having essentially the following objectives:

1. To survey the existing information on commercially important color motion picture processes and bring that body of information up to date.
2. To analyze and correlate the technical requirements of color motion pictures and evolve recommended practices for the guidance of the industry and as forerunners of future efforts for standardization.
3. To disseminate information as soon as it can be organized and verified for the edification and assistance of the motion picture industry.

PRESENTED: April 27, 1950, at the SMPTE Convention in Chicago.

JULY 1950 JOURNAL OF THE SMPTE VOLUME 55

In order to carry out that program, four subcommittees were organized. Lloyd Varden is Chairman of the color process symposium subcommittee. This subcommittee is working on a review of the literature on color motion picture processes which have attained some measure of commercial success. The chairman is arranging with authors or manufacturers to bring publications about these processes up to date. New processes not yet adequately described in technical publications are to be included in this symposium.

In view of the fact that several new processes for color motion pictures have been on the verge of commercial introduction, the work of this subcommittee has been delayed. It is felt that a thorough and accurate coverage of the processes, even if it has to be somewhat delayed, is preferable to an incomplete or superficial treatment. Your Chairman would like to add a plea here on behalf of the subcommittee chairman for full co-operation of the industry so that the information which is needed to make the report worth while will be made available in the near future.

The Color Symposium Report is not intended as a disclosure of confidential manufacturers' or consumers' techniques. Its primary purpose should be to give a condensed and factual review of the color processes available to the industry.

With a similar intent of providing basic information for the industry, a subcommittee on color film sound track characteristics has been active, with Lloyd Goldsmith as Chairman. This subcommittee has completed its assignment and the report of the committee was printed in the March JOURNAL.

Information about the general principles of color sensitometry has been very fragmentary. It has been recognized by the members of the Color Committee that there is a rapidly growing need for technical information in this field. This is especially true of matters relating to the control of new color processes which have become available to the industry and which can be processed by the motion picture laboratories.

Sensitometric methods are among the most important tools needed to control these processes; therefore, a special subcommittee on color sensitometry was organized to study this problem and provide a report for the guidance of the industry. The membership of the color sensitometry subcommittee has been organized under the chairmanship of Carl F. J. Overhage.

In outlining the scope of the sensitometry subcommittee's activities, no attempt was made to provide an immediate solution to specific problems which may confront the user of color materials. This basic information has to come from the film manufacturer and is

being supplemented daily by the well-known resourcefulness of the laboratory people in the industry. The subcommittee was asked to look beyond these immediate requirements and establish the more fundamental principles involved in color sensitometry and densitometry for future guidance.

Although our present understanding of these processes is still incomplete, it was felt that a report presenting the present knowledge in this field would be very helpful. It also would lead to the formulation of basic methods suitable for use throughout the industry, and thereby eventually prepare the ground for standardization in the field of color sensitometry.

A report entitled "The Principles of Color Sensitometry" has been completed. The report deals with most of the important aspects of color sensitometry and contains sections on:

1. Sensitometric exposure.
2. The processing of sensitometric tests.
3. Quantitative evaluation of color images, dealing with the different types of color densities, such as integral, analytical and equivalent neutral density involved in such evaluation.
4. Densitometer design principles.
5. Transformation between integral and analytical densities.
6. Interpretation of sensitometric results.
7. Statistical aspects of color sensitometry.

Those who had the opportunity to review this committee's report prior to publication unanimously agreed that the subcommittee did a very thorough and highly commendable job. The report was scheduled for publication in the June *JOURNAL* and reprints will also be made available in quantity because of the considerable demand that already exists for consolidated information on this subject.

Another subcommittee was established some time ago to investigate the spectral requirements of light sources and screens for color projection. Ronald Bingham is the Chairman of this subcommittee, which is working on a report which we hope will be helpful to those branches of the industry engaged in furnishing and maintaining projection equipment and screens. The main emphasis will be given to establishing the theoretically desirable energy distribution of light sources for the projection of all presently available color processes. In this connection, a study of the dye absorption characteristics of commercial two- and three-color processes is being made. At the same time, the spectral distribution of various types of light sources in use for 16- and 35-mm projection is being reviewed. It is not expected that the subcommittee will be able to make definite recommendations; however, in an area in which compromises are necessary

for practical considerations, the subcommittee will attempt to show those compromises which will have the least detrimental effect from theoretical considerations.

Another phase of this program will be a review for recommendations regarding the spectral reflectance characteristics of various types of projection screens for color.

As far as future plans of the Color Committee are concerned, there are at present two subjects on the priority agenda.

At the last meeting of the parent committee in Hollywood, it was suggested that we reopen the subject of phototubes to be used in connection with color film sound track reproduction. In 1947, the Color Committee prepared a report on the subject of blue-sensitive cells for the reproduction of dye tracks. A subcommittee on phototubes, with Lloyd Goldsmith as Chairman, made a study of the blue-sensitive cell and the report of this subcommittee stated that there are no important technical objections to the use of blue-sensitive cells for sound reproduction.

It was the consensus of the Color Committee at the time that the initiative for the conversion of the blue-sensitive cell would have to come from the film manufacturers and the report was temporarily shelved.

As indicated by the review of the subcommittee on color sound track characteristics, published in the March JOURNAL, the tendency has been toward sulfided sound tracks on multilayer color film materials, although it is generally recognized that silver tracks requiring no extra processing steps would be preferable. The advent of the lead sulfide cell, as yet confined to 16-mm projection equipment primarily, makes the whole situation a little more complicated, if not to say, slightly confused.

Little published information is available in regard to the response of lead sulfide cells to silver sulfide or dye tracks on color film. The Color Committee, in co-operation with the phototube subcommittee of the Sound Committee, is now seeking more such information.

Another subject which the Color Committee intends to take up in the near future is the question of color temperature and color temperature measuring instruments as they apply to color photography. It is intended to organize a subcommittee for a study of this subject. The objective of this subcommittee will be to review the theoretical and practical requirements of color temperature measurements in their relationship to color photography.

The Color Committee will welcome suggestions from the members of the Society regarding projects to be tackled by the Committee and which are within the scope of the activities of the Color Committee.

New American Standards

ON THE FOLLOWING PAGES appear two recently approved American Standards for scanning beam uniformity test films, and one proposed standard for the sound transmission characteristics of theater screens.

The two test film standards were developed by the joint Society and Research Council Committee on Test Films, and are based on the old war standard Z52.7-1944. In these new standards a departure has been made from past practice in preparing test film specifications in that Appendixes have been included which indicate the methods of using these films and the methods of evaluating the results attained.

The group responsible for the development of these standards believe the Appendixes very desirable because American Standards receive wide circulation and are used by many people not fully experienced in the field of motion pictures.

The proposed standard covering the sound transmission characteristics of theater screens has been developed by the Society's Sound Committee and is also based on a war standard—Z52.44-1945. However, the transmission characteristics specified in this proposal have been met by many types of theater screens which have given satisfactory performance in theaters for over twenty years.

On occasion, screens which have excessive transmission loss have been installed in theaters. When this has occurred, it has been partially offset by raising the gain of theater sound system and changing the equalization. In cases where the power output of the amplifier is close to the upper limit, such a procedure has resulted in excessive distortion.

Therefore, this proposal is being published for a ninety-day trial period. If at the end of that time no adverse criticism has been received, it will be processed as a regular American Standard.

American Standard
**Scanning-Beam Uniformity Test Film for
 16-Millimeter Motion Picture Sound Reproducers
 (Laboratory Type)**

ASA
 Reg. U. S. Pat. Off.
Z22.80-1950
 *UDC 778.534.4

1. Scope and Purpose

1.1 This standard describes a film which may be used for determining the uniformity of scanning-beam illumination in 16-mm motion picture sound reproducers. The recorded sound track shall be suitable for use in laboratories and factories.

2. Test Film

2.1 The film shall be a print from an original negative. It shall consist of a 1000-cycle, variable-area recording at full modulation of the 0.005-inch width and shall be approximately sinusoidal. The track shall move uniformly 0.067 inch from one edge of the scanned area to the other as shown in Fig. 1.

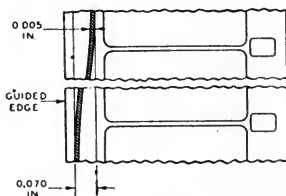

Fig. 1

2.2 The position of the sound track relative to the ends of the light beam at any instant shall be shown by a diagram appearing in the picture area, the size and location of which is shown in American Standard Location and Size of Picture Aperture of 16-Millimeter Motion Picture Cameras, Z22.7-1950, or any subsequent revision thereof approved by the American Standards Association, Incorporated.

2.3 The scanned area shall comply with the American Standard Sound Records and Scanning Area of 16-Mm Sound Motion Picture Prints, Z22.41-1946, and the film stock used shall be cut and perforated in accordance with American Standard Cutting and Perforating Dimensions for 16-Mm Sound Motion Picture Negative and Positive Raw Stock, Z22.12-1947, or any subsequent revisions thereof approved by the American Standards Association, Incorporated.

2.4 The length of this film shall be approximately 34 feet.

NOTE: A test film in accordance with this standard is available from the Motion Picture Research Council or the Society of Motion Picture and Television Engineers.

Appendix

(This Appendix is not a part of this American Standard.)

Before using the above test film it is recommended that correct placement of the scanning beam be determined by means of buzz-track test film as specified in American Standard Specification for Buzz-Track Test Film for 16-Mm Motion Picture Sound Reproducers, Z22.57-1947, or any subsequent revision thereof approved by the American Standards Association, Incorporated.

The uniformity of scanning beam illumination may be measured by means of a db meter

connected to the output of the sound projector amplifier. The illumination of the scanning beam should be adjusted according to the instructions furnished by the manufacturer and the variation of the output as registered on the db meter should be observed. The illumination is considered satisfactorily uniform when the output reading as measured by the meter is within $\pm 1\frac{1}{2}$ db across the entire scanning slit.

Approved June 12, 1950, by the American Standards Association, Incorporated

Sponsor: Society of Motion Picture and Television Engineers

*Universal Decimal Classification

Copyright, 1950, by American Standards Association, Inc.; reprinted by permission of the copyright holder.

American Standard

Scanning-Beam Uniformity Test Film for 16-Millimeter Motion Picture Sound Reproducers (Service Type)

ASA
Reg. U. S. Pat. Off.
Z22.81-1950
*UDC 778.534.4

1. Scope and Purpose

1.1 This standard describes a film which may be used for determining the uniformity of scanning-beam illumination in 16-mm motion picture sound reproducers. The recorded sound track shall be suitable for use in the routine maintenance and servicing of the equipment.

2. Test Film

2.1 The film shall be a print from an original negative. It shall consist of a 1000-cycle, variable-area recording at full modulation of the 0.005-inch width and shall be approximately sinusoidal. The track shall move uniformly 0.067 inch from one edge of the scanned area to the other as shown in Fig. 1.

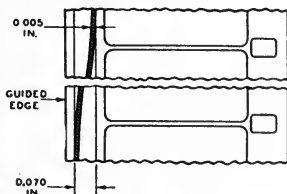

Fig. 1

2.2 The position of the sound track relative to the ends of the light beam at any instant shall be shown by a diagram appearing in the picture area, the size and location of which is shown in American Standard Location and Size of Picture Aperture of 16-Millimeter Motion Picture Cameras, Z22.7-1950, or any subsequent revision thereof approved by the American Standards Association, Incorporated.

2.3 The scanned area shall comply with American Standard Sound Records and Scanning Area of 16-Mm Sound Motion Picture Prints, Z22.41-1946, and the film stock used shall be cut and perforated in accordance with American Standard Cutting and Perforating Dimensions for 16-Mm Sound Motion Picture Negative and Positive Raw Stock, Z22.12-1947, or any subsequent revisions thereof approved by the American Standards Association, Incorporated.

2.4 The length of this film shall be approximately 3½ feet.

NOTE: A test film in accordance with this standard is available from the Motion Picture Research Council or the Society of Motion Picture and Television Engineers.

Appendix

(This Appendix is not a part of this American Standard.)

Before using the above test film it is recommended that correct placement of the scanning beam be determined by means of buzz-track test film as specified in American Standard Specification for Buzz-Track Test Film for 16-Mm Motion Picture Sound Reproducers, Z22.57-1947, or any subsequent revision thereof approved by the American Standards Association, Incorporated.

The uniformity of scanning beam illumination may be measured by means of a db

meter connected to the output of the sound projector amplifier. The illumination of the scanning beam should be adjusted according to the instructions furnished by the manufacturer and the variation of the output as registered on the db meter should be observed. The illumination is considered satisfactorily uniform when the output reading as measured by the meter is within $\pm 1\frac{1}{2}$ db across the entire scanning slit.

Approved June 12, 1950, by the American Standards Association, Incorporated

Sponsor: Society of Motion Picture and Television Engineers

*Universal Decimal Classification

PROPOSED AMERICAN STANDARD
Sound Transmission of Theater
Projection Screens

Z22.82

1. Sound Transmission Characteristics

1.1 The sound transmission characteristics of theater projection screens shall be such that the attenuation at 6000 cycles per second, with respect to 1000 cycles per second, is not more than $2\frac{1}{2}$ db and the attenuation at 10,000 cycles per second, with respect to 1000 cycles per second, is not more than 4 db.

The regularity of response shall be such that there is no variation greater than ± 2 db from a smooth curve at any frequency between 300 and 10,000 cycles per second. The general attenuation at and below 1000 cycles per second should not be greater than 1. db.

2. Method of Measurement

2.1 The sound transmission of the screen shall be measured by means of a loudspeaker, fed by an audio oscillator and amplifier, behind the screen, and a calibrated microphone, amplifier and output meter in front of the screen. The loudspeaker shall be of the type normally used in motion picture theaters for the size of screen being tested, and shall be placed so that no part of the loudspeaker is less than 2 feet from an edge of the screen with its mouth parallel to and separated from the screen by the recommended theater installa-

tion distance of from 4 to 8 inches (center cell in the case of a curved front multicellular horn). The microphone shall be located 10 to 12 feet in front of the screen and on the axis of the loudspeaker. The sound transmission of the screen at any frequency is then the difference in the sound level measured with the screen in place and with the screen removed.

2.2 Suitable precautions shall be taken to eliminate or minimize the effect of standing waves in the test room both in front of and behind the screen.

68th Semiannual Convention

Society members will meet on October 16 for their 68th Semiannual Convention. The Lake Placid Club, a restful private resort in the heart of the Adirondacks, will be the location. Bill Kunzmann, the Society's genial Convention Vice-President invites all members to attend, relax in delightful informal surroundings and derive maximum value from the many technical papers soon to be scheduled. The Papers Committee gives assurance that the program will be well organized, and that it will attempt to provide more adequate opportunity for discussion than has been customary for conventions in the recent past.

The growing scope of the Society's interests makes necessary adopting this and certain other practices now customary with the larger engineering societies. More efficient management of the program should result, with greater net benefit to members who attend technical sessions. Nine technical sessions are being scheduled—the first, including a Business Meeting, is to begin at 2:00 P.M., Monday, October 16. Differing somewhat from the format of previous conventions, the Monday evening session will feature the introduction of Officers and Governors-Elect and presentation of the Society's five major awards. The last session should end at about 5:00 P.M., Friday, October 20.

Previous conventions have had their lighter side, and the 68th is no exception. The Wednesday night Cocktail Party and Banquet are to be followed by a Costume Dance in which all who attend will participate and compete for recognition. Costumes will be as simple or as elaborate as the participants may desire.

Bill Kunzmann has announced appointment of the following Convention Committee Chairmen and asks that the membership give all possible aid to making the 68th Convention the best of all.

Local Arrangements, E. I. Sponable and W. C. Kunzmann

Papers Committee

Chairman, N. L. Simmons

Vice-Chmn., Montreal, H. S. Walker

Vice-Chmn., Chicago, R. T. Van Niman

Vice-Chmn., New York, E. S. Seeley

Vice-Chmn., Hollywood, L. D. Grignon

Vice-Chmn., Washington, J. E. Aiken

Publicity, Chairman, Harold Desfor

Registration and Information, E. R. Geib, assisted by P. D. Ries

Banquet, Hotel Reservations and Transportation, W. C. Kunzmann

Membership and Subscriptions, Chairman, Lee Jones

Assisted by A. G. Smith, Atlantic Coast Section Vice-Chairman

Projection and Public Address Equipment, E. S. Seeley

Ladies Reception Committee, Mrs. E. I. Sponable, Hostess

Co-hostess, Mrs. O. F. Neu

High-Speed Photography Question Box

Extensive use of high-speed motion pictures—and their corollary, time-lapse photography—as research tools is forcing many an engineer to become an accomplished photographer, to add to his other highly specialized experience. He puts the unfamiliar tools of photography to work because he has available no other means of securing the information he needs. Although photography in its more conventional aspects is basically complex, our researcher multiplies its complexities many times by crowding to the limit nearly every step in the process and thereby hands himself, as an amateur, a handful of problems that have been stumping the experts regularly for years.

Formal aids, such as high precision cameras, accessory optical devices, exposure measuring instruments and control mechanisms, already exist. Information about them has appeared in the JOURNAL and in a number of other publications, but very little has been written about techniques essential to good photographic results with cameras, film and processing under marginal operating conditions. To help fill this need, the JOURNAL will in the future carry periodically a High-Speed Photography 'Question Box' wherein an exchange of questions and answers will provide some measure of continuous technique orientation for users of high-speed or other scientific applications of photography.

There is little doubt that in many cases the problem in one laboratory will find a practical solution from the experience of another. If you have answers to the few questions that appear below, please communicate with Bill Deacy, Society Staff Engineer at the New York office. He will transmit your solution to the person who has the problem and will arrange for the answer to be published in a forthcoming issue of the JOURNAL.

Q1. High-speed motion pictures are required of moving parts inside a black bakelite device smaller than a dime and about $\frac{1}{2}$ in. deep. An Eastman camera is used operating at 4,000 and 8,000 frames/sec with the camera 13 in. from the object which is illuminated by a pair of No. 2 reflector spots placed $6\frac{1}{2}$ and $7\frac{1}{2}$ in. away.

A 2-in. lens is operated at $f/2$ with a +3 portrait auxiliary attachment. Insufficient exposure is obtained using Super XX film, and the heat generated is such that it alters the performance of the device under test. How can the illumination be increased and the heat removed? What new lighting equipment or techniques should be used?

Q2. Motion pictures are being photographed with a 16-mm Fastax Camera at 1250 frames/sec, using a 6-in. lens, object distance of 8 ft, Super XX reversal film and two 750-w reflector spot lamps. The subject consists of small parts of a mechanical device, moving at the rate of 15 to 30 cycles/sec. Specular reflections from bright wearing surfaces can be controlled with polarizing filters, but nearly all other surfaces are machined with similar finish so that adjacent moving parts or areas of intermittent contact are difficult to distinguish in the projected pictures. How can these several parts be made to stand out more clearly?

Q3. A manufacturer of air-borne instruments needs motion picture records of vibration effects on components of his equipment. The instruments under study are small and encased, making it necessary to illuminate and photograph through a hole in the cover. Vibration frequencies as high as 800 cycles/sec, with total object motion at times of as little as .001 in. must be observed. Is it possible and practical to study these phenomena with high-speed motion pictures; and if so, what type of camera, lens, exposure meter and what frame frequencies will be required? Also, what light source should be employed in the initial setup?

Q4. How can a 3×5 ft area of a dark machine be adequately lighted for photography at a frame frequency of 3,000? High amperage lines are not available.

Q5. Is special processing for reversal film available to users of high-speed photography? Longer first development would be helpful when film is known to be underexposed.

Engineering Committees

Magnetic Recording

The Magnetic Recording Subcommittee under the chairmanship of Glenn Dimmick has drawn up and circulated proposed dimensional standards for magnetic sound tracks on 35-, 17½-, and 16- and 8-mm motion picture film. These proposals are the result of a three-year attempt to develop standards that will meet with universal approval. While isolated opinions hold that some further modifications may be necessary, it is the majority opinion that publication and wide circulation of the current proposals will help crystallize thinking and lead to earlier agreement.

Of particular interest in the amateur field is the proposed standard for 8-mm magnetic tracks which will permit the addition of sound to 8-mm motion picture films. Several manufacturers are now preparing to announce 8-mm projectors with magnetic sound reproducers. If these standards, possibly with some modification, can be accepted soon, a tremendous saving for the manufacturers and the ultimate users will be realized. Early agreement will also prevent great confusion which will result if 8-mm sound films are not interchangeable among the projectors of various manufacturers.

These proposals cannot be scheduled to appear in the *JOURNAL* in less than sixty days, but draft copies are available from Society headquarters. If you wish to review them prior to publication, write Bill Deacy at headquarters, and he will be glad to supply you.

New Release Print Leader

Charles Townsend's Subcommittee of the Films for Television Committee is working on a proposed first version of a revised type of release print leader. The project was undertaken several months ago when the television broadcasters announced that the Academy leader Z22.55 does not meet their needs in at least three important respects. Precise timing of films, necessary in television broadcasting, is not possible. The long series of black frames immediately preceding the picture cause excessive flare under conventional television switching procedures and also prevent the control engineer from anticipating the normal picture gain setting for the picture coming up. Mechanical alignment of projectors and television cameras is particularly critical and should be checked, at least approximately, before every picture goes on the air.

From the outset, it was agreed that any new leader must fill the needs of both television and theater interests and should work well on both 35- and 16-mm release prints if it were to be unanimously accepted. Otherwise, serious confusion would be caused in film laboratories and exchanges by two types of leaders.

A 35-mm negative of the new proposal will be available very shortly. If you desire a trial print, Society headquarters will be glad to supply one in either 16- or 35-mm width.

Society Announcements

New Sustaining Member

The Society is pleased to welcome Neumade Products Corp. as the most recent addition to the rolls of our Sustaining Members. The total now stands at 73, with several more now negotiating. The financial support provided furnishes tangible evidence of faith in the Society's engineering committee work, and makes it possible for more projects to be undertaken and a higher percentage to be completed each year. The ambitious publications program, which includes not only the *JOURNAL* but also reports and symposia, also benefits all members.

The Index for Volume 54 was tacked by two spots of adhesive to the inside back cover of the JOURNAL proper in June in an effort to serve both those who have wanted the Index bound in the last issue of a volume and those who have as definitely wanted to receive Indexes as separately bound booklets.

The spine of the Journal beginning with this issue, shows a rearrangement made in an effort to show more clearly the progression and identity of numbers within each volume. This has been done chiefly in response to very helpful suggestions made by Lorin D. Grignon, Development Engineer of Twentieth Century-Fox.

Briefly Noted

Radio and Television Law, by Harry P. Warner, 1,095 pp., \$35.00, has been recently published by Matthew Bender & Co., Albany, N.Y. The author is known to JOURNAL readers as the coauthor, with J. E. McCoy, of "Theater Television Today," in the October, 1949, JOURNAL. Detailed information about the book is available in the form of an advertising letter from the publishers.

Radiofile is an index of radio and television articles appearing in the principal technical periodicals. This JOURNAL has been added to those previously indexed. *Radiofile* is an index by subject, not by title. It is issued bimonthly and is cumulative, listing all material of the current year, so that only the last index need be consulted. The year-end Annual is for permanent reference. The yearly subscription rate is \$1.50. Annuals are: for 1946, \$35; and 1947-49, \$.50 each. The publisher is Richard H. Dorf, 255 W. 84 St., New York 24.

"**Management Techniques to Match Speed With Efficiency**" is an article on common sense management by W. Walter Watts in the May, 1950, *Dun's Review*. "Wally" Watts is well known to Society members as Vice-President of RCA and a major proponent of theater television. In this article he speaks of coaching an industrial organization from within rather than managing from above, as a practical and successful way of enabling it to self-adjust to fast changing conditions. His is a philosophy that will interest all who are administrators in any industry. *Dun's Review* is 35¢ a copy, from Dun and Bradstreet, 290 Broadway, New York 8.

New Members

The following have been added to the Society's rolls since the list published last month. The designations of grades are the same as those in the 1950 MEMBERSHIP DIRECTORY: Honorary (H) Fellow (F) Active (M) Associate (A) Student (S)

Adams, Stanley H., Factory Representative, Movie-Mite Corp. Mail: 10609 W. 62 St., Shawnee, Kan. (A)

Bearman, Alexander A., Engineer, Twentieth Century-Fox Film Corp. Mail: 444 W. 56 St., New York 19. (M)

Bennett, Stanton D., Radio Engineer, Radio Station KOMO. Mail: 3437 36 Ave. W., Seattle 99, Wash. (A)

Choudhury, Siraj-ul-Islam, College of the City of New York. Mail: 150-8 Suffolk St., New York 2 (Apt. 17). (S)

Claybourne, J. Philip, Design Engineer, J. A. Maurer, Inc. Mail: 48 Avenel St., Avenel, N.J. (A)

Coleman, Theodore T., Motion Picture Producer. Mail: 12610 Brackland Ave., Cleveland, Ohio. (A)

Cook, Edmund G., Jr., Deputy Chief, AMC Photo Service Center, WP-AFB, Mail: Box 1107, Wright-Patterson Air Force Base, Dayton, Ohio. (A)

Daniels, Victor J., Daniels High Speed Motion Picture Corp. Mail: 395 Barry Rd., Rochester 17, N.Y. (A)

Edwards, Charles N., Photographic Engineer, U.S. Naval Photographic Center. Mail: 2952 Second St., S.E., Washington, D.C. (M)

- Fallier, Jephtha D.**, Camerman, Television Features. Mail: 31-84-33 St., Long Island City, N.Y. (M)
- Gippner, Gerald O.**, Technical-Engineering Staff, Movie-Mite Corp. Mail: 2114 Cleveland Ave., Kansas City, Mo. (A)
- Goldberg, Morris M.**, Motion Picture Photographer, Armed Forces Institute of Pathology. Mail: 245 Gallatin St., N.W., Washington 11, D.C. (A)
- Gordon, Larry**, Producer and Director, Television Features, Inc.; General Business Films, Inc. Mail: 480 Lexington Ave., New York 17. (M)
- Halprin, Sol**, Executive Director of Photography, Twentieth Century-Fox Films. Mail: 101 S. Vista St., Los Angeles 36, Calif. (M)
- Ham, Richard T.**, Instructor, Motion Picture Photography, The Art Center School. Mail: 849 S. Kenmore St., Los Angeles 5, Calif. (A)
- Hatcher, George D.**, Teacher-Television Projectionist, Johnstown City Schools and WJAC-TV. Mail: 1184 Agnes Ave., Johnstown, Pa. (A)
- Hatcher, Herbert E.**, Product Designer, Bell & Howell Co. Mail: 701 Ridge, Evanston, Ill. (A)
- Hershman, J. B.**, President, Radio and Television School, Valparaiso Technical Institute, Valparaiso, Ind. (A)
- Hessler, Gordon**, Film Editor, Films for Industry. Mail: 105 Riverside Dr., New York 24, N.Y. (A)
- Holmes, Porter**, Boston University. Mail: 24 Park St., Brockton 48, Mass. (S)
- Inderwiesen, Frank H.**, Radio-Television Engineer, Universal Television School. Mail: 1116 W. 40 St., Kansas City 6, Mo. (A)
- Leopold, Rudolf**, General Mechanical Engineer, A. B. Du Mont Laboratory. Mail: Demarest Ave., Oakland, N.J. (M)
- Levey, Lawrence**, Editor-Publisher. Mail: 304 W. 92 St., New York 25, N.Y. (A)
- Linden, Michael**, Librarian, Motion Picture Association of America, Inc. Mail: 168 Washington Park, Brooklyn 5, N.Y. (M)
- Lockwood, Harold A.**, Television Engineer, Farnsworth Television & Radio Co. Mail: 3216 Central Dr., Fort Wayne, Ind. (A)
- Matheson, Ralph G.**, President and General Manager, Matheson Company, Inc. Mail: 75 Greaton Rd., West Roxbury, Mass. (A)
- McIntosh, James S.**, Assistant Director, Educational Services, Motion Picture Association of America, Inc. Mail: 7813 Stratford Rd., Bethesda, Md. (M)
- McKnight, Boyd E.**, Engineer, Minnesota Mining & Manufacturing Co. Mail: 446 N. LaBrea Ave., Los Angeles 36, Calif. (A)
- Miller, Thomas H.**, Manager, Photographic Training Dept., Eastman Kodak Co., 343 State St., Rochester 4, N.Y. (A)
- Montes, Ventura**, Technical Adviser, CMQ Radio Broadcast & TV. Mail: Calle A bet. 7th & 9th, Playa Miramar, Habana, Cuba (A)
- Phillips, William D.**, University of Southern California. Mail: Hickory Hill, Claremore, Okla. (S)
- Sadkin, Marvin W.**, Motion Picture Laboratory Technician, George W. Colburn Laboratory, Inc. Mail: 2925 W. 56 St., Chicago 29, Ill. (A)
- Sandell, Maynard L.**, Engineer, Eastman Kodak Co., 343 State St., Rochester 4, N.Y. (M)
- Thompson, Orville I.**, Superintendent, DeForest's Training, Inc. Mail: 2533 N. Ashland Ave., Chicago 14, Ill. (M)
- Van Weyenbergh, C.**, Manager, Western Electric Co. (France). Mail: 20, Place des Martyrs, Brussels, Belgium. (A)
- Wilson, Willett R.**, Chief Engineer, Photolamp Section, Westinghouse Electric Corp. Mail: 45 Glenbrook Rd., Morris Plains, N.J. (M)
- Young, Robert P.**, Sales, General Aniline & Film Corp., Anseo Division. Mail: 95 Beekman Ave., North Tarrytown, N.Y. (A)

Letter to the Editor

With reference to Mr. Cummings' letter in the June JOURNAL (p. 766), it is noted that the words "the soda ash residue that remains. . ." ignore my previous statement ". . . that this film was clean and free of any extraneous matter when it ignited."

There is absolutely no sodium hydroxide, or soda ash as some call it, present on the washed and dried film because the material receives a very thorough cleaning, both mechanically and by washing, and it is well known that sodium hydroxide is very soluble. Furthermore, any minute trace that might be present would cease to

exist as sodium hydroxide and would be converted into the products of reaction between it and the gelatin, and any that might still then be left would be changed into sodium carbonate, also very soluble.

The chance of accidental contamination with sodium hydroxide is quite remote because of the method of the washing of the film.

Mr. Cummings describes the control in nitration as so accurate that there would be very little chance of overnitration.

Without going into too involved a chemical explanation, it is readily conceivable that cotton, being a natural product, does not always produce cellulose in exactly the same way; differences due to soil, weather, accidental injury to the plant and other factors would tend more or less to alter the cellulose, and it is quite possible that under these varying conditions some cellulose of the cotton might be susceptible to further nitration.

The writer has seen a blowout occur right at the nitrating spot in a chemical plant. The operators thought nothing of it, saying that it was a thing to be expected. The nitration kept right on regardless of the blowout because the plant was constructed in such a way that it could take care of it. Why did the blowout occur if the control is so perfect?

It is realized that spontaneous combustion due to high nitration is fortunately rare, but who knows exactly how rare? The point to stress is that with such a substance as cellulose nitrate, the storage conditions should be such as to insulate the fire when it *does occur*, a general point on which both the writer and Mr. Cummings agree.

June 22, 1950

JOSEPH H. SPRAY

Book Review

Handbook of Basic Motion-Picture Techniques, by Emil E. Brodbeck

Published (1950) by Whittlesey House (McGraw-Hill), 330 West 42d St., New York 18. i-xiii + 307 pp. text + 3 pp. index. Profusely illus. 6 × 9 in. Price \$5.95.

"Right at the outset of this book," says the author right at the outset of his preface, "there are a few vital truths which you should know. First is the fact that the *technique* of making motion pictures and the *mechanics* of making them are two different things. Technique is the 'art' and 'skill' of movie making. The mechanics of movie making are such things as learning to focus, to expose your film correctly, to load and wind your camera."

To members of SMPTE and readers of the JOURNAL, the mechanics of movie making should be an old story. Mr. Brodbeck's first 48 pp., therefore, may well not hold for them anything helpful or revealing. The bulk of his book, however, in which in ten major chapters he discusses the "techniques" of movie making should be of interest (and perhaps aid) to the practicing technician, especially if he makes movies on the side as a personal hobby.

Mr. Brodbeck's ten chapters take up such subjects as panning, using the tripod, shot breakdown, screen direction, matching action, newsreel technique, build-up, composition, indoor lighting and applied techniques. Each chapter presents the subject in the form of a lesson—with text, practice assignments and rules to remember. Mr. Brodbeck's approach to his subject is vigorous and forthright, his illustrations practical and informative. On the whole, however, the pictures suffer throughout this volume from muddiness of reproduction.

JAMES W. MOORE
Home Movies
New York, N.Y.

~ New Products ~

Further information concerning the material described below can be obtained by writing direct to the manufacturers. As in the case of technical papers, publication of these news items does not constitute endorsement of the manufacturer's statements nor of his products.

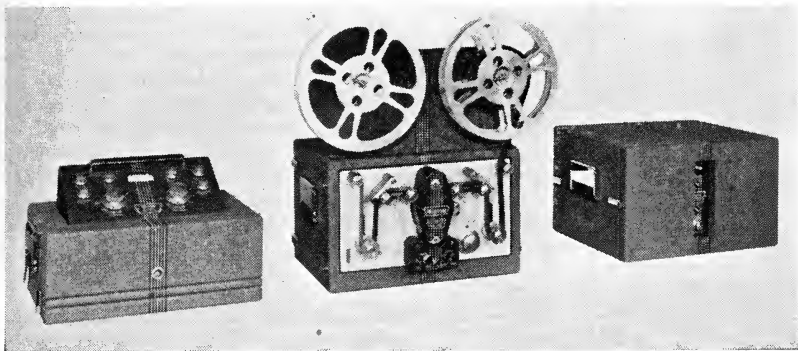

The Westrex 1035 Magnetic Recording System is a fixed studio or portable location recording system for the use of 35-mm magnetic film at a forward recording speed of 90 fpm and a reverse rewind speed of 270 fpm.

To take full advantage of the inherent signal-to-noise ratio of 35-mm magnetic film, a new line of amplifiers having exceptionally low noise has been developed. The transmission circuit consists of three amplifiers, two microphone preamplifiers, and one main recording amplifier, all basically identical, small in size and with a normal flat gain of 70 db from 30 to 10,000 cycles. Their frequency characteristic may be changed by means of interstage plug-in equalizer units.

The RA-1467-A Magnetic Recorder is driven by a single-phase, 50- or 60-cycle, 115-v, synchronous motor, but can also be supplied for operation with a three-phase, 50- or 60-cycle synchronous motor, an interlock motor, or a multi-duty combination of 220-v three-phase synchronous and 96-v d-c motor. Flutter, or "wow," has been reduced to a negligible value.

Position and dimensions of the recorded magnetic sound track are in accordance with the proposed Standard 58.301-B of the Academy Research Council. The recorder is convertible for use with 16-mm or 17½-mm magnetic film.

Tight loop threading path is used. The magnetic recording head is mounted at the point of optimum scanning and the monitor head is offset for magnetic monitoring of the recorded signal. Both the recording and monitor head circuits terminate in a single plug and jack connection within the enclosure which can be easily reversed to permit using the recording head to reproduce at the point of optimum scanning. Consequently the recording machine can also be used as a high-quality magnetic re-recording reproducer.

A driven footage counter adds on the forward run and subtracts on the reverse rewind to keep accurate count of film footage.

The RA-1484-A Power Control Unit contains a newly developed power supply, both line and load regulated, operating from a power source of 115-v, single-phase, 50- or 60-cycles. The Control Unit also contains the magnetic bias oscillator and the magnetic film monitoring amplifier.

The entire system is easily transportable and weighs approximately 190 lb, including all interconnecting cables. Further information is available from Westrex Corp., Hollywood Div., 6601 Romaine St., Hollywood 38, Calif., or Westrex Corp., 111 Eighth Ave., New York 11, N.Y.



The Line-Up Viewfinder is announced by the Hollywood Camera Exchange as the first light-weight "Zoom-type" viewfinder combining both the 16-mm and 35-mm fields, giving the proper perspective of the scenes being photographed, as well as the area covered by any lens. Useful for predetermining the proper lens, whether it be a telephoto or an extremely wide-angle lens, the calibrations range from 13- to 75-mm for 16-mm film and from 25- to 150-mm for 35-mm film. It is not convertible for 8-mm use and it is not to be used as an auxiliary lens; nor is it

designed to be attached to any camera. It measures $1\frac{1}{8}$ in. in diameter by $3\frac{1}{2}$ in. long and weighs 2 oz, being carried about the neck on a cord or in one's pocket. The price is \$15.50, f.o.b. Hollywood. Other information is available from the Hollywood Camera Exchange, 1600 Cahuenga Blvd., Hollywood 28, Calif.

Employment Service

POSITION AVAILABLE

Wanted: Individual who has had practical paid experience in the audio-visual field; must have knowledge of film storage procedures, circulating and maintenance of film, evaluation and catalog preparation. Must be able to meet the public and to supervise. Write: R. E. Herold, 5069 Montezuma St., Los Angeles 42, Calif.

POSITIONS WANTED

Cameraman - Director: Thorough knowledge of script-to-screen technique. Capable of own script preparation and production; 6 yr experience free-lance cameraman and producer; adept with all types 16-mm photographic and editing equipment. Wish permanent position with 16-mm industrial or TV producer; age 27, single, free to travel, details readily supplied. Robert Deming, 343 S. 13 East, Salt Lake City, Utah.

Producer-Director-Editor: 10 yr with major film producers. Thorough knowledge and experience script-to-screen production technique: directing, pho-

tography, editing, laboratory problems, sound recording, 35- and 16-mm, b & w and color. Specialist in research and prodn. of educational and documentary films; small budget commercial and TV films. Long experience in newsreels. Desire greater production possibilities, go anywhere. Member SMPTE, top refs. E. J. Mauthner, P. O. Box 231, Cathedral Sta., New York 25.

Mechanical-Electronic Engineer: B.S. degree in Mechanical Engineering; extensive design, mfg. experience, standard and drive-in theater picture and sound equipment; experience as engineering assistant to top management exec. corp. in radio TV. Write A. Kent Boyd, 3308 Liberty St., Austin, Texas.

On-the-Job G.I. Bill Training: Ambitious young man to be member of camera crew; grad. U.S. Army Signal Corps Schl.; experienced with Cine Spec., 70DA, Eyemo, Wall and Mitchell cameras; studied editing, art directing and cinematic effects at U.S.C.; married, non-drinker, serious; man for small studio TV work. P.O. Box 524, Alhambra, Calif.

SMPTE Officers and Committees: The roster of Society Officers was published in the May JOURNAL. The Committee Chairmen and Members were shown in the April JOURNAL, pp. 515-22; changes in this listing will be shown in the September JOURNAL.

Journal of the Society of Motion Picture and Television Engineers

VOLUME 55

AUGUST 1950

NUMBER 2

Characteristics of Motion Picture and Television Screens.....	FRANCE B. BERGER	131
Specifications for Motion Picture Films Intended for Television Trans- mission.....	CHARLES L. TOWNSEND	147
A 100,000,000 Frame Per Second Camera	M. SULTANOFF	158
Flutter Measuring Set.....	FRANK P. HERRNFELD	167
A Reflex 35-Mm Magazine Motion Picture Camera.....	ANDRÉ COUTANT and JACQUES MATHOT	173
Economy in Small-Scale Motion Picture Lighting....	ARTHUR L. SMITH	180
Component Arrangement for a Versatile Television Receiver.....	F. N. GILLETTE and J. S. EWING	189
Designing Engine-Generator Equipment for Motion Picture Locations.	M. A. HANKINS and PETER MOLE	197
Laboratory Practice Committee Report.....	JOHN G. STOTT	213
68th Convention.....		216
Board of Governors Meeting.....		216
Engineering Committees Activities.....		217
Letter to the Editor.....	By Ernest Lindgren	218
Obituaries.....		219
Journals Needed.....		219
Central Section Meeting.....		220
BOOK REVIEWS:		
<i>Film User Year Book, Volume II</i> , edited by Bernard Dolman.....	Reviewed by William K. Aughenbaugh	220
<i>The Organization of Industrial Scientific Research</i> , by C. E. Kenneth Mees and John A. Leermakers.....	Reviewed by G. T. Lorance	221
New Members.....		221
New Products.....		223
Meetings of Other Societies.....		224

ARTHUR C. DOWNES
Chairman
Board of Editors

VICTOR H. ALLEN
Editor

NORWOOD L. SIMMONS
Chairman
Papers Committee

Subscription to nonmembers, \$12.50 per annum; to members, \$6.25 per annum, included in their annual membership dues; single copies, \$1.50. Order from the Society's General Office. A discount of ten per cent is allowed to accredited agencies on orders for subscriptions and single copies. Published monthly at Easton, Pa., by the Society of Motion Picture and Television Engineers, Inc. Publication Office, 20th & Northampton Sts., Easton, Pa. General and Editorial Office, 342 Madison Ave., New York 17, N.Y. Entered as second-class matter January 15, 1930, at the Post Office at Easton, Pa., under the Act of March 3, 1879.

Copyright, 1950, by the Society of Motion Picture and Television Engineers, Inc. Permission to republish material from the JOURNAL must be obtained in writing from the General Office of the Society. Copyright under International Copyright Convention and Pan-American Convention. The Society is not responsible for statements of authors or contributors.

Society of Motion Picture and Television Engineers

342 MADISON AVENUE, NEW YORK 17, N.Y., TEL. MU 2-2185
BOYCE NEMEC, EXECUTIVE SECRETARY

OFFICERS

1949-1950

PRESIDENT
Earl I. Sponable
460 W. 54 St.
New York 19, N.Y.

PAST-PRESIDENT
Loren L. Ryder
5451 Marathon St.
Hollywood 38, Calif.

SECRETARY
Robert M. Corbin
343 State St.
Rochester 4, N.Y.

**EXECUTIVE
VICE-PRESIDENT**
Peter Mole
941 N. Sycamore Ave.
Hollywood 38, Calif.

**EDITORIAL
VICE-PRESIDENT**
Clyde R. Keith
120 Broadway
New York 5, N.Y.

**CONVENTION
VICE-PRESIDENT**
William C. Kunzmann
Box 6087
Cleveland 1, Ohio

1950-1951

**ENGINEERING
VICE-PRESIDENT**
Fred T. Bowditch
Box 6087
Cleveland 1, Ohio

TREASURER
Frank E. Cahill, Jr.
321 W. 44 St.
New York 18, N.Y.

**FINANCIAL
VICE-PRESIDENT**
Ralph B. Austrian
25 W. 54 St.
New York 19, N.Y.

Governors

1949-1950

Herbert Barnett
Manville Lane
Pleasantville, N.Y.

Kenneth F. Morgan
6601 Romaine St.
Los Angeles 38, Calif.

Norwood L. Simmons
6706 Santa Monica Blvd.
Hollywood 38, Calif.

Charles R. Daily
113 N. Laurel Ave.
Los Angeles 36, Calif.

John P. Livadary
4034 Cromwell Ave.
Los Angeles, Calif.

William B. Lodge
485 Madison Ave.
New York 22, N.Y.

1950-1951

Lorin D. Grignon
1427 Warnall Ave.
Los Angeles 24, Calif.

Paul J. Larsen
6906 S. Bradley Blvd.
Bradley Hills
Bethesda, Md.

William H. Rivers
342 Madison Ave.
New York 17, N.Y.

1950

F. E. Carlson
Nela Park
Cleveland 12, Ohio

George W. Colburn
164 N. Wacker Dr.
Chicago 6, Ill.

Edward Schmidt
304 E. 44 St.
New York 17, N.Y.

Malcolm G. Townsley
7100 McCormick Rd.
Chicago 45, Ill.

Edward S. Seeley
161 Sixth Ave.
New York 13, N.Y.

R. T. Van Niman
4501 Washington St.
Chicago 24, Ill.

Characteristics of Motion Picture And Television Screens

By FRANCE B. BERGER

GENERAL PRECISION LABORATORY, PLEASANTVILLE, N.Y.

SUMMARY: Two fundamental factors, brightness gain and reflectance or transmittance, determine the suitability of a screen material in any particular application. High brightness gain, which necessarily implies a narrow viewing angle, may be desirable in one application but not in another. The reflectance or transmittance of the screen material is a measure of the light efficiency.

Comparative figures for several commonly used screen materials are presented. Both front and rear projection screens are considered. Fundamental photometric concepts are reviewed and laboratory equipment is described. The figures are considered to be accurate to within about 5%, and are in reasonable agreement with the few published figures available.

AT VARIOUS TIMES in the past we have needed quantitative information regarding particular screen materials used in motion picture and television projection. A search of the literature on the subject revealed very few published figures and very little uniformity in the nature of the figures chosen for presentation. The lack of uniformity may be attributed to the fact that there are several systems of photometric units in common use, and, further, that certain photometric terms have been defined differently by various authors. The necessity for subsequent interpretation of published data detracts from the value of the information.

To facilitate our investigation, we were obliged to review the necessary theory, choose a system of units and definitions, and construct equipment for measuring the essential screen parameters. The purpose of this paper is to review the work that has been done and to present the results of the measurements which have so far been made.

The brightness of a screen as viewed by an observer in the audience depends not only upon the illumination falling on the screen from the projection optical system, but also upon the directional properties of the screen. Observers at different positions in the audience may see different brightness levels, depending upon the angle from which they view the screen. The screen's performance in this respect is governed by certain fundamental optical properties of the screen material. Before these properties can be discussed, though, optical terms which apply alike to all projection screens should be defined.

PRESENTED: April 25, 1950, at the SMPTE Convention in Chicago.

AUGUST 1950 JOURNAL OF THE SMPTE VOLUME 55

Following the definitions, the basic optical characteristics will be described in as nonmathematical a manner as possible. An exact treatment requires a mathematical approach, but since the mathematics may often obscure the physical concepts under discussion, they are relegated to appendixes.

Characteristics Common to Screens in General

Of the total incident light that is projected onto a screen, some is transmitted through the screen, some is reflected or scattered from the screen, and the rest is absorbed by the screen. The fraction of the total incident light that passes through the screen is called the *transmission factor* or the *transmittance* of the screen. The fraction which is reflected from the screen is called the *reflection factor* or the *reflectance*. The fraction which is neither transmitted nor reflected is called the *absorptance*. These three quantities are often expressed as percentages, their sum being, of course, 100%. For a front projection screen a large reflectance is desirable, and the transmittance is generally small. For a rear projection screen, large transmittance and small reflectance are desirable. The absorptance should be small in either case.

The color of a screen depends upon the spectral composition of the light projected onto the screen, and also upon the reflecting or transmitting properties of the screen material itself. Strictly speaking, the transmittance, the reflectance and the absorptance of a screen depend upon the wavelength of the incident light. For most purposes a projection screen should be "white," that is, it should reflect or transmit to the same extent light of all visible wavelengths. For the purpose of this paper we shall assume that we are dealing with white light and with white screens.

A screen material may be characterized as either specular or diffuse. The light transmitted by a sheet of glass, which passes through unchanged in its direction of propagation, is an example of *regular transmission*. The light reflected by a mirror leaves at a definite angle with relation to the angle of the incident light. Such reflection is referred to as *specular*. For convenience the term *specular* will be used in referring to either regular transmission or specular reflection. In contrast to specular effects, a beam of light falling on a blotter is reflected from the illuminated spot in all directions. A beam of light passing through a sheet of ground glass emerges in all directions. Such reflection and transmission are commonly referred to as *diffuse*. Diffusely transmitted or diffusely reflected light is referred to as *scattered* light.

Both the transmittance and the reflectance of a material can be separated into two parts, the specular and the diffuse. When this distinction between specular and diffuse transmittance or reflectance is not made, the term *total transmittance* or *total reflectance* may be used to so indicate. Most materials that are suitable for projection screens have small specular coefficients, and one simply refers to the "transmittance" or "reflectance" of the screen.

The relative amount, or intensity, of light scattered in the various directions is conveniently represented by a polar distribution diagram. Different screens have different scattering properties and are, therefore, represented by different distribution diagrams. A distribution diagram such as in Fig. 1A characterizes a diffusely transmitting screen. A screen material having appreciable specular trans-

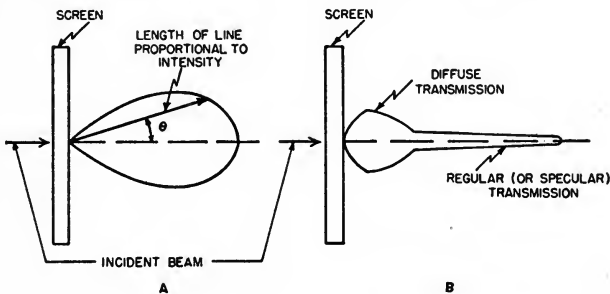

Fig. 1. Polar intensity distribution diagrams of rear projection screens: A, diffusely transmitting screen; B, screen exhibiting regular (or specular) as well as diffuse transmission.

mission in addition to diffuse transmission is represented by a diagram such as that shown in Fig. 1B.

Strictly speaking, polar distribution "diagrams" must be three-dimensional diagrams and the distribution "curves" are really surfaces. If the distribution is symmetrical about the normal to the surface, a simple plane diagram completely describes the directional scattering properties of the screen. If the distribution is unsymmetrical, and many practical screens have such unsymmetrical directional characteristics, the distribution is commonly represented by two plane diagrams; one for the distribution in a vertical plane, the other for the distribution in a horizontal plane.

In the examples cited, it has been tacitly assumed that the maximum intensity of the scattered light is observed in the direction normal to the screen surface. This may often be the case, but is by no means always true. In particular, if the direction of illumination is

oblique to the screen surface, the maximum illumination is often observed to be in a direction other than normal to the screen surface. Certain possible situations are represented by the diagrams in Fig. 2, which pertain to front projection screens.

It is well to emphasize that an intensity diagram and a brightness diagram are not identical. Intensity distribution diagrams have been used in the previous examples, but brightness distribution diagrams would have served just as well. The brightness in any given direction is proportional to the intensity in that direction divided by the

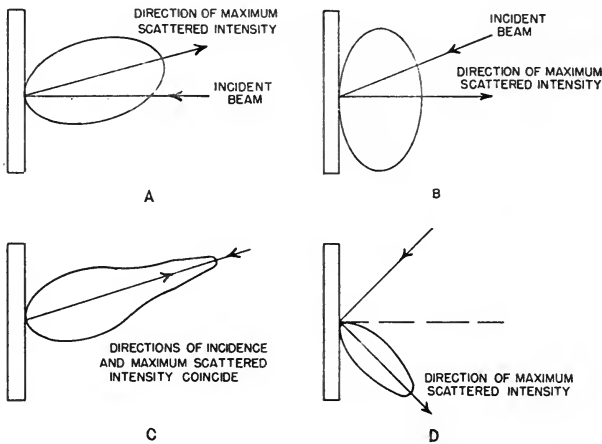

Fig. 2. Some of the possible types of intensity distributions for front projection screens: A, medium brightness gain screen with pattern asymmetrical with respect to the normal; B, diffusing screen with brightness gain less than unity; C, behavior typical of beaded screens; D, high brightness gain screen exhibiting marked specular behavior.

cosine of the angle between that direction and the normal to the screen. The two diagrams are therefore related.

*The Brightness Gain of a Screen**

The directional properties of a screen material can be represented to an extent adequate for many projection considerations by stating only a single numerical value. This value is the brightness gain. In order to define a numerical value for brightness gain, some specific directional characteristic must be chosen as a reference. We shall

* Discussion with Dr. W. W. Lozier following the presentation of this paper disclosed that the quantity herein defined as "effective brightness gain" has been called "apparent reflectance" by some investigators.

choose the particular scattering characteristic which defines a Lambert scatterer as our standard.

A Lambert scatterer is, by definition, one having a sphere tangent to the scattering surface as its three-dimensional intensity distribution diagram. It scatters with greatest intensity normal to its surface. Since it scatters symmetrically about the normal, it is adequately represented by its plane scattering diagram, which is a circle. A Lambert scatterer is often called a perfect diffuser.

The brightness of a Lambert source, whether an emitter or a scatterer, is independent of the direction from which it is viewed. The obliquity decrement in intensity is just compensated by the increase in source area corresponding to a constant projected area. A perfectly diffusing surface emitting, transmitting or reflecting N lumens per square foot of its area has, by definition, a brightness of N foot-Lamberts, which remains the same for all directions of viewing.

Any screen can be compared with a Lambert screen scattering the same number of total lumens per square foot of screen area. Let the brightness of the Lambert screen be B' . Let B_0 be the brightness of the screen in question when it is viewed in the direction in which it has maximum brightness. The brightness gain, G , of the screen can be defined as the ratio

$$G = \frac{B_0}{B'}$$

which is equivalent to taking the brightness gain of a Lambert scatterer as unity.

The mathematical representation of brightness gain is discussed in Appendix I. The above definition of brightness gain is in general use.¹¹ It should be mentioned, however, that another definition is sometimes used⁷ which gives numerical values just twice as large as the values of brightness gain herein defined.

A screen which has an elongated polar distribution diagram, such as that represented in Fig. 1A, has a brightness gain which is greater than unity. This type of screen is generally referred to as a *directional screen*. A material having a flattened rather than an elongated polar diagram, like that shown in Fig. 2B, has a brightness gain which is less than unity; such materials are seldom used for projection screens.

The brightness of a screen depends not only upon the illumination and the brightness gain, but also upon the reflectance or transmittance of the screen material. A useful parameter for screen comparison is

the *effective brightness gain*, which includes the effect of reflectance, R , or transmittance, T , and is defined as,

$$G_{\text{eff}} = RG \text{ (for front projection screens),}$$
$$G_{\text{eff}} = TG \text{ (for rear projection screens).}$$

Choice of Screen Material

The choice of a screen for use in a given situation depends on how the audience is distributed about the screen. The screen should direct as much light as possible toward the audience, and as little light as possible in other directions. A screen which is "tailored" to the audience will make the most efficient use of the available light from the screen.

It is evident that the vertical and the horizontal distribution diagrams of the screen need not be the same. A screen which confines the scattered light to the minimum vertical and horizontal angles consistent with the particular requirements will have maximum usable brightness gain. A screen with a lower brightness gain will not utilize the available light to the greatest advantage.

A screen which appears equally bright to all observers within the intended region of coverage of the screen and which has zero brightness to observers situated outside this region cannot be achieved in practice. Screen materials can, however, be chosen to approximate this condition reasonably well. Parameters which are useful in making such a choice are the horizontal and vertical angles of coverage. The brightness gain of a screen is related to these angles of coverage, usually defined as the angles between the directions in which the screen has half its maximum brightness.

It is frequently assumed that the light incident on the screen comes from a single well-defined direction. This assumption should, however, be used with care. In practice, the light incident on any point of the screen consists of a cone of rays coming from the projection lens aperture and converging at the point on the screen. Further, the rays falling on the edges and corners of the screen have a different angle of incidence than the rays at the center. In motion picture projection, the cone of rays converging at any point on the screen is very small, and the rays to opposite corners of the picture make a rather small angle with each other. Moreover, low brightness gain (wide angle) screens which closely approximate Lambert scatterers are generally used. Therefore, in motion picture practice, the assumption is valid. In television projection, on the other hand, the

angles involved are quite large and high brightness gain screens are generally employed. The range of angles of incidence of the light rays at the screen may be comparable to or larger than the angular width of the distribution diagram. When the incident convergent cone of rays is large, the effective distribution diagrams are broadened and the effective brightness gain is lowered, as shown in Fig. 3A. When the angle of incidence changes sufficiently over the screen area, the distribution diagram differs correspondingly for different regions of the screen. This generally will result in nonuniform brightness over the screen area, the effect becoming more noticeable at high brightness gain figures and at large oblique viewing angles. Curved

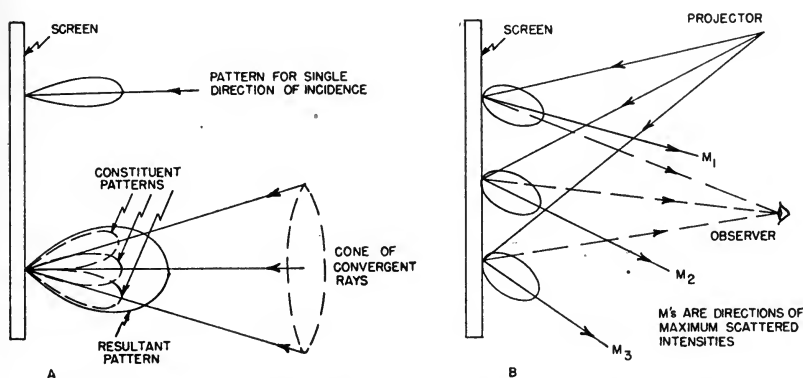

Fig. 3. A, diagrams illustrating the broadening of the intensity diagram that results when light is incident over an appreciable range of angles; B, illustrates the variation in relative brightness accompanying a variation in angle of incidence across the screen.

screens,⁷ auxiliary optical elements such as a Fresnel lens,¹¹ nonhomogeneous screens, or other innovations may offer advantages in these cases.

Experimental Equipment and Procedure

Of the various possible experimental procedures, the following was chosen as being the best adapted to measurement of small screen samples. A slide projector with a small circular aperture in the slide position projects a uniformly illuminated circular spot of light onto the screen sample. A visually corrected photronic cell, used as a detector, is mounted on an arm which can be rotated horizontally about the illuminated spot as a center. The illumination measured by the photronic cell is proportional to the candlepower of the ele-

mentary screen area. A polar plot of a series of measurements at different angles gives the horizontal intensity distribution curve. The screen sample can be rotated through 90° to obtain the vertical pattern. Figure 4 illustrates the apparatus. A known and fixed value of incident illumination is maintained by a line voltage regulator and a variac.

Initial calibration is performed with the lamp operating under known steady conditions. The total flux projected onto the illuminated spot is determined by removing the screen sample and allowing the light from the projector to fall on a large distant screen. The illumination on this large screen area is measured at numerous points

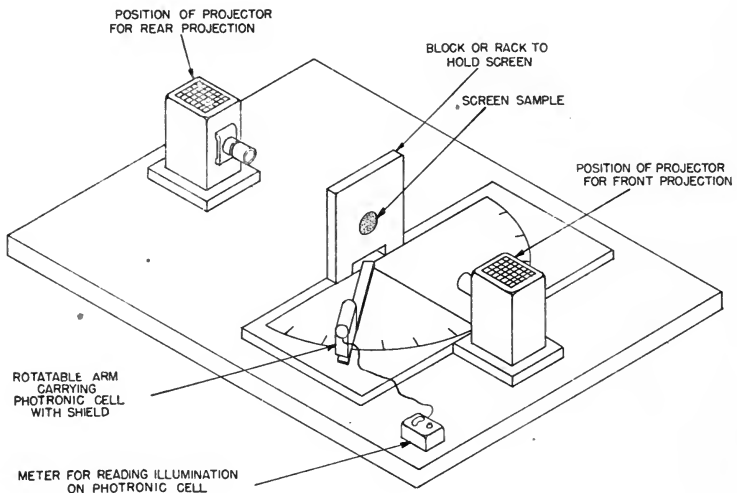

Fig. 4. Equipment used to determine screen parameters by the intensity method.

and total flux is determined by numerical integration over the entire area. This calibration method gives higher precision than can be obtained by measurements on the small, highly illuminated spot at the screen sample.

The light output from the projector may change after initial calibration due to aging of the lamp. To avoid the necessity for recalibration at frequent intervals, a series of measurements was made on a carefully prepared magnesium carbonate block. The pattern, brightness gain and reflectivity of the magnesium carbonate block were determined as accurately as possible. This block was then used as a secondary reference standard. Measurements with reference to the

magnesium carbonate were found to be satisfactorily reproducible and were in agreement with published values. Therefore, as a standardizing procedure on subsequent tests, the lamp voltage was adjusted to give an arbitrary photronic cell reading with the magnesium carbonate standard.

Another experimental method was used for measurement of large screen areas. In this case, the entire screen is illuminated with a projector and the screen brightness is measured directly, using a Macbeth illuminometer or an SEI (Salford Electrical Instrument) exposure photometer. In order to calculate reflectance and to guard against variations in the source, screen illumination is monitored by use of a footcandle meter.

The first method, involving candlepower measurement, is convenient for laboratory use. Its chief advantage is that only a small screen sample is required. The incident illumination can be precisely controlled. Further, the measurement is based on an electrical meter reading and is thus not subject to the human errors which may arise in visual photometry.

The second method, involving direct brightness measurement, can be used with large screen samples. The portability of the equipment and the nature of the measurements permit use under actual field conditions, as in a theater. The method is well suited for measurements at large angular departure from normal, where candlepower falls off very rapidly but brightness remains relatively constant.

Some screen samples were measured more than once, and were measured by both methods. The consistency of the results leads us to believe that the brightness gain values are good to $\pm 5\%$ with the lower gain figures being somewhat more reliable than the higher brightness gain figures. The reflectance values are likewise good to about 5%. A series of measurements on magnesium carbonate by the candlepower method shows $\pm 2\%$ consistency.

Experimental Results

Table I gives the results of laboratory measurement on a number of screens and of several miscellaneous materials. Some of the materials were measured by the intensity method and others were measured by both the intensity and the brightness methods. All data presented refer to measurements made with incident illumination normal to the screen surface. All of the screens are homogeneous, except the ribbed plastic screen with Fresnel lens; measurements on the latter pertain to the central region only. Some of the laboratory measurements are presented in Figs. 5 and 6.

Conclusions

Certain optical characteristics of projection screens have been dealt with rather extensively. It is hoped that this discussion will help the reader to picture more clearly the fairly complex problem with which we are dealing and to comprehend the meaning of those few parameters which we have considered.

TABLE I. Characteristics of Representative Screens

Screen	Brightness Gain, <i>G</i>	Reflec- tance, <i>R</i> %	Trans- mittance, <i>T</i> %	Effective Brightness Gain, <i>GR</i> or <i>GT</i>
<i>Miscellaneous Materials</i>				
Perfect screen	1.0	100	100	1.0
Magnesium carbonate	1.1	88	—	0.97
Traceolene paper	13.6	—	87	11.8
Opal glass	1.0	—	48	0.48
White blotting paper	1.4	61	—	0.85
Brushed aluminum	4.5	65	—	2.9
<i>Motion Picture Screens</i>				
Smooth-surface plastic (perforated)	1.15	72	—	0.83
Beaded	16.4	35	—	5.7
Nylon cloth	1.2	49	—	0.6
Metallized directional (perforated)	2.5	70	—	1.8
Glass cloth	1.7	47	—	0.8
<i>Commercial Television Screens</i>				
Translucent plastic #1	12.	—	54	6.5
Translucent plastic #2	6.2	—	62	3.9
Diffusing cloth	4.2	—	47	2.0
Diffusing glass	5.1	—	70	3.6
Ribbed glass	7.0	—	49	3.2
Ribbed plastic with Fresnel lens	8.0	—	43	3.2
Metal beaded	7.5	61	—	4.6

The experimental apparatus described and the procedure developed enable us to measure rapidly the more important optical characteristics of a screen material with an accuracy sufficient for most purposes. Measurements made on a number of motion picture screens, television screens, and other materials of interest, are believed to be accurate to within 5%. Our results are in reasonable agreement with the few published figures we have been able to find.

Acknowledgments

The measuring procedure herein described was developed by G. M. Rentoumis and the author. Mr. Rentoumis also carried out many

of the laboratory measurements; B. D. Plakun rendered editorial assistance.

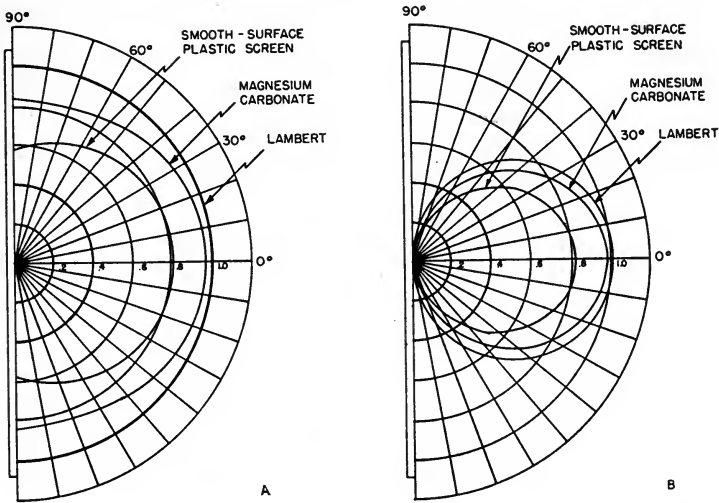

Fig. 5. Brightness and intensity patterns for a "perfect" screen (100% reflectance Lambert scatterer), the magnesium carbonate standard, and the smooth-surface plastic screen included in Table I. On the brightness diagram, A, the radial scale gives foot-Lamberts per foot-candle of illumination; on the intensity diagram, B, the radial scale gives candles per π square feet of screen area per foot-candle of illumination.

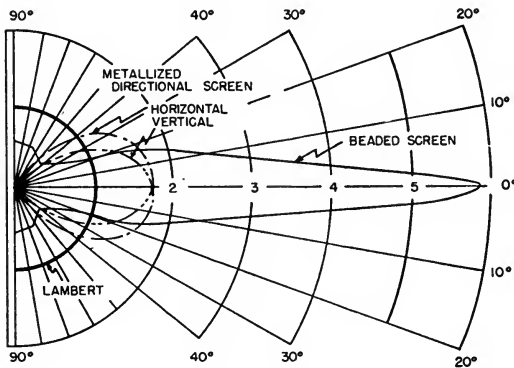

Fig. 6. Brightness patterns for a typical beaded screen and for a metallized screen. The pattern for a "perfect" screen is shown for comparison. The radial scale is graduated in foot-Lamberts per foot-candle of illumination.

APPENDIX I

Derivation of Expressions for Brightness Gain and Reflectivity

Brightness gain, G , has been defined as the ratio of brightness, B_0 , of a screen, as observed in the direction in which it has maximum brightness, to the brightness B_0' of a Lambert screen emitting the same total flux per unit area of screen surface. From this definition and from basic photometric concepts we shall derive an expression for the brightness gain in terms of the brightness distribution curve of the screen. Reflectance (or transmittance) will be expressed as a function of the gain and of other parameters.

From basic definitions, we may write,

$$dL = Cd\omega = B da \cos \Theta d\omega \quad (1)$$

where dL is the flux emitted in the elementary solid angle, $d\omega$, and where C is the intensity and B the brightness of the elementary source area da when observed in the direction making the angle Θ with the normal to da . A consistent set of units must, of course, be employed; e.g., L , C , B and da may be expressed in lumens, candles, candles per square foot, and square feet respectively. The total flux emitted from the elementary source da is then

$$L = \int dL = \int Cd\omega = da \int B \cos \Theta d\omega \quad (2)$$

where the integrations are to be carried out over the entire solid angle on the observer's side of the plane containing da .

In general, the brightness of a given source will be a function of direction which is not necessarily symmetrical about the direction of maximum brightness. That is, the brightness, B , must be expressed as a function of two variables, say the angles α and β , where β is the angle between the direction of observation and the horizontal plane, and α is the angle between the normal to the vertical element of area da and the projection of the direction of observation onto the horizontal plane. It is convenient to express the brightness, B , in any direction as the product of the maximum brightness, B_0 , by an angular dependence function, $g(\alpha, \beta)$, i.e.,

$$B = B_0 g(\alpha, \beta). \quad (3)$$

In terms of the co-ordinates α and β it can be shown that,

$$\cos \Theta = \cos \alpha \cos \beta \quad (4)$$

and that the element of solid angle can be expressed as,

$$d\omega = \cos \beta d\alpha d\beta. \quad (5)$$

Substituting Eq. (3), (4) and (5) into (2), we can now express the total flux as,

$$L = da \int B \cos \Theta \, d\omega = B_0 da \int_{-\pi/2}^{\pi/2} \int_{-\pi/2}^{\pi/2} g(\alpha, \beta) \cos \alpha \cos^2 \beta \, d\alpha \, d\beta. \quad (6)$$

Now, a Lambert source, by definition, has a brightness independent of the direction of observation; i.e., $g(\alpha, \beta)$ is a constant equal to unity. Setting $g(\alpha, \beta)$ equal to unity in Eq. (6) and evaluating the resulting simple integral gives for the total flux, L' , from a Lambert source of area da' and of brightness B_0' ,

$$L' = \pi B_0' da'. \quad (7)$$

Returning now to our definition of brightness gain, we see that it is expressed by the ratio of B_0 to B_0' , subject to the condition that $L/da = L'/da'$; hence from (6) and (7) we get the desired expression

$$G = \frac{B_0}{B_0'} = \frac{\pi}{\int \int g(\alpha, \beta) \cos \alpha \cos^2 \beta \, d\alpha \, d\beta}. \quad (8)$$

We could follow through a similar argument in which attention is focused on the intensity distribution rather than the brightness distribution. We would then find it convenient to define an intensity angular dependence function $f(\alpha, \beta)$ by

$$C = C_0 f(\alpha, \beta) \quad (9)$$

analogous to Eq. (3) and our resultant expression for brightness gain would be

$$G = \frac{\pi}{\cos \Theta_0 \int \int f(\alpha, \beta) \cos \beta \, d\alpha \, d\beta} \quad (10)$$

which is equivalent to Eq. (8) and wherein Θ_0 is the angle between the normal to da and the direction of maximum brightness.

The reflectance of a screen is defined as the ratio of the total reflected or scattered flux, L , to the incident flux, L_i . The scattered flux is given by Eq. (6) and the incident flux may be expressed as

$$L_i = \int E \, da \quad (11)$$

where E is the illumination on the screen and the integration extends over the total area under consideration. If we assume that E is uniform over this area, the integral sign may be dropped and da has the meaning previously assigned. Using Eq. (6) and (8) we may write,

$$R = \frac{L}{L_t} = \frac{B_0}{E} \int \int g(\alpha, \beta) \cos \alpha \cos^2 \beta \, d\alpha \, d\beta = \frac{\pi B_0}{EG} \quad (12)$$

where B_0 is expressed in candles per unit area and E is in lumens per unit area. If the maximum brightness is expressed in foot-Lamberts and the screen illumination is expressed in foot-candles, expression (12) becomes

$$R = \frac{B_0 \text{ (ft-L)}}{E \text{ (ft-c)}} \frac{1}{G} \quad (13)$$

It follows from this expression that the maximum brightness in foot-Lamberts divided by the illumination in foot-candles is numerically equal to the effective brightness gain, $G_{\text{eff}} = RG$. Equations (12) and (13) give, of course, the transmittance, T , rather than the reflectance, R , in the case of rear projection screens.

APPENDIX II

Treatment of Experimental Data

The experimental procedures described enable one to obtain a series of values of intensity or of brightness measured in different directions; i.e., to obtain C_0 or B_0 and the values of $f(\alpha, \beta)$ or of $g(\alpha, \beta)$ for certain values of α and β . In order to determine the brightness gain and reflectance (or transmittance) from these data it is necessary to evaluate the integrals occurring in Eq. (8) or (10). Although it is possible to fit the observed data with analytic functional representations of $g(\alpha, \beta)$ and $f(\alpha, \beta)$ it is generally more satisfactory to approximate the integrals by numerical methods.

Experimentally it is convenient and generally adequate to make measurements in the horizontal and vertical planes only, i.e., to determine $f(\alpha, 0)$ and $f(0, \beta)$. Let us use the notation $f(\alpha, 0) = H(\alpha)$ for the horizontal intensity pattern, and $f(0, \beta) = V(\beta)$ for the vertical intensity pattern. If Θ_0 is small, very little error is introduced by making the approximation,

$$f(\alpha, \beta) = H(\alpha) V(\beta) \quad (14)$$

For simplicity, we shall assume further that the patterns are symmetrical and that $\Theta_0 = 0$, whence from Eq. (10),

$$\frac{\pi}{G} = 4 \int_0^{\pi/2} H(\alpha) d\alpha \int_0^{\pi/2} V(\beta) \cos \beta \, d\beta \quad (15)$$

Approximating the integrations by summations and expressing the angles in degrees we have,

$$\begin{aligned} \pi/G &= \frac{4}{(57.3)^2} \left\{ \sum_j H(\alpha_j) \Delta\alpha_j \right\} \left\{ \sum_i V(\beta_i) \cos \beta_i \Delta\beta_i \right\} \\ &= 4 \frac{\Delta\alpha \Delta\beta}{(57.3)^2} \left\{ \sum_{j=1}^n H(\alpha_j) \right\} \left\{ \sum_{i=1}^m V(\beta_i) \cos \beta_i \right\} \end{aligned} \quad (16)$$

where $\Delta\alpha = 90^\circ/n$, $\Delta\beta = 90^\circ/m$, m and n are any integers, and where $\alpha_j = \Delta\alpha/2 + j\Delta\alpha$ and $\beta_i = \Delta\beta/2 + i\Delta\beta$.

In the more general case where the patterns are asymmetrical and where Θ_0 is not equal to zero, suitable numerical expressions superseding (16) can be developed by similar arguments. The brightness gain may be computed arithmetically after direct substitution of the observed data into Eq. (16) or its counterpart.

It might be noted that in using apparatus of the type illustrated in Fig. 4, the directly measured quantity is the illumination, E_d , falling on the detector. The intensity C , in candles, of the illuminated spot is simply

$$C = E_d r^2 \quad (17)$$

where E_d is in lumens per square foot (foot-candles) and r is the constant distance from the screen sample to the detector expressed in feet. Equation (12) for the reflectance (or transmittance) becomes, then, in terms of the directly measured quantities

$$R = \frac{L}{L_t} = \frac{\pi B_0}{EG} = \frac{\pi}{EG} \frac{E_d r^2}{da} \quad (18)$$

where E is the illumination on the sample of area da .

If the direct observations are of brightness rather than of intensity, one may compute H and V from the relations

$$H(\alpha) = g(\alpha, 0) \cos \alpha \quad (19a)$$

$$V(\beta) = g(0, \beta) \cos \beta \quad (19b)$$

and then use Eq. (16). Reflectance (or transmittance) may be calculated directly from Eq. (12), necessitating, of course, a measurement of the screen illumination, E .

The integral appearing in Eq. (10) may be thought of as the effective solid angle occupied by the scattered light. For moderately or highly directional screens this solid angle is roughly equal to the

product of the vertical and the horizontal angles of coverage, A and B , expressed in radians. Thus, a rough approximate expression for the brightness gain is

$$G = \frac{\pi}{AB \cos \Theta_0} \quad (20)$$

It is found by trial and error that the approximation is best if A and B are defined as the angles between the directions in which the intensities have fallen to one-third of their maximum values.

REFERENCES

1. A. C. Hardy and F. H. Perrin, *The Principles of Optics*, 632 pp. McGraw-Hill, New York, 1932.
2. E. M. Lowry, "Screen brightness and the visual functions," *Jour. SMPE*, vol. 26, pp. 490-504, May 1936 (contains a good bibliography).
3. R. P. Teele, "Photometry and brightness measurements," *Jour. SMPE*, vol. 26, pp. 554-569, May 1936.
4. W. F. Little and A. T. Williams, "Résumé of methods of determining screen brightness and reflectance," *Jour. SMPE*, vol. 26, pp. 570-577, May 1936.
5. "Physical concepts: radiant energy and its measurement," *Jour. Opt. Soc. Amer.*, vol. 34, pp. 183-218, Apr. 1944.
6. J. L. Stableford, "Projection screen efficiency," *Jour. Brit. Kinematograph Soc.*, vol. 10, no. 1, p. 37, Jan. and Feb. 1947.
7. W. E. Bradley and E. Traub, "A new television projection system," *Electronics*, vol. 20, p. 84, Sept. 1947.
8. "British screen brightness standards," *Internat. Proj.*, vol. 22, p. 18, Nov. 1947.
9. "Report of Screen-Brightness Committee," *Jour. SMPE*, vol. 50, pp. 260-273, Mar. 1948.
10. H. G. Boyle and E. B. Doll, "Compact projection television system," *Electronics*, vol. 21, p. 72, Apr. 1948.
11. R. R. Law and I. G. Maloff, "Projection screens for home television receivers," *Jour. Opt. Soc. Amer.*, vol. 38, no. 6, pp. 497-502, June 1948.
12. H. L. Logan, "Brightness and illumination requirements," *Jour. SMPE*, vol. 51, pp. 1-2, July 1948.
13. A. G. D. West, "Development of theater television in England," *Jour. SMPE*, vol. 51, pp. 127-168, Aug. 1948.

Specifications for Motion Picture Films Intended for Television Transmission

BY CHARLES L. TOWNSEND

NATIONAL BROADCASTING CO., NEW YORK, N.Y.

SUMMARY: Consideration is given to the major problems encountered in television reproduction of motion picture film. Present practices are discussed and special requirements of the television system are described. The qualities presently desirable in a motion picture film to fit it to that system are defined, along with explanatory exposition. An appendix lists the specifications for quick reference.

MANY YEARS of motion picture theater viewing have established a reasonably well understood norm for motion picture quality. When such motion pictures are transmitted by a television system it is presumably desirable to reproduce them with a quality as near that norm as the state of the art permits. It is not desirable to demand new end-result standards, or to require major changes in production techniques. It is pointed out, however, that both the film and the television system have inherent technical degradations, which are compounded in the final result. This discussion is directed toward defining those properties which a film image should exhibit for television use, while still retaining as much as possible of the established motion picture characteristics.

The problem is divided below into considerations of gray-range or transfer characteristic, detail rendition or resolution, and scene content effects.

I. TRANSFER CHARACTERISTIC

1. *Pickup Equipment*

Almost all television stations now use iconoscope tubes for film transmission. Under the intensive programs of research directed toward development of new television pickup devices it is possible that superior film transmission systems will become available in the future. For the present discussion, however, iconoscope transmission will be assumed.

2. *Characteristics of the Television System*

Special projectors are used for television as a means to change from the sound film frame rate of 24 per second to the television frame rate

A CONTRIBUTION: Submitted June 15, 1950.

of 30 per second. Alternate film frames are scanned three times, as against the others, which are scanned twice. This difference in handling does not alter the action on the film since the average rate of film travel is still the original 24 frames per second.

The projectors use a very short pulse of light, which can be supplied by a gap lamp without a shutter, or by an incandescent, or arc lamp with a rotating shutter having a very small open period. The shortness of the open period causes a severe light loss, so that only enough light is obtained for a small picture even though a lamp normally intended for large-screen viewing is used. This effect has a large influence on the maximum film densities usable, and upon the "noise" or graininess of the television system.

The iconoscope pickup tube has a screen which consists of millions of small photocells deposited upon a nonconducting film supported by a metallic plate. The photocells "see" the picture for a short period, and then are scanned in the dark. They must have good memory or "storage" if they are to supply good contrast over the whole plate. Also, their small-area sensitivity is influenced by adjacent area illumination, so that spurious signals are generated, which are only distantly related to the original scene content. These signal voltages must be balanced out by adding to them other oppositely "shaped" voltages, which constitutes the operation of "shading." In general, more shading is required when dark scenes are televised, and when large black areas are located near a frame edge. The latter case usually produces "flare," or a tendency for the black to "bleed off" to gray. Flare is an effect which can be reduced by proper film density control.

System "noise level" or electrical graininess* is also important in picture quality. It is inevitable that the electronic system should produce noise when the signals incoming are low. The amount of noise is determined to a great extent by the amount of amplification which must be used. A low signal, whether it be due to a dark film or a low sensitivity iconoscope, will require more-than-usual amplification and the picture will be noisy. This system "noise grain" is important in determining the effects of excess density and graininess in the photographic image.

* Noise level at any point in a transmission system is the ratio of the circuit noise at that point to some arbitrary amount of circuit noise chosen as a reference. This ratio is usually expressed in decibels above reference noise, abbreviated dbrn, signifying the reading of a circuit noise meter, or in adjusted decibels, abbreviated dba, signifying circuit noise meter reading adjusted to represent interfering effect under specified conditions.—From ASA C42 "American Standard Definitions of Electrical Terms."

Measurements of the transfer characteristic of iconoscopes indicates that when the above-mentioned effects of storage, shading and grain are properly controlled, the tube's output voltage is an almost linear function of film density over an appreciable range. This television system gray-range is important to the film manufacturer because some films permit a wider range of tones than does the electrical system. Attempting to compress a wide-range picture into a television system must result in the appearance of the effects of electrical "toes and shoulders," analogous to characteristics of film emulsions shown by the conventional H & D curves. The transfer characteristic encountered looks much like that of ordinary films, in that it is generally S-shaped, exhibiting a fairly sharp toe and a more round white-range shoulder. There is a reasonably linear central portion of the curve; but, if only that portion is used in reproduction, insufficient output voltage is generally obtained, increasing the electrical noise level beyond acceptability. Thus it becomes imperative to use as much as possible of the iconoscope characteristic, even though some compression is encountered.

Problems of compression are somewhat complex. If a completely compression-free scene is thrown on the plate of an iconoscope (as in the case of live pickup), the characteristic toe and shoulder are not excessive. Through long education most observers have come to expect and even demand controlled range compression. Such compression is valuable in reducing sudden brightness changes between scenes, and to permit presentations of scenes which if fully reproduced would be painfully bright or so dark as to lose all information. However, if a scene is televised which already has a normal amount of compression, then that compression and the system compression are cumulative, and the result is unsatisfactory. If a film is so made that every bit of acceptable toe and shoulder is already present, it would have to be reproduced on a toe-and-shoulder-free system. Our present television systems do not have that characteristic.

The effects of a change in exposure or development of a film are apt to be obscured when that film is reproduced on a television system because video controls permit easy change of contrast and average brightness. Some effects which will appear similar to gamma changes produced by variations in film processing can be obtained by electrical compressions, which can be introduced particularly well in the black signal range. Special equipment permits controlled bending of the electrical system transfer characteristic to expand the white signal range almost at will. Both "amount" and "break point" of such bending can be adjusted to suit an individual case. It is, how-

ever, inadvisable to depend too much upon such compensation, since the steep gradients required for large effects cause the electrical system to become "wild" and difficult to operate. In general, films should be made to have as little compression in their significant densities as the state of the art will permit. In this way only small compensations will be required, and good operational performance can be expected.

3. *Film Characteristics*

There is a real desire on the part of most film producers to make their product fit the needs of the television system. Many have asked for complete specifications for television films in the hope of obtaining inflexibly correct values and procedures. The information below will serve to define as far as possible these correct values and procedures, but will also indicate why they cannot be inflexibly specified.

Density range is the most important aspect of the television film. To provide good signal-to-noise ratio, the film must transmit as much light as possible. To stay within the tone-range of the system no more density range should be recorded than is expected to be reproduced. The numerical values of these limitations may be stated fairly firmly. The usual iconoscope tube can accommodate a density range of approximately 1.5. That is, the light energy in the high-lights should not exceed 32 times that in the darkest portions to be reproduced. Actually, a somewhat greater range can be transmitted, but only with excessive compression effects. The position of the 1.5 density range in the film characteristic is also important. With present projection illumination levels, the minimum significant density should not be greater than 0.4 if good signal-to-noise ratio is to be obtained. That is, maximum important high-lights should be placed approximately at 0.4, with some "white peaks" extending below this value only if they have little or no importance in the scene, or if no detail is present in them. The major reason that lower densities are not valuable lies in the fact that most films show compression effects in that range. Print characteristic curvatures between the densities of fog level and 0.4 are usually too great to be tolerated by a system which increases that curvature. Of course, there are printing systems which depend upon a balance between a long curved negative characteristic and a complementary print curve. In this case, the above statement may require modification, but it is believed that very little printing is done in this manner. When "normal" printing is used, best results will be obtained if the significant densities are placed in the range from 0.4 to

1.9, with only unimportant areas or areas lacking detail permitted to fall outside these limits. In cases where large black areas must appear at the bottom of the frame or where black backgrounds are required for short periods of time, a further reduction in density of these black areas is recommended. A maximum density value of 1.5 in these areas is more appropriate if flare and the resulting bleeding of the black are to be held to a minimum. Ordinarily such a background will be reproduced as black on the television system, since the original intention will be obvious to the video operator.

Many film producers have requested specifications on film stocks and development gammas rather than a required range of densities. It has not been possible to make any firm statements of this type for the following reasons:

Gamma is the parameter for which most specification requests are received. Without any information other than the question, "What gamma is best for television films?" no answer can be given at all. The term "print gamma" usually refers to the value of the slope of the density vs. exposure curve for a particular stock developed under some particular conditions. Usually it is read at the high-density end of the curve. When this is done an excellent measure of the effects of development is obtained, but with very little information concerning the appearance of the picture. As a tool for processing control, print gamma is excellent, but the picture density range is usually not "read." Thus two films may be handled so that their IIB densities may be plotted as straight lines from values of 1 to 2.5, but exhibit entirely different characteristics below that range. They would both have the same "gamma," as far as quoting a number is concerned, making such a quote an extremely unreliable basis for judging picture quality.

Again, if a negative is low in contrast, a higher print gamma is required than if it were "normal." Both of these conditions can produce good pictures, as can the case for a high contrast negative and a low gamma print. Obviously, some knowledge of the negative development would be required for print gamma specification.

"Print-through-gamma" is also an elusive quantity. Curve slopes are never read in the actual picture range, especially since evaluation of gradients in that range is difficult. The net result of combining two gammas is dependent, therefore, on the curve shapes, as well as the exact portions of those shapes actually used. Even when a producing company has arrived at standard developments for negatives and positives, the assignment of a particular print-through-gamma is dangerous because of variations in the original scene contrasts and in negative exposure.

Most film that is good for television use has employed a restricted scene brightness range. This does not mean "flat" studio lighting. All the accent lighting used so effectively by Hollywood can and should be retained. But the ratio of that light to fill-light must be reduced. Again it becomes a problem of fitting the scene into final print densities which can be faithfully reproduced. If it is judged that for a particular scene the brightness ranges that are high in value are the most important, then it may be that large values of back-light and high-light can be tolerated, and the densities representing these brightnesses must be printed within the range. But if it is judged that for another scene the low-value brightnesses are most important, then high-lights must be sacrificed, and exposure increased to get the print densities down within the specified range. If 100- or 200-to-1 films are made, only disappointment can result from compressing them into a 30-to-1 channel.

Many television films are made outdoors with enormous scene brightness ranges, and yet produce excellent results. Some of these films actually show a print density range of 3. This case is a good example of the above reasoning. If the wide range film is mostly small detail of trees, rocks, etc., the video signal will show no texture in the blacks or whites, but none is needed, since these areas are "texture" in themselves. As soon as a medium shot or close-up requires detail in light or dark areas, those areas must be protected from compression by placing them within the specified range. If the large range is maintained, faces will become blank white, and dark horses become animated charcoal drawings. Judicious use of reflectors or fill-light of any kind will reduce the range of most outdoor close-ups to permit the adjustment of exposure to produce the densities required.

From the above it will be seen that many combinations of negative gamma and print gamma can be made to yield good pictures, depending upon the control exercised in original scene brightness range and exposure. The final product is a range of densities, which has been specified; and the means by which an individual producer arrives at those values is largely a function of his own operating conditions.

II. RESOLUTION

1. Television System Characteristics

The television picture delivered to the home viewer is limited in resolution by the bandwidth specified by the Federal Communications Commission, and by the performance of the equipment utilized. In general, acceptable sharpness is obtainable under normal circum-

stances. Several studies have been made to determine just how sharp a picture can be broadcast in the present television channel. Tests with photographic methods whereby an ideal television system can be simulated, and the use of actual television equipment of a highly refined type, have both shown that present system standards can deliver truly excellent definition. That such results are not always attained can be attributed to the large number of system elements which are difficult to control. Some of these are discussed below.

Under normal circumstances the amplifiers and circuits of the television system impose no limitation on the transmission of fine picture detail. Pickup tubes, however, can exert a large effect on final picture sharpness. Ideally, such a tube should have full video voltage output at the highest frequency utilized. That is, the finest black-and-white detail to be transmitted should produce as much signal voltage as does any larger area. Present-day pickup tubes do not completely fulfill this requirement, having a reduced output level at the frequencies corresponding to fine detail in the picture. Electrical equalization is used to compensate for this effect, but this increases the fine-grain "noise" in the transmitted picture so that large amounts of compensation are not desirable. Great care must be exercised to see that the pickup tube is supplied with the best possible picture, in order that over-all degradation is kept to a minimum, since any degradation in the picture will be compounded with degradation in the television system.

Suppose for a moment that an audience will accept without comment a well-defined maximum loss in picture detail at a certain viewing distance. If a television picture having that loss is viewed in that manner, acceptable results are obtained. If a film picture having that loss is viewed in that manner, acceptable results are also obtained. However, if that film, which is acceptable, is viewed over that television system (which in itself is acceptable) seriously degraded and unacceptable pictures will result. Neither picture system in itself is bad, but the combination of the systems adds their individual losses, and the result is noticeably poor.

This introduces the idea that each element of a picture transmission system must be assigned its appropriate part of the total permissible loss. Each such loss must be as small as the state of the art permits. Good circuit design has reduced amplifier losses to a negligible value, but the enormous complexity of picture tube design and construction has not permitted attainment of that degree of perfection in their operation. It has thus long been good practice to assign the major portion of the total permissible resolution loss to the pickup tube. A

great deal of research is being devoted to reducing this loss but for the present it is well to continue to "pamper" the pickup tube.

In live-studio practice it is fairly usual for optical systems to deliver to the pickup tube photo-cathode images having limiting resolution in excess of one thousand television lines. Under such circumstances very little degradation is contributed by the optical image, and the net effective sharpness is that of the picture tube. With film, however, projected image resolution rarely reaches such a high value, and the net effective sharpness is below that of the pickup tube alone. It is interesting to note that live-studio pictures are noticeably degraded when the optical resolving power drops below 800 television lines.

Further complicating the resolution problem is the electrical grain or "noise" inevitable in present systems. If pictures having small "signal" content (low density range) are fed to such a system, amplifier gain must be raised beyond normal limits to regain normal operating levels. This increases the effect of noise, masking the fine detail in much the same manner as does the grain in a poorly made photograph.

Kinescope picture viewing tubes also are pertinent in a discussion of resolution. Good tubes having fine spots are available, but generally some loss should be allowed for this device. An effect called "blooming" is particularly important in film reproduction. Whenever an excessively wide gray-range is fed into the television system, very bright white areas are likely to produce high signals which are well above the general "tone" of the scene. In order to reproduce the lower signals properly, the voltages must be amplified more than usual before being fed to the picture tube. In this case the bright white signals are too high in level for normal operation and those areas blur, losing line structure and picture texture. A reasonable balance between "whites" and "blacks" is desirable for maximum sharpness.

2. *Film Capabilities*

Having established the resolution needs of the television system, it becomes possible to define the performance required of film systems designed for its use. Again, some portion of the total permissible resolution loss must be assigned to the photographic medium. But every effort must be made to match the live pickup sharpness, which means that very little loss can be so assigned. Photography is an old, established craft capable of excellent image sharpness, so it seems

reasonable that stringent requirements should be placed upon it, leaving more leeway for the infant television art.

Quite often it is said that film has such excellent resolution that there cannot be any problem in its television use. Published values of limiting resolution for many films seem to confirm this, but a closer investigation indicates differently. First, it must be remembered that the film resolving-power ratings are for "cutoff" conditions. That is, they state the highest value at which any line structure can be seen. This, of course, is at a very *low* contrast—far too low to be of any value to the television system. "Contrast" is "modulation" in the electrical system, and it is possible to plot the response of film in much the same manner as an electrical system. When this is done, it is discovered that films have no "flat bandwidth." That is, their contrast falls off as the size of the elements to be resolved decreases. If the total photographic system is allowed about 10% loss in contrast at the maximum television resolution, it is found that its limiting resolution value must be well above the television cutoff. As a result of this, the best 16-mm films will be found to be barely good enough. As a matter of practical fact, it is exceedingly difficult to realize a resolution of 400 television lines with a high value of contrast in an ordinary 16-mm release print. Such a print includes degradations due to all the elements of the photographic system, including the effects of printing. For the present, only the very best products and techniques can be combined to produce a 16-mm print which will not seriously limit the results obtainable through the television channel. Whenever feasible, 35-mm film should be used, and in this case also, the best methods should be followed. Unfortunately, not all television stations are equipped to transmit 35-mm film, but if original shooting is done in that size, good quality can be expected from most of the larger stations, and the rest can be served by reduction-printed 16-mm versions.

III. SCENE CONTENT

1. *Reproduced Area*

Reference is made to the *Television Test Film* of the Society of Motion Picture and Television Engineers. The projector alignment section of that film includes an implied standard definition of the area to be scanned. Many stations now have copies of this film, and it is believed that following its directions will lead to satisfactory results. Approximately 1½% of the standard projector frame is cut off in scanning at the top and bottom of the frame, and the sides are cut by

an amount required to maintain the 3×4 aspect ratio specified by law. The side losses are not the same for 35-mm film as for 16-mm film, due to the different film frame aspect ratios.

Alignment chart sections from the 35-mm and 16-mm versions of the test film can be purchased separately, thereby reducing costs. Frequent reference to these charts, along with the instruction book accompanying them, is recommended.

Also included in the above chart is a rectangle enclosing approximately 65% of the frame area. The lines forming it are placed so as to produce a 10% border within the televised frame. The area within the rectangle is believed to be reasonably well reproduced on the home receiver even when scanning is poorly adjusted and centering is badly set. Important information should be kept within this area, especially commercial copy titles or trade-marks.

2. "Busy" Scenes

Care should be taken to insure that a scene being photographed does not have a high-contrast background that will detract from foreground action when the picture is viewed on a small screen. Simplicity seems to be required in backgrounds for television more than for theater use, where images are not "crowded" by the frame size.

3. Shot Sizes

Television has long made good use of close-ups and medium shots. Small screen sizes are not the only reason for this. The resolution needed for a close-up is less than for a long shot, merely on the basis that less fine detail is needed to carry the intended information. Thus, receiving sets which are mis-tuned or are out of focus will reproduce close-ups when long shots will be hopelessly blurred.

The above is not intended to eliminate long shots. Establishing locale and impressions of size are as important as in the theater, but important details of wide-angle shots should be pointed up with clever accent lighting and reduction in unimportant competing detail.

4. Scene Tone Balance

Some refinements in smoothness of reproduction can be obtained when large black-and-white areas are needed, if they are used with care. Half-black, half-white pictures, with the dividing line running horizontally, usually require relatively large shading corrections. This is particularly true if the lower half of the picture is black. Sea-

scapes or any sky and land scene can fall into this category if no large foreground objects are available to break up the pattern. Also, sudden large changes in scene brightness should be avoided, as they place severe requirements on both transmitter and receiver "d-c insertion" performance. Smooth changes or small steps are usually reproduced without trouble. Cutting between shots of an object which have radically different background brightnesses can cause the object itself to appear to change tone, becoming darker with the light background, and lighter with the dark background. Avoid if possible the use of full daylight shooting of night scenes when the required effect is produced by purely photographic means. "Blacks" look severely compressed in that case, and video operators tend to raise their brightness control to bring out what may be there, but is not. If possible, always include some full-level high-light to define the "white signal" limit. Usually this can be done without harming the scene mood for direct projection and will greatly aid in television transmission.

APPENDIX: RECAPITULATION OF SPECIFICATIONS

1. *Density*. Normal contrast range, 1.5; minimum density, 0.4; and maximum density, 1.9.
2. *Gamma*. No exact statement possible, but generally the above will require that gamma be somewhat lower than usual in films intended for theater use.
3. *Resolution*. Limiting value, minimum, 800 television lines.
4. *Scene content*

Follow: SMPTE frame-size specifications in the Television Test Film.

Avoid: Sudden large brightness changes, large black areas near frame edges, "busy" backgrounds, too great gray range, artificial night shots.

REFERENCES

1. Otto Schade, "The electro-optical characteristics of television signals," *RCA Rev.*, (Publication #ST353, Tube Dept., Harrison, N.J.), 1948.
 2. R. B. Janes, R. E. Johnson and R. S. Moore, "Development and performance of television camera tubes," *RCA Rev.*, vol. 10, no. 2, pp. 191-233, June 1949.
 3. D. R. White (Chairman), "Films in television," *Jour. SMPE*, vol. 52, pp. 363-379, Apr. 1949.
 4. G. D. Gudebrod, "Television-film requirements," *Jour. SMPE*, vol. 53, pp. 117-119, Aug. 1949.
 5. A. J. Miller, "Motion picture laboratory practice for television," *Jour. SMPE*, vol. 53, pp. 112-113, Aug. 1949.
 6. *The Use of Motion Picture Films in Television*, 56 pp., Eastman Kodak Co., Motion Picture Film Dept., 343 State St., Rochester, N. Y., 1949.
- See also: "Television test film," *Jour. SMPTE*, vol. 54, pp. 209-218, Feb. 1950.

A 100,000,000 Frame Per Second Camera

By M. SULTANOFF

TERMINAL BALLISTIC LABORATORY, ABERDEEN PROVING GROUND, Md.

SUMMARY: Shock waves close to the edge of explosive charges have been successfully photographed at rates exceeding 100,000,000 frames/sec. These ultra high framing rates are obtained with a multi-slit focal plane shutter which is transported optically across the film plane by a rotating mirror. Linear shutter speeds up to 3,000 meters/sec are easily obtained, and the resulting framing rates with the proper selection of slit widths can be varied from 10^5 to 10^9 frames/sec. Each individual frame is composed of a series of lines, and the degree of "discontinuity" across each frame is proportional to the total number of frames.

THE EXPERIMENTAL STUDIES of the shock and detonation which accompany explosive reactions have been hampered by the lack of ultra high-speed instrumentation. Short duration optical studies are particularly required for the investigation of self-luminous detonation and shock waves.

The velocity of these transients averages about 8 mm per microsecond; therefore, usable photographic exposures of these transients must not exceed 10^{-7} sec. Kerr cell shutters¹ have been used to obtain a single or a few successive short duration exposures, while multi-lens cameras² have produced continuous short duration exposures, but at rates which are not adequately high. The O'Brien-Milne camera,³ which is rated at 10,000,000 frames/sec, but which displays poor resolving power, could not be obtained commercially, and its precise optical system made it impractical to build locally.

A motion picture camera which employs simple optical and mechanical systems to obtain up to 300 successive 4×4 in. frames at rates which can be varied from 10^5 to 10^9 frames/sec, and which exhibits satisfactory resolving power, is described in this paper.

THEORY OF GRID FRAMING

The standard variable slit focal plane shutter in common use exposes a time-space record as it travels across the film plane. Although the slit moves slowly across the film, the exposure time can be made extremely short by reducing the width of the slit.

PRESENTED: April 26, 1950, at the SMPTE Convention in Chicago.

The framing grid is a focal plane shutter with a series of parallel slits placed at regular intervals across it. This shutter, therefore, is required to move only the distance between two successive slits to expose the entire film. To understand how this grid records successive frames, consider a series of optically clear slits .0005 in. wide, cut at .015-in. intervals across a 4×4 in. optically opaque plate. If this grid is held in a fixed position on a 4×5 in. photographic plate,



Fig. 1. Single still photograph of spherical charge in firing position, taken through .0005-in. slit, .015-in. space grid.

a single exposure made through it would consist of a set of parallel lines which occupy only $\frac{1}{30}$ of the total picture area with an over-all dimension of 4×4 in. A sample exposure of this type is shown in Fig. 1. By moving the grid across the film perpendicularly to the slits for a distance of .0005 in., and exposing a second still picture in this new position, a second series of lines lying alongside the first set and again occupying only $\frac{1}{30}$ of the total picture area will be pro-

duced. Thirty such single pictures will result from only .015-in. movement of the grid, and will expose the entire film area. To the casual observer the resulting picture will be an indistinguishable jumble. However, by proper positioning of the grid, any one of the 30 exposures can be studied separately. This type of grid framing has been used for years in animated greeting cards and photographic advertisements.

If the photographic object is moving, and if the grid is moved at a uniform rate across the film for a distance of .015 in., the resulting picture can be viewed through the grid as 30 separate exposures, one at a time, or, by viewing through the grid moving at any uniform

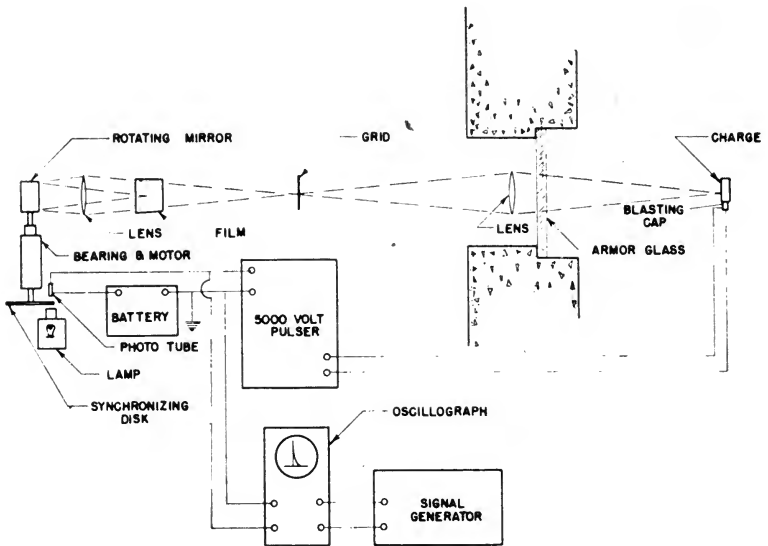

Fig. 2. Synchronizing circuit for ultra high-speed camera.

speed, flickerless motion pictures will be observed. This adaptation of grid framing has been described in papers delivered by Dr. Fordyce Tuttle of the Eastman Kodak Co.⁴

At this laboratory we have been successful in combining a stationary framing grid with a rotating mirror to obtain framing rates in excess of 10^8 frames/sec.

THE ROTATING MIRROR GRID COMBINATION

The optimum slit width for the multi-slit focal plane shutter appears to be of the order of .0001 in. A shutter with .0001-in. slits is required to move 10,000 in./sec to produce 10^8 frames/sec. It is

impractical to accelerate to, maintain, and decelerate from, such high velocities with a linearly moving shutter. A rotating focal plane shutter, on the other hand, has the double disadvantage of requiring tapered radial slits and the combination of a large diameter and high rotational velocity. A method for moving the image of the shutter across the film plane by reflection from a rotating mirror was obviously a simple solution to this problem. The rotating mirror optical system in a Bowen RC-3 Rotating Mirror Camera,⁵ although not adequate for this application, was available at this installation, and it was modified to take a 4×4 in. multi-slit framing grid and a 4×5 in. camera back.

A first lens is used to image the event on the grid. The combined event-grid is then focused by a second lens, whose image, after reflection from the rotating mirror, falls on the film plane as shown in

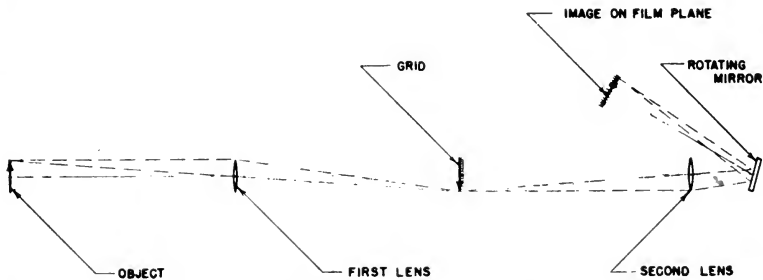

Fig. 3. Optical system of ultra high-speed camera.

Fig. 3. The photograph formed by the reflected grid differs from that formed through a grid moving across the film plane in that the latter records a varying-time-varying-space image, while the former, by virtue of the subject's fixed position with respect to the grid, records a fixed-space-varying-time record which is particularly suited to the studies of detonation and shock waves.

FRAMING RATE

The continuous motion of the image across the film does not form the well-defined frame of the intermittent or the rotating prism type of cameras. An infinite number of viewing positions of the framing grid are possible, leaving the framing rate undetermined. However, since the exposure time of any increment of film is equal to the time it takes a slit to move its own width, the reciprocal of this time is taken as the framing rate. Thus, each consecutive frame is viewed by moving the grid one slit width per frame.

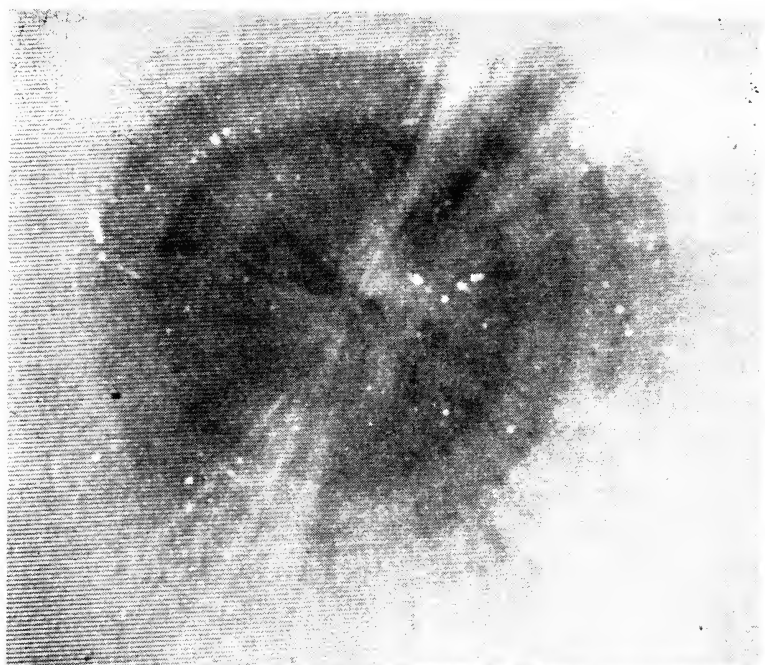

Fig. 4b. Single frame taken from Fig. 4a; negative; framing rate 1.1×10^8 frames/sec

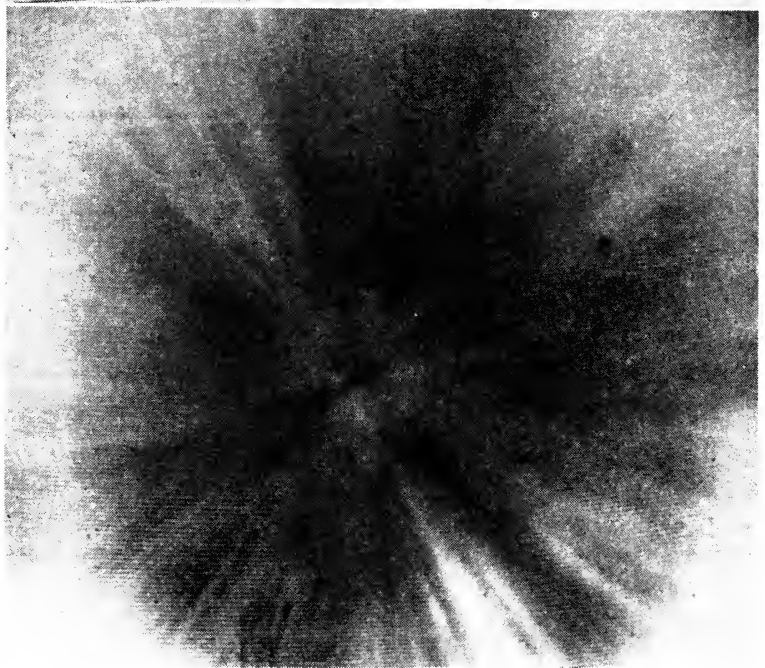

Fig. 4a. Complete exposure of detonating spherical charge; negative.

The rotational speed of the mirror being used can be varied up to 500 rps; with a 20-in. optical arm the maximum image speed is .122 in. per microsecond. The exposure time with a .0005-in. slit at the full rotational speed of the mirror is 4×10^{-9} sec, or 2.5×10^8 frames/sec. With a .0001-in. slit the framing rate is 1.25×10^9 frames/sec. With suitable optics, it is believed that sufficient light will be available from detonation and shock phenomena to take pictures at the rate of one billion frames per second.

THE CONTRIBUTION OF THE GRID TO THE RESOLVING POWER AND TOTAL NUMBER OF FRAMES

The resolving power, or more exactly, the measure of the "discontinuity" across the picture because of the nature of its line structure, expressed in lines per inch, is equal to the number of slits per inch. The number of slits per inch is determined by the slit width and the number of frames required. That is, with a .0005-in. slit if 30 frames are desired, the space between the slits must be 30 times .0005 in. or .015 in. Such a grid will have a "resolving power" across the slits of $1/.0005 + .015$ or about 65 lines/in. With a .0001-in. slit and the same resolving power, 150 consecutive frames are obtainable.

The total exposure time, with no double exposures, is the product of the exposure time per frame and the total number of frames without double exposures. With 30 frames taken at 100,000,000/sec, the total exposure time is 3×10^{-7} seconds. All of the pictures taken up to the present time have been of self-luminous shock waves. Double exposures are prevented by quenching the shock wave in an atmosphere of propane at a predetermined time. However, for investigating shock velocities, it has been found convenient to get multiple exposures (Figs. 4a and 4b), which permits the measurement of distance as a function of time on each individual frame.

COMPONENTS OF THE ULTRA HIGH-SPEED CAMERA

The components of this camera, shown in Figs. 5-7, are described below.

1. *First Imaging Lens.* One of a number of high-quality large aperture photographic objectives which are available is used depending on the size of the charge and the magnification of image desired at the framing grid. All of these lenses are long focal lengths (12 to 40 in.) as required by the physical setup in the blast chamber (Fig. 2).

2. *Framing Grid.* The grids most easily obtained and reasonably priced are made on opaque coated optical glass $4 \times 4 \times \frac{1}{8}$ in. The

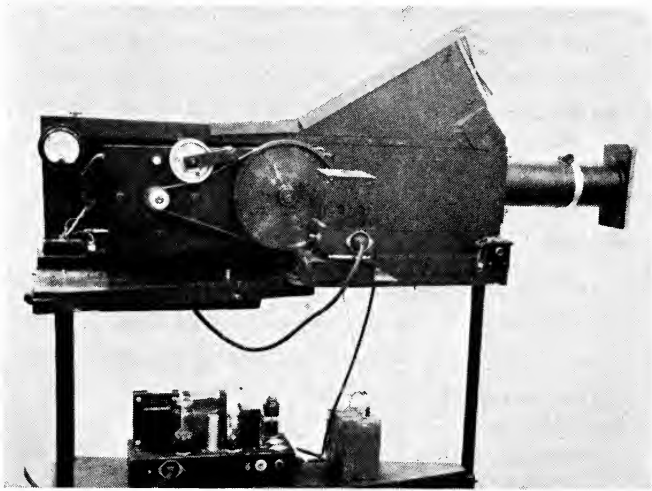

Fig. 5. Side view of camera.

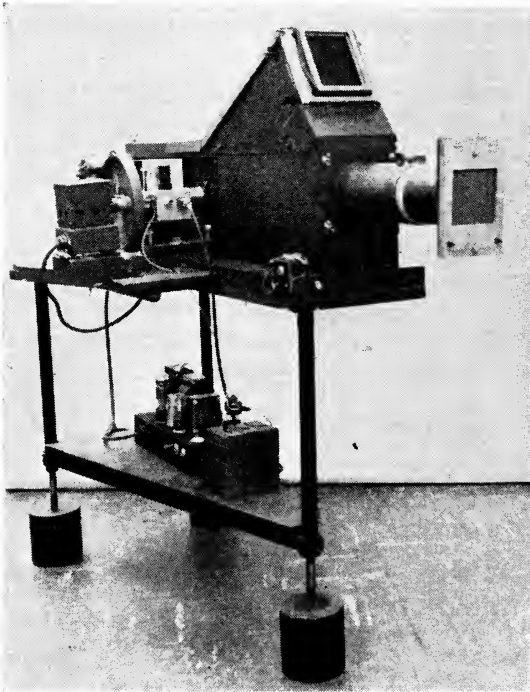

Fig. 6. Three-quarter front view of camera showing grid in position.

.0005- and .0001-in. slits are cut with corresponding flat diamond points on a dividing engine.

3. *Second Imaging Lens.* This lens has a focal length of 360 mm. With the 1:1 magnification from the grid to the film plane the mirror can be placed to give an effective optical lever of about 20 in. Several photographic objectives with apertures of about $f/4.5$ have been tested. A high-quality process lens corrected for a flat field appears to resolve the slits most accurately.

4. *Rotating Mirror.* The 1-in. square face octagonal mirror in the Bowen rotating mirror camera is the aperture stop of the system. A 2-in. square flat mirror designed to rotate around its face will not

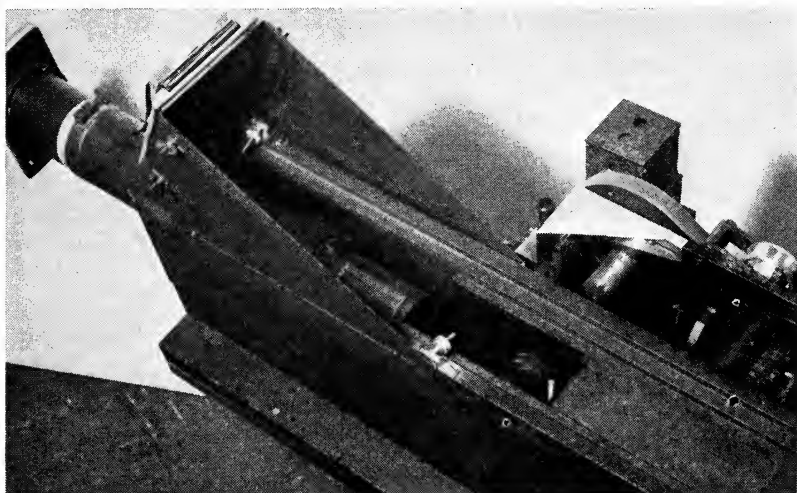

Fig. 7. Top view of camera showing optical system.

only take advantage of all of the light from the second lens but will eliminate the complicated form of the focal plane.

5. *Film Plane.* A standard 4 × 5 in. camera back is being used as illustrated.

6. *Synchronizing Circuit.* A hole in the wheel which drives the mirror passes a beam of light to a phototube which in turn fires a thyatron. This thyatron, operating at 400 v, then fires the charge directly or is used to trigger a timing circuit depending on the time requirements for the particular charge.

PHOTOGRAPHIC TECHNIQUE

Kodak Tri-X panchromatic plates have produced images of good density at exposure times of 10^{-8} sec. These plates are processed

in Kodak D19 developer for 20 min at 60 F. Base fog "latensification" of these plates has been used to obtain good image densities with developing times as short as 8 min at 65 F.

REVIEWING THE FILM

Since the magnification from the grid to the film plane is 1:1, the negatives or contact printed positives can be viewed by placing the grid directly over them. Motion pictures can be observed by moving the photographic plate across the grid and frame-by-frame viewing is accomplished with a micrometer feed. Measurements are made at a magnification of 10 with a Bausch & Lomb contour projector. The sample reproductions in this report were made by enlarging through the grid properly positioned on a positive plate.

CONCLUSIONS

The fundamental features of the design described in this report indicate limitless possibilities for obtaining ultra high-speed photographs of self-luminous phenomena. Probably, with the use of explosive-type flash bombs, or with Edgerton-type lights, nonluminous subjects can also be photographed at rates exceeding 10^8 frames/sec.

REFERENCES

1. A. M. Zarem, Marshall and Poole, "An electro-optical shutter for photographic purposes," NAVORD Report 1016, May 14, 1948.
2. J. Stanton, "The Bowen 76 lens camera," (a preliminary description).
3. Brian O'Brien and Gordon Milne, "Motion picture photography at ten million frames per second," *Jour. SMPE*, vol. 52, pp. 30-40, Jan. 1949.
4. Fordyce E. Tuttle, "High-speed motion pictures by multiple-aperture focal-plane scanners," *Jour. SMPE*, vol. 53, pp. 451-461, Nov. 1949.
———, "Improvements in high-speed motion pictures by multiple-aperture focal-plane scanners," *Jour. SMPE*, vol. 53, pp. 462-468, Nov. 1949. (The above also appear in *High-Speed Photography*, vol. 2, published by the Society of Motion Picture Engineers in 1949.)
5. I. S. Bowen, "The CIT Rotating Mirror Camera (Mod. 2)," April 27, 1945.

Flutter Measuring Set

BY FRANK P. HERRNFELD

ANSCO, HOLLYWOOD, CALIF.

SUMMARY: The Flutter Measuring Set was built to measure the low percentage flutter of present-day recording and reproducing equipment. The set conforms to the "Proposed Standard Specifications for Flutter or Wow as Related to Sound Records," as outlined in the Society's *Journal* for August, 1947, pp. 147-159.

IN KEEPING with the proposed specifications cited above, the instrument provides means for measuring percentage of flutter and drift. It will measure flutter at the nominal frequency of 3000 ± 200 cycles/sec. The input required for operation may be either +8.0 or -52.0 dbm. At these inputs, amplitude variations of ± 10 db will not change the measurement by more than 2%. The percentage flutter meter is calibrated in percent for 0.1, 0.3 and 1.0% full scale deflection. It indicates either true rms or average values by switching into the meter circuit either a thermocouple or selenium rectifier.

The percent drift meter is calibrated for 0.1, 0.3 and 1.0% drift. The drift meter is also used as an indicator to tune the Flutter Measuring Set to the incoming signal frequency. The set is capable of reading rates of flutter from 0 to 200 cycles/sec. Networks are provided to read the following rate bands on the percent flutter meter: 2 to 200, 2 to 20, 20 to 200, and 96 cycles/sec. The drift meter is used to read 0 to 2 cycles/sec flutter rates. Outputs for a rapid recording oscillograph and an oscilloscope are provided.

CIRCUIT

The flutter set consists of the following components:

- (a) A pre-amplifier.
- (b) A modulator-oscillator which converts the incoming 3000-cycle signal to 1000 cycles.
- (c) A limiting amplifier.
- (d) A frequency discriminating network which converts frequency-modulation into amplitude-modulation.
- (e) An amplifier to increase the amplitude of the modulation signal.
- (f) A selective network to break down the rate of the flutter into several bands.
- (g) An indicating device.

PRESENTED: April 24, 1950, at the SMPTE CONVENTION in Chicago.

The block diagram of the flutter set is shown in Fig. 1. With the input switch in the -52.0 -db position, the flutter set is designed to work from a nominal 500- to 600-ohm impedance. The input is ungrounded. The wiring of the input plug is so arranged that the flutter measuring set can be grounded on one side, or it can be used in a balanced circuit by grounding the center tap of the input transformer.

The pre-amplifier consists of a nominal 500- to 60,000-ohm input transformer and two high-gain pentode tubes. The voltage gain from the 500-ohm input to the output of the second stage is adjusted to 60 db. Negative feedback is used to adjust the gain and to reduce the output impedance of the amplifier. No attempt has been made

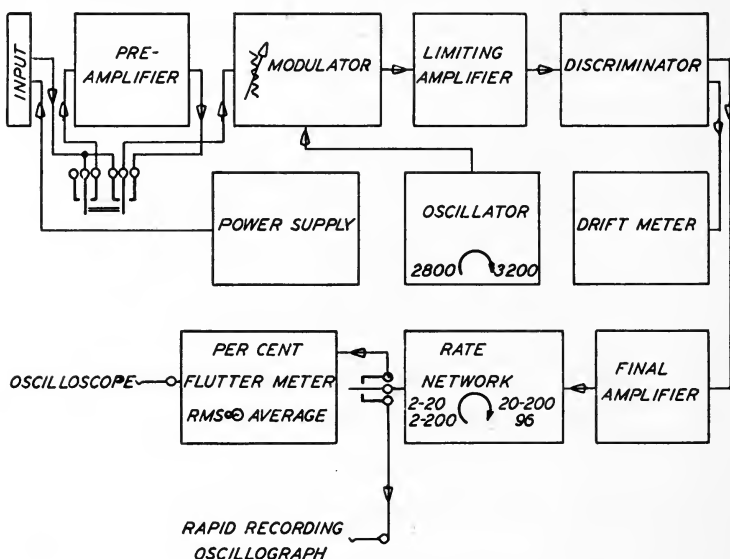

Fig. 1. Block diagram of flutter set.

to use the negative feedback for improving the frequency characteristic as the amplifier handles only a single frequency, namely, 3000 cycles/sec.

The input switch either connects the signal to the input transformer of the pre-amplifier giving the instrument a sensitivity of -60.0 db relative to 6 milliwatts or connects the input directly to the volume control preceding the modulator tube, giving the instrument a sensitivity of 0.0 db relative to 6 milliwatts. With the input switch in the 0.0-db position, one side of the circuit is grounded and the input looks like a true 4,000-ohm resistance.

In either position of the input switch an 85 volt polarizing voltage for a photoelectric cell appears on the input plug. This is done to

facilitate the use of the instrument, in the high-gain position, directly from a photoelectric cell.

The circuits for the modulator, oscillator and low-pass filter are shown in Fig. 2. The plate of the modulator tube is fed through the plate load resistance of the oscillator V2. The oscillator is of the electron-coupled type. Variations in the plate impedance of the modulator tube reflect very little into the oscillator section. The input to the modulator tube can be varied over ± 10 db from its nominal "calibration" input without changing the frequency of the oscillator more than ± 1 cycle at a mean frequency of 4,000 cycles.

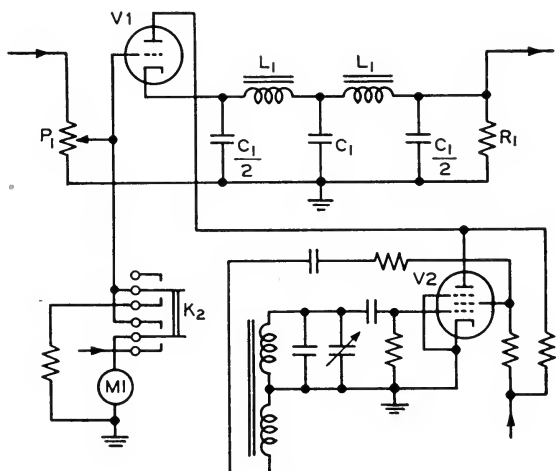

Figure 2.

This means that the instrument is capable of handling a signal with large amplitude changes without giving erroneous flutter readings.

The oscillator tunes from less than 3,800 to over 4,200 cycles. The discriminating network works at a frequency of 1,000 cycles; therefore, any input signal from 2,800 to 3,200 can be handled by the set.

The modulator tube is cathode loaded by R_1 . R_1 is chosen of such value that it is equal to the output impedance of the modulator tube:

$$R_1 = \frac{R_p}{1 + \mu}$$

R_1 = Load Resistance

μ = Amplification Factor of Tube

R_p = Dynamic Plate Impedance of Tube

The image impedance of the low-pass filter following the modulator is equal to R_1 , and its cutoff frequency lies at 1300 cycles. The low-

pass filter consists of two full constant-K sections, L_1 and C_1 . It will attenuate the signal and the oscillator tone by about 54 db, but will pass the beat, that is, the oscillator minus the signal frequency, unimpeded.

The output from the low-pass filter is fed directly into a three-stage limiting amplifier.

A duo-diode is located between the second and third tube of the limiting amplifier. It is connected in such a manner that it will clip both the negative and positive peaks of the signal.

The clipping starts at about 16 db below the normal input level of the flutter set. Clipping and the inherent insensitivity of the discriminating network to amplitude variation will make the output readings of the instrument virtually independent of variations in input

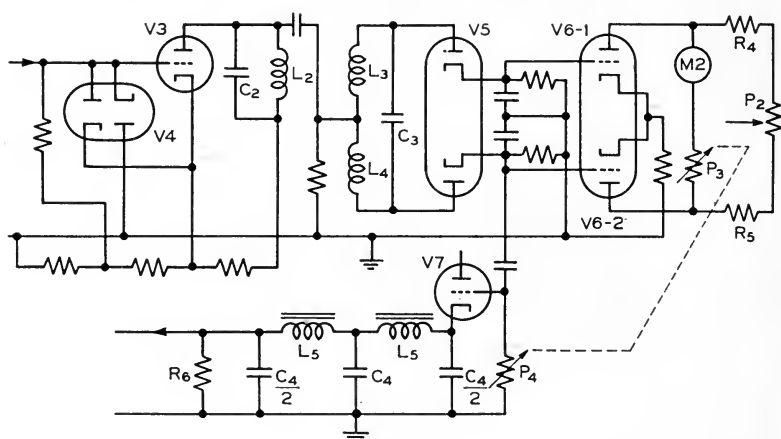

Figure 3.

voltage. The last stage of the limiting amplifier feeds into the discriminating network directly. Figure 3 shows the discriminator and allied circuits in detail.

The Q of the coils of the discriminating network and the coupling of L_3 and L_4 to L_2 must be such that the network will be able to pass a frequency band which is twice the maximum rate of flutter. Therefore the band width over which the network must be linear is from 800 to 1200 cycles/sec. For linearity it is important that the mutual coupling between L_2 and L_3 is the same as from L_2 to L_4 . For the same reason the product of $L_2 C_2$ must equal the product of $(L_3 + L_4) C_3$.

Careful adjustment of the discriminating network cannot be stressed too much, as the successful operation of the flutter measuring set depends on it.

The drift meter indicates rates between 0 and 2-cycles and is made up of V6, R_4 , R_5 , P_2 , and M2. The meter is also used as a tuning indicator to adjust the oscillator frequency to produce a 1000-cycle beat with the incoming signal. P_2 is used to adjust the plate currents of tube V6-1 and V6-2 to zero current through the meter M2 when no signal is applied.

V7 is a cathode-follower to couple the high impedance output of the discriminator to the low-pass filter $C_4 L_5$.

Again the load resistance R_6 is chosen of a value to make it equal to the output impedance of V7. The image impedance of the low-pass filter is the same as R_6 and the cut-off frequency is 250 cycles. The filter is a two-section constant-K type, and will attenuate the carrier frequency (1000 cycles/sec) by more than 50 db.

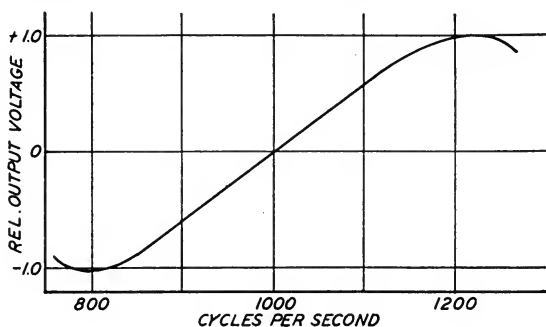

Figure 4.

P_3 and P_4 are two step potentiometers coupled by a common shaft, and are used to set the sensitivity of the flutter measuring set. They are set for 0.1, 0.3 and 1.0% flutter and drift measurements.

Figure 4 shows the response curve of the discriminating network when driven from a 10,000-ohm generator of constant amplitude. From this curve it is seen that the output is sufficiently linear with frequency to obviate the necessity for compensating circuits. When tested dynamically with a frequency-modulated audio-frequency oscillator (described by P. V. Smith and Ed Stanko in this JOURNAL in March, 1949) it was found that no nonlinearity existed.

The output from the low-pass filter is fed directly into the final amplifier. This amplifier has a frequency response uniform within 1 db from 1.5 to 200 cycles. Again negative feedback is used to adjust the gain and the output impedance of the amplifier. The plate voltage of the last tube is adjusted to such a value that the amplifier will work as a clipper at about 2 db above full-scale deflection of the meter. This is a very necessary precaution as transients frequently occur in

flutter measurements which may burn out the thermocouple of the meter.

The network following the final amplifier consists of a low-pass, high-pass and band-pass filter. Figure 5 shows the frequency characteristics of the three filters when inserted between a 2600-ohm generator and a 2600-ohm load.

The percent flutter meter is connected directly across the output of the network switch. The oscilloscope output is connected across the meter terminals. Short-circuiting these terminals will also short-circuit the meter. If the input impedance to the oscilloscope is normal (over 100,000 ohms), the meter readings will not be affected and both the meter and oscilloscope can be used simultaneously.

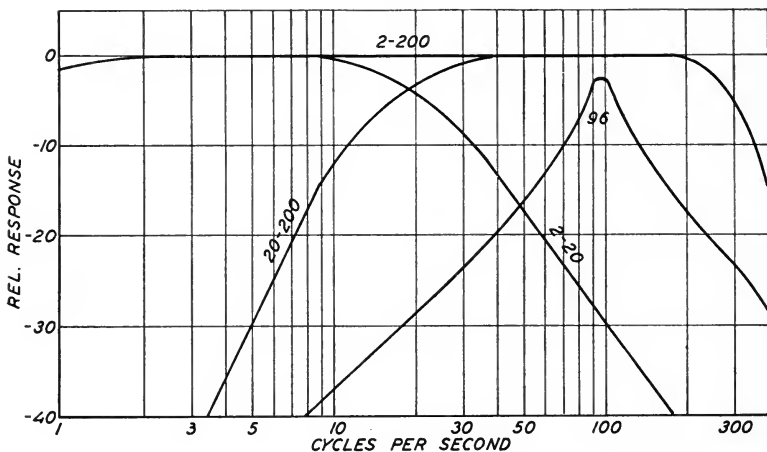

Figure 5.

The rapid recording oscillograph output is designed to work into a 500-ohm circuit. If the oscillograph is plugged in, it will automatically lift the meter circuit.

CONCLUSION

Two of the flutter measuring sets have been built and give satisfactory service. The circuit is stable and independent of line voltage fluctuation. Flutter readings of as low as 0.02% total, 2- to 200-cycle rate, are reproducible.

ACKNOWLEDGMENT

The writer wishes to acknowledge the very excellent assistance and co-operation of the Hollywood Engineering Dept. of RCA Victor Div., and in particular the help of Kurt Singer, who played an important part in the final calibration and testing of this design.

A Reflex 35-Mm Magazine Motion Picture Camera

BY ANDRÉ COUTANT AND JACQUES MATHOT

ETABLISSEMENTS CINÉMATOGRAPHIQUES ECLAIR, PARIS, FRANCE

TRANSLATED AND PRESENTED BY BENJAMIN BERG, HOLLYWOOD,
CALIF.

SUMMARY: A new portable professional 35-mm motion picture camera has been recently introduced into this country from France, embodying the following characteristics: reflex shutter, adjustable from 200° to 40° (viewing is through the taking lens at all times); instantaneous loading of 400- or 100-ft magazines; divergent three-lens turret permitting use of 24- to 500-mm lenses without interference; interchangeable 6- or 8-volt electric motor, hand or spring drive; double pull-down ratchet movement with unique system of pressure pads and spring tensions to insure steadiness. The exterior shape of the camera is designed to fit the body, thus insuring steady hand held operation. The flat base of the camera is made to fit the rapid mounting dovetail of the tripod head.

WE HAVE TOGETHER designed the Camerette (Patents Coutant-Mathot) which last year was introduced in the United States. The Camerette is manufactured in Paris, France, by the Etablissements Cinématographiques Eclair, manufacturers of the Caméréclair 400-Ft and of the Caméréclair Studio 1000-Ft cameras. The Camerette's name for the European market is "Caméflex."

In 1944, during the German occupation, we decided to put our ideas together to create a really modern portable camera. Drawing upon the twenty years of experience we had in the motion picture industry, we each had specific ideas about the conditions a portable camera would have to meet to answer the needs of the cameraman and the producer.

Our basic ideas have been patented, called "Patents Coutant-Mathot," and these patents cover the main Camerette features, most of which are completely new. We will be happy if we have succeeded in making the work of the cameraman easier, and if we have helped to improve motion picture camera techniques.

The principal characteristics of the camera are as follows:

General Shape. The shape of the camera with the 400-ft magazine attached is such that it can easily be hand held by resting the magazine on the shoulder, holding the camera by the motor with the right

PRESENTED: October 14, 1949, at the SMPE Convention in Hollywood.

AUGUST 1950 JOURNAL OF THE SMPTE VOLUME 55

173

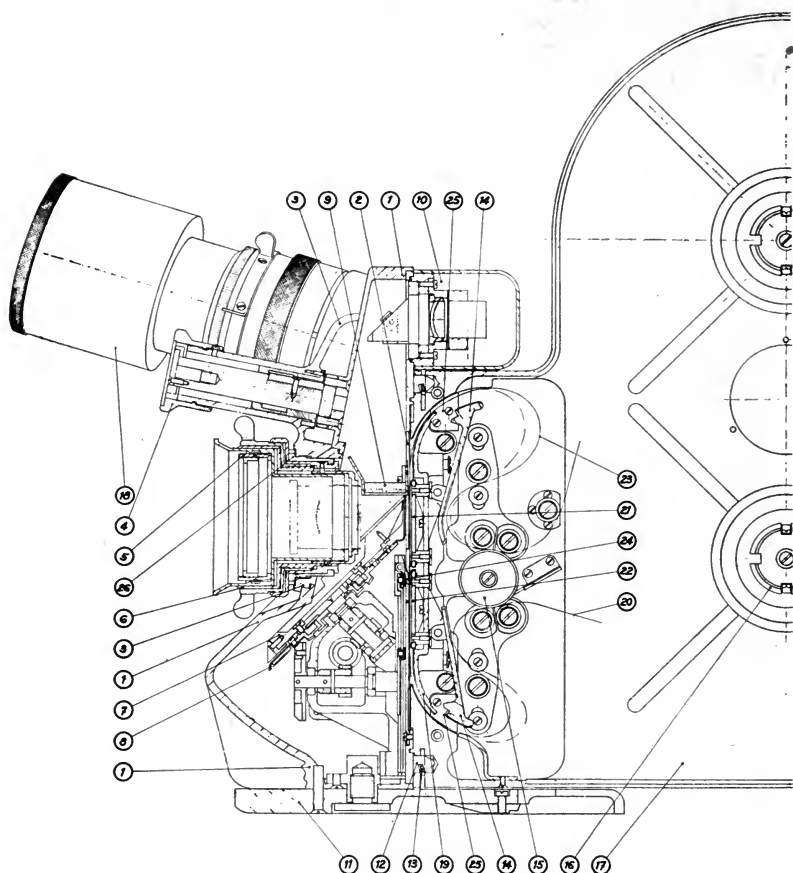

Fig. 1. Diagram of the Camerette.

- | | |
|--|--|
| 1. Front section | 15. Sprocket |
| 2. Front aperture plate | 16. Take-up hub with spring clips accepting standard film spools, male or female |
| 3. Base or seat of the turret | 17. 400-ft automatic film gate magazine |
| 4. Turret lock | 18. Lens shade shown on 100-mm lens |
| 5. Standard filter holder for lens | 19. Rear channel of film on magazine |
| 6. Lens mounting | 20. Film passage to take-up spool |
| 7. Silvered mirror placed on the front of the shutter blade | 21. Top pressure pad maintaining film No. 23 in proper position at the aperture No. 2 |
| 8. Shutter and its mounting | 22. Bottom pressure pad keeping the film properly aligned for the pull-down claws No. 24 |
| 9. Ground glass | 23. Film, upper loop |
| 10. Prisms | 24. Pull-down claws |
| 11. Flat camera base, fitting the special dovetail in rapid mounting tripod head | 25. Tempered steel pad for the lateral spring guides |
| 12. Magazine engaging bolt | |
| 13. Groove for magazine lock | |
| 14. Light traps which are automatically opened when magazine is attached to camera | |

hand, using the left hand to focus the lens, and support the camera. The balance and shape are such as to give extremely steady hand-held operation since the camera is held close to the body, and firmly supported. The flat base of the camera (Fig. 1-11) and the eyepiece swinging into the vertical viewing position allow for placing the camera on the ground without the use of any support. Use on the tripod is equally rapidly accomplished by means of the rapid mounting dovetail head.

Viewing is through the taking lens by reflection from an unbreakable front silvered mirror placed on the front of the shutter blade, and rotating with it (Fig. 1-7). This image is transmitted by a ground glass (Fig. 1-9) and prisms (Fig. 1-10) to the magnifying eyepiece. The eyepiece is fitted with a calibrated focusing adjustment, and can be set in three positions: horizontal for normal use, vertical when the camera is used from a very low angle, and, when not in use, the eyepiece is placed in the lowered position for storage in the carrying case. A self-closing light guard is provided for use in direct sunlight or other strong light; under normal lighting conditions its use is not required. The camera can be obtained with either right or left eyepieces. This reflex method of viewing eliminates the necessity of auxiliary finders, has the advantage of accurate framing with no parallax, and makes it possible to follow focus visually during actual filming.

Magazines. The automatic film gate magazines are available in either 400- or 100-ft film capacities, and can be used interchangeably. Magazines are instantly attached and locked to the camera unit by a simple pressure of the hand. Unlocking is equally rapid by pressing the locking knob and removing the magazine. Magazines can be changed while the camera is in operation. The camera has its best balance for hand-held operation with the 400-ft magazine, since the magazine can be supported on the operator's shoulder, permitting steadier work with less fatigue, because of the excellent weight distribution.

There are two fiber pressure pads on the front of the magazine, the upper pad maintaining the film in the proper position at the aperture, the lower one insuring steadiness, guiding the film in its relation to the pull-down claws, situated on the camera proper. The double pull-down claws, pressure pads and guides which keep the film traveling in a straight path past the aperture insure absolute steadiness.

The preloaded automatic magazines offer a distinct advantage in the saving of production time due to waits for reloading. For cold weather operations where loading becomes a problem because of the

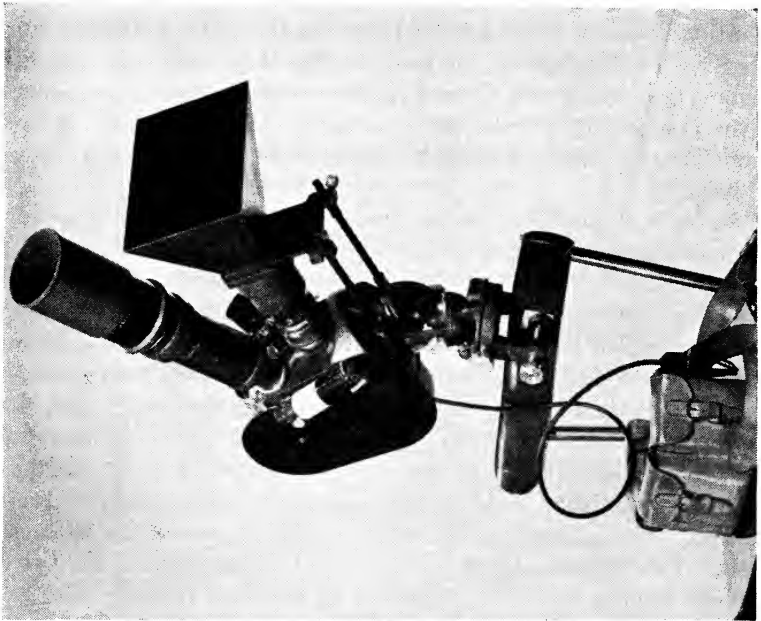

Fig. 3. Camerette with auxiliary clamp and battery pack.

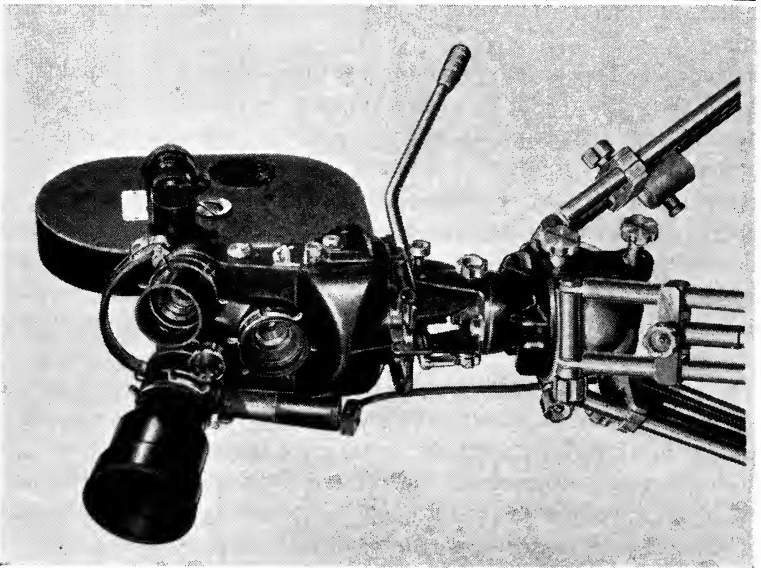

Fig. 2. Camerette.

necessity of wearing thick fur gloves, the preloaded automatic film gate magazine is the obvious solution. Loading the magazines is simple, and can be done in either darkroom or changing bag. The loops are formed in daylight, and are not critical. Film wound either emulsion in or out can be used.

Figure 4 shows the method of attaching the magazines to the camera.



Fig. 4. Attaching the film magazine.

Movement and Aperture Plate. The movement consists of two ratchet pull-down claws engaging the film, which is kept in its proper position by the two pressure pads on the film gate magazine. The top pad is designed to keep the film flat and in the focal plane. The surface of the pressure pad and the system of pressure applied are such as to avoid all pressure against a hard surface, thus preventing distortion of the film at the aperture. The bottom pad, which holds the film only at the edges, keeps the film properly aligned for the pull-down claws, insuring absolute steadiness. The lateral guidance is assured by two spring guides in the magazine, placed in the curved parts of

the film loops. By keeping this pressure in the loops, warping or twisting of the film is prevented, since there is more resistance to lateral pressure in the curved sections. The elimination of aperture pins permits simpler, more compact construction, with consequent freedom from mechanical failure and repairs. Another advantage of this type of movement is the camera's adaptability to extreme changes of temperature, since wide variations in film and perforation size can be tolerated.

The aperture plate is made of one piece of stainless steel, hand polished and undercut to prevent scratching. With the magazine removed, the plate is readily accessible for checking and cleaning. A special guard is provided for the aperture plate to prevent damage when the camera is dismantled for packing.

Shutter. The shutter blade, in front of which is placed the reflex mirror, has a maximum aperture of 200° . This is adjustable to 40° by means of a graduated shutter disc (sliding behind the reflecting mirror); its position is controlled by an exterior knob. The Camerette Model C has a 230° shutter, adjustable to 110° . See Fig. 1-8.

Drive. There are three alternative drives for the camera: electric motor, spring motor or hand-gear box. The change from one to the other can be rapidly and easily accomplished. The electric motors and hand-gear boxes are placed on the side of the camera at the right hand of the operator. The spring motor attaches to a special support on the back of the camera and rests beside the magazine. The standard electric motor serves as the handle for the camera.

The starting and stopping switches are in front and are operated by the little finger of the right hand. Speed control is obtained by turning the rheostat knob on the top of the motor with the thumb of the right hand, while holding the release catch with the index finger. This motor operates on either 6 or 8 volts of direct current supplied by a set of lead batteries. The batteries are mounted in a leather waist belt for carrying, and weigh 9 lb. An electric charger operating on either 110 or 220 volts is part of the standard equipment. The batteries have a capacity of 15 amp-hr and will operate ten 400-ft magazines, or 4000 ft of film, on one charge. The motor switch has three positions, the middle position cutting out the rheostat for a fraction of a second to help overcome starting inertia, enabling the camera to come to speed quickly. This position can be utilized also to change the camera from high to normal speeds without changing the setting of the rheostat.

The spring motor, used only in emergency, is entirely ball bearing mounted, and will resist extremely cold temperatures. It is capable of running 45 ft of film on each wind. There is a button for speed regulation, and a crank for winding.

The hand-gear box attaches in the same position as the electric motor. There are three gear ratios, one, eight, or sixteen frames per revolution of the crank. A 220-volt, 50-cycle synchronous motor is also available.

Turret. The divergent three-lens turret is designed to accommodate lenses from 24 to 500 mm without cut-off. The standard mounts are of the bayonet type, fitted with grips for focusing, and lens hoods with spring clips in which either the metal lens caps or filter holders can be inserted. Mounts are available for any standard lenses. Normally the camera is supplied with Kinoptik lenses which are coated F2 apochromats available in focal lengths from 25 to 500 mm. (See Figs. 1-5 and 1-6.)

Filters. Three types of filter mounts are supplied.

1. Round filters which clip inside the sunshade of each lens (diameter of filters 40 to 75 mm).

2. Gelatin filter holders placed behind the lens in the aperture.

3. Regular Wratten 3-in. square filters can be used in the matte box, which will accommodate two such filters. (Fig. 1-5 shows round-type filter holder incorporated in lens house.)

Tachometer. The camera is provided with a magnetic tachometer, graduated from 8 to 40 frames/sec.

Tripod and Tripod Head. The special tripod supplied with the camera is made of dural, and weighs only 13 lb with the normal legs. It measures, closed, 3 ft 5 in., and 5 ft 6 in. fully extended. Medium and baby legs are available and can be easily attached to the tripod head. The tripod head can be rapidly detached from the legs by means of a clamp. An auxiliary clamp is also provided, permitting fastening the camera on any type of support. The camera is mounted on the tripod by means of a dovetail which receives the flat base of the camera, and locked into place by a spring bolt. Pulling down on the spring bolt and starting the camera out of the dovetail by means of the cam lever on the tripod head frees the camera from the tripod. A pan handle is carried on a clip on the tripod.

The exterior of the camera is protected by a black anodized finish, which is very durable, weather and shock resistant. The camera, with motor, three lenses and 400-ft magazine, weighs only 14 lb.

Economy in Small-Scale Motion Picture Lighting

BY ARTHUR L. SMITH

211 CORNELL ST., ITHACA, N.Y.

SUMMARY: There is an apparent need and trend toward reducing the amount of electric power required for illumination in motion picture production. Although the interest in this situation extends through the entire industry, the greatest economic significance probably concerns the smaller nontheatrical producers, many of whom are working with direct 16-mm film. For present purposes, this report considers only the problem of small sets and field work.

IN A GENERAL CONSIDERATION of the lighting equipment required by small producers, several factors are immediately evident: (1) dependent on the location and size of the set or scene, the lighting required may vary considerably in both type and volume; (2) the quantity of lighting units available among small producers varies to great extremes; (3) the economy of operation is an almost universal problem; (4) the art of scene lighting is affected by the lighting units available; and (5) there are many electrical factors which must be given due consideration.

Specifically, such problems arise as how to accomplish filming with minimum power, how to decrease the expense of new power installations, how to provide an increased over-all lighting for the slower color films without greater amperage, how to acquire quantity lighting without adding many expensive lighting units, and how best to distribute the available electric power service from the viewpoint of economy. These questions are common to many small producers. Before attempting suggestions which may provide answers to some of these and other problems, it seems important to consider lighting in general.

During the rapid development of the theatrical film industry, standard lighting equipment evolved which in its entirety provides dozens of types, styles and wattages of illuminants. Two principal classifications, arc lamps and incandescent lamps, can be subdivided into a host of forms among the variously sized flood lamps, spot lamps and intermediates. This complexity of lighting equipment is justifiable within the major film studios. It is not possible, however,

A CONTRIBUTION: Submitted April 16, 1950.

for the small 16-mm producer to emulate such conditions, nor is that necessarily desirable. It is then a question of selecting the least number of lighting units which can provide adequate illumination for the scope of production involved. In simplifying the range of lamps, a primary consideration is that of achieving the possibility of well-balanced and well-modeled scene lighting. In the same sense that the creation of good lighting is an art, so are the lights the tools of the trade. In most instances it is critical that (1) a means be provided for creating a general level of all-over lighting, (2) that individual lights be available for specific modeling and accents, and (3) that a means is provided for creating high levels of directional penetrating light to create sunlight effects, produce specific shadows, and so forth.

Figure 1 contains a group of sketches illustrating a number of important basic types of lights. A present conclusion is that almost any producer will require certain of these units and particularly a number of adjustable spotlights and versatile flood units for modeling purposes.

There are many combinations of lighting equipment encountered among small producers. Filming has been done with a few simple reflectors on collapsible stands. More commonly, a small studio will have an assortment of fresnel lens keg spotlights, a number of open floods in various reflectors, and one or more high-wattage arc or incandescent spot units. Unless numerous standard floods are grouped to provide a basic level of illumination, the greatest problem usually appears as the need for a form of over-all gross lighting which is diffuse, of high intensity, of the lowest possible amperage and the least in expense.

One such system which seems to be acquiring popularity is low-amperage Colortran.¹ Another method, as devised by the author, employs banks of reflectorfloods in much the same manner as used in certain parts of television lighting.²

BANKS OF REFLECTORFLOODS

It is well known that the "photoflood" type of lamp, when burned at 110 to 120 v, will produce far more effective wattage per ampere than conventional incandescent lamps. The issuance of the reflectorflood lamps, which provide a built-in directional distribution of all their light, has proved to be of considerable value in the problem of concentrating large amounts of illumination in restricted areas. With a built-in reflector, the need for a larger controlling reflector is eliminated and an important gain is made in both space and expense.

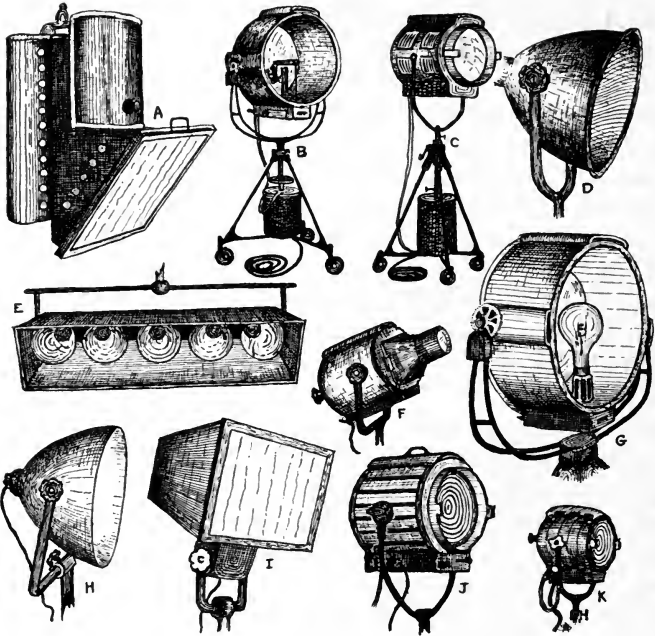

Fig. 1. Rough sketches of some basic types of lights: A, scoop; B, sun arc; C, arc spotlamp; D, rifle lamp; E, strip light; F, small spot with focusing snout; G, incandescent sunspot; H, open bowl flood; I, broadside; J, senior solarspot; and K, baby keg.

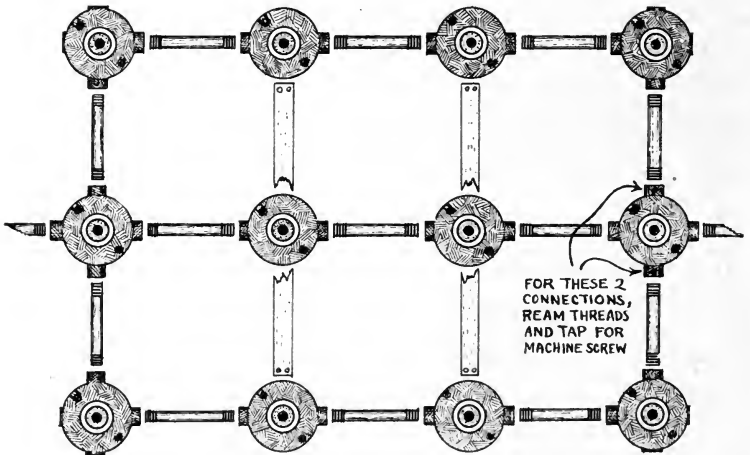

Fig. 2. "Exploded" view of lamp bank layout.

By grouping twelve such reflectorfloods into a bank, a highly potent source of light providing the equivalent of 18,000 w may be secured from an area of about 2×3 ft. Each such bank draws only 60 amp as contrasted to approximately 180 amp of normal lighting. The weight of cable required is drastically reduced both from the power source and to the individual lamps. Another added advantage is the simple and inexpensive means of constructing the lamp bank.

In the case of most good quality standard lighting equipment, there is no cheap substitute. With reflectorflood banks, however, it is very easy to provide an inexpensive assembly which lacks nothing in

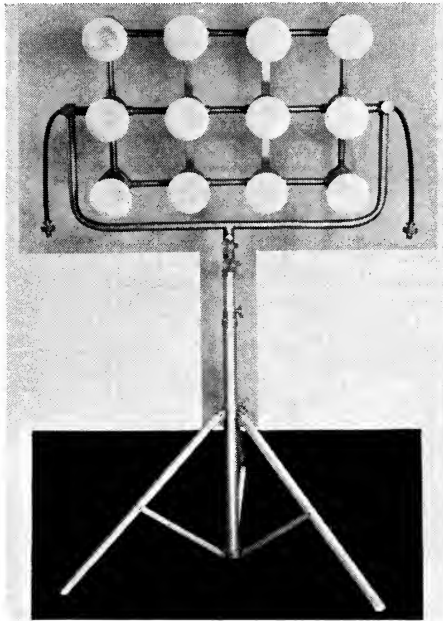

Fig. 3. Complete lamp on Saltzman stand.

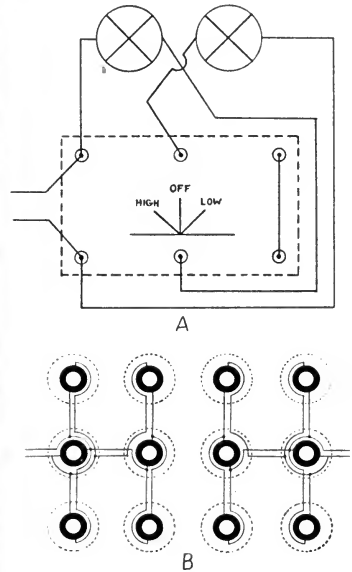

Fig. 4. A, simple series-parallel circuit with double-pole-double-throw, center-off switch; B, six lamps in parallel against six others.

utility. Lightweight cast aluminum condulets with appropriately placed and threaded connection points (Fig. 2) can be spaced by long 7- or 8-in. end-threaded nipples. To accommodate final assembly, strap bars can be added to the two central vertical rows. A framing yoke of conduit tubing can allow for angular positioning. The central yoke attachment to a stand can be constructed to permit rotation of the entire bank. This method of assembly provides all the necessary movement and setscrews may be used to retain locked positions. The stand itself may be of any desired type. In the

present instance, mobility was critical and the very light and rugged Saltzman collapsible magnesium stands were secured (Fig. 3). These stands have a remarkably long maximum extension and a firm base.

Thus for a total material cost of about \$60, which includes stands, lamp banks of 18,000 w can be secured. Five such banks used for diffuse fill-type of illumination can provide 90,000 w for only 300 amp. If this same area were lighted by the use of individual or strip 2,000-lamps, 45 bulbs drawing about 800 amp and occupying considerable space would be required.

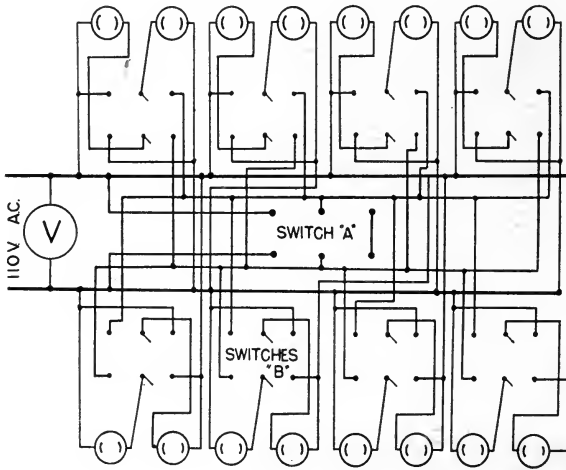

Fig. 5. Plan for a master plugging box based on series-parallel circuit and employing master switch. Switch "A" is Westinghouse Class 11-210-MS2 relay type operated by remote high-low-off push-button station. Switches "B" are Westinghouse reversing drum type N-103-E. Switch "A" may also be obtained for 220 v where input current is three-wire 220-110-v.

DIMMING DEVICES

One of the principal objections to the use of the photoflood-type light is its relatively short life. The expense as well as the nuisance of constant replacement has limited its use in professional filming. The answer to these problems is found in the use of dimming units whereby the lamps may be burned at reduced brightness during preparation and between takes. Since adjustable rheostats and transformers would be heavy and costly, the simple method of high-low switching by a series-parallel circuit appears as the most economical system.

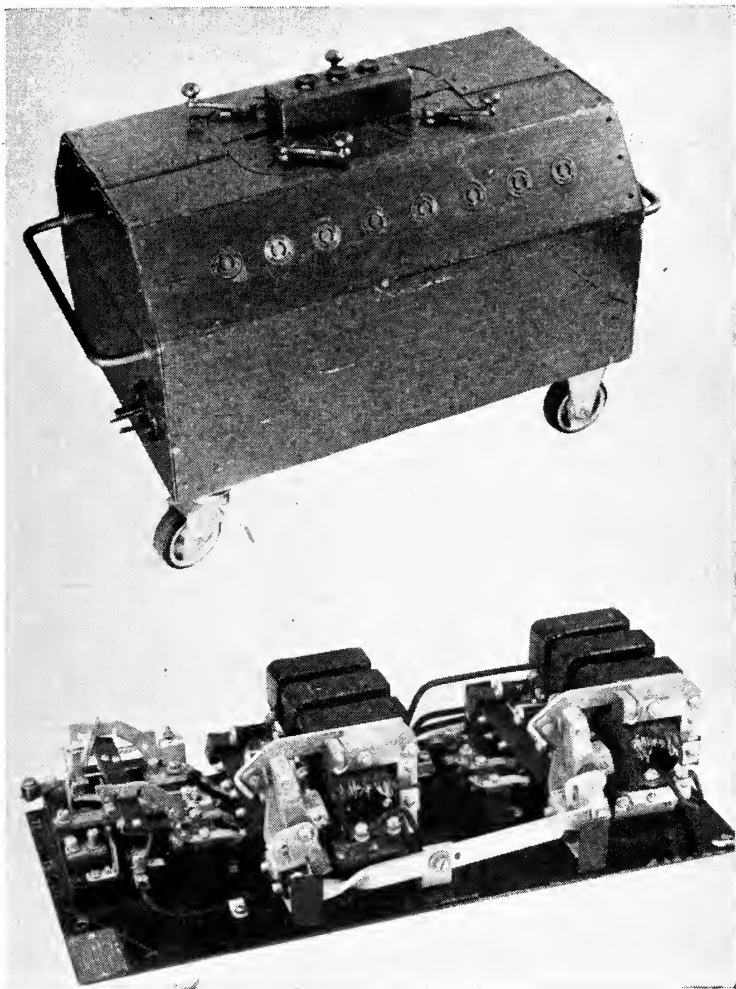

Fig. 6. Above, portable 300-amp capacity plugging box; below, master relay switch.

In the use of a series-parallel circuit, a double-pole-double-throw, center-off switch may be employed as in Fig. 4a. Since it would be impractical to use a switch for each pair of reflector-flood lamps, a bank of twelve lamps may be divided so that six are balanced against six while in series (Fig. 4b). To eliminate the confusion of multiple switching points, each pair of cables may be brought to a centrally located portable switching box. It is difficult to secure snap switches

of the double-pole-double-throw type which will carry a total load of 60 amp and the use of knife switches is not convenient. A drum switch, such as the Westinghouse Type N-103-E, can be easily modified to serve, is quite inexpensive, extremely rugged and of adequate rating.

The use of series-parallel switching may also be applied to other units employed on the set. Their cables also may be brought to a central plugging box and all the lighting controlled from a single area.

Where labor, time and efficiency are critical, a further refinement may be added. By using a special master relay switch operated by remote control, it is possible to have all of the lighting units in use controlled by a single high-low-off push-button station. Although the use of simple series-parallel circuits is quite common, the addition of a master switch seems to have been largely ignored in motion picture lighting. Several years ago, the author devised a circuit of this type³ which has since been revised to permit amperages up to 300 amp per master switch (Fig. 5). If more than 300 amp are required, extra master switches may be added and controlled by the same push-button station as the original.

In professional use, the plugging box and master switch (Fig. 6) are found to have notable advantages for saving time. Where small crews are employed, the entire set lighting may be culminated in a single box and switched to bright, dim or off with the touch of the cameraman's or director's finger. The cost of the switches for a master control plugging box accommodating sixteen lamps (for example, three twelve-lamp banks and ten other units) by remote control would be less than two hundred dollars. If the drum switches for individual pairs are eliminated, the cost will be much less than one hundred dollars.

ELECTRICAL CONSIDERATIONS

A problem which is related in economy and efficiency to lighting, concerns the electrical materials and factors involved in providing power. Although the time-honored Kleigl and other types of standard connectors and branch-offs seem still to be in predominant use, there seems also to be some justification for considering other devices. Any production set electrician who has used nonlockable plugs has doubtlessly experienced unplanned disconnections. Inexpensive Twistlock connectors will carry up to 20 amp and easily overload to 30 amp. Their use is so simple and their positive locking action so durable that it is surprising not to encounter them more often. When loads of greater power are to be carried, Hubbelock connectors may

be employed. Some of the four-contact type with pairs barred together are rated at 70 amp and have carried over 150 amp without trouble for the author. These connectors are available in styles which are watertight and for certain field work this advantage is critical. Four-prong Cannon-type plugs rated at 200 amp have been adapted satisfactorily.

Many producers decrease cable size and cost by bringing main power lines to a distribution point on a three-wire 220-110-v circuit.



Fig. 7. Lamp banks assembled and ready for use in small studio scene.

This device may also be used in connection with a remote control plugging box, half of the current going to each side of the box. In this instance, the weight of the cable will, of course, bear a relation to the capacity of the box and although an open temporary cable may be somewhat overloaded, an extreme in this regard may be dangerous as well as decrease the input voltage and cause a lowering in the intensity and color of the lamps. Fortunately voltage drops in main line cables are not as great with 220 v as with direct 110 v and this is an added advantage of the three-wire 220-110-v system.

If power is to be supplied through direct lines without series-parallel switching, a very durable, safe and inexpensive service can be obtained with the use of a breaker panel. For example, a panel having twelve 50-amp breakers can be used with twelve Hubbelock receptacles mounted in the gutters. By a curious coincidence an entire panel may be secured with optional breaker capacities up to 50 amp each without adding to the basic price of about sixty-five dollars. The main bus bars can also be specified of a weight to permit distribution of a total load of around 400 amp.

Many of the various electrical connectors and power boxes required for heavy amperage are extremely expensive. It is for this reason that it seems important to note those particular materials which are rugged, suitable and least expensive.

CONCLUSIONS

An attempt has been made to outline various means by which a small producer may secure a reasonably professional quantity and quality of motion picture illumination on a basis of added efficiency and economy. Standard types of lighting have been retained for modeling, accent, high key and character. The basic level of illumination is obtained by reflector flood banks which in turn are made efficient by means of a master switching box. This system of illumination provides added wattage by inexpensive means and the critical art of lighting employs essentially the same "tools" as those of the standard large scale studio. Heat from set lighting may be reduced by dim settings of either pair of switches or the master switch except for the time of actual shooting, thus providing comfort for the cast and extending lamp life by five or ten times.

A great many of the new and smaller production services are faced with the high acquisition cost of good-quality lighting units on today's market. Rather than sacrifice picture quality or operate largely with open lens apertures, it seems desirable to utilize a type of lighting which possesses both economic and professional advantages.

REFERENCES

1. "Packaged illumination," *Cinematographer*, Feb. 1949.
2. W. C. Eddy, "Television studio lighting," *Jour. SMPE*, vol. 49, pp. 334-341, Oct. 1947.
3. Arthur L. Smith, "A light dimming unit," *J. Biol. Phot. Assn.*, vol. 9 pp. 206-209, June 1941.

Component Arrangement for a Versatile Television Receiver

By F. N. GILLETTE

GENERAL PRECISION LABORATORY, INC., PLEASANTVILLE, N.Y.

AND J. S. EWING

THE HERTNER ELECTRIC CO., CLEVELAND 11, OHIO

SUMMARY: The requirements and the arrangement of the various elements of a rather versatile television receiving system are described. A commercial unit is used to illustrate some of the practical applications of ideas suggested in this paper.

COINCIDENT WITH large scale utilization of home television receivers, there has been an increasing demand for a television receiving system of a somewhat more elaborate nature, for a larger and more critical audience.

The demand of such a system can well be understood when one stops to consider the potentialities of television programs, not only for entertainment purposes, but also for educational and industrial uses. Several examples of possible applications of such a system can best be represented by the present-day use of both the Army and Navy of television for training and experimental programs. Philadelphia and other school systems are using television programs as an additional aid in their educational systems, and recently the medical profession has applied television for viewing surgical operations.

The utilization of such a system will be, in general, by an audience larger than can be accommodated by a single home-type receiver, and thus it is inferred that a projection type unit will be employed. The purpose of this paper is to discuss the arrangement and considerations given to the elements of such a system and later on to describe a unit employing some of these basic concepts.

Figure 1 shows a block diagram of a possible receiving system. This diagram describes a somewhat elaborate installation, showing a few of the possible combinations that can be achieved with this arrangement. However, by proper choice of basic elements this system can be reduced in magnitude and still provide suitable service, dependent on the size and requirement of the installation.

It should be noted from Fig. 1 that the system is broken down into groups of individual chassis, each performing a basic function of a tele-

PRESENTED: April 25, 1950, at the SMPTE Convention in Chicago.

vision receiving system. Certain ones of the chassis can be removed, modified, or added to the system in order to meet the requirements of the individual installation. Each of the principal chassis could obtain its own power supply so that its removal or addition would not affect the operation of the over-all system. This arrangement also simplifies testing and servicing.

The antenna lead-in cable is shown connected to the control box as the r-f (radio-frequency) tuner is situated in this unit. Locating the r-f tuner in this manner makes it possible to provide remote station selection without resorting to an elaborate servo or step-type mechanism. This feature is accomplished by connecting the out-

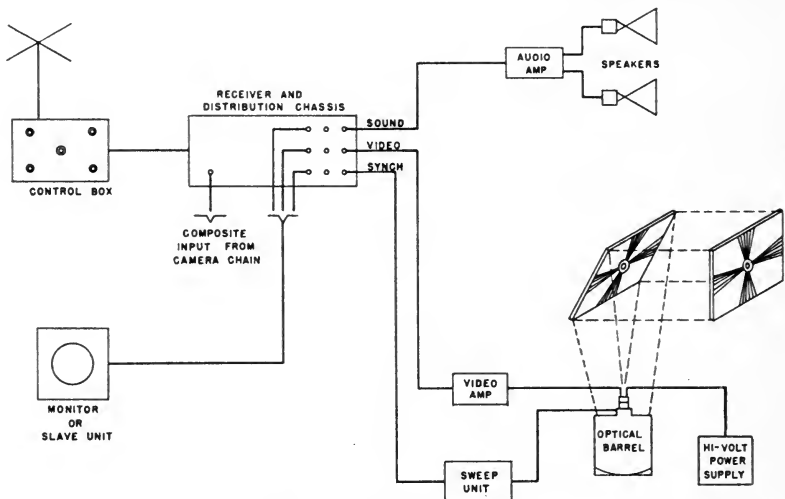

Fig. 1. A receiving system.

put of the mixer stage to the first i-f (intermediate-frequency) stage by means of a low-impedance link, coupled through shielded coaxial cable. If the unit is to be operated on other than the standard channels, it is only necessary to exchange the r-f tuner for one matching the desired frequencies, the only proviso being that the intermediate frequency of the system remain the same.

The r-f tuner should be of such design that a booster amplifier should not normally be required. Maximum useful sensitivity consistent with a good signal-to-noise ratio and unwanted signal rejection, without a sacrifice to bandwidth, are the prime requisites of the r-f tuner.

The remaining controls (also located in the control box), such as

contrast, brightness, tone, volume and the master power switch, should operate on d-c voltages wherever possible in order to reduce the amount of cable required at installation and also to eliminate the necessity of returning signal voltage to the control box, to avoid possible signal distortion.

The composite sound, synchronization and video signal is naturally brought into the receiver and distribution chassis at intermediate frequency. The i-f stages of the receiver follow the usual design pattern, with special precautions taken to insure proper bandwidth, sufficient gain and ample trapping for adjacent channel interference.

Based on past experiences, and with minor circuit changes, a convenient input jack should be provided, to permit the input from a closed loop camera chain to be easily switched into the circuit after the second detector.

In the system of this nature it is desirable to employ a well designed a-g-c (automatic-gain-control) circuit which would be located in the receiver and distribution chassis. Automatic gain control, besides reducing the effects of varying input signal levels, also helps to suppress random interference from noise signals. It is also of value in insuring that synchronization signals actuating the sweep circuits operate from the same relative level with each operating pulse. This type of operation serves to remove a certain amount of jitter in the picture, which would otherwise be noticeable.

In order to provide for maximum flexibility in the choice and location of the sound and projection system, the sound, synchronization and video signals, after proper separation and detection, are applied to individual low-impedance line-driven amplifiers. Several of these low-impedance amplifiers can be operated in parallel so as to provide additional outlets to monitor or "slave" units.

The size and method of producing the projected picture determine the ultimate design of the sweep chassis; however, certain fundamental features should be incorporated in its specifications. Maximum consideration should be given to the design of the sweep generation circuits to insure linearity of sweep, stable synchronization and elimination of pairing, because minor irregularities, not noticeable on small-size screens, are quite evident when the picture is enlarged.

To meet these requirements, it is advisable to utilize automatic synchronizing circuits in both the vertical and horizontal sweep generators. In order to retain flexibility and also to remove a possible source of interference to synchronization, the high-voltage power supply should be divorced from the sweep chassis.

The high-voltage power supply will depend on the type of projec-

tion system employed. It should be well regulated with respect to variations in line voltage and average picture brightness. In order to reduce the danger of shock hazard to operating personnel and also to reduce the size of the unit, it is desirable to operate the high-voltage power supply at a frequency higher than line frequency. The energy storage capacity of the filter units required at power-line frequencies makes these units quite lethal. If an r-f type of high voltage power supply is employed, adequate shielding should be provided in order to prevent interfering signals being picked up by the receiver chassis.

The video amplifier is placed in a separate chassis so that its size and location can be chosen to meet the type of projection unit employed. If a separate amplifier were not used, the distance between the projection equipment and the receiving equipment could be the limiting factor on the high-frequency response due to the shunt capacitance of the projection tube.

In order that the high fidelity transmission of the f-m (frequency-modulation) sound signal be used to advantage, the audio system should be of high quality to be capable of reproducing the audio-modulation range of 50 to 15,000 cycles/sec, which is used in the f-m transmission for television sound. Again, the power handling capability and location of the unit will be dependent on the type of installation.

The viewing system is dependent on the picture-size requirement of the installation. Two methods are currently being used; one is by direct view from the cathode-ray tube, the other by projection from the face of the cathode-ray tube; however, other methods are possible, such as film recording and projection.

The direct-view method is somewhat limited as to the number of people that can be accommodated by it. However, in some cases, this drawback can be circumvented by using a number of direct-view "slave" units. The technique used would be the same as that employed in home television receivers.

Figure 1 indicates a rear-view projection system. However, it is possible to use front projection with the optical barrel suspended from the ceiling, or mounted on a fixed or movable dolly. Projection from the face of the cathode-ray tube affords an excellent method for increasing the screen size; however, certain technical limitations place a limit on the size and brightness of the picture that can be obtained with this method. In order to obtain maximum results with this method, a highly efficient optical system must be employed. At present the Schmidt system, or variations of it, give the best results. Corrections should be made for distortion and aberration.

THE PRECISION TELEVISION RECEIVER

The Precision Television Receiver demonstrates some of the practical aspects of this paper. Although built as a packaged unit to simplify installation, it nevertheless incorporates some of the features

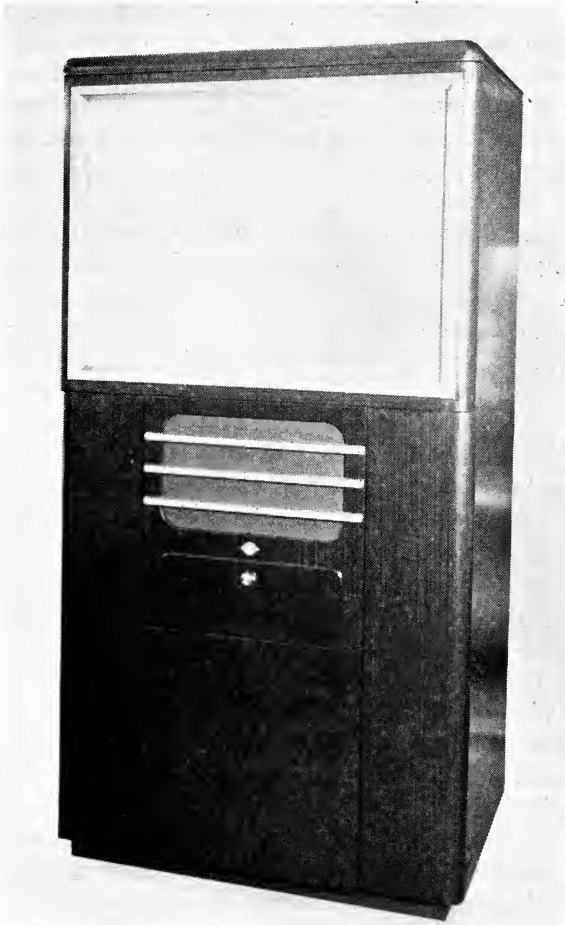

Fig. 2. The Precision Television Receiver.

discussed in this paper. Figure 2 shows the front view of the unit, and Fig. 3 shows the arrangement and interconnections of the various chassis used in this receiver. With minor changes, the components of this system can be extended to include the elaborate arrangement earlier described.

The precision Television Receiver Model L-10 features a 27×36 in. rear-projected picture. In order to obtain a picture of this size, a 5TP4 projection tube with 30 kv applied to the second anode is used in conjunction with a Schmidt optical system. The optical system consists of an optical barrel supporting the projection tube, the 12-in. front-surfaced spherical mirror and the corrector lens. A 45-deg, front-surfaced mirror located in the top section of the cabinet directs the reflected light onto the rear of a plastic translucent screen having directional properties. The high-light brightness as measured on a standard test pattern has been measured at 30 ft-L and the resolving power of the optical system has also been measured to be somewhat better than 1000 lines.

The r-f tuner is shown mounted on the receiver chassis but it can be conveniently removed to serve a remote location without changing its operating characteristics, because the output transformer used is designed so as to connect with the first i-f amplifier stage through a low-impedance link coupling. The cable used to effect the coupling can be any commercial, 90-ohm, shielded coaxial cable up to 50 ft in length.

Channel selection is made by switching to individually tuned circuits for each section of the tuner circuit. These tuned circuits are mounted on low-loss bakelite clips which snap into their individual sections on a turret selector. The sequence of selection can be easily arranged in any desired fashion. If desired, tuned circuits for operating on channels other than standard can easily be inserted. This tuner is capable of 100- μ v sensitivity at normal bandwidth with an average signal-to-noise ratio of eleven to one.

The first two stages of i-f amplification are common to both the sound and picture signals. The sound signal is separated from the picture signal in the plate circuit of the second stage and after additional amplification and limiting, the signal is then detected in a frequency discriminator stage. The picture signal passes through two additional i-f stages before being detected. Six trap circuits are utilized in the picture stages to remove the undesired adjacent channel and sound signals. After detection the video signal is applied to a cathode follower stage designed to match a coaxial cable feeding the remote video amplifier.

A separate detection stage is utilized to separate a portion of the video signal for operating the automatic gain control and synchronization separation circuits. The synchronization signal is further amplified before being applied to a cathode follower stage for line matching to the sweep chassis. The signal for automatic gain control is d-c amplified and filtered in three stages and is designed so as to give

separate delay characteristics to the r-f and the i-f stages controlled by automatic gain control. The amplified a-g-c circuit in this receiver will equalize the second detector output for a range of signals between 500 μ v minimum and 40 mv maximum.

The sound amplifier of this system is also shown mounted on the same chassis as the receiver; however, this unit can easily be divorced from the receiver chassis for remote-location purposes. The amplifier is capable of 20-w power output and when the bass and treble controls are cut out of the circuit, the response is essentially flat to 20,000 cycles. At 20-w output the harmonic content at center frequency

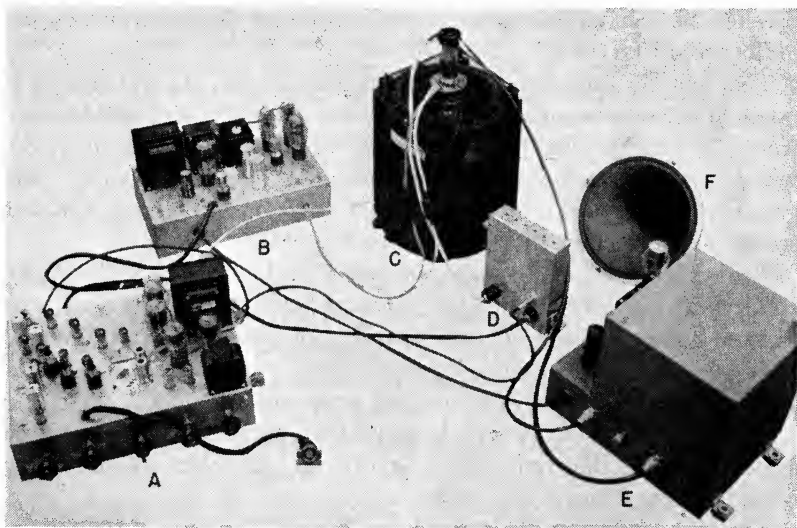

Fig. 3. Arrangement and interconnections of various chassis.

A, receiver and sound chassis C, optical barrel E, 30-kv high-voltage supply
 B, sweep chassis D, video amplifier F, speaker

has been measured to be $1\frac{1}{2}\%$. For the same power output, the harmonic content for both the lower and upper part of the frequency spectrum has been measured at 2.2% . A 12-in. permanent magnet speaker, with a power rating of 25 w, is used to load the sound amplifier.

The sweep unit is shown as an additional chassis and contains its own power supply. It is only necessary to change the deflection output transformers of this unit in order to operate projection tubes having a higher second anode voltage than the 30 kv rated as maximum for the 5TP4 tube. The horizontal and vertical sweep oscillators are

so well stabilized that under the worst condition of noise, where a picture is just barely visible through the snow, no trouble is encountered in maintaining synchronization.

The 30-kv high-voltage power supply is shown in its separate shielded chassis which includes its own low-voltage power supply. The unit operates on the r-f principle and develops the 30 kv by means of a voltage tripler circuit. The energy storage capacity is represented in effective shunt capacitance of 250 $\mu\mu\text{m}$. This small capacitance in series with a one-megohm resistor materially reduces the danger of shock hazards. The unit has a current capacity larger than is necessary for the operation of the 5TP4 projection tube. A 5-kv tap is taken off from a potentiometer and is used for electrostatic focusing of the projection tube.

The remote video amplifier completes the system and makes it possible to operate the projection tube at distances up to 50 ft away from the receiver chassis without any detrimental effects upon the video signal due to the shunt capacitance of the projection tube. The gain supplied in this unit is sufficient to drive tubes having a higher second anode voltage than the 5TP4.

Today, receivers of this type are being used as a part of the Army Reserve Training Program. Similar models have also been used with marked success in conjunction with school programs, and modified versions are being submitted to the Navy for approval for use in some of its training and experimental programs.

Associated with the present demands for a more elaborate television system, it is felt that units in the near future will contain many of the considerations given in this paper.

The authors gratefully acknowledge the collaboration of the following of the staff of General Precision Laboratory: Dr. R. L. Garman, Director of Research; T. P. Dewhurst, Project Engineer; R. Anderson; and E. H. Lombardi, whose engineering reports represented the basic source material for this paper.

Designing Engine-Generator Equipment for Motion Picture Locations

BY M. A. HANKINS AND PETER MOLE

MOLE-RICHARDSON Co., HOLLYWOOD, CALIF.

SUMMARY: Artificial lighting on outdoor motion picture sets is essential for both day and night photography. In most cases an electrical distribution system is not available at the selected location, and power must be supplied by electric generators driven by internal-combustion engines. Because standard, commercially available, engine-generator sets are not suitable for the special performance requirements encountered in motion picture photography it is necessary to design and construct special equipment having the required features. This paper describes and evaluates the engineering factors involved, and illustrates how each of the desired characteristics was attained in equipment recently constructed.

BASIC REQUIREMENTS

THE ENGINEERING FACTORS which must be considered in the design of engine-generator equipment for supplying electric power for lighting on motion picture locations are as follows:

1. *Electric Power.* The generated electric power should be 120-v, d-c, to supply satisfactorily both arc lamps, which require direct current, and incandescent lamps, which operate on either alternating or direct current. Experience has shown that engine-generator sets having a capacity of between 750 and 1,400 amp¹ will currently satisfy the load requirement in practically all cases, with those at or near the higher rating being more in demand. The increase in the number of color pictures being made on locations indicates a possible future demand for engine-generator sets having capacities above 1,400 amp, and a few sets capable of producing 2,000 to 2,500 amp have been constructed. However, in considering the feasibility of these larger units the advantage of increased capacity must be weighed against the disadvantage of decreased portability due to added size and weight. Also the relatively fewer occasions on which they can be used should be considered. To date, it has been generally accepted that it is more feasible to use two or more smaller, lighter, and hence more maneuverable, engine-generator sets to supply the higher current demands on location.

A three-wire d-c system is superior to a two-wire system for distrib-

PRESENTED: October 11, 1949, at the SMPE Convention in Hollywood.

uting large amounts of power.² A three-wire system produced by a single three-wire generator is not well suited for motion picture work because of the inherent variation in voltage caused by load unbalance, and such a system is best obtained by two generators connected in series. Driving two generators from one engine presents mechanical problems. When deciding upon the system to be used, the electrical advantages of the three-wire system should be weighed against the necessary mechanical complications required to produce it, and the decision is usually determined by the power rating. For engine-generator sets of capacities up to 1,400 amp which are to be driven by a single engine, experience has shown that it is better to use one two-wire generator and accept the disadvantages of the resulting two-wire distribution system. However, when considering larger loads up to 2,500 amp, the electrical advantage of the three-wire system becomes the governing factor, and a construction having two 120-v generators in series is to be preferred. Such plants should have two engines, one for each generator, thereby gaining an advantage in the form of flexibility, in that only one engine need be operated when the plant is supplying half-load or less.

Good, consistent lighting is dependent upon close control of the voltage at the load-end of feeder cables. The lighting load encountered on locations varies from a small fraction of the generator rating up to its maximum capacity. Feeder cables may be short or relatively long, dependent upon the conditions at the location. An appreciable increase in voltage cannot be tolerated because of the danger of damaging incandescent lamp filaments. Automatic voltage regulation to meet these operating conditions is essential.

Commutator ripple in the d-c voltage causes noise emission from carbon arcs which can be objectionable on sound sets. Generators for motion picture work should be so designed that their ripple voltage does not exceed $\pm \frac{1}{2}$ of 1% of rated voltage. Even then the ripple is, on many occasions, further reduced by means of filter circuits using choke coils and capacitors.³

Since the duty cycle of an engine-generator set is of an intermittent nature, a generator which will produce the required maximum amount of power for approximately one-half hour without injurious heating is considered to be adequate. Hence, much smaller and lighter weight generators can be used than would be the case if it were necessary to give them a continuous rating at the maximum output.

2. *Prime Mover.* Either a gasoline or diesel engine can be used to drive the generator and both types have been successfully employed. The speed-power curve of the engine should match the

generator requirements, bearing in mind that, as a protective measure, engine horsepower should be somewhat below that capable of driving the generator at an injurious load.

The engine should be equipped with a governor capable of manual adjustment to maintain automatically any desired speed within the generator operating range.

3. *Control.* The controls for both the engine and generator should be conveniently grouped so a single operator can quickly perform all operating functions required.

4. *Noise.* On sound locations the engine-generator set must be positioned so that its operation noise does not interfere with production. A design which effectively reduces the noise level saves setup time and permits the use of shorter feeder cables since the plant can be located closer to the action.

5. *Portability.* The engine-generator set should be as small and light in weight as possible. Its dimensions should allow passage through door-openings in railway cars, and be suitable for mounting on a truck or trailer. Maneuverability in and out of "tight spots" on locations is essential.

6. *Dependability.* More often than not, engine-generator sets operate in remote locations where supply parts and the repair-shop type of maintenance service are not available. A breakdown on such locations would hold up an entire company and increase production costs. For that reason the construction should be as foolproof as possible, using the minimum number of parts to satisfy operational requirements. The components employed should be of a standard commercial type which have proven their reliability under service conditions.

7. *Protective Devices.* Automatic-operating safety devices should be incorporated to protect the engine-generator set against damage caused by abnormal conditions.

8. *Maintenance.* The use of standard, readily available, commercially proven components greatly reduces the maintenance problem. In addition, the engine-generator set should be designed so that those parts which require periodic maintenance are readily accessible.

ATTAINING THE REQUIREMENTS

In order to illustrate methods which may be employed to meet the foregoing basic requirements, a particular design of a 150-kw engine-generator set recently manufactured by the Mole-Richardson Co. is described. The completed unit (Figs. 1 and 2) consists of a cubicle

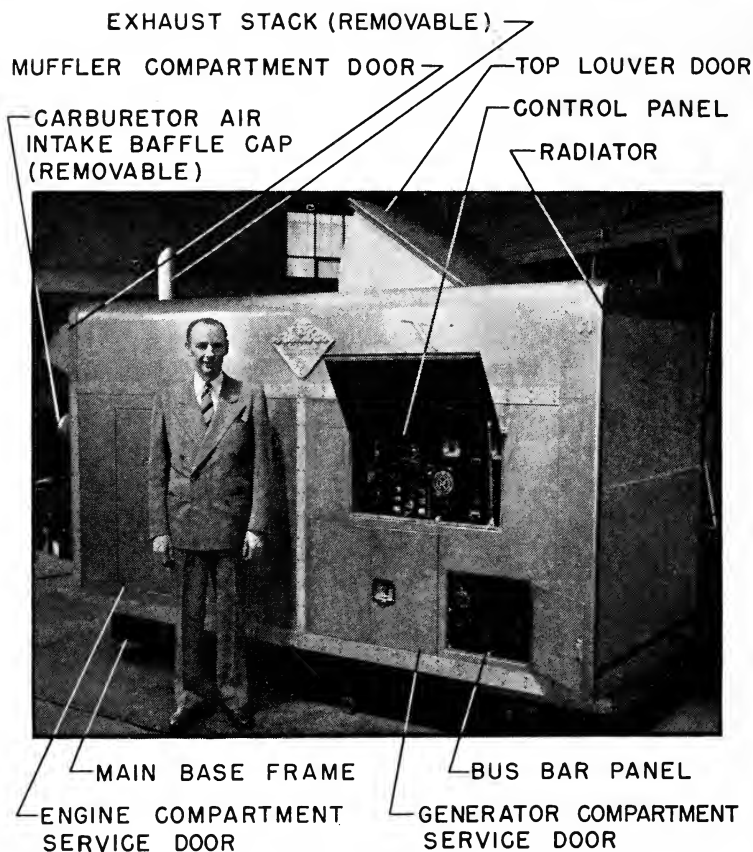

Fig. 1. 150 Kw engine-generator set.

54 in. wide by 72 in. high by 118 in. long and weighs approximately 10,000 lb. The enclosure forms the outside walls of three separate internal compartments: the generator compartment at the radiator end of the plant, the engine compartment at the rear of the plant and the muffler compartment at the top. All outer surfaces of the housing are polished, stainless steel. The design features directly related to the basic requirements are described as follows:

1. *Electric Power.* When contemplating the construction of a power-package, the electrical requirements and the engine must be simultaneously considered. Obviously, a special engine cannot be designed and built for this particular application, and one which will drive a generator of the approximate desired rating must be selected from those commercially available. Generator performance should

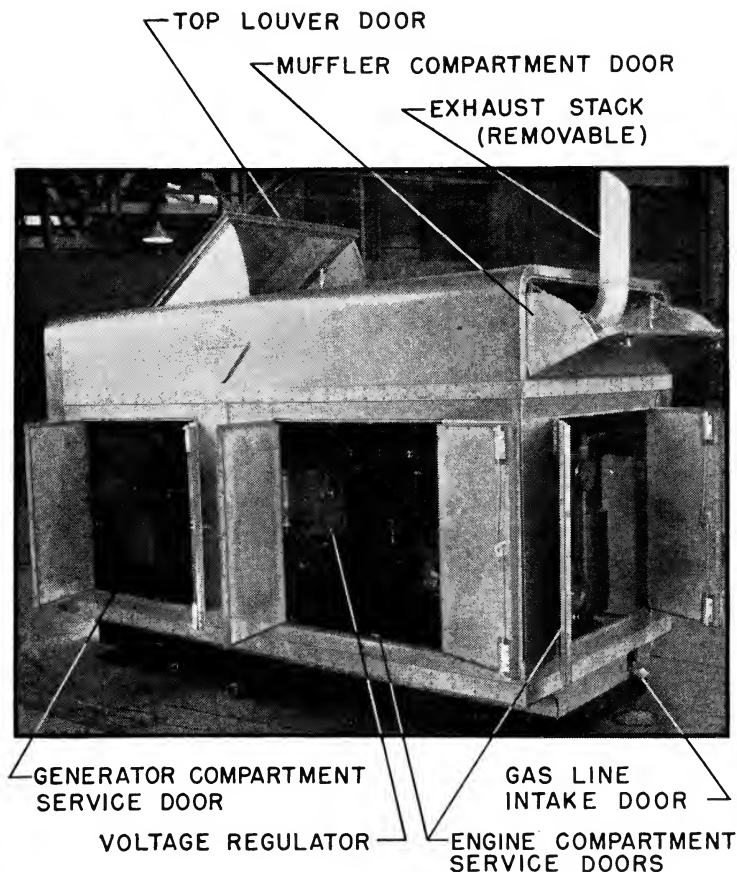

Fig. 2. Oblique view, off-side and rear.

conform to the speed-horsepower characteristics of the chosen engine, and modification of standard generator design is generally required.

In this instance, after consideration of available engines, it was decided to construct equipment capable of delivering 1,200 amp at 125 v, or 150 kw. To meet this requirement, a generator (Fig. 3) was chosen which has an intermittent duty rating of 1,400 amp, 125 v at 1,800 rpm, and a continuous rating of 1,000 amp, 125 v at 1,400 rpm. It will pick up its voltage at 1,350 rpm without exceeding rated field current. The voltage rating allows for a 5-v line drop when maintaining 120 v at the load-end of feeder cables. The generator is two-wire, self-excited, flat compounded, Class B insulated, and weighs approximately 2,500 lb. Its voltage ripple characteristic is within the allowable limit of $\pm \frac{1}{2}$ of 1% of rated voltage. An automatic

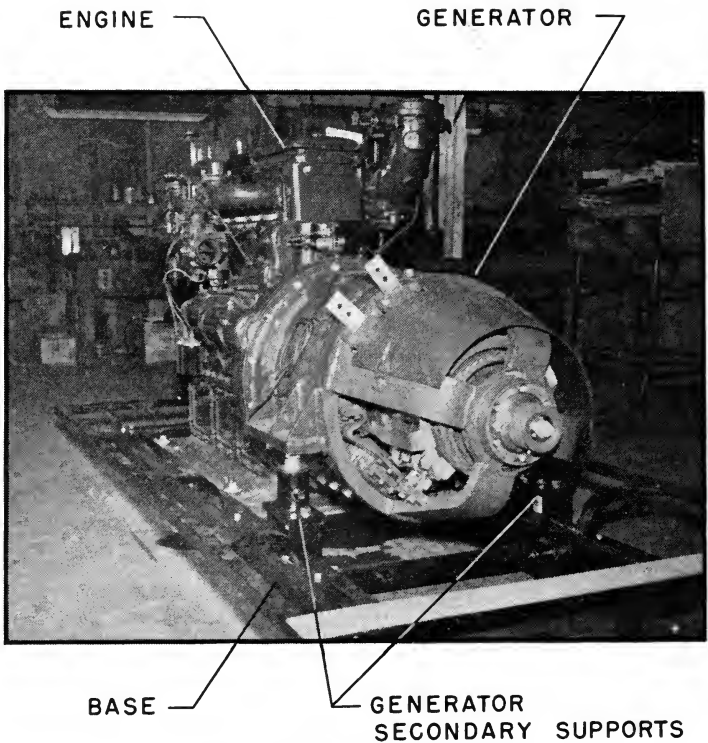

Fig. 3. Engine-generator assembly.

voltage regulator, located as shown in Fig. 2, maintains the proper voltage setting over the speed range of the generator. A field control rheostat is provided so that voltage can be manually controlled in case trouble should develop with automatic voltage regulation. A field control switch at the control panel permits the operator to select the type of voltage regulation desired.

2. *Prime Mover.* The engine (Fig. 4) selected for this application develops 275 hp at 1,800 rpm as shown by its speed-horsepower curve (Fig. 5). After allowance is made for the power consumed by auxiliary drives, the engine is nearly fully loaded by 150-kw generator output at 1,800 rpm. Likewise, the engine power-input conforms to generator power-output at 1,400 rpm. The load current can therefore be increased from 1,000 amp at 1,400 rpm to 1,200 amp at 1,800 rpm at a rate of about 50 amp for each additional 100 rpm. This is a desirable feature since there is no need to operate the engine at a speed higher than necessary to develop the required horsepower.

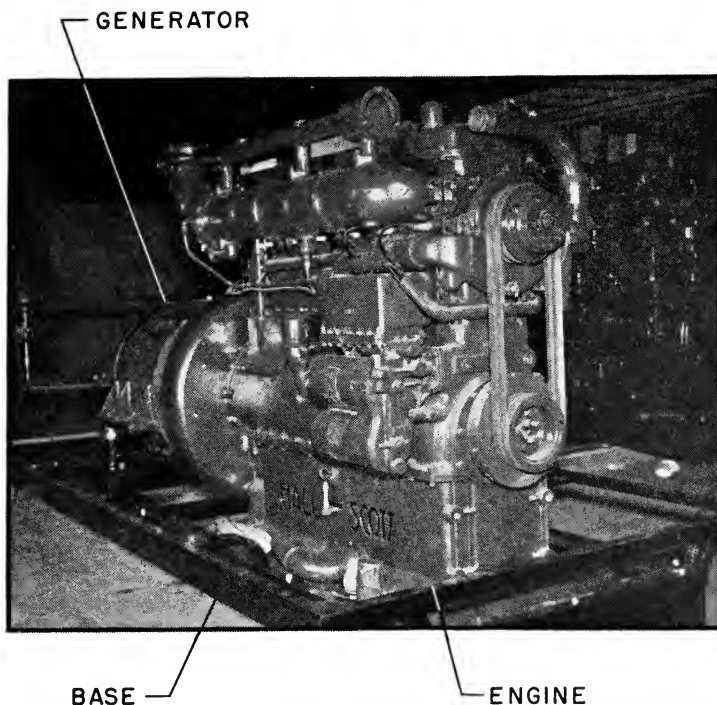

Fig. 4. Engine-generator assembly.

The engine is of the industrial type having six cylinders with a bore of $5\frac{3}{4}$ in., a 7-in. stroke, a displacement of 1,090 cu in., a compression ratio of 5.7 to 1, and a weight of approximately 2,600 lb. It is designed to consume ethyl gasoline fuel having an octane rating of approximately 80.

This engine is equipped at the factory with a governor adjusted to maintain an engine-operating speed of 1,400 rpm. The tension of an added external governor spring is varied by a knob at the control panel so engine speed can be adjusted above that which would otherwise be maintained by the governor proper. This allows the operator manually to adjust the automatic governor over the rated speed range of 1,400 to 1,800 rpm.

The generator end bell is designed to flange mount with a rabbet fit to the flywheel bell housing of the engine. The special resilient-type coupling (Fig. 6) is designed for connecting the generator shaft to the engine flywheel. The flywheel is modified to accommodate its portion of the coupling. This type of construction results in a mini-

imum of runout between the axis of rotation of the engine crankshaft and that of the generator armature and, therefore, insures long trouble-free coupling life. Mounting the generator direct to the engine bell housing results in a minimum over-all length of the coupled units.

The engine and generator coupled to form one integral unit are mounted to the main-base frame primarily by means of the industrial

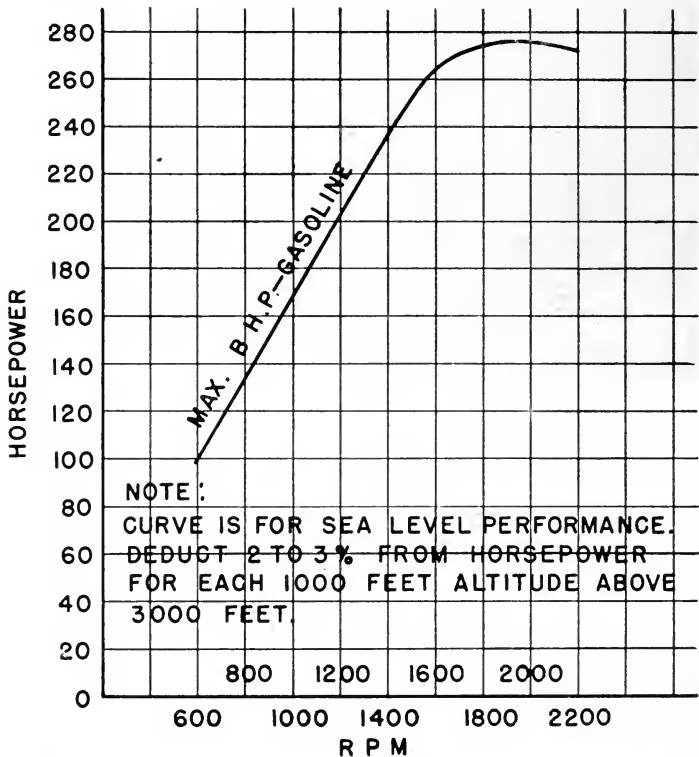

Fig. 5. Speed-horsepower curve for Hall-Scott model 400-0 engine.

base of the engine (Figs. 3 and 4). Thick rubber belting under the engine base and rubber bushings and washers at the holddown bolts prevent metal-to-metal contact between the engine and the main-base frame, minimizing the transmission of engine vibrations to the power plant structural members. Since the generator is an overhung weight mounted to the engine bell housing, secondary supports consisting of rubber tube-form mountings (Fig. 3), are positioned between the main-base frame and the ears of the generator with their upward

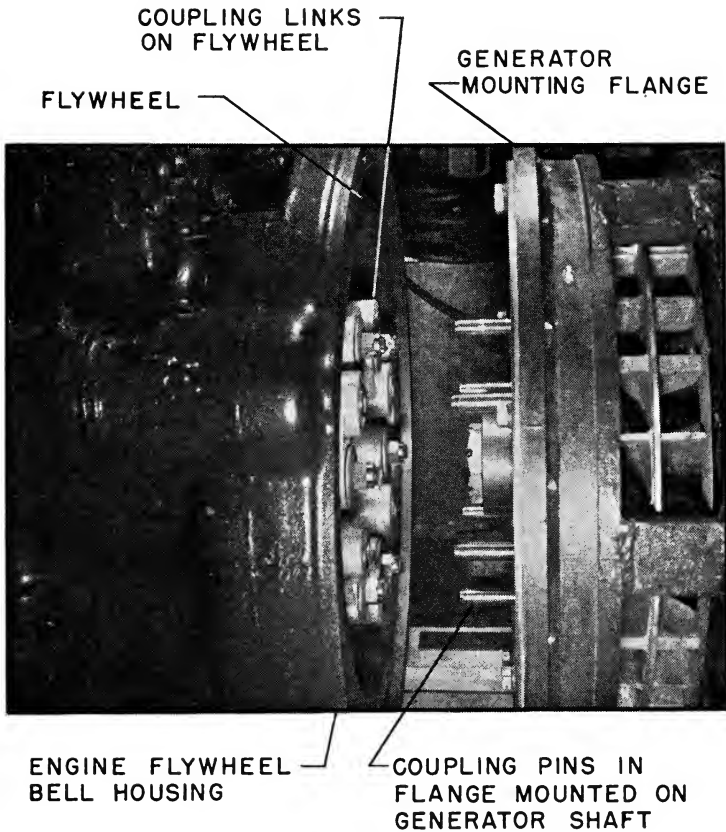

Fig. 6. Coupling.

thrust forces evenly adjusted for minimum strain on the engine bell-housing. Here again, there is no metal-to-metal contact with the main-base frame.

3. *Control.* All operating controls and adjustments of the engine-generator set are located on the control panel shown in Fig. 1 and illustrated in detail in Fig. 7. The controls and instruments are divided into two groups: the engine controls on the left and the electrical controls on the right.

4. *Noise.* The major portion of operational noise of an engine-generator set consists of engine mechanical noise, exhaust noise, radiator fan and cooling air noise, and carburetor-intake noise.

As described above, the engine and generator are resiliently mounted so there is no metal-to-metal contact with the structural members of the unit, thus minimizing the transmission of engine vi-

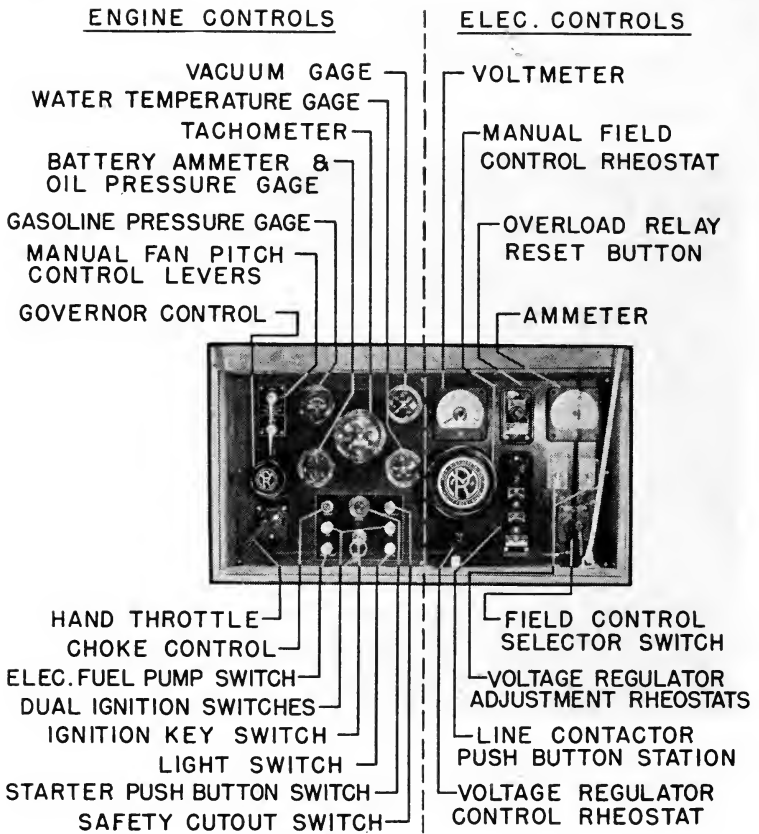

Fig. 7. Control panel.

brations to the housing. The engine is completely enclosed by the engine compartment, the walls of which are insulated against sound transmission. The wall construction consists of the following, enumerated in order of position from outside to inside: stainless steel sheet, sound-deadening undercoating, air space, sound-deadening undercoating, asphalt compound, fiber glass insulation, fiber glass cloth and perforated stainless steel sheet. (Since the engine is completely enclosed, cooling is dependent entirely upon the water-cooling system.)

The exhaust noise is reduced by a large muffler 14 in. in diameter by 6 ft long, mounted in the muffler compartment above the engine compartment. The walls of the muffler compartment are also insulated against sound transmission in the manner described above.

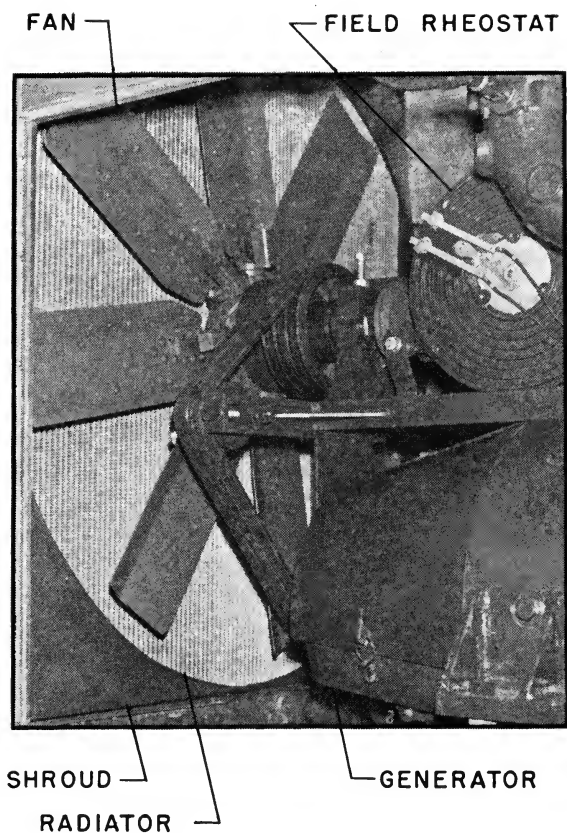

Fig. 8. View through off-side generator compartment service door.

A right-angle exhaust stack (Figs. 1 and 2) directs the exhaust gases in an upward direction.

The attainment of adequate engine cooling with a minimum noise from fan and air flow is primarily accomplished with the use of a radiator having an exceptionally large frontal area (Figs. 1 and 8). The radiator has approximately twice the capacity of those normally used in industrial applications of this engine thereby providing sufficient cooling with a relatively low air speed. This radiator also permits the use of a large 48-in. diameter, 8-blade fan (Fig. 8) which can provide the required rate of air flow at a low top-speed of 740 rpm. The fan is belt-driven from a sheave on a shaft extension at the commutator end of the generator.

A further reduction of fan and air noise is obtained by the use of a variable-fan-blade-pitch control system which automatically controls the pitch of the blades in accordance with the cooling-water temperature; thus no more air is passed through the radiator than is necessary. A manual control of the pitch of the fan blades permits the operator temporarily to feather the blades to zero pitch and stop the air flow, and the resultant noise, during a "take."

The cooling air, after being drawn through the radiator, passes through the generator compartment and is exhausted through the muffler compartment door, and top louver-door whose opening can be adjusted. On many occasions the power plant can be operated with the top louver-door closed, with all of the cooling air passing through the muffler compartment and exhausted upward at the rear of the plant. All walls of the housing are insulated, as explained for the engine compartment, and therefore are deadened against vibrations caused by air flow.

The carburetor-intake noise cannot be neglected. In this application outside air is drawn in through a baffled cap (Fig. 1), then through a large industrial-type air cleaner (Fig. 9), and into the carburetor. The baffled cap and air cleaner function as silencers.

5. *Portability.* The minimum over-all engine-generator set dimensions result from the following considerations: The 54-in. width accommodates a radiator having the desired capacity and in addition provides adequate clearance between the inside walls of the housing and the internal components for service and maintenance accessibility. The minimum height is determined on one end by a radiator of sufficient capacity, and on the other end by the combined heights of the engine and muffler. To reduce the latter, the engine mounting platform, consisting of steel channels welded crosswise and longitudinally, is recessed below the top surface of the main-base channel structure. Thus the minimum height requirement for the engine and muffler is made to conform to that required for the radiator. The length of the power plant is considerably reduced by the design of the short-coupled arrangement between the engine and the generator.

Such engine-generator set cubicles are either carried on trucks or trailers. In the design of this plant, the 54-in. width of the enclosure is reduced by a curved contour near its base to $33\frac{3}{4}$ in., which is slightly less than the standard 34-in. over-all width of the main frame of commercial trucks having the capacity to carry this power plant. The $9\frac{1}{4}$ -in. height above the bottom surface of the main base to the point where the power plant enclosure becomes 54 in. wide provides clearance over the rear wheels of the standard commercial trucks.

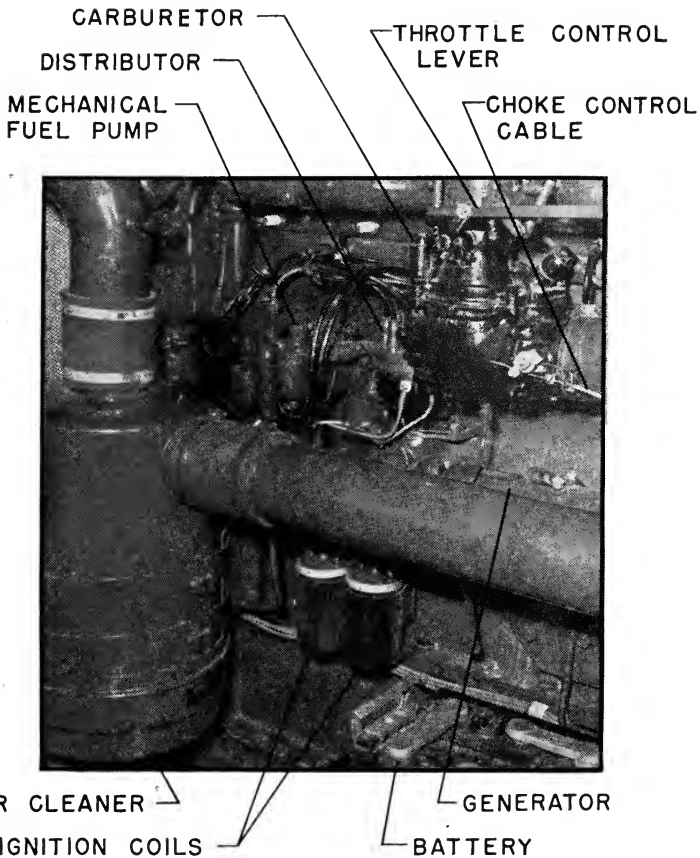

Fig. 9. View through engine compartment service door on operator's side.

This allows the power plant to be positioned low between the rear truck wheels, hence resulting in a minimum over-all height, and a minimum height of the center of gravity of the power plant above the ground. This same design feature is equally advantageous if the cubicle is to be mounted on a trailer.

Arrangements are provided for handling the cubicle as a unit. Heavy steel tubular members are welded crosswise through the main-base frame near the front and rear and other tubular openings are located at both ends. These tubular openings are for insertion of heavy steel handling bars or wheel axles.

6. Dependability. Dependability is necessary for trouble-free operation of all components. The engine chosen for this application is one which has proven its dependability in years of truck service, bus serv-

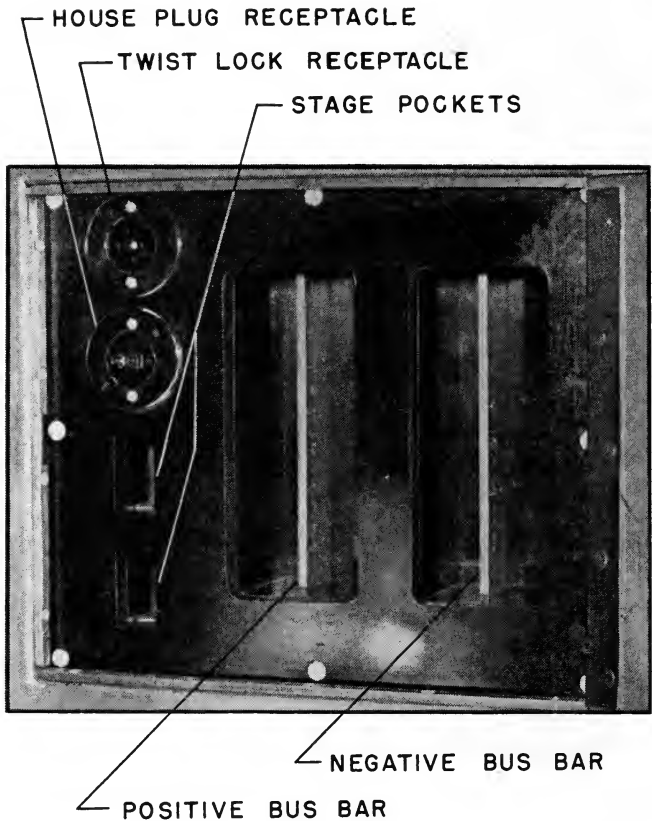

Fig. 10. Bus bar panel.

ice, in oil field locations and in other industrial applications. The generator is of a rugged design which has performed successfully in railway transportation equipment. The method used in coupling the generator to the engine insures long coupling life.

Wherever practical, automatic operating components are supplemented by manual controls to reduce the possibility of shut-down. The automatic voltage regulator is supplemented by manual field rheostat control. The pitch of the fan blades can be manually controlled in case of failure of automatic control. Should manual control become inoperative, the blades can be mechanically locked in their pitched position and operation continued.

There are, of course, inevitable possibilities of failure of equipment which could cause shut-down. The best insurance against such

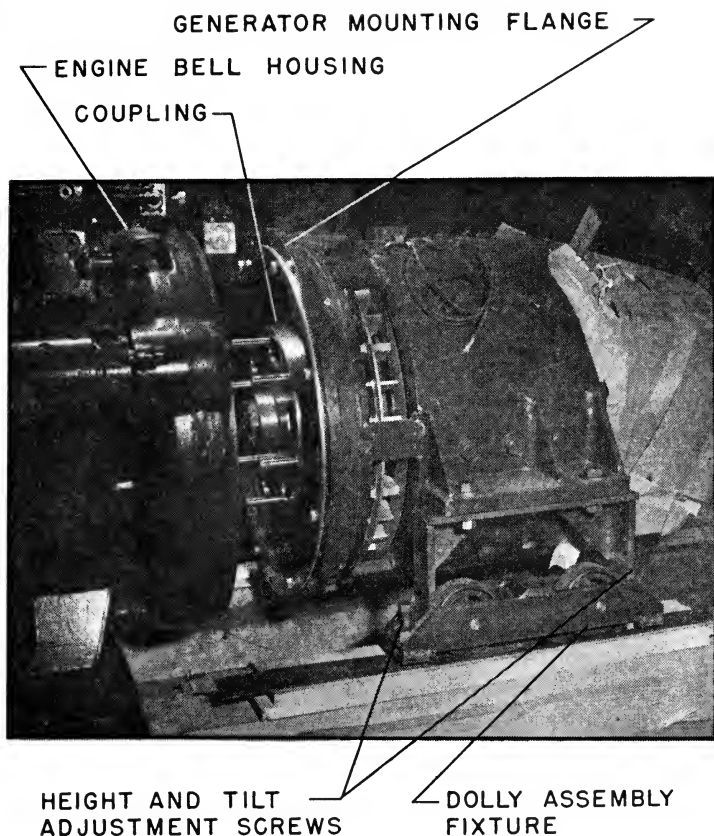

Fig. 11. Generator on dolly fixtures.

occurrences is the use of components which have by service proven their reliability.

7. Protective Devices. An overspeed governor, coupled to engine rotation, will open the ignition circuit and stop the engine before a damaging speed occurs. The engine cannot be restarted until the overspeed governor is manually reset by the operator.

A safety switch in the ignition circuit will stop the engine if a loss of oil pressure occurs, or if the cooling-water temperature becomes too high.

An overload relay, which will open the main line contactor, protects the generator against overloads.

The positive battery cable is grounded through a pin-plug arrangement so it can be conveniently and positively removed as a safety

precaution during servicing, or when the power plant is idle. All battery circuits, except the starter motor circuit, are fused.

A Thyrite discharge resistor, permanently connected across the generator shunt field, protects the field insulation against high voltage breakdown by limiting the induced voltage which momentarily appears when the field circuit is opened.

The positive and negative bus bars for external feeder-cable lug connections (Fig. 10) are recessed behind an insulation panel, and an insulation barrier is located between them for protection against short circuits. The convenience outlets at the left of the bus bars are fused.

8. *Maintenance.* Door openings in the enclosure are such that all components are accessible for routine maintenance. The housing is constructed in sections to provide access for general overhaul. The top section, or muffler compartment, is removable as a unit. Each of the sides consists of two separate wall panels, and the rear is made up of one panel, all of which are individually removable. External stainless steel trim strips not only serve to cover the joints between sections for the sake of appearance, but also as mechanical members which tie the housing sections together.

During a major overhaul of the power plant it may become necessary to detach the generator from the engine bell housing and separate the coupling. Adjustable dolly fixtures are provided (Fig. 11) which can be secured to the ears of the generator in place of the secondary supports. With the dolly wheels resting on the main base channels, the generator may be rolled in or out of engagement with the engine.

CONCLUSION

In the making of motion pictures the production-time factor is of such importance that every precaution against possible power failure should be given the utmost consideration. The engine-generator set must be sufficiently rugged to withstand hard travel over rough roads, yet deliver the maximum of power with constant performance. In spite of the fact that it is a highly specialized piece of equipment, it should, so far as possible, be designed for, and constructed of, units which have been proven dependable in other fields.

REFERENCES

1. "Report of Studio-Lighting Committee," *Jour. SMPE*, vol. 51, pp. 431-436, Oct. 1948.
2. "Report of Studio-Lighting Committee," *Jour. SMPE*, vol. 49, pp. 279-288, Sept. 1947.
3. B. F. Miller, "A motion picture arc-lighting generator filter," *Jour. SMPE*, vol. 41, pp. 367-373, Nov. 1943.

Laboratory Practice Committee Report

BY JOHN G. STOTT, COMMITTEE CHAIRMAN

IN THE FALL OF 1948, the writer proposed to John A. Maurer, then Engineering Vice-President of the Society, that a committee on chemical engineering practice be organized to provide Society members with much needed information on chemical and chemical engineering practice as it applies to our industry. Mr. Maurer agreed with the proposal and suggested that such a committee be organized as a subcommittee of the Laboratory Practice Committee. A subcommittee composed largely of chemists and chemical engineers working in the motion picture industry was accordingly appointed. Later it was suggested that this subcommittee expand its activities to include the entire function of the parent Laboratory Practice Committee under its present chairman. The committee was organized with East Coast and West Coast Sections, the West Coast Section under the co-chairmanship of Vaughn Shaner.

It was still intended that the parent committee would work primarily on chemical and chemical engineering problems as they relate to the motion picture industry. However, at the first meeting of the Committee held in New York City the members brought up so many other laboratory problems that the original objective concerning chemical problems was placed far down the agenda laid out at that meeting. Another meeting of the Committee was held in Hollywood during the Fall Convention of 1949 at which time the projects laid out by the East Coast Group were discussed and other projects added to the agenda. The complete proposed agenda came to be as follows:

1. Design of a special leader for television films to replace the Academy theater leader.
2. Aid in the standardization of screen brightness for 16-mm projection.
3. Establish a standard for the notching of 35-mm and 16-mm negative films.
4. Investigate the possibility of modifying sound and picture reduction printers to print forward and backward, and to employ 2000-ft negative feed and take-up.
5. Investigate the standardization of edge numbering of 16-mm.
6. Study recommendations for the splicing of 16-mm films.
7. Study recommendations regarding 16-mm projection emulsion position.
8. Study methods of bringing data on chemical and chemical engineering developments to the attention of Society members.

PRESENTED: April 28, 1950, at the SMPTE Convention in Chicago.

Other laboratory problems were discussed, but were tabled as either being under the jurisdiction of other Committees of the Society or entirely outside the sphere of activity of the Society.

The third meeting was held in New York. At that meeting V. D. Armstrong was appointed as the Laboratory Practice Committee representative on the Films for Television Committee which is undertaking the design of a television leader; therefore Mr. Armstrong is functioning in an advisory capacity to that Committee on any television leader production or use problems as they concern the motion picture laboratory. A report on this leader is forthcoming from this Committee.

Edward Cantor was appointed to make a cursory survey of 16-mm screen brightness presently used in New York, Midwest and Hollywood laboratories for print examination. It was felt that this would represent a first move toward a recommended screen brightness of 16-mm projection. When completed, these data will be submitted to the Screen Brightness Committee for their use in further studies.

Also, at the third meeting the Chairman was instructed to write to manufacturers of sound and picture reduction printers suggesting that they design these printers for forward and backward printing and provide facilities for printing from 2000-ft negatives. At the present writing the response from the printer manufacturers indicates no particular problem on the 2000-ft negative feature, but opinion is unanimous that the forward and backward printing feature would entail expensive design changes. Further examination of this project will be made.

Paul Kaufman was appointed to study recommendations for the notching of 35-mm and 16-mm negatives. This study has progressed satisfactorily, and a tentative standard for 35-mm will be proposed shortly. However, the 16-mm notching problem is going to be more difficult to resolve. It has been suggested by Lloyd Thompson that, in view of the present confusion and nonuniformity in 16-mm notching, an entirely new scene exposure changing system be adopted as a standard. Mr. Thompson has suggested that a magnetic cue system be used, which will eliminate the need for an actual notch in the film. This proposal will be considered in subsequent meetings.

The 40-frame edge numbering proposal for 16-mm was originally opposed because of the laboratory problem of picking replacements on 16-mm printed from 35-mm. When the proposed standard offering the optional privilege of edge numbering at the 40-frame interval or not edge numbering at all was submitted to the Committee, this original objection was withdrawn. It was felt that 16-mm replace-

ment from 35-mm preprint material could be picked by scene description as has been done in the past. Realizing that a 16-mm edge numbering standard was badly needed, it was agreed that any further complication of the 16-mm edge numbering situation by the Committee would be detrimental to the 16-mm industry.

The Committee has gone on record as opposing any change in the present 16-mm standard for emulsion position during projection. The laboratories printing 16-mm from 35-mm preprint material, which is by far the greatest dollar volume of product, end up with film projecting according to the present standard. Any change in 16-mm projection standards would require extensive and expensive alterations in existing printers, etc. It was felt that a change in 16-mm projection standards would impose severe economic hardship on the laboratory, greatly out of proportion to the benefit that would accrue to other film-using segments of the industry.

Thus far, no work has been done in the splicing of 16-mm films. A fourth meeting of the Committee was held also in New York. At this meeting Mr. Cantor reported on the 16-mm screen brightness survey of New York laboratories. The survey of Midwest and Hollywood laboratories is yet to be made.

At this meeting the chemical and chemical engineering problems were again discussed. Irving Ewig was appointed to start some work on these problems. Mr. Ewig is to make a survey of chemical and chemical engineering magazines and journals having data of interest to our industry. The Committee has requested that the Society subscribe to several periodicals to be submitted to committee members for abstracting. The Committee has also requested of Clyde Keith, Editorial Vice-President, that JOURNAL space be made available for publishing these abstracts to benefit all Society members. This was approved by Mr. Keith. Fred Bowditch, Engineering Vice-President, has authorized the reforming of a subcommittee on chemical engineering practice within the Laboratory Practice Committee. Hence, the original organization plan of the Committee has been realized.

A fifth meeting of the Committee was held at the 1950 Spring Convention in Chicago. At this meeting the afore-mentioned projects were discussed briefly and a long discussion ensued with representatives of the Armed Services on the 16-mm projection screen brightness problem. Further help on this problem has been offered by the Armed Services in an effort to arrive at a suitable standard for 16-mm screen brightness.

68th Convention

Feature items on the Papers Program include a Symposium on Film Registration that will appeal particularly to designers of film handling equipment. Recent study of film perforation shape as it affects steadiness in the camera, registration in printing and projection life of release prints will be reported upon at length. The years of formal experience with film perforated to current standards, together with surveys now under way, should provide a thorough engineering basis for proposed new film standards that will be of serious interest to all film, equipment and laboratory people.

Most of one day will be devoted to papers on several application aspects of high-speed motion picture photography. Adequate time is to be allowed for discussion from the floor of practical application problems.

Editing magnetic sound tracks in motion picture studio production will highlight another session and tie in with papers on magnetic recording equipment and studio practices.

Photographic sound recording on a new type of color motion picture release film will be discussed as will many other items of interest, including "T" stop calibration of camera lenses.

— *the place* is Lake Placid Club — *the time* is October 16–20 — *reservations* are now being accepted, so send the card you received recently (or write) to: Daniel Nelson, Reservations Manager, Lake Placid Club, Lake Placid, N.Y. — *families* are more than welcome — *informality* prevails — *you and your guests* will enjoy the outdoor recreation.

Members going to Lake Placid from the West should take the New York Central and change at Utica. Those from New York City, the South or areas connecting only with the Pennsylvania Railroad can arrange for overnight or day service from New York City directly to Lake Placid via the New York Central.

Air transportation from New York City can be made available on a charter basis provided there are enough reservations. Planes are tentatively scheduled to leave New York at 10 A.M. and 2 P.M. Sunday, October 15, and 10 A.M. Monday, October 16, with return flights leaving Lake Placid at 10 A.M., 2 P.M. and 6 P.M. Friday, October 20. Round-trip fare is \$40.00. If you desire a reservation on the plane, your check must be received by Society Headquarters before September 10. Please indicate your preference for departure times.

Board of Governors

On Wednesday, July 26, the Society's Board of Governors met for its third regular meeting in 1950. Fiscal affairs were discussed at length and the Board reports that, in general, operations for the first half-year compare very favorably with the budget estimate. One disappointing note, however, was the report on membership status which showed dues for nearly 10% of the entire membership still unpaid as of June 30. The Board is investigating the reasons for this heavy list of delinquents, so that appropriate steps can be taken to reinstate them, as well as to avoid a long list of delinquents next year.

Candidates for Society offices selected by the Nominating Committee for the annual fall election were ratified by the Board as were nominees for Journal

Award, Samuel L. Warner Memorial Award, SMPTE Progress Medal Award and Honorary memberships.

Having been away from motion picture activities for a number of years, Louis Pacent had resigned from membership in the Society. He now plans to renew his interest in technical motion picture matters and his reinstatement as a Fellow received unanimous endorsement by the Board.

Student chapters of University of Southern California and New York University have both been active recently. To help them along the Board has appointed Loren L. Ryder and William H. Rivers as Society advisers.

Engineering Committees

The summer months in recent years have been periods of relative inactivity for the Society's engineering committees, but the current load of standards projects and work related closely to television has kept several committees working diligently throughout the vacation season. Here, briefly, are two items of interest.

Theater Television

Under the Chairmanship of D. E. Hyndman, the Theater Television Committee's detailed study of performance requirements for interconnecting facilities will be continued with an examination of the effects of bandwidth variations, signal-noise ratio, distortion and compression on quality of the projected theater television picture.

Representatives of the common carriers, as well as manufacturers of equipment for this new industry, have taken an active part and have highly praised the efforts of Otto Schade in his study of the four fundamental characteristics. Work on bandwidth requirements has progressed very well. A figure for admissible random noise has been proposed, based upon a detailed and objective sampling procedure developed by Mr. Schade, using the "noise" level of motion picture film as a reference. Subjective comparison of the experimental results between film and television pictures has already been made on a limited scale and will be repeated again, using full-scale commercial equipment for both pictures in the near future.

Tentative conclusions have been made concerning square-wave distortion limits. Further work is now being done and will soon be discussed by the Committee.

Screen Brightness

For more than fifteen years, considerable time and effort have been devoted to the well-organized programs of the Screen Brightness Committee, work having begun seriously in the early thirties. A comparison method of estimating screen reflectivity was adopted, and sample gray cards to serve as reflection factor standards were bound into the *JOURNAL* for June 1933. Extended study of print density, vision and screen illumination produced a series of *JOURNAL* articles in the mid-thirties.

Measurement methods have always been a serious problem. Just before the last war the Committee, under Frank Carlson, began to develop a photoelectric screen brightness meter, but the press of other urgent matters stopped the program shortly after a specification was agreed on. Three years ago the project was revived under the joint guidance of Erwin Geib and Bob Zavesky. A preliminary

survey of eighteen theaters was encouraging and set the stage for an extended program by serving as a proving ground for several types of instruments, as well as providing a review of survey procedures. The Committee has now completed plans to start work on a somewhat larger survey of an estimated one hundred theaters ranging from small houses having fewer than five hundred seats to the largest in the country. Outdoor theaters and review rooms will also be included.

The screen brightness meter recently developed for the Committee by Allen Stimson of General Electric has been doubly checked for accuracy and will be used in succession by six survey teams. Cities included and team leaders are: Los Angeles, C. W. Handley; Chicago, C. E. Heppberger; Toledo, A. J. Hatch, Jr.; Rochester, F. J. Kolb, Jr.; Philadelphia, C. R. Underhill, Jr.; and New York, P. D. Ries. Considerable publicity for the survey has been given by the motion picture trade press, which will help to insure the co-operation of exhibitors and theater projectionists who were very generous with their time and assistance in the previous work.

Letter to the Editor

I was very interested to read in the March issue of the *JOURNAL* the article on spontaneous ignition of decomposing cellulose nitrate film and the appendix on p. 381 on the film decomposition tests which have been carried out in this country [England].

There is, however, an error in the introduction to the latter, which I should be very grateful if you would correct.

The British Film Institute is described as "a Government Department similar to the U.S. National Archives." Although the British Film Institute, including its National Film Library, is maintained chiefly by a grant from H.M. Treasury, it is not a Government Department in the full sense of the term. The only Government Department concerned mainly with film preservation is that of the Government Cinematograph Adviser, at H.M. Stationery Office, which has in its care the films of the Imperial War Museum and those made by certain Government departments which are Crown copyright.

The National Film Library of the British Film Institute is the only other official body in this country concerned with the permanent preservation of films and film records. Our scope, however, is wider in that we are concerned with the film, not only as an historical record, but also as an art, and the greater part of our collection consists of nongovernment films. I imagine that whereas the Government Cinematograph Adviser's Department corresponds to the U.S. National Archives, the National Film Library here corresponds more nearly to the Library of Congress project which was in operation some years ago.

I hope that this clarifies the position. It is easy for confusion to arise because we co-operate most closely with the Government Cinematograph Adviser in all our preservation work and Mr. S. A. Ashmore, who advises the Government Cinematograph Adviser on technical matters, is also a member of our own Technical Committee. . . .

ERNEST LINDGREN
Deputy Director and Curator
The British Film Institute

May 18, 1950

Obituaries

H. G. Christensen, who was actively engaged in motion picture production since 1914, died in New York on June 10, at the age of 56. He was a native of Chicago and studied art before entering the field of training and sales-presentation and film production. During World War I he was one of the Army's first instructors in aerial photography, having been assigned to the U.S. Army School of Aerial Photography at Rochester, N.Y. During World War II he directed the filming of many training subjects, including such secret ones as radar. He had been President of the West Coast Sound Studios and Vice-President of the Associated Sales Co., in charge of its motion picture department some years ago. He directed over 130 short subjects for Universal and had filmed many commercial and industrial subjects. He was co-author with L. S. Metcalfe of *How to Use Talking Pictures in Business*, published by Harper in 1938.

Lauriston Everett Clark, 45, Director of Engineering for Technicolor Motion Picture Corp., died July 9, 1950, in Hollywood, Calif. Death was caused by a blood clot following an operation performed two weeks before. He was born at Haverhill, Mass., August 2, 1904, and attended the Massachusetts Institute of Technology. He served as an officer in the Chemical Warfare Reserve from 1925 to 1926. Previously associated with Radio Corporation of America and Dunning-color, Mr. Clark joined Technicolor on January 1, 1943. He had been a member of this Society since 1929 and was also a member of the Academy of Motion Picture Arts and Sciences and the Optical Society of America.

Journals Needed

Motion picture technical books are being added to the cinema collection at Doheny Library, University of Southern California, and numerous issues of this Society's JOURNAL are needed to complete their reference file. Members who are willing to contribute any of those itemized below are asked to send a list of available copies to Boyce Nemece, Executive Secretary, so Society Headquarters can serve as a clearing house for all offers. In this way the Journals can be sent directly to USC without duplicating contributions or double handling of actual copies.

Under the Farmington Plan major libraries have been designated to collect publications from foreign countries on particular subjects, concentrating them at various locations within the United States. The University of Southern California has been designated the cinema center and consequently copies of every book on motion pictures published anywhere in the world will be sought for acquisition. Although official emphasis under this program is placed on books or pamphlets of foreign origin, USC also has a major interest in obtaining similar items which originate within the United States. The JOURNAL, being the industry's major technical reference source, is an important item in this latter group.

Issues currently missing from Doheny Library are:

TRANSACTIONS: Nos. 16, 18, 30, 31, and 35.

JOURNALS: Aug., Oct., Nov. and Dec. 1934; Mar., Sept. and Nov. 1938; Aug. and Dec. 1939; all months 1940; May and Aug. 1941; Apr. 1942; Sept. 1943; all months 1944; Aug. 1945; Dec. 1946; all months 1947; all months 1948; all months 1949; all months, to date, 1950.

Central Section

The National Electronics Conference in Chicago September 25-27, joined this year by the Institute of Radio Engineer's Chicago Section on the event of their 25th Anniversary, will also have support of the Central Section of SMPTE. Technical Sessions of the three-day conference at Edgewater Beach Hotel include 63 papers on a wide variety of subjects, ranging on the technical side from micro-wave spectroscopy, magnetic amplifiers and hermetically sealed ion chambers to a philosophical contribution "Is the Engineer Slipping" by E. A. McFaul, formerly of Northwestern University. Over 100 industrial exhibitors will be on hand with equipment displays.

R. T. Van Niman, NEC Publicity Chairman and Past Chairman of the SMPTE Central Section, reports the NEC Television Session (10:00 A.M. Tuesday, September 26) will be the September meeting of the Section. Three papers scheduled are:

"Television in Industrial Applications," by J. A. Good, Diamond Power Specialty Corp.

"Stereo Television in Remote Control," by H. R. Johnson, C. A. Hermanson and H. L. Hull, Argonne National Laboratory.

"The Genlock: A New Tool for Better Programming in Television," by John H. Roe, RCA Victor Division.

All SMPTE members are invited to attend this and any of the other 17 sessions and three luncheon addresses by: Wayne Coy, Chairman of the Federal Communications Commission; Mr. McFaul, noted above; and John V. L. Hogan, President, Interstate Broadcasting Co., Inc., and Past-President of I.R.E.

Programs will soon be available from Mr. Van Niman.

Book Reviews

Film User Year Book, Volume II, 1950, edited by Bernard Dolman

Published (1950) by Current Affairs Ltd., "Film User" Office, 19 Charing Cross Rd., London, W.C. 2. 320 pp., including advtg. $5\frac{3}{8} \times 8\frac{3}{8}$ in. Price, 10s. 6d.

The *Film User Year Book 1950* is a complete handbook of all the 16-mm and filmstrip activities in Great Britain for the year past. The various chapters deal with everything from projector placing diagrams and equipment to addresses to the British law in regard to the exhibitor.

All 16-mm film produced in the sponsored (commercial), entertainment, scientific and industrial, church and armed service fields is not only listed, together with the distributors' names and addresses, but also cross-indexed as to title and subject.

A complete census of film societies, distributors, producing companies, equipment manufacturers, recording studios, books and periodicals lists the names and addresses of practically everyone in the British Isles interested in any phase of motion pictures.

It is quite interesting to note that many major producers in the United States are releasing 16-mm prints of late hits through their British offices.

For the excellent data it contains, this book should be in the library of anyone interested in the British film industry.—WILLIAM K. AUGHENBAUGH, WLW-T, The Crosley Broadcasting Corp., Cincinnati, Ohio.

The Organization of Industrial Scientific Research, by C. E. Kenneth Mees and John A. Leermakers

Published (1950) by McGraw-Hill, 330 W. 42 St., New York 18. 368 pp. + 15 pp. index. 20 figs. + 9 tables. 6 × 9 in. Price \$5.00.

The Organization of Industrial Scientific Research is both a guide and a stimulus to the clear thinking that is so necessary to the organization and operation of a successful research laboratory. A study of this book will aid management in making wise decisions regarding the need for research and the appropriations for carrying it on. It will help those engaged in the direction and administration of research to improve the effectiveness of their laboratories. It will open new avenues of thought and understanding to the scientist who is beginning to be interested in, or confronted with, administrative problems.

While described as a "Revised Second Edition" (1st ed., 1920), this edition should be regarded as a new book with an excellent ancestor.

Part I presents the very interesting history and background of organized research in order to provide for an understanding of its present position, or status, in government, universities and industry. The amazing growth of research is outlined, together with ideas regarding the future.

Part II is concerned with existing research organizations. By example after example, by showing the needs, the accomplishments and the basic structures of organization, the present status of organized research is clearly presented.

Part III comprises well-organized material bearing on the problems of research organization, administration and co-operation with other phases of industrial activity. Here is no handbook, but here is wisdom and inspiration to help all engaged in research to understand their environment and to solve the problems of organization of personnel and facilities.

The authors have given freely of their knowledge and appreciation of the problems encountered in the organization of industrial scientific research, a field in which they are respected leaders.—G. T. LORANCE, 125 Gates Ave., Montclair, N.J.

New Members

The following have been added to the Society's rolls since the list published last month. The designations of grades are the same as those in the 1950 MEMBERSHIP DIRECTORY:

Honorary (H)	Fellow (F)	Active (M)	Associate (A)	Student (S)
Askren, Lee T. , Mechanical Engineer, Eastman Kodak Co. Mail: 111 Commodore Pkway, Rochester 10, N.Y. (M)			Caldwell, Philip G. , Engineer, American Broadcasting Co. Mail: 6285 Sunset Blvd., Hollywood, Calif. (M)	
Brown, Morris E. , Supervising Design Engineer, Eastman Kodak Co. Mail: 48 Roosevelt Road, Rochester 18, N.Y. (M)			Cooper, James B., Jr. , Supervisor, Photographic Dept., Univ. of Michigan Aeronautical Research Center. Mail: 603 Swift St., Ann Arbor, Mich. (A)	
Brown, Robert A. , Physicist, Remington Arms Co., Inc., Physics Section, Bridgeport 2, Conn. (A)			Craig, Bob , Distributor of Photographic Supplies, Craig Movie Supply Co. Mail: 8414 Valley Circle, Canoga Pk., Calif. (M)	
Buescher, R. E. , Hollywood Sound Inst. Mail: 827 4th St., Apt. 102, Santa Monica, Calif. (S)			Culley, Paul E. , Recording Engineer, Cinecraft Productions, Inc. Mail: 2515 Franklin Ave., Cleveland 13, Ohio. (A)	

- D'Andrea, Matthew J.**, Free-Lance Technician. Mail: 1589 Anderson Ave., Fort Lee, N.J. (M)
- Decker, Francis W.**, Motion Picture Technician, U.S. Air Force. Mail: 109 Central Ave., Dayton 6, Ohio. (A)
- Didriksen, Roald W.**, Television XMTR Supervisor, KPIX Associated Broadcasters, Inc. Mail: 1056 Cole St., San Francisco 17, Calif. (A)
- Edous, John R.**, Univ. of Southern Calif. Mail: 3379 Santa Ana St., Huntington Pk., Calif. (S)
- Ettlinger, Adrian B.**, Electrical Engineer, Columbia Broadcasting System, Inc. Mail: 84-50 Fleet Court, Rego Park, L.I., N.Y. (A)
- Exner, William L.**, Television Engineer. KPIX—Television. Mail: 2336-A Jones St., San Francisco 11, Calif. (A)
- Fouce, Frank**, Motion Picture Producer, Theater Owner. Mail: 3212 Griffith Blvd., Los Angeles, Calif. (M)
- Innamorati, Libero**, Engineer, Centro Sperimentale Cinematografia. Mail: Via Satrico, 43, Rome, Italy. (A)
- Jennings, James H.**, Chief Draftsman, Ampro Corp. Mail: 7006 N. Monon, Chicago, Ill. (M)
- Johnson, Charles A.**, Motion Picture Camera Rentals, Mark Armistead, Inc. Mail: 911 N. Formosa Ave., Hollywood, Calif. (A)
- Kagan, Phillip H.**, Service Manager, Du-Art Film Laboratories, Inc. Mail: 845 Gerard Ave., Bronx 51, N.Y. (A)
- Kinney, Earl C.**, Manager, Film Processing Laboratory, Eastman Kodak Co. Mail: 1416 Sunset Terrace, Western Springs, Ill. (M)
- Marino, Louis B.**, Hack Driver, National Transportation Corp. Mail: 911 East River Dr., New York, N.Y. (A)
- Martin, Gene F.**, Univ. of Calif., Los Angeles. Mail: 11024 Strathmore, Los Angeles 24, Calif. (A)
- Masters, Richard M.**, Tufts College Engineering School. Mail: 124 Cotton St., Newton, Mass. (S)
- Maulfair, Robert J.**, Archer School of Photography. Mail: 946 Magnolia, Los Angeles 6, Calif. (S)
- Moche, Walter E.**, Research Supervisor, E. I. du Pont de Nemours & Co., Inc. Wilmington, Del. (A)
- Muhl, Elinor P.**, Photographer, Dept. Aeronautical Engineering, Univ. of Minnesota. Mail: Rosemount Research Center, Bldg. 704-W, Rosemount, Minn. (A)
- Niemann, Fred S.**, Motion Picture Producer. Mail: 942 Lake Shore Dr., Chicago 11, Ill. (M)
- Niemeyer, John H.**, Industrial Technical Representative, Eastman Kodak Co. Mail: 204 Keotiak Rd., Park Forest, Chicago Heights, Ill. (A)
- Pasquariello, Vincent J.**, Univ. of Calif., Los Angeles. Mail: 6208 Homes Ave., Los Angeles 1, Calif. (S)
- Risk, J. E.**, Chief Engineer, KSD-TV, The Pulitzer Publishing Co. KSD-TV. Mail: 351 Fairway Lane, Kirkwood, Mo. (A)
- Severdia, Anthony**, Television Engineer-Projectionist, Associated Broadcasters, Inc., KPIX. Mail: 1440 Shafter Ave., San Francisco, Calif. (A)
- Snegoff, Mark**, Teacher, Univ. of Calif., Los Angeles. Mail: 1954 Pinehurst Rd., Los Angeles 28, Calif. (A)
- Tunncliffe, William W.**, Research Associate in Electronics (Airborne Television). Mail: 61-A Philips St., Watertown 72, Mass. (A)
- Verran, Bruce H.**, Univ. of Calif., Los Angeles. Mail: 2036 W. 79 St., Los Angeles 47, Calif. (S)
- Vinten, Charles**, Managing Director, Messrs. W. Vinten, Ltd. Mail: 715, N. Circular Rd., London, England. (A)
- Wentzy, Woodrow P.**, Head, Dept. Audio-Visual Education and Photography, South Dakota State College, Brookings, S.D. (A)
- West, Lawrence**, Television Camera Man, KPIX (Associated Broadcasters, Inc.). Mail: 1010 Curtis St., Albany 6, Calif. (A)
- Woods, George M.**, Projectionist-Repairman, Grieme & Fasken Theatres—Johnson's, Inc. Mail: Route 5, Wenatchee, Wash. (A)
- Yuen, Howard A.**, Radio Engineer, Associated Broadcasters, Inc. Mail: 640 Second Ave., San Francisco 18, Calif. (A)

CHANGE IN GRADE

- Haines, Jesse H.**, Television Engineer, A. B. Du Mont Laboratories, Inc. Mail: 340 E. Olney Ave., Philadelphia 20, Pa. (S) to (A)
- Newcombe, Charles R.**, In Charge, Electronics, Hallen Corp., Burbank, Calif. Mail: 1256 Elysian Park Ave., Los Angeles 26, Calif. (S) to (A)

CORRECTION

- Payne, Raymond W.** From: Laboratory Superintendent, Shelly Films, Ltd., Small Arms Administration Bldg., Longbranch, Toronto 14, Ont., Canada; To: Laboratory Superintendent, National Film Board of Canada, John & Sussex Sts., Ottawa, Ont., Canada. Mail: 931 Bank St., Ottawa, Ont., Canada.

— *New Products* —

Further information concerning the material described below can be obtained by writing direct to the manufacturers. As in the case of technical papers, publication of these news items does not constitute endorsement of the manufacturer's statements nor of his products.

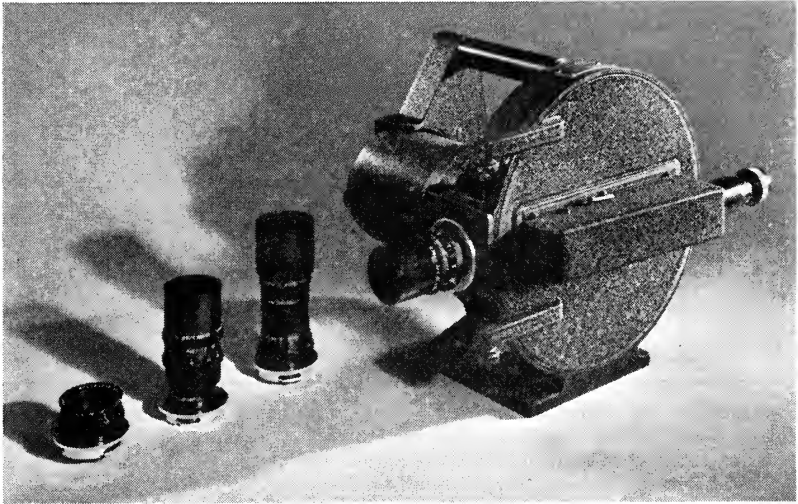

Fastax High-Speed Motion Picture Cameras are now manufactured, sold and serviced by Wollensak Optical Co., Rochester, N. Y., as a result of a recent outright purchase from the Western Electric Co. Fastax Cameras will be part of a newly formed division of Wollensak, known as the Technical and Industrial Division in High-Speed Photography. The new division is headed by John H. Waddell who had been with the Bell Telephone Laboratories since 1929. Under his guidance the Fastax was designed and perfected until it is called the world's fastest moving film high-speed camera and also the most versatile device for recording high-speed motion of either repetitious or transient nature. The first Fastax Camera to be designed used 16-mm film and took up to 4000 pictures a second. The second Fastax used 8-mm film at 8000 pictures a second. When a wider angle was desired for ballistics studies, a third Fastax was designed for 35-mm half-frame wide-angle pictures. This camera gives 3500 pictures a second and has an angle view of 40 degrees or a width of field of 71 ft, when the camera is 100 ft from the subject.

A **heat (infrared) deflector** is described in Bulletin MI-318 available from Fish-Schurman Corp., 230 East 45th St., New York 17. It is a filter of multi-layer interference film and is marketed as the XUR-96 Heat Deflector. The manufacturer reports that by installing the deflector at normal incidence in a motion picture carbon arc projector, either of the condenser type utilizing 185 amp or of the reflector type using up to 125 amp, without additional blowers or other artificial cooling it was possible to reduce the heat on the film gate so that no buckling or embossing of the film occurred, and that the deflector is colorless and transmits between 94% and 96% of the visible light and reflects back to the source, depending on what region of the infrared one measures, between 35% and 65%.

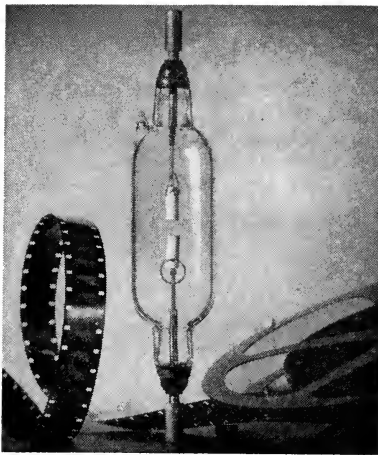

The new G-E Flashtube No. 231 has been developed with opaque shields surrounding the tube's thoriated tungsten electrodes designed to prevent formation of "incandescent trees," which in earlier flashtubes produced film travel "ghost," or double-image effects on the screen. This new flashtube is similar in principle to photographic flashtubes developed by General Electric during the war and since, and which are capable of emitting thousands of intense flashes of light with durations down to one-millionth of a second. This new flashtube for use as a television light source is in production and has a list price of \$48.00 plus tax.

Meetings of Other Societies

Sponsored by the Audio Engineering Society, the second Audio Fair will be held in New York City, October 26-28, at the Hotel New Yorker. There will be two floors of exhibits with demonstrations and technical papers scheduled for each of the three days.

Illuminating Engineering Society, National Technical Conference, Aug. 21-25,
Pasadena, Calif.

Biological Photographic Assn., Annual Meeting, Sept. 6-8, Hotel Sheraton,
Chicago

Institute of Radio Engineers, West Coast Convention, Sept. 13-15, Long Beach,
Calif.

Institute of Radio Engineers, National Electronics Conference, Sept. 25-27,
Chicago

Theatre Equipment and Supply Manufacturers' Association, Annual Convention,
Oct. 8-11, Stevens Hotel, Chicago

Audio Engineering Society, National Convention, Oct. 26-28, Hotel New Yorker,
New York

Optical Society of America, Oct. 26-28, New York

Theatre Owners of America, Annual Convention, Oct. 30-Nov. 2, Shamrock
Hotel, Houston, Texas

Acoustical Society of America, Fall Meeting, Nov. 9-11, Boston

SMPTE Officers and Committees: The roster of Society Officers was published in the May JOURNAL. The Committee Chairmen and Members were shown in the April JOURNAL, pp. 515-22; changes in this listing will be shown in the September JOURNAL.

Journal of the Society of Motion Picture and Television Engineers

VOLUME 55

SEPTEMBER 1950

NUMBER 3

New Television Camera Tubes and Some Applications Outside the Broadcasting Field.....	V. K. ZWORYKIN	227
CBS Television Staging and Lighting Practices... ..	RICHARD S. O'BRIEN	243
Motion Picture Instruction in Colleges and Universities.....	JACK MORRISON	265
Synchronous Recording on 1/4-In. Magnetic Tape... ..	WALTER T. SELSTED	279
Electrical and Radiation Characteristics of Flashlamps.....	H. N. OLSEN and W. S. HUXFORD	285
The Cine Flash—A New Lighting Equipment for High-Speed Cinematography and Studio Effects... ..	H. K. BOURNE and E. J. G. BEESON	299
A New Heavy-Duty Professional Theater Projector.....	HERBERT GRIFFIN	313
A New Deluxe 35-Mm Motion Picture Projector Mechanism.....	H. J. BENHAM and R. H. HEACOCK	319
68th Convention.....		327
Engineering Committees Activities.....		327
High-Speed Photography Question Box.....		328
BOOK REVIEWS:		
<i>The American Annual of Photography, Volume 64</i> , edited by Frank R. Fraprie and Franklin I. Jordan.....	Reviewed by John W. Boyle	331
<i>Practical Television Engineering</i> , by Scott Helt.....	Reviewed by E. Arthur Hungerford, Jr.	331
<i>Sound Absorbing Materials</i> , by C. Zwicker and C. W. Kosten.....	Reviewed by Hale J. Sabine	332
<i>American Cinematographer Hand Book and Reference Guide, Seventh Edition</i> , by Jackson J. Rose.....	Reviewed by John W. Boyle	333
<i>Theatre Catalog, 8th Annual Edition</i>	Reviewed by Leonard Satz	333
Current Literature.....		334
New Members.....		335
New Products.....		336
SOCIETY ENGINEERING COMMITTEES.....		337

ARTHUR C. DOWNES
Chairman
Board of Editors

VICTOR H. ALLEN
Editor

NORWOOD L. SIMMONS
Chairman
Papers Committee

Subscription to nonmembers, \$12.50 per annum; to members, \$6.25 per annum, included in their annual membership dues; single copies, \$1.50. Order from the Society's General Office. A discount of ten per cent is allowed to accredited agencies on orders for subscriptions and single copies. Published monthly at Easton, Pa., by the Society of Motion Picture and Television Engineers, Inc. Publication Office, 20th & Northampton Sts., Easton, Pa. General and Editorial Office, 342 Madison Ave., New York 17, N.Y. Entered as second-class matter January 15, 1930, at the Post Office at Easton, Pa., under the Act of March 3, 1879.

Copyright, 1950, by the Society of Motion Picture and Television Engineers, Inc. Permission to republish material from the JOURNAL must be obtained in writing from the General Office of the Society. Copyright under International Copyright Convention and Pan-American Convention. The Society is not responsible for statements of authors or contributors.

Society of Motion Picture and Television Engineers

342 MADISON AVENUE, NEW YORK 17, N.Y., TEL. MU 2-2185
BOYCE NEMEC, EXECUTIVE SECRETARY

OFFICERS

1949-1950

PRESIDENT
Earl I. Sponable
460 W. 54 St.
New York 19, N.Y.

PAST-PRESIDENT
Loren L. Ryder
5451 Marathon St.
Hollywood 38, Calif.

SECRETARY
Robert M. Corbin
343 State St.
Rochester 4, N.Y.

EXECUTIVE
VICE-PRESIDENT
Peter Mole
941 N. Sycamore Ave.
Hollywood 38, Calif.

EDITORIAL
VICE-PRESIDENT
Clyde R. Keith
120 Broadway
New York 5, N.Y.

CONVENTION
VICE-PRESIDENT
William C. Kunzmann
Box 6087
Cleveland 1, Ohio

1950-1951

ENGINEERING
VICE-PRESIDENT
Fred T. Bowditch
Box 6087
Cleveland 1, Ohio

TREASURER
Frank E. Cahill, Jr.
321 W. 44 St.
New York 18, N.Y.

FINANCIAL
VICE-PRESIDENT
Ralph B. Austrian
25 W. 54 St.
New York 19, N.Y.

Governors

1949-1950

Herbert Barnett
Manville Lane
Pleasantville, N.Y.

Kenneth F. Morgan
6601 Romaine St.
Los Angeles 38, Calif.

Norwood L. Simmons
6706 Santa Monica Blvd.
Hollywood 38, Calif.

Charles R. Daily
113 N. Laurel Ave.
Los Angeles 36, Calif.

John P. Livadary
4034 Cromwell Ave.
Los Angeles, Calif.

William B. Lodge
485 Madison Ave.
New York 22, N.Y.

1950-1951

Lorin D. Grignon
1427 Warnall Ave.
Los Angeles 24, Calif.

Paul J. Larsen
4313 Center St.
Chevy Chase, Md.

William H. Rivers
342 Madison Ave.
New York 17, N.Y.

1950

F. E. Carlson
Nela Park
Cleveland 12, Ohio

George W. Colburn
164 N. Wacker Dr.
Chicago 6, Ill.

Edmund A. Bertram
850 Tenth Ave.
New York 19, N.Y.

Malcolm G. Townsley
7100 McCormick Rd.
Chicago 45, Ill.

Edward S. Seeley
161 Sixth Ave.
New York 13, N.Y.

R. T. Van Niman
4501 Washington St.
Chicago 24, Ill.

New Television Camera Tubes And Some Applications Outside the Broadcasting Field

BY V. K. ZWORYKIN

RCA LABORATORIES DIV., RADIO CORPORATION OF AMERICA,
PRINCETON, N.J.

SUMMARY: The operation and performance characteristics of television camera tubes from the iconoscope to the image orthicon and vidicon are described briefly, stressing recent developments. The application of the vidicon in industrial television equipment and, in greater detail, possible uses of television techniques in astronomy are outlined.

THE DESCRIPTION of the television camera as an electric eye is as old as television itself. The reason for this is obvious, in view of the function of the television camera. Yet, to anyone viewing the images produced by early television systems, the term may well have seemed presumptuous and the comparison with the human eye remote.

The human eye is indeed a marvelous mechanism. It functions efficiently over a brightness range of one to one-hundred million, 10^{-6} foot-Lamberts to 10^2 foot-Lamberts. At low light levels quanta incident over a cone with a vertex angle of 30 min co-operate to produce a single visual sensation, while at high light levels visual angles as small as one minute are resolved. With a quantum efficiency of the order of 5% at low light levels, the contrast recognition of the eye is limited only by the statistical fluctuation in the incidence of the light quanta. This is given simply by the square root of the total number of quanta imaging a "picture element" of the object on the retina within the storage period of the eye, approximately a fifth of a second. It has been found experimentally that the recognition of brightness contrast between two picture elements of equal size requires that their average brightness difference should exceed the statistical fluctuation in brightness at least by a factor of 5. If, for instance, 1000 quanta on the average are absorbed in a particular picture element projected on the retina within the storage period of a fifth of a second, the statistical fluctuation will be 30 quanta or 3% of the element brightness; thus, in order that an element of equal size be distinguishable from the first element, it must

PRESENTED: October 13, 1949, at the SMPE Convention in Hollywood.

differ from it by 15% in brightness. This is the threshold contrast under the conditions here described. It is seen that, in general, the threshold contrast is inversely proportional to the square root of the brightness and the picture element area.

The same principles which govern the contrast recognition and sensitivity of the eye apply to any other light-sensitive devices, such as television camera tubes. The fact that photosensitive surfaces with quantum efficiencies of 5% and better are available suggests that, ultimately, pickup devices with sensitivity equal to that of the human eye can be achieved. Today this goal has in fact been attained, at least within limited ranges of operation. A brief outline

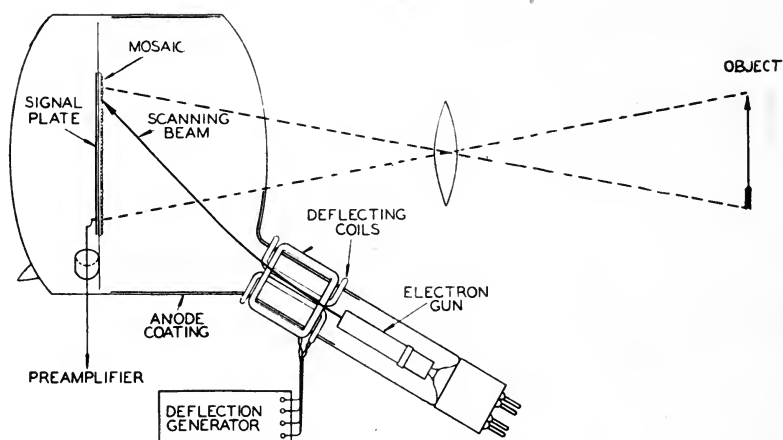

Fig. 1. Diagram of the iconoscope.

of the development will indicate the nature of the obstacles which had to be overcome and show where further progress may be expected in the future.

The first television camera tube which shows a close correspondence with the properties of the eye, the iconoscope, was conceived some 26 years ago.

In detail, the iconoscope (Fig. 1) functions in the following manner: The picture is projected on a mosaic of minute sensitized silver globules deposited on a mica plate. Under the influence of illumination these globules give off photoelectrons and are charged positively; the change in potential is determined both by the charge lost and the capacity of the element relative to a metal film on the back of the mica, the signal plate.

The surface of the mosaic is scanned in a regular line pattern—

525 lines every thirtieth of a second—by a sharply focused electron beam. The beam restores the original electrical potential wherever it strikes the mosaic. In doing so it releases from the signal plate a charge equal to the charge stored in the scanned element and this released charge applies a voltage pulse proportional to the stored photoelectric charge to the picture amplifier. The succession of these voltage pulses constitutes the video signal. Applied to the grid of a viewing tube, whose fluorescent screen is scanned in unison with the iconoscope mosaic, it reconstructs on the viewing screen the image projected on the mosaic.

A vital property which the iconoscope shares with the human eye and which was absent from all earlier television systems is storage. The video signal of the iconoscope is determined not only by the photoelectric charge released by the light at the instant of scanning, as in nonstorage systems, but by the charge stored by the light in the picture element considered throughout the period between successive scanings. Thus storage permits an increase in sensitivity by a factor equal to the total number of picture elements.

This gain is not realized in full in the iconoscope. The field conditions in front of the mosaic prevent efficient storage of charge and efficient utilization of stored charge for the formation of the video signal. These and other secondary factors combine to make the sensitivity of the iconoscope less than that of the eye by 3 to 4 orders of magnitude at low light levels.

In the iconoscope the scanning beam consists of 1000-v electrons which, at incidence on the mosaic, eject a considerable number of secondary electrons for every incident beam electron. The "redistributed" secondary electrons give rise to a spurious signal or "shading," which may require manual compensation by the monitoring engineer. The weak retarding field in front of the mosaic also serves to return to the emitting element, or to redistribute, a large fraction of the photoelectrons, impairing the efficiency of charge storage. Under normal operating conditions these causes reduce the video signal amplitude to about 5% of the value attainable with ideal collection.

It should be noted that the same factors which lead to relative inefficiency and the presence of shading also have some desirable consequences. These are perfect stability at all levels of illumination and a nonlinearity of response which compensates the nonlinearity of opposite sign of the viewing tube.

The first successful improvement on the iconoscope consisted in projecting the light image on a continuous transparent photocathode

and employing the photoelectrons so generated to form an electron image on the mosaic. The charges stored in this manner on the mosaic, and hence the output signal, were greater than in the ordinary iconoscope for two reasons: The continuous photocathode was more photosensitive than the mosaic and five or more secondary electrons left the mosaic for every primary photoelectron incident on it. The

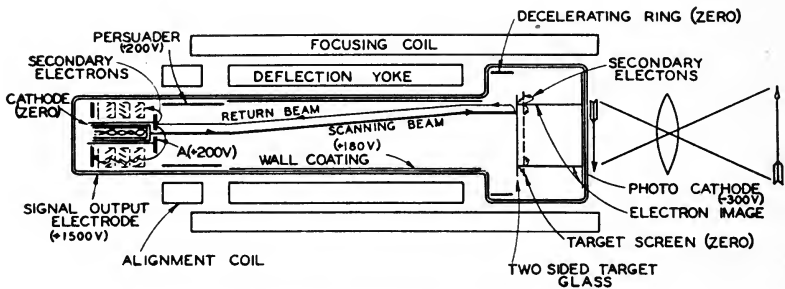

Fig. 2. Diagram of image orthicon.

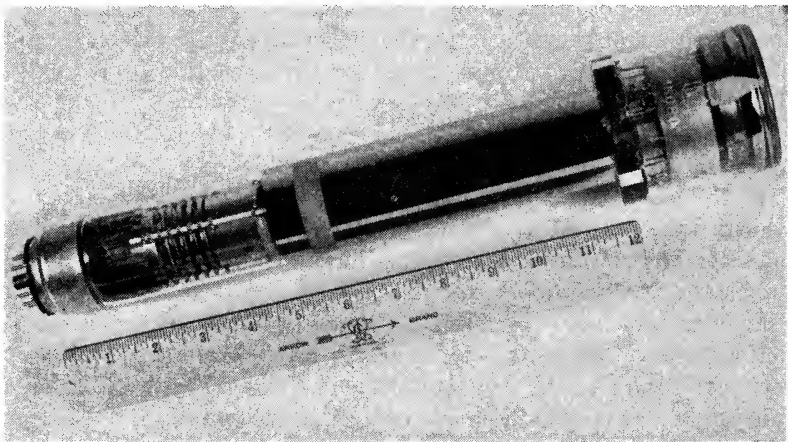

Fig. 3. Image orthicon.

“image iconoscope,” formed in this manner was, in fact, up to ten times more sensitive than the ordinary iconoscope. Modern versions of it are employed today, with considerable success, in France.

The image iconoscope increased the signal level and hence the sensitivity of the pickup tube, but left the unfavorable field conditions in front of the mosaic essentially unaltered. The orthicon on the other hand is distinguished by the presence of a strong collecting

field in front of the mosaic which guarantees complete collection of photoelectrons and secondary electrons and prevents the occurrence of spurious shading signals. This occurs when the surface is approximately at cathode potential.

The difficult problem which had to be solved before the orthicon became practical consisted in attaining a very small spot size at low electron velocities and retaining this, as well as the perpendicular direction of incidence of the beam on the mosaic, for all deflections. The problem was finally solved by immersing the tube in a longitudinal magnetic focusing field and superposing horizontal and vertical magnetic deflecting fields on it. The secondary electrons as well as those which are turned back in front of the mosaic follow very nearly the same paths as the incident beam and are ultimately collected by a diaphragm in front of the cathode. This method of focusing has proved so successful that better than thousand-line resolution has been achieved with it on a mosaic approximately two inches in height.

The performance of the orthicon is as expected. There is a complete absence of shading signals and a strictly linear relation between signal and light—up to a certain limit. Its sensitivity is approximately an order of magnitude greater than that of the iconoscope. It has given good service and in modified form is finding wide employment in England today.

The perfect stability of the iconoscope, the highly sensitive continuous photocathode of the image iconoscope, the freedom from shading of the image orthicon, and a high level of signal output made possible by secondary emission multiplication were finally combined in the image orthicon, developed in the middle forties. This ingenious tube is represented schematically in Fig. 2. The two-sided target, which takes the place of the mosaic, consists here of a very thin film of glass, whose conductivity is high enough so that differences of potential on its two opposite faces are largely wiped out by conduction in the course of a frame time. Yet the film is so thin that charge leakage from one picture element to its neighbors, within the same period, is negligible. To the right of the target is the image section of the tube. Photoelectrons ejected from the photocathode by the light image of the scene to be transmitted are focused magnetically on the glass target. Here they eject secondary electrons, which are either collected by a very fine-meshed target screen in front of the target or turned back to the target.

To the left of the target is the scanning section of the tube, which in most details resembles that of the orthicon already described.

However, the signal is carried by the return beam, from which a number of electrons equal to those removed from the target by secondary emission are abstracted. The return beam is incident on a diaphragm surrounding the scanning beam and ejects from it secondary electrons which spill over into an array of secondary emission sensitized pinwheels surrounding the cathode. These pinwheels function as stages of a secondary emission multiplier which amplifies the return beam by a factor of 300 to 1000. In the picture of the image orthicon (Fig. 3) the pinwheels are visible near the base of the tube.

The variation of the signal strength with illumination on the photocathode is shown for three image orthicons in the next figure

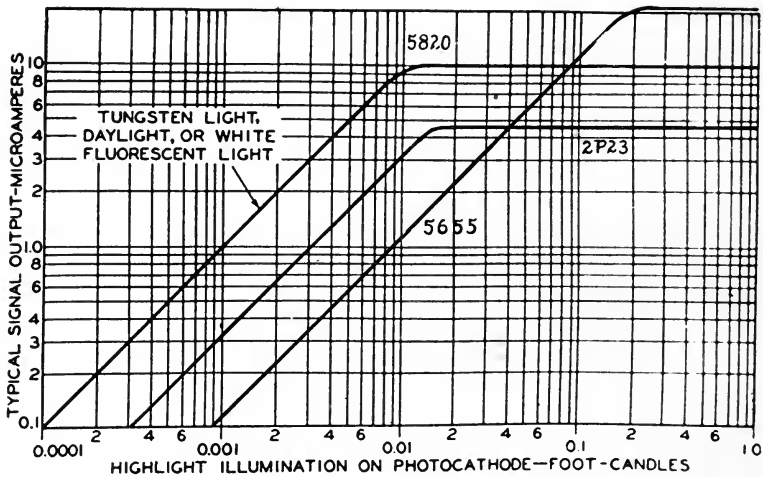

Fig. 4. Response characteristics of three image orthicons.

(Fig. 4). As long as the target potential remains below that of the target screen, the collection of the secondary electrons is virtually complete and the response perfectly linear, as indicated by the first part of the two curves. On the other hand, for higher intensities of illumination the response rapidly levels off and soon ceases to increase with further increase in illumination. Redistribution of electrons at the boundaries between regions corresponding to different illuminations then serves to establish edge contrasts which result in a fairly natural rendition of the scene.

It has been shown by Dr. Rose of the RCA Laboratories that the performance of any pickup device can be adequately described

in terms of the brightness, contrast and angular dimensions of detail of the object that can be perceived with the device employing a lens of given aperture and a given storage time. These several factors combine to yield a performance figure which, for an ideal system, becomes equal to the quantum efficiency of the primary photoprocess taking place in the device. Figure 5 shows the performance parameter as function of scene brightness for the human eye, motion picture film and several television pickup tubes. As might have been expected, no man-made device approaches the human eye in its

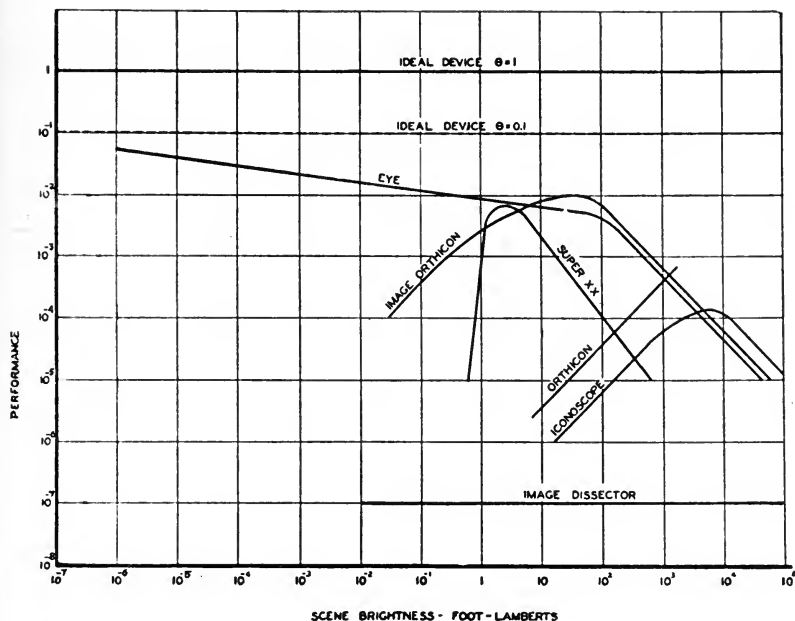

Fig. 5. Figure of merit of human eye, motion picture film and television pickup tubes as function of scene brightness (A. Rose).

range of satisfactory performance. Among man-made devices, on the other hand, the great superiority of the image orthicon at low light levels is clearly evident. It is seen, in fact, that the image orthicon has within a considerable range a performance figure of the order of 1%, that is nearly equal to the quantum efficiency of its photocathode; hence in this range it can justly be regarded as an ideal device.

It would be mistaken, however, to consider the image orthicon as an endpoint in camera tube development. Apart from the obvious goal of greater sensitivity of the photocathode and extension of the

range to still lower light levels, there is the challenge of simplifying the tube and its auxiliary equipment. It is clear that a tube of the complexity of the image orthicon presents many difficult production problems. In addition, added power supplies are needed for the secondary emission multiplier and the image section and the correspondingly large number of controls complicate the adjustment and servicing of the image orthicon camera.

A considerable advance in the properties of the photocathode has been achieved by substituting for the red-sensitive silver-cesium oxide (2P23, Fig. 6) and the blue-sensitive antimony-silver cesium surfaces

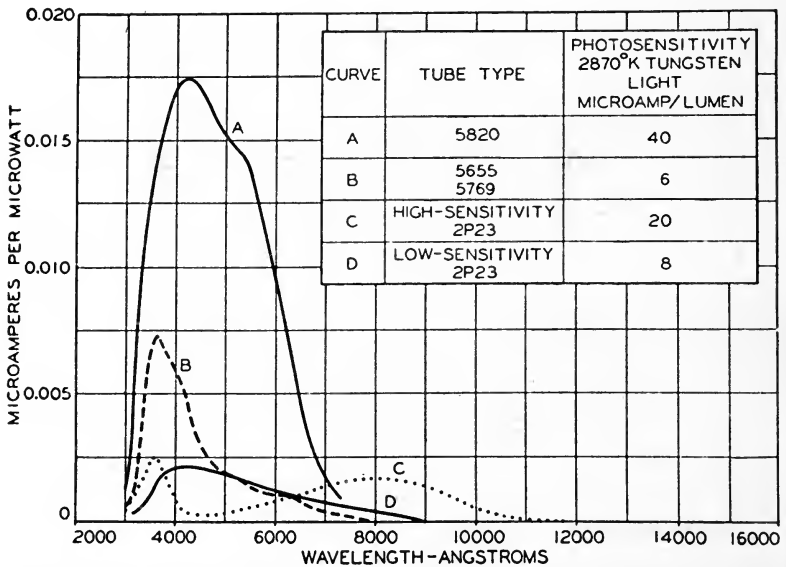

Fig. 6. Spectral sensitivities of different types of image-orthicon photocathodes.

(5655 and 5769, Fig. 6) a new type of bismuth-silver cesium surface (5820, Fig. 6). This not only doubles or triples the sensitivity of the earlier tubes, but greatly improves the match to the color sensitivity of the eye, leading to a more faithful and pleasing reproduction of the transmitted picture. The curves in Fig. 6 show the relative spectral sensitivities of the three types of photosensitive surfaces.

A great simplification in the pickup tube construction and the auxiliary equipment, without corresponding loss in sensitivity, has recently been attained in a new type of pickup tube, the vidicon.

Through the provision of a suitable photoconductive target deposited on a transparent signal plate, the intrinsic sensitivity of the

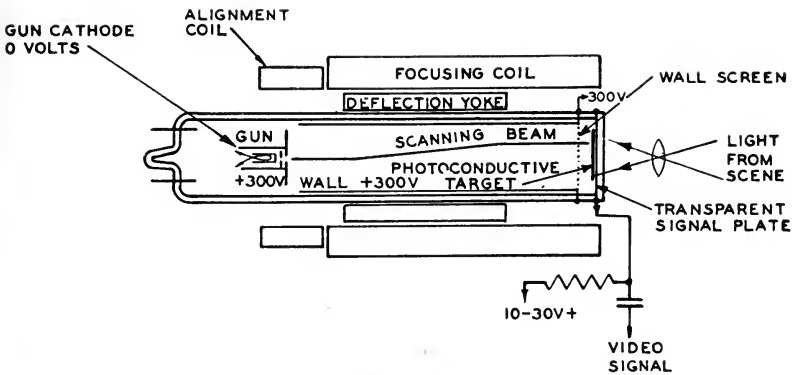

Fig. 7. Diagram of vidicon.

tube has here been raised to such a level that it has become permissible to dispense with the image section and secondary-emission multiplier. Low-velocity scanning is employed as in the orthicon and image orthicon: Light-induced conduction causes, in view of the positive bias on the signal plate, illuminated portions of the target to become positive. The positive charge so stored is neutralized by the scanning beam, giving rise to picture signal pulses in the signal plate lead (Fig. 7).

The small dimensions of the vidicon (Fig. 8)—it is only 1 in. in diameter—fit it ideally for industrial television purposes, where

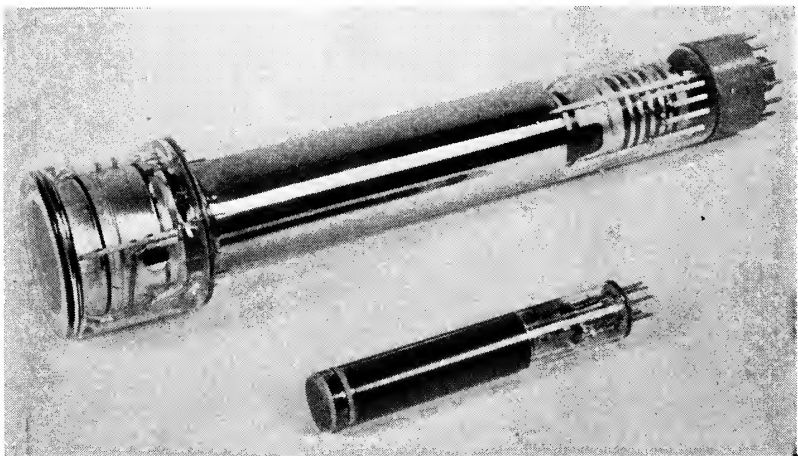

Fig. 8. Comparison of vidicon and image orthicon

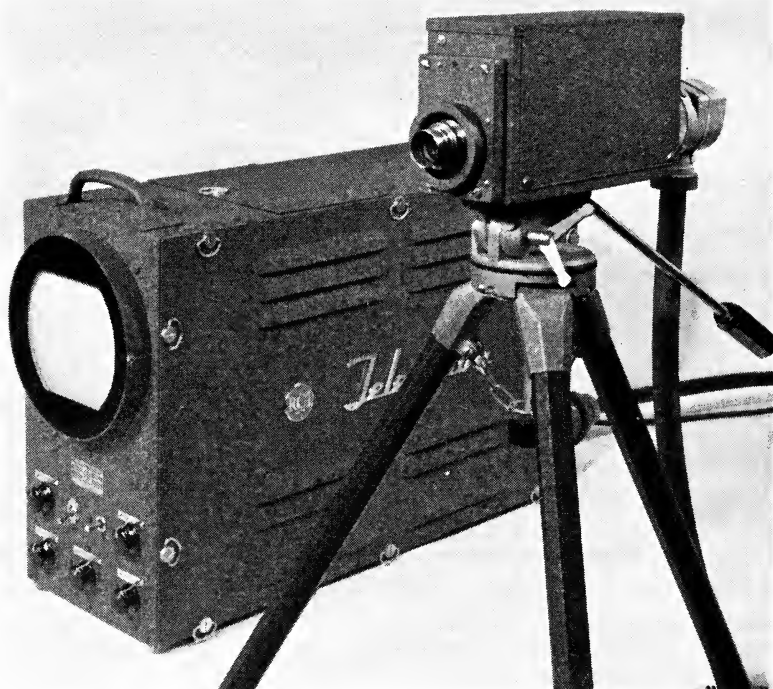

Fig. 9. Industrial television system incorporating vidicon camera.

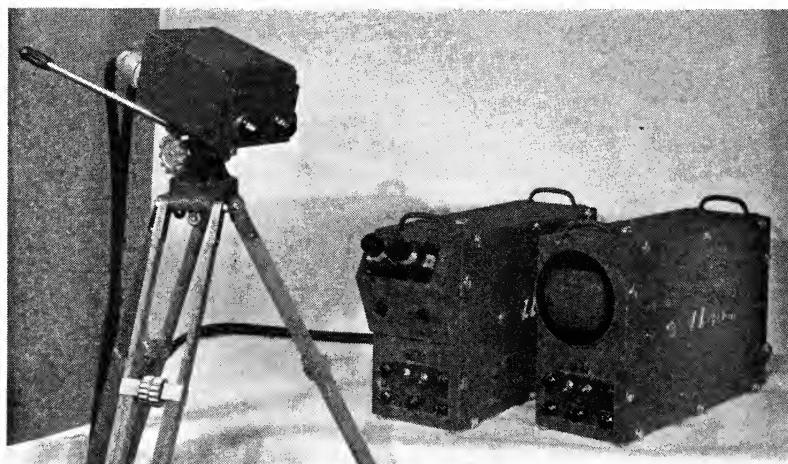

Fig. 10. Stereo television camera with control unit and monitor.

compactness and portability are decisive advantages. Figure 9 shows a vidicon camera weighing only $8\frac{1}{2}$ lb, together with a complete monitor control unit weighing some 50 lb. In practice, the control unit may be located 500 ft from the camera, being connected to it by cable. Equipment of this type has found many applications in industry, for surveillance and research, and in education, for the demonstration of microslides and surgical operations. For the latter purpose the three-dimensional representation yielded by a stereoscopic television camera (Fig. 10) proves particularly valuable.

The great sensitivity of the newer tubes which have just been described makes them eminently suitable for the transmission of pictures in natural color. High sensitivity is here needed, since the process of separating out the primary component colors of the picture invariably leads to a considerable loss of intensity. One system of color transmission which possesses the advantage of being readily

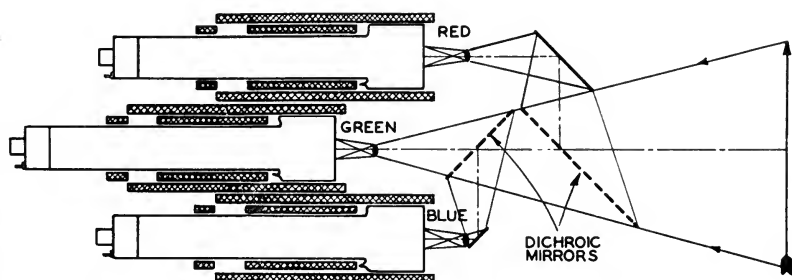

Fig. 11. Optics of image orthicon color camera for direct pickup.

fitted into the existing system of black-and-white broadcast television records the three primary color pictures on separate pickup tubes. Figure 11 shows schematically the arrangement of an appropriate color pickup camera employing three image orthicons. Dichroic reflectors serve to separate the light from the scene into its primary color components, so that different-color images, of identical size, are formed on the photocathodes of the three tubes.

The primary aim in the development of the devices which we have considered so far has been the creation of tools for a satisfactory broadcast television service. Yet their usefulness, and the usefulness of apparatus which may be readily derived from them, goes far beyond this, as we have already seen in connection with the industrial television camera. In particular in the scientific field television techniques can often be applied to great advantage. It is true that the requirements of science and entertainment are so different, often

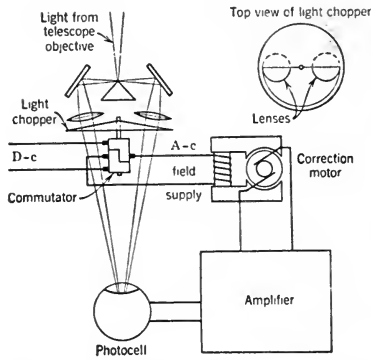

Fig. 12. Photoelectric clock drive Correction (Whitford and Kron).

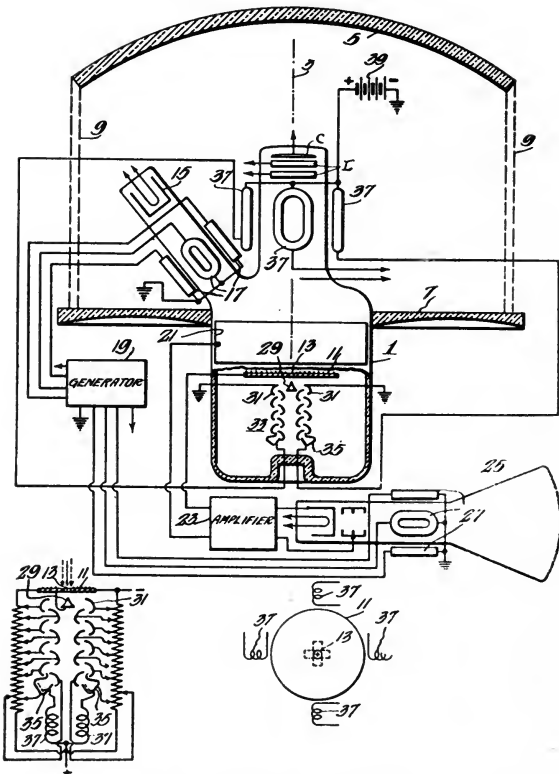

Fig. 13. The Telectroscope.

even diametrically opposed to each other, that our attitudes and methods in the two fields must need be quite different. We shall indicate some ways in which television methods may find application in the field of astronomy.

An obvious use is to let the television camera substitute for the observer at the eyepiece of the telescope, making possible remote control of the instrument with a minimum of thermal and other disturbances. Even if the astronomer himself might not deem it advisable to separate himself to that extent from his telescope, he might readily appreciate the advantages of letting visitors view his equipment and the stars with television eyes instead of with their own.

An electronic technique derived from television development may also be employed to flatten the image field of the Schmidt Camera and, eventually, increase its sensitivity. To this end the curved cathode of an image tube is made to coincide with the focal surface of the Schmidt Camera. This photocathode is imaged electronically on a flat fluorescent screen. In order to photograph the sidereal image, a photographic plate is placed in contact with the screen. Since the number of quanta ejected from the fluorescent screen by each accelerated electron may be made to exceed considerably the average number of quanta required to free a photoelectron from the photocathode, a shorter exposure time will be needed to leave a visible star record on the photographic plate. It is true that, though the image produced at the fluorescent screen is brighter than that at the photocathode, it is also "noisier," that is, contains less intrinsic information.

Television techniques may, furthermore, be employed to advantage for stabilizing star images. Whitford and Kron at Washburn Observatory many years ago installed a photoelectric guiding mechanism on a telescope to correct the clock drive (Fig. 12). A selected fixed star is imaged on the edge of a roof prism, which directs the split beams through opposite sides of a rotating 180° sector disk onto a multiplier phototube. If the intensity of the two beams is unequal an alternating current is generated which is employed to correct the clock drive so that the star image remains centered on the edge of the roof prism. Some time ago the author proposed an all-electronic system with the corresponding almost complete absence of inertia for compensating fluctuations in atmospheric refraction (Fig. 13). In the figure, the sidereal image is formed on the photocathode of an image iconoscope, the electron image of a particular fixed star being centered on a small aperture in the middle of the mosaic. The electrons forming this image fall on the vertex of a

pyramid, whose four sides act as first dynode for four electron multiplier structures. The output currents of the four multipliers pass through four deflecting coils, which serve to maintain the fixed star image centered on the pyramid, so that the sidereal image reproduced on a viewing tube screen appears stationary.

The above method requires the construction of a highly specialized complex electronic centering tube. The same end may, however, be accomplished with the aid of conventional television equipment in conjunction with suitable gating circuits. Figure 14 shows a block diagram of the circuit which may be employed for this purpose.

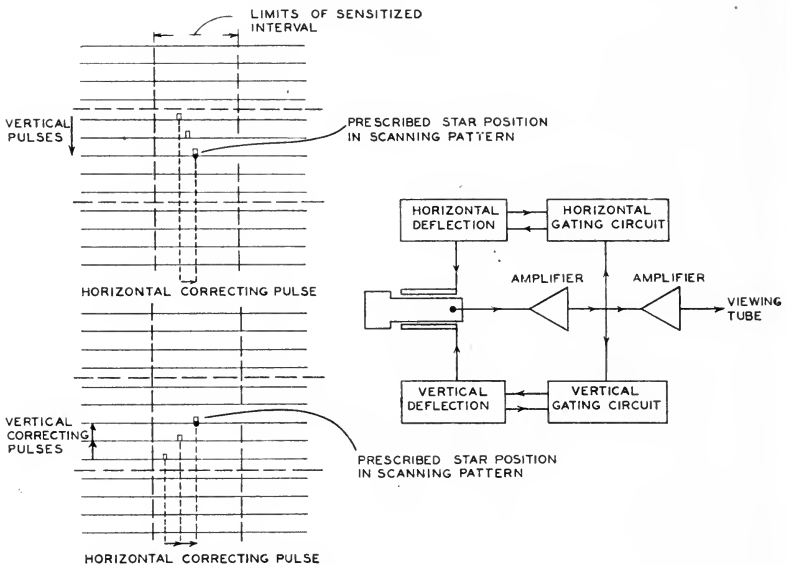

Fig. 14. Electronic image stabilizer for sidereal images.

The sidereal image is projected by the telescope on the photosensitive surface of the pickup tube so that the fixed star serving as "guiding star" is centered on it. Apart from the amplifiers and the television receiver on which the sidereal image is reproduced, centering circuits are provided whose purpose it is to maintain the scanning pattern centered on the guiding star image, independent of atmospheric fluctuations and minor clock errors. Here the output signal of the pickup tube is applied to two gating circuits which are sensitized over a series of time intervals covering a region of a few line widths about the prescribed position of the image of the guiding star in the scanning pattern. If the star image moves slightly in the course of

a frame time, the signal pulse causes the horizontal gating circuit to apply a horizontal centering signal to the tube deflection. The same pulse causes the vertical gating circuit to apply a vertical centering impulse corresponding to the difference in the line number of the actual and prescribed occurrence of the star pulse. To take account of storage, the gating circuits are blanked by the first impulse if, and only if, the latter occurs before the prescribed occurrence of the star pulse.

In speaking of the electronic stabilization of star images to compensate atmospheric disturbances and clock drive errors—a subject discussed last year by Professor Zwicky in Zurich—we have been able to keep our feet on the ground. We shall now contemplate the possibility of placing our telescope in a balloon and ascending to

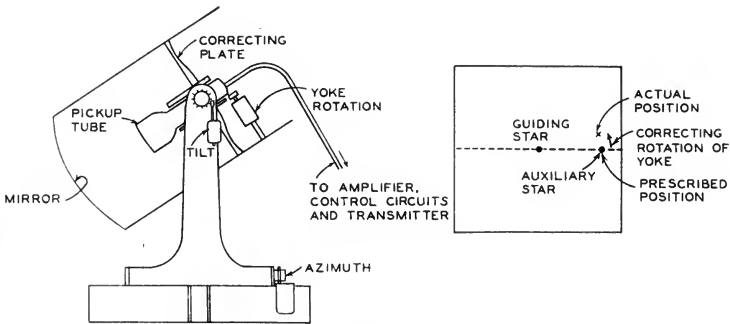

Fig. 15. Image stabilizer for balloon-mounted Schmidt telescope.

heights where atmospheric refraction ceases to play an appreciable role. We will now need electronic methods to maintain the proper orientation of the telescope in spite of the uncontrollable motions of the balloon and, eventually, to send the star images back to earth. Even though this method would not be applicable to the largest telescopes, the possibility of almost completely eliminating atmospheric effects might well render it of value.

We shall again direct our attention to the crucial problem, the stabilization of the sidereal image. As compared with the system for compensating atmospheric fluctuations, we must now count with the possibilities of much greater total displacements and of the rotation of the image. We can take account of the first factor by providing servomotors for the rotation of the telescope about a vertical axis and about a tilt axis (Fig. 15). These servomotors are controlled by the centering currents for the scanning pattern. A third servomotor is

provided to rotate the deflection yoke about the tube axis. This motor is controlled by pulses from an auxiliary guiding star, normally located near the periphery of the scanning pattern, on the horizontal line through the guiding star image. The circuit arrangement for this system is indicated in Fig. 16.

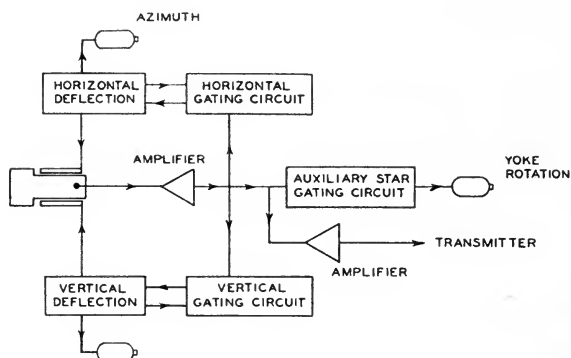

Fig. 16. Block diagram of image stabilizer.

We have mentioned a few ways in which television pickup tubes may perform a service in the field of astronomy. There are without doubt many other ways whose discovery demands familiarity with both the problems of astronomy and the possibilities and limitations of electronic equipment. Experience has shown consistently that material progress in any one field of science and engineering has had a beneficent effect on the development of all other fields. The development of electronic pickup tubes with sensitivities of the same order as that of the human eye should be no exception.

CBS Television Staging And Lighting Practices

By RICHARD S. O'BRIEN

COLUMBIA BROADCASTING SYSTEM, INC., NEW YORK, N.Y.

SUMMARY: Television as a visual medium must be operated within the boundaries of its technical characteristics to achieve good visual reproduction. The system handles a limited range of luminance, introduces luminance transfer distortion, exhibits spurious effects (halos, image orthicon ghosts, clouding, streaking) and has finite detail resolution. It is necessary to provide guidance whereby production personnel can fully exploit the present system.

Accordingly, rules have been formulated for each of the major production operations at CBS, viz., staging, lighting, camera operation and direction. Individuals working in these phases are thus enabled to perform their separate functions with assurance that their combined efforts will produce images which are both technically correct and artistically pleasing.

IF TELEVISION were a perfect visual reproduction medium, it would be possible to allow qualified artistic judgment to be the sole arbiter of staging practices. Television is not, as yet, a perfect transmission system. At the present stage of technical development it is necessary to temper artistry with technicality—to respect rules which recognize the characteristics of the present facilities.

It is an important engineering function to work toward improvement of technical performance. While this work is in progress, it is equally important to study the equipment as it exists and to determine the necessary boundary conditions in order that rational artistic-technical compromises can be made in current program production. The television studio practices which are discussed here have been found helpful in day-to-day operations by the Columbia Broadcasting System.

These practices, concerned principally with the control of scene luminance and content, are outlined in groups of co-ordinated rules for use in the staging (scenery preparation), lighting adjustment and camera operations phases of production. The work of the various production departments, though separated in time and location, is thereby guided to obtain picture quality which avoids known pitfalls and makes the best possible use of the television system.

In this presentation, a review of certain technical characteristics of the present facilities, including illustrations of spurious effects which

PRESENTED: April 25, 1950, at the SMPTE Convention in Chicago.

SEPTEMBER 1950 JOURNAL OF THE SMPTE VOLUME 55

243



Fig. 1-A. Halo.



Fig. 1-B. Halo.

Fig. 1. Halo

The heavy black fringe surrounding the young lady in A results from a shower of low-velocity secondary electrons emitted from the high-light areas on the image orthicon target. These electrons land on the surrounding dark area completely discharging the nearby portions. In B, a lighter background has been substituted and the halo has been greatly reduced. In this case, the secondary emission from the background area is now sufficient to alter the field configuration in the vicinity of the target causing the excess high-light area electrons to land properly on the collector mesh.

NOTE: The dashed-line ellipse is a mask placed on the picture monitors to bound the area within which essential picture information should be held to prevent subsequent cropping by receiver masks or the film recording process.

occur, is followed by the statement and discussion of some of the more important working rules which have been formulated. The intention is to indicate the nature of the approach which has been made toward control of production practices.

TECHNICAL LIMITATIONS OF TELEVISION

Aspects of the *present-day* television facilities which may constitute technical limitations are: total contrast range, shape of the contrast gradient or luminance transfer characteristic, interaction among adjacent picture areas, and detail resolving capability. The characteristics of the image orthicon pickup tubes, of the electrical transmission system and of the reproducing cathode-ray tubes all may contribute to the over-all distortion in picture quality. For a network originating studio, it is particularly important that careful control be exercised as network transmission facilities and television film recordings used for program distribution certainly cannot be expected to minimize picture defects produced in the studio.

Limited total contrast range constitutes one of the most basic problems. The ranges of luminance values which can be handled by several familiar systems are approximately as follows:

The human eye—for a particular luminance adaptation	100 to 1
35-Mm motion pictures—typical projection.	40 to 1
Live, direct-view television—ideal conditions.	40 to 1
Live, direct-view television—typical conditions	20 to 1
Kodachrome-type color film processes	15 to 1

It is important that, in the television scene to be transmitted, all subject matter have a luminance within the approximate 20-to-1 range handled by the system.

Distortion in luminance transfer characteristics may have the effect of increasing the apparent contrast between areas of a scene.

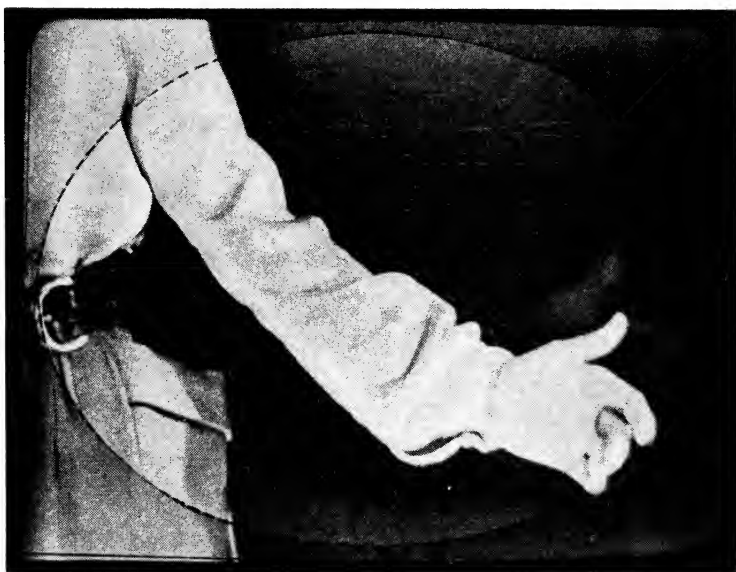

Fig. 2-A. Image orthicon ghost.



Fig. 2-B. Image orthicon ghost.

Fig. 2. Image Orthicon Ghost

The displaced image of the hand shown in A results from high-velocity secondary electrons emitted from the high-light area on the image orthicon target. These electrons travel as a group back toward the photo-cathode, eventually decelerating and returning to the target, producing a positive signal by knocking off secondary electrons as in the case of an ordinary electron image signal. The displacement results from travel through the axial magnetic field present. Here, too, it is possible to minimize the landing of this ghost image by maintaining less contrast between the high-light and the background areas. However, in B, the hand has simply been moved to the center of the raster, where the ghost travels along the axis of the tube and falls back on the high-light area without displacement. Slight defocusing of image focus would also reduce the ghost but at a sacrifice in resolution.

Through a typical direct-view receiver, for example, a 2-to-1 scene brightness difference may under some conditions appear as a 6-to-1 difference due to expansion introduced by curvature of the reproducing cathode-ray tube voltage-to-luminance transfer characteristic. In the studio, the transfer characteristic relating scene luminance to output voltage for the image orthicon tube is similar in shape to the familiar H&D curve for film but is influenced by the level of illumination incident on the image orthicon photo-cathode, by the ratio between high-light and average scene luminance and by adjustment of image orthicon target voltage. It is possible to have compression of one range of luminance values and expansion of another—all in the same scene. This problem again calls for careful control of over-all scene luminance distribution and for careful exposure and camera adjustments.

These troubles are caused in part by the electron redistribution process inherent in present-day operation of the image orthicon pickup tube. Several spurious effects which arise in the tube or associated equipment are even more objectionable at times because of their distinctive appearance. These effects of interaction between adjacent areas include:

Halo: A black area surrounding a bright high-light, resulting from a rain of low-velocity electrons emitted from the high-light area of the image orthicon target and particularly severe on highly polished jewelry, white clothing, and bald heads (see Fig. 1).

Image orthicon ghost: A spurious, displaced image of a high-light area, most noticeable with severe contrast between high-light and background, resulting from high-velocity secondary electrons emitted from the high-light area on the image orthicon target (see Fig. 2).

Clouding: An electronic fogging or mottling of large dark areas, similar in effect to lens flare, particularly severe where excessive contrast exists between large dark and large light areas and aggravated



Fig. 3-A. Clouding.



Fig. 3-B. Clouding.

Fig. 3. Clouding

The inability of the image orthicon to maintain high contrasts over large areas is indicated by the clouding within the silhouette in A. The halo effect serves to maintain a dense black over small areas but beyond its reach, the larger areas are a milky gray, spotted with dynode spots. Note that, although the halo effect holds small area contrasts, it is in the nature of all or nothing, so in other than a silhouette effect, severe distortion in luminance transfer would result. Reduction of the contrast from 35 to 1 to only 5 to 1, shown in B, enables a more uniform black reproduction. This clouding effect will be recognized as being similar to lens flare although it is purely electronic in this illustration.

by the tendency of multiplier electrode spots to show through in dark areas (see Fig. 3).

Streaking: A dark or light horizontal streak across the picture in line with excessively bright high-lights or long, heavy scenery lines, usually resulting from improper low-frequency characteristics in the transmission system (see Fig. 4).

These effects can be reduced or adequately hidden by the same careful control of staging, lighting and camera operation called for in working within the usable total contrast range and in obtaining good luminance transfer characteristics.

In the matter of detail resolving capability, television falls between 35-mm and 16-mm motion pictures. Good resolution is aided by the same careful staging and lighting called for above, as the camera can then be adjusted to peak performance rather than to a compromise which would accommodate a range of conditions. For example, some of the effects listed under clouding may be hidden by beam defocusing; the image orthicon ghost, by image defocusing; control of staging and lighting makes it unnecessary to throw away resolution to hide such effects.

STUDIO PRACTICES

As the various spurious effects and the distortion in luminance transfer characteristics are greatly aggravated by overexposure, principal objectives of studio practices must be the maintenance of uniform luminance ranges and scene content throughout a production and the establishment of conditions which are within the capabilities of the television facilities. From the transmission viewpoint only, a very "flat" scene is the easiest to handle. From the equally important artistic standpoint, however, as much contrast as possible is desired to provide scope for artistic expression, simulation of depth and establishment of mood. The technical group must sometimes relax technical quality requirements where special effects are desired momentarily; the staging and direction groups, on the other hand, must

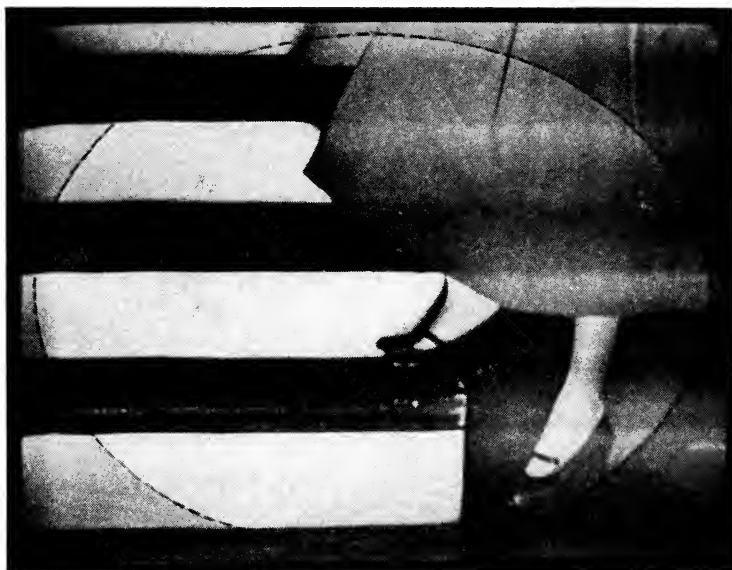

Fig. 4-A. Streaking.



Fig. 4-B. Streaking.

Fig. 4. Streaking

The white stair risers when aligned so as to parallel the television scanning lines produce pulse signals having large energy content on a number of scanning lines. In a video amplifier having improper low-frequency phase or amplitude response characteristics, a transient results, producing a streak across other portions of the picture. The streak may be of either the same or opposite polarity depending on whether leading or lagging low-frequency phase response is involved, for example. In the studio, the contrasts of large horizontal elements may be held down or the length of such elements along the scanning lines may be minimized by turning the element at an angle as in B.

become accustomed to somewhat more restrictive conditions than are prevalent in motion picture or legitimate stage production. Between the technical and artistic viewpoints lies an area for fundamental compromise, the boundaries of which working rules must seek to establish.

In practical production, the further problem of time and space separation among the various activities must be considered. The scenery may be prepared and costumes selected well ahead of the performance date. Lighting is planned in advance but adjusted after the prefabricated scenery with accompanying properties is set up in the studio. Camera facilities often are activated only during late stages of studio rehearsal. Thus, it is necessary that each major production operation be guided by rules which allow its performance independently but with assurance that the work will fit together as a co-ordinated whole. In the following sections, rules for each production phase are grouped together for convenience in reference with a discussion of the factors involved following each of the groups. Under the subject of staging, which includes scenery preparation, selection of properties, costuming and make-up, the reflectance of materials is controlled. Lighting practices are controlled as to illumination levels and distribution, this being the planning phase of lighting as compared to the mechanical adjustment which is often considered a staging operation. Methods of camera operation are guided to take advantage of controlled scene conditions in obtaining the best possible camera performance.

RULES FOR STAGING PRACTICE

1. The reflectance of large set areas and objects should be held between 25% and 50% for high-key scenes; between 10% and 25% for low-key scenes. Small details may range from 3½% (maximum black) to 70% (maximum white) reflectance. A 10-step, 20:1 gray-scale step wedge should be used as a reference standard.

2. Where colors are used, a limited number of samples should be

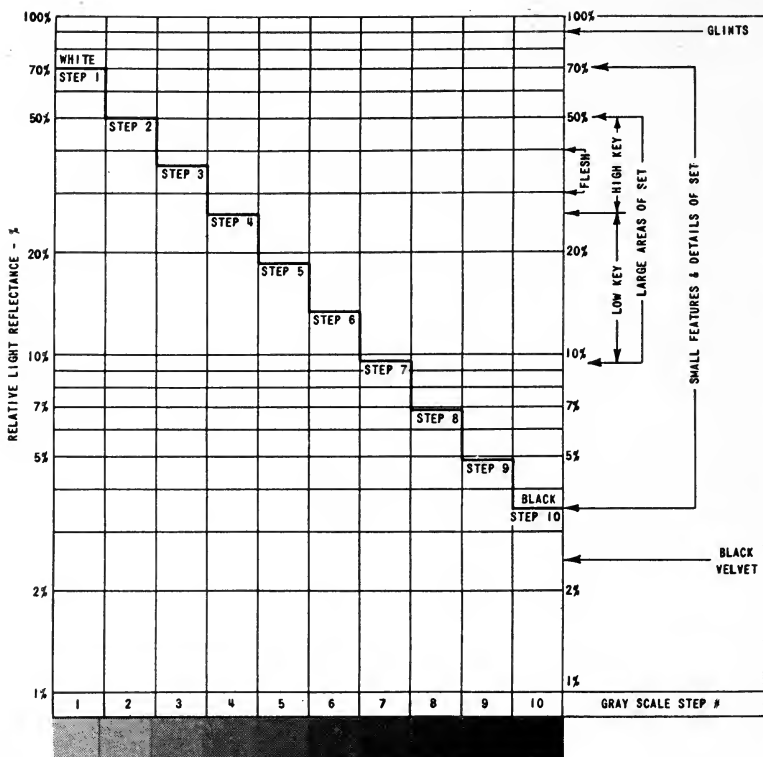

Fig. 5. Reflectance Values: Recommended reflectance value ranges for large and small scenery areas or objects are shown with respect to a 10-step, 20-to-1, reference gray-scale step-wedge. The total range for large scenery areas is held to 5 to 1 (approximately 10% to 50%) allowing for some additional variation from illumination distribution. Reflectance values indicated here are to be measured through a camera system by comparison with the calibrated gray-scale step-wedge, thus taking into account spectral distribution and surface texture.

selected and calibrated against the reference gray-scale by observation on a picture monitor.

3. Large adjacent areas should not differ in reflectance by more than 2 to 1 (2 steps on the reference gray-scale).

4. Large monotone areas, particularly dark ones, should be avoided or broken up with simple patterns, tree leaves, shadows, etc.

5. At least a small area of both extreme white and extreme black should be included in every scene to aid camera level adjustment.

6. Very dark or very white long horizontal lines or structures should be avoided.

7. Highly reflective areas or objects should be avoided or placed in

diffuse light against a light background and, if necessary, treated to reduce reflectance.

Discussion of Staging Practice

The reflectance* of scenery elements is keyed to performer's skin reflectance which is on the order of 30% to 40%¹³ (Fig. 5). If large background areas are too light, electron redistribution within the image orthicon camera tube from such areas may cause faces to be darkened; if the scenery is too dark, electron redistribution and spurious effects in the camera tube arising from the faces may disturb the background. The total range of reflectance for large areas covers only a 5-to-1 ratio (10% to 50%), allowing for some additional variation in over-all luminance to be contributed by adjustment of illumination distribution.

The use of color in staging is unnecessary for monochrome television transmission. However, if used carefully—as merely another way of obtaining a certain gray tone on the picture tube—there are no objections to its use. Prior to the establishment of a color-sample pre-calibration procedure, there was at least one case where a studio setting was carefully worked out in beautifully contrasted colors only to appear on the air as a complete monotone (the designer's red face produced the only different tone). The human eye tends to confuse color contrast with brightness contrast and, unaided, is often a misleading judge of staging propriety. One technique found to be safe is to paint scenery in graded tones of a single pre-calibrated color. Color is in television scenery to stay, it being felt by many that a more natural atmosphere is provided for the performers. Although this is a moot point, the practical approach is to use color but to control it in terms of easily determined pre-calibrated gray response.

Electronic spurious effects in the camera tube are most noticeable where large contrasts and large dark areas are present. Bright objects in front of dark backgrounds are a severe problem. The reflectance of starched white cloth may run as high as 90%; that of jewelry, musical instruments and other polished objects may run close to 100%, exhibiting specular reflectance. These values are almost three times the reflectance of skin. In many cases, the highlight area itself may be controlled by: painting-off kitchen appliances; using blue, tan or off-white clothing and stage papers; using

* Reflectance is taken here to indicate nonspecular reflectance averaged over the range of wavelengths accepted by the type 5820 image orthicon tube, and measured by comparison with the reference gray-scale, observed through a camera channel.

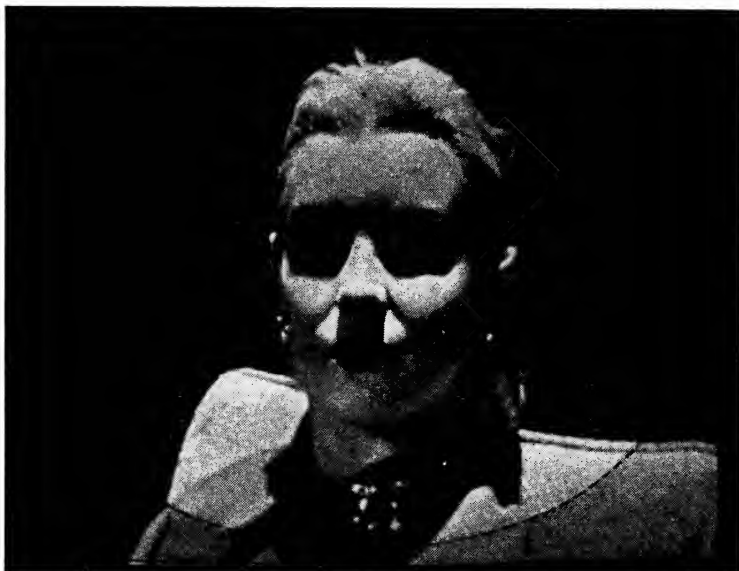

Fig. 6-A. Excess top-light.



Fig. 6-B. Excess top-light.

Fig. 6. Excess Top-Light

Illustration A was photographed from a camera control monitor; B was photographed directly on the studio floor with the same lighting. The increase in contrast through the television system is noted in comparing the two photographs. The shadow detail present in the direct photograph is lost in transmission through the system. Lighting contrasts which can be used for direct photography are excessive in television. Strong overhead lighting is particularly to be avoided.

matte surface stage photographs; or coating metallic surfaces with spray-wax or talcum powder. Bald heads may be toned down with make-up. In other cases, the background surrounding an uncontrollable high-light such as a piece of jewelry or a candle flame may be kept very light, being graduated off into darker areas of the scene.

It must be realized, of course, that maintenance of a limited range of reflectance among portions of a stage setting is only part of the story. The light which actually reaches the camera is a function not only of scenery reflectance but also of illumination level, which in turn must be held within its own set of limits.

RULES FOR LIGHTING PRACTICE

1. The first step in lighting a television scene should be to establish a diffuse and uniform base-light throughout the working area, including backgrounds. Measured with a photocell meter aimed toward all camera positions from the various performer positions, the following levels should be obtained for use with the type 5820 image orthicon equipped with a Wratten No. 3 filter:

With 4500 K (degrees Kelvin) white fluorescent light,
 100 ± 10 lm/sq ft*

With incandescent light (2870 K), 120 ± 10 lm/sq ft.

Components measured with the meter aimed vertically should not exceed the components measured with the meter aimed horizontally.

2. To provide depth, to separate objects and to add artistic interest, several types of effects-light should be added, usually from directional incandescent fixtures. The level of such components may be set to approximately the correct values by measurement with a photocell meter pointed toward the fixture from the performer positions with all other lights turned off, but should be set finally on the basis of appearance on a picture monitor.

Back-light: Should be directed from the lowest-light possible rear angle with an intensity between 1 and $1\frac{1}{2}$ times base-light level. Vertical, top-light is not back-light and should be avoided.

* Lumens per square foot is numerically equivalent to the older term, foot-candles.



Fig. 7-A. Fluorescent base-light (100 ft-c including eye-light, E below).

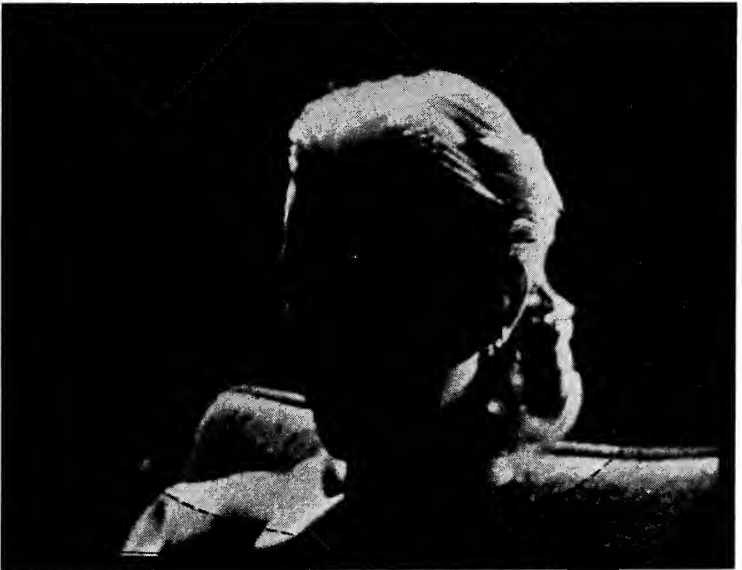

Fig. 7-B. Incandescent back-light ($1 \times$ base).

Modeling-light: Should be directed from a side-front position; may be adjusted to just cause shadows and will usually require an intensity of between $\frac{1}{2}$ and 1 times base-light.

Key-light: Similar to modeling but slightly more prominent—to give effect of a predominate source; may be from 1 to 2 times base-light level with base-light from the direction of the key-light fixtures reduced accordingly.

Eye-light: A very small amount of light to provide sparkle in a performer's eyes and to supplement the base-light for close-ups; usually from $\frac{1}{2}$ to 1 times base level.

3. Where special lighting effects such as spot-lighting, lights-out dramatic sequences, or moonlight effects are required, base-light may be lowered to a minimum of $\frac{1}{4}$ normal level and any special effects-lights then adjusted to bring total illumination level at the point of interest between 1 and $1\frac{1}{2}$ times the normal base-light level (meter aimed at camera).

4. Fluorescent (4500 K, white) and incandescent light sources may be intermixed without impairing color-response—where cameras are equipped with Type 5820 or 5826 image orthicons and blue-cutting filters such as Wratten No. 3. Incandescent sources may be dimmed to $\frac{1}{4}$ normal meter reading without impairing spectral response.

5. Self-luminous objects or areas such as exposed lamps, rear-lighted windows, or rear-projection high-lights shall be held (by dimming or other means) to produce, on a meter held a few inches from the area, a reading which does not exceed $\frac{3}{4}$ to 1 times the normal base-light level.

Discussion of Lighting Practice

Base-light corresponds to what often is called fill-light in motion picture practice. However, because of the contrast range and spurious response characteristics of the television system, this is the most important of all lighting components and it must be given the prominence of first attention—ahead of key- or other effects-light. The term, base-light, connotes the basic importance in television lighting of covering all picture areas with a very uniform illumination level. It is especially important that this base-light be uniform over the entire working stage area as viewed from all possible camera viewpoints and that it include low-angle front-light components. Where the reflectance of scenery and set fixtures is controlled, uniform, diffuse base-lighting will insure similar working conditions for all cameras on all sequences of a production. It has been found that these conditions can be adequately fulfilled with either fluorescent or incandescent



Fig. 7-C. Fluorescent base-light and back-light.



Fig. 7-D. Incandescent modeling-light alone ($1.7 \times$ base, strong enough to be key-light).

sources of light so long as good diffusion and even distribution are obtained. Mixtures of lighting types for this function are permissible. Excess top-light is to be particularly avoided as it is a prime source of electron halos and ghosts as well as darkened eyes and faces (Fig. 6).

Television pictures obtained with good base-lighting alone are technically good, but artistically incomplete. To achieve artistic quality, a relatively small amount of effects-lighting is required as compared with movie, legitimate stage or photographic practice. The television system cannot tolerate violent lighting contrasts; but, on the other hand, will produce pleasing results with relatively small intensity differences. The important technique is to use differences in quality or direction rather than brightness differences alone, to obtain the effect. There are an infinite variety of effects-light possibilities, and it is practical to catalog only a few very common types, with recommended intensities to indicate general technique (Fig. 7-A—G). In general, it is necessary to look at the result—on a picture monitor—not trusting direct visual observation on the set, to determine the effectiveness of any special lighting arrangements. The eye accepts too wide a range of contrast to be a reliable measuring instrument. It is desirable that the lighting directors become accustomed to this practice, as one job they must often perform is to correct or supplement any staging conditions which do not register as desired.

As to color response, camera-tube developments have simplified this problem greatly.³ Also, the subjective tolerance for visible color-to-gray distortion is actually somewhat greater than has been generally believed; most of television's notorious earlier troubles arose from erratic sensitivities of pickup tubes to nonvisible light components. At the present state of the art, it can be said that any light which appears reasonably white to the eye will produce satisfactory color-to-gray rendition on television. With a stage set having controlled reflectances, and with lighting which has been arranged to have a uniform base-light level with carefully adjusted artistic effects, the camera operating personnel are in a position, with a few additional precautions, to secure good results.

RULES FOR CAMERA OPERATION

1. The type 5820 image orthicon, used with a Wratten No. 3 filter, will require a normal lens aperture of from $f/8$ to $f/16$ when recommended light intensities are used. The exact lens setting should be adjusted to the point where the signals corresponding to maximum high-light areas just start to decrease in amplitude on the waveform monitor.



Fig. 7-E. Fluorescent base-light, back-light and modeling-light.



Fig. 7-F. Incandescent eye-light (including additional base-light measured as part of A).

2. All cameras used on a particular production shall be carefully adjusted to give matched gray-scale rendition against actual set backgrounds.

3. Image orthicon ghosts may be minimized by keeping the offending high-light in the center of the screen or, where necessary, by electron-image defocusing.

4. All control room monitors should be equipped with picture tubes of similar phosphor color and of similar voltage-to-luminance transfer characteristic. They should be adjusted to just go black with a blanking signal set to reference black amplitude. If in doubt, camera balance comparisons should be made on a single (line-output) monitor.

5. Signal levels should be carefully monitored to maintain true black-and-white signals at their respective reference levels, using the picture monitor to judge which peaks may be considered spurious or to judge conditions where no full peak signals exist.

Discussion of Camera Operation

Although some of the present-day image orthicon tubes will produce very satisfactory results from sets illuminated with only 20 to 30 lm/sq ft, there is about a 3:1 variation in sensitivity among tubes. To accommodate this range, to provide a margin for filter absorption and to accommodate special lens conditions, light intensities of the order of 100 lm/sq ft are recommended. Present practice is to use the lens stop to regulate exposure, contrary to the established motion picture practice of setting lens stop to achieve a required depth of focus. As pickup tubes become more uniform in sensitivity, this practice will undoubtedly be adopted in television. If necessary, base-light may be reduced to 50 lm/sq ft with appropriately wider lens apertures and if a uniform, diffuse distribution is maintained.

Although the sensitivity varies, the color response is quite uniform among present-day type 5820 and 5826 image orthicon tubes. The response of these tubes to infrared components is negligible and it has been found that a simple filter to remove the monochromatic mercury-line radiation present in fluorescent light enables satisfactory color match among various cameras and under various types of light. The Wratten No. 3 (or No. 6)¹⁰ filter has been found to be a good compromise between effective blue-rejection and loss in the transmission band, a filter factor of one lens stop being applicable.

Color response differences now seem to be less of a factor in gray-scale matching among cameras than lens flare, scene luminance content or camera misadjustment. With excess exposure, a considerable



Fig. 7-G. Full base-light, back-light, modeling and eye-light.

variation in luminance transfer characteristic may result from adjustment of image orthicon target potential. The more positive the voltage above beam cutoff, the greater the range of input luminance which can be accommodated. At the same time, electron redistribution effects decrease as the target voltage is made more positive so there is much less change in over-all luminance transfer characteristic as the average scene luminance is varied. A limit to the potential of the target above cutoff is set by beam-current noise; beam current being increased in proportion to target voltage to discharge all high-light areas. However, the fact that camera target voltage adjustment does influence over-all transfer characteristic may be used within limits to correct an unfortunate staging or lighting circumstance. These effects, though more apparent in the close-spaced tubes such as the type 5826, have been found to apply in a limited way to the type 5820 which has a wider target to mesh spacing. Video gain and blanking level adjustments also affect over-all luminance transfer characteristics.

Television signal monitoring techniques are similar to audio practice in that two devices are used: one to measure levels, the other to determine quality. However, the technique of monitoring by observation of waveform and picture monitors, lacks the years of refine-

ment and widespread operational use which lie behind use of the audio volume indicator meter and the loudspeaker. At the present, television monitoring techniques are somewhat primitive. To make the best use of the present facilities in balancing gray-scale, average signal level, and black-and-white peak level among cameras, picture monitors must be carefully set up and waveform monitors carefully calibrated and interpreted. Where definite maximum whites and blacks exist in a scene, level monitoring is straight-forward. Where glints or small insignificant blacks exist, they may be adjusted to exceed their respective reference levels—requiring judgment of their importance as viewed on the picture monitor. Where a very flat image is desired there may be no peak levels of reference amplitude at all; the video gain and blanking controls again have to be set by judgment of the image seen on the picture monitor.

In such cases, the faces of performers should be used as the basis of judgment, the voltage waveform corresponding to such areas normally being held between $\frac{1}{2}$ and $\frac{3}{4}$ of reference white level. It is unfortunate that no television equivalent of the standard audio volume indicator meter is available as yet. The importance of careful and accurate level monitoring is realized when it is considered that current practice calls for setting black peaks to a level which is 10% of total picture amplitude, a value which is only little more than the limiting accuracy in reading an oscilloscope. The dependence of image quality on careful camera adjustment and operation in no way lessens the requirement for careful staging and lighting practice. The technical job is made much simpler if the preceding steps have been done so as to minimize some of the problems, allowing concentration on the remaining ones. Achievement of uniform staging and lighting conditions makes possible optimum camera adjustment to obtain good results from all cameras throughout a show.

SUMMARY

An understanding of the technical characteristics of the present monochrome television facilities makes possible control of staging, lighting and camera operation to achieve technically correct and artistically pleasing images. In particular, characteristics of the television pickup and transmission facilities establish boundaries on overall range of luminance values, on luminance differences among adjacent areas, and on the shape and arrangement of scenery features. By setting forth working rules grouped for the various production activities which are often separated in both time and location, production personnel are enabled to work separately toward a unified final result.

It is realized that working rules cannot cover all cases—that they are subject to early obsolescence in such a rapidly changing art as television. However, by pointing out the general approaches, such rules enable the experimentally minded production team to guide their very commendable striving for better effects away from known blind alleys or even to make use of the limitations themselves.

Results which exploit the capabilities of the present television facilities to the greatest possible extent can be obtained in everyday operation when the system characteristics are known and respected.

ACKNOWLEDGMENT

The interested, helpful supervision of this work by William B. Lodge, Vice-President in Charge of General Engineering for CBS, and by Howard A. Chinn, Chief Audio-Video Engineer for CBS, is gratefully acknowledged. The excellent co-operation given in the course of the investigations by the various operations departments of WCBS-TV is very much appreciated. The author is particularly indebted to Ted Lawrence, Quality-Control Supervisor for CBS-TV, for the numerous contributions made in working out and actually applying these practices.

REFERENCES

1. O. H. Schade, "Electro-optical characteristics of television systems," *RCA Rev.*, vol. 9, nos. 1, 2, 3, 4; Mar., June, Sept. and Dec. 1948.
2. R. B. Janes, R. E. Johnson and R. S. Moore, "Development and performance of television camera tubes," *RCA Rev.*, vol. 10, no. 2, June 1949.
3. R. B. Janes, R. E. Johnson and R. R. Handel, "A new image orthicon," *RCA Rev.*, vol. 10, no. 4, Dec. 1949.
4. H. Kozanowski, "How to get the best picture out of your image orthicon camera," *Broadcast News*, RCA Publication, no. 54, Apr. 1949.
5. *Tips on Use of Image Orthicons*, (booklet), published by RCA Tube Dept., 1949.
6. R. M. Fraser, "Motion picture photography of television images," *RCA Rev.*, vol. 9, no. 2, pp. 202-217, June 1948.
7. H. E. Kallmann, "The graduation of television pictures," *Proc. I.R.E.*, vol. 28, no. 4, pp. 170-174, Apr. 1940.
8. D. G. Fink, "Brightness distortion in television," *Proc. I.R.E.*, vol. 29, no. 6, pp. 310-321, June 1941.
9. A. H. Brolly, "Television studio lighting," *Jour. SMPE*, vol. 53, pp. 611-622, Dec. 1949.
10. Richard Blount, "Lighting distortion in television," *Jour. SMPE*, vol. 53, pp. 625-634, Dec. 1949.
11. H. M. Gurin, "Illumination for television studios," *Tele-Tech*, Pt. I, vol. 8, no. 9, pp. 54-73, Sept. 1949; Pt. II, vol. 8, no. 10, pp. 34-57, Oct. 1949.
12. R. L. Kuehn, "Television photometry and optical background," *Tele-Tech*, vol. 8, no. 7, pp. 24-50, July 1949.
13. R. M. Evans, *An Introduction to Color*, 340 pages, John Wiley, New York, N.Y., 1948.

Motion Picture Instruction In Colleges and Universities

A Follow-up Study of the 1946 Report by John G. Frayne

By JACK MORRISON

UNIVERSITY OF CALIFORNIA, LOS ANGELES, CALIF.

AS THE HOT WAR of the 40's ended, there was much to be said about the growing use of film in education and about the teaching of film production in colleges and universities, with comprehensive curriculums supplemented by modern and suitably designed equipment. These views, in fact, were reflected in the *JOURNAL* article by Frayne cited in the note below. As Chairman of the SMPE Motion Picture Instruction Committee, Frayne reported the motion picture courses taught in the 102 institutions, colleges and universities which answered his questionnaire. The purpose of the study was to report to the Society what courses were being taught and where. The article closed with comments as to the possible value of this education to motion pictures as a profession and noted in particular the lack of technical courses. As of three years later—three years of unparalleled expansion in higher education—the present investigation proposes to follow up the Frayne study for the purpose of indicating possible trends and offering a reasonably definite idea of the present state of instruction in motion pictures in American colleges and universities after this period of relatively lush growth.

In order to compare the two reports simply, the Frayne breakdown of courses is followed as originally conceived. The Frayne report (1946) appears on the left side of the tabulation immediately following, and on the right is the follow-up study (1949). In addition to the information about units and semester hours included in the 1946 report, the 1949 report has a brief description of each course.

Because certain schools not included in the 1946 study have since then introduced courses, and because schools which have increased the number of their courses since that time would not appear in the parallel type of reporting, two additional summaries are necessary for a more comprehensive consideration of the growth in the period. These listings below, are shown on p. 273 through p. 277. One is a recapitulation of the courses dropped since 1946, and the other is a listing of schools which were not reported in the Frayne study and which have introduced motion picture courses since 1946. Due to the newness of the field, it is impossible to say how many institutions offering motion picture courses are still *not* included in this report.

A CONTRIBUTION: Submitted December 15, 1949. This follow-up study of "Report of the Committee on Motion Picture Instruction" by John G. Frayne, *Jour. SMPE*, vol. 47, pp. 95-106, Aug. 1946, was instigated by the American Educational Theater Association's Committee on Film, Radio and Television under the Chairmanship of Kenneth Macgowan and was reported at that Association's 1949 National Convention.

1946 REPORT

1949 REPORT

Colleges

New York University

.....Courses in Cinematography (Including Color).....
Motion Pictures 1 & 2: 3 sem hr/wk; 6 cr. *Cinematography*: Camera work, composition, lighting; general basic production course; 2 sem hr/wk.

Oregon State College

Educational Cinematography (Summer Session only): 3 term hr; 3 cr. 2 sem hr; 2 cr.

University of Denver

Motion Picture Making: 2 qtr hr; 2 cr.

Survey of Audio-Visual Materials & Equipment: Description not available; 5 qtr hr.

Film Techniques: Theory, principles and practice of camera techniques; lighting and composition; presentation of ideas, emotions and incidents by filmic means; creative application of movement, progression and tempo; individual projects in camera planning; 5 qtr hr.

Motion Picture Production: An intensive study of all the mechanical and literary problems contributing to the actual producing of a motion picture; emphasis to be placed on the four major non-theatrical types of film—industrial, educational training and documentary; analysis of typical productions in each category with critical evaluation; development of a working script by the individual student for a projected picture in one of the categories; observation on location with the university film unit; 5 qtr hr.

Ohio State University

Cinematography: 2 sem hr/wk; 2 cr.

Photography 515 (Motion Picture Photography): Lecture, laboratory, and practice in basic motion picture techniques; emphasis on 16-mm field; history of motion pictures, operation of cameras, types of lighting, film processing, elements of projection; 3 qtr hr.

University of Southern California

Cinema 115AB: 1st yr, 8 hr/wk; 8 cr. (and others, see bulletin)

115AB (Camera I, II): Theory, principles, and practice of camera techniques; lenses and their uses; lighting and composition; introduction to camera planning; 2 cr each.

Cinema 165AB: 2nd yr, 8 hr/wk; 8 cr. (and others, see bulletin)

165 AB (Camera III, IV): Advanced problems in the use of lighting for dramatic effect; creative use of lenses and filters; planning camera continuity and selecting camera angles; practical work on current productions; 2 cr each.

SUMMARY: 5 schools, 9 courses listed.

SUMMARY: 5 schools, 10 courses listed.

-*Courses in Photography (Including Color)*.....
- Iowa State College
Physics 316 and 650. (To develop photography in scientific fields): 4½ cr hr for 316; 3 cr hr or more for 650.
- University of Oregon
Rudiments of Photographic Journalism: 1½ sem hr/wk; 2 term cr.
- Oberlin College
Photography in the Department of Chemistry: Lab 1 or 2 three hr periods/wk; 2 or 3 hr cr.
Photography: 3½ sem hr/wk.
- Baylor University
P41b: 3 sem hr/wk for 1 sem; 2 cr.
- University of Detroit
News Photography: 3 qtr hr/wk; 3 cr.
Photography: 5 qtr hr/wk; 3 cr.
- University of Minnesota
Photography 151 (Introductory Photography): An introduction to photographic technique and its applications; fundamentals of photography and practice use of the dark room; 5 qtr hr.
Physics 41 B (Photography): Theory and application of the fundamental principles of photography; 2 hr.
- University of Minnesota
Motion Picture Photography: Covers the requirements of good cinematography with laboratory sessions on proper editing techniques, special effects and titling; 3 hr.
Applied Photography: Lectures, demonstrations and laboratory sessions on portraiture, architecture, landscape, news and illustration photography, retouching, mounting and darkroom work; 3 hr.
- Gustavus Adolphus College
Physics 211 (Photography): Taking and finishing pictures with particular emphasis on scientific aspects; laboratory work in development, printing, enlarging, color photography, making lantern slides, photomicrographs and retouching; 2 hr.
Physics 212 (Advanced Photography): Miniature camera techniques, advanced theory of development, hypersensitization, and chemical and physical reversal of photographic emulsions, advanced projection, toning and mounting of salon prints, development and printing of color film and 8-mm movie making and movie titling; 2 hr.

1946 REPORT

1949 REPORT

- Drake University
News Photography: 2 sem hr/wk; 2 cr.
- College of Emporia
Photography in Physics Department: 2 sem hr/wk; 2 cr.
Photography: 2 sem hr/wk; 2 cr.
- University of Colorado
Elementary Photography: 5 sem hr/wk; 5 cr.
- Brigham Young University
Advanced Photography: 3 sem hr/wk; 3 cr.
Photography (in planning stage at present).
- State College of Washington
Elements of Photography: 4 qtr hr; 4 cr.
- Northwestern University
Press Photography: 4 qtr hr; 4 cr.
- New York University
Motion Pictures 3 & 4: 2 sem hr/wk; 4 cr.
Photography: 3 sem hr/wk; 3 cr.
- Miami University
Elementary Photography (Still): 2 sem hr/wk; 2 cr.
Advanced Photography (Still): 4 sem hr/wk; 3 cr.
- 123 *Pictorial Journalism*: Illustration of the news story by picture and diagram; the picture magazine, films and other media; 2 hr.
- 124 *Camera Journalism*: Photography and use of pictures in newspapers, magazines, and syndicates; photographic field trips; 2 hr.
- Photography*: Elementary theory and practice of making exposures, developing and printing; 2 hr.
- News Photography*: Taking and processing pictures of news value; 3 qtr hr.
- Physics 26 (Theory and art of Photography)*: Lectures; lab. in photographic manipulation, determination of characteristics of photographic materials; 4 hr.
- Physics 187 (Advanced Photography)*: Description not available; 2 hr. No course listed.
- D 18 Principles of Photography*: Fundamentals of photography, operation of press camera, development of films, making of prints, compounding of chemical solutions, use of standard photographic equipment and materials; 4 qtr hr.
- E 10 Press Photography*: Advanced course; professionally supervised study practice of techniques followed by press photographers; 4 qtr hr.
- No course listed.
- Physics 289 (Photography)*: Gives not only a practical understanding of scientific principles of photography but also shows the importance of the media in conveying ideas; 4 hr.
- Principles of Photography*: Basic theoretical and practical course; 6 hr.
- Photography*: Hobby level course; 2 hr.

- Oregon State College
- Ph 161 (Rudiments of Photography)*: 2 term hr; 2 cr.
- Ph 361 (Hand Camera)*: 3 term hr; 3 cr.
- Ph 362 (Commercial)*: 3 term hr; 3 cr.
- Ph 363 (Composition Enlarging)*: 3 term hr; 3 cr.
- Ph 461, 462, 463 (Advanced Photography; Color, Photomicrography, Microscopic Motion Pictures)*: 3 term hr; 3 cr.
- Photographic Technique, Zool. 151-152* (Does not include motion picture but includes color-correct photography and some color photography): Sem I, 3 sem hr/wk; 3 cr. Sem II, 2 sem hr/wk; 2 cr.
- Photography and Art*: 4 sem hr/wk; 2 sem cr.
- University of Idaho
- Physics 161 (Rudiments of Photography)*: Based on college physics or chemistry; hand camera, developing, printing, enlarging, slides, etc.; 2 qtr hr.
- Physics 361, 362, 363 (Photography)*: 361—The hand camera, developing, printing, toning, enlarging, slides; 362—Commercial phases of photography; view cameras, copying, flashlights, indoor lighting, color correction, etc.; 363—The making of pleasing pictures; composition, carbon and carbo, paper negatives, enlarging negatives, etc.; 3 qtr hr each course).
- Physics 461, 462, 463 (Advanced Photography)*: Color, photomicrography, microscopy, motion pictures, miniature camera technique; 3 qtr hr (each course).
- "We offer . . . some work in photography . . . intended for the research type of student."
- No course listed.
- 511 Photography*: Use of the camera, characteristics of photographic emulsions, light filters and their uses, exposure problems, processing of negatives, contact printing, etc.; 3 qtr hr.
- 520 Engineering Photography*: Application of special photographic techniques; use of visual aids in the presentation of engineering data; production of blueprints, photostats, etc.; 3 qtr hr.
- 625 Scientific Photography*: Nature of photographic processes, characteristics of photographic materials and the application of photography to science; 3 qtr hr.
- 650 Advanced Photography*: Projection printing, portraiture, special effects, photo-engraving, lens testing, color photography, miniature camera work and motion pictures; 3 qtr hr.
- 699 Minor Problems in Photography*: Use of library and laboratory facilities for student to add to his knowledge and technique in some subjects in photography and to carry out minor investigations; 3 to 5 qtr hr (may repeat up to 10).
- St. Olaf College
- Ohio State University
- 3 courses*: 3 sem hr/wk (each course); 3 cr (each course).

1946 REPORT

1949 REPORT

University of Southern California	<i>Cinema 90, 91, 92</i> : 4 sem hr/wk (each course); 2 units (each course).	<i>50AB (Fundamentals of Photography)</i> : First semester—Photographic optics and chemistry, sensitometry, composition and lighting; Second semester—individual projects, theory and practice in composition, lighting, enlarging techniques and applied sensitometry; 2-2 hr.
		<i>92 Portraiture</i> : Individual projects; techniques and art of portraying character and personality; dramatic lighting, camera angles, posing, use of background, make-up, retouching; 2 hr.
	<i>Cinema 121AB</i> : 4 sem hr/wk (each course); 2 units (each course).	<i>121AB (Color Photography)</i> : First semester—Theory of color separation, densitometry and calibration of negative materials, lighting, exposing and developing separation negatives; Second semester—Densitometric evaluation of the negative, sensitometric evaluation of the positive, printing developing and mounting the positive, demonstration of carbo and wash-off processes; 3-3 hr.
	SUMMARY : 21 schools, 40 courses listed.	SUMMARY : 21 schools, 42 courses listed.
	<i>Public Speaking (Part of course)</i> .	<i>Courses in Sound Recording</i>
Georgia Institute of Technology	None, except in courses offered in radio techniques.	No course listed.
State College of Washington	None, except in courses offered in radio techniques.	No course listed.
New York University	<i>Motion Pictures 9 & 10</i> : 2 sem hr/wk; 4 cr.	No course listed.
Oregon State College	<i>Education 533</i> (Correlation of radio recordings with visual aids): 3 term hr; 3 cr.	No course listed.
University of Southern California	<i>Cinema 140</i> : 3 sem hr/wk; 2 cr.	<i>140AB Sound, I, II</i> : First semester—Principles of sound recording for motion pictures, types of equipment, production techniques, recording, playback, and scoring; Second semester—recording channels, microphones, amplification, transmission, disc and film recording units, effect of equalizers, distortions and discriminations in equipment and processes; 2-2 hr.
	SUMMARY : 5 schools, 4 courses listed.	SUMMARY : 5 schools, 2 courses listed.

- *Courses in Motion Picture Film Editing*.....
Motion Pictures 3I: 2 sem hr/wk; 2 cr.
Film Cutting and Editing Theory: Laboratory study of sound and silent film; 2 hr.
- University of Southern California
Cinema 135: 3 sem hr/wk; 2 cr.
135AB Editing, I, II: Equipment and techniques of motion picture editing; use of standard editing equipment; principles and mechanics of procedures; 2-2 hr.
185AB Editing, III, IV: Advanced problems in creative editing; practical work on current productions; 2-2 hr.
- Antioch College
Motion Picture Film Editing: 20 wk; 5 cr.
SUMMARY: 3 schools, 3 courses listed.
- Pennsylvania State University of Kentucky
, *Courses in Motion Picture Projection*.....
Teach 16-mm projection (But not for credit).
 "Elementary techniques of projection are taught in one of the Visual Education classes."
- Given both informally upon request of individuals and included in educational audio-visual instructional aids courses.
- New York University
 Antioch College
 Included in Motion Pictures 3 & 4.
 Classes conducted by students under extra-curricular committee
SUMMARY: 4 schools, no courses listed.
- Pennsylvania State University of Kentucky
, *Courses in Motion Picture Distribution*.....
Motion Picture Distribution.
 No course listed.
- Included in graduate courses on audio-visual aids in instruction. Commercial distribution for entertainment is not included.
- New York University
 University of Southern California
Cinema 150: 2 sem hr/wk; 2 cr.
150 Distribution and Exhibition: Survey of merchandising principles as they apply to films; advertising, trailers, exchanges, exhibiting, theater management; 2 hr.
SUMMARY: 4 schools, 1 course listed.

1946 REPORT

1949 REPORT

 <i>Courses in Economic Problems in Motion Picture Production and Exhibition.</i>	
New York University	<i>Motion Pictures 19 & 20</i> : 2 sem hr/wk; 4 cr. No course listed.	
University of Denver	Courses planned for 1946-1947 in School of Commerce. No course listed.	
University of Southern California	<i>Cinema 250 AB</i> : 2 sem hr/wk for 2 sem; 2 units/sem. 183 <i>Cinema and Society</i> : Influences of the American film on social groups in the United States and abroad from 1890 to the present; influences of the society on the cinema; 2 hr.	
	199 <i>Unit Management</i> : Production planning, breakdown and scheduling; cost estimates and location problems; 2 hr.	
	225 <i>Studio Production Control</i> : Supervision of writing, production and editorial departments; 2 hr.	
	SUMMARY : 3 schools, 4 courses listed. SUMMARY : 3 schools, 3 courses listed.	
University of Detroit <i>Courses in Film Processing (Still)</i>	
State College of Washington	A part of the lab work of General Photography. No course listed.	
University of Southern California	In planning stage. No course listed.	
	Covered in Cinema 90, 91, and 92. Covered in "Fundamentals of Photography," "Photoportraiture," and "Color Photography."	
	SUMMARY : 3 schools, no courses listed. SUMMARY : 3 schools, no courses listed.	
Oregon State College <i>Courses in Film Processing (Motion Picture)</i>	
	Included (16-mm) in course in Photography. No course listed.	
	SUMMARY : 1 school, no course listed. SUMMARY : 1 school, no course listed.	

Courses Dropped by Schools Since the 1946 Report

<i>School</i>	<i>Course</i>
<i>Cinematography</i>	
New York University	Motion Pictures 1 & 2
Ohio State University	Cinematography
University of Denver	Motion Picture Making
<i>Photography</i>	
Baylor University	Photography
Drake University	News Photography
New York University	Motion Pictures 3 & 4
St. Olaf College	Photography and Art
University of Oregon	Rudiments of Photographic Journalism
University of Southern California	Cinema 90 & 91
<i>Sound Recording</i>	
New York University	Motion Pictures 9 & 10
Oregon State College.	Education 533
<i>Motion Picture Distribution</i>	
New York University	Motion Pictures 19 & 20
Pennsylvania State College	Motion Picture Distribution
<i>Economic Problems in Motion Picture Production and Exhibition</i>	
University of Southern California	Cinema 250AB

Courses Reported Since the 1946 Report

(Includes Schools Not Reported by Frayne)

<i>Cinematography</i>	
Baylor University	Drama 388 The Film
College of the City of New York	Films 13 Fundamentals of Film Production
Drake University	Ed. 108 Audio-Visual Education Materials and Methods
New School for Social Research .	Elements of Cinematography
New York University	Cinematography
Ohio State University	Motion Picture Photography
Stanford University	The Technique of the Motion Picture
University of California at L. A. .	Motion Picture Photography and Sound
University of Denver	Ed. 336 Survey of Audio-Visual Materials and Equipments;
	Film Techniques
University of Minnesota	Motion Picture Photography
University of North Carolina . .	Motion Picture Production
Western Reserve University . . .	Motion Picture Production
West Virginia University	Ed. 251 Cinematography
<i>Photography</i>	
Boston University	News and Feature Photography;
	Advanced News and Feature Photography;
	The Preparation of Photographic Materials for Visual Education
Brooklyn College of the City of N. Y.	Design 45 Photography I;
	Design 46 Photography II
College of the City of New York	Motion Picture Photography;
	Advanced Motion Picture Photography
Columbia University.	Science 169P Photography for Teachers
Cornell University.	An introductory course in photography

Courses Reported Since the 1946 Report, cont'd

Depauw University	Composition and Photography
Drake University	Pictorial Journalism; Camera Journalism
Indiana University	Creative Photography; Elementary News Photography; Practical Work in News Photography; News Photography; Picture Editing Photography
Kansas State College of Agr. & App. Sc.	Photography
Miami University	Engineering Photography; Scientific Photography
Ohio State University	Photography
South Dakota State College of Agr. & Mech. Arts	A Camera Department
Texas Christian University . . .	Photography
Tulane University (Newcomb College)	Ed. 19d/e The Use of Photography in Teaching
University of Mississippi	Art 87 & 88 Photography
University of New Mexico	Elementary Photography
University of North Carolina . .	Physics 161 Rudiments of Photography;
University of Oregon	Journalism 451, 452, 453 Graphic Journalism
University of Southern California	Fundamentals of Photography
West Virginia University	Physics 216 Photography
<i>Sound Recording</i>	
Brigham Young University	Radio Production and Recording; Radio Sound Recording
College of the City of New York .	Film Music and Recording
Indiana University	Radio Broadcasting 278AB
Ohio State University	511, 512 (sound-on-film recording in 16-mm)
Pasadena City College	Radio Controls Laboratory 40
University of Southern California	140B Sound II
<i>Motion Picture Film Editing</i>	
Baylor University	Film and Television Production
College of the City of New York .	Motion Picture Editing; Advanced Motion Picture Editing
University of California at L. A. .	Motion Picture Editing 165AB
University of Southern California	135B Editing II; 185AB Editing III, IV
<i>Motion Picture Projection</i>	
Boston University	The Operation and Maintenance of Audio-Visual Equipment
Brigham Young University	Education 275 Audio-Visual Instruction
Iowa State College	Audio-Visual Methods in Education
Oregon State College	Audio-Visual Teaching Aids
University of Virginia	Ed. 57 Visual and Auditory Materials of Instruc- tion
West Virginia University	Ed. 221 Audio-Visual Resources for Instruction
<i>Motion Picture Distribution</i>	
College of the City of New York .	Distribution and Publicity in Motion Pictures
Indiana University	Administration of a College Center of Audio- Visual Materials
New School for Social Research .	Operating the Film Library
University of Virginia	Ed. 159 Administration of Audio-Visual Programs
West Virginia University	Ed. 322 Organized Programs of Audio-Visual In- struction

Courses Reported Since the 1946 Report, cont'd

Economic Problems in Motion Picture Production and Distribution

- Boston University Administration of a Motion Picture and Audio-Visual Aids Dept.
- New School for Social Research Film Production Methods
- University of Southern California Cinema and Society;
Unit Management;
Studio Production Control

Film Processing (Still)

- South Dakota State College of Agr. & Mech. Arts Photography 58AB
- University of Colorado News Photography

Film Processing (Motion Picture)

- University of Southern California 101AB Laboratory Practices and Procedures

Motion Picture Acting

- New School for Social Research Acting for Film, Television and Radio
- University of California at L. A. Acting for the Motion Pictures

Screen Writing

- Boston University Writing of Motion Pictures and Filmstrips
- College of the City of New York Motion Picture Writing;
Advanced Motion Picture Writing
- Columbia University F. A. Motion Picture;
Scenario Writing and Production
- New School for Social Research Basic Screenplay Writing;
Advanced Documentary Writing;
Feature Screenplay Writing Seminar
- New York University Writing the Screen Treatment
- Stanford University Technique of the Motion Picture
- University of California at L. A. Writing for the Screen 166AB
- University of Southern California Screenwriting I, II, III, IV;
Educational Screenwriting;
Documentary Screenwriting;
Seminar in Screenwriting
- Western Reserve University Practices in Script Writing

Motion Picture Directing

- College of the City of New York Motion Picture Directing
- New School for Social Research Film Direction
- New York University Intermediate Motion Picture Production
- Stanford University Technique of the Motion Picture
- University of California at L. A. Fundamentals of Motion Picture Direction
- University of Southern California Cinema Directing I, II, III, IV;
Seminar in Motion Picture Direction

Motion Picture Lighting

- University of Southern California 115AB & 165AB (Camera Classes)

Educational Film

- Boston University The Use of Audio-Visual Aids in Education
- College of the City of New York The Documentary Film as an Educational Tool
- Columbia University Science Films;
Production of Educational Motion Pictures
- Indiana University Utilization of Audio-Visual Materials;
Selection of Audio-Visual Materials;
Administration of Audio-Visual Materials;
Production of Audio-Visual Materials;
Administration of a College Center of Audio-Visual Materials;
Seminar in Audio-Visual Materials;

Courses Reported Since the 1946 Report, cont'd

Indiana University, <i>cont'd</i>	Research in Audio-Visual Materials; Thesis in Audio-Visual Materials; Workshop in Administration of the Audio-Visual Aids Program
Louisiana Polytechnic Institute	Use of Audio-Visual in the Classroom
New School for Social Research	Audio-Visual Aids in Education
Oregon State College.	Construction and Use of Audio-Visual Aids
University of California at L. A.	Educational and Documentary Film Techniques
University of Denver	Survey of Audio-Visual Materials and Equipment; Survey of Instructional Motion Pictures; Administration and the Supervision of the Audio-Visual Program
University of Kentucky	Visual Teaching; Motion Pictures in Education
University of Southern California	276AB Workshop in Educational Film Production
University of Wisconsin	Methods of Audio-Visual Instruction
<i>Documentary Film</i>	
College of the City of New York	Fundamentals of Film Production
University of California at L. A.	Nature and History of the Documentary Film
University of Southern California	208AB Documentary Production; Documentary Direction
<i>Animation</i>	
New School of Social Research	Graphics and Animation
University of California at L. A.	Fundamentals of Motion Picture Animation; Animation for Educational and Documentary Films; Animation for Entertainment Film
University of Southern California	148AB Principles and Mechanics of Animation
<i>Film History and/or Aesthetics</i>	
Boston University	The History of Motion Pictures
College of the City of New York	The History of Motion Pictures
New School for Social Research	March of Film; Seminar in Film Techniques
New York University	Introduction to Motion Pictures
Purdue University.	English 52 The Art of the Motion Pictures
Stanford University	History and Aesthetic Development of Motion Pictures
University of Connecticut	The Art of Motion Pictures
University of Southern California	Introduction and Survey of Motion Pictures 60AB; Filmic Expression 105AB; Cinema History and Criticism 200AB; Seminar in Creative Cinema 274AB
Wayne University	History and Appreciation of Motion Pictures
<i>Film Appreciation</i>	
Baylor University	Introduction to Drama, Television and Film
Columbia University.	Ed. 162 PRD, Photography and Radio Drama as Communication Arts; Ed. 209 MF, International Film Series
Fordham University	Motion Picture Appreciation and Criticism
Miami University	Motion Picture Appreciation
New School for Social Research	Basic Principles of the Mass Communication Arts; March of Film
New York University	Motion Picture Literature
Syracuse University	Cinema Appreciation
University of California at L. A.	Visual Analysis
University of Delaware.	Theater, Film and Radio
University of Denver	Film Arts

Courses Reported Since the 1946 Report, concl'd

University of Iowa	Cinematography
University of Kansas	The Motion Picture
University of Minnesota	Film and Drama; Humanities 52
University of Oregon	Appreciation of Drama
University of Toledo	Appreciation of the Motion Picture
<i>Film Design</i>	
New School for Social Research	Applied Stagecraft for Film and Television
Otis Art Institute	Motion Picture and Television Art Institute
University of California at L. A.	Motion Picture Costume Design; Motion Picture Design and Draftsmanship 167AB
University of Southern California	Art Directing I, II, III, IV; Art Direction 210AB
<i>Survey of Film Production and Techniques</i>	
Boston University	Workshop in Motion Pictures and Visual Aids; Motion Picture and Television Film Production
Columbia University	Production of Educational Motion Pictures
New School for Social Research	Film Production Methods
Pasadena City College	Stage Technology
University of California at L. A.	Motion Picture Survey; Film Technique
University of Denver	Motion Picture Production
University of Southern California	Motion Picture Production Techniques 175AB
University of Wisconsin	Local Production of Audio-Visual Materials
<i>Miscellaneous</i>	
Baylor University	Television and Film Workshop 207ABC
Boston University	Research in Motion Pictures and Audio-Visual Aids; Audio-Visual Aids in Health and Physical Educa- tion; Visual Presentation of Ideas; Principles of Motion Pictures and Audio-Visual Aids in Public Relations and Business
College of the City of New York	The Documentary Film in Labor Relations; Practice in Film Production
Columbia University	Audio-Visual Materials and Methods of Use; Lab Course in Audio-Visual Instruction; Administering the Use of Audio-Visual Materials
New York University	Advanced Individual Study
Stanford University	Stage and Screen
Texas Christian University	Research Problems in Speech-Drama
University of California at L. A.	Motion Picture Makeup; Elementary Motion Picture Workshop; Advanced Motion Picture Workshop; Summer Motion Picture Workshop 179CDE; Theory of Educational Film
University of Southern California	Motion Picture Technology; Cinematic Effects 153AB; Makeup for Motion Pictures; Public Relations in Motion Pictures; Unit Management; Production 205AB; Seminar in Motion Picture Engineering 211AB; Studio Production Control 225; Films for Television
Wayne University	Advanced History and Appreciation of Theater History

In conclusion, it may be safely said that despite the fast-growing attention given to the motion picture in education, the schools included in the Frayne study indicate little if any significant change in the teaching of the production of motion pictures in colleges and universities in the years from 1946 to 1949. Although the follow-up study reported 300 motion picture and "related" courses compared with Frayne's report of 86, it is possible that the number of institutions offering a comprehensive major in motion picture production is less than a half-dozen. This is probably a reflection of expense of equipment, lack of personnel and antipathy toward "trade school" courses.

Frayne's point that few technological courses are offered continues to be well founded. While it may be argued whether motion pictures is an art, a profession or a craft, there still does not appear to be enough study of the technical phases to assure motion pictures becoming understood and used as the distinctive educational tool it promises to be.

A great number of the courses added have been in audio-visual aids. It is obvious that the relationship between motion pictures in particular and audio-visual aids in general needs clarification. For example, one development to be noted in the follow-up study is the recurrence of a one-semester omnibus course which not only teaches a student all the phases of making a motion picture, but requires him to complete one as a project in the course. While this may serve a certain situation well, its effect on the development of motion picture production should be scrutinized carefully.

Finally, attention should be called to the lack of a generally accepted nomenclature in the field. This lack seriously impaired the effectiveness of this as well as the Frayne study. Attention to nomenclature, course description in relation to curricular concepts, and clarification of relationships to visual aids would be well worth the while of the American Educational Theatre Association's Committee on Film, Radio and Television and the University Film Producer's Association.

Synchronous Recording On 1/4-In. Magnetic Tape

By WALTER T. SELSTED

AMPEX ELECTRIC CORP., SAN CARLOS, CALIF.

SUMMARY: This article discusses the problem of synchronizing motion picture film with a sound track on standard 1/4-in. magnetic recording tape. The equipment for synchronizing the tape with film is the major subject discussed.

THE USE of magnetic tape for recording motion picture sound tracks has by now aroused great interest within the film industry. The system of recording a sound track directly on optical film is unnecessarily costly and risky and will soon be obsolete. Only too frequently retakes are necessary because of failure on the part of a performer or in later film processing. Failure to get a perfect track results in a great waste of film, time and developing cost. Magnetic recording can replace film recording entirely for sound track work and will save the industry a great deal of money.

Early work with magnetically recorded sound tracks was done with standard 35-mm motion picture film coated on one side. Later, the film was split down the center to save one-half of its cost. However, the cost of split 35-mm magnetic recording film is ten times as high as standard 1/4-in. unperforated tape. This difference in cost makes the latter recording medium appear to be most desirable if it can be used. Not only can it be used, but it has several other important advantages over the perforated tape, aside from that of cost. Storage space is reduced by 7 1/2:1 over the split 35-mm magnetic tape. Recording time per reel is increased by 2 1/2:1. Weight per reel is reduced by 2 1/2:1.

As everyone in the film industry knows, the problem of sprocket perforation flutter is a major problem which required considerable work to overcome. The use of 1/4-in. magnetic tape for sound track recording eliminates this problem as well. The manufacturers of magnetic recording materials have stated that the magnetic coating cannot be applied to 35-mm film as uniformly as it can on 1/4-in. tape. The greater uniformity obtainable on tape results in lower amplitude modulation of the recording and better high-frequency response. The 35-mm film base has approximately nine times the stiffness of 1/4-in.

PRESENTED: April 24, 1950, at the SMPTE Convention in Chicago.

tape. This greater stiffness results in poor head contact and consequent further amplitude and frequency response variations not found in using standard tape.

To be of any use to the motion picture industry, it is necessary to synchronize the sound track with the picture. Since no sprockets can be used with $\frac{1}{4}$ -in. magnetic tape, one must magnetically or optically mark the tape so that it can be reproduced later at a controlled rate. The optical methods of tape synchronizing normally utilize bars or spots on the back surface of the tape as guides to control the speed of playback and hence allow it to be synchronized with the film. The systems thus far tried using this type of tape marking are satisfactory except during starting. Due to the fact that the photoelectric sensing devices do not know whether the tape at start is running faster or

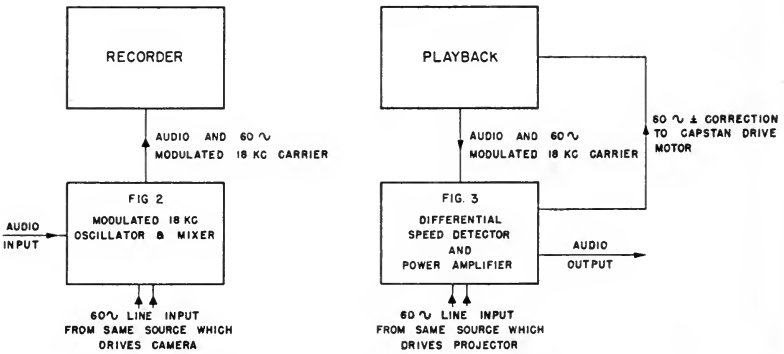

Fig. 1. Tape synchronizing system.

slower than synchronous, it is impossible for the sensing system to control the tape drive during starting. The lip-synchronous equipment described herein utilizes a magnetic marking system which has the advantage that it will without attention from an operator come to film-synchronous speed from standstill in a time corresponding to normal starting time for the associated recording equipment.

Figure 1 is a block diagram of the tape synchronizing system developed to be used with a standard Ampex Model 300 tape recorder. On the left side of Fig. 1 the block marked "Recorder" is a standard tape recorder without any modifications whatsoever. The block marked Fig. 2 is a small, lightweight, auxiliary unit which marks the tape magnetically during the time the original sound track is recorded. It will be noted that the audio signal to be recorded is fed into this unit marked Fig. 2 and before entering the recorder has added

to it an 18-kc carrier which is modulated by the frequency of the power line used to drive the picture recording camera. In Fig. 1 this is the input marked "60-cycle line input." However, the system will operate properly if some frequency other than 60 cycles is used. After making a recording with this setup, the tape contains the intelligence as well as 60 cycles riding on an 18-kc carrier. The relationship between the 60-cycle signal and the audio intelligence is the same relationship as the picture on the film recorded by the film camera bears to the same 60-cycle frequency. Hence, if during playback the 60-cycle signal on the magnetic tape can be held in fixed relationship with the power-line frequency driving the projection

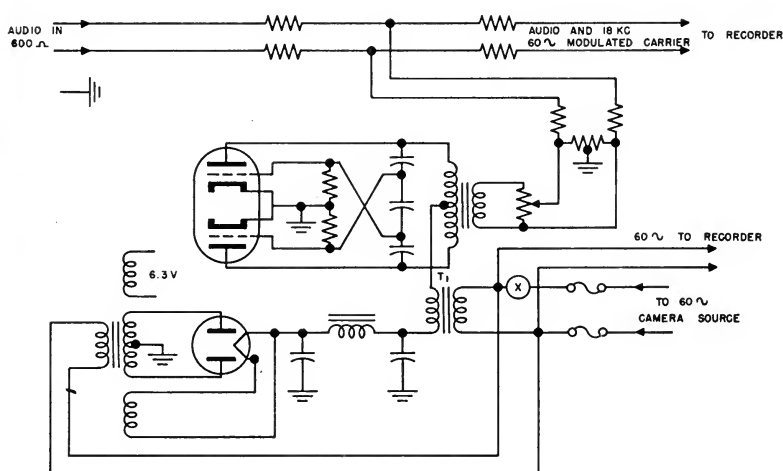

Fig. 2. Modulated 18-kc oscillator and mixer.

camera, the sound and picture will remain in a synchronous relationship. Figure 2 shows the electrical circuit of the modulator unit used with the recorder. It consists of a push-pull 18-kc oscillator, which is amplitude modulated by the 60-cycle line frequency through the modulation transformer, T_1 . Mixing of this modulated 18-kc carrier with the incoming audio frequency is accomplished by the balanced attenuator network shown in the upper portion of the figure.

Referring to Fig. 1 again, the block marked "Playback" represents the recorder when used as a playback machine. When a tape, which has been previously recorded with the equipment shown on the left side of Fig. 1, is played back, the output from the machine contains the audio intelligence and the 18-kc amplitude modulated carrier.

This signal is fed into the equipment shown in Fig. 3 which is the differential speed detector and power amplifier. This equipment controls the speed of the playback so that the rate at which the tape travels is exactly the same as the film playback. In Fig. 3 the block breakdown of the equipment used for this purpose is shown. In the upper left corner, the output of the playback amplifier enters the speed control system. In passing through the 18-kc rejection filter, the carrier and its modulation are removed, leaving only the audio intelligence at the output terminals. Before the 18-kc rejection filter, a tap is made which takes the 18-kc modulated carrier and the audio to the

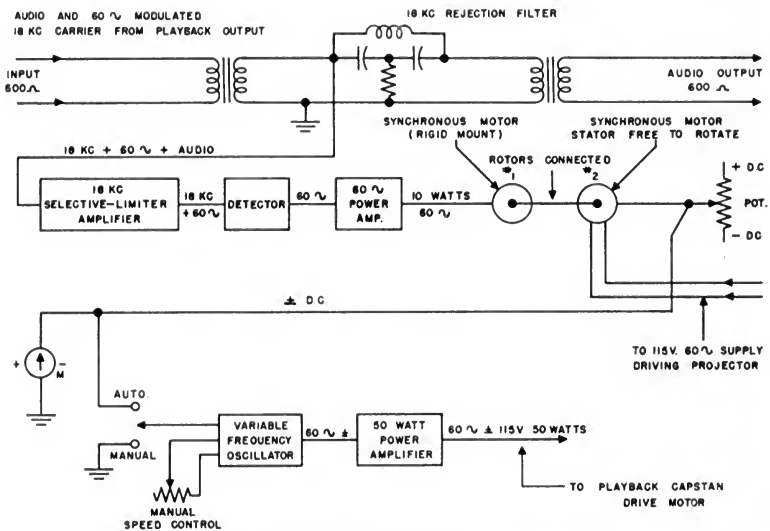

Fig. 3. Differential speed detector and power amplifier.

input of the 18-kc selective-limiter amplifier. Output of this amplifier feeds a conventional full-wave detector circuit which delivers at its output the approximately 60-cycle line frequency. The word "approximately" is used in this case because thus far we have not considered where the correction in the tape speed occurs. The 60-cycle output from the detector drives the power amplifier which delivers approximately 10 watts of power at 60 cycles. This amplifier has in its output stage two 6V6-type tubes. The heart of this synchronizing equipment lies in the use of the two synchronous motors shown at the output of the 60-cycle, 10-watt amplifier. The synchronous motor which receives its input from the 10-watt amplifier

is mounted rigidly. The output shaft of this motor is directly connected to the output shaft of an identical motor, but the second motor is mounted in such a way that its stator is free to rotate through approximately 180 degrees. When its stator rotates it operates the potentiometer shown to the right of these two motors. The second motor obtains its input from the 60-cycle supply used in operating the projector which is projecting the film associated with the sound on the tape being reproduced. The potentiometer driven by the stator of the second synchronous motor supplies a variable d-c voltage to the variable-frequency oscillator shown in the lower left corner of Fig. 3. The variable-frequency oscillator consists of a standard multi-vibrator which has a normal frequency of approximately 60 cycles. The output 60 cycles from the variable-frequency oscillator drives the 50-watt power amplifier, which in turn powers the playback capstan motor. This amplifier uses two Type 807 tubes in the output stage.

Assume for the moment that a tape has been threaded into the playback machine. This tape has previously been recorded by the equipment described in Fig. 2 at the same time that a picture film was made. When the playback equipment is started, the second synchronous motor will begin to operate and turn the potentiometer in such a direction as to increase the frequency of the variable-frequency oscillator. The output frequency of the 10-watt, 60-cycle amplifier will within approximately 0.1 sec be greater than 60 cycles, resulting in a rotational speed difference between the two motors which will very quickly turn the stator of motor number two in the opposite direction from that in which it first started to move, and correct the frequency of the variable-frequency oscillator so that the output derived from the tape exactly matches the power line frequency. When the frequency of the power feeding both of the two motors is identical, there is no resultant rotation of the stator of motor number two. This is the static condition which exists during normal playback. Assume that the frequency derived from the tape was 0.1% low. Then the synchronous motor number one would operate at a slower speed than synchronous motor number two, resulting in a slow change in the position of the stator of number two, which in turn, results in a change in the variable-frequency oscillator which will increase its frequency and hence correct the tape speed.

If it is necessary to cue the sound with the picture, for example during playback of a television show, it is possible to start the equipment a short time before or after the camera is started and have the sound track very closely match the picture. If, however, after starting, the

picture does not synchronize with the sound, that can be very easily corrected by the manual speed control associated with the variable-frequency oscillator. If the operator finds that a correction is necessary, he will make it by turning the manual speed control until the meter in the lower left corner indicates zero. At this time he throws the automatic manual switch to "manual," and increases or decreases the speed of the tape to synchronize it with the picture. When the picture has been thus synchronized, he readjusts the meter to zero, throws the automatic manual switch to the "automatic" position, and allows the automatic correction to carry on from there.

This equipment is designed specifically for use with any Ampex recording equipment and permits its use without requiring any modification of the standard recording equipment. The savings realized through the use of $\frac{1}{4}$ -in. magnetic tape for sound track recording far outweigh the cost of this additional control equipment, and through the use of magnetic tape the motion picture industry can realize even higher quality sound recording than it has in the past.

Electrical and Radiation Characteristics of Flashlamps

BY H. N. OLSEN AND W. S. HUXFORD

DEPT. OF PHYSICS, NORTHWESTERN UNIVERSITY, EVANSTON, ILL.

SUMMARY: Measurements of flashtube current and potential have been obtained using a radar synchroscope, and from these the power and energy supplied to the discharge for a wide range of operating conditions. Simultaneous observations of the time variation of the radiation in three spectral regions were recorded using multiplier phototubes. A lag of several microseconds in peak radiation behind peak power input is observed, the lag increasing with wavelength of the intense continuum produced by these discharges in rare gases. In addition to this change in quality of the radiation with time during the flash period, an increase in radiation efficiency with energy input occurs, the rate of increase being the highest for short wavelengths.

THE MOST INTENSE light source commonly available is the brilliant flash produced by the discharge of a condenser through a gas at reduced pressures. The spectrum of the radiation emitted is a continuum upon which a few emission lines are superimposed. In appearance the light is an intense white and produces an effective duplication of daylight illumination for photographic purposes. During the recent war, high current flashtubes were used extensively in reconnaissance photography. More recently rapid advances have been made in the application of gaseous discharge flashlamps in high-speed photography.¹ They are commonly employed for stroboscopic work and have recently been used in airport runway marker systems.

Intensities as high as 10^6 candles/sq cm have been obtained in single flashes in lamps where the average power input is 10 megawatts during the period of the flash. Light output efficiencies of the order of 50 lumens per watt have been measured in single-flash, high-current discharge tubes.²

The present report is concerned with electrical and radiation characteristics of flash discharges in quartz tubes filled with rare gases having pressures in the neighborhood of 100 mm Hg. Current, potential, and power input to the discharge, and light output as measured by means of phototube multipliers, were recorded on an oscilloscope screen. A triggering circuit has been designed to produce synchronous current pulses with a repetition error less than $0.1\mu\text{sec}$ (microsecond). Repetitive flashing at rates of from 1 to 60 flashes/sec were used in these experiments.

PRESENTED: April 26, 1950, at the SMPTE Convention in Chicago.

SEPTEMBER 1950 JOURNAL OF THE SMPTE VOLUME 55

285

Radiation efficiencies are found to increase rapidly with energy input in the visible and ultraviolet regions. In the present work separate radiation-time curves for the ultraviolet, visible and near infrared regions were obtained. In all cases the radiation reaches a peak several microseconds after the peak input power, the maximum emission occurring at progressively later times the longer the wavelength.

APPARATUS

Synchronous Pulse Generator

The equipment used for synchronous operation of flashtubes is shown in the block diagram, Fig. 1. A 10-in. disc of Dow metal is driven

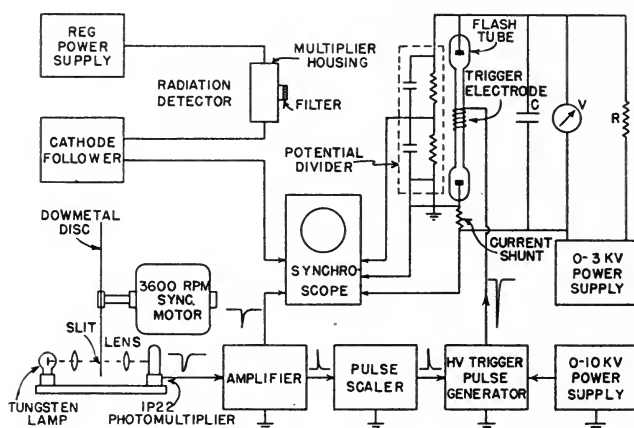

Fig. 1. Block diagram of apparatus.

at 3600 rpm by a Bodine Electric Co. $\frac{1}{20}$ -hp synchronous motor. A 0.2-mm radial slit on the periphery of the disc passes light from the linear filament of a GE Mazda, 75-v, 4-amp movie exciter lamp to an RCA 1P22 photomultiplier tube to provide sharply defined current pulses. These pulses are amplified and used to trigger the oscilloscope sweep and also to initiate the discharge in the flashtube.

A scaler circuit provides pulsing rates lower than the 60 pulses/sec set up in the multiplier. It consists of six binary stages so arranged that any desired number may be inserted in the circuit to reduce the pulsing rate by a factor 2^n , where n is the number of stages used. Thus, in addition to the 60 pulses/sec initial rate six other rates of 30, 15, 7.5, 3.75, 1.88 and 0.94 pulses/sec are available. In this

manner a wide variety of flash energies may be employed, permitting the average power input to the flashtube to be kept low enough to prevent overheating or excessive sputtering of electrode materials.

The flashtubes had plane parallel electrodes 17 cm apart, separated by a quartz envelope 16 cm long with an internal diameter of 4 mm. Most of the data here reported were obtained with tubes filled with neon or argon at a pressure of 75 mm Hg. The electrodes were connected permanently to a condenser charged to a potential less than the breakdown voltage (~ 4000 v) of the gases used. The discharge is initiated by the application of a very rapidly changing potential to an external "trigger" electrode located near the center of the quartz envelope. The action of the rapidly changing field is to produce sufficient ionization of the gas for a discharge to occur, and the condenser potential decreases in a few microseconds from an initial value of 1500–3000 to a few hundred volts. The dielectric strength of the un-ionized gas is restored in a few tenths of a millisecond after the initiation of the high-current arc. A power supply is used which is adequate to charge the condenser to the original potential between recurring discharges.

Control and Measuring Circuits

Figure 2 gives a detailed diagram of the pulse network, the current shunt and the potential divider circuit arrangement, and the multiplier phototube connections to the synchroscope.

To provide high-voltage pulses for initiating the discharge, the amplified photo-current pulses from the scaler circuit are transformed to very sharp positive pulses by an RCA 884 thyratron. These pulses are then impressed upon the grid of a Western Electric 5D21 hard tube pulse tetrode, normally biased to cut off, reducing the plate impedance from a high to a very low value. The trigger electrode is connected directly to the plate of the 5D21 tube and through a one-megohm resistor to a variable high-voltage supply. When a positive pulse reaches the grid the tube conducts and causes a sharp reduction in the potential of the external electrode from several thousand volts to a very low value. Observations using the fast sweep of the synchroscope indicated that the change occurs in less than $0.1 \mu\text{sec}$, or at a rate greater than 10^{11} v/sec. It was possible in this manner, using 6000 to 8000 v on the trigger electrode, to pulse successfully all the tubes used in this work in a perfectly consistent manner at any arbitrary rate for which overheating of the electrodes did not occur, and for observation periods of an hour or more.

All measurements were made with a Navy radar synchroscope

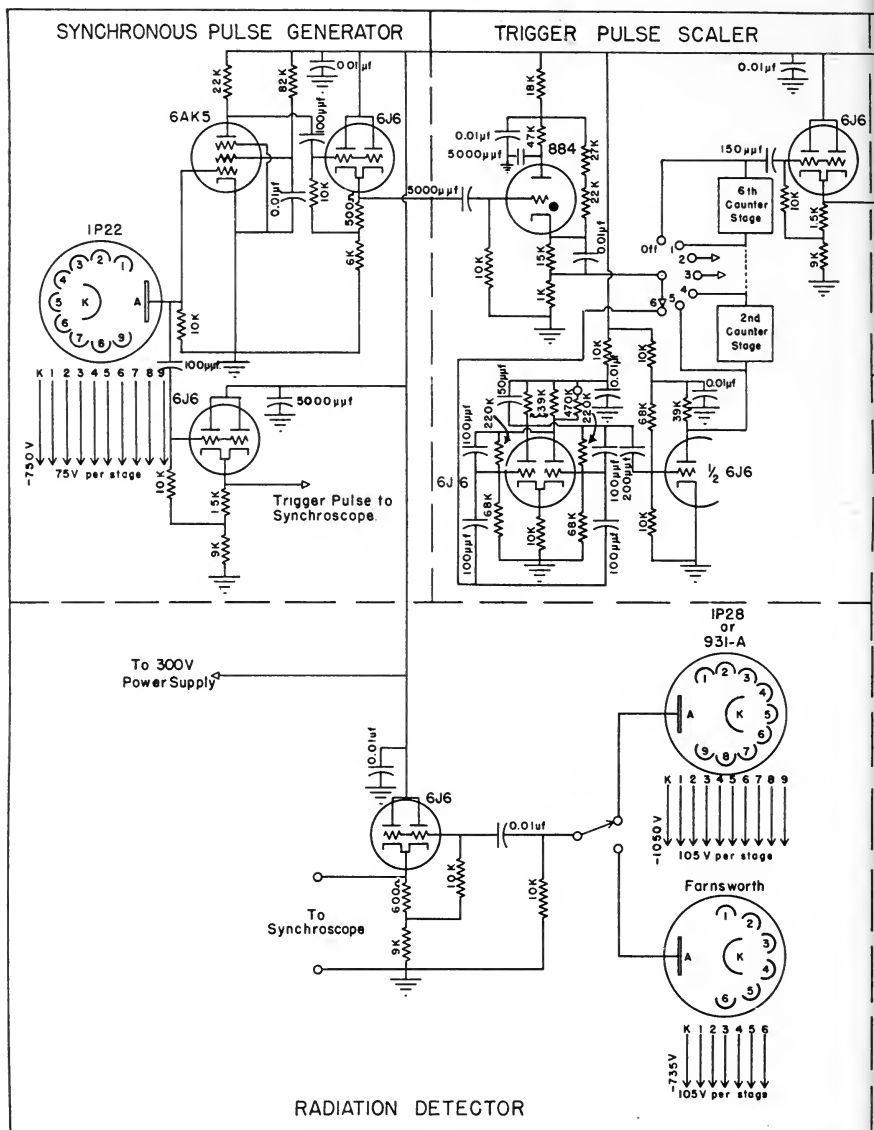
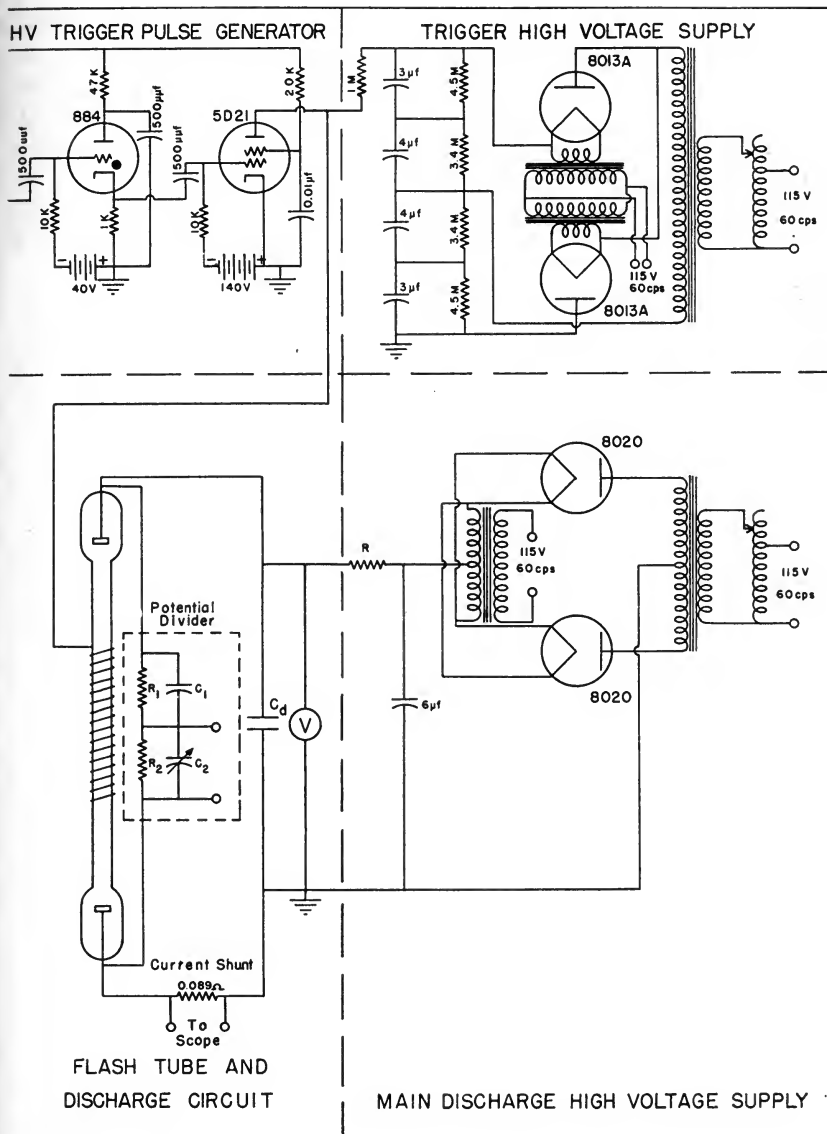

Fig. 2. Detailed



circuit diagram.

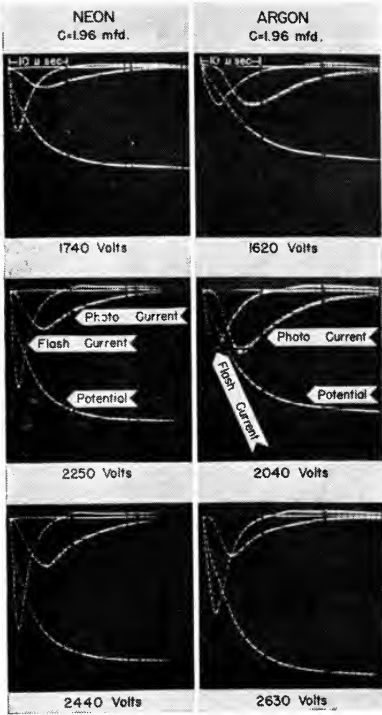

Fig. 3. Synchroscope traces of flash current, potential and photo-current.

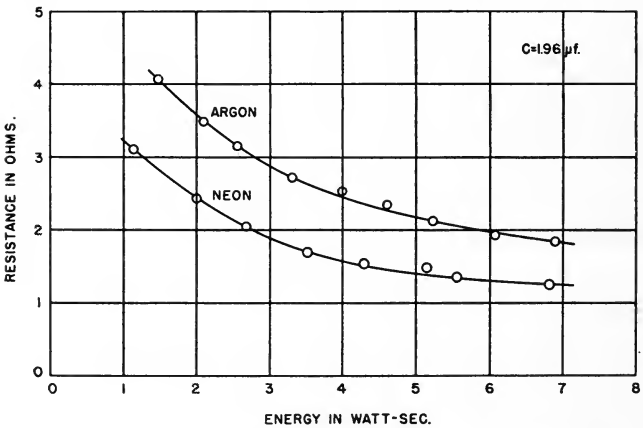

Fig. 4. Variation of tube resistance with flash energy.

Model TS-28/UPN having sweep ranges of 1-2, 10, 25 and 60 $\mu\text{sec}/\text{in.}$, and provided with time markers. The sweep was triggered by means of a positive or negative pulse from the pulse generator circuit. The low-impedance input circuits were properly matched with well shielded coaxial cables. Care was taken to use identical cables in order to give correct phase relations between current, potential and light pulses. Direct connections to the deflection plates were made at a terminal strip on the back of the instrument.

The experimental data were obtained from photographs of the synchroscope screen showing the synchronized recurrent traces of potential, flash current and photo-currents due to the emitted radiation. Successive exposures on the same negative were made of all pertinent traces for a given set of conditions in the flash-tube circuit. These photographed traces of the current, potential and radiation pulses are thus recorded on the same negative in the correct relative phase relationship.

Measurement of tube potentials was carried out by means of a compensated and shielded high-resistance voltage divider. Space does not permit a detailed description of this unit and of the care taken in determining the correct method of its use in the flash circuit.³ Check measurements showed that tube potentials read from the synchroscope photographs were in error by not more than $\pm 5\%$ for values above a few hundred volts.

Current pulses were obtained by the use of a specially constructed bifilar shunt element having a resistance of .089 ohm. Such elements are commonly employed in measuring heavy lightning surge currents.⁴ Peak pulse current values determined from oscilloscope traces were checked against magnetic link measurements. The greatest difference at high values of current, where errors due to self-induction in the shunt are largest, was about 8%. The average deviation in mean current values as determined by comparing the charges delivered by the condenser with the charges obtained by graphical integration of the synchroscope current trace amounted to $\pm 3\%$.

For radiation measurements in the ultraviolet region an RCA 1P28 multiplier phototube was used in conjunction with a Corning 9863 filter to give an over-all response extending from 2400 Å (Angstrom units) to 4200 Å with a peak at 3350 Å. For the broad "visible" region an RCA 931-A multiplier was used without filter. A narrow visible band was obtained by using the 1P28 multiplier with a Wratten K-3 (No. 9) filter which limited the response to the region between 4600 Å and 7000 Å. A six-stage Farnsworth multiplier with Cs-Ag-O cathode was used in conjunction with a Wratten A (No. 25) filter to

provide a response ranging from 6000 A to 12,000 A with a peak at 8500 A in the near-infrared region.

Since peak light intensities ranging up to 10,000,000 lumens are encountered at the highest flash energies, considerable attenuation was required to limit the operation to the region of linear response of the multipliers. A fixed amount of attenuation was provided by placing a piece of exposed photographic film over the opening in the multiplier housing. For controlling the photomultiplier currents during a series of measurements ranging from low to high peak light intensities a neutral Eastman Kodak filter having calibrated sectors was employed. In the present study light intensities are expressed in arbitrary units in each of the three spectral regions.

EXPERIMENTAL RESULTS

Figure 3 shows typical photographs of current, potential and photo-current traces for flash discharges in neon and argon. Exposure times of from 40 to 60 sec were required, so that at the repetition rate of 0.94/sec, each trace represents a large number of recurring discharges. The sharpness of these composite traces indicates the very precise manner in which the discharge repeats itself.

In these pictures the photo-current trace was obtained with the 931-A multiplier phototube and denotes radiation emitted in the broad visible range. Peak light intensities lag behind peak currents by about 5 μ sec at low potentials. This lag decreases as the input energy per flash is increased. The main objective of the present investigation was to study in detail the changes in intensity and quality of the radiation with energy input and with time during the flash period.

Flashtube Resistance

Following the method of Murphy and Edgerton,⁵ a quantity is used which we have called the "tube resistance." It is defined by the relation

$$R_t = V_m/I_m, \quad (1)$$

where I_m is the value of maximum flash current, and V_m is the potential difference between the electrodes at the time of peak current.

The variation of R_t with energy input per flash in neon and argon flashtubes of identical size and gas pressure is shown in Fig. 4.

It is found that the flash current decays in an exponential manner according to the equation

$$i = I_{\max} e^{-\lambda t}, \quad (2)$$

where the values of λ are given, within a mean error of $\pm 20\%$, by the relation

$$\lambda = 1/R_t C. \quad (3)$$

This shows that the rate of discharge of the capacitance, C , is very closely that to be expected in an RC circuit in which R is equal to the "tube resistance" defined in Eq. (1).

Energy Supplied to the Discharge

In order to determine radiation efficiencies, the fraction of the capacitor energy actually consumed in the discharge must be known. The power delivered to the tube as a function of time is calculated

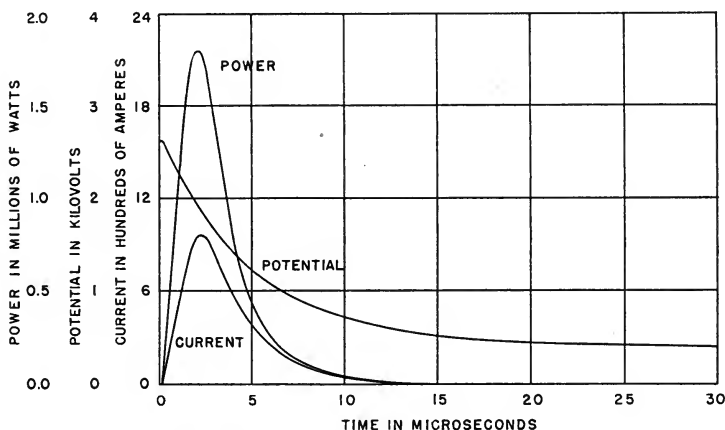

Fig. 5. Computed power-time curve.

from the product of simultaneous values of current and potential. An example of a power curve obtained in this way from replotted synchroscope traces is shown in Fig. 5. Graphical integration of the power curve yields, for each flashing condition, the energy delivered *per flash* to the discharge.

Energy calculations were carried out for one neon tube and one argon tube; three capacitors were used with potentials ranging from 1000 to 3000 v. The results appear in Fig. 6, where energy in watt seconds per flash is plotted against peak current values, both scales being logarithmic. Within the limits of experimental error, energy per flash is proportional to peak current, for a constant value of capacitance and variable voltage.

The measured energy consumed by the discharge differs from the energy of the charged capacitor by a fraction of one per cent at low potentials, and increases up to 15% at high potentials. The discrepancy will be much greater in circuits where lead wires of minimum length are not employed. In the present experiments the losses in leads and condensers correspond to those in a resistance of the order of 0.1 ohm in addition to the .089-ohm resistance of the current shunt.

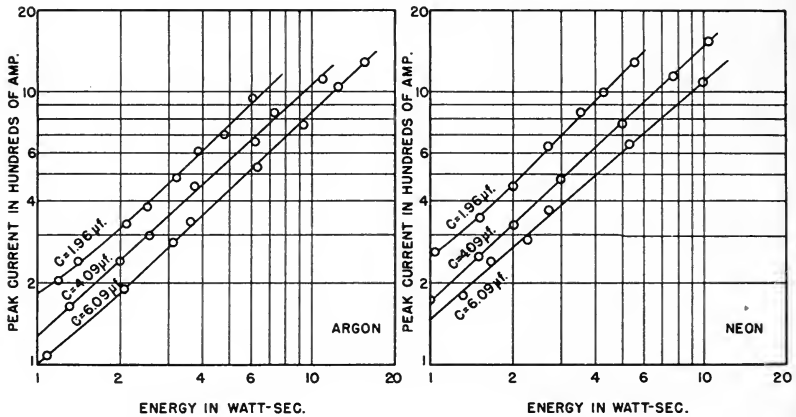

Fig. 6. Peak current vs. measured energy per flash.

Radiation Intensity vs. Input Energy

Measurements of the intensity of emitted radiation averaged over the entire flash period, determined either from single flashes or by using repetitive flashing, have shown that the following relation holds approximately:

$$\bar{S} = cW^n. \quad (4)$$

Here \bar{S} is the average (integrated) intensity, c is a constant for a given tube, W is the energy of the charged condenser, and $n \geq 1$, its value depending upon the filling gas and spectral quality of the radiation reaching the phototube.

Examples of such results are shown in Fig. 7 for GE FT-14 xenon-filled flashtubes. Curves (a), (b) and (c) were obtained in this laboratory at low pulse rates (~ 10 pulses/sec), using widely different values of capacitance. Readings were made using a 931-A phototube multiplier, and light intensity and flash energy are expressed in arbitrary units. Curve (d) is taken from results published by Edgerton, and the

Fig. 7. Radiation intensity vs. capacitor energy for GE xenon flash lamps.

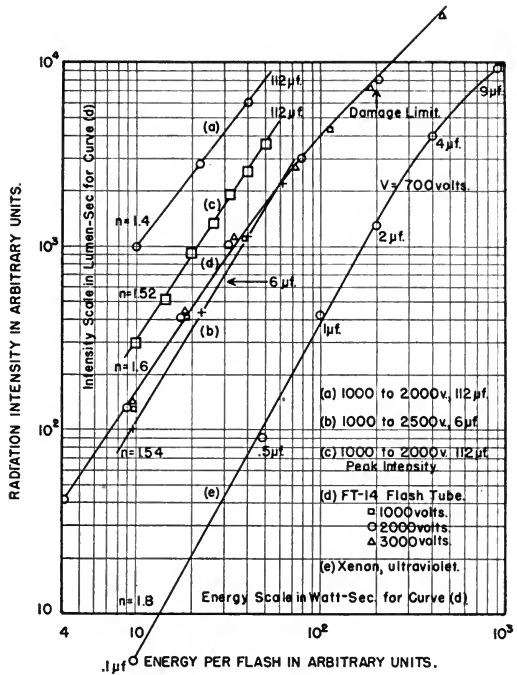
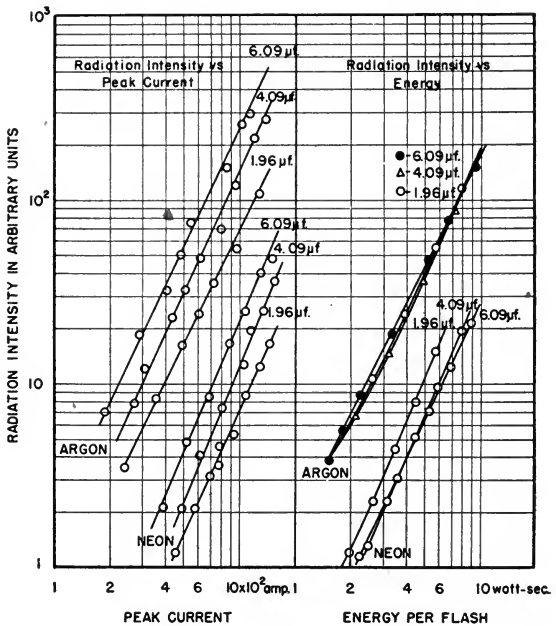

Fig. 8. Radiation intensity vs. peak current and flash energy for argon and neon.



integrated radiation is given in lumen-seconds as a function of the condenser energy per flash in watt-seconds. The value of n in all of these plots is about 1.5.

If an ultraviolet filter is used, light in the near ultraviolet region can be recorded. The FT-14 Tubes have a pyrex envelope and protecting outer chimney of pyrex, so that short-wave ultraviolet light is not transmitted. For this radiation the plot of Fig. 7 (e) was obtained, the slope of which yields the value $n = 1.8$. A large number of measurements on similar xenon-filled tubes of pyrex yielded a mean value of $n = 1.77$.

Additional measurements using a Farnsworth multiplier and infrared filter showed that $n = 1.0 \pm 0.1$ for xenon flashtubes. Hence, in the near infrared spectral region the efficiency is constant, the light intensity increasing linearly with flash energy.

The results of measurements of the integrated radiation emitted by argon- and neon-filled quartz tubes made in this laboratory, using a 931-A multiplier with no filter, are shown in Fig. 8. The mean value of n for argon is 2.15; for neon, 2.3. When measurements were carried out in the three spectral regions with the photomultiplier tubes and filters, described under Apparatus above, the results shown in Table I were obtained for radiation integrated over the entire flash period.

TABLE I. Value of n in the equation $\bar{S} = cW^n$

Region	Spectral Range	Mean Values of n	
		Neon	Argon
Ultraviolet	2400- 4200 Å	2.8	2.3
Visible.	4600- 7000 Å	2.1	1.8
Infrared	6000-12,000 Å	1.6	1.2

Phase Lag of Light With Respect to Flash Current

Ultraviolet radiation peak intensities and to a lesser extent peak visible light intensities in both neon and argon were found to increase more rapidly with flash energy than do the mean values of the integrated light intensities. In addition, these peak values occur earlier in the flash period the shorter the mean wavelength of the spectral region. This is indicated very clearly in the synchroscope traces of Fig. 9 for photo-currents in the three multipliers for identical flashing conditions. In these plots photo-currents representing light intensities in the three regions of the spectrum have been plotted so that peak values are nearly the same. Light intensities are comparable

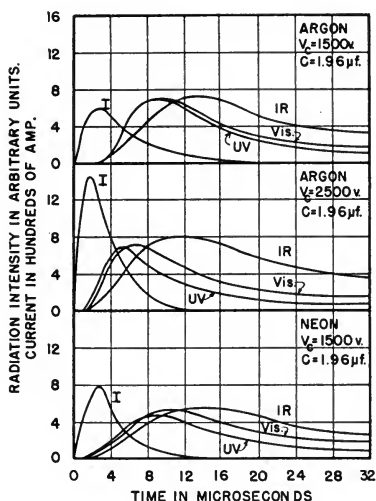

Fig. 9. Photo-current traces in three spectral regions.

only for any one trace; actually the intensities are highest in the ultra-violet, nearly as high in the visible and much lower than either of these in the infrared region.

DISCUSSION

There are two aspects of the results obtained in this work which are of importance in the use of flashtubes for photographic and illumination purposes, and which require consideration in a detailed analysis of the discharge process. The first is the rapid increase in radiation efficiency with energy input, the increase being greatest for short wavelengths. A study of flash discharges in capillary tubes reported by Hahn and Finkelnburg⁷ showed that the intensity of the continuum at all wavelengths increased as the *square* of the current density for densities greater than about 70,000 amp/sq cm. These authors believe that this continuum is largely due to the retardation of electrons in the fields of the ions in the discharge plasma (Bremscontinuum).

Observations in this laboratory of the nature of line spectra emitted by flash discharges show that, in the decaying portion of the radiation pulse, recombination of electrons and ions is occurring at a rapid rate. This process, involving "free-bound" transitions between electrons and ions, must also contribute to the observed continuum. The fact that radiation intensities vary not simply as I_{\max}^2 (where I_{\max} is the peak current), but as I_{\max}^n , where n varies from 1.2 to nearly 3.0 depending on wavelength, indicates that probably the exciting elec-

trons undergo considerable change in velocity distribution during the flash period thereby modifying the simple quadratic relationship predicted for Bremsstrahlung and recombination continua.

The second aspect to be noted is the fact that peak radiation occurs at different times depending on the spectral region observed. This phenomenon suggests the conception that the densely ionized plasma radiates as a "gray body" and exhibits a spectral maximum which is temperature dependent. Early in the discharge cycle the radiation peak is in the ultraviolet region indicating a high electron temperature. With cessation of current flow the plasma cools rapidly due to radiation, conduction and convection, and due also to the rapid expansion of the hot gases in the discharge column. As the mean electron temperature falls, the radiation peak shifts to longer wavelengths much as in the case of incandescent solids. Observations of electron excitation temperatures, both as a function of time during the flash and as a function of the energy supplied to the discharge, are being carried out in this laboratory in an attempt to correlate these two aspects of the condensed flash discharge.

REFERENCES

1. "High-speed photography," *Jour. SMPE*, vol. 52, pp. 5-116 of Part II, Mar. 1949.
2. J. H. Aldington, "The high intensity flash discharge tube," *Endeavour*, vol. 7, p. 21, Jan. 1948.
3. A description of a similar device has recently been published: H. J. White, "Transient response of high voltage resistance dividers," *Rev. Sci. Instr.*, vol. 20, pp. 837-839, Nov. 1949.
4. John H. Park, "Shunts and inductors for surge-current measurements," *J. Res. Nat. Bur. Stand.*, vol. 39, pp. 191-272, 1947.
5. P. M. Murphy and H. E. Edgerton, "Electrical characteristics of stroboscopic flash lamp," *J. App. Phys.*, vol. 12, pp. 845-855, Dec. 1941.
6. H. E. Edgerton, "Photographic use of electrical discharge flash tubes," *J. Opt. Soc. Amer.*, vol. 36, pp. 390-399, July 1946.
7. O. T. Hahn and W. Finkelnburg, "Continuous Bremsstrahlung and recombination radiation of electrons in the gas discharge plasma," *Zeits. f. Phys.*, vol. 122, pp. 37-48, 1944.

The Cine Flash

A New Lighting Equipment for High-Speed Cinephotography and Studio Effects

By H. K. BOURNE

MOLE-RICHARDSON (ENGLAND) LTD., LONDON, ENGLAND

AND E. J. G. BEESON

THE BRITISH THOMSON-HOUSTON CO. LTD., RUGBY, ENGLAND

SUMMARY: A new form of portable lighting equipment is described which has been designed especially to meet the needs of the high-speed cinephotographer who is always faced with the difficulty of obtaining sufficient light. Two compact-source mercury cadmium lamps are operated in series at their normal wattages of 1 kw, and are then flashed at 3, 5 or 10 kw for 5, 2 or 1 sec. The equipment consists of a control unit and two lightweight lamp-houses.

The light output is sufficient for color photography at speeds up to 3000 frames/sec, or for black-and-white photography with small lens apertures to give considerable depth of focus. The flash may be triggered from a micro-switch or from a camera switch. The steady light output from the lamps is sufficient to arrange and focus the subject.

METHODS OF ILLUMINATION

FOR THE SCIENTIFIC PHOTOGRAPHER the high-speed cinecamera is a valuable and potent tool enabling him to study extremely rapid motion with ease and certainty.¹ Projection of the cinefilm at a low speed enables the apparent movement to be slowed down so that it can be followed by normal vision. Using this technique, or that of projection frame by frame, a detailed analysis of the motion can be made and data such as the velocity, acceleration and position of the object under observation at various instants may be obtained. To the designer of machinery in particular, the technique of high-speed cinephotography has proved invaluable; without it many of his more difficult problems would still remain unsolved. Also, in the science of ballistics many advances may be attributed directly to the use of the high-speed cinecamera.

The chief applications of high-speed cinephotography lie in the fields of science and industry.² Modern high-speed cameras used in the majority of these applications generally operate at speeds up to 3000 frames/sec. At such speeds the exposure time is extremely short: only $\frac{1}{15000}$ sec at 3000 frames/sec. Such a short exposure

PRESENTED: October 13, 1949, at the SMPE Convention in Hollywood.

time necessitates an extremely high illumination; for example, even with a very rapid film such as Kodak Super XX, an illumination of some 10,000 ft-c (foot-candles) will be required to expose an average subject with an aperture of $f/2.8$ at 1500 frames/sec. Owing to the slow emulsion of color film, it is even more difficult to provide sufficient illumination for high-speed color cinephotography, and the photographer is continually faced with the problem of obtaining enough light to allow a small enough lens aperture to give adequate depth of focus. Fortunately in many applications of high-speed cinephotography the subject is small in size and an illuminated area of only 6 to 12 in. in diameter is often sufficient. It is fortunate too that at these high speeds long periods of exposure are rarely necessary and useful total exposure times generally lie between 1 and 5 sec. It thus appears that a lamp providing up to 100,000 ft-c over an area of not more than 1 ft in diameter, for a duration up to 5 sec, would satisfy many of the needs of the high-speed cinephotographer. Because many of the applications are in factories, laboratories and industrial organizations, light weight, robustness and portability are other essential requirements for the equipment.

The difficulty of obtaining adequate illumination was stressed in this Society's Symposium³ which included a number of valuable papers dealing with various aspects of the subject. In one paper dealing with lamps for high-speed photography, the requirements of the ideal light source were outlined and the paper then described the various methods which are being used for providing illumination. Each of these methods has certain limitations.

In the past, photographers have generally used standard film-studio incandescent spotlights for lighting the subject. For example, one M-R 414 Fresnel-lens spotlight with a 5-kw incandescent lamp produces approximately 10,000 ft-c over a 12-in. diameter spot at a distance of 5 ft. It is however, difficult to group enough spotlights closely together to obtain sufficient illumination; again, heating of the subject is extremely severe so that special means of cooling are often necessary. Another interesting but expensive method of lighting used in the United States⁴ is to produce a short continuous flash by successive firing of a number of aluminum foil flashbulbs mounted on a rotating disc and passing in turn in front of a mirror. Highly loaded, short-life filament lamps intended only for intermittent burning have also been employed successfully.⁵ The electronic flashtube is another light source which provides an extremely high light intensity but the duration of the flash is only a few microseconds so that, while it is eminently satisfactory for taking



Fig. 1. 1-10-Kw pulse-type compact-source lamp.

single high-speed still photographs, it is not suitable for cinephotography.⁶

None of the above methods meets all the requirements of the high-speed cinephotographer. The development of the discharge lamp has made possible a new means of obtaining a sufficiently high light output by flashing the lamp at a high overload, and special equipment has been designed to utilize this principle.

Certain technical problems necessitate ultra-high-speed photography at speeds far higher than 3000 frames/sec. Special cameras

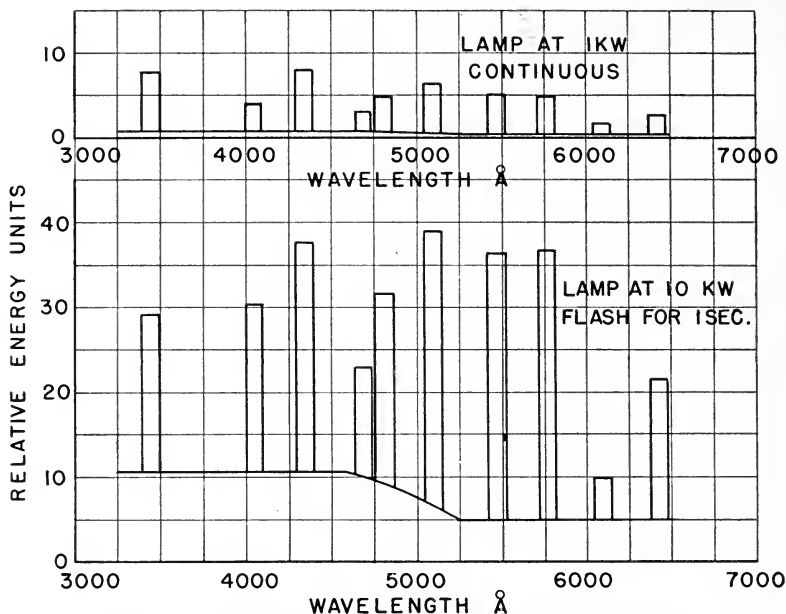

Fig. 2. Spectral distribution of mercury cadmium lamp.

are required, together with still higher lighting intensities. In this field, too, the new lighting unit described in this paper should be more effective than other sources hitherto available.

THE COMPACT-SOURCE LAMP

The compact-source mercury vapor lamp which is available in sizes from 250 to 10,000 w in England is now also becoming known in the United States.⁷ A typical lamp, which is shown in Fig. 1, consists of a spherical transparent quartz bulb containing mercury and a rare gas filling. Two tungsten electrodes between which an arc operates are sealed into the bulb and the current is led in by molybdenum foil seals diametrically opposite to one another. Brass caps are fitted at the end of the seals. Connections are made through a flexible lead to the anode and through the special base to the cathode of the lamp. The light source itself is small in size and has a brightness of approximately 35,000 candles/sq cm with a luminous efficiency of 45 to 50 lumens per watt. At the normal rated power the life of the lamp averages 500 hr. An important feature of the compact-source lamp is that it may be operated for short periods at ratings greatly in excess of its normal power, and under these pulsed conditions it produces a correspondingly high light output.⁸

The radiation from a compact-source mercury vapor lamp is dis-

continuous and consists mainly of yellow, green and blue lines superimposed on a relatively weak continuous spectrum. Owing particularly to the deficiency in red content this light source produces a distorted rendering of colors but a considerable improvement in the color rendering can be obtained by the addition of cadmium in the discharge.⁹ The discharge in cadmium vapor produces a powerful red line in the spectrum, while the gaps in the blue-green region of the mercury spectrum are filled by additional lines, so that the color of the radiation is better balanced. The color rendering also improves with increased current density in the arc so that the higher the wattage of the lamp the better is the color rendering. This improvement is due partly to broadening of the lines and partly to an increase in the amount of continuum at the higher current density. Spectral distribution diagrams of the mercury cadmium lamp operating at 1 kw and at 10 kw are shown in Fig. 2. These diagrams show that gaps still remain in the spectrum, but in spite of these gaps practical tests have shown that mercury cadmium compact-source lamps operating at powers above 2.5 kw give a satisfactory rendering of color with Kodachrome Daylight and similar emulsions.

CINEPHOTOGRAPHY ILLUMINATOR

A portable equipment using the principle of flashing a compact source lamp has been designed specifically to meet the illumination requirements of the high-speed cinephotographer. One equipment, known as the M-R 356 Cine Flash, illustrated in Fig. 3, consists of two lamp heads mounted on stands, and a control unit containing the ballast resistance and other components for operating the lamps.

The lamphouse, an interior view of which is shown in Fig. 4, is of a light sheet-metal construction. It contains a compact-source lamp mounted along the axis of a paraboloidal mirror and is fitted with a front diffusing glass. This optical arrangement gives a high light collection efficiency combined with uniform distribution. The mirror is made of metal so that it is robust and not liable to damage during transport of the equipment. By releasing the locking screws at the rear of the lamphouse, the lamp may be removed through the front of the housing for transport. The high-frequency choke required for the impulse striking circuit is mounted behind the mirror in the lamphouse.

The lamp is mounted in a prefocused holder and the focal position is set normally to produce a spot 10 in. in diameter at a distance of 4 ft from the unit with an illumination constant to within $\pm 15\%$ over its area. A fixed rather than variable focus ensures that the light output from the unit is constant so that the photographic exposure



Fig. 3. Cine Flash Equipment.

can be repeated accurately by setting the lamp at predetermined measured distances from the subject. In cases where it is necessary to cover a wider area with the lamps, the spread can be increased approximately threefold by using a front glass giving greater diffusion, but the light intensity is reduced to approximately $\frac{1}{10}$ in this case. A polar distribution curve of the equipment operating at 1 kw with the standard diffusing glass is shown in Fig. 5.

The light source is a color-modified mercury cadmium compact-source lamp normally rated at 1000 w but it differs from the standard type in that it has been designed specifically for this flashing service. The bulb is similar in design and dimensions to a standard lamp but special massive electrodes visible in Fig. 1 are provided to withstand

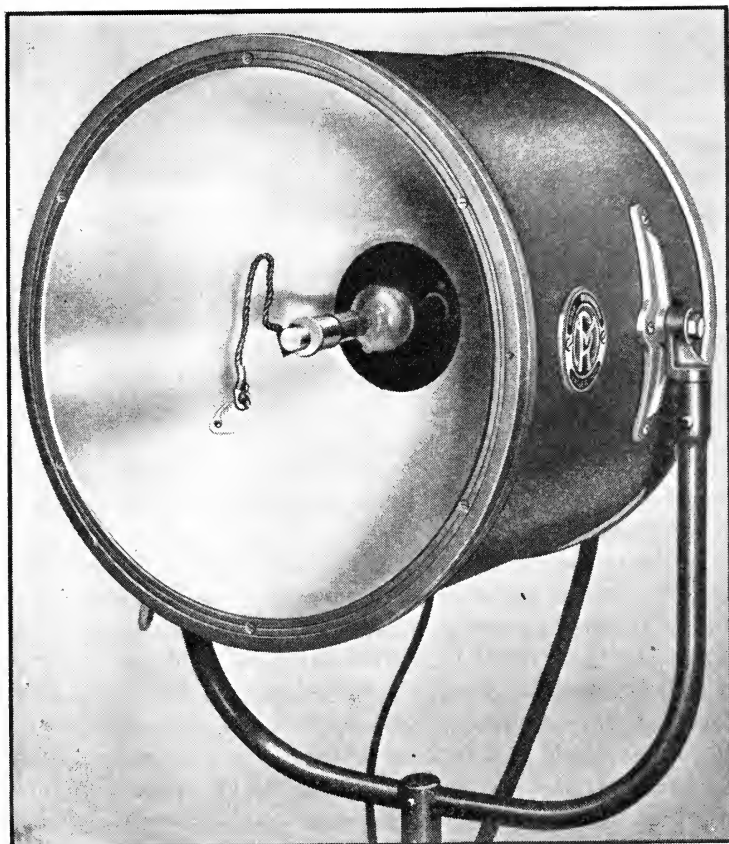

Fig. 4. Lamphouse with front glass removed.

the heavy overload conditions of flashing without fusing and consequent blackening of the bulb. A special construction giving good heat conduction is used to prevent melting of the electrode tips during the pulse. The very high current density in the flash condition ensures that the color of the radiation is good. As repeated flashing causes a further slight increase in the red content due to additional evaporation of cadmium at the higher bulb temperature, the color of the radiation does not stabilize completely until the lamp has been flashed several times in succession. Before taking a color photograph with this equipment, to ensure the best color rendering, it is therefore advisable to stabilize the color of the radiation by flashing the lamp several times. Alternatively the bulb may be preheated by a continuous moderate overload of some 50% for 30 sec. The overload is applied by depressing a push button; when this button

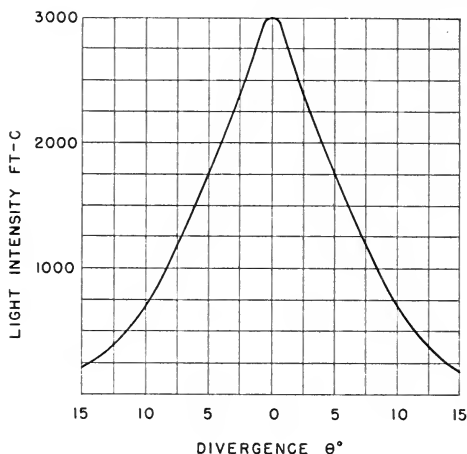

Fig. 5. M-R 356 Cine Flash polar distribution; lamp operating at 1 kw, measured at 10 ft with normal diffuser, 18,430 lumens from each lamp.

is pressed a red warning lamp lights up to indicate that the lamp is being overloaded.

The light output from a discharge lamp follows changes in the current through it almost instantaneously. For example when a compact-source lamp operates on alternating current at 50 cycles/sec. the light falls to 4% of the maximum at the end of each cycle. In order to prevent cyclic changes in exposure of the film it is therefore necessary to operate the lamp on a smoothed d-c supply and the ripple voltage should preferably not exceed 10% of the supply voltage.

The control unit is designed normally for operation from a 200- to 250-v d-c supply. When no d-c supply mains are available, the equipment must be operated either from a three-phase rectifier unit or from a mobile d-c generator.

OPERATION OF THE EQUIPMENT

The first type of equipment to be built consisted of a control unit with one lamp head. This equipment was demonstrated at the Royal Photographic Society on January 13, 1949, and subsequently at the British Kinematograph Society. Generally, however, two light sources are necessary for photography to obtain the necessary light distribution and modeling. Later equipment was therefore redesigned to operate two lamps in series with a single control unit thus enabling the light output to be doubled for the same current from the supply.

A mains voltage selector link on a panel at one end of the control unit is provided for setting the equipment for the particular supply voltage which can be read on the panel voltmeter. This ensures that

the lamps will always operate at their correct wattage. The lamps are started by a high-voltage impulse circuit contained in the control unit, the impulse being applied to the lamp through an insulated high-tension cable. The circuit produces a steep-fronted impulse of approximately 15 kv and will reignite the discharge even if the lamp has not cooled down completely so that inconveniently long delays usually associated with high-pressure mercury vapor lamps are reduced. The arc is ignited by opening and closing a spring-loaded striking switch on the control unit. This switch discharges a condenser through the primary of the pulse transformer and produces a high-voltage high-frequency impulse across the secondary winding. A high-frequency choke in series with one of the lamps and mounted in the lamp housing prevents the impulse from being short circuited by the low-impedance path through the supply mains.

Immediately the lamps strike, the lamp voltage indicated on the voltmeter falls to approximately 20 v and as they warm up the lamp voltage rises. When the total lamp voltage reaches approximately 100 v the starting resistance which limits the starting current should be short circuited by throwing the starting switch over to the "Run" position. After this the lamps will rapidly reach their final operating condition. Interlocking of the starting and striking switches prevents accidental striking of the lamp if the starting switch is in the "Run" instead of the "Start" position. The run-up process takes approximately 10 min.

The lamps are operated normally at 1000 w with a series ballast resistance. To flash the lamps a section of the resistance is short circuited by a contactor, the duration of the flash being predetermined by a resistance-condenser timing circuit. Selector switches controlling the power and duration of the flash are interlocked to give flashes of 3 kw for 5 sec, 5 kw for 2 sec or 10 kw for 1 sec, as required. The duration of the flash and the power in it are limited by temperature considerations; at 5 and 10 kw, melting of the electrodes is the limiting feature while at 3 kw the limit is set by heating of the quartz bulb. After the lamps have been flashed, an interval of at least 30 sec must elapse before they are flashed again, in order to prevent damage due to overheating. This interval is provided automatically by a timing circuit which must be reset manually by a push button before the lamp can be flashed a second time. This circuit cannot be reset until the necessary 30-sec interval has elapsed.

The desirability of preheating the lamps before taking a color photograph has already been mentioned. This is done by pressing the "Preheat" button in the control unit. Part of the ballast resist-

TABLE I. Characteristics of 1-10-kw Pulse Compact-Source Lamp

Over-all length	245 mm
Bulb diameter	45 mm
Arc length	6 mm
Lamp wattage	1, 3, 5, 10 kw
Lamp current, approximate	15, 40, 70, 125 amp
Lamp voltage, approximate	70 v

TABLE II. Illumination and Spot Size Given by Cine Flash

Dist., ft	Normal Glass		Glass Giving Wider Divergence	
	Illum. at center of spot, ft-c	Dia. of spot to 70% of max., in.	Illum. at center of spot, ft-c	Dia. of spot to 70% of max., in.
4	150,000	10	16,500	33
5	100,000	11	11,250	36
6	73,500	12	8,100	40
8	41,000	13	4,500	46
10	30,800	15	3,370	50
12	19,800	17	2,180	56
15	11,700	23	1,290	76
20	6,100	24	665	79
30	2,700	32	300	106

The above figures show the illumination and area covered by each lamp at various distances at 10 kw. The illumination at other wattages may be taken as proportional to the wattage.

ance is thereby short circuited and the required overload is applied to the lamps for 30 sec during which time the bulbs reach the correct temperature and the color stabilizes. The lamps should then be flashed within the next 30 sec; if they are not flashed within that time the preheating procedure should be repeated to offset the cooling which has occurred during the waiting period. Preheating is not necessary for black-and-white photography.

The flashing circuit can be operated either by a push button on the control unit or from an external switch connected by flexible leads to a socket in parallel with this push button. Momentary closure by a microswitch will operate the equipment and the flash can be initiated by a normal built-in camera switch such as that used on the Eastman high-speed camera. The time required to initiate the flash is limited chiefly by the speed of closing of the contactor; it is only a few milliseconds. Two sockets in parallel on the control panel enable several units to be flashed synchronously from the same switch if desired.

In normal operation at 1000 w, the lamp current is 15 amp. When

TABLE III. *Light Output From Cine Flash Unit*

	Light intensity at center of 12-in. circle at 4 ft from unit, ft-c	Flash duration, sec	Supply Current	
			230-v, d-c, amp	440-v, 3-ph., a-c, amp per ph.
Cine Flash				
At 1-kw rating	15,000	Continuous	15	5
At 3-kw	45,000	5	40	15
At 5-kw	75,000	2	70	25
At 10-kw	150,000	1	125	45
M-R 414, 5-kw Incan. Studio Spotlight	7,500	Continuous	22	

The figures above give the light output from each lamp with the normal diffusing glass. The values can be doubled if the spots from the two lamps are arranged to overlap one another.

the lamp is flashed at 10, 5 and 3 kw, the respective values of the current are 125, 70 and 40 amp, with corresponding durations of 1, 2 and 5 sec. Although the peak operating current of the equipment is very high, the duration of the surge is quite short. Even so, there may sometimes be a difficulty in providing these high peak currents in locations where the power supply is limited and it is therefore necessary before using the equipment to check that the supply mains are fused adequately.

Owing to the high light intensity given by this unit, exposure is best judged by making practical tests with the lamp at various distances from the subject. Once the correct exposure for a certain distance has been found there will be no difficulty in repeating the results. With the normal setting of the lamp the light intensity at the center of a 10-in. spot at 4 ft from the unit is approximately 15,000 ft-c at 1 kw, 45,000 ft-c at 3 kw, 75,000 ft-c at 5 kw and 150,000 ft-c at 10 kw. The exposure may also be measured with a meter with the lamp operating steadily at 1 kw and then decreased in proportion to the power in the flash.

Table I summarizes the chief optical and electrical characteristics of the lamp. Table II, which shows the light output and size of the spot at various distances from the lamphouse, will be found useful in estimating the exposure at other distances. At maximum power, the light intensity should be sufficient for taking a film at 1500 frames/sec with a fast emulsion and an aperture of $f/11$. With Kodachrome film the unit should give sufficient light when flashed at 10 kw for photography at 3000 frames/sec at a distance of 4 ft with an aperture

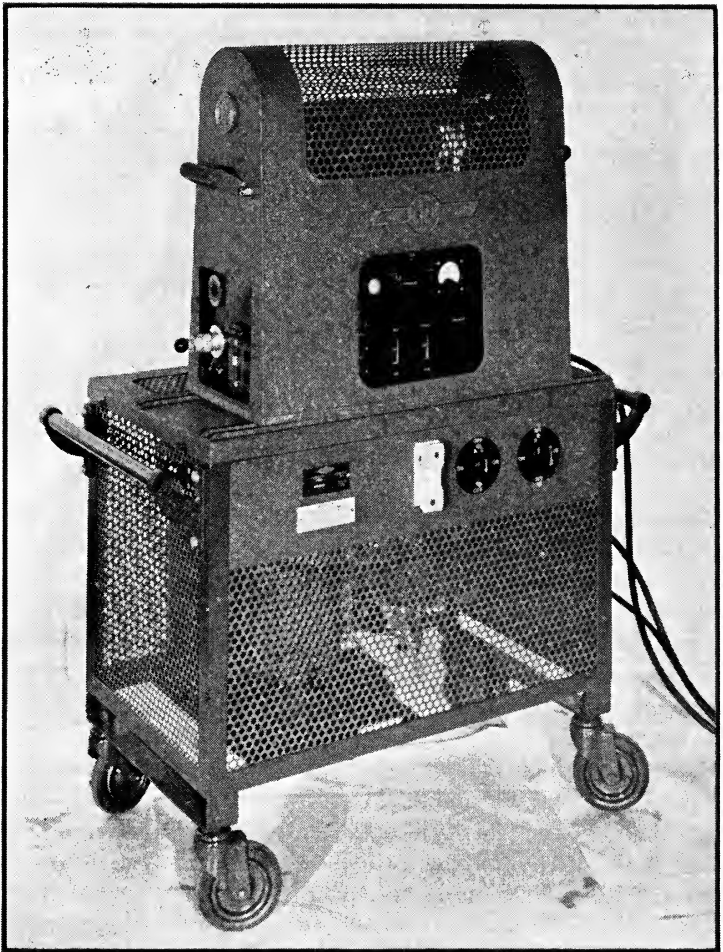

Fig. 6. Rectifier and Cine Flash Unit.

of $f/2.8$. Table III shows the current consumption of the Cine Flash Unit.

For operation from an a-c supply, when no d-c supply is available, a three-phase mercury vapor rectifier has been designed. This is mounted in a mobile framework which is also designed to carry the Cine Flash Unit on top of it. The rectifier and control unit are illustrated in Fig. 6. A smoothing circuit is built into the rectifier unit.

One of the first successful high-speed films made in Kodachrome



Fig. 7. Control box for lightning effects.

has recently been taken by Kodak Ltd. with the M-R 356 Cine Flash equipment. The subject of this film is the beating of an egg and the fall of a lamp bulb filled with colored paints. The subject was illuminated by three lamps arranged to flash in synchronism when the camera reached full speed. The film was made at 2500 pictures per second with a lens aperture of $f/2.7$. Two lamps were used for front-lighting and one for back-lighting at a distance of 4 ft from the subject.

Equipment of this type will no doubt prove useful in many photographic fields other than those of cinephotography. Scientific applications in which this equipment should find an immediate use include wind tunnel illumination, illumination for Schlieren equipment, projectile photography, underwater photography of projectile explosions or other phenomena. Another application of Cine Flash equipment is in lithographic printing.

The application of this equipment in the film studio appears to be limited to effects lighting as the duration of the flash is far too short for normal cinephotography. For example, the addition of another small control unit shown in Fig. 7 enables the unit to be used for producing artificial lightning or flashing effects for film studio, television or for theaters. This is done by dividing up the duration of the flash into 16 equal intervals, each of which corresponds approximately

to two frames of the film. The number of intervals or flashes may be chosen to produce the required effect by opening or closing any individual switches in the bank. If the equipment is then set to give say, a 10-kw, 1-sec flash, this flash can be broken up to simulate lightning, gun flashes or other effects. The residual light in the standard equipment is approximately $\frac{1}{10}$ of the maximum which is too high to give a good effect on the film. To produce the best effect the residual light can be reduced to approximately $\frac{1}{50}$ of the maximum by inserting an additional resistance to underrun the lamp considerably before the flash is produced. If no residual light whatever is required, a shutter can be used on the front of the lamp which is opened just before flashing the lamp. This method has the advantage that once the nature of the flash desired has been found by trial, the flash may be repeated as often as required.

The original work on the lamp development and its application was carried out in the Research Laboratory, the British Thomson-Houston Co. Ltd., Rugby, by the authors. The practical equipment described in this paper has been developed and built in the Mole-Richardson (England) Ltd. Experimental Dept. The authors wish to make acknowledgments to L. J. Davies, Director of Research, British Thomson-Houston Co., and to Mole-Richardson (England) Ltd. Acknowledgments are also due to the British Thomson-Houston Co. for the photographs which are Figs. 1 and 2.

REFERENCES

1. E. D. Eyles, "Some application of high-speed photography," *Phot. Jour.*, vol. 83, pp. 261-265; July 1943.
2. E. D. Eyles, "High-speed photography and its application to industrial problems," *Jour. Sc. Instr.*, vol. 18, pp. 175-184; Sept. 1941.
3. *High-Speed Photography*, a symposium, *Jour. SMPE*, Part II, pp. 1-129; Mar. 1949.
4. H. M. Lester, "Continuous flash lighting—an improved high-intensity light source for high-speed motion picture photography," *Jour. SMPE*, vol. 45, pp. 358-369; Nov. 1945.
5. R. E. Farnham, "Lamps for high-speed photography," *High-Speed Photography*, a symposium, *Jour. SMPE*, Part II, pp. 35-41; Mar. 1949.
6. H. E. Edgerton and K. J. Germeshausen, "Stroboscopic-light high-speed motion pictures," *Jour. SMPE*, vol. 23, pp. 284-297; Nov. 1934.
J. N. Aldington, "The electric discharge lamp," *Trans. I.E.S. (London)*, *Bright Light Sources*, Part 2, pp. 11-39; Feb. 1946.
7. H. K. Bourne, *Discharge Lamps for Photography and Projection*, Chapman and Hall, London, England, 1948.
8. E. J. G. Beeson, "A high-intensity light source for high-speed cinematography," *Phot. Jour.*, vol. 89B, pp. 62-67; May-June 1949.
9. F. E. Carlson, "New developments in mercury lamps for studio lighting," *Jour. SMPE*, vol. 50, pp. 122-138; Feb. 1948.

A New Heavy-Duty Professional Theater Projector

By HERBERT GRIFFIN

INTERNATIONAL PROJECTOR CORP., BLOOMFIELD, N.J.

SUMMARY: The paper describes the new Simplex X-L 35-mm projector mechanism which is now in production. High lights of the improvements are reduction in mechanical load on the gear train, improved lubrication, new lens mounts, more finger room for threading, a direct viewing telescope focusing device and over-all design simplification.

Driving Mechanism. Figure 1 is a general view of the complete mechanism. The main-drive gear assembly is an extremely simplified vertical unit operated in sealed ball bearings (Fig. 2). This ball bearing construction, which is used throughout, together with the direct high-speed drive, effects a reduction in mechanical load over past practice of approximately 66% at start and approximately 80% while running. Inasmuch as excess mechanical load both at starting and running is the cause of the majority of projector shutdowns this improvement is of particular significance.

The entire driving mechanism and the gear train are housed in an oil-tight enclosure and are visible at all times through a large transparent window which may be easily removed. The wide-face, heavy-duty type of gears are few in number and will require little, if any, attention. All high-speed shafts are equipped with ball bearings, and for added protection both upper and lower sprocket shafts are fitted with Oilite bearings.

Lubrication. Figure 3 shows the Spray-O-Matic lubrication system used. The entire area of this sealed-drive compartment is sprayed continuously by a fine film of oil which reaches every drive unit without allowing a drop to leak through to the film. The oil feed unit is simplicity itself—comprising a high-speed pump, a filter and a pipe. An oil gage fitted with a drainage petcock indicates the oil level. A change of oil is indicated approximately every eight to twelve months.

Intermittent Movement. The intermittent movement has been redesigned and the flywheel has been mounted directly on the camshaft thereby eliminating the intermediate gears to give quieter operation and lowered maintenance costs (Fig. 2). The entire movement may be removed from the nonoperating side of the mechanism. In order to assure parallel assembly the cam pin is ground to its close

PRESENTED: April 27, 1950, at the SMPTE Convention in Chicago.

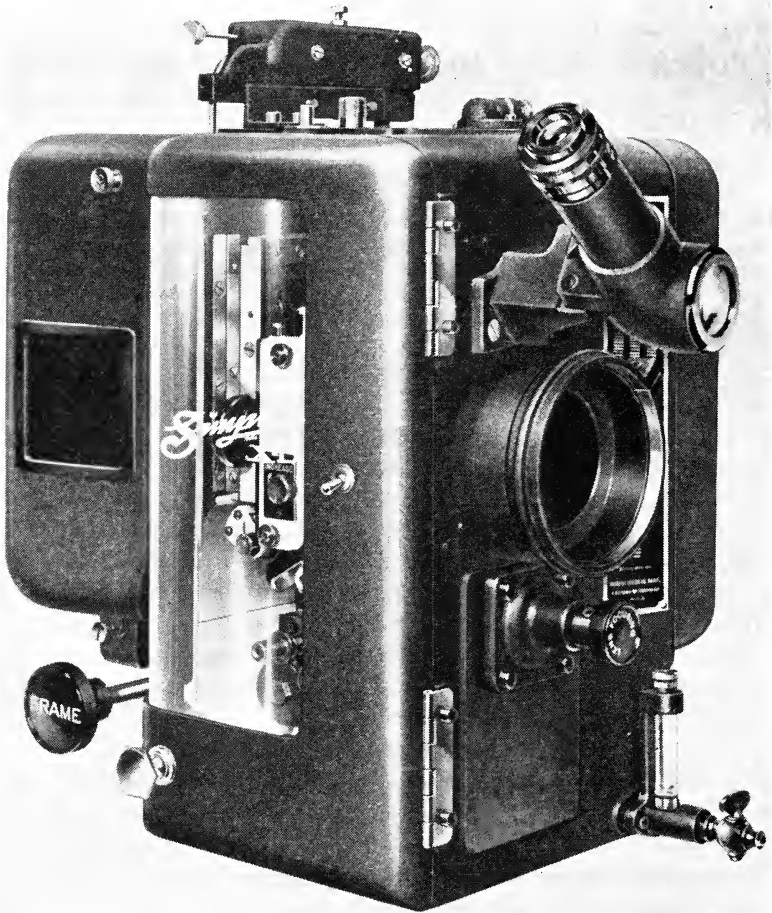

Fig. 1. Complete mechanism of the Simplex X-L 35-Mm Projector.

tolerance after assembly to the cam. The position of the cam pin with relation to the cam ring is slightly adjustable, thus providing simplicity of assembly and replacement.

Continuous lubrication of all parts of the movement is obtained through a separate pump comprising a pair of gears driven from the camshaft which force oil through the intermittent housing.

Shutter. One of the most important design improvements is the new single-cone type of shutter assembly which is located a little more than 1 in. from the aperture, thereby providing an increase in

illumination, compared with the cumbersome front and rear shutter assemblies (Fig. 4). The new shutter is maintained in correct timing by means of a sliding helical spline on the shutter shaft, there being no axial displacement between gears; thus gear noise is greatly reduced. A travel ghost adjustment knob is conveniently located at the top of the main frame.

Framing. The framing device shown in Fig. 2 has convenient handles which protrude from the side of the case and are located so that the picture may be framed from either side.

Lens Mount. Figure 1 shows the new lens mount made to hold accurately new-type lenses up to and including 4 in. in diameter and having speeds as fast as $f/1.6$. This is of particular importance in theaters with long throws and in drive-in theaters when lenses of focal lengths greater than 5 in. are required.

Quick, precise focusing of the lens is simplified by means of the unique Screenoscope device which is essentially an eight-power prismatic telescope mounted above the lens mount (Fig. 1). With the Screenoscope the projectionist may observe a highly magnified section of the screen and accomplish exact focus without eyestrain. As a matter of fact, obtaining a sharp and large focus of the tiny holes in the screen is easily and readily accomplished.

Spot Sight Box. A large eye-protecting viewing glass properly located for easy vision so the projectionist may readily observe the light spot on the film aperture replaces the conventional small spot sight box (Fig. 1).

Change-over. An instant-acting zipper type of change-over unit is part of the mechanism and is mounted above the shutter guard housing as shown in Fig. 1. The dowser blade is positioned between the arc lamp and shutter to protect the shutter blades against warpage and burning.

Threading Compartment. The operating side of the new mechanism is provided with increased "finger room," thus reducing the problem of threading in the film and affording extremely easy operation. A threading lamp lights automatically when the door is opened and additional illumination is provided in the door itself. The readily removable film trap and gate are equipped with long confining film guides and adjustable tension shoes. Means are provided for easily threading in frame by the incorporation of an additional aperture in the upper section of the film trap just below the guide rollers, and an indicator is provided on the outward bearing arm of the intermittent movement to signify when the movement is in the locked position. The interior of the operating side of the mechanism

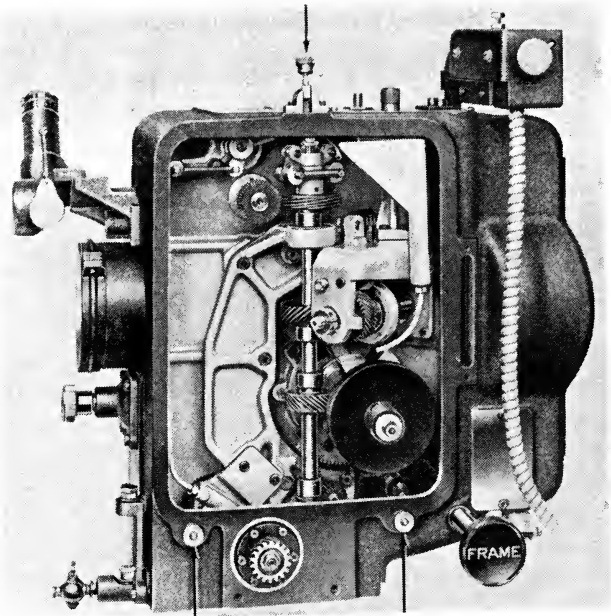

Fig. 2. Main drive assembly.

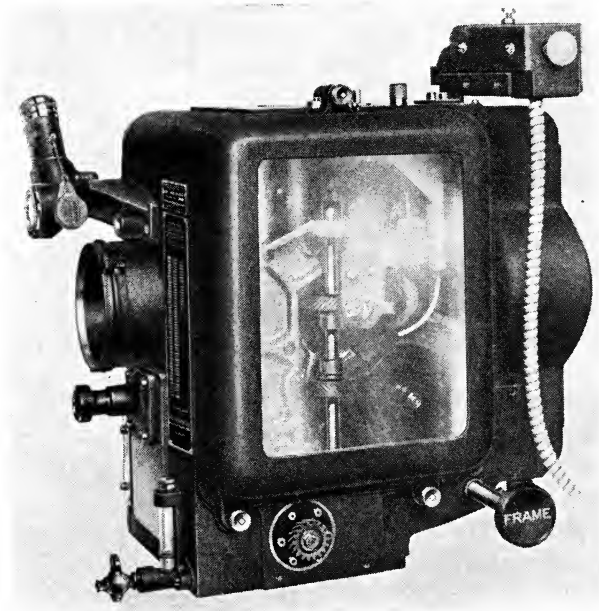

Fig. 3. Spray-O-Matic lubrication system.

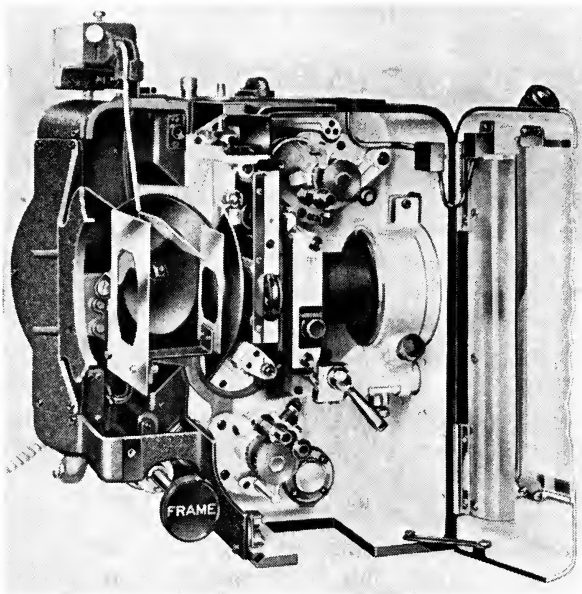

Fig. 4. Shutter assembly.

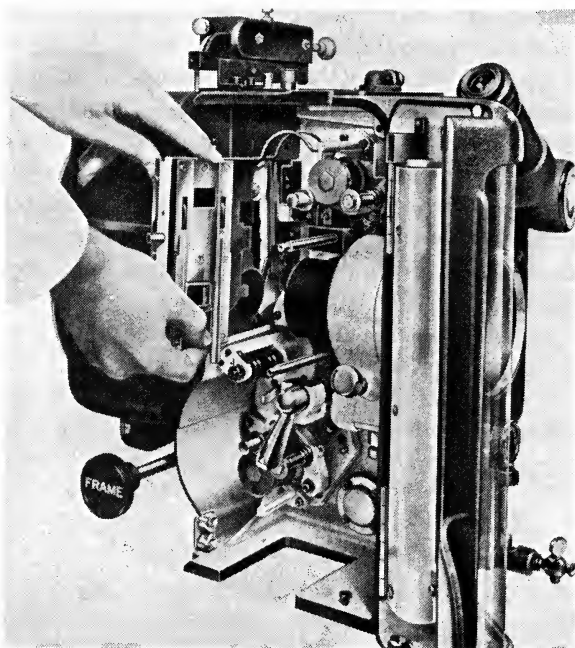

Fig. 5. Automatic safety trip.

is finished in white porcelain enamel and all corners are rounded to eliminate the possibility of dirt accumulation. While the film trap and gate assemblies follow closely the design of the E-7 Simplex mechanism assemblies, improvements have been incorporated which reduce the possibility of heat transference to the aperture plate. The adjustable gate shoe tension has been improved and a push-button gate closing means provided.

Automatic Safety Trip. An improved automatic safety trip is provided which will drop the fire shutter should a patch part above the intermittent sprocket (Fig. 5).

24-Tooth Sprockets. An important new design feature is that both upper and lower sprockets have 24 teeth, 8 more than the conventional type, and they operate at only 240 rpm, a reduction in speed of $33\frac{1}{3}\%$ over ordinary sprockets.

Cooling. Some cooling is obtained for the aperture and film gate by means of air drawn through an opening behind the shutter housing, forced past the film trap and discharged through openings on the operating side of the equipment so that a constant supply of cool air to the film trap is available at all times when the mechanism is in operation.

Upper and Lower Magazines. Both magazines are considerably deeper than usual, to accommodate bent exchange reels. The upper magazine is equipped with an observation lamp and a large porthole so that the remaining footage may be readily observed. Also, a well-designed film valve is provided by means of which, through the addition of a large flanged roller, the film path is maintained in correct alignment with the upper sprocket and scratching of the picture area or sound track is thereby eliminated. The lower magazine is provided with a similar valve and porthole and is also equipped with a newly designed even-tension take-up.

The improvements herein described have culminated a five-year period of designing and tooling-up, plus an exhaustive series of field tests in key circuit theaters operating fourteen hours daily over a span of sixteen months.

A New Deluxe 35-Mm Motion Picture Projector Mechanism

By H. J. BENHAM

BRENKERT LIGHT PROJECTION CO., DETROIT, MICH.

AND R. H. HEACOCK

RCA VICTOR DIV., RADIO CORPORATION OF AMERICA, CAMDEN, N.J.

SUMMARY: Development of a new deluxe 35-mm motion picture projector mechanism, to be known as the RCA-100, was recently completed and production is now under way. The keynote in the design is high-quality projection continuously over a long period of time without the necessity of costly periodic factory overhauls and replacement of parts. Over ten years of field experience with the Brenkert BX-80 projector mechanism has shown that automatic lubrication, a heavy rugged type of gear train, double rear shutters, unit construction and ease of serviceability are features essential to this objective. These features, together with new additions necessary to meet present-day requirements will be described in this paper.

Automatic Lubrication. In a well-lubricated system there is practically no wear of the metal parts because all contact takes place on films of oil between mating surfaces. In this automatic lubrication system a geared pump inside the housing delivers a continuous flow of filtered oil through a copper tube from the oil reservoir in the base of the mechanism to a rotary lubricator at the top of the gear train. This rotary lubricator is perforated at longitudinal spacings so the various holes are in line with the plane of each gear and bearing in the gear train. In operation, oil is pumped from the reservoir to the rotary lubricator and then showered over all of the parts in the gear compartment, providing lubrication at the right places continuously.

With this method of lubrication filtered oil is circulated throughout the entire gear side of the projector mechanism several times a minute. The heat generated in the intermittent is carried away by the circulating oil instead of remaining confined in the intermittent case. In this manner it also acts as an over-all cooling system in distributing local heat in the gear train throughout the whole mechanism.

Figures 1 and 2 illustrate the advantages of the automatic system over the oilcan or pressure-feed method. All shafts and bearings in the gear train are designed so that they are lubricated continuously

PRESENTED: April 27, 1950, at the SMPTE Convention in Chicago.

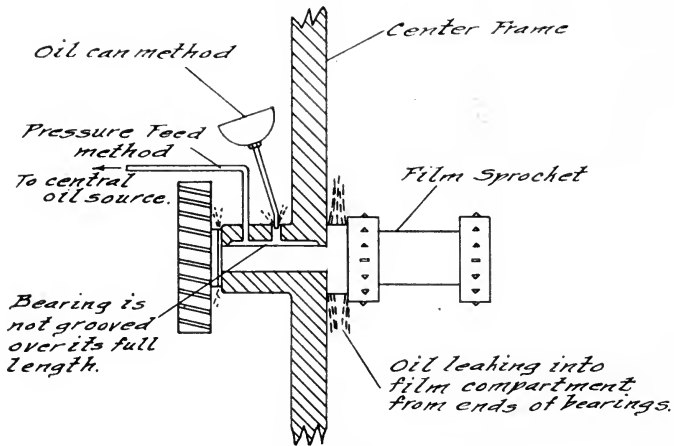

Fig. 1. Pressure-feed and oilcan methods of lubrication.

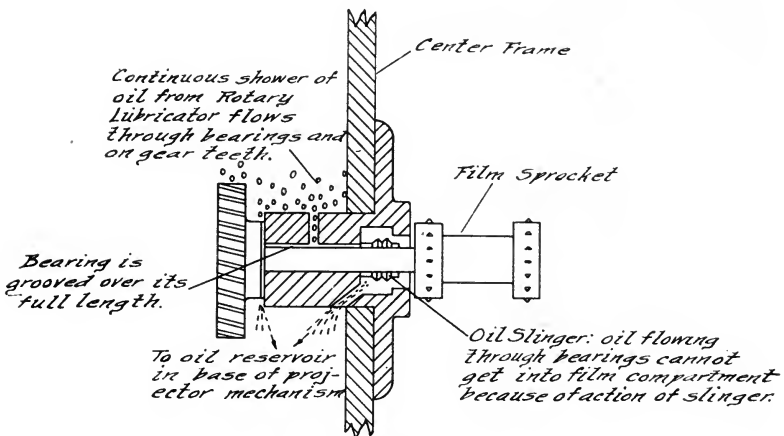

Fig. 2. Automatic lubrication.

over their entire length without any oil leaking from the gear compartment, as shown in Fig. 2.

Gear Train. The gearing in the new projector, shown in Fig. 3, consists entirely of helical gears running on parallel shafts, except for the shutter-shaft drive gears which are spiral bevel gears. This type of gearing can be set up for minimum backlash and with the meshing teeth of mating gears contacting each other over the full width of the gear face. This means smooth and quiet operation and

negligible wear over a long period of time which, of course, means maintaining the original accuracy built into the mechanism.

One of the other factors essential in correct gear design in a motion picture mechanism is to maintain a low gear ratio between the important drive assemblies such as the intermittent, main-drive gear assembly and shutter-drive assembly. This keeps vibration at a low level, and prevents it from traveling through the mechanism where it could increase wear between gear teeth and allow the light shutters

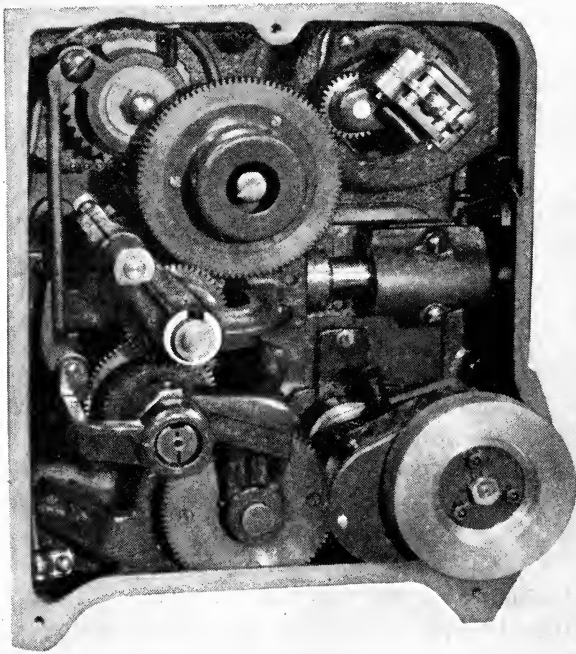

Fig. 3. Gear side of projector (gear cover removed).

to oscillate. Excessive oscillation of the shutters results in inferior projection unless the shutters are widened to compensate for this movement, in which case the efficiency of light transmission would decrease.

From a theoretical standpoint a gear ratio of 1:1 would be optimum for the least amount of wear, quietest operation and minimum vibration. A 1:1 gear ratio is impossible throughout a gear train where shafts rotate at different relative speeds, however, so we have done

the next best thing by using a 2:1 gear ratio between all important drive assemblies.

The light-shutter compensator gear assembly has an important role in the gear train. The purpose of this unit is to enable the picture to be framed at the aperture while at the same time keeping the action of the light shutters in perfect time with the pull-down action of the intermittent, without the use of angular sliding gears. When the framing handle is turned, the radial positions of the shutter drive gears are changed with respect to each other but they always mesh with identically the same teeth in their mating gears, over the same portion of the gear face. With this type of shutter compensator it is not necessary to change the position of the framing knob periodically. The projector will run smoothly and quietly with the framing knob in any position; wear and backlash between gears are eliminated; the same good picture definition and high efficiency of light transmission to the screen obtained originally, is maintained throughout the life of the projector.

Unit construction is used throughout the gear train. All assemblies are accurately located by dowel pins so that perfect alignment is assured without fitting and adjusting for proper backlash. All units are completely interchangeable.

Intermittent Mechanism. The intermittent, together with its star and cam, is shown in Fig. 4. All of the parts are large and heavily constructed. They can thus be manufactured with greater accuracy than could smaller ones and because of this the wear is negligible.

A cross section of the star wheel, shaft, sprocket and bearings is shown in Fig. 5. The star wheel and sprocket shaft are supported for over 60% of the shaft's total length. This long bearing support and the extension of the bearings directly to the star wheel and to the sprocket cause these parts to be held with extreme precision.

Bronze bearings are used throughout the intermittent because they can be manufactured with great accuracy and because of their long wearing qualities. Wear is reduced to a minimum through the use of this type of bearing with a continuous flow of oil through all parts of the intermittent unit.

The index pin on the cam is fitted with a hardened steel roller to eliminate the possibility of flat spots developing on the index pin. This is another instance of precaution which was taken to reduce wear to a minimum.

The intermittent can be removed and replaced in less time than is required to run a reel of film. The sprocket can be removed and replaced in less than one minute.

Film Compartment. The film compartment as shown in Fig. 6 is enclosed by a large glass door with the visible interior illuminated by two concealed lights. This aids in accurate threading of the mechanism and in easy inspection of all operating parts.

The oil gage, which is an integral part of the oil pump, is located

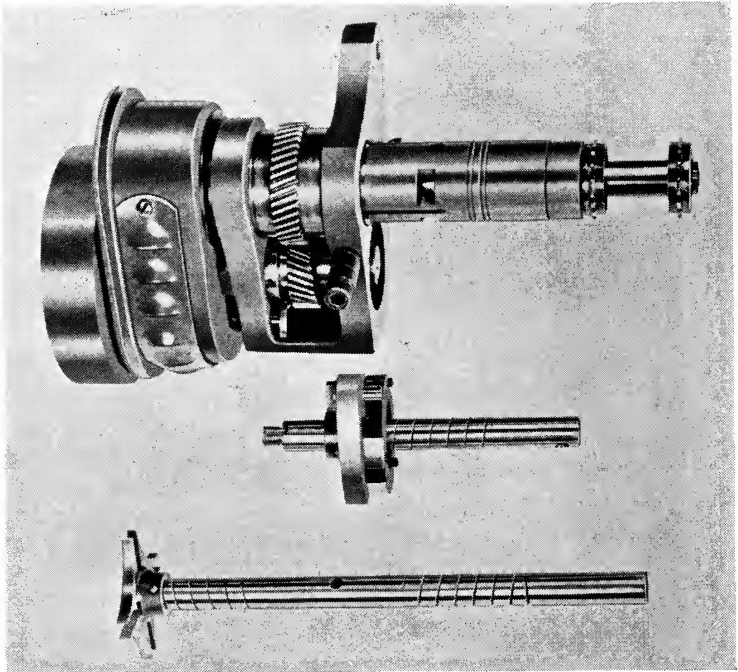

Fig. 4. Intermittent mechanism.

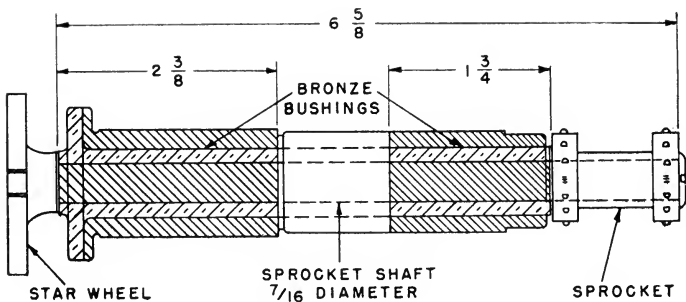

Fig. 5. Cross-section of star wheel, shaft and bearings.

in the lower front corner of the main case. Large entrance and exit oil ports assure correct oil level indications.

Unit construction is used throughout in the film compartment for accuracy and for easy servicing.

Light Intercepting Shutters. The design of the light shutters and associated gearing in a motion picture projector mechanism determine the efficiency of light transmission to the screen. Consistently high,

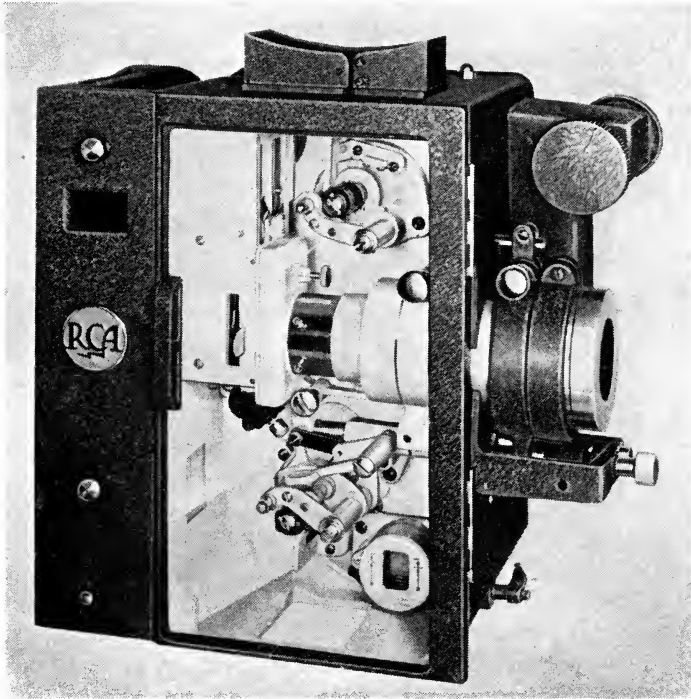

Fig. 6. Operating side of projector.

efficient light transmission is of great importance in large indoor theaters and in drive-in theaters where pictures up to 70 ft in width are projected. Two rear shutters are used in the projector mechanism rotating in opposite directions so that the light beam is cut simultaneously from the top and bottom. Wide experience has shown that double rear shutters are most desirable for the following reasons:

1. The efficiency of light transmission is increased more than 20%

above that which can be obtained from most projector mechanisms with a single shutter.

2. The light beam is shadowed so that a black, cool aperture is obtained over 12% longer than when one front and one rear light shutter are used.

3. Since the action of the light shutters is to cut the light beam from the top and bottom simultaneously, in a plane removed from

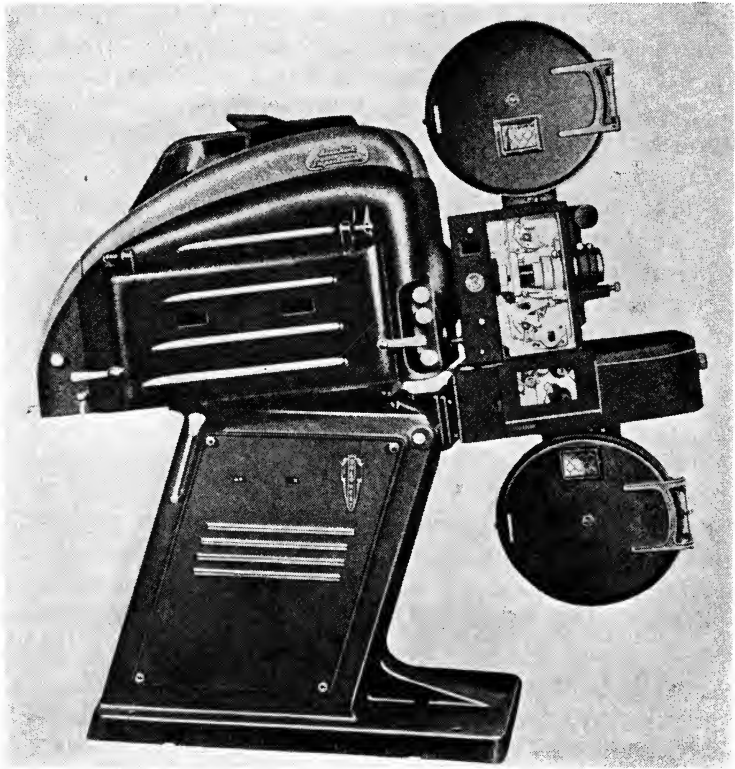

Fig. 7. Complete projector and sound assembly.

the film plane, the intensity of the light on the screen is gradually reduced to zero at the start of the pull-down and then gradually increased from zero to maximum at the end of the pull-down. High efficiency of light transmission can thus be obtained by designing the width of the shutter blades to take advantage of the small movement of film at the beginning and end of the pull-down period without any trace of a travel ghost.

4. From both an operating and an appearance standpoint, it is more desirable for both shutters to be located at the rear of the mechanism than to have one at the front and one at the rear. In those cases where a front shutter is used difficulty is sometimes experienced in removing the lens for cleaning, especially where the mechanism is located close to the front wall.

Heat Baffle. The use of powerful arc lamps in many theaters today makes it essential to baffle all stray light from the metal parts of the film trap to prevent it from becoming excessively hot. A heat baffle is used which consists of three metal plates spaced about $\frac{3}{16}$ in. apart and positioned in a vertical plane with the optical axis in such manner as to allow an $f/2.0$ beam of light to be projected to the picture aperture with a minimum light spill around the metal parts of the film trap.

The heat resulting from stray light intercepted by the heat baffle is carried away by a rotary fan located at the top of the main case, drawing air up past the sections of the baffle.

The entire film trap is completely enclosed with a metal light shield preventing stray light escaping from the picture aperture and shining into the projectionist's eyes.

Projection Lens Mount. The lens mount has been designed to accommodate the new long focal length $f/2.0$ projection lenses which are 4 in. in diameter. It is easily removed as a complete unit by the removal of four screws. A metal collar is provided with each projector mechanism so that standard diameter projection lenses in focal lengths up to 5 in. can be accurately held in this lens mount. Two knurled thumb screws in split rings, one at each end of the lens mount, hold the projection lens rigidly and accurately in position. Focusing is done by means of a knob at the front of the lens mount which is accessible from either side of the mechanism.

Figure 7 shows a complete projector assembly including the new Brenkert Supertensity Arc Lamp in combination with the new projector. This is typical of the units which are now being supplied for deluxe drive-in theaters throughout the country.

68th Convention

RESERVATIONS are coming in to the Lake Placid Club and to the Hotel Marcy, these in response to the Convention Advance Notice which went to all members in mid-August. If you have overlooked yours, ask Society headquarters for the information and make your arrangements without delay.

PAPERS have been scheduled for ten technical sessions; two evenings will be devoted to awards and Banquet; one evening is reserved for prerelease showing of a feature motion picture; and a prerelease feature motion picture will also be shown on one afternoon. Sessions topics, detailed in the Tentative Program being mailed separately, are:

Monday Afternoon	Television
Monday Evening	Award Presentation
Tuesday Morning	Television and TV Film Pictures
Tuesday Afternoon	Television, Sound Recording, Color
Wednesday Morning	Magnetic Recording
Wednesday Afternoon	High-speed Photography
Wednesday Evening	Cocktail Party, Banquet and Dance
Thursday Morning	High-Speed Photography
Thursday Afternoon	Film Registration, Aperture Calibration and Sound Recording
Thursday Evening	Color and Trick Photography
Friday Morning	Sound, Projector Carbon and Theater Television
Friday Afternoon	Theater Television

AT LAKE PLACID, there will be a program with many attractions: some new subjects and some generally familiar ones newly high-lighted; entertainment and recreation of inviting variety.

Engineering Committees Activities

Screen Brightness

The Screen Brightness Committee under Wallace Lozier's Chairmanship is now ready to start the 100-theater screen brightness survey which has been under discussion for the last six months. Actual measurements will begin about mid-September. Task groups responsible for survey work have been set up in Los Angeles, New York, Philadelphia, Chicago, Toledo and Rochester. The first theaters visited will be in the New York area, where it is planned to start with 30 indoor and two outdoor theaters.

The photoelectric instrument developed by Allen Stimson of the General Electric Co. has been checked to assure accurate measurements, and since there is only one in existence the survey will necessarily have to proceed slowly at first. General Electric has agreed, however, to supply instruments for \$345 each, providing ten or more can be manufactured at one time. All likely customers are being canvassed, and it is hoped to have before long additional instruments available to survey teams.

Every means possible will be taken by those making the survey to avoid up-setting normal theater operation, and at least 24 hours' notice will be given any house it is proposed to survey. With the exception of about 15 minutes for making actual screen measurements, the remaining data can be gathered during the regular show.

A word of thanks is due the *International Projectionist* for the excellent publicity they have given this project in both their June and July issues. We have every anticipation of a worth-while job being done.

Television

The first regular meeting of the Joint RTMA-SMPTE Committee on Television Film Equipment was held at the Hotel New Yorker on July 18. Their work got off to an excellent start with all of the SMPTE delegates on hand. The primary task at the moment is the completion of a specification for a 16-mm television film projector which originated within RTMA.

While the specification framework has been completed, many of the detail requirements need further study. Approximately a dozen task groups were organized and requested to prepare drafts of various sections for circulation to committee members prior to the next meeting. Standards for picture aperture size to be used in video recording and the area to be scanned in reproduction of opaques and slides were also discussed and recommendations will be made in the near future.

Magnetic Recording

Last April, Glenn Dimmick's subcommittee working on standards for magnetic recording recommended submitting proposed standards for track location on 35-, 17 $\frac{1}{2}$ -, 16- and 8-mm motion picture film to the Sound Committee for its recommendations on publication. The ballot was sent out early in July, but serious objections were received from one of the major studios which felt that the limited experience with the present proposals did not warrant wide circulation in the JOURNAL. Further action will be delayed until this problem is resolved within the Sound Committee.

High-Speed Photography Question Box

Here are answers to five questions on high-speed photographic techniques which appeared on p. 122 of the July JOURNAL. These answers were contributed by: J. H. Waddell of Wollensak Optical Co.; Henry M. Lester, Consultant; Kenneth Shaftan of Burke and James; and Eugene L. Perrine of the Armour Research Foundation.

Further questions and answers will appear in subsequent JOURNALS. If you wish to participate send either your questions or answers to Society Headquarters.

A1. This question concerned taking high-speed motion pictures of moving parts inside a black bakelite device the size of a dime. Speeds of 4,000 to 8,000 frames/sec were required. With methods now being used, insufficient exposure has been obtained when using Super XX film and heat generated

by the light source altered performance of the device under test.

One suggested solution was the use of continuous flash lighting units to provide ample light free of heating effects normally encountered with tungsten or arc illumination. Adequate exposure and depth of field can be secured by using two flash units properly placed, and a 2-in. lens with a suitable extension tube at effective apertures ranging from $f/6.3$ to $f/9$.

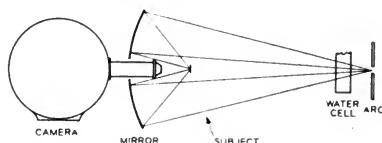

Figure A-1.

A second solution is proposed in Figure A-1. In this method the center was cut

out of a 12-in. diameter parabolic mirror of 6-in. focal length so that it could slip over the lens and extension tube of the camera. Precision quality Bausch & Lomb parabolic mirror has been used. Elliptical mirrors are better suited for this application when photographing extremely small areas, but where sharp focus of the light beam is not required the paraboloid is satisfactory. A small, hand-fed carbon arc using from 5 to 10 amp is used about 2 ft behind the subject, and the mirror adjusted so that the arc is focused on the area to be photographed. A water cell for removing the heat is placed in the beam close to the arc so that all light falling on the mirror passes through the cell. The proponent of this method states that sufficient illumination is obtained for magnification on the film of up to five times at a speed of 5000 frames/sec.

A third proposed solution uses a plane mirror with an elliptical hole large enough to accept the camera lens. The mirror is placed at an angle of 45° to the optical axis so that the light is reflected from the mirror to the subject. A partial reflection transmission mirror could be used instead, but that would reduce the exposure by a factor of approximately 50%, and only half the light would reach the subject. Satisfactory mirrors of this type may be secured from Evaporated Films, Inc., Ithaca, N.Y. It is also recommended that long focus lenses with extension tubes be used to secure adequate distance between the subject and the camera. If a water cell is used, as described on p. 450 in the article "High-Speed Photography" in the November 1949 JOURNAL, heat can be reduced to a negligible amount. It is also suggested that a G.E. 750-R lamp or a Rosslite of similar characteristics be employed. Distance from lamp to mirror to subject should be approximately 15 in. for maximum illumination. In making high-speed pictures of this type, a suitable exposure meter should always be used.

A2. The second question concerned high-speed motion pictures of small parts of a mechanical device moving at 15 to 30 cycles/sec. A Fastax camera is employed at a frame rate of 1250 frames/sec, with a 6-in.

lens, an object distance of 8 ft, Super XX reversal film, and two 750-w reflector spot lamps. Since all surfaces had similar finish, it was extremely difficult to distinguish between adjacent parts in the projected picture.

The first reply to this question suggested very diffuse lighting through use of a translucent tent between light and subject. It was pointed out that this would obviously result in a considerable loss of light, but with continuous flash lighting units this loss could be tolerated. By appropriate arrangement of the tent and choice of material, however, loss of light can be held to a minimum.

A second answer stated that if the light source is placed correctly, there should not be too much trouble from specular reflections when the exposure factor is correct. Bad flare is produced from machined parts when there is definite over-exposure in a high-speed camera. If the exposure is somewhat reduced, brightness of parts, even though made of brightly polished metal, should be easily controlled. The light source must be as near the camera as possible, and either G.E. Electric 750-R or Rosslite lamps should be used.

A3. Question 3 dealt with photographing vibration effect on various components of air-borne instruments. These instruments are extremely small and encased, making it necessary to illuminate and photograph through a hole in the cover. Vibration frequencies of 800 cycles/sec, with object motion as little as 0.001 in. are encountered.

The first reply pointed out that it is possible to photograph and illuminate through a hole in the cover of an encased instrument by high-speed photography only if the hole is large enough. The smallest hole believed to be feasible is about 5 in. in diameter. It was stated, however, that a somewhat smaller hole might be used with variations in technique.

The first method suggested was to direct the light output of a continuous flash lighting unit on a spherical mirror with a hole in the center for the camera lens. A second method was to surround the camera lens with an electronic flash tube, discharging its light output in synchronism with the high-speed camera shutter. It was pointed out that Dr.

Harold Edgerton of M.I.T. has designed an electronic flash lamp capable of doing this job. For conditions outlined in this question, it was suggested an Eastman Type 3 camera be used at frame rates of 3000 frames/sec. A movement of 0.001 in. could then be magnified about 200 times both in time and space, offering an adequate record, either on the screen or in still picture enlargements of single frames.

Another reply suggested use of a Fax-tax camera with auxiliary control equipment to secure 14,000 pictures/sec. Frame rates of this order are necessary for studying frequencies as high as 800 cycles/sec. It was also suggested that in studying vibrations of extremely small excursion extension tubes be used on camera lenses, and the pictures be projected at about a magnification of 100. Magnification of 100 times of a 0.001-in. excursion will then appear on the screen as 0.1 in. For lighting, a G.E. 750-R lamp should be used, so placed that the plane of vibration is clearly emphasized with respect to the stationary surrounding subject. At least two lamps should be used in this setup with a high-low series-parallel switch in order to focus the camera with lamps in series and expose with lamps in parallel.

A4. This question dealt with photographing a 3×5 ft area of a dark machine at a frame rate of 3000/sec. Here again inadequate exposure was being obtained, and high amperage power lines were not available.

The first reply stated that successful results had been obtained under similar conditions, using continuous flash lighting units on dark areas of up to 4 sq ft. In this case, also, the machine being photographed was black. The frame rate was 3000/sec, with the lens set at

$f/4$. Using Super XX film, a satisfactory record was attained. This type of lighting requires much less power than incandescent units.

A second reply suggests use of sunlight for illumination. If the equipment photographed is extremely dark, it may be necessary to use booster mirrors to light adequately the whole surface. Frame rates of 3000/sec are entirely possible in direct sunlight, but not behind windows.

A5. This question dealt with special processing for reversal film used in high-speed photography. The first reply named two manufacturers of processing equipment suitable for this type of work: Micro Record Corp., New York City; and Morse Instrument Co., Hudson, Ohio. It was pointed out, however, that while machines made by either of these companies could do a job of controlled processing, in both cases the task is tedious and far from satisfactory when a quantity of film is involved. Both require special drying facilities and great care in handling of films with black coatings. It was believed that the advantages of longer first development are questionable unless the additional development is accurately timed and definitely related to the degree of underexposure. Faster film such as Kodak's Linagraph (negative stock is 50% to 60% faster than Super XX reversal) might be used, and is simpler to process on the two units mentioned above. The best answer is to avoid working near the borderline of underexposure, which always results in pictures lacking in detail, definition, contrast and depth.

Another reply suggested referring this problem to the Houston Corp. in Los Angeles which builds special 16-mm processing equipment.

Journals Out of Stock: The Society's stock of JOURNAL issues for March, Part II, July, August and September, 1949, has been exhausted as a result of an unexpected increase in demand and the Society's Headquarters is anxious to purchase a stock of each. Members or libraries having extra copies available are invited to send them in. The going price is 75c.

Book Reviews

The American Annual of Photography, Volume 64, 1950. Edited by Frank R. Fraprie and Franklin I. Jordan

Published (1949) by the American Photographic Publishing Company, St. Paul, Minn. 208 pp. incl. 120 illus. + 38 pp. Who's Who + 30 pp. Advt. Paper bound, 7 × 10 in. Price, \$2.00.

This 1950 issue (Volume 64), I feel, surpasses all previous issues. Articles such as "The Work of Jose Ortiz-Echagüe" are entertaining and inspiring, especially when so splendidly illustrated. Other articles are equally well written and illustrated. Such articles as "Printing Exposure Determination by Photoelectric Methods" and "The Physiology of Film Base" will probably appeal more to our technically minded SMPTE members but such articles as "The Motion Picture Camera in Science and Industry," "The Camera as a Field Research Tool," "Photography in Industry and Science," "The Work of Eadweard Muybridge," in fact all of the sixteen diversified articles will appeal to anyone interested in the progress of photography, pictorial and otherwise.

There are some 67 full-page pictorial illustrations of an international nature which are intelligently described and analyzed by Frank R. Fraprie.

The Who's Who in Pictorial and Color Photography as well as the exhibition records for the past three years will be of special interest to those who are concerned with salon exhibition.—JOHN W. BOYLE, 139½ S. Doheny Drive, Los Angeles 48, Calif.

Practical Television Engineering, by Scott Helt

Published (1950) by Murray Hill Books, Inc. (A subsidiary of Rinehart and Co.), 232 Madison Ave., New York 16, N.Y. xv, 708 pp., including 30 pp. glossary, 14 pp. index, 387 illus. and numerous tables. 6 × 9 in. Price, \$7.50.

Mr. Helt's book is a significant contribution to the television-engineer-to-be. With the lifting of the freeze, the rush to install more television stations will be on in full force. Many electronics engineers will be faced for the first time with the day-to-day television operating problems. It appears that Mr. Helt was aiming toward that group particularly. They will find this book extremely helpful.

There is a certain unevenness in the density of theoretical treatment. Upon analysis, it becomes evident that this is just what Mr. Helt intended. For example, the section on studio lighting is right to the point with details of the type of lights to use and how to place them. Yet the theory of the image orthicon is covered in simple straight-forward language minus equations. This makes good sense because no operating engineer is going to design an image orthicon. He has only to recognize its operating characteristics and decide whether or not a tube should be used or rejected. Yet with lighting he can be a "designer" and with this book he has sufficient information to deal intelligently with the problem without reference to any other source material.

The discussion of lens theory is well handled and the bridge to electron optics skillfully presented. The advanced reader is naturally led to more rigorous texts on electron optics.

The importance of the cathode-ray tube oscilloscope to the television engineer cannot be overemphasized. Mr. Helt wisely goes into great detail to explain its operation and use. This chapter alone will make this book very important. He also gives interesting manufacturing information on cathode-ray tubes which provides the new television engineer with some useful background.

The chapter devoted to the synchronizing generator is quite complete. The theory and design concepts are well presented, particularly where they will provide a better understanding necessary to good maintenance technique. The succeeding chapters deal competently with video amplifiers and associated compensating circuits, power supplies and the receiver.

Mr. Helt makes a successful effort to provide the operating television broadcast engineer with a good understanding of the receiver. Too often, engineers overspecialize to a point where the station man has little understanding of the receiver man's problem. Yet no television system is complete without the home receiver.

With regard to the transmitter, more detailed information may be required. The author favors the studio engineer by providing helpful hints on approved maintenance procedures and best studio practice. The book is already long, nearly 700 pages.

Mr. Helt has succeeded in authoring a book which was greatly needed. He has accomplished his task with a professional quality. This book is fully recommended to the industry as a practical exposition of the engineering problems in television broadcasting.—E. ARTHUR HUNGERFORD, JR., General Precision Laboratory, Pleasantville, N. Y.

Sound Absorbing Materials, by C. Zwicker and C. W. Kosten

Published (1949) by Elsevier Publishing Co., 215 Fourth Ave., New York 3. 171 pages + 3 pp. index. 92 illus. $9\frac{1}{2} \times 6\frac{1}{2}$ in. Price, \$3.00.

The first-named author was formerly Professor of Physics at Delft Technical University, Netherlands, and is now connected with Philips Electrical Industries, Eindhoven. The second is Lecturer of Physics at Delft Technical University. Their book is essentially an account of the theoretical and experimental work done by them and by other European investigators, with some references to American sources, in developing along basic scientific lines the relation of the sound absorbing properties of materials to measureable physical characteristics of their composition and structure. The first chapter treats the use of acoustic impedance as a valuable intermediate step in this relation. In later sections the wave equations and impedance characteristics are derived for several types of absorbing media: an air-impervious compressible material with internal friction (sponge rubber), a porous material with an elastic frame (felt or mineral wool blanket), and a porous material with a relatively rigid frame, as exemplified by some of the common types of commercial acoustical materials. Methods of measurement of the material constants governing impedance, such as air-flow resistance, porosity (percent of voids), and compression modulus of the material structure are discussed. Measurement of impedance and normal incidence coefficients of small samples is covered in some detail, and typical experimental results are given.

Absorption by resonators is treated extensively. These include the simple Helmholtz resonator consisting of an air cavity with a small orifice and combinations of such resonators having staggered frequency responses. Practical constructions of this type have been used successfully in Europe for room acoustical correction. The basic resonator theory is extended to the more familiar case of a perforated rigid board over an air space which may be completely or partially filled with porous absorbing material. Useful design formulae and charts are included for the various cases. It is rather surprising that no mention is made of absorption by diaphragmatic vibration, which is utilized in the familiar curved plywood studio treatments and in at least one commercial material. Another

distinct type of absorber is the integrally perforated porous material. This is very widely used, but is touched on only briefly in the book, and no attempt is made to develop an adequate theory for this case.

In the final chapter, methods of absorption measurement at angles of incidence other than normal are briefly mentioned, and the difficulties in predicting absorption characteristics under random incidence or room conditions from normal incidence data are pointed out.—HALE J. SABINE, The Celotex Corp., Chicago 3, Ill.

American Cinematographer Hand Book and Reference Guide Seventh Edition, by Jackson J. Rose

Published (1950) by American Cinematographer Hand Book, 1165 North Berendo St., Hollywood 27, Calif. 299 pp., 3 pp. index, 85 tables, 10 photographs in color + 38 pp. advt. $6\frac{1}{2} \times 4$ in. Flexible binding. Price, \$5.00.

The Seventh Edition of this convenient pocket size hand book and reference guide has been expanded to 325 pages. It still contains the charts, formulas and technical information which professional cinematographers have been using for years but the book has been brought up to date with the addition of latest information on the various color processes: Technicolor, Monopack, Ansco, Kodachrome, Du Pont, Ektachrome, Bipack, Trucolor, etc. The new method of "Latensification" is explained as well as many of the newer gadgets being used in the professional field today. The color illustrations are extremely helpful in showing various "filter" results in monochrome. Magnetic recording, television photography and "T" stops are a few of the newer subjects. The author and compiler, Jackson J. Rose, A.S.C., has had the cooperation of his colleagues in the film industry and has been quick to use their suggestions for improving cinematography and finding a simpler way to achieve artistic photographic results.—JOHN W. BOYLE, 139 $\frac{1}{2}$ S. Doheny Drive, Los Angeles, 48, Calif.

Theatre Catalog, 8th Annual Edition, 1949-1950

Published (1950) by Jay Emanuel Publications, Inc., 1225 Vine St., Philadelphia 7. 1-528 pp. + i-x, profusely illus., includes advtg. $9\frac{1}{4} \times 12\frac{1}{4}$ in. Price \$5.00 (foreign shipments \$10.00 a copy).

This new *Theatre Catalogue* isn't the type of publication that motion picture and television engineers would normally read. It is, nevertheless, an impartial picture of motion picture operation and design, covering almost every phase of a fascinating business.

The engineer's interest in this great industry cannot properly be limited to his laboratory. Auditorium design is changing constantly and with it new problems confront the alerted engineer. Panoramic viewing conditions approaching the normal viewing conditions of the human eye are desirable, yet little has been done about it. Drive-in theaters are here to stay and so is theater television. Third dimension projection is a stimulus that theaters need badly. What is being done about it today?

The *Theatre Catalogue* not only discusses certain phases of projection and sound but dwells on design and construction, maintenance and management. The engineer must be familiar with these phases of the business, otherwise he cannot properly tackle theater operation problems.

Attention is directed, for instance, to the section on theater design and to the section on new equipment. Know well the ultimate use of equipment so carefully designed in the laboratory. Where and under what conditions will the finished motion picture be viewed by John Public? How can improvements be made in the over-all result? How can picture presentation be vitalized? What changes can be made to better a system of projection now essentially 23 years old?

The *Theatre Catalogue* is not primarily reading matter for an engineer—but it should be. By completely understanding a vast operation it is hoped that the motion picture and television engineers will: (1) see the inadequacy of current practices so that they may be improved; (2) publish the results of their findings freely so that others may develop the germ of an idea; (3) realize that they are likely to play as important a part as anyone else in this business' future; and (4) believe that their ideas are good as far as they go but that they do not go far enough.—LEONARD SATZ, Raytone Screen Corp., 165 Clermont Ave., Brooklyn, N.Y.

Current Literature

THE EDITORS present for convenient reference a list of articles dealing with subjects cognate to motion picture engineering published in a number of selected journals. Photostatic or microfilm copies of articles in magazines that are available may be obtained from The Library of Congress, Washington, D.C., or from the New York Public Library, New York, N.Y., at prevailing rates.

American Cinematographer

vol. 31, no. 5, May 1950
Pushbutton Zoom Lens for TV
(p. 160) H. I. SMITH
Adapting Motion Picture Lighting to
Television (p. 162) L. ALLEN

vol. 31, no. 6, June 1950
The Infra-Red Photographer Evaluator
(p. 196) S. HORSLEY

Matching Location Footage with
Studio Shots (p. 197) H. A. LIGHT-
MAN

Optical Effects with Any Camera
(p. 198) I. BROWNING

When and How to Use Camera Angles
(p. 201) P. TANNURA

Britons First With Tape Sound Unit
for Silent Home Movie Projector
(p. 204)

AnSCO Announces New 16-mm Color
Duplicating Film (p. 205)

Audio Engineering

vol. 34, no. 6, June 1950
The Columbia Hot Stylus Recording
Technique (p. 11) W. S. BACHMAN
An Adventure in Loudspeaker Design
(p. 14) H. T. SOUTHER

Considerations in the Design of Feed-
back Amplifiers (p. 17) H. I. KERROES

International Photographer

vol. 22, no. 5, May 1950
Are Cameramen Necessary on TV?
(p. 5) H. BRICH

The Camera Optical Engineer (p. 8)
R. L. GREENE

International Projectionist

vol. 25, no. 5, May 1950
Notes on Modern Projector Design
(p. 14) R. A. MITCHELL

vol. 25, no. 6, June 1950
Notes on Modern Projector Design,
Pt. II (p. 7) R. A. MITCHELL

Heat, Light Reflectivity is Upped by
Kodak Mirror (p. 11)

An Optical Alignment Check System
(p. 17) C. W. HANDLEY

New Simplex Sound System Shown by
IPC (p. 23)

U. S. Navy 16-mm Projection Specs
(p. 26) J. J. McCORMICK

Motion Picture Herald

vol. 180, no. 1, July 1, 1950
Safety Stock is Now 85% in Use by
Trade (p. 13)

Radio & Television News

vol. 43, no. 6, June 1950
RCA's New Direct-view Tri-color
Kinescopes (p. 46)

Tele-Tech

vol. 9, no. 7, July 1950
Experimental Tri-Color Cathode Ray
Tube (p. 34) C. S. SZEGHO
Process Screen Projection, Pt. I
(p. 39) R. A. LYNN and E. P.
BERTERO

New Members

The following have been added to the Society's rolls since the list published last month. The designations of grades are the same as those in the 1950 MEMBERSHIP DIRECTORY: Honorary (H) Fellow (F) Active (M) Associate (A) Student (S)

- Baumhofer, Hermine M.**, Archivist, Wright-Patterson Air Force Base. Mail: 532 Telford Ave., Dayton 9, Ohio. (A)
- Cleveland, H. W.**, Physicist, Eastman Kodak Co. Mail: 1669 Lake Ave., Rochester, N.Y. (A)
- Croze, Harold G.**, Motion Picture Projectionist, Lyric & Rialto Theatres. Mail: 855 S. 20th East St., Salt Lake City, Utah. (A)
- Del Porte, Earle N.**, Projection Supervisor, Station KSD-TV. Mail: 445 Alice Ave., Kirkwood 22, Mo. (A)
- Downes, L. C.**, Designer, TV Film Projection Equipment, General Electric Co. Mail: 947 James St., Syracuse, N.Y. (A)
- Duggan, Robert**, Owner, The Studio Lighting Co., 1548 N. Dearborn, Chicago, Ill. (A)
- Fallon, Louis F.**, Sales Representative, Ampro Corp. Mail: 985 Franklin Turnpike, Allendale, N. J. (A)
- Fulgham, Claude O.**, Vice-President in Charge of Management, Video Theatres. Mail: 111 $\frac{1}{2}$ N. Lee, Box 1334, Oklahoma City, Okla. (A)
- Julin, Kurt**, Technical Chief, A. B. Cosmorama. Mail: Skillnadsatan 60A, Gothenburg, Sweden. (M)
- Kinstler, Richard C.**, Head, Photographic Laboratory, Procter & Gamble Co., M. A. & R. Bldg., Cincinnati 17, Ohio. (M)
- Lepore, Alfred Louis**, Electro-Acoustic Engineer and Cameraman. Mail: 732 and 736 Manton Ave., Providence 9, R.I. (M)
- Nemeth, Ted**, Motion Picture Producer, Director and Cameraman, Ted Nemeth Studios, 729 Seventh Ave., New York 19. (M)
- Parker, Will A.**, Motion Picture and Television Consultant, Film Counselors, Inc. Mail: 60 Manursing Ave., Rye, N.Y. (A)
- Potts, Clifford F.**, Motion Picture Producer, Fordel Film Laboratories, 1187 University Ave., Bronx 52, N.Y. (M)
- Rivera, Joseph V.**, General Motion Picture Laboratory work and Dupe Printer, Circle Film Laboratory. Mail: 873 E. 162 St., Bronx 59, N.Y. (A)
- Saunders, James Arthur**, Assistant Engineer, Western Australian Government. Mail: 257 Crawford Rd., Inglewood, Western Australia. (A)
- Shagin, Ralph J.**, Photographic Merchandising Analyst. Mail: 686 Kent Ave., Teaneck, N.J. (M)
- Temple, Dwight Irving**, Television Engineer, Technical Supervisor, Columbia Broadcasting System, Inc. Mail: 47 Lockwood Ave., New Rochelle, N.Y. (A)
- Watson, Lloyd E.**, Research Chemist, Technicolor Motion Picture Corp. Mail: 1708 Scott Rd., Burbank, Calif. (A)
- Willoughby, Anthony Haydn**, Consultant Electrical Engineer, Sir Robert Watson-Watt & Partners, Ltd. Mail: 7 Gayfere St., Westminster, London, England. (A)

CHANGE OF GRADE

- Anderson, James A.**, Assistant Production Manager, Alexander Film Co., Colorado Springs, Colo. (A) to (M)
- Churko, John G.**, Sales Engineer, Century Lighting Co., Inc. Mail: 106 E. 108 St., New York 29, N. Y. (S) to (A)
- Williams, Paul A.**, Audio-Video Engineer, KPIX, Inc. Mail: 341 Hazelwood Ave., San Francisco 12, Calif. (A) to (M)

SMPTE Officers and Committees: The roster of Society Officers was published in the May JOURNAL. The Committee Chairmen and Members were shown in the April JOURNAL, pp. 515-22; changes in the Engineers Committees have been extensive and so the complete rosters are given on pp. 337-40 of this JOURNAL.

— New Products —

Further information concerning the material described below can be obtained by writing direct to the manufacturers. As in the case of technical papers, publication of these news items does not constitute endorsement of the manufacturer's statements nor of his products.

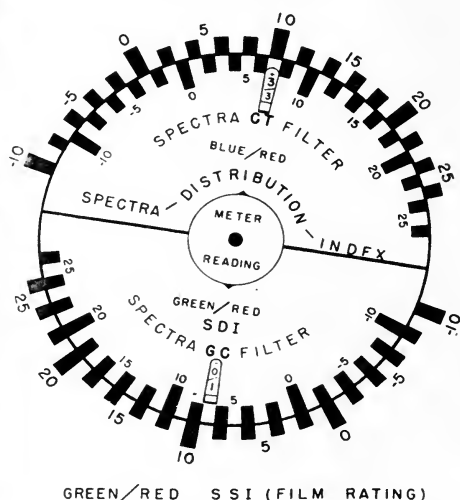
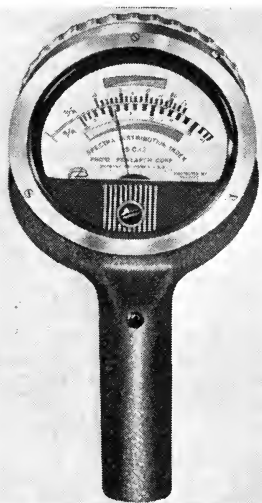

The Spectra Three-Color Meter is a new instrument recently announced by Photo Research Corp., Burbank, Calif., succeeding the firm's Spectra color temperature meter widely used in motion picture color photography.

Designers of the new instrument have spent several years developing a system which would relate the amounts of red, green and blue in an illuminant to the color balance of different types of color film and to the selection of any necessary corrective filters. The result is a log index derived from the ratios of blue to red and of green to red. The Spectra Index for photoflood lamps is 2.0/1.0 which means that a photoflood lamp emitting light of the color for which Type A color film is balanced will give a reading of 2.0 on the blue-red scale of the meter, and of 1.0 on the green-red scale.

If the B-R reading is more than one unit high or low, a correction filter of the turquoise-salmon series must be applied. If the G-R reading is more than half a unit away from the correct value, a correction filter of the green-magenta series must be placed over the lens. In either case, a computer (right, above) indicates directly the filter to employ. A card is furnished indicating the Spectra Index ratings of available color film materials.

To facilitate the use of the three-color system, the firm is also making a complete series of mounted glass filters to match the scales of the Three-Color Spectra. One series of filters, the *CT*, provide the usual type of correction for yellowish or bluish light. The new series, the *GC*, correct for a deficiency or excess of green in the illuminant.

In addition to supplying the new meter, Photo Research Corp. reports that it will convert any of the older two-color meters to the new model, at a reasonable charge, the shape and general construction of the instrument having been kept the same.

Society Engineering Committees

AS OF AUGUST 15, 1950

CINEMATOGRAPHY. *To make recommendations and prepare specifications for the operation, maintenance, and servicing of motion picture cameras, accessory equipment, studio and outdoor-set lighting arrangements, camera technique and the varied uses of motion picture negative films for general photography. (File 5)*

C. G. Clarke, *Chairman*, 20th Century-Fox Film Corp., Beverly Hills, Calif.

(Under organization)

COLOR. *To make recommendations and prepare specifications for the operation, maintenance, and servicing of color motion picture processes, accessory equipment, studio lighting, selection of studio set colors, color cameras, color motion picture films, and general color photography. (File 10)*

H. H. Duerr, *Chairman*, Ansco, Binghamton, N.Y.

R. H. Bingham	R. O. Drew	L. T. Goldsmith	C. F. J. Overhage
M. R. Boyer	A. A. Duryea	A. M. Gundelfinger	W. E. Pohl
H. E. Bragg	R. M. Evans	W. W. Lozier	G. F. Rackett
O. O. Ceccarini	J. G. Frayne	A. J. Miller	L. E. Varden

FILM DIMENSIONS. *To make recommendations and prepare specifications on those film dimensions which affect performance and interchangeability, and to investigate new methods of cutting and perforating motion picture film in addition to the study of its physical properties. (File 15)*

E. K. Carver, *Chairman*, Eastman Kodak Co., Kodak Park Works, Rochester 4, N.Y.

E. A. Bertram	W. G. Hill	N. L. Simmons	Fred Waller
A. F. Edouart	A. J. Miller	M. G. Townsley	D. R. White
A. M. Gundelfinger	W. E. Pohl	William Wade	

FILM-PROJECTION PRACTICE. *To make recommendations and prepare specifications for the operation, maintenance, and servicing of motion picture projection equipment, projection rooms, film-storage facilities, stage arrangement, screen dimensions and placement, and maintenance of loudspeakers to improve the quality of reproduced sound and the quality of the projected picture in the theater. (File 20)*

L. W. Davee, *Chairman*, Century Projector Corp., 729 Seventh Ave., New York 19

C. S. Ashcraft	C. F. Horstman	Paul Ries	Ben Schlanger
Frank Cahill	G. T. Lorance	Harry Rubin	J. W. Servies
R. H. Heacock	H. T. Matthews		

HIGH-SPEED PHOTOGRAPHY. *To make recommendations and prepare specifications for the construction, installation, operation, and servicing of equipment for photographing and projecting pictures taken at high repetition rates or with extremely short exposure times. (File 25)*

J. H. Waddell, *Chairman*, Wollensak Optical Co., 850 Hudson Ave., Rochester 5, N.Y.

H. E. Edgerton, *Vice-Chairman*, Dept. of Electrical Engineering, Massachusetts Institute of Technology, Cambridge 39, Mass.

E. A. Andres, Sr.	W. R. Fraser	C. D. Miller	Earl Quinn
K. M. Baird	W. H. Fritz	A. P. Neyhart	M. L. Sandell
D. M. Beard	Eleanor Gerlach	W. S. Nivison	Kenneth Shaftan
H. W. Crouch	C. C. Herring	Brian O'Brien	C. W. Wyckoff
C. H. Elmer	H. M. Lester	D. H. Peterson	A. M. Zarem
R. E. Farnham	L. R. Martin		

LABORATORY PRACTICE. *To make recommendations and prepare specifications for the operation, maintenance, and servicing of motion picture printers, processing machines, inspection projectors, splicing machines, film-cleaning and treating equipment, rewinding equipment, any type of film-handling accessories, methods, and processes which offer increased efficiency and improvements in the photographic quality of the final print. (File 30)*

J. G. Stott, *Chairman*, Du Art Film Laboratories, 245 West 55 St., New York, N.Y.

V. D. Armstrong	I. M. Ewig	O. W. Murray	V. C. Shaner
H. L. Baumbach	T. M. Ingman	W. F. Offenhauser,	J. H. Spray
D. P. Boyle	P. A. Kaufman	Jr.	Lloyd Thompson
O. E. Cantor	C. F. LoBalbo	W. E. Pohl	Paul Zeff
Gordon Chambers	J. A. Maurer	E. H. Reichard	

MOTION PICTURE STUDIO LIGHTING. *To make recommendations and prepare specifications for the operation, maintenance, and servicing of all types of studio and outdoor auxiliary lighting equipment, tungsten light and carbon-arc sources, lighting-effect devices, diffusers, special light screens, etc., to increase the general engineering knowledge of the art. (File 35)*

M. A. Hankins, *Chairman*, Mole-Richardson Co., 937 N. Sycamore Ave., Hollywood 38, Calif.

Richard Blount	Karl Freund	C. R. Long	D. W. Prideaux
J. W. Boyle	C. W. Handley	W. W. Lozier	Petro Vlahos

OPTICS. *To make recommendations and prepare specifications on all subjects connected with lenses and their properties. (File 40)*

R. Kingslake, *Chairman*, Eastman Kodak Co., Hawk Eye Works, Rochester 4, N.Y.

F. G. Back	J. W. Gillon	G. A. Mitchell	L. T. Sachtleben
A. A. Cook	Grover Laube	A. E. Murray	O. H. Schade
C. R. Daily	J. A. Maurer	W. E. Pohl	M. G. Townsley
I. C. Gardner			

PRESERVATION OF FILM. *To make recommendations and prepare specifications on methods of treating and storage of motion picture film for active, archival, and permanent record purposes, so far as can be prepared within both the economic and historical value of the films. (File 45)*

J. W. Cummings, *Chairman*, National Archives, Washington 25, D.C.

Henry Anderson	C. R. Fordyce	A. C. Hutton	W. E. Pohl
W. G. Brennan	J. E. Gibson	J. B. McCullough	W. D. Stump
J. W. Dunham	G. Graham	N. F. Oakley	

PROCESS PHOTOGRAPHY. *To make recommendations and prepare specifications on motion picture optical printers, process projectors (background process), matte processes, special process lighting technique, special processing machines, miniature-set requirements, special-effects devices, and the like, that will lead to improvement in this phase of the production art. (File 50)*

M. H. Chamberlin, *Chairman*, Metro-Goldwyn-Mayer Studios, Culver City, Calif.

(Under Organization)

SCREEN BRIGHTNESS. *To make recommendations, prepare specifications, and test methods for determining and standardizing the brightness of the motion picture screen image at various parts of the screen, and for special means or devices in the projection room adapted to the control or improvement of screen brightness. (File 55)*

W. W. Lozier, *Chairman*, National Carbon Div., Fostoria, Ohio

Herbert Barnett	L. D. Grignon	L. J. Patton	C. R. Underhill, Jr.
F. E. Carlson	A. J. Hatch, Jr.	J. W. Servies	H. E. White
Gordon Edwards	L. B. Isaac	B. A. Silard	A. T. Williams
E. R. Geib	F. J. Kolb	Allen Stimson	D. L. Williams
L. T. Goldsmith	W. F. Little		

16-MM AND 8-MM MOTION PICTURES. *To make recommendations and prepare specifications for 16-mm and 8-mm cameras, 16-mm sound recorders and sound-recording practices, 16-mm and 8-mm printers and other film laboratory equipment and practices, 16-mm and 8-mm projectors, splicing machines, screen dimensions and placement, loudspeaker output and placement, preview or theater arrangements, test films, and the like, which will improve the quality of 16-mm and 8-mm motion pictures. (File 60)*

H. J. Hood, *Chairman*, Eastman Kodak Co., 343 State St., Rochester 4, N.Y.
 H. W. Bauman G. A. Del Valle D. F. Lyman A. G. Petrasek
 W. C. Bowen J. W. Evans W. C. Miller A. C. Robertson
 F. L. Brethauer C. R. Fordyce J. R. Montgomery L. T. Sachtleben
 F. E. Brooker John Forrest J. W. Moore H. H. Strong
 F. E. Carlson R. C. Holslag W. H. Offenhauser, Lloyd Thompson
 S. L. Chertok Rudolf Kingslake Jr. M. G. Townsley
 E. W. D'Arcy W. W. Lozier

SOUND. *To make recommendations and prepare specifications for the operation, maintenance, and servicing of motion picture film, sound recorders, re-recorders, and reproducing equipment, methods of recording sound, sound-film processing, and the like, to obtain means of standardizing procedures that will result in the production of better uniform quality sound in the theater. (File 65)*

L. T. Goldsmith, *Chairman*, Eastman Kodak Co., 343 State St., Rochester 4, N.Y.
 G. L. Dimmick, *Vice-Chairman*, RCA Victor Division, Camden, N.J.
 F. G. Albin R. M. Fraser E. W. Kellogg G. E. Sawyer
 A. C. Blaney J. G. Frayne J. P. Livadary R. R. Scoville
 D. J. Bloomberg L. D. Grignon K. M. MacIlvain W. L. Thayer
 F. E. Cahill, Jr. Robert Herr W. C. Miller M. G. Townsley
 E. W. D'Arcy J. K. Hilliard G. C. Misener R. T. Van Niman
 R. J. Engler L. B. Isaac Otto Sandvik D. R. White

STANDARDS. *To survey constantly all engineering phases of motion picture production, distribution, and exhibition, to make recommendations and prepare specifications that may become proposals for American Standards. This Committee should follow carefully the work of all other committees on engineering and may request any committee to investigate and prepare a report on the phase of motion picture engineering to which it is assigned. (File 70)*

F. E. Carlson, *Chairman*, General Electric Company, Nela Park, Cleveland 12, Ohio

Chairmen of Engineering Committees

Richard Blount L. W. Davee M. A. Hankins F. J. Pfeiff
 E. K. Carver H. H. Duerr H. J. Hood Leonard Satz
 M. H. Chamberlin E. C. Fritts D. E. Hyndman J. G. Stott
 C. G. Clarke R. L. Garman Rudolf Kingslake J. H. Waddell
 J. W. Cummings L. T. Goldsmith W. W. Lozier

Members at Large

Gordon Edwards E. W. Kellogg D. F. Lyman Otto Sandvik
 C. R. Keith G. T. Lorance

Members Ex-Officio

F. T. Bowditch V. O. Knudsen G. M. Nixon F. W. Sears
 L. A. Jones J. A. Maurer

JOINT RTMA-SMPTE COMMITTEE ON TELEVISION FILM EQUIPMENT. *To make recommendations and prepare specifications on all phases of film equipment as used in the television broadcast stations. (File 75)*

F. N. Gillette, *RTMA, Chairman*, General Precision Laboratory, 63 Bedford Road, Pleasantville, N.Y.

E. C. Fritts, *SMPTE, Vice-Chairman*, Eastman Kodak Co., 333 State St., Rochester 4, N.Y.
 A. J. Brackett L. C. Downes R. M. Morris C. L. Townsend
 Pierre Boucheron J. A. Maurer N. F. Oakley M. G. Townsley
 P. F. Brown H. C. Milholland R. C. Rheineck H. E. White
 Sydney Cramer G. C. Misener J. H. Roe

FILMS FOR TELEVISION. *To make recommendations and prepare specifications on all phases of the production, processing and use of film made for transmission over a television system excluding video transcriptions. (File 80)*

R. L. Garman, *Chairman*, General Precision Laboratories, Inc., 63 Bedford Road, Pleasantville, N.Y.

M. R. Boyer	H. R. Lipman	R. M. Morris	C. L. Townsend
R. O. Drew	G. C. Misener	R. C. Rheineck	L. F. Transue
Richard Hodgson	Pierre Mertz	H. J. Schlafly	T. G. Veal
R. Johnston	H. C. Milholland	N. L. Simmons	H. E. White

TELEVISION STUDIO LIGHTING. *To make recommendations and prepare specifications on all phases of lighting employed in television studios. (File 85)*

Richard Blount, *Chairman*, General Electric Co., Nela Park, Cleveland 12, Ohio

H. R. Bell	H. M. Gurin	Robert Morris	W. F. Rockar
A. H. Brolly	Eric Herud	R. S. O'Brien	R. L. Zahour

THEATER TELEVISION. *To make recommendations and prepare specifications for the construction, installation, operation, maintenance, and servicing of equipment for projecting television pictures in the motion picture theater, as well as projection-room arrangements necessary for such equipment, and such picture-dimensional and screen-characteristic matters as may be involved in high-quality theater-television presentations. (File 90)*

D. E. Hyndman, *Chairman*, Eastman Kodak Co., 343 State St., Rochester 4, N.Y.

Ralph Austrian	T. T. Goldsmith, Jr.	Nathan Levinson	L. L. Ryder
G. L. Beers	Nate Halpern	W. W. Lozier	Otto Sandvik
F. E. Cahill, Jr.	Richard Hodgson	G. P. Mann	Ed Schmidt
James Frank, Jr.	C. F. Horstman	R. H. McCullough	A. G. Smith
R. L. Garman	L. B. Isaac	F. R. Norton	E. I. Sponable
E. P. Genock	A. G. Jensen	Harry Rubin	J. E. Volkmann
A. N. Goldsmith	P. J. Larsen		

TEST FILM QUALITY. *To develop and keep up to date all test film specifications, and to supervise, inspect and approve methods of production and quality control of all test films sold by the Society. (File 95)*

F. J. Pfeiff, *Chairman*, Altec Service Corp., 250 W. 57 St., New York 19, N.Y.

R. M. Corbin	Gordon Edwards	Joseph Spray	M. G. Townsley
Russell Drew	J. A. Maurer	J. G. Stott	

THEATER ENGINEERING. *To make recommendations and prepare specifications of engineering methods and equipment of motion picture theaters in relation to their contribution to the physical comfort and safety of patrons, so far as can be enhanced by correct theater design, construction, and operation of equipment. (File 100)*

Leonard Satz, *Chairman*, Raytone Screen Co., 165 Clermont Ave., Brooklyn 5, N.Y.

F. W. Alexa	Charles Bachman	James Frank, Jr.	Ben Schlanger
Henry Anderson	E. J. Content	Aaron Nadell	Seymour Seider
O. P. Beckwith	C. M. Cutler	E. H. Perkins	Emil Wandelmaier

Journal of the Society of Motion Picture and Television Engineers

VOLUME 55

OCTOBER 1950

NUMBER 4

Color Television.....FRANK H. MCINTOSH and ANDREW F. INGLIS	343
Addendum: Recent Developments in Color Television.....	364
Color Cathode-Ray Tube With Three Phosphor Bands.....	
CONSTANTIN S. SZEGHO	367
A Magnetic Record-Reproduce Head.....M. RETTINGER	377
Physical Principles, Design and Performance of the Ventarc High-Intensity Projection Lamps.....EDGAR GRETENER	391
The High-Speed Photography of Underwater Explosions..PAUL M. FYE	414
A Heavy-Duty 16-Mm Sound Projector.....EDWIN C. FRITTS	425
Interference Mirrors for Arc Projectors.....G. J. KOCH	439
Engineering Committees Activities.....	443
BOOK REVIEWS:	
<i>Questions and Answers in Television Engineering</i> , by Carter V. Rabinoff and Magdalena E. Walbrecht.....Reviewed by Richard H. Dorf	444
<i>Réunions D'Opticiens</i> , Tenues a Paris en Octobre 1946, Textes rassemblés par Pierre Fleury, André Maréchal et Mme. Claire Anglade, Institut d'Optique, Paris.....Reviewed by Dr. K. Pestrecov	445
<i>Photographie Instantanée et Cinematographie Ultra-Rapide</i> , par P. Fayolle et P. Naslin.....Reviewed by John H. Waddell	445
LETTERS TO THE EDITOR.....By J. F. Dunn	446
	By Don Norwood
	447
New Members.....	448
New Products.....	450
Meetings of Other Societies.....	451

ARTHUR C. DOWNES
Chairman
Board of Editors

VICTOR H. ALLEN
Editor

NORWOOD L. SIMMONS
Chairman
Papers Committee

Subscription to nonmembers, \$12.50 per annum; to members, \$6.25 per annum, included in their annual membership dues; single copies, \$1.50. Order from the Society's General Office. A discount of ten per cent is allowed to accredited agencies on orders for subscriptions and single copies. Published monthly at Easton, Pa., by the Society of Motion Picture and Television Engineers, Inc. Publication Office, 20th & Northampton Sts., Easton, Pa. General and Editorial Office, 342 Madison Ave., New York 17, N.Y. Entered as second-class matter January 15, 1930, at the Post Office at Easton, Pa., under the Act of March 3, 1879.

Copyright, 1950, by the Society of Motion Picture and Television Engineers, Inc. Permission to republish material from the JOURNAL must be obtained in writing from the General Office of the Society. Copyright under International Copyright Convention and Pan-American Convention. The Society is not responsible for statements of authors or contributors.

Society of Motion Picture and Television Engineers

342 MADISON AVENUE, NEW YORK 17, N.Y., TEL. MU 2-2185
BOYCE NEMEC, EXECUTIVE SECRETARY

OFFICERS

1949-1950

PRESIDENT
Earl I. Sponable
460 W. 54 St.
New York 19, N.Y.

PAST-PRESIDENT
Loren L. Ryder
5451 Marathon St.
Hollywood 38, Calif.

SECRETARY
Robert M. Corbin
343 State St.
Rochester 4, N.Y.

**EXECUTIVE
VICE-PRESIDENT**
Peter Mole
941 N. Sycamore Ave.
Hollywood 38, Calif.

**EDITORIAL
VICE-PRESIDENT**
Clyde R. Keith
120 Broadway
New York 5, N.Y.

**CONVENTION
VICE-PRESIDENT**
William C. Kunzmann
Box 6087
Cleveland 1, Ohio

1950-1951

**ENGINEERING
VICE-PRESIDENT**
Fred T. Bowditch
Box 6087
Cleveland 1, Ohio

TREASURER
Frank E. Cahill, Jr.
321 W. 44 St.
New York 18, N.Y.

**FINANCIAL
VICE-PRESIDENT**
Ralph B. Austrian
25 W. 54 St.
New York 19, N.Y.

Governors

1949-1950

Herbert Barnett
Manville Lane
Pleasantville, N.Y.

Kenneth F. Morgan
6601 Romaine St.
Los Angeles 38, Calif.

Norwood L. Simmons
6706 Santa Monica Blvd.
Hollywood 38, Calif.

Charles R. Daily
113 N. Laurel Ave.
Los Angeles 36, Calif.

John P. Livadary
4034 Cromwell Ave.
Los Angeles, Calif.

William B. Lodge
485 Madison Ave.
New York 22, N.Y.

1950-1951

Lorin D. Grignon
1427 Warnall Ave.
Los Angeles 24, Calif.

Paul J. Larsen
4313 Center St.
Chevy Chase, Md.

William H. Rivers
342 Madison Ave.
New York 17, N.Y.

1950

F. E. Carlson
Nela Park
Cleveland 12, Ohio

George W. Colburn
164 N. Wacker Dr.
Chicago 6, Ill.

Edmund A. Bertram
850 Tenth Ave.
New York 19, N.Y.

Malcolm G. Townsley
7100 McCormick Rd.
Chicago 45, Ill.

Edward S. Seeley
161 Sixth Ave.
New York 13, N.Y.

R. T. Van Niman
4501 Washington St.
Chicago 24, Ill.

Color Television

BY FRANK H. McINTOSH AND ANDREW F. INGLIS
CONSULTING RADIO ENGINEERS, WASHINGTON, D.C.

SUMMARY: The three major systems being considered by FCC are: (1) the CBS field sequential; (2) the RCA dot sequential; and (3) the CTI line sequential system. They are mutually exclusive in that different receiver circuit arrangements are required for each. Their principal characteristics will be described and related to the general problem of providing color television service to the public. The probable design factors upon which the FCC decision will be based, such as required bandwidth versus picture fidelity and resolution, and compatibility with existing black-and-white television systems will be covered in detail.

THE ENGINEERING PROBLEMS which must be solved in developing a system of color television are exceedingly complex, and to discuss all of them in a single paper is obviously impossible. The most fundamental problem, however, which must be faced in the development of a broadcast color television system, is the transmission of a picture of maximum possible quality in a minimum bandwidth. All systems of color television now being proposed represent various approaches to this problem, and in order to understand these systems it is necessary to have a general understanding of its nature. The first part of this paper will, therefore, be devoted to the general subject of television systems as related to bandwidth.

BANDWIDTH REQUIREMENTS OF COLOR TELEVISION

It is a well-known physical law that, with the type of amplitude modulation used for television broadcasting, the amount of information which can be transmitted is directly in proportion to the available bandwidth. This law constitutes a most important limitation to television performance. The amount of information transmitted in an ordinary black-and-white television signal requires a video band of approximately 4 megacycles or about 400 times as great as that required for a reasonably high fidelity audio signal. This video bandwidth is translated by the modulation process to radio-frequency bandwidth, and with single sideband amplitude modulation 6 megacycles of space in the radio-frequency spectrum is required to transmit a 4-megacycle video signal plus the accompanying audio channel on a separate transmitter.

PRESENTED: April 24, 1950, at the SMPTE Convention in Chicago.

Because of the serious shortage of available spectrum space, the problem of utilizing it to its utmost is probably the most serious facing the television engineer. A tremendous amount of ingenious research has been devoted to this problem, some of the most important results of which will be discussed here.

In a black-and-white television picture the information to be transmitted is the variation in brightness of various portions of the picture. The number of independent brightness values per second which can be transmitted is equal to twice the highest frequency passed by the system. Each one-half cycle period of time is sometimes called a Nyquist interval. With the standard monochrome television broadcast system, the highest frequency is 4 megacycles and the Nyquist interval is one-eighth of a microsecond. This means that the maximum number of independent brightness values (which is usually expressed as the number of picture elements) will be 8,000,000 per second. This number represents the product of the number of picture elements in a single picture and the number of pictures which are transmitted each second. It is quite apparent, therefore, that the smaller the number of pictures per second, the larger will be the number of picture elements and correspondingly the greater the resolution of the picture. For this reason it is desirable to transmit as few pictures per second as possible. The limit to the minimum number of pictures which can be transmitted per second is set by the factors of flicker and the blurring of moving objects. Of these, the problem of flicker is the more important and has received the greater amount of attention.

With standard monochrome television, the problem of flicker has been reduced by using an interlaced scanning system. In this system alternate lines are scanned during a period of one-sixtieth of a second. During the next one-sixtieth of a second, the other set of alternate lines is scanned so that the complete picture is transmitted in a period of one-thirtieth of a second. Because of the method of interlaced scanning, however, it has been determined that the large-area flicker is probably no more objectionable than would be the case if the complete picture were transmitted 60 times a second, though a less visible "interline flicker" is introduced, particularly when the received picture is bright. This 2-to-1 system of interlace, therefore, doubles the number of picture elements which can be transmitted within a given bandwidth.

In a 4-megacycle bandwidth capable of transmitting 8,000,000 picture elements per second and picture repetition rate of 30 per second, the maximum theoretical number of picture elements per

picture would be 266,000. This theoretical maximum is not reached in practice, however. There is a reduction of approximately 14% due to the time consumed during the horizontal blanking interval at the end of each line, and a reduction of approximately 8% due to the vertical blanking interval at the end of each field. From these considerations alone the picture elements which theoretically can be transmitted in a black-and-white picture are approximately 79% of 266,000 or about 210,000. There is an additional reduction factor which is due to the fact that *vertical* variations in brightness cannot occur at arbitrary positions but can occur only from one line to the next. Since the position of the scanning lines may not coincide exactly with the variations in brightness of the picture, the effective vertical resolution is not equal to the number of visible scanning lines. A factor of approximately 0.7 is normally used to express the reduction in resolution from this source. When these factors are all combined, the total number of picture elements which can be practically resolved is found to be about 147,000. This figure is equal to the product of the number of lines which can be resolved in the vertical direction which is about 338 ($525 \times 0.92 \times 0.7$) and the horizontal direction which is about 437 ($63.5 \mu\text{sec}$ (microseconds) $\times 0.86 \times 8$ lines/ μsec). When allowance is made for the 4-to-3 aspect ratio, the number-of-lines resolution in a horizontal distance equal to the height of the picture is computed to be 328 which is almost identical with the vertical.

HORIZONTAL INTERLACE

Since vertical interlace can be used to double the resolution of a picture for a given bandwidth, it is suggested that the resolution might be doubled again by using horizontal interlace also. This technique has been discussed at length in recent testimony before the FCC (Federal Communications Commission) in connection with the proceedings on color television and also in the literature.*

The fundamental objective to be achieved by this type of horizontal interlace is to cut the rate of picture transmission in half, thereby doubling the number of picture elements which can be transmitted in each picture. To accomplish this, the waveform to be transmitted is first sampled at approximately twice the highest frequency which can be transmitted. This is illustrated in Fig. 1 which shows a 6-megacycle sine wave sampled at the rate of 8 mega-

* Wilson Boothroyd, "Dot systems of color television," *Electronics*, Pt. I, vol. 22, no. 12, pp. 88-92, Dec. 1949; Pt. II, vol. 23, no. 1, pp. 96-99, Jan. 1950.

cycles, that is, a train of pulses having a repetition rate of 8 megacycles is amplitude modulated so that the height of each pulse is equal to the amplitude of the signal at that instant. In the television application, this sine wave would represent the output of the camera along one line of the picture. During the succeeding frame, assuming that no motion has occurred in the picture, this same sine wave will occur, and it is again sampled at the rate of 8 megacycles, but with the sampling points shifted by one-half cycle as indicated by the dotted lines. When pulses, amplitude modulated by a signal of greater frequency than 4 megacycles, are passed through amplifier

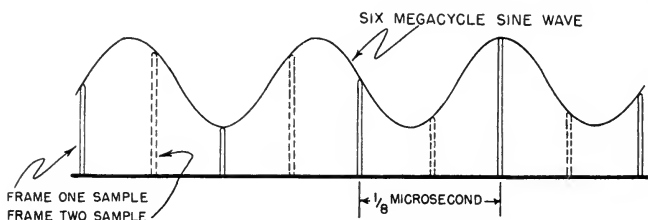

(a) ORIGINAL SIGNAL AND TRANSMITTER SAMPLES

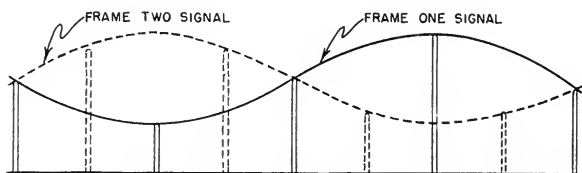

(b) TRANSMITTED SIGNALS AND RECEIVER SAMPLES

Figure 1.

circuits having a bandwidth of only 4 megacycles, mathematical analysis shows that the only frequencies passed will be the d-c component and a component equal in frequency to the difference between the signal and the sampling frequencies. Thus in this case, the transmitted signal for both frames will consist of a d-c component plus a 2-megacycle frequency. These 2-megacycle components, however, will be 180 deg out of phase as indicated in Fig. 1(b).

At the receiver, these 2-megacycle components are again sampled in synchronism with the transmitter, thus reconstructing the transmitter samples as indicated in Fig. 1(b). At this point, a number of mechanisms could be employed to present this information on the

kinescope—perhaps the most obvious of which would be to use these narrow samples to control the magnitude of a wider pulse occupying approximately $\frac{1}{16}$ μ sec in the signal applied to the kinescope. This would result in a series of dots being produced on the screen with the spaces between the dots being filled in alternate fields. In this way, it would be possible to have independent signal components occurring at the equivalent rate of 16 million per second which is equivalent to a bandwidth of 8 megacycles without horizontal interlacing. A more careful analysis indicates, however, that this process is not necessary. Instead, it is only required to pass the sample pulses through a filter, passing all frequencies up to but not including the sampling frequency. When this is done, it can be shown that two frequency components will appear in the output: first, the original signal frequency, 6 megacycles in this case; and second, the difference frequency, 2 megacycles in this case. In the succeeding frame, the difference frequency will again appear but 180 deg out of phase with respect to the first frame. If the sample output from the first frame is stored and added to the output of the second frame, the difference frequency components will cancel out, thus leaving only the signal frequency component. A cathode-ray tube with a phosphor of sufficient persistence when combined with the natural persistence of the eye provides a method for storing and adding these signals, the only limitation being that the negative values of brightness cannot be physically achieved. Consequently, if the output of the sampling circuit is applied directly to the control grid of the kinescope through a filter as described above, the signal components will be automatically produced correctly. As in the case of line interlace a new form of flicker will appear, "inter-dot" flicker, which is most visible with vertical arrays of dots, or vertical or diagonal lines, in the picture.

In the example given above, a specific frequency component of 6 megacycles was used for illustration. The following general description can be made for other frequencies. Assuming again that the transmission system will pass components from 0 to 4 megacycles and that the sampling rate is 8 megacycles, signal components from 0 to 4 megacycles will be unaffected by the sampling process and will be transmitted in the usual manner. Signal components from 4 to 8 megacycles will beat with the 8 megacycle sampling frequency and will appear in the transmitted signal as a difference frequency. These difference frequencies will likewise follow in the range from 0 to 4 megacycles. However, when resampled at the receiver, they are distinguishable from the original signal components by the fact that

on alternate frames, they will be 180 deg out of phase so that when they are sampled at the receiver the original signal frequency is restored.

When transmitting a color picture, in addition to variations in brightness, variations in color must also be transmitted. It might be thought, therefore, that the bandwidth required to transmit three primary colors would be three times as great as that required for black-and-white. Early experiments in color television followed this theory. At that time two methods were under consideration: the field-sequential system and the simultaneous system. In the simultaneous system, the three color signals were sent over separate channels so that the total bandwidth required was nearly three times that required for single black-and-white transmission. (The total was not quite three times as great, inasmuch as a reduced bandwidth was used for the blue signal; this could be done because the eye is not so sensitive to detail in blue.) In the field-sequential system, the successive fields were transmitted cyclically in the three primary colors, but when this was done it was found necessary to increase the field rate to approximately three times the black-and-white rate in order to avoid objectionable color flicker. This resulted in a nearly threefold increase in bandwidth to achieve the same picture resolution.

A closer analysis of the situation, however, indicated that this increase in bandwidth for the transmission of color is not inherently required. If a scheme could be worked out whereby a smaller number of pictures could be transmitted per second without objectionable flicker, the resolution of standard black-and-white could be maintained. Two of the three systems of color television now proposed to the FCC attempt to slow down the rate of picture transmission without a corresponding increase in flicker. These methods will be described later in connection with the individual systems proposed.

SEQUENTIAL METHODS OF COLOR TELEVISION

The simultaneous method of color television has now been abandoned for broadcast television because of its excessively large bandwidth requirements, and all three systems now proposed are sequential in nature; that is, the color information is sent in cyclical sequence and the retentivity of the human eye is employed to produce the illusion of a continuous color picture. The essential difference between the three systems lies in the color switching rate. This is illustrated in Fig. 2. On the left side of this figure is shown in schematic form the field-sequential system proposed by CBS (Columbia Broadcasting System). In this system, a complete field is

transmitted in one color. The following field is sent in the second color and the following field in the third, and so forth.

In the center of the figure is illustrated the line-sequential system proposed by CTI (Color Television, Inc.). In this system the color is changed at the end of each line so that each field contains a third of its scanning lines in each primary color.

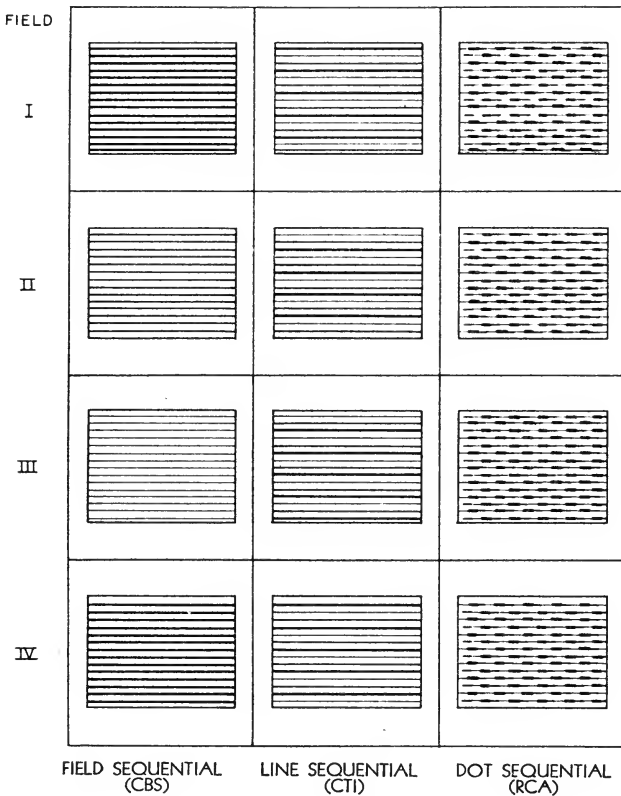

RED ———
 BLUE ———
 GREEN ———

Figure 2.

On the right side of the figure is shown the dot-sequential system proposed by RCA (Radio Corporation of America). In this system, the color is switched many times during each line. The rate currently proposed by RCA is to complete the color cycle in a period corresponding to a frequency of 3.6 megacycles.

The extreme difference in the color switching rate between the RCA system on one hand and the CBS on the other is such that the terminal apparatus suitable for the three systems differs considerably. These apparatus differences have tended to obscure the more fundamental difference in the color switching rate, which is the basic distinction between the three systems.

THE FIELD-SEQUENTIAL SYSTEM (CBS)

As stated above, CBS employs the field-sequential system wherein a complete field is transmitted in one color and the color change is made during the vertical blanking period. In order to avoid flicker, it has been found necessary to increase the field rate from the standard 60/sec employed by black-and-white television to 144/sec. Two fields are required to transmit the entire picture in a single primary color and 6 fields are required to transmit a complete color picture. There are, therefore, 24 color pictures transmitted each second, corresponding nicely to the current 35-mm motion picture frame rate (although it must be admitted that such "compatibility" is of far less importance than "compatibility" with present black-and-white television, discussed below).

Because the field rate has been increased from 60 to 144/sec with no change in the interlace pattern, there is an inevitable decrease in resolution in the ratio of 60 to 144. This decrease in resolution is divided between the vertical and horizontal directions. The vertical resolution is reduced by decreasing the number of scanning lines from 525 to 405, a reduction of approximately 27%. A single line occupies 34.4 μ sec as compared to 63.5 for present black-and-white. The number of Nyquist intervals in this period is, of course, reduced in the same ratio so that the horizontal resolution is reduced by approximately 46%.

In order to increase the horizontal resolution of the picture, a system of horizontal interlace somewhat similar to that described above, has been proposed by Dr. Peter Goldmark, inventor of the CBS system. This will restore the horizontal resolution to approximately the same value which exists for standard monochrome. It should be pointed out that this signal can be received without substantial degradation by a receiver not equipped with a sampling circuit. The resolution obtained in this case, of course, is not improved by the interlace process.

Since the CBS field rate is different from that employed by standard black-and-white, it is not a "compatible" system; that is, standard black-and-white receivers are unable to receive the CBS transmissions

even as black-and-white pictures without the addition of a special scanning adapter which will cause the receiver sweep circuit to operate in synchronism with the transmitter at the increased rate necessary. Messrs. Chapin and Roberts of the FCC Laboratory Division have developed an automatic adapter for the CBS system which is said to make it possible for the receiver sweep circuits to operate automatically in synchronism with the transmitter no matter which field rate is being transmitted. The installation of this device in a new receiver would, of course, increase its cost somewhat, and to adapt sets which have already been installed would cost somewhat more. This fact, plus the operational confusion which would result with dual standards, has perhaps been the source of the most severe criticism of the CBS system.

The CBS system employs the slowest color switching rate of the three and because of this it is the only system which can accomplish it by mechanical means. It has somewhat unfairly been accused of being inherently mechanical. This accusation is not fair inasmuch as any of the electronic terminal equipment, as employed by the other systems, could be used by CBS when suitably modified. Moreover, the possibility of color switching mechanically leads to certain definite advantages over all-electronic methods.

Some of the camera pickup equipment which could be used by CBS is illustrated in Fig. 3. At the top of this figure is shown the mechanical method which has been used almost exclusively by CBS in its experiments. With this device, a disc divided into segments covered with various color filters is rotated in front of the pickup tube. The shape of the filter segments and the speed of rotation of the disc is chosen in such a way that during each field a filter of given color will be in front of the pickup tube.

In the second drawing shown as Fig. 3(b), a system somewhat similar to that employed by CTI, has been adapted for use with the field-sequential system. Three lenses placed one above the other and each provided with a filter for one of the three primary colors focus three images on the light sensitive surface of the pickup tube. The horizontal sweep on the pickup tube is made to operate at its normal rate, but the vertical sweep operates at one-third the field frequency so that during one vertical period all three images are scanned. If the vertical sweep is perfectly linear and the images are properly positioned, a suitable field-sequential signal is created.

Figure 3(d) shows the camera employed by RCA. Here a single lens is used and the light emerging from the lens is made to pass through crossed dichroic mirrors. These mirrors transmit green

light directly to the center tube, one of them reflects red light to one of the tubes on the side while the other reflects blue light. Thus each of the three pickup tubes is illuminated constantly with light from one of the three primary colors. The outputs of the sweep circuits are applied to the deflection coils on the three tubes connected in parallel so that identical voltages are applied to each. Thus three signals are available constantly, one from each of the three tubes. In order to adapt this camera to the field-sequential system, it is only necessary to employ a gating circuit which will pass the output of

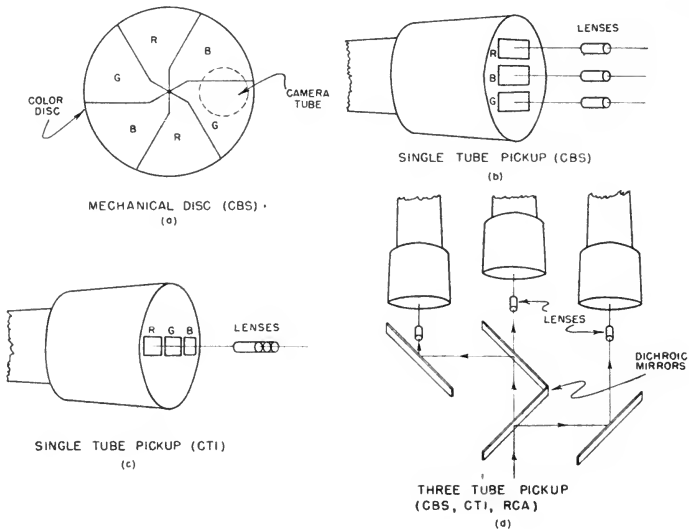

Figure 3.

each of the three camera tubes in sequence, switching at the end of each field.

In its demonstration CBS has used a mechanical system almost exclusively. This is probably due to the fact that only one tube is required and the fact that optical and electronic registration problems are avoided. The problems of registration are undoubtedly the most serious for electronic methods of color television and this is neatly solved by a mechanical disc.

The possible types of receivers which might be used with the CBS system are shown in Fig. 4. Figure 4(a) shows the mechanical method which is analogous to the system employed at the camera.

Here a disc divided into filter segments is rotated in front of the kinescope. This disc is synchronized in such a way that the red filter is in front of the picture tube when the red signal is being transmitted, the blue for the blue signal, and so forth. The eye then blends all three impressions together as a single colored picture.

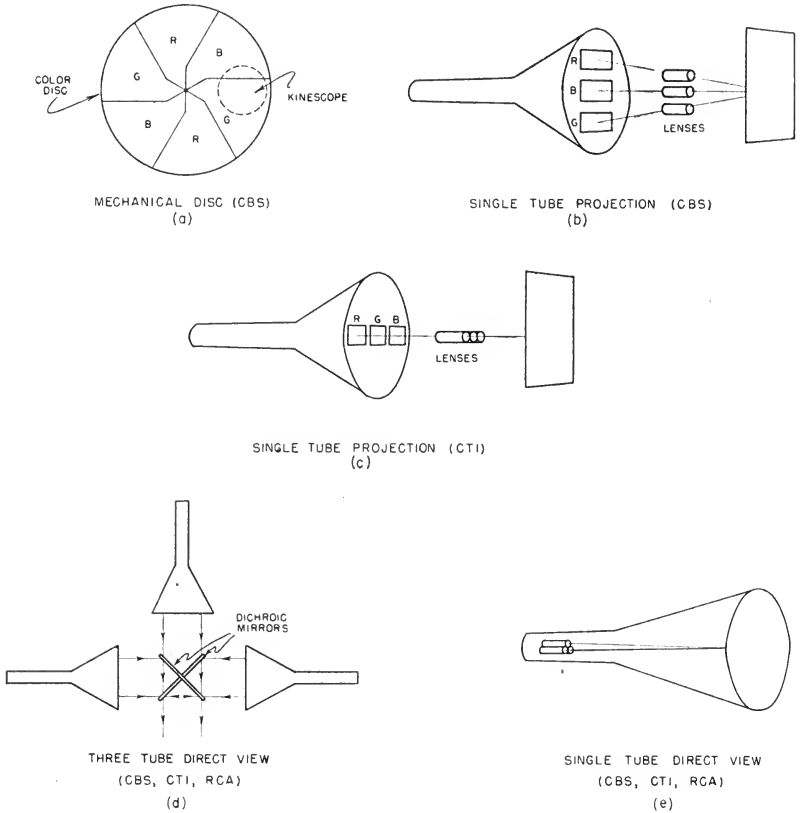

Figure 4.

Figure 4(b) shows a scheme similar to that shown on Fig. 3(b) for the camera. The phosphors on the face of the tube are deposited in three strips one above the other, each phosphor being chosen in such a way that the light emitted from it corresponds approximately to one of the primary colors. (In practice fairly good green and blue primaries can be achieved. The red primary at present contains too much yellow-green and a negative yellow-green filter is normally used.) The three images thus produced on the face of the tube are

superimposed by means of a lens system upon a projection screen, either reflecting or translucent, thus producing a color picture. Figure 4(d) shows a color receiver developed by RCA but which can also be adapted for use by CBS. Here three kinescopes are used. One of the tubes is viewed directly through a dichroic mirror while the virtual images of the other two are superimposed upon this direct image by means of the dichroic mirrors. These mirrors also provide the necessary filtering action so that one of the tubes provides an image in each of the three primary colors. The two virtual images superimposed on the face of the three tubes provide the illusion of a complete color picture. To adapt this receiver for the CBS system, it is only necessary to gate the input to the tubes so that the red tube operates with the red signal and the green with the green signal, and so forth.

Figure 4(e) shows the direct-view tube recently announced by RCA. The operation of this tube will be described later. This tube although developed by RCA for use in connection with its system could be adapted with ease to the CBS system.

Of these methods, CBS has used extensively only the mechanical system. The direct-view color tube has just been announced and has not been available for experimentation by companies other than RCA. As compared with the other two electronic methods, the mechanical system has the advantage of providing a means of producing a direct-view color picture at relatively low cost and with no registration problem. As in the case of camera equipment, the problem of registration is a very difficult one with electronic systems. On the other hand, the color disc has certain disadvantages, among which are its awkward size, and the fact that its use is limited to kinescopes of approximately 10-in. diameter due to the peripheral speed and awkward size of the whirling disc.

When the receiver and transmitter are operating on the same power line frequency, a synchronous motor can be used to operate the color disc. This will automatically stay in synchronism with the transmitter once it is set. In the case of the network programs where the problem of nonsynchronous power supply arises, it is necessary to transmit a phasing signal to keep the two in step. This signal as proposed by CBS consists of a series of impulses transmitted during the vertical blanking interval. By suitable circuitry, this impulse is made to operate the motor at the receiver in synchronism with the transmitter. The exact method to be used by CBS has not been disclosed.

THE CTI LINE-SEQUENTIAL SYSTEM

The line-sequential system proposed by CTI switches colors between (successive) lines during the horizontal blanking interval and in a given field, the lines are cyclically scanned in the three primary colors. Three possible sequences can be followed from frame to frame: a given line can always be traced in the same color, it can be traced in two of the primary colors or it can be traced in all three of the primary colors. Since 525 is (integrally) divisible by three, if a cyclic order were continuously maintained in color switching, the first situation would automatically follow; for example, the first line would always be in red, the second in green and the third in blue, and so forth. If during the vertical blanking interval, the cycle is upset so that, for example, one of the green lines is omitted, the "phase" of the color cycle will be shifted by one-third of a cycle. When this is done, a line which is scanned in red the first time can be scanned in blue the second and in green the third. This color shift is accomplished during the vertical blanking interval so that the shift in the color cycle is not noticeable. If one shift is performed every three fields, each line will eventually be scanned in two of the primary colors. This method of operation has, therefore, been termed by CTI, the "single-shift." If such a color shift is made during two out of three vertical blanking periods, each line will be scanned in all three primary colors and this method of operation has been termed by CTI as the "double-shift."

In a double-shift system, each line is scanned in all three colors and the color picture is, therefore, complete. With a single shift, one color is missing from each of the three lines. This has two effects: The vertical resolution of the picture is reduced by some amount, the exact reduction depending somewhat on the degree of saturation of the picture. If the picture consists of a single primary color, one-third of the lines will be black and the vertical resolution will be reduced by one-third. The reduction of vertical resolution for colors consisting of a mixture of primaries will be somewhat less. The second effect is the fact that the black lines will tend to show in the simple primary colors, and that the lines will be colored even when a white object appears in the picture. This is probably not a serious defect inasmuch as the eye is not sensitive to colors in such small areas as a single scanning line and the integrated effect of all the lines produces the proper color sensation at the eye, at least at a great enough viewing distance. With no shift in the color cycle, the same effects will occur except to a greater degree. The reduction in verti-

cal resolution with no color shift is so great that it has not been seriously proposed.

The choice of a proper scanning sequence is very important for the operation of the line-sequential system and a large number of combinations have been tried. Two of these are shown in Fig. 5, the first of which is a single-shift pattern in which each line is scanned in two of the primary colors while the second is a double-shift pattern in which each line is scanned in all three of the primary colors.

A third scanning sequence has recently been demonstrated by CTI which is described as the "interlaced shift." This is a double-

LINE	FIELD						
	I	II	III	IV	V	VI	VII
1	RED		GREEN		RED		GREEN
2		BLUE		RED		BLUE	
3	GREEN		BLUE		GREEN		BLUE
4		RED		GREEN		RED	
5	BLUE		RED		BLUE		RED
6		GREEN		BLUE		GREEN	
7	RED		GREEN		RED		GREEN
8		BLUE		RED		BLUE	

SINGLE SHIFT

LINE	FIELD						
	I	II	III	IV	V	VI	VII
1	RED		GREEN		BLUE		RED
2		GREEN		RED		BLUE	
3	GREEN		BLUE		RED		GREEN
4		BLUE		GREEN		RED	
5	BLUE		RED		GREEN		BLUE
6		RED		BLUE		GREEN	
7	RED		GREEN		BLUE		RED
8		GREEN		RED		BLUE	

DOUBLE SHIFT

Figure 5.

shift pattern in that each line is ultimately scanned in all three colors with six fields being required for a complete color picture. It departs from the standard interlace in that odd lines are scanned during three successive fields and the even lines on the next three. The purpose of this shift is to mitigate line crawl. This is accomplished by employing a sequence wherein continuous upward and downward motions of lines of each color occur simultaneously. While either of these motions can be seen if specifically looked for, the effects of the two cancel out as soon as the observer concentrates on the subject matter rather than the line structure. This sequence has been described by CTI as the best of all it has tried.

The line-sequential system as advocated by CTI employs the same number of fields per second, the same number of lines, and the same 2-to-1 interlace employed by standard black-and-white television. This, therefore, is a compatible system in that ordinary black-and-white receivers can receive the transmission in black-and-white without any changes or adjustments necessary.

Since the period occupied by one line is the same as for standard black-and-white transmission, the number of Nyquist intervals in one line is the same and the horizontal resolution is likewise identical. If the double-shift pattern is used, the vertical resolution is likewise identical while if the single shift is used, the vertical resolution is reduced by some factor which may be as high as one-third.

Any of the electronic cameras described in connection with the CBS system can be used with the CTI. The camera shown in Fig. 3(b) is modified by placing the three images side by side on the photosensitive surface rather than one above the other. The vertical sweep frequency is at the normal rate but the horizontal sweep is reduced to one-third of the standard value. Thus as the electron beam scans across the mosaic it strikes successively, a red, green and blue image area thus providing modulation for a red line, a green line and a blue line in order. At the end of the field any desired change in shift in the color cycle can be made so that the colors in the next field will be scanned in the desired order.

The three-tube camera can also be used (Fig. 3(d)). Here it is only necessary to switch the output of the three cameras in such a way that the red signal is transmitted for one line, the green signal for the next, the blue for the next, and so forth.

So far in its demonstrations, CTI has employed the single-tube type of pickup. This, of course, is considerably cheaper than the three-tube system employed by RCA. However, the problem of making the sweep sufficiently linear so that the three images can be maintained in proper registry has been quite bothersome, and it may be that the three-tube camera can be operated with greater ease. Also, the resolving power of existing orthicons provides a limitation to the resolution of the picture which can be obtained when three small images are placed side by side on the photosensitive surface.

Any of the electronic receivers described in connection with the CBS system can be used for the CTI line-sequential system. In the case of the single-tube projection receiver, the three colored images are placed side by side rather than one on top of the other (Fig. 4(c)). The vertical sweep operates at the normal rate while the horizontal operates at one-third of this value. With the RCA three-tube

receiver (Fig. 4(d)) it is only necessary to gate the input to the three tubes so that the red signal actuates the red tube for one line, the green for one line and the blue for another, and so forth. The RCA direct-view color tube (Fig. 4(e)) can also be used with the CTI line-sequential system. None of these tubes have been available to CTI as yet for experimentation. However, it seems apparent that the simplicity and direct-view characteristics of this will make it or some direct-view tube the ultimate answer to the receiver problem for the line-sequential system.

When the double shift is used, six fields occupying one-tenth of a second are required to trace every line in each of the primary colors. It is by thus slowing down the rate of transmitting the complete color information that CTI is able to maintain the resolution of black-and-white and transmit color in addition. With the field-sequential method, slowing down the picture repetition rate to this speed has resulted in very objectionable flicker. By switching colors at the end of each line, the flickering elements are broken up into lines rather than fields and are thus very much less noticeable to the eye. The crucial question in connection with the line-sequential system is whether this rate of color switching is sufficiently rapid or involves a small enough area to reduce flicker to an unobjectionable value. With certain scanning sequences and with certain types of subject material an objectionable line crawl or interline flicker seems to occur. Critics of this system contend that this is an inherent flaw in the system which cannot be solved by any apparatus refinement. Whether or not this is true has not been definitely established and, as indicated above, it is probably upon this factor that the success or failure of the line-sequential system will depend.

When the single shift is employed, a cycle is completed in four fields or one-fifteenth of a second. As might be expected, such a pattern is less susceptible to line crawl or flicker than the double shift. Again; no definitive answer has been determined with regard to the seriousness of the flicker problem with the single shift.

As compared with the RCA system, to be described later, the CTI system has the obvious advantage of much less complexity, plus the fact that it can operate in a system of reduced bandwidth such as existing coaxial cable with the natural loss in resolution but with no loss in color values. The main question with regard to this system is whether this simplicity has been achieved at too great a loss in performance. Until the question of interline crawl or flicker and its effect on picture quality has been definitely determined, it will be impossible to say whether or not this is the case.

THE RCA COLOR TELEVISION SYSTEM

The RCA color television system employs the most rapid color switching rate of the three sequential systems which have been proposed. For this reason, as might be expected, it is the most complex of the three, both with respect to the studio and receiving equipment. This system is, indeed, a marvel of ingenuity.

In its present form, the RCA color camera consists of three pickup tubes arranged as shown in Fig. 3(d) which provide simultaneously red, green and blue electrical signals. Each of these signals is first passed through a filter which separates the components below and above 2 megacycles. The high-frequency components from 2 to 4 megacycles are combined and are transmitted without color separation. This procedure is justified by RCA on the grounds that the eye is not sensitive to colors in the fine detail represented by the high-frequency components in the picture; consequently, it is not necessary to transmit this detail in color. This has been termed the "mixed highs" principle by RCA.

The three color signals containing frequency components up to 2 megacycles are then sampled at the rate of 3.6 megacycles, that is, during the period corresponding to one cycle of this frequency all three colors are sampled. The amplitude of each pulse sample is proportional to the corresponding magnitude of each of the primary colors in this portion of the picture. The sample pulses are then combined and passed through a filter which removes all frequency components above 4 megacycles. As a result, the 3.6 megacycle sine wave is produced as shown in Fig. 6(a). Examination of this figure indicates qualitatively that the phase of the resulting wave will be determined by the predominant color in the picture, the magnitude of the wave will depend on the difference between the highest and lowest samples, while the d-c level of the wave will depend on the average level of the three components. More precisely, it may be said that the hue of the picture is determined by the phase of the color wave, the saturation of the color is determined by the amplitude of the color wave, and the brightness of the picture is determined by the d-c content of the wave.

The color wave is combined with the "mixed highs" signal and both are then fed to the transmitter input and the signal is transmitted in the usual fashion.

At the receiver, the converse of this action occurs. The transmitted wave is first amplified and detected in the usual manner. The resulting video signal is then sampled in synchronism with the

transmitter and as a consequence, three sets of sampling pulses are made available—one for each color. These pulses are then passed through a low pass filter which results in a 3.6-megacycle sine wave, the amplitude of which is proportional to the amplitude of the sample pulses. This process is illustrated in Fig. 6(b). These signals are then combined with the “mixed highs” and the resulting signals are ready for application to the kinescopes or color tube.

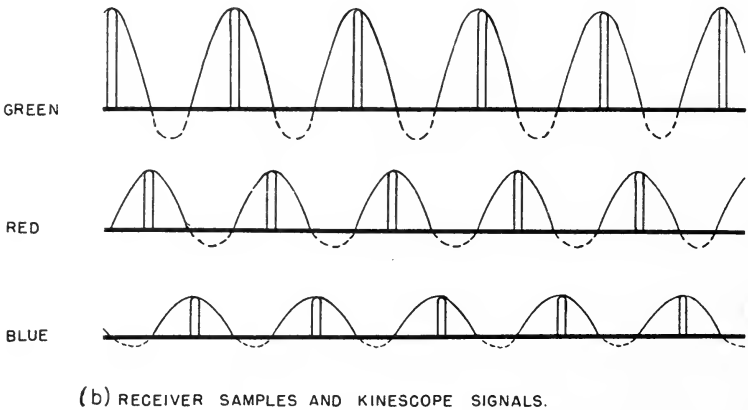
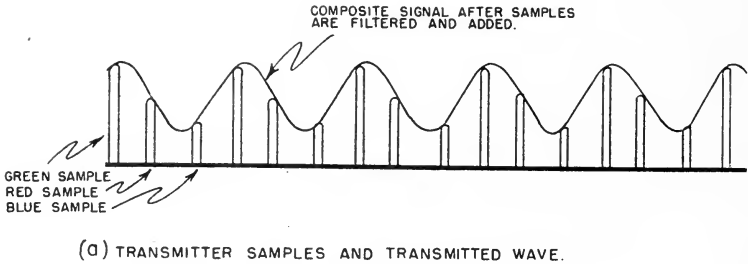

Figure 6.

In the case of the three-kinescope receiver illustrated in Fig. 4(d), each of these signals is applied to the corresponding kinescope grid. The sinusoidal form of this signal results in a series of dots being produced on the kinescope and when these three sets of dots are combined, the result is the dot-sequential color presentation illustrated in Fig. 2.

In the case of the direct-view color tube recently demonstrated by

RCA, the three signals are all applied to a single tube in a manner which will become apparent later when this tube is described.

In order that each portion of the screen be excited eventually with all of the three colors, it is necessary to shift the phase of the color cycle so that on succeeding frames, each portion of the screen will be excited sequentially in the three colors. If there were no overlap between the dots, it would require three frames in which to do this; however, because the width of the dots is about one and one-half times the distance between them, it is possible to cover the entire

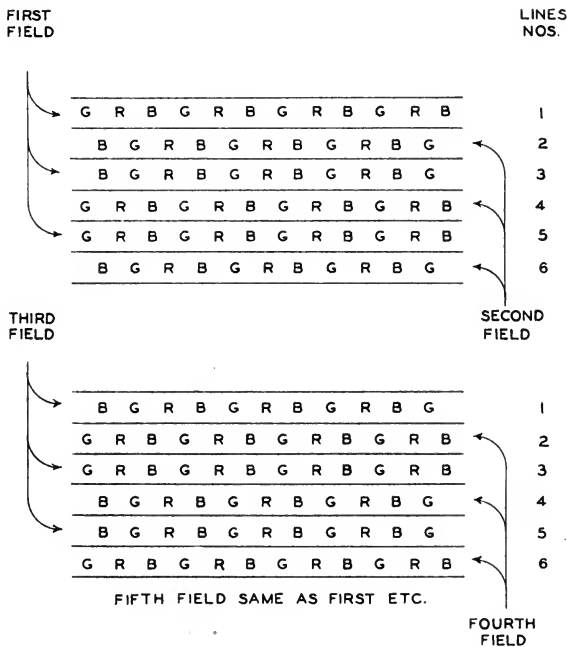

Figure 7.

area with three colors with two frames so that 15 complete color pictures are sent in each second. The order in which this is accomplished is shown on Fig. 7.

It is quite apparent that the transmission of color by the RCA system depends on accurate phasing of the sampler in the receiver with respect to the color wave in the transmitted signal. Any phase shift in the sampling oscillator with respect to this color wave will result in false colors being reproduced at the receiver. In its initial demonstrations before the FCC, RCA employed the trailing edge of

the horizontal synchronizing pulse to phase the sampling oscillator in the receiver. This did not appear to provide a sufficiently precise method of timing this circuit inasmuch as the colors during those demonstrations shifted constantly. Since that time, RCA has incorporated a short train of 3.6-megacycle oscillations on the "back porch" of the horizontal blanking pedestal. The receiver sampling oscillator is made to synchronize in frequency and phase with this burst of 3.6 megacycles of energy. With this arrangement any shift in the phase of the color wave due to the circuits through which it must pass will likewise shift the phase of this "burst" of energy and, accordingly, there is no change in the relative phase of the sampling oscillator and the color wave. This device seems to have been quite successful inasmuch as the color stability shown in pictures in later demonstrations was quite good.

As compared with the other two systems, the RCA system is said to be completely compatible with monochrome standards, to have geometric resolution equal to monochrome, and by breaking each line into dots, to avoid the interline flicker problem which is claimed by RCA to be the inherent flaw in the line-sequential method. On the other hand, this system has been criticized for its registration problem (which is present in any all-electronic system), its relative complexity and the fact that the signal cannot be transmitted over a 2.7-megacycle coaxial cable. RCA claims to have removed this last objection by developing a system for sampling the picture at a 2.4-megacycle rate for transmission over the coaxial cable and re-sampling the output of the cable at the 3.6-megacycle rate for transmission over the air. The RCA system is also claimed by its critics to be more susceptible to noise and interference from other stations than is the case with the other types of color transmission.

THE RCA DIRECT-VIEW COLOR TUBE

It has been quite generally agreed by most engineers who have testified concerning color television systems that, regardless of which system is adopted, the ultimate method of presentation will be a direct-view color tube. It is quite natural then, that the recent demonstration of the RCA color tube was the object of extreme interest on the part of all industry engineers. It was quite generally conceded by all who saw the demonstration that this tube represented a remarkable engineering feat. While the tube, admittedly, has considerable room for improvement, it can definitely be said that a direct-view color tube is in sight for commercial use. To date, the details,

particularly of the manufacture, of this tube have not been divulged by RCA, but a general description can be given.

Of the two types demonstrated, one contains three electron guns and the other only one. In both types, the color screen consists of an array of small, closely spaced phosphor dots arranged in triangular groups, each group containing a green emitting dot, a red emitting dot and a yellow emitting dot. In the tube demonstrated, there were 351,000 dots in all with 117,000 dots for each color. Inasmuch as a good red phosphor has not yet been developed, it is necessary to place a minus yellow-green filter in front of the screen in order to restore proper color balance to the picture.

About one-half inch behind the color screen is placed a metallic mask which contains 117,000 holes or one hole for each of the triangular dot groups. This hole is so positioned with respect to its associated dot group that the difference in the angle of oncoming beam determines the dot which will be excited and consequently which will be seen by the viewer.

In the case of the three-gun tube, the three guns are placed in a bundle as shown in Fig. 4(e) in the neck of the tube with their axes converging at the plane of the metallic screen. Because of the difference in angle at which beams from these three guns will strike the holes, each gun will excite the dots of one color only. Thus, it is necessary only to apply the red signal to one of the guns, the blue signal to another and the green signal to the third in order to provide a color picture. It is quite apparent that this tube could be used not only with the RCA dot-sequential but also with the field-sequential and line-sequential systems.

In the case of the single-tube kinescope, the beam is magnetically displaced, and this displacement is rotated so that, in effect, it occupies in time sequence, the positions of the three guns in the three-gun kinescope. As the beam displacement rotates, the angle at which the beam enters the holes in the perforated screen likewise changes and the different dots are excited in sequence. This tube can likewise be adapted to the dot-, line- or field-sequential systems by rotating the beam displacement at the dot, line or field rates. While the beam is being rotated in this manner, its intensity is modulated in accordance with the amount of color information present in the signal for the particular primary color being transmitted at the moment, this action automatically carrying out the sampling function.

It is apparent that with this tube, there will be 117,000 picture elements in the reproduced picture. This is a reduction in resolu-

tion as compared to what can be obtained in a 4-megacycle bandwidth and one of the lines of development now being pursued by RCA is the construction of a tube with a larger number of picture elements.

SUMMARY

The attempt here has been to distinguish between the three systems on the basis of the color switching rate rather than on the terminal equipment which may have been employed by the three proponents in their demonstrations. This has been done because it is a problem of choosing from among the three color switching rates that is before the Federal Communications Commission in setting engineering standards, rather than the problem of determining which company has developed the best apparatus. Once this decision is made by the FCC, it can be expected that the entire industry will turn to the problem of developing and improving transmitting and receiving equipment for the particular system which has been chosen. Tremendous developments have occurred within the last nine months in the field of color television, and if these continue at their present rate, it can confidently be expected that it will be a commercial reality within a very few years.

ADDENDUM, October 7, 1950

Recent Developments in Color Television

Since the record of the color television proceedings was closed by the FCC, two very interesting alternative systems have been publicly described. These are the frequency interlace system developed by the General Electric Co. and the "Uniplex" system developed by CTI. Neither of these has been tested to date to the extent of constructing complete transmitting and receiving apparatus. However, considerable study has been made of the theoretical aspects of each, and certain critical points have been tested under simulated conditions.

The GE frequency interlace system makes use of the fact that most of the energy in the video waveform is presumed to occur at harmonics of the line frequency of 15,750 cycles/sec. If each line were identical, the energy would be concentrated at these discreet frequencies. Due to the fact that the waveform changes from line to line, the frequency spectrum is spread out somewhat, and as a consequence it is believed by GE that picture information is concentrated in regions of the spectrum lying near the harmonics of the line scanning frequency and occupying about 54% of the total spectrum. Since the other 46% of the spectrum space is not occupied, it is theoretically available for transmission of additional information.

While research has not yet been carried to the extent of determining the best way in which to utilize this unused spectrum space for transmission of

color information, GE has suggested that it might be accomplished in the manner described below.

At the camera the three color signals are produced simultaneously. This could be accomplished, for example, with the RCA color camera. Each signal may contain frequencies extending to 4 megacycles. However, since the higher frequency components in the red and blue signals do not seem to be necessary for the transmission of detail, these signals would be filtered and thereby limit the red bandwidth to 1 megacycle and the blue bandwidth to 0.2 megacycles.

The green bandwidth, being retained to the full 4 megacycles, is considered to be the dominant signal, and it is used to modulate the transmitted carrier using the ordinary vestigial sideband type of transmission. A red subcarrier is then chosen having a frequency such that it will fall midway between two of the sidebands, produced by the green signal. This is accomplished by separating this subcarrier from the green carrier by an odd multiple of one-half the line frequency. One frequency suggested by GE is 3,189,375 cycles/sec which is the 405th multiple of 7,875 cycles/sec. This subcarrier is modulated with video signals from the red channel using a vestigial sideband type of modulation. The red sidebands would then theoretically be interleaved between the green sidebands with very little cross talk between them. A similar method would be used to multiplex the blue subcarrier on the green signal and the blue sidebands would be interleaved between the green in the same manner.

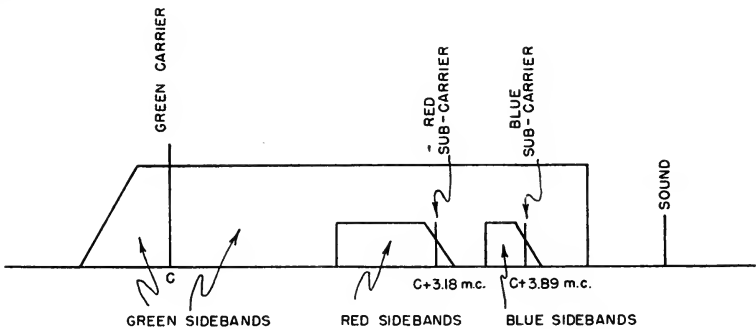

The optimum position of the blue carrier has not been determined. However, one possible arrangement is shown in Fig. 8 which shows the position of the green carrier, the red and blue subcarriers, and the spectral region occupied by the sidebands of each color.

In the color receiver the signal is passed through suitable filters which remove the portions of the spectrum which are not used by the color associated with its particular channel. No attempt is made to remove the interleaved information within this band of frequencies. Mathematical analysis shows that the cross talk which is present due to the presence of these undesired sidebands is 180° out of phase on successive frames so that the net signal over two frames is zero. To the extent to which the persistence of the phosphors and of the eye combines the images of two successive frames, this flicker will not be noticed. The signals accompanying each carrier would be demodulated and would be used to actuate a direct view color tube.

This system is compatible in that the same line field and interlace standards are used as for standard monochrome television. On a black-and-white receiver the green signal would be reproduced. According to GE "Cross talk [from the red and blue sidebands] would cause no trouble because it is geometrically in the same position on the screen as the green signal itself." The red and blue subcarriers would produce a dot pattern which according to GE has been tested and found to be unobjectionable.

The principal advantages claimed for the GE system are compatibility, absence of twinkle, crawl or flicker, and the absence of any precision timing equipment in the receiver. The most serious objection which has been made to the system is the degradation of the picture due to differences in propagation at the three carrier frequencies. The seriousness of this problem can be determined only by field testing.

The Uniplex system described by CTI employs a color switching rate between the dot sequential system of RCA and the line sequential previously advocated by this company. The color repetition rate is 1.008 megacycles which is the 64th harmonic of the line repetition frequency. This is slightly more than one-quarter of the rate at which the colors are switched in the RCA system. Thus the color segments on each line are about four times as long as with the RCA system and it could perhaps be described as a "dash sequential" system. In the transmitted waveform, red, green and blue signals are sent in sequence, the color cycle being completed in approximately 1μ sec. Mathematical analysis shows that such a waveform will contain very little energy at the third harmonic of 1.008 megacycles but the second and fourth harmonics will be transmitted and will enable reasonably rapid transition from one signal level to another as would be required by varying amounts of primary color in the portion of the picture being transmitted.

An ingenious color camera has been invented by CTI for use in connection with this system. This camera provides the video signal with one image orthicon using a filter printed on 35-mm motion picture film which passes in front of the lens and provides the suitable color separation. The system, however, is not limited to the use of this camera, and the RCA three-tube camera could be adapted to it with ease.

At the receiver the color switching is accomplished by a suitable gating circuit which is synchronized with the color switching at the transmitter by means of low-amplitude 3.024-megacycle signal which is transmitted continually. This signal is 180° out of phase on successive frames and to an extent is canceled out by the persistence of the phosphor and the eye. Color phasing is accomplished by transmitting a burst of energy at 1.008 megacycles during a portion of the vertical blanking period. The demodulated signal is gated in synchronism with the transmitter for separation of the three colors and the three signals are then applied to the picture reproducing device whatever it may be. It is felt that in all probability this will be a direct-view color tube.

The principal advantages claimed for this system are compatibility, a minimum amount of color contamination due to color cross talk, and considerably simplified apparatus. Simulated tests are said to have shown that small area flicker with this system would be no more serious than the RCA system even though the dots are somewhat longer.

Color Cathode-Ray Tube With Three Phosphor Bands

BY CONSTANTIN S. SZEGHO

THE RAULAND CORP., CHICAGO, ILL.

SUMMARY: A cathode-ray tube with a screen consisting of three phosphor bands fluorescing in the primary colors of red, blue and green may, in principle, be used to effect wholly electronic reproduction of television pictures in natural color if field- or line-sequential transmitting norms are employed. However, this tube inherently suffers from two limitations: the screen area is inefficiently utilized from the standpoint of light output, and the resolution capabilities are inadequate.

COLOR TELEVISION PICTURES transmitted by field- or line-sequential systems can be reproduced by a cathode-ray tube in a way which somewhat resembles the well-known Thomascolor system of color cinematography.¹ In the latter a scene is recorded on different parts of a film through primary color filters, for example, Wratten filters Nos. 26, 47 and 58. If the resulting black-and-white film images are projected through the same filters by a parallax-free optical system and superimposed, a picture in natural colors results. In a color television system, a corresponding series of black-and-white images, containing the light and shade values for the three primary colors, appear on different parts of the screen of a cathode-ray tube, having only one gun and one deflection system.² Primary color filters may be placed in front of the image sections of the tube and the color images derived therefrom are superimposed on a viewing screen by a suitable projection-optical system. Scanning of the three image areas of the tube screen may be in accordance with any of several well-understood processes. For example, with field-sequential transmission the individual areas are completely scanned in sequence and it is convenient to arrange the image areas one below the other. With line-sequential transmission, individual lines of the image areas are scanned in a repeating sequence and it is preferable to have these areas in side-by-side relation. The choice of the image-area orientation, the number of fields per second, the manner of interlace, etc., are dictated by the specifications of the color television system itself and will not be considered further. It is sufficient to note that in any case the color system is wholly electronic without any mechanical moving parts. Of course, since primary color images are superposed optically,

PRESENTED: April 25, 1950, at the SMPTE Convention in Chicago.

it is strictly a projection system and is not applicable to direct-view television. Moreover, as the picture tube has only one gun, it is not suitable for use with simultaneous color transmissions and the provision of discretely different image areas further limits the practical utility of the tube to systems of the field- and line-sequential scanning type because, in order to reproduce images transmitted by a dot sequential system, the spot would have to fly between picture points located in each of the three separate image areas which is not practically realizable. Other limitations, such as stringent requirements for linear scanning to insure registry of the three images, and matters of field or line flicker and line crawl, and the associated issue of compatibility with black-and-white transmissions will not be dealt with. The remainder of this paper is concerned only with the reproducing cathode-ray tube itself.

Fluorescent Screen

The Wratten filters mentioned above have an average light transmission of only about 15%, so that approximately 85% of the light is wasted. As the color system is of the projection type which inevitably involves a considerable light loss in the optical system used for superimposing the primary color images, the additional absorption in the filters is a material drawback. Therefore, the first step in the development of a new color tube for use in the system was to dispense with these filters. A cathode-ray tube was constructed having three image areas capable of fluorescing in the three primary colors in response to electron bombardment. Specifically, the screen consisted of three phosphor bands: a blue band of zinc sulfide activated with silver, a green band of zinc orthosilicate activated with manganese and a red fluorescing band of zinc cadmium sulfide activated with silver. The spectral distribution curves of these phosphors, as manufactured by Patterson Screen Division of E. I. du Pont de Nemours & Co., are shown in Fig. 1. In making the measurements for these curves, the phosphors were excited by ultraviolet light instead of cathode rays, but it is felt that this did not change their spectral distribution materially. Trichromatic coefficients (x and y), dominant wavelength and purity are given in Table I. Characteristic curves have been given for two red powders which were used in different tubes, and it may be seen from Fig. 1, where the cutoff of Wratten filter No. 26 is also shown, that a substantial portion of the energy of these phosphors falls in the unwanted orange region. It is possible that cadmium phosphates or borates would have more suitable spectral distribution, but they were not tried.

TABLE I. Characteristics of the Phosphors

No. (Patterson)	Q-20-1055	Q-36-1080	Q-37-1243	608
Material	ZnS	ZnCdS	ZnCdS	Willemite
Excitation	3650 A	3650 A	3650 A	2537 A
<i>x</i>	.156	.557	.602	.209
<i>y</i>	.084	.417	.357	.745
Dominant wavelength, m μ	467	590	602.5	536
% Purity	86	93	89	93

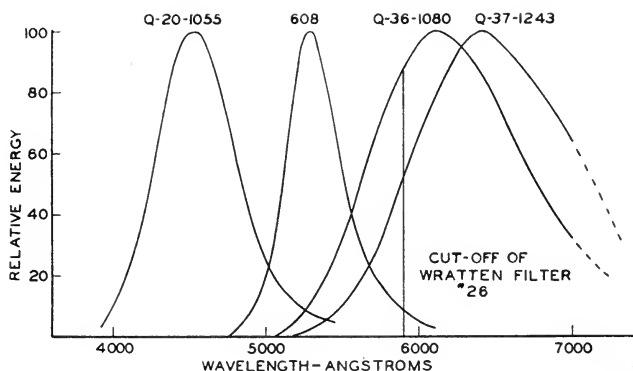

Fig. 1. Spectral energy distribution of the phosphors.

Experimental tubes with 7- and 10-in. diameter screens were made, the middle phosphor bands being approximately $1\frac{7}{8}$ in. and $2\frac{3}{4}$ in. wide, respectively. Two methods of screen application were tried and they will be described with reference to the apparatus shown in Fig. 2. In the first method, illustrated by the diagrams at the right of the figure, the cylindrical part of the tube envelope is cut open approximately 4 in. from the screen and a mask, comprising one or more stainless-steel sheet segments, is placed on the glass to cover approximately two-thirds of the screen area. The blue band is now settled by the customary settling technique on the remaining and exposed one-third area of the screen. Thereafter, the settling liquid is siphoned out, and the screen section is baked. The mask may then be inverted, covering the screen section already deposited, and exposing another section on which another phosphor material is settled and dried. In the next step, the mask is arranged to cover the two coated screen sections, leaving the third to receive a third phosphor in a similar manner. This is a laborious process, and the repeated moistening and drying steps may reduce the efficiency of the fluorescent bands.

In the second method employed, a settling chamber having three compartments made watertight with latex rubber, was used. If the same hydrostatic pressure is maintained in each compartment, the three screens may be settled simultaneously without seepage, and only one drying process is necessary. After the three-section fluores-

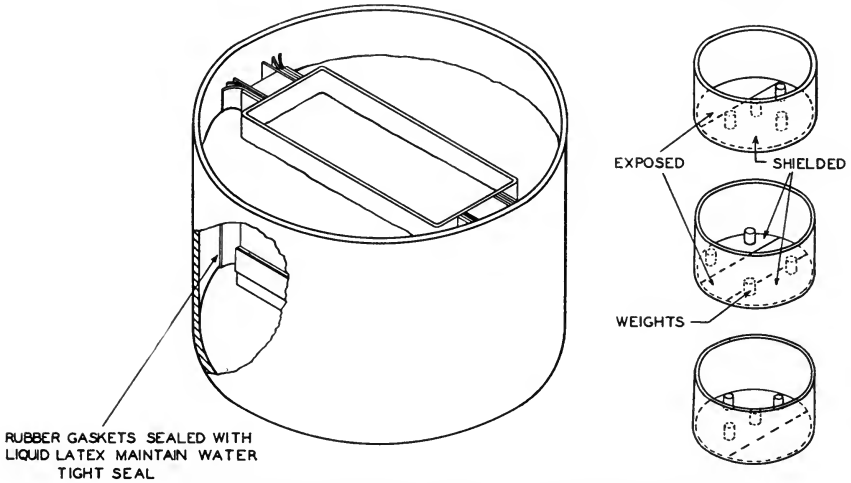

Fig. 2. Masks used in the preparation of the fluorescent screen.

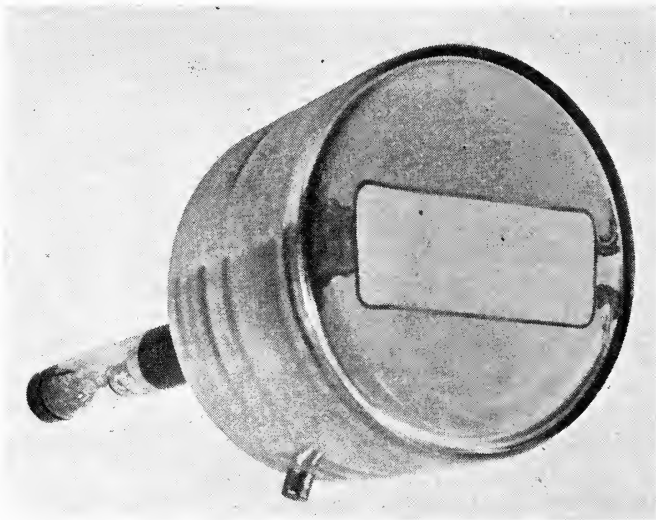

Fig. 3. View of 7-in. cathode-ray tube with three phosphor bands.

cent screen has been fabricated by whatever method chosen, the screen-bearing portion of the tube envelope is rejoined to the rest of the glass bulb, and the screen is aluminized, using the customary organic film basing and aluminum evaporation techniques. This aluminum backing removes the sticking potential that may otherwise be encountered in the operation of the tube and nearly doubles the brightness by functioning as a reflecting mirror. Figure 3 is a photograph of the completed screen, showing an approximately $\frac{1}{8}$ -in. wide gap between the color bands which is permissible as the beam is blanked out when scanning of these gaps would occur.

Consideration will now be given to the light output of such a banded screen. The area of one color image is approximately one-

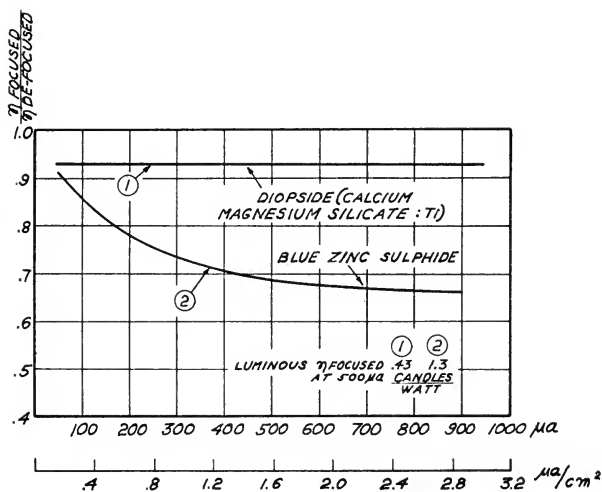

Fig. 4. Beam current density saturation of blue phosphors; aluminum backed, 25-kv, 525 lines, 30 frames. Upper abscissa scale: beam current; lower abscissa scale: raster current density.

ninth of the entire raster area of the tube. This means that only one-ninth of the light flux which could be made available, is utilized. The situation is even less favorable when saturation phenomena of the phosphors are taken into account. It is found that the zinc sulfide and zinc cadmium sulfide types of phosphors saturate considerably at the high current densities prescribed by the spot size necessitated by the small area of one color image. Their luminous efficiency drops at high beam current densities, as shown on Fig. 4 where the ratio of the luminous efficiency of a focused raster relative to a de-focused raster of a blue zinc sulphide is plotted in terms of the beam current. The luminous efficiency η was measured in candles per watt. The cross-sectional area of the de-focused spot was twice that of the focused spot and the focused spot-current density measured at $400 \mu\text{A}$

(microamperes) had the high value of approximately $\frac{1}{2}$ amp/sq cm. The corresponding raster-current density was relatively low as may be seen by reference to the lower abscissa scale of the figure. It is true that a nonsaturating blue phosphor, a calcium magnesium silicate, is available and its saturation characteristic is also shown on the figure, but this material is not very efficient, having a luminous efficiency at high-current densities of only about one-third that of the zinc sulfide. Consequently, its use would not improve light output. The green phosphor is also a silicate and saturates, although to a lesser extent than the blue and red phosphors used in making the tube.

In view of the small size of each color image the raster-current density of the tube is unusually large and, since the heat cannot be

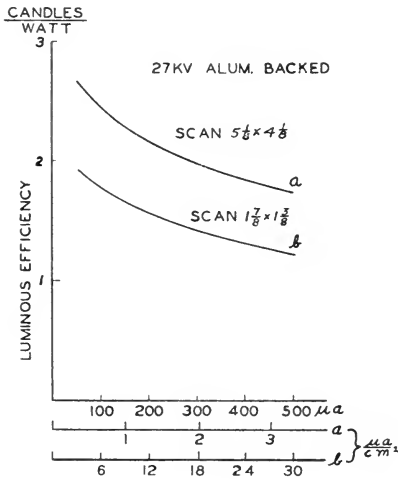

Fig. 5. Luminous efficiency of blue ZnS at two different raster current densities; aluminum backed, 27-kv, 525 lines, 30 frames. Upper abscissa scale: beam current; lower abscissa scales: raster current density.

adequately dissipated, the screen heats up. This is most undesirable because certain zinc sulfides lose luminous efficiency at elevated temperatures. This is shown in Fig. 5, where the luminous efficiency for a scanned area of $5\frac{5}{8} \times 4\frac{1}{8}$ in. is compared with that obtained in scanning an area nine times smaller. Of course, for sequential systems having lower field-scan rates per second, the drop would not be as pronounced because the temperature rise would be less.

Again, as a direct consequence of the high raster density or high screen loading, the fluorescent powders darken, an effect known as electron burning. When this occurs, the screen brightness drops 15-40% in a few hours of operation, and then remains essentially constant at that level. Another cause for diminished brightness is discoloration of the screen supporting glass resulting from X rays

released at 30 kv, which is the working voltage of this tube. Loss of brightness attributable to discoloration of the glass may be minimized by use of the new, nonburning glass No. 3459 of the Pittsburgh Plate Glass Co., instead of pyrex glass from which the first tubes were made.

Surface brightness of the green phosphor was measured after a few hours of operation and found to be approximately 7000 ft-L at 400- μ a beam current and $1\frac{7}{8} \times 1\frac{3}{8}$ in. raster, 525 lines, 30 frames. Corresponding figures for the blue and red phosphors were approximately 1700 ft-L and 1400 ft-L, respectively. With this brightness of the primary image areas, the highlight brightness of a colored picture on a 12×16 in. uniformly diffusing screen is in the order of 4.5 ft-L, if an optical system having a light-gathering efficiency of 10% is assumed and the Color Television Inc. transmitting norm is used.

While saturation limitations may one day be overcome by new and better phosphors, improvement of light loss due to insufficient utilization of the screen area may be visualized by scanning primary areas that are larger and give more light even though their aspect ratio is incorrect, so long as appropriate cylindrical lens elements are also used to gather light from the whole of the scanned area and project an image having the correct aspect ratio.

Resolution

The postage-stamp size of each color image imposes exacting resolution requirements, which are inherently impossible to meet with the present three-band tube. Approximately 475 lines must be resolved in each picture, a resolution of 12 lines per millimeter. Moreover, while one color-image area is approximately in the center of the screen, the other two are toward the edges, and excessive deflection de-focusing cannot be tolerated. Unfortunately, a small spot size in the center and minimum de-focusing toward the edges of a screen are contradicting requirements from the point of view of tube design.

A satisfactory prototype for a projection tube which has the required resolution on a small screen, corresponding to the central color area of the 3-band tube, does exist and has been described, for example, by H. Rinia, J. deGier and P. M. Van Alphen.³ The outline of such a tube is drawn at the top of Fig. 6, which also shows below schematically the geometry of the scaled-up models for two 3-band tubes having screen diameters of 7 in.

In the three color-band tube under consideration it is necessary to scan a distance in either the line or field direction equal to three times the corresponding dimension of one color area. In order to scan all

three primary-image areas, two possibilities suggest themselves if it is required to maintain the same deflection angle α which was required, because it was desired to operate this tube with deflection equipment available for 5TP4 projection tubes having a deflection angle of 50° . Using the notations of Fig. 6, the Helmholtz-Lagrange law defines the spot size in the center of the screen as follows:

$$y_{2(\text{center})} = \frac{\phi}{\theta} \sqrt{\frac{E_1}{E_2}} y_1$$

where $y_{2(\text{center})}$ is the radius of spot at the center of screen;
 ϕ semi-divergence-angle of the beam at the cathode side;
 θ semi-convergence-angle of the beam at the screen side;
 E_1 emission energy in electron volts;
 E_2 anode voltage; and
 y_1 radius of beam at crossover point.

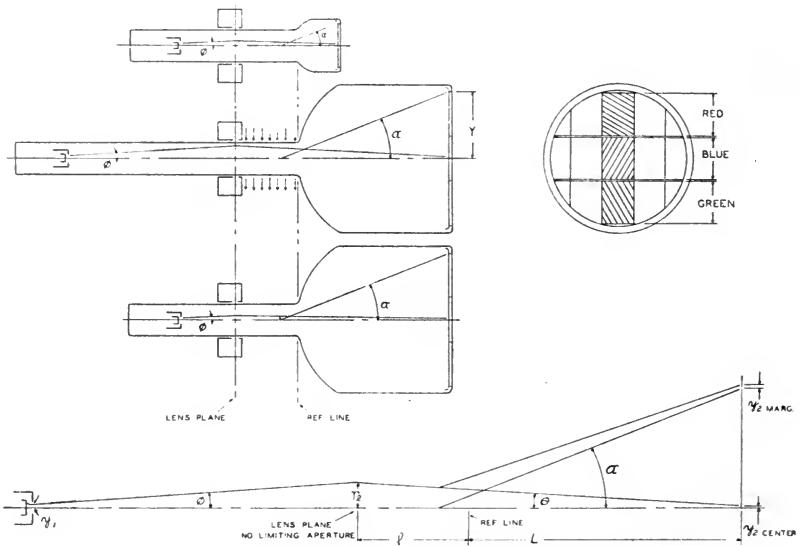

Fig. 6. Schematic of 7-in., three phosphor band projection tube.

If it is assumed that the electrical conditions for the tube are to remain constant, the center spot size varies inversely with the angle θ :

$$y_{2(\text{center})} \sim \frac{1}{\theta}$$

The formula expressing increase of spot radius in terms of beam deflection is⁴:

$$y_{2(\text{margin})} = \frac{3Y^2 r_l}{2\left(L + \frac{l}{2}\right)^2}$$

where $y_{2(\text{margin})}$ is the spot radius near the edge of the screen;
 Y half of the total deflection on the screen;
 r_l beam radius in the lens plane which is approximately equal
to the beam radius in the deflection field;
 l length of deflection field; and
 L distance from the end of deflection field to screen.

From the geometry of the arrangement, it is seen that

$$\frac{Y}{L + \frac{l}{2}} \approx \tan \alpha$$

where α is the deflection angle.

For constant deflection angle α :

$$y_{2(\text{margin})} \sim r_l.$$

Table II gives the beam radius at the lens and the convergence angle at the screen for the three cases illustrated in the figure and in the order recited, namely, the prototype tube with but a single small screen, the first mentioned scaled-up model and the last mentioned scaled-up model.

TABLE II

Case	Beam radius at lens	Convergence angle at screen
1	r_l	$\frac{3r_l}{3l + L} \approx \theta$
2	$3r_l$	$\frac{3r_l}{l + L} \approx \theta$
3	r_l	$\frac{r_l}{l + L} \approx \frac{\theta}{3}$

In Case 2 the center-spot size, determined by the reciprocal of the convergence angle, remains small as desired because θ remains approximately the same as in the prototype, but the marginal-spot size, determined by the beam radius at the lens, becomes larger because this radius increases threefold. In case 3 the convergence angle becomes too small and the center-spot size increases undesirably even though the marginal-spot size is maintained at substantially the desired value. It is manifest that at best a compromise solution

must be accepted for it is not apparently possible to scan all three primary-image areas while preserving the resolution at both the center and marginal portions of the screen.

Suitability for Theater Television

The question which must be in the minds of motion picture engineers—whether or not this tube may ultimately be used for color television projection in theater installations—has been answered in the foregoing analysis. The light requirements for large screen work are increased manifoldly, at least 100 times for a 15 × 20 ft picture. The poor utilization of the screen area for light output rules out the three-band cathode-ray tube for this service. For monochrome theater television, a cathode-ray tube having a minimum of 10-in. diameter and a fast Schmidt optical system are presently required, and it is the opinion of the author that if the complication of three optical systems to superimpose primary-color images is to be added, it would be more advantageous to make use of three cathode-ray tubes and simultaneous color transmissions. Local conversion of the sequential information for simultaneous modulation of three guns with the aid of storage tubes could also be visualized. This would increase light output by a factor of 27 and be of material help in overcoming the greatest hurdle of theatre projection: insufficient light output.

Acknowledgment: The author is greatly indebted to Dr. E. Meschter of the Patterson Screen Div., E. I. du Pont de Nemours & Co., for the spectral distribution measurements.

REFERENCES

1. L. R. Kistler, "The projection of Thomascolor motion pictures," *Intern. Proj.*, vol. 20, no. 7, pp. 12-14, July 1945.
2. R. Lorenzen, U.S. Pat. 2,200,285 (1940).
3. H. Rinia, J. deGier and P. M. van Alphen, "Home projection television," *Proc. I.R.E.*, Pt. I, vol. 36, no. 3, pp. 395-400, Mar. 1948.
4. A. Wallraff, "Spot distortions in cathode-ray tubes with wider deflection angles," *Arch. für Elektrotechnik*, vol. 29, pp. 351-355, 1935.

A Magnetic Record-Reproduce Head

By M. RETTINGER

RADIO CORPORATION OF AMERICA, RCA VICTOR DIV.,
HOLLYWOOD, CALIF.

SUMMARY: It is the purpose of this paper to discuss various features of a combination magnetic record-reproduce head of the ring-shaped type, known as MI-10794, with emphasis more on the general principles of construction than details of assembly. Shown in the paper are various lamination shapes for ring-type heads; the change of head inductance with change of front-gap and back-gap spacer thickness; the lamination stacking factor as a function of lamination thickness; the shape of the lamination employed for the subject head; flux distribution patterns about the front-gap of a record head for various thicknesses of front-gap spacer; the "gap effect" of a reproduce head; the output voltage and inductance of a reproduce head as a function of the front-gap reluctance; and a photograph of the finished record-reproduce head.

RING-SHAPED magnetic record and reproduce heads were first described in 1935 in a paper by E. Schuller.¹ The term ring-shaped heads does not refer specifically to circular cores, but includes rectangular, semicircular, diamond, trapezoidal, and even triangular shapes, as shown in Fig. 1. In general, therefore, a ring-shaped magnetic record or reproduce head may be defined as one in which the magnetic material forms a quasi-toroidal enclosure with one or more air gaps, and with the magnetic medium bridging one of these gaps, commonly spoken of as the front-gap, and contacting the structure on one side only.

When a second gap is inserted in the core so as to divide it into two symmetrical halves, the second interstice may be termed the back-gap. Each hiatus usually contains a nonmagnetic spacer, the "front" and "back" spacer, although some commercial ringheads have butt joints. One or more coils may be wound around the core, and the entire assembly is usually placed in a high-permeability can to act as a magnetic shield. It is the purpose of the following to discuss various features of one such head, known in RCA as the MI-10794 combination magnetic record-reproduce head, with emphasis more on general principles of construction than details of assembly.

HEAD INDUCTANCE

The inductance of the head varies with the thickness of both the

PRESENTED: April 24, 1950, at the SMPTE Convention in Chicago.

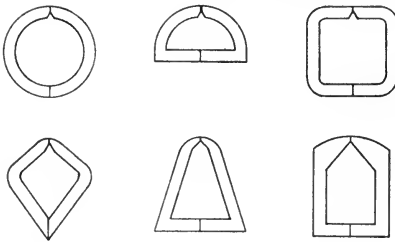

Fig. 1. Core shapes for magnetic heads.

front- and the back-gap spacers, and is given approximately by the equation

$$L = \frac{KN^2}{r + R}$$

where r = reluctance of front-gap;

$$= \frac{l}{wd}$$

l = gap-length, cm,

d = gap-width, cm,

w = gap-depth, cm,

R = reluctance of back-gap;

$$= \frac{l_o}{w_o d_o}$$

l_o = gap-length, cm,

w_o = gap-width, cm,

d_o = gap-depth, cm,

N = number of turns,

K = constant.

The above equation is true as long as the reluctance of the core material is small compared to the reluctances of the gaps; otherwise, an additional term for the core reluctance must be introduced in the denominator of the above equation. Figure 2 shows the variation of inductance with thickness of front- and back-gap spacers; these curves, calculated by the above equation, correspond closely with observed values.

Magnetic record heads of the ring-shaped core type are usually constructed with a low-impedance winding, and reproduce heads, with a high-impedance winding. The reason for the low impedance of a record head lies in the fact that the line to the head has a certain amount of capacity, which represents a leakage path for the high-frequency-bias current which is almost always used. If the record head had a high inductance, the line leakage would constitute a con-

siderable loss. In the case of the reproduce head, where no bias frequency is employed, a high-impedance winding on the head is satisfactory, provided the length of the cable connecting the head with the reproduce preamplifier is short and otherwise is so constructed as to have a low leakage capacity, otherwise high-frequency signal losses may be suffered.

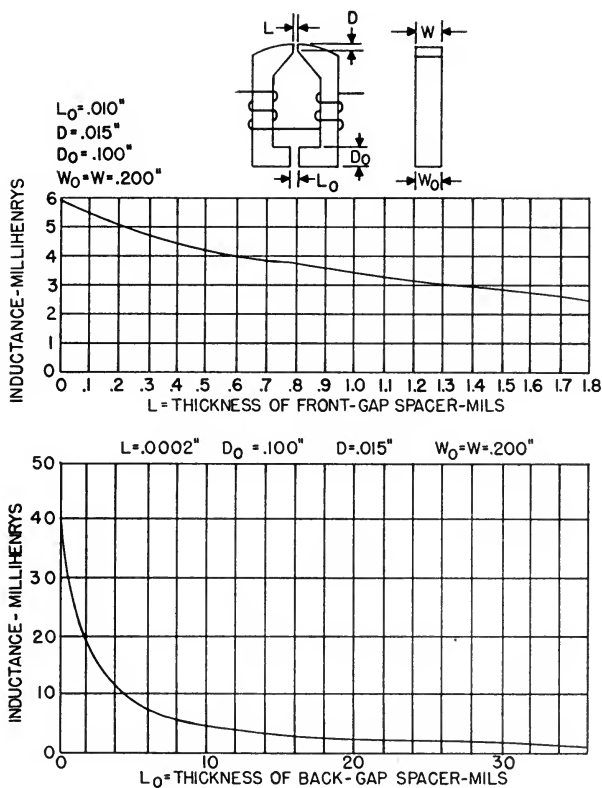

Fig. 2. Upper part of figure shows variation of head inductance with thickness of front-gap spacer. Lower part of figure shows variation of head inductance with thickness of back-gap spacer.

For the head under consideration, which can be used either as a record or as a reproduce head, the inductance is 5 mh (millihenrys). This means, essentially, that a step-up transformer with a high turns ratio is required in the associated amplifier when the unit is employed as a reproduce head. As such, the combination is equivalent to a reproduce head with a 2-h (henry) inductance, which, of course, represents a head of impractical construction. Therefore,

since for maximum voltage on the first tube grid of the reproducing amplifier a step-up transformer is still necessary with heads of feasible or practicable inductances, a reproduce head with a 5-mh inductance does not appear to present difficulties or complications.

Besides the number of turns on the winding and the thicknesses of the front- and back-gap spacers, the inductance of the head is determined by the lamination material and the number of laminations in the core. Extremely thin laminations, say 2 mils thick, to reduce eddy current losses to a minimum, are difficult to handle and exhibit a low stacking factor. By stacking factor is meant the per cent space occupied by the laminations themselves, exclusive of the space taken up by the cement between the laminations. As an ex-

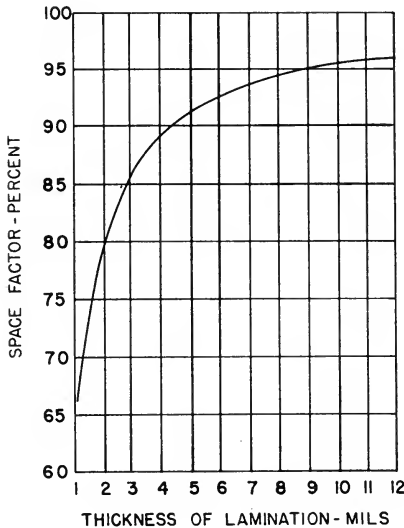

Fig. 3. Variation of space or stacking factor of magnetic head core with lamination thickness.

ample, consider a core 200 mils wide, containing 80 two-mil laminations held together by 79 layers of cement each 0.5 mil thick. In this case the space factor would be 80%. When 6-mil laminations are used, held together by layers of cement each 0.5 mil thick, the actual space taken up by the laminations in the 200-mil-wide core comes to 92%. Figure 3 shows the space factor as a function of lamination thickness for a 200-mil core. Thicker laminations mean not only that fewer turns of wire will be required to obtain the desired inductance, but also that the flux density in the laminations will be less, because the space factor is greater, thereby reducing possible distortion in the head at high audio and bias currents.

Figure 4 shows the approximate shape of the lamination used.

FRONT-GAP

In the case of the record head, the front-gap exists for the purpose of providing a leakage flux path for magnetizing the magnetic tape as it passes over the head in recording. Concerning the reproduce head, if no front-gap reluctance existed, the flux from the tape would merely pass through the pole tips and not through that part of the core on which the coil is wound and in which it is desired to induce an electromotive force.

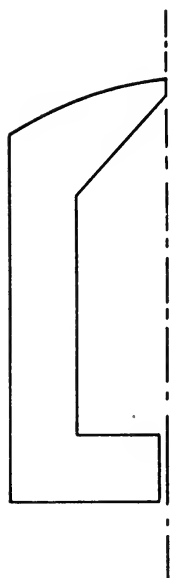

Fig. 4. Approximate shape of lamination used in subject magnetic head.

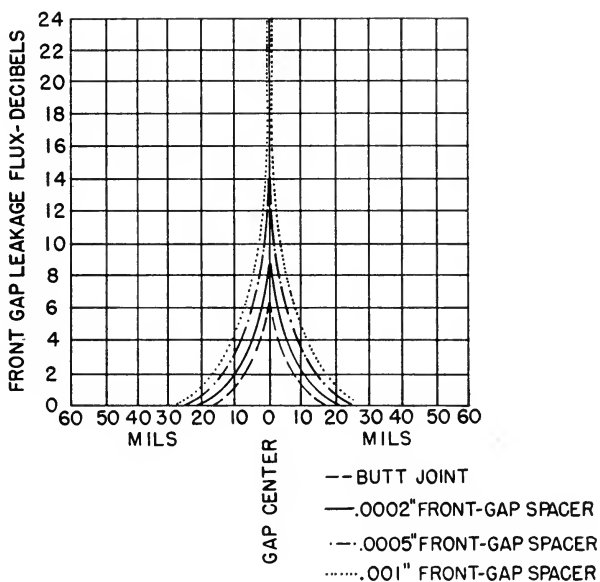

Fig. 5. Leakage flux distribution about front-gap of a ring-type magnetic record head, in the absence of a recording medium, when spacers of different thicknesses are inserted in the gap while constant current is supplied to the head.

Figure 5 shows leakage path distributions about the front-gap of a ring-type magnetic record head, in the absence of a recording medium, when spacers of different thicknesses are inserted in the gap while constant current is supplied to the head. The spacer serves the double purpose of maintaining the nonmagnetic gap parallel and to avoid the accumulation of ferrous dirt which would change the performance of the head. The curves were obtained by moving the head past a single loop of No. 46 wire. The head was fastened to a brass rack, and the pinion for the rack was driven by the curve

recorder; in this manner a measure of the flux density with respect to the distance traversed by the head was secured on the curve paper. The greater leakage flux with increasing thickness of front-gap spacer, or increased front-gap reluctance, is clearly evident.

It should be noted again that the curves were obtained without a magnetic medium over the gap. Hence, they are useful chiefly for comparing heads and do not necessarily show the actual leakage flux distribution when the head is in operation; that is, when magnetic tape is lying on the head or when it is passing over it.

In an RCA standard head, the front-gap spacer consists of a very hard nonmagnetic alloy. This alloy is considerably harder than the lamination material, and hence prevents the forming of burrs on the pole tips. These burrs tend to short-circuit the gap, and to alter the head performance. To prevent the accumulation of electrostatic charges on the head, the spacer is grounded to the mumetal housing, as is the cable shield.

After the head is assembled, the tape-bearing surface of the cores must be polished to secure proper scanning. This is obtained by lapping the head with successively finer aluminum oxide or silicon carbide papers in a jig to give the required contour on the head. Final polishing leaves a well-defined gap, free of bridging burrs, when examined with a $500\times$ microscope.

For obtaining sufficient high-frequency response, particularly as far as the reproduce head is concerned, the "length" of this gap is very important. As far back as 1935, E. Schuller, in the paper cited at the beginning of the article, noted that "the magnitude of this magnetic gap, that is, the extent of the recording magnetic field in the direction of the tape travel, should be approximately one-fifth of the smallest half-wave length." This criterion is more applicable to d-c biasing, however, than to a-c biasing, according to S. J. Begun,² who writes that "when a-c bias is employed, the effect of the length of the recording gap is practically negligible when the recording field is uniform and sharply defined." Hence, by employing for the record head a thinner than necessary front-gap spacer, namely, the spacer required for the reproduce head (see below), some loss in sensitivity is incurred, as may be seen from Fig. 5.

Schott³ has determined that the output of a reproduce head varies as

$$20 \log \frac{\sin \frac{\pi d}{\lambda}}{\frac{\pi d}{\lambda}}$$

where $d = \text{effective gap-length}$,
 $\lambda = \text{recorded wavelength}$.

The physical gap-length, however, is not equal to the effective gap-length, the latter being from 10 to 50% larger. Figure 6 shows the "gap-effect," as calculated by the above equation.

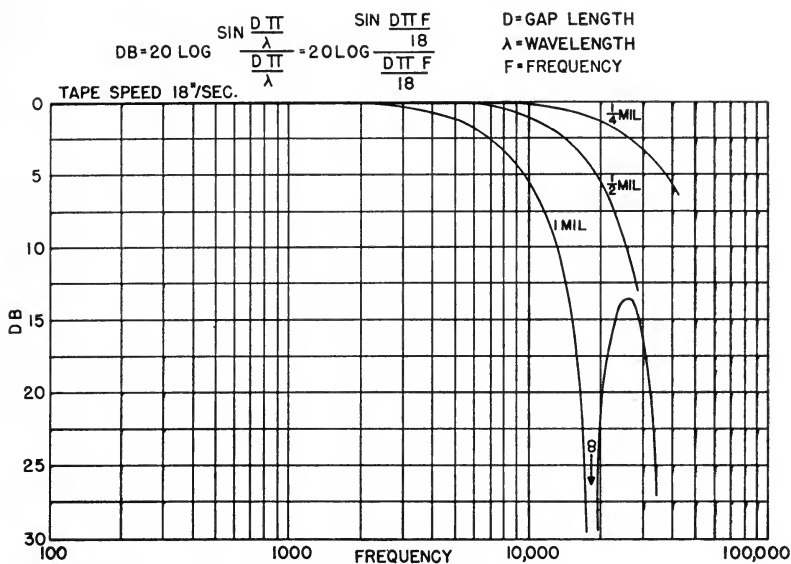

Fig. 6. Figure shows "gap effect" of a reproduce head, or variation of reproduce head output with frequency for various front-gap spacers.

BACK-GAP

A back-gap is frequently introduced in ring magnetic record and reproduce heads to reduce d-c magnetization with a consequent lowering of the noise produced by such magnetization. This is effected by "shearing" the hysteresis curve of the lamination material, as shown in Fig. 7. When the d-c magnetizing force in a closed ferrous ring is reduced to zero, the ring will have a residual induction as indicated by the point A in the figure. When a large back-gap is inserted in the toroid, however, a "shearing" of the hysteresis curve is effected, and the remanent induction, B, becomes rather small.

It may now be desirable to point out significant differences between record heads and reproduce heads for a better understanding of these transducers.

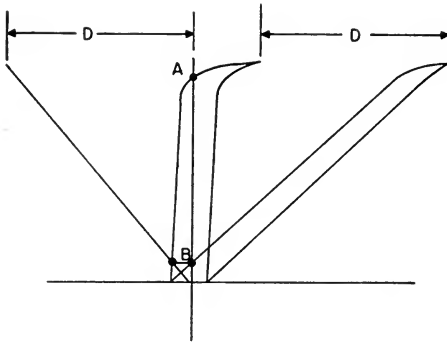

Fig. 7. Figure shows effect of "shearing" the hysteresis loop of the magnetic record head lamination material.

	Record Head	Reproduce Head
Head resonance	Frequency of resonance, determined by head inductance and leakage capacity, should be higher than bias-current frequency.	Frequency of resonance should be higher than highest frequency to be reproduced.
Shielding	Relatively unimportant, because field generated by head is much greater than external fields.	Very important because field generated by recorded medium is small.
Recording field	Effective gap-length is, within limits, not critical.	Effective gap-length should be as small as possible.
Magnetic material	Should show low eddy-current and hysteresis losses, to prevent heating and magnetic saturation at bias-current frequency.	Heating and magnetic saturation are unlikely to occur.
Impedance	Should not be high, to prevent bias-current losses in head and leads to head by leakage capacity.	Not critical.
Size	Within limits, not critical.	Should be small to reduce hum pickup.

The preceding is concerned chiefly with a delineation of the significant characteristics, both in performance and construction, of magnetic record and reproduce heads. The following presents a mathematical analysis of these units, more from the point of view of design considerations than from the standpoint of circumscribing their operational behavior.

The action of a reproduce head may be explained by means of Fig. 8. Assuming the tape to be a constant flux (high reluctance) generator providing a flux ϕ_o , we have across the tape head:

Fig. 8. Magnetic schematic of a reproduce head.

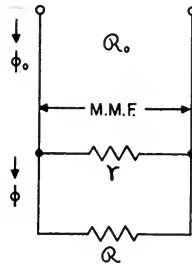

$$\begin{aligned}
 \text{Magneto-motive force} &= \phi_o R_o \\
 &= \phi_o \frac{rR}{r + R} \\
 &= \phi R \\
 \phi &= \phi_o \frac{r}{r + R}
 \end{aligned}$$

where

ϕ = flux through the core

r = reluctance of front-gap

R = reluctance of rear-gap plus core reluctance

The voltage generated in the coil of the reproduce head will be

$$\begin{aligned}
 E &= N \frac{d\phi}{dt} = N \frac{d\phi_o}{dt} \frac{r}{r + R} \\
 &= \frac{KNr}{r + R}
 \end{aligned}$$

A measure of the reproduce head efficiency is given by*

$$\begin{aligned}
 Q' &= \frac{E^2}{L} = \frac{\left(\frac{K_1 N r}{r + R} \right)^2}{\frac{K_2 N^2}{r + R}} \\
 &= \frac{K_3 r^2}{r + R}
 \end{aligned}$$

where, as before, r = front-gap reluctance

R = back-gap reluctance

K_1, K_2, K_3 = constants

N = number of turns

L = inductance of reproduce head

E = output voltage of reproduce head

* Advanced by L. J. Anderson, Radio Corporation of America, RCA Victor Div., Camden, N. J.

If in the above equation we set $R = ar$, we get

$$Q' = \frac{K_3 r}{1 + a}$$

If r is held constant, the efficiency is proportional to $1/(1 + a)$; see Fig. 8A.

R = BACK-GAP RELUCTANCE
r = FRONT-GAP RELUCTANCE

$$DB = 10 \text{ LOG } \frac{1}{1+a} = 10 \text{ LOG } \frac{1}{1+\frac{R}{r}}$$

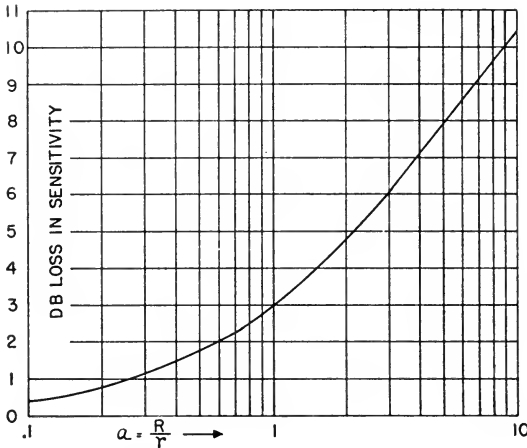

Fig. 8A. Loss in decibels, in reproduce head sensitivity as the back-gap spacer is made thicker while maintaining constant head inductance and front-gap reluctance.

The voltages of two reproduce heads of similar construction and equal number of turns are related as follows:

$$\frac{E_1}{E_2} = \frac{r_1(r_2 + R_2)}{r_2(r_1 + R_1)}$$

$$\text{or db} = 20 \log \frac{E_1}{E_2} = 20 \log \frac{r_1}{r_2} \frac{(r_2 + R_2)}{(r_1 + R_1)}$$

where r_1, r_2 = front-gap reluctances of heads 1 and 2 respectively,
 R_1, R_2 = back-gap reluctances of heads 1 and 2 respectively,
 E_1, E_2 = output voltages of heads 1 and 2 respectively.

If we now make the following substitutions

$$\begin{aligned} r_1 &= ar_2 \\ R_1 &= R_2 = R \\ R &= br_2 \end{aligned}$$

the above equation can be written: $\text{db} = 20 \log \frac{a(1+b)}{a+b}$

It is seen (Fig. 9) that an increased reluctance at the front-gap (as when wear on the head reduces the pole face depth, d , in Fig. 2) increases the output voltage from a reproduce head. This increase in the voltage is to some extent dependent on the reluctance of the back-gap. In Fig. 9 the abscissa represents the factor by which the reluctance of the rear-gap is larger than that of the front-gap, and in which the ordinates show the gain in output in decibels resulting from increasing the front-gap reluctance by the factor a . For example, a head having a rear-gap reluctance equal to the front-gap reluctance ($b = 1$) will provide a 2.6-db gain in output when its front-gap re-

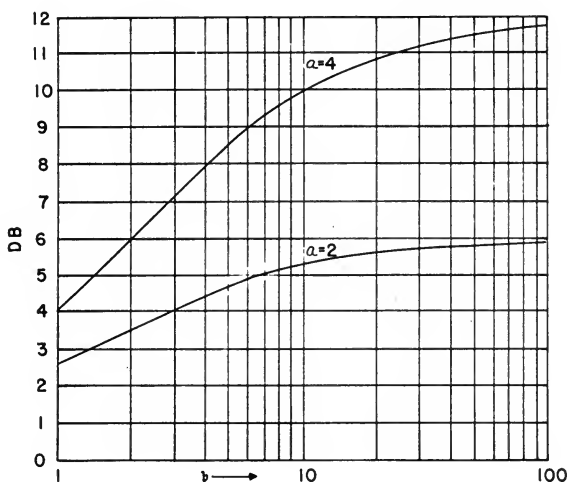

Fig. 9. Variation of magnetic reproduce head output with ratio of rear-gap to front-gap reluctance for two kinds of head.

luctance is doubled ($a = 2$), as when wear on the head has reduced the pole face depth, d , to one-half its former dimension; a head having a rear-gap reluctance which is ten times as great as the front-gap reluctance ($b = 10$) will provide a 5.3-db gain in output when its front-gap reluctance is doubled ($a = 2$), as when wear on the head has reduced the pole face depth, d , to one-half its former dimension.

Whenever wear on top of the head increases the front-gap reluctance, a decrease in the inductance occurs. This variation in inductance is given by

$$\frac{L}{L^1} = \frac{r^1 + R}{r + R}$$

where L = inductance of head when head was first put in operation,
 L^1 = inductance of head after wear on top of head has increased its front-gap reluctance,
 r = front-gap reluctance when head was first put in operation,
 r^1 = front-gap reluctance after wear on top of head has decreased the pole face depth, d ,
 R = rear-gap reluctance.

In Fig. 10, the abscissa represents the pole face depth in mils and the ordinates indicate the inductance and the gain in output voltage in decibels from a reproduce head as the top of the head becomes worn.

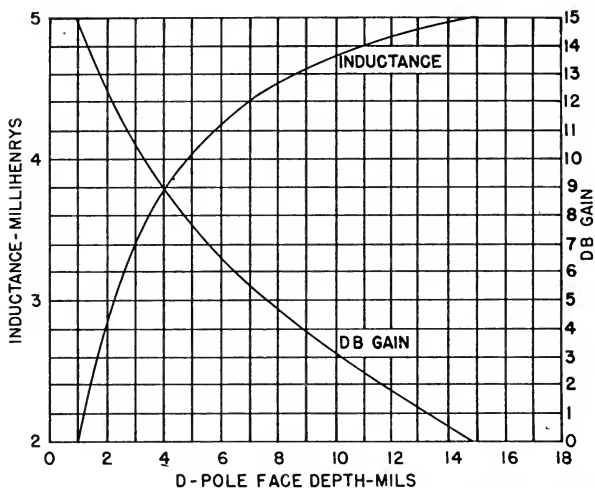

Fig. 10. Variation of reproduce head inductance and reproduce head output with pole face depth of front-gap.

Assuming the initial pole face depth to be 15 mils, then the inductance of the head is 5 mh. When wear on the head has reduced the depth to 5 mils, the inductance has decreased to 4 mh while the output voltage from the head has increased 7.5 db. If the front-gap is truly a rectangular parallelepiped, so that the gap does not become wider with decreasing pole face depth, the frequency response will remain relatively unaffected even though the sensitivity increases.

CONSTRUCTION

The core assembly is embedded in plastic which, at the same time, acts as the bonding agent between the two telescoping high-permeability cans which comprise the housing for the head. The plastic

has a dielectric constant of 3.7 at 50 cycles and 3.6 at 1 megacycle, at 22 C, which is practically equivalent to that of quartz.

The fact that the cores are not clamped mechanically, always an undesirable condition for permalloy laminated structures, but are embedded in a substance of greatly different mechanical impedance than the metal housing, makes the head singularly free of microphonics.

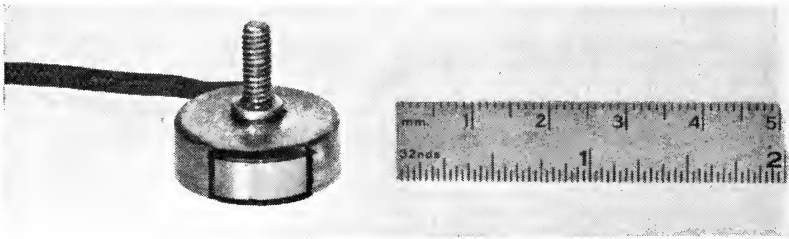

Fig. 11. Photograph of MI-10795 magnetic record-reproduce head.

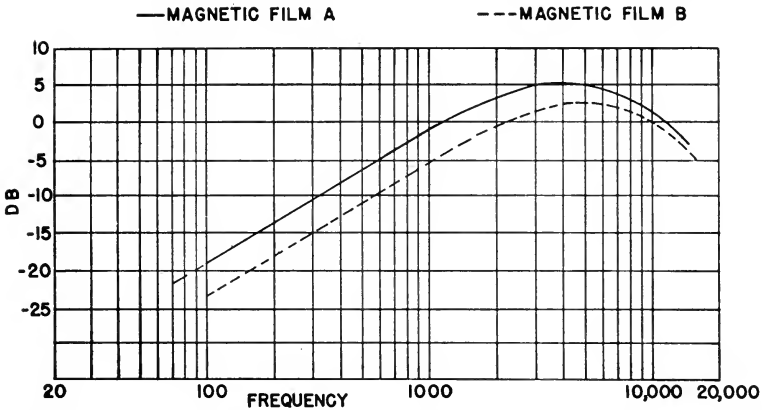

Fig. 12. Combination of subject head response and magnetic film characteristic for two types of film when constant current is supplied to the record head and the recording is reproduced on the same head.

Figure 11 shows a photograph of the completed head. The 18-8 stainless steel stud, shot-welded to one of the mumetal cans, is used for fastening the unit to the ball of a ball-and-socket type of mounting which allows longitudinal, lateral and transverse adjustments⁴ of the head.

Figure 12 shows the combination of head response and film characteristic for magnetic film A and magnetic film B, when constant

current is supplied to the record head and the recording is reproduced on the same head and measured with a high-impedance vacuum tube voltmeter. The 68-kc bias current for the measurement was .016 ma; the signal current, 2 ma; the film speed, 18 in./sec; and the output voltage (in the case of the A film) at the peak frequency for 100% modulated track,* 2 mv. Since demagnetization effects on the film are not readily dissociable from gap effects, Fig. 12 does not represent the frequency response of the head; it does still, however, serve as a valuable criterion for the head response to those familiar or experienced with the subject.

The head is $\frac{7}{8}$ in. in diameter, and thin enough so that three heads, without studs, can be mounted in a line to produce, on 35-mm magnetic film, a triple track with each .200 in. wide.

SUMMARY

Summarizing, this head has proven to be a good commercial product for these reasons:

1. High quality performance: This includes not only the extended frequency-response range from 30 to 18,000 cycles, but also high sensitivity, absence of microphonics, low bias-current requirements and low hum level due to its small size (approximately 3 cu/cm or .183 cu in./cm).

2. Low manufacturing cost in respect to quality: This is achieved by the manufacture of a larger number of identical parts, with a consequent reduction of cost per item, and by the reduction of the actual number of components in each head, particularly machined parts, such as mechanical clamps, terminal blocks, etc.

3. The reproduce head is identical with the record head, so that the user requires fewer spare parts for his recording machine.

Acknowledgment: The author is grateful to Mrs. E. Addington for valuable assistance rendered in the construction of the subject head.

REFERENCES

1. E. Schuller, "Magnetische Schallaufzeichnung," *Electrotechnische Zeitschrift*, pp. 1219-1221, Nov. 7, 1935.
See also German AEG patent No. 617796 (1935).
2. S. J. Begun, *Magnetic Recording*, p. 64, Murray Hill Books, Inc., New York, 1949.
3. Wien Schott, "Einfluss der Schragstellung des Spaltes bei Intensitätschrift," *Zeitschrift der Techn. Physik*, vol. 17, p. 275, 1936.
4. Terms are those defined by N. M. Haynes, "Magnetic tape and head alignment nomenclature," *Audio Engineering*, vol. 33, no. 6, p. 22, June 1949.

* 100% was defined as the recording level at which 2% second harmonic distortion is obtained at 400 cycles.

Physical Principles, Design and Performance of the Ventarc High-Intensity Projection Lamps

BY EDGAR GRETENER

DR. EDGAR GRETENER, A.G., ZURICH, SWITZERLAND

SUMMARY: The Ventarc lamps represent a new series of high-intensity carbon arc lamps for motion picture projection recently developed by the author at Zurich, Switzerland. The blown arc of the new lamp produces a distribution of brilliance which is highly advantageous for the illumination of the aperture. By using a new negative electrode the arc can be pushed up to an extremely high brilliance. The precision feed control of the Ventarc insures a perfect homogeneity and invariability of the screen illumination. The visible radiation of the arc is effectively concentrated on the projecture aperture by an entirely new optical system. Heating of the film is minimized by eliminating all invisible radiation. No surplus energy not useful at the screen has to pass through the film.

A NEW SERIES of high-intensity projection arc lamps has been developed by the Edgar Gretener Company at Zurich, Switzerland. These lamps employ a number of fundamentally novel design features which are of considerable technical interest and which form the basis for this paper.

I. THE LIGHT SOURCE

The light source employed in the Ventarc lamps is a "blown arc," invented by the author some years ago. Some historical remarks will be of interest before particulars of the present design are discussed.

Experiments were made in 1932 at the central laboratories of Siemens, Halske A.-G., Berlin, in connection with the development of a new super high-intensity lamp for use with lenticular color film projection systems. This lamp was to compensate, by increased crater brilliance, for at least part of the light lost in the color filters, and was to realize a distribution of brilliance over the positive crater rotationally symmetrical and constant in time. These requirements are essential for correct color rendition and brightness in projecting the Berthon-Siemens film. At that time a solution of this problem was found by employing air blast concentration of the arc, water-cooled jaws clamping the positive carbon immediately behind the

PRESENTED: April 27, 1950, at the SMPTE Convention in Chicago.

crater and a radical reduction in thickness of the positive carbon shell.*

It is very interesting to see that the latest trends in development of normal high-intensity arcs for high light output follow fundamental principles already discovered in the course of the above-mentioned development activities, e.g., water-cooled contacts, positive carbons with thin shell and operation with short protrusion. In comparison with these, air-blast concentration of the arc has not, to date, been given the attention it deserves, in our opinion.

Investigation of brilliance distribution in the positive crater of a conventional 150-amp lamp with rotating positive carbon led to the following conclusions (Fig. 1):

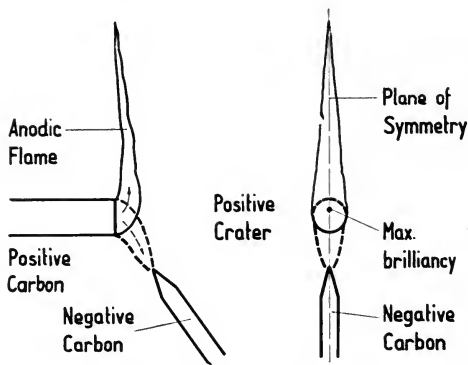

Fig. 1. High-intensity arc.

1. Taking the average in time, the brilliance distribution is symmetrical with respect to that plane, through the axis of the positive carbon, which separates the tail flame of the arc into two identical halves.

2. The peak value of brilliance is located above center, in that region where the arc tail flame issues from the crater, i.e., where the product of current density multiplied by the volume of gas assumes a maximum value.

The lack of rotational symmetry in the distribution of brilliance in a customary Beck arc is due to the fact that the current of anodic gases and the electrical current follow diverging paths outside the positive crater. Consequently, gas concentration and electric current density are not distributed symmetrically about the axis of the positive carbon.

* E. Gretener, "A brief survey of the physics and technology of the Berthon-Siemens color process," *Jour. SMPE*, vol. 28, pp. 447-463, May 1937.

Such observations led to the following conclusions, which were then made the basis for development of a new lamp (Fig. 2):

1. Both the current of anodic gases and the electric current have to be aligned with the axis of the positive carbon in order to obtain the desired rotational symmetry of brilliance distribution. This may be obtained with coaxial electrodes by directing a slightly converging conical air blast, along the positive carbon, which issues from the housing of the positive carbon and proceeds toward the negative electrode. This air blast produces an effective concentration of the anodic flame in the cylindrical space in front of the positive crater.

2. The current load may be raised to a maximum value by employing a positive carbon with a very thin shell. This shell is burned off by the oxidizing effect of the air blast, leaving only a thin crater edge,

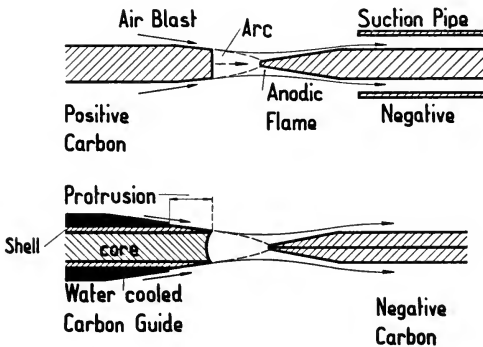

Fig. 2. Blown arc.

but the insulating effect of the air blast always confines the discharge column to the front of the positive carbon.

3. The positive carbon is surrounded by water-cooled jaws immediately behind the arcing end which protect the rear parts of the shell from oxidation by the air blast and avoid excessive calcination of the forward portion of the positive carbon. This measure prevents a decrease of the initial higher brilliance toward the lower more stable value which is generally observed after a new carbon is burned in.

4. The arc plasma is put into fast rotation by means of a current coil coaxial with the positive carbon. This increases the symmetry of distribution of brilliance with respect to the carbon axis, and also avoids formation of dark areas in the arc plasma, which would otherwise appear at extremely high current densities.

Rotation of the arc plasma is caused by the coil (Fig. 3) producing a magnetic field, H , which diverges from the positive toward the

negative terminal of the arc. Contrarily, the electrical flux lines, j , of the arc converge from the positive crater toward the tip of the negative electrode. Due to the rotational symmetry of both these fields, a resultant torque is produced which puts the arc plasma in rapid rotation about the arc axis.

As a result of all these features the blown arc possesses practically unlimited current capacity. Provided the thickness of carbon shell is suitably varied, the brilliance increases in linear relation with the arc current and seems to be limited only by the consumption rate of the positive carbon. The voltage characteristic of the arc is sufficiently positive so that this fact, together with the fixed shape of the

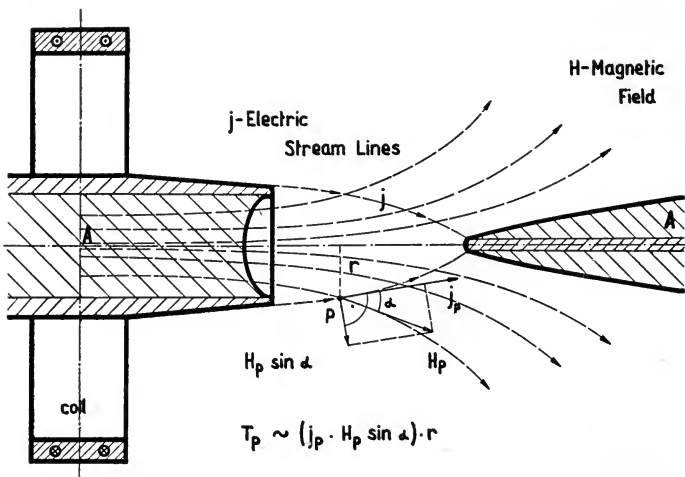

Fig. 3. Magnetic rotation of arc.

arc stream, permits the use of a power supply only slightly higher in voltage than the arc itself.

Practical difficulties are presented by formation of a mushroomlike growth of rare earth carbide on the tip of the negative electrode if the lamp is run with short arc gap and high consumption rate of the positive carbon, but such difficulties can be overcome by appropriate construction of the negative electrode.

Today the blown arc of the Ventarc lamp, which has undergone important further development during the past years, shows the following special features:

1. With increased current loading of the positive core, the maximum brilliance, as observed from outer mirror zones, is located between the center and the outer edge of the crater. A distribution of brilliance

across the positive crater is obtained as shown in Fig. 4, which permits uniform illumination of the film gate with high efficiency when used in conjunction with the optical system newly developed for the Ventarc lamps. Figure 4 shows the brightness variation across horizontal and vertical crater axes, in a plane perpendicular to the carbon axis, as recorded from a 50° angle of view to said axis. It is seen that the distribution of brilliancy is very flat, thus giving a high average brightness in comparison with the peak value.

2. The air blast employed for arc concentration will not cause additional oxidation if appropriate choice is made of thickness and

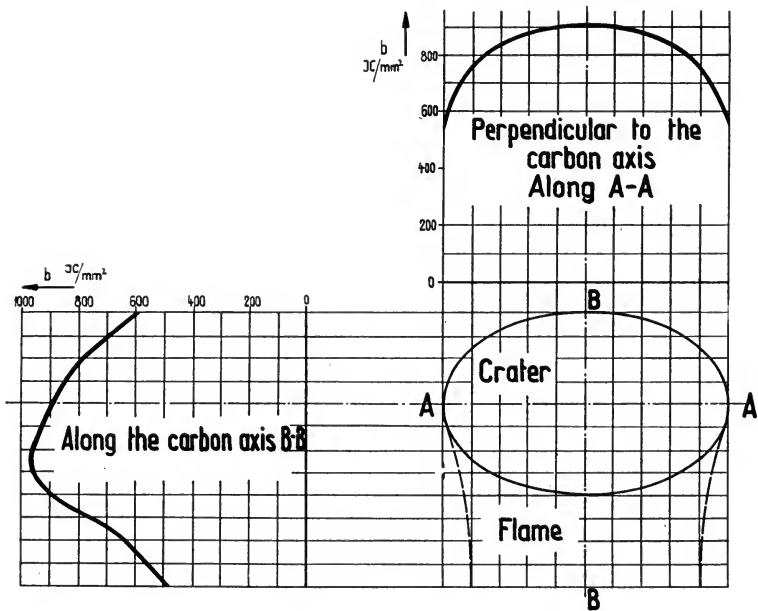

Fig. 4. Blown arc: distribution of brilliancy b ; $\alpha = 50^\circ$.

material of the carbon shell and of velocity of the air blast. Experiments employing nitrogen and carbon dioxide instead of air show practically the same result as regards brilliancy and consumption rate.

3. Even without water cooling, the blown arc is stable and relatively indifferent to overload. If positive carbons of the best brand available today are used, no decrease of initial brilliancy will be observed in the interval during which a new carbon burns in. It is, however, necessary that the carbon be pre-cratered in manufacture to the form it will assume in operation.

4. The Ventarc lamps do not produce soot, since complete oxida-

tion of the material evaporated from the core is effected by the continuous supply of fresh air.

5. Operation of the blown arc is independent of the position of the lamp in space, which is very convenient for projection with steep inclination of the optical axis.

6. Since the direction of air and vapor currents is symmetrical around the edge of the positive crater, this edge will always be formed perpendicular to the axis of the positive carbon. The necessity of rotating the carbon is thereby avoided, although this is quite indispensable in normal Beck high-intensity lamps operated with high current-density.

7. As viewed from the side, concentration of the arc by the air blast produces a very abrupt change in brilliance at the border line be-

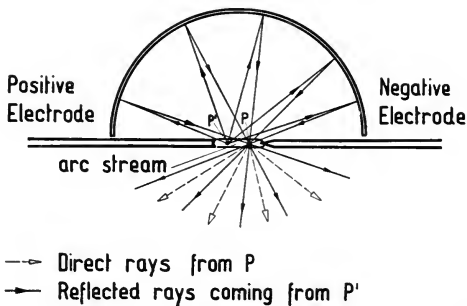

Fig. 5. Auxiliary mirror.

tween the positive shell and the intensely luminous anodic flame. As this border line is always at right angles to the carbon axis, it offers an ideal reference point for a high precision feed control which will position the positive crater exactly at the focal point of the concave reflector.

II. THE NEGATIVE ELECTRODE

Problems posed by the negative electrode of a blown arc have caused considerable difficulties. It must, however, be understood that in arcs of high current-density different conditions prevail for short gaps and long gaps.

1. For special purposes a lamp with an extremely long gap was developed, which produces a luminous flux of 5,000,000 lm drawing 350 amp at 180 arc volts with a gap of 80 mm.

By the use of a small water-cooled auxiliary mirror, an inverted image of the arc was focused on the arc itself (Fig. 5). Thereby the

brilliance measured at right angles to the arc axis was raised to a value of at least 1100 to 1200 IC/mm² (International Candles per square millimeter) along the entire length of the arc (Fig. 6). The positive carbon employed was 12 mm in diameter with a core of 9 mm; the negative carbon was 11 mm in diameter. In spite of the enormously high output of the arc and increased consumption rate of the positive carbon, the negative electrode gave no difficulty, since sufficient oxygen penetrated the arc to prevent formation of mushrooms on the negative tip. Therefore, by operating a blown arc at the relatively high voltage necessary with a normal high-intensity arc with angular trim, the gap can be enlarged so that formation of carbide deposits on the tip of the negative carbon is avoided.

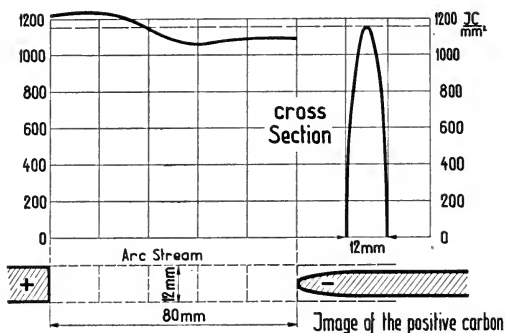

Fig. 6. Brilliancy of arc-stream at 350 amps, 180 volts.

2. For projection lamps, arc voltage should be as low as possible because a long arc wastes energy with additional heating of the lamp house.

Attempts were made to reduce the formation of carbides at short arc lengths by appropriate choice of material for the core of the negative electrode. A basic solution to these difficulties could not be obtained in this way, however.

Formation of mushroomlike deposits is caused by evaporation products which deposit on the negative tip inside the plasma of the arc, where they cannot be oxidized. Thus the deposit on the negative tip continually enlarges. This difficulty is avoided if the evaporation products tending to deposit on the negative tip are transported instead out into the air, where they rapidly oxidize.

This continuous transport is accomplished by replacing the customary rod-shaped negative electrode with a slowly rotating thin disc of graphite, the negative spot of the arc being located on the sharp

edge of this disc (Fig. 7). The gases of the arc flame are exhausted by two suction pipes, one on each side of the disc. Reduced thickness of the graphite disc, sharpening of its edge, and arranging of the disc in a meridional plane of the optical system reduce additional shadowing of the luminous flux by the cathode disc to a negligible value.

This disc-shaped cathode permits satisfactory operation of a highly loaded blown arc with extremely short gap. Measurements taken in 1948 (Fig. 8) show continuous increase of the brilliance for increasing arc currents. The brilliance attainable in such lamps seems to be limited only by the consumption rate of the positive carbon. A 12-mm positive carbon with 9-mm core, operated at 420 amp, 75 volts produced 2000 c/mm² at 60° to the carbon axis, with a consumption rate of 62 mm/min. This consumption could be reduced by using direct water-cooled jaws in combination with special carbons developed

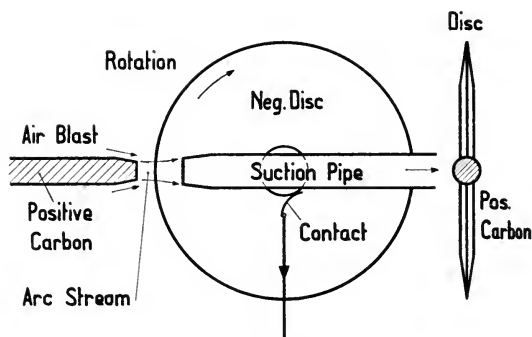

Fig. 7. Disc lamp.

by National Carbon. It must also be understood that this brightness value in no way represents a limit that may not be surpassed.

In such a lamp an approximately linear relationship exists between arc current and brilliance. The positive carbon used in the present lamp is correctly adapted to a current of 200 amp. For higher values of arc current, shell thickness would have to be reduced. By appropriate choice of material, carbon shell thickness and velocity of the air blast, even better results might be obtained.

In these experiments, the core of the positive carbon employed was designed for normal searchlight use and therefore was of special composition to ensure stability of the arc. Since this problem does not arise in the blown arc, the salts in the carbon may be chosen on the basis of maximum brilliance only thus yielding even more favorable results.

A practical difficulty in adapting the disc arc lamp for use in cinema projectors is presented by the comparatively short focal length of the reflector. In order to ensure a sufficiently long period of operation, the diameter of the disc must exceed the focal length of the usual mirror. In order to locate the crater of a disc lamp at the focal point, a slot would have to be provided in the reflector to accommodate the rear part of the disc. This would complicate lamp design, particularly for the suction pipes, which would then interfere with the support, the drive and the means for current supply to the cathode discs.

Such difficulties are avoided by employment of a ring cathode in place of a disc (Fig. 9). The ring passes around the positive head and the arcing spot is located on the sharpened inner edge of the ring.

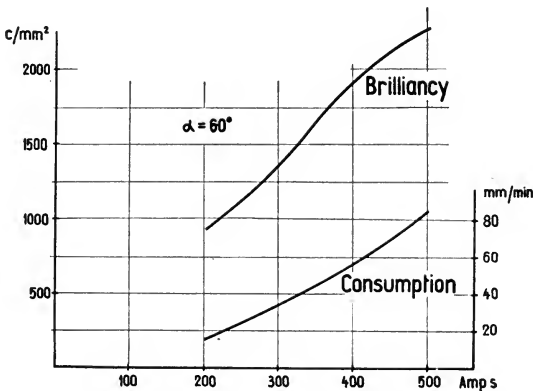

Fig. 8. Brilliancy and consumption rate of a short blown arc.

Appropriate design and arrangement of the lamp mechanism reduce the additional shadowing caused by the cathode ring to a negligible value.

The active part of the cathode ring is made of artificial graphite set in a metal mounting. The life of a single ring in a 100-amp Ventarc lamp is approximately 15 hr. Easy replacement is provided. The drive mechanism for rotating the ring as well as the supply of current to the ring is effected through the metal mounting.

The inner edge of the ring is guided by two ceramic rollers located on each side of the positive head, so that the length of the arc gap is practically independent of consumption of the inner edge. The ring support may, however, be adjusted manually to regulate the value of arc current, although no such adjustment is required during a normal projection period.

Extremely high operational stability is obtained by a Ventarc lamp with the ring cathode, as the arcing spot on the ring is kept practically fixed in space.

Striking of the arc is effected by feeding the positive carbon forward until it touches the cathode ring and subsequently withdrawing it to the normal operating position.

III. CARBON FEED CONTROL

1. Separate positive and negative carbon feed controls are employed in the Ventarc lamps. Requirements for positive feed control, to maintain the crater in the focal plane of the illumination system, increase in precision with the efficiency of the illumination system.

For accurate photoelectric feed control, the shape of the arcing edge of the positive crater must remain constant and in a plane at

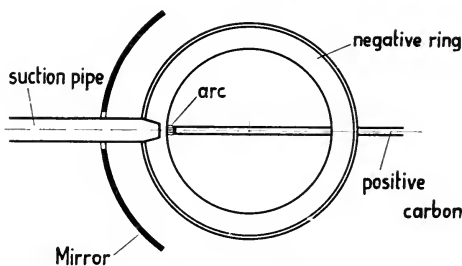

Fig. 9. Lamp with negative ring-electrode.

right angles to the axis of the carbon, a condition readily met by the air-blown arc.

In order to obtain maximum sensitivity of the regulating system, it is desirable to increase, as far as possible, the sharp change in brilliance between the forward edge of the positive shell and the base of the anodic flame.

A blown arc is capable of meeting these requirements as extremely high brilliance is obtained in front of the positive carbon by the concentration of the anode flame. This difference in intensity between the anode flame and the positive carbon is greatest in the blue and ultraviolet spectral region.

With these favorable features a blown arc permits the use of a very simple and accurate positive feed control (Fig. 10). This method may be employed without difficulty, even in blown-arc lamps with arc currents as low as 25 amp. By means of a small lens the crater edge is imaged at right angles to the carbon axis upon a slotted diaphragm.

Behind the slot is a phototube (RCA 929) which is particularly sensitive to blue and ultraviolet radiation. This phototube governs the feed of the positive carbon by a glow discharge tube and magnetic clutch. The feed mechanism is actuated as soon as the carbon burns back beyond its normal position, and when the crater protrudes a bit too far, the feed control is stopped. Such a control is accurate within ± 0.1 mm and is practically free of inertia so that it may execute several feeding cycles per second. As the regulation system does not contain electrical contacts, the operational reliability is very high, with practically no breakdowns. Any manual misplacement of the positive carbon is automatically corrected.

2. In the smaller Ventarc lamps equipped with a conventional negative carbon, the negative feed control is based on keeping the arc

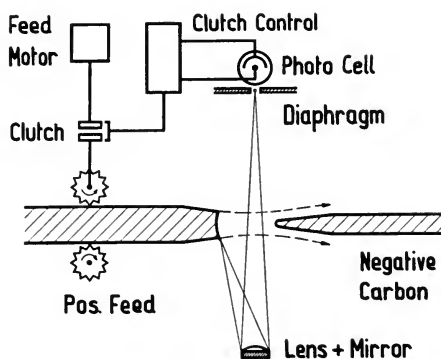

Fig. 10. Positive regulation.

current constant. If current is low, the negative carbon is fed forward, shortening the arc gap until the current increases to its standard value. If the current is high, the reverse effect is obtained by increasing the length of the arc.

This method of feed control reaches accuracies of $\pm 2\%$ by an extremely simple design without electrical contacts and is consequently of very high reliability.

In large Ventarc lamps equipped with disc or ring cathodes, the cathode is manually adjusted so that the gap corresponding to the desired standard value of the arc current is obtained. Due to the extremely low consumption rate of the cathode, resetting of the cathode is not necessary during a projection period.

3. Because of the high stability and constant brilliance in a blown arc and because of the favorable conditions for positive and negative electrode feed control, a steadiness of screen illumination is obtained

amounting to $\pm 2\%$ to 3% over a whole projection period. Moreover, this is accomplished automatically and independently of the attention of the operator.

Life tests of the positive feed control, extending over more than 10,000 hr, show excellent results. Two Ventarc lamps in commercial use in a motion picture house at Zürich throughout the past year have required no readjustment of the positive feed control up to the present time.

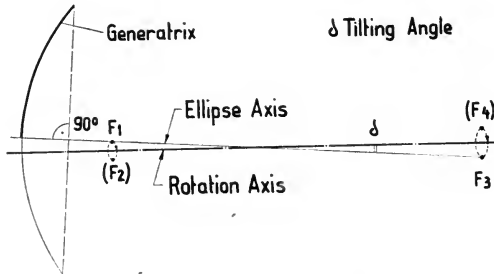

Fig. 11. Generation of new mirror.

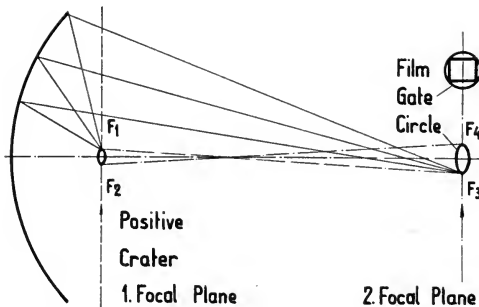

Fig. 12. New mirror for Ventarc lamps, four-focii type.

IV. THE NEW OPTICAL SYSTEM OF THE VENTARC LAMP

1. The Ventarc lamps are equipped with a new optical system which is adapted to the particular distribution of brilliance of the blown arc and therefore gives excellent uniformity of screen brightness with high light efficiency. Referring to Fig. 11 the reflecting surface of the mirror is generated by rotating round an axis the arc of an ellipse the main geometrical axis of which is inclined to the rotation axis by an angle, δ . The value of this tilting angle, δ , is determined by the desired location of the crater images on the aperture plate and the focal distances involved (Fig. 12). As the axis of the generating

ellipse is tilted in such a way that its two focal points do not lie on the optical axis, the reflector possesses two focal circles, oriented at right angles to the optical axis of the projection system. One of these circles is made to coincide with the crater edge and the second one is made to circumscribe the aperture (Fig. 12).

Ideal properties of such an optical illumination system are obtained

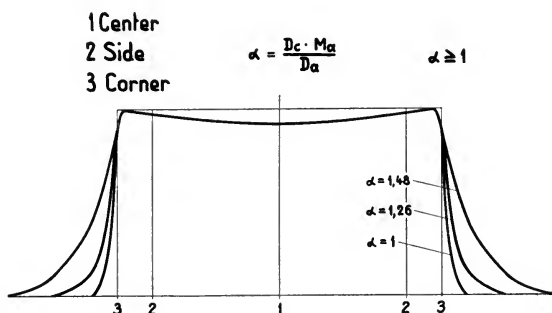

Fig. 13. Light distribution through the film aperture.

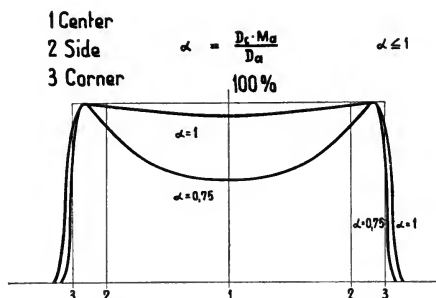

Fig. 14. Light distribution through the film aperture.

if the crater diameter, D_c and the axial magnification ratio of the mirror, M_a , are made to satisfy the following condition:

$$D_c \cdot M_a = D_o \cdot \alpha$$

in which D_o is the diameter of the focal circle at the aperture, and the constant α has a value of unity.

In this case the light distribution on the aperture is as shown by curve I, Fig. 13.

With the same focal circle, D_o , maintained at the aperture, but with $D_c \cdot M_a$ made greater than D_o , i.e., $\alpha > 1.0$, diverging distribution curves are obtained as additionally shown in Fig. 13. The greater extent of these latter curves is the result of crater images tangent inside the

focal circle, but larger than the aperture diagonal and so indicative of reduced efficiency.

If the product, $D_c \cdot M_a$, is smaller than, D_o , i.e., $\alpha < 1.0$, light distribution curves are obtained (Fig. 14) which indicate that the projection screen is now darkest in the center. Here the crater images tangent inside the focal circle are too small to carry sufficient light to the center of the aperture.

This particular type of reflector facilitates adaption of the optical system to any particular projector; for in contrast to the customarily employed elliptical reflectors, the angle of inclination represents an additional degree of freedom in design.

2. In optical illumination systems for projection lamps one condition is of paramount importance: the axes of all light beams passing

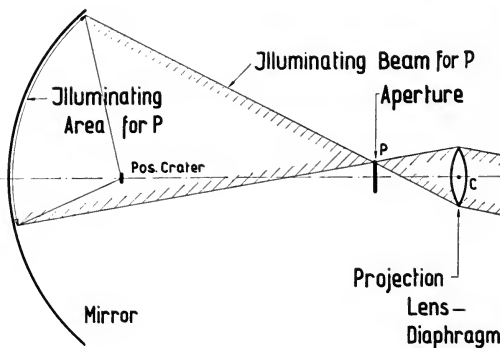

Figure 15.

through every point, P , in the aperture must intersect at the center of the entrance pupil, c , of the projection lens (Fig. 15).

In order to obtain a high efficiency of illumination, only such parts of the reflecting surface should appear luminous from a point, P , as are cut out of the reflecting surface by the extension of a cone having its apex at P , and with the pupil of the projection lens as its base.

The new illumination system for the Ventarc lamps has been laid out to meet fully this requirement, in combination with a projection lens of 100-mm (4-in.) focal length.

A very simple and conclusive test for this quality of the reflector may be made in the following way: the positive crater is replaced by a screen of homogeneous luminosity and photographs of the reflector are taken from points at the center and corners of the aperture, showing the portions of the mirror surface that appear luminous from these points. The theoretical form of the luminous areas on the mirror

to be expected for each of these points may be calculated and compared with the actual form of the areas shown by the test photographs. This method provides a convincing criterion for the quality of the reflectors. For instance, a measure of light distribution over the illuminated spot on the aperture plate is obtained directly from the ratio of the size of the luminous areas in the center to the size of such areas at the sides or corners. Figure 16 represents such a test

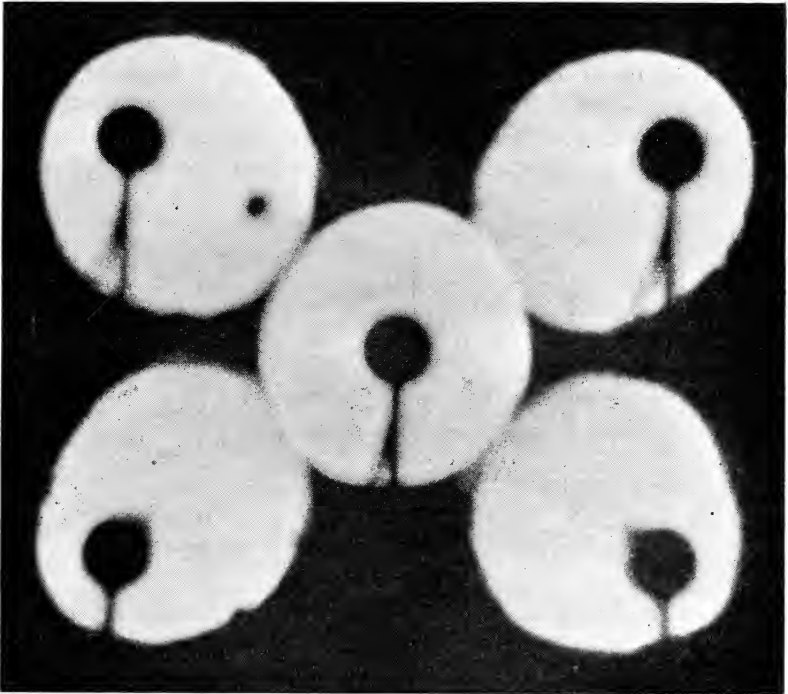

Fig. 16. Test photograph.

photograph showing the illuminated areas of a Ventarc reflector as seen from the center and corners of the film aperture.

3. The requirement, $D_c \cdot M_a = D_o$, can be met with reasonable expense in the conventional coaxial optical system only for small diameters of the crater corresponding to arc currents up to 75 amp. In view of the minimum length of carbon which must be accommodated between the crater and the film aperture at higher currents, mirrors of very large diameter and excessive cost are demanded.

To avoid such difficulties a deflected light path is employed in the

Ventarc lamp with highest light output. Figure 17 shows the actual arrangement: the positive carbon is arranged vertically (in the lamp house), the concentrating air blast is directed upward so that the normal thermal rise of the flame gases adds to the effect of the blast. The optical axis of the illumination system is deflected by a mirror into alignment with the projection axis. The positive carbon passes through a slot in the deflection mirror, and its necessary length no longer affects the dimensions of the illumination system.

As it is impossible to satisfy all desirable conditions—such as homogeneity of illumination on the aperture plate, optimum speed of the illumination beam and appropriate location of the plane of a diaphragm—by suitable formation of the reflecting surfaces alone, the foregoing system is designed to give an intermediate image (Fig. 17) much larger than the aperture. The subsequent introduction of an

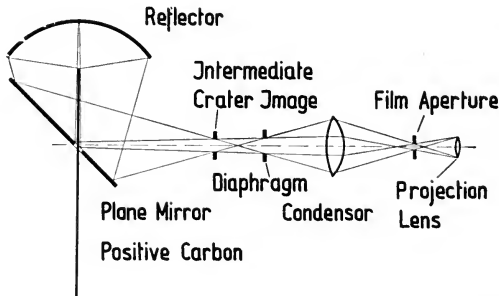

Fig. 17. Optical system for Ventarc with ring-cathode.

additional condenser lens is not objectionable, as this may be surface-treated to reduce reflection losses. The same is true of the deflection mirror which may be so constructed with a reflection index of 97%.

4. The illumination system of a Ventarc lamp, designed for a crater diameter of 6.3 mm, produces a cone of light at the aperture of $f/1.8$ speed. A similar system designed for a larger crater would only increase the speed of the light beam at the aperture, and this would be useless with present-day projection lenses, already filled by an $f/1.8$ cone. A higher light output may be attained only by increasing the brilliance of the positive crater, i.e., by increasing the current density and consequently the consumption of the positive carbon. The layout of the Ventarc lamp with ring cathode provides for this possibility, as the essential dimensions of the interior parts and of the lamp house offer sufficient space to permit an increase of the positive carbon loading to 150 or 200 amp.

V. SCREEN LUMENS

1. A most important requirement for a good projected picture is effective luminous flux arriving at the projection screen. Assuming uniform illumination of the aperture, the following formula is valid for the luminous flux, L , illuminating the film:

$$L = l \cdot F \cdot \Theta$$

where l represents the brilliancy of radiation in the plane of the aperture measured in candles per mm^2 ; F , the area of the aperture in mm^2 ; and Θ , the solid angle by which the pupil of the projection lens is seen from the film. An evaluation of this very simple relation is represented by Fig. 18, in which shadowing caused by the positive carbon guide mechanism is neglected.

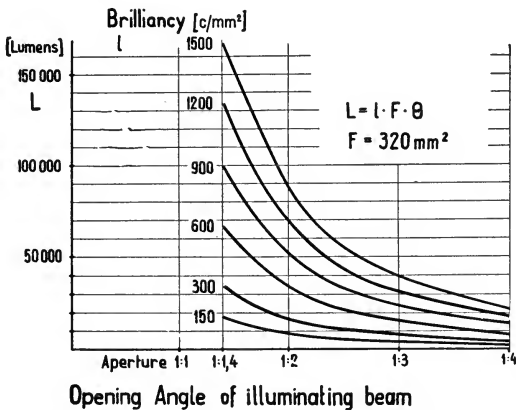

Fig. 18. Lumens through the film aperture.

It is not, however, the peak value of brilliance measured at the most advantageous angle and at the brightest spot of the positive crater which is significant here, but rather the average of the brilliance over the crater surface at all angles. This average brilliance, which determines the luminous flux through the aperture, is a considerably smaller fraction of the peak brilliance than is generally presumed. For instance, the assumption of a homogeneous illumination of the image field with an average brilliance of only 750 c/mm^2 , leads to the amazing value of 46,000 lm in the aperture plane.

The figures of peak value of brilliance in the positive crater generally contained in technical publications ought to be supplemented by a specification of the average brilliance all over the utilized surface

of the crater, in order to avoid false impressions of the performance of different light sources.

2. The heat capacity of the film is limited, and may not exceed a maximum value of 0.5 W/mm^2 even if forced air cooling of the film is employed. It is therefore necessary to restrict the luminous flux to the useful luminous region of the spectrum, so that maximum lumens through the aperture are obtained without exceeding the admissible radiation density.

3. Next to uniform distribution and constancy in time, uniformity in color of the screen illumination is of great importance. Any variation of color across the screen is decisively detrimental to the artistic value of projection.

A very good criterion for the uniformity in color of the screen illumination is obtained by measuring the relative value of the green and the red component at the center and the corners of the screen by means of a phototube and color filters.

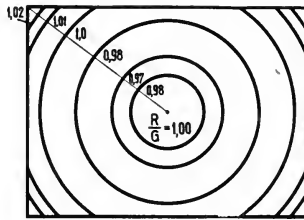

Fig. 19. Red-to-green ratio of the screen illumination for the Ventarc, 50 amp.

The results obtained with the Ventarc 50-amp are indicated in Fig. 19. It must be emphasized that with Ventarc lamps the distribution of such values is rotationally symmetrical, whereas with customary high-intensity lamps symmetry only exists relative to a vertical line through the center of the picture. Extension of such measurements beyond the corners of the screen is recommended, as this permits prediction of the extent to which the red-and-green component in the corners will deviate if slight maladjustment of the projection system occurs.

In view of the considerable importance of color uniformity, standard tolerances should be set up for the red-to-green ratio on the projection screen.

VI. LIGHT OUTPUT OF THE VENTARC LAMPS

The light output of the Ventarc lamps is illustrated by Fig. 20. The types of the series hitherto developed cover an effective screen

illumination range from 3550 up to 30,000 lm with arc currents of 20 to 100 amp. All such lamps are equipped with reflector illumination systems.

The ratio of screen lumens to power consumption may be employed as a quality coefficient of a projection lamp (Fig. 20). An average coefficient of 6 lm/w is obtained by the Ventarc lamps where the

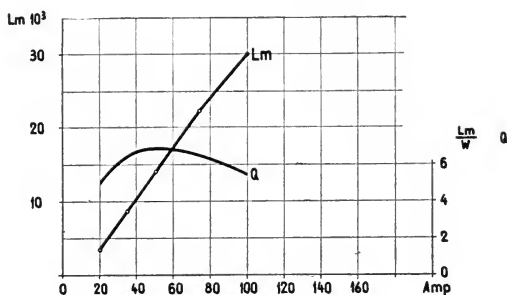

Fig. 20. Screen lumens of the Ventarc lamps side-to-center ratio 80%.

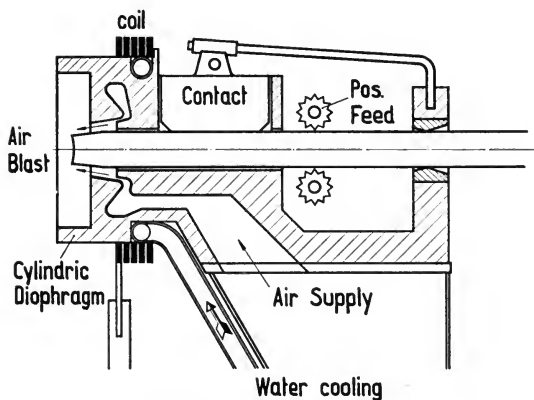

Fig. 21. Positive head.

brightness at the lateral boundaries of the screen amounts to at least 80% of the value at the center.

VII. CONSTRUCTION FEATURES OF THE VENTARC LAMPS WITH RING CATHODE

1. The positive head (Fig. 21) is water-cooled and the carbon support and contacts for current supply are in good thermal contact with the water-cooled parts. As no decrease of the brilliance is observed after a new carbon has properly burned in, direct water cooling of the

current contact is dispensed with as that would require considerable complication of design. As far as a reduced consumption rate can be achieved by using the special carbons of National Carbon, direct water-cooling of the jaws can be provided.

The magnet coil is mounted behind the water-cooled parts of the positive head. It is thus protected against direct radiation and its current loading may consequently be made exceedingly high.

The blower nozzle is made of a special acid- and heat-resistant steel. The nozzle may easily be replaced, but under conscientious operation the attainable period of life is very long.

The air velocity may be regulated by means of a valve so that the optimal value for any current load of the positive carbon may be set exactly.

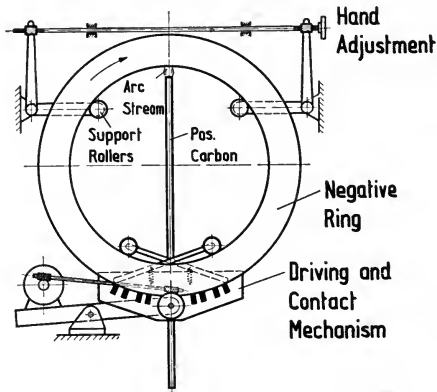

Fig. 22. Negative ring system.

To avoid excessive irradiation and heating of the lamp house by the highly intense anode flame, the water-cooled positive head is equipped with a cylindrical diaphragm, provided with the necessary ports for the observation of the crater and of the positive feed control. Heating of the lamphouse is effectively reduced by this diaphragm.

2. The ring cathode poses some constructional problems (Fig. 22), as, for instance, the mounting, drive and current supply of the cathode ring.

The two rollers previously mentioned, which guide the ring at substantially constant arc length, are shown in the vicinity of the positive head.

A symmetrical application of the current to the arc through both halves of the ring is essential as distortion of the arc would result from

the magnetic fields excited by an unsymmetrical admission of current. Facilities permitting an easy replacement of the cathode ring are of practical importance; the rear wall of the lamphouse may be opened as a whole for the mounting of a new ring.

3. The cathode ring and deflection mirror are arranged so that the ring completely embraces the mirror. Shadowing of the illuminating beam is thereby minimized. The somewhat higher shadowing occurring at the screen center improves the uniformity of screen illumination.

4. Compressed air is provided by a blower separated from the lamphouse. The particular construction of the lamp (Fig. 23) permits utilization of one single blower to supply air alternately to two lamps.

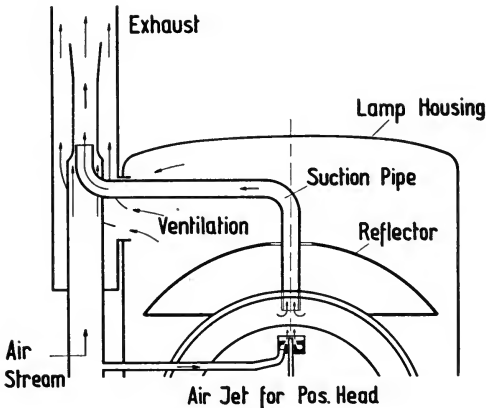

Fig. 23. Air jet system.

This solution presents important technical and economical advantages, namely:

(a) The hot flame gases do not pass through the blower so that difficult technical problems, e.g., excessive heat, choking by deposits, etc., do not arise.

(b) The blower runs on cold air thus obtaining a higher efficiency.

(c) The blower is mounted separately from the lamp, so that constructional complications such as spring mounting, silencing, heat insulating and access for cleaning purposes are avoided.

(d) Since only one blower system is required for two lamps, this may be built of higher quality. Silencer and dust filter are required only once, but simultaneously serve for two lamps. The diameter of the blower wheel may be increased and the rotation speed lowered as no restriction of the space exists. Consequently the commutator

motor hitherto required for Ventarc lamps may be replaced by a squirrel-cage motor which is superior on account of its sturdiness and service-free operation.

Because of the fixed position in space of the ring cathode, the Ventarc lamp provides additional safety against damaging of the positive head, in case of failure of the positive feed control. In such a case, the positive carbon would burn back until the arc was extinguished by the minimum current relay or by the air blast.

APPENDIX

The particular form of the discharge of the blown arc permits determination of the absorption rate of the arc plasma A , the volumetric brilliance, b_v , and the saturation value of brilliance, b_{\max} , for increasing

Positive

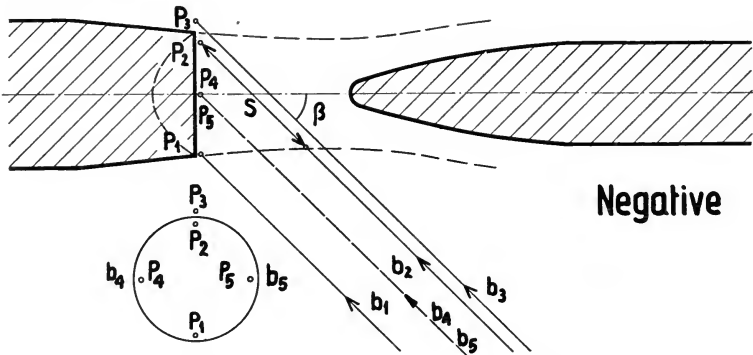

Fig. 24. Blown arc: volume brilliancy and absorption.

diameters of the carbon assuming constant current density in the positive crater. This saturation value in the interesting range rises proportionally with the arc current. By measuring the values of brilliancy, b_1 , b_2 and b_3 at the respective points, P_1 , P_2 and P_3 in a direction inclined by an angle, β , to the axis of the carbon, a very simple calculation arrives at the following relations (Fig. 24):

$$A = \frac{1}{S} \cdot \log_e \frac{b_1}{b_2 - b_3}$$

$$b_v = A \cdot \frac{b_1 \cdot b_3}{b_1 - (b_2 - b_3)}$$

or

$$b_{\max} = \frac{b_v}{A} = \frac{b_1 \cdot b_3}{b_1 - (b_2 - b_3)}$$

S stands for the length of the line of sight through the arc stream looking towards points P_2 or P_3 .

These relations hold for a very shallow crater as indicated by Fig. 24. In case of a deeper crater the value b_1 has to be replaced by $b_1^* = \frac{1}{2}(b_4 + b_5)$ which is self explanatory with regard to Fig. 24.

By inserting the particular values measured with a 200-amp blown arc

$$b_1 = 700 \quad b_2 = 1000 \quad b_3 = 950 \quad [\text{IC}/\text{mm}^2]$$

the following figures are obtained:

$$\begin{aligned} A &= 0.25 \\ b_p &= 256 \quad [\text{IC}/\text{mm}^3] \\ b_{\max} &= 1025 \quad [\text{IC}/\text{mm}^2] \end{aligned}$$

In this case the absorption of a layer of the arc plasma 1 mm in thickness amounts to 22%. The absorption rate of the arc plasma rapidly increases towards the region of short wavelength. This observation provides an explanation for the occurrence of brown areas inside the plasma at high current-density.

NOTE: A 100-amp model of the new lamp was set up and demonstrated at the SMPTE Chicago Convention.

The High-Speed Photography Of Underwater Explosions

BY PAUL M. FYE

NAVAL ORDNANCE LABORATORY, SILVER SPRING, MD.

SUMMARY: A brief review of the techniques used in photographing underwater explosions at the Underwater Explosives Research Laboratory and the Naval Ordnance Laboratory for the past several years will be given. The Fastax (35-Mm), Eastman Hi-Speed and a rotating-mirror frame camera have obtained pictures ranging in speed from 2000 to 30,000 frames/sec. Explosions of charges weighing up to one pound have been photographed at depths down to two miles. In the very deep water photography the equipment which synchronized the explosion with the flashbulbs, timers, etc., was self-started by means of a pressure switch. Typical results will be shown.

MANY TYPES of transient phenomena have been studied by means of high-speed photography. In the past few years, underwater explosion phenomena have been included in such studies at a number of laboratories, notably the David Taylor Model Basin in this country and the Naval Construction Research Establishment in Great Britain.¹ Presented here is a brief outline of the work by a number of people at the Underwater Explosives Research Laboratory (UERL) and the Naval Ordnance Laboratory (NOL) where methods have been developed for the photography of explosive charges ranging in size from 1 oz to 300 lb. The techniques used by other laboratories, in most cases, have restricted the explosion to that which can be contained in a tank and consequently the charge size has usually been about 1 gram.

The work described here has all been conducted in the ocean from a ship. In general, two types of high-speed photography have been used in the UERL studies of underwater explosion phenomena: (1) the photography of shock waves² by means of a short-duration light source (10^{-6} sec); and (2) the photography of explosion bubble expansion and contraction by means of motion pictures.³

As is well known, an underwater explosion results in a rapidly expanding shock wave followed by a succession of pressure pulses.⁴ The later pressure pulses are caused by the repeated collapse of the gas globe formed by the hot expanded gaseous products of detonation.

PRESENTED: April 26, 1950, at the SMPTE Convention in Chicago. This paper is based in part on work done for the Bureau of Ordnance under Contract NOrd 9500 with the Woods Hole Oceanographic Institution, Woods Hole, Mass., and in part on work at the Naval Ordnance Laboratory.

It is the photographing of the oscillations of this gas bubble with which the following is concerned.

Some of the requirements of such photography are: (1) sufficiently clear water to permit the proper spacing of equipment and explosive charges; (2) appropriate cameras contained in water and explosion resistant cases; (3) synchronization of the lights and camera with the detonation; (4) light sources; (5) precise speed control of the camera or timing marks on the film; and (6) a rig for mounting and maintaining the position of each component.

The requirement of very clear water results from the camera-to-object distance required in some of this work. For example, using a $2\frac{1}{2}$ -in. focal length lens on the Eastman Hi-Speed camera, the angle of view under water is only about 5 deg and the target must be 40 ft away to get a 4-ft field. Sufficiently clear water was found off the Florida coast near the Bahamas and in the Caribbean Sea. In general, clear water can be found in the tropical latitudes where it is not contaminated by shore drainage. A convenient measure of the water clarity is obtained by means of a Secchi disk which is simply an 8-in. white circular disk. The limiting depth to which it can be lowered in the sea and remain visible is a reliable and reproducible measure of clarity.^{5,6} The waters mentioned had a Secchi disk reading ranging from 135 ft to 160 ft. A rough rule for such photography is that adequate resolution can be obtained for a camera-to-target distance equal to about one-half the Secchi disk reading.

The cameras used in this work included the Eastman Hi-Speed, the 35-Mm Fastax and a rotating-mirror frame camera of NOL design. These cameras were shock-mounted in a heavy, watertight case to prevent damage from an explosion. Figure 1 shows the case used with the Eastman camera. The NOL designed camera, which was used at depths as great as 2 miles in the ocean, was enclosed in a spherical case which was 22 in. ID and had a $1\frac{1}{4}$ -in. wall. The camera lens viewed these deep explosions through a 1-in. thick window covering a $1\frac{1}{4}$ -in. hole.

The camera designed by S. J. Jacobs (NOL) and A. A. Klebba (Woods Hole Oceanographic Institution) is essentially a modified Bowen camera. The image is focused on a spinning mirror which has the focal axis of the taking lens system for its axis of rotation. The plane of reflection of the mirror is 45 deg to this axis. The image is thus reflected through the framing lens to the stationary film. One hundred framing lenses provide 100 pictures. With the mirror revolving at the rate of 18,000 rpm, 100 pictures can be taken at the rate of 30,000 fps. An auxiliary shutter prevented multiple exposure.

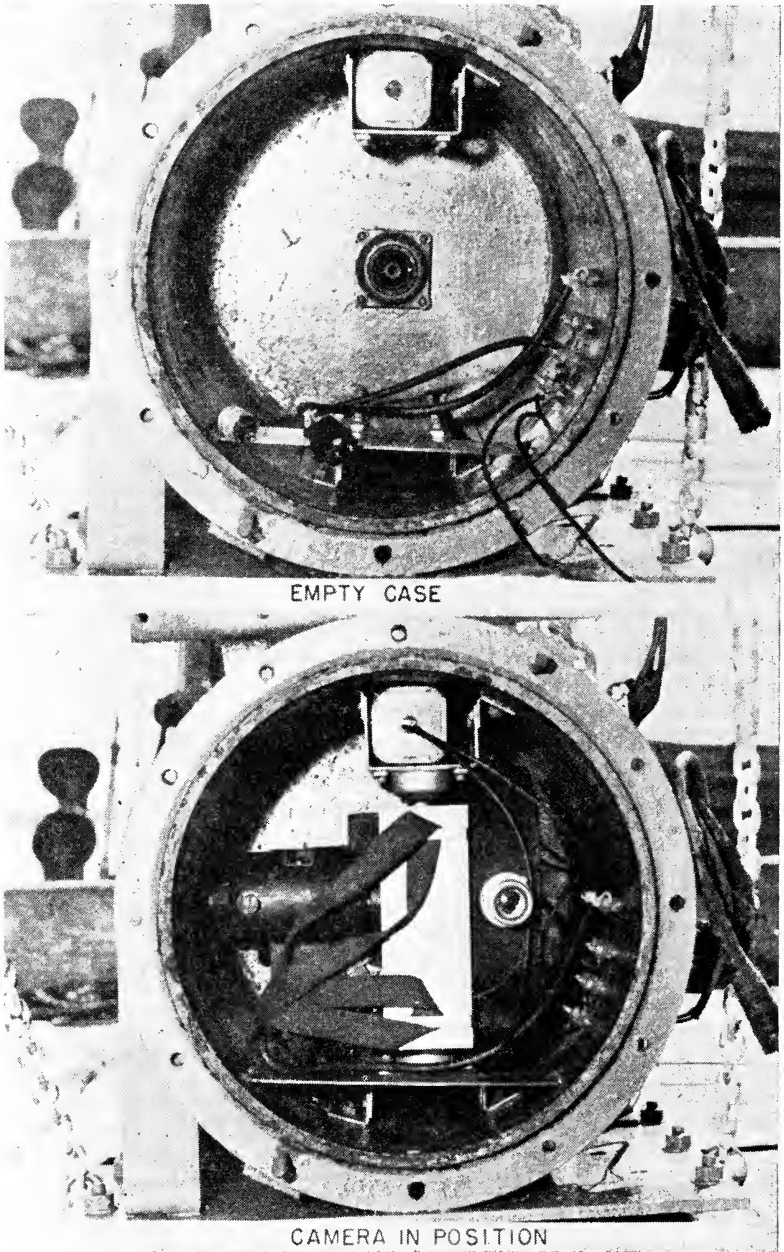

Fig. 1. High-speed camera and "explosion proof" case.

Such frame speeds were required for the very deep photography in which the oscillations of the explosion bubble are much more rapid than in shallow water. The Eastman and Fastax cameras were not used at depths greater than 1,000 ft.

The light source most commonly used consisted of a number of focal plane flashbulbs, having a duration of about 70 msec (milliseconds). On occasions when a longer light was necessary, such flashbulbs were fired in series. Miniature bulbs were used for the very deep work. It was necessary to provide protection from the explosion for these bulbs by a watertight case having a Lucite window.

For the work at less than 1,000 ft. with the Eastman and Fastax cameras electrical power to operate the cameras and a timing signal was provided through cables from the ship. Since knowledge of the precise depth at which the experiment was performed was very important, a depth gage was used to measure the static pressure and hence the depth to within 2%. For some experiments a Bourdon gage was photographed by a small camera at the instant of the explosion. For others the Bourdon gage element actuated a potentiometer which was one arm of a Wheatstone bridge. The latter method permitted continuous reading by means of cables to the surface and consequently was more convenient for an accurate pre-setting of the depth.

It was impossible to have electrical cables leading from the camera to the surface for work at depths of one and two miles. The power for the camera in this case was supplied by miniature wet cells, and the entire equipment was self-operated after the closing of a depth switch. The sequence of events necessary to obtain photographs included: the starting and stopping of the camera motor, the operation of the shutter, the firing of the 1-lb explosive charges, and the firing of 20 to 40 No. 6 focal plane flashbulbs. These events, which had to be synchronized with a precision of the order of $\frac{1}{4}$ msec, were started by the closing of a switch triggered by hydrostatic pressure. Two pressure switches, one actuated by a Bourdon gage mounted in the camera case and one which involved the movement of a spring-backed piston, had an accuracy of better than $\pm \frac{1}{2}\%$ in depth.

Since the Fastax camera did not have a built-in firing switch, it was necessary to fire the charge from the laboratory ship. In order to fire the charge automatically when the camera had reached maximum speed and the photoflash bulbs were near peak intensity, and to turn off the camera, the firing circuit and camera power circuit were combined as shown in Fig. 2.

A typical operation would be as follows: when the safety switch is

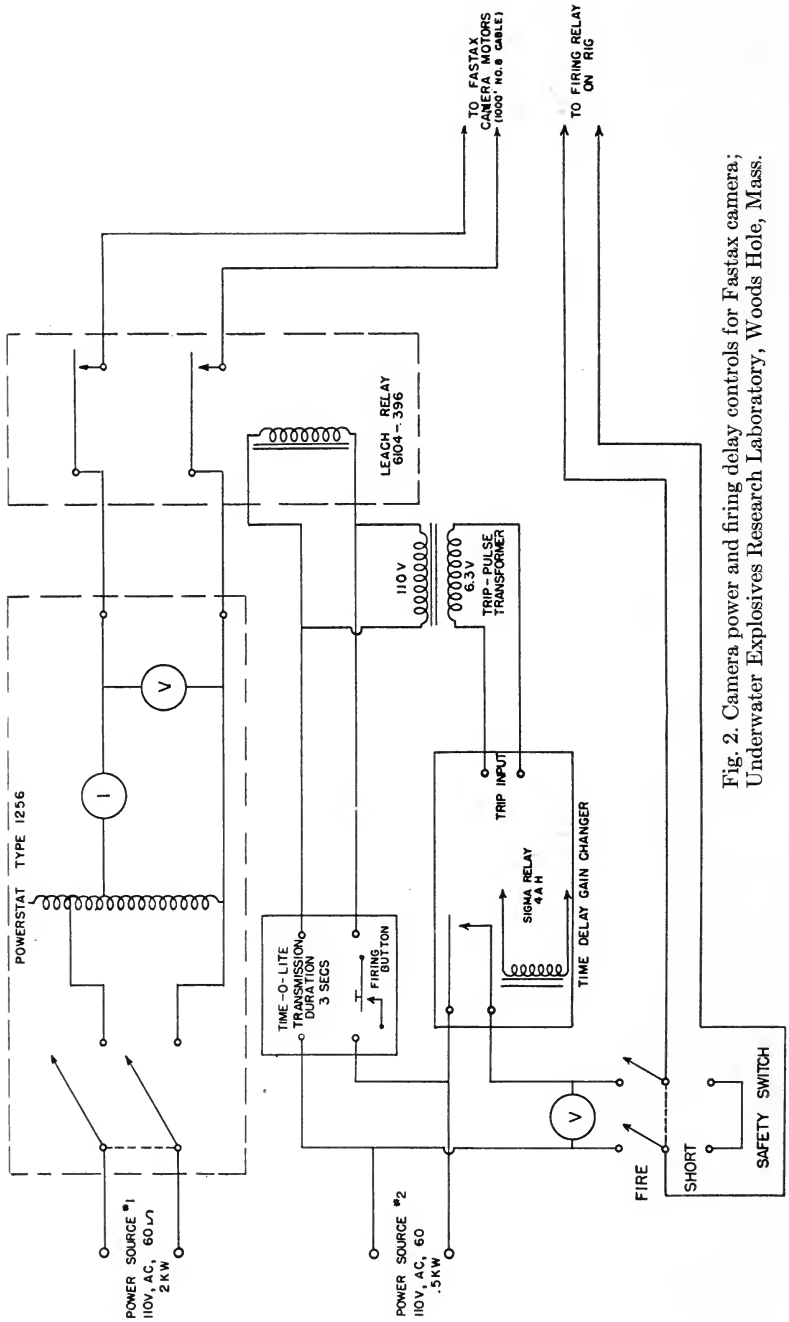

Fig. 2. Camera power and firing delay controls for Fastax camera; Underwater Explosives Research Laboratory, Woods Hole, Mass.

thrown and the firing button on the Time-O-Lite* is pressed, a 110-v current is transmitted to the camera power relay and trips the electronic time delay.³ The camera then starts and is up to speed in a little more than a second. At 1.5 sec, the time delay gain changer closes an internal relay which transmits the 110-v a-c power to the firing relay on the rig. This fires the flashbulbs and the charge, the latter being delayed a few milliseconds by a series resistor so that the bulbs can be at maximum brilliance when detonation occurs. After 3 sec, the Time-O-Lite turns off the power to the camera relay, thus stopping the camera after the film has run through. These times may easily be changed to suit other conditions.

As shown in Fig. 3, all the necessary components in their respective pressure cases were mounted on a rigid frame. Such steel frames,

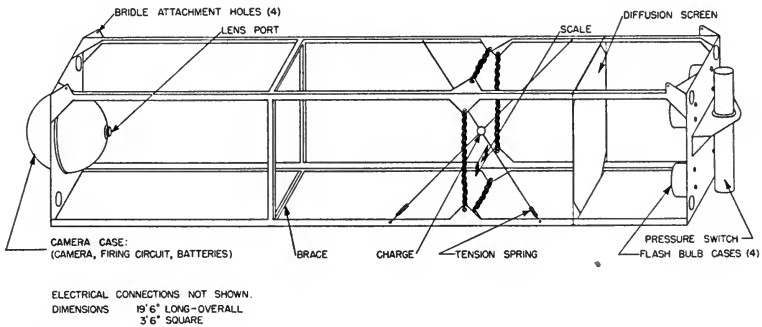

Fig. 3. Deep sea camera apparatus. Electrical connections not shown.
Dimensions: 19 ft 6 in. long, over-all; 3 ft 6 in. square.

built of channel and angle iron in lengths varying from 10 ft to 40 ft, were used for explosive charges weighing up to about one pound. Since the operation of the camera was automatic with the closing of the depth switch, this entire rig, weighing about 1,200 lb, was simply lowered to the preset firing depth by a single steel cable.

In Fig. 4 are shown some typical results using the Eastman Hi-Speed camera. Here is shown the explosion of 25 grams of tetryl at a depth of 350 ft. The scale above the charge is 12 in. long. The charge was placed 20 ft from the camera where the field of view was about 20 in. \times 28 in. The first frame shows the undetonated cylindrical charge. Detonation occurred between the first and second frames. The bubble, in this case, grows to its maximum size in 5.5 msec and has collapsed to a minimum at the end of 11 msec. The

*Time-O-Lite Master Model M-49, Industrial Timer Corp., Newark, N.J.



Fig. 4. Explosion of 25 grams tetryl at 350 ft.

successive expansions and contractions are clearly shown. The unsymmetrical shape of the bubble at its minimum is typical of such explosions in shallow water and is the result of carbon particles left behind in the water by the collapse of the gas globe. Front-lighting was provided by four No. 31 GE photoflash bulbs placed midway between the camera and the charge. A white background was used to silhouette the object. The exposure was made at $f/2.7$ and the camera speed was 2200 fps. The film used was Super-XX Panchromatic Negative. Twice the normal development time in D-76 produced reasonable contrast. The camera was focused by means of a ground glass in air, taking a distance in air three-fourths of the object distance under water.

An oscillating bubble such as is produced by an underwater explosion has interesting characteristics when it is near a surface. Such a bubble is repulsed by a free surface and is attracted by a rigid surface. For example, the bubble from a 1-oz charge when fired just beneath the water surface will go down instead of up. An example of a shallow water explosion is shown in Fig. 5. This photo-

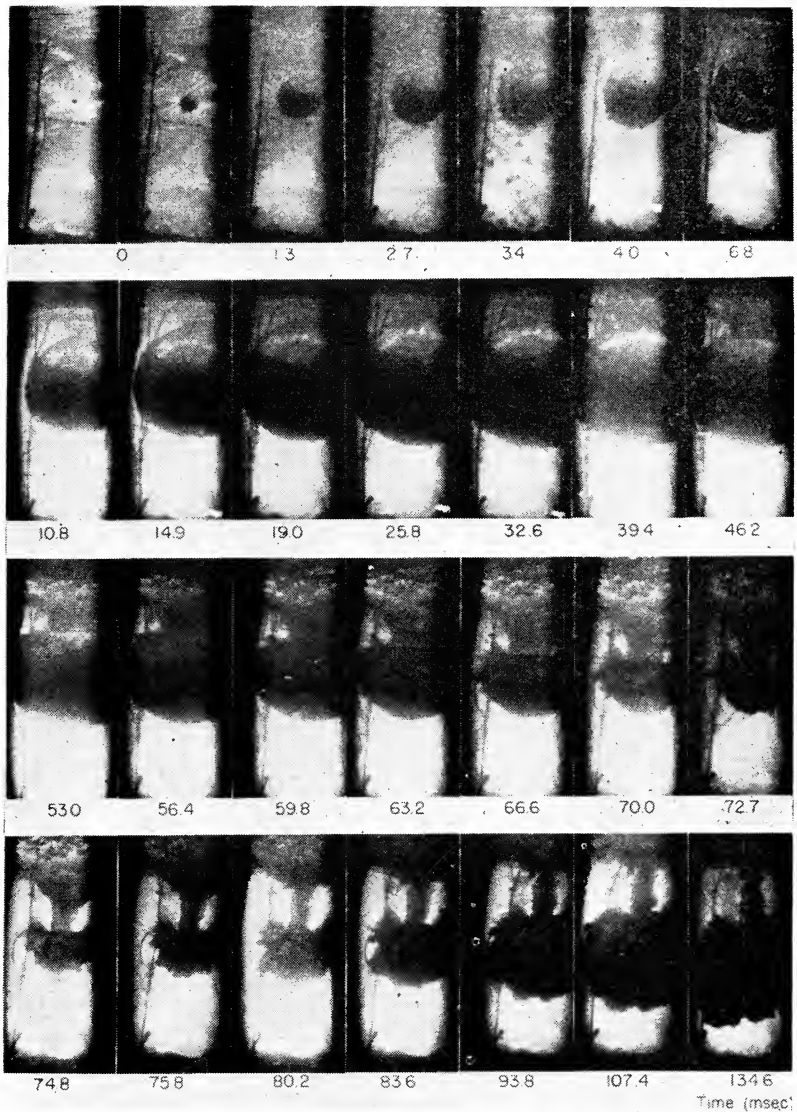

Fig. 5. Explosion of 25 grams tetryl charge 1 ft 9 in. beneath surface.

graph was obtained by using the 35-Mm Fastax camera. Here back-lighting was used and two sets of No. 31 photoflash bulbs were set off in sequence in back of a translucent screen behind the charge. The circuit used to fire the flashbulbs in sequence, 50 to 90 msec apart,

is shown in Fig. 6. The 25-gram tetryl charge was 1.75 ft beneath the surface. Small cavitation bubbles resulting from the passage of the shock wave partially obscure the early frames. At its maximum size the bubble is approximately tangent to the water surfaces. As the bubble collapses there is pronounced interaction with the surface. A large tubular connection to the atmosphere permits air to enter the bubble in which the pressure is less than atmospheric when it is close to its maximum. Enough air thus enters the bubble so that its volume at minimum size is larger than for the deeper shots. The tubular space between the bubble and the surface is apparently not a continuous open tube after the minimum, since the bubble once more expands and does not vent.

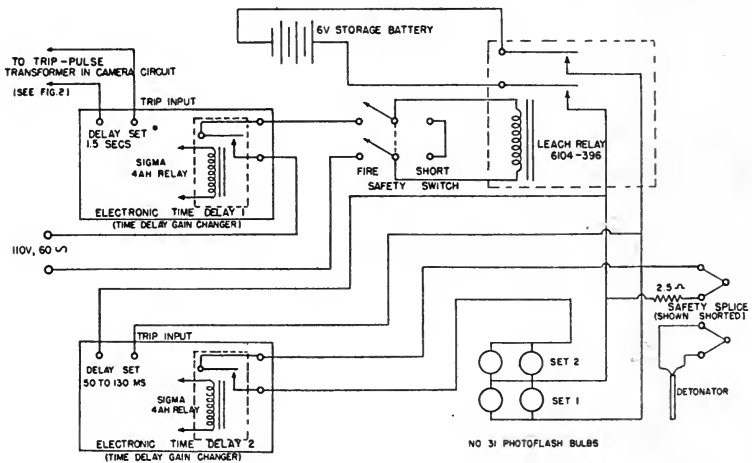

Fig. 6. Sequence firing circuit for two sets of flashbulbs; Underwater Explosives Research Laboratory, Woods Hole, Mass.

An example of the results using the NOL camera to photograph very deep explosions is shown in Fig. 7. This shows the explosion of a 1-lb spherical charge at a depth greater than two miles. Again the first frame shows the unexploded charge which was $3\frac{1}{4}$ in. in diameter. The detonation light can be seen in the second frame. A linear scale is provided by the black squares in the lower part of each frame. The distance between the inside edges of the squares is 12 in. and between the outside edges it is 18 in. The maximum and minimum bubble diameters are $12\frac{1}{2}$ in. and $5\frac{1}{2}$ in. respectively. The most notable difference in such deep explosions, as contrasted with shallower ones, is that the bubble more nearly retains spherical

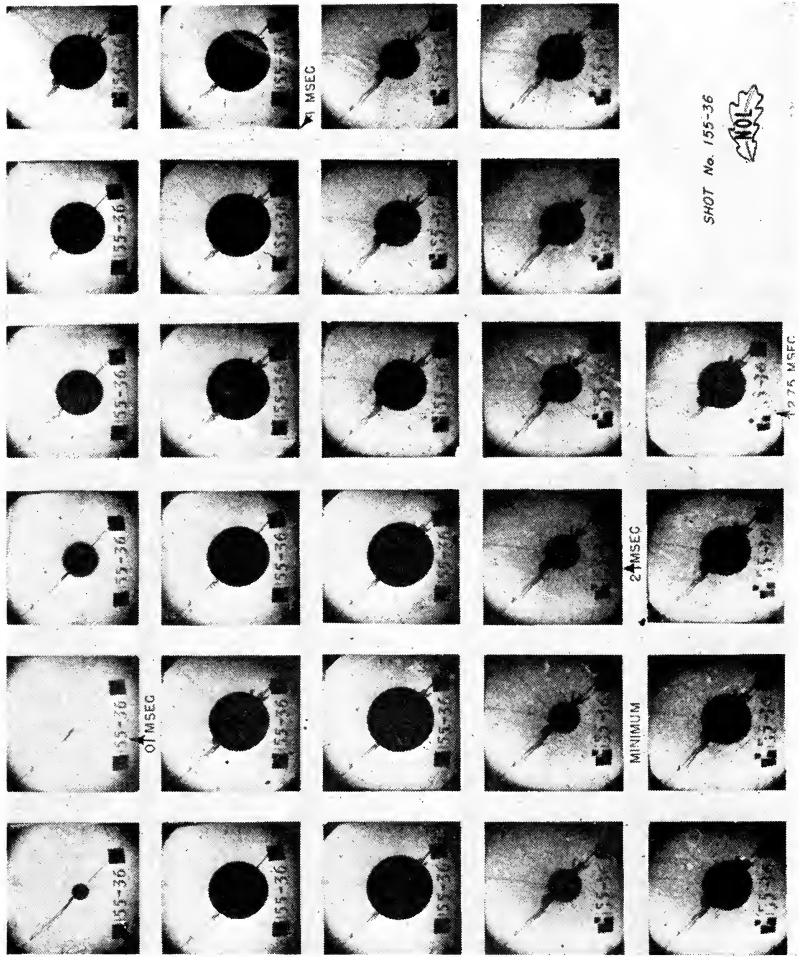

Fig. 7. Explosion of one-pound charge at 12,000 ft.

symmetry throughout its cycle. The carbon particles from the explosion have apparently not progressed outside the gas globe. This has permitted the accurate measurement of the variation of bubble volume with time which is of considerable theoretical importance in the study of explosion phenomena. The reproducibility obtainable from such photographs is illustrated in Fig. 8 in which is plotted the variation of bubble diameter with time for a 1-lb charge at a depth of 6,000 ft.

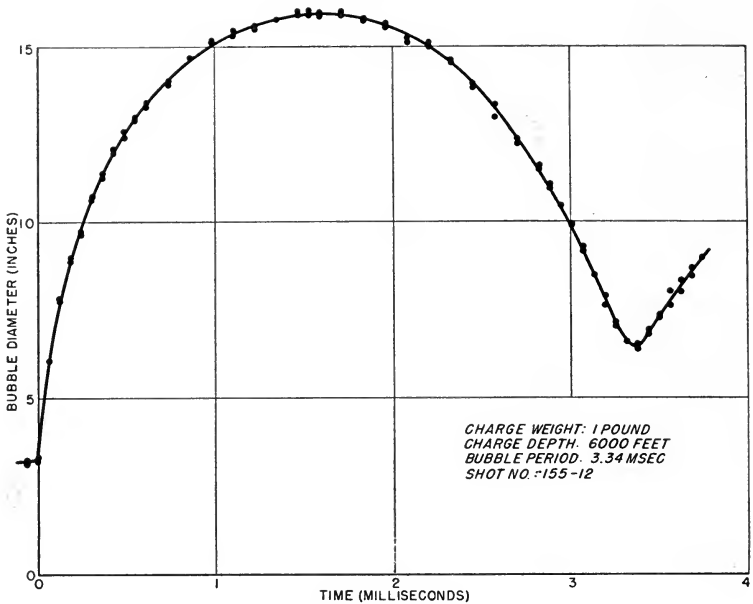

Fig. 8. Variation of bubble diameter with time.

In conclusion it may be pointed out that high-speed photography of explosion phenomena has advanced in the last decade from a curiosity to one of the most valuable tools available for the study of explosions.

REFERENCES

1. D. A. Senior, "High-speed photography of underwater explosions," *Phot. Jour.*, Section B, 86B, 25, 1946.
2. J. E. Eldridge, Paul M. Fye and R. W. Spitzer, "Photography of underwater explosions, Pt. I," OSRD Report No. 6246, Mar. 1947.
3. E. Swift, Jr., Paul M. Fye, J. C. Decius and R. S. Price, "Photography of underwater explosions, Pt. II, High-speed photographs of bubble phenomena," NavOrd Report No. 95-46, Dec. 1946.
4. Robert H. Cole, *Underwater Explosions*, Princeton University Press, 1948.
5. M. Ewing, A. Vine and J. L. Worzel, "Photography of the ocean bottom," *Jour. Opt. Soc. Amer.*, vol. 36, pp. 307-321, June 1946.
6. F. A. Jenkins and I. S. Bowen, "Transparency of sea water," *Jour. Opt. Soc. Amer.*, vol. 36, pp. 617-623, Nov. 1946.

A Heavy-Duty 16-Mm Sound Projector

By EDWIN C. FRITTS

CAMERA WORKS, EASTMAN KODAK CO., ROCHESTER, N.Y.

SUMMARY: An intermittent sprocket pulldown with accelerated geneva drive has its own directly connected synchronous motor. The remaining sprockets and shutter are driven by a second synchronous motor. The two systems, engaged temporarily for starting, run mechanically independent to eliminate shock forces and obtain an inherently flutter-free sound drive. New optics throughout give high picture and sound resolution. Tungsten and arc light sources are provided. Other features include a high-quality amplifier, independently driven accessories, turret accommodation for instantaneous lamp replacement, improved base-up mounting of lamp and improved floor mounting.

SIXTEEN-MILLIMETER CINEMATOGRAPHY is a quarter of a century old. From the start, it has found increasing application in organizational functions such as teaching and training, although it was inaugurated to provide personal motion pictures. During the last war, it was used extensively in training and recreational programs, especially by the armed forces. Under hard military usage, projectors wore out rapidly and were generally unsatisfactory for that type of service. This led to the development of Joint Army and Navy specifications, JAN-P-49, for a projector that would be adequate for the services. A great deal of effort was put into these specifications, which were scaled to the ideal objective rather than to one that could easily be attained. A postwar review of the potentialities of 16-mm equipment soon disclosed that amateur projectors were not adequate for testing purposes and that little could be done in evaluating other 16-mm equipment and processes until a new projector was available.

The projector described in this paper was developed to meet the essential features of the JAN specifications. We believe that the intent of all the items is met and that in some respects the requirements of the specifications are exceeded. This projector, named the Eastman 16-Mm Projector, Model 25, was designed to meet the demands of the growing civilian market as well as the needs of the military forces. Also, it was designed in anticipation of marked improvements in the whole 16-mm process.

PRESENTED: April 24, 1950, at the SMPTE Convention in Chicago.

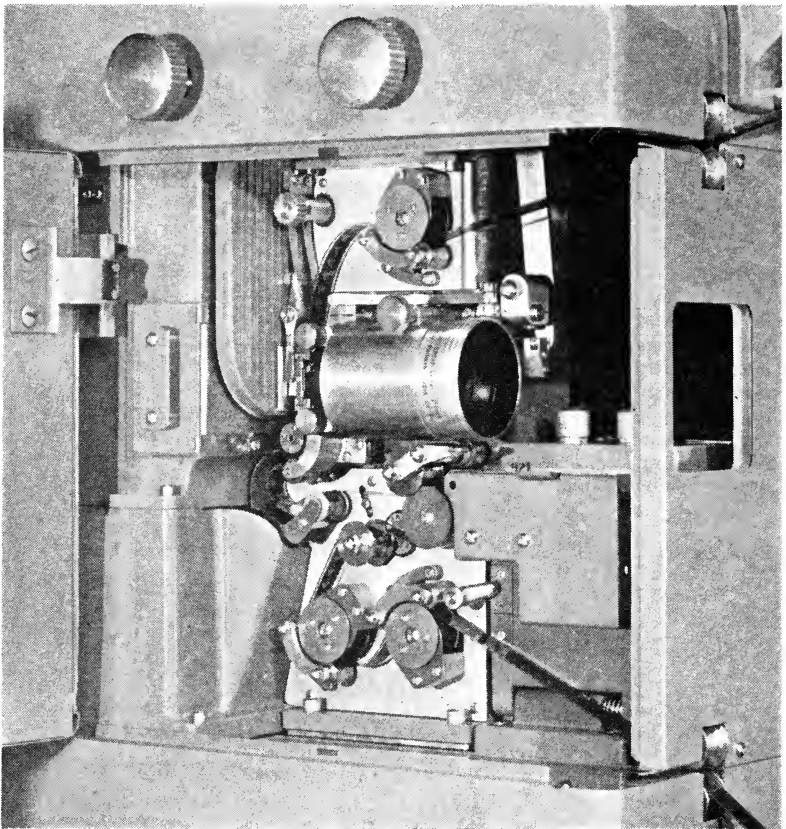

Fig. 1. Film threading path.

Electrical Linkage. A study of the problems of wear, noise, and flutter suggested that much might be gained in designing the mechanical system primarily to control the occurrence and magnitude of extraneous forces that give rise to these three troubles. Movement of the film intermittently in the gate requires a mechanism that has inherently high accelerations. The forces generated are proportional to the masses that are accelerated, and their effect is felt in all the mechanism connected to the intermittent. The intermittent disturbances can be kept out of the other sections of the mechanism by filtering, just as flutter is reduced in conventional projectors.

While the projector is running, there is no other acceleration. If, then, the intermittent is isolated and driven separately, the remainder of the mechanism is protected from these disturbances.

Also, the system, including the shutter and the sprockets, can be designed for a minimum of flutter, flicker, noise and wear. The Model 25 is so divided, each unit having its own motor. The sprocket-shutter mechanism, contained by the main casting, is driven by a four-pole 1800-rpm synchronous motor, which has its rotor mounted on the top end of a vertical shaft. For the intermittent mechanism, a special synchronous motor having a speed of 1440-rpm is provided.

Since the intermittent is separated from the shutter, some means of exact phasing is necessary. To provide this phasing, two special synchro-gears mesh in the usual way during starting, but as the motors pull into synchronism, their teeth float clear of each other. This clearance is provided by removal of alternate teeth from conventional gears. To assure proper contact of the teeth, each of these gears is made of two such cutaway gears assembled side by side with the teeth of one opposite the spaces of the other.

This principle of isolation of mechanical systems by electrical linkage is carried further by the use of three additional motors to drive the take-up spindle, the rewind spindle, and the blower. Each motor is chosen specifically for the particular job it has to do.

Figure 1 shows the positions of the sprockets, gate and shutter housing. Figure 2 reveals the intermittent system complete with its motor and synchro-gear. In Fig. 3 we see this system assembled to the sprocket-shutter mechanism. This rear view shows the motor for the intermittent and its synchro-gear in mesh with an identical gear on the sprocket-shutter mechanism. In order to show these parts, the flywheel for the sound system was removed.

Pulldown System. The pulldown mechanism comprises an intermittent sprocket assembly housed in a separate casting and driven directly by the specially designed 1440-rpm synchronous motor.

Various means of driving the intermittent sprocket, including a "drunken" screw, were considered. However, the geneva star was found to be the most desirable. Here the star does not conform strictly with conventional motion picture practice, because it has eight positions instead of the usual four. A four-frame sprocket would be far too small for 16-mm work, and an eight-frame size seemed the best compromise with respect to the mass of the sprocket and the acceleration in the drive. Basically the driving angle of an eight-position geneva movement is 135 deg, but in this projector, it is accelerated to 57 deg by an off-center driving system. In order to keep bearing loads within reason, we divided this acceleration between two off center driving elements arranged in series, as shown in the skele-

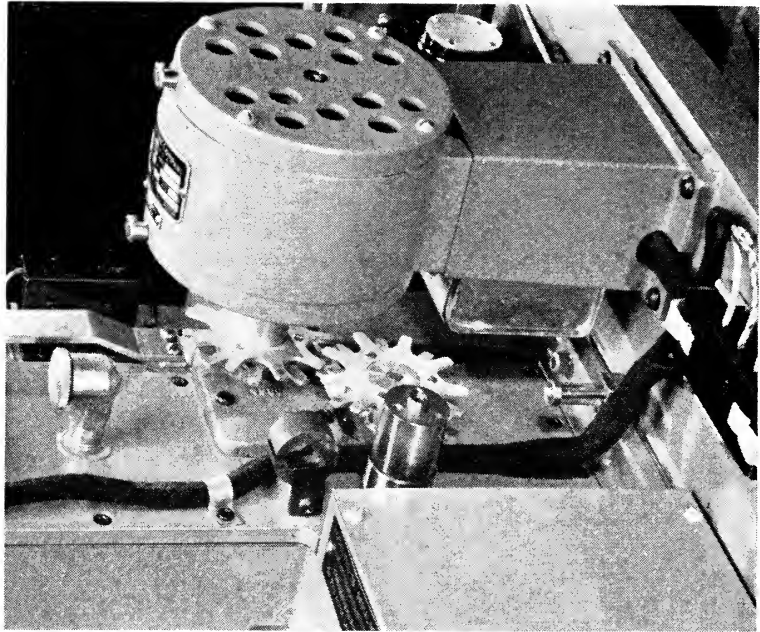

Fig. 3. Assembly of intermittent motor to main mechanism

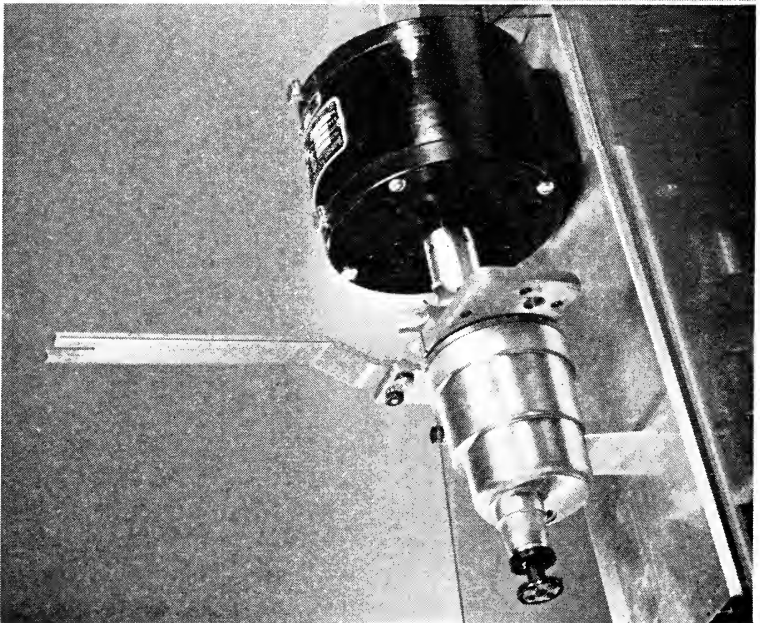

Fig. 2. Intermittent system.

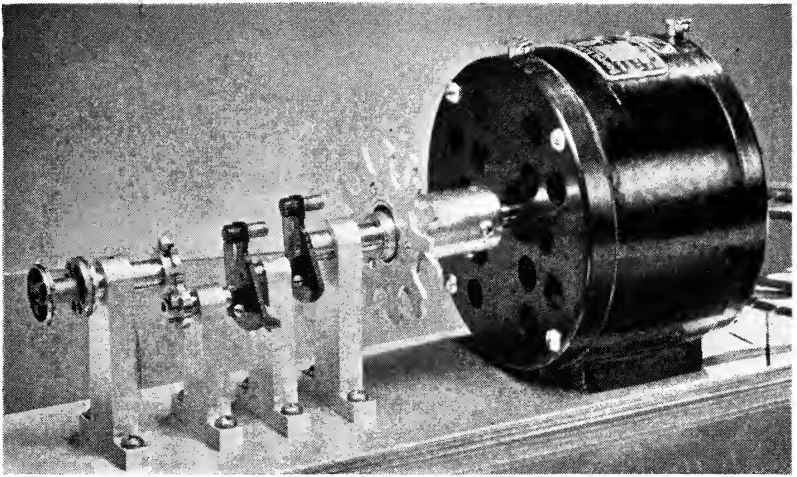

Fig. 4. Skeleton of intermittent system.

ton system (Fig. 4). Viewing from left to right, we see the sprocket, the geneva and its driver, the two balanced accelerators, the synchro-gear and the motor. Inside the hub of the synchro-gear, there is a coiled-spring flexible coupling that has an important function. With this system substituted for a more rigid coupling, there is a material improvement in the quietness of the action. It would be expected that such a flexing element would increase the time required for the pulldown action. However, the oscillating system formed by the spring coupling and the moment of inertia of its load may be tuned to produce the normal 57-deg pulldown. In a model of the projector adapted to television, this tuning is adjusted to produce an action somewhat less than 50 deg.

The intermittent assembly is fitted with two mounting trunnions that are concentric with the sprocket. Thus the unit can be rotated for framing by means of the lever shown in Fig. 2. This lever engages an eccentric on a shaft that extends to an external knob.

Because of the precipitous change from positive to negative acceleration, which is characteristic of the geneva movement, any gears with their necessary backlash in the drive train would be subjected to shock forces. Furthermore, the oscillatory nature of the drive through the flexible coupling would aggravate this trouble, but the use of the 1440-rpm motor eliminates the gearing that would otherwise be needed, thus precluding its troublesome backlash. Two of the three remaining elements that could introduce backlash are the slots and splines of the accelerators. Since they have an

appreciable area of contact, which is not possible with gears, the film of oil between them effectively cushions these forces. Thus a quiet, durable mechanism is obtained. The third element is the pin of the geneva movement. This is made with high precision and has also the benefit of the oil bath.

The 1440-Rpm Motor. The rotor of this motor has five poles. The stator has four poles, each wound in one-fifth of the circumference. At a given instant, the motor is polarized as shown on the right of Fig. 5. In a conventional motor, such as the one at the left in Fig. 5, once synchronous speed is achieved, the poles of the rotor maintain the same polarity unless the motor is overloaded. In this new motor, also, each pole of the rotor maintains the same polarity as it passes the four poles of the stator. But as it passes the open position in the stator, it "loses step" and is forced into a reversal of polarity as it faces the next stator pole. The time required to pass the four poles is $\frac{4}{120}$ sec, the same as required for one revolution of a conventional 1800-rpm motor. However, the rotor has turned but $\frac{4}{5}$ of a revolution during this time. Thus its speed is 1440 rpm.

Sprocket-Shutter System. Ordinarily, the hunting characteristics of synchronous motors cause excessively large shock forces in gearing when parts, such as a shutter, having large moments of inertia are included in the mechanism. This condition, much as in the case of the intermittent, would cause noise, rapid wear of the gears, and flutter in the sound system. In this projector, a protection is

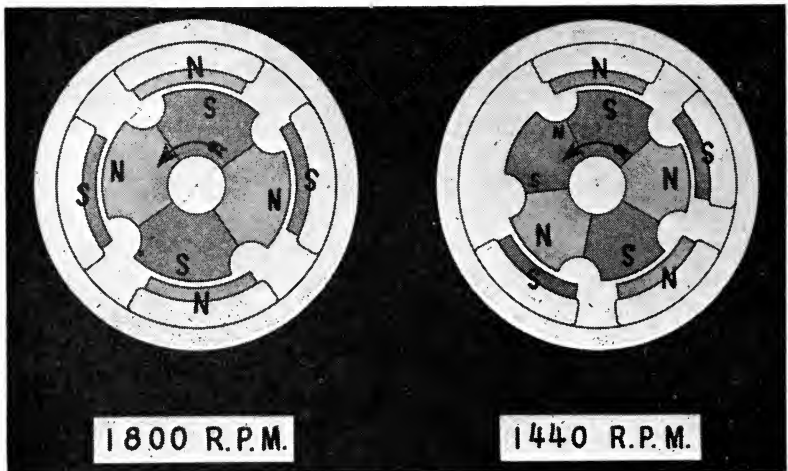

Fig. 5. Diagram to show 1440-rpm motor action.

afforded by a spring coupling between the shutter and its shaft. Thus the reaction torque is reduced, and the hunting of the motor is suppressed. The single-bladed shutter runs at 2880 rpm to give two interruptions of the light per frame of film. It was placed as near the gate as possible in order to provide the minimum angle for covering the light beam.

All three continuous sprockets feed twelve frames of film per revolution. The film is guided with minimum side clearance through these sprockets. They are provided with separate, spring-actuated rear flanges that permit free passage of splices that are not aligned perfectly laterally. All sprockets are of hardened steel.

The problem of meeting all requirements in constructing the gate is perhaps the most difficult in designing any projector. It always seems necessary to make some compromises. We use projection lenses that will resolve at least 90 lines/mm over the whole frame if the film is flat. These lenses were described by W. E. Schade¹ at the Fall 1949 meeting of SMPE. However it is a problem of long standing to hold a film flat against its normal curl and against the thermal distortions caused by the light beam. Here a compromise has been made in curving the gate to a radius of 3 in. When the focus is adjusted to obtain the best average definition for the center and the edges of the screen, a dynamic resolution of 60 lines/mm is obtained. This curved construction also insures against scratching of the film, caused by contact between the gate and the picture and sound areas of the film. For threading, the gate is moved forward with the lens, and it returns to position with the focus of the lens undisturbed. As in framing, focusing is controlled by a knob on the outside of the case. The pivots of this linkage are spring-loaded to take out backlash, and the knob is provided with a lock. Four sapphire pads are used for side-guiding the film.

General Structure. The lamphouse is mounted on a casting that encloses the blower, which is mounted directly on the shaft of a 1725-rpm induction motor. This assembly is mounted on a base casting, as are the assemblies containing the intermittent motor, the main mechanism, and the pre-amplifier. An enclosing case is carried by the same casting. The supply arm mounted on the case completes the projection-head assembly. This whole combination is supported on a pedestal-cabinet that places the projector the correct distance from the floor. This is shown in Fig. 6, which shows the projector adapted for arc illumination. If the arc lamphouse and the rectifier are covered, the appearance is that of the tungsten model.

A platform pivoted about a hinge pin at the top rear edge of the

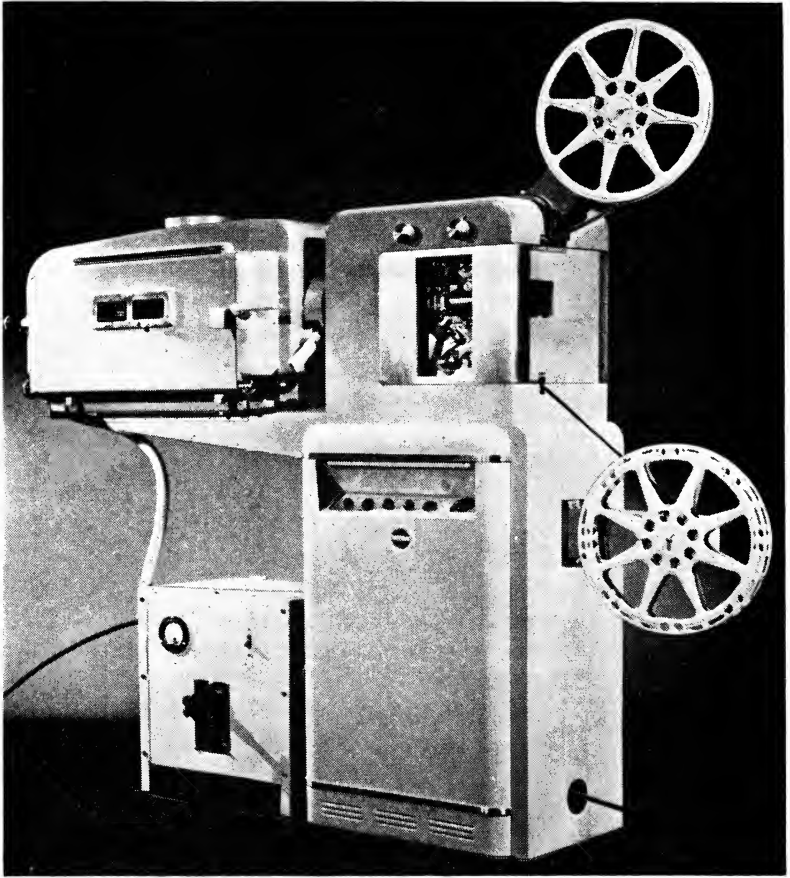

Fig. 6. Complete arc model of projector.

pedestal holds the projection head. It can be tilted, by means of a jackscrew inside the front of the pedestal, for projection to a screen located above or below a horizontal plane through the lens. Two positions for the hinge pin provide two ranges of tilt. The pedestal also supports the take-up arm.

Tungsten Illuminating System. A base-up, 1000-w, 10-hr lamp with an improved basing ring is used. This new method provides more accurate alignment of the filaments, better candle-power maintenance, and improved ventilation. A dual lamp support, Fig. 7, permits rapid replacement of a burned-out lamp. Without stopping the projector, the operator can quickly swing out the old lamp and move a new one into place by means of the lever shown. Then the

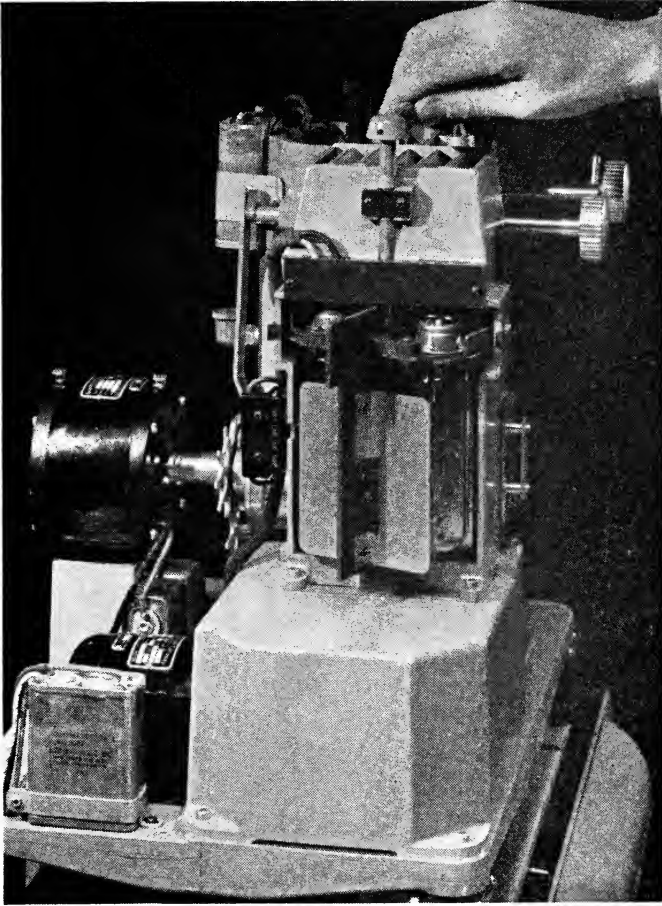

Fig. 7. Turret holder for tungsten lamps.

defective lamp can easily be removed from the top for replacement. A specially designed condenser provides the $f/1.5$ cone of light needed for the objective lenses.

Arc Illuminating System. For arc illumination, the tilting platform is replaced by one that is extended to carry the lamphouse for the arc. Of special design and styling, this arc lamp is made by the Strong Electric Co. A condenser that supplements the mirror is placed in the same position as the condenser for the tungsten lamp. A heat filter located immediately in front of the lamphouse is essential for black-and-white film, but it can be swung out of position for color film.

The Sound System. Three rather distinct functions characterize a sound system. First, the film must be moved with a high degree of uniformity of motion and in a precise location past a scanning position. Second, the film must be scanned with a light beam of proper dimensions. Third, the modulated light from the film must be converted into a modulated electrical signal, and this signal must be amplified for reproduction.

From the foregoing discussion, it will be seen that particular pains have been taken to meet the first requirement, in that the film-driving mechanism was designed as an inherently flutter-free system. It is isolated completely from disturbances originating in the intermittent movement, and the spring coupling for the shutter minimizes the effect of hunting in the motor. Other features provided to meet the requirement include the following: the linkage between the motor and the sound sprocket is through a single-stage worm and worm wheel; the ball bearings carrying the sound drum shaft are mounted in a quill to assure optimum alignment; and the sound sprocket is designed after Chandler² to minimize flutter arising from a lack of match in pitch between the sprocket and film. Thus the system is designed throughout for a minimum of flutter.

Between the sound drum and the sound sprocket the film passes over an idler mounted on a spring-held arm. The oscillation of this arm is viscously damped by a film of silicon fluid. Tension in the loop is provided by an eddy-current drag between an aluminum disc on the flywheel and a fixed permanent magnet. A separate take-up sprocket provides a free loop on the other side of the sound sprocket in order to keep the functioning of the sprocket constant as it feeds the film from the sound loop, and to protect the sound loop from disturbances originating in the take-up.

The "slitless"-type sound reproducer is essentially as described by McLeod and Altman.³ An image of the filament of the exciter lamp is formed on the film. An intermediate image formed by a special curved cylindrical element is free of filament character. It is 0.05 of the width of the source, is curved toward the objective, and is limited in length by a suitable field stop. This intermediate image, in turn, is focused on the film, at a further reduction of 3 to 1 by a highly corrected microscope objective, as a flat image that is uniform in width and in light intensity throughout its length.

The last point is necessary in order to reproduce variable-area tracks at reasonably low distortion values. Also, the level of illumination must be sufficient to give a high signal-to-noise ratio. Our measurements of distortion are in terms of intermodulation obtained

with especially prepared, variable-area test films. Since it is difficult to evaluate the width of the slit by straight optical methods, the equivalent value is derived from the amount of attenuation of the high frequencies on SMPTE 16-Mm Multifrequency Test Film. The reference level for noise measurements is obtained from the SMPTE 400-Cycle Signal-Level Test Film.

It is well known that the reproduction characteristics of commercially produced 16-mm films vary over a wide range. In the absence of precision projection equipment, it has been difficult to demonstrate the ultimate quality of either picture or sound. This projector is designed for best reproduction of films made according to

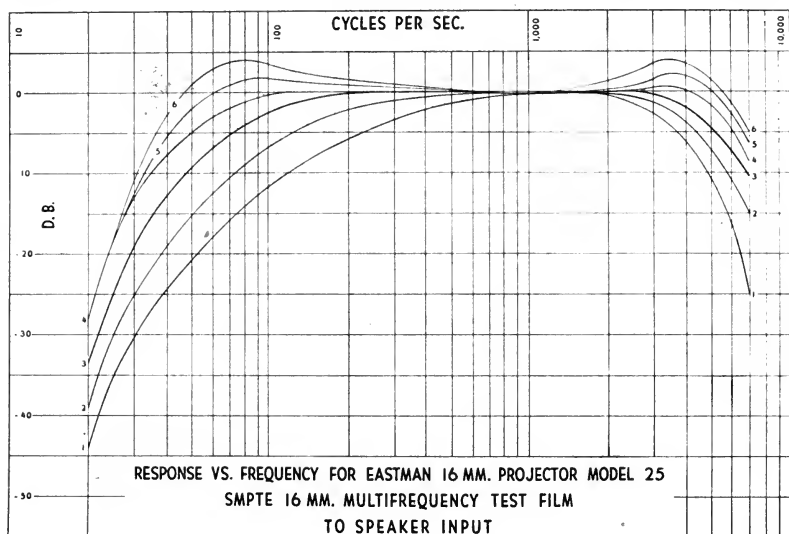

Fig. 8. Response versus frequency curves.

the most advanced production practice. At the same time, it is necessary to handle the full range of quality encountered in films coming from current production. Added to this is the problem of the great variations in listening conditions encountered in 16-mm operation. A wide range of equalization to meet these conditions is provided by step-switch controls on both the low and high frequencies. The curves for these steps shown in Fig. 8 represent the response from SMPTE 16-Mm Multifrequency Test Film.

Electronic System. The electronic system is divided between a pre-amplifier on the projector head and an assembly mounted in the pedestal, with controls as shown in Fig. 6. In the latter assembly,

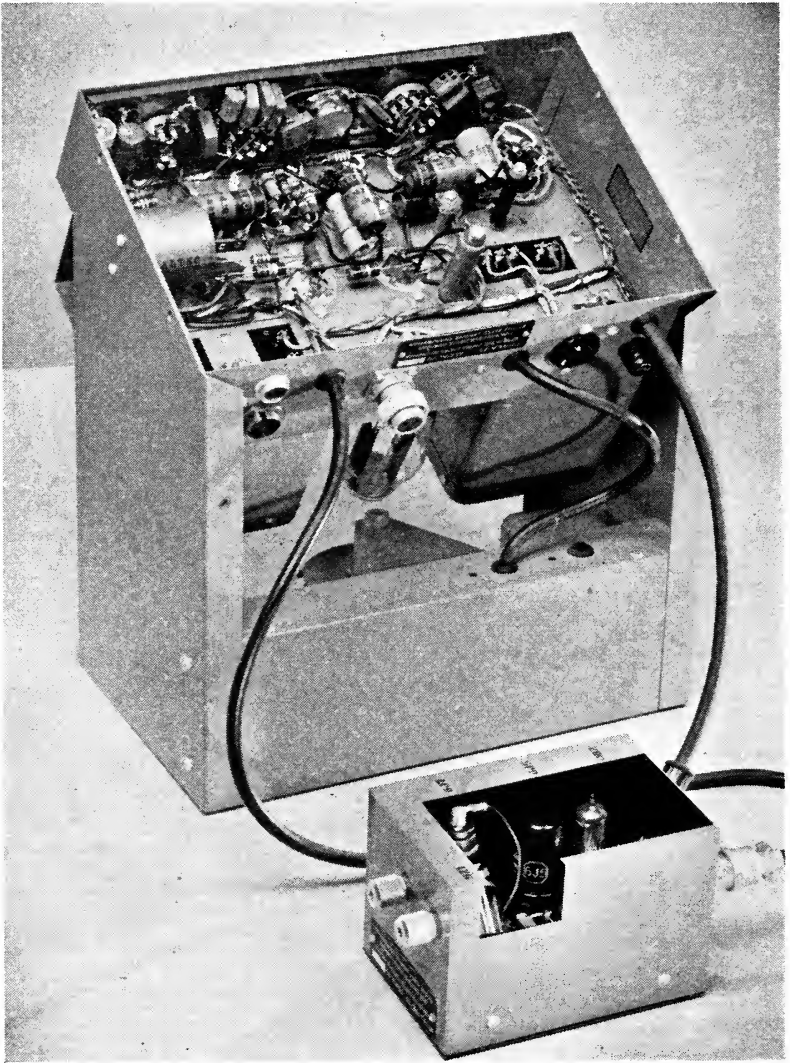

Fig. 9. Amplifier and power supply system.

there is the main amplifier and a d-c power supply for the exciter lamp and the heaters in the pre-amplifier. Figure 9 shows the complete electronic system dismantled and open for servicing. This equipment was engineered in cooperation with the Altec Lansing Corp. and is manufactured by them. It is designed primarily to drive their 604B or 800 loudspeaker. The 604B is supplied in a special

cabinet styled to match the projector, but the 800 is their standard, unmodified speaker. Altec Service Corp. will supervise the installation of the equipment and offer their facilities for servicing it.

Controls. The main power switch connects the system in the following sequence:

1. All circuits are off, but it is possible to energize the rewind circuit by means of the lever on the take-up arm.
2. Blower, rewind, and take-up are on, the last two at reduced voltage, as described below.
3. Blower, take-up at full voltage, and the two motors for the mechanism are on.
4. To point 3 is added the projection lamp for full operation.

After the projector is threaded and the switch is set on position 2, the torque motors located in the two arms are operated at reduced voltage to take up all slack film and pull it gently against the sprockets. This part of the threading, therefore, is assured before projection is started. At the take-up, this elimination of the slack minimizes the possibility of damaging the film as it tightens. At the supply spindle it serves the same purpose, and it also prevents overrunning of the supply reel. Both the torque and the speed of the take-up are adjusted to accommodate a minimum reel-hub diameter of $4\frac{5}{8}$ in. Operation of the lever on the take-up arm disengages the take-up motor and puts full voltage on the rewind motor in the upper arm.

Lubrication. Lubrication of the intermittent is by an enclosed splash bath, while the shutter-sprocket mechanism is flooded with oil from an impeller pump on the bottom of the vertical shaft. Ball bearings are used whenever feasible, and all other bearings are designed for infrequent attention.

SPECIFICATIONS

PICTURE

Lenses: Focal lengths of 2, $2\frac{1}{4}$, $2\frac{5}{8}$, and 3 in. All luminized and all $f/1.5$.

Resolution of lens: At least 90 lines/mm over a flat field.

Dynamic Resolution: 60 lines/mm.

Light Source: Tungsten 1000-w, 10-hr lamp,

Improved base-up mounting,

Arc, 46-amp, nonrotating, positive, high-intensity, with 7-mm positive, and 6-mm negative copper-coated carbons,

11-in. mirror with supplementary condenser lens. Carbon trim for 80 min.

Shutter transmission: 60% with two interruptions per frame.

Illumination: Shutter running, no film;

Tungsten: 450 lm;

Arc: With heat glass for black-and-white film, 2000 lm;

Without heat glass for color film, 2500 lm;

Steadiness: Horizontal unsteadiness less than 0.00025 in.,

Vertical unsteadiness less than 0.0005 in.

SOUND

Flutter: Less than 0.2% rms.

Equivalent Slit Width: 0.0003 in.

Intermodulation Distortion: 5% including scanning beam and amplifiers.

Signal-to-Noise Ratio: 55 db, using SMPTE 400-Cycle Signal-Level Test Film.

GENERAL

Elevation: 10 deg above horizontal, 17 deg below horizontal.

<i>Weights:</i> Projection head	90 lb,
Pedestal with amplifier	165 lb,
Complete tungsten model	255 lb,
Complete arc model with rectifier	640 lb.

Dual Projection: Common amplifier and instantaneous change-over device.

CONCLUSION

The ultimate technical possibilities of 16-mm cinematography are far from being realized. But as each step of forward progress is made, we can see that the potential uses of more highly developed equipment and processes are great indeed. By careful selection of films this projector will demonstrate the quality attainable in individual items such as picture definition, steadiness and sound resolution. At present it is seldom that one film has high quality in all these respects, largely because of the lack of adequate equipment at some point in the production of the film. However, much work is now being done, and the day may not be far off when 16-mm motion pictures come into their own for more serious semiprofessional and professional uses. We believe that this projector, in all functional respects, now raises the limits imposed by projection apparatus above those set by other equipment and processes. We offer it as a precise tool to be used in bringing to pass this day of realization for 16-mm motion pictures.

REFERENCES

1. W. E. Schade, "A new $f/1.5$ lens for professional 16-mm projectors," *Jour. SMPTE*, vol. 54, pp. 337-344, Mar. 1950.
2. J. S. Chandler, "Some theoretical considerations in the design of sprockets for continuous film movement," *Jour. SMPE*, vol. 37, pp. 164-176, Aug. 1941.
3. J. H. McLeod and F. E. Altman, "An optical system for the reproduction of sound from 35-mm film," *Jour. SMPE*, vol. 31, pp. 36-45, July 1938.

Interference Mirrors For Arc Projectors

By G. J. KOCH

DEVELOPMENT DEPT., CAMERA WORKS, EASTMAN KODAK CO.,
ROCHESTER, N.Y.

SUMMARY: A large fraction of the radiation from an arc lamp consists of infrared and ultraviolet energy. By coating the arc mirror blank with multilayer interference films instead of with silver, the major portion of the visible light can be reflected while most of the infrared and near ultraviolet radiation is transmitted. Hence, this type of mirror reduces film distortion caused by overheating, and because of the selective nature of the reflection, it affords a means of controlling the color quality of the illumination.

ONE OF THE BASIC PROBLEMS that must always be faced in the design of high-intensity projectors is the possibility of overheating and buckling the film. This difficulty is particularly acute in the case of motion picture film projected by arc lamp illumination, where a great deal of energy is concentrated on a small area of film. The customary approach to this problem is to absorb the troublesome infrared radiation with a heat-absorbing glass placed between the light source and the film.

Another approach to this problem is the use of multilayer interference filters to separate the visible light from the infrared and ultraviolet radiation. Interference filters designed to transmit visible light and reflect infrared and ultraviolet have proved useful, but their effectiveness is restricted by the limited band of infrared energy which they reflect. Hence, such filters are usually less efficient than heat-absorbing glasses. They are useful, however, as supplementary filters or in applications where high efficiency is not necessary and where breakage of heat-glass is a major problem.

Much more nearly complete separation of light and heat can be obtained if a multilayer filter is used in the inverse manner, that is, to reflect the light and transmit the infrared and ultraviolet radiation. The mirror in an arc lamphouse is particularly well suited for this purpose. If the mirror blank is coated with interference films instead of with silver, most of the visible light can be reflected, and most of the infrared and near ultraviolet radiation transmitted as illustrated in Fig. 1.

PRESENTED: April 24, 1950, at the SMPTE Convention in Chicago.

The interference films shown in the diagram consist of four to eleven layers of transparent or semitransparent materials of alternately high and low refractive index. There is a wide variety of materials, including dielectrics and semimetals, that have optical properties suitable for this purpose. Magnesium fluoride or sodium aluminum fluoride are the customary low-index materials, and zinc sulfide or titanium dioxide, the usual high-index materials. The thickness of the films is controlled so that visible light is reflected from each film in phase with the light reflected from the other films; hence, the combination produces high reflection. In general, however, for wavelengths outside the visible region, the component reflections are out of

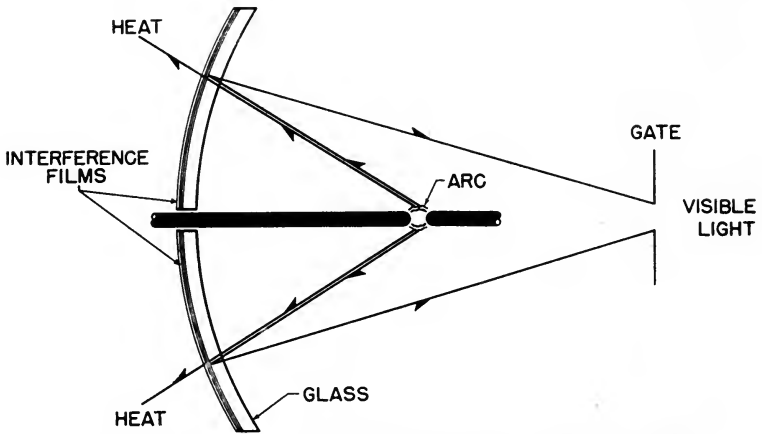

Fig. 1. Simplified diagram showing position of arc, mirror and gate.

phase, which results in low reflection and high transmission. Thus, the multilayer coating is a selective mirror that reflects visible light and transmits infrared and near ultraviolet radiation.

Figure 2 includes a curve showing the approximate reflectivity versus wavelength for an interference mirror of this type. A second curve showing approximately the spectral reflection of a silvered mirror is shown for comparison. It reveals the large reduction in reflection in the infrared and near ultraviolet parts of the spectrum secured with the interference mirror. In fact, for infrared and near ultraviolet radiation, the thin films act as low-reflection coatings, allowing those regions of the spectrum to pass through the mirror with little attenuation. But for visible light the films act as high-reflection coatings with a reflectivity equal to or greater than that of a silvered mirror.

The exact shape of the reflection-wavelength curve depends primarily on the following factors: the reflectivity at each film interface, the number of layers, the optical thickness of each layer relative to that of the other layers, the dispersion and absorption characteristics of the materials, and the angle of incidence of the light. The calculations involved in the design of efficient combinations are so formidable that graphical and analogue computing devices have proved most helpful.

The films are deposited on the glass mirror blank in a high-vacuum coating system. The procedure consists in successively evaporating

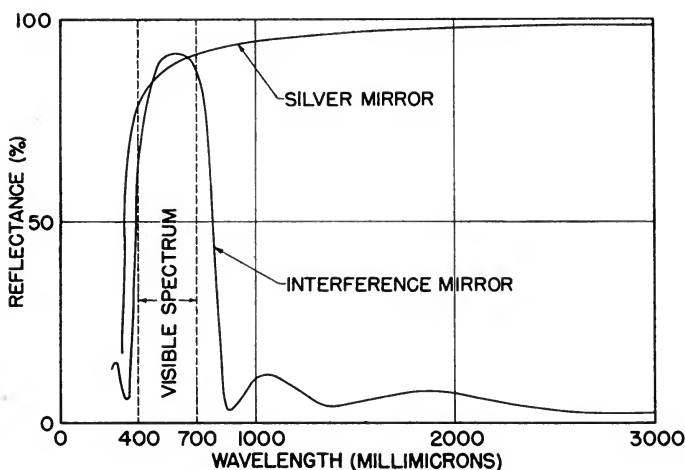

Fig. 2. The spectral reflectance of a multilayer interference film compared with that of a silver film.

the required number of layers on the glass blank, which rotates continuously in the high-vacuum chamber. Critical control of the thickness of each layer is obtained by the use of a photoelectric monitoring system that indicates the thickness of the material as it condenses on the glass. Successful mirrors have been made with the coatings on the front surface instead of the rear, but damaging of the multilayer films by the sputtering of the arc makes such mirrors less practicable. A high-temperature lacquer sprayed and baked on the films protects them from mechanical damage. It has been found that the lacquer actually improves the optical efficiency of the layers by increasing their transmission in the infrared region.

Although mirrors made in this way are still in the development stage the tests made on them have been very encouraging. Measurements

on the first arc lamp samples showed that the illumination at the gate contained more visible light and less total radiation than that obtained from a standard silvered mirror with light shade of Aklo heat-absorbing glass in the beam. Even the most efficient heat-absorbing glasses show a gradual decrease in transmission from wavelengths of 600 to 1000 millimicrons; hence they allow an appreciable amount of near infrared energy to reach the film. But interference mirrors are not limited by this fundamental absorption characteristic. Both calculations and experiments have shown that considerably sharper cuts can be obtained with interference reflectors than with silvered reflectors used with heat-absorbing glasses. In the ultraviolet region also, the decrease in reflection with wavelength is sharp but detailed measurements have not yet been made. Certainly the peak at 390 millimicrons in the arc emission curve is greatly reduced.

A second advantage of such mirrors is that they eliminate the problem of breakage of heat-glass. Since the interference films absorb little radiation, and since they are distributed over the large area of the mirror blank, they do not get nearly so hot as a heat-absorbing glass. Actually, the absorption of infrared by the glass mirror blank itself is largely responsible for the temperature rise observed.

Probably the most important advantage these mirrors have over a silvered mirror used with a heat-absorbing glass is the control that can be attained over the color quality of the light. By proper adjustment of the thickness of the interference layers, the color of the reflected light can be varied over a wide range. This factor is of major importance for the projection of color film. Our experimental arc mirrors for 16-mm projectors are coated so that light from a high-intensity arc is modified to give satisfactory color balance for the projection of Kodachrome film.

The development work on this type of mirror is still in the laboratory stage. Further details, such as life tests and more efficient combinations of layers, are being investigated. When these tests are complete we plan to try the coatings on 14-in. mirrors for tests in 35-mm arc projectors.

Engineering Committees

New Release Print Leader

In July, we prematurely announced the availability of a newly proposed release print leader. Contrary to expectations, the first prints were found unsatisfactory after trial at a few of the New York television stations; consequently, another version was made up and prints were distributed to all of the television networks in New York. On Friday, September 8, Charles Townsend's subcommittee met and approved this version for limited trial distribution. After consultation with Dr. Garman, Chairman of the parent committee, and Fred Bowditch, Engineering Vice-President, it was agreed to make up a fairly substantial quantity of both negatives and prints. All of those requesting samples as a result of the July announcement, as well as others known to have an interest in this project, have now been supplied.

There has been some concern among those responsible for this work that rather general distribution at this time may cause difficulties. It has been the hope from the start that one leader can be developed, which will serve the theater, television and the 16-mm fields equally as well. If the trial leaders now being distributed should get into general use, it would certainly mean the existence of two leaders and the possibility of considerable confusion; therefore, a letter was sent with each sample, requesting the recipients to use the leaders only for experimental purposes and to withhold any wider use until the committee has had an opportunity to review all comments.

Committee Ballots

During the last six months, members of Engineering Committees have been extremely lax about returning their ballots on proposed standards, recommendations or committee reports. Often when members feel that they have no comments or critical interest in a particular subject, they fail to take any action to notify Society headquarters to that effect. Consequently, the balloting is not closed because of the belief that the missing votes represent objections to a proposal. It is realized that in some cases committee members need time to make a thorough investigation before casting a formal ballot. In those cases, however, it would be most helpful if such were reported so as to save the time and money spent sending out repeated follow-ups.

At the present time, six engineering ballots are in process. One, "16-mm Review Room Characteristics," was mailed on May 29, 1950. The ballot was sent to 72 committee members and to date just half have been returned. This is a very poor response for a project that two years ago was considered important enough to warrant considerable activity. Listening tests and meetings were held in Astoria, New York City, Washington and Chicago. Equipment was shipped around and committee members spent time and money traveling to those sessions. After all of that time and effort, it is most unfortunate that the project should be held up merely because members neglect to vote.

Possibly, there is some fault in our method of operation which is causing the delays. If this is true, we would greatly appreciate your suggestions.

Book Reviews

Questions and Answers in Television Engineering, by Carter V. Rabinoff and Magdalena E. Walbrecht

Published (1950) by McGraw-Hill, 330 West 42d St., New York 18. 283 pp. + 2 pp. appendix + 16 pp. index. 175 illus. 6 × 9 in. Price \$4.50.

Although book lists today abound with volumes whose titles include "television," by far the majority deal with television receiver servicing or with the theory and design of receivers. Books which treat television as a many-faceted field, no part of which is more important than the other parts, are not common. This volume is such a work.

It is divided into twelve chapters: Antennas, Radiation, and Transmission Lines; R.F. and I.F. Amplifiers, Converters, and Oscillators; The Limiter, Clipper, Detector, and Sync Separator; Video Amplifiers; Deflection Systems; Cathode-Ray Tubes, Camera Tubes, and Photoelectric Cells; Images and Patterns; Optical Systems and Illumination; Transmitters; Standards, Laws, and Regulations; Receiver Principles, Filter Theory, and Power Supplies; and Analysis of Two Typical Receivers.

The book is intended as a reference source for those who are in the television field and as a "semi-textbook" for those who need to clarify and organize their knowledge. It is singularly successful in both roles, primarily because of the adoption and intelligent treatment of the question-and-answer technique. A writer whose object is simply to give an explanation of a certain rather wide subject too often tends to ramble, to lack organization, to use too many words, and to avoid being specific.

The authors here, however, have voluntarily bound themselves to the asking of the logical questions and to answering them specifically, succinctly and precisely. In this way, they have made each piece of information definitely useful in doing a certain job or in the study of a particular phenomenon or piece of equipment. They have paralleled the thoughts of the reader who uses the book for reference, for his reason for referring to the book in the first place is because he has a question in mind.

As a learning aid for readers who need to consolidate their knowledge the book is valuable because the questions have been chosen to carry the subject through in logical order. The reader who starts at the beginning of the book need not be an electronics specialist. He is introduced to the special character of v.h.f. propagation, the reasons for antenna design and the practical calculations, receiver inputs and other receiver circuits. The explanation of scanning methods leads into a discussion of cathode-ray tubes and photocells, which naturally carries forward to images and patterns. These three subjects are all linked with both transmission and reception. The next section, on optical systems and illumination, will be quickly understood by motion picture men and will make the pieces of the previous explanations fall into place neatly.

The section on transmitters is basic enough for instruction, but is also specific enough, with elementary calculations and figures to be of aid to the television specialist. Many of these questions, in fact, parallel those in FCC licence examinations, and may be used as review material for prospective examinees. In this section there is particular reference to the special applications of motion picture techniques to television.

The important definitions, FCC regulations, and standard practices in transmission are given in the standards section. The receiver section is devoted largely

to the points that do not ordinarily get full treatment, such as projection systems, filter configurations, and power supplies. The final chapter is a stage-by-stage breakdown of an RCA and a GE receiver from a design standpoint, with, in many questions, the interesting and instructive approach of asking the "why" of certain design provisions. The appendix contains additional information on proposed u.h.f. channels, metropolitan and community stations, interference ratios, allocations, power radiation regulations, and auxiliary (mobile pickup and relay) stations. The index is unusually complete and helpful.

This volume is not large enough to contain all the information that every reader might need at some time or other; but it is certainly a highly useful one to keep in any technical library, especially in conjunction with some of the more conventional books on receivers and other specialized divisions of the television field.—RICHARD H. DORF, Television Consultant, 255 W. 84th St., New York 24.

Réunions D'Opticiens, Tenues a Paris en Octobre 1946, Textes rassemblés par Pierre Fleury, André Maréchal et Mme. Claire Anglade, Institut d'Optique, Paris

Published (1950) by Editions de la Revue d'Optique, 165, Rue de Sèvres; 3 et 5, Boulevard Pasteur, Paris (15^e). xv + 673 pp. 6 × 9 in. Price on request.

This is a collection of 131 scientific papers presented by 109 authors at an international convention held in Paris in October, 1946. The volume contains numerous illustrations. It represents a summary of all modern research trends in the field of theoretical and applied optics.

The volume covers the following topics: basic theoretical studies, theory of aberrations, structure and perception of optical images, optical instruments, optical surfaces and materials, optical measurements, sources and receptors physiological optics and color, ophthalmological optics, spectroscopy, molecular optics, polarimetry, astronomical and atmospherical optics, and corpuscular optics.

While being of much interest to anyone interested in fundamental optical investigations, this volume is not intended as a textbook nor can it be used as such; and, of course, it is not an engineering manual. For this reason, a practical motion picture engineer will not find in this volume much that is of direct use to him, unless he wants to make himself acquainted with powerful new ideas and tools which at some future time may considerably influence motion picture art and engineering.—DR. K. PESTRECOV, Bausch & Lomb Optical Co., Rochester 2, N.Y.

Photographie Instantanée et Cinématographie Ultra-Rapide, par P. Fayolle et P. Naslin

Published (1950) by Editions de la Revue d'Optique, 165, Rue de Sèvres; 3 et 5, Boulevard Pasteur, Paris (15^e). Price on request.

Messrs. Fayolle and Naslin have undertaken to produce a text on high-speed photography, something that has been needed for a long time. There have been previous publications but they have generally covered only a small portion of the field. Tulpholme in his book, *Photography in Engineering*, discusses high-speed photography in one chapter. Other phases have been covered in *Lehrbuch der Ballistik* and in other numerous papers. Now, Messrs. Fayolle and Naslin have consolidated much of this lore in one text.

The summarization that they have given covering the optical problems of high-

speed photography is well done. The discussions of light sources and the various cameras which are in existence are good; and, for a text, to serve as a background in high-speed photography, it is invaluable today, if for no other reason than that no other such source exists.

There are, however, some exceptions to be taken to the text and your reviewer has written the authors that they have neglected many of the advances that have been made in the United States in the last two or three years, advances which have been described in the symposia on high-speed photography held by the Society of Motion Picture and Television Engineers. Such include the high pulse-rate Edgerton flash unit, the late advances in flashtube design by General Electric, the design of rotating prism cameras, and the development and use of high-speed motion picture cameras in this country. Furthermore, there is no reference to the incandescent lights which have been developed by General Electric for high-speed photography. Your reviewer might be a little biased but he feels that, if rotating prism cameras are discussed, then the two kinds that are manufactured in this country should be discussed rather than confining the description to one. Since the two cameras are about equally popular in this country, an impartial review should include discussions of both.

For those who are seriously interested in high-speed photography, it is felt that this book is a must. Ability to read French is not a requirement for understanding this book quite thoroughly.

It should be noted that the next major project of your Society's High-Speed Photography Committee is to produce an American textbook. Whether that will be chiefly the work of one man or the result of the efforts of the Committee as a whole is not yet established, but there will soon be a text in English in production.—JOHN H. WADDELL, Industrial and Technical Photographic Division Fastax Cameras, Wollensak Optical Co., Rochester 21, N. Y.

Letters to the Editor

Re: Light Measurement for Exposure Control

[The publication of a paper under this title by Don Norwood, May 1950 JOURNAL pp. 585-602, has elicited the following comments.]

I was very interested to read the above noted article, for my development of the Duplex Incident Light Exposure Meter Technique has meant that for the last three years or so I have been working on almost parallel lines.

Before noting some further developments, I hope you will permit me to correct Mr. Norwood's statement on p. 595, in which he claims that his "concept of *Effective Illumination*, which takes into account illumination intensity and relative positions of observer, subject and light source *has not heretofore been crystallized or formulated*" [the latter italics are mine]. In contradiction to this statement, reference may be made to the November 1948 *British Kinematography* containing my article "Exposure Technique for Reversal Materials," from which it may be noted that I described this effect (which I named the "Duplex" technique) over two years ago before a meeting of the British Kinematograph Society in London.

Since reading my paper in 1948, a slight improvement over my originally described "Horizontal Duplex" method has been developed. The new recommended "Direct Duplex" method, which has been worked out by my colleague L. C. Walshe and myself, still consists of taking two readings with an incident light meter (of the flat window type), namely a "camera direction" reading (as

previously recommended) and a "major source direction" reading (as originally recommended for use alone by P. C. Smethurst, who first introduced the incident light meter technique in England in 1936—see his paper in *British Kinematography*, vol. 1, no. 1).

The required exposure for average work is then given by simply taking the geometric mean of the two Duplex readings, i.e., the mid-point on the stop scale between the two readings. For clear-cut conditions this technique will be found to line up almost exactly with the exposure levels recommended by the principal reversal color film manufacturers, and it has proved to be highly successful in practice. It has, incidentally, already been fully described in a book on this subject which is in preparation and will be published in due course . . .

July 21, 1950

J. F. DUNN

1 Deneway, Bramhall
Cheshire, England

In comparison with Mr. Dunn's statement that he has been working on almost parallel lines for the last three years or so, I should note that my experience with incident light exposure meters date from 1933 when my first incident light exposure meter (of the hemisphere light-collector type) was constructed. That meter was rigorously tested for several years, and patent application was made in 1938 (U.S. Patent 2,214,283).

The principle involved in that meter took into precise account both light intensity and the geometric relationship of keylight, subject and camera, as described in the aforementioned paper.

Work on other types of incident light exposure meters, which are based on the same fundamental principle, has proceeded since that time. See: U.S. Pat. #2,489,664, application filed in 1946; and U.S. Pat. #2,444,464, application filed in 1947. Both applications were filed prior to the time when Mr. Dunn reports the beginning of his endeavors, circa 1947. Explanation was made on p. 585 of May 1950 JOURNAL, that evolving patent protection had made full release of basic data inadvisable until 1948, when the paper was written. The JOURNAL publication showed that the Society received the paper in February 1949.

It has been recognized that some workers in this field have had a more or less hazy realization that more was involved in incident light measurement for exposure control than a simple measurement of light intensity. Various corrective expedients have been proposed by some of these workers, such as pointing a meter with a plane surface light collector toward the camera from subject's position; pointing said meter toward principal light source; aiming said meter toward a point halfway between said light source and said camera; pointing meter at camera and at light source in turn and using a mean reading as suggested by Mr. Dunn. However, none of these makeshift methods appears to indicate a full and clear-cut realization of the basic principles involved in the matter. None of the experimenters have, to my knowledge, brought forth precise and comprehensive formulae such as those shown in (15) and (16) on p. 595 of the May JOURNAL.

I do not agree that Mr. Dunn in describing his Duplex Method in *British Kinematography* has given a clear-cut, well crystallized comprehension of all the factors involved, as well as a formula for accurate solution of the problem. For instance, his formula for calibration of incident light meters was preceded by a quite similar formula on p. 14-6 of the *I.E.S. Lighting Handbook*, published in 1947. Neither formula takes into account the vital factor of geometrical relationship of subject, camera and light source. If this relationship were understood it would seem that it would have been put into Mr. Dunn's formula.

It is of interest to examine under specific conditions Mr. Dunn's recommended method of operation. As an example, we find that Mr. Dunn's Direct Duplex Method would give identical exposure control settings for a *cross-lighted* arrangement (90° keylight angle), and a *back-lighted* arrangement (135° keylight angle), where other factors remain constant. Reference to instructions issued by leading color film manufacturers (see Note 5, my paper) will show that a considerable difference in exposure control setting is recommended for *cross-lighted* and *back-lighted* conditions. The difference is usually about one *f*-stop. It is generally believed that reversal color film will not tolerate an error of one *f*-stop. Therefore Mr. Dunn's "two-readings" method when used with color film under the common conditions described above will give errors which lie outside the acceptance latitude of the film. This also negates Mr. Dunn's statement (next to last paragraph in his letter) that his method lines up with recommendations of film manufacturers . . .

August 5, 1950

DON NORWOOD
1470 San Pasqual St.
Pasadena 5, Calif.

New Members

The following have been added to the Society's rolls since the list published last month. The designations of grades are the same as those in the 1950 MEMBERSHIP DIRECTORY:

Honorary (H) Fellow (F) Active (M) Associate (A) Student (S)

- Alaimo, James J.**, American Television Inst. Mail: 4652 N. Kenmore Ave., Chicago 40, Ill. (S)
- Anderson, A. Stephen**, Recording Technician, 949 Third Ave., New York 22, N.Y. (M)
- Band, Edward A.**, Television Engineer, National Broadcasting Co. Mail: 1317 Second Ave., New York 21, N.Y. (A)
- Benham, E. E.**, Television Engineer, KTTV, Inc. Mail: 5240 Beeman, North Hollywood, Calif. (A)
- Blackwell, L. H.**, Cinematograph Engineer, L. H. Blackwell & Co., 133 Empire Rd., Perivale, Greenford, Middlesex, England. (M)
- Brown, Robert J.**, American Television Inst. Mail: Arlington Trailer Ct., Arlington Heights, Ill. (S)
- Buckingham, William D.**, Engineer, Western Union Telegraph Co. Mail: 86 Post Lane, Southampton, Long Island, N.Y. (M)
- Casterlin, Charles C.**, Head Paying-Receiving Teller, Hamilton National Bank, Dupont Circle Branch. Mail: 3345 Stephenson Pl., N.W., Washington 15, D.C. (A)
- Chinn, Howard A.**, Chief Audio & Video Engineer, Columbia Broadcasting System, Inc. Mail: 6 Knollwood Rd., Tuckahoe, N.Y. (M)
- Creutz, John**, Radio Engineer, Old Dominion Dr., McLean, Va. (A)
- Davies, Hugh B.**, Sound Service Technician, Gaumont-Kalee Ltd. Mail: 6 Cornish Rd., Toronto, Ontario, Canada. (A)
- Davis, Harold C.**, American Television Inst. Mail: 1313 W. Grenshaw, Chicago, Ill. (S)
- Diebold, Jerome C.**, Executive Assistant, Wilding Picture Productions, Inc. Mail: 1345 Argyle St., Chicago, Ill. (M)
- du Preez, H. S. J.**, Technical Organizer, Karfo Films. Mail: 53 Sixth Ave., Melville, Johannesburg, South Africa. (M)
- Edey, Erwin**, Sound Timer, DeLuxe Laboratories, Inc. Mail: 15 Lindley Ave., Tenafly, N.J. (A)
- Faust, Roland J.**, Motion Picture Writer-Director, Indiana University. Mail: 2126 E. Seventh St., Bloomington, Ind. (M)
- Fegan, Albert A.**, Electronic Technician-Projectionist, U. S. Navy & Local Theaters. Mail: 17 W. Magnolia St., Stockton 3, Calif. (A)
- Foulds, Blair**, Commercial Engineering Manager, General Precision Lab., Inc., 63 Bedford Rd., Pleasantville, N.Y. (M)
- Gawel, Eugene W.**, American Television Inst. Mail: 8200 Brandon Ave., Chicago 17, Ill. (S)

- Giroux, George R., Jr.**, Television Assistant Director, KTTV, Inc. **Mail:** 800 N. Maple, Burbank, Calif. (A)
- Hicks, Willard L.**, Head, Engineering Photographic Dept., Burroughs Adding Machine Co. **Mail:** 4114 Larchmont Ave., Detroit 4, Mich. (M)
- Horn, James H.**, Sales, Ampro Corp. **Mail:** 140 Riverside Dr., New York 24, N.Y. (A)
- Jensen, Stanley E.**, Quality Control, Motion Picture Processing, Eastman Kodak Co. **Mail:** 3319 Greenbrier Dr., Dallas, Tex. (A)
- Johnson, James**, Sound Engineer, British Lion Studios. **Mail:** 18 Colbrook Ave., Hayes, Middlesex, England. (M)
- Johnson, Warner A.**, Development Engineer, Minneapolis Honeywell Regulator Co. **Mail:** 1322 S. Chicago, Freeport, Ill. (A)
- Johnston, Kenneth S.**, Theater Sound Inspector, Gaumont-Kalee Ltd. **Mail:** 140 Sunnyside Ave., Toronto, Ontario, Canada. (A)
- Kay, William**, Assistant Manager, 16-Mm. Motion Picture Exchange, Film Center, Inc. **Mail:** 3606 New England Ave., Chicago, Ill. (A)
- Kreuser, John A.**, Camera Designer, Bell & Howell Co. **Mail:** 3015 N. Nagle Ave., Chicago 34, Ill. (A)
- Lefkowitz, George**, RCA Institute. **Mail:** 592 Beech Terrace, Bronx 54, N.Y. (S)
- Lewis, Lawrence**, Projectionist, 20th Century Theatres. **Mail:** 8 Rossmore Rd., Toronto, Ontario, Canada. (A)
- McGill, Howard I.**, Sales & Engineering, Zack Radio Supply Co. **Mail:** 1426 Market St., San Francisco, Calif. (A)
- McNamee, Raymond J.**, American Television Inst. **Mail:** 4915 W. Lexington St., Chicago 44, Ill. (S)
- Mitchell, Wayne**, University of Southern California. **Mail:** 3520 South Hoover Blvd., Los Angeles 7, Calif. (S)
- Morrow, Donald J.**, Cameraman-Director, Educational Film Lab., c/o U. S. Indian School, Santa Fe, N.M. (A)
- Nelson, Charles R.**, American Television Inst. **Mail:** 4906 N. Kenmore Ave., Chicago, Ill. (S)
- Pacent, Louis G.**, President, Pacent Engineering Corp., 79 Madison Ave., New York 16, N.Y. (F)
- Pike, Donald E.**, Technical Director, National Broadcasting Co. **Mail:** 87 Garrabrant Ave., Bloomfield, N.J. (A)
- Porrett, Fred**, Motion Picture Cameraman, 106 Washington Place, New York 14, N.Y. (M)
- Rouzer, Danny**, Cameraman, Cine-Tele Productions. **Mail:** 7022 Melrose Ave., Hollywood 28, Calif. (A)
- Schofield, Henry J.**, Assistant Cameraman and Laboratory Technician, D'Andrea Films. **Mail:** 2511 West End Ave., Nashville, Tenn. (A)
- Schuchman, Nathan**, Television Cameraman, NBC-TV. **Mail:** 2137 Ocean Parkway, Brooklyn 23, N.Y. (A)
- Seeger, Edward W.**, American Television Inst. **Mail:** 418 Franklin Ave., River Forest, Ill. (S)
- Sidel, H. P.**, School Director and Writer, The School of Modern Photography. **Mail:** 410 E. 57 St., New York 22, N.Y. (M)
- Silverman, Samuel L.**, Purchasing Agent and Credit Manager, Precision Film Laboratories, Inc. **Mail:** 1844 E. Fourth St., Brooklyn 23, N.Y. (M)
- Smith, Fred S.**, American Television Inst. **Mail:** 4520 N. Hazel, Chicago 40, Ill. (S)
- Soltys, Richard J.**, University of Southern California. **Mail:** 1114 North Cedar St., Glendale 7, Calif. (S)
- Somers, Arthur A.**, Photographer, 3412 Superior Park Dr., Cleveland Heights, Ohio. (A)
- Stedman, Dean C.**, University of Southern California. **Mail:** P.O. Box 766, Cluster, S.D. (S)
- Swift, William C. G.**, Sound Engineer, Paramount Pictures Corp. **Mail:** 346 Richbell Rd., Mamaroneck, N.Y. (A)
- Taraba, Vilem**, Technical Manager, State Film Studios, Barrandov, Prague, Czechoslovakia. (A)
- Young, Charles W.**, Photographer, Pennsylvania State College Ordnance Research Laboratory. **Mail:** 643 Fairway Rd., State College, Pa. (A)
- Young, Keith D.**, University of Southern California. **Mail:** Willard Hall, 942 W. 34 St., Los Angeles 7, Calif. (S)

CHANGE OF GRADE

- Herold, Ralph E.**, Audio-Visual Coordinator, Los Angeles Public Library. **Mail:** 5069 Montezuma St., Los Angeles 42, Calif. (A) to (M)
- Morrison, Ernest W.**, Cameraman, U.S. Air Force, Lookout Maintenance Laboratory. **Mail:** 564 Larchmont Blvd., Los Angeles 4, Calif. (S) to (A)
- Thomas, John W.**, Radio and Sound Serviceman, 3736 South Michigan Ave., Chicago, Ill. (S) to (A)

CORRECTION

- Haines, Robert A.**, because of a copy-editing error, appears in the 1950 Membership Directory with an address (at St. Louis) which is out of date since 1946. The listing should be:
Haines, Robert A., Senior Engineer, FEC Motion Picture Service, SSS, GHQ, Far East Command, APO 500, c/o Postmaster, San Francisco, Calif. (A)

— New Products —

Further information concerning the material described below can be obtained by writing direct to the manufacturers. As in the case of technical papers, publication of these news items does not constitute endorsement of the manufacturer's statements nor of his products.



All-metal reflectors, made by combining two metals by electroplating, have a front surface protective coating of rhodium which is an element from the platinum family, exceptionally high in reflectivity and reported the only metal available with sufficient reflectance and able to withstand successfully the damaging effects of high-intensity carbon arcs. The manufacturer, Heyer-Shultz, Inc., Cedar Grove, N.J., reports that fabrication to close tolerances permits interchanging similar models made years apart, with a minimum of reflector adjustments by the projectionist.

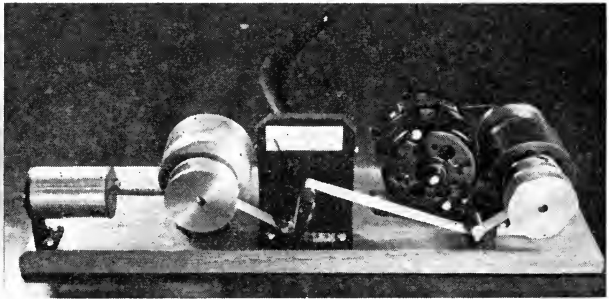

PM Hysteresis clutches and brakes were recently developed by Duncan & Bailey, Inc., 785 Hertel Ave., Buffalo, N.Y. They provide for smooth application of torque from conditions of 100% slip to zero slip or operate continuously at any slip or torque condition through a wide range of rotational speeds and power capacities. Bearing drag is the only load present when these devices operate in the unenergized conditions and the characteristics of power application depend upon the performance of the control mechanisms employed.

Torque bears a linear relation to control current and for instantaneous application of control power engagement is rapid but shock loads are absent and response time is generally proportional to control power impressed. A typical value for 30 w of applied control power and 100 oz-in. of torque is 100 milliseconds. A one-quarter horsepower unit operating at 1750 rpm has frequency response of 2 cycles per second.

Control current required is roughly one-tenth of the power output of the device when operated as a coupling. Type PM-3 using 25 w of control power will transmit 375 w at 3400 rpm.

With any of a wide variety of servo or external control systems, these units working as either transmitters or drag elements can be used to provide constant speed, torque, tension or repetitive cycling within performance limits of about

1%. Input rotational speeds up to 10,000 cycles are permissible as are rapid cycling operations, limited only by resulting rise in temperature. Design of the housing provides for sufficient heat dissipation and performance is within rated capacities as long as temperature rise does not exceed 300 F for continuous operation.

Illustrations show the external clutch housing and one constant tension application employing two units—one as a transmitter and one as a brake, actuated by a sensing device which responds to changes in diameter of the loaded feed spool. Detailed performance data and dimensions are available from the manufacturer who also designed the FM (fluid magnetic) clutch for specialized and somewhat less severe applications. Magnetic friction grab couplings for industrial applications with torque ratings of 80 in.-oz or 40 ft-lb are also available.

A special viewfinder ground glass for 35-mm motion picture cameras shows the portion of the scene most likely to be reproduced on a home television receiver. This pattern gives the cinematographer an accurate check of the average cut-off losses which must be allowed for in order to have a good visual presentation on television. The etched pattern is based on the first section

of the Society of Motion Picture and Television Engineers test film as described and illustrated in the February 1950, JOURNAL, p. 211. The striped area represents the section lost at the time of scanning in the television station. The inside rectangle is approximately 80% of the picture area. Tests indicate that this area is reasonably well reproduced on most home receivers. Television Ground Glass for the Mitchell camera etched with the television aperture is available directly from Greiner Glass Industries Co., 781 E. 142 St., New York 54. Television Ground Glass for other cameras is also available. Prices on request.

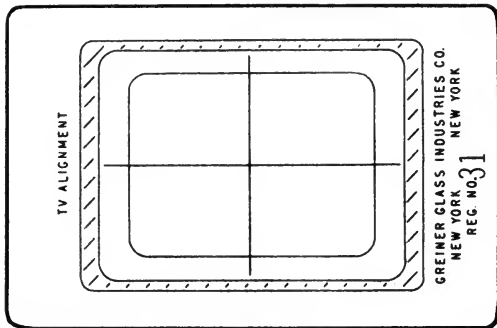

Ground Glass $\times 3$

SMPTE Officers and Committees: The Roster of Society Officers was published in the May JOURNAL. For Administrative Committees see pp. 515-518 of the April 1950 JOURNAL. The most recent roster of Engineering Committees is on pp. 337-340 of September 1950 JOURNAL.

Meetings of Other Societies

Audio Engineering Society, National Convention, Oct. 26-28, Hotel New Yorker, New York

Optical Society of America, Oct. 26-28, New York

Theatre Owners of America, Annual Convention, Oct. 30-Nov. 2, Shamrock Hotel, Houston, Texas

Acoustical Society of America, Fall Meeting, Nov. 9-11, Boston

Statement of the Ownership, Management, Circulation, *Etc.*, Required by the Act of Congress of August 24, 1912, as Amended by the Acts of March 3, 1933, and July 2, 1946, of *Journal of the Society of Motion Picture and Television Engineers*, published monthly at Easton, Pa., for October 1, 1950.

State of New York }
County of New York } ss.

Before me, a Notary Public in and for the State and county aforesaid, personally appeared Boyce Nemeč, who, having been duly sworn according to law, deposes and says that he is the Executive Secretary of the *Journal of the Society of Motion Picture and Television Engineers* and that the following is, to the best of his knowledge and belief, a true statement of the ownership, management (and if a daily, weekly, semiweekly, or triweekly newspaper, the circulation), *etc.*, of the aforesaid publication for the date shown in the above caption, required by the Act of August 24, 1912, as amended by the Acts of March 3, 1933, and July 2, 1946, embodied in section 537, Postal Laws and Regulations, printed on the reverse of this form, to wit:

1. That the names and addresses of the publisher, editor, managing editor, and business managers are:

Name of—

Post Office Address—

Publisher, Society of Motion Picture and Television Engineers, Inc., 342 Madison Ave., New York 17, N. Y.

Editor, Victor H. Allen, 342 Madison Ave., New York 17, N. Y.

Managing Editor, None.

Business Manager, Boyce Nemeč, 342 Madison Ave., New York 17, N. Y.

2. That the owner is: (If owned by a corporation, its name and address must be stated and also immediately thereunder the names and addresses of stockholders owning or holding one per cent or more of total amount of stock. If not owned by a corporation, the names and addresses of the individual owners must be given. If owned by a firm, company, or other unincorporated concern, its name and address, as well as those of each individual member, must be given.) Society of Motion Picture and Television Engineers, Inc., 342 Madison Ave., New York 17, N. Y.

Earl I. Sponable, President, 460 W. 54 St., New York 19, N. Y.

Robert M. Corbin, Secretary, 343 State St., Rochester 4, N. Y.

Frank E. Cahill, Jr., Treasurer, 321 W. 44 St., New York 18, N. Y.

No stockholders.

3. That the known bondholders, mortgagees, and other security holders owning or holding one per cent or more of total amount of bonds, mortgages, or other securities are: (If there are none, so state.)

None.

4. That the two paragraphs next above, giving the names of the owners, stockholders, and security holders, if any, contain not only the list of stockholders and security holders as they appear upon the books of the company but also, in cases where the stockholder or security holder appears upon the books of the company as trustee or in any other fiduciary relation, the name of the person or corporation for whom such trustee is acting, is given; also that the said two paragraphs contain statements embracing affiant's full knowledge and belief as to the circumstances and conditions under which stockholders and security holders who do not appear upon the books of the company as trustees, hold stock and securities in a capacity other than that of a bona fide owner; and this affiant has no reason to believe that any other person, association, or corporation has any interest direct or indirect in the said stock, bonds, or other securities than as so stated by him.

5. That the average number of copies of each issue of this publication sold or distributed, through the mails or otherwise, to paid subscribers during the twelve months preceding the date shown above is: (This information is required from daily, weekly, semiweekly, and triweekly newspapers only.)

BOYCE NEMEC, Exec. Secy., Business Manager.

Sworn to and subscribed before me this 21st day of September, 1950.

(Seal) Elisabeth J. Rubino
Notary Public, No. 41-3390800, Queens
County.

(My commission expires March 30, 1951)

Journal of the Society of Motion Picture and Television Engineers

VOLUME 55

NOVEMBER 1950

NUMBER 5

Synthetic Color-Forming Binders for Photographic Emulsions	
A. B. JENNINGS, W. A. STANTON and J. P. WEISS	455
An Improved Video System for Television Studios	NEWLAND F. SMITH 477
Infrared Photography with Electric-Flash	FREDERICK E. BARSTOW 485
Magnetic Sound Film Developments in Great Britain	O. K. KOLB 496
Improvements in Large-Screen Television Projection	T. M. C. LANCE 509
Trends of 16-Mm Projector Equipment in the Army	JAMES A. MOSES 525
Foreign Versions	VICTOR VOLMAR 536
A Progress Report of Engineering Committee Work	F. T. BOWDITCH 547
Biological Photographic Association	549
Current Literature	550
New Members	551
BOOK REVIEWS:	
<i>Photographic Optics</i> , by Allen R. Greenleaf	
Reviewed by Oscar W. Richards	552
<i>A Grammar of the Film</i> , by Raymond Spottiswoode	
Reviewed by Russell C. Holslag	553
New Products	554

ARTHUR C. DOWNES
Chairman
Board of Editors

VICTOR H. ALLEN
Editor

NORWOOD L. SIMMONS
Chairman
Papers Committee

Subscription to nonmembers, \$12.50 per annum; to members, \$6.25 per annum, included in their annual membership dues; single copies, \$1.50. Order from the Society's General Office. A discount of ten per cent is allowed to accredited agencies on orders for subscriptions and single copies. Published monthly at Easton, Pa., by the Society of Motion Picture and Television Engineers, Inc. Publication Office, 20th & Northampton Sts., Easton, Pa. General and Editorial Office, 342 Madison Ave., New York 17, N.Y. Entered as second-class matter January 15, 1930, at the Post Office at Easton, Pa., under the Act of March 3, 1879.

Copyright, 1950, by the Society of Motion Picture and Television Engineers, Inc. Permission to republish material from the JOURNAL must be obtained in writing from the General Office of the Society. Copyright under International Copyright Convention and Pan-American Convention. The Society is not responsible for statements of authors or contributors.

Society of Motion Picture and Television Engineers

342 MADISON AVENUE, NEW YORK 17, N.Y., TEL. MU 2-2185
BOYCE NEMEC, EXECUTIVE SECRETARY

OFFICERS

1949-1950

PRESIDENT
Earl I. Sponable
460 W. 54 St.
New York 19, N.Y.

PAST-PRESIDENT
Loren L. Ryder
5451 Marathon St.
Hollywood 38, Calif.

SECRETARY
Robert M. Corbin
343 State St.
Rochester 4, N.Y.

EXECUTIVE
VICE-PRESIDENT
Peter Mole
941 N. Sycamore Ave.
Hollywood 38, Calif.

EDITORIAL
VICE-PRESIDENT
Clyde R. Keith
120 Broadway
New York 5, N.Y.

CONVENTION
VICE-PRESIDENT
William C. Kunzmann
Box 6087
Cleveland 1, Ohio

1950-1951

ENGINEERING
VICE-PRESIDENT
Fred T. Bowditch
Box 6087
Cleveland 1, Ohio

TREASURER
Frank E. Cahill, Jr.
321 W. 44 St.
New York 18, N.Y.

FINANCIAL
VICE-PRESIDENT
Ralph B. Austrian
25 W. 54 St.
New York 19, N.Y.

Governors

1949-1950

Herbert Barnett
Manville Lane
Pleasantville, N.Y.

Kenneth F. Morgan
6601 Romaine St.
Los Angeles 38, Calif.

Norwood L. Simmons
6706 Santa Monica Blvd.
Hollywood 38, Calif.

Charles R. Daily
113 N. Laurel Ave.
Los Angeles 36, Calif.

John P. Livadary
4034 Cromwell Ave.
Los Angeles, Calif.

William B. Lodge
485 Madison Ave.
New York 22, N.Y.

1950-1951

Lorin D. Grignon
1427 Warnall Ave.
Los Angeles 24, Calif.

Paul J. Larsen
4313 Center St.
Chevy Chase, Md.

William H. Rivers
342 Madison Ave.
New York 17, N.Y.

1950

F. E. Carlson
Nela Park
Cleveland 12, Ohio

George W. Colburn
164 N. Wacker Dr.
Chicago 6, Ill.

Edmund A. Bertram
850 Tenth Ave.
New York 19, N.Y.

Malcolm G. Townsley
7100 McCormick Rd.
Chicago 45, Ill.

Edward S. Seeley
161 Sixth Ave.
New York 13, N.Y.

R. T. Van Niman
4441 Indianola Ave.
Indianapolis, Ind.

Synthetic Color-Forming Binders For Photographic Emulsions

BY A. B. JENNINGS, W. A. STANTON AND J. P. WEISS
TECHNICAL DIV., PHOTO PRODUCTS DEPT., E. I. DU PONT DE
NEMOURS & CO., INC., PARLIN, N.J.

SUMMARY: The development of synthetic color-forming binders and their application to photographic emulsions is discussed. These accomplishments have made possible the manufacture of a release positive color film designated Du Pont Type 275.* A résumé of some of the novel features of the stock is given and the utilization of the material as a color release medium is covered. Details of the printing and processing of both picture and sound records are given.

ONE OF THE WAYS of creating a dye image in proportion to the latent image in a photographic film is known as coupling color development.† It was disclosed originally by Rudolph Fischer¹ in 1912. In fact, in 1914, Fischer and Siegrist² published the results of a thorough study of the chemistry involved, and disclosed several classes of reactions that could be used and suggested various photographic elements utilizing them. Of these classes of reactions, those useful in the formation of the azomethine and indophenol‡ dyes involved in the process to be described later can be represented by the following equations:

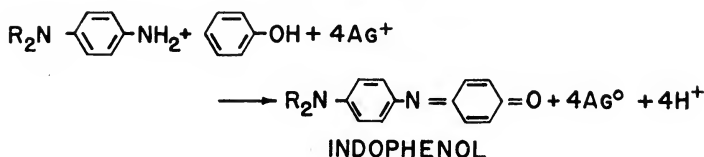
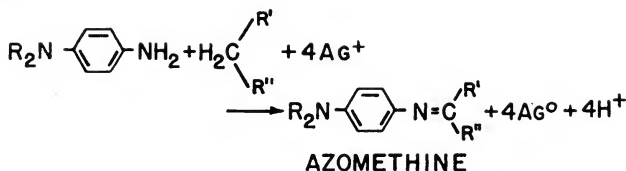

PRESENTED: October 11, 1949, at the SMPE Convention in Hollywood.

* The product on safety base is now designated Du Pont Type 875.

† It has also been called indirect color development, secondary color development, dye coupling development, and color-forming development.

‡ Properly called indoaniline dyes by the strictest chemical authorities, but almost always referred to as indophenol dyes in the photographic literature.

Although the exact mechanism of these reactions is still not completely understood, an oxidation product of the developing agent produced in the reduction of the exposed silver halide reacts in some way with the coupler to form the dye in direct proportion to the amount of silver formed. When the silver is removed, only the dye image remains.

In addition to comprehending the full possibilities of coupling color development, Fischer and Siegrist disclosed a broad picture of the various specific classes of developing agents and couplers that were applicable. Over the years this knowledge has been extended by numerous investigators.

DEVELOPMENT OF SYNTHETIC COLOR-FORMING BINDERS

Today there are commercial processes involving the application of the above reactions, for example, those in which the couplers are in developing solutions with the developing agent and those in which the couplers are in the emulsions. The former yields monochrome pictures readily, but three-color pictures only by rather complicated processing procedures. The latter readily yields three-color pictures, avoiding the cumbersome processing, provided the couplers are immobilized in their respective layers in the film. Such immobilization is necessary to avoid contamination of the various layers through wandering of the couplers.

The first solution to the coupler mobility problem came by placing substituents in the color coupler molecules in positions which did not affect the coupling power or quality. Although a reasonably high solubility in alkaline solutions was retained, these substituents increased the molecular dimensions of the couplers considerably and thus reduced the rate of diffusion from one layer to another to a tolerable amount. Such a system thus utilizes three chief components in its emulsions: (1) silver halide, (2) binder and (3) coupler.

The newest method devised for overcoming coupler mobility, and one that at the same time offers other advantages, is the use of synthetic binders for the photographic silver halides which are at the same time couplers. Such binders make possible the complete elimination of gelatin from emulsions useful for color photography. Since the color-forming groups are a part of the binder, the use of a third component in addition to the gelatin and silver halide of the basic black-and-white emulsions is not necessary.

CHEMICAL ASPECTS OF COUPLING COLOR DEVELOPMENT
WITH SYNTHETIC POLYMERIC BINDERS

It will be recalled from experience in the handling of black-and-white films that the development of the photographic image, unlike many familiar chemical reactions, is not an "instantaneous" process. This is because in addition to the time required for diffusion of the developer solution throughout the emulsion layer, the act of development itself is regarded as a surface reaction taking place at the interface of the emulsion grains and the liquid developer solution.

In coupling color development the situation becomes still more complex because a third reacting species, namely, the color coupler, is involved and because the developing agent itself, after becoming partially oxidized in the development step, must then undergo a second reaction with the color coupler. Before this second process can occur, however, it becomes necessary for the partially oxidized developer to move about in search of coupler molecules with which to react. It is because of this sequence of steps in the color coupling process that the dye deposits may not reside in the immediate locale of the developed grains of silver but rather in a diffuse cloud nearby. It has been noted earlier that Fischer's early work in this field had been extended with a variety of techniques for making monomeric color couplers immobile in emulsion layers. Under such circumstances, however, the bulk of the coupler may be situated at some distance from the silver halide grains, making it necessary for migration of the intermediate reaction products of the color developer to take place. As a consequence, reaction with coupler molecules may occur diffusely in the vicinity of the grain, rather than in a concentrated zone at the surface of the grain. Furthermore, during the migration of the partially oxidized developer molecules, secondary reactions may occur, thereby reducing still further the efficiency of the over-all process.

The utilization of chemically combined color coupling nuclei in a polymer molecule simplifies the process of coupling color development. Since the synthetic polymer is the sole emulsion binder in a given emulsion layer, and since the polymer contains an abundance of color coupler nuclei as part of its chemical structure, high efficiency in the process of color coupling is achieved. A practical consequence of achieving high efficiency in dye generation is an enhanced compactness of dye-image deposit as defined by the silver image itself. Definition and sharpness of image in three-color prints is apparent as a result.

THE APPLICATION OF SYNTHETIC COLOR-FORMING BINDERS TO COLOR PHOTOGRAPHY

The successful utilization of the principle of dual-purpose emulsion binders has resulted in the development of a new motion picture color positive stock designated Du Pont Type 275. As one would expect, the evolution of a photographic color process based entirely on the complete replacement of gelatin with synthetic polymers has involved a variety of complex research problems.

At the outset, it was necessary to undertake the chemical synthesis of polymeric materials having properties permitting their use in place of gelatin, the traditional photographic emulsion medium. Up to this time, no completely satisfactory non-gelatin materials had been developed, even for application in the black-and-white field. In addition to properties permitting their use as emulsion media, the further requirement was imposed upon the new polymers that they must function in the capacity of couplers for use in a process of color photography. Three different color-forming binders were in fact required, each capable of producing a different subtractive color component, yet having related qualifications for the other important role.

The complex chemistry of these new polymers, while a broad subject in itself, is being touched upon only briefly in this paper because of limitations of space. For those to whom this subject is of interest, further treatment is to be given elsewhere.*

Having produced synthetic color-forming binders, a second essential step leading to the construction of a color film product was the development of methods for making the emulsions and for coating the new materials. In a number of significant respects, the technology which emerged differs markedly from practices which have become conventional for gelatin systems.

The new synthetic color-forming binders, in general, satisfy the exacting requirements for the medium in which the photographic silver halide is suspended. These requirements have been generalized by Mees³ as follows: "It must keep the emulsion grains perfectly dispersed to eliminate clumping and consequent granularity of the photographic image; it must be stable for a long period of time, so that both the undeveloped and the processed emulsion are reasonably permanent; it must impart no undesirable photographic characteristics to the emulsion grains; it must be such that it can be handled in a relatively simple and yet accurately reproducible manner, so that emulsions can be made and coated by practicable procedures; and,

* This portion of the work has been carried out mainly in the Experimental Station Laboratories of the Chemical Dept., Wilmington, Del.

finally, it must allow the penetration of processing solutions without impairment to its strength, toughness, and permanence after the processing operations are completed."

While a number of synthetic binders, including polyvinyl alcohol, have been studied as replacements for gelatin, those which have proven practical for color emulsions are acetals of polyvinyl alcohol. Commercial methods have been developed for the manufacture of those selected for use. The coupling and other groups introduced by acetalization modify the properties of the parent polyvinyl alcohol to the extent that practical binders result. A typical structural unit for a synthetic color-forming polyvinyl acetal binder can be represented:

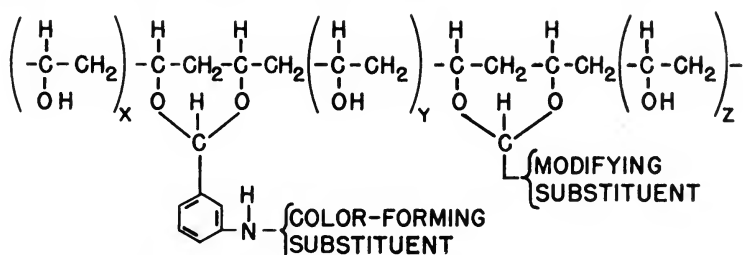

It is to be kept in mind that any coupling nucleus and developing agent that gives a dye of suitable color characteristics can be chosen, since mobility of the couplers and solubility of the final dye is not a problem. Also, while the coupling groups are very close to the site of the development reactions, the rate of reactivity is influenced by the coupling nucleus; so that this factor remains important in their selection. This latter is particularly important in multilayer structures where lower layers are less accessible to processing solutions than the upper layers.

Although the new technique quite nicely avoids some of the problems previously involved in coupling color development, it introduces new problems in the manufacture of photographic products. Gelatin, although having certain disadvantages, has some properties very useful to the photographic emulsion maker. These are its ability to form thermally reversible gels at convenient temperatures, and its contribution to the establishment of suitable photographic properties. So far, it has been difficult to synthesize binders that combine these properties so that, if the step were desirable for some other reason, the synthetic binder could be substituted directly for gelatin. Nevertheless, it has been possible to devise a technology for making and handling photographic emulsions and films utilizing the polyvinyl acetal color-forming binders.

In the making of a photographic emulsion the first step establishes the physical characteristics of the silver halide grains. This involves precipitation of silver halides in the presence of the binder, or part of it, and changing the size distribution of the grains by an operation in which the larger grains grow at the expense of the smaller ones.

It is next necessary to wash the emulsion to remove soluble reaction products of the first step which cannot be tolerated in the finished film. The reaction involved in the precipitation can be very generally stated as being silver nitrate plus alkali metal halide yielding silver halide and alkali metal nitrate:

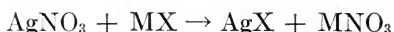

where the alkali metal nitrate (MNO_3) represents the reaction product which must be removed. In gelatin technology it is the custom to chill the emulsion so that it forms a firm gel and in this state reduce it to small pieces by physical means, thereby increasing the amount of surface. The small pieces can then be leached with cold water to remove the undesirable reaction products which are extremely soluble in comparison to the silver halides. Since the new synthetic color-forming binders do not readily form gels in the manner of gelatin, it has been found convenient to devise chemical procedures for precipitating the emulsions and washing them.

In addition to being a necessary step in the handling of gelatin emulsions, the maintenance of the emulsions in the chilled state is necessary to slow down the rate of decomposition of the gelatin, which is a material so susceptible to putrefaction under some conditions that preservatives in addition to the chilling are required to make the procedures practicable. The new synthetic color-forming binders are by their chemical nature free of this difficulty.

After removal of the undesired by-products, the emulsion is ready for its final treatments before coating. With gelatin emulsions the washed pieces are melted by the application of heat before proceeding with the finishing treatments. With the new synthetics, the washed emulsion is simply redissolved. The actual finishing operations themselves, including extra-sensitizing procedures, addition of sensitizing dyes where needed, adjustment of $p\text{H}$, addition of wetting agents, etc., are strictly comparable for the two systems.

In the coating and drying operations necessary for applying the finished emulsions to film base, the differences between the two systems are again very apparent. With gelatin emulsions, the applied layer is chilled immediately after coating to form a firm gel and gradually dried from this gel state. The solidification procedure is

necessary to prevent flowing of the thin layers with formation of an uneven and nonuniform coating. With the new synthetic color-forming binders, chemical procedures have been devised for coagulating the emulsion to a nonfluid state before drying begins. This has been accomplished by treating the base suitably at the time it is made.

PHYSICAL CHARACTERISTICS OF SYNTHETIC POLYMERIC BINDERS

During the work on development of the synthetic color-forming binders and their application in Du Pont Type 275, it became apparent that the new polymers could confer upon a photographic product a number of unusual physical characteristics, not all of which were visualized at the outset. Some of these properties may have important technical significance in the future, and they will be reviewed before discussing the properties and performance of the stock itself.

Brittleness and lack of flexibility, particularly at low humidities, are well-known properties of gelatin. In contrast, the synthetic polymers which have been discussed exhibit a high degree of flexibility, toughness and resistance to abrasion. A composite polymer monopack structure, for example, composed only of functional photographic layers, each a few ten thousandths of an inch thick and having a total thickness of only 0.001 in. can be shown to be strong and self-supporting after solvent removal of the base support.

In an experiment such as that just described, and in analogous treatments with a variety of solvents, it is apparent that the developed dyes as well as the color-forming binders are polymeric and accordingly completely insoluble. Thus, problems in connection with waxing, cleaning or polishing operations will be minimized. The tendency of gelatin to respond rapidly to thermal changes is apparent to a much lesser degree in the case of the synthetic polymers. While the implications of this property have not been fully explored as yet, one advantage that may accrue is processing at elevated temperatures.

STRUCTURE OF DU PONT TYPE 275

Du Pont Type 275 is a monopack subtractive color film having all dye-generating layers superposed on one side of the support and requiring no stepwise processing or transfer operations. It utilizes cyan (minus-red), magenta (minus-green), and yellow (minus-blue) synthetic color-forming binders of the type discussed above. The structure is shown in Fig. 1. The functions of the various layers on the base are as follows:

1. The top emulsion layer, unsensitized to other than blue light, receives the magenta image from the green analysis record by printing

with blue light. The yellow dye that is present and which distributes itself throughout the film absorbs the blue light as it passes through and prevents it from exposing the bottom layers which, since they contain silver halides, are also blue-sensitive. The yellow dye dissolves out during processing.

2. The separator layers prevent interlayer effects, not those usually caused by migration of the coupler molecules, since in this film these have been immobilized by making them an integral part of the binder, but those caused by migration of oxidized developer molecules between adjacent layers.

3. The middle emulsion layer, sensitized only to red light in addition to its inherent blue sensitivity, receives the cyan image from the red analysis record by printing with red light.

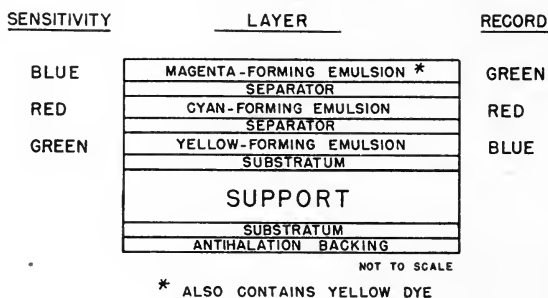

Fig. 1. Structure of Du Pont Type 275 Color Film, Release Positive.

4. The bottom emulsion layer, sensitized only to green light as well as retaining its inherent blue sensitivity, receives the yellow image from the blue analysis record by printing with green light.

5. The substratum layers anchor the emulsion and backing layers to the film base.

6. The antihalation backing coated on the rear of the film absorbs any light passing through the emulsions into the base, so that it cannot be reflected from the back surface of the film and cause halation. During development the backing dye is decolorized, and later on, during the washing steps, the entire backing layer dissolves off spontaneously without mechanical scrubbing. The spectral absorption of the backing is shown in Fig. 2, there being ample density at all wavelengths where protection from halation is required.

It is to be noted here that the layers other than the emulsion layers

are also prepared using synthetic polymers, thus completely eliminating gelatin from a commercial photographic product. The physical properties, such as water sensitivity and swelling, of all the different polymers used have been balanced in order to make a film of satisfactory characteristics. At the same time, the permeability of the layers

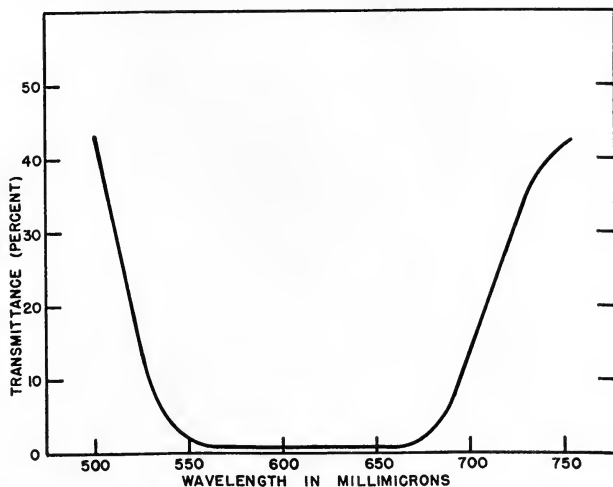

Fig. 2. Spectral absorption of the antihalation backing.

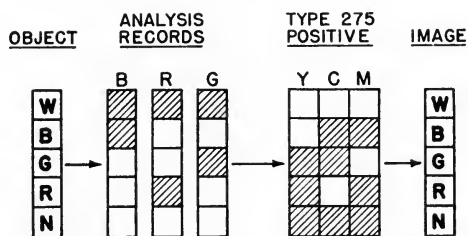

Fig. 3. Color reproduction with Du Pont Type 275.

B = Blue C = Cyan G = Green M = Magenta
 N = Neutral R = Red W = White Y = Yellow

to processing solutions has been maintained at a high level in order to keep the lag between the start of development in the outermost layer and the lower layers at a minimum. Fortunately, the physical properties of the synthetic color-forming binders can be balanced by adjustment of the number of color-forming nuclei present and by the introduction of other groups.



Fig. 4. Wedge spectrogram showing sensitivity peaks of magenta, yellow and cyan layers.

PHOTOGRAPHIC CHARACTERISTICS

Since this film is designed for printing from color separation records, it is possible to have a layer arrangement and sensitivity as shown without regard to the kind of light originally required to make the various records. This is explained in Fig. 3. The arrangement chosen has been adopted in the interest of resolution (sharpness) with the various images positioned in order of importance, namely, the green-record image in magenta on top, the cyan (red-record) image next and the yellow (blue-record) last.

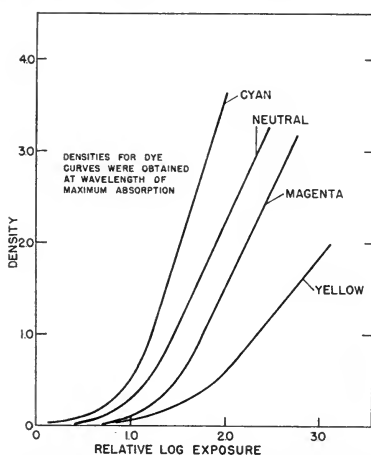

Fig. 5. Sensitometric curves for individual layers and neutral scale.

A wedge spectrogram showing the spectral response of the complete film is shown in Fig. 4. This shows peaks at 440, 550, and 710 $m\mu$ (millimicrons) for the magenta, yellow and cyan layers, respectively. The peak at 440 $m\mu$ in the magenta layer is produced

by the instrument used, the peak for the silver halide used actually being at about 390 $m\mu$.

Photographic characteristics have been adjusted to permit printing from color analysis records having equal effective contrasts. The sensitometric curves of the various layers for a standard set of developing conditions using the developing agent *p*-aminodiethylaniline are shown in Fig. 5, with densities measured at the wavelength of maximum absorption of each dye. A similar set of curves was selected as a goal of the work by calculations made from a neutral sensitometric curve of desired characteristics ($\gamma = 2.5$, straight-line densities to 2.8) and the absorption characteristics of the dyes from the color-forming binders selected for use. The absorption curves of

the various dyes and their contributions to a neutral density of 1.0 are given in Fig. 6.

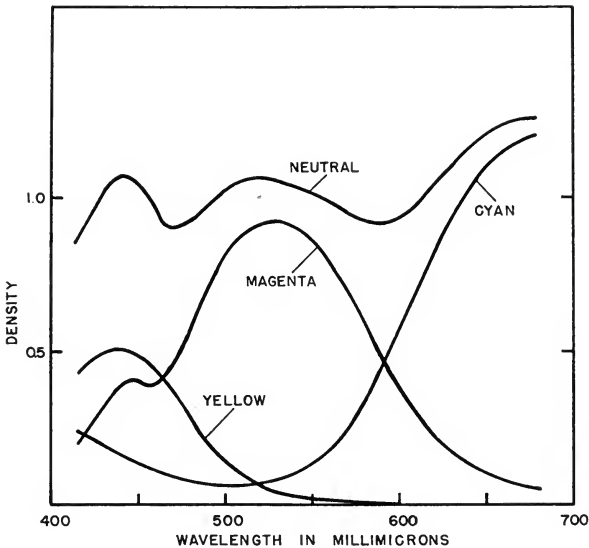

Fig. 6. Spectral characteristics of component dyes and resulting neutral.

PRINTING DU PONT TYPE 275 COLOR FILM

To make pictures on Du Pont Type 275 Color Film, Release Positive, three-color separation negatives must be printed onto the one release film in such manner that the positive image of each color separation is recorded only in the proper dye-generating layer. Naturally the three dye images in each frame must be superimposed in register. Because of the complex nature of the stock, only limited variation of contrast can be achieved in processing, so the primary control of contrast and balance lies in adjusting the contrast of the negatives. These requirements mean, for the present, that Type 275 must be printed in a register printer from three black-and-white separation negatives, each printing exposure being made through a narrow-pass filter so that the image will be confined to the appropriate subtractive color.

Any black-and-white three-color separation negatives may be used to print Type 275 provided they have the following characteristics:

1. Proper color separation;
2. Correct orientation for same-side printing;
3. Good register;
4. Acceptable sharpness;
5. Reasonably fine grain;
6. Appropriate contrast.

Negatives meeting these specifications may be derived from such existing or proposed methods as: stripping film, beam-splitting cameras, filter-wheel cameras, and separations from monopack color films.

To amplify these characteristics somewhat, the first means that each separation must record only the intended color aspects of a scene. The red negative, for example, must not respond to blue or green in addition to red, otherwise color degradation will result. Most directly exposed negatives meet this requirement quite well. Separations from color positives are often acceptable, but may be improved by masking.

Correct orientation for one-side printing requires the mirror-image reversal of at least one of the negatives obtained with beam-splitting cameras or stripping film. Since this can be done in optical printers of the type commonly used in the industry, this is usually no problem.

The requirements of good register, acceptable sharpness, and fine grain are common to all color work. The excellent resolving power of Type 275 emphasizes the need for good register and fine grain, because there is almost no diffusion of the image to cover up poor register or coarse grain in the negatives.

Figure 7 illustrates the contrast requirements for negatives to be used with Type 275. It shows a comparison between a black-and-white fine-grain release positive and the gray-scale or "equivalent" density characteristic curve of the color film. A black-and-white print with full tonal range may encompass the densities 0.15 to 2.3, which correspond to a density range of 1.1 in the negative. In the case of color films, experience shows that the density range in the print is typically somewhat greater, perhaps 0.15 to 2.8. The density scale in the negative must be correspondingly somewhat higher, about 1.45, which is 1.3 times as great. Thus, while negatives for black-and-white use typically have a γ of 0.65 to 0.7, negatives for contact printing of Type 275 should be at γ 0.85 to 0.90. This factor 1.3 is almost exactly the gain in contrast of projection printing compared with contact printing. Thus, negatives of the same contrast as normally used in black-and-white practice may be printed optically on Type 275.

Inasmuch as the contrast of the new color film is subject to only relatively small adjustment via processing, the gamma of the negatives is the major variable by which the contrast of the final image may be controlled. If negative gamma is not appropriate to begin with, it will be necessary to alter it by duping.

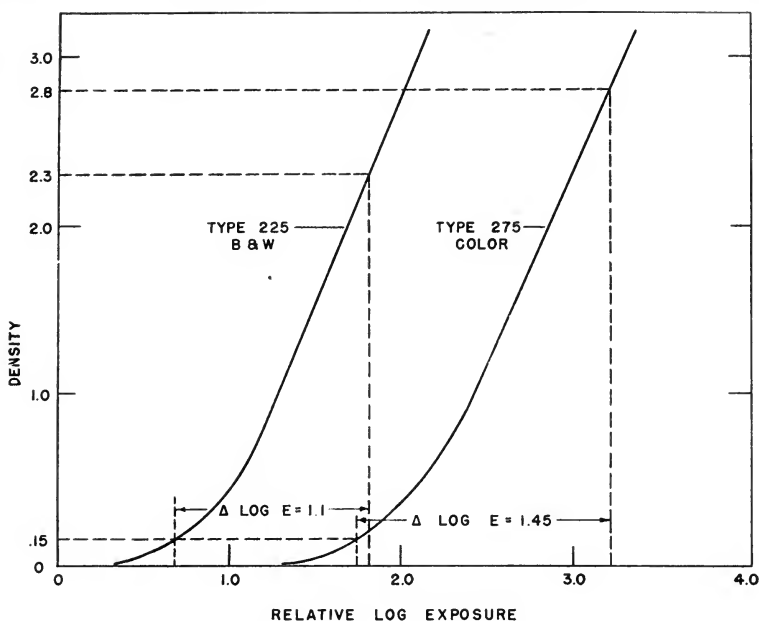

Fig. 7. Comparison of H&D curves for color and black-and-white positives, illustrating contrast requirements for negatives.

Exposing Filters

Having obtained a suitable set of separation negatives, the next step is to expose each record into the proper emulsion layer of the print film. Figure 1 has shown the relation between the spectral sensitivity of each layer and the dye generated in that layer by color development. The top layer is blue-sensitive and forms the magenta dye, thus it must be printed from the green-record negative. The middle layer is sensitive to red light and its image is cyan; so it is exposed from the red-record negative. The bottom layer develops yellow; so it receives the blue-record image by printing with green light, to which the layer is sensitive. The color sensitivity of each layer bears no required relationship to the color of the subtractive dye it carries, for it is simply a means of confining each exposure to the proper layer. The proper exposing color is obtained by using a narrow-pass filter over the light source.

The wedge spectrogram (Fig. 4) shows the spectral region to which each layer is sensitive, aiding the selection of exposing filters. Sensitivity of the top, magenta-forming emulsion extends from the ultra-

violet to about $490\text{ m}\mu$. The response of the green-sensitive emulsion begins at about $495\text{ m}\mu$, so, clearly, the blue filter must cut off at wavelengths shorter than this value. The green sensitivity extends to about $590\text{ m}\mu$, with a peak at $550\text{ m}\mu$. The red sensitivity begins at $600\text{ m}\mu$ and peaks at $710\text{ m}\mu$. The selection of practical filters involves finding ones with maximum transmissions of the desired colors and minimum leak of undesired wavelengths. The most efficient set is:

Blue—Corning 5113, half-thickness;
Green—Defender 60G;
Red—Corning 2403, full-thickness.

There is enough variation among filter batches so that individual filters should be checked photographically, or on a spectrophotometer. Similarly, filters in production use should be checked from time to time for constancy.

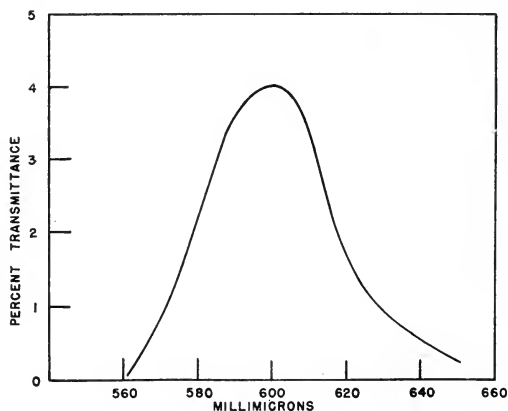

Fig. 8. Spectral curve of safelight filter.

Safelight Filters

Related to color sensitivity is the question of safelights. Re-examining Fig. 4 suggests that the most efficient safelight would transmit freely at one or other of the two gaps in sensitivity, at $495\text{ m}\mu$ or at $600\text{ m}\mu$. The $600\text{-m}\mu$ gap has been chosen because it is a little wider. A spectrophotometric curve of the safelight filter designed for this film is shown in Fig. 8. An infrared-absorbing component is desirable in the safelight, because the cyan layer has considerable infrared sensitivity to wavelengths which most organic dyes begin to transmit rather freely. With the filter illustrated, a five-minute ex-

posure is safe with an illumination of 0.02 ft-c. While this is not quite as bright as safelights commonly used with black-and-white positive, it is very bright indeed for a film having essentially panchromatic sensitivity.

It is interesting to note in passing that a monochromatic source emitting the wavelength of one of the gaps in sensitivity would make a very efficient safelight indeed. Although the "D" lines from a sodium arc do not fall quite at an ideal wavelength, they do produce very high illumination for a given level of "safety."

Printing Equipment and Illumination Requirements

A registration printer, either optical or contact, is required for exposing the picture images onto Type 275, because this operation involves three successive printings from separation negatives. Any conventional printer of this class may be used; the only additional specification over black-and-white printing is that filters must be placed between the light source and film.

Any standard light-change device may be used. These include traveling mattes, apertures, and lamp voltage control. It should be noted in the latter connection that perfect freedom is permissible in varying lamp voltage. Since the exposures are made through narrow-pass filters, this process does not require that the source be operated at a fixed color temperature. Whatever the mechanism, it is desirable to have fine printer-point steps to give maximum control over color balance.

Regarding illumination requirements in the printer: a 500-w incandescent lamp 10 in. from the film plane, with spherical mirror, in a contact printer with $\frac{1}{10}$ -sec exposure time gives ample exposure.

PROCESSING DU PONT TYPE 275 COLOR FILM

Processing of Du Pont Type 275 Color Film consists of four chemical treatments, with water washes or rinses between. The steps are shown in Table I.

TABLE I. Processing Steps for Du Pont Type 275 Color Film.

1. Develop	10-12 min	6. Wash	4 min
2. Wash	1-2 min	7. Second fix	4 min
3. First fix	6 min	8. Wash	10 min
4. Wash	5 min	9. Dry	—
5. Bleach*	5 min		

* Note: If sulfiding of track is employed, this may be done after a 1-min wash following Step No. 5. Processing then proceeds to Step No. 6.

After the film has been exposed in the printer, it is developed in a color developer. Here a silver image is developed in each layer, and concurrently the final dye images are also generated. Following a wash, the film passes to the first fixer, where all silver halide not used in the primary image is dissolved. The next treatment is a bleach which converts the silver image to silver ferrocyanide, which is dissolved by the second fixer. If the sound track is to be sulfided, this may be done following the bleach, before the second fix. Water washes are necessary between chemical treatments to avoid excessive contamination of one solution with another, which might lead to shortened solution life and the possibility of stain on the film. As with other films, a final wash is used to remove all processing chemicals from the emulsions. Drying is accomplished in the usual manner.

The processing times given in Table I are based on 70 F solution temperatures. While the temperature of the developer should be held quite constant ($\pm 1/2$ deg) for uniform results, temperature control is not particularly critical in the subsequent steps, since the reaction in each treatment is to be carried to completion.

Temperatures other than 70 F may be used if more convenient. Higher temperatures lead to shorter processing times, and may be very desirable in cases where machine capacity is limited. Type 275 has been processed successfully with all solutions at 90 F or above, without the need for special hardening treatments.

The times listed in Table I for processing steps beginning with the first wash have been selected as the minimum, in the interest of developing-machine compactness. Additional treatment time is permissible if machine capacity is available, and would provide a wider safety factor to assure complete reaction.

Processing Solutions

Table II gives formulas of solutions for processing.

The developer formula given in Table II should be considered approximate, and may vary for individual processing machines, depending upon conditions of agitation, etc. The reason for this is evident from a consideration of the complex structure of the film. It is obvious that the three emulsion layers do not have the same accessibility to developer, image formation naturally progressing more rapidly in the upper layers, which the developer reaches first. Thus, proper contrast balance to give a gray-scale is achieved only under a restricted range of processing conditions. Over-all contrast cannot be altered significantly by a simple change of development time as in black-and-white film, because a departure from the proper developing

time, with no other compensating change, throws the contrast relations of the three layers into incorrect balance. Since different developing machines do not give identical results, some adjustments may be needed to obtain a balanced development.

In general, the composition of processing solutions, particularly the developer, must be maintained to closer tolerances than are allowable in black-and-white photography. It is imperative that replenishment be based on accurate analytical techniques. It is recommended that the developer be replenished continuously, though the other solutions, which have wider tolerances, may receive batchwise additions of re-

TABLE II. Formulas for Processing Type 275 Color Film.

<i>Developer</i>		<i>First Fixer</i>	
<i>p</i> -Aminodiethylaniline		Hypo, crystals	240 g
Monohydrochloride	2.5 g	Sodium Sulfite, anhyd.	15 g
Sodium Sulfite, anhyd.	10.0 g	Borax	18 g
Sodium Carbonate, mono-		Acetic Acid, 28%	43 cc
hyd.	47.0 g	Potassium Alum	20 g
Potassium Bromide	2.0 g	Water to make	1 l
Water to make	1.0 l		
	<i>pH</i> = 10.5 (approx.)		<i>pH</i> = 4.5 (approx.)
			For use: dilute 1 part solution to 2 parts water
<i>Bleach</i>		<i>Second Fixer</i>	
Potassium Ferricyanide	100 g	Hypo, crystals	200 g
Boric Acid	10 g	Water to make	1 l
Borax	5 g		
Water to make	1 l		<i>pH</i> = 8.0 (approx.)
	<i>pH</i> = 7.0 to 7.5		

plenisher. Analytical techniques are available, but their description is outside the scope of this paper.

Processing Machine Design

Figure 9 illustrates a form of continuous developing machine for Type 275 Color Film. The sketch is schematic and is intended to suggest only the proper tank arrangement. As far as details of design and construction are concerned, this particular process does not necessitate any features different from good black-and-white practice. In fact, a black-and-white machine may be converted provided it has enough tanks to allow proper arrangement of solutions.

SOUND TRACKS

Sound reproduction problems peculiar to multilayer color films with dye-image tracks have been the subject of several papers in the JOURNAL. Special techniques have had to be developed for dye-image sound tracks, for it is now generally recognized that they cannot be used directly with the red-sensitive phototubes which are now standard for theater motion picture projectors.⁴ It is the universal characteristic of organic dyes suitable for three-color images that they are quite transparent in the near-infrared spectral region to which the 868 phototube has its greatest response. The result of trying to use such a combination inevitably is weak modulation and poor signal-to-noise ratio.

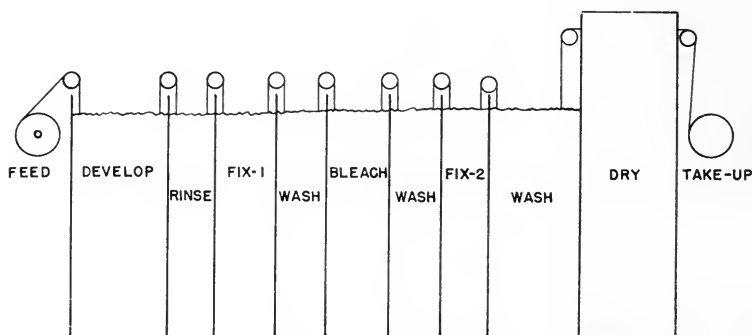

Fig. 9. Schematic arrangement of processing machine.

Two solutions to this dilemma have been found. One is to use a magenta-dye sound track in conjunction with a phototube with an S-4 photosurface.^{5,6} The spectral response of such a phototube when illuminated with a tungsten lamp has its peak at about $530\text{ m}\mu$, which is near the maximum absorption of the magenta dye. Thus, variations in magenta density modulate the phototube strongly. A second solution is to convert the silver image formed in the sound track during development into silver sulfide, which is relatively non-transparent in the near infrared, hence can be used with standard red-sensitive phototubes. Both of these methods can be utilized successfully with Du Pont Type 275 Color Film. The former has the advantage of simplicity, for it requires no extra treating steps; it also has certain technical superiorities. The latter has the advantage of expediency; it yields tracks which may be played with the present, existing phototubes.

Magenta Sound Tracks

When a phototube with S-4 sensitivity is to be used for reproduction, a sound track is applied to Type 275 Color Film in a manner completely analogous to black-and-white practice. The sound negative is simply printed on the color positive using the blue-exposing filter to confine the image to the magenta-forming emulsion, and the film is developed as described without any additional treatments to the sound track.

The top density and contrast of the magenta image, while dictated by picture requirements, are quite appropriate for sound reproduction. In particular, the high resolving power of the magenta emulsion confers good high-frequency response to a magenta track.

Because the contrast of the magenta image as "seen" by a blue-sensitive phototube is somewhat lower than black-and-white release positive, variable-density negatives intended for printing on Type 275 should have somewhat higher contrast than is used with black-and-white positive. A Du Pont Type 228 negative developed to a IIB control gamma of about 1.2 will yield a magenta track with minimum intermodulation for positive track densities in the neighborhood of 0.6 density. Likewise, variable-area sound negatives should have higher track density than if intended for black-and-white use. In cross-modulation tests a magenta track, printed from a Du Pont Type 201 negative developed to a IIB gamma of 3.5 and having a track density of 2.5, had optimum cancellation for a 1.15 density.

Actual intermodulation data for magenta sound tracks are represented by the solid curve of Fig. 10, and cross-modulation data appear in Fig. 11. These distortion measurements were made with a 1P37 phototube in the sound reproducer, and the track densities read with a blue-sensitive phototube in the densitometer.

Sulfided Sound Tracks

A sulfided sound track is produced on Type 275 by an edge treatment following the bleach, but preceding the second fix. At this point in the processing the original silver image has been converted to silver ferrocyanide by the bleach. This compound reacts very rapidly with sodium sulfide to form silver sulfide, which has the desired opacity to near-infrared radiation.

The picture image also contains silver ferrocyanide, so it is obvious that the entire film should not be treated with sodium sulfide. Therefore, an applicator which treats only the sound track with the sulfiding solution must be used. Such applicators are not novel, and many

forms have been used successfully. To keep the solution from diffusing to undesired areas, its viscosity is raised by the addition of a thickening agent.

Sulfiding Solution

Distilled water (125 F)	750 cc
Sodium Carboxymethylcellulose, medium viscosity	20 g
Sodium Sulfide, nonahydrate	63 g
Water to make	1 l

Stir thoroughly with a mechanical stirrer and filter while hot. Cool to room temperature before using.

The film should receive a 30- to 60-sec water rinse following the bleach bath to eliminate excess ferricyanide solution. At this time, the film is removed from the machine and prepared for the sound-track beading operation. An air blow-off should be used to remove excess liquid from the surface of the film. Best results are obtained when the emulsion is partly dried by passing the film through a drying chamber.

The film travel is so arranged that a developing time of one full minute is allowed following the application of the sulfiding solution. At the end of this period, the sound track area is subjected to a small, high-velocity water stream directed to wash the treating solution toward the perforations. This removes the excess sulfiding solution. The film is now returned to the machine for completion of the normal process, the next treating bath being the second fix.

Sound tracks to be sulfided are exposed in a slightly different way than are magenta tracks. While it would be desirable from the point of view of sharpness to print the track in the top layer only, the amount of silver in the magenta emulsion alone is too low to produce a silver sulfide track of the desired density. Thus, it is necessary to utilize the lower emulsions by printing with white light, even though some loss of high-frequency response results.

The following operating conditions were found at the Du Pont laboratories to give satisfactory results. A variable-area negative recorded on Du Pont Type 201 Sound Recording film was exposed to give a negative track density of 2.5 with the film processed to gamma 3.5. This track was printed onto Type 275 with unfiltered incandescent light and sulfided as described. Cancellation of 30 db or more occurred at positive track densities in the neighborhood of 1.2. A variable-density sound negative recorded on Du Pont Type 226 processed to a IIB gamma of 1.5 yielded a color sound print with minimum intermodulation at positive track densities about 0.6.

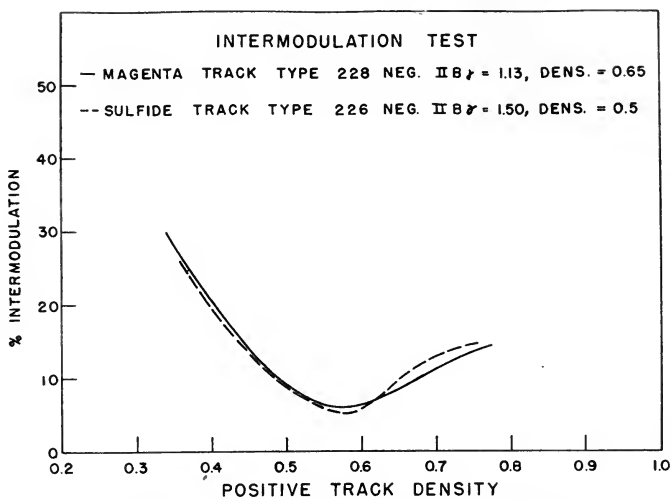

Fig. 10. Intermodulation curves for magenta and sulfide variable-density sound tracks.

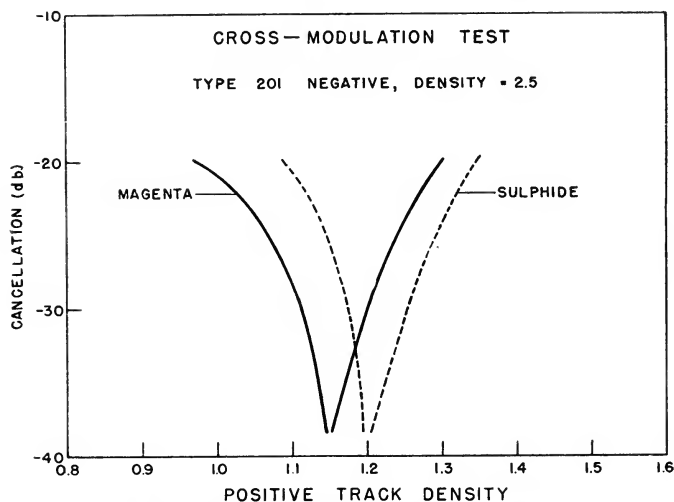

Fig. 11. Cross-modulation curves for magenta and sulfide variable-area sound tracks.

The dashed curves in Figs. 10 and 11 show actual intermodulation and cross-modulation data, respectively, for sulfided sound tracks played with a standard 868 phototube. The track densities likewise were measured with a red-sensitive phototube as the receiving element of the densitometer.

Volume output of both magenta and sulfided sound tracks is normal, being within 1 or 2 db of a standard silver track. Signal-to-noise ratio is somewhat better than black-and-white positive, attributable to the exceedingly fine grain structure of the colored image. Following are typical signal-to-noise ratios comparing the three types of track for variable-area recording without noise reduction:

Fine-grain Release Positive (black-and-white)	36 db;
Type 275 magenta track (1P 37 cell)	38 db;
Type 275 sulfide track (868 cell)	40 db.

High-frequency reproduction with color sound tracks is somewhat inferior to silver tracks. This is particularly true of sulfided tracks. The loss is caused partly by the high negative track density requirement and partly by the fact that a sulfided track utilizes all three of the emulsion layers of the color film. At 9000 cycles a magenta variable-area track is about -2 db from a silver track, while the sulfided track is about -7 db from the silver reference. Some high-frequency boost during recording may be necessary with the latter combination.

ACKNOWLEDGMENT

The developments reported in this paper were made possible through the combined efforts of many Du Pont research workers. In addition to the work in the laboratories of the Technical Division, Photo Products Dept., Parlin, N.J., extensive contributions have been made by the Chemical Department, Experimental Station, Wilmington, Del.

REFERENCES

1. R. Fischer, German Patent No. 253,335, 1912.
2. R. Fischer and H. Siegrist, "The formation of dyestuffs by means of oxidation with irradiated silver halides," *Phot. Korr.*, vol. 51, pp. 18-21, 1914; pp. 208-211, 1914.
3. C. E. K. Mees, *The Theory of the Photographic Process*, p. 59, Macmillan, New York, 1942.
4. R. Gorisch and P. Gorlich, "Reproduction of color film sound records," *Jour. SMPE*, vol. 43, pp. 206-213, September 1944.
5. A. M. Glover and A. R. Moore, "A phototube for dye image sound track," *Jour. SMPE*, vol. 46, pp. 379-386, May 1946.
6. R. D. Drew and S. W. Johnson, "Preliminary sound recording tests with variable-area sound tracks," *Jour. SMPE*, vol. 46, pp. 387-404, May 1946.

An Improved Video System For Television Studios

BY NEWLAND F. SMITH

WOR-TV, NEW YORK

SUMMARY: A new video system and a new arrangement of television studios have been devised at WOR-TV. This system adds considerably to the flexibility of a television station by permitting combination of any of the station's cameras in any combination in several studios for programming. This is accomplished by using a separate "camera control center" where all camera control operations are carried out. Individual studio control rooms provide for program direction and switching of the cameras for a particular program.

IN DESIGNING a television studio system at the present time the primary consideration is to make the whole system as flexible as possible—first, because television broadcasting is still a relatively new art, and therefore constantly changing as new ideas are developed; and second, because program requirements for television shows vary constantly from day to day, each program making different demands on the technical facilities.

Purposing to make a television studio as adaptable as possible in all its phases, the Television Engineering Department of WOR proceeded with the design of its new television studios, located on West 67th Street in New York. The arrangement of the studios in this building incorporate several novel ideas, of which we shall discuss here the separation of the camera control operators from the program direction and switching center.

The camera control operators for all studios are centrally located in one room called the Camera Control Center. Thus the program director is not distracted by having to look over the shoulders of the technical operating personnel or by any confusion arising from their being in the same room.

In this system the program director has directly in front of him, at his console, monitors on each of his local cameras, plus two preview monitors for switching up the cameras from some other source which might be cut in to his program. In addition, the switching control panel is located on this desk for the video switcher who sits beside the program director.

By centrally locating all camera control units in one place, further

PRESENTED: October 16, 1950, at the SMPTE Convention in Lake Placid, N. Y.

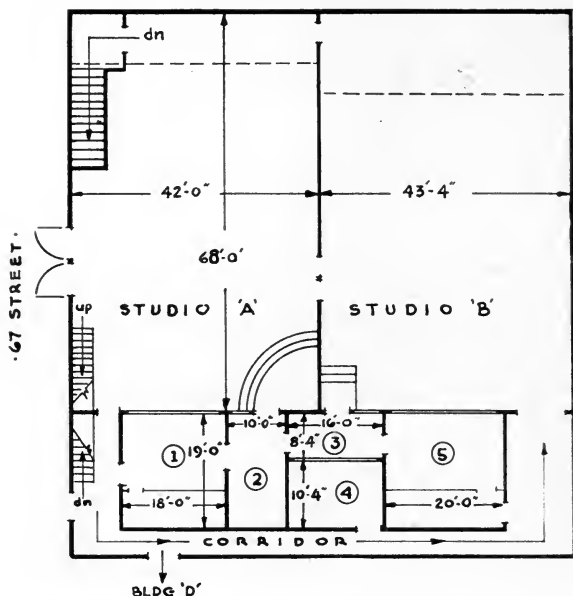

Fig. 1A. Floor plan of first floor showing studios and control rooms; (1) Control Room A, (2) Announce Booth D, (3) Announce Booth E, (4) Control Room C, and (5) Control Room B.

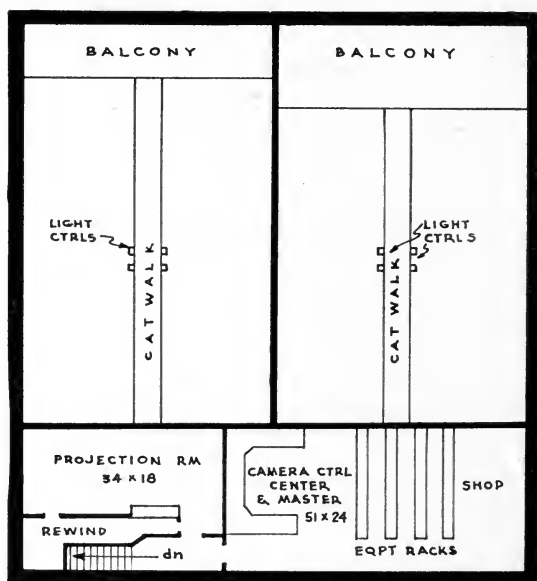

Fig. 1B. Floor plan of second floor showing projection and master control rooms and upper part of studios.

advantages from a technical point of view are realized. First, maintenance operations on the equipment are no longer hampered during rehearsal and program periods by the presence of program personnel in the same room, and, in case of trouble, replacement of equipment in the Camera Control Center is greatly facilitated. Secondly, the flexibility of operation is greatly increased. For example, any combination of the eight studio cameras and three film cameras can be

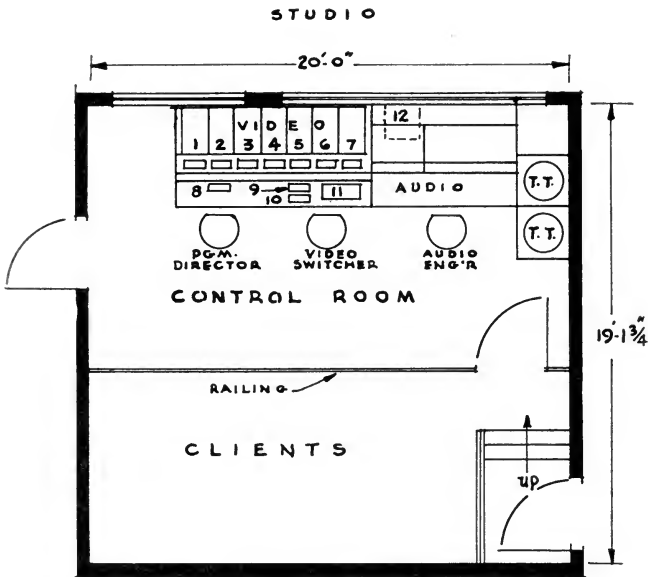

Fig. 2A. Typical floor plan of studio control rooms at 67th Street.

Video Console Components

- | | |
|-----------------------|------------------------------------|
| (1) preview monitor 1 | (7) preview monitor 2 |
| (2) camera monitor 1 | (8) director's intercom panel |
| (3) camera monitor 2 | (9) projection room remote control |
| (4) camera monitor 3 | (10) technical director's intercom |
| (5) camera monitor 4 | (11) switching panel |
| (6) line monitor | (12) receiver monitor |

used in any combination on any program switched through any of the program control rooms. This flexibility is further increased by the use of a camera cable patch panel in the Camera Control Center, enabling any of the studio camera controls to be patched to cables leading to any of the main studios or announce studios. Thirdly, centralized camera control eliminates the electrical delay problem which arises when several studios are located at different distances from the Master Control Room.

With this new arrangement, it is possible to realize a saving in the number of operating personnel assigned to camera control functions.

The control room space in the 67th Street Studios is divided as shown in Figure 1A. Three studio or program control rooms are provided here, each of which has identical facilities. One of these control rooms is normally used with each of the two large studios. The control room floor level is about two feet above the studio floor. A large window in each control room permits good viewing of the studio.

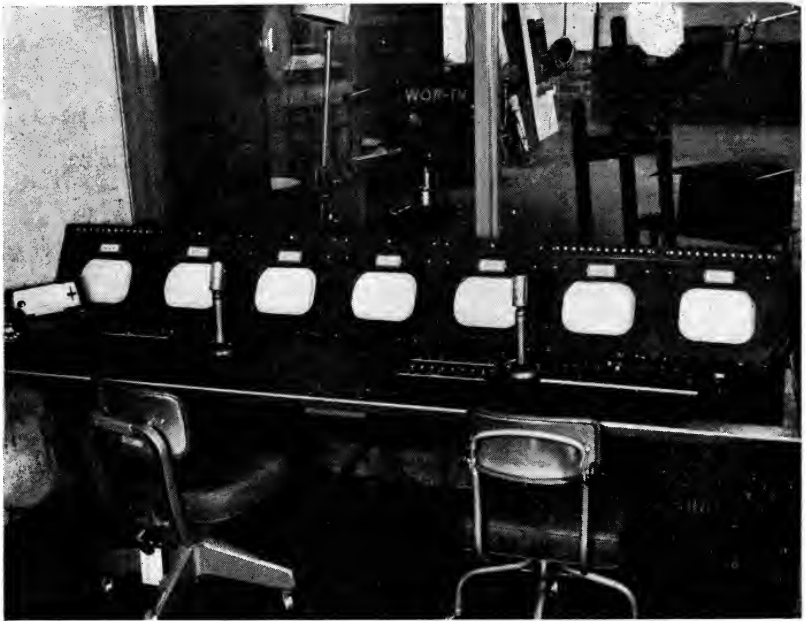

Fig. 2B. Director's console in studio control room.

The third control room, Studio "C" Control Room, is normally used for handling of remote or film programs. Film inserts on remotes are easily handled in this control room by routing the remote signal through the Studio "C" switching system. In addition, all station breaks and film spot announcements are handled in the Studio "C" Control Room. A typical studio control room arrangement is shown in Figs. 2A and 2B. Here the program director's console with its switching control panel is located on the left with the audio control console and turntables on the right. The camera switching is con-

trolled from each director's console by means of a push-button panel containing sixty momentary contact push buttons. These control circuits operate video switching relays located centrally in the Camera Control Center for all studios.

Each of the three studio camera switching systems consists of a relay bank of twelve inputs with five outgoing channels. This permits the handling of up to eight local camera signals and three remote composite signals through any studio control room. In addition, the twelfth input to the switching system is used as an "Effects" input for switching in a super-position, lap dissolve or other type of effect, as required. The five outgoing channels feed the two preview monitors in the director's console, the effects mixer amplifier, and the main program output of that studio.

The space above the program control rooms on the second floor contains the Film Projection Room and the combination Camera Control Center and Master Control Room (Fig. 1B). In the Camera Control Center all of the camera control units are located together in a large U-shaped console. In addition, forty equipment racks house the associated amplifiers, power supplies, synchronizing generators and the power supplies for all the studios.

In the camera control section, eight studio camera controls, each with its picture monitor and oscilloscope and two line monitors form the section facing the studios. A special feature of the Camera Control Center is the camera cable patch panel shown on the right side in Fig. 3. This is mounted on the wall directly adjacent to the camera control units themselves. The sockets mounted on these panels correspond to cables leading to the various studios. The camera cable pigtailed that plug into these sockets correspond to the eight studio camera control units. Thus, the eight camera controls can be distributed in any combination among the fifteen circuits to the various studios depending upon program requirements. This adds greatly to the flexibility of the over-all system and makes it possible to take care of almost any special requirement. Furthermore it reduces the total number of camera chains required in such an aggregate of studios.

It is thus that, in case of trouble with the equipment during a program or rehearsal, it is very easy to patch in a spare camera control unit so that the equipment giving trouble may be released for maintenance.

In addition to the patching of the camera control units to any of the studios on the camera cable patch panel, it is, of course, necessary to patch the video outputs of the camera controls on the coaxial jack panels which are mounted in racks adjacent to the program control

room where the switching is done. Also, of course, it is important that tally light circuit information and intercommunication facilities for the particular camera and camera control follow the proper program console. For this purpose a special tally and intercommunication patch panel is provided in the equipment racks directly above the coaxial jack panels. Thus, any camera control can be set up on any of the three camera switching systems for tally and intercommunication control. In this way a camera control operator may plug in a headset to any one of the control sections which he is working and have complete two-way intercommunication with the video switcher down in



Fig. 3. Camera Control Center with camera cable patch panel at right.

the program control room and also with the cameramen. In addition, on a separate earphone he may listen to the program audio from that studio.

The film camera control sections are located adjacent to and on the left of the studio camera control sections, forming part of the over-all console. Switching of these and patching is handled in a manner similar to that of the studio camera controls with the exception that the camera cable from each camera control is tied directly to its corresponding film camera in the projection room.

The film projection room is next door to the Camera Control Center. Here three iconoscope film camera chains are installed, each

with a mirror multiplexer system to combine optically several sources of film or slides on one camera. Two 35-mm film projectors, two 16-mm film projectors, a Gray "Telop" (opaque projector), three 2×2 slide projectors and a straight opaque projector comprise the film room projection equipment. Picture monitors for each of the camera chains are located in equipment racks beside the projectors, enabling the projectionist to line up each of his film cameras before being switched on the air. An intercommunication system associated with each film camera enables the projectionist to be in communication with anyone of the three program control rooms to which he is assigned.



Fig. 4. Master control switching console.

In the Camera Control Center is also located the master control switching equipment. The master control switching section is the left wing of the large U-shaped console (Fig. 4). This equipment is all relay-operated and comprises a switching system for handling six studios to four outgoing channels. It is a preset switching system for both audio and video and is arranged for either simultaneous or independent audio-video switching as required. Provision is made for either tripping all four outgoing channels with a single master switch or any group of them together. A picture monitor and oscilloscope

as well as an audio monitor and audio level meter are assigned to each outgoing channel so that levels on each outgoing channel can be set independently as well as monitored.

Two synchronizing signal generators are provided, one for standby use in case of trouble. An RCA Genlock unit has also been installed which permits the line-by-line as well as field-by-field phasing of the local synchronizing signal generator with an incoming remote signal. This permits the use of a remote signal in lap dissolving and superposition with local cameras and it has been found to be particularly effective with film commercials inserted during remote programs.

The new WOR-TV Studios have been in use since about the first of February. During this time it has been found that the facilities have met almost all of the requirements put upon them by the Program Department. Flexibility in meeting these requirements has been apparent in producing programs that would have been very difficult under more usual conditions. In addition, centralized camera control operation has resulted in helpful economies in both manpower and maintenance.

Infrared Photography With Electric-Flash

BY FREDERICK E. BARSTOW

EDGERTON, GERMESHAUSEN & GRIER, INC., BOSTON, MASS.

SUMMARY: Electric-flash sources produce infrared as well as visible and ultraviolet light. Using only the infrared portion, the guide number for infrared film is equal to or higher than the guide number for Kodachrome using the visible portion from the same source. Factors affecting the infrared output are discussed. Described is a small airplane instrument panel photographic recorder using an infrared filter over the flashtube to avoid distraction of the pilot. The short-duration infrared flash gives very readable records on 16-mm film at one-second intervals.

THE EXISTENCE of the infrared portion of the spectrum has been known since the early part of the last century, and infrared photographic records have been produced for over sixty years. However, it was not until 1931, when advances in sensitive materials were made, that the application of infrared photography became practical.¹ Photography using wavelengths longer than 13,000 Å (Angstrom units) is still difficult. Present-day applications depend on: (1) the ability of infrared radiation to penetrate haze; (2) differential absorption and reflectance of these long wavelengths by different materials; and (3) the inability of the human eye to respond to infrared light. These properties have led to the use of infrared in aerial photography, camouflage detection, crime detection, medicine, botany, and many other fields.

For some subjects the source of infrared radiation is the subject itself, but in all other cases some external source must be used. Common infrared sources are sunlight, incandescent light, arc lights and photoflash lamps. Less common, although not new, is the use of electric-flash (stroboscopic or high-speed lights) which makes possible the practice of infrared photography using very short exposures. It is this type of infrared light source and its application with which this paper is concerned.

Twelve or fifteen years ago electric-flash techniques were little known, but today their use is commonplace.² Several papers on this subject have been published in this Journal.^{3,4} However, it is less generally known that an electric-flash source emits a great deal of infrared radiation. Figure 1, a typical spectral distribution curve of

PRESENTED: April 26, 1950, at the SMPTE Convention in Chicago.

a commercial electric-flash tube, shows that the energy reaches a maximum in the blue, decreases to a minimum in the near-infrared, and then increases again. The energy per 100-Å band in the infrared is approximately half the energy per 100-Å band in the visible. The total energy in the visible region of 4,000 to 7,000 Å is only about three times the total energy in the infrared between 7,200 and 8,700 Å, but this figure will vary considerably between tube types and with other circuit constants. Thus it is seen that electric-flash is an effective source of infrared light.

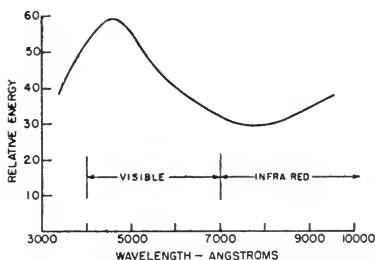

Fig. 1. Spectral energy distribution for a typical flashtube; data supplied by General Electric Co.

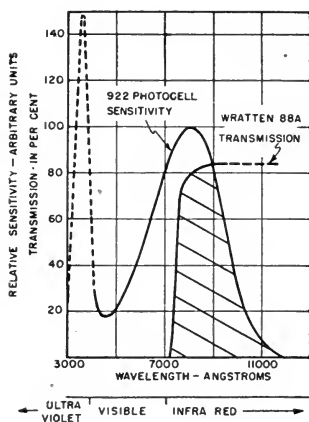

Fig. 2. Characteristics of the red-sensitive photocell and Wratten 88A filter used for measuring infrared radiation. The shaded region represents the response of the combination.

INFRARED EFFICIENCIES

The spectral energy distribution of Fig. 1 is for a standard commercially available electric-flash tube used for normal black-and-white or color photography. The question immediately arises as to the possibility of changing the tube design or operating conditions to increase the infrared output. Factors which should be investigated are voltage, capacity, tube loading, tube dimensions, gas pressure

and types of gases. To obtain some indication of the effect of voltage and capacity on infrared output, three types of tubes were investigated. Infrared light measurements were made with a special integrating-type light-meter⁵ designed for use with electric-flash, which employed a red-sensitive photocell and a Wratten 88A infrared filter.⁶ Figure 2 shows the sensitivity curve of the photocell and the transmission curve of the 88A filter. This filter has a transmission of less than 0.1% below 7,200 Å. The overlapping of the two curves (shown by the shaded area) represents the region of response of this combination of filter and photocell. This region extends from 7,200 to 12,000 Å.

Using the methods of measurement described, three different types of flashtubes were investigated to determine the effect of voltage and, to a limited extent, energy loading on the infrared output. The General Electric Co. FT-110 is a new flashtube designed for 1,000-v operation in portable electric-flash equipment. Its infrared effi-

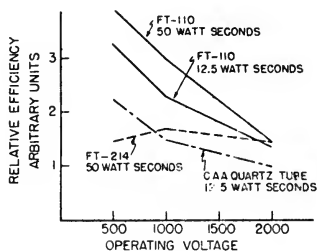

Fig. 3. Effect of operating voltage on the infrared efficiency of several flashtubes.

ciency, as shown in Fig. 3, is nearly three times as high at 500 as at 2,000 v when operated at 50 w-sec (watt-seconds), and approximately twice as high when operated at 12.5 w-sec. The CAA (Civil Aeronautics Administration) flashtube shows an infrared efficiency more than twice as high at 500 as at 2,000 v. This tube is a very small quartz lamp designed specifically for an infrared instrument recorder described later in this paper. The GE FT-214 is a standard 2,000-v flashtube used for portable and semiportable flash equipment. Its infrared efficiency remains approximately constant over this voltage range. From these limited data, it is probably safe to state that for maximum infrared efficiency a flashtube should be designed for as low voltage as is consistent with proper starting characteristics and flash duration.

The other design factors of tube dimensions, gas pressure and type of gas also may very well affect the infrared efficiency and should be investigated as they have been for the visible region.²

GUIDE NUMBER

Although the energy in the infrared approaches the energy in the visible region of an electric-flash source, the lower sensitivity of infrared film makes the over-all combination of electric-flash source, filter and infrared film considerably slower than the electric-flash panchromatic film combination. However, it is as fast as, or slightly faster than, the electric-flash Kodachrome combination. These speeds can be considered in terms of the commonly used guide num-



Fig. 4. Electric-flash infrared photograph; note "freezing" of fan blade.

bers (aperture or f -stop multiplied by distance). For example, a small electric-flash unit might have a guide number of 150 to 200 for super-speed panchromatic film, a guide number of 30 for Kodachrome, and a guide number of 30 to 50 for infrared film when a Wratten 88A filter is used. It is understood that if a Wratten 87 filter, which cuts off at approximately 7,600 Å, is used, the guide number will be reduced. It can be said in general that the infrared guide number will be at least equal to the Kodachrome guide number for a given electric-flash unit. Any subject that can be photographed in color can probably be photographed in infrared with identical equipment.

A commercial 10,000-w-sec flash unit having a guide number for Kodachrome of 250 could be used to photograph in infrared an area of several thousand square feet at an aperture of $f/3.5$. A press photographer's portable strobe unit could be used for figure length photographs at perhaps $f/2.5$, and finally, working toward smaller and smaller areas, infrared photomicrographs with electric-flash should be well within the realm of possibility. Figure 4 is an infrared photograph taken with a flash unit using a guide number nearly 50% higher than the guide number which normally would be used for Kodachrome.

A DATA RECORDER USING ELECTRIC-FLASH INFRARED LIGHT

Development

An ideal application of electric-flash as a source of infrared light is represented in a small automatic data recorder or "cockpit observer" for photographically recording instrument readings in aircraft during flight tests. The development of an instrument for use on extended flights was sponsored by the Civil Aeronautics Administration and participated in by the Fairchild Camera Co. through a contract with the CAA in 1936. It was extended through a contract with Eastman Kodak in 1941. The intention was to filter out all visible light and photograph with infrared in order to remove all possibilities of distracting the pilots. Incandescent sources were originally used, but the relatively long exposures required resulted in blurred images due to aircraft vibration. Electric-flash as the infrared light source offered the possibility of eliminating this defect.

A CAA Contract with Edgerton, Germeshausen & Grier, Inc., in 1943 resulted in two special 16-mm cameras and an experimental 110-v a-c electric-flash unit. The cameras constructed by the Eastman Kodak Co. were adaptations of the standard 16-mm Magazine Cine Kodak. The spring motors were removed and electric motor-drives substituted. Fast-acting overriding shutters were incorporated to give a short exposure despite the slow operating speed of two frames per second. This was necessary to minimize the effect of daylight which would have superimposed an additional exposure of long duration. Contact synchronizers with zero time delay were also incorporated for synchronizing the electric-flash. The cameras proved to be very satisfactory for this application.

In 1947 the application requirements of the equipment were changed to those of a flight test recorder, in particular, for small aircraft. Inasmuch as the principal requirement was to have a source of

illumination essentially invisible to the pilot, C. W. Wyckoff of the Edgerton, Germeshausen & Grier staff undertook to re-evaluate the relative merits of working in the ultraviolet or infrared regions of the spectrum. It was determined that although the over-all efficiency in the ultraviolet region was considerably greater than that in the infrared, it would have been necessary for the pilot to wear light yellow glasses to cut out the blue portion of the spectrum. In addition to this disadvantage, the contrast using ultraviolet light was considerably less than that obtained with infrared light. Further, the ultraviolet light would cause the luminescent dial paints to glow,

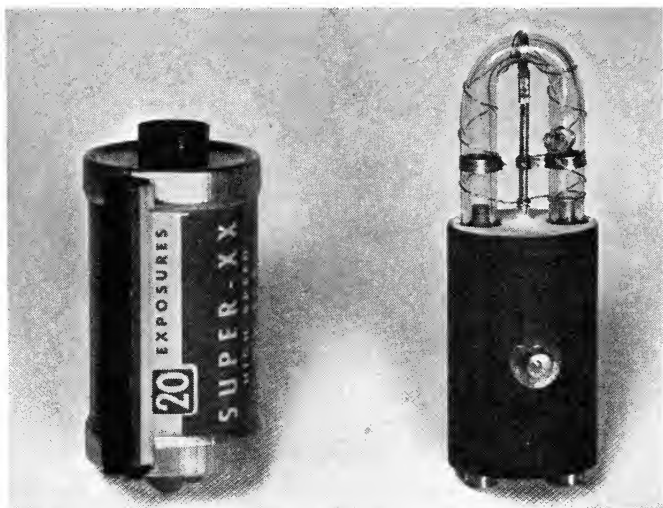

Fig. 5. Quartz flashtube for infrared recorder compared in size to a 35-mm film cartridge.

which might or might not have been a disadvantage. Having concluded that an infrared source had the greater advantage, the CAA outlined certain requirements for the recorder: (1) area to be covered, 11×14 in.; (2) camera to instrument panel distance, 36 in.; (3) maximum aperture, $f/1.9$; (4) picture rate, one per second; (5) power source, 12-v battery; and (6) minimum size and weight.

A few simple photographic tests with standard flashtubes indicated that a special flashtube would be desirable. Two seemingly incompatible factors enter into the design of a flashtube which is to be operated at high repetitive rates. If it is small, it will overheat due to the average power input, but will have high efficiency. If it is

increased in size to handle the average power, it will have low efficiency, requiring in turn a higher average power input. When these conditions apply, it is advantageous to construct the tube of quartz which can be operated at a much higher temperature level than glass, and a compromise must be made between efficiency and power handling ability. For the CAA recorder, a small quartz U-shaped tube (see Fig. 5) was designed which had a reasonable efficiency and was able to handle the necessary power without overheating. Its size permitted the use of a very small reflector without sacrificing reflector efficiency. As shown in Fig. 3, its infrared efficiency is about 50% higher at 500 than at 1,000 v and hence a voltage operating level of 475 to 500 v was chosen. This voltage level has the advantage of simplifying the power supply design for an airborne application. The dimensions of the tube and gas pressure are such as to give reliable starting at this voltage. A special mounting base protects the fragile graded quartz-to-tungsten seals and fits into a standard

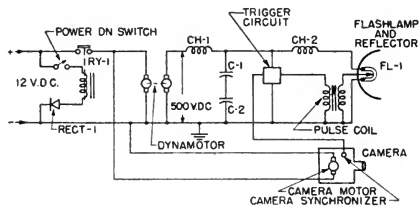

Fig. 6. Schematic diagram of infrared electric-flash instrument recorder.

fluorescent starter socket which locks the flashtube in place, but at the same time makes it easily removable. Adequate spacing for the spark lead is obtained by placing its termination well up on the side of the base. Using a Wratten 88A filter over a small reflector, 4 in. in diameter, a Wratten 88 filter over the lens, and infrared film, an input to the flashtube of 12 to 14 w-sec gives the illumination required for the recorder.

Circuit

The circuit (Fig. 6) has several features of particular interest. Inasmuch as the primary power source was to be an aircraft 12-v battery, one of three types of conversion was available: (1) vibrator, transformer and rectifiers; (2) d-c to a-c inverter, transformer and rectifiers; or (3) 12-v d-c to 450-v d-c dynamotor. Dynamotors are generally preferred to vibrators in aircraft and eliminate the need for transformers and rectifiers and therefore were chosen as the means

of voltage conversion. This would not have been practicable if the voltage requirement had been much above 500 v.

Two 220- μ f 475-v electrolytic capacitors (C-1 and C-2) are conservatively operated in series to give an energy storage of about 12 w-sec. Chokes CH-1 and CH-2 both serve to prevent "hold-over" in the flashtube FL-1. A "hold-over" in a flashtube is a continuous glow which occurs if an attempt is made to recharge the capacitors too rapidly. The tube is in a highly ionized state after being flashed

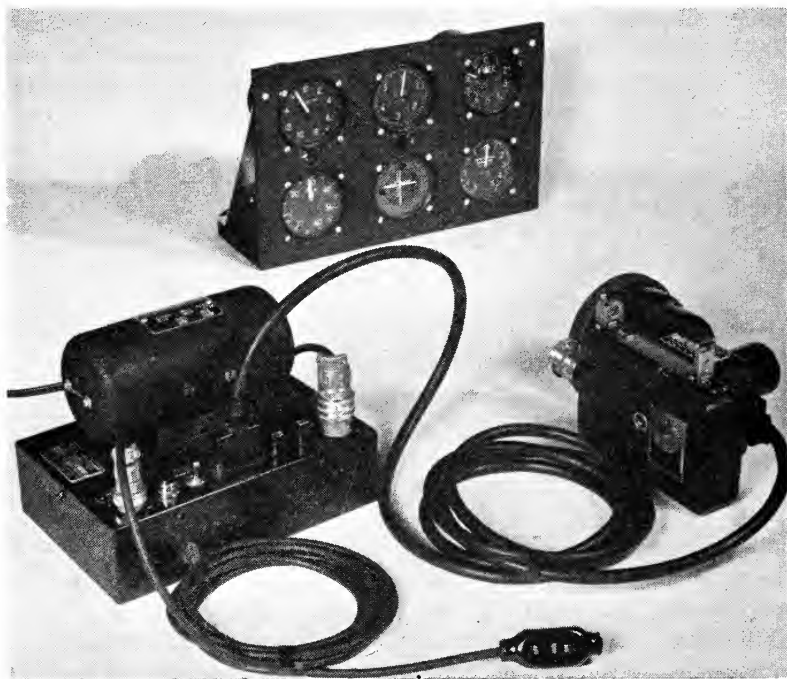

Fig. 7. Complete infrared electric-flash instrument recorder, showing power unit, camera and lamphouse assembly, cables and a mock-up of instruments.

and, if sufficient current is supplied, the tube will not deionize but will remain conducting and act as a short circuit across the power supply. A choke (CH-1) acts as a high impedance immediately after flashing to limit the current and thus prevent "hold-over." On the other hand, over a period of one second it acts as a relatively low impedance and therefore allows the capacitors C-1 and C-2 to charge fully before the next flash. An additional choke (CH-2) in series with the flashtube also tends to prevent "hold-over" by causing a

slight reversal of voltage, thereby allowing the tube to deionize. The amount of reversal must be limited to a small value to prevent damage to the electrolytic discharge capacitors.

To prevent inverse output voltage from the dynamotor, which in turn would cause failure of the electrolytic capacitors, it is necessary to prevent operation of the dynamotor in the event that the polarity of the battery voltage is ever reversed. This is accomplished by placing a selenium rectifier in series with the coil of the main control relay RY-1 which prevents its closing if the polarity of the voltage is incorrect.

The cameras described previously have had new 12-v d-c governor-controlled motor-drives installed to operate them at one frame per second to within an accuracy of about 1%. The nonreversal protection described above also prevents the camera motors from driving the film in the wrong direction.

Mechanical Design

Figure 7 shows the complete unit (total weight 18 lb), which includes the power supply, camera, lamphouse assembly and cables. A test bank of instruments is also shown. The motor-drive, governor, and lamphouse are attached to the camera, but the lamphouse may be removed for side-lighting by releasing two small snaplocks. Slack cable coiled inside the motor-drive housing allows operation of the lamp up to 30 in. from the camera. The total weight of the camera unit (including camera, motor-drive, and lamphouse assembly) is approximately 4 lb. The camera and lamphouse are shown in Fig. 8 which illustrates how a Wratten 88A filter is held in place over the reflector by a grooved rubber ring that also serves to prevent any unfiltered light leaking around the edge of the filter. It will be noted that the camera also has an infrared filter (a Wratten 88) and that the flashtube is located so that the legs of the U are in a horizontal plane. This orientation tends to spread the light in the horizontal direction corresponding to the longer axis of the 16-mm frame. The power supply is a rectangular aluminum box with all components attached to the cover for easy servicing. The dynamotor is placed on top for maximum cooling.

In the laboratory the unit has operated very satisfactorily. Figure 9 is an infrared photograph of a test instrument bank taken with the recorder at 36 in., an angle of 30 deg, and an aperture of $f/1.9$. As data can be taken readily from exposures made at $f/2.8$, it should be possible to photograph areas slightly larger than specified, and by the use of two recorders, more extensive instrument panels can be

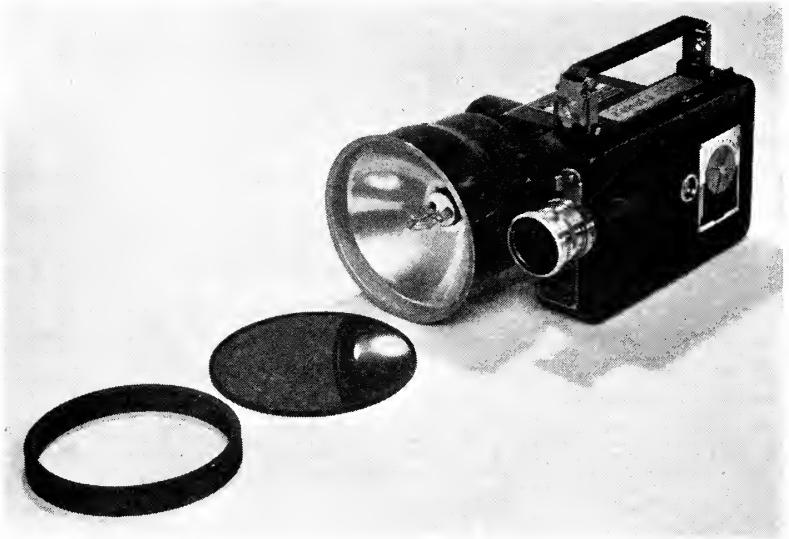

Fig. 8. Camera and lamphouse assembly showing infrared filter and rubber retaining ring removed.

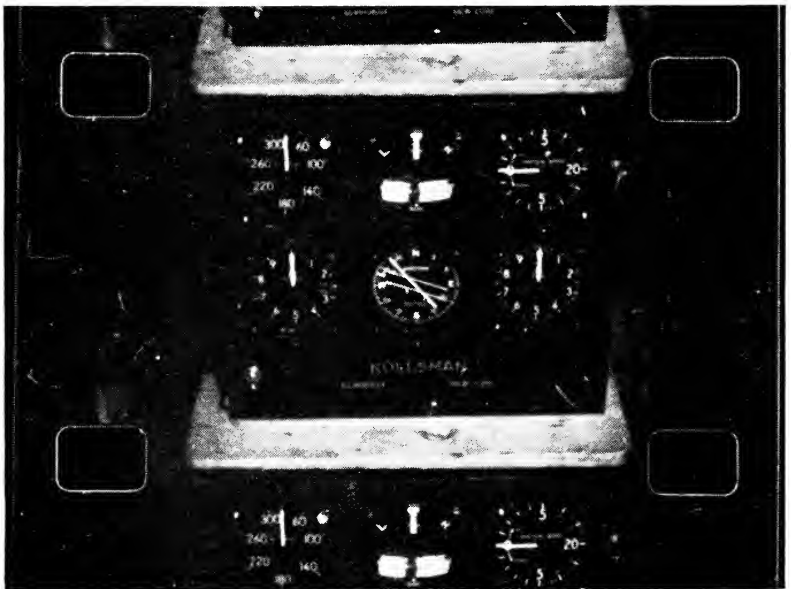

Fig. 9. Enlargement of section of 16-mm film made with the CAA infrared electric-flash instrument recorder.

observed. At the operating rate of one per second a series of over 2,000 photographs covering a flight test of over 30 min is possible without reloading.

In contrast to special recording systems which require a separate bank of test instruments, this device can be readily installed in the cockpit of even the smallest aircraft to record data from the standard instrument panel. However, without the infrared filters it is also adaptable for use in recording much larger aircraft instrument installations located where the flashing light would not distract the pilot. Installation and testing of this infrared recorder in a DC-3 airplane is now being carried on by the CAA.

CONCLUSIONS

Commercial electric-flash techniques can be used to provide infrared light for infrared photography. Guide numbers at least as large as those for Kodachrome can easily be obtained. The efficiency of electric-flash as an infrared source is generally highest for a tube designed to operate at the lowest practicable voltage. An aircraft instrument recorder, or "cockpit observer," employing electric-flash as an infrared source has been designed and shows satisfactory performance in laboratory tests.

REFERENCES

1. W. Clark, *Photography by Infrared*, 2d ed., John Wiley & Sons, New York, 1946. (An extensive treatment of infrared photography.)
2. H. E. Edgerton, "Photographic use of electrical discharge flashtubes," *J. Opt. Soc. Amer.*, vol. 36, no. 7, pp. 390-399, July 1946.
3. H. E. Edgerton, "Electrical-flash photography," *Jour. SMPE*, vol. 52, pp. 8-23, Mar. 1949.
4. K. J. Germeshausen, "New high-speed stroboscope for high-speed motion pictures," *Jour. SMPE*, vol. 52, pp. 24-34, Mar. 1949.
5. H. E. Edgerton, "Light-meter used with electronic flash," *J. Photo. Soc. Amer.*, Part II, Photographic Science and Technique, pp. 6-10, January 1950.
6. *Wratten Light Filters*, p. 69, Eastman Kodak Company, Rochester, N.Y., 1945.

Magnetic Sound Film Developments in Great Britain

BY O. K. KOLB

BRITISH ACOUSTIC FILMS, LTD., LONDON, ENGLAND

SUMMARY: The introduction of magnetic sound film recording and reproducing apparatus into Great Britain is described as well as the types and characteristics of magnetic film available. Details and the general circuit arrangement of the apparatus are given together with a description of special apparatus which has been used for adding a visible signal indication record to the invisible magnetic sound track. Apparatus which has been evolved for the bulk wiping of magnetic film stock is also described as well as experience gained with different types of magnetic film joints.

MOST PEOPLE are familiar with the Telegrafone, the name which Poulsen gave to his magnetic sound recorder and reproducer, in which a steel wire was run past a magnetic head to which signals were fed and thereby recorded on the wire, the signals being subsequently picked up again from the steel wire by means of the same or a similar magnetic head.

The steel wire recording system developed very slowly, mostly due to the absence of any large developments in the electronic field, but when, after World War I, thermionic valve amplifiers, good microphones and good loudspeakers were developed, the steel wire was again taken up but only for speech and signal (e.g., Morse) recording. It did not find its way into the motion picture industry chiefly for two reasons:

Firstly, the quality was not very good and could not compare with that of photographic sound.

Secondly, the speed of the steel wire was much too fast to allow it to be synchronized satisfactorily with the picture.

The Magnetophone: Successor to the Telegrafone

Some years before World War II, Pfleumer in Germany had developed the use of magnetic iron oxide powders on tapes as a magnetic sound recording medium and the Allgemeine Elektrizitäts Gesellschaft had marketed a machine for the use of it; but even this new apparatus, called the Magnetophone¹ did not open the field of application to the motion picture industry, since the quality was still of the standard of a dictating machine.

A CONTRIBUTION: Submitted March 9, 1950

High-Frequency Bias for Magnetophone Tape

However, further developments during World War II, especially in Germany by Braunmühl and Weber,² who applied the high-frequency-bias method of recording to the oxide tape, changed the situation materially, as they produced a magnetic sound record greatly improved and far superior to the old d-c³ or even a-c⁴ biased Telegrafone and the Magnetophone, d-c operated until that time. It was now possible to obtain a quality comparable and even superior to any other recording means with a frequency response up to 20,000 cycles/sec and with the tape running at the reasonable speed of about 30 in./sec.

Application to the Motion Picture Industry

The motion picture industry now started to take an interest in these new developments in magnetic recording and the possibilities of introducing magnetic sound into the industry were examined in different countries.

In Great Britain immediately after World War II an examination of the advantages of the application of magnetic sound to the film industry was made. Investigations at that time revealed that a very high quality could be obtained from magnetic sound record carriers at a considerably reduced speed. At the speed of standard 35-mm film a frequency range up to 10,000 cycles/sec was obtained while at 16-mm speed up to 7,000 cycles/sec was obtainable and even at 8-mm speed up to 3,500 cycles/sec could be reproduced.

In addition to the excellent frequency response a very good signal-to-noise ratio was obtained, being at least 10 db better than the best photographic sound film recorded with a ground noise reduction system.

Nevertheless, a lot of development work had to be undertaken subsequently to enable the new type of sound recording to be introduced into the studios. This work consisted mainly of two parts: firstly, the manufacture of perforated film base with the new magnetic coating; and, secondly, the provision or adaptation of apparatus for the recording and reproduction of the new type of sound record carrier.

Magnetic Film Stock

Figure 1 shows three different types of magnetic film coatings (A, B and C) which have been evolved for use in the motion picture industry. In type A (Fig. 1) the coating is applied over the entire width of the film. For this purpose large sheets of a suitable non-

inflammable base are coated and afterwards slit and perforated. Large quantities of the base material can be coated quickly in this way but the slitting and perforating of the coated material quickly blunts the tools used for these operations due to the abrasive action of the iron oxide coating and resharpening of the knives and punches is necessary after a relatively small number of reels have been made.

Type B (Fig. 1) illustrates a kind of magnetic film with which this drawback has been overcome by slitting and perforating the base material before applying the coating. In this case the coating is applied only to the surface between the two rows of perforation holes. This has the further advantage that it enables the usual footage and edge numbers to be retained along the entire length of the reel.

Type C (Fig. 1) is a third kind of magnetic film where the magnetic coating extends over only approximately half the width of the film space between the perforation holes, the other half being provided

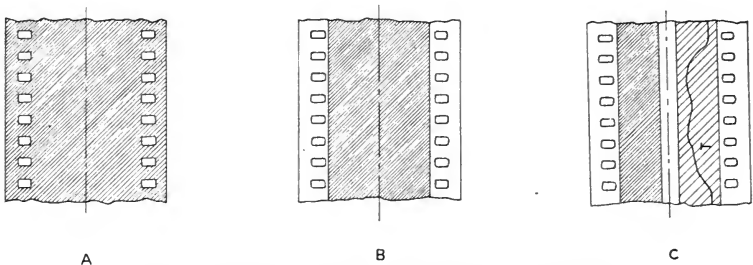

Fig. 1. Different types of magnetic film coatings.

with a layer of a white or light-colored material upon which notes, cue signs and other visible indications can be made, for example, for synchronization purposes.

Optimum Bias and Frequency Response

Magnetic sound film stock eventually became available from several sources in appreciable quantities and comparisons and measurements were made of the different manufacturers' products in order to use them in the most suitable way. It was found that the various coatings differed considerably and usually required a change in the amount of the supersonic bias in order that the best results could be obtained from each different coating.

Figure 2 illustrates graphically the output level of three different kinds of magnetic film stock plotted versus the bias current.

Curve A refers to a medium-hard coating from which the maximum

output is obtained with a bias current of approximately 80 ma (milliamperes).

Curve B refers to a soft British film; it gives its optimum output when the bias current is about 45 ma.

Curve C represents the behavior of a sample of Continental stock which requires a bias current of about 70 ma in order to obtain its maximum output.

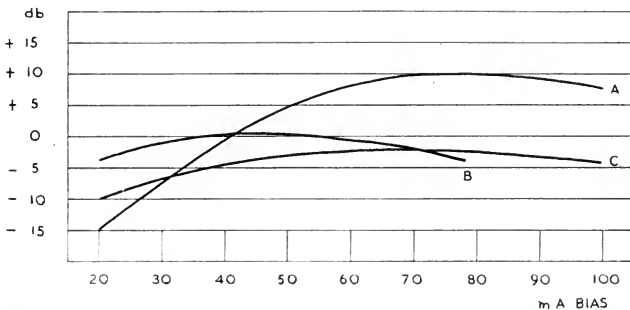

Fig. 2. Output level of different magnetic films plotted versus bias current (A, American; B, British; and C, Continental film stock).

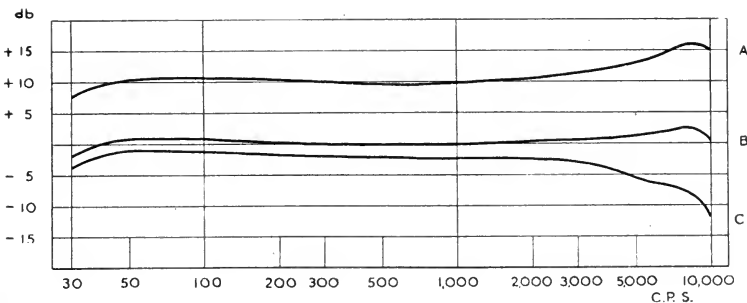

Fig. 3. Frequency response of different magnetic films at optimum bias current for each film (A, American; B, British; and C, Continental film stock).

Investigations also showed that different types of magnetic film stock exhibited different sensitivity and frequency responses. Figure 3 gives an example of three different types of stock in which the curves shown illustrate measurements made with the bias current adjusted to give the maximum output from each different make of film. The recording and playback equipment was adjusted in such a way as to give an almost flat response for the British film (curve B); with the same adjustment a medium-hard American film (curve A) gave 10 db

more output and, in addition, an increased top response. Curve C refers to a Continental sample of magnetic film from which it will be seen that the output signal strength is down 2 db compared with the British film while a poorer top response is also exhibited.

Compensation for the differences in output and top response can, of course, be made in the playback amplifier but at the cost of increased background noise in the case where considerable boosting in the higher audio range is required.

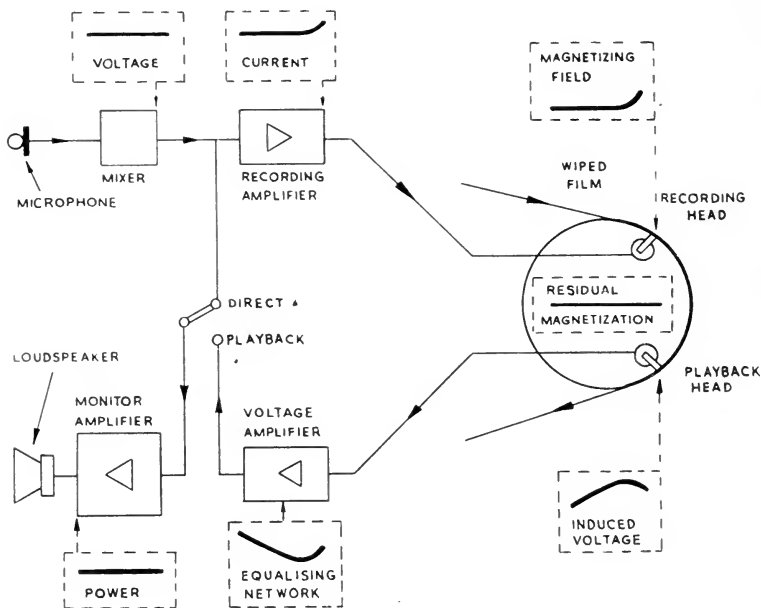

Fig. 4. Block diagram of magnetic sound film system.

General Circuit Arrangement

Once the required magnetic film stock had been obtained and its characteristics and response curve ascertained the next step was to provide the necessary apparatus for actually recording and reproducing sound magnetically. As the same or even better results must be expected from the new magnetic system as from the well-established photographic sound channels, it was an obvious step to adapt existing photographic sound apparatus to the new system, the main difference being that the optics and provision for optical adjustments are eliminated and replaced by a magnetic head consisting of a coil having an annular core of soft magnetic material with a well-defined gap.

In Fig. 4 the general layout of a magnetic sound-on-film system is schematically illustrated. The signal current created by the sound impinging upon the recording microphone is passed on to a voltage amplifier and mixer having a straight line response. From there it is fed to a recording amplifier with a pre-emphasizing characteristic compensating for losses, particularly of the higher frequencies, incurred in the transfer of the signals from the magnetic recording head to the magnetic sound film. The curve shown above the recording amplifier block illustrates schematically the pre-emphasis to which the signal current is subjected prior to the actual recording step so that the signals recorded on the sound carrier then have an almost straight line frequency characteristic.

The sound record carrier, with its magnetic layer now magnetized, passes round the recording drum to a second magnetic head (playback head) which can be used either for reproducing or for monitoring while recording takes place. As the frequency characteristic of the signals picked up from the film is not straight it has to be equalized by the inverted characteristic of a special equalizing network and voltage amplifier the output of which is passed to a power amplifier feeding the reproducing loudspeaker.

In order to adjust the equipment and, also, for purposes of comparison during recording, a change-over switch is provided by means of which the signals from the microphone amplifier can be fed either directly to the monitor power amplifier and the loudspeaker or, alternatively, via the recording amplifier and head, record carrier, reproducing head and amplifier to the same power amplifier and loudspeaker. If the apparatus is properly adjusted there will be no audible difference between the sound from the loudspeaker reproduced directly and that played back through the magnetic recording and reproducing channel.

Recording and Reproducing Equipment for Magnetic Film

Figure 5 illustrates the general assembly of an equipment which has been adapted from photographic sound film apparatus and can be used not only for the magnetic recording of sound but also for reproducing it in synchronism with a complementary picture film. It consists of a combined recording and reproducing machine driven by a synchronous or an interlock motor and an assembly of amplifiers and ancillary units. The equipment can be connected to any microphone input or mixer table (not shown in the photograph). A special wiping head for erasing any signals remaining on the film from a previous recording is provided in the path of the film before reaching

the recording point thus allowing previously recorded films to be re-used.

Figure 6 is a view of a photographic sound camera which has been adapted for recording sound on magnetic film. A feature of particular interest in this camera is the manner in which the recording and playback heads have been mounted.

Long experience in recording and reproducing sound films has shown that it is most advantageous to record on and reproduce from the film when the latter passes round a drum connected to a shaft

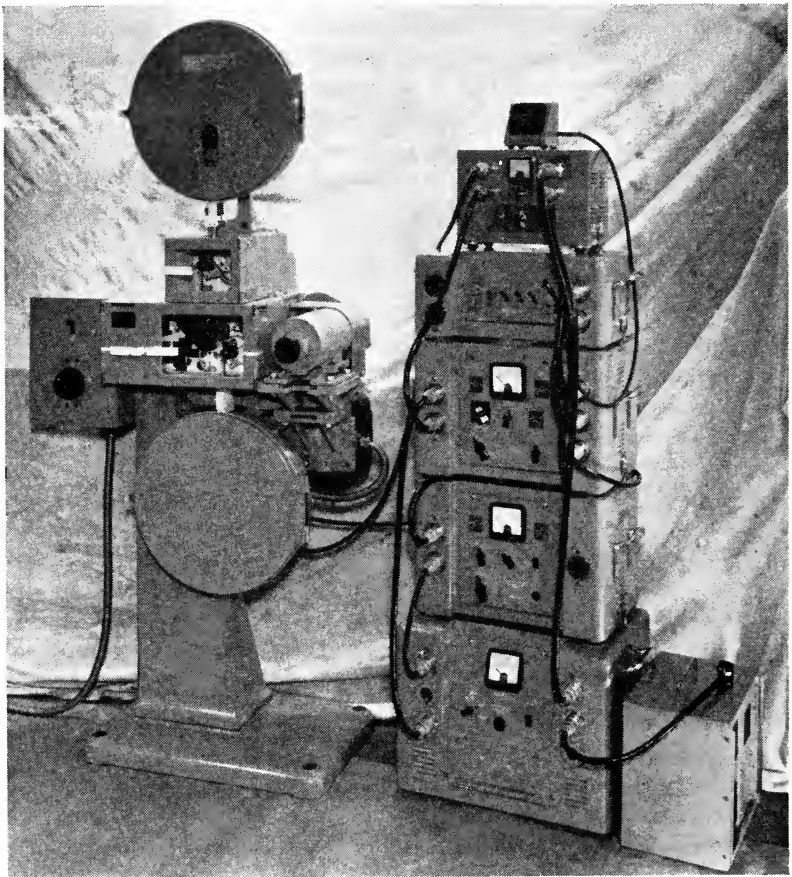

Fig. 5. General assembly of magnetic sound film recording and reproducing equipment and amplifier stack.

carrying a flywheel because inertia is added to the film which, itself, is virtually without mass.

This procedure has been followed in the camera illustrated by Fig. 6 with the additional arrangement that the flywheel drum has been constructed with an annular recess within which the magnetic heads are accommodated. The arrangement is such that the magnetic layer faces the drum while the film is supported on the outer parts only, the middle portion of the film, that is, the part covering the recess, being without any other support except for that of the curved surface of the magnetic heads which are located inside the cylindrically shaped portion of the film passing round the drum.

In cross section the flywheel drum is H-shaped, the horizontal bar of the H coinciding with the drum axis, the space above and below the axis being occupied by the heads which are supported on rigid arms placed in such a way as not to interfere with the passage of the film through the apparatus. The ends of the arms remote from the

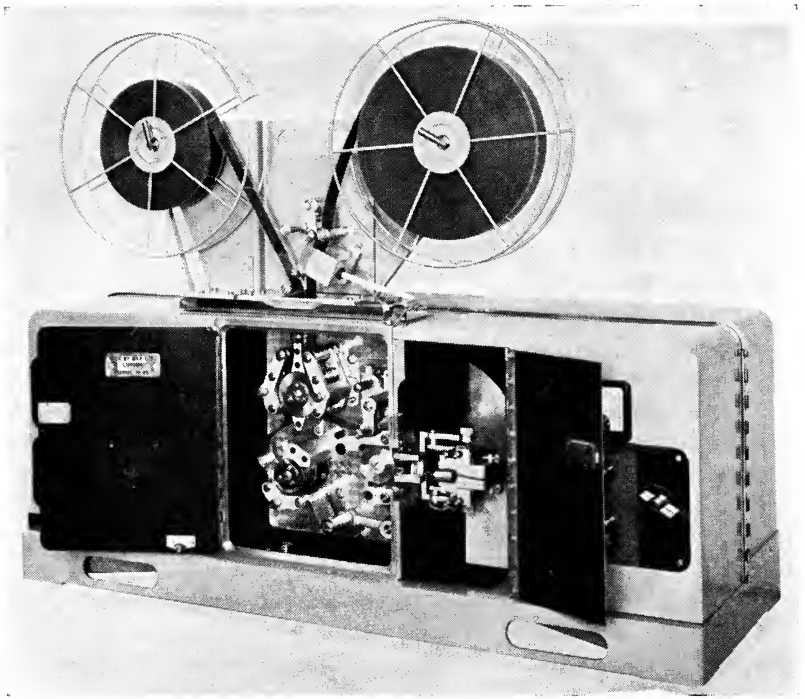

Fig. 6. Magnetic sound film camera with the magnetic heads mounted inside the recording drum.

heads are connected to a mechanical assembly by means of which all movements necessary for adjustment are carried out.

Synchronization

Contrary to a photographic sound record, it is impossible on a magnetic record to ascertain whether or not sound has been recorded on the film merely by looking at it and should sound have been recorded it is impossible to see where the recorded signals begin or end.

The simplest way of obtaining an approximate idea of the beginning and end of sound passages on the film for the purposes of synchronization, editing and cutting is to rely upon an audible signal reproduced from the film. This was easily arranged on the existing photographic sound-editing machines by removing the optical system and exciter lamp and replacing these parts with a magnetic pickup head.

In certain cases it is more advantageous to provide the editor with a visible indication of the actual sound signals. This visible indication could be a registration of similar indication of the actual signals or a registration of their envelope or an indication derived from them.

In Fig. 1-C the envelope of the invisible magnetic sound signals contained in the left side of the sound record is indicated by the trace T on the right side. This visible registration of the sound signals can be effected in several ways, for example:

(a) by an inking method in which a small nib fed with indelible ink traces the envelope of the sound waves;

(b) by a stylus which engraves the visible indication on the white coating; or by

(c) a dry chemical process in which a stylus made of a special metal reacts with a chemical compound in the white coating shown in Fig. 1-C.

Method (c) has given the best and quickest results and has been used on film stock of the kind shown in Fig. 1-C in which the white coating consists of zinc oxide mixed with a nitrocellulose lacquer and coated on the film. The recording stylus is made of bronze or brass or a similar alloy and the reaction between the metal stylus and the coating forms the trace T. This latter process has the advantage that it is entirely dry and can be carried out at almost any speed.⁵

Figure 7 illustrates apparatus which has been evolved for the purpose of adding a visible signal indication record to a magnetic sound film; this consists of a magnetic pickup head of the ring-shaped kind (recognizable in the photograph by the circular side plate held in position by screws) which is arranged in contact with the magnetic

coating on the film on which sound has already been recorded. This head picks up the recorded signals and the induced currents are fed to an amplifier, rectified, and applied to an electro-mechanical device located adjacent to the magnetic head. This device carries a stylus, in a somewhat similar manner to a gramophone needle, at the end of the arm shown protruding from the casing. The device is energized when the rectified signal currents are fed to it and the stylus, which is of the metallic alloy kind described above, traces a visible signal indication of the type shown in Fig. 1-C corresponding to the adjacent magnetically recorded sound signals. From this trace it will be seen that periods of silence are indicated by a straight, unmodulated line while sound passages are indicated by modulation of the

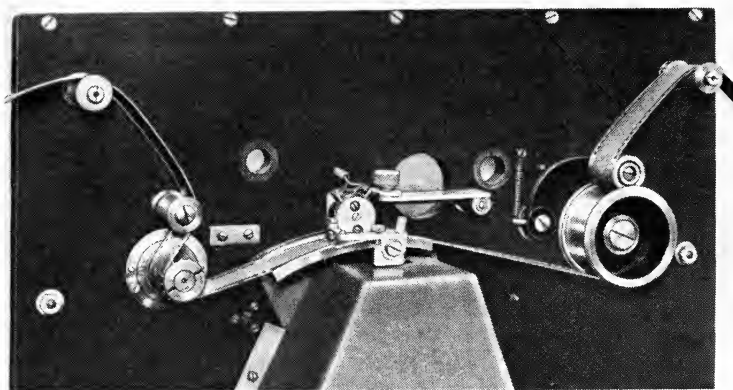

Fig. 7. Apparatus for adding a visible signal indication record to the magnetic sound film.

line. By these means the beginning and end of words and sound passages can be easily and accurately located whereby the editing and precise cutting of the magnetic sound record is greatly facilitated.

Joints

During the editing and cutting of the magnetic sound films a certain amount of trouble was experienced at first when making the joints as it was found that steel scissors and film splicers having steel plates and cutters often tended to magnetize any such joints made with them.

Magnetization caused in this way is only partly removed by running the film over the usual erasing head as the latter loses contact near and on the joint and therefore effects only a partial erasure.

Two ways have been evolved for overcoming this difficulty.

When it is only a question of joining a number of scenes and editing the different takes, the quickest method has been found to be to join the individual lengths of film together in the usual way and to punch a hole (either round or preferably diamond-shaped) through the position of the joint on the sound track as shown in Fig. 8-A. The cutting, splicing and punching tools for carrying out this operation should be nonmagnetic and preferably made of nonferrous material; in this respect tools made of beryllium copper have so far proved to be the most satisfactory.

However, should the cutting and punching be done with steel tools it has been found that demagnetization of the joint with an erasing tool helps to make it silent.

This erasing tool or, as it is better known, "magnetic brush," consists of an iron bar surrounded by a coil which is connected to the ordinary mains current supply. The tool which, in effect, constitutes a low-frequency magnetic field, is provided with a handle and this gives it the appearance and ease of handling of a soldering iron.

This instrument has proved very satisfactory in all cases where small amounts of remanent magnetism have had to be removed from

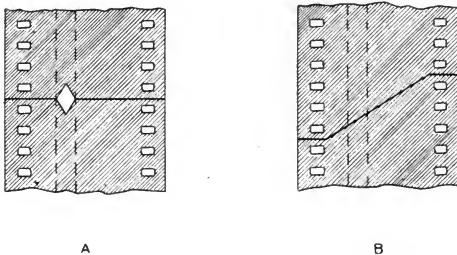

Fig. 8. Magnetic sound film joints (A, for joining separate takes; and B, for joining lengths of stock wiped for re-use).

film joints or other small articles by simply touching or gently brushing it over the item to be demagnetized.

The second method of eliminating remanent magnetism from film joints has been found to be of most value in cases where lengths of wiped stock (film stock from which a previous recording has been erased) are joined together and again made available for recording. In this case it has been found best to remove all existing joints, including those punched through in the manner described above, and to make fresh oblique joints of the kind shown in Fig. 8-B. This type of joint has proved to be very satisfactory in practice as well as being silent and it is even possible to record sound signals over such a joint, after demagnetization, without any noticeable effect when the sound is reproduced.

Bulk Wiping

The magnetic film stock is generally kept for the sake of convenience in the form of reels or spools and the erasing or wiping is usually effected by unwinding the film, drawing it past a magnetic erasing head, and then rewinding it on to a further spool.

However, as large reels up to a length of one thousand feet or more are usually employed in practice, it will be appreciated that a considerable time is needed to carry out the erasing operation while there is always the danger of insufficient demagnetization at the joints due to loss of contact with the erasing head and the necessity of paying particular attention to the demagnetization of them.

It would therefore be highly advantageous if the recorded signals on a whole reel could be erased in a single operation without the

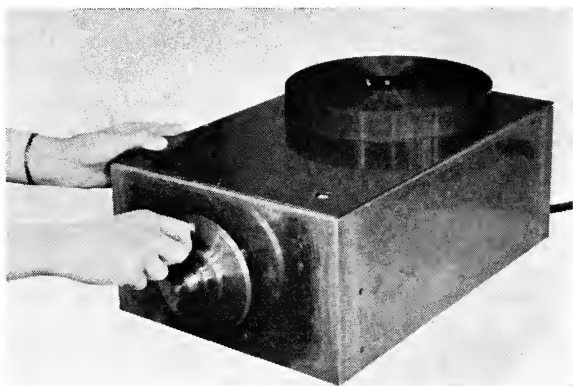

Fig. 9. Laboratory model of apparatus for wiping magnetic film in bulk.

necessity of the reel being rewound, that is, so that the magnetic signals are erased while the film itself is maintained in a reeled, i.e., bulk form.

Such means for the bulk wiping of magnetic sound records have been devised and consist of a turntable upon which the reel is rotated in mutual combination with the translatory movement of an electro-magnet which produces an erasing field.

Figure 9 illustrates the original laboratory model of the apparatus which has been evolved. The film is placed on the turntable which is then rotated by means of the handle through internal gearing. A lead screw forming part of the drive mechanism also drives an electro-magnet toward and then, upon reversal of the direction of rotation

of the handle, away from the rotating reel of film so that this is evenly and uniformly demagnetized throughout, including all the joints in it.

Conclusion

The use of magnetic sound in the motion picture studios has only really just begun and the evolution of a new technique to handle it to its best advantage has not yet been fully completed.

While there are many instances where photographic stock cannot be used for practices for which magnetic stock can now be employed it is difficult to visualize any developments which will bring magnetic sound actually into the cinemas because of the commercial as well as technical difficulties of replacing photographic sound there.

The answer to the question which is often asked as to whether magnetic recording will ever completely replace photographic recording seems to be: No. Rather, does it appear that there will be a happy combination of the two kinds of recording: the magnetic recording in the studios up to the time when the final photographic negative is prepared from which the release prints are made, and the photographic system, as now, in the cinemas themselves.

Nevertheless, there may be applications of magnetic sound, tentative as yet, in which it will play an ever increasing part as, for instance, in the preparation of recorded television programs where the fact that the magnetic sound records do not need processing is a great attraction.

REFERENCES

1. E. Schüller, ETZ, Bd. 56 (1935).
2. U.S. patent applications for "Method for magnetic sound recording" filed in the U.S. Patent Office, Oct. 2, 1941; published under Serial No. 413380 on May 18, 1943.
3. Pedersen and Poulsen, U.S. Pat. No. 873083, Dec. 10, 1907.
4. Carlson et al., U.S. Pat. No. 1640881, Aug. 30, 1927.
5. *Nature*, Aug. 1, 1942, p. 153.

Improvements in Large-Screen Television Projection

By T. M. C. LANCE

CINEMA-TELEVISION, LTD., LONDON, ENGLAND

AT THE INTERNATIONAL TELEVISION CONFERENCE held at Zurich in 1948, Captain A. G. D. West read a paper in which he described the project which he had formulated for providing large-screen television to cinemas in London. In this paper he discussed the sources of program material, the distribution plan, the installation in the cinemas and other features, including the need for higher definition and the study of audience reaction.¹

Previous Demonstration

After Captain West had read his paper at Zurich he pressed ahead with the objective of showing realistically the salient points of his plan for cinema television in a series of demonstrations to many interested bodies at a cinema in Bromley, Kent.² Each of these demonstrations included programs built up partly from the B.B.C. transmissions and partly from our own film scanner and studio at Sydenham.

The press comments were highly complimentary, and Captain West was extremely enthusiastic over the opportunity given to Cinema-Television to bring our equipment to Milan and demonstrate it in cooperation with the Marconi Company at this great Exhibition.

During the last year our technicians have had many second thoughts, some of which have been incorporated in this first design of equipment and others have still to be further experimented with in the laboratory. We have also learned much about the performance of this unique type of equipment in theaters, about the presentation of television programs and the problems of meeting the stringent conditions imposed by the public safety authorities.

It is against this background that I am presenting my paper today. I propose to indicate the general arrangement of the projector being

REPRINTED, with a few parts omitted, from *British Kinematography*, vol. 15, pp. 178-190, Dec. 1949, by permission of *British Kinematography* and the author. The paper was read at the International Television Congress at Milan on September 13, 1949, at which it was followed by a demonstration of the equipment, in conjunction with Marconi transmitting equipment.

demonstrated here in Milan, to describe some of the improvements made since last year and to consider future work for the extension of these improvements.

Reception Requirements

The first essential requirement for the projector was to be able to receive either programs of national or sporting interest through the B.B.C. Television Service, or supporting or similar programs over the cinema organizations' private circuits.

While the Television Advisory Committee has laid down that in England the standards of transmission for the broadcast television service will remain fixed for a number of years, the standards selected for the cinema's own circuits are at present their own concern. The opportunity will, therefore, be taken to increase the number of lines and the bandwidth in order to reduce the cause of the major criticism of large screen projection.

The dual transmission necessitated the receiver operating first on the 405-line, 2/1-interlace standard transmitted from Alexandra Palace in North London on 45 megacycles/sec, and alternatively on the 625-line 2/1-interlace standard transmitted from the Crystal Palace in South London on 480 megacycles/sec.

We have approached this problem in two ways. Firstly, the receiver has been designed to receive the 480 megacycles/sec as a super-heterodyne having an intermediate frequency of 45 megacycles/sec, which can be brought into operation as a straight receiver by changing aerial inputs when program sources are changed. Such cinemas would be fitted with a double aerial system. In this system the choice of program is the responsibility of the individual cinema exhibitor.

Short-Wave Relay System

The second and more interesting proposal is to receive the B.B.C. program from the Alexandra Palace at a conveniently placed relaying station and retransmit both programs to the cinemas over the 480-megacycles/sec circuit. This may prove a solution to the problem of interference from automobiles, electric signs and machinery in the West End theater district, because on the higher frequency a better signal-to-noise ratio may be expected through the use of directional aerial systems, particularly if at a later date a higher frequency is allocated to this new service.

This second system has the great advantage of bringing the whole television circuit under the control of one program director, so that

preselected introductory material can be transmitted before an eagerly expected event the nature of which does not allow of accurate timing. Thereby one of the criticisms of instantaneous projection in comparison with the intermediate film method of large screen television is removed.

The relay station chosen for the first experiments stands on the highest ground in the South of London, and our aerials are located on the top of a water tower in the grounds of the Crystal Palace, giving an undisturbed coverage of the London basin containing most of the suburbs, and particularly the West End area.

I would like to remark that it is a peculiarity of English television that, while being so eminently modern, it seems to be located in nineteenth-century palaces, the Alexandra Palace and the Crystal Palace, neither of which is in fact a palace and one of which does not now exist.

Construction of Equipment

The circuit of the receiver and the video chain of the projector are similar to those being described by Mr. J. E. B. Jacob in a separate paper to this convention.³

Figure 1 is a block diagram of the projector which shows considerable simplification over that shown last year.

To meet installation requirements the equipment is divided into four groups of units:

1. The units contained in the projector itself, which is located in the auditorium and should for this reason contain as little equipment as possible;

2. The units contained on the racks in the television operating room, which can be remote up to 100 ft from the projector, and by virtue of the separate picture monitor and indicating instruments need not be in a place where the large screen can be seen by the operator;

3. The high-tension unit which can be located anywhere within the cinema building; and

4. A small control unit which can be installed in the auditorium or the projection box at which small adjustments can be made to the picture quality, brightness, electrical focus and sound volume.

Video Chain

The function of the main units in the video chain is self-explanatory from an examination of the diagram. It will be noted that a gamma corrector is included. This is only at present an approximate correc-

tion for the nonlinear characteristics of certain studio cameras used in the transmission and can be cut in and out at will by the operator. Further work is planned in the design of this corrector as it may be desirable to have a variable gamma control.

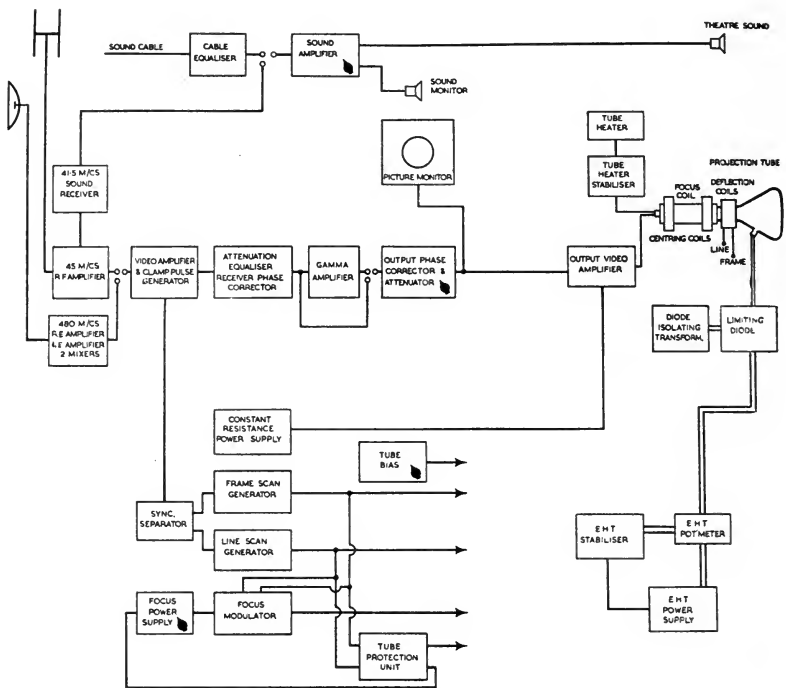

Fig. 1. Block diagram of projector system; power supplies and stabilizer are omitted for clarity.

Position of Projector

The design of this projector was commenced with certain experience and knowledge gained from operating a smaller projector with a half-scale Schmidt system.

We knew that larger optical systems could be designed and manufactured, and would give a resolution good enough for 625-line definition, and we also knew the luminous efficiency of our phosphors.

We decided that as much of the electrical equipment as possible was to be placed outside the auditorium for reasons just given, but where should the projector itself be placed? A survey was made of a large number of London cinemas; as Captain West showed last year,

most London cinemas have a circle, and the film pictures are projected down from the operating box at steep angles to the screen, having sufficient depth of focus to accommodate the variation in projection distance and sufficient illumination to allow the use of nondirectional screens. The Schmidt system for television, however, cannot be more than 10° off normal axis to the screen, so that in most cinemas the television projector must be located either on the front of the circle or on the floor of the auditorium. The front of the circle or balcony is, of course, the ideal position, but the throw distance is peculiar to each cinema and such an installation would in general call for individual "tailored" design of the optics. The cost and time occupied to complete and manufacture each optical system would, under these conditions, be prohibitive.

The suggestion has been made that to maintain projection normal to the screen the projector could be hung from the roof on a hydraulic cylinder, which would lower it into position when required and retract it when the film projector was operating; but there are very few cinemas in London where this device would not obscure the viewing of at least 20% of the audience.

Optical System

The decision was made to standardize on a 40-ft throw from projector to screen, and the system designed by Imperial Chemical Industries, Ltd., to our specification, consists of a mirror 27 in. (68.5 cm) in diameter, and a correcting plate which has an aperture of 18 in. (45.7 cm).⁴ The speed of the system is $f/1.14$, the magnification being 27.7, which, to cover a screen diagonal of 20 ft requires an image on the cathode-ray tube of 8.66 in. diagonal. The angular field of the optical system is 14° each side of the axis.

Cathode-Ray Tube Assembly

Figures 2 and 3 illustrate the general assembly of the cathode-ray tube and optical system.

1. The 27-in. diameter glass mirror with the front surface aluminized and weighing 85 lb (38.5 kg) is supported in rubber-lined clamps. These clamps are arranged so that the lower two which bear the weight of the mirror are spaced at 45° each side of the vertical, as with this disposition there is the minimum distortion of the mirror due to its own weight.

2. Is a black shield of the same diameter as the face of the tube placed on the axis of the mirror to prevent reflection of light back from the tube onto its own face, thereby reducing contrast in the picture.

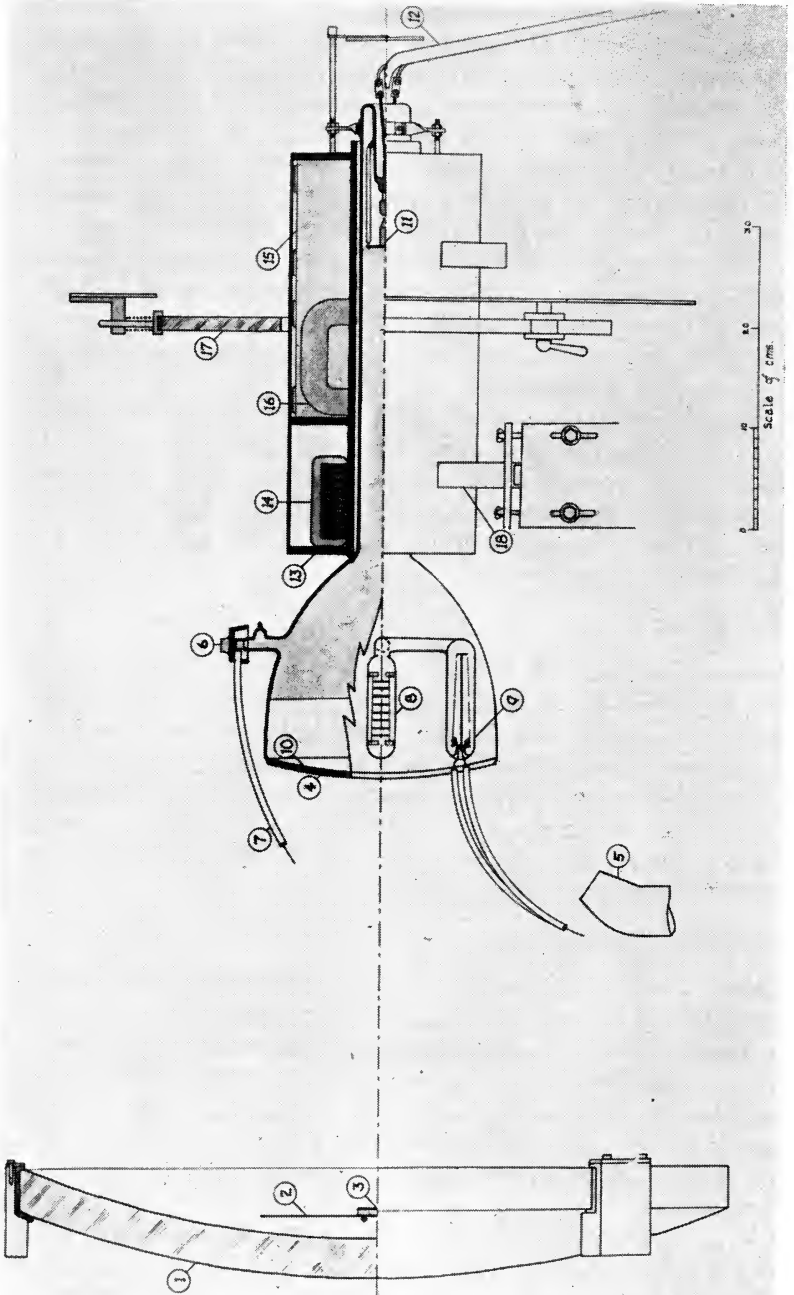

Fig. 2. Cathode-ray tube and optical system.

3. On the center of this plate is a selenium photocell which measures the average brightness of the picture and the reading of which is indicated back on the control equipment. This cell is used to indicate the average beam current, as all tubes are calibrated in the laboratory and marked with the reading of the photocell current corresponding to 1-ma beam current of the tube.

4. Is the face of the projection tube. This is an optically polished hard glass disc, the radius of which is approximately half the radius of the mirror. This plate carries the phosphor which is bombarded by the electron beam on one side, and to restrict the temperature rise of

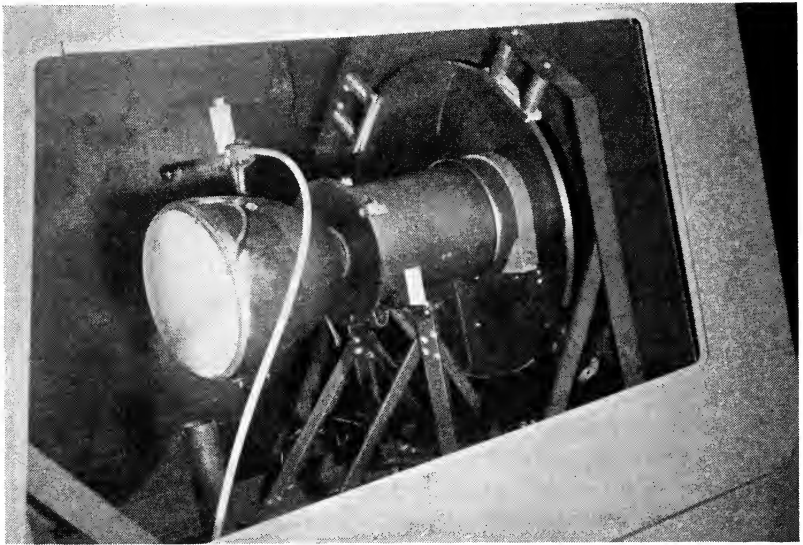

Fig. 3. Assembly of cathode-ray tube and corrector plate.

the phosphor, air at room temperature is blown across the face from an air nozzle. In the future it is planned to treat the outer face of the tube with an antireflecting coating.

5. Is the air nozzle, the design of which is quite critical to give uniform cooling over the whole face without noise. These two requirements go against each other, and a compromise has been found which is reasonably successful on normal television programs.

6. Is the anode connection to the tube made through an internal wire connection welded to a large platinum disk pressed into the inner surface of the glass envelope. The size of the disk is sufficient to ensure a low resistance contact to the graphite internal coating of the

tube. The tube is exhausted through the side tube carrying the anode connection.

7. Is the lead-in cable which is polythene-insulated. The diameter of this cable is surprisingly small, but on d-c conditions is adequate for 60 kv without trouble.

8. Is one of the two getter tubes. This one contains 12 batalum getters which can be fired by high frequency. The first is fired when the tube is manufactured and first sealed to the pump. At certain periods during life two or more additional getters are fired to maintain a good vacuum.

9. The second getter tube contains a zirconium wire getter which is continually heated during the running of the tube and the use of which has been found very advantageous. Unfortunately since the getter is near the anode coating it is necessary to maintain it at anode potential which involves a heating transformer insulated to full anode volts and two extra H.T. connections.

10. Is the electron-permeable aluminum coating applied to maintain the phosphor at anode potential and prevent "sticking," and which also considerably improves the contrast of the picture by obscuring internal reflection of light. The presence of the aluminum film also enables us to use a bright tungsten cathode, and the light from this, which is considerable, is also obscured.

11. Is the gun assembly which will be described separately, but attention is drawn to the heavy connectors necessary to maintain stabilized heater voltage with the heavy current of 14 amp required by the tungsten strip cathodes.

12. Is a small air jet, which is directed into the pinch, for the purpose of cooling the pinch and copper lead-out wires. Note that the assembly ends with an obscuring disk to prevent the light from the cathode falling directly onto the viewing screen.

13. A crucial point of the design is a thick polythene insulating sleeve tested to withstand 100 kv to earth, which provides the main insulation between the tube and the scan and focus coils which are at earth potential. Initially we relied on the glass neck of the tube to provide this insulation, but although each piece of glass was given a prolonged test at double working voltage we had many losses of tubes due to the puncturing of the glass after a few hours' run. The insulating sleeve is welded to a disk of the same material which protects the scan coils against flash-over from the outer surface of the glass on damp days.

14. Is the deflection unit. This consists of four windings on an iron-toothed stator having 30 teeth. In order to obtain the insulation

required the minimum wall thickness of the sleeve under the scanning yoke is 6.5 mm, and the problem of supplying sufficient scan current in these coils is very difficult, particularly at 15 kc, which is the line frequency for 625 lines, and also as the coils appear at the end of a long cable.

15. Is the focus coil. This is a complicated and costly unit. It consists of a long solenoid embracing the electrode system of the tube and having eight parallel windings so as to give the minimum practical resistance. The focus current is modulated at line and frame frequency, a worth-while improvement for high-voltage tubes having large deflection angles.

16. Is two sets of deflection coils, one used to center the beam in the focus coil and the other to center the scanned area or raster, on the face of the tube with the optical system. This electrical method of centering removes the need for accurate mechanical adjustments and greatly facilitates the realignment of tubes when these have been changed. In the same way we have found that only one in four of the tubes requires readjustment for the centering in the optical system to allow for the axial alignment of the tube neck to face. When the center of curvature of the tube has been placed on the axis then the adjustment to center the raster on to the center of the viewing screen is very slight and can be made electrically.

17. Is the correcting plate. This is held in four grooved rollers, the upper two of which are spring loaded and the other two are on eccentric rollers so that the plate can easily be centered on the optical axis while maintaining its parallelism to the mirror. In setting up these large Schmidt systems we have found that the spacing between the mirror and the correcting plate is uncritical, and we may in future make the correcting plate easily removable for tube changing, as this would simplify the internal arrangements of the tube mount.

18. The tube is held in position by being pressed into the polythene sleeve in the front and lightly clamped by the screws at the rear. Thus tube and focus coil mount are inserted into the optical system as one unit when a change is necessary. The focus coil mount is carried in the optical system on two girders made to be very rigid in the vertical plane, but designed to obscure as little light as possible. These girders are supported at the ends outside the optical path on adjustable supports.

Construction of Cathode-Ray Tube

The next most important item of the projector is the cathode-ray tube. Continuous improvement has been made in the performance

of the projection tubes under the arduous conditions called for by the specification. The tube produces 900 lm of luminous flux at 50 kv and a beam current of 5 ma. On a television picture the average current is generally about 1–1.5 ma. with peaks between 10–15 ma.

Figure 4 shows the external appearance of the projection tube alongside the focus and deflection unit previously described. The optically polished and curved face, the double getters and the electrode system can be easily recognized.

The main body of the tube is a mould-blown glass bulb, and all the parts are constructed of the same boro silicate glass manufactured by Chance Bros. and known as "Hysil." The face is sealed to the bulb in a special jig, gas fires being used in the normal manner. All the glass is given a preliminary E.H.T. test to double the working voltage,

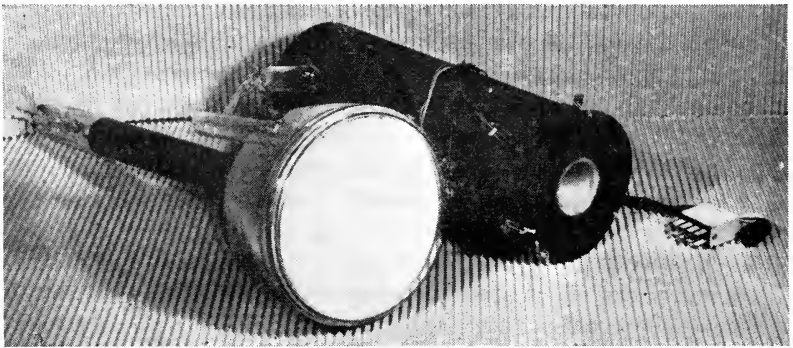

Fig. 4. Projection tube and coils.

as many failures have been traced to minute bubbles in the neck ionizing under working conditions and bursting.

Electrode System

The tube is a simple triode with the anode and modulator carefully cleaned and polished to reduce point discharges and cold emission at 50 kv.

The main problem was that of obtaining sufficient emission to give a focused beam current of 15 ma, and of the many cathode structures tested the most satisfactory was the flat top filament tape of pure tungsten. This was superior in that the unfocused beam was substantially circular, and hence made better use of the available focusing and deflection aberration-free areas, and also the spot passed through focus in a more symmetrical manner.

The dimension of the flat plateau of the cathode is approximately 1.5 mm square, and the thick tungsten strip was mounted in a rigid assembly with filament support radiators, which were found essential to avoid overheating the pinch, with resulting cracking. This cathode gives 10 ma for a 0.0025-in. spot at 50 kv, and requires a heater current of 14 amp at 2.05 v. The anode/modulator spacing is 3.5 mm, which results in a 9-deg beam angle for a drive of 430 volts at 1,040 volts cut-off. These spot sizes are made at 10 ma as a point of reference, but it should be noted that very little swelling occurred on increasing the beam current to 15 ma.

Pulse Testing

For testing the tubes and in particular for the measurement of focused spot diameter under full load conditions, a simple pulse modulation circuit was developed. It was desired to examine the spot sizes and shapes under a microscope for a series of experimental electrode systems. The specification calls for a 0.0025-in. (0.063-mm) diameter spot for 10-ma beam current at 50 kv. These projection tubes require about 1,000-v bias, and to avoid screen burning with a stationary spot a circuit was devised which provided as a drive a pulse of quarter-microsecond duration, variable in amplitude up to 1,000 v. In this a length of transmission line of 100-ohm characteristic impedance is terminated by a ladder attenuator of 100-ohm input impedance, through a spark-gap consisting of two points separated by an intervening gap, across which passes an electrically floating spoke rotated on a synchronous motor shaft. The line is charged through a high series resistance from a 3,000-v source, and when discharged by the gap gives a square pulse across the attenuator. The latter is necessary to reduce the high charge voltage implicit in the spark-gap discharge, and is also convenient for applying varying grid drives as required.

Beam currents are measured by the standard slide-back method, with the modification that to avoid heavy loading of the tubes, the d-c measurement is taken by applying a similar but broader pulse derived from a trigger circuit with cathode-follower output. The beam current pulse resulting from this modulation is readable on an oscilloscope suitably calibrated. The apparatus is simple and has given satisfactory service.

Cooling

A series of experiments have been made on liquid cooling and air cooling the face of the projection tube. It was found that the light

output measured under peak white conditions dropped by about 10% when the temperature of the outside face was raised from 20 C to 100 C; the temperature of the screen material itself under steady-state thermal conditions was then about 90° higher than the outside temperature.

The main difficulty in the problem of cooling the phosphor is that the thermal conductivity of the glass is low. Unfortunately in order that the tube shall withstand the atmospheric pressure with safety, particularly considering the bending moment on the glass seal, we have to use a plate 5 mm thick. From the point of view of thermal conductivity the phosphor layer corresponds to an extra 1 mm of glass. If, however, the face seal could be made in a manner whereby the stresses across the joint were normal to the radius at that point then the glass could be reduced to at most a third of this thickness, thus reducing the thermal conductivity so that the cooling of the phosphor would not be a serious problem, and an increase in luminous efficiency could be expected.

Experiments with an air blower have shown that there is a good possibility of obtaining adequate cooling by this means, and we are experimenting in the design of a silent nozzle to give an air jet to maintain the tube face at room temperature.

Effect of Heat on Phosphors

Experiments made 18 months [early 1948] ago on the effect of temperature rise, show that the efficiency of the yellow silicate dropped by 50% at 120 C, which meant that for satisfactory operation the outside face of the projection tube would have to be maintained at a temperature of less than 0 C, and plans were seriously discussed for cooling the face by a liquid cell; the projector would then have to include a small refrigerator.

The improvement in the temperature effect brought about by 18 months' work in phosphor development is clearly shown in Fig. 5.

(a) Is for a blue sulfate which we were forced to use at that time in the absence of any other blue phosphor;

(b) Is the temperature characteristic of an early projection silicate; while

(c) Is the best projection silicate at present available.

It has become obvious to us that the design of the projection cabinet must be very carefully worked out to restrict the entry of dust and moisture. It may even become necessary that heaters will have to be included to prevent condensation within the cabinet when the apparatus is not in use.

If these precautions are not observed carefully, brushing and sparking will occur over all the high-tension insulators and surfaces of the electrical equipment, as well as on the optical components.

Phosphor Development

To the nontechnical observers of our projection demonstrations over the past 18 months, the principal improvement has been in the color of the picture. Formerly the picture was a greenish-yellow, now it is a blue-white, giving a good color contrast with the subdued red lighting demanded by the authorities for cinemas in England.

However, we still regard phosphor development as the most important item in our program. We have to date produced two components which give the required color with reasonable brightness

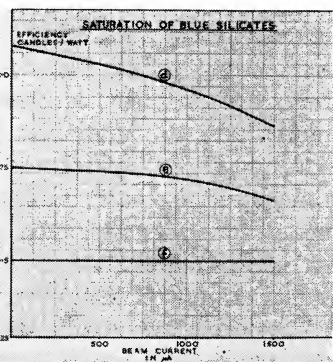
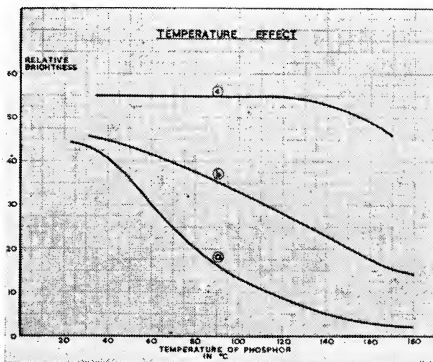

Fig. 5. Temperature effect on phosphors.

Fig. 6. Efficiency of phosphors.

when mixed, and which saturate to an equal amount, so that color changes with modulation are not noticeable. We have to a certain extent reduced screen burning, but there is still the serious disadvantage of outgassing of the phosphor during life to be overcome.

The control of particle size is also under investigation, as it is essential with a mixture of two phosphors to avoid color separation in the screen and to produce a uniform thickness of screen to assist the deposition of the aluminum film which has to lie in close contact with the phosphor.

The particle size of the two phosphors is under 5 microns, and the blue component is under 1 micron. The screen thickness averages 100 microns, and the density is about 8 milligrams per square centimeter. The aluminum film has a thickness of 0.1 to 0.2 micron.

The two components of our screen are both silicates, and approxi-

mately 800 experimental phosphors were made before we obtained a formula which has produced a blue silicate which shows no saturation effect under test conditions at 50 kv and a focused current of 1.5 ma. This is shown as curve (f) on Fig. 6. This test condition corresponds to a screen loading of 2 amp/sq cm; the peak white conditions will, of course, be ten times this.

The other two curves are (d) the most efficient blue silicate which can be obtained, which, it will be seen, has an efficiency roughly double our non-saturating phosphor at low beam currents, but also shows the highest saturation effect; and (e) which is the phosphor being used in the present tubes.

Aging of Phosphors

During life under projection conditions the phosphor suffers from a change of body color, and as this is observed as a darkening, it is known as "screen burning." This effect in some phosphors is reversible, and the darkening can be reduced by heat treatment; but there is also a darkening of the glass which is not reversible, and which has been assumed to be solarization due to the X-ray action on the glass. We have proved that when the glass is in contact with manganese-free phosphors this effect can be reduced to within 10% of the light absorption for a screen life corresponding to a life of the tube determined by the evaporation rate of the tungsten cathode.

The problems for the future are to overcome these adverse effects and also aim for an increase in luminous efficiency. The best phosphor in Fig. 6 has an efficiency of only about 1 c/w. We have always set the physicists the target of 5 c/w. We do not know if this is theoretically possible; but, if it is, then we can predict a big step forward in projection television.

E.H.T. (Electrical High-Tension) Supply

One very important item on which considerable work is at present being concentrated is the E.H.T. supply. With a triode tube of the dimensions given the regulation and stabilization of the E.H.T. demands very close tolerances if defocusing on load is to be avoided. At the same time precautions have to be taken to limit the energy from the power pack in the event of a discharge within the projection tube.

We are at present using large 50 cycles/sec voltage-doubling rectifier units which can give 10-ma continuous output at 55 kv. These are prewar in design and very cumbersome, but have given reliable service in a number of installations.

The regulation of the rectifier is between 65 kv on open circuit to 55 kv on 10-ma load, which is not sufficient. Originally we had stabilization on the primary of the transformer, but this does not eliminate ripple in the pack or take up rapid changes; a new circuit has therefore been evolved, shown in Fig. 7, which gives a control to 1%. This is built around the development of a special high-voltage stabilizing triode and a high-voltage limiting diode. The operating of these tubes is self-explanatory, but it is still essential to place the diode as close to the projection tube as possible in order to reduce the energy

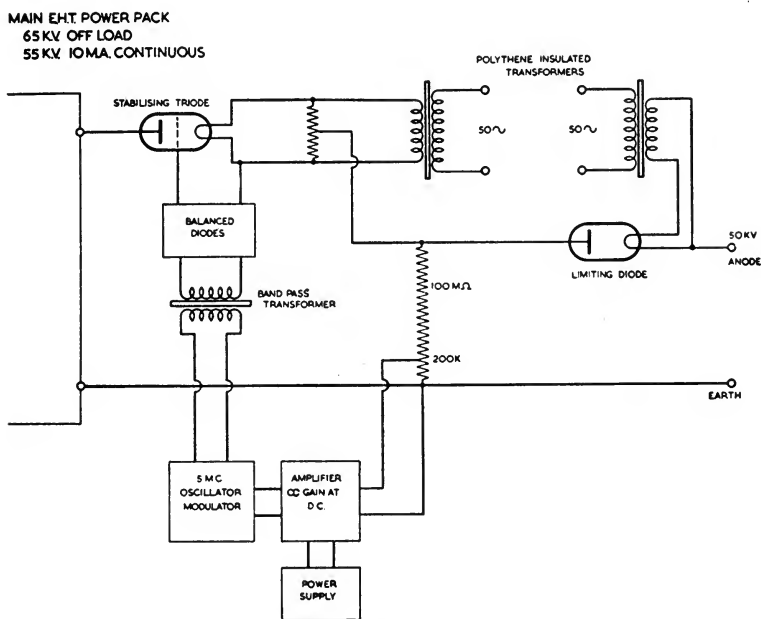

Fig. 7. E.H.T. supply circuit.

involved in the discharge of the cable capacity between the diode and the tube, within the tube.

Special high-voltage transformers of small dimensions have been evolved for this circuit. Their design has been made possible by the use of polythene-insulated wire and the application of the new technique of welding polythene screens over the windings.

Conclusion

To summarize, this paper has briefly described some of the many problems which have been attacked in the development of our

cinema television projector; improvements introduced during the last 18 months [up to a year ago] have been indicated and certain clues have been given to future developments.

In conclusion I wish to enumerate those of my colleagues to whom credit is due and gladly acknowledged for the solutions to the main problems involved in the cinema television projector. To Mr. T. C. Nuttall for general advice throughout our work; to Mr. E. D. McConnell for his consideration first of the optical requirements and then of the design of the whole of the electrical equipment excluding the receiver and video chain which Mr. J. E. B. Jacob evolved; to Dr. K. Samson and Mr. W. H. Buchanan for the development of the projection tubes and special triodes and diodes; to Mr. R. B. Head for his work on the phosphors and the many others within and outside our organization, who played their part as the happy team directed by our late chief, Captain West.

I must thank Cinema-Television, Ltd. for making it possible for me to be here in Milan and for permission to read this paper.

REFERENCES

1. *Brit. Kinemat.*, vol. 13, No. 6, p. 183, Dec. 1948.
2. *Brit. Kinemat.*, vol. 14, No. 1, p. 19, Jan. 1949; *Ideal Kinema*, p. 27, Jan. 1949.
3. "High quality television monitors," to be published in *J. Br. Inst. Radio Engineers*.
4. *J. Telev. Soc.*, vol. 5, No. 3, p. 86.

Trends of 16-Mm Projector Equipment in the Army

BY JAMES A. MOSES

ARMY PICTORIAL SERVICE DIV., OFFICE OF THE CHIEF SIGNAL OFFICER, DEPARTMENT OF THE ARMY, WASHINGTON, D.C.

SUMMARY: The Army's use of 16-mm sound motion picture projection equipment during the past decade is outlined. A brief description of the Army standard 16-mm projector set AN/PFP-1 is given, with particular reference to features which provide increased light and sound output, higher sound fidelity and improved maintenance characteristics.

"To make available portable 16-mm projectors capable of giving satisfactory performances in the extreme sub-zero temperatures of Alaska, Iceland and Greenland, or the tropical heat and humidity of the South Pacific and the China-Burma-India Theater, as well as overcome the factor of wear and overuse at home in training millions of men and women in every phase of the complexities of w-a-r." THAT was the unprecedented assignment with which the Signal Corps and Army Pictorial Service were confronted in the early part of the past war. The time, money and effort expended and the degree to which this challenge was met is a story in itself, yet in presenting a comprehensive picture of the trends in Signal Corps 16-mm projectors during the past decade it will be necessary to elaborate upon certain exploratory work and resultant findings of the war years as well as to show numerous "flash backs" to trace the progress from early adoption and use, through World War II and the postwar development, testing and adoption of the new Projector Set AN/PFP-1(-) which has been especially designed by the Signal Corps to meet the rugged requirements of the Army. Methods employed at present, or in future projects, for improving projection techniques, effecting greater care and proper handling of projectors or alleviating certain maintenance problems, yet maintaining extreme portability, will also be covered.

Although a satisfactory 16-mm sound-on-film projector appeared on the commercial market in 1931, for the next ten years the Signal Corps limited the scope of 16-mm projection activities to tests and experiments. However, with the passage of the Selective Service Act in 1940, induction of thousands of men into the military service and formulation of plans for the use of 16-mm training films in the audio-

PRESENTED: April 24, 1950, at the SMPTE Convention in Chicago.

visual program, almost overnight the requirements for 16-mm films and sound projectors mushroomed into a large-scale operation. The Signal Corps Photographic Laboratory at the War College printed sizable quantities of 16-mm reduction prints from their 35-mm negatives and, as utilization of the new prints was contingent upon availability of suitable 16-mm projection equipment, local "off the shelf" procurements of several commercial models resulted. Selection of the 16-mm equipment was made after three weeks of testing during which time each type of projector was subjected to approximately 500 hr of continuous operation.

The turn of events on December 7, 1941, and entry of the United States into a shooting war initiated a greatly expanded program of photographic functions and operations within the Signal Corps. The Chief Signal Officer was assigned the responsibility at the outset for providing visual training aids, which included: the production and distribution of training films; combat photography for both military and historical purposes; morale of troops in presentation of entertainment motion pictures; and photographic laboratory, development and research. The scope widened further, with the progress of war, to cover all aspects of ground photography and, in some cases, it was necessary to take to the air. No precedents had been set to guide the task of supply that had to be accomplished in a comparatively short period of time; and the organization of pictorial activities and operation of procurement, storage and issue, starting with a system of trial and error, emerged into the Signal Corps' present Army Pictorial Service.

No planned procurements for projection equipment and supplies were in existence until late 1942, when Army Pictorial Service established the Photographic Equipment Branch to review requirements and initiate procurement action for various major items of projection and other pictorial equipment. Signal Corps specifications for projectors were practically nonexistent at that time. However, with the establishment of the Pictorial Engineering and Research Laboratory (PEARL) in early 1943, the Army standardization of projectors and other pictorial materials was begun. It was also a responsibility of the Laboratory to investigate, design and develop new types of photographic equipment. There the nucleus of what is now the Photographic Branch of Squier Signal Laboratory (SCEL), Fort Monmouth, N.J., commenced to make tests of 16-mm projectors and allied equipment, to write procurement specifications, training manuals and technical literature. Viewed in retrospect, it was a tiny and seemingly inconsequential organization in relation to the part it was des-

tined to play in one of the greatest photographic assignments the world has ever known.

During the period 1942-1945 the Signal Corps procured more than 16,000 16-mm projectors from several commercial manufacturers. This equipment offered the advantages of portability, ease of operation, low cost and availability. Naturally the maintenance and operation of several different types of projectors posed many problems in the field, yet these were due to the unusual requirements of the Army rather than any shortcomings of the commercial models. Cumulative utilization data show that during some of the most intensive thirty-day training periods more than 200,000 prints of 16-mm training films, almost a quarter of a million shows, were projected to military personnel; in addition, thousands of 16-mm entertainment films were being shown during this same period in overseas areas. Such usage is a lasting testimonial to the performance of the civilian model 16-mm projectors which were suddenly mustered into the Army and handed a seemingly impossible assignment. Equipment which had been designed for civilian use was often employed to project under conditions equal to and sometimes surpassing those recommended for 35-mm projection equipment. Performances at extreme temperatures and under other conditions of global warfare made the operation of each 16-mm projector of the Signal Corps an individual problem, with such factors as overuse, fluctuating electrical supply, fungus growth, corrosion and improper lubrication facilities contributing to the complexities. In spite of the climatic conditions, wear and frequent lack of parts for a particular type of projector, no difficulties arose which could not be overcome by improvisation, local fabrication or substitution. For example, if exciter lamps were not available, jeep and motorcycle tail lamps were modified and used instead of the regular exciter. This and many other ingenious methods were responsible, time and again, for "keeping the show going."

The importance of properly trained operating and maintenance personnel was recognized from the outset and resulted in establishment of projectionist schools in all film libraries and exchanges and projector repair shops in centrally located spots in the Zone of the Interior and theaters of operations. Pickup and return of equipment and films were restricted to duly accredited graduates from the projectionist schools. These licensed operators were also authorized to replace lamps, belts, fuses and tubes, and to clean and lubricate the projectors. Equipment requiring higher echelons of maintenance was sent to the projector repair shops. These preventive

measures greatly assisted in minimizing damage to both equipment and films.

Although no 16-mm projector, designed for military use, was produced during the war, the models delivered to the Army during the later years of World War II represented a considerable improvement over their prewar counterparts.

The first move toward development of an entirely new 16-mm sound projector was the creation of the "Joint Army-Navy Specifica-



Fig. 1. Projector Set AN/PPF-1() 16-mm motion picture sound equipment.

tion, JAN P-49" on May 31, 1944. Although the JAN Specification assured the performance characteristics required for military use, it provided no means of standardization or interchangeability of parts, between successive procurements. The importance of parts uniformity and interchangeability was already being noted because of recurrent problems of the field in attempting to satisfy the maintenance requirements of several different types of projectors. This was further influenced by such accessory circumstances as: (1) the fact that replacement of existing equipment was not anticipated for a

minimum of three years; (2) factual experience had proven that maintenance demands increase with the age of the equipment.

The JAN P-49 Specification was used as a basis for the Signal Corps Development Specification SCEL 4001. On May 2, 1946, a contract was awarded to the DeVry Corporation for development of a 16-mm projector designed primarily for Army use. Experimental models of this equipment were delivered to the Signal Corps Engineering Laboratories in December, 1947, where subsequent engineering tests resulted in a number of minor modifications. In January, 1950, modified test models were received by SCEL and these were made available for extensive service tests which were conducted under cognizance of Army Pictorial Service Division, Office of the Chief Signal Officer. Accumulation of the test data was effected by a series of tests held at Fort Myer, Fort Belvoir, Fort Meade, Fort Monroe and the Pentagon. An attempt was made to observe and evaluate the performance of the test models under all available conditions presently required by the Army. Continued use of the test projectors, under varied conditions, indicated improvements in light and sound output, sound fidelity and maintenance facilities. Such characteristics permit improved projection, in Department of the Army theaters, recreation halls, etc., to large audiences. The test models were used for both single unit and dual projection to various size groups, in film library projectionist schools, in film library maintenance shops, and were issued to units for showing Army training films under actual classroom conditions, in exactly the same manner as is employed for utilizing present 16-mm equipment.

A "Questionnaire" was prepared and issued to all units testing the new models. This form requested the users to indicate either "satisfactory" or "unsatisfactory" about the following: picture brightness and image quality on matte screen, sound quality and volume; ease of threading; ease of adjusting projection lamp for maximum uniformity and brightness; lens focusing adjustment; tilt adjustments, rewinding operation; switching arrangement and convenience in operation; change-over operation, amplifier controls; lower loop setting device; framing adjustment; picture gate closing; noise of projector mechanism; flutter content; installation, servicing, cleaning and/or sufficiency of projection and exciter lamps, condenser and projection lens, aperture and pressure plates, sprockets and rollers, fuses, belts, reel arms and attaching cables; size, weight and ease of carrying; and over-all physical design and construction of the equipment.

A consolidation of the test data submitted by the users indicated unanimously favorable comments on all items of major importance and was so conclusive that the few minor modifications and changes made necessary by the test report did not require further testing before final adoption of the equipment. On February 27, 1950, the Projector Set AN/PFP-1-() was classified standard type by Signal Corps Technical Committee action.

Before presenting further information about requirements for certain features included in the newly developed equipment, it is best that a description of the projector set AN/PFP-1 be given (Fig. 1).

This three-package unit consists of a projector, 20-w amplifier and speaker, with a screen and other accessories included as supplementary

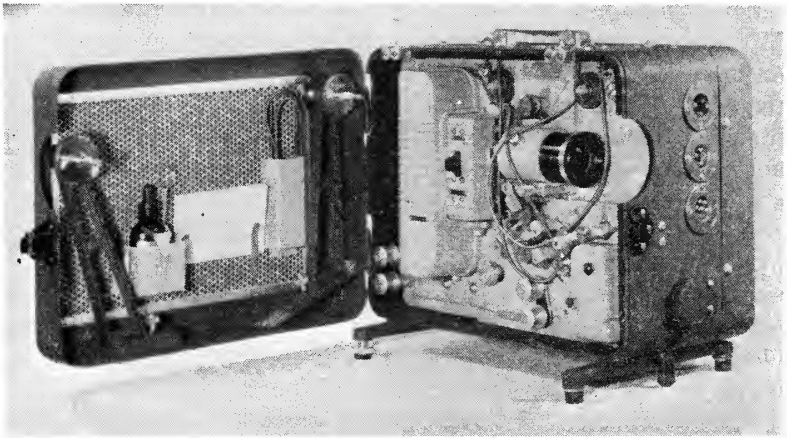

Fig. 2. AN/PFP-1-() Projector Component; case door open, showing location of reel arms, spares and accessories.

items in the set. The equipment has withstood all tests pertaining to severe temperature and humidity conditions. The projector is released expressly for use with incandescent lamps; however, provisions have been made for use of a supplemental light source where greater illumination is required and this unit will be portable in nature and packaged in a fourth case. In development, particular attention was given to the corrosion protection of the projector, amplifier and loudspeaker. Where corrosion-resistant material was not practical due to design limitations, suitable treatment was given the material to assure its being satisfactory and durable. Basically the projector machine mechanism is comprised of a central casting of aluminum which is

treated so as to afford the maximum protection from corrosion. The use of aluminum affords a weight reduction which is essential in order to meet the portability requirements and still have adequate strength and minimum vibration.

The general design of the projector (Fig. 2) is such that it features replacement by assembly and subassembly, it being understood that a motion picture projector is essentially a precision device and that frequently personnel involved in the maintenance of the projector would be insufficiently trained to make a basic mechanical replacement where such replacement involved a high degree of mechanical skill. This resulted in making an assembly of the motor and gearbox and a major assembly of the soundhead, so as to allow storage of this unit

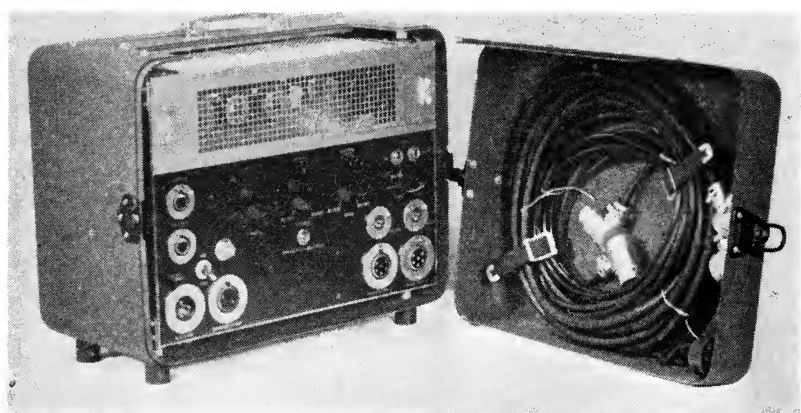

Fig. 3. AN/PFP-1(-) Amplifier Component; cover removed, showing location of photocell cable, changeover harness and bridging cable.

and rapid replacement where the essential film and test instruments are not available for its correct alignment after repair.

The shuttle and cam comprising the intermittent movement are accessible from the front of the projector and can be replaced by relatively inexperienced personnel in less than a half hour. Further, it is unnecessary to remove any other part of the projector mechanism in order to gain access to the intermittent. This system is designed to permit film movement with two damaged or torn perforations and framing of the picture on the screen without shift of the projected aperture.

The amplifier (Fig. 3) features complete accessibility for replacement of defective parts or for checking of its performance electrically.

It, too, is constructed in accordance with component requirements and is suitably protected against corrosion, fungus and high humidity conditions.

The loudspeaker (Fig. 4) is an 8-in. permanent-magnet cone speaker which has withstood all tests with regard to mechanical strength, vibration and shock. The case-deadening material utilized is glass fiber pads forming an acoustic sound-deadening material impervious to the effects of extreme temperature, humidity or fungus.

Close attention has been paid to operational convenience throughout the entire design and the threading of the projector is straightforward with a minimum number of sharp turns. Three basic features have been incorporated into the projector for greater convenience. They are: (1) location of a threading knob on the side with index marks to indicate when claw is projecting, thereby facilitating matching the perforations to the shuttle teeth; (2) lower loop length adjustment is provided by a small diagonally facing knob located under the intermittent and change-over housing. This device permits correct presetting of the lower loop for film having varying degrees of shrinkage or wear; (3) an exteriorly operated loop setter. The lower loop can be reset while the projector cover is closed by pressing the reset button on top of the projector. As has been noted above, almost all of the components are removable as assemblies. Where such is not the case, they are mounted on sub-panels to allow movement without wiring discontinuity.

The projector proper is operative from either direct current or alternating current of voltage ranges from 105 to 129 v. The amplifier is a 60-cycle a-c unit operating over the same voltage range. A converter is required where direct current is the normal supply. The projector and amplifier will perform satisfactorily on either 50 or 60 cycles without change of the mechanism and the equipment performs equally well at both frequencies. The projector motor itself utilizes an electrical centrifugal governor for its speed control, the cooling or associated motor not being governed but of the same essential electrical components as the projector motor.

The projector is provided with a one-point central lubrication system containing an oil supply adequate for 100 hr of continuous operation. The intermittent shuttle and cam are supplied by this oiling system and no grease is required for their operation.

The electromagnetic change-over system functions without relays and is motivated by a press button located in the rear of each projector on the switch panel. By these means projector change-overs are

accomplished instantaneously. The change-over wiring is supplied as a harness and normally carried with the amplifier since the change-over is designed for operation on alternating current. An exciter-lamp type of change-over is used for sound and a dowser interposed between the first condenser and light source for the picture.

The normal light sources for the projector set are 750- and 1000-w projection lamps, medium pefocus base, 115-v, 25-hr life. To overcome the element of error in the pefocus base, a mechanical lamp

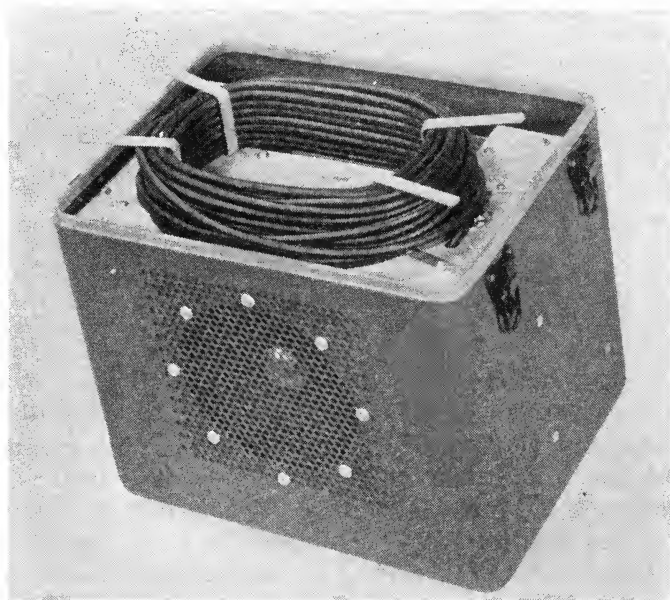

Fig. 4. AN/PFP-1(-) Loudspeaker Component; showing cover removed and location of cable.

base shifter is built into the projector so that the whole lamp assembly can be shifted horizontally and laterally in such a manner as to assure maximum screen illumination. Once the lamp is properly positioned it will require no further attention throughout its life.

The soundhead used in the projector was developed under specifications which set standards equally as rigid as those established for 35-mm reproduction. The exciter lamp is made readily accessible by the removal of the exciter-lamp cover. Light from the exciter lamp, as projected through the optical system and modulated by the film, is

picked up by a prismatic type of light pipe and transmitted to the rear of the soundhead casting where it is reflected to the lead sulfide photocell, which is rigidly mounted on the soundhead casting, thus eliminating all photocell microphonics.

It is fitting, at this point, that credit be given to the Society of Motion Picture and Television Engineers and its committees for making available to the Armed Forces and to industry a fine series of test films without which the projection equipment just described could never have been developed, since it is essential first to have the tools for measurement before any product can result.

The improved features contained in the equipment just described did not come about by mere arbitrary action, but each is the result of considerable study regarding the relative potency of particular requirements. Throughout the entire development program, however, two factors have been carefully considered. These are: (1) maintenance of Army 16-mm projectors had been difficult and costly because of the lack of assemblies and subassemblies. This condition was further aggravated, in many cases, by the absence of qualified projector repairmen; (2) average attendance and conditions under which films are projected in the Army show definite needs for greatly increased sound and light output and higher sound fidelity. It should be re-emphasized that factual information resulting from evaluations made during what was the largest full-scale training, educational and entertainment film program ever undertaken, has provided immeasurable guidance on many matters pertaining to development of the Projector Set AN/PFP-1. Perhaps unsatisfactory showings of entertainment films to groups of two thousand men in New Guinea or lack of adequate sound or illumination during the showing of training films in the Post Theater at Camp Hood, are partially responsible for increased sound and light output in the new design. Low voltages encountered in the Mediterranean, or the South Pacific, undoubtedly played a major role in the provisions for a compensator for fluctuating and low voltages.

The postwar period has made some interesting and helpful contributions, too. Continued increases in Regular Army film usage, together with that of National Guard, Organized Reserves and ROTC, further indicate the requirement for 16-mm equipment with greater sound and light output. Utilization data obtained by a consolidation of Film Library Reports for the period from October 1, 1949, through December 31, 1949, shows that Signal Corps films were shown more than 228,000 times to audiences totaling more than

17,500,000, or an average of 76 persons per individual show. This high average means that many of the showings were attended by several hundreds and even thousands.

The Army and the Signal Corps have not relied solely upon the development of a new 16-mm projector to improve conditions surrounding the use of Army training films. Other similar projects are:

(1) New Special Regulation, distributed in November, 1949, which outlines latest procedures to be observed in the operation of film libraries and film and equipment exchanges. This regulation includes a detailed course of instruction for 16-mm projectionists and covers proper care and storage of equipment;

(2) A new training film entitled *Technique of Good Projection* is in process of production. This film will impress the projectionists with the importance of adding a "professional touch" to Army projection. The outline for a second training film entitled *Principles of Operation of the Projector Set AN/PFP-1* is now being prepared; and

(3) Last, but of equal importance, is the Instructional Film Research Program in which the Army is participating along with the Navy and Penn State College in an effort to determine better the techniques which can be most profitably employed in the future to assure *better films* and their *better use*.

Foreign Versions

By VICTOR VOLMAR

MONOGRAM INTERNATIONAL CORP., NEW YORK, N.Y.

SUMMARY: Dubbing, subtitling and related production techniques are described. Spoken and written language rules and pitfalls are noted, and taboos are tabulated.

BEFORE OUR AMERICAN MOTION PICTURES can be exhibited to non-English-speaking peoples, they have to be either "dubbed," subtitled or narrated in the foreign language.

Dubbing is a tedious process of substituting words in the foreign language for those spoken by the players in English. It is important that the substituted speeches be as long as the original ones, and that the lip movement be the same, especially on the closing sound of each speech.

The prevailing system for dubbing in America has been that of making loops, one endless loop for each scene. Each loop is about thirty feet long and is played over and over again, while the foreign speakers listen carefully for their parts and may suggest changes in the wording. After a good deal of practice and a number of trials, they finally decide to attempt the recording. While the picture is run off silently, the sound shut off or heard on only one earphone, the members of the group speak their parts in the pretranslated foreign language. The scene is then immediately sent to the laboratory for developing and printing and is played back the next day, together with the music-and-effects track, with which it eventually will be mixed, i.e., printed together. The scene is edited, i.e., cut, or done over again, if necessary.

Several operations are necessary in order to subtitle pictures. Each picture has to be "spotted." Spotting is the fixing of the exact length and position of the subtitles. A no-splice print has to be secured for the spotter. With the print on a miniature combination of motion picture projector, screen and loudspeaker called a "moviola" (Fig. 1), on which the film can be played forward and back and stopped, the spotter enters, on a full continuity (a list of all the words spoken in the picture), the exact footage for each scene. Then he types what is called his spotting list and on it he condenses the dialogue in accordance with the footage for each scene, to enable the audience to read

A CONTRIBUTION: Submitted July 13, 1950.

the subtitle as well as to look at the picture. The spotting list, on which the spotter also indicates who is speaking to whom and gives additional information and explanations necessary for comprehension of the action, is then given to the various translators who translate the



Fig. 1. Spotter Nat Hoffberg, with the latest type Moviola. Hoffberg, who started in the business many years ago, did his first spotting from Vitaphone records when frames destroyed in the picture had to be replaced by black frames, in order to maintain synchronization.

condensed dialogue into their respective languages, not exceeding the footage allowed for each subtitle.

Cards or a continuous roll are then printed with the foreign subtitles, and the laboratory, by means of a pre-cut control strip which ad-

vances each title at the proper footage, makes a full-length title negative (Fig. 2). Short or Debrise title negatives, which are cheaper and necessitate only a short title roll, because each title is printed only once, are less popular now, since there is as yet no machine which will make them adaptable for 16-mm prints. The procedure may vary somewhat with each laboratory.

Before starting to make the prints in the foreign languages, a foreign main-title background negative is needed, i.e., the beginning of the picture without all the titles and credits, so that the main titles and credits can be superimposed on it in the foreign languages. From the opening of the first scene, the picture is printed like any domestic print, except that the foreign title negative is run through the printer at the same time, so that the foreign titles (black on the title negative) appear transparent on the finished print and white on the screen. The sound track remains the same for the entire picture, except where there are narrations, which may be substituted in the foreign languages.

In addition, some companies first make a full-length negative of "scratch titles" in English, usually typewritten, which is then printed together with the picture negative and the resultant print is projected for examination of length and convenience of titles.

In the case of color prints, subtitles are added by various processes. Either the subtitles appear in a black frame at the bottom of the picture, or the titles are created by taking the emulsion off the base, by hot stencil, which burns the titles out of the color, or by the more popular stencil-etching process, in which the titles are etched out of the color. The last-named process was particularly successful in an Alpine picture, as the titles usually appeared on a white background, but the etching created a thin, colored line around each letter, which made it stand out perfectly.

Trailers follow the same procedure as pictures. The foreign trailer is printed from a trailer negative without lettering, plus a title negative, for which all large main titles and credits are photographed from hand-drawn cards, the same as the opening of a picture. The dialogue, translated in subtitles, is photographed from typeset printed cards (Fig. 3). The English sound track is usually kept for the foreign version, except where narrative parts may be substituted. Entirely new, independent trailers of important pictures may be made in the foreign languages, stressing in each the particular points in the picture that would especially appeal to that particular foreign-language audience.

Subtitling must be simple, direct and concise. Entire sentences

may have to be expressed in a few words which will fit into one, two or at most three lines at the bottom of the projected image. Difficult words and ambiguity must be avoided. To this end at least one large company, from time to time, sends a selection of the most difficult and controversial titles to an outside translation bureau for their retranslation into English, to see whether they will convey the proper meaning.



Fig. 2. John Casolaro, of the C & G Film Effects Co., at the camera, photographing titles for superimposition. Title negatives for foreign versions are produced on this camera.

For some countries, such as Belgium, pictures are subtitled in two languages, French and Flemish. For others, such as Egypt, as many as four languages are used, with two sets of titles flashed from slides onto each side of the screen, with possibly a live or recorded narrator's voice in a fifth language.

Again, other countries, like Italy, Spain and Western Germany,

will permit only dubbed versions to be shown. They are also preferred in France and usually are done in France.

The system of narration mentioned above is particularly suited for the lesser-used languages, like Arabic, which many can understand but few can read. A sound track is made of a running explanation of the happenings on the screen and is mixed with the sound-and-effects track, and sometimes even with the original English dialogue, which is then heard in the background.

In examining the situation in the leading languages, we may turn first to Latin America, where Spanish is spoken with slight variations in vocabulary and pronunciation by nineteen nations (including Spain itself), so that it is impossible to assemble a dubbing crew to suit them all. This is one of the reasons why even the largest companies are abandoning the dubbing system in favor of subtitling, at least for Spanish and Portuguese. Another reason is that many foreign moviegoers, though they may not understand a word of English, still prefer to hear the players' real voices, especially when these are famous for diction and delivery. There are other foreign patrons who speak English and would resent it if the original dialogue were eliminated, and there are still others who go to the cinema not only to be entertained but also to learn English. It is probably no exaggeration to say that motion pictures, as an agent for the dissemination of the English language, rate second only to the presence of the members of our armed forces in many parts of the world.

Several foreign governments now see, in subtitling, a means of encouraging the far-flung masses to learn to read and write, and therefore insist on correct grammar and the latest spelling for each picture. Thus motion pictures contribute considerably to the eradication of illiteracy abroad.

Pictures made in Spain can be relied upon for having dialogue spoken in the pure Castilian of Spain, with hardly any slang. Slang is mainly the product of a metropolis, and Spain has no real metropolis. Both Madrid and Barcelona, the latter being Catalanian, besides, are cities of only one million inhabitants. The same is not quite true of pictures made in Argentina. These definitely bear the linguistic imprint of a big city, Buenos Aires. Mexican pictures, which in the past have been woven mainly around rural life, contain a number of Mexican expressions which are not readily understood elsewhere.

Spanish pictures made in Spain are linguistically acceptable to Hispano-American audiences, but American pictures, if they were dubbed by Spaniards, would not be. The Latin American objects to the "ceceo." There is something like a "neutral" Hispanic pronun-

ciation, that, for instance, of the radio broadcasters from this country and from the British Broadcasting Company. However, it is difficult to obtain such "neutral" pronunciation from all the members of

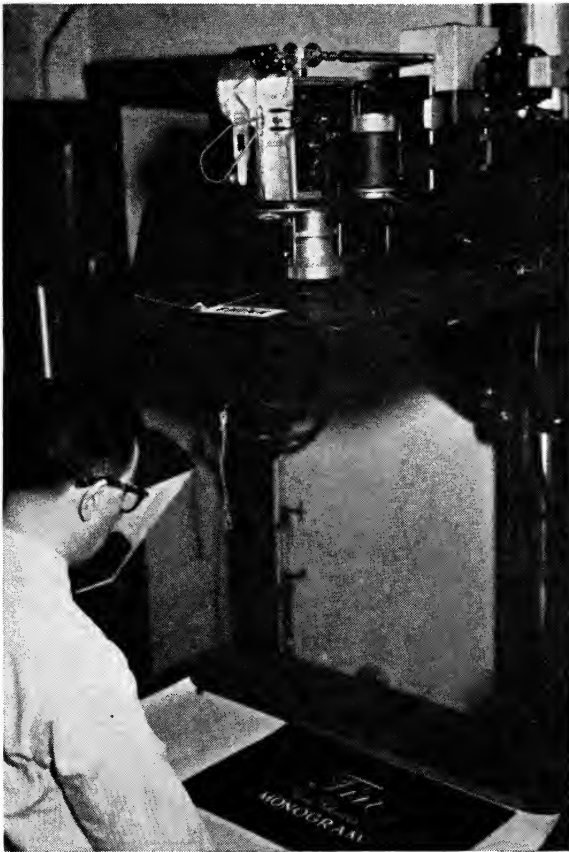

Fig. 3. Hugo Casolaro, of the C & G Film Effects Co., at an animation stand, which is used to photograph hand-drawn cards, inserts and stills for pictures and trailers, and on which optical effects can be achieved.

a dubbing crew. The audience usually is able to determine immediately whether the dubbed voice is that of a Mexican, an Argentine, a Cuban or a Puerto Rican. Furthermore, dubbing, unlike radio news broadcasting, demands the use of colloquialisms. A cow hand cannot very well speak like a college professor.

Even in subtitling pictures in Spanish there are difficulties. Names of plants and animals, especially, change from one country to another. Translators must guard against regional expressions and those that have a double, sometimes objectionable, meaning.

Portuguese is spoken with slight variations in Brazil, where in some remote regions the ancient Portuguese still prevails, the same as Canadian French still contains many archaic French terms. Portuguese spoken in Portugal varies considerably from region to region, Portugal being an older country. Vocabularies of Portugal and Brazil also differ, and subtitled versions are made with the Brazilian vocabulary, as the Brazilian audience is so much larger. If no separate version is made for Portugal, some companies send their translations to Portugal for checking and then change only those titles which would not be properly understood in Portugal.

The Brazilian and the Portuguese Academies recently agreed on a common, simplified spelling. Although it is far from universally observed, this simplified spelling is usually used in the subtitles, or it should be. The latest edition of the *Pequeno Dicionário Brasileiro da Língua Portuguesa*, published in Brazil, should be consulted, and also, especially for the change of accents in the plural, the *Pequeno Vocabulário Ortográfico da Língua Portuguesa*, the official work of the Academia Brasileira de Letras, and approved by the Academia das Ciências de Lisboa.

French dialogue, which adheres to the speech of Paris, invariably includes a good deal of the "langage populaire," the popular lingo, which is somewhat between real argot (slang) and French. Everybody in France uses it, even in the best circles. It is a terminology which is not contained in textbooks or school grammars, but which one must know if one wants to converse in French. Sometimes regional accent is mixed in (mainly the Southern, such as that of Fernel, who is a Marseillais), but the body of the picture is always in French.

Dubbing is always done in the Paris pronunciation, which is about standard French, and French subtitles are in pure French plus the above-mentioned "langage populaire."

Italian films are invariably in pure Italian (Tuscan), unless there is dialect mixed in in spots. As in Spain, there is no slang in Italy, since the various dialects, which sometimes amount to separate languages, like Piedmontese, take the place of slang. Dubbing and subtitled should always be in pure Italian and should present no difficulties.

Though Dutch and Flemish are now spelled alike, the terminology varies in the two countries. Therefore separate subtitled versions are usually made, especially since Flemish always appears together with French subtitles since Belgium is a bilingual country. The pronunciation of Dutch differs considerably from that of Flemish, so that separate dubbed versions would have to be made for Holland and Belgium.

A similar situation exists for Denmark and Norway, where the written languages are about the same but the pronunciation varies greatly.

Swiss and Austrian audiences may resent it when subtitles and dubbing are done by Germans, as the terminology and the accent in pronunciation differ slightly.

Now a new problem has arisen in Indonesia, and at least one company is making versions subtitled in Dutch and Indonesian Malay, which is generally understood throughout all the islands, though each has its own language. Malay titles happen to be long, especially since the language forms plurals by repeating the nouns, i.e., orang is man and orang orang, men, so that the art of the translator will be to cut them down.

A few words may be added on the selection of foreign titles. These may be close translations of the original English titles, free translations, or altogether different. In many cases they have to be altogether different. A title like "Hellzapoppin," of course, could never be translated literally.

All foreign titles are accepted and registered by the Motion Picture Association, provided there is no conflict with the same or a similar title; or if there is, that an agreement has been reached with the conflicting company, so that, as a rule, no two pictures by American companies will be sent into the same territory with the same title. But there is no control over other than American pictures, and any title duplications with other than American pictures have to be adjusted locally.

It is not amiss also to point out that spotters, who are in a sense the foreign editors of a picture, and translators be men of general culture who, besides knowing at least two languages, should also have some artistic sense. A general or commercial translator or even a journalist usually cannot translate subtitles satisfactorily, at least not without some practice. It is desirable that the translator keep in constant touch with the intellectual life of the country or countries of his language, as he must be familiar with the latest developments in the lan-

List of Taboos

(See the last paragraph of the text for relative value of this list.)

	Superimposed titles	Dubbing before export	Any gun play	Excessive shooting	Riots in jails	Crime & gangsterism	Technique of crime	Murder	Executions	Corpses	Horror	Brutality	Bank robberies	Train holdups	Juvenile crimes	Cruelty to children	Rough treatment of women	Rodeo sequences	Any drinking scenes	Drunkennes	Drug habit	Kissing scenes	Excessive sex
Argentina
Australia	x	x
Belgium
Bolivia
Brazil	x	.	x
Burma	x	x
Canada
Ceylon
Chile	x
China (until 1949)
Colombia	x
Costa Rica ²
Cuba
Czechoslovakia	x
Denmark	x	.	.	.	x
Dominican Republic
Ecuador ³	.	.	.	x	x
Egypt ³	x	.	x	.	.	x	x	.	.	x	.	x
El Salvador	x	x
Finland
France ³	x	x
French Indo-China
Greece	x	x
Guatemala
Haiti
Honduras
India	.	.	x	x
Indonesia	.	.	.	x
Iran	x	x
Iraq
Ireland
Israel ⁴
Italy	x	x
Jamaica	x
Lebanon
Mexico
Netherlands	.	.	.	x	x	x
Neth. West Indies	x
New Zealand	x
Nicaragua
Norway	x	x
Pakistan
Panama
Paraguay ⁵
Peru	x	x
Philippines	x
Poland
Portugal	x
Siam ⁶	x	.	x	.	.	.	x	.	.	.	x
Singapore ⁷	.	.	.	x	x	x	x	x	.	.	.	x	x
South Africa	x	x	.	x	.	.	.	x	.	.	x	x	x
Spain
Sweden	x	x	x	x	.	.	.	x
Switzerland	x	x
Syria
Trinidad	.	.	.	x	x	x
Turkey
United Kingdom
Uruguay	x	.	x	x	x	x
Venezuela ⁸

¹ Province of Quebec.

² Practically no censorship.

³ Lenient.

⁴ Lenient but getting

Immorality	Nudity	Divorce	Obscene story	Vulgar titles	Bad English	Spitting	Details of surgery	Mental Hospital scenes	Religious propaganda	Anti-Semitism	Support on country's religion	Support of superstition	Acroy: contributors	Attacks on Zionism	Anti-contributors to Zionism	Anti-Arab attitude	Attacks on régime	Impersonation of the King	Labor on royalty	Lauding violence	Resistance capitalism	Resistance movement	
	x																					Argentina	
																							Australia
																							Belgium
																							Bolivia
																							Brazil
																							Burma
																							Canada
																							Ceylon
																							Chile
																							China (until 1949)
																							Colombia
																							Costa Rica ²
																							Cuba
																							Czechoslovakia
																							Denmark
																							Dominican Republic
																							Ecuador ³
x	x																						Egypt ⁸
x																							El Salvador
																							Finland
																							France ³
																							French Indo-China
																							Greece
																							Guatemala
																							Haiti
																							Honduras
																							India
																							Indonesia
																							Iran
																							Iraq
																							Ireland
																							Israel ⁴
																							Italy
																							Jamaica
x																							Lebanon
																							Mexico
																							Netherlands
																							Neth. West Indies
x																							New Zealand
																							Nicaragua
																							Norway
																							Pakistan
																							Panama
																							Paraguay ⁵
																							Peru
																							Philippines
																							Poland
x																							Portugal
																							Siam ⁶
x																							Singapore ⁷
x	x																						South Africa
																							Spain
																							Sweden
																							Switzerland
																							Syria
																							Trinidad
																							Turkey
																							United Kingdom
																							Uruguay
																							Venezuela ⁶

stricter. ⁵ No censorship. ⁶ Very lenient. ⁷ Extremely severe. ⁸ Severe.

guage, especially with popular expressions. One can imagine what effect it would have on an American audience if a soldier of World War II were called a doughboy.

In the tabulation herewith are shown taboos in the various countries of the world, including the English-speaking ones. This list was compiled mainly from issues of the "Motion Picture and Equipment Bulletin" of *World Trade in Commodities*, published by the U.S. Department of Commerce. It is necessary to point out that the number of checks after the name of a country do not necessarily form a criterion for its severity. These checks merely state on what grounds pictures have been rejected in the past, usually because they were found objectionable to an extreme degree under the particular headings. Other countries with fewer checks may be more severe, but as motion picture companies know this they will not even send pictures into these countries if they expect rejections, or they will edit the pictures in advance. For a few countries in the table the author has not found any recent, definite information, so there are no x marks.

A Progress Report of Engineering Committee Work

By F. T. BOWDITCH, ENGINEERING VICE-PRESIDENT

THE SEPTEMBER JOURNAL lists 19 Engineering Committees with a total of 313 members. More than 40 separate projects are presently under review by these groups; some have one project each, others as many as 10. So it is obviously impractical here to review all this activity in any detail. Instead, this report will be confined to a few highlights which indicate current trends.

One trend is the considerable increase in the number of committee meetings being held, in large part the result of the excellent coordination and secretarial activities of our Staff Engineer, W. H. Deacy, Jr. Ten such meetings are scheduled during the five days of this Convention, which is, as far as I am aware, a new high in this form of activity. Much of this is engineering survey work, such as that of the Screen Brightness Committee in its investigation of 100 typical theaters from coast to coast, the excellent work of the Color Sensitometry Subcommittee, the High-Speed Photography Survey, the study of air conditioning by the Theater Engineering Committee, and many others equal in importance to these few examples.

Also of major interest is the committee work in the field of standardization, where—to name only a few—typical projects now include the preparation of a new film leader suited to both television studio and motion picture theater projection, a method of calibrating and marking camera lenses in terms of light transmission, the specification of a standard base for a new projection lamp, the dimensional characteristics of magnetic sound tracks, and the continued work in the field of cutting and perforating motion picture film.

We have yet to find a satisfactory answer to the basic problem of when to standardize. An excellent time would be early in a new art, before machines and methods in different companies become fixed in conflicting fashion, but basic information is meager then. Unfortunately, too, the need to standardize is not usually anticipated until actual conflict arises, and the resolution of the differences cannot help but cause economic loss to someone. Standardization becomes extremely difficult in such a case, although it is a pleasure to report increasing evidence of cooperative give-and-take in these matters. The

PRESENTED: October 17, 1950, at the SMPTE Convention at Lake Placid, N.Y.

extremely important function of the Society in providing a neutral meeting ground cannot be underestimated and everything possible is being done to maintain this impartial atmosphere.

Present trends are also represented by the new Engineering Committees formed this year. One of these is the Optics Committee, under Dr. R. Kingslake, which is presently concerned with the lens calibration standards and the dimensional properties of projection lenses. Our newest Engineering Committee is the Test Film Quality Committee, under F. J. Pfeiff. It is charged with the responsibility of maintaining the high production standards which are an essential part of this very important activity of the Society. Finally, the increasing importance of the engineering work of the Society in the television field has been recognized by a realignment and expansion of our committee organization there. The Theater Television Committee, under Don Hyndman, of course continues, and to this have been added new ones: Television Studio Lighting under Richard Blount; Films for Television under R. L. Garman; and, jointly with RTMA, Television Film Equipment with F. N. Gillette as chairman, representing RTMA, and E. C. Fritts as Vice-Chairman, representing SMPTE.

The real strength of the Society, which determines how well we continue to be regarded as the foremost technical group in matters concerning television and motion pictures, lies as much in this work of the Engineering Committees as it does in the high quality of the papers presented at the Conventions and in the *JOURNAL*, and in the many important management functions conducted through the Board of Governors. The writer is indeed grateful to the many Engineering Committee chairmen and members involved, and to the Staff Engineer, who discharge these important responsibilities so capably.

Biological Photographic Association

In 1931 a group of some thirty medical photographers met in New Haven to exchange ideas about their work. As a profession, theirs was one of photography's youngest, but these delegates had worked in it sufficiently to believe in its importance. They were also discovering that medicine's needs for new types of illustrations could not be filled by workers who remained each in his own darkroom, unaware of the experiences of others.

Medical advances were posing such problems as (to mention some in the motion picture field alone): records of surgical procedures made under aseptic conditions; films showing the movements of internal organs such as the vocal cords, the eardrum, the stomach; cinemicrographs of minute organisms; lapse-time photography of growth, as in the development of bacterial colonies; high-speed records of reflex motions; serial photographs of the fluorescent screen, etc. Much of this work entailed the use of precision instruments; all of it called for careful experimentation. Obviously, a clearinghouse was needed for the exchange of information.

Because medical photography is so closely allied with clinical and research medicine, the delegates decided that their organization should be formed as a scientific rather than a trade society. Its aim should be the advancement of photography through the free exchange of ideas. Membership is open to any individual, professional or amateur, who applies photography to the study or teaching of science. Since there is an interrelation of problems over a wide field, the society's scope has not been limited to medicine alone. The organization was named the Biological Photographic Association, the term "biological" covering all branches of science concerned with living forms.

In its subsequent years of growth, the BPA has developed in accordance with these charter plans. It is an incorporated, nonprofit organization, whose members are scientists, teachers, designers of precision equipment, naturalists, and, of course, a growing core

of biological photographers. Chapters have been formed in Boston, Mass.; New York, N.Y.; Philippi, W.Va.; Cleveland, Ohio; Chicago, Ill.; and Los Angeles, Calif. Foreign members are eligible and are increasing in number.

The Journal of the Biological Photographic Association is at present in its eighteenth volume. It is the only journal which concentrates on the now well-established field of biological photography. Published quarterly, it comprises a volume of about 200 pp., describing the technics required in all phases of still and motion picture photography and photomicrography. General questions such as the planning of departments, the filing and projection of pictures, the preparation of exhibits, etc., are also discussed. Most back numbers are available from the Editor. Microfilm or photoprint copies of individual articles may be ordered through the Secretary.

Each September, the Association meets in a city chosen by the members. These annual sessions, through a varied program of demonstrations, round tables and original papers, offer the beginner an introduction to the field and the advanced worker a review of new developments. Important features are the Technical Exhibit for the display of equipment, and the Salon.

It is important for the biological photographer to know what is currently available, not only for his own sake, but because he may have to give advice on the purchase of photographic equipment to staff members of his medical school, hospital or research center. The Annual Salon of prints, transparencies and motion pictures offers a cross section of the best work being produced in biological photography. Awards are given for entries of outstanding merit. For work of consistent excellence over a period of years, or for valuable contributions to the field, the Association has since 1946 conferred the title of Fellow of the Biological Photographic Association on members approved for advanced rat-

ing by the Board. Other important awards are: for the outstanding biological photographer of the year; for the best paper presented at the meeting; and for the best article in each volume of the *Journal*.

Annual dues are \$5.00 including *Journal* subscription. Correspondence about membership should be addressed

to the Secretary, Lloyd Varden, Pavelle Color Inc., 533 W. 57th St., New York 19. Correspondence about manuscripts or nonmember subscription to the *Journal* should be sent to the Editor, Louis P. Flory, Boyce Thompson Institute for Plant Research, Yonkers 3, N.Y.

Microfilm copies of the *JOURNAL* are now available from University Microfilms, 313 N. First St., Ann Arbor, Mich. The *JOURNAL* will be available on microfilm only in a complete year, that is, the two 1950 volumes will be available sometime after the December 1950 issue is published. Microfilm copies will be made available only to those who have subscribed to the paper edition.

By using microfilm, the library may keep the printed issues unbound and let them circulate for the two or three years of greatest use. The microfilm is supplied on metal reels, carefully labeled, and is, of course, designed to supplant the bulky bound volumes which crowd the space of libraries. Microfilm editions cost about the same as binding a volume.

Films in Review is a new magazine now nearing completion of its first year of publication by the National Board of Review of Motion Pictures, Inc., 31 Union Square West, New York 3. Its editor writes that he will welcome contributions by all who have ideas which they would like to bring to a lay audience which is interested in the general aspects and quality of motion picture production as well as the aesthetic, economic, censorship and international phases of the art and industry. Illustrative material can be used, and 1500 words is the most desirable length of article.

Current Literature

THE EDITORS present for convenient reference a list of articles dealing with subjects cognate to motion picture engineering published in a number of selected journals. Photostatic or microfilm copies of articles in magazines that are available may be obtained from The Library of Congress, Washington, D.C., or from the New York Public Library, New York, N.Y., at prevailing rates.

American Cinematographer

vol. 31, no. 9, Sept. 1950
New "All-Direction" Baby Camera-Dolly (p. 307) L. GARMES
Shooting 16-Mm Color for Blow-up to 35-Mm (p. 308) C. LORING
New Three-Color Meter for Evaluating Illuminant Quality (p. 310) L. MOEN

Audio Engineering

vol. 34, no. 8, Aug. 1950
Transient Testing of Loudspeakers (p. 9) M. S. CORRINGTON
Imagery for Describing Reproduced Sound (p. 14) V. SALMON

Electronics

vol. 23, no. 9, Sept. 1950
Frequency-Interlace Color Television (p. 70) R. B. DOME

Ideal Kinema

vol. 15, Oct. 6, 1949
Kinema Technique and Equipment in Holland (p. 17) R. H. CRICKS
RCA Discloses Its Colour-Television Method (p. 25)

vol. 16, Feb. 9, 1950
Post-War Improvement in Projector Design (p. 19) R. H. CRICKS

International Projectionist

vol. 25, no. 8, Aug. 1950

Projector Shutters: Design, Performance (p. 5) L. DAVEE

Types of Projection Shutters Now in General Use (p. 8)

vol. 25, no. 9, Sept. 1950

Minimizing Flicker in Projection (p. 5)

R. A. MITCHELL

Uniform Screen Light Distribution; Elliptical Reflector Mirrors (p. 13)

R. A. MITCHELL

Motion Picture Herald

vol. 181, no. 1, Oct. 7, 1950

Technicolor Change to Reduce Costs Sharply (p. 35) W. R. WEAVER

Motion Picture Herald Supplement

(Better Theatres), Oct. 7, 1950

What About Three-Dimensions? Is It Practical? Is It Coming? (p. 63)

G. GAGLIARDI

Proceedings of the IRE

vol. 38, no. 9, Sept. 1950

The Present Status of Color Television (p. 980)

Mixed Highs in Color Television (p. 1003) A. V. BEDFORD

New Members

The following have been added to the Society's rolls since the list published last month. The designations of grades are the same as those in the 1950 MEMBERSHIP DIRECTORY:

- | Honorary (H) | Fellow (F) | Active (M) | Associate (A) | Student (S) |
|--------------|---|------------|---------------|---|
| | Albert, Harold R., Jr. , Production Supervisor, Motion Picture, U.S. Air Force. Mail: 16011 Manhattan Pl., Gardena, Calif. (M) | | | Motion Picture Distribution and Production, Shell Oil Co. Mail: 37 Poppy Lane, Hicksville, Long Island, N.Y. (M) |
| | Arvonio, John , Producer, Director and Sound Consultant, 750 Grand Concourse, Bronx 51, N.Y. (M) | | | Gunst, Margaret J. G. , Research Chemist, Denham Labs. Mail: 85 Harley St., London, England. (A) |
| | Braden, Hillis R. , Manager, Audio Visual and Photo Division, Hoover Bros., Inc. Mail: 1020 Oak St., Kansas City, Mo. (M) | | | Hamilton, Vernon P. , Motion Picture Laboratory Manager, Strickland Film Co., 220 Pharr Rd., Atlanta, Ga. (A) |
| | Craven, T. A. M. , Radio Consulting Engineer, Craven, Lohnes and Culver. Mail: 1242 Munsey Bldg., Washington 4, D.C. (M) | | | Hughes, Hovie H. , Motion Picture Producer, Edward Schumann and Associates. Mail: 118 W. Johnson St., Madison 3, Wis. (A) |
| | Crocker, Leslie C. , Motion Picture Photographer, American Television Productions, Inc. Mail: 24 Brookwood Dr., Maplewood, N.J. (A) | | | Kiel, John P. , Engineer, Producers Service Co. Mail: 6554 Blewett Ave., Van Nuys, Calif. (M) |
| | Dunn, Walter E. , Head, Purchasing and Maintenance, Century Theatres, 132 W. 43 St., New York 18, N.Y. (A) | | | Knight, Paul , Engineer, J. A. Maurer, Inc. Mail: 494 South Ocean Ave., Freeport, N.Y. (A) |
| | Faichney, James B. , Motion Picture Producer-Director, International Motion Picture Division, Department of State. Mail: 36 Violet Ave., Hicksville, N.Y. (M) | | | Kreuter, Adolph C. , Artist and Designer, Rockford Paint Manufacturing Co. Mail: 304 S. Horace Ave., Rockford, Ill. (A) |
| | Fuhlrott, Ruth A. , Research Chemist, Technicolor Motion Picture Corp. Mail: 8753 Dorrington Ave., Hollywood 38, Calif. (A) | | | McNary, James C. , Consulting Engineer, McNary and Wrathall. Mail: 906 National Press Bldg., Washington 4, D.C. (M) |
| | Gillette, Dale , Medical Photographer, Cedars of Lebanon Hospital. Mail: 429 N. Mariposa Ave., Los Angeles 4, Calif. (A) | | | Miles, John R. , Designer, John R. Miles Industrial Designs. Mail: 4821 N. Sheridan Rd., Chicago 40, Ill. (M) |
| | Golash, Edmund S. , Research Laboratory Assistant, Twentieth Century-Fox Film Corp. Mail: 9 Second Ave., New York, N.Y. (A) | | | Mills, Lt. Col. Morris H. , 4721 N. Chelsea Lane, Bethesda 14, Md. (M) |
| | Greene, Edward Jesse, Jr. , In Charge, | | | Nafzger, Lester H. , Chief Engineer, RadiOhio, Inc. Mail: 903 S. Roosevelt Ave., Columbus 9, Ohio. (A) |
| | | | | O'Brien, J. F. , Theater Equipment Sales Manager, Radio Corporation of America, RCA Victor Division. Mail: 245 Crystal Lake Ave., Audubon, N.J. (M) |

- Pangborn, Herbert W.**, Engineer in Charge of Television, Columbia Broadcasting System. **Mail:** 6512 Orion St., Van Nuys, Calif. (M)
- Parisier, Maurice I.**, Communications Expert, 1475 Broadway, New York 18, N.Y. (M)
- Piscitelli, Marco J.**, American Television Inst. **Mail:** 1433 W. Flournoy St., Chicago 7, Ill. (S)
- Queeny, Edgar M.**, Jarville Studios, Route 13, Mason, Kirkwood 22, Mo. (M)
- Reese, Warren B.**, Engineer, Macbeth Corp. **Mail:** 282 Hudson, Cornwall-on-Hudson, N.Y. (A)
- Romrell, Clarence**, Photographic Engineer, Tru-Vue. **Mail:** 1234 Glenhurst Court, Rock Island, Ill. (M)
- Rota, Luigi**, Director, Sociedad Radio-tecnica Ecuatoriana. **Mail:** P.O. Box 414, Quito, Ecuador, South America. (A)
- Sandell, Wesley R.**, Quality Control Engineer, Eastman Kodak Co. **Mail:** 14633 Killion St., Van Nuys, Calif. (A)
- Schade, Otto H.**, Research and Development Engineer, Radio Corporation of America, RCA Victor Division. **Mail:** 32 Francisco Ave., West Caldwell, N.J. (M)
- Scharf, Erwin**, Motion Picture Director, City of New York. **Mail:** 72 Park Terrace West, New York 34, N.Y. (M)
- Sogge, Ralph H.**, University of Southern California. **Mail:** 942 W. 34 St., Los Angeles 7, Calif. (S)
- Thomsen, Jack**, American Television Inst. **Mail:** 6554 Stewart, Chicago, Ill. (S)
- Vadillo, Frank**, General Manager, Gran Bazar S.A. **Mail:** P.O. Box 160, Merida, Yucatan, Mexico. (A)
- Veideman, William R.**, Service Manager, Photo and Sound Co. **Mail:** 3548 18 St., San Francisco 10, Calif. (M)
- Viles, Frank L.**, Engineer, Television Broadcasting, Radio-Television of Baltimore, Inc. **Mail:** 4402 Roland Ave., Baltimore 10, Md. (A)
- Warner, James G.**, Motion Picture Technical Adviser, Kodak Ltd., The Mall, Lahore, Pakistan, India. (A)
- Warren, Dave**, Salem College, Salem, W.Va. (S)

CHANGES IN GRADE

- Balakrishnan, A. V.**, Graduate Assistant, Electrical Engineering, University of Southern California. **Mail:** 1166 $\frac{1}{2}$ W. Adams Blvd., Los Angeles 7, Calif. (S) to (A)
- Bent, William W.**, Field Executive, Boy Scouts of America. **Mail:** 4313 Normal Ave., Los Angeles 27, Calif. (S) to (A)
- Buckner, Ralph E.**, 1155 N. Sycamore Ave., Hollywood 38, Calif. (S) to (A)
- Horstman, Edward C.**, Chief Engineer, American Broadcasting Co., Inc. **Mail:** 1630 North Shore Ave., Chicago, Ill. (A) to (M)
- Humphrey, John H.**, Senior Audio Visual Technician, University of Minnesota. **Mail:** 6634 Central N.E., Minneapolis, Minn. (S) to (M)
- Johnston, Jack H.**, Freelance Camera-man, 810 N. Highland Ave., Hollywood 38, Calif. (S) to (A)
- Nichols, Ralph M.**, Editor and Technical Advisor, Bob Jones University, Box 597, Greenville, S.C. (S) to (A)
- Sterling, Lyn**, Cinematographer, Bob Baker Productions. **Mail:** 3673 Fredonia Dr., Hollywood 28, Calif. (S) to (A)

DECEASED

- Brawner, Cloyce B.**, c/o Mrs. Virgie Brickenridge, Tuckerman, Ark. (A)

Book Reviews

Photographic Optics, by Allen R. Greenleaf

Published (1950) by Macmillan, 60 Fifth Avenue, New York 11. 197 pp. + 2 pp. bibliography + 8 pp. appendix + 6 pp. index. 81 illus. 6 × 9 in. Price \$4.75.

The objective of this book is to supply the photographer with a knowledge of optics. The first six chapters describe the general properties of lenses and their aberrations, and also include the usual general formulas of first order optics. The history and kinds of optical glasses are then covered in 4 $\frac{1}{2}$ pp. Image formation by small apertures receives half as much space. Lens descriptions, based on Kingslake's classification of patent literature, comprise 64 pp. and two appendixes

of 8 pp. Choosing and testing a lens, focusing, shutters, camera accessories, estimating exposure, perspective, printing, slide projection and stereoscopy are briefly discussed in the remaining 100 pp.

The definitions given are clear and should be helpful to a beginner in this field. A possible objection to the book is that it gives so little information on so many topics. Some of the author's choices will not please many readers. In testing lantern slide and film projectors, for example, he cites one American Standard on illumination and temperature measurement, but makes no mention of another on lens resolution testing. Two pages of the 5½ pp. allotted to filters are used for transmittance curves of four filters. Rather than republish these, might it have been more useful to have explained what the transmission of combined filters would be, and how computed, rather than stating that one particular combination would transmit too little light for practical importance?

To have compressed as much in so small a book is a real accomplishment. The material may be adequate and not too technical for a large audience. To the reviewer it seems to have too little information on any subject other than lenses, for more than orientation. Perhaps it will stimulate the reader enough so that he will turn to more complete books.—OSCAR W. RICHARDS, Research Laboratory, American Optical Co., P.O. Box 137, Stamford, Conn.

A Grammar of the Film, by Raymond Spottiswoode

Published (1950) by University of California Press, Berkeley and Los Angeles, Calif. 328 pp. including charts and index, 12 pp. illus. 6 × 9 in. Price \$3.75.

A Grammar of the Film, subtitled "An Analysis of Film Technique," will be interesting to the engineer or technician who considers the philosophy of the motion picture. Here is an attempt to set forth the functions of the cinema from out of a somewhat scholastic atmosphere which assumes that the medium's reason for existence is to fulfill an aesthetic ideal. We can understand the author's rather academic pronouncements along these lines when we learn that the text was written in 1933, when he was a student at Oxford.

However, since any careful consideration of the film in this aspect is worthy of attention and since the impact of the film on the finer senses ought not to be disregarded, even by engineers, Mr. Spottiswoode's early and later thoughts on what constitutes the foundations and the superstructures of film aesthetics are stimulating, even though sometimes controversial and often obscure.

Here, for instance, the reader may find an extensive discussion and definition of the much-abused term "documentary" as applied to films, the nature and significance of the abstract film, montage and cutting from the point of view of the film's advance as an art form, in addition to many of the author's original theories, with which the reader may or may not agree.

Because of the time at which it was written, some of the discussions are inconclusive and it is interesting to note the actual developments of sound and color in comparison with the author's earlier predictions. The text progresses from definitions to film categories, technique of the film through analysis and synthesis and various critical opinions and polemics.—RUSSELL C. HOLSLAG, Precision Film Laboratories, Inc., 21 W. 46th St., New York 19.

— New Products —

Further information concerning the material described below can be obtained by writing direct to the manufacturers. As in the case of technical papers, publication of these news items does not constitute endorsement of the manufacturer's statements nor of his products.



The G-E Electronic Pointer, type TV-34-A, is a new television programming tool consisting of a rack-mounted chassis and a control unit. It permits the commentator to insert a black or white pointer about 30 lines high and 7 lines wide at any point in the broadcast TV picture. The control is similar to the stick of an airplane, and a toggle switch selects either a black or white pointer. Further information is available from G-E Commercial Equipment Div., Electronics Park, Syracuse, N.Y.

Spray-type air washers, humidifiers and dehumidifiers for laboratories, theaters and industrial applications are announced in a new bulletin, No. 7, available from Buensod-Stacey, Inc., at 60 E. 42d St., New York 17, or at P.O. Box 1755, Charlotte 1, N.C.

Self-centering film-track pin-hole plates are now on the market, manufactured by Heyer-Shultz, Inc., Cedar Grove, N.J., as an improvement over that firm's pin-hole aperture plates for optical alignment of projectors. The new style plate is designed to be placed in the film path with the positioning block, which is spot welded to one side of the plate, inserted into the aperture opening itself. The plate is made in the 2-in. size illustrated here, for use in all projectors. A 6-in. size has been designed for possible use with different types of projection heads, as described in the manufacturer's instruction booklet.

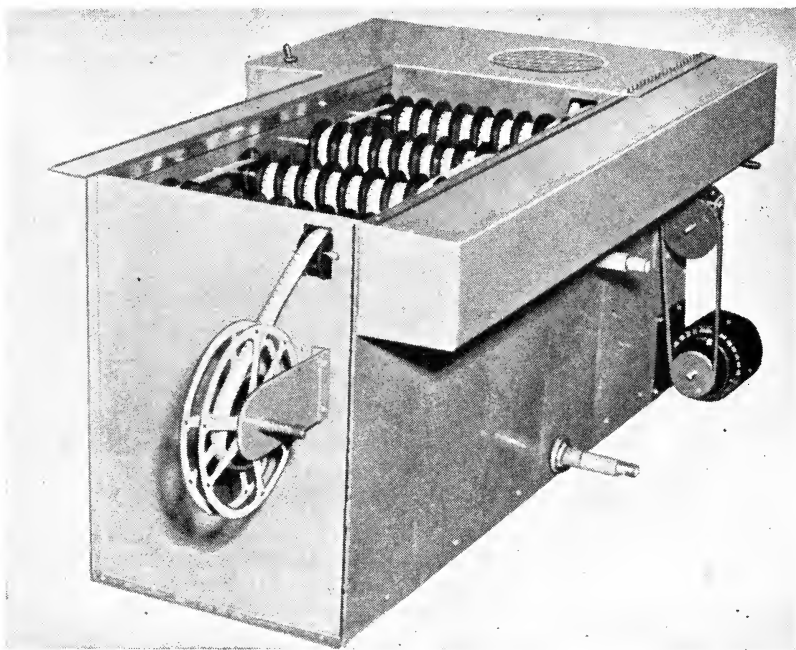

This automatic 16-mm film processing machine is now marketed by S.O.S. Cinema Supply Corp., 602 W. 52d St., New York 19. It is called the Bridgmatic Jr. and is described as a low-cost model designed for film handling by TV stations, educational institutions and film producers. It is 51 in. long, 21 in. high and 21 in. wide; has patented overdrive, air squeegees, built-in drybox, heating elements and neoprene-lined, steel 2-gal. tanks. An hour's output is 600 ft of positive film or 160 ft of negative. One gallon of solution is used in each tank.



The new $f/1.3$, 15-mm Wide Angle Balowstar is now available to 16-mm motion picture camera users from the Zoomar Corp., 381 Fourth Ave., New York 16. It is a 12-element coated lens designed by Dr. Frank G. Back to make photography possible under adverse light conditions. This lens can be used on any standard camera turret without interfering with the fields of the other lenses and, despite its short focal length, has clearance of $15\frac{1}{2}$ mm. The design allows use of a conventional short mount, making it unnecessary to remove the lens when the turret is revolved.

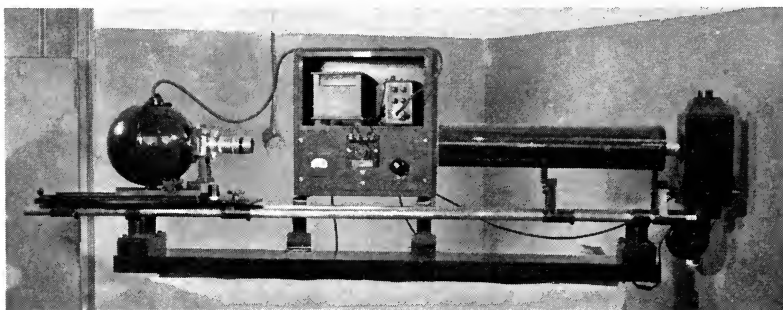

"T-stop" calibration of lenses for 8-, 16- and 35-mm cameras in focal lengths of 13-mm to 300-mm ($f/4.5$) is now done by National Cine Equipment, Inc., 20 West 22d St., New York 10. The collimated source method is used, as outlined in "Report of Lens-Calibration Subcommittee," *Jour. SMPE*, vol. 53, pp. 368-378, Oct. 1949. The equipment illustrated employs a photomultiplier tube, d-c amplifier and a series of fixed diaphragm stops as reference standards.

SMPT E Officers and Committees: The Roster of Society Officers was published in the May JOURNAL. For Administrative Committees see pp. 515-518 of the April 1950 JOURNAL. The most recent roster of Engineering Committees is on pp. 337-340 of September 1950 JOURNAL.

Journal of the Society of Motion Picture and Television Engineers

VOLUME 55

DECEMBER 1950

NUMBER 6

President's Convention Address.....	E. I. SPONABLE	559
Motion Pictures and Television (Convention Address).....	V. K. ZWORYKIN	562
Motion Picture Production for Television.....	JERRY FAIRBANKS	567
Lighting Methods for Television Studios.....	H. M. GURIN	576
Electrical Printing.....	J. G. FRAYNE	590
Motion Picture Studio Use of Magnetic Recording.....	L. L. RYDER	605
High-Speed Photography of Reflection-Lighted Objects in Transonic Wind Tunnel Testing.....	E. R. HINZ, C. A. MAIN and ELINOR P. MUHL	613
U.S. Naval Underwater Cinematography Techniques... ..	R. R. CONGER	627
35-Mm Ansco Color Theater Prints from 16-Mm Kodachrome.....	ADRIAN MOSSER and LINWOOD DUNN	635
New Laboratory for Processing Monopack Color Film.....	KRISHNA GOPAL	639
68th Convention.....		647
SOCIETY AWARDS.....		649
New Fellows; Journal; Honorary Members; Samuel L. Warner Memorial; Progress Medal		
Convention Speech.....	TERRY RAMSAYE	652
New Society Medal.....		653
Engineering Activities.....		654
Employment Service.....		656
New Members.....		656
Obituary.....		657
Papers Presented at Lake Placid Convention.....		658
Honorary Members and SMPTE Honor Roll.....		660

ARTHUR C. DOWNES
Chairman
Board of Editors

VICTOR H. ALLEN
Editor

NORWOOD L. SIMMONS
Chairman
Papers Committee

Subscription to nonmembers, \$12.50 per annum; to members, \$6.25 per annum, included in their annual membership dues; single copies, \$1.50. Order from the Society's General Office. A discount of ten per cent is allowed to accredited agencies on orders for subscriptions and single copies. Published monthly at Easton, Pa., by the Society of Motion Picture and Television Engineers, Inc. Publication Office, 20th & Northampton Sts., Easton, Pa. General and Editorial Office, 342 Madison Ave., New York 17, N.Y. Entered as second-class matter January 15, 1930, at the Post Office at Easton, Pa., under the Act of March 3, 1879.

Copyright, 1950, by the Society of Motion Picture and Television Engineers, Inc. Permission to republish material from the JOURNAL must be obtained in writing from the General Office of the Society. Copyright under International Copyright Convention and Pan-American Convention. The Society is not responsible for statements of authors or contributors.

Society of Motion Picture and Television Engineers

342 MADISON AVENUE, NEW YORK 17, N.Y., TEL. MU 2-2185
BOYCE NEMEC, EXECUTIVE SECRETARY

OFFICERS

1949-1950

PRESIDENT
Earl I. Sponable
460 W. 54 St.
New York 19, N.Y.

PAST-PRESIDENT
Loren L. Ryder
5451 Marathon St.
Hollywood 38, Calif.

SECRETARY
Robert M. Corbin
343 State St.
Rochester 4, N.Y.

**EXECUTIVE
VICE-PRESIDENT**
Peter Mole
941 N. Sycamore Ave.
Hollywood 38, Calif.

**EDITORIAL
VICE-PRESIDENT**
Clyde R. Keith
120 Broadway
New York 5, N.Y.

**CONVENTION
VICE-PRESIDENT**
William C. Kunzmann
Box 6087
Cleveland 1, Ohio

1950-1951

**ENGINEERING
VICE-PRESIDENT**
Fred T. Bowditch
Box 6087
Cleveland 1, Ohio

TREASURER
Frank E. Cahill, Jr.
321 W. 44 St.
New York 18, N.Y.

**FINANCIAL
VICE-PRESIDENT**
Ralph B. Austrian
25 W. 54 St.
New York 19, N.Y.

Governors

1949-1950

Herbert Barnett
Manville Lane
Pleasantville, N.Y.

Kenneth F. Morgan
120 Broadway
New York 5, N.Y.

Norwood L. Simmons
6706 Santa Monica Blvd.
Hollywood 38, Calif.

Charles R. Daily
113 N. Laurel Ave.
Los Angeles 36, Calif.

John P. Livadary
4034 Cromwell Ave.
Los Angeles, Calif.

William B. Lodge
485 Madison Ave.
New York 22, N.Y.

1950-1951

Lorin D. Grignon
1427 Warnall Ave.
Los Angeles 24, Calif.

Paul J. Larsen
4313 Center St.
Chevy Chase, Md.

William H. Rivers
342 Madison Ave.
New York 17, N.Y.

1950

F. E. Carlson
Nela Park
Cleveland 12, Ohio

George W. Colburn
164 N. Wacker Dr.
Chicago 6, Ill.

Edmund A. Bertram
850 Tenth Ave.
New York 19, N.Y.

Malcolm G. Townsley
7100 McCormick Rd.
Chicago 45, Ill.

Edward S. Seeley
161 Sixth Ave.
New York 13, N.Y.

R. T. Van Niman
4441 Indianola Ave.
Indianapolis, Ind.

President's Convention Address

By EARL I. SPONABLE

Ladies and Gentlemen:

THIS CONVENTION brings back some old memories. The TRANSACTIONS of the Society record that we had a previous convention here just about this time twenty-three years ago. We met at Whiteface Inn, located about three miles northwest of here on Lake Placid. The Society members apparently liked this environment, for a second convention was held at Whiteface Inn the following year. Since that time, we have been oscillating between New York and Hollywood, with a stopover now and then at Chicago and Washington.

Our first meeting here was also my first as an Active Member of the Society. I was just a neophyte in the business at that time. I presented a paper entitled "Some Technical Aspects of the Movietone." That meeting in 1927 was practically at the beginning of commercial sound-on-film motion pictures.

Reading a bit in the TRANSACTIONS of that year is rather fascinating. Here is the first paragraph of the Progress Report:

"Thomas A. Edison, when quizzed on his eightieth birthday as to the future of motion pictures, replied, 'Onward and upward.' He struck the keynote of the industry. One need not stretch the imagination far to paint a picture of the future in which sound synchronization, television, and stereoscopic principles are combined to give super entertainment and service. Some day we may sit at home and see a great play, enacted in a magnificent theater in a distant city, and hear the words of the actors and the musical accompaniment."

This passage, written twenty-three years ago, predicted accurately the home television of today. The prophecy seems well on the way to fulfillment.

Again, the TRANSACTIONS of that time listed 232 members of the Society. We now have 3,300. Then there were six Standing Committees: two of these, "Standards and Nomenclature," and "Theater-Lighting," dealt with engineering problems; while the other four (Papers, Membership, Publicity and Advertising) handled administrative matters. Today we have some 20 Engineering and 17 Administrative Committees, as well as the Headquarters Staff of eleven regular employees. The two-a-year TRANSACTIONS have long since been superseded by our monthly JOURNAL, which is recognized everywhere as the engineering record of the motion picture business.

PRESENTED: October 16, 1950, at the SMPTE Convention at Lake Placid, N.Y.

Anyone so honored as to be elected President of this Society wishes most fervently to pass the job on to his successor with the feeling that the Society has prospered under his guidance. I am proud to have served you during two most significant years in the Society's history. These two years have seen great challenges in our industry — competition from new forms of entertainment — increased production costs — the threat of another war — an inflationary national economy — and all the problems attendant on such far-reaching circumstances. We have come through these two years, on the whole, very well indeed. Let me review some of the high points.

One of the accomplishments to which we may point with pride is the publication of a number of extremely useful documents. These will, I hope, mark the beginning of an ever-increasing effort to make more generally available the scientific and technical advances resulting from the work of our membership. These documents include a guide to "Films in Television"; a reprint of a 30-page JOURNAL article on "Theater Television Today"; three volumes on high-speed photography; a tabulation of characteristics of color film sound tracks; a report on the basic principles of color sensitometry; and a reference file on 35-mm sound heads. All of these are in addition to the regular monthly JOURNAL. For the last two years the Editors have not found it possible to keep the number of JOURNAL pages within the authorized budget because of the substantially larger volume of valuable contributions.

A change of the Society's name to include the words "and Television," together with a revised constitution and bylaws, was approved by the membership during this two-year period. This change has resulted in a substantial gain in membership from the ranks of television engineers. Increased interest has been shown in television projects, standards and contributions to the JOURNAL of timely papers on television subjects. The current convention program reflects our augmented television activities.

Theater television, although still limited in scope, has become a reality. The Theater Television Committee has contributed largely to the general interest now being shown in this new medium, and this committee has also been responsible for coordinating the related interests of exhibitors, equipment manufacturers and the common carriers. Film is now a permanent part of television, and many of the motion picture standards developed by the Society have been adopted by the broadcasters. Several unique problems which appeared were referred to our Engineering Committees, and an outstanding example of the practical help provided by such committee work is the Televi-

sion Test Targets now available on both 16- and 35-mm film, currently being used in almost every television station.

Other test films, some supplied jointly by the Society and the Motion Picture Research Council, are coming into wider use than ever before. Recently a Test Film Quality Control Committee has been appointed to insure that the level of technical accuracy required by the published specifications shall be maintained.

Thirteen New American Standards affecting motion pictures have been formally adopted during the past two years, bringing the total to 60. Today 20 engineering committees are actively working on over 40 different projects.

It is, of course, quite impossible to record adequately here all the assistance given me by the members of the Society; I cannot let the opportunity pass, however, without mentioning the active and loyal support of Boyce Nemece and the rest of the Administrative Staff without which the work of the Society would be rather ineffective. Fred Bowditch has ably organized the engineering activities of the committees; and Bill Kunzmann be praised: I have been relieved of all worries about conventions. To all the rest, my sincerest thanks, and I am sure you will each continue to help my successor as wholeheartedly as you have helped me.

So much for the past; what of the future? We want more members, particularly from the television field. We are grateful for the sustaining support we have received, but we must have more if we are to carry on and expand to supply the services required in our field. We need to enlarge the JOURNAL to serve better both television and motion pictures. These problems are always with us, but the organization and running of our national conventions is becoming more difficult and complex as the Society becomes larger and the interests of its members more varied. I wonder whether the national conventions should be replaced by regional ones, with more emphasis on technical and less on social activities, or whether we would not do well, perhaps, to give up completely, in the near future, the two National Conventions a year and plan instead to hold only one National Meeting with the Local Sections taking more of the load in supplying forums for our speakers and papers for publication. This would constitute a major policy change — please think about it and give your new Board of Governors the benefit of your opinions. With your continued support, Edison's words "Onward and upward" will still be the motto of the Society and of the motion picture and television industries, as we look confidently toward the future.

Motion Pictures and Television

By V. K. ZWORYKIN

RCA LABORATORIES DIV., RADIO CORPORATION OF AMERICA,
PRINCETON, N.J.

MAN, from the beginning, has sought to extend the range of his vision. Once upon a time he called upon the oracle or the soothsayer to overcome the barrier of time and distance. Our present, more skeptical, age relies instead upon the ingenuity of the scientist and engineer to translate past into present and to bring distant scenes within our immediate reach.

The means which accomplish this end are known to us as motion pictures and television. The fact that the development of motion pictures preceded that of television may be regarded as an historical accident—a consequence of the fact that the evolution of the electronic industry lagged behind that of the chemical industry. In fact, I am inclined to regard the historical sequence as an illustration of man's tendency to work out the more complicated problem first.

Viewed from the larger perspective of history, the two developments may well be regarded as simultaneous, being separated at most by a single generation. The present readjustments imposed by the arrival of television on the motion picture industry may well be likened to the readjustment which a slightly older child must undergo upon the arrival of the new baby. While the initial phase of this readjustment may be painful, presently each of the two children will lay its proper claim on the affections and attentions of its parents. More than that, each child will have a good influence on the development of the other. It is evident even now that the motion picture industry and television will complement each other, mutually increasing the effectiveness of their services, rather than compete for the favor of the public.

Pursuing the analogy a little further, it might have been hoped that the experience in raising the first child, motion pictures, might have smoothed the way for the second, television. Alas, that hope seems to have proved illusory. The disputes regarding frame frequency, aspect ratio, definition, etc., which marked the infancy of motion pictures are dogging our footsteps even now in television, impeding the adoption of internationally recognized standards.

The repetition of the same pattern in the development of motion

PRESENTED: October 16, 1950, at the SMPTE Convention at Lake Placid, N.Y.

pictures and television is nowhere more evident than in the field of color. It was obvious from the start, in both motion pictures and television, that natural-color pictures were the ultimate objective. Black-and-white pictures were but a step along toward that goal, however important an interim role they have played and are playing. In both motion pictures and television, the black-and-white picture has enjoyed and will enjoy preference over a color picture as long as it is distinctly superior technically. Once the technical difficulties of color reproduction are overcome, the color picture will tend to displace the black-and-white picture even with a material difference in production costs.

Development of Color in Motion Pictures

But let us return to the early beginnings of color in motion pictures and television. In both fields the first workers attempted to solve the problem by the same, most obvious, method: the transmission and projection in sequence of the partial images in the primary colors, relying on the persistence of vision to fuse the successive color fields into a single natural-color picture. The first attempts to employ this "field-sequential" method in motion pictures were made by Friese-Greene in England around the turn of the Century. Albert Smith began to exploit it commercially in the United States under the name of "Kinemacolor" in 1908. Both inventors employed identical rotating filter disks in front of the camera and the projector. To reduce the required speed of the disk, they contented themselves with a two-color process, i.e., an orange and a blue-green filter.

One of the earliest findings with the two-color Kinemacolor process was that flicker effects were much more serious than expected. To reduce them to a level comparable with that attained with 16-fields/sec black-and-white film, it was found necessary not merely to double the film speed, but to increase it to 50 or 70 pictures/sec. Furthermore, moving objects showed a rainbow effect at the leading and trailing edge, corresponding to the shift of the object in the interim between the projection of successive monochrome fields. Film consumption was excessive in view of the high speed of the machine. Presently, as Frederic Talbot tells us, people tired of the novelty of so-called "natural-color" film and the expense of installing a special high-speed projector for this exclusive purpose was no longer balanced by a comparable return. Kinemacolor, with its field-sequential system of color projection, was a distinct failure.

With the exception of the Gaumont process, in which the three partial images were recorded and projected simultaneously on special

film, all subsequent commercial processes of color motion pictures concentrated on processes in which the color film could be projected by standard black-and-white projection equipment. Thus, the Eastman Research Laboratories, perhaps the first to recognize the importance of avoiding special equipment for the projection of color pictures, developed their old two-color Kodachrome positive film, in which successive frames on a negative obtained essentially by the Kinemacolor process were printed back to back and appropriately dyed with the complementary colors. Prizmacolor, introduced to the public in 1921, attained the same end of a two-color film suitable for standard projection by a different process incorporating numerous refinements. Both, in view of the field-sequential method of camera exposure, still retained the defect of rainbows on moving objects. They were finally eliminated by employing simultaneous exposure as well as simultaneous projection, a universal feature of all color motion picture systems. With the exception of the old Kodacolor process, introduced in 1928 for 16-mm motion pictures, all of these furnish true natural-color transparencies for projection with a standard projector. Kodacolor utilized a special lenticular film which was exposed and projected with a color line screen inserted in the lens.

The Newer Color Processes

The majority of the newer color processes employ color film in standard motion picture cameras. It may be either of the screen type such as old Agfacolor and Dufaycolor or of the tripack type such as Kodachrome, introduced in 1935 by Mannes and Godowski, as well as Ansco color and new Agfacolor. By contrast, the Technicolor process employs a special camera which exposes simultaneously three films through a beam-splitting system. I wish to point this out specifically to show that specialized equipment and processing is no bar to the success of a color system, *provided* that it is confined to the production end of the system. The quality of the resulting film and the ease of duplication are here the factors of primary importance.

So much for the development of color motion pictures. Even before the Kinemacolor process was launched, the brothers Andersen had applied for a patent applying the same field-sequential principle to color television. By 1929 James Logie Baird could demonstrate, in Glasgow, 20- to 30-line color pictures formed with a Nipkow disk flying spot system; the filters were mounted directly over the three successive aperture spirals of the disk. A similar disk served to present to the eye the three (red, green and blue) partial images in sequence. Ten years later the same inventor had raised the number

of lines in his color pictures to over a hundred. The field frequency was 100, as compared with 60 for black-and-white pictures. Needless to say, these color pictures could scarcely be classed as entertainment.

Even in those early days that method did not seem good enough for public acceptance. Efforts were renewed to attain color television pictures of entertainment quality using the field-sequential system. The number of lines was raised to a value comparable with that employed in black-and-white television. On the other hand, the field frequency was permitted to assume—and is still permitted to assume in the field-sequential system—a value less than three times the field frequency of black-and-white television. The resultant excessive color flicker confirmed the experience of Kinemacolor.

The Simultaneous System

The very same factor which sealed the doom of Kinemacolor—namely, the impossibility of either projecting Kinemacolor film with a standard projector or of projecting standard film with a Kinemacolor projector—finally caused RCA to abandon, in 1946, the field-sequential method in favor of a simultaneous system. This simultaneous system corresponds most nearly to the Gaumont color system and would, in fact, have been its perfect analog if the special film for the Gaumont system had had three frames of standard height placed side by side and if, in addition, standard black-and-white projectors would be able to utilize such film without change, projecting just one of the three film strips; and a Gaumont projector would be able, in turn, to project an ordinary black-and-white film. In short, the simultaneous system is perfectly compatible, as well as free from color flicker. However, just as the Gaumont system utilizes three times as much film material as a black-and-white projector, the simultaneous system demands three times the bandwidth of—or at least substantially greater bandwidth than—a black-and-white television transmission.

The final objective of confining a perfectly compatible color system with resolution comparable to that of black-and-white television in a standard television channel was achieved in the dot-simultaneous system by dot interlacing and the superposition of “mixed high” signals, analogous to the gray picture giving the finest detail in the Technicolor process. Color flicker is eliminated by the successive transmission of color dots at a rate of many millions per second. The camera is identical with that for the simultaneous system: in close analogy with the Technicolor camera, a beam-splitting system directs the light of the three monochrome partial images to three separate pickup tubes (corresponding to three separate negative

films). If the signals, combined by a transmitter sampling system, are applied to an ordinary black-and-white receiver (that is, the color film is reproduced on black-and-white film and run through a standard projector) a high-quality black-and-white picture results. If, in the same receiver, the black-and-white kinescope is replaced by a tricolor kinescope and receiver sampler (corresponding to the tricolor positive) the natural-color picture is reproduced. Finally, a black-and-white transmission will be correctly reproduced in black-and-white on the tricolor tube, just as a black-and-white negative printed on color film would yield a black-and-white projected picture. Thus, technical solutions have been attained in color television which are a close analog to the solution presently employed in color motion pictures. The development of a practical single tricolor pickup tube, in analogy to the use of color film in the motion picture camera, would round out the comparison.

It is my conviction that the path blazed by the motion picture industry, leading to compatible color motion pictures characterized by freedom from color flicker, is appropriate also for color television. The development of the dot-simultaneous system and of the tricolor kinescope demonstrates that it can be readily achieved. In this manner, I firmly believe, color television can be of greatest benefit to the public, for purposes of both entertainment and instruction.

Motion Picture Production For Television

BY JERRY FAIRBANKS

JERRY FAIRBANKS, INC., HOLLYWOOD, CALIF.

SUMMARY: A new technique of motion picture filming has been developed, making important economies in theatrical production costs. Titled the "Multicam Process," this technique utilizes three or more cameras operating simultaneously from three or more different angles or on long, medium and close-up shots. The system permits a picture to be photographed in continuous action, cuts from one camera to another being indicated by "sync" marks on the selected film, and corresponding lines exposed on the sound film. The marking and "sync" devices are automatic. The Multicam Process makes it possible to film completely 30-min programs in a day, and to film "live" shows as they are televised.

DEVELOPMENT OF A NEW TECHNIQUE of motion picture filming now makes it possible to produce motion pictures at costs heretofore considered unlikely. The perfection of a multiple camera system tremendously cuts the time required to film all types of motion pictures, greatly lowers production expenses and makes it possible for television film producers to compete from a budget standpoint with kinescope-recorded shows.

The Multicam System developed in our research laboratories utilizes three or more 16-mm or 35-mm Mitchell cameras which can operate simultaneously, filming three or more different angles of a scene and getting long, medium and close-up shots at the same time. The procedure is similar to the use of three cameras in telecasting "live" video.

Combining the best advantages of both television and film shooting, the system permits a picture to be photographed in continuous action, including cuts from one camera to another.

During the shooting of numerous productions we have found that the new technique cuts previous production schedules by sometimes as much as 500%. *Nocturne*, a half-hour musical telecast weekly by KNBH in Hollywood, was completely filmed in a little more than three hours. Programs in the "Silver Theater" series, each a 30-min dramatic presentation, were filmed in eight hours. *The Triumphant Hour*, a feature-length production which called for many exteriors, star appearances, and much trick photography, was photographed in

PRESENTED: October 17, 1950, at the SMPTE Convention in Lake Placid, N.Y.

four days. Such programs as "The Ed Wynn Show," "Truth or Consequences," "This Is Your Life" and "The Alan Young Show" were filmed simultaneously with the Los Angeles telecast or radio taping of the programs. In each of these cases 30 min of film was photographed in 30 min. "Major studio" schedules for the same type of filming would be from 10 days to two weeks. *The Triumphant Hour* would have been in production several months.

Numerous technical problems were surmounted during 36 months of research and experimentation in perfecting this system. Among the foremost of these was the invention of a marking device to synchronize picture and sound tracks. This was required because the new system called for cameras to be turned on and off numerous times during the filming of long sustained scenes. The only other alternative was to let all cameras run continuously from the start, necessitating a tremendous waste of negative film.

The problem was surmounted by the development of a device in each camera that leaves a synchronizing mark on the action film when the camera is up to speed, identifying the camera. Also, a similar device on the sound recorder exposes a line or lines on the sound film, identifying the cameras in operation throughout the scene. In this manner, the sound film becomes the key to the cutting and inserting of all scenes shot by the different cameras. The marking and synchronizing devices are entirely automatic and do not require cameramen to operate additional equipment.

The synchronizing devices are operated through the camera motor circuits and load-actuated time-delay relays. When the cameras are started, lights fog a small spot on each frame of the film passing through the cameras for a period of one second. One dot is marked on the negative for Camera 1, two dots for Camera 2, three for Camera 3, etc. At the end of the one-second period, the time-delay relays automatically switch off the action-film fogging lamps and instantly switch on the sound-film fogging lights. One line is marked on the sound film for Camera 1, two lines for Camera 2, etc. The film editor can tell which cameras were in operation during any one scene merely by glancing at the sound film.

The action film is marked by exterior fog lights that are reflected from the blimp glasses through the lenses. In 35-mm filming with Mitchell BNC cameras, the synchronizing fog lights are mounted in the interior of the cameras. Three lamps are mounted in the sound recorders in light-proof housings with small apertures adjacent to the film just under the main drive sprocket. The motion of the film over the apertures marks the fog lines which identify the cameras

and the synchronous start. In 35-mm filming, a different relay box is used because of the heavier motor of the BNC, but the principle is the same.

Only one extra wire is required to complete the synchronizing circuits to the cameras. This line is carried on the standard four-wire cable for the three-phase 220-v synchronous motor used to operate the camera.

Two pairs of wires comprise the signal circuit from the relay to the recorder. During location filming this synchronization is carried by two signal channels leased from the telephone company. These channels, of course, are in addition to the equalized recording channel and order wire which also are furnished by the telephone company during shooting at broadcasting auditoriums or locations. Portable equipment, featuring the synchronizing device, can be used when it is not feasible to lease telephone lines and when such lines are not available.

Perfection of 16-Mm Cameras

Another obstacle faced in developing the new system was the perfection of 16-mm cameras that could follow focus at all times and a view-finder that would give cameramen the exact image in the exact focus that was being recorded on film. Equipment was especially constructed by the Mitchell Camera Corp. to our specifications. Finders were coupled with camera lenses so that an adjustment of the finder focus would correct for parallax and camera lens focus. In short, equipment has been perfected so that if a scene is in focus on the finder it also is in focus on the film (Fig. 1).

Initially the cameras were mounted on standard tripods which, in turn, were mounted on three-wheel dollies equipped with caster wheels. Experience showed, however, that when the tripods were moved forward and then reversed or moved at a slight angle, the caster wheels caused an irregular movement of the cameras as the wheels shifted their position. This was undesirable as it caused a shift in the pictures being photographed during the camera movement. As a result, new-type tripod structures were perfected which permit steering of the tripod wheels from the panning handles of the cameras. The improved camera-supporting tripods can be steered for movement in any desired direction at any desired moment.

This new three-wheel dolly and tripod stand is fitted with 5-in., 1.5-in. doughnut, semisolid tires. To steer it, the operator rotates a motorcycle-like grip handle which causes all three wheels to turn at the same time in the same direction, permitting a complete 90°

movement of the tripod (Fig. 2). The stand also can be used as an improved tricycle-type dolly by locking the two rear wheels and steering by the front wheel.

The steering handle is mounted on the right side of the standard panning and tilt head so that the follow-focus knob can be operated by the cameraman. The steering handle is also the panning and tilt handle and the motor switch is conveniently mounted on the handle.

For rapid raising and lowering of the stand, a screw-actuated elevating device is operated by a hand wheel. Telescoping supporting rods make for rigidity for all operating heights.

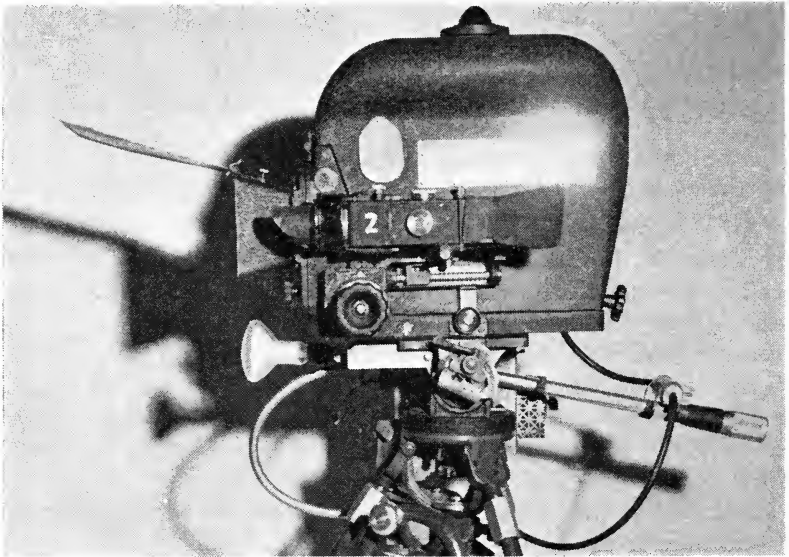

Fig. 1. A side view of the Multicam Camera. Finders are coupled with camera lenses so that an adjustment of the finder focus corrects for parallax and camera lens focus.

Eyelights have been mounted below the matte box on each camera blimp as well as over the blimps, to be used or not as the operator desires (Fig. 3). Each has a control mechanism to regulate the intensity of the light so that it will match the general set lighting. A transformer operated from the motor circuit with rheostat control supplies the electricity.

Each camera blimp is equipped also with an action light so that the cast and technicians will know exactly which cameras are in operation and the director will know if the scene is being filmed according to

plan. The action lights operate only if camera motors actually are running. Thus, they are used, too, as an instrument to notify the operator if the camera motor develops trouble during a scene. Camera cables, in many instances, are suspended overhead in sets to eliminate as many ground cables as possible.

A departure from previous motion picture methods, the new process required the development of a much faster and more efficient stage-operation technique and production system. General procedure, heretofore, has been to set up a tentative timetable of scenes to chart the course of production. This served more or less as a guide

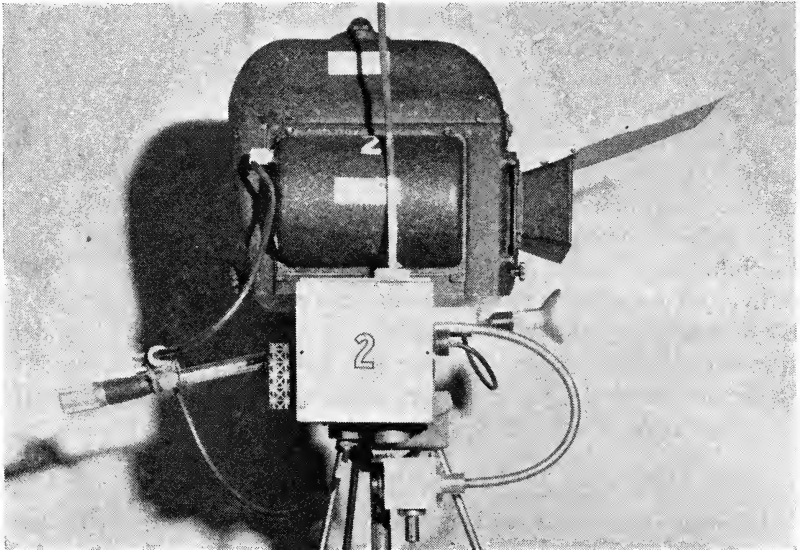

Fig. 2. A side view of the Multicam Camera showing motorcycle grip handle which is used to steer equipment. Eyclight transformer box and control are also shown.

to the construction department and set decorators. Players seldom memorized lines more than a day in advance of shooting and usually only for the scenes to be filmed. Camera angles were determined on the spot and rehearsals held while the technical crew stood by. The director in many instances was the only one who had knowledge of the master plan. Details were left until the night before shooting. Technicians and cast members learned about them the day of filming.

Under the Multicam System every detail is completely planned in advance. Sets and decorations for the entire screen play are con-

structured and dressed in advance. The cast, which has rehearsed on another stage, is as prepared as it would be for the opening night of a stage play. Every camera movement is planned long in advance on paper and all lighting is ready. One rehearsal is held on the stage. Its purpose is to give the camera operators the opportunity of executing what has been planned for them. The entire scene is then filmed, with the three cameras getting the various angles and long, medium and close-up shots. The average scene under the Multicam System runs many times longer than the average scene under the conventional method. Rarely is the footage under five minutes and seven to eight minutes is the average. In some instances, when a minimum of sets and complicated action is called for, 30 min of finished film can be photographed in 30 min.

A set of "production scripts" prepared for every technician and player is the key to the entire stage-operation technique. These script layouts outline in detail every camera movement and cues for cutting in and out of scenes. Each camera is designated with a number and color to identify any particular camera and its position and field of coverage. Cameramen and technicians study their "scripts" in advance just as thoroughly as do the players. While individual cameramen receive layouts covering only their own schedule of operations, the director and cast are given a master "production script" that shows the plan for the three or more cameras. Relative markings in the story script also show the cameras that will be in operation at any particular time in the story continuity.

Lighting Techniques

Lighting of sets always has been an important factor in production time. Lighting under the Multicam System averages less than five minutes and in many instances there is no loss of production time at all as every set is prelighted. The time-saving factor here added to the time gained by shooting only long, sustained scenes totals a huge saving in costs.

Perfection of the lighting technique also required many months of experimentation. The problem was to perfect a means of lighting a set so that no matter where the actors moved the light would be uniform. At the same time, it was necessary to devise a system that would practically eliminate cables from the stage floor. This was a "must" because the Multicam System requires the quick and easy movement of camera and sound boom equipment during shooting.

The main lighting system, as it has been developed, consists of banks of 300-w reflector lights. These banks are hung so that the

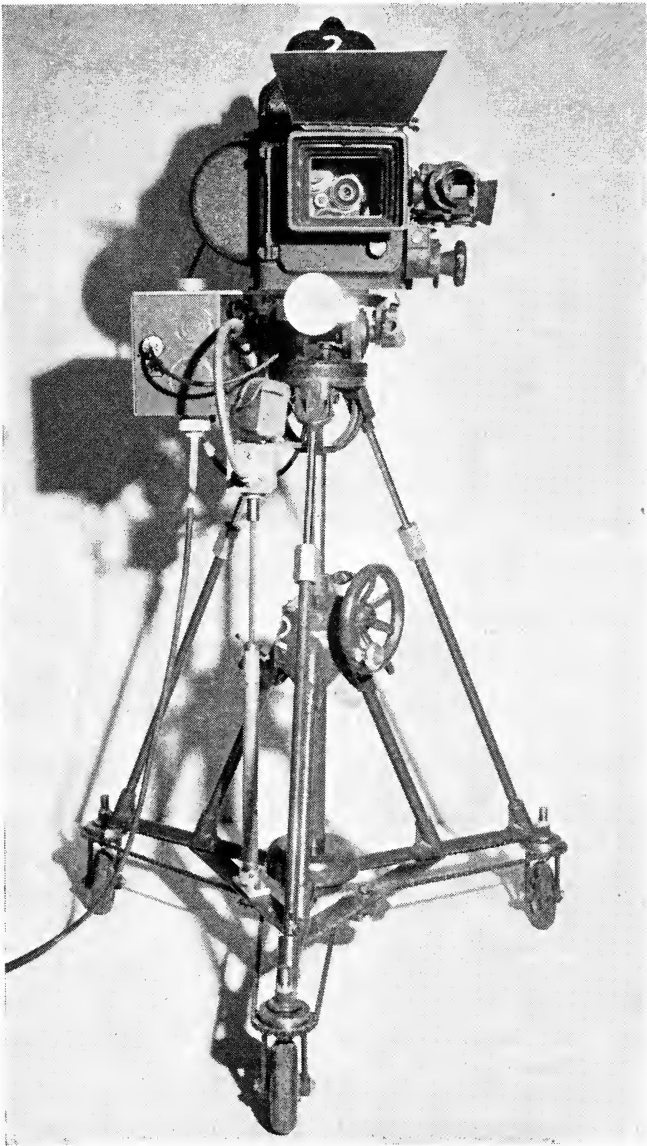

Fig. 3. Front view of Multicam Camera, showing camera equipment especially constructed by the Mitchell Camera Corp. and tripod equipment especially constructed by Mole-Richardson, Inc. Note the eyelight located below matte box, viewfinder arrangement, action light and hand wheel to operate screw-actuated elevating device. Guards over wheel chains have been removed for the photos. The three wheels are able to turn at the same moment in the same direction, permitting a complete 90° movement of the tripod.

tilt and swing adjustment can be made from the floor. This method makes for speed in giving an even, over-all illumination of the set, and when properly used, avoids dark or hot spots.

Back- and effect-lighting are handled in standard studio procedure with incandescent spotlights mounted on parallels. Once these are adjusted, they remain the same throughout shooting of the particular set. Smaller banks of reflector lights are used on the floor for side lighting. Cables for lamps and all electrical equipment are suspended.

The floor also is used as an aid in our lighting. A very light-colored floor covering, suitable to dolly on, is used to help eliminate chin, nose and eye shadows. Where the floor is in the picture in long shots, rugs, of course, are used. The combination of this flooring and bank lighting gives an over-all modeling that is photographically pleasing. It eliminates the unflattering shadows that live television lighting seems to accentuate. It also does away with the accentuated make-up that is often used in live telecasting.

With the exception of the synchronizing marking system, sound recording offered no major problems. Multiple recorders are used in the filming of long shows, saving the expense and work of developing larger magazines. Regular studio sound equipment, with a few innovations of our own, is used. Additional microphones are spotted overhead out of camera range to obtain complete coverage of the entire set.

Cast rehearsals, without camera and lighting equipment, are held on a nonshooting stage with similar props and furniture available. This prevents the tying up of the main sound stages and the expensive equipment located there. Here the director works out all his "business" and the cast familiarizes itself with the dialog and action. While rehearsals are thorough, they are not as demanding as those necessary for a live show which involve working under lights and with cameras.

The new technique was perfected, too, for the filming of live programs simultaneously with the actual telecast of a show. Special 1200-ft magazines are used for our 16-mm cameras, and the Eastman Kodak Co. prepares special 1200-ft negative film rolls to our specifications for this type of work. For 35-mm filming, 2000-ft magazines are used. An intercommunications system has been built so that cameramen can receive instructions in much the same manner as a live-video cameraman. This system also is available to us during filming on our stages. Tests, however, have proved that the "pro-

duction script" method gives excellent results and that earphones are unnecessary during stage shooting.

Quality in all our filmed programs is as good as in any "major studio" motion picture. Prints have proved that the system provides lighting, sound and clarity of picture far superior to those produced by the best kinescopes made to date. This has been proved beyond question several times by alternating, in a sample reel, footage from one of our programs and footage from a kinescope of the same show. The difference is startling, especially when seen on a closed circuit.

The ultimate aim of kinescope recordings is to obtain a quality comparable to live television or film. Realization of this goal is still many years away and current kinescoping leaves much to be desired. It remains to be seen, even when kinescopes are perfected, whether they will be even as acceptable as film. At present, photographing from a tube of 525 lines is similar to photographing a newspaper engraving. Imperfections in the engraving (and electronic lines of the tube) are always transferred to the copy.

This new method of film production does away with all the objectionable features of kinescopes and makes it possible for a star to do an entire series in a short period of time, not tying him to a regular weekly schedule. The show can be filmed in Hollywood, Chicago or New York at a time convenient to the actor and can be released whenever the sponsor desires. Not only is the actor's appearance protected, but so is his performance. Retakes always can be made if necessary. Furthermore, the technique catches all the spontaneity of live video because the players go through the story in much the same way as they would for a stage play.

By preplanning every move, streamlining stage-operation techniques and minimizing waste footage and coverage, shooting time is cut many times below what formerly was thought possible. The film, in a sense, is precut and an efficiency in production obtained that never before has been equalled. The net result is a tremendous saving in costs.

The savings in production costs have attracted the attention of many producers. Negotiations now are under way for use of the system by several of Hollywood's foremost studios.

Lighting Methods for Television Studios

BY H. M. GURIN

NATIONAL BROADCASTING CO., NEW YORK

SUMMARY: A brief review of the characteristics of a highly sensitive television camera tube relative to sources of illumination is given. Recent improvements in special fixtures and facilities that have contributed to more rapid adjustment and better directional controls are discussed. There are relationships between staging and lighting of sets, and consideration of capabilities has produced some definite rules for normal studio operation. It is important that staging and lighting be carefully studied and planned in detail before camera rehearsals begin.

ONE OF THE most significant contributions to the rapid advances in television has been the development of a highly sensitive camera pickup tube. In scenes reproduced by a television system, the lighting on the set has the most obvious and direct bearing upon the quality of the television image. The relationship, therefore, between the pickup tube, the light requirements and the lighting methods to produce a picture of the original scene which is as pleasing as the technique and methods allow, is of primary importance.

The characteristics of the most popular pickup tube currently in use in many studios, type No. 5820* image orthicon, have been well described elsewhere, but for the sake of more clearly explaining the considerations in devising lighting methods now employed, they will briefly be repeated here. Figure 1 shows its spectral sensitivity curve, and Fig. 2 the relative sensitivity with respect to other camera pickup tubes previously used. It is important to note that the spectral curve of the No. 5820 image orthicon approaches the average eye sensitivity curve and leads one to expect intuitively that a subject will appear in a television screen as a comparable luminescent body in a manner similar to the eye, regardless of the illuminant used. There is no question that a high infrared response in a pickup tube will produce absurd gray scale renditions of certain subject matter which reflect infrared readily. However, with the introduction of an infrared cut-off filter, "normal" black-and-white pictures can be obtained. A

PRESENTED: October 16, 1950, at the SMPTE Convention at Lake Placid, N.Y.

* R. B. Jones, R. E. Johnson and R. R. Handel, "A new image orthicon," *RCA Review*, vol. X, No. 4, pp. 586-592, Dec. 1949.

similar situation could be imagined in the blue end of the spectrum. Fortunately, by the use of an approximation to the eye-sensitivity curve, one would automatically safeguard against any unusual effects even though the color sensitivity of the eye does not enter the problem

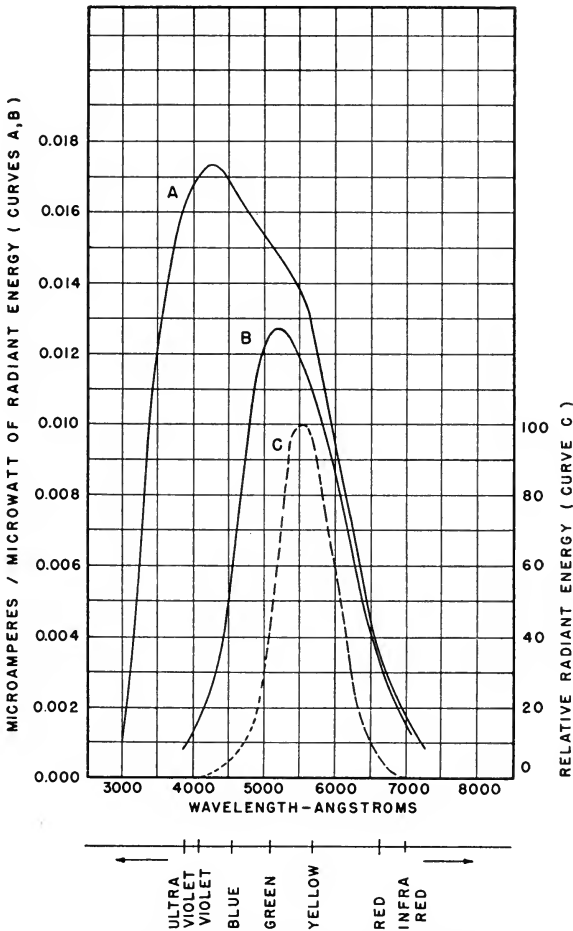

Fig. 1. Spectral sensitivity characteristic of Type 5820 image orthicon with and without filter for equal values of radiant flux at all wavelengths; Curve A is without filter; Curve B is with Wratten No. 6 filter; Curve C is spectral characteristic of average human eye.

directly in viewing a black-and-white picture. In practice, if the eye accepts the combination of light source and material reflectance as being "natural," the results in terms of black-and-white on the television screen will also be acceptable. Actually, with incandescent

light there is probably no great necessity of using the filter as indicated on the previous curves with the No. 5820 image orthicon, since the color components which the filter attenuates are present to only a small degree. With fluorescent light, which has much more energy in the blue-violet region, the use of the No. 6 Wratten filter may be justifiable.

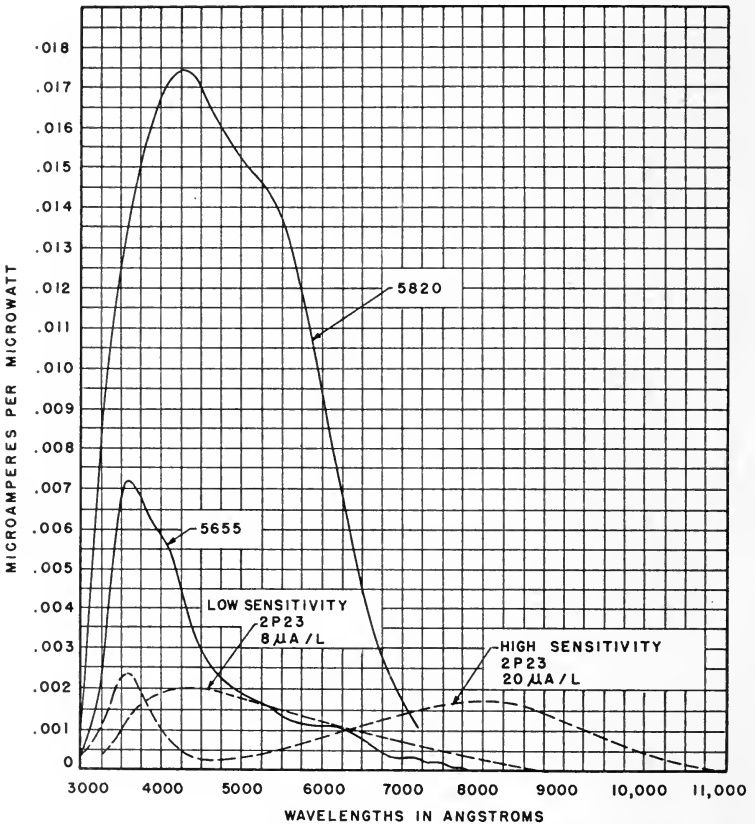

Fig. 2. Spectral response characteristic of various image orthicons.

The introduction of the No. 5820 image orthicon with its higher sensitivity has greatly reduced the light levels now required for good performance. It is no longer necessary to provide the high lighting levels in a studio which were required with previous types of pickup tubes. Thus, emphasis has shifted from providing lighting with as

little associated heating as possible, which is characteristic of fluorescent sources, to providing lighting sources of extreme versatility.

Incandescent sources can be diffused or highly concentrated and can be dimmed or doused easily. In addition they are more maneuverable, take up less installation area, and are simpler and cheaper to install and maintain. With the diminished lighting levels now usable for obtaining satisfactory pictures, the heat generated with incandescent lamps assumes only minor importance as compared to the operating advantages which can be gained by their use. In small areas, however, where heat dissipation or air conditioning is a problem and where maneuverability or special lighting techniques are not essential, fluorescent lighting may yet have useful application.

The minimum lighting for a picture which is good technically is the illumination level on an average subject which will enable a camera to produce a picture of acceptable signal-to-noise ratio. It is apparent that the light reflected from the subject rather than incident light is useful to the camera and therefore the subject material will be assumed to have average reflectance determined from normal television practices and the "base" or general illumination will be uniform where it is used. Under such conditions the recommended average lighting levels are those capable of producing a picture of good technical quality (see Table I).

TABLE I. Average Incident Light Required for RCA Image Orthicon No. 5820

Lens Stop, $f/1.9$	2 - 4 ft-c, Incident Light
2.8	4 - 8
3.5	6 - 12
*5.6	12 - 32
*8	32 - 65
11	60 - 120
16	120 - 240

*Normally used

It is recognized that this will furnish only a starting point for the wide variations in subject lighting which may be called for to obtain dramatic effects dictated by the mood and impression the producer wishes to create. In many cases it may be necessary to operate under conditions which do not satisfy requirements for a good technical picture but which do create the desired illusion.

The field of dramatic lighting is so broad and subject to so many psychological and personal factors that it does not lend itself to precise analysis. It is the purpose of this paper to present several operating

methods in a mechanical "sense" rather than in an artistic approach, leaving to the producers' talents and imagination the exploitation of the tools provided to the best advantage.

Functionally, television studio lighting equipment may be grouped into three distinct types as follows with their appropriate accessories: (1) floodlights; (2) spotlights; and (3) strip lights.

Floodlights are used primarily to furnish the "base" or general illumination and should provide a uniform, broad distribution of light. This has been rather satisfactorily accomplished by the use of a light-weight, open aluminum reflector capable of handling interchangeably a variety of lamps ranging from 500 to 2000 w. For improving diffusion, inside frosted lamps are preferable; and if even more diffusion is desired, a spun glass filter can be mounted across the reflector opening. Clusters of small sealed-beam reflection lamps have also been used successfully to obtain somewhat higher levels of incident light for general illumination. Where the flexibility in handling of equipment and space requirements are not critical, fluorescent lamps in suitable reflectors can also be used for floodlighting. In dramatic sequences where the light beam pattern must be very carefully controlled, a conventional Fresnel spotlight set for proper beam spread with a spun glass diffuser can be especially helpful.

For illuminating cycloramas, conventional strip lights with sealed-beam reflector lamps can be used to excellent advantage. Spread lens roundels and diffusers are also available for modifying light beams of individual lamps. Some care must be exercised, however, to adjust properly the angle of incidence so that the surface illumination is not too "hot" along the edges.

Spotlights are probably the most important lighting fixture in the studio today. Together with the appropriate accessories, such as barn doors, snoots,* adjustable irises, and diffusers, spotlights provide the most flexible medium for obtaining the maximum number of artistic effects.

They are used primarily to supply the key or principal illumination which falls on a subject or at a point where important action takes place to set the mood of the scene. Spotlights are an essential element in providing modeling light to enhance the appearance of a subject particularly where texture is involved.

Since the television image is a two dimensional picture reproducing a three dimensional scene, the importance of separating the most important element of picture interest from the surrounding backgrounds

* Appliances which can be fitted on the front of the lamphouse in order to adjust or shape the beam pattern.

cannot be overemphasized. This effect can be achieved with the proper use of spotlights by backlighting; at the same time the artistic effect of glistening highlights in the hair is added.

One of the most important limitations in a television system is the contrast range which can be handled to permit distinguishing detail in the shadows. This range is restricted for most purposes to 40:1 but is frequently less when the program is recorded on film for retransmission by television. This limitation makes the use of fill-light a significant adjunct to the modeling light and may be obtained by diffused spotlights or suitable floods. The proper use of fill-light also helps to remove any harsh lines and soften the contours particularly around the lips, nose and chin.

In theatrical presentations, one of the effects commonly encountered is the "follow-spot." While this method of illumination is very effective for a long over-all view, television usage is also concerned with a close-up of the subject and unfortunately the follow-spot usually puts the performer in a very harsh and unfavorable position in which imperfections, normally unobserved by remote inspection, are highlighted. Consequently, the follow-spot must be used judiciously.

Other special effects such as venetian blinds shadows, fire-lighting, cloud effects, etc., are obtained with spotlights having adjustable irises or by a projector with a motor driven "effects disc" which create the illusion of movement.

Eliminating Excessive Top-Light

One of the most frequent criticisms received in television was that most of the light seemed to come from above, resulting in highlights on the top of the head, the bridge of the nose and on the shoulders, leaving deep shadows around the eyes, nose and chin, and thereby making the subject most unattractive. These effects were due to the necessity of mounting most of the lighting equipment on the ceiling to give the maximum mobility to the cameras and microphone boom on the studio floor.

The seriousness of this problem was recognized and some steps to correct this fault were devised by using the inverted pyramid arrangement of lights whereby the fixtures in the center of the studio were placed at the lowest possible point to clear any floor-mounted equipment and the other fixtures raised upward toward the walls. This system, however, was found not flexible enough for studios where scenery shifting was frequent and where no two program set arrangements were identical, as in the case of a series of dramatic performances. As a result, a new pantograph fixture was developed and is

shown in Fig. 3. The principal advantage gained was the ability to raise and lower the light source to any given point thereby avoiding steep angles for front and side lighting, and doing this without sacri-

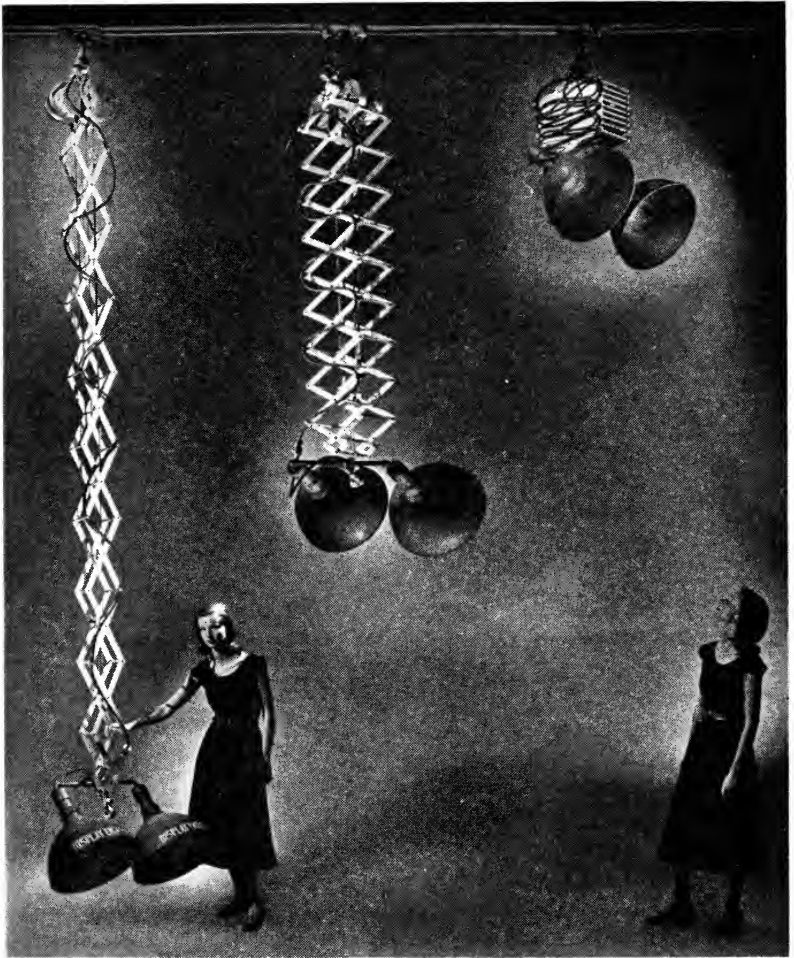

Fig. 3. Pantograph fixture for vertical adjustment of lighting units.

ficing the ability to rotate and tilt it for the proper directivity. It was also apparent that the number of floor lamps normally required for fill-light could be reduced, thereby extending the freedom of action of the studio cameras. For maximum coverage with a minimum of

actual handling, a sufficient number of pantograph units (one for every 15 sq ft of floor area) should be provided. Experience has proven further that sets of varying heights could also be more readily accommodated without undue rehangng or changing of the overhead structure from which the spotlights, floods, etc., were supported.

Recently, overhead tracks, placed sufficiently close and running the length of the studio, were installed and the lighting fixtures were hung on trolleys so they could be pushed to any desired point along the track length. Figure 4 illustrates how the installation appeared

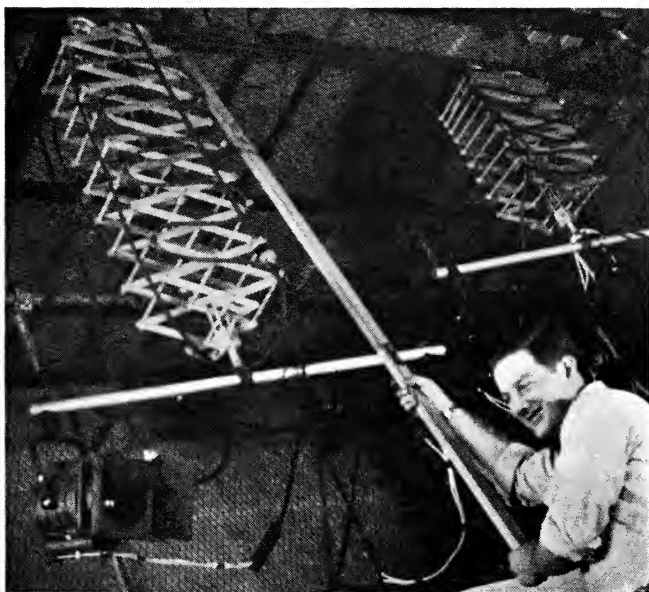

Fig. 4. Pantograph units on overhead tracks, Studio B, NBC Uptown Studios.

upon completion a short time ago. While it is anticipated that the length of time in setting up the lighting arrangement for a particular performance will be diminished and that fewer fixtures will be required in the studio, the installation has not been in use long enough to permit accurately evaluating its merits.

Inasmuch as the television studio floor must be kept as free of obstructions as possible for maximum flexibility in scenery arrangements and camera movement, the structure for supporting the lighting equipment itself becomes of utmost importance. One of the practical systems devised at NBC was a fixed gridiron of $1\frac{1}{2}$ -in. pipe, 4 to 6 ft

on centers, and as close to the ceiling as possible with clearance for raceways, ductwork, pipes, conduit, sprinklers, etc. The reason for mounting the grid close to the ceiling is to permit the erection of high sets without the necessity of an expensive and time consuming re-hanging and installation of the grid when sets higher than the usual 10 ft are called for in a particular program.

It is from the fixed grid that the adjustable pantograph is usually supported. Recently a series of pipe battens suspended from the permanent grid by lines and pulleys have been hung across the entire ceiling of one of the newly modified television studios (Fig. 5). The

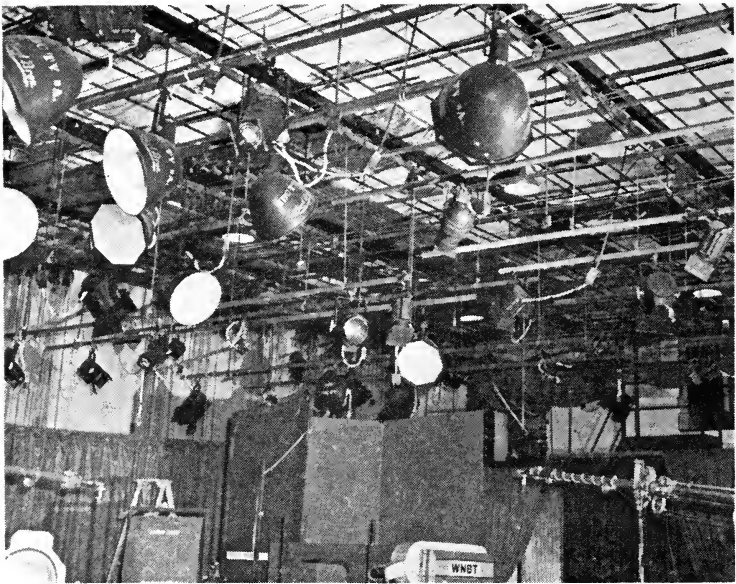

Fig. 5. Overhead batten lighting system, Studio 3A, Radio City, New York.

batten permits the raising and lowering of an entire series of lamps and it is envisioned that if additional unit flexibility is desired, the pantograph can be hung on the batten.

It would be advantageous to be able to walk over a grid on a catwalk for adjustment of scenery or relocating lighting fixtures, but the reduction in the effective studio height in most cases would be undesirable. Catwalks on the walls of the studios are even less desirable than above the grid because of the limited areas which can be served to advantage and because of the space under them which is obstructed

from overhead lighting. In any case, whatever structural appendages are included in a television studio, careful consideration must be given to the scenery and sets which are to be used to avoid any interference in erection and handling.

Developing Flexible Electrical System

In order to cope with the variety of program material usually encountered in a television workshop studio, a flexible electrical system of controls is of considerable importance. Practical considerations have limited the present systems to a-c power and while certain advantages are recognized for d-c power, this discussion will be confined to the former method. The electrical system for television lighting generally consists of a system of power input, a system of controllers, a central terminating point for conveniently energizing a number of branch circuits, and a system of branch outlets permanently and conveniently installed and distributed around the studio working area.

It has been found that for studio areas below 4000 sq ft, approximately 30 to 40 w/sq ft, installed, should provide ample power. For studios above 4000 sq ft, 15 to 25 w/sq ft, installed, should be sufficient. This does not imply that the total power indicated would actually be used but does apply to a unit area for the maximum requirements (lens stop $f/16$).

For controls, a master switch to control all the power to the studio, except work lights, is a prerequisite for total blackouts. This effect can be more readily obtained much more rapidly and with less complications electronically at the video console. However, black-outs for a particular area within a studio are desirable and may be obtained by subdividing the studio and using a number of submaster switches to extinguish relatively large amounts of illumination.

A further step in providing a flexible lighting system includes the use of dimmers. Several installations have been completed in which power is fed to a series of transformer-type dimmers and then fed to a number of branch circuits. By breaking down the available lighting power through the main, submaster and individual branch circuits through the dimming system each outlet can be individually controlled. The extent to which dimming can be used must be governed by the effective change in color temperature of the illuminant and its resultant influence on the subject. The use of dimmers should, therefore, be avoided in reducing the light on a live subject or on backgrounds which have colors; but dimmers may be used for rapid transition effects. It is worth noting that all the switches and controls can be operated under conditions of low illumination with a high

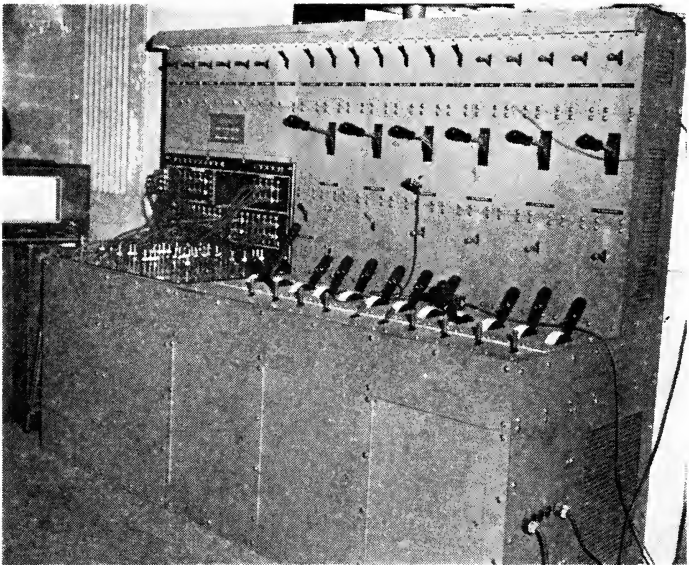

Fig. 6. Patchcord switchboard and dimmer panel,
Studio B, NBC Uptown Studios.

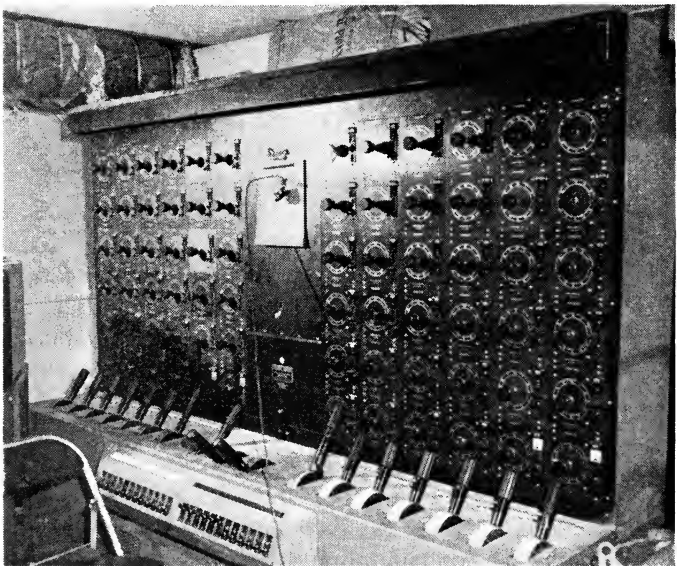

Fig. 7. Rotating selector switchboard and dimmer panel,
Studio 3A, Radio City, New York.

degree of accuracy and a minimum of noise. Typical installations are illustrated in Figs. 6 and 7.

From the central terminating point, branch outlets, approximately one to each 20 to 30 sq ft, are distributed to the ceiling grid from raceways having pigtail connectors and to outlets around the periphery of the studio. Where a fixed stage is included within a studio, floor pockets along the sides and near the edge are very useful. In a general purpose studio it has been found that three to four times as many outlets as branch circuits should be installed.

Experience has shown that the painting of scenery for monochromatic rendition on television need not be confined to varying shades of gray. Instead, the use of colors on sets should be encouraged particularly since it has been found to provide a definite stimulus to the performers as well as to audiences. This practice, however, is guided by a thorough knowledge of the translation of the colors to the gray scale on the television system under known operating conditions. Using a light source of approximately 2900 K (degrees Kelvin), 111 different shades of cold water paints have been calibrated to a corresponding shade of gray in a 10-step gray scale ranging in relative density from .03 to 1.5, similar to the test chart of the Radio and Television Manufacturers Assn., as reproduced by a standard RCA television camera chain with a No. 5820 pickup tube. In general, dead white paints and highly reflective surfaces, such as enamels and chromium plated materials, are avoided. Similarly, very dark paints, dark velour drapery and dead black surfaces are also avoided. It has been found that the desired contrasts can be achieved by accurate and independent control of the incident light striking backgrounds and/or objects to obtain a given amount of reflectivity from these surfaces.

With suitable television equipment, proper light sources, flexible fixtures and adequate facilities and controls, the ability to obtain consistently good television lighting depends on the skill and cooperation between the technical staff and the program department. It is particularly important, where time and money are involved, that each is aware of what the other is striving for. From the very first step in creating a set design, the technical staff should be kept fully informed of the intentions and desires of the program group. Prerehearsal conferences are necessary to make sure that the set designer does not show shadow lines from light coming from the right when the actual source in the studio comes from the left. For flawless performances, rehearsals must include lighting cues to insure the proper dimming, black-outs, table lamp and room light switching, etc., and that they

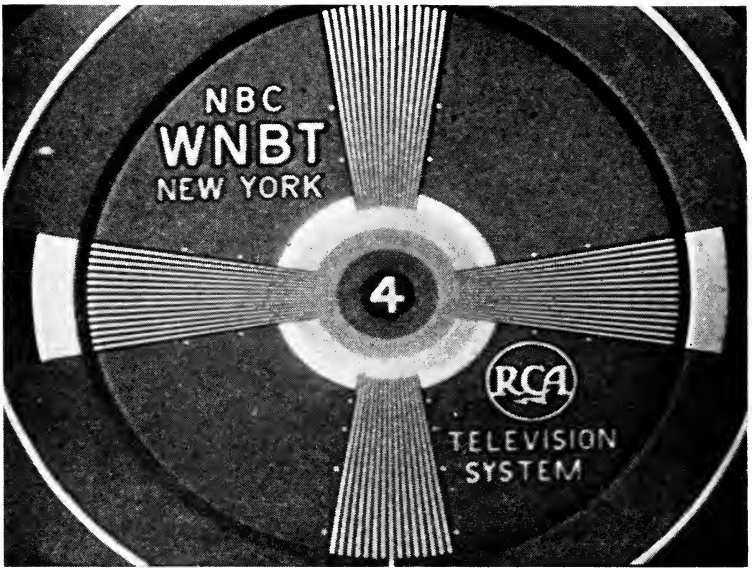

Fig. 8. Test pattern photographed on control booth monitor.



Fig. 9. Test pattern photographed on conventional home receiver by a member of the technical staff.

are accurately timed. Retakes are impossible and mistakes must be eliminated as much as is humanly controllable.

The final criterion in judging studio lighting cannot be gaged by the appearance of the picture on the home receiver alone. The influence of several factors which have a cumulative effect must also be taken into consideration. These include the nonlinearity of the system, amplitude distortion from repeater links, the broadcast transmitter and the home receiver itself. Practical experience has shown that the more rigorous control and adjustment of a monitor kinescope in the television control booth is much more useful and precise in controlling studio lighting to produce a signal capable of good reproduction on the average home receiver. Figure 8 illustrates a test pattern photographed on a studio control monitor, and in Fig. 9 the same image is shown as it appeared on a well-adjusted home receiver of a member of the engineering staff.

In a cooperative effort, the full appreciation of the experience and knowledge acquired of the television studio lighting methods and limitations can lead to a consistently improved television picture of high technical standards and artistic effort. The best results can be obtained only through the use of imagination, originality and thorough planning in applying sound fundamental principles.

The author is grateful to the many who were associated with the design and installation of the most recently completed studios and who supplied specific information. Particular thanks are extended to F. R. Rojas of the Audio Video Facilities Group and to A. W. Protzman of NBC's Television Operations for their assistance and contributions. The entire program of improving the present lighting systems and preparing for future development is continuing under the direction of O. B. Hanson, NBC Vice-President and Chief Engineer.

Electrical Printing

By JOHN G. FRAYNE

WESTREX CORP., HOLLYWOOD, CALIF.

SUMMARY: This paper reviews deficiencies in present photographic printing techniques of 35- and 16-mm films and shows how they are overcome in electrical printing as defined in the paper. The technique for electrical transfer of variable-density and area tracks to reversible color films is described. For transfer to black-and-white release films both the direct-positive variable-area and supersonic "toe" density techniques are compared for this type of recording service.

THERE IS MUCH INTEREST in the motion picture and television industries on the subject of electrical printing. We shall define this as the production of sound prints by recording from a master sound print, either photographic or magnetic, onto the composite release print. The action would, of course, be printed by the customary photographic methods.

It may well be asked why electrical printing should be substituted for the more customary contact printing of sound prints. The newer technique must inevitably be more complex and costly since the principal elements of precision sound reproducing and recording systems must be incorporated into an electric printer. This is to be contrasted with the primordial simplicity of the customary Bell & Howell Printer. With a specially designed electric printer, the manual operations could probably be reduced to those customary in the photographic printer, but until such printers are generally available the electrical printing process must necessarily be more expensive and slower than the standard photographic printing procedure.

The reasons for electrical printing must be sought beyond the economic factors involved. Improved quality can be the only sound basis on which a comparison of the two methods can be justly compared. To understand this phase of the problem, it is well to review briefly the difficulties presented in photographic contact printing. In the 35-mm field a sound contact print is customarily made by wrapping the negative sound film and the printing raw-stock film with emulsions in contact around a sprocket wheel. The sprocket employed in the Bell & Howell Models D and E consists of two hubs each having 64 teeth. The hollowed-out center area of the sprocket permits the passage of the light beam from the printing lamp through the rear of the sprocket and through an appropriate stationary

PRESENTED: October 18, 1950, at the SMPTE Convention in Lake Placid, N.Y.

aperture, finally reaching the positive emulsion through the soundtrack negative. In 16-mm printing the same principles are employed, the only essential difference being the use of a sprocket wheel having twenty 16-mm type sprocket teeth. The linear speed in printing varies over wide ranges to as high as 180 ft/min for 35-mm film.

Since the positive film lies outside the negative, it must of necessity ride higher on the printing sprocket teeth. If we assume for the moment that the sprocket-hole pitch of the two films is identical, they will present an uneven match to the sprocket-tooth pitch. Thus, if the pitch of the developed negative should be a perfect fit to the sprocket teeth the same pitch on the positive would in this case be underpitched as compared to the sprocket teeth. This, as is evident from Fig. 1-A, would result in the positive film being driven only by

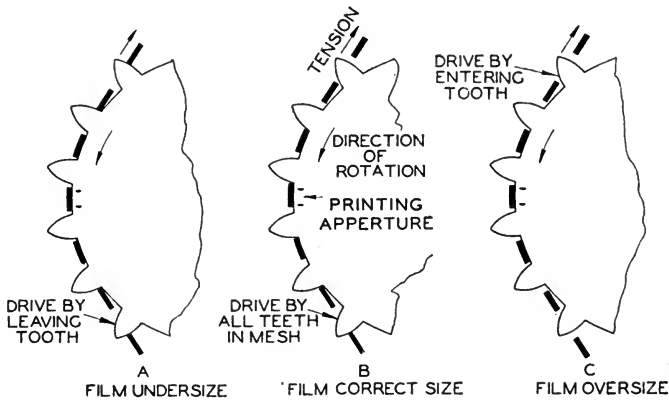

Fig. 1. Effect of film pitch on sprocket-tooth propulsion of film.

the leaving tooth. On the other hand, if the pitch of the positive film is a perfect match for the sprocket teeth, then an equally pitched negative will be overpitched with regard to the sprocket. This results in the negative film being driven by the entering tooth as indicated in Fig. 1-C. In both cases discussed above, the films, negative in the first, positive in the second, are perfectly matched to the teeth and the film is driven by all the meshed teeth as in Fig. 1-B.

In both these instances slippage of one film surface against the other takes place upon disengagement of the driving sprocket tooth. This results in (a) a velocity or flutter disturbance at the sprocket-hole frequency (96 cycles for 35-mm, 24 cycles for 16-mm), and (b) an amplitude modulation of the signal at these respective rates. The latter effect has been studied in great detail by Crabtree.¹

Some of the amplitude modulation effects produced in a 9000-cycle tone in 35-mm film printed on a contact printer are shown in Fig. 2 for various pitch differentials between negative and positive films. This figure shows that for a nominal positive film pitch of 0.1870 in. the amplitude modulation of a 9000-cycle tone becomes progressively better as the negative goes from an overpitch value of 0.18715 in. to a subpitch value of 0.1866 in. becoming more pronounced again at a pitch of 0.1864 in. The effect on the steady amplitude of a 9000-cycle

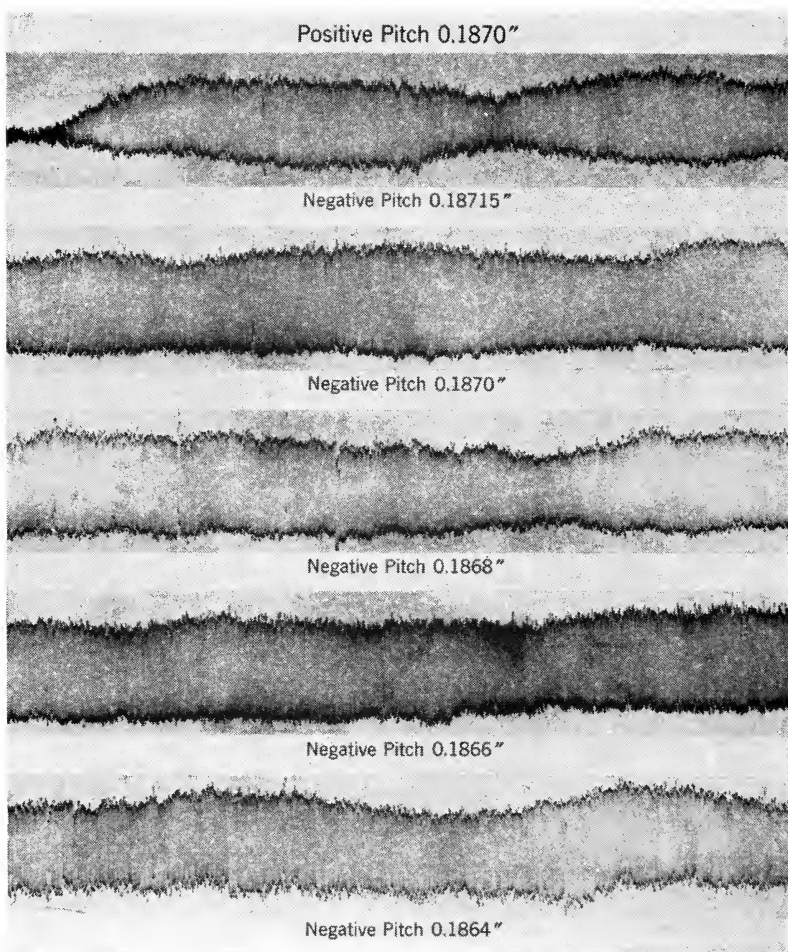

Fig. 2. Amplitude modulation effects for various pitch differentials between negative and positive films.

tone is shown in Fig. 3. This shows that the maximum print response (minimum printing loss) occurs for a pitch differential of 0.0004 in. irrespective of the type of sprocket-hole film perforations employed.

The situation with respect to 16-mm film is much worse than that indicated by Crabtree who obtained his data from 35-mm film running at 18 in./sec. The effects he found at 9000 cycles would exist at

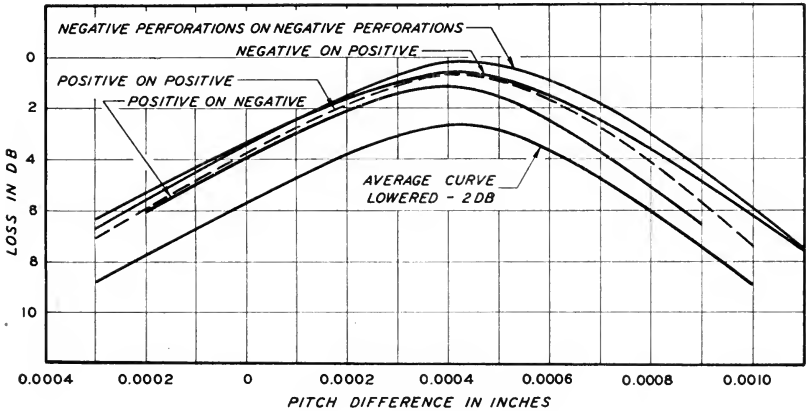

Fig. 3. High-frequency response for various pitch differentials between negative and positive films.

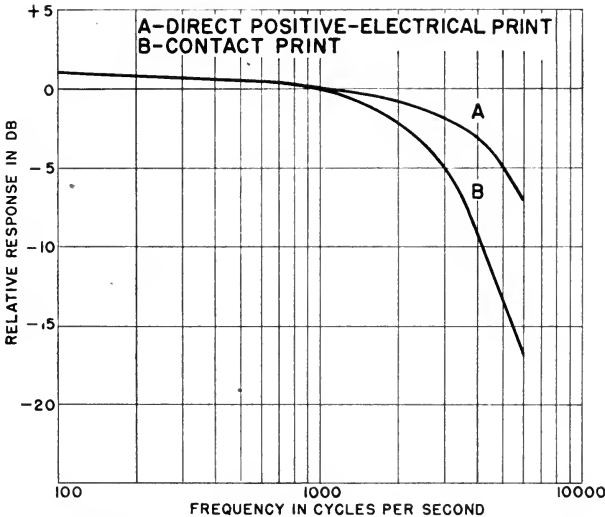

Fig. 4. High-frequency response from 16-mm direct-positive electrical print and contact print.

3600 cycles on 16-mm. The impairment of quality in the 5000-6000-cycle region in 16-mm would be comparable to that for 12000-15000 cycles in 35-mm. In view of Crabtree's findings for 9000 cycles (2-mil wavelength), it is not difficult to appreciate the greater deterioration in quality at the higher frequency or shorter wavelength. This is borne out by the steady-state frequency losses in 16-mm printing as depicted in Fig. 4 for a typical 16-mm contact print. In the same figure is shown the frequency response of a direct-positive (electrical print) in which the contact printing process is eliminated. In each film the various frequencies from 50 to 6000 cycles were recorded at constant modulation of the same light-valve modulator.² The net printing loss at 5000 cycles is about 8 db.

In addition to these data affecting high-frequency response, even more deleterious effects on sound quality are found in the uneven relative velocity of the films as they pass over the scanning sprocket. These appear in 35-mm film as severe 96- and 192-cycle flutter components, and in 16-mm film mainly as 24- and 48-cycle components. Thus, although a negative may have a flutter content as low as 0.1%; a contact print made from this negative may have a flutter content of 0.25% or higher. Flutter at these rates adds a fuzziness to pure tones and is particularly noticeable on the higher frequencies.

Experience to date indicates that the degradation of quality is more serious in 16-mm printers than in 35-mm. This is partly due to more progressive measures taken to improve 35-mm printers. These include the use of air pressure to maintain better contact between films and the elimination of one set of teeth on the printer associated with the use of high tension in the films as they pass by the printing aperture. The use of subpitch sound negatives especially with new non-shrinking safety-base films tends to reduce the effects noted above. When these films come into universal use contact printing may lose some of its present disfavor.

The idea of recording directly onto the composite sound picture release film has been discussed for a number of years but it is only recently that it has been given serious consideration. It must be realized at the outset that the use of electrical printing means the substitution of re-recording techniques in place of the customary photographic printing and that each "print" means the repetition of the re-recording process. This has the immediate advantage of the lower flutter content of a high-grade film-pulling mechanism over that found in commercial contact printers. In practice it means a reduction from flutter values of at least 0.25% to values not exceeding 0.1% and with corresponding improvements in sporadic amplitude

modulation. Along with improved flutter performance, an immediate improvement is found in high-frequency response. As was pointed out previously, this improvement is particularly noticeable in 16-mm recording.

Color Films

The field in which electrical printing appears to offer the most immediate advantages is in reversible 16-mm color films such as Kodachrome or Ansco Color. The practice most widely employed today with these films is to make an original direct-positive variable-area track and then print this directly onto the color film. This involves only one printing operation and is much to be preferred over the negative-positive black-and-white master which involves two printing operations with their attendant distortions. With the adoption of electrical printing from a magnetic-track master film, no printing processes would be involved and therefore all the effects, flutter and high-frequency losses would be minimized.

It can be shown that outstanding improvement is made, for example, in making a variable-density track by electrical printing on Kodachrome. In transferring variable-density to Kodachrome, the normal practice consists of (a) recording a variable-density negative, (b) making a variable-density print, and (c) printing this onto the Kodachrome. This process usually results in a sharp increase in intermodulation distortion as shown in Fig. 5 where curves for an original black-and-white variable-density print and the Kodachrome transfer are given. A further difficulty is the loss of modulation level in the transfer. This cannot be accounted for alone by the high photocell density of the Kodachrome, indicating a loss of over-all gamma or contrast in the Kodachrome reversal processing. Attempts, however, to correct this situation by resorting to a higher gamma on the black-and-white result in a further increase in intermodulation distortion.

When resort is made to electrical printing directly on Kodachrome or Ansco Color, the intermodulation distortion versus track density relationships are as shown in Fig. 6. While the minimum of about 20% compares roughly with that found in the other process, the abnormal modulation loss has disappeared and the output bears a direct relationship to the photocell track density. Also the deleterious effect of slippage resulting from the second printing operation is now missing with resultant over-all improvement in sound quality. The high-frequency response is also considerably improved.

A more limited experience with producing a variable-area track on

Kodachrome by the electrical printing method indicates that the results are not as satisfactory as with variable density. The so-called "balance" density occurs at a "clear" track visual density of about 0.7. This abnormally high clear track density results in (a) a low output from the film and (b) a high noise level. It is also found that the high-frequency response is very poor, being about 5 db less at 5000 cycles than in a comparable variable-density track. Further, an impractical value of recording lamp current is required to produce a reversal density of 0.7. As a result of these considerations, the use of variable-area electrical printing technique on reversal color films has not progressed very far to date.

The most marked improvement in making an electrical transfer to Kodachrome is obtained when the original track is either a direct-positive variable-area or a magnetic recording. In this case no printing process whatever is employed so that the maximum quality can be expected. This is especially evident in the transfer from magnetic recording since in this case the higher signal-to-noise ratio on the original track and the absence of the customary photographic-bias background disturbances make the magnetic medium an ideal one for the transfer. Either of these films (photographic or magnetic) may be 35-mm originals, thus giving better opportunity for obtaining a wider frequency response than if 16-mm originals were used.*

Black-and-White Films

For black-and-white tracks the transfer must be necessarily a direct-positive recording since the transfer must be made to the positive film on which the picture negative is also printed by the customary photographic means. If the sound track is of the variable-area type, the recording technique is well established. Thus, if the galvanometer type of modulator is employed, the method described by Dimmick³ is directly applicable. This method uses a d-c bias type of noise reduction but differs from the ordinary negative-positive process in that the noise-reduction envelope is recorded in advance of the signal. This anticipation method of recording the bias envelope offsets the normal time delay of the noise-reduction filter and eliminates the clipping of initial modulation peaks on steep wave-front signals.

The variable-area direct-positive method is ideal for recording on a fine-grain high-contrast emulsion such as EK-5372. In this film a

* A demonstration film shown at the conclusion of this paper was an example of an electrical transfer from a magnetic original to a reversal variable-density color print. The film demonstrated the good quality that can be obtained with this method.

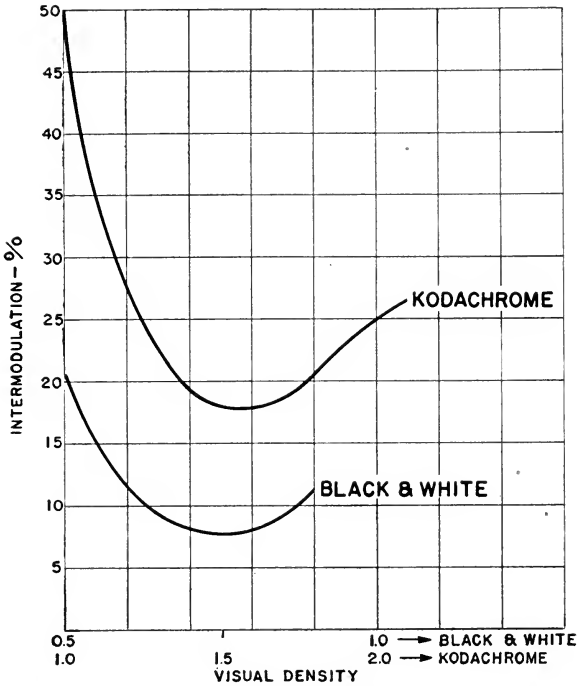

Fig. 5. Intermodulation characteristics for contact prints on black-and-white and Kodachrome 16-mm films.

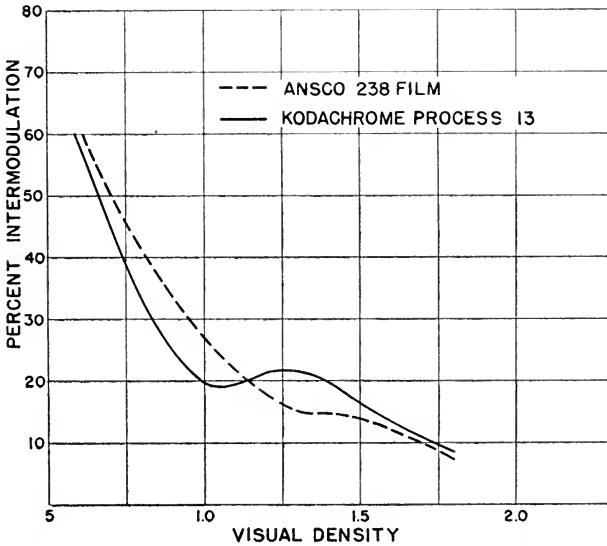

Fig. 6. Intermodulation characteristics for electrical printing on Kodachrome and Ansco Color films.

balance density including the gray base of 1.3–1.4 may be attained in a direct-positive recording.⁴ Although this is somewhat lower than the silver density values normally used on release prints, a satisfactory signal-to-noise ratio may be obtained. However, in making a direct-positive transfer to a release-type emulsion like EK-7302 or Du Pont 225, the grain noise is considerably increased over the normal negative-positive process. As shown in Fig. 7 the balance density in this case on EK-7302 is around 0.5. This low density results in a considerable increase in grain noise over that in a normal variable-area print with an opaque silver density of about 1.40. The low balance density also affects the actual amount of noise reduction that may be realized. Thus, in a normal variable-area track we may consider the opaque area as contributing a negligible amount of noise. However, in the case of the low-density direct positive, the grain noise contributed by the gray area is actually increased for the biased condition. Thus, for a negligible bias-line width of say 2 mils, the grain noise is effectively increased by 3 db over the unmodulated unbiased condition. Thus, if grain noise were the only noise factor, the use of d-c bias would accentuate rather than attenuate it. The clear area is, of course, reduced in the biasing action and the noise from dirt and scratches in this area is reduced accordingly. At the same time, dirt and scratches will cause noise to be produced in the gray area. A further difficulty is the fact that the signal level is reduced by approximately 2.5 db when the "opaque" area is reduced in density from the normal 1.4 to 0.6. The net result of these factors is to effect a serious limitation in the signal-to-noise ratio of a direct-positive variable-area print on release-type emulsions.

In order to overcome this difficulty, it has been proposed that in the case where an electrical print is made from an original variable-area direct positive the latter be purposely overexposed in a manner analogous to that of overexposing a variable-area negative for printing to a variable-area positive. To do this effectively it would probably be necessary to reproduce with high fidelity the resulting distorted cycloidal wave shape of the original track and then record with equally high fidelity these same components on the transfer print which in this case is itself distorted photographically. With the frequency limitations imposed on 16-mm reproducing and recording, it is obviously impossible to do this as completely as desired. However, reference to Fig. 8 shows that some measure of success of balancing out distortions may be obtained. In this case the original variable-area direct-positive x-modulation tests were recorded for densities varying from about 0.8 to 2.2, using EK-5372 type emulsion.

These were transferred electrically to EK-7302 type emulsion and the resulting x-modulation products measured for print densities varying from about .70 to 1.20. Figure 8 shows the cancellation of the unwanted 400 cycles in db plotted against negative density for four print densities. It will be noted that there is a definite shift toward higher optimum negative densities with increasing print densities

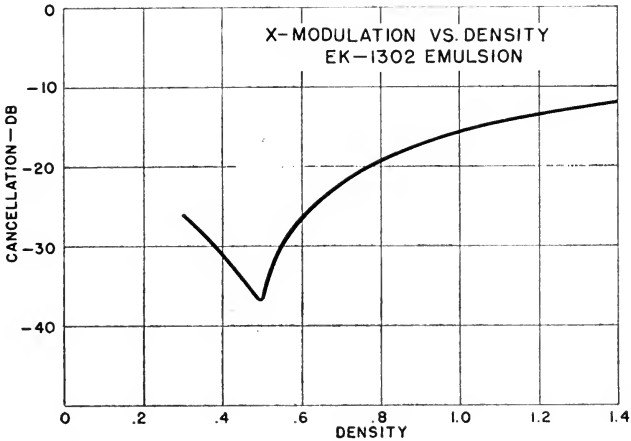

Fig. 7. Cross-modulation for EK-7302 direct-positive.

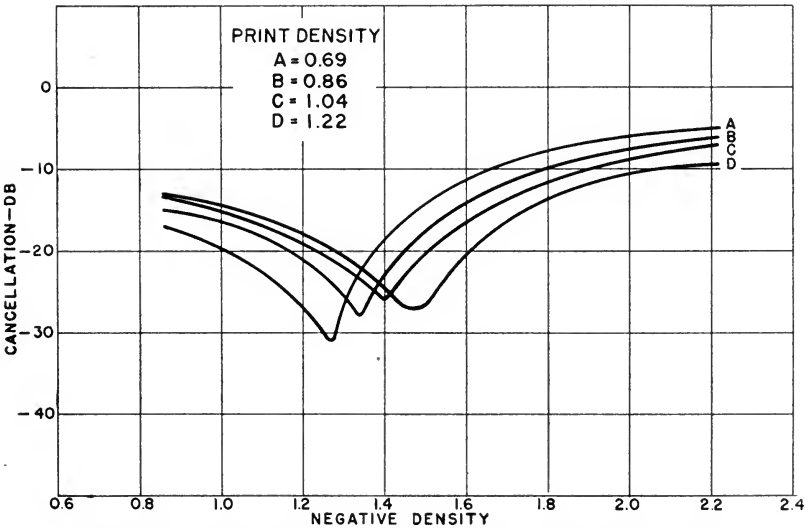

Fig. 8. Typical family of cross-modulation curves for various electrical print densities.

with only a relatively small increase in x-modulation distortion. Thus, for these film combinations (EK-5372 and EK-7302) it is possible to use a print density as high as 1.20 from a corresponding negative density of 1.5. This arrangement results in a marked decrease in print grain noise (about 10 db) with only a minor increase in x-modulation. In making this transfer the input to the electric printer was essentially flat to about 6500 cycles, the losses on the original film being compensated for by electrical equalization. It should be noted here that this result is based on a given set of developing conditions and the use of certain emulsions. It has not been established that similar results can be obtained under the wide variations of film processing inevitably encountered in the industry.

Another method of obtaining a higher electrical print density is the use of a predistorting amplifier in the transfer process to compensate for the distortion resulting from the use of higher than the balance density. In this case the original (direct-positive or magnetic track) would be a normal low-distortion recording. The distorting amplifier would then insert distortion products which result in an out-of-phase cancellation of the normal film distortion. Since the distortion products attributable to fill-in are normally even-order harmonics, a similar complementary distortion would of necessity have to be introduced in the transfer circuit. This indicates the introduction of a certain amount of controlled rectification in the transmission circuit. In the case of a relatively high-impedance modulator, such as a galvanometer, insertion of the latter directly in the plate circuit of the driving-amplifier tube would readily permit the introduction of this type of distortion. If the driving amplifier is operated on a nonlinear portion of the output-tube characteristic and the galvanometer is properly "poled" in the circuit, it is at least theoretically possible not only to cancel out the original overexposed film distortion components but at the same time correct for the "zero" shift by virtue of the changing plate current. The writer understands that this method of compensation has been tried out with moderate success but he has had no personal experience with the technique.

Variable-Density Direct-Positive

The recording of a black-and-white variable-density direct-positive presents some difficult photographic problems. It is well known⁵ that the ordinary straight-line variable-density negative is highly distorted and cannot be reproduced directly except through a specially designed amplifier.⁶ However, the use of the "toe" region of the

positive H&D curve when the gamma is sufficiently high offers reasonable linearity over a portion of the curve. Toe recording has been practiced since the earliest days of sound recording using both direct reproduction from the negative as well as from a toe print made from the former.⁷ Reasonably high quality can be obtained from toe reproduction as long as d-c biasing is not employed. The use of the latter results in operation into the more curved region of the film characteristic which introduces considerable distortion in the lower level sounds and results in undesirable volume expansion of higher level signals. Also the use of a d-c bias with a toe negative reverses the normal transmission-exposure relationship and results in a higher noise level for low-level signals. This situation can be rectified by reversal of the bias current by which the modulating light-valve ribbons are biased open for low-level operation, returning to the normal spacing for the higher-level input. While this technique results in normal noise reduction in the reproduced signal, it, of course, precludes the use of reverse bias. Also the difficulties attendant on the use of toe recording and referred to previously are, of course, still present.

Recently a very novel method of obtaining a variable-density direct positive with a minimum distortion has been described in the *JOURNAL*.⁸ In this method a supersonic bias is superposed on the modulating light-valve ribbons along with the ordinary signal currents. The supersonic bias is applied at a constant amplitude and at sufficiently high frequency so that, for 16-mm at least, it is not recorded on the film to any appreciable extent and is not reproduced in the normal reproducing process. It has been found that a 24-kc bias is satisfactory for 16-mm. The use of any higher bias frequency results in spurious modes of ribbon vibration. The purpose is to convert the light transmitted by the normal modulation of the valve to a wave shape which when combined with the toe photographic characteristic gives a nearly linear relationship between signal light-valve current and the projected film transmission. It has been found that good linearity is obtained when the peak amplitude of the bias current gives about 200% modulation of the ribbons. When normal signal currents are applied they have the effect of shifting the mid-point of the bias oscillation. With the use of 200% bias the valve is more than closed for at least a portion of each bias cycle, this being made possible by the passage of the biplanar ribbons past each other.

The manner in which the supersonic bias works is best understood by reference to Fig. 9. Without the bias, the light transmitted through the valve is directly proportional to the ribbon opening as

shown by line OB. Also without the bias, no light is transmitted for any closed positions of the ribbons such as OA. With the bias applied, the ribbon opening undergoes a sine-wave variation corresponding to the bias peak amplitude. When the signal amplitude is greater (in the opening direction) than that of the bias as at E, the average value of the transmitted light is not changed. However, for instantaneous signal amplitudes such as between D and E the valve is closed during a portion of the bias cycle and the transmitted light

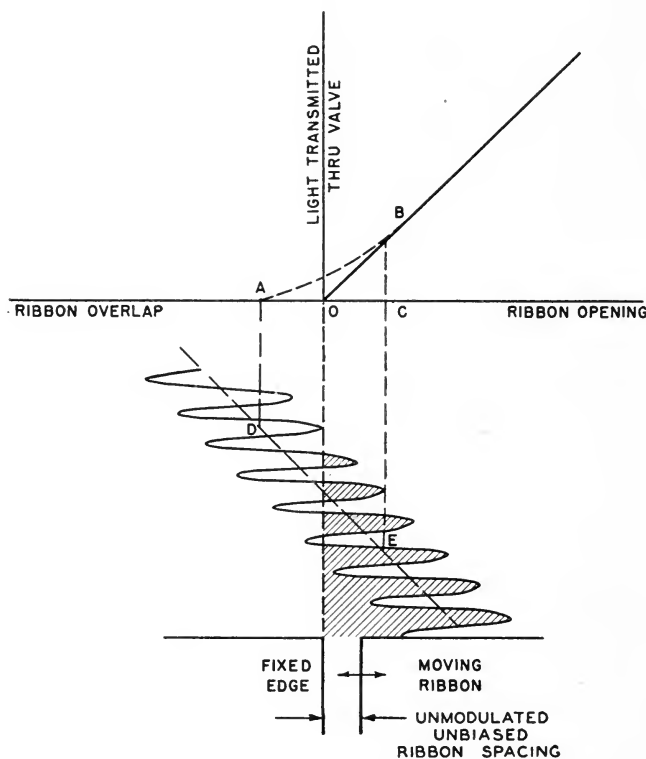

Fig. 9. Change in exposure produced during recording with a-c bias.

is in the form of a series of supersonic pulses as shown in the shaded portion of the figure. For signal amplitudes of negative polarity, such as at D, the valve remains completely closed at all times. This point represents the overload condition of the supersonic valve. For signal amplitudes lying between D and E, the average transmitted light lies along the curve AB. This represents the effective exposure of the film and this combined with the normal "toe" transmission

characteristic of the film gives an improved linear relationship between film transmission and input signal current.

The improvement in linearity is substantiated by the use of an intermodulation test.⁹ Figure 10 shows intermodulation distortion for a normal toe recording and one made with supersonic bias. It will be noted that the distortion drops from a low of about 25% to a minimum of about 4% when the bias is applied. The latter occurs at a projected transmission of about 58%. This means that a very "light" sound track results which is subject to extraneous noise from scratches and dirt. The grain noise is, however, reasonably low due to operation near the 50% film transmission value which normally gives the maximum signal-to-noise ratio for a variable-density track. However, without the use of a superposed d-c bias the grain noise is somewhat excessive.

It is possible to use a combined d-c and a-c bias and obtain further noise reduction. In fact, this technique is being currently used in a

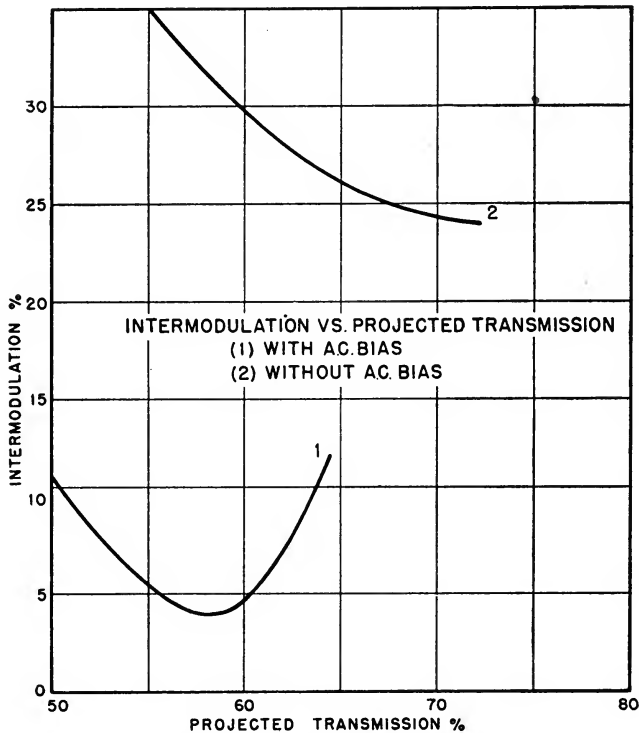

Fig. 10. Intermodulation vs. projected transmission with and without a-c bias.

Hollywood 16-mm studio where it is reported that an effective 4 db of noise reduction is obtained. It is difficult to obtain more than this amount without serious distortion of low-level signals and also volume expansion, as is obvious from reference to the curving characteristic of Fig. 9 for lower film-transmission values.

Summary

The difficulties hitherto inherent in contact printing of sound tracks, particularly with 16-mm films, have increased interest in what is coming to be known as electrical printing. In this process the release sound track is recorded directly on the composite print. This method obviates the difficulties inherent in contact printing and permits correction of sound level and frequency equalization in the transfer process. Electrical printing may be done on reversible color films by recording standard negative sound track with standard d-c bias. For electrical printing on black-and-white positive emulsions, either a direct-positive variable-area or a direct-positive variable-density print may be made. With the former, a d-c type of bias can be employed to enhance the volume range. With the latter, the use of a supersonic bias eliminates the distortion otherwise found in "toe" variable-density positives. The high average transmission of films made with the latter method assures not only a high output but also a fairly good signal-to-noise ratio. The addition of a d-c bias adds still further to the permissible volume range. In all electrical printing techniques, the resulting prints show improved flutter performance, have better steady-state high-frequency response and have considerably less amplitude modulation of the higher frequencies.

REFERENCES

1. J. Crabtree, "Sound film printing," *Jour. SMPE*, vol. 22, p. 98, Feb. 1934.
2. L. B. Browder, "Direct-positive variable-area recording with the light valve," *Jour. SMPE*, vol. 53, p. 149, Aug. 1949.
3. G. L. Dimmick and A. C. Blaney, "A direct-positive system of sound recording," *Jour. SMPE*, vol. 33, p. 479, Nov. 1939.
4. D. O'Dea, "Comparison of variable-area sound recording films," *Jour. SMPE*, vol. 45, p. 1, July 1945.
5. John G. Frayne and Halley Wolfe, *Elements of Sound Recording*, p. 275, John Wiley, New York, 1949.
6. W. J. Albersheim, "Device for direct reproduction from variable-density sound negatives," *Jour. SMPE*, vol. 29, p. 274, Sept. 1937.
7. John G. Frayne and Halley Wolfe, *Elements of Sound Recording*, p. 288, John Wiley, New York, 1949.
8. C. R. Keith and V. Pagliarulo, "Direct-positive variable-density recording with the light valve," *Jour. SMPE*, vol. 52, p. 690, June 1949.
9. J. G. Frayne and R. R. Scoville, "Analysis and measurement of distortion in variable-density recording," *Jour. SMPE*, vol. 32, p. 648, June 1939.

Motion Picture Studio Use Of Magnetic Recording

BY LOREN L. RYDER

PARAMOUNT PICTURES, INC., HOLLYWOOD, CALIF.

SUMMARY: Experience to date indicates that magnetic recording can improve quality, simplify operation and reduce cost in motion picture making. Further, the extent to which these objectives are accomplished is largely dependent upon the willingness to change technique and equipment.

THROUGH THE YEARS the motion picture industry has evolved a very satisfactory but complex system of handling, and recording on, photographic film. Most of the quality improvements have required modifications and additions to existing equipment, complicating rather than simplifying the system. The conversion to magnetic recording is the first large step toward simplification in twenty years. It involves enough advantageous changes to justify this reconsideration of the entire procedure.

If we define an ideal magnetic recording system, the definition would call for all of the mechanical procedures to be automatic, all manual operation to be simple and foolproof, all magnetic film to be available for re-use, production equipment to be light in weight and the release quality to retain the quality heard at the microphone. We can come surprisingly close to accomplishing these objectives. The Paramount West Coast Studio and Ryder 16 MM Services, Inc., are now using the methods and equipment described in this paper.

The over-all procedure involves a suitcase production recording channel using 17½-mm magnetic film, a system of transferring the print takes to direct-positive photographic film for editing and an edge numbering device for identifying and synchronizing all film. 35-Mm magnetic film is used for all dubbing and scoring. The transferring during picture finishing is largely from magnetic to magnetic.

The production recording channel is in effect a sound storage unit. Except for microphone placement and mixing, it is completely automatic and requires no attention. The complete channel, including mixer unit, power unit and recording machine, loaded ready for use, weighs less than 100 lb. Figure 1 is a picture of the complete production recording channel.

PRESENTED: April 24, 1950, at the SMPTE Convention in Chicago.

DECEMBER 1950 JOURNAL OF THE SMPTE VOLUME 55

605

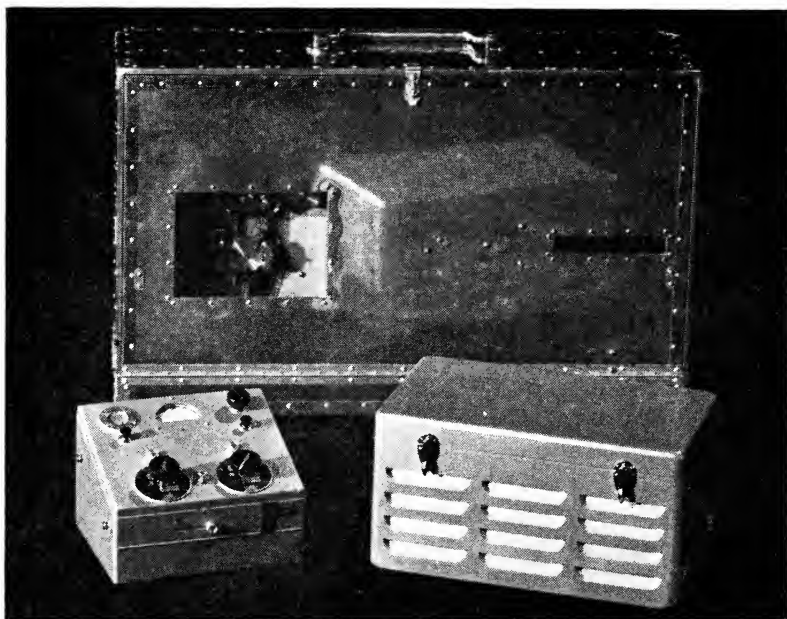

Fig. 1. Complete channel

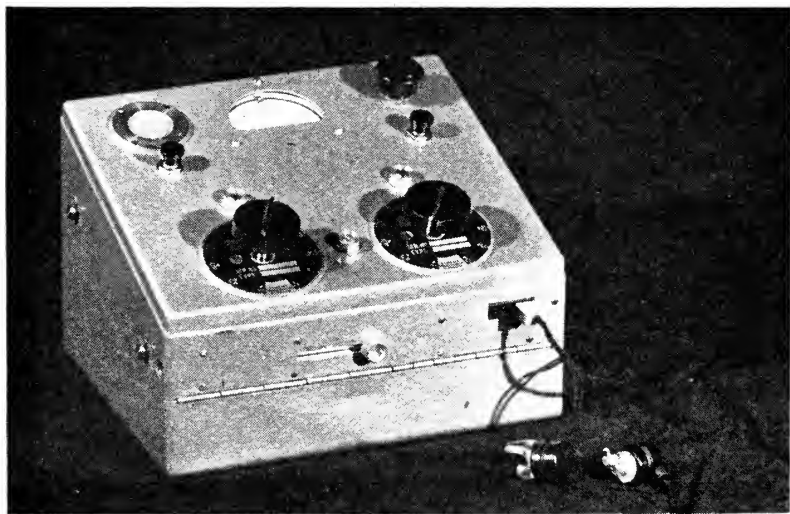

Fig. 2. Mixer, including recording amplifier.

All recording amplification, including the preamplification, is enclosed in the mixer unit, Figs. 2 and 3. The input to the two dials accommodates either dynamic or ribbon microphones. The mixer unit output is fed through the power unit to the recording machine. Playback monitoring is available to the mixer by pressing a button. The mixer unit also includes an announce microphone with control button, a dialog or music equalization control, and a rotary control switch. The switch positions are: "off," "A supply on," "A and B supply on" with normal volume indicator setting, "A and B supply on" with 6-db attenuation in the volume indicator circuit, "A voltage" measurement on the volume indicator meter and "B voltage" measurement on the volume indicator meter. A special feature of this mixer unit is that two such units can be clipped together to form a four-dial mixer.

The power supply is from dry batteries when shooting on location and from a power unit for studio use. The power supply is plugged into the cable between the mixer unit and recorder, thus reducing the number of cables to the mixer unit. Tap switches are located in the battery box for maintaining proper voltage as measured at the mixer unit. A set of batteries lasts four to six days of production shooting.

The recording machine, Fig. 4, uses the Alexis Badmaieff two-flywheel system of film stabilization and movement. This provides low flutter and extremely good contact as the film complies with the recording and playback heads. The recorder case also includes the bias oscillator, pre-equalizer and playback amplifier, all powered and under the control switch of the mixer. The playback amplifier filament supply is wired through the playback control switch so that the filaments are only fired up when the mixer is listening to playback monitoring. The recording machine is driven by a $\frac{1}{50}$ -hp synchronous motor, either 100-v, a-c, single phase, or 220-v, three phase. At Paramount 220-v, three-phase motors are used. For studio operation the recording machine gains its motor power in return wires from the camera. Under this arrangement the recording machine starts and stops under the control of the cameraman. The camera is synchronously driven from the 220-v, three-phase studio supply. D-c-a-c or multi-duty type motors are used on the cameras when shooting on location. The a-c windings from the motor, which are normally used for interlocking, are in this case used as a power supply for driving the recorder. On location, the same as at the studio, the equipment is started and stopped by the cameraman. A special camera motor which the writer is having built includes an automatic speed control built into the handwheel of the camera motor. The recording

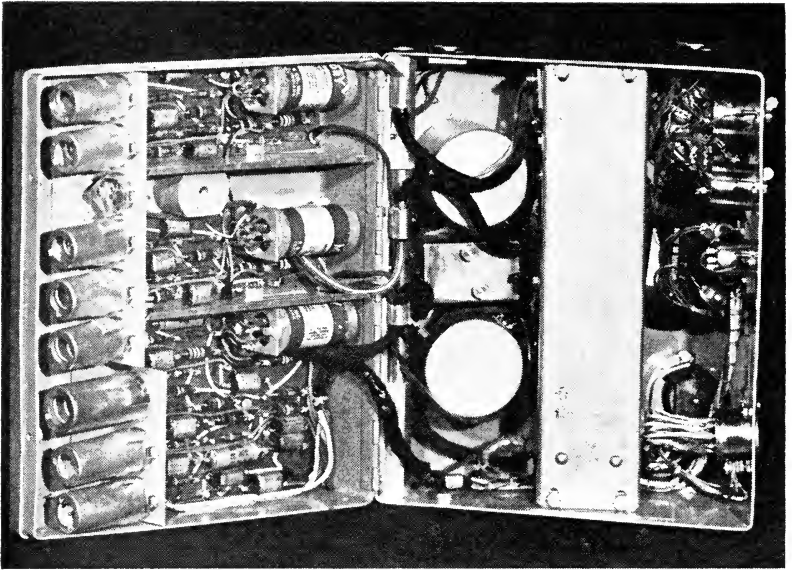

Fig. 3. Interior view of mixer.

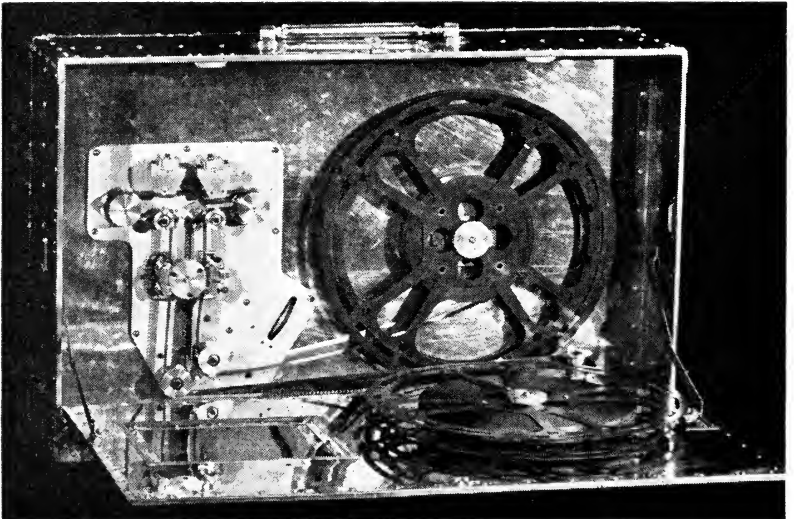

Fig. 4. Automatic recorder.

machine loaded with 2,500 ft of magnetic film weighs less than 50 lb. The feed reel is on the hinged front cover and can be operated either open or closed. Lucite windows in the front cover permit viewing the operation or checking the available footage without opening the case. The case is made of $\frac{1}{4}$ -in. balsa wood laminated with aluminum. There are no switches or operating controls either in or on the recording unit.

The plan of operation at Paramount is to service, load and unload all units at the recording plant prior to each day's work. Two complete channels are sent with each production. In operation the recording units are exchanged rather than reloaded. When shooting at the studio, the used recording unit is replaced with a freshly loaded recorder from the Recording Building. The second mixer unit supplies four dials when required. Trouble shooting on production is eliminated. The complete channel is exchanged in case of trouble or suspicion of trouble.

Synchronization can be by clapstick or, in the case of Paramount, a magnetic bloop signal is recorded on the magnetic film along with completion of automatic slating in the camera. The take numbers are announced by the mixer during the 5-sec period while the equipment is coming up to speed and stabilizing. Each roll of magnetic film is marked with the production number and given a sequential number. All rolls of magnetic film at the Paramount plant have a master punch synchronizing mark at the head end of the roll. The sound mixer's log lists all takes in sequence and indicates the roll numbers and also the printed takes. The take footage information can be obtained from the cameraman at the end of the day, if desired; however, this procedure is no longer found necessary at Paramount.

As fast as complete rolls of magnetic film are received at the Recording Building, the print takes are transferred to direct-positive photographic "electro-prints" which in turn are developed and used for editing. The transfer reproducer has the Alexis Badmaieff film movement mounted on a panel as shown in Fig. 5. This reproducer is equipped with a counter and is capable of fast winding, both forward and backward. The roll of magnetic film is threaded on this machine starting at the punch synchronization mark with the counter at zero. The operator fast winds down through the roll, monitoring and checking his log until the synchronization click for the first print take is located. The click is stopped under the reproduce head and a pencil mark is made between the sprocket holes on the magnetic surface of the film. The footage information is recorded on the log as an expedient for reprinting.

The direct-positive recording machine is equipped with a special photographic marking device that exposes the production number, the scene number, the take number and the footage at one-foot intervals along the edge of the film. The sound recording is by the supersonic direct-positive system described by C. R. Keith and V. Pagliarulo in their paper "Direct-Positive Variable-Density Recording With the Light Valve" (*Jour. SMPE*, vol. 52, pp. 690-698; June 1949). After setting the edge numbering device, the recording machine is interlocked with the transfer reproducer and turned over for the length of the take.

Paramount has also developed a 5,000-ft 35-mm magnetic recorder known as a sound storage unit. These machines operate automatically and are played in multiple with the direct-positive recorder, thus gaining a protection record of all printed takes. The 5,000-ft rolls are used on both sides and stored until the completion of the picture.

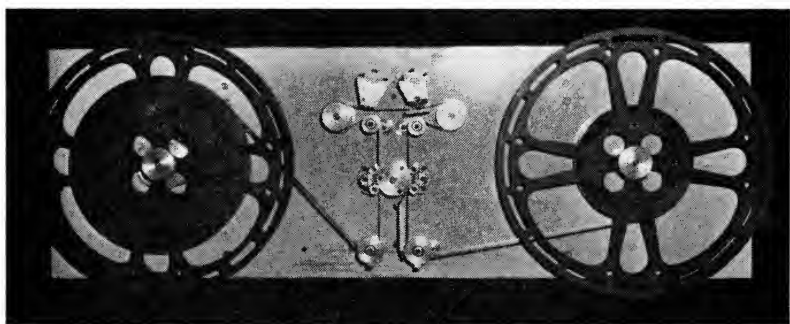

Fig. 5. 17 $\frac{1}{2}$ -Mm reproducer.

The direct-positive prints are developed, synchronized with the picture prints for daily running and then used for cutting. A special print-on numbering machine has been built to edge number the picture film with the same numbers that appear on the sound print. This makes it such that every foot of positive film in the entire plant can be identified and synchronized without further coding. All reprints carry the same numbers and, therefore, can be identified and synchronized without cross coding. It is contemplated that eventually the picture numbering will be done photographically in the camera.

Two of the Badmaieff 35-mm rack-mounted panel-type recording units are used for each scoring channel. The machines are used alternately. 1,000-Ft lengths of 35-mm film are threaded on the punch synchronization mark and fast wound down to the predeter-

mined footage for the start of music. A pencil mark is made at the edge of the film at this point for future location of the synchronization mark. While the first take is in progress the second recording machine is threaded. In case of playback the recorded film is fast rewound to the footage and edge mark, thence played back. The selected takes can go immediately from the scoring room to the dubbing room. When threaded on the punched synchronization mark they are properly synchronized and ready for dubbing. When desired the double scoring recorder can be used as a transfer machine to consolidate selected takes on fewer lengths of magnetic film. All out-take film is erased for re-use on the day following the scoring. A 5,000-ft film storage unit is bridged on each scoring channel as a protection against damage or loss of the master scoring record.

A special machine has been developed to provide a visible oscillograph-type modulated signal on the magnetic film. The writing is done with a BB ball point pen. In the procedures thus far described the modulation writer is used only when accurate checking of modulation is required for deletions in music sequences.

All library sound effects and music are to be on 35-mm magnetic film. This film will carry modulation writing for convenience in synchronization. When setting up sound effects for dubbing, the sound effects will be transferred to 1,000-ft lengths of magnetic film. The transferring will be done on a machine corresponding to the double scoring recorder, except that this machine will also have a synchronously driven picture and sound reproducer for playing and viewing the cutting print. In operating this machine it will then be possible to determine where effects are wanted, then place them on the 1,000-ft length of magnetic film by the simple procedure of transferring.

The dubbing sound prints are now obtained by the direct-positive method. At an early date the dubbing prints will be a magnetic transfer from the 17½-mm original by the procedure used in obtaining sound effects.

The dubbing recording machine is a double unit, the same as the scoring recorder. The selected takes from this recorder are transferred to a release photographic negative for release printing. At Ryder 16 MM Services, Inc., all release printing of sound is done by the direct-positive "electro-printing" method which saves the cost of a sound negative and improves the quality. A print loss is avoided by the simple expedient of avoiding printing. A similar procedure may eventually be used at Paramount. All erasing of magnetic film is done on Goodell-type noise erasers. This eraser has been found

to be more satisfactory and safer than using erasing units on the recording and reproducing machines.

At this point it might be well to mention that with the exception of the few deletions in music there is no cutting or mutilating of the magnetic film. A method is being developed to eliminate this cutting. The photographic editorial sound print is the only film cut. The writer contemplates presenting a paper at the next Society convention on editorial equipments and method.

Although this paper is not complete in every detail, almost all mechanical processes are automatic, all manual operations are simple and made foolproof by devices such as the playback monitoring and the use of sound storage units. The magnetic film is available for re-use, the production equipment is light in weight and the quality of magnetic recording is well established by demonstration and use. An effort has been made to gain a consistent and satisfactory product. The freedom from defective work has been very gratifying.

Paramount now has used magnetic equipments on eleven major productions. All productions now shooting and all future productions will be recorded on these equipments. Ryder 16 MM Services, Inc., has used this equipment in a simplified form for approximately a year in the making of television, entertainment, religious, industrial and educational 16-mm motion pictures.

One of the large measurable economies is the elimination of production sound negative and the processing of it. Other large savings include the elimination of a sound truck and the reduced footage of photographic prints, especially in scoring and dubbing. The time saving that is effected in production and picture finishing is difficult to measure. However, experience to date indicates that this saving may actually be larger than all of the other savings put together. Although the over-all savings is large, it should be pointed out that it takes time and effort to make such a change and a few steps of the procedure will prove more complex.

The writer wishes to express his appreciation to Alexis Badmaieff, Barry Eddy and the members of his staff at the Paramount Studio for their able assistance and cooperation in working out the many details of the magnetic recording system which has been described in this paper.

High-Speed Photography Of Reflection-Lighted Objects In Transonic Wind Tunnel Testing

By E. R. HINZ, C. A. MAIN, AND ELINOR P. MUHL

DEPT. OF AERONAUTICAL ENGINEERING, INSTITUTE OF TECHNOLOGY, UNIVERSITY OF MINNESOTA, MINNEAPOLIS, MINN.

SUMMARY: There follows a discussion of the use of the Marley High-Speed Camera in special adaptation for study of objects within the test channel of a transonic wind tunnel. Included are a description of the original camera and an outline of some changes required to adapt it for the photographing of nonluminous objects. Also given are methods used to coordinate the camera exposure time with the position of the moving object "bullet" and external lighting apparatus to produce 58 pictures at a rate of 100,000/sec.

INTRODUCTION TO THE PROBLEM

IN CONNECTION with a Bureau of Aeronautics research contract, it was necessary to study the behavior of bullets in the transonic wind tunnel test section. Bullets were purposely shot to pass the test sections at different orientations. It was, therefore, desired to have pictures made at speeds of approximately 100,000 frames/sec, with a minimum of 50,000 frames/sec. The test section of this transonic wind tunnel measures 16 × 16 in. The interior test section can be observed through 1-in. thick circular plate glass windows which are 17 in. in diameter. It is through the window that the camera views the subject. The subject must also be illuminated through these windows as the high-speed air precludes the use of any lighting equipment inside the channel, without making major structural changes.

In selecting a camera with which to make these photographs, the high frame speed requirements eliminated many of the better known high-speed cameras. Of those cameras which had the desired frame speed, the Marley high-speed camera, manufactured by C. F. Palmer, Ltd., of London, was the most readily available. Two of these cameras had been purchased by the U.S. Navy and one of these was supplied to the University of Minnesota, Dept. of Aeronautical Engineering, by the Bureau of Aeronautics for use in this work.

PRESENTED: April 26, 1950, at the SMPTE Convention in Chicago. This paper is a review of the developments effected under contract with the U.S. Navy Bureau of Aeronautics.

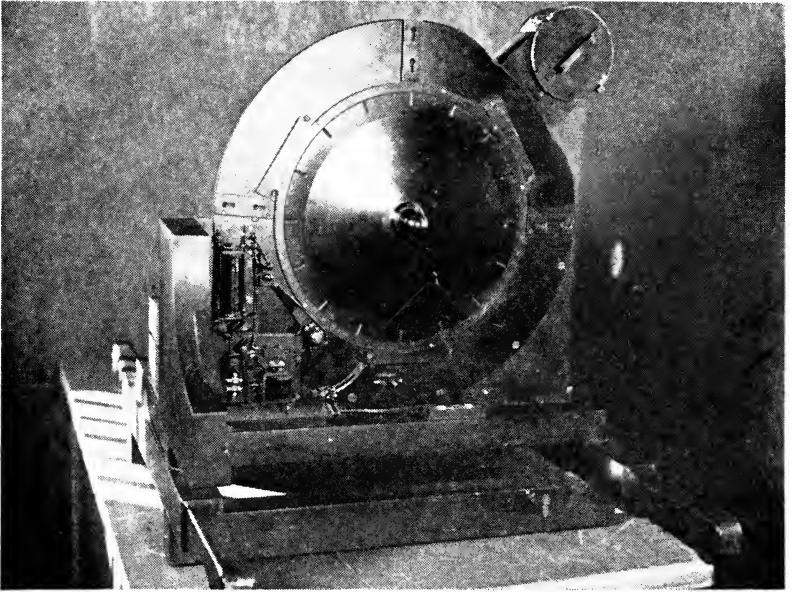

Fig. 1. Marley Camera, front view.

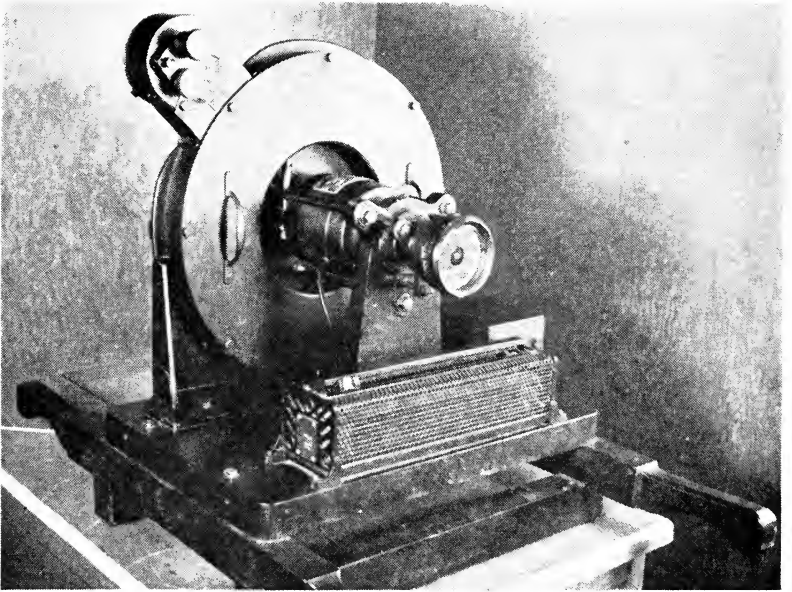

Fig. 2. Marley Camera, rear view.

The camera was originally designed to photograph explosions and other self-luminous phenomena, and it was the manufacturer's opinion that it could not be used for photographing reflection-lighted objects. Extensive development work was required to adapt the Marley camera to this sort of photography.

A brief description of the Marley high-speed camera has been published in this JOURNAL.¹ This article described the design use of the camera in recording a subject of high luminosity.

DESCRIPTION OF CAMERA

The camera consists of a set of 59 lenses arranged in a circle. Radial slots, cut in the periphery of a disc mounted to revolve in front of the lenses, expose each lens as the rotor disc rotates. Extremely high speeds of exposure are obtained by using the principle of the vernier, and providing the disc with a number of slots which is prime to the number of lenses. The camera is daylight loading and unloading and uses a 2-meter length of 35-mm perforated film, which must first be loaded into a special cassette. Views of the camera are shown in Figs. 1 and 2.

The 59 lenses are disposed round a circle of 1-ft diameter. An annular shutter ring is arranged to slide in front of the circle of lenses. This shutter ring is covered by a stationary annular cover plate with 59 narrow slots. This cover plate, with $\frac{1}{32}$ -in wide slots, forms diaphragms for the lenses, which are 3.5 in. in focal length and are thus stopped down to an aperture of about $f/27$. The rotor is provided with 16 slots and is mounted directly on the shaft of an electric motor on the main frame of the camera. Behind each of the 59 lenses a small surface-aluminized mirror is placed at an angle to reflect the light radially outward onto a strip of film which lies inside the cylindrical shell of the camera body. The lenses, mirrors and film guides are shown in Fig. 3 with the camera backplate removed.

The shutter, which normally controls the period during which exposures are made, is a flat annular ring with 59 $\frac{1}{4}$ -in. wide slots. By rotating it in its guides, all the lenses may be uncovered simultaneously and by rotating it farther in the same direction they may be closed again. This rotation, with the shutter in the cocked position is effected by three tangential springs located around the periphery. The shutter is controlled by the mechanism located to the left of the front plate of the camera. Details of the mechanism are shown in Fig. 4. The movement of the shutter is controlled by lever A which engages with the shutter ring by means of a rack. The shutter is cocked by pressing down this lever thus tensioning the three tangential

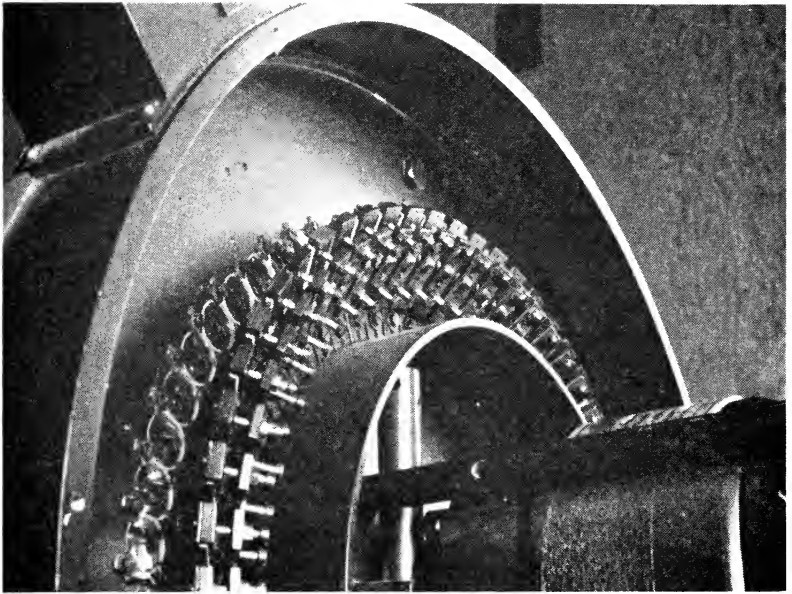

Fig. 3. View of mirror and lens system.

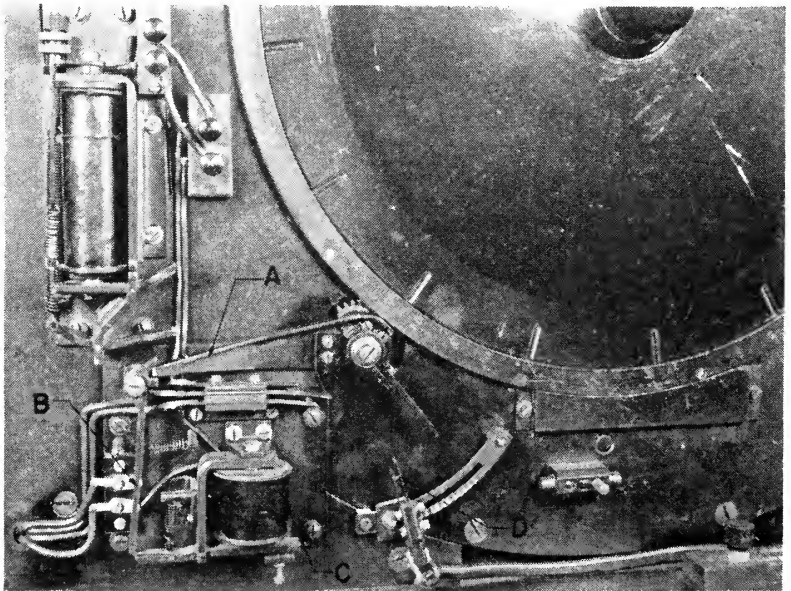

Fig. 4. Shutter mechanism.

shutter springs. Lever A is held in position by the catch on lever B. Lever B is released by energizing the associated tractive electromagnet C, whereupon the shutter rotates, uncovering the lenses for about 5 to 6 milliseconds. Adjustable firing contacts, D, are provided to initiate an electrical impulse during the short interval that lever A is in contact with them, thus providing a means for starting the action to be photographed while the shutter is open.

A shutter arresting device is provided so that the shutter may be opened before the action to be photographed takes place and closed immediately after. The shutter arrester device is shown in Fig. 5 with the shutter in the arrested position. The arresting device comprises a spring-loaded lever, C, which absorbs some of the energy of the flying shutter; the armature of the portable electromagnet B restrains the lever D, holding the shutter arm in the fully open position until the current is interrupted. The spring contacts, E, mounted below and actuated by the lug on lever A serve to energize the arresting coil, B, and break the circuit of the release coil, F, just as lever A starts to move; thus obviating undue heating of the coils which are heavily loaded. The firing contacts are held in the closed position by lever A as shown in this figure.

RATE OF EXPOSURE

The rate of exposure is governed wholly by the rotor disc speed. All 59 lenses are exposed with approximately 22.25° rotation of the rotor disc. The rotor disc is driven by a 6,000-rpm, 230-v universal motor. The speed, which can be varied by a series resistance mounted at the back of the camera, is ascertained by means of a permanently coupled tachometer. With the rotor disc turning 6,000 rpm, the rate of exposure is 95,500 frames/sec. At this rate of exposure the time required to expose all 59 frames is $618 \mu\text{sec}$ (microseconds) resulting in approximately $10.5 \mu\text{sec/frame}$. At 4,500 rpm the exposure rate is 71,500 frames/sec or approximately $14 \mu\text{sec/frame}$. The examples cited indicate how the speed of the rotor controls the exposure rates of the camera.

PRELIMINARY CAMERA DEVELOPMENT

Extensive development work with the Marley Camera was required to make the necessary adaptations for photographing reflection lighted objects. In the camera as supplied, the lenses were focused to give sharp definition at 22 ft. By utilizing the maximum adjustment of the aluminized mirrors in both the vertical and angular planes it was

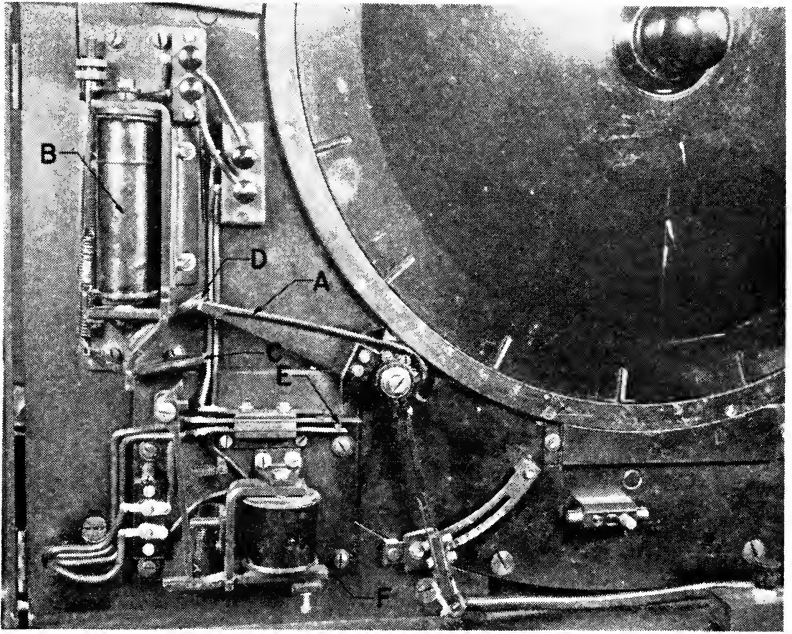

Fig. 5. Shutter in arrested position.

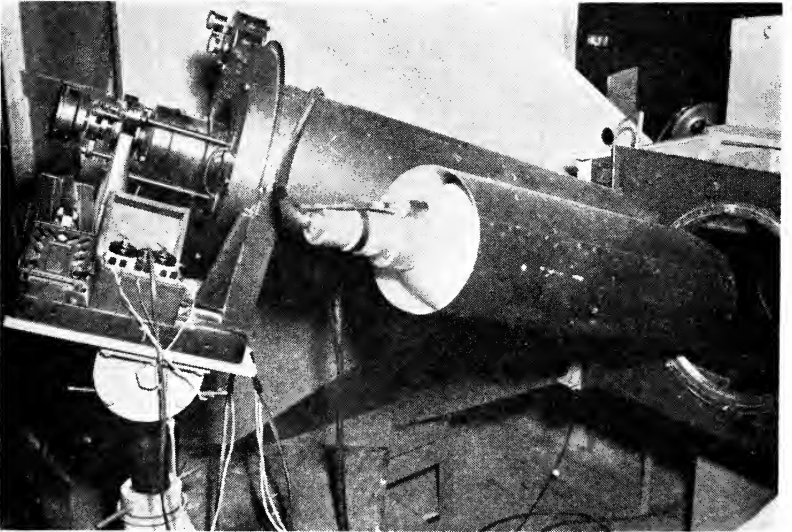

Fig. 6. Marley Camera and mount at transonic wind tunnel.

found that reasonable definition was possible at 53 in. from the object to the lens plane. The shortest distance possible was desirable due to the size of the subject and to reduce overlapping of the images as there are no dividers which clearly define each frame. Overlapping can be eliminated by using a black nonreflecting background for the areas outside the desired field. This method of controlling overlap was feasible for experimental exposures, but was not suitable for the wind tunnel situation. The reduction of overlapping on the negative was accomplished by mounting a cylindrical tube on the camera as shown in Fig. 6. This light tunnel was painted a dull black which eliminated internal reflections, decreased overlapping by limiting the field of view and reduced the interference of extraneous light.

Since the exposures were of very short duration it was desirable to have a film of maximum speed. However, this and other requirements of film and development were mutually exclusive. A good degree of contrast was needed with a minimum of grain so that the 35-mm film would result in good enlargements for analysis. The film-development combination that was finally found to be most suitable from all points of view was with Eastman Kodak Linagraph panchromatic film and D-72 (Dektol) developer in a 1:1 solution at one and one-half times recommended development time. This was found to give a good degree of contrast without objectionable grain size in a six-times enlargement.

The camera exposure sequence does not follow a simple consecutive one, two, three pattern. Also, the initial frame in the sequence is a haphazard incident, whereby the exposures may start with any one of the 59 apertures that is in coincidence with a rotor slot at the time the shutter opens or the illumination reaches an intensity sufficient for exposure. As a means of identification, the apertures were numbered in a clockwise direction with number one chosen at the twelve o'clock position when facing the camera. In viewing the film the initial exposure is first determined, then there are 48 numbers between consecutive exposures, i.e., if number 1 was the initial exposure the second in the sequence would be number 49, the third, 38, etc. Therefore, the exposure where the action under consideration starts is first determined and the sequence is followed through with the above system which is applicable regardless of the position of the initial exposure.

The stand built to support the Marley Camera for the wind tunnel tests was a modified airplane wing jack. This unit allows the camera to be raised or lowered and tilted as necessary, as shown in Fig. 6.

ILLUMINATION

The illumination problem presented a difficult obstacle in conjunction with the use of the Marley Camera. Others familiar with the camera were skeptical of the possibility of providing sufficient light to photograph nonluminous objects.

Early experiences with the camera showed that sufficient light, about 42 megalumens, could be obtained with a battery of photoflash bulbs for satisfactory exposure. However, the arrangement of an array of flash bulbs to be focused through a 17-in. diameter window and the elimination of the resulting reflections was a formidable problem. Also, the photoflash bulbs have a variable ignition time resulting in an effective flash time of 30 to 50 milliseconds. In conjunction with the duration of the flashbulbs, the period of operation of the mechanical shutter requires 5 to 6 milliseconds which would expose each frame ten times if all 16 slots of the rotor were used at 6,000 rpm. Inasmuch as the mechanical shutter operation cannot be speeded up and a high exposure rate was required, the only suitable light source was electronic flash equipment capable of controlling the duration of exposure.

A standard Strobe-IV flashtube power supply unit satisfactorily fulfilled the requirements of short duration and high output. The Strobe-IV is produced by Strobe Research, Milwaukee, Wis. It is designed for an output of 1,000 wsec (watt-seconds) and is equipped so that the energy may be divided by plug-in outlets into energy levels of 1,000, 500 and 250 wsec. General Electric flashtubes types FT-403 and FT-503 were used with the Strobe-IV power supply.

The General Electric flashtube FT-403 has a rated output of 45 megalumens at 480 wsec. Figure 7 shows the characteristic time-intensity curve of the FT-403 at 2 kv and 250 μ f or 500 wsec, and of the FT-503 at 4 kv and 250 μ f or 2,000 wsec from information supplied by General Electric. In common with all capacitor-flashtube light sources, the actual duration of the flash is long, compared to its photographic effectiveness, because of the relatively weak illumination produced by the tail of the time-intensity curve. Accordingly in evaluating such curves, exposure time with electrical flash can be defined as the time that the light intensity is above one-third of the peak value. The Strobe-IV power supply provides 500 wsec for the FT-403 with 2,675v and 140 μ f resulting in a peak light intensity of 45 megalumens with effective light for a duration of approximately 500 μ sec.

The illumination setup used for the tests consisted of the Strobe-IV

power supply unit and two FT-403 electronic flashtubes. These were disposed on opposite sides of the wind tunnel, illuminating the test section through the two plate glass windows in the walls of the wind tunnel. In another series of tests the FT-503 was used providing a peak intensity of 75 megalumens with an effective light duration of approximately 800 μ sec.

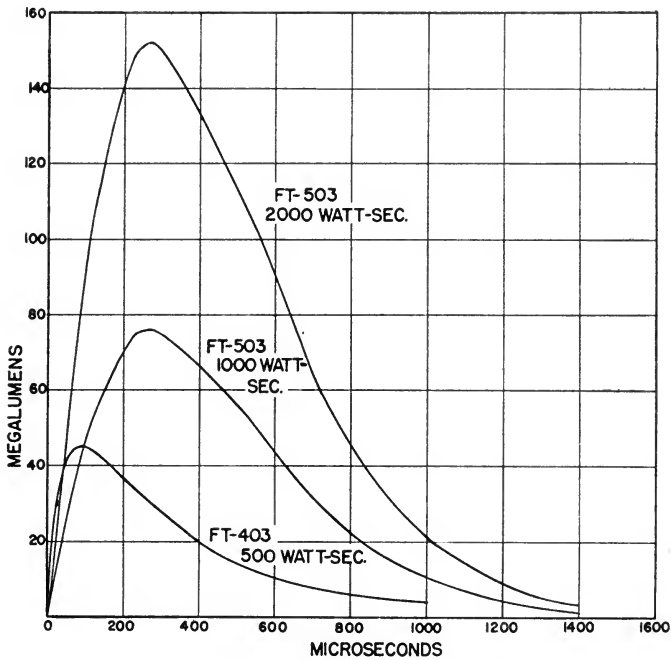

Fig. 7. Flashtube time-intensity curves.

TIMING AND ELECTRONICS

The necessity for accurate timing was imperative for complete success of the testing program. The timing problem required the elimination or restriction to a minimum of all operating variables. The adaptation of the electronic flash equipment which was reliable and consistent simplified the problem and revealed some of the other variables. The mechanical shutter was found to be erratically variable. However, the shutter arrester device provided a convenient means of eliminating this difficulty using the flash duration and rotor speed to govern the exposure time. The use of the shutter arrester device also eliminated the inherent delays of the electromag-

netic and solenoid-plunger units involved. The high-speed airflow in the wind tunnel precluded the use of microphone pickups and other timing devices placed in or near the test section. A special wire holder was mounted on the muzzle which provided a positive means of determining when the bullet was 6 in. from the muzzle. The only troublesome variable that remained was the variation in bullet velocity, and

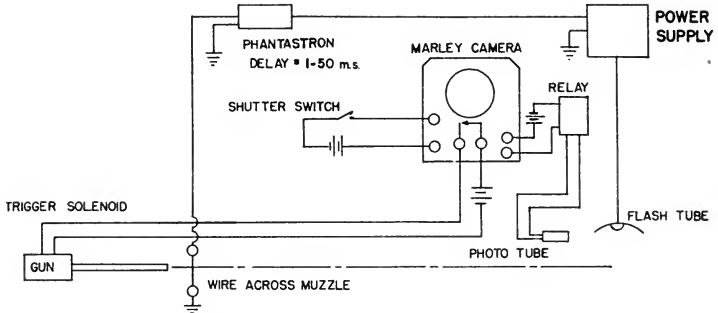

Fig. 8A. Operating diagram. *Sequence:* (1) shutter released manually; (2) camera contacts fire gun; (3) gun breaks wire, starts pulse into relay; (4) delayed pulse fires light; and (5) light on phototube closes camera shutter.

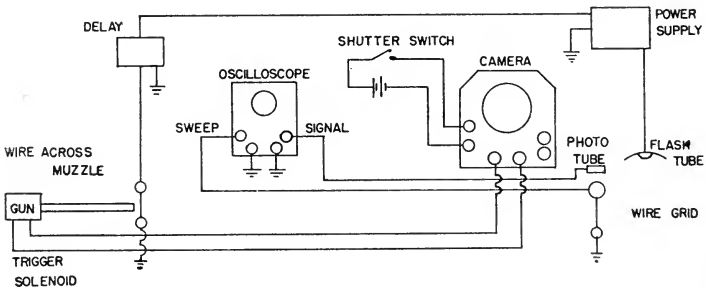

Fig. 8B. Timing calibration diagram. *Sequence:* (1) shutter released manually; (2) camera contacts fire gun; (3) gun breaks wire, starts pulse into delay; (4) bullet breaks wire grid, starts sweep; (5) delayed pulse fires light; and (6) phototube shows light pulse on screen with peak of light at beginning for correct timing.

this variation was reduced to a minimum by temperature control and careful handling.

Since the gun was located at a distance of 10 ft from the center of the test section, a delay unit was required in the circuit to compensate for the time required for the bullet travel. A phantastron delay unit was constructed with a variable control delay of .3 to 15 milliseconds

or with a change in capacity a delay of 1 to 50 milliseconds was possible.

The final complete camera, gun and flash operating circuit resulted in a series operation in which no two units required simultaneous interdependence. The components of this circuit (Fig. 8) and the sequence of operation was as follows:

1. A control panel containing a power control switch and a triggering switch initiated the sequence of events.

When triggered, the tractive electromagnet was energized from an external source of 200-v d-c power which released the shutter. The shutter was retained in the open position by the shutter arrester. The shutter arrester portative electromagnet was energized from an external 12-v battery. The adjustable contacts actuated by the shutter lever were adjusted to close when the shutter was arrested in the open position.

2. The gun was fired with a special 24-v solenoid-plunger mechanism. The solenoid was energized by a 24-v battery through the set of adjustable contacts on the Marley Camera.

3. A wire in a special holder on the muzzle was broken by the bullet 6 in. from the end of the barrel. As the wire broke, it triggered a 2D21 thyatron which imposed a negative pulse on the phantastron delay circuit. The phantastron delay unit emitted a sharp positive pulse of about 25 μ sec duration at 150-v amplitude.

4. The delay pulse triggered the Strobe-IV electronic flash unit. The triggering circuit of the unit originally consisted of an OZ4 cold cathode thyatron which supplied a pulse into an ignition-type high voltage transformer to initiate firing the flash tubes. It was necessary to modify this trigger circuit due to erratic triggering of the cold thyatron. The OZ4 was replaced by a type 2050 hot cathode thyatron. This made a marked improvement in the bad time jitter previously encountered in triggering the flashtube. It also allowed the addition of a longer cable between the delay unit and the flashtube trigger unit without appreciable difficulty in triggering due to attenuation of the sharp delay pulse.

5. The illumination emitted by the flashtubes activated a photoelectric cell and amplifier to de-energize the shutter arrester solenoid allowing the shutter to close.

The output of the photoelectric cell fired a thyatron which, through a common cathode resistor, cut off the plate current of a triode tube, de-energizing a normally closed relay in the plate circuit. The shutter arrester control circuit was manually energized to prevent overheating of the windings.

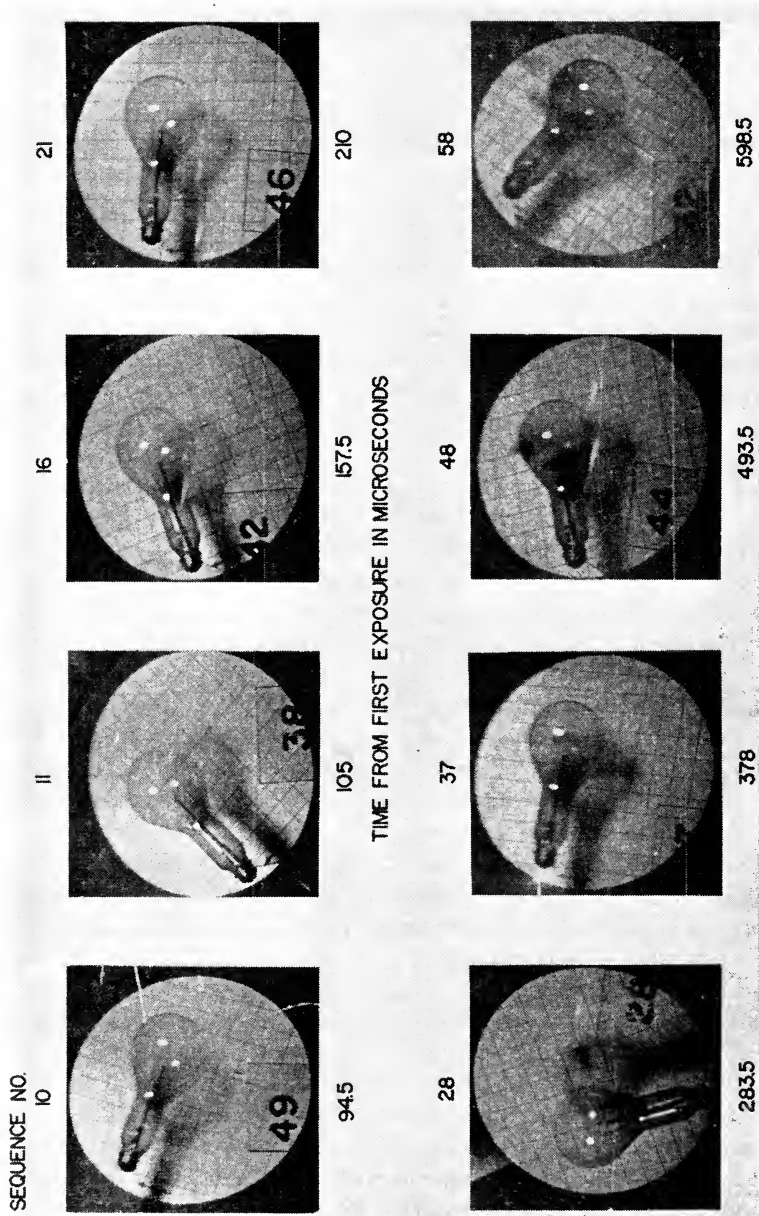

Fig. 9. Series of photographs of a .22-caliber bullet passing through an electric light bulb. Exposure rate, 95,500 frames/sec; exposure time, 10.5 μ sec/frame; illumination, one General Electric FT-403 at 3 ft.

In the timing calibrations, oscilloscopes were used to show the time relationship of the flashtube output to the bullet position at the center of the test section. A wire grid assembly was placed in the center of the test section and fired into. The bullet breaking a wire in the wire grid, energized the oscilloscope single sweep. The output of a photoelectric cell placed near the electronic flashtube was fed into the vertical deflection plates so that that part of the light occurring after the grid wire broke appeared at the beginning of the sweep. Two sweep speeds were used: a 4-millisecond, for setting rough placement; and a 600- μ sec, for fine adjustment of the delay setting. Consequently, by adjusting the delay circuit, the peak illumination could be controlled in relation to the bullet position. The timing and electronics problems were solved by W. Y. Fish of our electronics group and the optical problems by E. H. Wrench.

Figure 9 presents excerpts of a series of photographs of a .22-caliber bullet passing through an electric light bulb. This sequence was taken at 95,500 frames/sec with one FT-403 flashtube at a distance of 36 in. from the object. The angular orientation of the frames is due to the disposition of the lenses about a circle. Consequently, each lens views the subject from a different angle. The numbers on the individual frames are lens numbers or frame numbers previously described and do not represent the order of exposure. Unfortunately many examples of the use of this equipment are not available for showing at this time because of the type of material they are concerned with.

PROJECTED USES

In considering the possible uses to which this camera may be put in the future, it seems more appropriate to describe the conditions under which the camera could be made useful, than to suggest specific situations. Such a list would probably omit many possibilities which are not presently apparent.

Through the manipulation of the different variables, it is possible to operate this camera at speeds from about 1,000 to 96,000 frames/sec. It appears, however, that the chief advantage of this camera lies in its ability to photograph at high frame speeds, as there are a number of cameras which give good results at lower frame speeds, and do not have some of the disadvantages of this camera. At its upper range the Marley Camera is capable of photographing rapidly moving objects as they pass through a given field of view, or any rapid change taking place. It is now established that it is possible to use

this camera for photographing either selfluminous objects or objects illuminated by reflected light.

In the future, the construction of separators inside the camera is advisable, to eliminate overlapping on the film of images from adjacent lenses. In photographing selfluminous objects, for which the camera was designed, this would probably be unnecessary but would not be detrimental. For photography by reflected light it would eliminate the necessity of a black background surrounding the object and/or the use of a light tunnel or similar device for limiting the field of view. Although the light tunnel eliminated the most objectionable overlapping, there still was some present. While the pictures obtained served the purpose, it was felt after the tests were completed that the addition of separators to the camera would have made the job of analysis an easier one.

REFERENCES

1. G. A. Jones and E. D. Eyles, "Recent British equipment and technique for high-speed cinematography," *Jour. SMPE*, vol. 53, pp. 502-514, Nov. 1949; also in *High-Speed Photography*, vol. 2, pp. 76-88, Nov. 1949 (reprinted from the Nov. 1949 *Jour. SMPE*).
2. General Electric Flashtube Technical Information Bulletin, L. S. 110, Jan. 1948.
3. William, Mortensen, *Flash in Modern Photography*. 2d ed., Camera Craft Publishing Co., San Francisco, 1947.
4. Harold E., Edgerton, "Electrical-flash photography," *High-Speed Photography*, Part II of *Jour. SMPE*, vol. 52, pp. 8-23, Mar. 1949.

U.S. Naval Underwater Cinematography Techniques

By R. R. CONGER, AFC, USN

MOTION PICTURE DEPT., U.S. NAVAL PHOTOGRAPHIC CENTER,
ANACOSTIA 20, D.C.

SUMMARY: The Navy's earlier procedures in underwater cinematography are reviewed, then the progress to the latest equipment and methods used by the Naval Photographic Center. From knowledge gained on location tests, current techniques stress extreme mobility and versatility using a single cameraman. The motion picture camera and deep sea diving equipment now in use are briefly described.

DURING WORLD WAR II several training films were made under water with some success; however, water conditions under which this photography was performed were considered the most ideal. Even then it was recognized that the range of operations was limited.

A standard 35-mm motion picture camera was contained in a hastily constructed watertight housing; but because external operating controls were completely lacking, it could be used successfully only with difficulty.

Due to its bulk, the Kluge (so named for the sound it made when dropped into the water) had little or no maneuverability, and the problems encountered with this early type of crude equipment are too numerous for discussion here.

On these earlier trials, photographers were merely "checked out" on the diving equipment and a regular Naval diving crew was on location to assist and guide them.

Using the Kluge underwater blimp, the camera crews were sent to Ocala, Fla., and tried to operate under water as a camera crew would on a sound stage. Much of the film footage, time and crewmen's energies were expended shooting "slates" for each take, etc. Underwater exposure was determined haphazardly by such methods as placing an exposure meter in a glass jar, or reading the surface reflections from the water and dividing by a predetermined factor, and by on-the-spot test development. Using such cumbersome equipment and methods, the Motion Picture Section of the U.S. Naval Photographic Center completed four very fine training films

PRESENTED: October 19, 1950, at the SMPTE Convention in Lake Placid, N.Y.

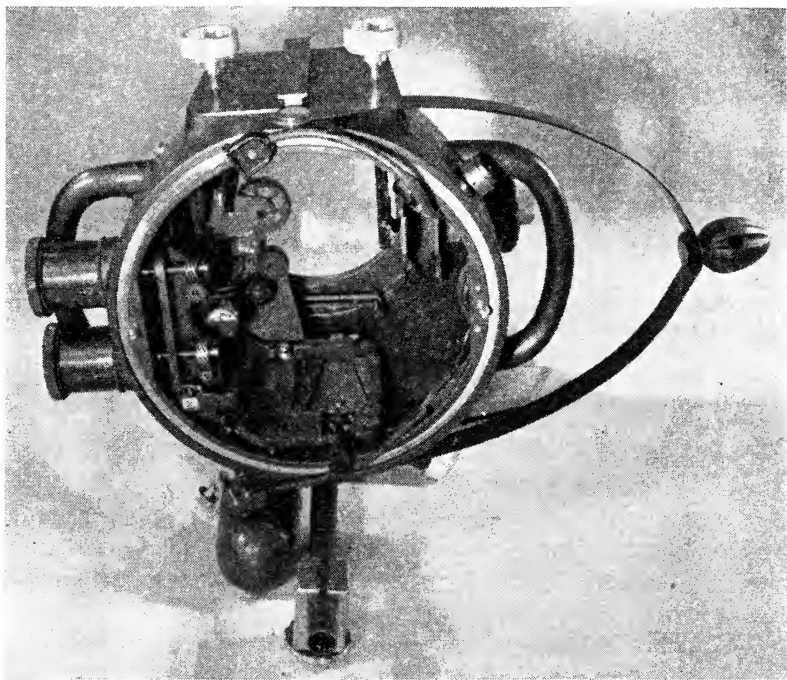

A side view of the front section of the Aquaflex 35-mm underwater motion picture camera housing reveals the geared receptacle for the Camerette and the exterior control knobs (*Photo by Victor Kayfetz*).

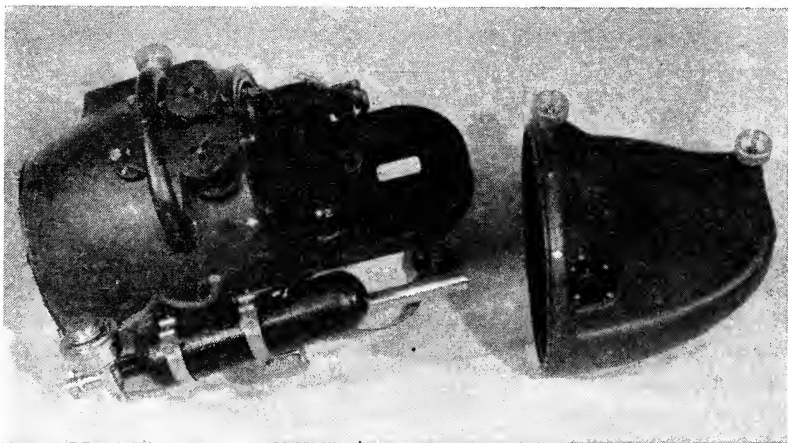

Front section of the Eclair Aquaflex with camera magazine battery tray and compressed air bottle in place ready to receive the rear closing section (*Official Photograph, U. S. Navy*).

for the Deep Sea Diver Series, one in 35-mm Monopac Color and three in 35-mm black-and-white.

Two later and more expensive underwater housings were built for the Berndt-Maurer 16-mm motion picture cameras. Although they included some improvements, these blimps also lacked all essential safety features and were less successful than their predecessors.

Other than a limited amount of undersea cinematography done by LCDR E. R. F. Johnson, USNR, (whose paper "Undersea cinematography" was published in the *JOURNAL*, vol. 32, pp. 3-17, Jan. 1939) who was recalled to active duty and utilized his own special equipment, underwater cinephotography in the U.S. Navy has been virtually at a standstill since World War II.

The "Aquaflex" 35-mm underwater motion picture camera, of French design and manufacture, was procured by the Bureau of Aeronautics for the purpose of determining its adaptability to Naval photography. The evaluation tests were conducted by the U.S. Naval Photographic Center in the clear waters off St. Thomas, V.I., utilizing Naval production motion picture cameramen who had been properly schooled to attain the rating of a U.S. Naval Deep Sea Diver.

The Eclair Aquaflex is the only camera manufactured specifically as a self-contained, motor-driven, underwater motion picture camera with external lens controls and automatic interior pressurization. This professional submarine motion picture camera of revolutionary concept is entirely independent of air supply and electric cables leading to the surface.

The Aquaflex is primarily an Eclair Camerette (Camerette) (described in the *JOURNAL*, vol. 55, pp. 173-179, Aug. 1950, by Benjamin Berg, the North American Representative for the Eclair Motion Picture Camera Co., Paris, France) which is contained in an underwater housing with external controls to operate the lens diaphragm, focus, and starting switch. The Camerette is driven by a 6-8-v, 7-amp motor which is powered by four 2.6 nonspillable, lead, wet-cell batteries. It is supplied with 28-, 40-, and 75-mm coated $f/2$ Kinoptic lenses. However, these are not interchangeable under water. Small lights are located in the Aquaflex blimp to illuminate the interior exposure meter, film speed tachometer, internal-external pressure differential gage, and the film footage counter located on the 400-ft film magazine. These lights go off when the starter switch is turned down to give the motor maximum voltage. The Camerette utilizes a reflex optical system so that the diver-photographer views the image through the taking lens. The shutter may be set at any

desired opening from 200° to 35° , thus presenting an exposure choice from $\frac{1}{14}$ at 8 frames/sec to $\frac{1}{415}$ at 40 frames/sec.

The front section of the Aquaflex contains the plastic photographing port, the control gears and camera mount, the batteries and wiring, the pressure gages and exposure meter, plus all the necessary mechanisms for controlling the Camerette under water. The rear section covers the 400-ft film magazine, contains the three smaller viewing



Underwater Cameraman R. R. Conger, AFC, USN, in a relaxed shooting position, setting the diaphragm stop on the exterior knob (*Official Photograph, U. S. Navy*).

ports and seals the camera. The Aquaflex is delivered with two 400-ft film magazines, three 1-liter compressed air bottles, and other accessories, plus the necessary filling adaptors and camera case. The detachable wings and vertical rudder aid greatly in transporting and stabilizing the camera under water. With them it is possible to guide the camera with one hand, using the other to aid in swimming. The camera wings actually act as a planing surface, so that the

photo-diver can sight on his target through the view-finder, kick his flippers and guide himself by tilting and banking the camera in a manner similar to a plane flying through the air. The Aquaflex, complete, weighs about 107 lb in air, but can be adjusted to have either positive, negative or neutral buoyancy, under water.

The encased Camerette has the appearance of being rather delicate in design, but its ruggedness was proven by two accidental floodings in salt water. The equipment was rinsed in fresh water several times and blown dry with high-pressure air before cleaning each integral part with 180-proof alcohol and reiling. On the first flooding the camera motor was metered to have almost "O" ground, but was still capable of turning the camera over at 24 frames/sec. After both floodings the Camerette and Aquaflex blimp were completely disassembled, cleaned, reiled, and were back in operation the next morning.

During the repair operations it was found that the surface mirror on the shutter which provides the reflex vision was alcohol soluble, and so could not be cleaned with ordinary lens cleaner. This was one of the many facts omitted in the letter of instructions received with the underwater camera. Being on location, the mirror could not be recoated, but the mirror's subsurface polished plastic base provided enough reflection to continue operations. This fault was later rectified by a recoating with aluminum and an over-coating of quartz.

The Aquaflex is by no means leakproof, but the supply-demand type compressed air valve is so regulated that the housing contains about 3 psi over the sea pressure at any depth the camera may be taken. The camera air supply is carried in a charged cylinder, compactly arranged on the under side of the Aquaflex blimp. As the Aquaflex is descending, the demand valve increases the interior pressure to equal the depth pressure, plus 3 psi. On the ascent the demand valve closes and excess air pressure escapes through a relief valve. The 3-psi interior-exterior pressure difference should always remain the same and is visible on a gage located in the Aquaflex blimp.

Due to its design and form-fitting construction, the Aquaflex necessitates modifying the former methods of underwater motion picture camera operation as well as locomotion.

During the evaluation tests, all of the standard deep-sea and shallow-water diving helmets, as well as the standard and modified versions of the shallow-water diving face plates, used by the U.S. Navy, were tested and none was found adequate for use with the Aquaflex because of the placement of the reflex view-finder port

Of the seven American and foreign swim-type face masks tested, only one, the French "Squale" face mask, was found satisfactory. It was later found that this rubber face mask is the type used by the French underwater cinematographers.

Because the Aquaflex is a completely free and mobile underwater unit, the photo-diver must be equipped with self-contained or free diving equipment. Of all the American self-contained diving units tested, only one was found usable and it has an undesirable face



Diver wearing Cousteau Aqualung and swim fins, photographed at a depth of 85 ft, with an exposure of $\frac{1}{40}$ sec, $f/2$, using Eastman Plus X film (*Official Photograph*, U. S. Navy).

mask. This unit is an oxygen rebreathing system and is limited to a depth of 60 ft.

In the ordinary supplied-air or self-contained diving units, much of the diver's time, movement and thought are consumed in the manual regulation of his breathing system control valves. This is undesirable for photography as the diver may have to stop in the middle of a "take" for this operation. The French "Aqualung" was tested and found to be a completely automatic compressed-air self-contained diving unit. It has a separate mouthpiece breathing

hose with which the "Squale" face mask may be used. This is the ideal situation as it leaves the photo-diver's hands free to operate the camera, and his mind is free to concentrate on his photographic work and the sequences needed.

Both the Aquaflex and the Aqualung operate on the same automatic supply-demand principle. The greater the water pressure, the greater the pressure of the air supplied to both the diver and the Aquaflex. Both the camera and photographer are of neutral bouyancy so that the photographer, with the aid of swim fins on his feet, is able to



Puffer, or blowfish, photographed at a depth of 40 ft
(*Official Photograph, U. S. Navy.*)

swim with the camera in any direction or to any depth down to approximately 200 ft.

During the tests the photographer descended with the Aqualung to a depth of 120 ft. With the Aquaflex he descended to a depth of 95 ft and obtained usable film footage without the use of supplementary lighting equipment.

However, it cannot be too highly stressed that all the compressed-air diseases, intoxicating effects, and decompression problems which plague the diver using other deep sea rigs are also present when using the Aqualung, and the photo-diver must be in excellent physical and mental health and thoroughly trained as a diver.

Once the photo-diver is completely familiar with his equipment, he will find it an easy matter to swim after and photograph large fish and other moving objects, obtaining angle, follow and moving shots, hitherto undreamed of. He will find that the camera maneuvers easily under water even in currents and tides. When using the Aquaflex and the Aqualung, he may hover over his subject—rising and falling only an inch or so with his own respiration—to make steady shots comparable to tripod shots.

The clear waters most favorable for undersea photography are found in tropical bays, lagoons and other sheltered areas where the horizontal visibility is greatest. These warm, still waters are also attractive to large and oftentimes potentially dangerous fish.

The photo-diver's working location is usually on or near the sea bottom where there are moray eels, octopuses and other fearsome-looking creatures. During the tests, these fish did more to enhance the picture value than to hinder the photographer. The underwater crew encountered quite a few manta or sting rays, several large sharks, many barracuda (one of which measured $5\frac{1}{2}$ ft in length), and three moray eels, one having a head at least 5 in. wide. The bat-like appearance and thrashing barbed tail of the fast-moving manta rays made the crew uneasy, although none attempted to attack. With explosives, the crew killed a shark which measured over 14 ft in length. Many large barracuda approached the crew as close as 7 ft and actually swam with them, but seemed merely curious. The moray eels live in and around small caves in the coral and are definitely dangerous.

Oddly enough, the photo-diver's most troublesome enemy is the coral. After prolonged exposure to water the diver's skin is soft and is easily cut on the jagged coral. These wounds take six weeks or longer to heal and leave pronounced scars. However no fish were attracted by bleeding from cuts of this type.

The underwater use of the Aquaflex by the motion picture and television industry is limited only by the imagination. The undersea life is intensely interesting. It is a beautiful new world to be brought to the screen.

For the teacher, underwater films can bring to the classroom an accurate living and biology text in color.

For the scientist engaged in various phases of underwater research, pictures can be obtained which would permanently record the performance of ship hulls, the geological features of sea bottoms, and the characteristics and habits of plant and marine life.

35-Mm Ansco Color Theater Prints From 16-Mm Kodachrome

BY ADRIAN MOSSER

FILMEFFECTS OF HOLLYWOOD, CALIF.

AND LINWOOD DUNN

RKO-RADIO PICTURES, INC., HOLLYWOOD, CALIF.

SUMMARY: This paper describes one of the successful methods of bringing the 16-mm motion picture to the 35-mm screen in color. The information presented is the result of more than two years research and work in this field by Filmeffects of Hollywood.

THE PRESENT ANSCO 35-mm color method for motion pictures has been in successful use since 1945. It consists principally of Ansco 735 as the camera film, which is a 35-mm three-color stock of the reversal type, printed on a higher contrast reversal stock, Ansco 732, which is color-balanced with the 735.

The Ansco Color 732 has also been found to be ideally suited to the making of 35-mm three-color theater prints directly from 16-mm reversal color originals. The 732 stock is exposed on an optical printer, enlarging from the 16-mm color original. The sound is printed from a 35-mm direct-positive sound track and the film is processed, waxed, and is then ready for theater projection. In this simple manner, a three-color image can be transferred from a 16-mm original directly to a 35-mm theater print, in one step. There are no intermediate films involved, and there are no registration problems. Prints can be made at the rate of thirty to sixty feet per minute.

The simplicity of this direct blowup color print procedure, combined with the economy of shooting three-color productions on a low cost 16-mm original, makes this method highly attractive to producers who require only a limited number of release prints for their particular market, and to whom costs are of paramount importance.

In the last two years, some theatrical producers, principally foreign, have produced feature length films on Eastman Kodak's excellent 16-mm Commercial Kodachrome, for release in 35-mm Ansco Color, through this direct blowup method. The over-all savings are appreciable, where the quantity of release prints required is small, as compared to the cost of working in any other 35-mm three-color method.

PRESENTED: October 11, 1949 at the SMPE Convention in Hollywood.

The old major studio maxim, "film is the cheapest thing on the lot," does not apply to this class of production, as the budgets are closely calculated for a limited market. Additional costs incidental to photographing in 35-mm three-color, such as raw stock, laboratory processing, shipping and equipment costs, might well determine the difference between profit and loss on some productions.

Another use for direct blowup theater prints is for the industrial and documentary film market. As a rule producers in this field work exclusively in 16-mm color, and their films are exhibited to 16-mm nontheatrical audiences. Occasionally, however, there will be a need for a few 35-mm color prints for special showcase showings in theaters and large auditoriums. Inasmuch as intermediate film steps are not necessary before the first print can be made, even a single print may be ordered without incurring the usual costly preparation work.

For many of the producers using the direct blowup release print process, it is their first attempt at making a film in color. Shooting in 16-mm sometimes misleads to further economy, particularly in the selection of equipment and technical personnel. Such economy is false, and can be quite disastrous when the film must compete in the theaters with original 35-mm pictures. The smaller size and comparatively low cost of 16-mm should not lead the producer to believe that other requirements have been reduced proportionately. As in all color processes, the quality of the release print depends a great deal upon the perfection of the original photography. A poorly photographed scene in black-and-white can often get by because its deficiencies are recorded only in tones of gray. The same scene photographed poorly in color will usually show up badly and as a glaring misrepresentation of reality.

The cameraman must pay particular attention to lighting contrasts, color values, and exposures. Also, filming in color causes the problems of make-up, costuming and set decoration to grow in importance. All of these arts become increasingly vital factors to be considered in striving for photographically smooth 35-mm color theater prints.

Cameras and accessories must be selected with great care. Excellent professional 16-mm equipment, with critically sharp lenses, is now available. This equipment is of standard design, and can be used in conjunction with most other existing studio equipment, with little change in operative technique required. Most of the difficulties incurred by cameramen shooting color for the first time, arise from insufficient knowledge of the limitations of the particular material they are using. For this reason, it is just as important in 16-mm to

use seasoned technicians, as it is in any other color photography, regardless of the type or size film used.

Editorial work can be carried out in several ways. If desired, a 16-mm color work print or black-and-white reversal work print can be made. For 35-mm producers, perhaps the handiest method would be to use a 35-mm black-and-white work print, which allows for editorial and dubbing operations to proceed in conventional fashion, utilizing standard equipment. Filmeffects has developed a method of making blowup black-and-white work prints economically, and with maximum safety to the original. This method consists of printing a 16-mm black-and-white dupe negative from the original, on positive stock using a continuous printer. This "temporary" dupe negative is then put in a special high-speed blowup printer, which enlarges to 35-mm black-and-white safety positive stock. Edge numbers from the 16-mm color original are transferred to the sound track area of the 35-mm work print during the procedure, making the matching of the original color a comparatively simple job. Great care should be taken in the handling of the original film, as the slightest abrasions or scratches are obviously magnified in the 35-mm blowup. The best of major studio negative cutting procedures should be practiced to the letter in order to insure the cleanest and most nearly scratch-free original possible. Plans are now being made to offer to producers in this area, a new film lacquering service which should insure a much wider margin of safety in the handling of originals.

When a great number of lap dissolves are desired in a release print, the original is generally assembled in A and B rolls. This arrangement permits the dissolves to be made each time while printing directly from the camera original. If the optical effects are few or involved, dupe sections incorporating the effect can be cut in with the original. Corrections are made semiautomatically, where necessary.

Although routine color release printing is generally done from the 16-mm original to obtain the highest quality prints, producers occasionally require 35-mm black-and-white negatives for certain export use, where the market may be more limited. This type of work has proven to be quite satisfactory, and very acceptable commercially. 35-Mm color printing masters can also be made from the 16-mm original, for the making of theater prints by contact.

The Acme-Dunn Optical Printer used in making the Ansco Color blowup release prints, features a 16-mm projector head equipped with a Bell & Howell type shuttle movement. This movement is fitted with two register pins placed side by side to accommodate double

perforated originals, or they can be reset one above the other for the single perforated. The 35-mm camera head is also of the Bell & Howell type, with a positive-matted aperture, and a variable opening shutter for the making of fades and dissolves. The light source is a 750-w projection lamp, fitted with a highly efficient condensing system. Provision is made between the lamphouse and film for diffusion screens and color-correction filters. Lenses used are the 4-in. $f/4.5$ Cooke Copying, and the 4-in. $f/2.8$ Eastman Printing Ektar.

In most cases, a single print is made in one passage of the original through the printer. Sound synchronization is indicated at the tail end of the newly exposed reel of raw stock, which is then run tail end first through a 35-mm sound printer to make the sound track exposure. The track required for this process must be a 35-mm positive image in negative position, generally obtained by re-recording to a direct positive. The exposed print is then processed by the Houston Color Laboratory, the average time being about 9 min in the first developer and $7\frac{1}{2}$ min in the color developer, using the Ansco Color 732 release positive stock. A temperature of 68 F is maintained in both the first and second developers. During processing, the sound track area is sulfide-coated to render the unexposed areas of the dye track opaque. Twenty-five to fifty prints are usually sufficient to meet the requirements of the market for this type of production.

We are grateful for all of the help we have received in this work, from the expert technicians connected with the companies mentioned. With their continued cooperation, we hope to advance further, making use of the promising new commercial color films which we know the next year will bring forth. The future looks bright for the 16-mm color theatrical producer, as quality will improve and the costs should be reduced.

New Laboratory for Processing Monopack Color Film

BY KRISHNA GOPAL

FILM DIVISION, GOVERNMENT OF INDIA, BOMBAY, INDIA

SUMMARY: A new laboratory has been designed to utilize for the first time the system of pump and spray processing for all its different operations, except for the developer.

WITH THE INCREASING DEMAND FOR COLOR in this country it was thought that the introduction of a system which called for little change in equipment as far as cameras and other studio equipment was concerned, would be ideal for the purpose. Studios in India are fairly well equipped with cameras, possessing as they do the latest, and in many cases even the BNC Mitchells, and the equally good Continental Super-Parvos, but the use of arcs is still a luxury which few can afford. Under the circumstances a color film of the monopack variety adapted for a color temperature of the Tungsten light was considered the most suitable as a solution of India's immediate needs for color.

The Gevaert organization of Belgium had recently put their "Gevacolor" on the market and their local agents offered to import this material in limited quantities. Samples were offered to different producers, tests were carried out, and the exposed negatives flown back to either Antwerp or Brussels for processing. The results were satisfying, but little more could be done because local producers insisted on seeing their rushes within two or three days if not on the next day, while the time it took to fly the film to the continent and back was sometimes as long as one month or more, if no import difficulties were encountered. There seemed no other alternative but to build a laboratory in India itself.

The writer has been interested in color for some considerable time, and it fell to him to design this particular laboratory. The demands of Gevacolor film, which in principle are perhaps the same for all such color material, were carefully studied in personal discussions with Gevaert technicians. Independent laboratories, such as those of Eclair in Paris and Denham in England, were also consulted because of their experience in processing this type of film. As a result of these studies the present laboratory was designed. The construction itself

A CONTRIBUTION: Submitted July 11, 1950.

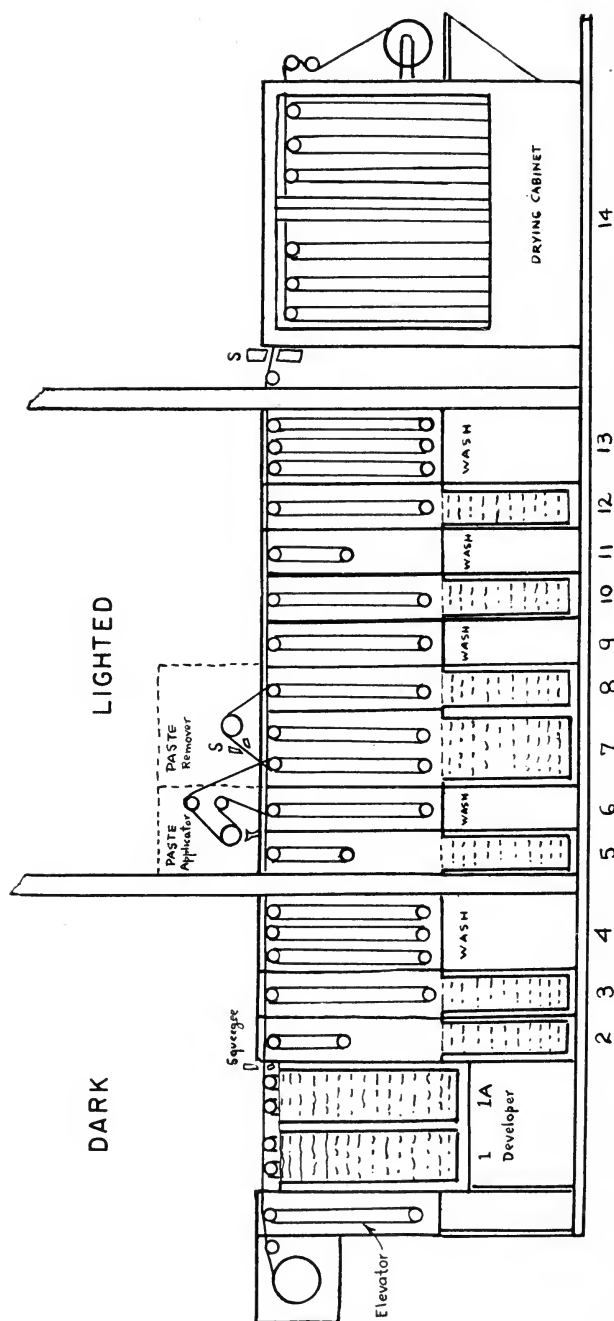

Fig. 1. Diagram of pump and spray processing machine for Gevacolor film.

1-1A, Developer; 2, Stop; 3, Hardener; 4, Wash; 5, Dilute bleach; 6, Wash; 7, Bleach; 8, Stop; 9, Wash; 10, Fixing; 11, Wash; 12, Hardener; 13, Wash; and 14, Drying.

was entrusted to a local firm specializing in this class of work, and was taken in hand early this year. Five months later the machine was ready for operation. Utilizing as it does the pump and spray instead of deep tank processing for twelve out of its thirteen operations, this machine is believed to be the first of its kind.

Gevacolor film, like Ansco film, has its color formers incorporated within each of its three layer emulsions, but unlike Ansco it is not of the reversible type. Instead it develops into a negative having colors complementary to the original subject, and has to be printed on a similar though slower material to produce a color positive. A first development in a normal developing bath is therefore unnecessary, and the film is led directly into the color developer.

Briefly the layout of the machine (Fig. 1) is as follows:

Exposed film, after passing through a normal feed elevator assembly, passes straight into the developer tank (Fig. 2). This is provided with eight powerful underwater jets directed against each of the moving strands of film and fed by a high-capacity, stainless-steel pump. Solution for the pump is drawn from the bottom of the tank. A subsidiary inlet at the intake of the pump provides a means for continuous replenishment. At this stage any developer carried over by the film as it emerges from the tank is drawn off by means of a suction squeegee. After this first development the film does not enter any deep tanks for further treatment, but is led instead into a series of stainless-steel cabinets mounted over tanks of similar material. Solutions from these tanks are pumped through strong jets on the emulsion side of the film from the top, whence it flows down the moving film and returns to the tank below (Figs. 3 and 4). For continuous replenishment, the same method is employed as that for the initial developer. It will be noticed from the accompanying diagram (Fig. 1) and photographs that in no cabinet does the loop of film descend low enough for any direct contact with the solutions. The different steps for negative development are:

- | | | | |
|--------------|-----------|------------|--------------|
| 1. Developer | 5. —* | 9. Wash | 12. Hardener |
| 2. Stop Bath | 6. —* | 10. Fixing | 13. Wash |
| 3. Hardener | 7. Bleach | 11. Wash | 14. Drying |
| 4. Wash | 8. —* | | |

* Used only for positive prints (see text below).

The treatment for positive development is slightly different. The first development takes place in a second tank, the contents of which are slightly different, mainly in its bromide content, from those of the negative developer bath. Thence, the procedure up to wash No. 4

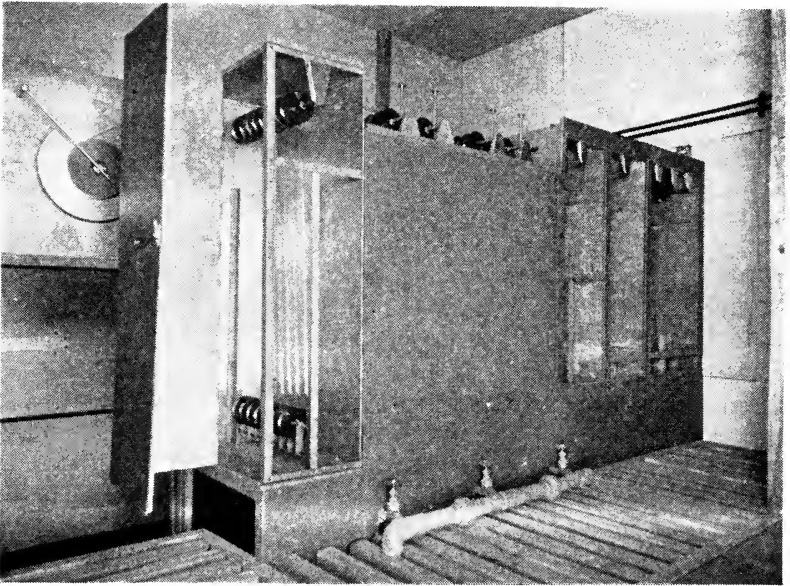

Fig. 2. View of the dark section of the developer tank with elevator cabinet open.

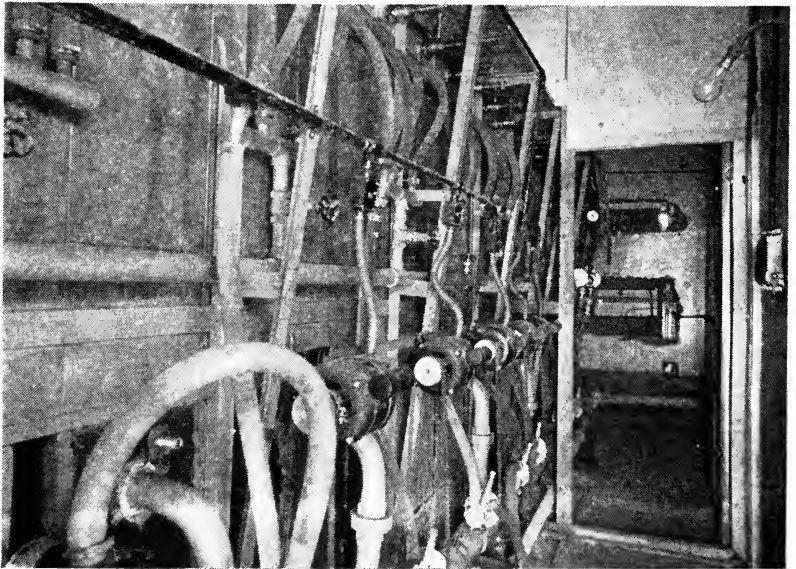

Fig. 3. Rear, close-up view of the machine from the drying end, showing pumps, motors, piping, etc.

is identical. Then a dilute bleach and wash are given in cabinets 5 and 6, after which the film is brought out on top of the cabinet where a special applicator applies a paste containing the main bleaching solution on the picture side only, leaving the sound side untreated. The film then enters cabinet 7 and is allowed to run on the first bank without the pump being switched on. Once more it is brought out on top, the paste removed by means of a suction squeegee, and thence

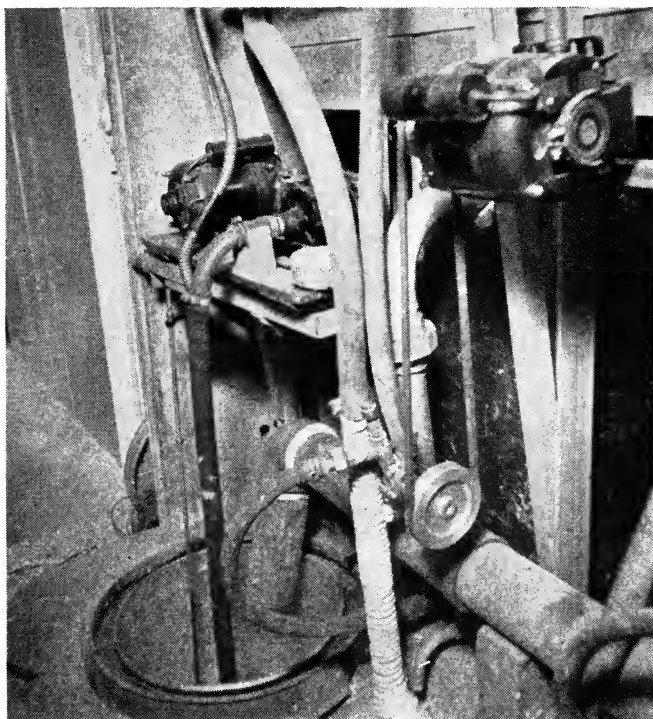

Fig. 4. Rear, close-up view of the machine, showing one circulation pump and chilled water pump.

taken to cabinet 8 for a further stop bath, and thereafter through the wash-fix-wash-hardener and wash stages exactly as for the negative. This treatment leaves the film with an unbleached, black-and-white sound track.

To facilitate these change-overs, all top shafts are provided with independent clutches. The drive itself is by means of one drive sprocket per shaft screwed tightly to it and after the first free roller.

There are in all six free rollers besides the sprocket, providing for six loops per bank.

The lower assembly has all independent and freely moving rollers and is itself capable of free movement in a vertical direction alongside two stainless-steel guide rails. It is sufficiently weighted to give the requisite amount of tension to the film.

A partial view of the lighted section of the machine is shown in Fig. 5.

The over-all speed of the machine is 500 ft per hr, and the size of the film loops is approximately 4 ft each, giving an approximate time of 5 min for each bank.

As the time required for certain operations is less than 5 min, the guide rails have been extended allowing the lower assemblies to be suitably raised to give the correct time.

Friction drive has not been very popular in this country, and while it would probably have given much smoother results in the long run, it was felt advisable to retain standard Indian practice in at least this respect, everything else being so revolutionary and more likely to keep the operators' attention engaged elsewhere.

The construction is of stainless steel throughout, except for such parts as do not come in direct contact with the solutions. The pumps are of American manufacture. The drive sprockets, as well as all the free rollers, have been so designed that they can accommodate both 35- and 16-mm film. The machine can thus be used for both sizes of film, although it has not yet been tried out with 16-mm film.

Temperature is regulated by providing thoroughly insulated jacket tanks for all solution tanks, round which precooled water is circulated. Two independent systems have been provided, one exclusively for the developer with a thermostatic control differential up to 0.5F, and the other for the rest of the solutions and with a much broader thermostatic differential control. As an additional precaution against undue rise of temperature, both the dark and the lighted ends of the machine have been air conditioned to a temperature of about 72F.

The drying cabinet has been placed in the general drying room of the main laboratory building along with three other drying cabinets for standard black-and-white Fonda machines (Fig. 6). At present the film is dried by heating refiltered room air to a temperature of about 90F, thus getting whatever reduction in humidity is possible, and driving this air through the cabinet by means of a blower of the fan type. This air is finally allowed to escape into the outside atmosphere. As proper control of humidity is not possible by this method, plans for a complete dehumidifying and air-conditioning unit are

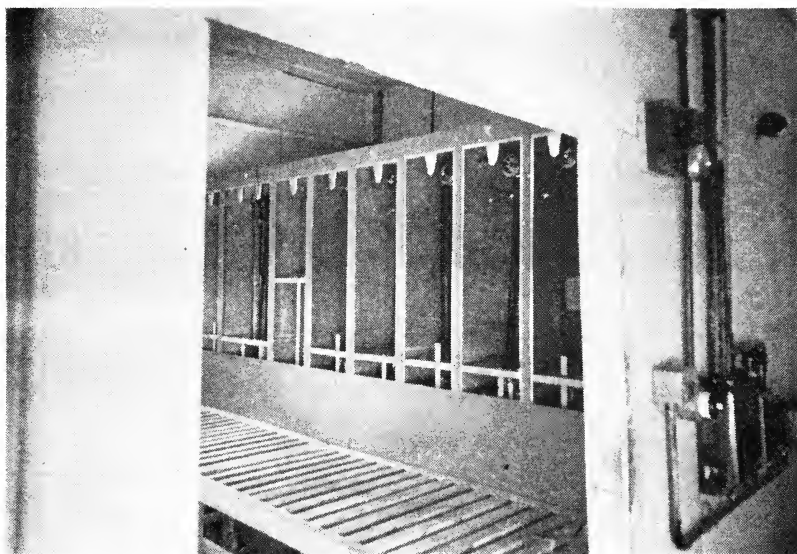

Fig. 5. Partial view of the lighted section of the main machine.

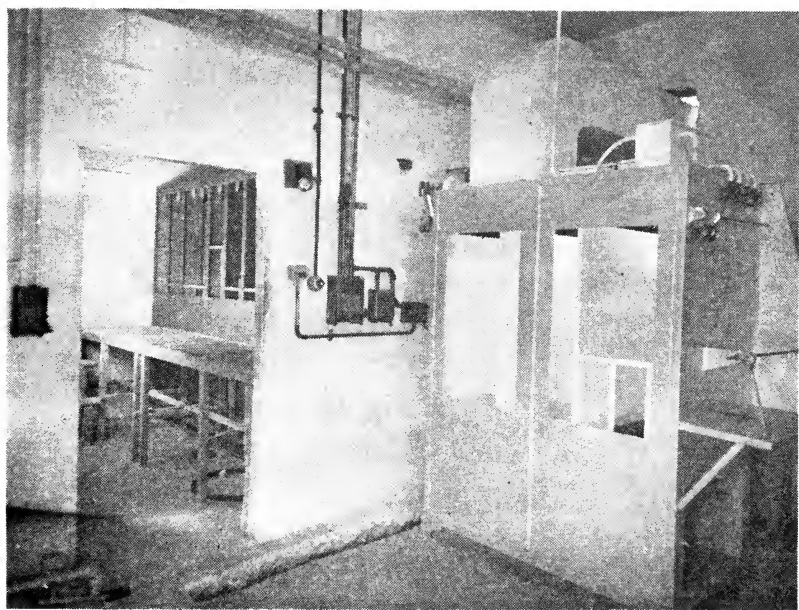

Fig. 6. Front view of machine, showing drying cabinet and portion of lighted section. Air filter has been removed.

under way, but in the meanwhile by-pass ducts from the existing black-and-white machines are being connected, so that the existing units could be utilized by simply shutting off the black-and-white machines.

The main difficulty however, was to obtain 400 to 500 gal of cold water at about 65F per hr for wash purposes. When it is realized that the average temperature of water in this country is in the neighborhood of 85 or 90F, the difficulty will be appreciated. The existing plants in the laboratory were found to be hopelessly inadequate, and a special high-capacity cooler of the instantaneous type had to be installed.

The total electrical load for the machine, including all motors, pumps, coolers, air conditioners, etc., is approximately 25 kw.

Errata

M. Rettinger, "A magnetic record-reproduce head," *Jour. SMPTE*, vol. 55, p. 390, Oct. 1950.

Page 390, line 3: *For .016 read 16*

Ibid., lines 20 and 21: *For 3 cu/cm or .183 cu in./cm). read 3 cu cm or .183 cu in.)*.

68th Semiannual Convention

The 1950 fall convention of the Society was the first in many years to be held away from a large city. Society Officers, whose duty it was to select the place of meeting, felt that easy exchange of ideas and renewal of old friendships during recent big city meetings had been reduced to nearly zero by attractive opportunities to "do a little business" between sessions. As a consequence, the comradeship that characterized earlier Society conventions had all but disappeared. Feeling that business and current increase in membership, together with the addition of a comparatively heavy interest in television matters should not be permitted to depersonalize these functions, they agreed to try holding another resort convention. The unanimous choice was the Lake Placid Club in the Adirondack Mountains of upper New York State. Enthusiastic attendance of members from all parts of the United States and Canada proved the appropriateness of this location as a site for the Society's 68th convention in thirty-four years.

Sufficient free time between sessions or committee meetings was provided for old-timers to talk with their friends, and for members newly active to meet others with common interests. Ample discussion time during technical sessions was allowed also, by limiting in advance both the number and length of papers scheduled. Members were generally enthusiastic about the way this convention was handled, favoring particularly the unhurried atmosphere.

Several equipment displays in the lobby of the Club attracted members during off hours. General Precision Laboratories demonstrated a 16-mm professional projector which was recently developed. Mr. Frank H. McIntosh had his unique amplifiers on exhibit, with several new magnetic recording and reproducing equipments made by Westrex. RCA showed microphones, recording equipment and a 16-mm sound projector, equipped to reproduce release prints having magnetic sound track in the conventional photographic track position. Reeves Soundcraft provided the release prints. Members who were not familiar with equipment used in high-speed photography, examined thoroughly the Fastax Camera, displayed by Wollensak.

Coffee, light refreshments and a comfortable place for off-hours conversation were provided to all comers by the Club Coffee Shop, which remained open throughout the convention under the generous auspices of the Radio Corporation of America.

Board of Governors Meeting

Preceding the convention opening by one day, the Board of Governors met Sunday, October 15, to hear reports of Society activities for the third quarter of the year. Recommendations to individual officers, as well as to the Society headquarters staff were made, covering current policy questions and certain specific aspects of the Society's work for the concluding quarter. Among items on the Board's agenda were: individual and sustaining membership programs; the consideration of possible scholarships that might be awarded sometime in the future; a plan to revise the Society's Administrative Practices (those general rules which apply to operation of committees and the Headquarters office), and the current work on the design of a new Society emblem to symbolize in simple style the scope of the Society's work more adequately than does the present combination of film reel and television picture tube.

At the close of the meeting, a panel of tellers was appointed to count ballots for the annual election of members to the Board. Successful candidates were:

Peter Mole, President; Herbert Barnett, Executive Vice-President; John G. Frayne, Editorial Vice-President, William C. Kunzmann, Convention Vice-President; Robert M. Corbin, Secretary; and Governors—William B. Lodge, Oscar F. Neu, Frank E. Carlson, Malcolm G. Townsley, Thomas T. Moulton, Norwood L. Simmons and Lloyd Thompson.

These new officers and Board members assume their official duties January 1, 1951, but many will have been busy during the intervening months with appointment of committees, potential project assignments or plans for some portion of the 1951 budget.

Lake Placid

Transportation to the convention threatened to be a problem, since all available space on Colonial Airlines and on New York Central trains to Lake Placid had been reserved from Saturday through Monday, October 16, by Society members. Supplemental transportation, however, was furnished by a large number of East Coast members who drove their own cars so that no one was left out. There were several who drove long distances: Mr. and Mrs. Emery Huse from Hollywood; Mr. and Mrs. George Colburn from Chicago; and Mr. and Mrs. R. T. Van Niman from Indianapolis.

Many arrived early or stayed after the proceedings had officially terminated on the afternoon of Friday, October 20, to enjoy the scenery or play a little golf. Total registration was 218, not including Army, Navy and Air Force representatives. Bill Kunzmann's most optimistic estimate of attendance was exceeded by at least nineteen registrants.

In accord with Earl Sponable's plan to have informality prevail, there was no formal luncheon on Monday and no awards were presented during the banquet and dance Wednesday evening. The threat of "no speeches" which had become a familiar and traditional figure of speech was at last a well-kept promise, with the result that not a single formal word was uttered during the mid-week festivities. To the contrary, some of the members provided a handsome share to their own entertainment. George Colburn made more than tolerable music come out of a "musical broom." John Frayne distinguished himself by "calling" several square dances in his best stentorian tones.

Not all was fun and frolic, however, for the convention did have its serious side. Ed Seeley, Program Chairman, with the generous aid of Walter Simons and the entire Papers Committee, had prepared a well-organized program of technical papers. Related items appeared on the same session so that members who were interested in only one group of papers were not required to sit through the entire convention to hear them. All papers on the program are listed at the back of this issue. One paper from this convention appeared in the November JOURNAL and six others are published in this issue.

The Annual Business Meeting of the Society was called to order at 2:00 P.M., Monday afternoon, by Mr. Sponable. Members were asked to vote on formal approval of the proposed award of Honorary Membership to Dr. Zworykin for his early work in the development of television. Approval was unanimous.

Magnetic tape recordings were made of all the questions and answers that made up the discussions following many of the 51 papers or reports presented during the 9 technical sessions. Throughout the convention, Harry Braun and Bob Sherwood operated both the Altec public address equipment and RCA tape recorder. The Columbia Broadcasting System furnished four microphones, used to pick up discussion questions from the meeting floor. Immediately following the convention, Clyde Keith had the recordings transcribed and has since provided the

Editor with 50 pp. of manuscript that should add materially to the value of the papers when they appear later in the pages of the JOURNAL.

Publicity was very nicely handled by Harold Desfor and by Miss Melican of the Society Headquarters staff, who wrote and released two publicity stories each day, one mailed from Lake Placid and the other delivered at the same time by messenger in New York to the wire services, motion picture and television trade papers, and the New York daily newspapers. As a result of careful attention to publicity, this convention received better press coverage than any previous one.

The reaction of nearly all who attended was enthusiastic and, without being trite, it is safe to say that from nearly all viewpoints the 68th Convention was a success. There was one unfavorable aspect, however, that deserves mention. The remote location made it impractical for many members, who usually attend for one or two days, or who wished to hear specific papers, to be on hand. Under more customary circumstances, when a convention is held in New York City or in Hollywood, nearly one-half of the 400 to 800 members who attend do so on a daily basis. These members are persons whose interest is specialized or whose work prevents them from attending all sessions. They are the ones who stand to benefit most from papers and subsequent discussions. Being largely Associate and Student members, they will ultimately be the Active members of the Society and consequently will be accepting positions of future responsibility in the industry.

ANNUAL AWARDS

Growth of both motion pictures and television from a comparatively few basic ideas to the proportions of a major industry has been marked by occasional technical milestones, each primarily contributed by one individual. The Society attempts to recognize these important contributions by conferring several annual awards to persons adjudged most worthy of receiving such honors. This year, one entire session, Monday evening, was set aside for recognition of the work of twenty-one individuals.

New Fellows of the Society

President Sponable formally inducted the following as new Fellows of the Society:

- Gerald J. Badgley*, U.S. Naval Photographic Center
- George L. Beers*, Radio Corporation of America, RCA Victor Div.
- Herbert E. Bragg*, Twentieth Century-Fox Film Corp.
- Fred W. Gage*, Warner Brothers Pictures, Inc.
- Raymond L. Garman*, General Precision Laboratory, Inc.
- Watson Jones*, Radio Corporation of America, RCA Victor Div.
- Frederick J. Kolb, Jr.*, Eastman Kodak Co.
- John P. Livadary*, Columbia Pictures Corp.
- William B. Lodge*, Columbia Broadcasting System
- Boyce Nemeč*, Society of Motion Picture and Television Engineers
- Charles Rosher*, Metro-Goldwyn-Mayer
- John H. Waddell*, Wollensak Optical Co.
- Emerson Yorke*, Emerson Yorke Studio



Dr. Frederick J. Kolb, Jr., (center) of the Eastman Kodak Co., receives the 1950 Journal Award from Earl I. Sponable, President of the Society. At left is Charles R. Fordyce, also of Eastman Kodak Co., who received the Samuel L. Warner Memorial Award Medal.

Journal Awards

Frederick J. Kolb, Jr., of the Eastman Kodak Co., was presented the Journal Award for "Air Cooling of Motion Picture Film for Higher Screen Illumination," published in the December 1949 JOURNAL.

C. R. Keith, Western Electric Co., and *Vincent Pagliarulo*, then of the Western Electric Co. and now with Technicolor Motion Picture Corp., received honorable mention for "Direct-Positive Variable-Density Recording With the Light Valve," published in the June 1949 JOURNAL.

Robert Herr, *B. F. Murphey* and *W. W. Wetzel*, of the Minnesota Mining and Manufacturing Co., received honorable mention for "Some Distinctive Properties of Magnetic-Recording Media," published in the January 1949 JOURNAL.

New Honorary Members

Dr. Edward W. Kellogg, long and well known to Society members as Director of Advance Development for RCA Victor Div., now retired, was formally made an Honorary Member of the Society.

Dr. V. K. Zworykin, Vice-President and Technical Consultant for RCA Laboratories, Princeton, N.J., was made an Honorary Member.

Samuel L. Warner Memorial Award

Charles R. Fordyce, of the Eastman Kodak Co., was presented the medal of the Samuel L. Warner Memorial Award for his efforts and the achievement of the development of triacetate safety base film.

Dr. Fordyce was born in 1902 at Springville, Iowa. After receiving his AB



Dr. V. K. Zworykin, (left), Vice-President and Technical Consultant of RCA Laboratories Div., is presented with the Society's Progress Medal by Earl I. Sponable, President of the Society.

and MA degrees from Cornell College in Iowa in 1925, he attended the graduate school of Cornell University, Ithaca, N.Y., from which he received his PhD degree in 1929.

In July, 1929, Dr. Fordyce became associated with the Eastman Kodak Company as a chemist in the Kodak Park plant. The following 15 years he devoted to research work on the manufacture of cellulose derivatives and their commercial uses for photographic film base and for plastics. In 1944 he was appointed Assistant Superintendent of Kodak Park's Department of Manufacturing Experiments and in 1947 Superintendent of that Department, which position he holds at the present time. His duties include supervision of experimental and plant development work on the manufacture and improvement in quality of photographic film. He is the author of several technical papers on the chemistry of cellulose esters and of over fifty patents, most of which concern cellulosic materials and their uses for photographic film and plastics.

Dr. Fordyce has served as Secretary of the Division of Cellulose Chemistry of the American Chemical Society from 1939 to 1944 and as Chairman in 1948.

Progress Medal Award

Dr. V. K. Zworykin, Vice-President and Technical Consultant, RCA Laboratories Div., Princeton, N.J., was presented with the Society's annual Progress Medal Award, in recognition of outstanding contributions to the development of television.

Dr. Zworykin was born in Mouron, Russia, in 1889. He was graduated from the Petrograd Institute of Technology with the degree of Electrical Engineer. At the close of World War I he came to the United States and promptly became

a citizen. He received the degree of Doctor of Philosophy from the University of Pittsburgh in 1936. Soon after coming to this country, Dr. Zworykin joined the research staff of the Westinghouse Electric and Manufacturing Co. where he worked in the fields of photoelectric emission and television. Some of this work involved photosensitive devices for sound motion pictures. Dr. Zworykin's conception at this time of the principles of the iconoscope and the kinescope laid the basic foundation for his work on the development of all-electronic television.

In 1929 Dr. Zworykin became associated with RCA as Director of the Electronic Research Laboratory, and in 1947 he was made Vice-President and Technical Consultant of the Radio Corporation of America, RCA Laboratories Division.

Although Dr. Zworykin has probably contributed more than any other man to the science of television, he has not confined his talents to this one phase of the electronics art. His broad interest in varied fields of endeavor has always been an outstanding characteristic of his scientific work. This is illustrated by the fact that the U.S. Patents which he holds range from gun-fire controls to devices for reducing star motion in astronomical instruments.

Dr. Zworykin has made important contributions to the technical literature on television and electronics through publication of technical articles and in particular through coauthorship of four books: *Photocells and Their Applications*, *Television*, *Electron Optics and the Electron Microscope*, and *Photoelectricity and Its Application*.

Guest Speaker

Terry Ramsaye, coming to the Convention as the sage of New Canaan, Conn., and Consulting Editor of the *Motion Picture Herald*, noted: "We have all come a long way to be here tonight . . . not measuring miles but rather milestones of progress of this Society. An observer seasoned with experience must realize that, when he scans the agenda of this convention and surveys the array of scientific skills and achievements represented in the registration and this audience.

" . . . there is evidence of a growing consciousness in the Society of its development into an order of entity which the industry, with its arts of expression and communication, has never had before. It has had to come by evolutionary processes."

[From the speaker's inimitable and widely ranging recollections of scientific and economic developments, only the following paragraphs are recorded.]

"The currently widening horizons of this Society arrive in a most timely fashion. For far too many years the technology, the engineering, was something special. It was apart and far remote from the predominant interests of the industry. A large proportion of the early scientific magic for the movies came from Rochester in a can. And after the can arrived the rest was done largely by rule of thumb and little secret formulas in the hip-pockets of the cameramen and what we called 'laboratories.' I can well remember when about 1914-15 I had to exert extreme pressure to get cameramen of the movies to use panchromatic negative. Some of the best of them told me it was the bunk . . .

"The basic motion picture originated in sources far external to the amusement world, including Room 5 of the Edison Laboratories. Color became a commercial fact from a technological group centered at the Massachusetts Institute of Technology, led by Dr. Kalmus. Sound was added to the implementation of the screen from the outside, too, from such sources and contributors as DeForest, Case and Sponable, the Telephone Company and General Electric. I hardly need to comment about television. . . Every big scientific and technical enhance-

ment of the art has had to fight its way into acceptance. None has been really welcomed.

"Small wonder then that the Society has been a while winning a way into the appreciation and understanding of movieland. Today that process is well under way. The time is auspicious.

"Contemplating my appearance here before you this evening I turned back to the record of an occasion eighteen years and ten days ago when I spoke before the Society. I was bold enough then to suggest that it would be wholesome if the motion picture industry could be imbued with some of the respect for discipline in their art and commerce in something of the same terms in which the engineer has to regard the laws of his science and craft.

"Also in the memory of that night those eighteen years ago are some pointedly germane utterances from Dr. Alfred N. Goldsmith, with whom I shared the platform. Let me read a paragraph or two from his remarks that night. He was most prophetically relevant.

"The SMPE is beginning to feel that it is coming to be regarded as the major exponent of organization and of systematic analytical endeavor in the field of motion pictures by important manufacturing and producing interests. . . . Some of these interests have, unfortunately been slow to recognize how important the Society can be to the industry. Some of them have developed their own individual organizations within their own corporations to a high degree, but they have failed to understand that this is not sufficient. It is necessary to organize the whole industry . . . so that one may not interfere with the progress and development of the other."

"Progress has been made, but what he said then may well be said again. The inclusion of the field of television, which is in fact another device for the capture, creation and transmission of motion pictures, in the functioning of this Society is a direct step in the indicated direction. It will be well if this Society should become more audibly articulate about itself and its works. . . ."

New Society Medal

The Board of Governors of the Society has just approved, by letter-ballot, the creation of a television award medal to take a place beside the Samuel L. Warner Memorial Medal and the Progress Medal, which are presented annually to the individuals who have contributed most to the science of sound recording and to the general field of motion picture technology.

The new award, to serve as a symbol of recognized achievement in the combined fields of television and theater television, has been offered by the Radio Corporation of America, through its President, Frank M. Folsom. It will consist of a gold medal and formal certificate of achievement, made available annually for presentation to an individual selected by a Society Award Committee.

Recent technical contributions will be the major consideration in selecting the recipient, who must have personally done the work which qualifies him, or if others were importantly concerned, he must have contributed the basic idea and have been intimately associated with its subsequent development.

The award, to be first presented in 1951, will be known as the "David Sarnoff Medal," bearing the name of a distinguished industrial executive, who is recognized to have played a major role in aiding the technical development and subsequent successful commercialization of television.

Engineering Activities

New Staff Engineer

Henry Kogel is the Society's new Staff Engineer, having replaced Bill Deacy who resigned to take up the challenge of engineering opportunities with Reeves Soundcraft.

Henry Kogel has come to the Society from Sperry Gyroscope Co. where he was a Project Engineer, specializing in developmental work on demodulators, electronic and magnetic amplifiers and instrument servomechanisms. Two of his specialties were the designing of all required test equipment and the producing of components for magnetic control systems. Henry is an electrical engineer, having been graduated from Columbia University in 1948. His undergraduate work at the University of Michigan was interrupted by five years of military service with the Army Signal Corps, where his electrical interests were applied to radio communications. Since leaving the Army in 1946, he completed his study at Columbia, taught courses in electrical theory, radio and television maintenance, and, like Bill Deacy, had an opportunity to practice industrial engineering—in Henry's case it was the planning of a plant layout and production system for a New York corporation.

Bill Deacy was transferred and thoroughly absorbed by the end of November in his new work at Reeves Soundcraft Corp., 10 E. 52d St., New York 22. Reeves manufactures magnetic recording tapes, films and television tubes. Bill is primarily occupied with Reeves' new program of putting magnetic stripes on film. Bill, who is a product of the Lehigh University School of Electrical Engineering, spent three and one-half years with the George S. May Co., during which he applied his industrial management talents to complete overhaul of an enormous commercial laundry and, among others, to a wire cloth mill. For two years before the United States was involved in the war in Africa, Bill worked with the Overseas Division of Douglas Aircraft on the construction of air bases across Africa, the Middle East and India. On return to this country in 1943, he joined the staff of the American Standards Association and, while working with J. W. McNair at ASA, he made an indelible mark in the electrical components and photographic war standards work sponsored by the War Production Board and in which this Society played a major role. For over two years, Bill has been, in effect, Assistant Engineering Vice-President for our Society, and his contributions are not only well known but are well documented by the technical material published in the JOURNAL. We all wish him the best of good fortune in his new venture.

Engineering Committees Activities

Although neither the number of man hours spent at committee meetings nor the bulk of the meeting minutes which follow is a measure of useful results, they are both clear signs that members are active on Society projects and that something is being accomplished. From that point of view, members who attended the 68th Convention ran up an impressive score: 116 of them attended 11 different meetings over the 5 days. In the process, they generated enough rational discussion and arrived at enough conclusions to fill 71 pp. of formal minutes on a variety of subjects. Several merit mention in this general review of those proceedings.

Screen Brightness

A nationwide survey now being made of screen lighting conditions in about 100 motion picture theaters was discussed by the Screen Brightness Committee, and

a report on the West Coast portion of that survey, recently completed under Charlie Handley's guidance, was reviewed. The members agreed upon procedures to be followed by local survey teams in the remaining theaters. The next step calls for a series of incident and reflected light readings in New York film laboratory screening rooms. One of the major objectives of this project is to provide studios and film laboratories with data on present and recommended practices for theaters. Another is to tell projection equipment manufacturers how the equipment they make is actually used. Better understanding of current theater projection room practices and knowledge of light levels employed should be of considerable help to the general cause of improved picture quality. Chairman of the Committee is Wallace Lozier.

Test Film Quality

F. J. Pfeiff called a meeting of his Test Film Quality Committee to study the best possible combination of procedures which would insure maintaining high overall quality of the many test films produced by the Society and sold both through the Society and through the Motion Picture Research Council. A number of details were considered at length and it is likely that this new committee will be handing out specific projects at its next meeting early in 1951.

Color

The Color Committee, under the Chairmanship of Dr. H. H. Duerr, again looked into the use of lead sulfide phototubes with motion picture sound tracks in color. At the present time there are a variety of lead sulfide cells having different response characteristics, and in the interests of uniform reproduction, manufacturers now using them are testing all cells for response in the infrared. The Committee hopes to arrive at a standard test which manufacturers may apply and which would pave the way for general adoption of the lead sulfide cell, if they feel that the change is a beneficial one. Original plans to prepare and publish a comprehensive review of all motion picture color processes now in use were upset by the reluctance of some film companies to supply the essential information. A new angle of attack is being considered, with the hope that it will be more productive. A subcommittee was appointed to arrive at a more descriptive term than "color temperature" to describe the spectral characteristics of light sources used in commercial color photography.

Film Dimensions

Final adoption of proposed standards for 32-mm perforations on 35-mm raw stock has been again deferred because some members of Dr. E. K. Carver's Committee on Film Dimensions feel that there was inherent danger in the ultimate slitting of 35-mm stock to the 16-mm width. Not all motion picture film is coated on safety base; therefore the possibility of nitrate film being slit still remains, as does the question of the moral obligation of those who are concerned with the standardization of film dimensions. A standard would, however, be an aid to equipment designers and manufacturers.

Work over the past several years on a proposed single negative-positive perforation for 35-mm films has been drawing nearer completion. Several wear tests have been conducted on two possible combination sprocket holes and the committee has tentatively agreed to circulate a ballot on its recommendations for adoption of the new proposal, known as the Dubray-Howell perforation.

Several other committee projects reviewed at length during the 68th Convention will be reported upon in the January JOURNAL.

Films for Television

The Committee on Films for Television, under the Chairmanship of Dr. R. L. Garman, met informally to talk over work on the development of a proposed new release print leader that might serve equally well not only for both 16- and 35-mm films in theaters but also for television broadcasting use. Emulsion position problems in 16-mm release prints that have plagued users of educational films for years are now giving trouble in television projection. Prints made by commercial processes may have the emulsion and therefore the sound track facing the screen or facing the projection lamp and it is often necessary to splice both kinds of prints together on the same reel. If picture and sound track are in focus in one position, they are out of focus in the other and agreement on one position is essential if television picture and sound quality from a film program are ever to be predictably good.

Employment Service

Position Wanted: Belgian, 38; specialist in high-speed photography, educational and documentary films; thorough knowledge and experience script-to-screen production technique; first-class organizer; desires position as executive director of production plant (10 to 100 crew) in the States; married, more details on request. Write LB27, c/o Fred J. Pagenstecher, Seeley Lake, Mont.

New Members

The following have been added to the Society's rolls since the list published last month. The designations of grades are the same as those in the 1950 MEMBERSHIP DIRECTORY:

Honorary (H) Fellow (F) Active (M) Associate (A) Student (S)

Aronson, Arthur H., Cameraman, Taylor Film Co. **Mail:** 864 Linn Dr., Cleveland 8, Ohio. (A)

Avellana, Angel P., Recording Engineer, Movie Technical Services. **Mail:** 192 La Torre, Sta. Ana, Manila, Philippines. (A)

Bremer, Frank V., Vice-President, Bremer Broadcasting Corp. **Mail:** 1020 Broad St., Newark 2, N.J. (M)

Buscher, Chris P., Jr., American Television Inst. **Mail:** 1017 S. Oak Ave., Oak Park, Ill. (S)

Castagnaro, Dominick, Development Engineer, National Broadcasting Co. **Mail:** 1726 75 St., Brooklyn 4, N.Y. (A)

Faunce, Nat L., Audio-Visual Sales, Westcott, Slade & Balcom. **Mail:** 210 Waterman Ave., East Providence, R.I. (A)

Flaherty, Robert H., Hollywood Sound Institute. **Mail:** 5608 Lexington Ave., Los Angeles, Calif. (S)

French, Hubert, Television Technician, National Broadcasting Co. **Mail:**

795 Meeker Ave., Brooklyn 22, N.Y. (A)

Friedman, Thomas B., Chief Engineer, Television Station WXEL. **Mail:** 1900 E. 30 St., Cleveland, Ohio. (M)

Genis, Daniel, University of Southern California. **Mail:** 2714 Severence St., Los Angeles 7, Calif. (S)

Gretener, Edgar, Engineer, Dr. Edgar Gretener A.G., Ottenweg 25, Zurich 8, Switzerland. (M)

Haidar, Chicralla, University of Southern California. **Mail:** 903 W. 35 St., Los Angeles 7, Calif. (S)

Jacobs, Arthur A., Sound Technician and Production Assistant, Toby Anguish Productions. **Mail:** 11568 Blix St., North Hollywood, Calif. (A)

Jacobs, George G., Chief Engineer, KOTV, Cameron Television. **Mail:** 3050 S. Madison St., Tulsa, Okla. (A)

Johnson, Winston O., Mechanical Research Engineer, E. I. du Pont de Nemours & Co. **Mail:** Brinton Lake, Concordville, Pa. (M)

Kear, Frank G., Consulting Radio Engi-

- neer, 1703 K St., N.W., Washington, D.C. (M)
- Klynn, Herbert**, Artist, United Productions of America. **Mail:** 4440 Lakeside Dr., Burbank, Calif. (A)
- Krone, Robert**, University of Southern California. **Mail:** 3713½ McClintock Ave., Los Angeles 7, Calif. (S)
- Kuehn, Rudolph**, Television Development Engineer, National Broadcasting Co. **Mail:** Apt. 2, 655 Bryant Pl., Ridgefield, N.J. (A)
- Maasdam, Felber**, Cameraman, Soundman, 410 N. Rossmore, Hollywood, Calif. (M)
- McCandlish, Doris**, Color Technician, Color Service Co., Inc. **Mail:** 36 Claremont Pl., Mt. Vernon, N.Y. (A)
- McMurray, Glenn D.**, University of Southern California. **Mail:** 3422 S. Flower, Los Angeles 7, Calif. (S)
- Miller, Brainard H.**, University of Southern California. **Mail:** 835 W. 32 St., Los Angeles 7, Calif. (S)
- Mourad, A. Z.**, Sub-Manager, United Films Co. **Mail:** Bahari Building, 1, Ismailieh Square, Flat No. 19, Cairo, Egypt. (A)
- Newman, Harold H.**, Director of Television, Century Theatres, 132 W. 43 St., New York, N.Y. (A)
- Newman, Sydney C.**, Executive Producer, National Film Board of Canada, John & Sussex Sts., Ottawa, Ontario, Canada. (A)
- Painter, Richard O.**, Assistant Head, Electronics Dept., General Motors Proving Ground. **Mail:** 415 E. Commerce, Milford, Mich. (A)
- Schubert, Walter M.**, Motion Picture Sound Technician, Altec Service Corp. **Mail:** 561 N.W. 42 St., Miami, Fla. (M)
- Schubert, Wenzel J.**, Sales Engineer, Fairchild Camera & Instrument Corp. **Mail:** 51-01 39 Ave., Long Island City, 4, N.Y. (A)
- Schwartz, Walter A.**, Part Owner, Perfect Film Laboratory. **Mail:** 156 E. 184 St., Bronx, N.Y. (A)
- Sebern, Theodore W.**, Assistant Director, Walt Disney Productions. **Mail:** 726 N. Lincoln Ave., Burbank, Calif. (A)
- Shearer, B. F., Jr.**, Sales Manager, B. F. Shearer Co. **Mail:** 2318 Second Ave., Seattle, Wash. (A)
- Sinha, J. K.**, University of Southern California. **Mail:** "Devashram," Mithapur, Patna, G.P.O., Patna, Bihar, India. (S)
- Sollenberger, George A., Jr.**, Sound Technician, Hughes Sound Films. **Mail:** 759 Race St., Denver, Colo. (A)
- Taylor, Stanley E.**, University of Southern California. **Mail:** 921 Ireland Ave., Muskegon, Mich. (S)
- Transue, Laurence F.**, Research Chemist, Photo Products Dept., E. I. du Pont de Nemours. **Mail:** Du Pont Club, Parlin, N.J. (M)
- Tsu-Ming, Hu**, University of Southern California. **Mail:** 1156 W. 36 Pl., Los Angeles, Calif. (S)
- White, J. D.**, Contact Engineer, Radio Corporation of America. **Mail:** 20-20 Calyne Dr., Apt. 11, Fairlawn, N.J. (A)
- Zupansky, Milo**, American Television Inst. **Mail:** 5327 N. Winthrop Ave., Chicago 40, Ill. (S)

CHANGES IN GRADE

- Carter, William H., Jr.**, Vice-President, General Manager, Carter Music Co. **Mail:** 1201 Leeland Ave., Houston 2, Tex. (A) to (M)
- Gaylord, Lt. Col. James L.**, Commanding Officer, Lookout Mountain Laboratory, USAF. **Mail:** 1000 Kagawa, Pacific Palisades, Calif. (S) to (A)
- Kantor, Bernard R.**, Assistant Sound Technician and Lighting Engineer, Lookout Mountain Laboratory, USAF. **Mail:** 901 W. Exposition Blvd., Los Angeles 7, Calif. (S) to (A)
- Moyses, Kern**, President, Peerless Film Processing Corp., 165 W. 46 St., New York 19, N.Y. (A) to (M)
- Weiner, Stuart A.**, Motion Picture Photographer, Board of Water Supply, City of New York. **Mail:** Box 748, Tempe, Ariz. (A) to (M)

Obituary

Anthony G. Wise died in Los Angeles on October 4. He was born in 1882 in Freeport, Ill. He worked for Bell & Howell Co. and was also associated with the Consolidated Laboratory before 1925 when he joined Metro-Goldwyn-Mayer where he was Laboratory Engineer. He was a regular attendant at Society meetings, and his technical contributions in committees and meeting discussions materially aided the industry. He had been a member of the Society since 1930.

Papers Presented at the Lake Placid Convention, October 16-20

LISTED BY SESSIONS

MONDAY AFTERNOON

- Newland F. Smith, WOR-TV, New York, "Improved Video System for Television Studios."
H. M. Gurin, National Broadcasting Co., New York, "Lighting Methods for Television Studios."
J. L. Sheldon, Corning Glass Works, Corning, N.Y., "Characteristics of All-Glass Television Tubes."
Peter Goldmark, Columbia Broadcasting System, New York, "Color Television."
W. L. Norvell, Remington Rand, Inc., New York, "Television Application in Industry, Business, Education and Research."

TUESDAY MORNING

- R. L. Garman, General Precision Laboratories, Inc., Pleasantville, N.Y., "Films for Television Committee Report."
W. K. Grimwood and T. G. Veal, Kodak Research Laboratory, Rochester, N.Y., "Dynamic Transfer Characteristic of a Television Film Camera Chain."
Thomas T. Goldsmith, Jr., Allen B. DuMont Laboratories, Passaic, N.J., "Engineering Aspects of Teletranscriptions."
Jerry Fairbanks, Jerry Fairbanks, Inc., Hollywood, Calif., "Motion Picture Production for Television."
L. W. Morrison, Bell Telephone Laboratories, Murray Hill, N.J., "Wire Television Transmission in Telephone Areas."
F. N. Gillette, General Precision Laboratories, Pleasantville, N.Y., "Joint RTMA-SMPTE Committee on Television Film Equipment Report."

TUESDAY AFTERNOON

- F. T. Bowditch, National Carbon, Cleveland, Ohio., "Activities of Society's Engineering Committees."
G. C. Misener, AnSCO, Binghamton, N.Y., "Application of AnSCO Color Positive Film, Type 248."
A. C. Lapsley and G. P. Weiss, E. I. du Pont de Nemours & Co., Parlin, N.J., "A Versatile Densitometer for Color Film."
Karl Freund, Photo Research Corp., Burbank, Calif., "Simplified Index for Color of Illuminants."
Lloyd E. Varden, Pavelle Color, Inc., New York, "Semiautomatic Color Analyzer."
R. Hodgson and J. Hammer, Paramount Pictures Corp., New York, "High-Temperature Film Processing—Its Effect on Quality."
L. Katz, Raytheon Manufacturing Co., Waltham, Mass., "Ultrarapid Drying of Motion Picture Film by Means of Turbulent Air."

WEDNESDAY MORNING

- L. T. Goldsmith, Warner Brothers Pictures, Inc., Burbank, Calif., "Sound Committee Report."
G. R. Crane, J. G. Frayne and E. W. Templin, Westrex Corp., Hollywood, Calif., "Professional Magnetic Recording System for 35-, 17½- and 16-Mm Films."
Loren L. Ryder, Paramount Pictures Corp., Hollywood, Calif., "Motion Picture Equipment and Methods for Editing Magnetic Films."
R. H. Ranger, Rangertone, Inc., Newark, N.J., "Editing Advantages Inherent in Quarter-Inch Magnetic Tape."

John G. Frayne, Westrex Corp., Hollywood, Calif., "Electrical Printing."
M. Rettinger, Radio Corporation of America, RCA Victor Div., Hollywood, Calif., "A-C Magnetic Erase Heads."

WEDNESDAY AFTERNOON

J. H. Waddell, Wollensak Optical Co., Rochester, N.Y., "High-Speed Photography Committee Report."
John H. Hett, New York University, Bronx, N.Y., "High-Speed Schlieren Studies of Flames."
Malcolm D. Pearson, Whitin Machine Works, Whitinsville, Mass., "High-Speed Photography in Textile Industry."
Messrs. Andres and Roganti, Photo Engineering Group, Wright Field, Dayton, Ohio, "Instrumentation at Air Materiel Command."
Myron Prinzmental, Institute of Medical Research, Los Angeles, Calif., "Photography of the Heart."

THURSDAY MORNING

Subcommittee on Lighting for High-Speed Photography Report.
H. P. Mansberg, Allen B. DuMont Laboratories, Clifton, N.J., "Oscillograph Recording Camera."
Harold E. Edgerton, Massachusetts Institute of Technology, Cambridge, Mass., and Charles W. Wyckoff, Edgerton, Germeshausen & Grier, Inc., Boston, Mass., "A Rapid-Action Shutter With No Moving Parts."
Richard R. Conger, Naval Photographic Center, N.A.S., Anacostia, Washington, D.C., "Underwater Cinematographic Techniques."
J. H. Waddell, Wollensak Optical Co., Rochester, N.Y., "New Approach to High-Speed Photographic Sales and Service."

THURSDAY AFTERNOON

E. K. Carver, Eastman Kodak Co., Rochester, N.Y., "Film Dimensions Committee Report."
Edward Schmidt, Reeves Soundcraft Corp., Long Island City, N.Y., "Modernized Commercial Sound Recording."
J. A. Maurer, J. A. Maurer, Inc., Long Island City, N.Y., "Linearity Compensation Methods in Variable-Density Recording."
W. V. Wolfe and W. F. Kelley, Research Council, Inc., Hollywood, Calif., "Recent Studies on Standardizing the Dubray-Howell Perforations for Universal Applications."
R. P. Shea, Producers Service Corp., Hollywood, Calif., "Problems of Registration in Process Photography."

THURSDAY EVENING

A. E. Murray, Bausch & Lomb Optical Co., Rochester, N.Y., "Diffuse and Collimated 'T-Numbers'; A Review and Description of New Bausch & Lomb Equipment."
L. G. Dunn, RKO-Radio Pictures, Hollywood, Calif., "A Graphic Example of Modern Composite Cinematography."
W. F. Kelley and W. V. Wolfe, Research Council, Inc., Hollywood, Calif., "Technical Activities of the Motion Picture Research Council."

FRIDAY MORNING

B. Passman, International Projector Corp., Bloomfield, N.J. and J. Ward, General Precision Laboratories, Pleasantville, N.Y., "New Theater Sound System."
Harold N. Christopher, Bell Telephone Laboratories, Murray Hill, N.J., "Observer Reaction to Nonsimultaneous Presentation of Pictures and Associated Sound."
M. T. Jones and F. T. Bowditch, National Carbon, Cleveland, Ohio, "Carbon Arc Characteristics That Determine Motion Picture Screen Light."

Benjamin Schlanger and William A. Hoffberg, Theater Engineering and Architecture Consultants, New York, "Effects of Television on the Motion Picture Theater."

FRIDAY AFTERNOON

- D. E. Hyndman, Eastman Kodak Co., Rochester 4, N.Y., "Theater Television Committee Report."
R. L. Garman and R. W. Lee, General Precision Laboratories, Inc., Pleasantville, N.Y., "Comprehensive Proposal for a Closed Loop Theater Television System."
R. V. Little, Jr., Radio Corporation of America, RCA Victor Div., Camden, N.J., "RCA PT-100 Theater Television Equipment."
L. E. Swedlund and C. W. Theirfelder, RCA Victor Division, Lancaster, Pa., "Projection Kinescope 7NP4 for Theater Television."
E. Stanko and C. Y. Keen, Radio Corporation of America, RCA Service Co., Inc., Glouster, N.J., "Installation of Theater Television Equipment."

HONORARY MEMBERS

Lee de Forest
Edward W. Kellogg

A. S. Howell
V. K. Zworykin

The distinction of Honorary Membership in the Society is awarded to living pioneers whose basic contributions when examined through the perspective of time represent a substantial forward step in the recorded history of the arts and sciences with which the Society is most concerned.

SMPTE HONOR ROLL

Louis Aimé Augustin Le Prince
William Friese-Greene
Thomas Alva Edison
George Eastman
Frederic Eugene Ives
Jean Acme Le Roy
C. Francis Jenkins
Eugene Augustin Lauste
William Kennedy Laurie Dickson

Edwin Stanton Porter
Herman A. DeVry
Robert W. Paul
Frank H. Richardson
Leon Gaumont
Theodore W. Case
Edward B. Craft
Samuel L. Warner
Louis Lumiere
Thomas Armat

Elevation to the Honor Roll of the Society is granted to each distinguished pioneer who during his lifetime was awarded Honorary Membership or whose work was recognized subsequently as fully meriting that award.

Journals Out of Stock: The Society's stock of JOURNAL issues for March, Part II, July, August, September, 1949, and February, 1950, has been exhausted as a result of an unexpected increase in demand and the Society's Headquarters is anxious to purchase a stock of each. Members or libraries having extra copies available are invited to send them in. The going price is 75c.

SMPTE Officers and Committees: The Roster of Society Officers was published in the May JOURNAL. For Administrative Committees see pp. 515-518 of the April 1950 JOURNAL. The most recent roster of Engineering Committees is on pp. 337-340 of September 1950 JOURNAL.

JOURNAL of the **SOCIETY of MOTION PICTURE and TELEVISION ENGINEERS**

THIS ISSUE IN TWO PARTS

Part I, December 1950 Journal . Part II, Index to Volume 55

INDEX TO AUTHORS

July—December, 1950 . Volume 55

- BARSTOW, FREDERICK E.
Infrared Photography With Electric-Flash Nov. p. 485
- BEESON, E. J. G., with BOURNE, H. K.
The Cine Flash, A New Lighting Equipment for High-Speed Cinephotography and Studio Effects Sept. p. 299
- BENHAM, H. J., with HEACOCK, R. H.
A New Deluxe 35-Mm Motion Picture Projector Mechanism Sept. p. 319
- BERGER, FRANCE B.
Characteristics of Motion Picture and Television Screens Aug. p. 131
- BLACKBURN, WAYNE
Study of Sealed Beam Lamps for Motion Picture Set Lighting July p. 101
- BOURNE, H. K., with BEESON, E. J. G.
The Cine Flash, A New Lighting Equipment for High-Speed Cinephotography and Studio Effects Sept. p. 299
- BOWDITCH, F. T.
A Progress Report of Engineering Committee Work Nov. p. 547
- CARLSON, R. S., with EDGERTON, H. E.
The Stroboscope as a Light Source for Motion Pictures July p. 88
- CLEVELAND, H. W.
A Method of Measuring Electrification of Motion Picture Film Applied to Cleaning Operations July p. 37
- CONGER, R. R.
U. S. Naval Underwater Cinematography Techniques Dec. p. 627
- COUTANT, A., with MATHOT, J.
A Reflex 35-Mm Magazine Motion Picture Camera Aug. p. 173
- CRANDELL, F. F., with FREUND, K. and MOEN, L.
Effects of Incorrect Color Temperature on Motion Picture Production July p. 67
- DUERR, HERMAN H. (Chairman)
Color Committee Report July p. 113
- DUNN, L., with MOSSER, A.
35-Mm Ansco Color Theater Prints from 16-Mm Kodachrome Dec. p. 635
- EDGERTON, H. E., with CARLSON, R. S.
The Stroboscope as a Light Source for Motion Pictures July p. 88
- EWING, J. S., with GILLETTE, F. N.
Component Arrangement for a Versatile Television Receiver Aug. p. 189
- FAIRBANKS, JERRY
Motion Picture Production for Television Dec. p. 567
- FRAYNE, J. G.
Electrical Printing Dec. p. 590
- FREUND, K., with CRANDELL, F. F. and MOEN, L.
Effects of Incorrect Color Temperature on Motion Picture Production July p. 67

- FRITTS, EDWIN C.
A Heavy-Duty 16-Mm Sound Projector Oct. p. 425
- FYE, PAUL M.
The High-Speed Photography of Underwater Explosions Oct. p. 414
- GIESELER, L. P.
The Pressurized Ballistics Range at the Naval Ordnance Laboratory July p. 53
- GILLETTE, F. N., with EWING, J. S.
Component Arrangement for a Versatile Television Receiver Aug. p. 189
- GOPAL, KRISHNA
New Laboratory for Processing Monopack Color Film Dec. p. 639
- GRETENER, EDGAR
Physical Principles, Design and Performance of the Ventarc High-Intensity Projection Lamps Oct. p. 391
- GRIFFIN, HERBERT
A New Heavy-Duty Professional Theater Projector Sept. p. 313
- GURIN, H. M.
Lighting Methods for Television Studios Dec. p. 576
- HALL, J. S., with MAYER, A. and MASLACH, G.
A 16-Mm Rapid Film Processor July p. 27
- HANKINS, M. A., with MOLE, P.
Designing Engine-Generator Equipment for Motion Picture Locations Aug. p. 197
- HEACOCK, R. H., with BENHAM, H. J.
A New Deluxe 35-Mm Motion Picture Projector Mechanism Sept. p. 319
- HERRNFELD, FRANK P.
Flutter Measuring Set Aug. p. 167
- HINZ, E. R., with MAIN, C. A., and MUHL, ELINOR P.
High-Speed Photography of Reflection-Lighted Objects in Transonic Wind Tunnel Testing Dec. p. 613
- HUXFORD, W. S., with OLSEN, H. N.
Electrical and Radiation Characteristics of Flashlamps Sept. p. 285
- INGLIS, A. F., with MCINTOSH, F. H.
Color Television Oct. p. 343
- IVES, C. E., with KUNZ, C. J.
Simplification of Motion Picture Processing Methods July p. 3
- JENNINGS, A. B., with STANTON, W. A., and WEISS, J. P.
Synthetic Color-Forming Binders for Photographic Emulsions Nov. p. 455
- JOHNSON, WAYNE R.
An Experimental Electronic Background Television Projection System July p. 60
- KOCH, G. J.
Interference Mirrors for Arc Projectors Oct. p. 439
- KOLB, O. K.
Magnetic Sound Film Developments in Great Britain Nov. p. 496
- KUNZ, C. J., with IVES, C. E.
Simplification of Motion Picture Processing Methods July p. 3
- LANCE, T. M. C.
Improvements in Large-Screen Television Projection Nov. p. 509
- MAIN, C. A., with HINZ, E. R., and MUHL, ELINOR P.
High-Speed Photography of Reflection-Lighted Objects in Transonic Wind Tunnel Testing Dec. p. 613
- MASLACH, G., with HALL, J. S., and MAYER, A.
A 16-Mm Rapid Film Processor July p. 27
- MATHOT, J., with COUTANT, A.
A Reflex 35-Mm Magazine Motion Picture Camera Aug. p. 173
- MAYER, A., with HALL, J. S., and MASLACH, G.
A 16-Mm Rapid Film Processor July p. 27
- MCINTOSH, F. H., with INGLIS, A. F.
Color Television Oct. p. 343
- McKIE, ROBERT V.
Variable-Area Sound Track Requirements for Reduction Printing onto Kodachrome July p. 45
- MOEN, L., with CRANDELL, F. F., and FREUND, K.
Effects of Incorrect Color Temperature on Motion Picture Production July p. 67
- MOLE, P., with HANKINS, M. A.
Designing Engine-Generator Equipment for Motion Picture Locations Aug. p. 197
- MORRISON, JACK
Motion Picture Instruction in Colleges and Universities (A Follow-Up Study of the 1946 Report by John G. Frayne) Sept. p. 265
- MOSES, JAMES A.
Trends of 16-Mm Projector Equipment in the Army Nov. p. 525
- MOSSER, A., with DUNN, L.
35-Mm Ansco Color Theater Prints from 16-Mm Kodachrome Dec. p. 635

- MUHL, ELINOR P., with HINZ, E. R., and MAIN, C. A.
High-Speed Photography of Reflection-Lighted Objects in Transonic Wind Tunnel Testing Dec. p. 613
- O'BRIEN, RICHARD S.
CBS Television Staging and Lighting Practices Sept. p. 243
- OLSEN, H. N., with HUXFORD, W. S.
Electrical and Radiation Characteristics of Flashlamps Sept. p. 285
- RETTINGER, M.
A Magnetic Record-Reproduce Head Oct. p. 377
See also Errata Dec. p. 646
- RYDER, L. L.
Motion Picture Studio Use of Magnetic Recording Dec. p. 605
- SELSTED, WALTER T.
Synchronous Recording on $\frac{1}{4}$ -in. Magnetic Tape Sept. p. 279
- SMITH, ARTHUR L.
Economy in Small-Scale Motion Picture Lighting Aug. p. 180
- SMITH, NEWLAND F.
An Improved Video System for Television Studios Nov. p. 477
- SPONABLE, E. I.
President's Convention Address Dec. p. 559
- STANTON, W. A., with JENNINGS, A. B., and WEISS, J. P.
Synthetic Color-Forming Binders for Photographic Emulsions Nov. p. 455
- STOTT, JOHN G. (Chairman)
Laboratory Practice Committee Report Aug. p. 213
- SULTANOFF, M.
A 100,000,000 Frame Per Second Camera Aug. p. 158
- SZEGHO, CONSTANTIN S.
Color Cathode-Ray Tube with Three Phosphor Bands Oct. p. 367
- TOWNSEND, CHARLES L.
Specifications for Motion Picture Films Intended for Television Transmission Aug. p. 147
- VOLMAR, VICTOR
Foreign Versions Nov. p. 536
- WEISS, J. P., with STANTON, W. A., and JENNINGS, A. B.
Synthetic Color-Forming Binders for Photographic Emulsions Nov. p. 455
- ZWORYKIN, V. K.
New Television Camera Tubes and Some Applications Outside the Broadcasting Field Sept. p. 227
Motion Pictures and Television (Convention Address) Dec. p. 562

INDEX TO SUBJECTS

July—December, 1950 . Volume 55

CINEMATOGRAPHY

Effects of Incorrect Color Temperature on Motion Picture Production, F. F. Crandell, K. Freund and L. Moen
July p. 67

A Reflex 35-Mm Magazine Motion Picture Camera, A. Coutant and J. Mathot
Aug. p. 173

U.S. Naval Underwater Cinematography Techniques, R. R. Conger
Dec. p. 627

COLOR

Effects of Incorrect Color Temperature on Motion Picture Production, F. F. Crandell, K. Freund and L. Moen
July p. 67

Color Committee Report, (H. H. Duerr, Chairman)
July p. 113

Color Television, F. H. McIntosh and A. F. Inglis
Oct. p. 343

Color Cathode-Ray Tube With Three Phosphor Bands, C. S. Szegho
Oct. p. 367

Synthetic Color-Forming Binders for Photographic Emulsions, A. B. Jennings, W. A. Stanton and J. P. Weiss
Nov. p. 455

35-Mm Anseo Color Theater Prints From 16-Mm Kodachrome, A. Mosser and L. Dunn
Dec. p. 635

New Laboratory for Processing Monopack Color Film, K. Gopal
Dec. p. 639

EDITING

Foreign Versions, V. Volmar
Nov. p. 536

EDUCATION

Motion Picture Instruction in Colleges and Universities, A Follow-up Study of the 1946 Report by John G. Frayne, J. Morrison
Sept. p. 265

FILMS

General

Specifications for Motion Picture Films Intended for Television Transmission, C. L. Townsend
Aug. p. 147

Synthetic Color-Forming Binders for Photographic Emulsions, A. B. Jennings, W. A. Stanton and J. P. Weiss
Nov. p. 455

35-Mm Anseo Color Theater Prints From 16-Mm Kodachrome, A. Mosser and L. Dunn
Dec. p. 635

Test

Z22.80-1950, Scanning-Beam Uniformity Test Film for 16-Mm Motion Picture Sound Reproducers (Laboratory Type)
July p. 118

Z22.81-1950, Scanning-Beam Uniformity Test Film for 16-Mm Motion Picture Sound Reproducers (Service Type)
July p. 119

GENERAL

Motion Picture Instruction in Colleges and Universities, A Follow-up Study of the 1946 Report by John G. Frayne, J. Morrison
Sept. p. 265

Foreign Versions, V. Volmar
Nov. p. 536

Biological Photographic Association
Nov. p. 549

U.S. Naval Underwater Cinematography Techniques, R. R. Conger
Dec. p. 627

HIGH-SPEED PHOTOGRAPHY

The Pressurized Ballistics Range at the Naval Ordnance Laboratory, L. P. Gieseler
July p. 53

The Stroboscope as a Light Source for Motion Pictures, R. S. Carlson and H. E. Edgerton
July p. 88

High-Speed Photography Question Box
July p. 122
Sept. p. 323

A 100,000,000 Frame Per Second Camera, M. Sultanoff
Aug. p. 158

Electrical and Radiation Characteristics of Flashlamps, H. N. Olsen and W. S. Huxford
Sept. p. 285

The Cine Flash, A New Lighting Equipment for High-Speed Cinephotography and Studio Effects, H. K. Bourne and E. J. G. Beeson
Sept. p. 299

The High-Speed Photography of Underwater Explosions, P. M. Fye
Oct. p. 414

Infrared Photography with Electric-Flash, F. E. Barstow
Nov. p. 485

High-Speed Photography of Reflection-Lighted Objects in Transonic Wind

Tunnel Testing, E. R. Hinz, C. A. Main and Elinor P. Muhl Dec. p. 613

ILLUMINATION, Projection

Physical Principles, Design and Performance of the Ventare High-Intensity Projection Lamps, E. Gretenner Oct. p. 391

Interference Mirrors for Arc Projectors, G. J. Koch Oct. p. 439

ILLUMINATION, Studio

Effects of Incorrect Color Temperature on Motion Picture Production, F. F. Crandell, K. Freund and L. Moen July p. 67

The Stroboscope as a Light Source for Motion Pictures, R. S. Carlson and H. E. Edgerton July p. 88

Study of Sealed Beam Lamps for Motion Picture Set Lighting, W. Blackburn July p. 101

Economy in Small-Scale Motion Picture Lighting, A. L. Smith Aug. p. 180

Designing Engine-Generator Equipment for Motion Picture Locations, M. A. Hankins and P. Mole Aug. p. 197

CBS Television Staging and Lighting Practices, R. S. O'Brien Sept. p. 243

Electrical and Radiation Characteristics of Flashlamps, H. N. Olsen and W. S. Huxford Sept. p. 285

The Cine Flash, A New Lighting Equipment for High-Speed Cinematography and Studio Effects, H. K. Bourne and E. J. G. Beeson Sept. p. 299

Infrared Photography with Electric-Flash, F. E. Barstow Nov. p. 485

Lighting Methods for Television Studios, H. M. Gurin Dec. p. 576

INSTRUMENTS

Flutter Measuring Set, F. P. Herrfeld Aug. p. 167

LABORATORY PRACTICE

Simplification of Motion Picture Processing Methods, C. E. Ives and C. J. Kunz July p. 3

A 16-Mm Rapid Film Processor, J. S. Hall, A. Mayer and G. Maslach July p. 27

A Method of Measuring Electrification of Motion Picture Film Applied to Cleaning Operations, H. W. Cleveland July p. 37

Variable-Area Sound Track Requirements for Reduction Printing Onto Kodachrome, R. V. McKie July p. 45

Laboratory Practice Committee Report (John G. Stott, Chairman) Aug. p. 213

Electrical Printing, J. G. Frayne Dec. p. 590

35-Mm Ansco Color Theater Prints From 16-Mm Kodachrome, A. Mosser and L. Dunn Dec. p. 635

New Laboratory for Processing Monopack Color Film, K. Gopal Dec. p. 639

PRINTING

A Method of Measuring Electrification of Motion Picture Film Applied to Cleaning Operations, H. W. Cleveland July p. 37

Electrical Printing, J. G. Frayne Dec. p. 590

PROCESSING (See Also Laboratory Practice)

Simplification of Motion Picture Processing Methods, C. E. Ives and C. J. Kunz July p. 3

A 16-Mm Rapid Film Processor, J. S. Hall, A. Mayer and G. Maslach July p. 27

PRODUCTION

Foreign Versions, V. Volmar Nov. p. 536

Motion Picture Production for Television, J. Fairbanks Dec. p. 567

PROJECTION

Characteristics of Motion Picture and Television Screens, F. B. Berger Aug. p. 131

Interference Mirrors for Arc Projectors, G. J. Koch Oct. p. 439

Trends of 16-Mm Projector Equipment in the Army, J. A. Moses Nov. p. 525

PROJECTION, Background

An Experimental Electronic Background Television Projection System, W. R. Johnson July p. 60

PROJECTORS

A New Heavy-Duty Professional Theater Projector, H. Griffin Sept. p. 313

A New Deluxe 35-Mm Motion Picture Projector Mechanism, H. J. Benham and R. H. Heacock Sept. p. 319

A Heavy-Duty 16-Mm Sound Projector, E. C. Fritts Oct. p. 425

Trends of 16-Mm Projector Equipment in the Army, J. A. Moses, Nov. p. 525

SMPTE ACTIVITIES

President's Convention Address, E. I. Sponable Dec. p. 559

Committees

Color Committee Report, (H. H. Duerr, Chairman) July p. 113

Laboratory Practice Committee Report (John G. Stott, Chairman) Aug. p. 213

Society Engineering Committees (Listing) Sept. p. 337

A Progress Report of Engineering Committee Work, F. T. Bowditch Nov. p. 547

SOUND RECORDING

Variable-Area Sound Track Requirements for Reduction Printing Onto Kodachrome, R. V. McKie July p. 45

Proposed American Standard for Sound Transmission of Theater Projection Screens, Z22.82 July p. 120

Flutter Measuring Set, F. P. Herrnfeld Aug. p. 167

Synchronous Recording on $\frac{1}{4}$ -In. Magnetic Tape, W. T. Selsted Sept. p. 279

A Magnetic Record-Reproduce Head, M. Rettinger Oct. p. 377
See also, Errata Dec. p. 646

Magnetic Sound Film Developments in Great Britain, O. K. Kolb Nov. p. 496

Electrical Printing, J. G. Frayne Dec. p. 590

Motion Picture Studio Use of Magnetic Recording, L. L. Ryder Dec. p. 605

STANDARDS

Z22.80-1950, Scanning-Beam Uniformity Test Film for 16-Mm Motion Picture Sound Reproducers (Laboratory Type) July p. 118

Z22.81-1950, Scanning-Beam Uniformity Test Film for 16-Mm Motion Picture Sound Reproducers (Service Type) July p. 119

Proposed American Standard for Sound Transmission of Theater Projection Screens, Z22.82 July p. 120

TELEVISION

An Experimental Electronic Background Television Projection System, W. R. Johnson July p. 60

Characteristics of Motion Picture and Television Screens, F. B. Berger Aug. p. 131

Specifications for Motion Picture Films Intended for Television Transmission, C. L. Townsend Aug. p. 147

Component Arrangement for a Versatile Television Receiver, F. N. Gillette and J. S. Ewing Aug. p. 189

New Television Camera Tubes and Some Applications Outside the Broadcasting Field, V. K. Zworykin Sept. p. 227

CBS Television Staging and Lighting Practices, R. S. O'Brien Sept. p. 243

Color Television, F. H. McIntosh and A. F. Inglis Oct. p. 343

Color Cathode-Ray Tube With Three Phosphor Bands, C. S. Szegho Oct. p. 367

An Improved Video System for Television Studios, N. F. Smith Nov. p. 477

Motion Pictures and Television, V. K. Zworykin Dec. p. 562

Motion Picture Production for Television, J. Fairbanks Dec. p. 567

Lighting Methods for Television Studios, H. M. Gurin Dec. p. 576

THEATER TELEVISION

Characteristics of Motion Picture and Television Screens, F. B. Berger Aug. p. 131

Improvements in Large-Screen Television Projection, T. M. C. Lance Nov. p. 509

INDEX TO NONTECHNICAL SUBJECTS

July—December, 1950 . Volume 55

Awards

FELLOW AWARDS—1950 Recipients

Dec. p. 649

Badgley, G. J.	Kolb, F. J., Jr.
Beers, G. L.	Livadary, J. P.
Bragg, H. E.	Lodge, W. B.
Gage, F. W.	Nemec, B.
Garman, R. L.	Rosher, C.
Jones, Watson	Waddell, J. H.

Yorke, Emerson

HONORARY MEMBERS—1950 Recipients

Dec. p. 650

Kellogg, E. W.	Zworykin, V. K.
----------------	-----------------

JOURNAL AWARD—1950 (Recipients)

Dec. p. 650

Herr, Robert	Murphey, B. F.
Keith, C. R.	Pagliarulo, Vincent
Kolb, F. J., Jr.	Wetzel, W. W.

PROGRESS MEDAL AWARD—1950 (Recipient)

Zworykin, V. K. Dec. p. 651

SAMUEL L. WARNER MEMORIAL AWARD—1950 (Recipient)

Fordyce, Charles R. Dec. p. 650

New Society Medal Dec. p. 653

Book Reviews

Handbook of Basic Motion-Picture Techniques, by Emil E. Brodbeck (Reviewed by James W. Moore) July p. 126

Film User Year Book, Vol. II, 1950, edited by Bernard Dolman (Reviewed by William K. Aughenbaugh) Aug. p. 220

The Organization of Industrial Scientific Research, by C. E. Kenneth Mees and John A. Leermakers (Reviewed by G. T. Lorraine) Aug. p. 221

The American Annual of Photography, Vol. 64, 1950, edited by Frank R. Fraprie and Franklin I. Jordan (Reviewed by John W. Boyle) Sept. p. 331

Practical Television Engineering, by Scott Helt (Reviewed by E. Arthur Hungerford, Jr.) Sept. p. 331

Sound Absorbing Materials, by C. Zwikker and C. W. Kosten (Reviewed by Hale J. Sabine) Sept. p. 332

American Cinematographer Handbook and Reference Guide, Seventh Edition, by Jackson J. Rose (Reviewed by John W. Boyle) Sept. p. 333

Theatre Catalog, 8th Annual Edition, 1949-1950, Jay Emanuel Publications, Inc. (Reviewed by Leonard Satz) Sept. p. 333

Questions and Answers in Television Engineering, by Carter V. Rabinoff and Magdalena E. Walbrecht (Reviewed by Richard H. Dorf) Oct. p. 444

Réunions D'Opticiens, Tenues a Paris, en Octobre 1946, Textes rassembles par Pierre Fleury, André Maréchal et Mme. Claire Anglade, Institut d'Optique, Paris (Reviewed by Dr. K. Pestrecov) Oct. p. 445

Photographie Instantanée et Cinématographie Ultra-Rapide, par P. Fayolle et P. Naslin (Reviewed by John H. Waddell) Oct. p. 445

Photographic Optics, by Allen R. Greenleaf (Reviewed by Oscar W. Richards) Nov. p. 552

A Grammar of the Film, by Raymond Spottiswoode (Reviewed by Russell C. Holslag) Nov. p. 553

Conventions

68th Semiannual Convention July p. 121 Aug. p. 216 Sept. p. 327 Dec. p. 647

President's Convention Address, E. I. Sponable Dec. p. 559

Convention Speech, Terry Ramsaye Dec. p. 652

Papers Presented at the Convention Dec. p. 658

Current Literature

Sept. p. 334 Nov. p. 550

Letters to the Editor

By J. H. Spray	July p. 125
E. Lindgren	Aug. p. 218
J. F. Dunn	Oct. p. 446
Don Norwood	Oct. p. 447

New Products

The Westrex 1035 Magnetic Recording System July p. 127

Hollywood Camera Exchange Line-Up Viewfinder July p. 128

Fastax High-Speed Motion Picture Cameras Aug. p. 223

New Products, cont'd.

Fish-Schurman Corp. Heat (Infrared) Deflector	Aug. p. 223
G-E Flashtube No. 231	Aug. p. 224
Photo Research Corp. Spectra Three-Color Meter	Sept. p. 336
Heyer-Shultz, Inc., All-Metal Reflectors	Oct. p. 450
Duncan & Bailey, Inc., PM Hysteresis Clutches and Brakes	Oct. p. 450
Greiner Glass Industries Co. Special Viewfinder Ground Glass for 35-Mm Motion Picture Cameras	Oct. p. 451
The G-E Electronic Pointer	Nov. p. 554
Buensod-Stacey, Inc., Spray-Type Air Washers, Humidifiers and Dehumidifiers	Nov. p. 555
Heyer-Shultz, Inc., Self-Centering Film-Track Pin-Hole Plates	Nov. p. 555
S.O.S. Cinema Supply Corp. Automatic 16-mm Film Processing Machine	Nov. p. 555
Zoomar Corp. <i>F</i> /1.3, 15-mm Wide Angle Balowstar	Nov. p. 556
National Cine Equipment, Inc., "T-Stop" Calibration of Lenses	Nov. p. 556

Obituaries

Christensen, H. G.	Aug. p. 219
Clark, L. E.	Aug. p. 219
Wise, A. G.	Dec. p. 657

Section Meeting

Central Section of SMPTE	Aug. p. 220
--------------------------	-------------

SOCIETY, General

Board of Governors	Aug. p. 216
	Dec. p. 647
Engineering Committees Activities	
July p. 123	Aug. p. 217
Sept. p. 327 & 337	Oct. p. 443
Nov. p. 547	Dec. p. 654
Honorary Members and SMPTE Honor Roll	Dec. p. 660

