

506.13
D2W23

PV21

5/18/50
2/

JOURNAL

OF THE

WASHINGTON ACADEMY OF SCIENCES

VOLUME 32, 1942



BOARD OF EDITORS

RAYMOND J. SEEGER
GEORGE WASHINGTON UNIVERSITY

G. ARTHUR COOPER
U. S. NATIONAL MUSEUM

JASON R. SWALLEN
BUREAU OF PLANT INDUSTRY

ASSOCIATE EDITORS

W. EDWARDS DEMING
PHILOSOPHICAL SOCIETY

HARALD A. REHDER
BIOLOGICAL SOCIETY

CHARLOTTE ELLIOTT
BOTANICAL SOCIETY

C. F. W. MUESEBECK
ENTOMOLOGICAL SOCIETY

EDWIN KIRK
GEOLOGICAL SOCIETY

T. DALE STEWART
ANTHROPOLOGICAL SOCIETY

HORACE S. ISBELL
CHEMICAL SOCIETY

PUBLISHED MONTHLY

BY THE

WASHINGTON ACADEMY OF SCIENCES

450 AHNAP ST.

AT MENASHA, WISCONSIN

ACTUAL DATES OF PUBLICATION, VOLUME 32

- No. 1, pp. 1-32, January 24, 1942.
- No. 2, pp. 33-64, February 17, 1942.
- No. 3, pp. 65-92, March 14, 1942.
- No. 4, pp. 93-124, April 16, 1942.
- No. 5, pp. 125-156, May 16, 1942.
- No. 6, pp. 157-188, June 16, 1942.
- No. 7, pp. 189-220, July 17, 1942.
- No. 8, pp. 221-252, August 14, 1942.
- No. 9, pp. 253-284, September 15, 1942.
- No. 10, pp. 285-320, October 28, 1942.
- No. 11, pp. 321-352, November 16, 1942.
- No. 12, pp. 353-376, December 22, 1942.

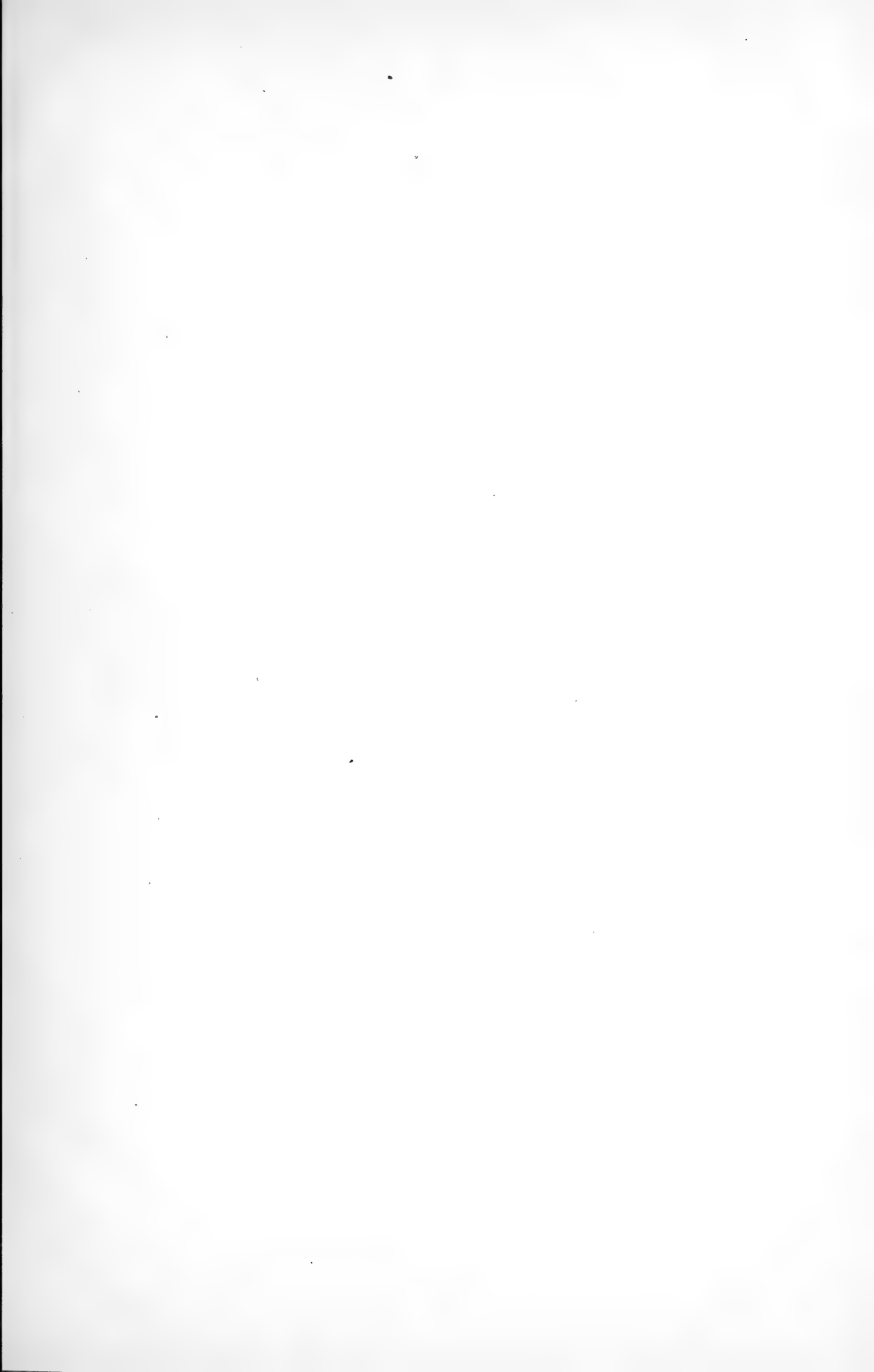



66
1023
VOL. 32

JANUARY 15, 1942

No. 1

JOURNAL

OF THE

WASHINGTON ACADEMY OF SCIENCES

BOARD OF EDITORS

JAMES H. KEMPTON
U. S. BUREAU OF PLANT INDUSTRY

RAYMOND J. SEEGER
GEORGE WASHINGTON UNIVERSITY

G. ARTHUR COOPER
U. S. NATIONAL MUSEUM

ASSOCIATE EDITORS

LEWIS V. JUDSON
PHILOSOPHICAL SOCIETY

AUSTIN H. CLARK
ENTOMOLOGICAL SOCIETY

HAROLD A. REHDER
BIOLOGICAL SOCIETY

EDWIN KIRK
GEOLOGICAL SOCIETY

CHARLOTTE ELLIOTT
BOTANICAL SOCIETY

T. DALE STEWART
ANTHROPOLOGICAL SOCIETY

HORACE S. ISBELL
CHEMICAL SOCIETY

PUBLISHED MONTHLY

BY THE

WASHINGTON ACADEMY OF SCIENCES

450 AHNAP ST.

AT MENASHA, WISCONSIN

Entered as second class matter under the Act of August 24, 1912, at Menasha, Wis.

Acceptance for mailing at a special rate of postage provided for in the Act of February 28, 1925.

Authorized January 21, 1933.

Journal of the Washington Academy of Sciences

This JOURNAL, the official organ of the Washington Academy of Sciences, publishes (1) short original papers, written or communicated by members of the Academy; (2) proceedings and programs of meetings of the Academy and affiliated societies; (3) notes of events connected with the scientific life of Washington. The JOURNAL is issued monthly, on the fifteenth of each month. Volumes correspond to calendar years.

Manuscripts may be sent to any member of the Board of Editors. It is urgently requested that contributors consult the latest numbers of the JOURNAL and conform their manuscripts to the usage found there as regards arrangement of title, subheads, synonymies, footnotes, tables, bibliography, legends for illustrations, and other matter. Manuscripts should be typewritten, double-spaced, on good paper. Footnotes should be numbered serially in pencil and submitted on a separate sheet. The editors do not assume responsibility for the ideas expressed by the author, nor can they undertake to correct other than obvious minor errors.

Illustrations in excess of the equivalent (in cost) of two full-page line drawings are to be paid for by the author.

Proof.—In order to facilitate prompt publication one proof will generally be sent to authors in or near Washington. It is urged that manuscript be submitted in final form; the editors will exercise due care in seeing that copy is followed.

Author's Reprints.—Fifty reprints without covers will be furnished gratis to authors of scientific papers. Covers bearing the name of the author and title of the article, with inclusive pagination and date of issue, and reprints, will be furnished authors at cost when ordered.

Envelopes for mailing reprints with the author's name and address printed in the corner may be obtained at the following prices: First 100, \$4.00; additional 100, \$1.00.

<i>Subscription Rates</i> .—Per volume.....	\$6.00
To members of affiliated societies; per volume.....	2.50
Single numbers.....	.50

Correspondence relating to new subscriptions or to the purchase of back numbers or volumes of the JOURNAL should be addressed to William W. Diehl, Custodian and Subscription Manager of Publications, U. S. Bureau of Plant Industry, Washington, D.C.

Remittances should be made payable to "Washington Academy of Sciences" and addressed to 450 Ahnaip Street, Menasha, Wis., or to the Treasurer, H. S. Rappleye, U. S. Coast and Geodetic Survey, Washington, D.C.

Exchanges.—The JOURNAL does not exchange with other publications.

Missing Numbers will be replaced without charge provided that claim is made to the Treasurer within thirty days after date of following issue.

OFFICERS OF THE ACADEMY

President: AUSTIN H. CLARK, U. S. National Museum.

Secretary: FREDERICK D. ROSSINI, National Bureau of Standards.

Treasurer: HOWARD S. RAPPLEYE, U. S. Coast and Geodetic Survey.

Archivist: NATHAN R. SMITH, U. S. Bureau of Plant Industry.

Custodian of Publications: WILLIAM W. DIEHL, U. S. Bureau of Plant Industry.

JOURNAL

OF THE

WASHINGTON ACADEMY OF SCIENCES

VOL. 32

JANUARY 15, 1942

No. 1

ETHNOLOGY.—*A scientific approach to African colonization.*¹ O. F. COOK,
Lanham, Md.

Going fifty years ago from western New York to Liberia, and there observing the results of African colonization from the United States, was an experience that in retrospect appears very different from any noted in published accounts of African travel or racial history. The difference may be ascribed largely to the absence of previous contacts, commitments, or teachings of a nature to affect, even unconsciously, the observation and study of racial characters and relations. A prolonged and intensive controversy had raged in the northern States before the Civil War, and echoed widely through the period of Reconstruction, but it was possible in a rural community to grow up without acquiring any racial presumptions or knowing any Negroes. Visiting Africa with congenial associates was an opportunity that an interest in nature could not refuse.

Negroes in numbers were seen for the first time at Monrovia and in the settlements along the St. Paul River in December, 1891. Two widely contrasting groups were apparent, the civilized "Liberians" and the primitive "natives," living in separate communities with the customs and conditions of the native life but little disturbed. A racial viewpoint was provided in advance, before the Liberian people were studied, or Negroes in our southern States. Several visits were made to Liberia, and subsequent contacts with the Cotton Belt extended through many years. Agricultural explorations in several tropical and subtropical countries, Puerto Rico, Haiti, Panama, Costa Rica, Guatemala, Mexico, Peru, Egypt, Palestine, and China afforded

¹ Received May 10, 1941.

a basis of judgment regarding the status of Liberia.

Social elements must be admitted in racial evaluations, since different ways of living may largely determine cultural development among primitive peoples. The African system of living in compact villages is a form of social organization that provides only limited contacts between the children and the parents, and little opportunity for experience to accumulate through successive generations, thus explaining the generally backward state of civilization among the natives of Africa. A few years after leaving Liberia I observed an essentially different system among primitive peoples in Central America, not living in villages but in scattered families. The two systems were described and contrasted in this JOURNAL, March 4, 1912, "Definitions of Two Primitive Social States."

It seems remarkable that the need of knowing the native life of the Negroes in Africa seldom is recognized. Only one author has been found, a writer of letters from San Domingo before the French Revolution, who reflected that knowledge of native conditions would be required in order to estimate fairly the hardships or privations suffered by the Negroes in slavery. Hundreds of foreign missionaries, of course, have lived among the African tribes and have recounted incidents of native life, but rarely have they attempted to interpret the racial character or to project a racial future. Missionaries in Liberia often are devoted entirely to the natives, with little or no interest in the civilized Liberians, descendants of the colonists who returned to Africa from the United States.

JAN 24 1942

Colonization was a constructive effort in the field of race relations and had a background of scientific interest at the period of inception. The field operations often were mismanaged and many difficulties arose from lack of knowledge of tropical economic plants and tropical diseases; also from interest being diverted by the sectional tensions that brought us to the Civil War. The numerical result of colonization must appear insignificant, less than 20,000 civilized people scattered in small settlements along 300 miles of the African coast. Yet the Liberians have attained their principal object of escaping the racial tensions that often were felt acutely in the United States. They feel sure that their people never will be contented in America and that the pioneer effort in civilizing and developing the African home-land eventually will be followed and appreciated.

Thomas Jefferson and George Washington were the traditional sponsors of the policy of colonization. Jefferson studied the racial problem from many sides, including the need of educating the more capable Negroes, in order that they might furnish the necessary skill and leadership for the new communities in Africa. Washington instructed his executors to provide such education for some of his freedmen. Many slaves and freedmen were educated during the early period of colonization and later were assisted in emigrating and establishing themselves in Liberia. The policy of forbidding the education of Negroes developed later, opposing the demand for immediate abolition and racial equality in the United States. The interest of Washington and Jefferson eventuated in the formation of the American Colonization Society, in December, 1816. The first president of the Society, elected in January, 1817, was Justice Bushrod Washington of the Supreme Court, a nephew of George Washington.

Henry Clay, Andrew Jackson, William H. Crawford of Georgia, and several other eminent statesmen were elected as vice-presidents.

Liberia has had its place on the map of Africa for more than a century, a challenge to historians to understand, explain, and evaluate the effort made and the experience gained in this unique colonial undertaking. Many historical or descriptive accounts of Liberia and the colonization movement have been written, but usually they disregard the basic interest that existed more than a century ago among both races in the southern States in working out a gradual and peaceful emancipation of the slaves and restoring them to Africa on a civilized footing. The little book *Liberia* published in 1913 by Prof. Frederick Starr, of the University of Chicago, contains a detailed history of colonization and of resulting progress among the natives. A large, two-volume, richly illustrated work, *Liberia*, by Sir Harry Johnston, appeared in 1906.

In view of the possibility of an eventual return to the plan of resettlement of American Negroes in Africa, the nature of the pioneer undertaking should be better known—how such an interest developed, what the settlements in Africa accomplished, what the limiting requirements proved to be, and whether these requirements could now be met. It was supposed that the colonization project would lapse completely with the Civil War, but small numbers of Negroes have continued to go to Liberia and several movements for large-scale resumption of colonization have occurred, showing that an underlying interest still exists. A recent proposal in the field of colonization is that of Senator Bilbo of Mississippi, presented in a speech before the first session of the Seventy-sixth Congress, April 24, 1939. Colonization appears much more feasible now than it was in the former century.

BOTANICAL FORERUNNERS OF COLONIZATION

Two tropical botanists of the eighteenth century, Aublet and Smeathman, were presented in this JOURNAL, July 15, 1940, as pioneers against slavery. Although these

men have not figured in histories of the anti-slavery movement, they appear to have given the first scientific attention to African slavery as a racial problem, before the

French Revolution affected colonial policies and brought the racial questions into political controversy. It is not without interest that the plan of repatriating the Negroes in Africa arose in the early period of scientific exploration of the Tropics.

Wadstrom's monumental *Essay on colonization*, published in 1794, states that Smeathman was "the person who first proposed a *specific plan* for colonizing Africa, with a view to civilization." Wadstrom was a Swedish economist and had made a voyage to Africa on a French vessel. He projected an elaborate agricultural and commercial development that was expected to absorb the activities of the natives and thus put an end to the slave trade.

Smeathman's plan of repatriating Negroes from England or from America was developed after several years had been spent among the natives in the vicinity of Sierra Leone. Emancipation served as a military measure in the Revolutionary War, as later in the Civil War. Thousands of refugee Negroes had been sent from Virginia, South Carolina, and Georgia to the West Indies in the war period, while several hundreds of destitute and distressed people had drifted to London. These were to form the colony at Sierra Leone, but Smeathman died before the expedition sailed, and the settlement soon was abandoned. Yet reports of the undertaking reached America and served at least as suggestions in developing the project of colonizing Negroes from the United States.

Wadstrom and many later historians overlooked a brief but significant paper on African colonization by Ferdinando Fair-

fax, of Richmond, Va., that appeared in December, 1790, at Philadelphia in a short-lived pioneer journal of popular science and general literature, *The American Museum or Universal Magazine*. The statement by Fairfax provides a nexus between Smeathman's project at Sierra Leone and the development in the United States of the policy of returning the Negroes to Africa. No reference to this paper has been found, and it may not be accessible in many libraries. A photographic copy is reproduced in Fig. 1.

Although Smeathman was not mentioned by Fairfax, the statement that "England, not long since, made an experiment of this kind, which was found not to succeed" undoubtedly refers to the effort at Sierra Leone. The proposal to repeat the experiment in spite of the initial failure leaves no doubt of an underlying approval of the plan. Fairfax sensed the danger of tensions and conflicts arising from arguments addressed "rather to the feelings than to the cool deliberate judgment."

Letting the free Negroes go back to Africa prepared to live as civilized people appeared to Fairfax an acceptable solution of the racial problem. A failure of later generations to continue a project may not lessen the interest of the original suggestion. Returning the Negroes to Africa appeared before the Civil War as the only practicable alternative of slavery, and many writers of the pre-War period rested in the belief that a practical solution would be worked out in Liberia. Daniel Webster and Abraham Lincoln looked to colonization as the eventual adjustment.

SMEATHMAN A BOTANICAL EXPLORER

Aublet and Smeathman were botanical explorers, not actuated by the zeal of missionaries or philanthropists but by the desire to see the plants and animals of the tropical countries and the human inhabitants as well. Earlier botanists, Plumier, Jacquin, and others, had discovered a new plant world in the West Indian Islands, but the forest floras of South America and Africa were still unknown. Adanson had

botanized in Senegal from 1749 to 1754, and even in the previous century a little plant material had come from the Gold Coast, but vast regions remained untouched.

Aublet in Guinea and Smeathman in Sierra Leone collected hundreds of new plants, but their interest was not restricted to the herbarium specimens. Smeathman has distinction among entomologists for first describing the specialized castes and

fact, and the like (think when they flaked their thirst; the fearful victim in vain was hunted, and the barred at which would be done to insubviate by a legislative interference (with- out voluntary consent) in private prop- erty, which had been acquired and pooled under the laws of the country. But no practicable scheme has yet been proposed, which would unite all these principles of justice and policy, and extend even to the region of peace in- tending to remove all ground for oppo- sition, and the goal all has hitherto been offered to the public upon this subject, has been addressed, rather to the feelings, than to the cool and deliberate judgment. The following plan is therefore submis- sive, without appeal, since it is only intended to suggest the idea, which may be improved by some able hand. It seems to be the general opinion, that emancipation must be gradual, first, to deprive a man in one, of all the rights to the property of his negroes, which, as in this country, would never be forfeited to; and the resources of government are by no means adequate to making, at once a full compensation. It must therefore be by voluntary con- sent—consequently in a gradual man- ner. It is equally agreed, that, if they be emancipated, it would never do to allow them all the privileges of citi- zens; they would therefore form a se- parate interest from the rest of the com- munity. There is something very re- pugnant to the general feelings, even in free intercourse, and the privilege of intermarriage with the white inhabi- tants, which the other freedom of our country enjoy, and which only con- form one common interest. The re- membrance of their former situation, and a variety of other considerations, forbid this privilege—and as a proof, where is the man of all those who have liberated their slaves, who would mar- ry a son or a daughter to one of them? So that these provisions, inasmuch as whatever they may be called, would be found to operate so powerfully as to be influential. And though the laws

should allow these privileges, yet the same effect would still be produced, of forming a separate interest from the rest of the community; for the laws cannot operate effectually against the sentiments of the people.

If this separate interest of a great a number in the same community, be once formed, by any means, it will en- danger the peace of society; for it can- not exist within the neighbourhood of other states, without danger to the peace of each.—How much lets, then, between the inhabitants of the same country? This suggests the propriety, and even necessity of removing them to a distance from this country. It is there- fore proposed,

That a colony should be settled, un- der the auspices and protection of con- gress, by the negroes now within the united States, and be composed of those who already, as well as those who, at any time hereafter, may become libe- rated by the voluntary consent of their owners; since there are many who would willingly emancipate their slaves, if there should appear a probability of their being so disposed of, as neither to injure themselves nor the commu- nity. As an additional inducement, gov- ernment may, as the resources of the country become greater, offer a reward or compensation, for emancipation.

There is, however, in the mean time, a sufficient number to form a very con- siderable colony.

That congress should frame a plan, and appoint the proper officers for the government of the colony in its infant state, until the colonists should them- selves become competent to that busi- ness.

That there should be suitable pro- visions made for their support and de- fence. And

That, to forward their progress in the useful arts, and supply them for the necessities of life, congress should be authorized to purchase a considerable number of those who are intended to be sent over after the first settlement, and to provide them with the necessaries of life, which should be the establishment of fe-

his posterity and that there is hardly any man who will not, from some of these motives, be induced to industry, if placed in a situation where there is no other resource.

All these motives are now wanting to the people in question: but who can say that, when, by a change of situation, they shall operate in their full force, they will not have their effect?
Richmond, March 6, 1790.

Thoughts on propriety of reading.
I have often wondered why those who have the charge of instructing children in the art of reading, do not teach them to read poetry as well as prose; I know it may be justly said, "Because, ingenious, they do not know how to read it themselves;" but if the practice were attended to, this objection would be obviated: I am not afraid to assert, that he who under its reads read- ing poetry properly, giving due empha- sis and making musical cadences, is al- ways a good, if not an elegant, reader, of every other species of writing; his voice has become smoother, and his in- tellect is more jud, as well as in- clined to maintain himself and family, they made a pleasy.

It may, however, be urged, that the negroes (having contracted such dispo- sitions for indolence as always to require compulsion) will never voluntarily la- bour for subsistence. It is granted, that this would be the case, were they to remain among us, where they find some is rewarded by this compliance to the metre: because it is rhyme, he may pry upon others; and it is even probable, that, for a little time after their removal, the force of habit would operate in a considerable degree. But there can be no doubt, but that the same circumstances, which have once influenced mankind in any situation, will, in the same situation, actuate their again. And let us consult hu- man nature—we shall find, that no man would labour but through ne- cessity, or, after this necessity is over- come, without some stimulus to honour or grandeur, either to himself or to

But this can, by no means, be admit- ted as decisive: the number they sent over, was very small, compared to what we should be able to send; and per- haps, the means they adopted were in- competent to the accomplishment of the object. But did not the same thing occur in the first settlement of Virginia? These were two more able, before they succeeded; nor did the colony, at last, begin to flourish, until proper en- couragements were given to industry, by the prospect presented to each man, in- dividually, of receiving the reward of this industry, by commercial intercourse with other countries, and by the bene- fit which would result immediately to himself or to his family. This is com- firmed by a circumstance recorded in the history of this colony, viz. when they first began to labour for subsis- tence, the plan was, that the produce of each man's labour, should be put into the common stock, from whence all should be supplied as occasion required. The consequence was, that they never made enough for their support, and were once or twice near starvings; but as soon as each man had his own ground assigned him, with directions to maintain himself and family, they made a pleasy.

It may, however, be urged, that the negroes (having contracted such dispo- sitions for indolence as always to require compulsion) will never voluntarily la- bour for subsistence. It is granted, that this would be the case, were they to remain among us, where they find some is rewarded by this compliance to the metre: because it is rhyme, he may pry upon others; and it is even probable, that, for a little time after their removal, the force of habit would operate in a considerable degree. But there can be no doubt, but that the same circumstances, which have once influenced mankind in any situation, will, in the same situation, actuate their again. And let us consult hu- man nature—we shall find, that no man would labour but through ne- cessity, or, after this necessity is over- come, without some stimulus to honour or grandeur, either to himself or to

each line. I must beg pardon of the reverend clergy among us, when I say, having remarked the manner, in which the generality of them read the psalms and hymns on Sundays in our churches, I suppose I must do here a minute, and observe, that no one has a more felicitous and respect for them and their office than I have; and that I give their

Fig. 1.—"Plan for liberating the Negroes within the United States," by Ferdinando Fairfax, of Richmond, Va. From *The American Museum or Universal Magazine*, December, 1790, Philadelphia.

social habits of the African termites, a study that may have conduced to interest in human adjustments. The date of Smeathman's exploration given in the recently published *Flora of West Tropical Africa*, by Hutchinson and Dalziel, is several years too late. "Smeathmann," with the final letter doubled, is listed as "Agent—Conductor of the scheme for settling freed slaves at Freetown in 1787." This is the date of the attempted colony and of Smeathman's death, but his account of the termites was published in 1781, and his botanical collecting probably was done in the preceding decade.

According to R. H. Fox, in *Dr. John Fothergill and his friends*, Smeathman was engaged in 1771 to spend three years investigating "the natural history and products of Spain and the West Coast of Africa." Fox states that Smeathman went later to the West Indies, and Smeathman says: "My stay in the West Indies was with a view to inform myself of tropical cultivation, previous to my return to Africa." The range of scientific interest in the Fothergill coterie was remarkable. One of Fothergill's friends was Peter Collinson, known to American botanists for supporting the explorations of the Bartrams.

Smeathman says that his plan of colonization was based on "observations made in a 4 years residence," doubtless referring to his stay in Africa, most of the time among the natives, learning their ways of living and working under the local conditions. The native foods and methods of production were considered, as well as the need of introducing crops from other countries. His views of the need and advantage of labor for continued health and enjoyment of life in tropical countries were far in advance of his time, or even of our present time, since traditional habits of social parasitism still vitiate our relations with other races. Smeathman seems to have been entirely free from the notion so prevalent in tropical countries, and doubtless of oriental origin, that physical labor is degrading and marks an inferior social caste. He says:

If I was to conduct this enterprise, I would lift the first axe and the first hoe myself; and may say without vanity, since it is said from

experience, set an example of labour and industry in cultivation. For husbandry, far from being to me a drudgery, is the most delightful amusement. I attribute all the extreme good health I enjoyed by intervals in Africa, with the soundness of my constitution at this hour, to the hard labour I then sustained with infinite pleasure, often contemplating with how much greater enjoyment I could labour, in prosecuting such an attempt of civilization. It would be our business to take not only the seeds common in the climates, but also all the seeds to be procured from warmer regions, of use in food or medicine. Our own hot-houses would furnish us with coffee, American indigo, aloes and other useful plants; and I should think the chocolate tree (*theobroma cacao*) might be procured. These are not indeed primary objects, but by the time they increase, will be very worthy of attention.

Much of the subsequent history might have been different if Smeathman had lived and made the experiment that he had in mind. With all their difficulties and failures, the colonies planted at Sierra Leone and in Liberia may be said to have demonstrated that communities of civilized Negroes could be established in Africa, but the significance of these pioneer undertakings was overlooked in the period of intensive controversy. The death of Smeathman may be said to have aborted the project, in the absence of any successor with comparable experience and insight. The later operations in the United States developed no leaders with scientific interest and tropical experience that would qualify them as normal successors of Smeathman.

Smeathman's plan may have been an echo or resumption of an earlier project by Fothergill as noted by Fox:

Fothergill joined with his friends in the moral crusade against slavery and all its works. His practical mind, ever seeking ways to remedy the ills of men, projected a scheme for settling a colony of freed negroes in Africa to cultivate the sugar-cane, and he was ready, it is said, to subscribe 10,000 pounds towards the expense. He received a letter, however, from Anthony Benezet of Philadelphia, one of the most enlightened advocates of the slave, in

1773, discouraging the plan: it was better, he thought, that the negroes should live together with whites in a mixed community.

White people were not excluded from Smeathman's plan, or from Wadstrom's extensive scheme, which had hundreds of prominent patrons. A large agricultural and

commercial organization was planned in great detail. Wadstrom made an intensive study of the economic principles that should govern such undertakings, including precautions for preventing harmful speculation in "imaginary paper," to keep his project from becoming another "South Sea Bubble."

BIOLOGY AND RACIAL STUDY

The biological sciences provide us with methods and experience in observing and taking account of diversity and also furnish the actual backgrounds of conditions of life as settings for our problems of human welfare and racial adjustments. Ethnology, the science of race, admittedly is a branch of biology, and the same will be true of sociology and economics as soon as these sciences are developed beyond the philosophic stage of abstract terms and formal distinctions.

A racial interest that is real and functional has to be a biological interest, a natural taste for seeing, appreciating, and understanding the diversities of nature. The complexity of biological facts places them beyond the range of merely verbal or "philosophical" minds, unaccustomed to observation. Inferences are useful if they lead us to observe more closely, but not if they lead only to abstractions. Seeing what can be seen is the basic impulse of mental development. The dialectic philosophy of Plato and his successors is a serious impediment to science, as Bacon so clearly perceived. More general interest and understanding of plant and animal life is the best assurance of substantial progress in the social or racial sciences.

The diversities of people are of a piece with the diversities of plants and animals, a part of the same creation. The diversity of

living forms and the complexity of the limiting factors are the most general and significant of all biological facts. We gain understanding of life as we learn to appreciate and to take account of the infinite variety of adjustments made possible through diversity of form and function. Science is our effort to see clearly, which often is difficult, so that special precautions are required. Goethe gave us a general warning that "we see only what we know," meaning that we have to become familiar with our facts before we reach the stage of effective vision. Casual observations and inferences may be thoroughly misleading, as often has occurred in the racial controversies.

Naturalists have a basic social function in extending our view of the living world. Not only the facts that science substantiates, but also the careful tentative methods of scientific study, must be more widely diffused in order to be appreciated and applied by a far larger proportion of the general public, before we may hope to deal constructively with our human relations. The most important applications of the biological sciences in racial welfare are in the nature of community undertakings and require full understanding by the functioning personnel as the basis of effective cooperation.

IS SCIENCE ALOOF FROM RACIAL PROBLEMS?

The charge of science holding aloof from human interests is echoed frequently in the discussion of racial relations. Problems of public information are vastly more difficult in fields of thought that have suffered from controversy, but to say that science eschews

controversy may not be an adequate defense in an age of revolution. Controversies are said to prove nothing, but they show that facts are obscure or deficient. Neglecting to bring a significant fact to public attention, leaving it concealed and disre-

garded in "technical literature," may appear even more culpable from a standpoint of social responsibility than a failure to make original investigations.

Science may need to admit a responsible function in popular knowledge. The actual state of public opinion or belief regarding any field of knowledge is a fact that science may determine and report. Freedom of controversy is abused when ascertained facts are disregarded or misrepresented in a manner to misinform the public. A traditional assumption has been that scientific facts may be left to speak for themselves, but often they are smothered by "the natural conservatism of all professional people." Important discoveries may lie dormant for many years, like Mendel's reports of his basic experiments in heredity. A published record may establish priority among scientific specialists, but may not be an adequate defense at the bar of social responsibility.

The spirit of controversy is repugnant to science because controversy deals with arguments rather than with facts, and because language is perverted, so that customary forms of expression become too misleading for scientific use. Thus scientific study is impeded or even inhibited during a period of intensive controversy. The entire field of racial thought was devastated during the last century to an extent that is hardly to be appreciated. But by going back to earlier writers it is possible to see that racial differences were observed and noted like other biological facts, without being complicated by the controversial intrusions of later periods.

The small paper relating to Aublet was noticed in *Science News Letter* of October 6, 1940, in a manner to show how the traditions of the antislavery crusade carry forward to the present day, even in the field of scientific reporting. Aublet had been presented as an early example of an interest in human welfare on the part of a scientific explorer, hidden in an old book of technical botany that no conventional historian would be expected to consult. The scientific interest of this early reaction to slavery was completely sidetracked in *Science News Letter* by dressing Aublet in the conventional

character of the petulant reformer, instant in protest: "His writings contain in addition to the customary Natural History descriptions and travel notes, frequent references of strong disapproval of the institution of negro slavery. He opposed the system, not only because of its inhumanity to the blacks, but because of the deterioration in character it brought about in the white owners and overseers."

This is not Aublet's attitude, but an echo of the antislavery controversy, with the subversive implication that social reforms are possible only through sanguinary struggles, as with the many writers who assume that our Civil War was necessary. "It needed a great war and the convulsion of the nation to establish their principles in the mind of the majority." A false philosophy of revolution is implied in this theory of social progress requiring intensive agitation by militant minorities, disregarding the scientific outlook to wider understanding of our human nature and the world we live in, "the increase and diffusion of knowledge." Progress means more understanding, not more irritation.

Aublet was a reformer, but not an agitator. If he had a scientific sense of social responsibility it extended in the case that was cited only to placing on record an opinion reached through observation of Negro slaves in the French colonies, that they were people of peaceable temperament who for colonial purposes did not need to be held in slavery, which was proved by later events. Aublet's four volumes on the plants of French Guiana, although titled as *Histoire*, are not a work of "natural history" in our modern sense, but of formal Latin and French descriptions of genera and species, hundreds of engraved plates, and thousands of drawings of structural details. Travel notes are not interspersed, nor are there protests against "the institution of negro slavery," an expression of later usage. The separate short chapter of "Observations on the Slave Negroes" is not controversial, and nobody is denounced. Aublet, Smeathman, Jefferson, and Fairfax were strongly opposed to slavery but sought understanding and constructive courses.

JEFFERSON'S APPEAL TO "NATURAL HISTORY"

The charge of science neglecting racial questions is not new, since it was rather directly implied in Thomas Jefferson's *Notes on Virginia* written in 1781. It seemed to Jefferson that science should be able to give more definite answers to questions that even then were being debated from widely different standpoints:

To our reproach it must be said, that though for a century and a half we have had under our eyes the races of black and of red men, they have never yet been viewed by us as subjects of natural history. I advance it therefore as a suspicion only, that the blacks, whether originally a distinct race, or made distinct by time and circumstances, are inferior to the whites in the endowments both of body and mind. It is not against experience to suppose, that different species of the same genus, or varieties of the same species, may possess different qualifications. Will not a lover of natural history then, one who views the gradations in all the races of animals with the eye of philosophy, excuse an effort to keep those in the department of man as distinct as nature has formed them. This unfortunate difference of colour, and perhaps of faculty, is a powerful obstacle to the emancipation of these people. Many of their advocates, while they wish to vindicate the liberty of human nature are anxious also to preserve its dignity and beauty. Some of these, embarrassed by the question "What further is to be done with them?" join themselves in opposition with those who are actuated by sordid avarice only. Among the Romans emancipation required but one effort. The slave, when made free, might mix with, without staining the blood of his master. But with us a second is necessary, unknown to history. When freed, he is to be removed beyond the reach of mixture.

Although Jefferson in another place refers to the slave population as "this blot in our country," the system of slavery was in mind, not the racial color. The context relates to a law passed by the Legislature of Virginia to prohibit further importation of slaves. "This will in some measure stop the increase of this great political and moral

evil, while the minds of our citizens may be ripening for a complete emancipation of our human nature." Few writers, if any, with equal interest and opportunity of critical observation, have placed on record higher estimates of Negro ability and character. The charge of pilfering is explained and excused, while essential moral qualities are recognized:

Whether further observation will or will not verify the conjecture, that nature has been less bountiful to them in the endowments of the head, I believe that in those of the heart she will be found to have done them justice. That disposition to theft with which they have been branded, must be ascribed to their situation, and not to any depravity of the moral sense. The man, in whose favor no laws of property exist, probably feels himself less bound to respect those made in favor of others. . . . Notwithstanding these considerations which must weaken their respect for the laws of property, we find among them numerous instances of the most rigid integrity, and as many as among their better instructed masters, of benevolence, gratitude, and unshaken fidelity. The opinion, that they are inferior in the faculties of reason and imagination, must be hazarded with great diffidence. To justify a general conclusion, requires many observations, even where the subject may be submitted to the anatomical knife, to optical glasses, to analysis by fire, or by solvents.

Moral qualities are found among Negroes, and mental abilities as well, beyond any development that could be expected from the usual exercise of such qualities in the native life of Africa, limited as it is by the universal village system. The Negroes had had no experience with our institutions of property. The ability of the race is much greater than its native attainments would indicate. Regarding the moral abilities being better developed than the mental abilities, the opposite opinion was strongly stated to me by Gen. S. C. Armstrong, from his extensive experience at Hampton Institute. Such questions obviously would be affected by opportunities of exercising and mani-

festing the various abilities.

Jefferson saw that statistical study, as we now say, would be required as the basis of general conclusions on the nature and extent of the racial differences, rather than rare examples of special talent, although he was interested in these. He considered Benjamin Banneker, the "Negro Astronomer," as an authentic example of Negro ability, "the son of a black man born in Africa and a black woman born in the United States, who is a very respectable mathematician." This was in 1791, in a letter to Condorcet transmitting an almanac that Banneker had prepared while employed at the instance of Jefferson "in laying out the new Federal City on the Potomac." But in writing to Joel Barlow in 1809 Jefferson reflects that Banneker doubt-

less was prompted by Ellicot "who was his neighbor and friend, and never missed an opportunity of puffing him. I have a long letter from Banneker which shows him to have had a mind of very common stature indeed." Many other Jefferson letters touched on different phases of the racial problem and showed the same scientific avoidance of general conclusions, unless supported by facts of common knowledge. Thus Jefferson refers to racial crossing, but not in the manner of those who look to an ultimate fusion as a solution of the racial problem. "The improvement of the blacks in body and mind, in the first instance of their mixture with the whites, has been observed by everyone, and proves that their inferiority is not the effect merely of their conditions of life."

GENOLYTIC HYBRIDS

The slower progress of ethnology on the side of genetics is shown in racial crossing still being debated on traditional lines, with no account taken of a fact now widely known among biologists, that later generations of hybrid plants and animals often differ profoundly from the first generation. Even where the first generation of a hybrid stock is uniform, and regularly exceeds the parental types in vigor and productiveness, the later generations may show a wide range of diversity, including many sterile or otherwise abnormal individuals, some resembling the first generation, but few equal to the original parents. Diversity and deterioration continue in successive generations, even where selection for desirable characters is applied.

This phenomenon of deterioration in later generations of hybrid stocks has received less attention than would be expected, possibly because no distinctive name has been suggested. The term *genolytic* would be appropriate for this class of hybrids, uniform and fertile in the first generation, but diverse and degenerate in the later generations, as if the mechanism of heredity had become loose-jointed and only partially effective. The diversity is not limited to the range between the parental differences, but

often is extraparental, a fact recognized in 1909 in Bureau of Plant Industry Bulletin 147, *Suppressed and intensified characters in cotton hybrids*. Genolytic bovine hybrids were described in the *American Naturalist* for April, 1913, "Mendelism and Interspecific Hybrids." Genolytic cotton hybrids were illustrated in the *Journal of Heredity* for February, 1915, "Two Classes of Hybrids." Mendelian alternative inheritance of various contrasting characters is shown, of course, in all such hybrids and has received attention, but the genolytic diversity is a fact of even greater significance in racial crossing and is in need of separate study.

Under the former theory of blended inheritance it was supposed that the racial mixtures eventually would reach a stage of intermediate uniformity in all their characters, but now it is known that the racial crosses yield patchwork populations through many generations. The extent of racial crossing in the United States often is greatly overestimated on account of a popular belief that the only unmixed people are very black, with the skin as dark as the hair. In reality most of the natives of the interior of Liberia and the neighboring regions are brown rather than black, and often rather

light. Only rare individuals among the Liberian natives are black like the Congo people, a few of whom were settled in Liberia, from captured slave-ships.

AUBLET AND JEFFERSON

Aublet's assay of the racial temperament of the Negroes as quiet, kindly people evidenced a deeper insight than was attained by many others who sought to interpret the Negro character. Even to Thomas Jefferson it seemed reasonable to ascribe the atrocities of the revolution in Haiti to racial animosity, without considering what the mobs had done in Paris, or the suicidal perfidies of Bonaparte and Le Clerc, or Rochambeau's despairing resort to *Schrecklichkeit*. The peaceful history of Liberia should figure in the racial reckoning, as well as the sanguinary history of Haiti.

The effect of slavery on the white people was the critical fact with Aublet, without irrelevant debate on the loss or gain to the Negroes. Jefferson saw the social lesions of slavery as clearly as Aublet, and his statement is more specific:

There must doubtless be an unhappy influence on the manners of our people produced by the existence of slavery among us. The whole commerce between master and slave is a perpetual exercise of the most boisterous passions, the most unremitting despotism on the one part, and degrading submissions on the other. Our children see this, and learn to imitate it; for man is an imitative animal. This quality is the germ of all education in him. From his cradle to his grave he is learning to do what he sees others do. If a parent could find no motive either in his philanthropy or his self love, for restraining the intemperance of passion towards his slave, it should always be a sufficient one that his child is present. But generally it is not sufficient. The parent storms, the child looks on, catches the lineaments of wrath, puts on the same airs in the circle of smaller slaves, gives a loose to the worst of passions, and thus nursed, educated, and daily exercised in tyranny, cannot but be stamped by it with odious peculiarities. The man must be a prodigy who can retain his manners and morals undepraved by such circumstances. . . . With the morals of the people,

their industry also is destroyed. For in a warm climate, no man will labour for himself who can make another labour for him. This is so true, that of the proprietors of slaves a very small proportion indeed are ever seen to labour. And can the liberties of a nation be thought secure when we have removed their only firm basis, a conviction in the minds of the people that these liberties are of the gift of God?

Thus with Jefferson as with Aublet, the question did not turn primarily on the Negroes being inferior, or being badly treated, but on slavery as a social institution. Jefferson saw that the manners and minds of his people were affected unconsciously by the keeping of slaves, even as John Woolman had observed. The North did not know the Negroes, and the South was not aware of being affected by the Negroes. Both sections may learn eventually what their forefathers overlooked. Charles Francis Adams, second of that name, a grandson of John Quincy Adams, speaking at the University of South Carolina in 1913, formally recanted the belief of New England abolitionists in political equality and race absorption: "In this all-important respect I do not hesitate to say we theorists and abstractionists of the North, throughout that long anti-slavery discussion which ended with the 1861 clash of arms, were thoroughly wrong."

Slavery as a social institution could not be defended, but emphasis on the wrongs and hardships of the Negroes carried the issue to debatable ground. "The basis of abolition is the wrongs of the Negro through slavery." Advantages for the Negroes could be urged with all who admitted a missionary responsibility for bringing "savages" out of heathenism. Jefferson, because he had deeper convictions of democracy than any other statesman, could feel a more radical aversion, and sought by every means to remove such an obstacle to the development of free institutions in the United States.

AN INHIBITORY SOCIAL SYSTEM

Smeathman's account of the native people near Sierra Leone is in line with Jefferson's call for biological study of the racial characters. Features of native polity that bore upon the question of establishing civilized communities were noted by Smeathman, and he was led to believe that no serious interference need be expected, as proved by later experience. Settlements were made among many native tribes in Sierra Leone and Liberia, not in all cases without friction, but on the whole with little difficulty, showing that this aspect of the native character had been correctly judged. It was observed that the native polity was based on slavery, and that it tended in several ways to limit development. "Hence it is evident that their government is neither calculated to promote the happiness, nor the increase of the community."

Jefferson noted as a limiting factor of social organization among the Indians "their having never submitted themselves to any laws, any coercive power, any shadow of government," a state of mind with which he sympathized. "It will be said, that great societies cannot exist without government. The savages therefore break them into small ones."

Smeathman was aware that the attainments of the African race were not a just measure of its ability and looked forward to a study of the factors that determined the exercise and development of ability, beyond merely physical conditions. "Whatever may be said of effects of local situations and the extremes of heat and cold, it probably will be found hereafter that all men, in their dispositions and conduct of life, are formed more by artificial than by natural causes—in short, by custom and habit." The power of custom and habit is firmly embedded in the native African system of living in compact villages, which plainly tends to restrict the mental development of the children, on account of the slight contacts with the parents. The waking hours of childhood are spent mostly with other children, running about in little squads, only casually associated with parents or elders.

The alternative system of social organization, the children fully associated with their parents, living in separate families scattered upon the land, is exemplified among primitive people in tropical America, as already stated. Terms were suggested in the paper published in 1912 to carry the distinction between the two social systems, *sympedic* for the African system with the children herding together and *choripedic* for the American system with the children remaining apart. The children are socialized prematurely under the African system, while in America they develop as members of family groups. The village system has the social effect of restricting cultural progress, so that the racial carry-over and accumulation of experience does not extend to the stage of civilization.

Neither the arts of civilized life nor the outlook on life that we call consciousness are attained under the African village system, only a state of perennial childhood. George Santayana, Plato of our present day, says that "society itself is an accident to the spirit," but this is because we have not perceived the genetic relation of the parental contacts. The conscious mind is a social attainment, a structure formed by gradual accretion of experience through the overlapping generations, like a coral reef building up to the ocean level, not a sudden magical growth like Jack's beanstalk reaching the sky. Limiting the individual development limits the racial development. The social system of the native Africans is essentially self-limiting. Smeathman observed that the natives have "a very singular jurisprudence . . . which renders improvement unacceptable to the public, and ingenuity dangerous to the possessor." Contacts with civilization have largely removed these limitations, as one appreciates in knowing personally a capable, cultured, considerate, thoughtful man, like Arthur Barclay, afterward President of Liberia. The prompt return of civilized Negroes to barbarism, predicted by many writers, has not occurred, either in Liberia or in Haiti.

JEFFERSON AND FAIRFAX

The paper by Fairfax may be considered as a sequel of Thomas Jefferson's *Notes on Virginia*, reported to have been written in 1781 but not issued in America till 1787. Objections to slavery were strongly stated and several vivid passages might seem to be "addressed rather to the feelings than to the cool and deliberate judgment" which Fairfax sought. Jefferson was not unconscious of writing with heat against slavery. "It is impossible to be temperate and to pursue this subject through the various considerations of policy, of morals, of history—natural and civil. We must be contented to hope they will force their way into every one's mind." Yet Jefferson wished to avoid needless offense and may have delayed publication on this account. A small edition of the "Notes" was privately printed in France in 1784 or 1785, but Jefferson refused to have his "strictures on slavery" issued separately, "at least till I know whether their publication would do most harm or good."

Jefferson recognized the need of the races being separated and outlined a policy of gradual emancipation, education, and colonization of the Negroes, but leaving the location indefinite, except that "transportation to Africa" was suggested for "slaves guilty of offences." It remained for Fairfax to combine Jefferson's policy with Smeathman's plan, and to perceive the underlying interest to the Negroes of coming again into contact with their own people, and of being thus enabled to appreciate and extend the civilization which they had acquired during their sojourn in America. To believe what American Negroes often are told, that they have been deprived of a valuable racial culture, is a mistake that is hardly to be

corrected except by direct knowledge of native life in Africa.

A limited circulation of the Fairfax paper may be inferred from the absence of any reference in *The Virginian history of African colonization*, by Rev. P. Slaughter, published at Richmond in 1855, a work that stresses the value of colonization as a missionary enterprise, and even the value of slavery as a training in civilization. "Africa gave to Virginia a *savage* and a *slave*, Virginia gives back to Africa a *citizen* and a *Christian*." The entire credit of the colonization project is claimed by Slaughter for Virginia. "If any scheme of policy is thoroughly Virginian, it is the scheme of African colonization." This claim would have had additional support from the interest of Fairfax as a member of the family distinguished for its association with George Washington.

The title of the paper by Fairfax, "Plan for Liberating the Negroes within the United States," is somewhat misleading, since the return of the Negroes to Africa is an essential feature. In reality it was a plan for abolishing slavery in the United States through the resettlement of the Negroes in Africa. A scientific character may be claimed for a consistent effort like that of Fairfax to understand a complex and difficult problem. The paper is short, of nearly the same wordage as the Declaration of Independence, and gives an impression of the policy of African colonization as fairly "thought through." Words may be said to "crystallize thought" if they bring the essential facts vividly before us. "The great quality of the mind is finality," by which it was possible for the Declaration of Independence to create a new allegiance.

COLONIZATION AND THE CIVIL WAR

The plan of education, colonization, and gradual emancipation, as outlined by Jefferson in the *Notes on Virginia*, would not have led the nation to the disaster of the Civil War. The judgment of history is challenged when a policy devised by a statesman like Jefferson is disregarded. No other

subject appears to have had more of his attention than the racial problem. What other statesman was more scientific, or constructive, or devoted to human welfare? "The effectiveness of a social objective lies in the methods employed to achieve it and not in its noble intentions."

Jefferson's plan of colonization included the suggestion "to send vessels at the same time to other parts of the world for an equal number of white inhabitants." The alternative course was considered: "It will probably be asked, 'why not retain and incorporate the blacks into the state, and thus save the expense of supplying by importation of white settlers the vacancies they will leave?' " To Jefferson it appeared that this course was not practicable. He was convinced that the two races should not be mongrelized, that they would not be reconciled to each other, and that they eventually would need to be separated, which colonization would bring about.

But Americans of that period would not let the Negroes go back to Africa. Abolitionists condemned colonization as in league with slavery, sectional feeling became more inflamed, and the youth of the Nation was sacrificed. Millions of new immigrants were brought from Europe to replace that "lost generation," the wives they would have married, and the families of pioneer children they would have raised. Instead of replacing the Negroes as Jefferson had proposed, we destroyed one an-

other. No question in America today is more in need of critical attention than our racial relations, not for emergency reasons, but because the racial questions occasion a general confusion of thought in our national problems. The only escape is by way of better understanding and of finding constructive courses.

The sacrifice to sectional feeling in the Civil War confers no permanent immunity from social disorders. Tensions now are being generated by the system of tenant farming, which is one of the sequels of slavery and emancipation, a form of "near-slavery" that incidentally replaced direct ownership. Slavery as a legal institution has been discarded, but commercial and industrial exploitations of backward or dependant people are reckoned as legitimate. Our "advanced" nations are destroying each other in a struggle for control of primitive peoples as producers of raw materials and customers for manufactured goods, in order to support our competing industrial systems. Eventually it may be seen that all the forms of social parasitism are self-limiting and dysgenic, as slavery proved to be.

THE BIRACIAL PROSPECT

A large population of free Negroes "forming a separate interest from the rest of the community" was foreseen by Fairfax as a social and political danger. The separation of the races was considered necessary by Jefferson and all the "founding fathers," including Abraham Lincoln, for two essential reasons, one biological, to avoid mongrelizing, the other social, to avoid the condition of "separate interest" that gradually has developed and is now being recognized in textbooks of sociology in describing the United States as "a biracial nation." Biracial is a recent word, dating from 1922 in the Supplement of the Oxford Dictionary, "Belgium is bilingual and biracial."

Efforts to avoid biracialism may be traced far back. Economic dependency among the free Negroes attracted attention even in the eighteenth century. Statistics were collected showing more frequent crimes

and diseases than among the slaves, and on these grounds several States passed laws regulating the emancipation of slaves, or excluding free Negroes. "It has ever been the policy of Virginia to allow the master to free the slave. But since 1806 her laws have required all slaves thereafter manumitted, to leave the Commonwealth." Pennsylvania had a law requiring a bond to be executed, to protect the community from freedmen becoming public charges.

Competition of free Negroes with white labor also was opposed by various expedients, sharply protested by abolitionists, as William Jay in 1835. "The laws of Ohio against the free blacks are peculiarly detestable, because not originating from the fears and prejudices of slave-holders. Not only are the blacks excluded in that State from the benefit of public schools, but with a refinement of cruelty unparalleled they

are doomed to idleness and poverty, by a law which renders a white man who employs a colored one to labor for him for one hour liable for his support through life. By a late law of Maryland, a free Negro coming into the State, is liable to a fine of fifty dollars for every week he remains in it. If he cannot pay the fine, he is sold." Colonization often was urged as a means of avoiding these economic obstacles to the emancipation of the slaves.

The conclusion reached in South Africa, from intensive study and experience with

the racial problems, is that neither race is advantaged by its contacts with the other race. The exploitive relations tend to deterioration, since both races are deprived and inhibited. Limiting the range of activity for one race also establishes a limitation for the other race. Social parasitism is a condition of adverse selection, and is essentially antiracial. Measures of gradual separation are being attempted under the policy of "trusteeship" or "indirect rule," reviewed in the *Journal of Heredity*, May 1930, "Race Segregation in South Africa."

THE WHITE MAN'S GRAVE

Some of the underlying difficulties, not recognized when colonization was projected, may be appreciated by taking account of facts determined since the work began. Sierra Leone very early became known as "The White Man's Grave," and other regions of the West Coast shared the same evil fame. The climate of West Africa was considered "deadly" to the European race, until it was found, near the end of the last century, that malaria and yellow fever were carried by mosquitoes.

Few white people have been able to live and work in Liberia or other parts of West Africa long enough to be practically useful. Most of them did not survive the preliminary period of becoming accustomed to the tropical life and gaining the experience that is necessary to deal with the local conditions. The effective field work was done largely by Negroes, Paul Cuffy, John Kizzel, Lot Carey and Elijah Johnson, father of President Hilary Johnson. The assistance that was needed from white men, as foreseen by Smeathman and Fairfax, could be furnished to only a slight extent. The same mortality was encountered in missionary undertakings. "Let thousands fall, but Africa be redeemed."

A medical discovery that may have great importance is reported recently from South America, a simple and effective method of immunizing against yellow fever. This disease, although not definitely recognized in Africa until the present century, probably has been the most serious hazard of life and

progress. The malaria of West Africa is a severe "pernicious" type, with symptoms so closely parallel to those of yellow fever that the two diseases were not distinguished. The Negro colonists from America suffered severely, and many died.

Members of the European race often lived only a few days or a few weeks after landing in Africa, although a few survived for many years and remained vigorous. Frequent replacements were the rule in colonial governments and commercial agencies along the West Coast. In the face of such hazards, merely living from day to day could be felt as an achievement, lending a "charm" to life in Africa, which some preferred, declaring England or Germany "too dull."

Liberia is a pleasant land, and its climate is better than in many tropical countries, the daily maximum often not exceeding 90° F., and seldom above 93°, moderated in the dry season by the "harmattan" winds from the north. Mosquitoes generally are scarce in Liberia, screening precautions are not difficult, and in many districts simple measures of drainage or grading may give complete protection. The natives had partial protection by clearing all vegetation from the sites of their villages and keeping fires all night in the houses. Explorers seem to have better health than missionaries or merchants, perhaps from being more vigorous men and taking more exercise, which doubtless facilitates dermal excretion.

AFRICA A DENUDED CONTINENT

The notion of tropical Africa as in a "virgin state" of unexploited agricultural resources is entirely fallacious. Primitive agriculture has been practiced for long periods and has altered profoundly the natural condition of the plant world. Most of the forests are secondary growths, on land that has been denuded and abandoned after long periods of repeated clearing and burning. The same is true of other tropical regions, in America and in Malaysia. Doubtless Africa had in the prehuman period a complete forest cover, even of great areas that now are deserts, grasslands or "open bush." The former presence of woody vegetation would account for the Sahara and the Arabian Desert not being provided with a true desert flora of plants adapted to open conditions, such as the cacti, *Agave*, *Euphorbia*, *Mesembryanthemum*, or *Stapelia*, that have developed in the American deserts and in South Africa. The mountains of tropical Africa have highly specialized plants on the slopes above the forests. Forest vegetation forming a canopy of shade adjacent to naked desert is shown in a recent work by L. M. Nesbitt, *Hell-hole of creation*, 1931, describing the Abyssinian Danakil, a region of extreme conditions with many districts not inhabited.

The original tropical forests, when such areas are found, have specialized plants that are tolerant of shade, but this undergrowth flora is entirely exterminated when the forest is destroyed and is only slowly replaced in secondary growth. The tropical forests also have specialized faunas of millipeds, insects, and other small animals that live on the surface or in the humus layer of the forest soil, but not in forests of recent growth. With repeated clearing and burning the humus layer is removed and the sterile subsoil exposed. Trees give place to stunted bushes, and eventually the stage of open

fire-swept grass lands is reached, which sets a limit to the primitive system of agriculture, as explained in the Smithsonian Report for 1919, "Milpa Agriculture, a Primitive Tropical System."

Among pastoral peoples grasslands are utilized and denudation may be carried to the stage of complete desert. Goats and camels may destroy not only the grass but also the woody vegetation. Recent studies show that the desert of Sahara is advancing rather rapidly to the southward, in the French and British colonies. An active denudation of a densely inhabited district was witnessed 70 years ago in the interior of Liberia. Benjamin Anderson, a Liberian explorer, reached the Mandingo country in 1869, and wrote a report, *A journey to Musardu, the capital of the Western Mandingoes*, which was published by his backers in New York, Henry M. Schieffelin and Caleb Swan.

Referring to a locality called Vuccah or Yukkah, Anderson says: "At Mahommadu, the south-east slope strikes the plain at a great angle; but at Vukkah, it rests upon a series of small table-lands that extend out a half-mile before they finally come down into the plains. The vast spaces of grass and reddish soil are relieved by patches of dense vegetation, marking the gullies and ravines. Heavy blocks of granite are set in the sides of the Vukkah hills, awaiting only to be loosened by the rains to roll from their places to the bottom. At night, the whole country seems on fire, from the burning of the grass." Anderson in 1868 found at Boporu a large native town estimated at 3,000 people, and several adjacent towns, or a total estimate of 10,000 for the district. Thirty years later the site of Boporu, visited by the writer in April 1892, was a grassy expanse entirely uninhabited.

PERMANENT AGRICULTURE WITH TREE CROPS

The alternative of continued erosion and denudation in tropical countries is a general change from annual short-season crops to

permanent tree crops. A vast range of food products is obtainable from trees, and eventually it may be considered that tillage

agriculture, required for the annual field crops, is out of place in the tropics. A few of the tree crops, those that furnish commercial products, are widely known, while others have only local use and many potentially valuable species are still to be domesticated, as the several different trees that produce rubber.

A permanent soil cover is made possible where tree crops are grown, with no occasion for plowing, weeding, or cultivating. Sloping lands are promptly injured by exposure of the soil surface, especially in regions of heavy rainfall. The native African agriculture moves every year to a new clearing, often at a distance from the previous "farm." Only field or garden crops are planted, rice, sesame, and others, most of them ripening in a few weeks. Cassava and bananas continue bearing for several months, and remnants may be gleaned for two or three seasons, until the plants are completely smothered by "the bush."

In various parts of Africa the natives made extensive use of edible fruits of forest trees, or of oil extracted from the seeds, but

no tree crops were domesticated, since this is feasible only among people settled permanently on the same land. The natives of America allowed many useful trees, as sapotes, sapodillas, avocados, bread-nuts, anonas, and chirimoyas, to grow around their settlements, but only cacao in Guatemala and coca in the valleys of the eastern Andes appear to have reached the stage of commercial cultivation. Date palms, olives, and figs were the traditional tree crops of the Mediterranean region.

Under the African system of agriculture relatively small populations can be supported. If people become numerous larger forest clearings must be made, the forest area is more rapidly exhausted, and crops become more precarious. Villages may move to other districts, or the people may scatter and starve in a season of famine. The problem of colonization in Africa is not to replace the native tribes, but to replace the destructive methods of primitive agriculture and create conditions of permanent production from tree crops.

TROPICAL PLANT INTRODUCTION

Developing permanent systems of tree-crop agriculture is a vast undertaking in the field of plant introduction and experimental study. Hundreds of different kinds of trees furnish food and other useful products in tropical countries. Many years will be required for each series of experiments with tree crops and many decades or even centuries may elapse before such a project can be far advanced, although even slight progress may be valuable.

In each country the native tree crops, if any, should be utilized as far as possible and studied carefully as standards for comparing with introduced trees, in cultural behavior or in economic utility. The wealth of potential tree crops may be judged by noting the range of possibilities in the single group of palms. Starch is obtainable from *Metroxylon* and *Caryota*; sugar from *Arenga*, *Caryota*, *Borassus*, *Phoenix*, *Jubaea*, and many others; edible oils from numerous kinds, as *Cocos*, *Elaeis*, *Attalea*, and *Oeno-*

carpus; edible fruits from *Phoenix*, *Guiljelma*, *Butia*, *Hyphaene*, and *Mauritia*; fibers from *Raphia*, *Attalea*, *Astrocaryum*, and *Mauritia*; and vegetable ivory from *Phytelephas*, *Palandra*, *Coelococcus*, and *Hyphaene*. Although no other order of plants may promise such utility as the palms, tree crops probably can be found to replace many of the tillage crops, if not all.

Smeathman's proposed introduction of cacao may seem prophetic, since cacao is the first of the commercial tree crops to be adopted by native Africans and carried to large-scale production, competing with America and Asia. The future of Liberia, as of other "undeveloped" tropical countries, to a great extent will be determined by the introduction of tree crops from other regions. Tropical trees are localized to a remarkable extent, both the wild and the cultivated kinds, except the few commercial species that have been widely distributed.

The slave trade provided early communi-

cation between Brazil and West Africa, and many plant introductions took place in that period. America was rich in food plants, while Africa was poor. With the single exception of the sorghums, all the important food crops of Africa are supposed to have been introduced—rice, taro, and bananas, from Asia; cassava, maize, tobacco, pineapple, peanuts, and many others, from America. Even the so-called "African oil palm," *Elaeis guineensis*, probably was introduced from Brazil to the Portuguese settlements on the coast of Africa.

The most serious difficulties of colonization may not lie in introducing or developing new products, but in readjustments of customs and habits, notably those relating to food, which have a special, instinctive inertia. The introduction of a potentially valuable new crop may be entirely ineffective if people will not use it. The difficulty of inducing the French people to use the potato, and their refusal during the World War to eat any of our Indian corn, are familiar examples. The bread-fruit tree and the "African" oil-palm were introduced to the West Indies in the eighteenth century for feeding the slaves, but they were not

adopted. Some of the colonists in Liberia preferred to starve rather than eat cassava. People usually can be inducted to taste an unfamiliar food, and readily give an adverse opinion. Only a few are tolerant to the extent of making a practical test. Diversified agriculture and varied diet are the modern ideals recently enforced from the knowledge of vitamins.

In view of the many needs of special knowledge and training, capable American Negroes may go to Africa, not as outcasts or refugees, but as participants in a vast progressive undertaking, nothing less than a reconstruction of the African Continent. The widest expanses of livable land in the entire world are in Africa, now largely denuded and lying waste but capable of being reclaimed and utilized in permanent production. Liberia may be made what it originally was intended to be, a center of progress in the arts of civilized life. All the special talent that can be developed among the Negroes of America, in agriculture, biology, chemistry, conservation, sanitation, medicine, dietetics, or other sciences, may be used constructively.

BIOPHYSICS.—*Effect of temperature and time on the x-ray sensitivity of maize seeds.*¹ LOUIS R. MAXWELL, J. H. KEMPTON, and VERNON M. MOSLEY, U. S. Bureau of Plant Industry.

Temperatures of dry maize seeds² during the time of x-irradiation determine, to a certain extent, the size and number of surviving seedlings. Maximum x-ray sensitivity occurs for temperatures within the range 0°C. to about 25°C.; values extending either above or below this range produce a greater resistance to x-rays; this includes cooling by

the use of liquid air and heating to 66°C. The present investigation is concerned with simultaneity between temperature and x-irradiation, determined by heating or cooling before, during, or after irradiation. Time also may be a factor influencing recovery.

EXPERIMENTAL PROCEDURE AND RESULTS

Descriptions of the x-ray apparatus, dosage chamber, procedures for cooling, heating, and growing the seeds are covered by earlier papers.² Exposure times used for irradiation, heat treatments, and cold treatments were from 4½ to 5½ hours. The seeds were always placed on the same metal surface during exposure to the x-rays to insure a constant amount of back-scattering. The seed stock was taken from a large, carefully mixed lot of Funk Yellow Dent that had been stored at 2–4°C. A constant dosage of 35 kr³ at 45 kv was used throughout in order to produce a high percentage of delayed deaths⁴ at room temperature. Seedling heights were recorded every 48 hours following germination, and any plants that failed to increase in height between the second and third measurement were considered dead. Height measurements were frequently continued to insure correctness of the number of dead and living plants. Mean heights reported are averages of height measurements of both living and dead plants taken on a given date, usually the third measurement. Not unexpectedly, however, it has been found that the number of survivors depends upon the growing conditions in the greenhouse. In some cases a dosage of 35 kr will result in the delayed

death of all plants, a condition frequently found with winter plantings, while occasionally during the summer months most of the plants survive. This behavior constitutes a variable factor that must be superimposed on the following results as a systematic error. It has been reduced, however, by limiting the planting dates to the period extending from October to May.

X-ray sensitivity in relation to temperature changes before, during, and after x-ray treatment.—Effects of cooling with liquid air are shown in Table 1, which includes results obtained in two separate experiments. The first, conducted in April, 1940, resulted in no survivors; however, the height of the dead plants from seeds held at a temperature of –187°C. during the time of irradiation was slightly greater than that of any of the other plants. Since no survivors were obtained in this instance, the experiment was repeated in May, 1940. Height measurements show a definite resistance to x-rays for the seeds held at –187°C. during irradiation. In addition, the number of survivors for this treatment is significantly greater than the number found for any of the other treatments. It is also evident that cold treatment following irradiation at room temperature has a detrimental effect both on the mean height and number of survivors.

Similar results were obtained by cooling with a mixture of CO₂ snow and alcohol, which gave a seed temperature of –66°C. Table 2 summarizes the results, which show that –66°C. during irradiation produces an

¹ Received August 28, 1941.

² MAXWELL, LOUIS R., and J. H. KEMPTON. Journ. Washington Acad. Sci. 29: 368. 1939.

KEMPTON, J. H., and LOUIS R. MAXWELL. Journ. Agr. Res. 62: 603. 1941.

³ kr is the abbreviation for a unit of dosage, the kilo-roentgen, equal to 1000 "r."

⁴ COLLINS, G. N., and LOUIS R. MAXWELL. Science 83: 375. 1936.

increased resistance to the effects of x-rays, as indicated both by the height of plant and the number of survivors. In addition, it is seen that this same degree of cooling after x-ray treatment also increased the sensitivity to x-rays. There is an increase of 3.62 mm in mean height of seedlings from seeds cooled before irradiation as compared to those seeds kept at room temperature, which is greater than the amount required for statistical significance. The difference in survival number, however, is not significant.

Increasing the temperature to 50°C. provided another region of investigation. Table 3 shows the results of an experiment conducted in March, 1940, in which there were no survivors, but a significant increase in plant height for heating during irradiation as compared with the other treatments; the latter were not statistically different. In a repetition of this experiment in December, 1940, a large number of plants lived when the seeds were held at 50°C. during irradiation. Mean plant height of "during" is definitely greater than in any of the other treatments, in agreement with the experiment of March, 1940. Furthermore, it is clear that seeds heated to 50°C. before x-raying produced significantly smaller seedlings than any of the other treatments. Differences in seedling height between "after" and the "irradiated controls" are not significant. The proportion of plants surviving was essentially alike in the "before," "after," and "irradiated control" groups.

Recovery with time.—As a means of determining whether there is a recovery from x-ray injury with the time elapsing from irradiation to planting, four lots of seeds were x-rayed at different times and planted together. Heat treatments of 50°C. were given before, during, and after x-raying, and in addition there were corresponding x-rayed control samples at each irradiation period kept at room temperature throughout.

These treatments were given in the four periods: September 16 to 19; September 30 to October 3; October 22 to 25; and November 18–22. In each period 200 seeds were

x-rayed for each heat treatment, giving 800 x-rayed seeds for each of the four periods. Upon completion of the laboratory treatments the samples were stored at room temperature until the planting date. As the planting arrangement could accommodate only half the total number of seeds at one time, two separate plantings were made, the

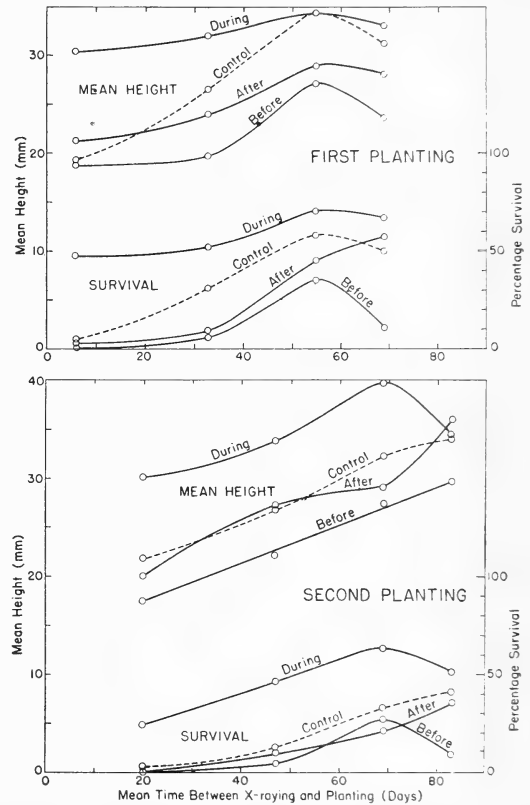

Fig. 1.—Curves showing mean heights and percentage survival of maize seedlings from two plantings of x-rayed seed (35 kr) receiving various heat treatments (50°C.) and held at room temperature for different periods before planting. The controls were irradiated and held at room temperature throughout. Differences in mean height in excess of 2.20 mm have probabilities less than 0.01.

first on November 26 and the second on December 10, immediately following the harvest of the first planting. The numerous lots were randomized, with all treatments appearing twice in each planting flat and with twelve flats in each planting period.

The two plantings provided eight different mean elapsed times between x-raying and planting, extending from 6 to 83 days.

Only 100 seeds could be irradiated at a time, so that it required 4 days to complete one set of exposures, with 200 seeds used for each heat treatment. However, the variance introduced through this duplication proved to be no greater than was to be expected on the basis of chance, leading to the conclusion that the unavoidable time interval of 4 days within each x-ray period does not produce differences in seedlings behavior large enough to be detected by the methods here used.

Table 4 gives the mean heights for the several treatments for the two plantings and Fig. 1 illustrates the results graphically. It is evident that the two growing periods, although separated in time by only two weeks, produced seedlings differing in size. Gross features of the environment were not noticeably different in the two periods. The planting technique controlled the available moisture, and the greenhouse temperatures were approximately controlled by thermostats, but the amount of sunlight was a free variable. Thermograph charts for the two periods are not dissimilar; however, very small differences in temperature may produce measurable results. At least the analysis of variance showed that the two clinostats on which the flats were rotated differed significantly, which may be interpreted as a temperature effect as the benches on which they were mounted side by side also supported the steam radiators.

Although the two growing periods resulted in seedlings significantly different in size, they did not result in differential responses to the seed treatments. The single interactions of planting dates with the two treatment variables (1) elapsed time between x-raying and planting and (2) high temperature before, during, or after irradiation were not significantly greater than the error term.

Analysis of variance showed, furthermore, that both treatment variables produced significant differences in seedling size. Seeds treated at 50°C. during irradiation produced the tallest plants for waiting periods up to and including 55 days in the first planting and through the 69 day period in the second planting. For longer periods the

mean heights of "during" and "room temperature" were not significantly different in either planting, and this is true also for "after" in the second planting. Mean height of plants from seeds heated before irradiation was consistently lower than for any of the other treatments, although not always significantly so.

There was a significant interaction of x-ray dates with the time at which the temperature was applied to the seeds. This resulted from a differential recovery among the heat treatments with waiting period. For the seeds planted 20 days after x-raying, the several heat treatments gave rather wide differences in mean height, which became practically the same after 83 days elapsed before planting. The size of the seedlings from seeds heated during x-raying was rather constant for all waiting periods while the other heat treatments gave mean heights increasing with time. Seedling size for any given category depends upon the three elements, planting date, elapsed time, and temperature treatment, as the triple interaction of these variables was found to be significant.

Table 5 gives the distribution of number of living and dead plants obtained as a function of elapsed time between x-raying and planting, while in Fig. 1 the corresponding percentage survivals are shown graphically. The χ^2 test for the four temperature treatments, irrespective of time lapse from the date of x-raying, showed for both plantings that the difference between number of dead and living plants in the four groupings was not one of chance. For the first planting $\chi^2=185.73$; for the second, 156.87, both of which are clearly too great with seven degrees of freedom to be considered chance departures. In both plantings the large contribution to χ^2 was made by the group treated during irradiation because in each case the proportion of alive to dead seedlings was relatively high in this treatment in agreement with the measurements of height. A continuous increase in survival is noted up to the fifty-fifth day for the first planting and the sixty-ninth day for the second planting, also in agreement with results observed for seedling height. The

second planting with its taller seedlings gave a significantly higher death rate of 76.0 ± 1.10 per cent than the value of 65.7 ± 1.2 per cent, which was observed for the first planting.

Thus it is evident from both the measurements of size and from the proportion of living to dead plants that the seedlings from the four x-raying periods were not alike. The nature of this experiment is such that the observed changes in seedling size and in survivors between successive x-rayed samples cannot be ascribed with certainty

only to the time elapsing between x-raying and planting. Undoubtedly there are other and unknown variables connected with the samples x-rayed at different times, but in the present design there is no way to separate the effects produced by elapsed time between x-raying and planting from other possible variables. Therefore, although the experiment discloses an apparent recovery from x-ray injury with time in these air dry seeds, it should be kept in mind that there may be a less esoteric explanation when the experiment has been repeated.

DISCUSSION

The observed reduction in x-ray sensitivity brought about by cold treatments during the time of irradiation may be caused by the absence of certain thermal or low energy reactions that normally take place when the seeds are irradiated at room temperature, as suggested earlier.² Svedberg and Brohult⁵ have shown that under irradiation by ultraviolet and α particles *Helix* haemocyanin will split into half molecules when held at either room temperature or liquid-air temperature. However, when haemoglobin and serum albumin were irradiated, they decomposed readily at room temperature and 0°C ., but at liquid-air temperature no forms of low molecular weight were found for haemoglobin, while serum albumin showed only slight decomposition. These proteins apparently respond quite differently to irradiation; splitting of *Helix* haemocyanin is evidently produced by initial or primary high energy reactions which are independent of temperature. Haemoglobin and serum albumin, on the other hand, will decompose only when the temperature is high enough to permit thermal reactions to occur. The observed low temperature behavior of maize seeds is not so striking as in the case reported for haemoglobin and serum albumin, although certain similarities are apparent.

Detrimental effects produced by cold treatments following irradiation can be explained as simply an additive effect of x-

rays and cold treatments, for it has been shown earlier that cold treatments alone will cause a retardation in subsequent growth of maize seedlings.⁶ However, this simple theory fails for cold treatment at -187°C . before irradiation in which case no change in x-ray sensitivity was observed.

Increased x-ray sensitivity induced by heating prior to irradiation was expected in view of former work⁷ where normal 8-percent moisture dry maize seeds oven-dried to 2-percent moisture before irradiation showed a considerable increase in susceptibility to x-rays. Moisture content of the seeds alone may be an important factor in determining the resistance to x-rays. Heat treatments following x-irradiation produced no appreciable changes in sensitivity, also confirming previous results.

Temperature effects were the greatest when the heat treatment and x-ray absorption occurred simultaneously causing a large reduction in x-ray sensitivity. No adequate explanation is offered for this phenomenon; however dry maize seeds are living systems that undoubtedly attempt to throw off or recover from the x-ray induced effects as soon as they appear. Ability to recover is evidently strengthened by increasing the temperature during irradiation.

The above discussion has been concerned with variations in response when seeds are planted soon after treatment. If the seeds

⁵ SVEDBERG, T., and S. BROHULT. *Nature* **143**: 939. 1939.

⁶ MAXWELL and KEMPTON. *Op. cit.*

⁷ KEMPTON and MAXWELL. *Op. cit.*

are held at room temperature before planting for various periods extending up to 69 or 83 days, three noticeable effects occur: (1) There exists a general but a varying amount of recovery with time for all the treatments used; (2) the marked reduction in sensitivity of seeds heated during irradiation as compared to those heated after

x-raying, or to the irradiated controls, finally disappears by the end of the 69- or 83-day period; (3) seeds heated before irradiation although showing some recovery with time are consistently the most susceptible to the radiation. The results seem to indicate also that a certain limiting amount of recovery with time is attainable.

SUMMARY

(1) Dry maize seeds held at temperatures ranging from -187°C . to 50°C . during exposure to x-rays, dosage 35 kr, showed a maximum sensitivity in the region 0 to room temperature, in confirmation of earlier work.

(2) To decrease the x-ray sensitivity of dry maize seeds by hot or cold treatments the high or low temperatures must prevail during the time of irradiation. A possible exception occurred for a cold treatment at -66°C . before irradiation where a slightly significant decrease in sensitivity was found.

(3) Cold treatments following irradiation increase the effects produced by x-rays in

an apparently additive manner.

(4) Heat treatments prior to irradiation increase the x-ray sensitivity.

(5) Time elapsed between x-raying and planting gives rise to the following results: (1) A general but varying amount of recovery with time for all the treatments used, (2) the marked reduction in sensitivity of seeds heated during irradiation compared to "after" or the "irradiated controls" finally disappears by the end of 69 or 83 days, (3) seeds heated before irradiation although showing recovery with time are consistently the most susceptible to irradiation.

TABLE 1.—EFFECT OF A SEED TEMPERATURE OF -187°C . BEFORE, DURING, AND AFTER IRRADIATION WITH X-RAYS (35 kr) ON SIZE OF SEEDLINGS AND NUMBER OF SURVIVORS COMPARED WITH IRRADIATED CONTROLS AT ROOM TEMPERATURE THROUGHOUT.

Number and mean height	Date	Cold treatment (-187°C .) relative to time of x-raying			Irradiated controls at room temperature throughout
		<i>Before</i> ¹	<i>During</i>	<i>After</i>	
Number of seedlings . . .	1940 April ⁴	173	175	176	178
Number of survivors . . .		0	0	0	0
Mean height (mm)		13.42 ²	15.31	13.42	14.39
Number of seedlings . . .	May ⁵	173	170	166	174
Number of survivors . . .		73	115	12	63
Mean height (mm)		19.86 ³	33.02	10.45	20.41

¹ 180 seeds planted for each treatment.

² Differences in mean height must exceed 1.09 mm to be significant.

³ Differences in mean height must exceed 2.94 mm to be significant.

⁴ Elapsed time between x-raying and planting was 6 to 12 days.

⁵ Elapsed time between x-raying and planting was 7 to 12 days.

TABLE 2.—EFFECT OF A SEED TEMPERATURE OF $-66^{\circ}\text{C}.$ BEFORE, DURING, AND AFTER IRRADIATION WITH X-RAYS (35 kr) ON SIZE OF SEEDLINGS AND NUMBER OF SURVIVORS COMPARED WITH IRRADIATED CONTROLS AT ROOM TEMPERATURE THROUGHOUT.

Number and mean height	Date	Cold treatment ($-66^{\circ}\text{C}.$) relative to time of x-raying			Irradiated controls at room temperature throughout
		<i>Before</i> ¹	<i>During</i>	<i>After</i>	
Number of seedlings . . .	1940 April ³	173	176	164	177
Number of survivors . . .		28	77	4	17
Mean height (mm)		25.77 ²	36.04	17.33	22.15

¹ 180 seeds planted for each treatment.
² Differences in mean height must exceed 2.88 mm to be significant.
³ Elapsed time between x-raying and planting was 3 to 6 days.

TABLE 3.—EFFECT OF A SEED TEMPERATURE OF $50^{\circ}\text{C}.$ BEFORE, DURING, AND AFTER IRRADIATION WITH X-RAYS (35 kr) ON SIZE OF SEEDLINGS AND NUMBER OF SURVIVORS COMPARED WITH IRRADIATED CONTROLS AT ROOM TEMPERATURE THROUGHOUT.

Number and mean height	Date	Heat treatment ($50^{\circ}\text{C}.$) relative to time of x-raying			Irradiated controls at room temperature throughout
		<i>Before</i> ¹	<i>During</i>	<i>After</i>	
Number of seedlings . . .	1940 March ⁵	93 ¹	95	95	93
Number of survivors . . .		0	0	0	0
Mean height (mm)		14.27 ²	21.91	14.84	14.70
Number of seedlings . . .	December ⁶	189 ³	186	189	189
Number of survivors . . .		0	67	2	7
Mean height (mm)		18.19 ⁴	30.23	20.66	20.55

¹ 96 seeds planted for each treatment.
² Differences in mean height must exceed 2.22 mm to be significant.
³ 192 seeds planted for each treatment.
⁴ Differences between means must exceed 1.62 mm to be significant.
⁵ Elapsed time between x-raying and planting was 1 to 3 days.
⁶ Elapsed time between x-raying and planting was 8 to 22 days.

TABLE 4.—MEAN HEIGHTS (MM) OF MAIZE SEEDLINGS FROM TWO PLANTINGS OF SEEDS X-RAYED AT 35 kr RECEIVING VARIOUS HEAT TREATMENTS AND HELD AT ROOM TEMPERATURE FOR DIFFERENT PERIODS BEFORE PLANTING.

First planting, November 26, 1940					Second planting, December 10, 1940				
Mean elapsed time between x-raying and planting (days)	Heat treatment ($50^{\circ}\text{C}.$) relative to time of x-raying			Irradiated controls at room temperature throughout	Mean elapsed time between x-raying and planting (days)	Heat treatment ($50^{\circ}\text{C}.$) relative to time of x-raying			Irradiated controls at room temperature throughout
	Before	During	After			Before	During	After	
6	18.83 ¹	30.39	21.33	19.25	20	17.55	30.07	20.00	21.85
33	19.86	32.15	24.04	26.65	47	22.18	33.81	27.31	26.80
55	27.02	34.38	28.86	34.42	69	27.42	39.81	29.04	32.22
69	23.75	33.16	28.06	31.28	83	29.78	34.75	36.11	34.35

¹ Differences exceeding 2.20 have probabilities less than 0.01.

TABLE 5.—NUMBER OF LIVING AND DEAD MAIZE SEEDLINGS FROM TWO PLANTINGS OF SEEDS X-RAYED (35 kr) AT VARIOUS HEAT TREATMENTS AND HELD AT ROOM TEMPERATURE FOR VARIOUS PERIODS BEFORE PLANTING.

First planting, November 26, 1940									Second planting, December 10, 1940									Total		
Mean elapsed time between x-raying and planting (days)	Heat treatment (50°C.) relative to time of x-raying						Irradiated controls at room temperature throughout		Mean elapsed time between x-raying and planting (days)	Heat treatment (50°C.) relative to time of x-raying						Irradiated controls at room temperature throughout		Total		
	Before		During		After					Before		During		After						
	Living	Dead	Living	Dead	Living	Dead				Living	Dead	Living	Dead	Living	Dead			Living	Dead	Total
	Living	Dead	Living	Dead	Living	Dead				Living	Dead	Living	Dead	Living	Dead			Living	Dead	Living
6...	0	93	44	49	2	92	4	89	20...	0	96	23	70	0	95	3	93	76	677	753
33...	6	89	50	45	9	85	30	65	47...	4	92	43	50	10	84	12	82	164	592	756
55...	33	61	66	28	43	52	55	39	69...	26	70	60	35	20	74	31	63	334	422	756
69...	11	85	63	30	54	40	46	46	83...	9	87	50	47	34	61	39	46	306	442	748

BOTANY.—*Three new varieties and two new combinations in Citrus and related genera of the orange subfamily.*¹ WALTER T. SWINGLE, U. S. Bureau of Plant Industry.

In preparing an extended treatment of the taxonomy of the aurantioid plants, entitled "The Botany of Citrus and its Wild Relatives of the Orange Subfamily (Family Rutaceae, Subfamily Aurantioideae)," which will be published shortly, I have found it necessary to describe a few new genera, new species, and new varieties as well as to make a number of new combinations. This paper, and five others previously published since April 1939,² have cleared the ground for my new classification of the entire subfamily.

¹ Received November 28, 1941.

² SWINGLE, WALTER T. *A new taxonomic arrangement of the orange subfamily Aurantioideae.* Journ. Washington Acad. Sci. 28: 530-533. Dec. 1938.

—Clymenia and Burkillanthus, new genera, also three new species of Pleiospermium (Rutaceae-Aurantioideae). Journ. Arn. Arb. 20: 250-263, pls. 1-3. Apr. 1939.

—Limnocitrus, a new genus, also new species of Wenzelia. Paramignya and Atalantia (Rutaceae-Aurantioideae). Journ. Arn. Arb. 21: 1-25, pls. 1-4. Jan. 1940.

—New varieties and new combinations in the genera Clausena, Oxanthera, and Triphasia of the orange subfamily Aurantioideae. Journ. Washington Acad. Sci. 30: 79-83. Feb. 1940.

—Three new species of Citropsis, also new varieties of Atalantia and Fortunella (Rutaceae-Aurantioideae). Journ. Arn. Arb. 21: 116-133, pls. 1-4. Apr. 1940.

Citrus macroptera var. *Kerrii* Swingle, n. var.

Differt a specie fructu maiore, cortice fructus multe crassiore; vesiculis pulpiferis non solum ad parietes dorsales loculorum fructus sed etiam numerosissimis ad parietes laterales colligatis.

Differs from the typical form in having larger ovoid fruits, up to 8 or 9 cm in diameter instead of 5-5½ cm; pulp-vesicles attached in large numbers to the side (radial) walls of the locules for ⅔ to ¾ of the distance from the dorsal walls of the segments to the core of the fruit; peel very thick, 12-14 instead of 5-6 mm, as in the typical form; flowers (known only from one collection, *Kerr 11933*) small, 4- or 5-merous with 16-20 stamens borne on slender, free filaments.

Type specimen.—Thailand, Nakwan Sawan, Kampéngpat, Mé Lamung, alt. 540 m; lat. 16°15' N.; long. 98°58' E., Dr. A. F. Q. Kerr, Herb. Aberdeen University No. 6081.

Remarks.—This interesting new orange is a member of the subgenus *Papeda*, the species of which have numerous droplets of acrid, bitter oil in the pulp-vesicles, because of which the fruits are inedible and are called bitter-oranges.

This variety was discovered by Dr. Kerr in west-central Thailand. At the type locality he reports it to be a "common tree in the ever-green forest" and also notes that it grows "up

to 10 meters high." The type material and another collection, *Kerr 11983*, from Ban Kragê, Thailand, were kindly lent to me by Prof. J. R. Matthews, curator of the Herbarium, University of Aberdeen, Scotland. This Thailand bitter-orange has long, stout, sharp spines on the lower branches (Fig. 1, B) but shorter ones or none on the fruiting branches (Fig. 1, C). This variety differs strikingly from the typical form of *Citrus macroptera* in having fruits with a much thicker, chalky-white peel covered by a thin,

19877). This material differs from the Thailand type specimens chiefly in having strongly acuminate leaves (Fig. 1, D), those of Dr. Kerr's collections being narrowed to a blunt apex (Fig. 1, B).

Citrus reticulata var. *austera* Swingle, n. var.

Differt a specie suco acidissimo; fructibus minoribus.

Differs from the typical form in having smaller fruits with intensely acid pulp.

Type.—Ch'ao-chou, Kwangtung Province.

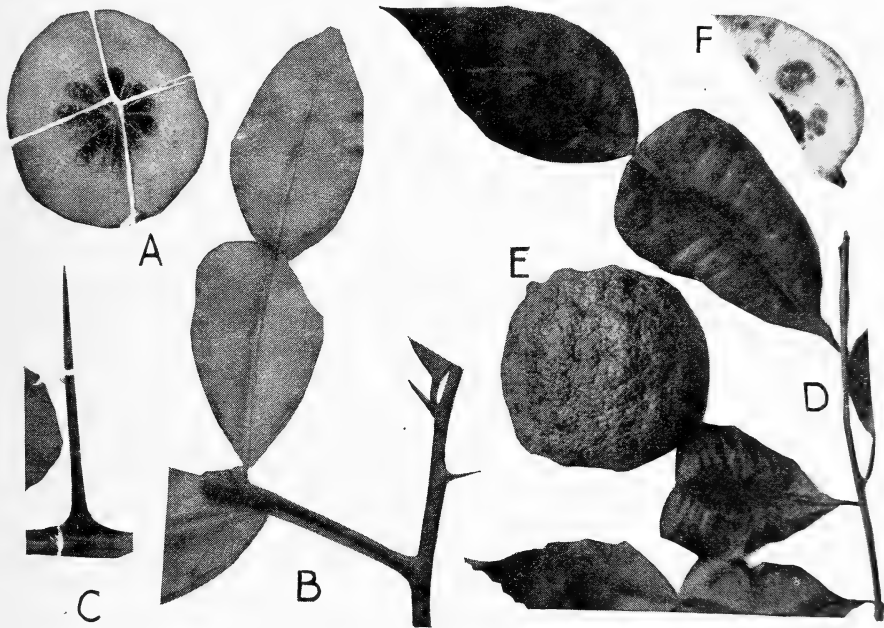

Fig. 1.—*Citrus macroptera* var. *Kerrii* Swingle, n. var.: A, Fruit in cross section; B, fruiting branch with very short spines; C, long spine on young shoot (A, B, C all from the type specimen); D, twig with acuminate leaves; E, entire fruit; F, part of a cut fruit (D, E, F all from Tung Kung, Tonkin, Indochina, Groff 19877). One-half natural size.

green, surface layer only about 1 mm thick, which has numerous very small oil glands. The segments of the half-grown fruits contain very small pulp-vesicles only 1.5–2 mm long, borne on stalks 1–3 mm long, which are attached both to the dorsal wall of the locule and also in large numbers to the lateral (radial) walls for two-thirds to three-fourths of the distance from the dorsal wall of the locule to the core. Apparently this same variety occurs at Tung Kung (lat. 22°15' N., long. 102°50'E.) in northern Tonkin near the Chinese border (Groff

China, Groff 233 (1918), Herb. Lingnan University, Canton, China.

Remarks.—G. W. Groff in 1918 wrote a detailed description for me of this variety, called *suan chieh* in Chinese (*sün kat* in Cantonese), and commonly grown in the Swatow region of southeastern China for use as a rootstock. As it is grown from seeds and not propagated by grafting it is evidently able to reproduce itself indefinitely from seeds and is not to be confused with any of the numerous *Citrus* hybrids, mutations, and monstrosities, many of which

can be propagated only by grafting. I have drawn up from Groff's manuscript tabulations and outline figures wherein he compares the characters of 7 sour mandarin (*kat*) varieties the following description:

Fruits slightly depressed globose, 2.9–3.3 cm long, 3.3–3.6 cm diameter, with smooth, loose peel about 4 mm thick, capucine yellow (Ridgway's pl. 3) when ripe; oil glands small, round, far apart, fragrant; segments 9, easily separated; segment walls thin, tender, white; core

6–8 mm diam. soft; pulp deep chrome (Ridgway's pl. 3) composed of small, short pulp-vesicles, clinging together but irregularly arranged and easily broken; juice reddish yellow, very sour; seeds about 9, rounded at one end, pointed at the other, showing white parallel lines from base to tip; leaves lanceolate-elliptical, blades 6.8–2.5 cm, rather acutely cuneate at the base and narrowed to a blunt apex, with about 10 pairs of lateral veins; petioles nearly wingless.

This variety is widely grown about Swatow, China, where it is used as a rootstock upon which to graft the *mi-tang-ka*, honey-pot orange, and other famous varieties widely exported from Swatow.

Probably some of the other sour mandarins called *kat* by the Cantonese are forms of this variety. Some of the so-called *kat* varieties with large fruits, which as they ripen may become sweet enough to eat, are probably hybrids between this variety (*austera*) and sweet mandarins (*Citrus reticulata* Blanco) or sweet oranges (*Citrus sinensis* (Linn.) Osbeck). A hybrid between *Citrus reticulata* var. *austera* and some species of kumquat belonging to the genus *Fortunella* is commonly cultivated in *Citrus* collections under the name calamondin.

***Murraya alata* var. *hainensis* Swingle, var. nov.**

Differt specie folioliis junioribus minute puberulentibus.

Differs from the typical form in having the leaflets minutely pubescent on both surfaces when young, while the species itself has leaves always completely glabrous.

Type.—China, Hainan Island, Strand at Haichow, *McClure 7611*, Herb. Nat. Arboretum, Washington, D. C.

Remarks.—Both this variety and the typical form are very small trees with leaves having a plainly winged rachis and are distinct from other species of the genus *Murraya*.

***Clausena heptaphylla* var. *Engleri* (Tan.) Swingle, n. comb.**

Clausena Engleri Tan. in *Mededeel, van's Rijks Herb.* 69: 6. 1931.

***Murraya microphylla* (Merr. and Chun) Swingle, n. comb.**

Clausena microphylla Merr. and Chun in *Sunyatsenia* 2: 251. 1935.

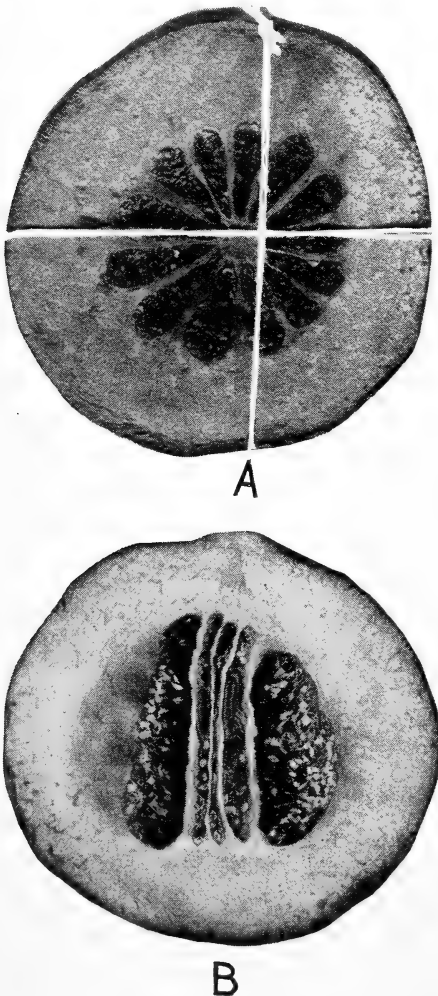

Fig. 2.—*Citrus macroptera* var. *Kerrii* Swingle, n. var. A, Cross section of half-grown dried fruit; B, longitudinal section of fruit, both fruits from the type tree showing thick white peel and minute pulp-vesicles. Natural size.

ENTOMOLOGY.—Notes on *Harmostes*, with descriptions of some new species (*Hemiptera: Corizidae*).¹ H. M. HARRIS, Ames, Iowa.

Because the earlier descriptions dealt largely with color and because it is now recognized that intraspecific variation in color is very great, entomologists in general have had great difficulty in identifying specimens of *Corizidae*. The present notes are offered in an attempt to make known structural features that it now appears may be of some worth in segregating species of the genus *Harmostes* Burmeister.

For the privilege of studying the types of the species described by Berg I am indebted to Dr. Max Biraben, Jefe del Departamento de Zoología (Invertebrados) del Museo de La Plata. Dr. Jose A. de Carlo has kindly sent me for study the specimens belonging to the collection of the Museo Argentina de Ciencias Naturales and H. G. Barber has sent the undetermined material in the collection of the U. S. National Museum. Dr. Carl J. Drake and John C. Lutz have graciously permitted me to study the tropical species represented in their extensive collections.

***Harmostes procerus* Berg**

1879. *Harmostes procerus* Berg, Hemip. Argentina: 91.
 1922. *Harmostes procerus* Pennington, Physis 5: 166.
 1924. *Harmostes procerus* Jensen-Haarup, Ent. Medd. 14: 329, figs. 10c, 10d.
 1941. *Harmostes procerus* Torre-Bueno, Bull. Brooklyn Ent. Soc. 36: 86.

I have had the privilege of studying the type series of this species. One of the specimens bears the pin label "*Typus*" and a second label "*Harmostes procerus* Berg." This individual, a male in good condition, also carries the label "Banda Oriental." I designate it *lectotype* and have added a label. The other specimens in the type series all bearing Berg's "*Typus*" label are designated paratypes.

The species appears to be common in the Argentine. It exhibits a wide range in color variations and seems to bear a somewhat similar relation to the South American *Harmostini* as *H. reflexulus* (Say) does to the North

American forms. Gibson was wrong in his synopsis of the original description when he said of the pronotum, "lateral margins strongly crenulate," as was Torre-Bueno also in placing the species in that section of his key with lateral margins of pronotum smooth. As a matter of fact, the edge of the pronotal side margins is very minutely, obsoletely crenulate. The membrane is not spotted but is marked with a more or less distinct fuscous streak through its middle. This is sometimes distinctly divided by the pale veins.

In addition to the type series I have seen a long series of specimens from Montevideo and various localities in the Argentine belonging to the La Plata Museum, the Museum of Buenos Aires, the U. S. National Museum, and the Pennington collection. The size varies from 5.5 mm, small males, to 8.4 mm, larger females. Jensen-Haarup has figured the male genital segments.

***Harmostes prolixus* Stål**

1860. *Harmostes prolixus* Stål, Rio Janeiro Hemip. 1: 30.
 1879. *Harmostes prolixus* Berg, Hemip. Argentina: 91.
 1922. *Harmostes prolixus* Pennington, Physis 5: 165.
 1924. *Harmostes prolixus* Jensen-Haarup, Ent. Medd. 14: 327, figs. 10a-b.
 1934. *Harmostes prolixus* Blote, Zool. Meded. 17: 254.
 1941. *Harmostes prolixus* Torre-Bueno, Bull. Brooklyn Ent. Soc. 36: 85.

The La Plata collection contains the specimen recorded by Berg from "Corrientes" and two additional specimens from Córdoba. The Museum of Buenos Aires collection contains a specimen from La Paz, Dep. San Javier, Córdoba, and another from Bolivia, Steinbach, 1916. I have seen other specimens from Grand Chaco, Paraguay; Cuatro Ojos and Santa Cruz, Bolivia; Prov. Buenos Aires and Puesta, Argentina; São Paulo and Nova Teutonia, Brazil.

The species is closely related to *Harmostes raphimerus* Spinola but has a narrower, more elongate form, and the pronotal lateral margin is very narrow and sharply reflexed. The bucculae end on or slightly before a line drawn

¹ Received August 21, 1941.

through front margin of eyes. The entire clavus and corium, except for a small area near apex of middle basal cell of corium (cell R or discal cell), is coarsely punctate. The male parameres are distinctly shorter and broader than depicted in Jensen-Haarup's figure and the rim of the genital capsule extends across the base of the median process and caudad to it. In *procerus*, however, it is the margin of the capsule that is produced as is figured.

Harmostes apicatus Stål

1860. *Harmostes apicatus* Stål, Freg. Eug. Resa., Ins.: 238.
 1879. *Harmostes apicatus* Berg, Hemip. Argentina: 91.
 1917. *Harmostes apicatus* Gibson, Ent. News 28: 444.
 1922. *Harmostes apicatus* Pennington, Physis 5: 165.
 1924. *Harmostes apicatus* Jensen-Haarup, Ent. Medd. 14: 327, fig. 10f.
 1934. *Harmostes apicatus* Blote, Zool. Meded. 17: 253.
 1941. *Harmostes apicatus* Torre-Bueno, Bull. Brooklyn Ent. Soc. 36: 86.

The two specimens recorded by Berg from Buenos Aires and Corrientes are present in the La Plata collection. Other examples before me are from Buenos Aires and Tigre, Argentina; Horqueta and Grand Chaco, Paraguay; Villa Montes, Izozo, Cuatro Ojos, and Santa Cruz, Bolivia; and Para and Nova Teutonia, Brazil.

The small size, the rather wide and punctate reflexed lateral margins of the pronotum, the transparent and impunctate (except for marginal rows) inner cells of the corium, and the short bucculae, which taper posteriorly to a point opposite front half of eyes, are distinctive features. The pronotal edge while not caloused and completely smooth can not be called crenulate (cf. Gibson).

In all the specimens I have seen there is a more or less distinct infuscation in the apical cells of the corium. The hind margin of the male genital capsule is sinuately emarginate, with a small angular notch at its middle.

Harmostes serratus (Fabricius)

1794. *Acanthia serrata* Fabricius, Ent. Syst. 4: 75.
 1794. *Coreus gravidator* Fabricius, Ent. Syst. 4: 133.
 1803. *Coreus gravidator* Fabricius, Syst. Rhyng. 199.

1852. *Harmostes perpunctatus* Dallas, List Hemip. 2: 521.
 1868. *Harmostes serratus* Stål, Hemip. Fabriciana 1: 67.
 1934. *Harmostes serratus* Blote, Zool. Meded. 17: 254.
 1939. *Harmostes serratus* Barber, Sci. Survey Porto Rico 14 (3): 326.
 1941. *Harmostes serratus* Torre-Bueno, Bull. Brooklyn Ent. Soc. 36: 83.

I have seen specimens of what I take to be *serratus* from Antigua, Trinidad, Hayti, Colombia, and Panama. This form has a very wide range, and the complex consists of several incipient and as yet unfixed species or it is a highly plastic thing. As might be expected, the literature concerning it is involved.

Lateral margins of pronotum pale, reflexed and with a row of 10 to 12 clean-cut teeth extending well up on hind lobe and there giving way to coarse serrations. Tylus, as seen from the side, conspicuously angularly produced, reaching to distal fifth of antennal I. Spine of antenniferous tubercule much longer than in *affinis*, the distance from front of eye to apex of spine greater than length of an eye. Bucculae about attaining a point opposite middle of eye. Antennal III distinctly longer than II, IV about one-half of III. Humeri of pronotum distinctly angular. Male paramere short, broad. Membrane spotted. Clavus and entire corium, except small area at apex of emboliar suture (median furrow), opaque, coarsely punctate.

Harmostes affinis Dallas

1852. *Harmostes affinis* Dallas, List Hemip. 2: 522.
 1879. *Harmostes serratus* Berg, Hemip. Argentina: 90.
 1907. *Harmostes affinis* Van Duzee, Bull. Buffalo Soc. Nat. Sci. 8 (5): 13.
 1909. *Harmostes affinis* Van Duzee, Bull. Buffalo Soc. Nat. Sci. 9: 161.
 1917. *Harmostes affinis* Gibson, Ent. News 28: 441, 442.
 1922. *Harmostes serratus* Pennington, Physis 5: 164.
 1939. *Harmostes affinis* Barber, Sci. Survey Porto Rico 14 (3): 326.
 1941. *Harmostes affinis* Torre-Bueno, Bull. Brooklyn Ent. Soc. 36: 83.

Specimens are at hand from Florida, Texas, Mexico, Panama, Colombia, Antigua, Brazil, Paraguay, and Argentina and a long series from various localities in Bolivia. The Argentina specimens are those recorded by Berg and Pennington as *H. serratus* (Fabricius).

The species shows considerable variation and at times is very difficult to separate from *H. serratus* (Fabricius). As pointed out by Van Duzee and by Barber, however, in their extremes the two forms may readily be separated by the degree of development of the tylus, antenniferous spines, and denticulations of lateral edge of pronotum and by the length of the antennal segments and rostrum. It will remain for future studies to show whether *affinis* and *serratus* are distinct segments of a widely distributed and highly plastic species complex and therefore worthy of more than subspecific rank.

Apex of tylus angularly rounded, not distinctly produced, the distance from tip of jugum to tip of tylus distinctly less than length of an eye. Lateral edge of pronotum serrate in front and becoming crenulate posteriorly on hind lobe. Distance from front of eye to apex of antenniferous spine less than length of eye.

Harmostes dorsalis Burmeister

1835. *Harmostes dorsalis* Burmeister, Handb. d'Ent. 2: 307.
 1881. *Harmostes dorsalis* Distant, Biol. Centr.-Amer., Rhyn. Heterop. 1: 168.
 1917. *Harmostes dorsalis* Gibson, Ent. News 28: 439, 444.
 1934. *Harmostes dorsalis* Blote, Zool. Meded. 17: 254.
 1941. *Harmostes dorsalis* Torre-Bueno, Bull. Brooklyn Ent. Soc. 36: 89.

This species was described from Mexico and is the haplotype of the genus, yet it apparently has remained unknown to workers since the time of Burmeister. Distant, in working up the Mexican species for the Biologia, passed it over as unknown, and Gibson on the basis of determinations made by Heidemann placed it in synonymy with *H. serratus* (Fabricius). Blote has more recently recorded the species from Brazil without comment. Of the species I have seen from Mexico it appears to me that the form treated above as *H. affinis* is the one that will most likely prove to be *dorsalis*. A careful study of Burmeister's generic diagnosis with particular attention to the characters of the head, antennae, antenniferous spine, and pronotal margins, as well as the abbreviated color description of the species only serves to intensify my suspicion.

Harmostes formosus Distant

1881. *Harmostes formosus* Distant, Biol. Centr.

Amer., Rhyn. Heterop. 1: 167, pl. 15, fig. 15.

1917. *Harmostes formosus* Gibson, Ent. News 28: 442.

1941. *Harmostes formosus* Torre-Bueno, Bull. Brooklyn Ent. Soc. 36: 84.

There is in the National Museum a male specimen labeled Atencingo, Mexico, June, 1922, E. G. Smyth, and determined as *formosus* by Mr. Barber. The species is very distinctive by reason of its irregularly dentate lateral margins of the pronotum, the strongly raised posterior lobe with broadly rounded somewhat flaring humeral angles, the long, convex head, the short antennae, and long rostrum. In texture of hemelytra and type of clasper it is nearest *croceus* Gibson and *bicolor* Distant.

Head longer than broad (40:35), distinctly longitudinally convex. Antennae not so long as head, pronotum and scutellum combined, segment I just attaining apex of head, II enlarged at apex, IV not over 4 times as long as thick; proportions, 14:30:30:20. Bucculae tapering posteriorly and ending before a point opposite middle of eye. Rostrum reaching base of third segment of venter.

Pronotum twice as wide as long (66:33), the disk coarsely punctate and rugose, the anterior angles prominent, the lateral margin wide and irregularly serrate in front, narrowing and becoming crenulate backwards to humeri, the latter broadly rounded. Scutellum slightly longer than wide. Hemelytra coriaceous, not noticeably punctate. Membrane spotted, appearing smoky due to dark wings beneath. Metasternum with prominent borders to rostral channel, these high and truncate in front. Venter sulcate at middle of two basal segments. Genital characters of *reflexulus* type, but parameres with characteristic proportions.

Length, 9.0 mm. Width, across humeri, 3.0.

The color is deeper than depicted by Distant. The apices of antennal II and III, all of IV, the apices of the tibiae, the tarsi, and the base of hind tibiae are more deeply colored. The hind tibiae are stout and distinctly compressed.

Harmostes marmoratus Blanchard

In his notes on the Argentinian species of *Harmostes* Jensen-Haarup treats as *marmoratus* a form that surely is not the true Chilean *marmoratus* of Blanchard. Perhaps as he himself indicates he was dealing only with strik-

ingly colored examples of *H. procerus* Berg. I have given elsewhere notes on the structural features of specimens of *marmoratus* from the Reed Chilean collection.

Harmostes imitabilis, n. sp.

Size medium; form slender, elongate. General color yellowish testaceous, with a roseate tinge, the veins of hemelytra distinctly reddish. Head distinctly longer than wide across eyes (29:24). Spines of antenniferous tubercles short. Tylus compressed, prominent, as seen from the side crenulate, reaching to middle of first antennal segment. Antennae long, longer than head, pronotum and scutellum conjoined; proportions, 18:24:26:17 (female, 20:26:29:19). Bucculae fairly low and long, tapering posteriorly, reaching to a point about opposite middle of eye. Rostrum relatively short, just attaining metasternum, segment I not extending to line of hind margin of eyes; proportions, 15:18:10:12. Pronotum about one and one-half times as wide as long (37:25) only slightly raised posteriorly, the median smooth line obsolete in front and behind but quite conspicuous at the interlobe constriction; the sides straight, their margins narrow, reflexed and finely crenulate; the anterior angle acute, only slightly produced and placed behind the fine collar; humeral angles obtuse. Scutellum longer than broad. Hemelytra with clavus and exocorium coriaceous and coarsely punctate, the rest hyaline and impunctate except for an incomplete marginal row bordering the veins; membrane extending well beyond margin of abdomen, clear; venter pale, the trichobothria dark and conspicuous. Legs pale, the hind femora extending just to apex of abdomen. Male genital capsule deeply, rectangularly excavated at apex, the parameres slender, their tips dark, recurved.

Length, 6.2–7.7 mm. *Width* across humeri, 1.7–2.2 mm.

Holotype, male, and *allotype*, female, Lujan, Prov. Buenos Aires, Argentina, December 8, 1938, C. J. Drake, collector (my collection). *Paratype*, one male taken with type.

This species has the size and form of *H. procerus* Berg, with which it is very closely allied. From *procerus* it is differentiated by the more convex and laterally sloping disk of pronotum and the narrower pronotal side margins, as well as by the character of the male genital

capsule which in *procerus* is roundly produced at the middle beneath. As in *procerus* the punctures of the pronotum and clavus are very large and coarse. In the male there is visible through the membrane two sublateral elongate dark spots on the last dorsal segment. The second antennal segment is somewhat enlarged and flattened at the base as in *procerus*.

Harmostes petulans, n. sp.

Size medium for the genus; body oblong. General color yellowish to greenish testaceous, marked with dark testaceous to brown; the head, front lobe of pronotum and scutellum at times varying toward orange. Head faintly broader across eyes than its median length (23:22), above rather horizontal and somewhat longitudinally convex; clypeus compressed laterally, raised, its edge only slightly granulate, in front more or less rounded and not produced, reaching to distal third of first antennal. Spines of antenniferous tubercles as seen from above short, slender, slightly incurved; from the side, almost triangular. Bucculae short, rather high and of equal height throughout, ending abruptly at a line drawn through front margin of eyes. Antennae short, about as long as head, pronotum and scutellum combined, length of segment I faintly less than width of head between eyes (12:13); proportions, 12:20:21:17 (female, 13:22:22:19). Rostrum extending to middle of metasternum, segment I reaching only to a point about opposite hind margin of eyes; proportions, 15:14:11:13. Pronotum nearly twice as wide as long (male, 40:22; female, 46:24), distinctly raised posteriorly, with a median smooth line which is most prominent between the lobes; the lateral margins moderately wide, sharply reflexed, punctate, the edge almost smooth (obsoletely granulate) and forming a straight or barely sinuate line; anterior angles only slightly produced, placed a little behind the very narrow collar; humeral angles obtusely rounded. Scutellum equally as long as wide, the apex broadly rounded. Hemelytra with clavus and exocorium thickly punctate, the other cells transparent and impunctate except for a marginal row around their borders. Membrane clear, without darker markings, extending well beyond apex of abdomen. Prothorax as seen from the side with the reflexed upper edge shiny, smooth, with only a few

punctures. Metapleuron strongly sinuate along its hind margin. Hind femora projecting distinctly behind apex of abdomen. Hind tibiae without a distinct dark annulus at apex. Venter with the usual trichobothriae which are pale and inconspicuous; sixth segment rather strongly laterally compressed in the female. Male genital capsule with its hind margin almost straight, or widely truncate, between the prominent lateral angles. Male clasper slender, the apex dark, recurved and bifid.

Length, 5.1–6.2 mm. *Width* (across humeri), 1.9–2.3 mm.

Holotype, male, and *allotype*, female, Cuatro Ojos, Bolivia, September 1917 (in my collection). *Paratypes*, one male, taken with types; one female, Villa Montes, Bolivia, November, 1917; one male, Lima, Peru, February 2, 1939, Carl J. Drake; one female, Argentina, 1939.

This species is perhaps nearest *Harmostes minor* Spinola which it superficially resembles very much. In *minor*, however, the bucculae taper posteriorly and the pronotal margin is broader and not so strongly reflexed. The specimens at hand show considerable color range. At times the clavus is darkened basally and the veins of hemelytra and the pronotum are flecked with reddish. The small distal cell of the corium is smoky in all specimens at hand.

Harmostes insitivus, n. sp.

Moderately small, elongate-oval, rather strongly flattened. Pale testaceous, conspicuously speckled with reddish brown. Head about equally as long as broad (21:22), not noticeably arched above; tylus low, not produced anteriorly, extending faintly beyond middle of first antennal segment. Spines of antenniferous tubercles short, from above very slender, from the side almost triangular. Antennae short, subequally as long as head, pronotum, and scutellum conjoined, length of segment II equal to distance between eyes, IV stout, dark, thickest beyond the middle; proportions, 11:13:17:12. Bucculae low, gradually sloping posteriorly, reaching about to a point opposite hind margin of eyes. Rostrum extending to middle of metasternum, segment I very slightly exceeding bucculae. Pronotum flat for the genus, twice as broad as long (35:17), the lateral edges straight, the side margins rather wide and only slightly sloping; base not broader than hemelytra. Scutellum

equally as broad as long (15). Hemelytra with clavus and exocorium strongly coriaceous and thickly punctured, of corium not so strongly coriaceous and less profoundly punctured; membrane speckled with brown. Hind femora not attaining apex of abdomen. Venter rough, speckled with brown. Male genital capsule, strongly produced at middle of hind margin, produced portion broadly rounded.

Length, 4.5 mm. *Width*, across humeral angles, 1.6 mm.

Holotype, male, and *allotype*, female, Cauquenes, Chile, September, my collection. *Paratype*, one male taken with type.

This species is probably nearest *marmoratus* in the nature of the antennae, bucculae, hemelytra, and genital capsule but is very distinct by virtue of its more oval and more flattened form, the nature of the pronotal margins, the spotted membrane, the more greatly produced median portion of male genital capsule and the lower bucculae. The front angles of the pronotum are not especially sharp and the distance across humeri is not greater than width across base of hemelytra.

Harmostes gemellus, n. sp.

Size small to medium for the genus; form rather oblong-oval, quite broad behind the head. Greenish to yellowish testaceous, the pronotum, scutellum, clavus, and distal portion of corium tinged with brown, the expanded margin of pronotum and exocorium spotted with brown. Head rather flat above, slightly longer than broad (male, 23:21; female, 26:24). Tylus rather narrow and high, granulate or obsolete crenulate, reaching slightly beyond middle of first antennal segment. Spines of antenniferous tubercle very slender from above. Antennae short, not longer than head, pronotum and scutellum combined, and segment II about equal to width of frons plus one eye, slightly swollen at apex; IV stout, suddenly enlarged at basal third, not over 4 times as long as thick; proportions, 12:15:16:13 (female, 14:17:18:15). Bucculae rather high, sloping sharply, ending before middle of eyes. Rostrum extending to rear of metasternum.

Pronotum twice as wide as long at median line (male, 40:19; female, 51:22), the sides sinuate, their margins very wide and broadly reflexed, the edge almost smooth; front lobe short and narrow, the hind lobe prominently

raised and strongly widened; median line present; disc granulate as well as punctate; front angles obtuse, humeral angles broadly rounded. Scutellum subequally as long as broad. Hemelytra as broad as pronotum, the clavus and corium, except for cell enclosing embolial fracture (discal cell), thinly coriaceous and thickly punctate. Membrane clear, without darker markings. Metapleuron concave along hind margin. Hind femora just attaining tip of abdomen. Venter broad, the trichobothriae pale, inconspicuous. Male genital capsule short, its hind margin beneath widely excavate and bi-sinuate. Male clasper slender, the tip darkened and recurved.

Length, male, 4.4 mm; female, 5.6 mm. *Width*, at base of pronotum, male, 1.8 mm; female, 2.3 mm.

Holotype, male, Lujan, Buenos Aires, Argentina, December 18, 1938, Carl J. Drake (author's collection). *Allotype*, female, Lima, Peru, February 2, 1938, Carl J. Drake.

Harmostes confinis, n. sp.

Form elongate oval, the humeri projecting. Yellowish testaceous, the pronotum, scutellum, and hemelytra with brownish markings. Head slightly longer than broad (23:25), rather flat above, the spines of antenniferous tubercles as seen from above long and slender, the tylus high, slightly produced, but not attaining middle of first antennal segment. Antennae longer than head, pronotum and scutellum combined, the second segment in length subequal to width of head, about 6 times as long as thick; proportions 17:21:20:20 (female, 19:24:26:23). Bucculae rather high, gradually tapering backward, ending a little before hind margin of eye. Rostrum reaching on metasternum.

Pronotum twice as wide as long (male, 50:22; female, 60:30), with median smooth line pale and prominent, hind lobe raised and strongly widened so that the lateral edges are concave, side margins quite wide, the anterior lateral angles sharp, distinctly produced; the humeral angles broadly rounded, flaring. Scutellum about as long as wide. Hemelytra with clavus and exocorium coriaceous and strongly punctate, the remainder of corium thin, translucent, and smooth except for a marginal row of punctures bordering the veins. Membrane

without darker markings and with only 8 to 10 long veins. Metapleuron with hind margin concave. Venter pale, trichobothria inconspicuous. Hind femora extending beyond apex of abdomen. Male genital capsule somewhat flattened beneath, hind margin almost straight, only slightly and very widely emarginate.

Length, male, 6.0; female, 6.7 mm. *Width*, across humeri, male, 2.3 mm; female, 2.7.

Holotype, male, Valparaiso, Chile, my collection. *Allotype*, female, El Salto, Santiago, Chile.

Harmostes fusiformis, n. sp.

Small, elongate-oval, widest slightly behind the middle. Head testaceous, slightly reddish above, longer than broad (28:24), longitudinally convex, the tylus reaching slightly beyond middle of first antennal segment. Antenniferous spines slender, projecting forward, distance from eye to apex of spine equal to length of eye. Bucculae long, tapering, extending about to base of head and to apex of first rostral segment. Rostrum reaching on metasternum. Antennae short, segment I stout, surpassing tylus by less than half its own length, the three basal segments subequal in length, each equal to width of head between eyes (15). Pronotum yellowish testaceous, flat, coarsely punctate, with a median, smooth raised line on anterior two-thirds, the sides almost straight, converging anteriorly, their edges minutely crenulate, the front angles produced and prominent. Scutellum concolorous with pronotum, one-third longer than broad (20:15). Hemelytra, greenish, the clavus and endocorium reddish, entirely coriaceous, the clavus and exocorium coarsely punctate, the endocorium with punctures bordering the veins. Membrane narrow, twice as long as wide, reaching slightly beyond apex of abdomen, clear hyaline. Legs short, reddish testaceous, hind femora not approaching apex of abdomen. Venter swollen, sixth segment in female compressed laterally.

Length, 5.5 mm. *Width*, at base of pronotum, 1.52 mm; at widest point, 2 mm.

Holotype, female, Quintin, Peru, Dr. P. Weiss, collector (U. S. N. M.).

The small size, coriaceous hemelytra, flattened pronotum, uniform length of the three basal antennal segments, and the almost fusiform shape combine to make this species unique in the genus. Its general habitus is suggestive of brachypterism.

PROGRAMS OF THE ACADEMY AND AFFILIATED SOCIETIES¹

THE ACADEMY (Cosmos Club Auditorium, 8:15 p.m.):

Thursday, February 19. *The Aztecs of Mexico.* GEORGE C. VAILLANT.

NATIONAL GEOGRAPHIC SOCIETY (Constitution Hall, 8:15 p.m.):²

Friday, January 16. *America flies.* J. PARKER VAN ZANDT.

Friday, January 23. *Java prepares.* DAVID GRIFFIN.

COLUMBIA HISTORICAL SOCIETY (The Mayflower, 8:15 p.m.):

Tuesday, January 20. *Mrs. John H. Eaton (Peggy O'Neal).* ALLEN C. CLARK.

BOTANICAL SOCIETY (Cosmos Club Auditorium, 8 p.m.):

Tuesday, February 3. *Medicinal plants of the Iroquois.* WILLIAM N. FENTON.

AMERICAN SOCIETY OF MECHANICAL ENGINEERS, Washington Section (Pepeco Auditorium, 8 p.m.):

Thursday, February 12. *Adventures in electricity.* PHILLIPS THOMAS.

SOCIETY OF AMERICAN BACTERIOLOGISTS, Washington Branch (U. S. Naval Hospital, 26th and E Streets, NW., 8 p. m.):

Tuesday, January 27. *Fate of Mycobacterium tuberculosis, Pseudomonas aeroginesa, and Salmonella typhimurium in scavenger birds.* DON R. COBURN and PSYCHE W. WETMORE.

Aerobacter aerogenos and Escherichia acidi lactici as causes of mortality in turkeys. HUBERT BUNYEA and ANGUS D. MACDONALD.

Tuberculosis case findings in George Washington University students, with reference to variations in susceptibility and resistance. LELAND W. PARR.

MEDICAL SOCIETY OF THE DISTRICT OF COLUMBIA (1718 M Street, NW.):

Wednesday, January 21. Panel discussion on *Peripheral vascular diseases.*

Moderator: WALLACE M. YATER. Participants: NORMAN E. FREEMAN, A. WILBUR DURYEE, J. ROSS VEAL.

Wednesday, January 28. Pediatrics Section symposium on *Evaluation of some common diagnostic pediatric procedures:* (1) Shick test, ERNEST L. STEBBINS; (2) Tuberculin skin test, HUGH J. DAVIS; (3) Differential blood count in pertussis, Spinal puncture in poliomyelitis, Dick test, and Significance of blood findings in chemotherapy, E. CLARENCE RICE. Discussion by H. H. DONNALLY, JOSEPH S. WALL, V. L. ELLICOTT, GEORGE C. RUHLAND.

¹ Notices to be published in this space must reach the Senior Editor, Raymond J. Seeger, not later than the 28th of the month.

² Lectures open only to members of the National Geographic Society who have subscribed to season tickets.

CONTENTS

	Page
ETHNOLOGY.—A scientific approach to African colonization. O. F. COOK.....	1
BIOPHYSICS.—Effect of temperature and time on the x-ray sensitivity of maize seeds. LOUIS R. MAXWELL, J. H. KEMPTON, and VERNON M. MOSLEY.....	18
BOTANY.—Three new varieties and two new combinations in <i>Citrus</i> and related genera of the orange subfamily. WALTER T. SWINGLE.....	24
ENTOMOLOGY.—Notes on <i>Harmostes</i> , with descriptions of some new species (Hemiptera: Corizidae). H. M. HARRIS.....	27

This Journal is Indexed in the International Index to Periodicals

6.15
D2 W23

VOL. 32

FEBRUARY 15, 1942

No. 2

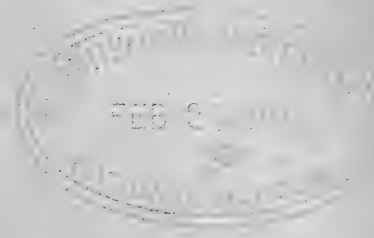

JOURNAL

OF THE

WASHINGTON ACADEMY

OF SCIENCES

BOARD OF EDITORS

RAYMOND J. SEEGER
GEORGE WASHINGTON UNIVERSITY

G. ARTHUR COOPER
U. S. NATIONAL MUSEUM

JASON R. SWALLEN
BUREAU OF PLANT INDUSTRY

ASSOCIATE EDITORS

W. EDWARDS DEMING
PHILOSOPHICAL SOCIETY

C. F. W. MUESEBECK
ENTOMOLOGICAL SOCIETY

HARALD A. REHDER
BIOLOGICAL SOCIETY

EDWIN KIRK
GEOLOGICAL SOCIETY

CHARLOTTE ELLIOTT
BOTANICAL SOCIETY

T. DALE STEWART
ANTHROPOLOGICAL SOCIETY

HORACE S. ISBELL
CHEMICAL SOCIETY

PUBLISHED MONTHLY

BY THE

WASHINGTON ACADEMY OF SCIENCES

450 AHNAIP St.

AT MENASHA, WISCONSIN

Entered as second class matter under the Act of August 24, 1912, at Menasha, Wis.

Acceptance for mailing at a special rate of postage provided for in the Act of February 28, 1925:

Authorized January 21, 1933:

Journal of the Washington Academy of Sciences

This JOURNAL, the official organ of the Washington Academy of Sciences, publishes (1) Short original papers, written or communicated by members of the Academy; (2) proceedings and programs of meetings of the Academy and affiliated societies; (3) notes of events connected with the scientific life of Washington. The JOURNAL is issued monthly, on the fifteenth of each month. Volumes correspond to calendar years.

Manuscripts may be sent to any member of the Board of Editors. It is urgently requested that contributors consult the latest numbers of the JOURNAL and conform their manuscripts to the usage found there as regards arrangement of title, subheads, synonymies, footnotes, tables, bibliography, legends for illustrations, and other matter. Manuscripts should be typewritten, double-spaced, on good paper. Footnotes should be numbered serially in pencil and submitted on a separate sheet. The editors do not assume responsibility for the ideas expressed by the author, nor can they undertake to correct other than obvious minor errors.

Illustrations in excess of the equivalent (in cost) of two full-page line drawings are to be paid for by the author.

Proof.—In order to facilitate prompt publication one proof will generally be sent to authors in or near Washington. It is urged that manuscript be submitted in final form; the editors will exercise due care in seeing that copy is followed.

Author's Reprints.—Fifty reprints without covers will be furnished gratis to authors of scientific papers. Covers bearing the name of the author and title of the article, with inclusive pagination and date of issue, and reprints, will be furnished authors at cost when ordered.

Copies	4 pp.	8 pp.	12 pp.	16 pp.	Covers
50	\$2.00
100	\$1.25	\$2.00	\$3.20	\$3.40	2.75
150	2.00	3.20	5.10	5.40	3.50
200	2.65	4.20	6.60	7.00	4.25
250	3.20	5.00	8.00	8.45	5.00

Envelopes for mailing reprints with the author's name and address printed in the corner may be obtained at the following prices: First 100, \$4.00; additional 100, \$1.00.

<i>Subscription Rates.</i> —Per volume.....	\$6.00
To members of affiliated societies; per volume.....	2.50
Single numbers.....	.50

Correspondence relating to new subscriptions or to the purchase of back numbers or volumes of the JOURNAL should be addressed to William W. Diehl, Custodian and Subscription Manager of Publications, Bureau of Plant Industry, Washington, D.C.

Remittances should be made payable to "Washington Academy of Sciences" and addressed to 450 Ahnaip Street, Menasha, Wis., or to the Treasurer, H. S. Rappleye, U. S. Coast and Geodetic Survey, Washington, D.C.

Exchanges.—The JOURNAL does not exchange with other publications.

Missing Numbers will be replaced without charge provided that claim is made to the Treasurer within thirty days after date of following issue.

OFFICERS OF THE ACADEMY

President: HARVEY L. CURTIS, National Bureau of Standards.
Secretary: FREDERICK D. ROSSINI, National Bureau of Standards.
Treasurer: HOWARD S. RAPPLEYE, U. S. Coast and Geodetic Survey.
Archivist: NATHAN R. SMITH, Bureau of Plant Industry.
Custodian of Publications: WILLIAM W. DIEHL, Bureau of Plant Industry.

JOURNAL

OF THE

WASHINGTON ACADEMY OF SCIENCES

VOL. 32

FEBRUARY 15, 1942

No. 2

*Science and War.*¹ AUSTIN H. CLARK, U. S. National Museum.

In times of national emergency it is incumbent upon all of us, both as individuals and as members of any organization to which we may belong, to do everything within our power for the public good. We who are engaged in science are no longer justified in appraising the world and our fellow men in the light of their bearing upon our specialty, as in times of peace we are inclined to do. We must broaden our outlook and integrate our activities and our thoughts with that will-to-victory that animates us all.

Victory, as we all know, will be achieved primarily by our armed forces working in cooperation with those of our allies, and in collaboration with our diplomats. An all-out victory, however, demands that we give thought to certain social and economic aspects of present-day and future existence that lie beyond the scope of military and diplomatic activities.

Most of these social and economic aspects are already being cared for by various agencies either directly under, or more or less closely connected with, Governmental agencies. There are, however, a few of outstanding importance, though involving a relatively small number of individuals, that can better be carried on, or at least supervised or encouraged, by organizations such as the Washington Academy of Sciences or similar bodies than by any Governmental agencies.

Academies of science are representative of the scientific activities in the communities in which they are situated. The Wash-

ington Academy of Sciences includes within its membership representatives of all the branches of science in the Government service and in the local educational institutions. Each member has his special affiliations, but the Academy as a whole is capable of independent action insofar as such action does not interfere with the work, or run counter to the policies, of the various agencies with which its members are affiliated.

As a preface to the discussion of the needs of science in the present emergency may I, at the risk of being boresomely repetitious, tax your patience for a few minutes by reviewing briefly the history of science in relation to human society?

From the earliest times of which we have a record to the present day, the history of man has been marked by constant changes in the social systems, changes that often were abrupt and violent. One form of social structure or of government has succeeded another. Small but powerful social or political units have grown by accretion or by conquest into great kingdoms or empires. These kingdoms or empires eventually have decayed or fallen apart, the fragments maintaining a longer or shorter separate existence, or becoming merged into other larger units.

Together with these frequent social, political, or economic readjustments of the past we see a constant and fairly continuous development of other forces which to a large extent are independent of transient political conditions. We note a growing interest in and understanding of the products of the earth and their uses. We also are able to trace the ever-increasing subjugation of the forces of nature, which

¹Address of the retiring president of the Washington Academy of Sciences delivered at the 309th meeting of the Academy, January 15, 1942. Received January 15, 1942.

more and more come to be the servants instead of the enemies of man.

The greatest of all human achievements was the control and use of fire. We have no knowledge of when or how fire was first transformed from a terrifying natural phenomenon into man's most useful servant, for no human race exists that does not know, to some extent at least, the use of fire. Second among human achievements was the fashioning and use of tools and weapons. The origin of the use of tools is lost in the far distant past. The earliest tools we know were crudely fashioned from stone. The technique of making tools gradually improved, and many of the stone axes, choppers, projectile points, and other objects fashioned by early human types are marvels of technical skill. Then came the weaving of textiles from plant or animal fibers and the molding of pottery vessels, followed by the appearance of bronze. Not long after the appearance of bronze utensils of various sorts, the wheel and axle appeared in Asia, soon spreading to Europe.

From the Bronze Age onward the knowledge of the use of natural products and the control of natural forces have shown a fairly continuous development, and to an ever-increasing extent have become an integral part of the fundamental basis of progressive human societies.

Since the beginning of the present century the advance in the knowledge and understanding of the products and forces of nature has been greater than in all the thousands of years preceding—or at least since the subjugation of fire, the first fashioning of tools, and the domestication of animals and plants.

Whether we like the idea or not, we are now living in an age, and under conditions, in which science plays a dominant part, and the established scientific principles that underlie many of the most familiar of our present-day improvements were unheard of, or considered fallacious, no longer than a generation ago. Our children regard as commonplace necessities all sorts of things that to us of the older generation still seem to be more or less miraculous innovations—the talkies, the radio, the air-

plane, the wire-photograph, the neon light, the modern motor-car, and many others. This is self-evident to all; but the implications inseparable from a culture based ever more intensively and extensively on increasingly abstruse science are not as yet fully appreciated.

The progress that through the ages has been made in the understanding of natural phenomena and in the utilization of natural products is continuing at an accelerated pace, and will continue in the future, in spite of what may happen in the next few years. It may be locally obstructed, or even brought to an end, but somehow, somewhere, it will carry on.

The present struggle is no more a contest in the military field than it is in the field of science. It is quite possible to win the war on the battle front, but lose it in the laboratory. The Germans and the Japanese both are well aware of this. So are our friends the Russians. They are waging their battles in their laboratories as vigorously as on the firing line.

We in this country must see to it that, so far as possible, the steady advance of science is maintained. At the present time we are utilizing to the maximum extent our scientific resources and our scientific personnel to aid in our war effort. We are doing this, I have reason to believe, more extensively, more efficiently, and more effectively than any other country.

But this is not enough. Various branches of science not of immediate military application are in the long run quite as essential for our progress and our welfare as are those forms of engineering, of physics, and of chemistry that underlie the construction and the use of modern implements of warfare. These are the many and varied types of pure science, lines of work leading to results seemingly of no importance that all too often are regarded merely as a form of mental exercise undertaken solely for the personal satisfaction and gratification of the person concerned. What we call pure science is simply a branch of science for which no economic application has as yet been found. But at any time a body of uncoordinated facts may suddenly and unexpectedly

fit into an integrated whole, to our great advantage. Without its advance fringe of competent workers in pure science constantly probing the great unknown and accumulating masses of data with no apparent immediate application, the broader aspects of scientific progress soon would languish, and we would eventually lose heavily. Pure science is likely to suffer severely in times like the present—in times when it would seem to be the wisest course to give it the maximum encouragement.

Recently I have received, passed by the German censor and wrapped in several unfolded signatures of an edition of Horace, an elaborate memoir on the Isopoda, a group of wretched little crustaceans commonly called wood-lice or sow-bugs. The last publication received by the National Museum Library from the Institute of Scientific Research, Manchukuo, was devoted to a detailed account of the butterflies of Yablonya, Pin-chiang Province. Evidently the Germans and the Japanese consider it worth while to encourage work in lines of pure science apparently quite unconnected with military affairs. If it is worth while for them—and we must admit that both nations are military-minded—why is it not worth while for us?

In Germany and in Japan things are done in ways that are not practicable with us. If Der Führer considers the detailed study of wood-lice worth while from the point of view of furthering the Nazi aims, wood-lice will be studied, and the people will accept as of value to themselves, even if they do not applaud, the results of the studies. In Japan, science has been brought to high popular favor in the past 40 years through the example and excellent leadership of a group of powerful and highly respected noblemen, and a number of these noblemen, including some members of the Imperial Family and the grandson of the last Shogun, are enthusiastic entomologists.

There is a natural tendency to say, "Well, if the Germans and the Japanese choose to squander their slender resources by supporting and publishing trivialities of this sort, let them go ahead and do it." But let us look at the matter from a different view-

point. In the future, if any American student wishes to study the Isopoda of the Philippines and the Netherlands East Indies, he must base his work on the memoir referred to, and in the same way students of the butterflies of eastern Asia must follow the Japanese lead. No scientific man objects to working with his colleagues in any country. To that extent science is international. What patriotic scientific men do object to is the possibility of having in the future to play second fiddle to scientific men in other lands, not because they are in any way inferior, but because they were unable to carry on their work.

In this country we do not have a Führer who can dictate what science may or may not do, and we do not want one. Neither do we have a group of powerful noblemen to chart a course for us. We do not want them either. At the same time, we have no desire to be outdone by countries dominated by these human phenomena.

In this country, progress in any line of science is mainly dependent upon the willingness of the people to support work in that particular line which, in turn, is dependent upon popular interest and appreciation.

We have among us at the present time very many people who are by no means science-minded. Their attitude varies all the way from passive superciliousness to outspoken hostility. Not a few go so far as to say that science is the cause of the present war, such people being the spiritual descendents of those who, a little over a hundred years ago, tried to suppress the friction match on the ground that it would stimulate the activity of fire-bugs. Many in our country districts have their own peculiar ideas about the moon and stars, ideas in regard to which they are exceedingly sensitive, while in the cities many are very supercilious regarding the value of entomology except, perhaps, when it comes to discouraging the activities of bed bugs.

We who are engaged in scientific work, and who understand its importance in the general complex of present-day human affairs, often fail to realize how recently science has been able more or less success-

fully to overcome various forms of popular prejudice and to secure the favor of a very large section of the general public.

The present popular attitude toward science can not properly be understood without some knowledge of the public attitude in the more or less recent past. I propose therefore to digress for a moment in order to indicate briefly the changes that have taken place here and in England since the early days of the settlement of the country. At that time, in the reign of Queen Elizabeth, Galileo was still a student at the University of Pisa, Tycho Brahe had just completed his observatory, and Paracelsus and Agricola only recently had died. In those days science was almost wholly included in the subject of theology, and scientific work was restricted within narrow bounds by the dogmas of the theologians. In the words of the Marquess of Salisbury science was "the knowledge gained not by external observation, but by mere reflection. The student's microscope was turned inward upon the recesses of his own brain; and when the supply of facts and realities failed, as it very speedily did, the scientific imagination was not wanting to furnish to successive generations an interminable series of conflicting speculations."

For some time there had been a growing restiveness against the restrictions placed on scientific investigations by the theologians. This restiveness began to take the form of concerted action in the first half of the seventeenth century. As early as the reign of Charles I, about 1645, there existed in England an organization referred to by the Hon. Robert Boyle, seventh son of the first Earl of Cork, as the "Invisible College." This "Invisible College" was first suggested by Theodor Haak (or Hank), a German from the Palatinate, then resident in London. It consisted of weekly meetings at which the results of experimental work in philosophy, in its broad sense, were discussed. This was rather an unorthodox procedure for the time, but those who attended the meetings were among the ablest men of England, and included theologians as well as others. One of the theologians was Dr. John Wilkins, afterward

Bishop of Chester, who had married Robena, sister of Oliver Cromwell. Another participant was Sir Christopher Wren, who later laid down the plan for the College of William and Mary.

According to Dr. Cromwell Mortimer, "had not the Civil Wars happily ended as they did, Mr. Boyle and Dr. Wilkins, with several other learned men, would have left England, and, out of esteem for the most excellent and valuable Governor, John Winthrop the younger, would have retir'd to his new-born Colony [Connecticut] and there have established that *Society for promoting Natural Knowledge*, which those Gentlemen had formed, as it were, in *Embryo* among themselves."

Emigration to America was, however, forestalled. On November 28, 1660, the "Invisible College" became visible as "The Royal Society of London for Improving Natural Knowledge." On the Wednesday following, word was brought that King Charles II approved the design of the meetings; in October, 1661, the King offered to be entered one of the Society; and in the next year the Society was incorporated under the name of the Royal Society, the first charter of incorporation passing the Great Seal on July 15, 1662.

Although the Royal Society remained in England, both the College of William and Mary and Harvard College received considerable amounts of money from the estate of the Hon. Mr. Boyle after his death in January 1691-92.

Science now began to assume a new aspect. Charles II had in effect declared that there is nothing irreligious in reporting facts. So records of observed facts and their interpretation in the light of other facts began to supersede introspection in which the aid of facts was regarded as superfluous, combined with interminable commentaries on the works of Aristotle.

Following the Restoration, science in England became largely an occupation of the aristocratic and the wealthy and for the most part was followed along lines that had little or no economic application. In the public mind it came to be identified more or less completely with the aristocracy

and to be regarded as partaking of the same aloofness from the general run of human affairs that characterized the social life of the upper classes. The natural result of this was that when, in the Victorian era, the champions of the lower classes began to gain a considerable following, they, or at least many of them, attacked science as one of the perquisites of the aristocracy. This attitude is well illustrated by Charles Dickens's "Mudfog Papers" published on the occasion of the first meeting of the British Association for the Advancement of Science.

Since that time science in England gradually has come more and more into popular favor. Applied science has made rapid strides and is now quite as fully developed and as highly regarded as it is in any other land. The rise in the prestige of applied science, however, has not been accompanied by any noticeable decline in the popularity of pure science, so that here we find the two types advancing side by side in more or less ideal balance. But, unfortunately, science in England still does not have the complete confidence of the public, and is not by any means free from neglect, disparagement, or even attack in the popular press.

In this country the history of science has been somewhat different. In early colonial times scientific effort was devoted mainly to making known the natural resources of the new land, particularly the plant and animal life. But applied science early attracted the attention of the colonists. In 1612 John Rolfe perfected a method of curing tobacco so that it would reach England in good condition, and as early as 1617 Samuel Argall wrote that "ground wore out with maize will bring English grain."

In later colonial times applied science, especially in certain engineering branches, was systematically discouraged in the fear that the colonies might become competitors of the mother country in the production of manufactured goods.

It was possibly partly as a reaction from this suppression that after the Revolution science stood high in the favor of the representatives of the American people, its most

insistent and powerful advocates being Thomas Jefferson of Virginia, Benjamin Franklin of Pennsylvania, and John Adams of Massachusetts. But it was some time before the new country was sufficiently well organized to enable the people to devote much thought to science. When they did, a spontaneous interest, taking various strange and crude forms, appeared, particularly in the agricultural areas. This crude popular science—and pseudoscience—gradually became amalgamated with the more orthodox science of the schools and colleges, and we note, especially after the middle of the last century, an enormous expansion of applied science in all forms, later very largely supported by Federal and State appropriations made possible by active and widespread interest among all the different groups in our population.

In this country popular interest in science is twofold, arising both from the vista of economic betterment resulting from applied science, and from its appeal to the imagination. We all like to look forward to the day when we shall be even more comfortable than we are now. But we all have a non-material side. We like to get away from the hard realities of every-day life and to contemplate the unknown, and beyond that the unknowable. We all would like to know more about the world we live in. What would we find a few hundred miles down in the earth, or 20,000 feet below the surface of the sea? We would like to know more about the stars; are there any other worlds like ours? And what is it like in interstellar space? We would like to know more about ultimate human origins—indeed, about very many things concerning which our present information is vague and fragmentary. Now although popular interest in science is more general and more widespread in this country than it is in any other, it tends to gravitate in these two directions, toward the directly economic and toward the mysterious. Between these two extremes lies a broad intermediate field in which our people as a whole take little interest, but which is intensively cultivated elsewhere. This is the descriptive branch of pure science, the results of which are of no immediate eco-

conomic import and are not mysterious.

Popular interest in science must not only be maintained, it must be increased if we are to hold our own in the years to come, for whether carried on under Government support or in endowed institutions of learning, the full development of our scientific potentialities is dependent upon a sympathetic public attitude. In order to secure, to maintain, and to increase public interest in and sympathy toward scientific work, and to convert the still disconcertingly numerous unbelievers, it is essential that we continually provide the public with news regarding scientific progress in all lines of interest to them, from both the material and non-material or philosophical viewpoints. Such impersonal news is especially desirable in times of national emergency, when it can be made to serve as a welcome relief from distressing accounts of mortal combat.

Fortunately in this respect we are in an excellent position. More and better science is carried in our daily press and other journals than in those of any other country, and science is less frequently disparaged and denounced here than elsewhere. There is still room for improvement, but nevertheless conditions are reasonably satisfactory. For this we have chiefly to thank the National Association of Science Writers the members of which, in addition to knowing science, know the public mind and are able to present the advances in science in terms everyone can understand. We are fortunate in having among the members of the Academy two of the outstanding members of this Association, Mr. Thomas R. Henry of the *Evening Star* (a past president) and Dr. Frank Thone of *Science Service*.

Publicity for science is not of direct concern to the Academy, but I wish to bring to your attention the vital importance of this aspect of scientific activity—for salesmanship is as important for science as it is for everything else—and to urge you all to do everything you can to help in this essential work.

Progress in science is possible only with the support of an interested and appreciative public. It is also possible only through

the efforts of a carefully selected and adequately trained personnel. This is a matter that heretofore scarcely has received the attention it deserves.

At the present time a very serious danger to our continued progress in science has arisen. This is the induction into the Army of many young men who would be of vastly greater value to the country if they were permitted to continue their studies, or to remain in research positions. The matter is further complicated by the fact that as a rule the most valuable of these young men are those most likely to enlist on their own initiative.

After the last war there was a marked scarcity of able young scientific men. This was most noticeable, perhaps, in the biological sciences, though it was more or less noticeable in other branches as well. Many promising young men were killed. Others, as a result of several years spent in the various armies, found themselves unable to make the necessary readjustment to scientific work. Still others tried to readjust themselves but were only partially successful. Breaking the thread of continuity of effort between the impressionable boy in the formative period and the mature man can not but result in a certain amount of dislocation. We are reminded of the old Berber proverb—

Teaching boys is like ploughing earth,
Teaching men is like ploughing rock,
Teaching old men is like ploughing water.

There are two ways out of this dilemma. Either the student may be placed on a deferred list so that he may be enabled to continue his studies uninterrupted, or he may be assisted in carrying on his work, to whatever degree may be found practicable, while in the service.

Many young botanists and zoologists would welcome an opportunity for collecting specimens and continuing their studies in regions new and strange to them. Such material as they collected could be sent home to be identified, or to be stored until their arrival. Activities of this nature carried on in their spare hours would go far toward overcoming that feeling of bore-

dom that afflicts almost everyone stationed at an isolated army post or naval base, and there is no reason to believe that these activities would in any way detract from their military efficiency.

It is not assumed that anything of this sort would be practicable with an army in the field, on ships at sea, or at certain naval bases. But there are numerous places where the men of our armed forces will be stationed with nothing but monotonous routine to occupy their minds and where such recreation would be both practicable and welcome.

Not only would this work benefit the men engaged in it; it would also go far toward filling many gaps in our knowledge of the distribution of animals and plants, and of other features connected with them, and I am sure that the curators of most of our larger museums and herbaria would be glad to cooperate and to encourage most cheerfully the young men concerned. By such sympathetic assistance and encouragement the morale of many young men could be maintained, and the gap in the continuity of their work in their chosen field largely filled in.

In army posts and naval bases a young zoologist or botanist who spends his spare time catching insects or pressing plants will at first be an object of ridicule to his associates, both officers and men. His situation, however, is by no means without precedent—and most honorable precedent. It may comfort him to realize that the world's leading authority on the *Hesperiidae*, a peculiarly difficult group of butterflies especially characteristic of America, is Brigadier General William H. Evans of the Royal Engineers, while in the Royal Navy Rear Admiral Hubert Lynes is the leading authority on a very puzzling group of small African birds. Some time ago the collections of the British Museum were enriched by a fine collection of butterflies presented by Captain Lord Byron.

There are many military men, now as well as in the past, who have, or have had, biology as a hobby and have made notable contributions to the subject. In our own Army I may mention Colonel Thomas L.

Casey, Colonel Wirt Robinson, Colonel Martin L. Crimmins, and Lieutenant Colonel Edgar A. Mearns, and there are many others. Looking at the matter in a more frivolous light, is a young man using his spare time to continue his studies, and at the same time to advance our knowledge of animals and plants, any more ridiculous than an ancient tough old sea-dog in the fore-castle engaged in fine embroidery work with delicately colored silks, to the accompaniment of blood-curdling oaths?

A vast amount of such work has been done by the personnel of foreign armies and navies in the past, particularly by officers in the British services. In fact, at one time our own Navy assigned interested young officers to the Smithsonian Institution for instruction in the collection and preservation of material. One of these young officers especially, Lieutenant William E. Safford, subsequently made notable contributions to the collections of the Institution. I see no reason why, in the interest of the maintenance of morale and of scientific progress, this procedure can not be revived and extended to the enlisted personnel.

Whether in its material or in its non-material aspects, progress in science is dependent upon the fostering of the scientific spirit. The scientific spirit is more than mere curiosity. It is an insatiable curiosity that impels one to learn everything that is known about a given subject, and then to go further and broaden and extend that knowledge by personal investigation and research, in spite of all difficulties and discouragements—and these are always many.

The spirit of science is inborn, though it may appear in anybody, anywhere, in any class, or group, or race. We are fortunate in having a population in which the scientific spirit is widespread, though we have not always encouraged it as perhaps we should have done. We have encouraged it mainly in our graduate schools, and in them chiefly when it was directed toward some objective of more or less immediate economic interest.

In order to develop the scientific spirit to the maximum, as it must be developed if we are to hold our place in the world of the future, we must watch for it at its in-

ception, and whenever and wherever it is found encourage it. In the British Navy the average age of an officer at the time of entering the service is $12\frac{1}{2}$ years. By the time a young man has attained the grade of ensign his whole outlook on life has been aligned with the Navy tradition. Something comparable to this is needed in science. Naturally, many of the boys and girls who are enthusiastic about science in their school days later devote themselves to other lines of activity. But the time and energy spent in encouraging these will be more than repaid by the superior excellence of those who finally take up science as their life work. Besides, those who, interested in science in early youth, later enter some other field of activity will form the nucleus of a sympathetic background for those who make of science their career.

Here we find a real opportunity for service on the part of the Academy. Some means should be devised whereby all the children in the local schools showing a special aptitude for science may be watched and their progress followed. If they show exceptional promise they should be en-

couraged and, if necessary, assisted in completing their education in the most advanced of our graduate schools. Already some of the State academies of science are performing this service to their communities through junior academies of science, or through various science clubs, or through both combined. Why should the Washington Academy of Sciences not undertake it?

We are facing a long war, and a very serious war, a war that, to a far greater extent than any previous war, will be fought on two fronts, in the field of arms and in the laboratory. Our enemies understand this thoroughly and are acting accordingly. We are building a military machine of surpassing power and efficiency. We must at the same time build up a scientific personnel of corresponding power, efficiency, and morale, reinforced by a continuous and adequate flow of highly trained and thoroughly competent replacements able to carry on successfully after the military phase of the struggle is ended. I ask you all, and each of you individually, to do all in your power toward making our scientific front invincible.

PHYSICS.—*A review of the methods for the absolute determination of the ohm.*¹

HARVEY L. CURTIS, National Bureau of Standards.

It is nearly half a century since the critical review of Dorn² on the absolute determinations of the ohm was published. In that review, the methods then available were discussed and the results which had been obtained were analyzed. Since then the number of available methods has considerably increased, principally by the introduction of those that employ alternating currents. Some of the older methods, however, are still very important, so that a complete review has been undertaken of all the determinations that have been made.

The resistance of a conductor is, by Ohm's law, the ratio of the potential difference at its terminals to the continuous current through it. If both the potential difference

and current are measured in terms of length, mass, time, and the permeability of a medium, the value of the resistance is in absolute units. However, most methods for the absolute determination of resistance avoid the direct measurement of either the potential difference or the current, since only the ratio of these quantities is required. In many methods there is an induced electromotive force that can be computed from the electromagnetic equations, and the current can be determined from its mechanical effects. In such cases the equations for determining the electromotive force and current can often be so combined that the resistance of a circuit, or of a portion of one, can be obtained without measuring either a current or potential difference.

The various methods that have been used are classified in Chart I. Following each

¹ Received October 11, 1941.

² *On the apparent value of the ohm.* *Wiss. Abh. PTR 2: 257. 1895.*

specific method there is given in the chart the name of the man who proposed it. In addition to the chart a brief description is given of each method listed therein. Also there is usually given for each method an estimate of the accuracy that can be obtained by its use.

CHART I: A CLASSIFICATION OF THE
METHODS FOR ABSOLUTE MEASURE-
MENT OF THE OHM³

- A. Calorimetric method (Joule).
- B. Methods involving an induced electromotive force.
 - I. Relative motion of a coil and magnet.
 - 1. Damping of a magnet (W. Weber).
 - 2. Rotation of a magnet (Lippman).
 - 3. Dropping of a magnet (Mengarine).
 - II. Rotation of a coil in the earth's magnetic field (the earth inductor).
 - 1. Earth inductor with rotation through 180° (W. Weber).
 - 2. Earth inductor with uniform rotation.
 - a. Earth inductor with separate tangent galvanometer (W. Weber).
 - b. Combined earth inductor and tangent galvanometer (the revolving coil of the B.A. Committee) (Lord Kelvin).
 - III. Nonuniform motion of a conductor in the magnetic field of a current.
 - 1. Damping of a vibrating coil (Nettleton and Lewellyn).
 - 2. Displacement of a coil (Kirchhoff).
 - IV. Uniform motion of a conductor in the magnetic field of a current (generator with air-cored magnets).
- 1. Commutating generator.
 - a. Average value of generated electromotive force (Rosa).
 - b. Maximum value of generated electromotive force (Lippman).
- 2. Homopolar generator (Lorenz apparatus) (Lorenz).
- V. Varying currents in a mutual inductance.
 - 1. Transient currents (Rowland).
 - 2. Commutated currents.
 - a. Sudden reversal of current (Roiti).
 - b. Step-by-step reversal of current (Wenner).
 - 3. Sinusoidal currents.
 - a. Intermediary capacitance (Campbell).
 - b. Two mutual inductances (Campbell).
 - c. Two-phase measured currents (Campbell).
 - d. Two mutual inductances with two-phase balanced currents (Wenner).
- VI. Varying currents in a self inductance.
 - 1. Transient currents (Maxwell).
 - 2. Commutated currents (Curtis).
 - 3. Sinusoidal currents.
 - a. Intermediary capacitance calibrated by a commutator bridge (Rosa).
 - b. Intermediary capacitance calibrated by a resonance bridge (Grüneisen and Giebe).

A. CALORIMETRIC METHOD (JOULE)

The calorimetric method of determining the ohm was of great importance during the early days of absolute measurements, since the electromagnetic laws involved are very different from those used in any other method. It requires not only a determina-

³ This chart is slightly modified from the one given in the book by the author on *Electrical measurements*, McGraw-Hill Book Co. In the book a few methods are discussed in considerable detail.

tion of the heat generated by a current in a resistance, but also some measurement that will give the value of the current in absolute units. This measurement of current can be made with greater accuracy than a strictly mechanical determination of the mechanical equivalent of heat. Hence this method has generally been used to determine the mechanical equivalent of heat in terms of the electrical units of resistance and current.

B. METHODS INVOLVING AN INDUCED ELECTROMOTIVE FORCE

The methods of determining resistance that involve an induced electromotive force may be divided into six general classes, depending on the method of inducing the electromotive force. Each class may be divided and subdivided according to the type of apparatus used.

I. RELATIVE MOTION OF A COIL AND MAGNET

Three methods have been suggested in which an electromotive force is induced by moving a magnet with respect to a coil:

1. *Damping of a Magnet (W. Weber)*

A small magnet is pivoted or suspended at the center of a coil of wire of known dimensions, the plane of which is vertical and lies in the direction of the earth's field. The period and damping of the magnet are observed both when the circuit through the coil is open and when it is closed. The difference in damping on open and closed circuits is caused by the reaction on the magnet of the current in the coil. This in turn depends on the electromotive force induced in the coil by the swinging magnet and on the resistance of its winding. The resistance of the coil is computed from the period and damping of the magnet, and the dimensions of the coil, without determining the induced electromotive force or the current. This method has been successfully used by several observers, one of whom claims a precision of a part in 10,000.

2. *Rotation of a Magnet (Lippman)*

The maximum electromotive force induced in a coil by the rotation of a magnet is balanced against the drop in potential over a resistance in which there is a known current. This method seems incapable of giving results of high accuracy.

3. *Dropping of a Magnet (Mengarine)*

The dropping of a magnet through a coil induces an electromotive force in the coil and the current produced is a function of the resistance. The magnetic field of the

current decreases the acceleration of the magnet. The resistance of the coil can be computed from the mass and strength of the magnet and its change in acceleration together with the dimensions of the coil. While this method has been proposed, it does not appear to be capable of giving precise results.

II. ROTATION OF A COIL IN THE EARTH'S MAGNETIC FIELD (THE EARTH INDUCTOR)

In this class are included the methods involving an induced electromotive force that is produced by a coil rotating in the earth's magnetic field. The rotation may be through 180° only or it may be continuous. Both of these methods have been used by several investigators, each of whom has made some modifications of the original method as proposed by W. Weber.

1. *Earth Inductor with Rotation through 180° (W. Weber)*

The coil of an earth inductor is placed with its plane perpendicular to the horizontal component of the earth's field and suddenly rotated through 180° . The induced electromotive force causes a ballistic deflection of the needle of a tangent galvanometer to which the coil is connected. The value of the earth's field does not need to be known if it is the same at the earth inductor and at the galvanometer. The resistance of the circuit which includes the coil and galvanometer is computed from their dimensions, and the period and damping of the galvanometer magnet.

2. *Earth Inductor with Uniform Rotation*

The uniform rotation of an earth inductor has two modifications. In one the rotating coil is connected to a tangent galvanometer through a commutator. The galvanometer measures the average value of the induced current. In the other the current induced in the rotating coil is measured by the deflection of a magnet suspended at the center of the coil.

a. Earth inductor with tangent galvanometer (W. Weber).—When a tangent galvanometer is employed with a uniformly rotating earth inductor having a commutator the current through the galvanometer does not change direction but varies from zero to a maximum. Consequently the galvanometer must measure the average current flowing through it. The resistance of the circuit including the rotating coil and galvanometer is determined from the rate of rotation of the coil and the dimensions of the revolving coil and of the coils of the tangent galvanometer.

b. Combined earth inductor and tangent galvanometer (the revolving coil of the B.A. Committee) (Lord Kelvin).—In combining the earth inductor with a galvanometer, a small magnetic needle is suspended at the center of a coil which rotates around a vertical axis. The induced electromotive force produced by rotating the coil in the earth's field causes an alternating current in the coil, which reacts to produce a deflection of the needle. This deflection oscillates slightly but the oscillations are negligibly small if the time of a revolution is much less than the natural period of vibration of the magnetic needle. Since the current is alternating, its value depends on the inductance of the coil as well as on its resistance.

The rotating coil method as just described was used in 1864 in establishing the B.A. unit, which was subsequently found to differ from the absolute ohm by about 1.5 per cent. Since then much more accurate measurements have been made by this method, but in no case has the result been as accurate as a part in 10,000.

III. NONUNIFORM MOTION OF A CONDUCTOR IN THE MAGNETIC FIELD OF A CURRENT

This class of methods is similar to the preceding except that a coil carrying a current replaces the magnet.

1. *Damping of a Vibrating Coil* (Nettleton and Lewellyn)

The secondary of a mutual inductor is so suspended that it can vibrate about an axis of symmetry, the zero position being the

position for zero mutual inductance. With a steady current in the fixed coil, the period and damping of the vibrating coil, both on open and closed circuit, are measured. Then with this same current in the fixed coil, another current having a known ratio to the first is sent through the moving coil producing a measured angular deflection. The mutual inductance is then computed for this angular position of the coils. This gives sufficient data for computing the resistance of the vibrating coil. The method has given results that do not appear to be in error by more than a few parts in 10,000.

2. *Displacement of a Coil (Kirchhoff)*

A moving coil is connected to a galvanometer that can be used ballistically. There is a known current in a neighboring fixed coil. The moving coil is displaced suddenly, giving a throw to the moving element of the galvanometer. The resistance of the circuit of which the galvanometer is a part is computed from the current in the stationary coil, the dimensions of the coils, and the deflection and constants of the galvanometer. Kirchhoff displaced the coil by giving it a translation in the direction of its axis but most of the other experimenters have used a rotation.

This is the first method ever used for the absolute measurement of resistance but is now of historical interest only.

IV. UNIFORM MOTION OF A CONDUCTOR IN THE MAGNETIC FIELD OF A CURRENT (GENERATOR WITH AIR-CORED MAGNETS)

The electromotive force of a generator, in which the magnetic field is produced by an iron-free coil and in which the armature has a simple geometric form, can be computed from the dimensions of the generator, the rate of motion of the armature, and the current in the coil. Three methods have been used for determining resistance as the ratio of the induced electromotive force to the current in the coil:

1. *Commutating Generator*

In the case of the commutating generator, a coil or coils rotate in the magnetic field of

the generator, producing an alternating electromotive force in the rotating coil. The rotating coil is connected to the outside circuit through a commutator so that in the outside circuit the current does not change direction. The basic principles involved in the commutating generator are excellent, but no satisfactory experimental test of either of the two modifications has been made. Either modification seems suitable for measurements of high precision.

a. Average value of generated electromotive force (Rosa).—If the commutator is of such a type that the connections to the armature are reversed when the electromotive force is zero, the average value of the generated electromotive force must be balanced against the constant drop in potential over a resistance in series with the field coils of the generator. The essential measurements are the dimensions of the coils and the speed of rotation.

b. Maximum value of generated electromotive force (Lippman).—This method requires a commutator of such a type that contact is made only when the generated electromotive force is a maximum. This maximum electromotive force can be balanced against the drop in potential over a resistance in series with the field coils of the generator. The essential measurements are the same as in the preceding method.

2. Homopolar Generator (Lorenz Apparatus) (Lorenz)

A homopolar generator suitable for measuring the absolute value of a resistance is often called a Lorenz apparatus. It consists of an armature in the form of a disk whose axis coincides with the axes of the field coils of the generator. As an example, the disk may be concentric and coaxial with a long solenoid which has an inside diameter larger than that of the disk. When the disk rotates each of its radial elements cuts the magnetic field produced by the current in the solenoid. Hence there is an electromotive force between the axis and circumference of the disk that can be computed from the dimensions of the disk and solenoid, the speed of rotation of the disk, and the current in the solenoid. This induced

electromotive force is balanced against the fall in potential in a resistance which is in series with the solenoid. The value of this resistance is thus obtained in absolute units.

The Lorenz method has been used more often than any other, but it has inherent weaknesses, which are discussed in a later section. In the hands of skillful manipulators, an accuracy approaching 10 ppm may be obtained as the average of a considerable number of observations.

V. VARYING CURRENTS IN A MUTUAL INDUCTANCE

The ratio of the electromotive force induced in the secondary of a mutual inductor to the varying current in the primary can be employed to determine the absolute value of a resistance. The mutual inductor must be of such form that its inductance can be computed from its measured dimensions.

1. Transient Currents (Rowland)

A transient current is produced in the secondary of a mutual inductor by opening or closing the circuit containing both the primary and a constant electromotive force. During the time that the current is increasing or decreasing in the primary, an electromotive force is induced in the secondary which depends on the mutual inductance and the rate of change of current in the primary. The secondary is connected to a ballistic galvanometer so that the integral of the current produces a deflection of the galvanometer which depends on the resistance of the circuit.

Since this method depends on the reading of a deflection, results more accurate than a part in a thousand cannot be expected. This method has points of similarity with the method of Kirchhoff (III-2) in which one coil is displaced relatively to a second coil carrying a current.

2. Commutated Currents

A commutated current in a circuit containing the primary of a mutual inductance is obtained by periodically reversing the connections to the electromotive force. An alternating electromotive force is induced in the secondary of the mutual inductance. By

means of a second commutator this becomes a series of unidirectional pulses in the external circuit. The average or maximum value of this pulsating electromotive force is compared with the drop in potential over a standard of resistance in the circuit containing the primary.

(a) *Sudden reversal of current (Roiti).*—The commutator may produce a sudden reversal of the current in the primary so that the induced electromotive force in the secondary is, for each reversal, a short, intense pulse. The comparison of the average electromotive force in the secondary with the maximum potential difference across the resistance in the secondary is difficult.

This method has some promise, but requires an extensive modification of the experimental procedure that has been used before it can be expected to give results of precision.

(b) *Step-by-step reversal of current (Wenner).*—The commutator and associated apparatus may be so designed that the current in the primary is increased and decreased in steps while the current through a standard resistor in the primary circuit is nearly constant during any half cycle. The induced electromotive force in the secondary is a series of small and frequent pulses. The total electromotive force in the secondary is made more uniform by introducing an electromotive force produced by an induction generator and by the insertion in the secondary circuit of a large, iron-cored inductor. The fall in potential over the standard resistor in the primary is balanced against the average electromotive force in the secondary. The electromotive forces introduced into the secondary by the generator and the inductance do not affect the balance since the integral value of each is zero.

A determination by this method is in progress at the National Bureau of Standards and is giving results of the highest accuracy.

3. Alternating Currents

The use of alternating currents in precise electrical measurements has largely developed in the last three or four decades, dur-

ing which time very few absolute ohm determinations have been made. Several methods have been proposed and given at least a preliminary trial:

(a) *Intermediary capacitance (Campbell).*—The use of an intermediary capacitance with a mutual inductance involves two different bridges, one of which uses alternating current, the other pulsating current. In the alternating current bridge, the mutual inductance is measured in terms of a capacitance and two resistances. In the pulsating current bridge the same capacitance is measured in terms of a resistance, and the number of pulses per second. By combining the equations of the two bridges, the value of one resistance can be determined in terms of the mutual inductance, the number of pulses per second, and the ratio of two resistances.

The simple theory of this method assumes that the capacitance has the same value for both methods of measurement and that the distributed capacitance of the mutual inductance produces a negligible effect on the computed result. The first assumption is justified if an air capacitor is employed but the second may introduce an error for some types of inductors.

(b) *Two mutual inductances (Campbell).*—In the method involving two mutual inductances, the secondary of one is connected in series with the primary of the other. Then the electromotive force in the secondary of the one is balanced against a resistance in series with the primary of the other. A diagram of the electrical connections is given in Fig. 1, by means of which the description of the method can be simplified. By different adjustments of resistances and inductances, the current in either the upper or the lower circuit of the right-hand portion of the diagram can be made zero at every instant. In either case, the product of two resistances in these circuits is proportional to the product of the square of the frequency of the alternating current and of the values of two inductances. The method is very direct, but the corrections for the inductances of the resistors are not easy to evaluate. An accuracy of a few parts in a million may be attainable.

(c) *Two-phase measured currents (Campbell).*—By using a two-phase, alternating current circuit, the electromotive force in the secondary of a mutual inductance having its primary in one phase can be balanced against the drop in potential over a resistance in the second phase. The currents in the two phases have a phase difference of 90° so that the induced electromotive force in the secondary of the mutual inductor can be made equal, at every instant, to the drop in potential over the resistance. The resistance is determined in terms of the frequency, the mutual inductance, and the

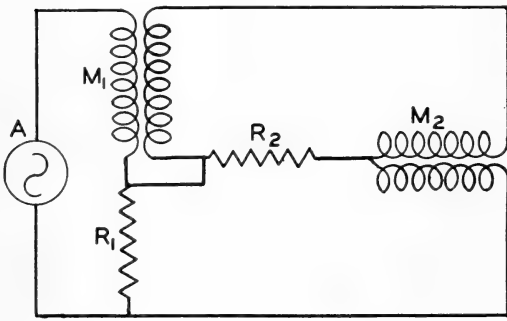

Fig. 1.—The method of Albert Campbell, which employs two mutual inductors in series. As originally described, the resistances R_1 and R_2 and mutual inductances M_1 and M_2 are adjusted to make the current zero in the lower loop of the right-hand side. In the modification by Picard, the adjustments are so made that the current is zero in the upper loop.

ratio of the effective values of the currents, which is obtained by the direct measurement of the current in each phase. These currents can not be measured with high precision, so that an accuracy of a part in 10,000 is all that can be expected of this method.

(d) *Two mutual inductances with two-phase balanced currents (Wenner).*—Two mutual inductances can be so used in a two-phase, alternating current circuit that the currents do not need to be measured, provided a double balance is employed. The primary of one inductor is in one of the phases of the alternating current, and that of the other inductor in the opposite phase. The electromotive force in the secondary of each mutual inductance is balanced against

the drop of potential in a resistance in the circuit of the opposite phase. The arrangement is symmetrical as shown by the diagram of Fig. 2. The product of the two resistances is proportional to the square of the frequency and to the product of the two mutual inductances. The method has never been given an experimental test but appears

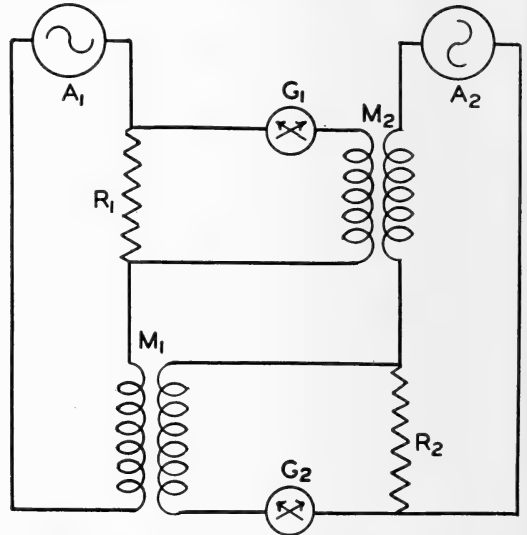

Fig. 2.—The two-phase method using two mutual inductances and requiring two balances. The two windings A_1 and A_2 in the armature of a generator produce alternating electromotive forces which differ in phase by 90° . The resistances R_1 and R_2 , and the mutual inductances M_1 and M_2 , are adjusted until there is no deflection of either of the vibration galvanometers G_1 and G_2 .

capable of giving results of the highest accuracy.

VI. VARYING CURRENTS IN A SELF INDUCTANCE

Self inductance methods that employ a varying current can be classified according to the kind of current employed, such as transient current, commutated current, and alternating current. Regardless of the kind of current, the method involves the use of a self inductor of such form that its inductance can be computed from its mechanical dimensions. A single-layer solenoid wound with round wire makes a suitable self inductor, as it can be precisely constructed and accurately measured, and as exact formulas for the calculation of its induct-

ance are available. Since no other form so well fulfills all essential requirements, the single-layer solenoid has been exclusively used in recent determinations of the absolute value of the ohm where a self inductance is involved.

1. *Transient Currents (Maxwell)*

To employ transient currents with a self inductance, the inductor is placed in one arm of a Wheatstone bridge. There is a key in the battery arm and another in the galvanometer arm. The galvanometer is of the ballistic type. With both keys closed, the bridge is balanced. Then the key in the battery arm is opened, producing a ballistic deflection of the galvanometer. From the period of the galvanometer, the self inductance of the inductor, and the ratio of the resistances in two of the bridge arms, the absolute resistance of a third arm in the bridge can be determined. This method is of historic interest only.

2. *Commutated Currents (Curtis)*

The use of commutated currents in connection with a self inductance for the absolute measurement of a resistance requires a balanced Wheatstone bridge with one commutator in the battery circuit and another in the galvanometer circuit; the two commutators having a phase difference of approximately 90° . A pulsating current is produced in the galvanometer. A second Wheatstone bridge can be employed to send, through the galvanometer, a direct current which just balances the integral value of the pulsating current. The value of the sum of two resistances is determined in terms of a self inductance, a time, the ratio of two electromotive forces, and the ratio of two resistances. The method appears to be capable of giving results of the highest accuracy.

3. *Sinusoidal Currents*

All the methods so far proposed for the use of sinusoidal currents with a self inductance have involved the use of an intermediary capacitance. With such a capacitance, two entirely independent measurements must be made, one to measure a resistance in terms of inductance and ca-

pacitance, and the second to determine this capacitance in terms of resistance and time. From the two results, the resistance in terms of inductance and time can be computed.

a. Intermediary capacitance calibrated by a commutator bridge (Rosa).—The method requires two bridges; one an alternating current bridge to measure the self inductance in terms of a capacitance and two resistances, the other a pulsating current bridge for measuring the same capacitance in terms of resistance and time. By eliminating the capacitance from the equations of the two bridges, the resistance of one arm is given in terms of the self inductance, the number of pulses per second, and two ratios of resistances.

The simple theory of this method assumes that the residual inductances of the resistors in the alternating current bridge are negligible, and that the capacitance has the same value in the two bridges. To eliminate the effect of the residual inductances, there is substituted for the inductor a conductor of the same resistance but made from high resistivity material and having a form such that its inductance can be computed from its dimensions. In this way the effect of residual inductances in the resistors can be accurately evaluated. The capacitance has the same value in both bridges when the dielectric of the capacitor is either a vacuum or air. This method is capable of giving an accuracy of a few parts in a million.

b. Intermediary capacitance calibrated by a resonance bridge (Grüneisen and Giebe).—This method also requires two bridges, but both use alternating current. The first bridge is the same type as that used in the preceding method; the second is a resonance bridge in which the product of a capacitance and inductance is proportional to the reciprocal of the square of the frequency. The balance of a resonance bridge is affected by extraneous capacitances and by the wave form of the alternating current. While the fundamental principles of this method indicate that it should give a precise result, the experimental difficulties have not yet been overcome.

DISCUSSION OF PRECISION METHODS

There are great differences in the accuracy that can be obtained by the different methods. At the present time an accuracy of ten parts in a million should be the goal in any absolute measurement of the ohm. The characteristics that a method must possess in order to give results of high precision are:

1. The resistance to be measured must be that of a standard resistor having a low temperature coefficient.
2. The method must be a null method or one in which galvanometer deflections are only of secondary importance.
3. The method must give the value of a resistance directly in terms of length, time, and permeability, without an absolute measurement of any derived quantity such as current, power, magnetic induction, or magnetic moment.

Applying these requirements to the methods that have been outlined, we see that they can not be satisfied by the calorimetric method (A), by the methods involving a magnet (B, I), by the methods making use of the earth's magnetic field (B, II), by the methods using a nonuniform motion of a coil (B, III), or by methods requiring transient currents in either a mutual or self inductance (B, V, 1, and B, VI, 1). Of the methods that are not thus eliminated, there is only one, the homopolar generator of Lorenz (B, IV, 2), that does not use either commutated currents or alternating currents. The discussion of precision methods will therefore be made under these headings rather than by following the order given in Chart I.

1. THE HOMOPOLAR GENERATOR

The homopolar generator of Lorenz (B, IV, 2), in which the electromotive force induced in a rotating disk by the magnetic field of a current is balanced against the fall in potential in a resistance carrying the current, fulfills all the requirements for a precision method enumerated in the pre-

ceding section. However, there are certain experimental difficulties. The earth's magnetic field induces an electromotive force in the disk, which is added vectorially to that resulting from the current. This difficulty has usually been minimized by making the axis of the disk perpendicular to the direction of the earth's field. In the Lorenz apparatus of the National Physical Laboratory two rotating disks are mounted near the ends of a long shaft. The magnetic field produced in one disk by the current in one set of coils has the opposite direction from the field produced in the other disk by the current in another set of coils. The electromotive forces induced by the current have opposite directions in the two disks, while those induced by the earth's field have the same direction. Hence, the sum of the electromotive forces in the two disks is independent of the earth's field. Another difficulty encountered when using a single disk is the impracticability of making a connection at the center of a disk, but this is avoided by using two disks. An unsolved difficulty results from the heating produced by the friction of the brushes on the rotating disk. This introduces into the circuit of the balancing galvanometer thermal electromotive forces at the brushes. These thermal electromotive forces are very erratic and may be as large as several microvolts, while the induced electromotive forces may be only a thousand times as large. The erratic deflections of the balancing galvanometer must be integrated over a period of several minutes in order to estimate the balance point that the galvanometer would have if thermal electromotive forces were absent. This apparatus at the National Physical Laboratory was used by Smith in 1912 and by Vigoureux in 1936. Each claimed an accuracy of 20 ppm as the average of a large number of measurements. To improve on this accuracy, either the induced electromotive force would have to be increased or the thermal electromotive forces decreased, without introducing any other uncertainty.

2. METHODS EMPLOYING COMMUTATED CURRENTS

Commutated currents or electromotive forces may be used in connection with a mutual inductance, a self inductance, or the armature of an air-cored generator. In the Lippman method (B, IV, 1, b) the maximum value of an induced electromotive force is employed, while in all the other methods the average value is used.

The Lippman method has some of the features of the Lorenz method. The important difference is that the electromotive force is induced in a rotating coil. This coil may have a number of turns, so that the induced electromotive force may be so large that thermal electromotive forces are of no importance. However, the dimensions of the coil while rotating must be accurately determined. This method has not been used for 50 years, but with modern apparatus it should give results of the highest accuracy.

The methods that measure the average value of the commutated currents (B, IV, 1, a; B, V, 2; and B, VI, 2) or electromotive forces have the common difficulty that the current or electromotive force to be measured is made unidirectional by a commutator that reverses the connections to the measuring apparatus when the current or electromotive force is exactly zero. The average value of the pulsating current or electromotive force resulting from the commutation must be compared with a constant current or electromotive force. Probably this can be so well accomplished for all methods that employ commutated currents that each will give results of the highest accuracy. This has been definitely shown at the National Bureau of Standards by Wenner and associates for the method which uses a mutual inductance, but the details of the work have not yet been published.

3. METHODS EMPLOYING ALTERNATING CURRENTS

Alternating current methods have, in recent years, been employed with both mutual and self inductances. At present, more research work is being done to perfect

this class of methods than is the case with any other class. An important group in this class employs an intermediary capacitance which is used in an alternating current bridge with an inductance and also in a pulsating current bridge without the inductance. This requires that the capacitance have the same value in the two types of bridges. That this is a correct assumption for an air capacitor appears to be justified since measurements with different frequencies of alternating current and different rates of pulsation for the pulsating current give the same value of the inductance provided the frequencies and the pulsations are so small that extraneous effects are negligible.

Methods belonging to this group are being used at the Physicalisch-Technische Reichsanstalt of Germany, the Electro-technical Laboratory of Japan, and the National Bureau of Standards. Only two publications giving the details of the experimental procedure have appeared in the last decade. Both of these are by Curtis, Moon, and Sparks, of the National Bureau of Standards, who employed self inductances. The results obtained by using the three inductors described in their first paper showed discrepancies which apparently resulted from slight imperfections in the construction of the inductance standards, although these standards gave evidence of being the equal of any that had been produced elsewhere. In the second paper, they describe a self inductor which has such uniform dimensions that the uncertainty in the computed inductance was much less than that for their previous inductors. The electrical measurements have been improved, so that the final result appears to be in error by only a few parts in a million. It seems probable that equally good results can be obtained with a mutual inductance, but Yoneda who is using one at the Electro-technical Laboratory has not yet published the details of his work.

The method of Campbell (B, V, 3, b), which uses two mutual inductances (Fig. 1), requires a very stable frequency and an alternating current for which the wave form

is very nearly sinusoidal. In the form as originally proposed, some copper resistances have to be evaluated. Picard's modification avoids this difficulty, but requires the evaluation of both a self and a mutual inductance. In any case there are a number of correction terms depending on the residual inductances of resistors and the capacitances of each part of the apparatus to other parts and to earth. If the apparatus is suitably designed and properly operated, either modification of this method will give results of high accuracy.

A determination was recently made at the National Physical Laboratory by Hartsorn and Astbury using Campbell's original method. They estimate that the error in their electrical measurements is less than 5 ppm, while there is an uncertainty in the value of the computed inductance of their standard mutual inductor of 10 ppm. A determination using the Picard modification has recently been made at the Laboratoire Central d'Electricité by Jouaust, Picard, and Héron. They had so much difficulty in constructing their inductor and in making precise mechanical measurements upon it that their result is not of high accuracy.

Wenner's two-phase method (B, V, 3, d) also seems capable of giving results of high accuracy. It requires the simultaneous balancing of two circuits. (See Fig. 2.) The wave form of the current in both phases must be nearly sinusoidal, the frequency constant, and the phase angle between the currents must be known. It is a promising method that has never been given an experimental test.

In Table 1 is given in chronological order a list of all the important results on the absolute ohm. All results have been reduced, when necessary, to the length of the mercury column, 1 mm² in cross section and maintained at 0°C., which would give a resistance of one absolute ohm. This reduction has been necessary for many of the results that were obtained between 1875 and 1885, when investigators usually gave the value of the B.A. unit in absolute ohms. These results have been converted to the

length of the standard mercury column by using the values obtained in contemporary measurements on the resistivity of mercury. Also the reduction has been required for all results obtained during the last two decades when investigators have expressed their results in terms of the international ohm as maintained by their national laboratory. These results can readily be converted to mean international ohms as a result of the international comparisons that have been made at periodic intervals. The mean international ohm is the mean of the units of the national laboratories. Hence, recent results have been reduced to the same basis as the earlier results by assuming that the mean international ohm is represented by a column of mercury at 0°C., which has 1 mm² cross section⁴ and a length of 106.3000 cm.

The bibliography included in this review has been prepared not only to give references to the different determinations but also to present the salient facts connected with the work.

This paper is a historical study of an important phase of physics. The question of the present relationship between the absolute ohm and international ohm has been intentionally omitted. The International Committee of Weights and Measures decided in 1939 that the most probable value of this relationship is

$$\begin{aligned} 1 \text{ mean international ohm} \\ = 1.00048 \text{ absolute ohms.} \end{aligned}$$

A more definite value will be promulgated by this committee when conditions warrant. A committee of the National Research Council has under consideration the question of recommending a value to be used in the United States.

⁴ The specifications for the mercury ohm as prepared by the Chicago Electrical Congress of 1893 give the mass of mercury instead of the cross section of the tube. This was adopted because the cross section is experimentally determined from the mass and density of the mercury and the length of the tube. By specifying mass, a knowledge of the density of mercury and of the cross section of the tube is not required. However, the Congress intended that the cross section of the tube should be 1 mm².

TABLE I.—RESULTS OF ABSOLUTE DETERMINATIONS OF THE OHM

Year	Author	Principle of method	Number in chart	Results expressed in length of Hg column (cm) having cross section of 1 mm ²		Remarks
				Published	Deduced or corrected	
1849	Kirchhoff	Displacement of a coil	B, III, 2		140	Results expressed in terms of resistivity of copper.
1851	W. Weber	Earth inductor	B, II, 1		91	Results expressed in Jacobi's units.
		Damping of magnet	B, I, 1		91	
1862	W. Weber	Earth inductor	B, II, 1		98	
1863	Maxwell, Stewart, Jenkin	Rotating coil in earth's field	B, II, 2, b		105.02 or 104.70	Authors give magnitude of difference from 1864 result but not sign.
1864	Maxwell, Stewart, Jenkin	As above	B, II, 2, b	104.56	104.86	Results used to establish the B.A. unit. Corrected value by Jenkin in 1871.
1867	Joule	Generation of heat	A		105.91	Results expressed as 1 B.A. unit = 0.98953 ohm.
1870	Kohlrausch	Earth inductor	B, II, 1	102.9		A careful research. Result confirms that of B.A. Committee.
1873	Lorenz	Rotating disk	B, IV, 2	107.1		
1877	H. F. Weber	Damping of magnet	B, I, 1	104.79		
		Mutual inductance with transient currents	B, V, 1	104.67		
1878	Rowland	Generation of heat Mutual inductance, transient currents	A B, V, 1	104.71	105.7	Results expressed as 1 B.A. ohm = 0.9911 earth quadrant/sec.
1881	Rayleigh, Schuster	Rotating coil in earth's field	B, II, 2, b		105.8	Author's result 1 B.A. ohm = 0.9893 earth quadrant/sec.
1882	Dorn	Damping of magnet	B, I, 1	105.46		Author's result 1 B.A. unit = 0.98651 earth quadrant/sec and 1 mercury unit = 0.95418 B.A. unit.
1882	Rayleigh	Rotating coil in earth's field	B, II, 2, b		106.23	
1882	H. Weber	Rotating coil in earth's field	B, II, 2, b		106.14	Result given as 1 B.A. unit = 0.9877 ohm.
1883	Glazebrook, Dodds, Sargent	Mutual inductance, transient currents	B, V, 1		106.22	Result given as 1 B.A. unit = 0.98665 ohm.
1883	Rayleigh, Sidgwick	Rotating disk	B, IV, 2	106.214		Also states 1 B.A. unit = 0.98677 × 10 ⁻⁹ C.G.S.
1884	Wiedemann	Earth inductor	B, II, 1	106.19		Authors state that result with mutual inductance is the more reliable.
1884	H. F. Weber	Earth inductor	B, II, 1	105.31		
1884	Himstedt	Mutual inductance, commutated currents	B, V, 2	105.98		
1884	Mascart, deNerville, and Benoit	Earth inductor Mutual inductance transient currents	B, II, 1 B, V, 1	106.33 106.30		
1884	Roiti	Mutual inductance, commutated currents	B, V, 2	105.896		Corrected by Dorn. Estimated results accurate to 1 per cent.
1884	Wild	Damping of magnet	B, I, 1	106.027	106.2	
1884	Baille	Damping of magnet	B, I, 1	105.7		Preliminary results.
1884	Rowland, Kimball	Mutual inductance, transient currents	B, V, 1	106.34		
1885	Fletcher	Rotating disc Generation of heat	B, IV, 2 A	106.32	105.90	Results expressed as 1 B.A. unit = 0.9104 earth quadrant/sec.
1885	Lorenz	Rotating disc	B, IV, 2	105.93		A very careful determination. Correction by author. Also state: 1 B.A. unit = 0.9863 ohm. Corrected by Leduc.
1885	Himstedt	Mutual inductance commutated currents	B, V, 2	106.08		
1888	Kohlrausch	Damping of magnet	B, I, 1	106.32		A very careful determination. Correction by author. Also state: 1 B.A. unit = 0.9863 ohm. Corrected by Leduc.
1889	Dorn	Damping of magnet	B, I, 1	106.243	106.245	
1889	Duncan, Wilkes, Hutchinson	Rotating disk	B, IV, 2	106.34		A very careful determination. Correction by author. Also state: 1 B.A. unit = 0.9863 ohm. Corrected by Leduc.
1890	Wuilleumier	Commutating generator. Maximum electromotive force	B, IV, 1, b	106.267	106.32	

TABLE 1.—RESULTS OF ABSOLUTE DETERMINATIONS OF THE OHM—*Continued*

Year	Author	Principle of method	Number in chart	Results expressed in length of Hg column (cm) having cross section of 1 mm ²		Remarks
				Published	Deduced or corrected	
1890	Jones	Rotating disk	B, IV, 2	106.307		
1891	Wiedemann	Earth inductor	B, II, 1	106.265	106.249	Recomputed by Peter.
1894	Jones	Rotating disk	B, IV, 2	106.326		Estimates accuracy as 1 in 10,000.
1895	Himstedt	Mutual inductance commutated currents	B, V, 2, a	106.282		
1897	Ayrton, Jones	Rotating disk	B, IV, 2		106.274	Result expressed as 1 Board of Trade ohm = 1.00026 true ohms.
1899	Guillet	Mutual inductance, commutated currents	B, V, 2, a	106.20		
1912	Campbell	Mutual inductance, sinusoidal currents a. Two-phase b. Intermediary condenser	B, V, 3, c B, V, 3, a		106.327 106.329	Results in N.P.L. units. Author's estimate of error is 1 in 10,000. Preliminary.
1914	Smith	Rotating disk	B, IV, 2	106.245		Author's estimate of error is 4 in 100,000.
1920	Grüneisen, Giebe	Self inductance, sinusoidal currents with intermediary condenser	B, VI, 3, a	106.246		Result given is 1 int ohm = 1.00051 ± 0.00003 abs ohms
1925	Campbell	Two mutual inductances	B, V, 3, b	106.246		Author's estimate of error is 1 in 10,000.
1936	Curtis, Moon, Sparks	Self inductance with intermediary capacitance	B, VI, 3, a		106.2519	Result expressed as 1 NBS int ohm = 1.000450 abs ohms.
1937	Vigoureux	Rotating disk	B, IV, 2		106.2471	Result expressed as 1 NPL int ohm = 1.000495 abs ohms.
1937	Yoneda	Mutual inductance with intermediary capacitance	B, V, 3, a		106.2506	Result expressed as 1 ETL int ohm = 1.000455 ± 20 abs ohms.
1937	Hartshorn, Astbury	Two mutual inductances in series	B, V, 3, b		106.2464	Result expressed as 1 NPL int ohm = 1.000501 abs ohms.
1938	Jouaust, Picard, Héron	Two mutual inductances in series	B, V, 3, b		106.245	Result expressed as 1 LCE int ohm = 1.00052 abs ohms.
1938	Curtis, Moon, Sparks	Self inductance with intermediary capacitance	B, VI, 3, a		106.2488	Result expressed as 1 NBS int ohm = 1.000479 abs ohms.
1939	Zickner	Self inductance with intermediary capacitance	B, VI, 3, a		106.241	Result expressed as 1 PTR int ohm = 1.00051 abs ohms.
1939	Wenner, Thomas, Cooter, Kotter	Mutual inductance with commutated currents	B, V, 2, b		106.2482	Result expressed as 1 NBS int ohm = 1.000485 abs ohms.

BIBLIOGRAPHY ON ABSOLUTE OHM MEASUREMENTS

(All titles are given in English)

1849. G. R. KIRCHHOFF.

Determination of the constant on which the intensity of the induced current depends.
Ann. Phys. Chem. **76**: 412.

This is the first determination of a resistance in terms of mechanical units and permeability. The primary purpose of the article was to determine the permeability of air in terms of the resistivity of copper. The final conclusion was, "The constant ϵ equals

unity if the unit of velocity is 1000 ft/sec and the unit of resistance is a copper wire of a square line cross section and a length of 0.434 inch." The Prussian/foot = 31.4 cm. 144 lines = 12 inches = 1 foot.

1851. WILHELM WEBER.

Measurements of electrical resistance according to an absolute standard. Ann. Phys. Chem. **82**: 337. (Translated in Phil. Mag. (4) **22**: 226, 261, 1861.)

Outlined a complete system of electric units based on the mechanical units. Gave two methods for determining the absolute ohm; one the earth inductor rotating through 180° and the other the damping of a magnet. The two results agree to 0.3 per cent. Results were given in Jacobi's units and have been reduced to the length of a mercury column by values given in 1864 B.A. Report. See complete reference below (1863-64).

1862. WILHELM WEBER.

On electrical measurements. Abh. Math. Klasse Göttingen Ges. **10**: 3. (Also printed separately under the title *Zur Galvanometrie*, Göttingen, 1862.)

A very long article dealing with many phases of electrical measurements. States result on ohm (p. 58) as the Siemens standard resistance = 10257000 meter/second. If this refers to a Siemens Einheit, then the length of the mercury column is 98 cms for an absolute ohm. The B.A. report of 1865 gives the value as 96. The author notes the unsatisfactory state of resistance standards.

1863-64. J. CLERK MAXWELL, BALFOUR STEWART, and FLEMING JENKIN.

Description of an experimental measurement of electrical resistance made at King's College. Rep. British Assoc. **33**: 163, 1863; **34**: 345, 1864. (Also in Reports of the Committee on Electrical Standards of B.A. edited by F. E. Smith, pp. 140, 166.)

Results used to establish the B.A. unit of resistance. Individual results differ by several per cent. There was an uncertainty of 2 per cent in the mercury resistors then available while the probable error of the 1864 result was only 0.1 per cent.

1867. J. P. JOULE.

Determination of the dynamical equivalent of heat from the thermal effect of electric currents. Rep. British Assoc. **37**: 474. (Also in Reports of Electrical Standards Committee of B.A. p. 256, 1913; edited by F. E. Smith.)

Makes experiments with both mechanical and electrical calorimeter. Does not emphasize the result on the ohm.

1870. F. KOHLRAUSCH.

Determination of the Siemens unit of resistance in absolute measure. Nachr. Ges. Wiss. Göttingen (abstract) **10**: 513. (Also Ann. Phys. Chem., Ergänzungsband 6, p. 1, 1874; translation: Phil. Mag. (4) **47**: 294, 342, 1874.)

Uses the same apparatus as employed by W. Weber in 1862. Rowland, in Phil. Mag. (4) **50**: 161, 1875, suggested a modification of the theory which might change the result by 2 per cent.

1873. L. LORENZ.

The electrical resistivity of mercury in absolute measure. Ann. Phys. Chem. **149**: 251.

First use of the rotating disk as a homopolar generator. The resistance measured, about 0.002 ohm, was too small to compare accurately with a mercury column 1 meter long.

1877. H. F. WEBER.

Electromagnetic and calorimetric absolute measurements: The absolute value of Siemens unit of resistance in electromagnetic measure; the relation between current-work and the heat-evolution in stationary galvanic currents; and the absolute values of some constant hydroelectric forces in electromagnetic measure. Natur. Ges. Zurich, Vierteljahrsschr. **22**: 273. (Translation in Phil. Mag. (5) **5**: 30, 127, 189, 1878.)

Used three methods and concluded that all gave the same result. His value agreed with that of the B.A. Committee.

1878. HENRY A. ROWLAND.

Research on the absolute unit of resistance. Amer. Journ. Sci. **115**: 281, 325, 430. (Also Collected Papers, p. 145.)

First experimenter to show definitely that the B.A. unit was in error by more than 1 per cent.

1880. W. WEBER and F. ZÖLLNER.

An apparatus for use in absolute measurements in electrodynamic with practical applications. Ber. Sächs. Ges. Wiss. Math-Phys. Klasse **32**: 77.

Work interrupted by death of Zöllner. Completed in 1884 by G. Wiedemann.

1881. LORD RAYLEIGH and A. SCHUSTER.

Determination of the ohm in absolute measure. Proc. Roy. Soc. **32**: 104.

Used the method employed by Maxwell, Stewart, and Jenkin, with much of their apparatus. Improved method of obtaining inductance of coil. Used water motor for driving coil.

1881. G. CAREY FOSTER.

Account of preliminary experiments on the determination of the ohm in absolute measure. British Assoc. Rep. **51**: 423. (Also Reports of Committee on Electrical Standards, p. 296, 1913; Electrician **7**: 266, 1881.)

Described a method in which the electromotive force induced in a coil rotating in the earth's field is balanced against the fall of potential of a known current in the resistance to be measured. Preliminary results check B.A. ohm.

1882. LORD RAYLEIGH.
Experiments to determine the value of the British Association unit of resistance in absolute measure. Phil. Trans. Roy. Soc. **173** (pt. 2): 661.
 Used same method as in previous experiment but constructed new apparatus. Gave value in B.A. units. To convert to mercury column, see Rayleigh and Sidgwick on the Specific Resistance of Mercury, Proc. Roy. Soc. **34**: p. 27. 1882.
1882. G. LIPPMAN.
The methods to be employed for the determination of the ohm. Journ. Physique (2) **1**: 313.
 Proposed a method for balancing the maximum electromotive force of a continuously rotating earth inductor against the fall in potential in a resistance produced by a measured current. No results.
1882. J. JOUBERT.
Method for determination of the ohm. Compt. Rend. Acad. Sci. **94**: 1519.
 Suggested a method in which (1) the effective electromotive force induced in a coil rotating in the earth's field is measured by an electrometer, and (2) the drop in potential over a resistance through which a known current is flowing is measured by the same electrometer. No results.
1882. HEINRICH WEBER.
The rotation inductor, its theory and its use for the determination of the ohm in absolute measure. (Published in book form by Teubner, Leipzig, 1882, translated in Phil. Trans. Roy. Soc. **174** (pt. 1): 223. 1883.)
 Used a rotating coil in the earth's field with axis horizontal.
1882. E. DORN.
The determination of the Siemens unit in absolute measure. Ann. Phys. Chem. **253**: 773.
 Use a method that depended on the damping of a magnet.
1882. A. ROITI.
Method for the determination of the ohm. Atti. Acc. Sci. Torino **17**: 588. (Also Nuovo Cimento **12**: 60. 1882.)
 Outlined method for using a commutated current with a mutual inductance. No result.
1883. R. T. GLAZEBROOK, J. M. DODDS, and E. B. SARGENT.
Value of the British Association unit of resistance. Phil. Trans. Roy. Soc. **174** (pt. 1): 223.
 Worked under direction of Lord Rayleigh.
1883. LORD RAYLEIGH and MRS. H. SIDGWICK.
Experiments, by the method of Lorenz, for the further determination of the absolute value of the British Association unit of resistance. Phil. Trans. Roy. Soc. **174** (pt. 1): 295. (Abstract in Proc. Roy. Soc. **34**: 438. 1883.)
 This research was very carefully planned and skillfully executed.
1883. M. BRILLOUIN.
Methods for the determination of the ohm. Comp. Rend. Acad. Sci. **96**: 190.
 Suggested the use of alternating currents in connection with a mutual inductance. No results.
1883. J. FROELICH.
On the determination of the ohm by dynamical methods. Ann. Phys. Chem. **255**: 106.
 Gave a rough outline of a method that involves the rotation of one coil with respect to another. The important contribution is a formula for computing mutual inductance.
1884. G. WIEDEMANN.
On the determination of the ohm. Abh. Berlin Akad., Phys. Kl., **3**: 75. Lumière Electrique **12**: 419.
 Continued work of Weber and Zöllner (1880), which was interrupted by Zöllner's death. Value of 106.265 cm of mercury given in Abh. Berlin Akad. Corrected to 106.19 in Lumière Electrique.
1884. H. F. WEBER.
The absolute value of the Siemens mercury unit and the magnitude of the ohm in terms of a mercury column. (Published in book form by Zürcher & Furrer of Zürich.)
 Observed ballistic throw of a tangent galvanometer produced by the rotation of an earth inductor through 180°.
1884. F. HIMSTEDT.
On a method for determining the ohm. Ann. Phys. Chem. **258**: 281.
 Published a method of using a mutual inductance with commutated currents but gave no result on the ohm. Fundamental principle same as that of Roiti.
1884. M. MASCART, F. DE NERVILLE, and R. BENOIT.
Determination of the ohm and its value in terms of a column of mercury. Ann. Phys. Chem. (6) **6**: 5. (Abstract in Journ. Physique (2) **3**: 230. 1884.)
 Used two methods: One an earth inductor with galvanometer and the other a variable mutual inductor substituted for the earth inductor.

1884. A. ROITI.

Determination of the electrical resistance of a wire in absolute measure; preliminary note. Nuova Cim. (3) 15: 97. (Also Atti Accad. Sci. Torino 19: 643. 1884.)

Used a mutual inductance with commutated current.

1884. G. MENGARINI.

Method for the determination of the ohm in absolute measure. Atti Accad. Lincei (3) 8: 318.

Proposed a method by which the resistance of a horizontal coil may be measured from the decrease in acceleration of a magnet falling through the coil and the electrical energy induced in the coil. No results.

1884. H. WILD.

Determination of the value of the Siemens unit of resistance in absolute electromagnetic units. Ann. Phys. Chem. 259: 665. (Original publication in Trans. St. Petersburg Acad.)

Original Value of 106.027 later corrected by Dorn (Ann. Phys. Chem. 271: 273. 1888) to 106.2.

1884. J. B. BAILLE.

On the determination of the ohm by the method of the damping of a moving magnet. Ann. Télégr. 11: 89, 131.

1884. H. A. ROWLAND and A. S. KIMBALL.

Report in Philadelphia Electrical Congress, p. 41. 1884; Electrical World 6: 27. 1885.

Reporter's account of Rowland's paper before the British Association in La Lumière Electrique 26: 188. 1887. Second article reprinted in Rowland's Collected Works, p. 239. A personal letter from one of Rowland's assistants stated that, in disassembling the apparatus, Rowland discovered two pieces of iron in the frames on which the coils were wound. That made him uncertain as to the results, so that only preliminary values have been published.

1885. L. B. FLETCHER.

A determination of the B.A. unit in terms of the mechanical equivalent of heat. Phil. Mag. (5) 20: 1; Amer. Journ. Sci. 130: 22.

Work done at Johns Hopkins University, Baltimore, Md., using Rowland's value of the mechanical equivalent of heat.

1885. L. LORENZ.

Determination of the electrical resistance of a mercury column in absolute electromagnetic units. Ann. Phys. Chem. 261: 1.

Gave more attention to the mercury ohm than to the absolute measurement.

1885. F. HIMSTEDT.

A determination of the ohm. Ann. Phys. Chem. 262: 547. (Translation in Phil. Mag. (5) 20: 417. 1885; Sitz. Ber. Akad. Wiss. Berlin, pt. 2; 753. 1885. Corrections in Ann. Phys. Chem. 264: 338, 1886; 267: 617. 1887.)

Used same method as in 1884. Value of 105.98 finally corrected to 106.08.

1888. F. KOHLRAUSCH.

On the electrical resistivity of mercury. Ann. Phys. Chem. 271: 700. (Also Collected Works, vol. 1, p. 773.)

A very elaborate set of experiments giving considerable attention to the mercury ohm.

1889. E. DORN.

A determination of the ohm. Ann. Phys. Chem. 272: 22, 398.

A very elaborate determination with observations running over more than a year. Compared resistances with the mercury ohm of Kohlrausch.

1889. L. DUNCAN, G. WILKES, and C. T. HUTCHINSON.

A determination of the value of the B.A. unit of resistance in absolute measure by the method of Lorenz. Phil. Mag. (5) 28: 98.

Used Rowland's apparatus. Result in B.A. units and in terms of the mercury column as obtained from work of Hutchinson and Wilkes, Phil. Mag. (5) 28: 17. 1889.

1890. M. H. WUILLEUMIER.

Determination of the ohm by the electrodynamic method of M. Lippman. Journ. Phys. 9: 220.

Rotated a coil inside a long solenoid, comparing the maximum induced electromotive force with the drop in potential over a resistance in series with the solenoid. Leduc (Compt. Rend. Acad. Sci. 118: 1246. 1894) corrected result for finite length of solenoid.

1890. J. V. JONES.

On the determination of the specific resistance of mercury in absolute measure. Phil. Trans. 182: 1.

Mercury contained in a paraffin trough. Method of rotating disk used for resistance measurements.

1891. G. WIEDEMANN.

On the determination of the ohm. Ann. Phys. Chem. 278: 227, 425.

Completion of the work of W. Weber and Zöllner for which there was a first report in 1884. Peter (Ber. Versich. Akad. Wiss. Leipzig, Math.-phys. Kl., 46: 139. 1894) corrected result by considering finite cross section of coil of tangent galvanometer.

1894. J. V. JONES.

On the determination of the international ohm in absolute measure. Rep. British Assoc. Adv. Sci., 1894, p. 123. (Also Rep. Comm. of B.A. on Electrical Standards, p. 489, 1913.)

Used same apparatus as in 1890.

1895. F. HIMSTEDT.

On an absolute resistance measurement. Ann. Phys. Chem. **290**: 305.

Used a mutual inductance with commutated currents. Measured primary and secondary currents by a tangent galvanometer. The mutual inductance consisted of a coil within a solenoid. Employed two solenoids and several coils. Results vary by a few parts in 10,000.

1897. W. E. AYRTON and J. V. JONES.

On a determination of the ohm made in testing the Lorenz apparatus of the McGill University, Montreal. Rep. British Assoc. Adv. Sci., 1897, p. 212. (Also Rep. Comm. of B.A. on Electrical Standards, p. 567, 1913.)

Result expressed in Board of Trade ohms; was later reduced to mercury ohm by F. E. Smith (Coll. Res. of NPL **11**: 209, 1914. Reduction on p. 217).

1899. A. GUILLET.

Direct determination of an absolute kilohm. Journ. Physique (3) **8**: 471.

Commutated currents were used with a mutual inductance and differential galvanometer. Apparatus poorly described.

1908. E. B. ROSA.

A new method for the absolute measurement of resistance. Bull. Bur. Standards **5**: 499.

Gave theory of a method using a commutating generator. No results.

1912. ALBERT CAMPBELL.

On the determination of the absolute unit of resistance by alternating current methods. Proc. Roy. Soc. London **87**: 391.

Used mutual inductance with two different methods, (1) two-phase measured currents, and (2) intermediary condenser. Purpose was to investigate methods rather than obtain an exact result.

1914. F. E. SMITH.

Absolute measurement of a resistance by a method based on that of Lorenz. Phil. Trans. Roy. Sci. **214-A**: 27; NPL Coll. Res. **9**: p. 209.

This determination, made at the National Physical Laboratory, is more precise than any that preceded it. Every source of error

was checked. Almost simultaneously (see Report of National Physical Laboratory for 1912, p. 39) a comparison of the resistance standards used was made with the mercury ohm.

1920. E. GRÜNEISEN and E. GIEBE.

A new determination of the absolute unit of electrical resistance. Wiss. Abh. P.T.R. Charlottenburg **5**: 1, 1921. (Abbreviated article in Ann. Phys. **368**: 179, 1920.)

A determination using self inductance and alternating current. Accuracy compares with that of Smith. Measurements completed in 1914, but publication delayed by war. A direct comparison was made with Smith's resistance standards. Result showed that the error of a mercury ohm determination is of the same order as the error in an absolute determination.

1925. A. CAMPBELL.

On the determination of resistance in terms of mutual inductance. Proc. Roy. Soc. London **107**: 310.

Simple experiments to test feasibility of the method that employs two mutual inductances in series.

1936. H. L. CURTIS, C. MOON, and C. M. SPARKS.

An absolute determination of the ohm. Journ. Res. Nat. Bur. Standards **16**: 1.

Three different self inductors were used.

1937. J. E. P. L. VIGOUREUX.

Determination of the ohm by the method of Lorenz. Coll. Res. NPL **24**: 209, 1936-7.

Used apparatus described by F. E. Smith (1914) but remeasured the mechanical dimensions.

1937. RINKICHI YONEDA.

Absolute determination of electrical resistance. Proc. Verb. Comm. Int. Poids et Mes. (2) **18**: 178.

Used alternating currents with a mutual inductance. An intermediary capacitance was employed.

1937. L. HARTSHORN and N. F. ASTBURY.

The absolute measurement of resistance by the method of Albert Campbell. Phil. Trans. Roy. Sci. **236A**: 423.

An extremely careful determination. Estimated uncertainty is 5 ppm for the electrical measurements and 10 ppm for the value of the computed inductance. There are numerous small corrections.

1938. R. JOUAUST, M. PICARD, and R. HÉRON.

Determination of the unit of resistance in the CGS electromagnetic system. Bull. Soc. Franc. Elec. (5) **8**: 1.

An extensive investigation, but the apparatus available gave results accurate only to parts in a hundred thousand. Used Piccard's modification of Campbell's method (Compt. Rend. Acad. Sci. 189: 125. 1929).

1938. H. L. CURTIS, C. MOON, and C. M. SPARKS.

A determination of the absolute ohm, using an improved self inductor. Journ. Res. Nat. Bur. Standards 21: 375.

Used a self inductor of superior construction.

1939. G. ZICKNER.

On the condition of the experiments for the determination of the international ohm in absolute units. MS. Report to the International Committee of Weights and Measures. Not yet published.

1939. F. WENNER, J. L. THOMAS, I. L. COOTER, and F. R. KOTTER.

Preliminary report on the absolute measurement of a resistance based on the reversal of a direct current in a mutual inductance. A report sent to the International Committee of Weights and Measures in December, 1938.

Apparatus not described.

1940. H. L. CURTIS and L. W. HARTMAN.

A dual bridge for the measurement of self inductance in terms of resistance and time. Journ. Res. Nat. Bur. Standards 25: 1.

An experimental test of the method for using commutated currents with a self inductance.

MEDICAL ENTOMOLOGY.—*Experimental transmission of endemic typhus fever by the sticktight flea, Echidnophaga gallinacea.*¹ JOSEPH E. ALICATA, Hawaii Agricultural Experiment Station, University of Hawaii.

In 1931, Dyer, Rumreich, and Badger (1, 2) first demonstrated the natural infection of the rat fleas *Xenopsylla cheopis* and *Ceratophyllus fasciatus* with endemic typhus. The fleas were collected from wild rats trapped at typhus foci in Baltimore, Md., and Savannah, Ga. In 1931 and 1932 Dyer (3, 4) and collaborators were also able to demonstrate experimentally the susceptibility of these fleas to endemic typhus. In 1932, Mooser and Castaneda (5) reported experimental transmission of this disease by the following fleas: *Leptopsylla musculi*, *Ctenocephalus* (= *Ctenocephalides*) *felis*, *C. canis*, and *Pulex irritans*. Blanc and Baltazard (6) also reported *P. irritans* as a carrier of endemic typhus. In 1933 Workmann (7) reported the experimental transmission of endemic typhus by *Xenopsylla astia*.

¹ Published with the approval of the director as Technical Paper No. 93, Hawaii Agricultural Experiment Station. This study has been conducted through special funds appropriated by the Public Health Committee, Chamber of Commerce of Honolulu. Received October 6, 1941.

The writer is indebted to Drs. R. E. Dyer and N. H. Topping, of the National Institute of Health, U. S. Public Health Service, Washington, D. C., for supplying the Wilmington strain of endemic typhus used in the experiments reported in this paper. Acknowledgment is made also to Dr. R. D. Lillie, of the National Institute of Health, for the histological examination of the brain of one of the experimental animals.

The present paper deals with the experimental transmission of endemic typhus by the sticktight flea *Echidnophaga gallinacea*. So far as is known to the writer, the susceptibility of this flea to endemic typhus has not previously been reported.² The finding is of considerable interest in the Hawaiian Islands since the flea is of common occurrence on rats as well as on dogs, cats, mongooses, and chickens. According to a survey conducted by Eskey (8), *E. gallinacea* has been found on 13 percent of the rats trapped in the city of Honolulu. This flea frequently infests rats in large number, Eskey having shown that about 52 percent of the fleas collected on rats of the island of Oahu were found to be sticktight fleas.

EXPERIMENTAL DATA

On April 12, 1941, about 150 sticktight fleas were obtained from the ears of a dog in Honolulu. In order to be assured of absence of natural infection, 50 fleas were emulsified in physiological saline solution

² After this paper was sent to the editor, the writer noted a recent publication by Dr. G. D. Brigham (Pub. Health Rep. 56(36): 1803-1804. Sept. 5, 1941) reporting the recovery of typhus virus from sticktight fleas (*E. gallinacea*) removed from two rats collected in Georgia. This report adds to the public health importance of these fleas.

and injected intraperitoneally into two guinea pigs. Neither of these animals developed any signs of typhus fever during a period of two weeks, nor was either found immune following experimental inoculation with a known endemic typhus virus (Wilmington strain) obtained from National Institute of Health, U. S. Public Health Service. The remaining fleas were placed on the body of a white rat freshly inoculated

were placed into a small test tube overnight. The following morning the fleas and eggs were removed from the test tube, and all the feces of the fleas found adhering to the walls of the test tube were taken up in saline solution and inoculated intraperitoneally into a male guinea pig (No. 53). At the same time all the fleas were emulsified in saline solution and inoculated intraperitoneally into a male guinea pig (No. 54).

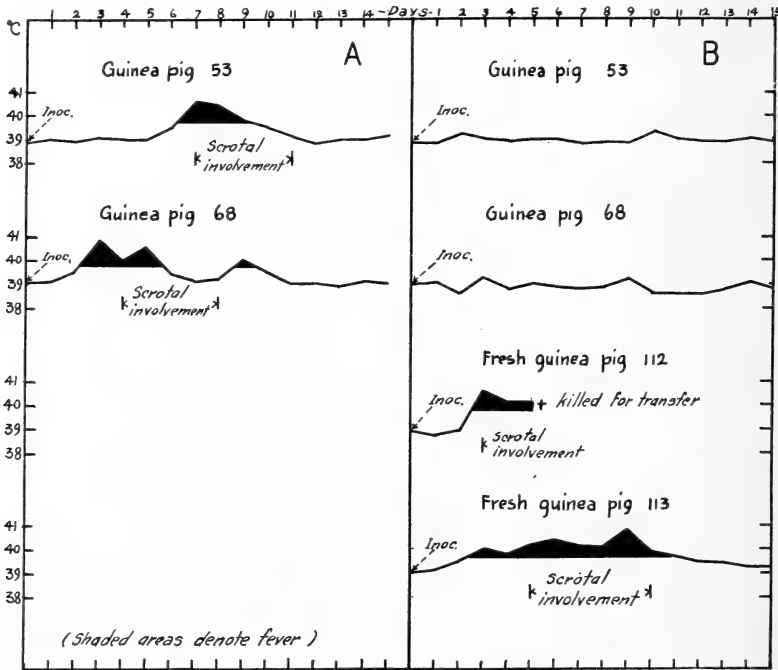

Fig. 1.—Cross immunity test: Daily temperature records of (A) guinea pigs inoculated with virus recovered from the sticktight fleas; (B) guinea pigs inoculated with the known endemic typhus virus (Wilmington strain).

with 2.5 cc of testicular washings from a guinea pig experimentally infected with the Wilmington strain of endemic typhus. Two guinea-pig controls, injected with the same inoculation, developed typical fever and scrotal reaction.

Most of the fleas that were placed on the rat attached themselves in a short time to various parts of the body particularly around the ears, eyes, and face. Thirteen days after the experimental infestation the rat was killed by a blow on the head, and 82 fleas were carefully removed. These fleas

A few days after these inoculations, both guinea pigs developed clinical typhus.

Guinea pig 53 was later found to be immune when inoculated with the Wilmington strain of endemic typhus (Fig. 1). Guinea pig 54 (first generation) was killed on the second day of fever and testicular involvement, and testicular washings from this animal were inoculated into guinea pig 57 (second generation). From this animal the strain was passed to three guinea pigs, 68, 69, and 70 (third generation), and later the strain was passed from guinea pig 69 to

guinea pig 97 (fourth generation). All the guinea pigs involved in the passage of the virus developed clinical endemic typhus. One of the animals (No. 68) of the third generation was then tested for susceptibility to endemic typhus and was found immune. Blood cultures made from the guinea pigs were uniformly negative. Scrapings from the tunica vaginalis of these animals also revealed intracellular rickettsial bodies.

no agglutination in any dilution; second week, complete agglutination (four plus) in the 1:10 and 1:20 dilutions and partial (two plus) in the 1:40 dilution. Third week, complete agglutination in 1:10, partial (two plus) in 1:20, and traces (one plus) in 1:40. Fourth week, complete agglutination (three plus) in 1:10 and traces (one plus) in 1:20.

The brain of one of the guinea pigs (No. 70) reported in these experiments was submitted to Dr. R. D. Lillie, of the National

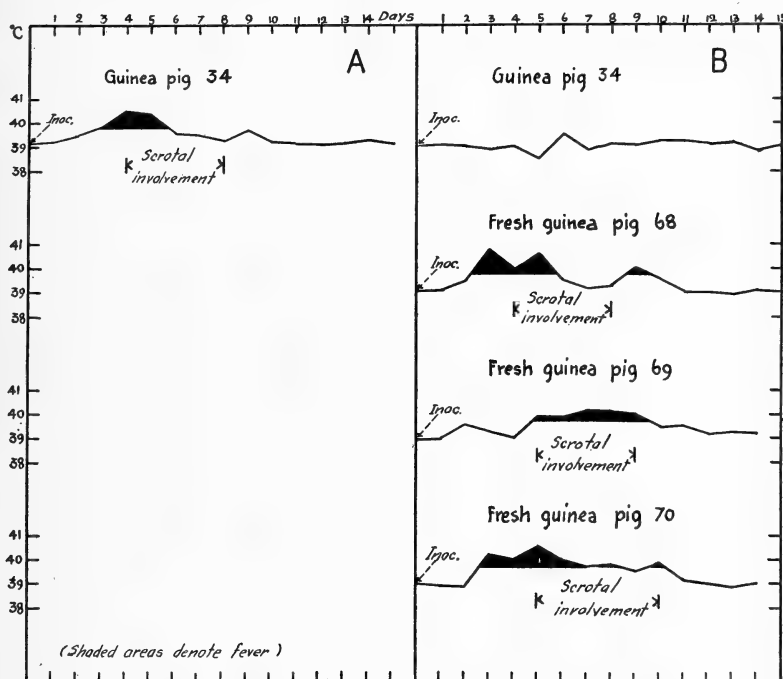

Fig. 2.—Cross immunity test: Daily temperature records of (A) guinea pig inoculated with the known endemic typhus virus (Wilmington strain); (B) guinea pigs inoculated with the virus recovered from the sticktight fleas.

As indicated in Figs. 1 and 2, cross-immunity tests were found to be complete between the flea strain of virus and that of the known endemic typhus (Wilmington strain).

A rabbit was inoculated with testicular washings from guinea pig 97 infested with the flea strain of virus. The rabbit was tested at weekly intervals for the presence of *B. proteus* OX₁₉ agglutinins in the serum, and the following results were obtained: Just before inoculation and one week later,

Institute of Health, Washington, D. C., for histological examination. Sections from this brain revealed lesions which in type and distribution were consistent with typhus infection.

SUMMARY

The virus of endemic typhus (Wilmington strain) has been successfully transferred to sticktight fleas as a result of allowing the fleas to feed on an experimentally infected

rat. An emulsion of the feces of these fleas and an emulsion of the body of these fleas produced clinical typhus when inoculated into guinea pigs.

Clear cut cross-immunity has been shown in guinea pigs inoculated with the virus from the fleas and with a known endemic typhus virus (Wilmington strain).

Histological examination of the brain of one of the guinea pigs inoculated with the strain of virus recovered from the fleas revealed characteristic lesions of typhus fever.

Agglutinins for *B. proteus* OX₁₉ were demonstrated in the serum of a rabbit inoculated with the strain of virus recovered from the fleas.

LITERATURE CITED

1. DYER, R. E., RUMREICH, A., and BADGER, L. F. Publ. Health Rep. **46**: 334. 1931.
2. DYER, R. E., RUMREICH, A., and BADGER, L. F. Journ. Amer. Med. Assoc. **97**: 589. 1931.
3. DYER, R. E., CEDAR, E. T., LILLIE, R. D., RUMREICH, A., and BADGER, L. F. Publ. Health Rep. **46**: 2481. 1931.
4. DYER, R. E., WORKMANN, W. G., BADGER, L. F., and RUMREICH, A. Publ. Health Rep. **47**: 931. 1932.
5. MOOSER, H., and CASTANEDA, M. R. Journ. Exp. Med. **55**: 307. 1932.
6. BLANC, G., and BALTAZARD, M. Compt. Rend. Soc. Biol. **124**: 1058. 1937.
7. WORKMANN, W. G. Publ. Health Rep. **48**: 795. 1933.
8. ESKEY, C. R. Publ. Health Bull. 213, 70 pp. 1934.

ZOOLOGY.—*Description of a new genus and species of copepod parasitic in a shipworm.* CHARLES BRANCH WILSON, State Teachers College, Westfield, Mass.¹ (Communicated by WALDO L. SCHMITT.)

So far as known, the first internal copepod parasites reported from the shipworm, *Teredo*, are some that were discovered by Dr. C. H. Edmondson, of the University of Hawaii, in the course of a study of shipworms taken from Honolulu Harbor. In view of the large number of *Teredos* that have been handled in the course of many studies of these destructive mollusks, the copepod parasite here described can not be very common or it would have been found before. Concerning its occurrence, Dr. Edmondson has written me as follows:

"The copepod was first observed during the fall of 1939, when fully 75 percent of the specimens of *Teredo milleri* Dall, Bartsch, and Rehder, 1938 (B. P. Bishop Mus. Bull. **153**: 209, 210) over 30 mm in length recovered from Honolulu Harbor were found to be parasitized. The parasite has appeared in shipworms at three additional localities about Oahu, and also in Hilo Harbor, Hawaii, and at Kahului, Maui.

"Six shipworms, five species of *Teredo* and one of *Bankia*, in Hawaiian waters are known to serve as hosts of the parasite.

"The female clings tightly to the lining of the infrabranchial cavity of the host by means of stout, sharp mouthparts, while the male is likely to be unattached in the cavity and when released from the host is capable of swimming quite freely. Because of the greatly inflated body the female is capable of but slight movement when detached from the shipworm."

Teredicola, new genus²

Diagnosis.—*Female*: First three thoracic segments enlarged and fused with the head into a cylindrical body. Fourth and fifth segments abruptly reduced in length and width; genital segment about as large as the fifth segment; abdomen 3-segmented; caudal rami slender rods, each tipped with two setae. Ovisacs as long as the enlarged anterior body; eggs minute and numerous.

Male: Much smaller than the female, first segment only fused with the head, the others free. The first four segments with lateral plates diminishing in size backward. Abdomen 4-segmented, segments about equal in size. First antennae 6-segmented; second antennae 2-segmented, prehensile; maxilliped one stout

¹ Dr. Wilson completed this paper some months before his death on August 18, 1941. Received October 28, 1941.

² Dr. Wilson did not specify the family for this genus, but in correspondence with Dr. Edmondson he mentioned that it "evidently belongs to the family Clausidiidae which includes many of the Cyclopoida that infest annelids and mollusks."—W.L.S.

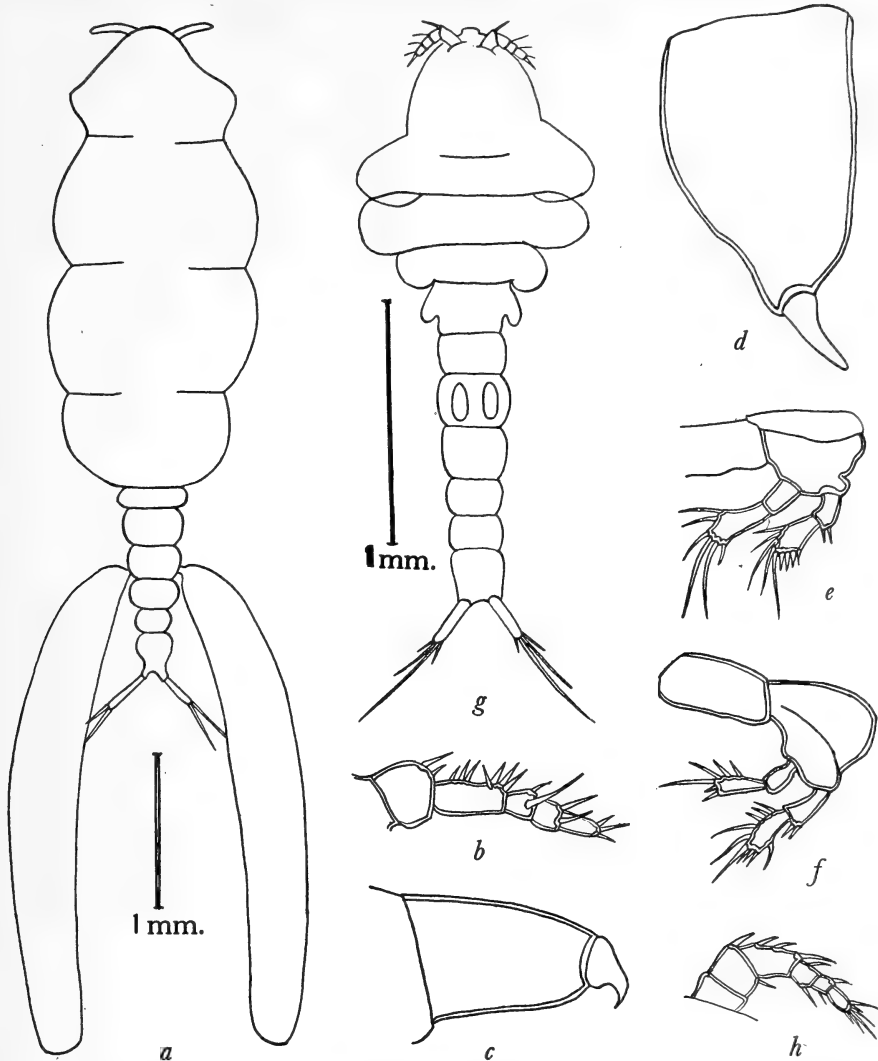

Fig. 1.—*Teredicola typica*, new species: a, Dorsal view of female; b, first antenna of female; c, second antenna of female; d, maxilliped of female; e, f, first and second legs of female; g, dorsal view of male; h, first antenna of male.

segment tipped with a claw. Two pairs of swimming legs biramous, rami equal and 2-segmented.

Genotype.—*Teredicola typica*.

***Teredicola typica*, new species**

Fig. 1, a-h

Description.—*Female*: First three thoracic segments more or less fused with the head and with one another to form a cylindrical body a little more than twice as long as wide. Fourth and fifth segments reduced to a third of the width of the first and second segments, the fifth segment twice as long as the fourth. Genital segment about the same size as the fifth

segment and subspherical in form. Abdomen 3-segmented, the first and third segments about the same width and length, the second segment shorter and a trifle narrower. Caudal rami narrow cylindrical, as long as the anal segment and widely divergent, each with two terminal setae as long as the ramus itself.

First antennae 6-segmented, the two basal segments considerably widened, the third segment the longest and the fifth segment the shortest, all except the basal segment bearing setae. The second maxilla and maxilliped are each made up of a single stout segment tipped with a strong claw, the one on the maxilla acute and curved into a semicircle, the one on the maxilliped blunt and nearly straight. Two

pairs of biramose swimming legs, the rami 2-segmented and of approximately the same length. Each end segment is armed with many setae of different lengths; each basal exopod segment has two small setae at its outer distal corner, while the basal endopod segments are unarmed.

Total length 4.43 mm. Enlarged cylindrical body 3.20 mm long, 1.50 mm wide.

Male: Much smaller than the female, the body made up of ten segments, the first three considerably widened, the remaining seven regularly tapering a little backward. The head is fused with the first thoracic segment, which carries a lateral plate or lamella on each side. The next three segments also carry lateral plates diminishing in size to become mere knobs on the fourth segment. The fifth segment, genital segment, and the four abdominal

segments have convex lateral margins and differ but little in length. The caudal rami are like those of the female except that each has four terminal setae, the two outer ones very short, the middle ones as long as the ramus.

The first antennae arise from the dorsal surface of the head close to the anterior margin and are strongly curved backward. The mouthparts and swimming legs are like those of the female.

Total length 2.35 mm. Width of first segment, including wings, 1 mm.

Material examined.—A dozen specimens, including both sexes, were taken from the body cavities of Teredos in Honolulu Harbor, Oahu, Hawaii, by Dr. C. H. Edmondson. A single male and a female have been selected to serve as types of the new genus and species and have been given U.S.N.M. no. 79639.

PROCEEDINGS OF THE ACADEMY AND AFFILIATED SOCIETIES

THE ACADEMY

371ST MEETING OF THE BOARD OF MANAGERS

The 371st meeting of the Board of Managers was held in the Library of the Cosmos Club on Friday, December 5, 1941. President CLARK called the meeting to order at 8:07 P.M. with 19 persons present, as follows: A. H. CLARK, F. D. ROSSINI, N. R. SMITH, W. W. DIEHL, J. H. KEMPTON, J. H. HIBBEN, F. C. KRACEK, J. E. GRAF, F. H. H. ROBERTS, JR., F. G. BRICKWEDDE, R. M. HANN, M. C. MERRILL, W. A. DAYTON, H. L. CURTIS, W. RAMBERG, and, by invitation, R. J. SEEGER, G. A. COOPER, J. M. COOPER, and H. G. DORSEY.

The minutes of the 370th meeting were read and approved.

President CLARK announced the following appointments: Committee of Tellers, L. B. TUCKERMAN (chairman), R. W. BROWN, and GEORGE TUNELL; Committee of Auditors, P. A. SMITH (chairman), H. G. AVERS, and C. H. SWICK.

Chairman GARNER of the Committee on Meetings reported that the December meeting of the Academy would be held in the Auditorium of the U. S. National Museum.

The Board considered individually and duly elected to membership the seven persons (six resident and one nonresident) whose nominations had been presented on November 7, 1941.

The Committee to consider the policy for

future editions of the Directory, H. L. CURTIS (chairman), F. C. KRACEK, L. W. PARR, and F. H. H. ROBERTS, JR., presented a report carrying the following recommendations:

(a) The Academy shall continue the established practice of publishing the Directory biennially.

(b) As soon as possible after January 1, 1942, and every year thereafter, there shall be published an addendum to the Directory, giving the officers of the Academy and of the affiliated societies for the calendar year. It will not be necessary to include the officers of certain societies that change in the middle of the year. The format for publishing these addenda should be at the discretion of the Secretary and Treasurer.

(c) In future editions of the Directory, there shall be reserved space for the officers of the two following years. This space, for each society, shall come directly under the list of officers and shall have printed across it "Reserved for officers for 1944, etc."

(d) The publication of the Directory shall be entrusted to the Secretary and Treasurer.

The Board approved this report, with the insertion of "and new members of the Academy" at the end of the first sentence in part (b). It was further moved and carried that these addenda be supplied to all members of the Academy and to all purchasers of the Directory.

The committees on awards for scientific achievement for 1941, J. M. COOPER, General Chairman, reported that the work was completed. For the committee on the biological sciences, Chairman J. M. COOPER recommended that the award for 1941 be presented to G. ARTHUR COOPER, of the U. S. National Museum. For the committee on the engineering sciences, Chairman H. G. DORSEY recommended that the award for 1941 be presented to THEODORE R. GILLILAND, of the National Bureau of Standards. For the committee on the physical sciences, W. E. DEMING, chairman, President CLARK reported a recommendation that the award for 1941 be presented to STERLING B. HENDRICKS, of the U. S. Bureau of Plant Industry.

On request of the Secretary, the Treasurer was authorized to increase the allotment for the office of the Secretary by the amount of \$49.85 for the year 1941.

The Custodian and Subscription Manager of Publications, W. W. DIEHL, reported that the situation with regard to back volumes of the JOURNAL was vastly improved and that there were now on hand seven complete sets and one set lacking but six single numbers, and that to date three complete sets of the JOURNAL have been sold.

Adjournment was made at 9:07 P.M.

308TH MEETING OF THE ACADEMY

The 308th meeting of the Academy was held jointly with the Washington Section of the American Institute of Electrical Engineers in the Auditorium of the U. S. National Museum at 8:15 P.M. on Thursday, December 18, 1941, with H. L. CURTIS, Vice President of the Academy, representing the Washington Section of the American Institute of Electrical Engineers, presiding. KARL B. MCEACHRON, research engineer in charge of the High Voltage Engineering Laboratory of the General Electric Company at Pittsfield, Mass., delivered an illustrated address entitled *Lightning*. DR. MCEACHRON told the story of researches on lightning and described the production of lightning artificially, the photographing of natural lightning, the effects of lightning discharges as a function of location and their relation to old superstitions and beliefs, and the investigation of a number of so-called "pranks"

of lightning. He disclosed that deaths from lightning have averaged 390 annually for this country since 1924, just a little more than attacks from animals and only a tiny fraction of the deaths caused by automobiles; that the real danger of lightning is to property; that office buildings and factory buildings offer excellent protection to their occupants; that suburban homes are not so likely to be struck as isolated buildings on a farm; that the ordinary lightning flash seen by the observer is not a brilliant bolt from the sky, but rather the union of a cloud streamer with another streamer from the earth; that lightning may strike many times in the same place, as it has on the top of the Empire State Building in New York City; that lightning rods do not keep lightning away but serve to attract the electrical discharge and to lead it safely to the ground; that every flash of lightning is not accompanied by a clap of thunder; and that thunder is the result of a pressure wave caused by the sudden expansion of air created by a quick lightning discharge.

There were about 175 persons present. The meeting adjourned at 10:15 P.M.

NEW MEMBERS

The following persons were recently elected to membership:

ERNEST GOLSAN HOLT, chief of the Wildlife Management Section, U. S. Soil Conservation Service, in recognition of his biological and ornithological investigations and, more recently, his contributions to wildlife management.

HERBERT LUDWIG JACOB HALLER, principal chemist, Division of Insecticide Investigations, U. S. Bureau of Entomology and Plant Quarantine, in recognition of his contributions in the field of insecticidal chemistry, particularly with regard to pyrethrum flowers.

MILTON HARRIS, director of the Textile Foundation Research Associateship at the National Bureau of Standards, in recognition of his work on the chemical and physical structure of the textile fibers, wool, silk, cotton, and rayon.

MARIO MOLLARI, professor and director of the Department of Bacteriology and Preventive Medicine, Georgetown University, in

recognition of his work on the diseases of man caused by fungi and bacteria.

JACINTO STEINHARDT, physical chemist on the Textile Foundation Research Associateship at the National Bureau of Standards, in recognition of his studies on the chemical structure of the wool molecule.

FREDERICK LOVEJOY WELLMAN, associate pathologist, U. S. Bureau of Plant Industry, in recognition of his contributions in plant pathology and in particular his researches on club root of crucifers, banana wilt, and tomato wilt.

HALBERT MARION HARRIS, associate professor of entomology, Iowa State College, Ames, Iowa, in recognition of his work in the field of systematic entomology, in particular in the classification of the Hemiptera.

JOSEF PIKL, research chemist, E. I. DuPont de Nemours & Co., Wilmington, Del., in recognition of his contributions to the chemistry of the compounds of the indol series.

HERBERT HOLDSWORTH ROSS, systematic entomologist, Illinois State Natural History Survey, Department of Education, Urbana, Ill., in recognition of his work in insect taxonomy, with special reference to the classification of the sawflies and caddisflies.

HARRY AARON BRIGHT, chief of the Section on Metal and Ore Analysis and Standard Samples, National Bureau of Standards, in recognition of his work in metallurgical analysis.

REGINA FLANNERY, research associate, Department of Anthropology, Catholic University of America, in recognition of her contributions to the anthropology of the Algonquian peoples, especially the northeastern and eastern.

WILLIAM MCKINLEY GAFAFER, senior statistician, National Institute of Health, in recognition of his statistical investigations in the field of public health, and his studies in medical history.

GUSTAV ERNST FREDERICK LUNDELL, chief

of the Division of Chemistry, National Bureau of Standards, in recognition of his work in inorganic analytical chemistry.

PAUL SALMON ROLLER, physical chemist, Eastern Experiment Station, U. S. Bureau of Mines, in recognition of his contributions to the physical chemistry of nonmetallic minerals, especially with reference to the properties of fine particulate matter and the measurement of these properties.

LEWIS WILLIAM BUTZ, biochemist, U. S. Bureau of Animal Industry, in recognition of his work in organic chemistry and biochemistry, and in particular that on diene syntheses of condensed ring systems related to the steroids.

JOHN PUTNAM MARBLE, research associate in geochemistry, National Research Council, in recognition of his contributions to mineral analysis, with particular reference to the estimation of geologic time.

JOHN R. MATCHETT, chemist, U. S. Bureau of Narcotics, in recognition of his work in the chemistry of narcotic drugs, particularly cannabis (marihuana).

WILLIAM HENRY SEBRELL, chief of the Division of Chemotherapy, National Institute of Health, in recognition of his contributions to the study of human and animal nutrition, in particular on pellagra ariboflavinosis.

JAROMIL VACLAV SLADEK, instructor in biochemistry, Georgetown University, in recognition of his work in biochemistry and organic chemistry.

JOHN TUCKER, JR., Chief of the Section on Cement and Concrete, National Bureau of Standards, in recognition of his studies in concrete and in the application of the mathematical theory of probability to problems in the strength of materials.

LEON WILSON HARTMAN, president of the University of Nevada, Reno, Nev., in recognition of his contributions to radiometry and electrical measurements.

FREDERICK D. ROSSINI, *Secretary*

PROGRAMS OF THE ACADEMY AND AFFILIATED SOCIETIES¹

- THE ACADEMY** (Cosmos Club Auditorium, 8:15 p.m.):
Thursday, February 19. *The Aztecs of Mexico*. GEORGE C. VAILLANT. (Jointly with the Anthropological Society of Washington.)
Thursday, March 19. Awards for scientific achievement, 1941.
- CHEMICAL SOCIETY OF WASHINGTON** (Cosmos Club Auditorium, 6:30 p.m.):
Thursday, March 12. Annual banquet—Award of the Hildebrand prize.
- NATIONAL GEOGRAPHIC SOCIETY** (Constitution Hall, 8:15 p.m.)²:
Friday, February 20. *With the Albees in the Sierras*. RUTH and WILLIAM ALBEE.
Friday, February 27. *Cruising tropic seas in Idle Hour*. CAPT. DWIGHT LONG.
Friday, March 6. *California cyclorama*. BRANSON DE COU.
Friday, March 13. *Defrosting Alaska*. KARL ROBINSON.
- MEDICAL SOCIETY OF THE DISTRICT OF COLUMBIA** (1718 M Street, N.W.):
Wednesday, February 18. *The value of cystometry in the every-day practice of surgery and medicine*. REED N. NESBIT.
Wednesday, February 25. *Ovarian deficiencies and their treatment*. FULLER ALBRIGHT.
Wednesday, March 11. *The minimum laboratory procedures essential to the diagnosis of blood dyscrasias*. GEORGE J. BRILMYER.
The importance of laboratory examinations in the administration of the sulfonamides. THOMAS M. PEERY.
The chemical and cytological changes in spinal fluid in disease. LESTER NEUMAN.
The significance of blood protein and nitrogen variations. H. H. LEFFLER.
Laboratory examinations essential in the diagnosis of obscure fevers. LT. ALFRED GOLDEN.
Comparative usefulness of whole blood and plasma transfusions. JANVIER W. LINDSAY.
- BOTANICAL SOCIETY OF WASHINGTON** (Cosmos Club Auditorium, 8 p.m.):
Tuesday, March 3. *Photoperiodic responses of Biloxi soy bean*. H. A. BORTHWICK and M. W. BARKER.
A bacterial disease of the giant cactus. LEE M. HUTCHINS.
- AMERICAN SOCIETY OF MECHANICAL ENGINEERS**, Washington Section (Pepco Auditorium, 8 p.m.):
Thursday, March 12. *Some properties and uses of explosives*. WILBERT J. HUFF.
- SOCIETY OF AMERICAN BACTERIOLOGISTS**, Washington Branch (Georgetown University School of Medicine, 3900 Reservoir Road, 8 p.m.):
Tuesday, February 24. *Studies in skin disinfection; Price's method for the evaluation of mercurials*. E. P. CASMAN.
Capsule formation in the genus Brucella. CORNELIA COTTON.
Correlations of the cultural characteristics in the genus Lactobacillus. RALPH P. TITSLER, MORRISON ROGOSA, and EARLE O. WHITTIER.

¹ Notices to be published in this space must reach the Senior Editor, Raymond J. Seeger, not later than the 28th of the month preceding that of publication.

² Lectures open only to members of the National Geographic Society who have subscribed to season tickets.

CONTENTS

	Page
SCIENCE AND WAR. AUSTIN H. CLARK.....	33
PHYSICS.—A review of the methods for the absolute determination of the ohm. HARVEY L. CURTIS.....	40
MEDICAL ENTOMOLOGY.—Experimental transmission of endemic typhus fever by the sticktight flea, <i>Echidnophaga gallinacea</i> . JOSEPH E. ALICATA.....	57
ZOOLOGY.—Description of a new genus and species of copepod parasitic in a shipworm. CHARLES BRANCH WILSON.....	60
PROCEEDINGS: THE ACADEMY.....	62

This Journal is Indexed in the International Index to Periodicals

JOURNAL
OF THE
WASHINGTON ACADEMY
OF SCIENCES

BOARD OF EDITORS

RAYMOND J. SEEGER
GEORGE WASHINGTON UNIVERSITY

G. ARTHUR COOPER
U. S. NATIONAL MUSEUM

JASON R. SWALLEN
BUREAU OF PLANT INDUSTRY

ASSOCIATE EDITORS

W. EDWARDS DEMING
PHILOSOPHICAL SOCIETY

C. F. W. MUESEBECK
ENTOMOLOGICAL SOCIETY

HARALD A. REHDER
BIOLOGICAL SOCIETY

EDWIN KIRK
GEOLOGICAL SOCIETY

CHARLOTTE ELLIOTT
BOTANICAL SOCIETY

T. DALE STEWART
ANTHROPOLOGICAL SOCIETY

HORACE S. ISBELL
CHEMICAL SOCIETY

PUBLISHED MONTHLY

BY THE

WASHINGTON ACADEMY OF SCIENCES

450 AHNAP ST.

AT MENASHA, WISCONSIN

Entered as second class matter under the Act of August 24, 1912, at Menasha, Wis:
Acceptance for mailing at a special rate of postage provided for in the Act of February 28, 1925:
Authorized January 21, 1933:

Journal of the Washington Academy of Sciences

This JOURNAL, the official organ of the Washington Academy of Sciences, publishes (1) Short original papers, written or communicated by members of the Academy; (2) proceedings and programs of meetings of the Academy and affiliated societies; (3) notes of events connected with the scientific life of Washington. The JOURNAL is issued monthly, on the fifteenth of each month. Volumes correspond to calendar years.

Manuscripts may be sent to any member of the Board of Editors. It is urgently requested that contributors consult the latest numbers of the JOURNAL and conform their manuscripts to the usage found there as regards arrangement of title, subheads, synonymies, footnotes, tables, bibliography, legends for illustrations, and other matter. Manuscripts should be typewritten, double-spaced, on good paper. Footnotes should be numbered serially in pencil and submitted on a separate sheet. The editors do not assume responsibility for the ideas expressed by the author, nor can they undertake to correct other than obvious minor errors.

Illustrations in excess of the equivalent (in cost) of two full-page line drawings are to be paid for by the author.

Proof.—In order to facilitate prompt publication one proof will generally be sent to authors in or near Washington. It is urged that manuscript be submitted in final form; the editors will exercise due care in seeing that copy is followed.

<i>Subscription Rates.</i> —Per volume.....	\$6.00
To members of affiliated societies; per volume.....	2.50
Single numbers.....	.50

Correspondence relating to new subscriptions or to the purchase of back numbers or volumes of the JOURNAL should be addressed to William W. Diehl, Custodian and Subscription Manager of Publications, Bureau of Plant Industry, Washington, D.C.

Remittances should be made payable to "Washington Academy of Sciences" and addressed to 450 Ahnaip Street, Menasha, Wis., or to the Treasurer, H. S. Rappleye, U. S. Coast and Geodetic Survey, Washington, D.C.

Exchanges.—The JOURNAL does not exchange with other publications.

Missing Numbers will be replaced without charge provided that claim is made to the Treasurer within thirty days after date of following issue.

OFFICERS OF THE ACADEMY

President: HARVEY L. CURTIS, National Bureau of Standards.

Secretary: FREDERICK D. ROSSINI, National Bureau of Standards.

Treasurer: HOWARD S. RAPPLEYE, U. S. Coast and Geodetic Survey.

Archivist: NATHAN R. SMITH, Bureau of Plant Industry.

Custodian of Publications: WILLIAM W. DIEHL, Bureau of Plant Industry.

JOURNAL

OF THE

WASHINGTON ACADEMY OF SCIENCES

VOL. 32

MARCH 15, 1942

No. 3

GEOPHYSICS.—*Geophysical measurements in the laboratory and in the field.*¹
H. E. McCOMB, U. S. Coast and Geodetic Survey.

It has been recorded that, in the beginning, Jehovah created the heaven and the earth. Since those early days time has wrought many changes, not only in the universe at large as we suspect it exists today, but upon this planet upon which our senses seem to indicate to us we are living and striving to preserve some kind of continuity of that life. Experience and experiments tell us that, among other things, this planet, the earth, is surrounded by an ionosphere, a stratosphere, an atmosphere, and a magnetic field. Those portions of the earth that are on or immediately below the surface are called the hydrosphere (water area) and the lithosphere (crust). Within a relatively thin film of the atmosphere, the hydrosphere, and the lithosphere, we observe the effects of forces that are continuously and relentlessly modifying the earth. The science that treats of these forces is known as geophysics, and in this field we find such sciences as geodesy, seismology, geomagnetism, meteorology, volcanology, hydrology, and tectonophysics.

This paper deals briefly with certain physical measurements in geomagnetism and in seismology, describes in some detail a few of the instruments and methods used in such measurements, and compares some of the results obtained in the laboratory with results obtained in the field with the same equipment. While these few illustrations by no means cover the whole field, either in the experiences of the author or of his immediate associates, they will serve to illustrate the complex nature of some of the

¹ Address of the retiring President of the Philosophical Society of Washington delivered at the 1194th meeting of the Society, January 17, 1942. Received February 2, 1942.

projects upon which we are working—projects that involve questions of law, regulations, policy, funds, personnel, and equipment.

In the field of geomagnetism, one of our main objectives has been, and still is, the production of magnetic maps, charts, and tables, applicable to the United States and its possessions. Unfortunately it is necessary to reconstruct or revise these charts and tables at intervals of a few years simply because the earth's magnetic field is not uniform and because it is changing continuously in both direction and intensity. The magnetic meridian at a particular site is defined as the vertical plane fixed by the direction of the earth's field at that site. The true meridian at the same site is a vertical plane containing the earth's axis. The latter is determined by astronomical observations and for convenience may be marked by the establishment of a permanent monument erected at some distance from the site. It is usually more convenient to erect the mark and then determine its true azimuth.

The angle between the true meridian and magnetic meridian is known as magnetic declination. The direction of the magnetic field changes as time passes, and while many of these changes are irregular and some may even be classed as violent, there is, after all, considerable regularity in these changes. At Cheltenham, Md., for example, the direction of the field has changed from N. 5° 41' W. to N. 7° 06' W. during the past 30 years, the average rate being about 3' per year. This is known as secular variation or secular change. Where the rate of secular change has been fairly uniform for several years, it is reasonably safe for all

practical purposes to predict changes for a few years in advance. This rate has been diminishing for the past few years, and at present it is practically at zero at Cheltenham. In addition to this secular variation, the direction of the field normally passes through a complete cycle of change every solar day. The normal daily range in declination at Cheltenham is of the order of 4 or 5 minutes of arc. Likewise, the total field intensity varies in direction and magnitude from day to day and from year to year. All these changes vary over wide ranges for different parts of the earth. In order to make it possible to obtain continuous records of all the fluctuations, magnetic observatories have been established in various parts of

Alaska to Puerto Rico, and from Maryland to Hawaii.

The base, the standardizing observatory, is at Cheltenham, Md. The buildings there are constructed of nonferrous materials throughout and are insulated against temperature changes. It has been found convenient to record photographically the changes in magnetic declination and the horizontal and vertical components of the field intensity. The declination variometer consists of a small magnet suspended in a damping chamber by a fine quartz fiber, which, when in proper adjustment, is free of torsion. A plane mirror attached to the magnet system permits photographic recording. For convenience, the recording dis-

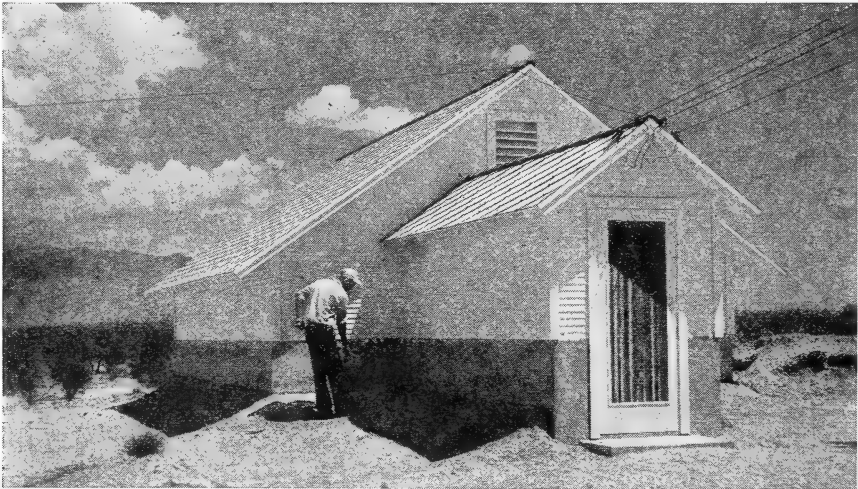

Fig. 1.—Magnetic variation observatory at Tucson. The photographic recording instruments are mounted on concrete piers within the building, which is constructed of nonmagnetic materials and the interior is well insulated against temperature changes.

the world. One of the earliest of these observatories was established at Girard College, Pennsylvania, in 1838, and was operated almost continuously with eye-reading instruments for 6 years, beginning with 1840. In 1852 the Smithsonian Institution established a magnetic observatory on the Smithsonian grounds and operated the first photographic recording instruments in this country. Since the early part of the present century the Coast and Geodetic Survey has operated observatories at five widely separated sites, ranging from southern

tance is usually arranged so that 1 millimeter change of ordinate corresponds to a change of direction of the field of one minute of arc. The mirror is prismatic, that is, it has three aluminized surfaces, the angles being such that should the image from the central mirror move beyond the limits of the recorder at either side, a reserve image will enter the picture and prevent loss of record. The intensity instruments are not so simple. The instrument that records the changes in the horizontal component of the field is similar to the dec-



H. E. McComb, retiring President of the Philosophical Society of Washington.



lination variometer, but the suspended magnet is oriented so that its axis is approximately at right angles to the field and is held in this position by the torsion of a quartz fiber. Under the assumption of certain ideal conditions, namely, that the instrument, except for the magnet, is non-magnetic, that the rigidity modulus of quartz remains constant, that the magnetic moment of the suspended magnet does not

experience has shown that most of the specifications cannot or at least have not been maintained over long periods of time in the field.

The quartz fibers are relatively large, being of the order of 30 to 40 microns in diameter. In the early installations, the fibers were attached to their supports by fused shellac, but in the course of time shellac will yield and the magnet will drift away

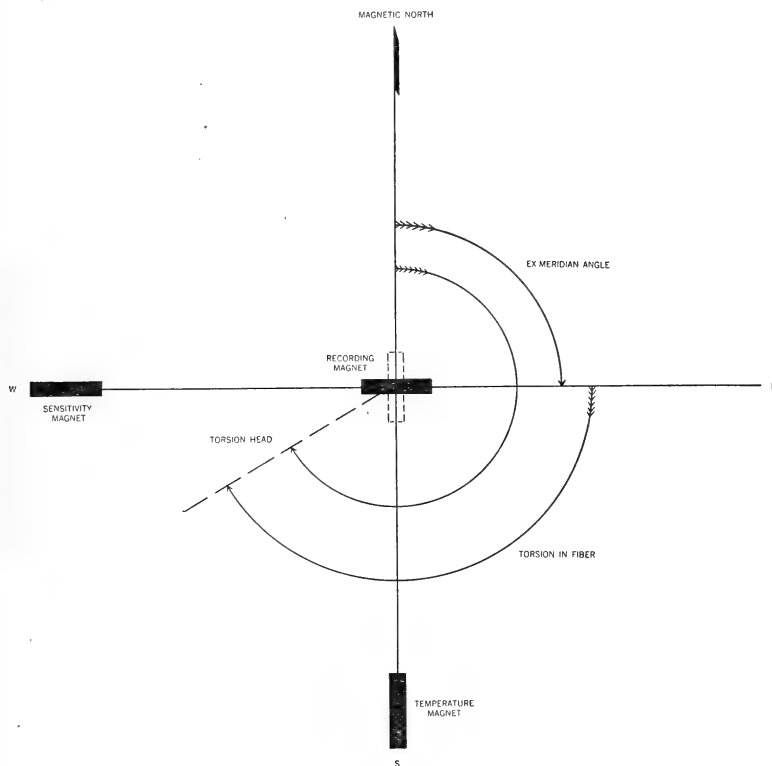

Fig. 2.—Arrangement of recording magnet and control magnets on a unifilar horizontal intensity variometer.

change, that there is no relative motion between the quartz suspension and its upper and lower attachments, that the temperature remains constant, and that there are no natural or artificial mechanical vibrations disturbing the system, then and only then is the angular motion of the suspended magnet a measure of the changes in the horizontal component of the field. While all these specifications may be met and may be maintained with sufficient precision for a few hours or a few days in the laboratory,

from its normal position. This difficulty has been overcome by bending the ends of the filament or by making the fibers with enlarged, pear-shaped ends, which furnish sufficient bearing surface to eliminate slipping of the fiber relative to its supports. Some of the quartz fibers used in these instruments have been under constant torsion of two or three radians for many years. There is evidence that they have suffered little if any permanent strain.

We have not yet found a bar magnet

whose magnetic moment remains constant, and all the magnets that we have tested have temperature coefficients. Thus we find ourselves attempting to measure something that is changing continuously, with a measuring device the parts of which change in several ways while the operation is in progress. It is recognized that conditions of this kind are the rule rather than the exception in all physical measurements, even in the laboratory, but in this particular operation we are not attempting to determine the value of some constant; we are attempting

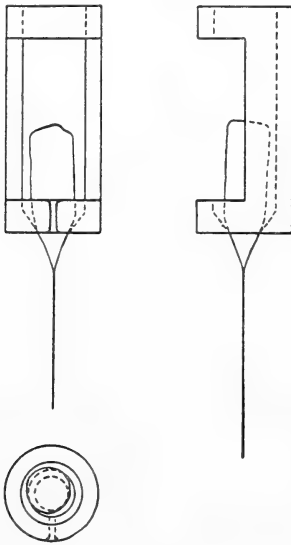

Fig. 3.—La Cour type of quartz fiber suspension showing enlarged ends resting in conical cups.

to record, with some accuracy, the changes in the horizontal component of the field. In spite of every reasonable precaution, we find that the magnetogram may be, and usually is, a record of the algebraic sum of the changes in the field intensity and changes in the instrument parts. Since both the rigidity modulus of quartz and the magnetic moment of the suspended magnet have temperature coefficients so large that they must be taken into consideration, the observatories are well insulated against sudden or large changes in temperature. In addition, the intensity instruments are compensated for temperature in a simple and effective manner.

The vertical-component instrument is simply a delicate magnetic balance. It is similar in many respects to the ordinary analytical balance, the basic difference being that the beam of the magnetic balance is a permanent magnet. The magnet is balanced against gravity on quartz or steel knife edges, and when in proper adjustment is extremely sensitive. To give some idea of the sensitivity of one of these balances it can be stated that when operating under normal conditions, a mass of 0.2 milligram, if placed at the end of the beam, would just about upset it. The moving system is, of course, provided with a suitable mirror for photographic recording. The latest type of recording magnet is that devised by Dr. D. la Cour of the Danish Meteorological Institute. The magnet, knife edges, and the mirror are made from one piece of special magnet steel. The instrument as a whole is so designed that the magnet may be operated in a vacuum. Here again is an instrument that is required to operate continuously over long periods and that is expected to provide a record of the changes in the vertical component of the field.

The three variometers that have been described, together with a suitable photographic recorder, constitute what is known as a magnetograph. The record we obtain from such a set-up is called a magnetogram.

In order to be able to analyze these records quantitatively, it is necessary to know something about the sensitivity of each component. Such measurements are made at regular intervals and consist simply of noting the deflection produced on each component by the application of a known field, properly directed.

Magnetic fields are commonly expressed in gauss, that is, lines of force per square centimeter in air. For convenience, it has been found practical in geomagnetic work to use a much smaller unit, the gamma, which is 0.00001 gauss. Also in common use is the milligauss, which is 100 gammas. The average value of horizontal component of the earth's field at Cheltenham Observatory at the present time is around 18,200 gammas. This is known as the absolute value, and at an observatory it may be determined

easily and quickly with a sine galvanometer to an accuracy of perhaps one gamma. If the absolute value is determined at the moment when the H curve of a magnetogram coincides with an arbitrary base line, then we may assign that absolute value to the base line. Once we have determined the base line value, it is a simple matter to scale the absolute value for any particular moment or to scale the average value for any interval.

Unfortunately there is only one sine galvanometer in the United States suitable for measuring H to an accuracy of one gamma. Except for the electromagnetic method, the only other known method of

comparable with that which can be attained with the sine galvanometer. The usual method and one by no means satisfactory is to measure the angle of inclination of the field and from this value and the known value of the horizontal component derive a value of the vertical component. At an observatory a single value of dip can be determined by means of an earth inductor to an accuracy of perhaps one-half minute of arc. In latitude 40° N. an uncertainty of $0.5'$ in inclination gives an uncertainty of about 50 gammas in the derived value of the vertical intensity. In practice the uncertainty is much less, since average values are used.

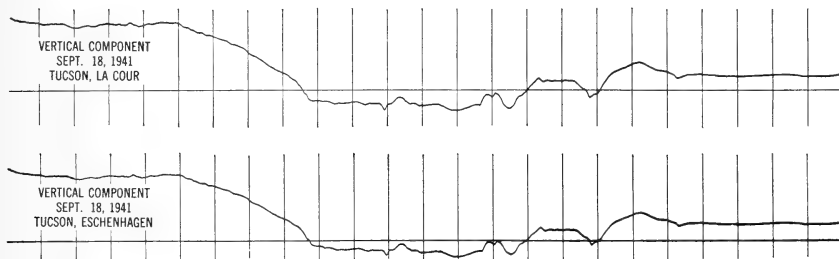

Fig. 4.—Magnetograms recorded by two types of vertical intensity variometers operating simultaneously in different observatories at Tucson. The new observatory, in which the La Cour instrument operates, is partly underground. The vertical lines are hour-marks, the first being at 8.00 a.m., local standard time.

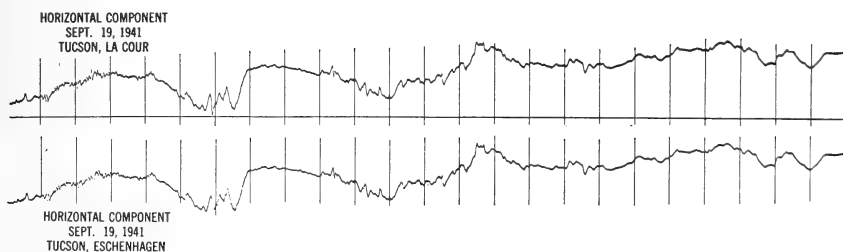

Fig. 5.—Magnetograms as recorded by two types of horizontal intensity variometers under conditions similar to those described under Fig. 4.

determining the absolute value of H is by means of a magnetometer. Experience has shown that, under most favorable conditions, the results obtained with magnetometers may be expected to be in error by as much as 5 to 10 gammas.

There are no electromagnetic instruments in the United States suitable for making a direct measurement of the absolute value of the vertical component to an accuracy

From all this it should be apparent that, even though observatory values may be given to gammas, the uncertainty in the absolute values may be much greater. However, in spite of the fact that there may be considerable uncertainty in the absolute values of some of the elements, the magnetograph furnishes an excellent continuous record of the changes in these elements to a surprisingly high degree of accuracy. This

is fortunate, since in recent years there has been considerable demand for immediate and fairly complete information concerning the so-called magnetic character of the day and its shorter intervals. Data of this kind are supplied daily to investigators in radio transmission. The time may not be far distant when through cooperative efforts of many agencies it may be possible to make fairly reliable forecasts of the quality of radio reception to be expected.

Let us now consider what happens when we attempt to make a magnetic survey of large areas such as the United States. Obviously, the first step is to make a great many observations, well distributed over

interpolate secular change in order to cover areas in which actual observations have *not* been made. While the isogonic chart gives a general picture of the situation as it applies to any particular magnetic element, it may not be safe to rely upon absolute values scaled from a chart or interpolated between two or more stations at which actual observations have been made. The primary reason for this is that the distribution of the earth's field is by no means so uniform as the large scale charts would seem to indicate. This lack of uniformity is due primarily, of course, to magnetic materials in the earth's crust, and it is well known that the composition of the crust is



Fig. 6.—Magnetic observing tent and magnetic station at Kineo, Maine (Moosehead Lake), in 1910. Field observations are made within the tent to protect the instruments against wind, rain, or direct rays of the sun.

the whole area, the density of stations to depend primarily upon funds available for the project. As a result of rather intensive work, covering a period of about 50 years, observations have been made at some 6,000 stations. Data from these observations have been compiled and brought up to date and are graphically represented in what is known as an isogonic chart of the United States. Similar charts have been compiled for horizontal and vertical intensities for the same area. Several of these stations have been selected to serve as so-called repeat stations, that is, stations at which observations are made at intervals of a few years for the determination of secular change. Experience has shown that it is reasonably safe to

anything but uniform. If these magnetic materials or formations lie on or near the surface, their effects on the distribution of the field a few feet above the surface may be quite large. If the magnetic materials lie deeply buried under formations that are practically nonmagnetic, the distribution of the field at the surface may be relatively uniform and the chances of bringing some order out of the results by a reasonable number of observations may be fairly good. This condition exists generally in the western half of the Great Plains region of the United States, where the crustal layers near the surface consist of thick beds of limestone, overlaid by the so-called "loess" formation.

Many surprises, however, await the observer who is overoptimistic. One of the greatest of these surprises, in the experience of the author, happened in northwestern Iowa, a region in which one would not expect to find any large magnetic anomalies. Nevertheless, many areas were found in this region where the magnetic declination differed by 2 to 3 degrees within a radius of a few hundred feet, and tests indicated that this condition prevailed for miles around. The surface geology gave no indication that such conditions might exist. On the other

tion and intensity of the field may vary over wide ranges with change in elevation above the surface. Differences of several degrees in declination have been observed by simply altering the height of the instrument. This is precisely what one should expect. Most of the land observations for declination and horizontal intensity are made with the center of the magnet at varying elevations of 4 to 5 feet above the surface of the ground, depending upon the height of the particular observer. This is fortunate, in a way, since the values found represent condi-

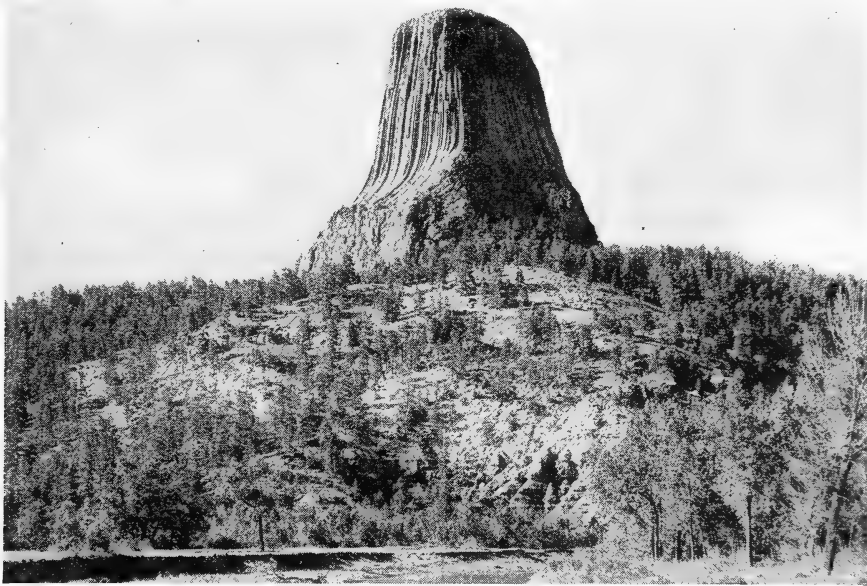

(Courtesy National Park Service)

Fig. 7.—Devils Tower, Wyo. A basaltic lava formation, usually quite magnetic, fragments frequently showing distinct polarity.

hand, there are large areas where we know from experience that anomalies are the rule rather than the exception. In the eastern half of Idaho, the eastern half of Oregon, and the southern half of the State of Washington there are vast areas in which highly magnetic basalt lies on or just below the surface. Whether the basalt is *in situ* or is strewn over the area as talus or rubble, the magnetic disturbance is there. If these areas were only small, we could simply ignore them or by-pass them, but it is not so easy to by-pass or ignore the greater part of three whole States. Observations in such disturbed areas have shown that the direc-

tions as they exist in the layer or region above the surface where they will be most useful. But we should not be surprised if in a moderately disturbed area, a tall observer obtains values decidedly different from those obtained by another not so tall.

Let us take the not uncommon case where we have three stations located in a disturbed area. Suppose that the observed values of declination at stations *A*, *B*, and *C* are 22.7° E., 30.4° E., and 25.1° E. and that it is desired to know the value at some intermediate point *D*, within the boundaries defined by *A*, *B*, and *C*. It should be obvious, even to one who has never made magnetic

observations in such an area, that a mean value, a weighted mean value, or an interpolated value, under such conditions, will, more than likely, *not* represent the facts. The value at *D* may be much smaller or even much larger than those at *A*, *B*, and *C*. Even though observations are made systematically at hundreds of sites in the area, interpolated values would have little meaning. True, the average of all of them might closer represent the average value for the area at the elevation above the surface at which the observations were made, but nothing more. Suppose again that the area contains no natural magnetic material scattered about, but that we distribute promiscuously over the area hundreds of large bar magnets of sufficient size and moment to produce distortions of the kind we know exist in some disturbed areas. Would any practical magnetician, would any mathematician or physicist be so optimistic as to hazard a guess as to the probable value of a magnetic element at some random point in the area? I cannot answer for the mathematician or the physicist, but I can tell you what the practical magnetician would like to do about such a situation. He would recommend that the limits of the disturbance be delineated with reasonable precision, whether the disturbing cause be natural or artificial, and so indicate the area on the chart.

Let us now consider the case where it is desired that we know something about the declination or intensity on or near the surface of navigable waters such as a narrow channel or a bay or a harbor bordered by land areas that are known to be highly magnetic. If the land areas adjacent to the channel are highly magnetic, it is almost certain that the same condition exists at the bottom of the channel. The distribution of the field at any position above the surface of the water will depend not only upon the nature of the disturbance on shore and at the bottom but upon the depth of the water and the distance off shore. We know that these magnetic effects die out rapidly with distance, but we first must know something about the nature and extent of the disturbance before we can estimate even approxi-

mately what the effects are at a distance. Interpolation of declination values between two or more shore stations is about as risky as an attempt to estimate values of declination high above the surface of the earth by extrapolation. Either process might be reasonably safe if one could know something about the nature and extent of the disturbing influence, but if the data upon which calculations are based were obtained by assumptions the extrapolations may mean exactly nothing in practice.

I repeat, it is not possible to obtain a perfect picture of the distribution of magnetism in a highly disturbed area (disturbing influence near the surface) even though the area be covered with stations spaced every few feet horizontally and vertically. The average of observed values is simply the average value, nothing more. It tells you practically nothing about a particular value at a particular latitude, longitude, and elevation.

If the geological structure or formation causing the disturbance lies buried to some depth below the surface, then it is possible to make some order out of chaos, because of the fact that the effects die off rapidly with distance and the gradients become less steep. One of the most satisfactory instruments used in making a magnetic survey is the vertical-intensity field balance. This is similar in many respects to the laboratory or observatory instrument but is so designed that it can determine differences in the vertical component to a fairly high degree of accuracy in a short time and at comparatively low cost. Practically all the magnetic surveys made by oil companies have been carried out with instruments of this type. The technique is simple. One observer makes continuous or nearly continuous observations at a base station with one instrument while other observers cover the adjacent area with similar instruments. Following a definite program of checks and comparisons at the beginning and end of a day's routine it is possible to eliminate from the final results the effects of diurnal variation. A magnetic survey of central South Dakota has recently been completed by the South Dakota State Geological Survey,

and the results have been compiled as a vertical intensity chart. It would be almost impossible to complete a survey of this kind if the magnetic formation were at or near the surface. One of the great disappointments in a map of this kind is that it cannot be joined up readily to a similar adjacent chart. The values are all relative, no absolute value of the vertical intensity having been determined. Here again is a very practical problem and one that at present can be met to a limited extent by means of an earth inductor and a magnetometer. In other words, it is necessary to determine the absolute value of the vertical intensity at the base stations and then obtain the absolute values at any position in the survey by applying differences as obtained by means of the field balance. This method is satisfactory if one is satisfied with absolute values, the accuracy of which is no better than 40 to 50 gammas or about $\frac{1}{2}$ milligauss in the middle latitudes.

I have just tried to show that there is no particular problem in securing data of sufficient accuracy for magnetic charts in an undisturbed area, but that in highly disturbed areas the charts and tables may not represent actual conditions at random points in that area. We also know that a great many additional precise observations taken at random over large areas would not clarify the general picture a great deal; perhaps they would only tend to confuse us still more. The first important element in the whole observing program in the field is that the establishment and preservation of certain master repeat stations is recognized. Reasonably precise observations at these stations furnish the necessary data for revision of charts at regular intervals. The second important element is that there is urgent demand for special intensive surveys in limited areas.

If we had a perfect three-dimensional picture (motion-picture, by the way) both in direction and intensity of that portion of the earth's field that is useful in magnetic surveys and in other geomagnetic investigations, would it serve any more useful purpose than the picture we now possess? In general, I think not. In special cases, yes.

In the first place, there are only a few individuals who would understand how to use the precise data, and in the second place there are comparatively few instruments so designed as to make possible the utilization of more precise data.

Now we have almost forgotten one of the most important elements in this whole observing program—the observer himself. Consider for a moment what happens when the observer, Mr. X, carries on a day's routine of magnetic work in some remote corner of the country. When observing conditions are ideal, the task is relatively simple, but experience has shown that ideal conditions rarely exist for the man in the field. It seems to be axiomatic that as soon as the observing program starts, all inanimate nature in the immediate neighborhood suddenly comes to life, as it were, and marshalls its forces to defeat the observer. The wind and the rain; the blistering heat or the freezing cold; the desert dust or the tropical humidity; yes, even animate nature in the form of swarms of persistent mosquitoes join the battle against the observer; but the show must go on. Occasionally none of these evil things seems to be on the alert, and then it happens, not infrequently, that the very elements being measured go on a rampage, and Mr. X finds himself in the midst of a magnetic storm that may last for days. Needless to say, it takes courage, strategy, stamina, and an almost insane desire on the part of the observer to complete the task. Any one of the opposing elements or forces may be the immediate cause of significant errors in the results. Compare these field conditions with those which are obtained at an observatory or in the laboratory. In the laboratory, reasonable safeguards have been set up to eliminate, neutralize, or compensate for the hostile elements, but in the field the observer is practically on his own. He must substitute strategy and judgment for the comforts and compensations of the laboratory and while being eternally vigilant and on the alert he must, at the same time, make scientific observations requiring the utmost in care and skill. Small wonder that, under average conditions in the field, some combination of

opposing forces or circumstances introduce elements that may influence the results adversely.

Let us now turn our attention to another branch of geophysics, seismology, or the science of earthquakes. In the instrumental and operational side of this science we find many problems strikingly similar to those one meets in geomagnetism. Instruments are developed and perfected in the laboratory and then they are scattered far and wide over areas to be investigated. Investigators have confined their attention principally to four main branches of the science—(a) The delineation or charting of worldwide seismic zones (teleseismic studies); (b) intensive studies of restricted areas (regional investigations); (c) seismic prospecting (search for oil, minerals, etc.); and (d) investigations of strong seismic motion (destructive earthquakes).

Owing to the great interest taken in teleseismic work in recent years, especially in the United States, it is now possible to locate rather quickly, and probably with sufficient accuracy for most purposes, the epicenters of practically all earthquakes that are of sufficient intensity to set up seismic waves that can be recorded at some distance by delicate instruments known as seismographs. Nearly all these seismographs are of the inertia type, in which a pendulum of some kind, horizontal or vertical, is set up in such a manner that its motion is restricted to one degree of freedom. The support for the pendulum is of rigid construction, and this in turn is rigidly attached to the underlying geological formation or foundation. When the foundation, that is, the ground, is displaced in the direction in which the pendulum is free to move, the pendulum has already made up its inanimate mind to try to remain at rest relative to its support and in general it succeeds reasonably well. The relative motion between the center of oscillation and the ground is a function of the ground period, the natural period of the pendulum, the degree of damping of the pendulum, and other factors. In ordinary teleseismic work these ground motions are usually extremely small at a recording station. Different methods

have been devised for magnifying the apparent motion of the pendulum to such a degree that it can be detected or measured. This magnification may be accomplished mechanically, electromagnetically, electrostatically, optically, or by combinations of these methods. All modern seismographs are designed for continuous photographic registration. It is customary to set up two or three instruments oriented at right angles to each other, the idea being that two or three components of the motion will be recorded and thereby furnish data from which, theoretically at least, the complete ground motion can be deduced. Complete analysis would include displacement, velocity, acceleration, distance and direction to the epicenter, and perhaps some other elements of which the author has not yet been informed. It will not be possible, in a short paper, to describe all the different types of instruments now in operation. Their number is legion, but in general, their effectiveness (or their efficiency or their usefulness) is a function not only of the magnification and some other instrumental constants but also of their sturdiness and their ability to remain in adjustment and to operate reasonably well over long periods of time, far from home.

Let us take one of these modern teleseismic seismographs through some laboratory tests and then transport it to some remote seismological station, say in the West Indies or Alaska, and compare the results that we have obtained under laboratory conditions with those that we get in the field. The instrument to be described is of the electromagnetic type. To the steady mass is attached a coil of nonmagnetic copper wire, which is free to move with the steady mass in a strong, radial, magnetic field. The terminals of this coil are connected to a high-sensitivity galvanometer equipped with suitable optical parts for photographic registration. Shunted across this circuit is a variable resistance to provide proper damping. Essentially this is a motor-generator, or, in this case, a generator-motor. When the ground moves it takes everything else with it including the magnetic field of the seismometer magnets, but

the pendulum and the coil tend to remain at rest. We then have relative motion between coil and magnetic field; an emf is set up, and current flows in the circuit, and the galvanometer responds. The dimensions of the seismometer and the galvanometer have been so designed that for ground periods such as one encounters in teleseismic work the angular motion of the galvanometer is perhaps 5 to 20 times greater than the angular motion of the seismometer pendulum. Further magnification is obtained by optical lever so that the overall nominal magnification of the system is from 1,000 to 2,000, depending upon the particular instrument.

One of the methods of testing the efficiency of a seismometer is to place it on a shaking table, the motions of which can be

whole apparatus was located in a room about 30 feet below the ground level so that there was reasonable assurance of stability. Table displacements as small as 1 micron could be recorded without difficulty. The seismometer just described was mounted upon this table along with two other seismometers of radically different type, and the responses of the different instruments to known motions of the table were measured and compared. Also, the responses of the different instruments to harmonic motions varying in frequency from 30 cps to 1 cycle in 30 seconds were determined, thereby furnishing data from which so-called magnification curves were prepared. The character of the response records for the three different instruments show remarkable similarity. The electromagnetic seismograph

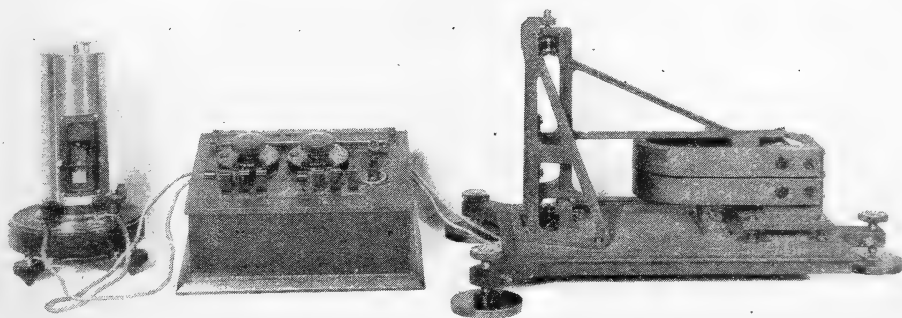

Fig. 8.—Wenner seismometer, bridge, and commercial galvanometer modified for photographic recording. A modern electromagnetic type of seismometer used in teleseismic registration.

controlled arbitrarily and measured accurately. Since the magnification of the teleseismic instrument is usually high, it is necessary that such a shaking table be of sturdy construction and supported on a firm foundation so that one may be assured that the measured motions of the table relative to the ground are reasonably accurate. In cooperation with the Survey, such a shaking table was set up at the National Bureau of Standards a few years ago. It consisted essentially of a triangular slab of concrete suspended near each vertex by piano wires attached to rigid concrete piers, which were poured upon and rest upon natural, undisturbed, leached gneiss. The

was then subjected to critical routine operating tests for several months, after which it was installed and placed in routine operation in the Franklin Institute, at Philadelphia, where it has been in continuous operation, without appreciable interruption, for several years. This is a remarkable record and is a good example of what can happen when an instrument is operated at a station where conditions are quite as satisfactory as they would be in the best of laboratories. The efficiency or effectiveness of this instrument in recording ground motion is well illustrated in the Franklin Institute records of an earthquake that occurred on April 15, 1941, about 3,600

kilometers southwest of Philadelphia. The azimuth of the epicenter was in the neighborhood of 45° to each of the two horizontal component instruments, and the seismograms are almost duplicates, at least for the first 2 or 3 minutes. When earthquake waves and instruments behave in this manner it is not difficult to estimate the azimuth of the epicenter, but performance of this kind is the exception rather than the rule.

With electromagnetic instruments having small dimensions and high magnification it should be apparent at once that the mag-

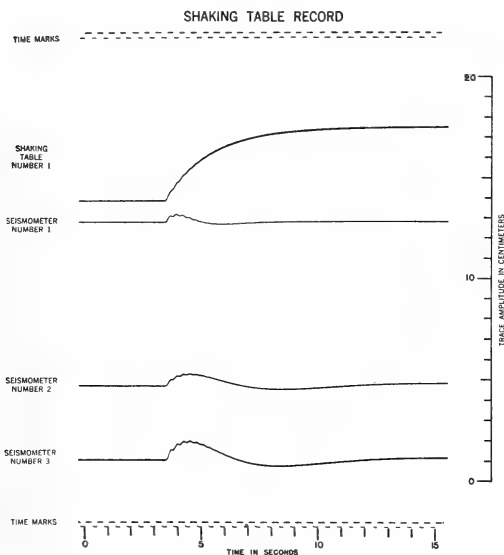

Fig. 9.—Shaking table record showing the response of three different types of seismometer to a sudden displacement of the table. The table motion is magnified about 400 times.

netic field in which the seismometer coil moves must be reasonably uniform over the full range of motion if the sensitivity of the system is to be uniform over that range. This matter has been investigated fully and the latest instruments of this type have been adjusted to this condition. Also the system has been equipped with a so-called dynamic tester, which permits testing the sensitivity of the individual components quickly and accurately under routine operating conditions. Such tests, if recorded daily, furnish data that can be used in estimating the approximate nominal magnification of the particular component at that time. While

these devices have proved highly satisfactory in extended laboratory tests, they have not shown much promise in the field.

Instruments of the type described above and equipped with dynamic testers, after having passed their physical examination and laboratory tests, have recently been placed in routine operation in San Juan, Puerto Rico. Experience has shown that in a climate where the humidity is excessive and the mean temperature rather high many things can happen to a delicate instrument in a comparatively short time. A minute growth of fungus, perhaps invisible to the unaided eye, may contrive to be born and flourish in the most inaccessible part of the instrument, and if it obstructs the motion of the pendulum or the galvanometer in the slightest degree, the usefulness of that instrument is precisely zero. Extra precautions have been taken to seal up these instruments and operate them in air that has been thoroughly dried. Such precautions are usually not considered necessary even in extended laboratory tests, but they seem to be imperative in the tropics. Once an instrument is placed in operation in the field, however, its usefulness is measured by its continuity of service since it frequently out of commission for one reason or another it may not be operating when the unpredictable earthquake waves arrive. Its primary function is to record them, *all of them*, when they do arrive. It frequently happens that the type of instrument that produces records that are the best from the point of view of the seismologist who must interpret these records is the one that is most difficult to keep in operation in remote places. For this reason we usually find it necessary to compromise by sacrificing perfect performance of limited duration for reasonably good performance with no interruptions.

We have tried to follow this same policy in our program of investigation of strong seismic motion. When this project was initiated several years ago by the Coast and Geodetic Survey there was little reliable information available upon which to formulate a program of attack. But the heat was on, funds were appropriated for the project,

and it was necessary to achieve some kind of success in a few short months lest the support be withdrawn because we had accomplished nothing. The seismological literature was searched, seismologists, mathematicians, physicists, geologists, and structural engineers were canvassed and consulted for advice. After all the available evidence was in, a decision was made. We would concentrate on strong motion accelerometers; but, lest we find ourselves on the wrong track, allotments were made for a few instruments of other types. The work was divided up

our major effort has been concentrated on the accelerograph, it will receive the attention here.

The original accelerometer consisted essentially of a copper loop supported rather rigidly by a quadrifilar suspension. The copper loop served the double purpose of steady mass and damping vane and was so arranged as to oscillate between the pole pieces of a strong permanent magnet. In reality it was a miniature, short period, low magnification, optical, seismometer. It was subjected to some laboratory tests with ex-

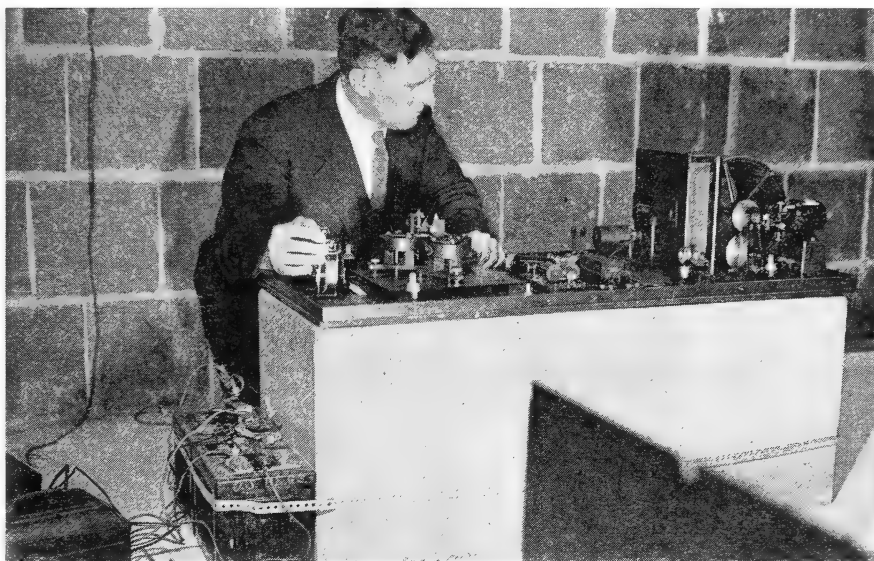

Fig. 10.—Typical accelerograph station in a seismic area. The whole instrument is securely bolted to a concrete pier and is protected by a metal cover. Note that storage batteries, which supply light and power for operation of the instrument, are lashed to the pier to guard against interruption of power during a major earthquake.

among cooperative agencies. Out of the National Bureau of Standards came the accelerometer; from the University of Virginia came an intermediate period mechanical instrument; from funds provided by the National Research Council came the tiltmeters; and from the Survey came the strong-motion displacement-meters, vibration meters, and the automatic recorders for use with the accelerometers. The recorder in combination with a group of three accelerometers is now known as an accelerograph. Again it is quite impossible here to describe all these instruments. Since

experimental recorders, and since it gave promise of meeting requirements it was placed in quantity production. Within a comparatively short time 10 complete, three-component accelerographs were in routine, stand-by operation in seismic zones on the west coast. The field installations came none too soon. Within three months came the Long Beach earthquake, and all the accelerographs in that area operated and furnished records that were reasonably good when all the circumstances are taken into consideration. It was apparent at once, however, that certain improvements were

quite essential especially in the matter of recording. Also, the quadrifilar suspension, while its performance in the laboratory was eminently satisfactory and although it could be adjusted and tuned within a reasonable time, presented quite a problem in the field, especially since there were 30 of them to keep in adjustment. One cannot spend all his time making adjustments. Otherwise, the earthquakes might never have an opportunity to make use of the accelerometers. As a result of further laboratory experiments and tests, the pivot accelerometer was developed and at the same time combined with a low-magnification

attachment, which, it is believed, will record the strongest shocks without loss of record. Since there are now about 150 of these units in operation in the United States, it is quite obvious that servicing these instruments is no small task. While we may have sacrificed accuracy in some degree by the use of pivot instruments, they have made it possible, because of their ease of assembly and adjustment, to keep the program going.

In cooperation with the Massachusetts Institute of Technology the Survey has conducted some shaking table investigations with these accelerographs. The whole ac-

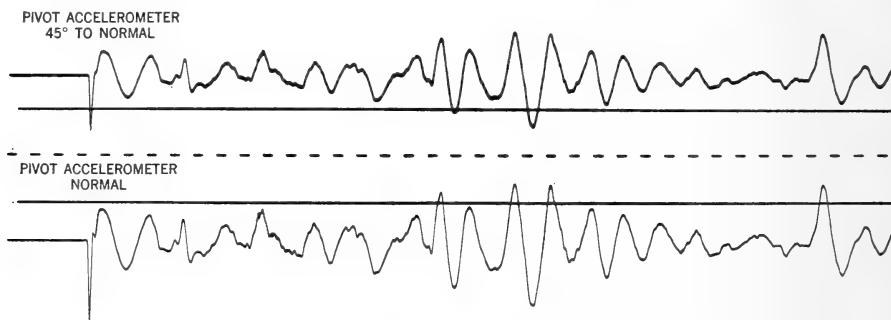

Fig. 11.—Shaking table record at Massachusetts Institute of Technology showing response of two pivot accelerometers to sudden and irregular motions of the table. One accelerometer is oriented at 45° to the direction of motion. The time marks (broken line) are spaced at one-half second between centers.

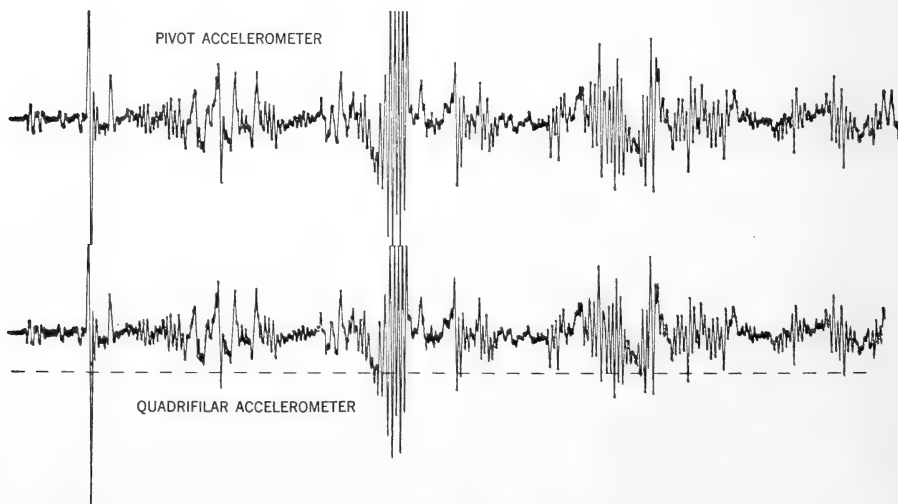

Fig. 12.—Shaking table record at Massachusetts Institute of Technology showing response of pivot and quadrifilar accelerometers to the same table motion. Time marks (broken line) are spaced at one-half second between centers.

celerograph was mounted upon a sturdy shaking table, which was so designed that oscillations of variable frequencies and amplitudes as well as irregular motions could be obtained. By means of an ingenious photoelectric device the table was made to simulate the ground motion to which one of the accelerographs was subjected in the Long Beach earthquake. The accelerograph then reproduced with considerable fidelity the accelerogram that had been recorded originally at Long Beach. In one of the tests a pivot accelerometer and a quadrifilar accelerometer were allowed to record simultaneously. Casual examination of the records would seem to indicate that they are duplicates. Intensive study, however, has shown that if an attempt is made to derive ground displacements from the records made with pivot instruments, serious discrepancies appear that seem to be due primarily to slight shifts of the pivots in their bearings. These discrepancies may or may not be of engineering significance. Only time and possibly further experiments may decide the matter.

There is still much to learn about the dynamics of destructive earthquakes. We do know, of course, that when one of these major earthquakes occurs near a center of population the loss in life and damage to property may be terrific. We know also that certain engineering structures are totally demolished while others nearby escape with only slight damage. As a result of rather intensive investigations in engineering laboratories and owing in no small part to our own field work in connection with the determinations of natural periods of engineering structures when subjected to artificial vibrations, building codes have been improved in certain States to the extent that some kind of earthquake-proof construction must be included in specifications before building permits will be issued.

We do not know when or where earthquakes are likely to occur in the future, but it does not seem unreasonable to expect that most of the earthquakes of the future will continue to occur in regions where they

have occurred before, that is, in seismic zones. However, wishful thinking or expert opinions to the contrary will not prevent them from happening anywhere on the earth, but that phase of the problem must be left for time alone to solve. It is believed that the published results of our investigations of strong seismic motion have been effective in convincing engineers and others that by exercising reasonable precautions in their building specifications, property damage and loss of life during a major earthquake may be reduced considerably. If our influence along this line has contributed in any degree whatsoever to the saving of life and property, our efforts have not been in vain.

In conclusion I should like to make a few remarks about the necessity of *keeping on the track* in carrying on this geophysical work. If it is our appointed duty to collect certain data in the laboratory or in the field, or if it falls to our lot to translate these data into language that the public can understand and use, then let us stay on the track and do that job. Whether or not we may like it, all of us must perform a certain amount of deadily routine. Until we learn that lesson and learn it thoroughly we cannot solve these geophysical problems nor can we keep the production line moving.

If, while I am supposed to be standardizing a magnetometer I spend weeks and weeks determining the induction factor of one of its magnets to an accuracy of 0.1 percent when I am fully aware of the fact that I need to know it to an accuracy of only 5 percent, I may be having a perfectly jolly time—yes, I may be thrilled with the results, but I have lost sight of my objective—I am off the track. By the same token, if the statistician who is compiling and publishing geophysical data insists on extracting the last drop of tribute from his instruments or from the man on the firing line who is operating them, sooner or later he will find that his production line is not moving ahead but has stopped. That statistician has indicted himself under an old but unrepealed statute—the *law of diminishing returns*.

ZOOLOGY.—*A new species of Amphipoda from Uruguay and Brazil.*¹ CLARENCE R. SHOEMAKER, U. S. National Museum.

In July, 1941, some amphipods of the genus *Hyaella* Smith, taken in the river Imbé, a stream flowing into Lake Tramadai in the State of Rio Grande do Sul, Brazil, were sent to the U. S. National Museum for identification. These specimens superficially resembled *Hyaella azteca* var. *inermis* Smith, but, upon dissection, characters were observed that distinguish them from that form of *Hyaella azteca* (Saussure). I am, therefore, describing them as a new species, as follows:

Hyaella curvispina, new species

Male.—Eye dark, slightly reniform or oval. Antenna 1 about as long as the head plus the first three or four body segments and reaching to about the middle of the flagellum of antenna 2. Peduncular joints successively shorter and narrower; flagellum longer than peduncle and composed of about 11 joints, which do not carry sense-organs. Antenna 2, fifth peduncular joint longer than fourth; flagellum much longer than peduncle and composed of about 14 joints, which do not carry sense-organs.

Right mandible, molar strong and well developed, seta on inside edge and a tuft of setules at base between it and spine-row, which contains two long and one shorter spine; cutting-edge toothed and accessory plate well developed and toothed; a knoblike protuberance on inside surface at base of molar. Maxilla 1, inner plate with two apical plumose setae; outer plate with nine serrate and pectinate spine-teeth; palp small and ending in a narrow sharp point. This palp is much smaller in proportion than in *H. azteca*. Maxilla 2 normal, inner plate shorter than outer and bearing, in addition to the terminal spines, two plumose setae on upper inner margin. Maxillipeds, inner plate longer than outer plate and reaching beyond the middle of outer plate, the truncate upper margin armed with three teeth; outer plate rather short, inner margin armed with two or three rows of slender spines, but no spine-teeth; palp rather short and broad with the inner dis-

tal corners of the second and third joints produced into lobes; fourth joint rather weak and bearing a long slender nail.

Gnathopod 1 shorter and stouter than in *H. azteca*; fifth joint subequal in length to sixth, lobe of lower margin bearing a row of long and short spines; sixth joint a little longer than wide, palm oblique and convex, armed throughout with a row of slender spines, and defined by a lobe bearing a short spine, below which on the inside surface of joint is a similar spine; hind margin of joint bearing a slender spine and an armament of the minute pectinate scales which occur also in *H. azteca*; the front margin also bears a spine near the middle and an armament of pectinate scales distally; seventh joint fitting palm, bearing a nail and a few pectinate scales on outer margin, and a row of minute spinules on inner margin. Gnathopod 2 rather short and robust; palm quite oblique, convex and with only a mere suggestion of the tooth normally found near the hinge of the seventh joint in *H. azteca*. The hind margin of sixth joint is rather short and somewhat produced or lobed at the defining angle of palm; the inner surface of the defining lobe of the palm bearing an armament of pectinate scales. Seventh joint fitting palm with the apex dipping into a shallow pocket.

Peraeopods 1 and 2 much alike in shape and spinous armature, but 2 slightly the longer. Peraeopods 3 to 5 much alike but increasing consecutively in length, second joints much expanded with lower hind margin produced into a broad rounding lobe.

Lower hind corners of metasome segments 2 and 3 somewhat produced and sharply angular. Uropods not very spinose, but the inner margin of uropod 1 bearing on the inner margin usually one but sometimes two long slender curved spines which are very characteristic of the males of this species. Uropod 3 with ramus subequal in length to peduncle. Telson as long as wide, reaching to about the end of peduncle of uropod 3, and bearing apically two stout spines and several slenderer and shorter spines. Length of male 9 mm from front of head to end of uropod 1.

The gill arrangement is the same in both

¹ Published by permission of the Secretary of the Smithsonian Institution. Received December 12, 1941.

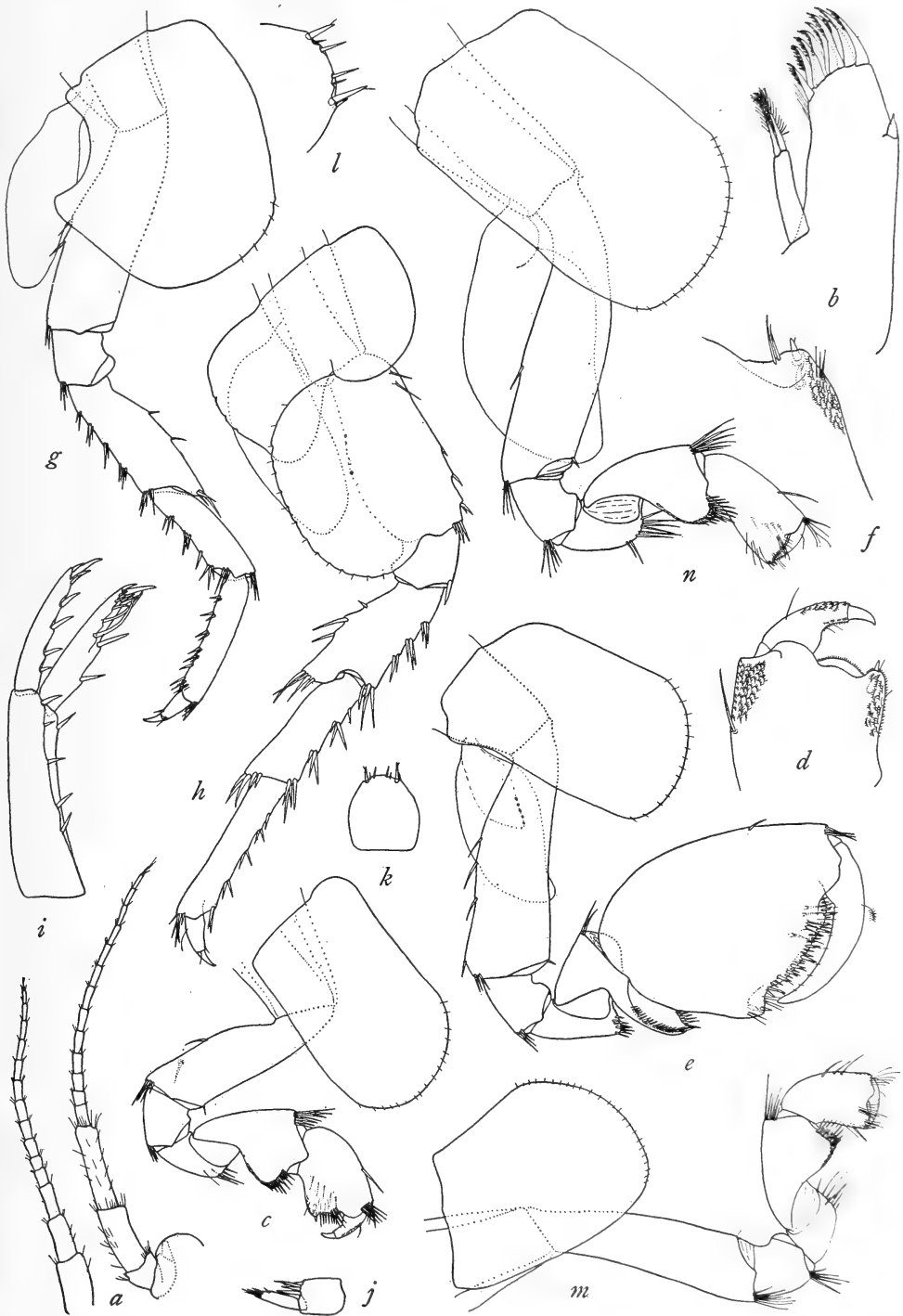

Fig. 1.—*Hyalella curvispina*, new species: Male: *a*, antenna 1 and antenna 2; *b*, maxilla 1; *c*, gnathopod 1; *d*, end of gnathopod 1 showing the pectinate scales on inside surface of joint; *e*, gnathopod 2; *f*, defining angle of palm of gnathopod 2 showing the pectinate scales on inside surface; *g*, peraeopod 2; *h*, peraeopod 3; *i*, uropod 1; *j*, uropod 3; *k*, telson; *l*, end of telson showing spines. Female: *m*, gnathopod 1; *n*, gnathopod 2.

sexes. Each of the mesosome segments 2 to 6 bears a pair of coxal gills and a pair of simple lateral sternal gills, while segment 7 bears only a pair of lateral sternal gills. This species has no dorsal teeth.

Female.—The female is like the male except in the gnathopods and the first uropod. Gnathopod 1 is longer and slenderer than in the male; the sixth joint is proportionately narrower and the palm is transverse; the front and hind margins bear a few spines and a few pectinate scales. Gnathopod 2 much like gnathopod 1 but longer and slenderer; sixth joint equal in length to fifth, widening distally and with palm slightly chelate; hind margin well provided with pectinate scales on inner distal surface. Uropod 1 does not have the long curved spines on the inner ramus. Length of female 9 mm from front of head to end of uropod 1.

Type locality.—Small mud puddles which dry up in summer (5 to 15 cm deep), near Montevideo, Uruguay, December, 1932, Ricardo Thomsen, collector. Type, a mature male, U. S. N. M. no. 79388.

Other records.—There are specimens of this species in the National Museum taken at the following localities:

Paso de la Arena (fresh water), near Montevideo, Uruguay, November 27, 1925, Ricardo Thomsen, collector.

Montevideo, Uruguay (from General Buzano's Place), December 10, 1925, Ricardo Thomsen, collector.

Pajas Blancas, quite near the sea coast, but still fresh water, near Montevideo, Uruguay, December 7, 1932, Ricardo Thomsen, collector.

Carrasco Creek, near Montevideo, Uruguay, December 11, 1925, Ricardo Thomsen, collector.

From a well, 20 meters deep, subsoil line, near Montevideo, Uruguay, July or December, 1932, Ricardo Thomsen, collector.

Among the roots of *Pontederia* and *Rhynchospora* in the river Imbé, flowing into the Lagoa de Tramandai; littoral of Rio Grande

do Sul, Brazil, June, 1941, Herm. Kleerekoper, collector.

Remarks.—The gill arrangement is slightly different from that of *Hyaella azteca* of North America. In *H. azteca* there are no lateral sternal gills on the second body segment, whereas they are present in *H. curvispina*.

Prof. A. S. Pearse, in describing *Hyaella ornata* from the State of Veracruz, Mexico, said that the specific name was given on account of the tubercles that cover parts of the anterior margins of the last two segments and the posterior margins of the last four segments of the first gnathopods of both sexes and that are found also on the same places on the second gnathopods of the female, but appear only on the posterior margins of the fourth and sixth segments of the second gnathopods of the male. These tubercles, when highly magnified, have the appearance of oblong scales armed on their convex edges with very minute teeth or spinules, which give them a pectinate appearance. On the sixth joint of the first gnathopods of both sexes these scales are directed away from the central longitudinal axis of the joint on the outside surface and toward the axis on the inside surface. Those of the seventh joint are directed away from the inner concave margin on the outside and toward it on the inside surface.

I have examined specimens of *Hyaella* from several localities in the state of Veracruz, which is the type locality for *H. azteca*, and find that they all possess these pectinate scales. I am therefore of the opinion that *H. ornata* is a synonym of *H. azteca*. These scales appear on all the specimens of *Hyaella* from Mexico I have been able to examine. In passing northward, westward, and eastward from Mexico in the United States the scales appear to become considerably less in number and less conspicuous. I believe that all the specimens of *Hyaella* I have seen from Mexico and the United States are *Hyaella azteca*, which is a very variable species, and that they all possess these scales in varying degrees.

ICHTHYOLOGY.—*The first record of the ophichthyid eel Scytalichthys miurus (Jordan and Gilbert) from the Galapagos Islands, with notes on Mystriophis intertinctus (Richardson).*¹ LEONARD P. SCHULTZ, U. S. National Museum.

In identifying a small collection of fishes made by Dr. Waldo L. Schmitt in the Galapagos Islands, I had opportunity to study a specimen of *Scytalichthys miurus* (Jordan and Gilbert). Jordan and Davis (Rept. U. S. Comm. Fish and Fisheries for 1888, pt. 16, pp. 634–636. 1892) described the subgenus *Scytalichthys*, genotype *Ophichthys miurus* Jordan and Gilbert, and based the generic distinction on “vomerine teeth in one series of about four slender depressible canines; tail very short, much shorter than rest of body.” Jordan and Evermann (U. S. Nat. Mus. Bull. 47, pt. 1, pp. 386–387. 1896) copied Jordan and Davis in their generic description. It is my good fortune to have at hand all the specimens studied by those authors, as well as some additional specimens. The vomerine teeth of the types of *Ophichthys miurus* Jordan and Gilbert, U. S. N. M. no. 2304, are fixed and not depressible or movable (except where broken loose from their bases). Although the types of *S. miurus* are small specimens, the teeth have the same arrangement as in the larger specimen (total length 685 mm) collected by Dr. Schmitt in Aeolian Bay, South Seymour Island, April 11, 1941, U. S. N. M. no. 119785. From the above-mentioned specimens I have made a sketch of the teeth giving the actual number of teeth in the jaws as counted by me along with their relative sizes (Fig. 1, a).

Closely related to *S. miurus* is *Mystriophis intertinctus* (Richardson) from the West Indies to the region of Florida. The arrangement of the teeth in this species is similar but very distinct from that in *S. miurus*. After examining all seven specimens available (U. S. N. M. nos. 6956, St. Thomas, W. I.; 23635 and 49797, Florida; 5984 and 31891, Florida), I made a sketch of the dentition of *M. intertinctus* showing the relative number of teeth and their relative sizes (Fig. 1, b).

A comparison of the dentition of these

two species indicates without exception that the vomer and dentary have but a single row of caninelike teeth on *S. miurus* but a double row on *M. intertinctus*. The teeth on the maxillary of *S. miurus* are in two rows anteriorly and four rows posteriorly, but on *M. intertinctus* in but two rows. The teeth at front of upper jaw are likewise entirely different. It is concluded therefore that since these differences are so

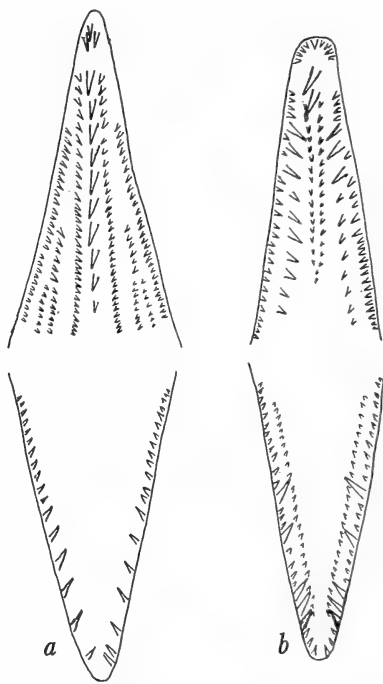

Fig. 1.—a, Dentition of *Scytalichthys miurus* (Jordan and Gilbert); b, dentition of *Mystriophis intertinctus* (Richardson).

great the two species should be considered generically distinct. Thus *Scytalichthys* should be given full generic rank as was done by Jordan, Evermann, and Clark (Rept. U. S. Bur. Fish. for 1928, pt. 2, p. 89. 1930) but not on the basis of *depressible canines on the vomer*. It should be based instead, among other characters, on the dentition as indicated in this study, on the small pectoral fins that are $1\frac{1}{4}$ length of eye, and origin of dorsal fin one head length behind gill openings.

¹ Published with the permission of the Secretary of the Smithsonian Institution. Received January 6, 1942.

PROCEEDINGS OF THE ACADEMY AND AFFILIATED SOCIETIES

THE ACADEMY

372D MEETING OF THE BOARD OF MANAGERS

The 372d meeting of the Board of Managers was held in the private dining room of the Cosmos Club on Friday, January 9, 1942. In the absence of President CLARK, Vice-President H. E. McCOMB called the meeting to order at 8:10 P.M., with 14 persons present as follows: H. E. McCOMB, F. D. ROSSINI, N. R. SMITH, W. W. DIEHL, J. H. KEMPTON, F. C. KRACEK, F. G. BRICKWEDDE, M. C. MERRILL, W. A. DAYTON, H. L. CURTIS, L. W. PARR, C. L. GARNER, and, by invitation, R. J. SEEGER and G. A. COOPER.

The minutes of the 371st meeting were read and approved.

For the Executive Committee, the Secretary reported that this committee met at the Cosmos Club on December 5, 1941, at 9:30 P.M., with Messrs. A. H. CLARK, H. L. CURTIS, J. E. GRAF, and F. D. ROSSINI present, to review the action recently taken by the Committee with regard to the investment of \$5,200 that has come into the treasury from the closing out of two previous investments (see minutes of the Board of Managers meeting on November 7, 1941, and October 3, 1941). The Committee considered investing these funds in 4½ per cent cumulative preferred stock of the Citizens Bank of Takoma Park, Md., which stock was currently available for purchase, but agreed that the reinvestments should be made as previously planned, namely, investment in savings accounts in federally-insured savings and loan associations, the total amount in each to be not more than \$5,000. The Treasurer was further authorized to transfer \$300 from the checking account to the funds for reinvestment to make the total \$5,500. Of this amount, \$500 and \$1,000 are to be added to the accounts in the Northwestern Federal Savings and Loan Association and the First Federal Savings and Loan Association, respectively, bringing the total in each to \$5,000. The remaining \$4,000 is to be placed in a third federally-insured savings and loan association.

For the Committee on Meetings, Chairman GARNER reported the speaker for the February meeting to be GEORGE C. VAILLANT, director

of the Museum of the University of Pennsylvania, Philadelphia, Pa.

For the Committee on Membership, Chairman KRACEK presented nominations for membership for six persons, four honorary and two nonresident.

The Committee of Tellers appointed to canvass the votes on the affiliation of the Washington Section of the American Society of Civil Engineers, L. B. TUCKERMAN (chairman), R. W. BROWN, and GEORGE TUNELL, presented their report as follows: The Committee met on December 9, 1941. It compared the ballot envelopes with the list of the members of the Academy in good standing and found 202 ballots from members in good standing; 2 ballots from members in arrears; 1 ballot in unsigned envelope; total 205. The count of the ballots from members in good standing showed: For affiliation 196; against affiliation 6; total 202. The Board formally declared the Washington Section of the American Society of Civil Engineers affiliated with the Academy.

The Secretary reported the following data concerning membership: Deaths, 1; acceptances to membership, 6; qualified for membership, 4; retirements, 2. The status of the membership as of January 8, 1942, was:

	<i>Regular</i>	<i>Retired</i>	<i>Honorary</i>	<i>Patrons</i>	<i>Total</i>
<i>Resident</i>	435	33	3	0	471
<i>Nonresident</i>	128	18	13	2	161
	—	—	—	—	—
<i>Total</i>	563	51	16	2	632

Under new business, the Board authorized the appointment of two committees: One to study the matter of the affiliation of the Academy with the American Association for the Advancement of Science; and the other to consider questions relating to the Committee on Membership, involving the establishment of a greater continuity in the personnel of the Committee and general criteria for honorary membership. The meeting adjourned at 9:40 P.M.

309TH MEETING OF THE ACADEMY

The 309th meeting of the Academy was held in the Assembly Hall of the Cosmos Club at 8:15 P.M. on January 15, 1942, with Vice-President H. E. McCOMB, representing the

Philosophical Society, presiding. The retiring president of the Academy, AUSTIN H. CLARK, delivered an address entitled *Science and war*, which was published in the February 15, 1942, issue of the JOURNAL. Following his address, President CLARK took the chair and adjourned the meeting at 9:15 P.M.

44TH ANNUAL MEETING OF THE ACADEMY

The 44th annual meeting of the Academy was held on January 15, 1942, immediately following the 309th regular meeting of the Academy. President CLARK called the meeting to order at 9:25 P.M., with about 75 persons present. The minutes of the 43d annual meeting were approved as published on pages 155 to 164 of the JOURNAL of April 15, 1941.

Report of the Secretary

The Secretary presented the following report for 1941:

During 1941 a total of 39 persons (32 resident and 7 nonresident) were elected to membership, all of whom accepted. Of these, 11 were elected in recognition of their work in chemistry, 5 in zoology, 3 in entomology, 3 in physics, 2 in agronomy, 2 in geology, and 1 each in anthropology, astronomy, bacteriology, biochemistry, cartography, cytology, engineering, helminthology, horticulture, medicine, parasitology, plant pathology, and public health.

Because of their retirement from active work, 10 members (5 resident and 5 nonresident) were placed on the "retired" list. Resignations were accepted from 9 members in good standing (4 resident and 5 nonresident).

During 1941, 10 deaths (7 resident and 3 nonresident, including 1 patron) were reported to the Secretary as follows:

- MRS. HENRY L. HIGGINSON, Boston, Mass., May 6, 1935.
 MAX WEBER, Amsterdam, The Netherlands, February 7, 1937.
 WILLIAM WILLIAMS GILBERT, Washington, D. C., December 22, 1940.
 DAYTON CLARENCE MILLER, Cleveland, Ohio, February 22, 1941.
 MORTON GITHENS LLOYD, Washington, D. C., April 26, 1941.
 ERNEST WERNER EICKELBERG, Washington, D. C., May 20, 1941.
 CLAUDE HALE BIRDSEYE, Washington, D. C., May 30, 1941.
 DAVID IVES BUSHNELL, JR., Washington, D. C., June 4, 1941.

HUGH McCORMICK SMITH, Washington, D. C., September 28, 1941.
 ERNEST EVERETT JUST, Washington, D. C., October 27, 1941.

On January 1, 1942, the membership was as follows:

	Regular	Retired	Honorary	Patrons	Total
Resident	433	33	3	0	469
Nonresident	127	18	13	2	160
Total	560	51	16	2	629

During the period from February 7, 1941, to January 9, 1942, the Board of Managers held seven meetings, with an average attendance of 17 persons. One of two special committees carried over from 1940 completed its work. Of the six special committees appointed by the President during the past year, four completed their work and two will carry over.

During the past year, the Academy held seven meetings, beginning with the 303d and ending with the 309th, as follows:

On February 20, 1941, jointly with the Philosophical Society of Washington, with an address by P. W. BRIDGMAN, of Harvard University, entitled *The changing position of thermodynamics*.

On March 20, 1941, for the presentation of the Academy's Awards for Scientific Achievement for 1940, to HARRY DIAMOND, of the National Bureau of Standards, in the engineering sciences, and to FERDINAND G. BRICKWEDDE, of the National Bureau of Standards, in the physical sciences.

On April 17, 1941, to hear reports on various phases of the 1940 South American Eclipse Expedition, sponsored by the National Geographic Society and the National Bureau of Standards, from IRVINE C. GARDNER, CARL C. KIESS, and THEODORE R. GILLILAND, of the National Bureau of Standards, PAUL A. McNALLY, S. J., of Georgetown University, and EDWARD O. HULBERT, of the U. S. Naval Research Laboratory.

On October 16, 1941, jointly with the Philosophical Society of Washington and the Washington Society of Engineers, with an address by FRANCIS W. REICHELDERFER, of the U. S. Weather Bureau, entitled *Some famous weather maps*.

On November 27, 1941, jointly with the Anthropological Society of Washington, with an address by MATTHEW W. STIRLING, of the

Bureau of American Ethnology (assisted by Mrs. Stirling), entitled *Treasure trove of Mexican archeology*.

On December 18, 1941, jointly with the Washington Section of the American Institute of Electrical Engineers, with an address by KARL B. MCEACHRON, of the General Electric Company, entitled *Lightning*.

On January 15, 1942, with an address by AUSTIN H. CLARK, the Retiring President of the Academy, entitled *Science and war*.

Accounts of the first five of these meetings have been published in the JOURNAL under the Proceedings of the Academy, and the last two will soon appear. One of the meetings was held in the Auditorium of the U. S. National

Museum and the other six in the Assembly Hall of the Cosmos Club.

On January 9, 1942, the Board of Managers formally declared the Washington Section of the American Society of Civil Engineers affiliated with the Academy, as a result of the favorable vote of the membership of the Academy in a balloting by mail which began November 10, 1941, and ended December 9, 1941. There are now a total of 20 societies affiliated with the Academy. On motion, the report of the Secretary was accepted.

Report of the Treasurer

The treasurer, H. S. RAPPLEYE, submitted the following report for 1941:

CASH RECEIPTS AND DISBURSEMENTS

RECEIPTS:

From dues 1939.....	\$ 5.00
From dues 1940.....	95.00
From dues 1941.....	2,470.80
From dues 1942.....	55.00
From subscriptions 1940.....	8.70
From subscriptions 1941.....	543.90
From subscriptions 1942.....	245.70
From sales of JOURNALS.....	458.76
From sales of Directory.....	26.85
From payments for reprints.....	535.49
From interest on deposits.....	48.89
From interest on investments.....	928.88
From sale of Butler notes.....	1,190.12
From sale of Ell & Kay property.....	4,000.00
From withdrawn for investments.....	8,500.00
 Total receipts.....	 \$19,113.09
Cash balance Jan. 1, 1941.....	1,120.52
 To be accounted for.....	 \$20,233.61

DISBURSEMENTS:

For Secretary's Office 1941.....	\$ 499.24
For Treasurer's Office 1941.....	202.12
For JOURNAL printing 1940.....	250.36
For JOURNAL printing 1941.....	2,407.42
For JOURNAL reprints 1940.....	30.99
For JOURNAL reprints 1941.....	567.66
For JOURNAL illustrations, 1940.....	23.93
For JOURNAL illustrations, 1941.....	253.83
For Custodian & Subs. Mgr., 1941.....	37.79
For Custodian & Subs. Mgr. (Special)*.....	108.50
For JOURNAL Office, 1940.....	24.33
For JOURNAL Office, 1941.....	242.02
For Meetings Committee, 1940.....	46.25
For Meetings Committee, 1941.....	306.70
For Directory, 1941.....	341.35
For dues returned.....	10.00
 Total Disbursements.....	 \$ 5,352.49

* Special fund allotted to Subs. Mgr. to buy odd copies of JOURNAL.

Bank debit memos as follows:

Dues, 1941.....	\$ 6.29	
Subscriptions, 1941.....	1.59	
Subscriptions, 1942.....	1.38	
Interest on investments.....	20.00	
		\$ 29.26
Deposited in Savings Account.....		48.89
		\$ 5,430.64
Cash Balance Dec. 31, 1941.....		4,802.97
		\$10,233.61
Invested in Northwestern Federal Savings & Loan Assn.....		5,000.00
Invested in First Federal Savings & Loan Assn.....		5,000.00
Total.....		\$20,233.61

RECONCILIATION OF BANK BALANCE

Balance as per cash book 12-31-41.....		\$4,802.97
Bank Balance American Sec. & Trust Co. per statement 12-31-41.....	\$4,930.15	
Receipts not deposited.....	25.25	
		\$4,955.40

Checks outstanding, not cashed:

No. 170.....	\$21.50	
791.....	16.25	
792.....	9.00	
793.....	5.00	
794.....	1.50	
795.....	13.50	
796.....	33.15	
797.....	46.89	
798.....	5.64	152.43
		\$4,802.97

INVESTMENTS

409 Shares stock of Washington Sanitary Improvement Co., par value \$10 per share, cost.....		\$ 4,090.00
20 Shares stock Potomac Elec. Power Co., 6% Pref., cost.....		2,247.50
4 Certificates Corporate Stock of the City of New York, 1 for \$500 and 3 for \$100, cost.....		800.00
1 Bond of Chicago Railways Co., #1027; interest at 5%, due 1927; par value \$1,000 less \$250, cost.....		713.87
1 Real Estate Note of T. Q. Donaldson (#6 of 12) dated June 26, 1937 (extended to 1943); interest 5%; cost.....		1,000.00
2 Real Estate Notes of Yetta Korman et al., dated October 5, 1938 for 3 years (#7 of 37 for \$500, and #8 of 37 for \$500); cost.....		1,000.00
Extended from 1941 to 1944 with interest at 4½%		
**2 Certificates (1 for \$4,000 and 1 for \$1,000)—First Federal Savings & Loan Assn., Nos. 914 & 1063.....		5,000.00
**2 Certificates (1 for \$4,500 and 1 for \$500)—Northwestern Federal Savings and Loan Assn., Nos. 1380 and 1441.....		5,000.00
Deposited in savings account, American Sec. & Trust Co.....		45.75
		\$19,897.12
Cash book balance Dec. 31, 1941.....		4,802.97
Total Assets.....		\$24,700.09

Total Assets Dec. 31, 1940.....	\$25,468.75
Total Assets Dec. 31, 1941.....	24,700.09
Decrease.....	\$ 768.66

* These certificates were purchased with the approval of the Executive Committee of the Board of Managers with money received from the following sources:

Butler Notes.....	\$1,190.12
Savings Acct.....	\$8,500.00
Checking Acct.....	309.88

The original investment in the Butler notes was \$2,000 on which only \$1,190.12 was realized when the property was sold—a loss of \$809.88 on the investment.

ALLOTMENTS

	<i>Allotted</i>	<i>Receipts</i>	<i>Expended</i>
Secretary's Office.....	\$ 499.85*		\$ 499.24
Treasurer's Office.....	225.00		202.12
Journal.....	3,100.00	+ \$535.49 = \$3,635.49	3,548.21†
Meetings Committee.....	350.00		306.70
Custodian & Subs. Mgr.....	120.00		37.79‡
Membership Committee.....	10.00		—
Executive Committee.....	10.00		—
Journal Clerical Asst.....	240.00	} = \$300.00	266.35
Journal Misc. Expense.....	60.00		
Directory.....	350.00		341.35

* Original allotment of \$450 plus additional allotment of \$49.85.

† This includes bill for December JOURNAL printing and estimated amount of December reprints.

‡ This amount does not include a bill for \$1.90 outstanding from 1941 expenses.

Report of the Committee of Auditors

The Committee of Auditors, P. A. SMITH (chairman), H. G. AVERS, and C. H. SWICK, presented the following report:

The accounts of the Treasurer of the Washington Academy of Sciences for the year 1941 were examined by your committee on January 13, 1942. The neat and orderly manner in which the records were found is a matter for especial commendation. All receipts and disbursements in his report were verified against all vouchers and balance sheets from the bank. Vouchers are properly approved and the report is correct. Securities listed in the Treasurer's report were inspected on January 13, 1942, and the statement of assets of the Academy is correct.

On motion, the reports of the Treasurer and the Committee of Auditors were accepted.

Report of the Archivist

The Archivist, N. R. SMITH, presented the following report:

Since this is the first formal report of the Archivist, the larger items now in the Archives are listed: A complete bound set of the Proceedings of the Academy from 1899 to 1911, a complete bound set of the JOURNAL from 1911 to date, both in good condition.

Of the Directories published by the Academy since 1899 only two editions are missing, viz: 1901 and 1912. Prior to the publication of the Academy Directory, the Joint Commission of Scientific Societies published directories each year beginning with 1889 and ending with 1898. Of these ten editions, the following six are missing: 1889, 1890, 1891, 1893, 1894, and 1896. Although strictly speaking these may not belong to the Academy Archives, it is felt that they should be included and some effort be made to complete the set. Therefore, if anyone has copies of the missing editions mentioned above, the Archivist will be very glad to have them.

One mysterious small package has remained sealed since March 23, 1898. The label says, "This package containing the ballots by which the nucleus of the Washington Academy of Sciences was selected as presented by the Joint Commission of Scientific Societies to the Academy with the request that it be not opened within 20 years. Its official history appears on pages 41, 45, 46, and 55 of 'Record Joint Commission Vol. II, 1897.' Sealed and delivered March 23rd, 1898. Marcus Baker, Secretary, Joint Commission."

The main bulk of the material turned over

to the Archivist consists of old records of the secretaries and the treasurers together with nomination blanks and correspondence. Up to 1912, all correspondence was copied into letter press books which are in the Archives. Since then the correspondence has been filed in various ways, each officer having his own likes in the matter. This dusty material is being sorted as time permits.

On motion, the report of the Archivist was accepted.

Report of the Board of Editors

The Board of Editors, J. H. KEMPTON, R. J. SEEGER, and G. A. COOPER, submitted the following report for 1941:

Volume 31 of the JOURNAL for the calendar year 1941 consisted of 12 issues totaling 528 pages. It contained 62 original articles of which 36 were by members of the Academy and 26 were communicated. Space was distributed as follows:

Natural Sciences	319½ pages	60 per cent
Physical Sciences	151¼ pages	29 per cent
Proceedings	40½ pages	8 per cent
Obituaries	10¾ pages	2 per cent
Index	6¾ pages	1 per cent

There was appropriated by the Board of Managers to the Editors for printing, illustrating, reprints, and mailing the JOURNAL \$3,100; for clerical assistance \$240; for postage and incidentals \$60—a total of \$3,400. Of this sum there was expended for clerical assistance \$240; for postage and incidentals \$28.93; and for printing, illustrating, reprints, and mailing \$3,545.54. The total cost of issuing Volume 31 was, therefore, \$3,814.47. Of this amount authors, institutions, or societies paid \$604.48 to cover the cost of excess illustrations, printing costs, and reprints, leaving \$3,209.99 to be charged to the Editors' budget of \$3,400. There is, therefore, an unexpended balance of \$190.01.

At the close of the year the Editors had on hand and accepted for publication 13 manuscripts totaling 259 typewritten pages and 18 illustrations.

On motion, the report of the Board of Editors was accepted.

Report of the Custodian and Subscription Manager of Publications

The Custodian and Subscription Manager of Publications, W. W. DIEHL, presented the following report for 1941:

The stocks of Academy publications available for sale as revealed by the appended inventory are more complete than during the previous year. At the beginning of the year 1941 by special action of the Board the Custodian was authorized to augment the then depleted supply of certain volumes of the JOURNAL sufficient to secure a reserve available to purchasers of unbroken sets, particularly in the interest of prospective institution subscribers. This was to be accomplished by means of a fund supplied by the sale of complete sets. Since this fund was available early in the year it has been possible to purchase advantageously most of the numbers needed; and at the present time there are lacking but six numbers in older volumes and three recent volumes, all in one set, to complete the authorized reserve: eight sets Vols. 1–30, six sets Vols. 11–30, and 13 sets Vols. 16–30. To this reserve there have been added two additional sets, Vols. 1–29, released for sale on order of the Board by the Secretary of the Academy and the Editor of the JOURNAL. That this policy of assembling reserve sets has been justified is attested by the fact that although three of these reserve sets were sold during the year to institutions, we are still in a position to meet any reasonable demand in the near future.

Contrasted with the favorable aspects of stocks at hand the subscription list is less satisfactory.

Nonmember subscribers in the United States..... 89

Nonmember subscribers in foreign countries..... 40

Geological Society of Washington..... 15

Because conditions have not warranted the expenditures anticipated the amount actually used, chiefly in maintaining correspondence, has been but \$37.79 of the budget allowance, leaving an unexpended balance of \$82.21.

On motion, the report of the Custodian and Subscription Manager of Publications was accepted.

Report of the Tellers

The Committee of Tellers, L. B. TUCKERMAN (chairman), and R. W. BROWN, presented their report as follows on the annual election of officers for 1942 and on the amendments to the bylaws:

A total of 237 ballot envelopes were delivered to the Committee by the Secretary. Of these, 2 bore no signature and 1 bore the signature of a member in arrears.

In the remaining 234 envelopes there were found 184 ballots on the Amendments to the Constitution and 234 ballots for Officers and Manager of the Academy.

The count of the ballots on the Amendments showed

For the Amendments.....	182
Against the Amendments.....	1
Not voting.....	1

The count of the ballots on Officers of the Academy showed

For President, HARVEY L. CURTIS	222
For Secretary, FREDERICK D. ROSSINI	221
For Treasurer, HOWARD S. RAPPLEYE	221

Examination of the preferential ballot for Managers by the Hare system showed 4 unmarked ballots and 30 ballots which were invalid because marked with crosses from which no first choice could be determined, leaving 200 valid ballots. The Droop quota was therefore $(200+1)/(2+1)=67$. The count of the ballots showed the necessary quotas for ROBERT F. GRIGGS and FRANK C. KRACEK, after transfer of votes from the fourth place.

Nominations for Vice-Presidents

For the respective affiliated societies, the Secretary presented the following nominations for Vice-Presidents of the Academy for 1942:

Philosophical Society of Washington:	WILLIAM G. BROMBACHER
Biological Society of Washington:	ERNEST P. WALKER
Chemical Society of Washington:	HERBERT L. HALLER
Entomological Society of Washington:	AUSTIN H. CLARK
National Geographic Society:	ALEXANDER WETMORE
Geological Society of Washington:	JOHN B. REESIDE, JR.
Medical Society of the District of Columbia:	FRED O. COE

Columbia Historical Society:	ALLEN C. CLARK
Botanical Society of Washington:	JAMES E. McMURTREY, JR.
Archaeological Society of Washington:	ALEŠ HRDLÍČKA
Washington Section of the Society of American Foresters:	WILLIAM A. DAYTON
Washington Society of Engineers:	PAUL C. WHITNEY
Washington Section of the American Institute of Electrical Engineers:	FRANCIS B. SILSBEE
Washington Section of the American Society of Mechanical Engineers:	WALTER RAMBERG
Helminthological Society of Washington:	EMMETT W. PRICE
Washington Branch of the Society of American Bacteriologists:	LELAND W. PARR
Washington Post of the Society of American Military Engineers:	CLEMENT L. GARNER
Washington Section of the Institute of Radio Engineers:	HERBERT GROVE DORSEY
Washington Section of the American Society of Civil Engineers:	HERMAN STABLER

On motion, the Secretary was instructed to cast a unanimous ballot for these Vice-Presidents.

Awards for Scientific Achievement for 1941

President CLARK announced the recipients of the Academy's Awards for Scientific Achievement for 1941, as follows:

For the Biological Sciences, to—

G. ARTHUR COOPER, U. S. National Museum, *in recognition of his distinguished service in invertebrate paleontology, notably for discovery of anatomical structures hitherto unknown.*

For the Engineering Sciences, to—

THEODORE R. GILLILAND, National Bureau of Standards, *in recognition of his distinguished service in originating automatic ionosphere recordings for continuously variable radio frequencies.*

For the Physical Sciences, to—

STERLING B. HENDRICKS, U. S. Bureau of Plant Industry, *in recognition of his distinguished service in determining the constitution of micaceous and other complex minerals.*

As business from the floor, remarks were made by ATHERTON SEIDELL and W. J. HUMPHREYS. The former suggested two ways in which the Academy could increase its service to science, one by publishing in the JOURNAL lists of the publications issued by the Govern-

ment in scientific fields and the other by maintaining in its library a complete file of Government publications. The latter suggested first, that the Archivist could advertise in the JOURNAL the need for certain old Directories in order to complete the files, and second, that a committee should be appointed to examine the sealed package of ballots (see report of the Archivist), which was requested by the Joint Commission of the Scientific Societies not to be opened within 20 years of March 23, 1898.

President CLARK appointed Past Presidents ALEXANDER WETMORE and T. WAYLAND VAUGHAN to escort the new President, HARVEY L. CURTIS, to the chair. After a short address, President CURTIS declared the meeting adjourned at 10:20 P.M., for a social hour.

FREDERICK D. ROSSINI, *Secretary*.

ANTHROPOLOGICAL SOCIETY

The Anthropological Society of Washington at its annual meeting held January 20, 1942, elected the following officers: President, GEORGE S. DUNCAN; Vice-President, JULIAN H. STEWARD; Secretary, REGINA FLANNERY; Treasurer, T. DALE STEWART; Members of the Board of Managers, WM. N. FENTON, H. W. KRIEGER, R. UNDERHILL, J. E. WECKLER, and WALDO R. WEDEL. A report of the membership and activities of the Society since the last annual meeting follows:

Life members.....	2
Active members.....	43
Associate members.....	11
<hr/>	
Total.....	56

The members elected during the year were: Sister BERNARD COLEMAN, Mrs. MARGARET D. FOSTER, S. L. PERCHICK, and J. E. WECKLER, all active members.

Through death the Society lost one associate member, DAVID IVES BUSHNELL, JR. The following resolution was adopted:

Whereas: David I. Bushnell, Jr., a member of this Society for more than 30 years, passed from this life on June 4, 1941, and

Whereas: Mr. Bushnell was closely associated with the members of this Society during the greater part of that time, was a collaborator in the work of the Bureau of American Ethnology and the Smithsonian Institution, and the author of numerous valuable papers in ethnology and archeology, which appeared in the publications of the Bureau and the Institution, and in the

American Anthropologist, the organ of the Anthropological Society,

Be it resolved: That the Anthropological Society of Washington hereby expresses its high appreciation of Mr. Bushnell's work, its deep sense of the loss suffered by our science in his removal from among us, and on the part of our membership a profound feeling of personal bereavement.

The Treasurer's report is as follows:

Funds invested in Perpetual Building Association (with interest to date).	\$1636.74
21 shares Washington Sanitary Improvement Co. (par value \$10 per share).....	210.00
2 shares Washington Sanitary Housing Co. (par value \$100 per share)	200.00
U. S. Savings Bond, Series G (on order)	500.00
Cash in bank.....	188.20
<hr/>	
	\$2734.94

Bills outstanding:

To American Anthropological Association.....	\$55.00	55.00
		<hr/>
	\$2679.94	
Total as of January 18, 1941..	2529.81	
		<hr/>
Increase.....	\$ 150.13	

It was decided to set aside a portion of the annual increase each year as a reserve for publication. When funds are adequate these funds may be appropriated to underwrite the publication of anthropological papers to be known as "Contributions from the Anthropological Society of Washington" and published as Memoirs of the AAA. Special attention will be given to studies of the history and archeology of the early inhabitants of the District of Columbia and vicinity, since no other society assumes responsibility for such studies.

Papers presented before the regular meetings of the Society were as follows:

January 21, 1941, 697th meeting, WALDO R. WEDEL, *Archeology and environment in the Great Plains*.

February 18, 1941, 698th meeting, T. DALE STEWART, *Archeological investigations at the historic Indian village of Patawomeke in Stafford County, Va.*

March 18, 1941, 699th meeting, held jointly with the D. C. Chapter of the American Sociological Society, JOHN PROVINSE, *Cooperative effort in sociology and anthropology*.

April 15, 1941, 700th meeting, INA C. BROWN, *Social structure and the status of the American Negro*.

October 21, 1941, 701st meeting, ROBERT H. LOWIE, *Nimuendajá's findings among the Botocudo.*

November 27, 1941, 702d meeting, held jointly with the Washington Academy of Sciences, MATTHEW W. STIRLING, *Treasure trove of Mexican archeology.*

December 16, 1941, 703d meeting, WALTER W. TAYLOR, *Cave exploration in northern Mexico.*

REGINA FLANNERY, *Secretary.*

CHEMICAL SOCIETY

535TH MEETING

The 535th meeting was held in Corcoran Hall, George Washington University, on Thursday, October 9, 1941, at 8:15 P.M., with Dr. H. L. HALLER as Chairman. After routine business of the Society, 14 papers were presented by 24 authors in four sections as follows:

Biochemistry, DR. H. M. DYER, *presiding*

Plant gonadotropes. J. T. BRADBURY and E. T. GOMEZ.

A comparative study of methods for the determination of vitamin C. JOSEPH H. ROE and JAMES M. HALL.

Co-carcinogenesis. M. J. SHEAR and JOSEPH LEITER.

A crystalline protein fragment from a wheat lipoprotein. A. K. BALLS, W. S. HALE, and T. H. HARRIS.

Organic chemistry, DR. E. E. FLECK, *presiding*

The influence of structure on the hydrolysis of glycosides by the enzymes of almond emulsin. WILLIAM WARD PIGMAN and NELSON K. RICHTMYER.

Centers of asymmetry in the chlorophyll molecule. LEWIS J. SARGENT.

Problems confronting the pharmaceutical chemist. F. H. WILEY.

Physical chemistry, DR. F. D. ROSSINI, *presiding*

Transition behavior of some of the sulphide-type compounds of silver. FRANK C. KRACEK.

Mechanism of the decomposition of ammonia. STEPHEN BRUNAUER, KATHARINE S. LOVE, and R. G. KEENAN.

Photochemical reduction of methylene blue in fats and oils. GEORGE R. GREENBANK and GEORGE E. HOLM.

Some metallic ion complexes. J. E. DRALEY.

Inorganic and analytical chemistry, DR. P. S. ROLLER, *presiding*

Preparing refractory materials for analysis by treatment with HCl at elevated temperatures. EDW. WICHERS and W. G. SCHLECHT.

Determination of free silica in the presence of silicate by hydrofluosilicic acid. F. H. GOLDMAN.

Some aspects of the coordination chemistry of the platinum group. R. GILCHRIST.

536TH MEETING

The 536th meeting was held in Room 108 of the Chemistry Building, Georgetown University, on Thursday, October 30, 1941, at 8:15 P.M., with H. L. HALLER as Chairman. The speaker of the evening was Dr. B. H. NICOLET, of the Bureau of Dairy Industry, Beltsville, Md., who spoke on the subject *The use of periodic acid on the study of proteins.*

537TH MEETING

The 537th meeting was held in the Auditorium of The Catholic University of America, on Thursday, November 13, 1941, at 8:15 P.M., with H. L. HALLER as Chairman. Election of officers for the Society for 1942 took place, the results being as follows:

President: NORMAN BEKKEDAHL.

Secretary: E. R. SMITH.

Treasurer: M. M. HARING.

Councilors: N. L. DRAKE, W. D. COLLINS, H. L. HALLER, R. M. HANN, J. H. HIBBEN, F. O. RICE, F. D. ROSSINI, M. X. SULLIVAN, E. WICHERS.

Managers: J. J. FAHEY, R. GILCHRIST, S. B. HENDRICKS, C. HEURICH, D. B. JONES, N. K. RICHTMYER.

The speaker of the evening was Prof. ALEXANDER SILVERMAN, head of the Department of Chemistry, University of Pittsburgh, who spoke on the subject *Glass: Today and tomorrow.*

538TH MEETING

The 538th meeting was held in the Auditorium of the Cosmos Club, on Thursday, December 11, 1941, at 8:15 P.M., with H. L. HALLER as Chairman. The speaker of the evening was Prof. HENRY EYRING, Chemistry Department, Princeton University, who spoke on the subject *A theory of some rate and thermodynamic properties of surfaces, including boundary lubrication.*

NORMAN BEKKEDAHL, *Secretary.*

PROGRAMS OF THE ACADEMY AND AFFILIATED SOCIETIES¹

THE ACADEMY (Cosmos Club Auditorium, 8:15 P.M.):

Thursday, March 19. Awards for scientific achievement, 1941.

Thursday, April 16. *Cosmic emotion*. PAUL R. HEYL.

PHILOSOPHICAL SOCIETY OF WASHINGTON (Cosmos Club Auditorium, 8:15 P.M.):

Saturday, March 28. *Adsorption of gases and vapors in solids*. STEPHEN BRUNAUER.

ANTHROPOLOGICAL SOCIETY OF WASHINGTON (U. S. National Museum, 8 P.M.):

Tuesday, March 17. *The Jesuits in South America*. ALFRED MÉTRAUX.

CHEMICAL SOCIETY OF WASHINGTON (Cosmos Club Auditorium, 8:15 P.M.):

Thursday, April 9. *The electrophoretic study of proteins*. D. A. MACINNES.

NATIONAL GEOGRAPHIC SOCIETY (Constitution Hall, 8:15 P.M.):²

Friday, March 20. Program to be announced.

Friday, March 27. *Hawaii*. Capt. JOHN CRAIG.

Friday, April 3. *Familiar birds turn movie stars*. ARTHUR A. ALLEN.

MEDICAL SOCIETY OF THE DISTRICT OF COLUMBIA (1718 M Street, N.W., 8 P.M.):

Wednesday, March 18. *Syphilis looks at the doctor*. NELS A. NELSON.

Sound and color film: *Syphilis, its diagnosis and management*.

Wednesday, March 25. Presentation of papers selected as meriting prizes among those submitted by house officers in the District of Columbia.

Wednesday, April 8 (program by Washington Heart Association). *Cardioangiography—the x-ray visualization of the heart chambers and great vessels by contrast substance*. ISIDORE SHULMAN. Discussion led by BERNARD J. WALSH.

Incomplete rupture of the aorta—a cause of cardiac pain and cardiac murmurs. THOMAS M. PEERY. Discussion led by JOHN A. REISINGER.

Wednesday, April 15 (program by Obstetrical Board). *Report of the Obstetrical Board*. HERBERT P. RAMSEY.

Responsibilities of the hospital obstetric staff conference in relation to the problems of maternal welfare. PHILIP F. WILLIAMS.

The county maternal welfare committee; possibilities for postgraduate education. HARVEY B. MATTHEWS.

Obstetrical care in the United States. EDWIN F. DAILY.

BOTANICAL SOCIETY OF WASHINGTON (Women's Club of Chevy Chase, Md., 7 P.M.):

Thursday, April 2. Annual dinner, followed by illustrated lecture:

Fairchild Tropical Expedition. EDWARD P. BECKWITH.

AMERICAN SOCIETY OF MECHANICAL ENGINEERS, Washington Section (Pepco Auditorium, 8 P.M.):

Thursday, April 9. *The Washington National Airport—its conception construction, and maintenance*. JOHN GROVES.

SOCIETY OF AMERICAN BACTERIOLOGISTS, Washington Branch (Georgetown University School of Medicine, 3900 Reservoir Road, 8 P.M.):

Tuesday, March 24. *Influence of culture media and hydrogen-ion concentration on production of color variance in certain plant bacteria*. AGNES J. QUIRK.

Relation of vitamin deficiency to fatal pneumococcus infection in mice. JERALD G. WOOLEY and W. H. SEBRELL.

¹ Notices to be published in this space must reach the Senior Editor, Raymond J. Seeger, not later than the 28th of the month preceding that of publication.

² Lectures open only to members of the National Geographic Society who have subscribed to season tickets.

CONTENTS

	Page
GEOPHYSICS.—Geophysical measurements in the laboratory and in the field. H. E. McComb	65
ZOOLOGY.—A new species of Amphipoda from Uruguay and Brazil. CLARENCE R. SHOEMAKER.....	80
ICHTHYOLOGY.—The first record of the ophichthyid eel <i>Scytalichthys miurus</i> (Jordan and Gilbert) from the Galapagos Islands, with notes on <i>Mystriophis intertinctus</i> (Richardson). LEONARD P. SCHULTZ.....	83
PROCEEDINGS: THE ACADEMY.....	84
PROCEEDINGS: ANTHROPOLOGICAL SOCIETY.....	91
PROCEEDINGS: CHEMICAL SOCIETY.....	92

This Journal is Indexed in the International Index to Periodicals

JOURNAL OF THE WASHINGTON ACADEMY OF SCIENCES

BOARD OF EDITORS

RAYMOND J. SEEGER
GEORGE WASHINGTON UNIVERSITY

G. ARTHUR COOPER
U. S. NATIONAL MUSEUM

JASON R. SWALLEN
BUREAU OF PLANT INDUSTRY

ASSOCIATE EDITORS

W. EDWARDS DEMING
PHILOSOPHICAL SOCIETY

C. F. W. MUESEBECK
ENTOMOLOGICAL SOCIETY

HARALD A. REHDER
BIOLOGICAL SOCIETY

EDWIN KIRK
GEOLOGICAL SOCIETY

CHARLOTTE ELLIOTT
BOTANICAL SOCIETY

T. DALE STEWART
ANTHROPOLOGICAL SOCIETY

HORACE S. ISBELL
CHEMICAL SOCIETY

PUBLISHED MONTHLY

BY THE

WASHINGTON ACADEMY OF SCIENCES

450 AHNAP St.

AT MENASHA, WISCONSIN

Entered as second class matter under the Act of August 24, 1912, at Menasha, Wis.
Acceptance for mailing at a special rate of postage provided for in the Act of February 28, 1925:
Authorized January 21, 1933.

Journal of the Washington Academy of Sciences

This JOURNAL, the official organ of the Washington Academy of Sciences, publishes (1) Short original papers, written or communicated by members of the Academy; (2) proceedings and programs of meetings of the Academy and affiliated societies; (3) notes of events connected with the scientific life of Washington. The JOURNAL is issued monthly, on the fifteenth of each month. Volumes correspond to calendar years.

Manuscripts may be sent to any member of the Board of Editors. It is urgently requested that contributors consult the latest numbers of the JOURNAL and conform their manuscripts to the usage found there as regards arrangement of title, subheads, synonymies, footnotes, tables, bibliography, legends for illustrations, and other matter. Manuscripts should be typewritten, double-spaced, on good paper. Footnotes should be numbered serially in pencil and submitted on a separate sheet. The editors do not assume responsibility for the ideas expressed by the author, nor can they undertake to correct other than obvious minor errors.

Illustrations in excess of the equivalent (in cost) of two full-page line drawings are to be paid for by the author.

Proof.—In order to facilitate prompt publication one proof will generally be sent to authors in or near Washington. It is urged that manuscript be submitted in final form; the editors will exercise due care in seeing that copy is followed.

Author's Reprints.—Reprints will be furnished in accordance with the following schedule of prices:

Copies	4 pp.	8 pp.	12 pp.	16 pp.	20 pp.	Covers
50	\$2.00	\$3.25	\$ 5.20	\$ 5.45	\$ 7.25	\$2.00
100	2.50	4.00	6.40	6.75	8.75	2.75
150	3.00	4.75	7.60	8.05	10.25	3.50
200	3.50	5.50	8.80	9.35	11.75	4.25
250	4.00	6.25	10.00	10.65	13.25	5.00

<i>Subscription Rates.</i> —Per volume.....	\$6.00
To members of affiliated societies; per volume.....	2.50
Single numbers.....	.50

Correspondence relating to new subscriptions or to the purchase of back numbers or volumes of the JOURNAL should be addressed to William W. Diehl, Custodian and Subscription Manager of Publications, Bureau of Plant Industry, Washington, D.C.

Remittances should be made payable to "Washington Academy of Sciences" and addressed to 450 Ahnapp Street, Menasha, Wis., or to the Treasurer, H. S. Rappleye, U. S. Coast and Geodetic Survey, Washington, D.C.

Exchanges.—The JOURNAL does not exchange with other publications.

Missing Numbers will be replaced without charge provided that claim is made to the Treasurer within thirty days after date of following issue.

OFFICERS OF THE ACADEMY

President: HARVEY L. CURTIS, National Bureau of Standards.
Secretary: FREDERICK D. ROSSINI, National Bureau of Standards.
Treasurer: HOWARD S. RAPPLEYE, U. S. Coast and Geodetic Survey.
Archivist: NATHAN R. SMITH, Bureau of Plant Industry.
Custodian of Publications: WILLIAM W. DIEHL, Bureau of Plant Industry

JOURNAL OF THE WASHINGTON ACADEMY OF SCIENCES

VOL. 32

APRIL 15, 1942

No. 4

ANTHROPOLOGY.—*The Ainu double foreshaft toggle harpoon and western North America.*¹ GORDON W. HEWES, University of California. (Communicated by HENRY B. COLLINS, JR.)

O. T. Mason (1900, p. 233) noted the similarity of Ainu double foreshaft harpoons to those of northwestern North America. Distributional data are now far more complete for the latter area, and it seems worth while to reexamine an apparently significant Asiatic-American parallel. First, as to the Asiatic occurrence, it must be admitted that the writer has not been able to find any descriptions of the Ainu implement that include material unavailable to Mason in 1900. Hitchcock (1890, pp. 470–471, 494) described and illustrated an Ainu harpoon in the U. S. National Museum collection, but this differs in details from Batchelor's reference (1892, pp. 154–155); subsequent references to Ainu double foreshaft harpoons in the literature are unfortunately content to refer to these sources (e.g., Montandon, 1937). Batchelor's further Ainu writings reproduce the 1892 drawing. The following quotation and Fig. 1, *a*, constitute Batchelor's original reference:

Trout and pike are caught with a spear called *chininiap*, or *apniniap*. The handle of this spear is about eight or nine feet long, and when fitted up ready for use it is fully ten feet in length. As will be seen from the figure, this spear has two heads to it, which are fastened to the pole by means of string. These heads are barbed, and consist of two parts—an iron point and a bone foundation. As soon as a fish is struck with this spear, the barbed heads come off the points of the pole, but the fish is secured by means of the strings which are attached to

the spear-heads and back part of the shaft or pole.

Unmentioned but noteworthy are the string connecting the foreshafts midway between the toggles and the main shaft and the fact that one of the foreshafts is shorter than the other. In the drawing the strings from the toggles are clearly shown attached to the shaft; while other Ainu specimens may have longer lines, held in the user's hand, or lying coiled in the canoe; such is not the case here. Hitchcock deals with a larger device, used for seals, whales, turtles, and large fish; it is shown in Fig. 1, *b, c*. Though the arrangement and proportions of the two foreshafts, toggles, and the reinforcing string between the foreshafts are the same, the toggles are connected to a tough strip of hide, to the middle of which is attached a long, braided, bark, rope line, shown looped around the main shaft and passing on into a loose coil. This line when the harpoon is in use is stated to pass over the ornamented crotch at the distal end of the shaft, shown in Fig. 1, *c*. The length of the National Museum's specimen's shaft is 15 feet.

Thus there seem to be two types of double foreshaft toggle harpoons used by the Ainu, the one for smaller fish—trout and pike—in which the toggles are tied directly to the shaft, and a larger one, with a long hand line, for sea mammals, sharks, and swordfish. It is probable that for the smaller fish, the harpoon was thrust, not thrown clear of the user's hands, and the quarry retrieved simply by pulling in the shaft, to which the embedded toggle is attached. With sea mammals and larger fish, the whole harpoon is thrown clear, the user

¹ Received September 24, 1941. The author is indebted to Prof. E. W. Gifford and Dr. Margaret Lantis for helpful suggestions and criticism.

retaining the line in his hands; the floating wooden shaft impedes the efforts of the animal to escape. Japanese paintings illustrate this technique (Greedy, 1884, p. 52). Findeisen (1929, p. 28 ff.) mentions the two types of harpoons and contrasts them in respect to the toggle-lines. The Ainu are

mareks have been described by many writers on the Ainu, including Hitchcock, Batchelor, Montandon. The Ainu also fish with hook and line, nets, traps, etc.

In northeast Asia, only the Ainu and Amur peoples fish with harpoons (Findeisen, 1929, p. 28), and while Chukchi, Koryak,

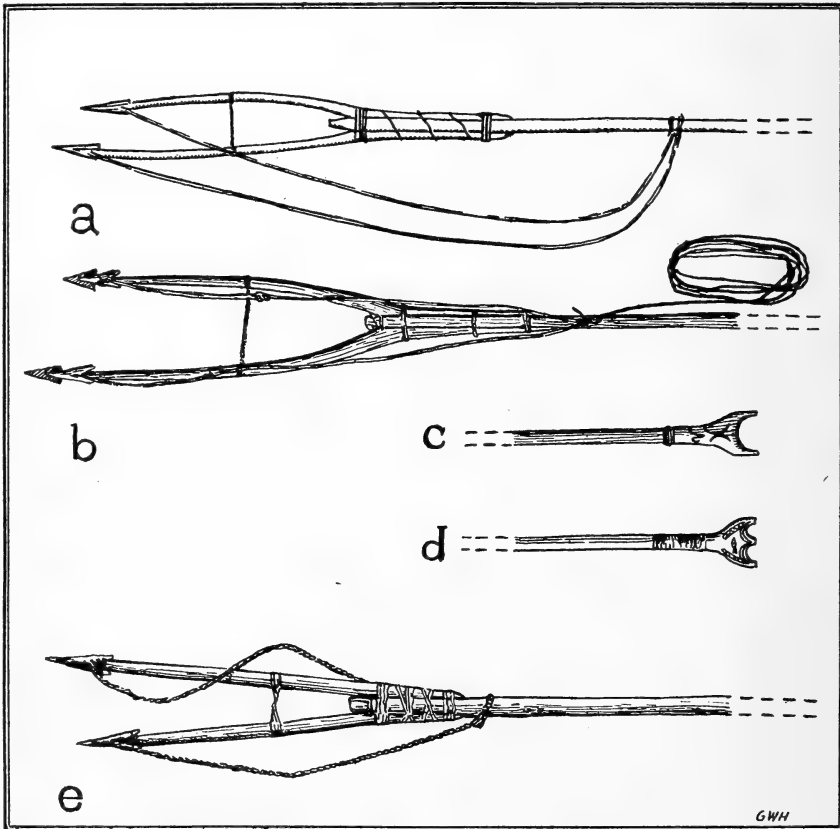

FIG. 1.—*a*, Ainu harpoon (after Batchelor, 1892, p. 154); *b*, Ainu harpoon (after Hitchcock, 1890, p. 470); *c*, Ainu harpoon, base of shaft showing ornated device (Hitchcock, 1890, p. 470); *d*, Kwakiutl harpoon base device (after Goddard, 1924, p. 61); *e*, Wailaki (California) harpoon, from a photograph by the writer, 1940.

said by Hitchcock to poison their toggles occasionally with aconite (presumably this would apply only to the sea-mammal harpoon, as there would be no need to poison harpoon points for fish). On the Asiatic-American distribution of this poison, see Heizer's report (1938a). The Ainu do most of their salmon (*Oncorhynchus*) fishing not with harpoons, but with the *marek*, an iron hook resembling a gaff, but with a trigger action that pins the fish to the shaft;

and Kamchadal used harpoons for sea-mammal hunting, these were all of the single-toggle type, or the socketed foreshaft and multiple barbed head type. The double foreshaft toggle harpoon is restricted to the Ainu; review of the available Gold, Gilyak, and Udekhe material yields references only to single toggle and barbed types. Harpoon fishery has been described for the Manchu and Gold (Lattimore, 1933, pp. 33-34), as well as for the coastal Udekhe (Arsenjew,

1924, vol. 2, pp. 137, 276). The Sakhalin Ainu use a sealing spear with a single offset foreshaft, for use under the edges of broken ice (Greedy, 1884, pp. 274-275).

The situation in western North America is decidedly different (see Fig. 2, map). The double foreshaft toggle harpoon occurs in 60 native tribes at least, from Vancouver Island southward along the coast almost to San Francisco Bay, and inland from the

toggle head were used by many groups as alternatives to the double foreshaft type, and by some groups exclusively, though in the northwestern California area by preference rather than through ignorance of the double foreshaft device. In the eastern Plateau and the northeastern Basin, only single toggle harpoons were employed. Finally, many types of thrusting and hurling implements, often confused in the

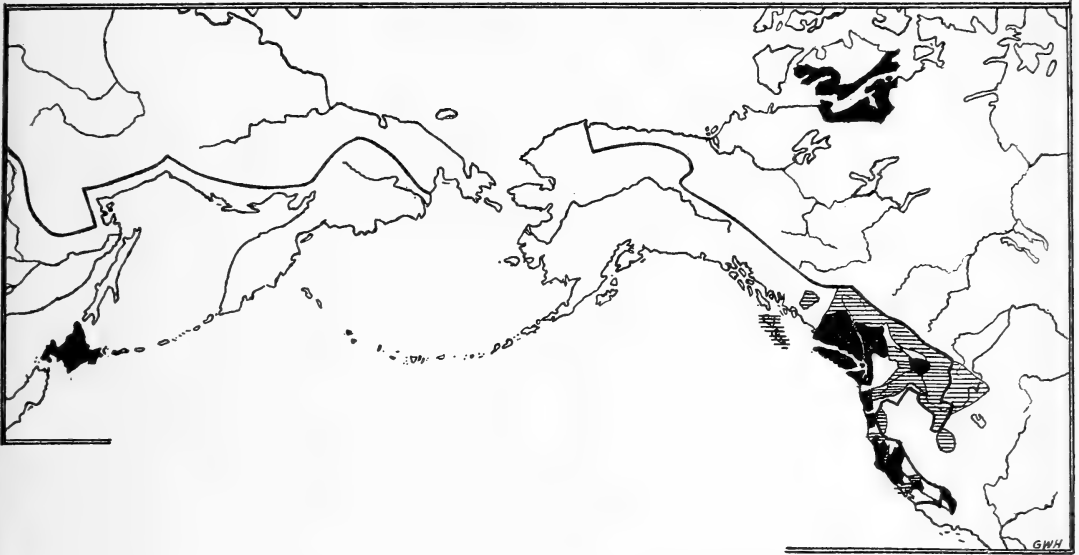

FIG. 2.—The North Pacific area, showing the distribution of double foreshaft toggle harpoons (in black), single toggle harpoons (in Northwest coast, Plateau, and California-Basin areas only; horizontal hatching), and the boundaries of Pacific salmon, i.e., *Oncorhynchus*, fishery (heavy black line).

Chilkotin to the southernmost Yokuts of the San Joaquin Valley, as well as on the Arctic coast among the Copper Eskimo. Over most of the area within the Pacific drainage, the implement is used for taking the large salmon (*Oncorhynchus*), but on the southern Northwest coast the device was employed frequently for seal and porpoise.

One must carefully distinguish the double foreshaft toggle harpoon in western North America from other harpoon and harpoon-like devices used in the pursuit of aquatic animals. From Alaska south as far as the Mattole River in California, the larger sea mammals were taken with a single-pointed barbed harpoon. Harpoons with a single

literature with harpoons, were used: Barbed fish-spears, gaff hooks, bidents, and tridents. The trident fish-spear, or leister, was common in western North America, though the literature indicates that it was lacking, at least in recent times, south of the Columbia River, except among the Umatilla (Ray, MS.). Transitions between trident and harpoon occur in the Plateau, in which the three prongs were detachable as a unit, the main shaft fitting into a socket in the butt of the middle prong (Ray, MS.; and Ray, 1933).

The following lists of tribes and references constitute the basis of the map, Fig. 2 (the listings in parentheses are uncertain):

TRIBES USING DOUBLE FORESHAFT TOGGLE HARPOONS IN NORTHWESTERN AMERICA

- Copper Eskimo—Rasmussen, 1932.
 Kwakiutl—Boas, 1909; Barnett, 1939.
 Nutka—Curtis, 1916.
 Gulf of Georgia Salish—Barnett, 1940.
 Sanetch—Barnett, 1939.
 Cowichan—Barnett, 1939.
 Nanaimo—Barnett, 1939.
 Pentlatch—Barnett, 1939.
 Comox—Barnett, 1939.
 Slaiamun—Barnett, 1939.
 Klahuse—Barnett, 1939.
 Homalco—Barnett, 1939.
 Sechelt—Barnett, 1939.
 Squamish—Barnett, 1939.
 Lummi—Stern, 1934.
 Puget Sound—Haerberlin and Gunther, 1930.
 Skokomish—Gunther, MS.
 Klallam—Gunther, MS.
 Makah—Gunther, MS.; Mason, 1900.
 Quinault—Olson, 1936.
 Chilkotin—Morice, 1910.
 Lillooet—Ray, MS.
 Thompson—Teit, 1900.
 Okanagan—Teit, 1930.
 Coeur d'Alene—Ray, MS.
 Lower Chinook—Ray, 1938.
 Tillamook—Barnett, 1937.
 (Alesa—Drucker, 1939).
 Siuslaw—Barnett, 1937.
 Galice Creek Athabaskans—Barnett, 1937.
 Chetco—Barnett, 1937.
 Tolowa—Driver, 1939.
 Yurok—Driver, 1939.
 Karok—Driver, 1939.
 Hupa—Driver, 1939; Goddard, 1903.
 Wiyot—Driver, 1939.
 Chilula—Driver, 1939.
 Mattole—Driver, 1939.
 Sinkyoné—Driver, 1939.
 Kato—Driver, 1939; Essene, MS.
 Coast Yuki—Driver, 1939; Gifford, 1939.
 Lassik—Essene, MS.
 Yuki—Essene, MS.
 Pomo-Kabedile—Gifford and Kroeber, 1937.
 Buldam-Willits—Gifford and Kroeber, 1937.
 Kacha-Bida—Gifford and Kroeber, 1937.
 Shanel (North)—Gifford and Kroeber, 1937.
 Yokaia—Gifford and Kroeber, 1937.

- Northeastern—Gifford and Kroeber, 1937
 Klamath (and Modoc)—Spier, 1930.
 (Achomawi—Kniffen, 1928).
 Yana—Gifford and Klimek, 1936.
 Wintu—DuBois, 1935.
 Hill Wintun—Gifford and Kroeber, 1937.
 Miwok—Barrett and Gifford, 1933.
 Mono-Tuhukwadj—Driver, 1937.
 Wopunuch—Driver, 1937.
 Entimbich—Driver, 1937.
 Waksachi—Driver, 1937
 Yokuts-Choinimni—Driver, 1937.
 Wukchamni—Driver, 1937.
 Yaudanchi—Driver, 1937.
 Yauelmani—Driver, 1937.
 Kern River Bankalachi—Driver, 1937.

TRIBES USING SINGLE TOGGLE HARPOONS IN NORTHWESTERN AMERICA

- Aleut—Jochelson, 1925.
 Western Eskimo—Nelson, 1897.
 Ingalik—Osgood, 1940.
 Kutchin, Crow and Peel R.—Osgood, 1936.
 (Tahltan—Emmons, 1911).
 Babine—Morice, 1910.
 Haida—Mason, 1900.
 Kwakiutl—Barnett, 1939.
 Nutka—Curtis, 1916.
 Cowichan—Barnett, 1939.
 Pentlatch—Barnett, 1939.
 Comox—Barnett, 1939.
 Squamish—Barnett, 1939.
 Skokomish—Gunther, MS.
 Makah—Mason, 1900; Densmore, 1939.
 Shuswap—Teit, 1909.
 Okanagan—Teit, 1930.
 Kutenai—Teit, 1909; Turney—High, 1941.
 (Flathead—Teit, 1930).
 Sanpoil-Nespelem—Ray, 1933.
 Spokane—Curtis, 1911.
 Coeur d'Alene—Teit, 1930.
 Nez Percé—Spinden, 1908.
 Lower Chinook—Ray, 1938.
 Santiam Kalapuya—Jacobs, MS.
 Alesa—Drucker, 1939.
 Tututni—Barnett, 1937.
 Takelma—Sapir, 1907.
 Chetco—Barnett, 1937.
 Tolowa—Drucker, 1937; Barnett, 1937.
 Yurok—Driver, 1939.
 Karok—Driver, 1939.
 Wiyot—Driver, 1939.

- Chilula—Driver, 1939.
 Chimariko—Driver, 1939.
 Van Duzen (Nongatl)—Driver, 1939.
 Sinkyone—Driver, 1939; Nomland, 1939.
 Lassik—Essene, MS.
 Coast Yuki—Driver, 1939.
 Yuki—Essene, MS.
 Pomo-Kalekau—Gifford and Kroeber, 1937.
 Shanel (South)—Gifford and Kroeber, 1937.
 Meteni (Fort Ross)—Gifford and Kroeber, 1937.
 Wappo—Driver, 1936.
 Pomo-Makahmo—Gifford and Kroeber, 1937.
 Hill Patwin—Gifford and Kroeber, 1937.
 Nisenan—Beals, 1933.
 Shoshoni-Lemhi—Steward, 1941.
 Snake River—Steward, 1941.
 North Fork of Owyhee River—Steward, 1941.
 Battle Mountain—Steward, 1941.

TRIBES USING BARBED HARPOONS IN
 NORTHWESTERN AMERICA

- Aleut—Jochelson, 1933.
 Western Eskimo—Nelson, 1897.
 Ingalik—Osgood, 1940.
 Tanaina—Osgood, 1937.
 Eyak—Birket-Smith and DeLaguna, 1938.
 Tlinkit—Krause, 1885.
 Haida—Mason, 1900; Curtis, 1916.
 Kwakiutl—Boas, 1909.
 Nutka—Mason, 1900.
 Quinault—Olson, 1936.
 (Thompson—Teit, 1900).
 Tillamook—Barnett, 1937.
 Siuslaw—Barnett, 1937.
 Kus—Barnett, 1937.
 Sixes River—Barnett, 1937.
 Cheteo—Barnett, 1937.
 Tolowa—Barnett, 1937; Drucker, 1937.
 Yurok—Driver, 1939.
 Wiyot—Driver, 1939.
 Mattole—Driver, 1939.
 (Chumash and Nicoleño—Nelson, 1936).

Illustrated specimens of double foreshaft toggle harpoons from northwestern America show the expectable local variations in details and workmanship, so that it is fairly easy to pick out examples that closely resemble the Ainu types (see Fig. 1, *e*). The large Nutka and Kwakiutl porpoise and

seal harpoons are similar in most details, including dimensions, to the Ainu specimen illustrated by Hitchcock (1890, fig. 85, p. 470; cf. Boas, 1909, p. 488 ff., and Curtis, 1916, p. 74). Even the construction of the toggles is similar; the foreshafts are of unequal length (more so in the Nutka and Kwakiutl examples than in the Ainu), and, perhaps most significant of all, the base of the main shaft has an expanded device, slightly indented at two points along the butt to form a blunt trident. This object, like the Ainu crotched shaft base, is decorated—in a Kwakiutl specimen, with a fish design and ornamental border. The Pentlatch in the Gulf of Georgia perhaps approach the Ainu more closely, for they use a “cupped” base as an alternative to the blunt “trident” (Barnett, 1939, p. 229; a diagram of the trident base is shown on p. 279, n. 39). Boas (1909, p. 495) suggested that the notched handle-end device is closely related to the spear-thrower. If the suggestion were valid, we would expect to find similar devices on the bases of harpoons and spears among peoples who possess the spear-thrower, since it is lacking on the southern Northwest coast and is also unknown to the Ainu. Tlinkit, Eskimo, and Aleut harpoons and spears have nothing resembling the crotched or trident expanded base. If similarities must be found, the expanded crotch bases of harpoon *arrows*, as used on the Bering Sea, are more convincing, although the writer is inclined to question the significance of this parallel (Mason, 1900, pl. 16, fig. 4, and pl. 17, fig. 2; cf. Kwakiutl arrows, in Goddard, 1924, p. 76, *e*). According to Hitchcock, the expanded base on the hurling harpoon is for the line to pass over; if this is true, Japanese drawings of the Ainu about to hurl harpoons are at fault, because they show the line going no farther than the thrower's hands. Mason's drawing (1900, fig. 19, p. 226) of a Quinault using a harpoon of this type has the line coiled in the thrower's right hand, while Curtis (1916, pl. 74) shows the Nutka harpoon line coiled on the thrower's left wrist. Whatever the etiology of the device may be, the striking similarity of the Ainu and southern Northwest coast

occurrences remains significant, in the absence of anything similar in between.

In another detail, closer correspondences are to be found in the harpoons from certain Californian groups. The reinforcing string connecting the foreshafts of unequal length is present on both types of Ainu double foreshaft toggle harpoons. Although this is not noted from the southern Northwest coast (it may have been present but gone unnoticed by the authors of our sources), it is a common trait of Wailaki, Mattole, Yuki, and Lassik harpoons in northwest California. The author's informants in the latter area explained the string connecting the foreshafts as a necessary reinforcement, "to keep the prongs from spreading" in the words of a Mattole. A Wailaki added that the string might be adjusted in order to alter the distance between toggles.² The inequality of the foreshafts was explained variously by informants in this area. A Mattole said that the longer prong was held above, and that the shorter foreshaft and its toggle would strike the fish if the upper one missed; similar reasons were voiced by a Yuki and a Sinkyone, the latter remarking that young men used a single foreshaft type, since they had good aim. A Wailaki thought the inequality was to prevent simultaneous breakage of the points of both toggles if the harpooner struck a submerged rock by mistake.

A simple experiment in water with models will convince anyone that the presence of two divergent foreshafts increases the likelihood of a successful strike, if the foreshafts are held one above the other. A quick thrust carefully aimed at the refracted image of a submerged object, in any but a vertical direction, will carry the point of a single shaft well above the actual target; to the error of aim due to refraction is added the tendency for the buoyant shaft to swerve upward. While practice with a single foreshaft harpoon might enable one to compensate for the refraction by aiming well below the apparent position of the target, it seems that use of two foreshafts is a simpler and surer way of overcoming the difficulty.

² Field notes of the author, 1940.

How is the Ainu harpoon to be interpreted in the light of these facts? Direct trans-Pacific diffusion from Yezo to the southern Northwest coast and California, or the reverse, seems quite improbable. On a pure age-area basis, diffusion would seem to have been from America to Asia, since the trait is far more widespread in the former continent. If careful search of Japanese sources showed no evidence for the Ainu occurrence prior to the early nineteenth century, one might venture to ascribe its introduction to the ubiquitous Aleut sea-otter hunters in Russian service, who may conceivably have picked up knowledge of the device while hunting on the American coast anywhere from Vancouver Island to California.³ Conclusive settlement of this point requires Japanese documentation which the writer at present cannot undertake, but the facts surrounding the Ainu trait under discussion, together with archeological hints from Japan itself, to say nothing of the improbability of Aleuts as neutral go-betweens in the transfer, leads the writer to seek for a more plausible explanation based on present evidence.⁴

Independent invention of double foreshafted toggle harpoons in Yezo and northwestern America, while not transcending ethnological possibilities, also seems doubtful. A convergence theory might well cite the numerous transitional types between single toggle harpoons and double foreshaft toggle harpoons, such as double foreshaft types, wherein one point is fixed, the other detachable, as reported from some Mono and Yokuts groups by Driver (1937, n. 157), or double foreshaft *fish-spears*, along with tridents and bidents detachable as a

³ Mason (1900, p. 298) notes the introduction of Aleutian harpoon arrows and the sinew backed bow to the Kuriles (presumably to the Kurilian Ainu) by nineteenth-century Aleut otter hunters; aboriginally the Yezo Ainu used a simple yew bow. (The double foreshaft toggle harpoon is not mentioned by Jochelson, 1933, for the Aleut.)

⁴ One is reminded, however, of the caution with which one must approach any question of autochthony of artifact types by Heizer's critical inquiry into the status of the Santa Barbara (Chumash) spear-thrower (1938b, pp. 137-141), wherein a device long uncritically regarded as indigenous to California is tentatively attributed to Mexican Indian contacts in post-Spanish times.

whole from the shaft, found in the Plateau (Ray, 1933; Ray, MS). The Eyak used a bident fish-spear with nondetachable barbs (Birket-Smith and DeLaguna, 1938). Further, the actual advantages of divergent foreshafts as demonstrated by the experiment described above, might be adduced as evidence to prove the likelihood of independent invention. There is no gainsaying the fact that the harpoon toggle principle has been applied to a variety of related thrusting and hurling implements in northwestern America. Nevertheless, the continuous or near-continuous distribution of double foreshaft toggle harpoons within the coastal area of the *Oncorhynchus* fishery in northwestern America, and the peripheral distribution of other forms such as tridents detachable as a unit, single-toggle harpoons, etc., strongly suggests a single origin for the double foreshaft type, without of course denying the rather obvious derivation of the invention from a simple, single-toggle harpoon ancestor. The Copper Eskimo occurrence, illustrated by Rasmussen, may fit into the general interpretation later on in this paper. Typologically, both the Ainu examples belong in the western American series. There is nothing in the harpoon situation of the Amur and north-eastern Asiatic region to correspond to the variety of transitional forms encountered in northwestern America. Outside the Yezo region, fishing and sea-mammal harpoons are uniformly either single toggle or single barbed-headed types, the latter provided with the elaborate bone or ivory slotted foreshaft typical of the Bering Sea. Improbability of the convergence of Ainu and American forms is increased by the occurrence of such features as the crotched and ornamented base, unequal length of foreshafts, and the presence of reinforcing string between them. A survey of harpoon types in various parts of the world indicates that while there is undoubtedly an ultimate limitation of the possibilities of formal variation in these devices, the range is very great (Gruvel, 1928, pp. 81-90).

An interpretation based on assumption of an earlier continuity in the distribution of the double foreshaft toggle harpoon from

Yezo to the southern Northwest coast seems to be called for. As both barbed and toggle single-pointed harpoons have wide distributions in both northeastern Asia and America, there can be no serious suggestion that the continuity of double-foreshaft toggle harpoons assumed in this interpretation represents the prior type. *Barbed* harpoon heads occur frequently in archeological sites in the northern Eurasiatic region, beginning as far back as the European Magdalenian and aspects of similar antiquity from Siberia such as Vercholensk Mountain and Mal'ta (Childe, 1936; see also, s. v. Sibirien, Ebert's *Realexikon der Vorgeschichte*). Moreover, in the Mesolithic remains from Ulan Khada, Lake Baikal, which are regarded by some as approaching the postulated proto-American culture of the first migrants, fish-spears and harpoons of barbed type occur (Clark, 1940).⁵ In America, the earliest and still the most widespread harpoon type is barbed; Fuegian harpoons are barbed and provided with wedge-shaped tangs (Mason, 1900, pl. 2, p. 213). Single toggle harpoons likewise have a more extensive distribution in time and space than the specialized double foreshafted toggle variety. Birket-Smith (1929, pt. 2) has a discussion of these distributions.

Except under unusual conditions for preservation, evidence for double-foreshafted toggle harpoons does not survive archeologically. Bone toggle-heads by themselves give no indication of their use in pairs, while wooden foreshafts and lashing seldom last more than a few years in the ground. Our interpretation is thus practically restricted to inferences from ethnography and the negative evidence of archeology. As stated above, barbed harpoons occur within the northwestern American distribution of double foreshaft toggle harpoons, along the coast, where they are used for sea mammals but not for fishing. Inland, there is archeological evidence for the abandonment of barbed fishing harpoons at no remote time, in regions where toggle harpoons were used subsequently, or harpoons were

⁵ They occur also in Predynastic Egypt; cf. Bates, 1917.

given up altogether. In the ethnography of the Lower Sacramento Valley, there is no clear evidence of the use of barbed fishing harpoons; element lists and ethnographies cite only the toggle type (cf. Beals, 1933, fig. 1, p. 431—Nisenan). Yet, in the area occupied historically by Patwin, Nisenan, and northern Yokuts, archeology yields numerous unilaterally and bilaterally barbed harpoon points. These are not associated with the *Early* culture horizon, but occur in the *Late Period* (Lillard, Heizer, and Fenenga, 1939, pl. 29; Heizer and Fenenga, 1939, fig. 1, p. 384). Schenck and Dawson (1929, p. 369, pl. 80) attribute them to Aleut sea-otter hunters operating at the beginning of the nineteenth century, but this supposition is not entertained by later investigators.

A Kacha-Bida (Northern) Pomo informant stated that double foreshaft toggle harpoons were recent introductions, and that anciently only single-pointed fish-spears were used (Gifford and Kroeber, 1937, p. 173, n. 210). In the same general area the writer noted a well-preserved multibarbed fish-spear found near Clear Lake under conditions suggesting some antiquity, now in the Lake County Museum, Lakeport. Questioning of native informants at Clear Lake and elsewhere in northern California yielded only denials that any such spear type was known. This evidence, unsatisfactory as it is, indicates that multibarbed fish-spears and harpoons were formerly in use in inland central California, though they went out of use before the period covered by memories of surviving informants. Archeological evidence of a similar abandonment of barbed harpoons has come from central Utah (Gillin, 1940, pp. 170–171) and from the Red River Valley, N. Dak. (Jenks, 1932, pp. 456–459).

In the Eskimo area and in southern Alaska, both toggle-heads and barbed harpoon points occur in the most ancient horizons. While changes in the construction of toggle-heads are significant criteria for Eskimo culture periods, there is no level at which toggles suggestive of the cruder type used on double foreshaft toggle harpoons

in the northern Plateau and California occur (Collins, 1940, p. 550 ff., pl. 16). Even at Ipiutak, Point Hope, presumably antedating any other Eskimoid culture in the Bering Sea region, toggle and barbed harpoon heads occur, though not with great frequency (Rainey, 1941, p. 170). No evidence bearing on our problem has yet come to light from the recent work in central Alaska on accidentally discovered artifacts from muck-deposits, in apparent association with Pleistocene fauna, though it is worth while to note the recognition of a long archeological sequence, which must extend far back of the advent of Eskimo culture on the Bering Sea (Rainey, 1940; Jenness, 1940, pp. 14–15).

On the Asiatic side there are examples of both barbed and toggle harpoons from Japan (Kishinouye, 1909, pp. 336, 341, pl. 22); DeLaguna has drawn attention to the striking similarities in the placement of line holes on toggles from neolithic Japan and Port Möller, Alaska Peninsula (DeLaguna, 1934, p. 189). Soviet work on the lower Amur has yielded archeological results that should be made available in full to American investigators; brief notices and summaries are not enough (Field and Prostov, 1937, pp. 457–490; cf. Zolotarev, 1938).

The Jesup expedition established the hypothesis that there had been an original cultural continuity from the Palae-Asiatic peoples to the Indians of British Columbia, interrupted by the advance of the Eskimo culture in the Bering Strait region. Subsequent work in the north Pacific area has established a continuity, though the relative antiquity of its components has yet to be determined (Birket-Smith, 1930, p. 623; Jenness, 1940, p. 6). Some of the connections seem to have been very early obliterated perhaps by the crystallization of Eskimo culture, while others have surviving links in the Aleutian chain. Collins (1940, p. 583) discusses a number of these and also mentions the very frequent gap in such distributions on the northern Northwest coast; south Alaskan traits which are lacking among the Tlingit and Tsimshian, but which are retained in full vigor on the

southern end of Vancouver Island (Collins, 1940, pp. 576-577). Lantis's (1938, p. 448) whaling cult, to mention only one example, has a gap from Nutka to Kodiak, which can be explained most plausibly by assuming the abandonment of whaling along all but the southernmost Northwest coast. On the west, it is easy to account for the gap in traits between Yezo and the Chukchi Peninsula; the advent of reindeer nomadism in northeast Asia, radically altering the economic pattern of the Tungusic peoples north of the Amur, must have eliminated many fishing and sea-mammal-hunting specializations on the borders of the Sea of Okhotsk. Bogoras (1929, p. 600) has mentioned the difficulties of combining serious fishing with extensive reindeer breeding.

The isolated occurrence of the Ainu double foreshaft toggle harpoon and the wide distribution of the same device in western America may be tentatively interpreted in the following way:

At an early period, perhaps not much later than the time of the first migrations into the New World, use of barbed fish-spears and harpoons was general from northern Asia far into North America. Exploitation of the annual salmon runs around the shores of the North Pacific from the Amur to California, in which barbed harpoon and fish-spears played a part, was probably established relatively early. Sea mammals, especially those frequenting the shoreline, were taken with barbed harpoons. Secondly the use of single toggle harpoons spread through this area; the present evidence certainly suggests the priority of barbed heads, even though toggles are easier to fabricate.

At a time antedating the crystallization of Eskimo culture on the Bering Sea coasts, the double foreshaft toggle harpoon was invented, possibly on the southern Northwest coast; this invention was spread north and westward, carrying with it details such as the crotched shaft end device, and reinforcing string between divergent foreshafts, either directly across Bering Strait, or, more probably, by way of the Aleutians. Whether it reached Yezo from the Kuriles, or via Sakhalin and the western edge of the Sea

of Okhotsk, does not alter the shape of the present conjecture. Gradual abandonment of the double foreshaft toggle device north and west of Yezo may have been due to shift in economic pattern occasioned by reindeer breeding; on the Bering Sea littoral, the abandonment may have been caused by the specialization of sea-mammal-hunting techniques, the growth of dependence on hook and line fishing, and on net fishing. The rôle of fish-trap devices—weirs, pens, fyke baskets, etc.—requires separate study; it can not have been insignificant. On the northern Northwest coast, while no elaboration approaching that of the Eskimo sea-hunting and sea-fishing techniques occurred, the same forces that led to the lapse of whaling, originally continuous from Kodiak to Nutka, may have caused the abandonment of double foreshaft harpoons.

By the time typical Eskimo culture and its influences were settled in the Bering Sea region, and the northern Northwest coast culture had begun to differ from that of the southern coast, the Ainu may have been the only group in northeastern Asia still retaining the double foreshaft toggle harpoon. The Northern Athabaskans who transmitted the trait to the Copper Eskimo must have likewise given it up; the north-western American distribution had shrunk to the coastal margin of the *Oncorhynchus* area. Scanty evidence in California makes it possible that occurrences of double foreshaft toggle harpoons represent a relatively recent extension southward.

Although there is much archeology yet to be derived from shellmounds in the north Pacific area, the writer feels that they will not yield any extensive series of harpoons with their two toggles still lashed to the spreading foreshafts. The improbability of obtaining such evidence means that the ultimate solution of the present problem must come from other sources.⁶ A careful

⁶ The Late Predynastic and Early Dynastic Egyptian bident fish-spear, used by nobles for sport-fishing, is known only from paintings. No archeological specimens survive. This device, while it is not a harpoon, has foreshafts of unequal length, giving it a superficial resemblance to the double foreshaft harpoons discussed here (cf. Bates, 1917, pp. 232-245).

laying of the ghosts of the Aleut sea-otter hunters by an exhaustive historical study of their effects on the coastal cultures of the North Pacific from Yezo to Baja California is urgently called for.

LITERATURE CITED

- ARSENJEV, WLADIMIR. *In der Wildnis Ostsi-biriens—Forschungsreisen im Ussurigebeit* (tr. Franz Daniel), 2 vols. Berlin, 1934.
- BARNETT, HOMER G. *Culture element distributions: VII, Oregon coast*. Univ. California Anthropol. Rec. 1: 155-204. 1937.
- . *The coast Salish of Canada*. Amer. Anthropol. 40: 120-141. 1938.
- . *Culture element distributions: IX, Gulf of Georgia Salish*. Univ. California Anthropol. Rec. 1: 5. 1939.
- BARRETT, S. A., and GIFFORD, E. W. *Miwok material culture*. Bull. Public Mus. Milwaukee 2(4): 117-376. 1933.
- BATCHELOR, JOHN. *The Ainu of Japan*. London, 1892.
- BATES, ORIC. *Ancient Egyptian fishing*. Harvard African Studies 1: 199-271. 1917.
- BEALS, R. L. *Ethnology of the Nisenan*. Univ. California Publ. Amer. Arch. and Ethnol. 31: 335-414. 1933.
- BIRKET-SMITH, KAJ. *The Caribou Eskimos*. Rep. 5th Thule Exped. 5. 1929.
- . *The origin of Eskimo culture: A rejoinder*. Amer. Anthropol. 32: 609-624. 1930.
- BOAS, FRANZ. *The Kwakiutl of Vancouver Island*. Mem. Amer. Mus. Nat. Hist. 8 (pt. 2). 1909.
- . *Tsimshian mythology*. Ann. Rep. Bur. Amer. Ethnol. 31: 27-1137. 1910.
- BOGORAS, W. *The Chukchee*. Mem. Amer. Mus. Nat. Hist. 11 (pt. 1). 1909.
- . *Elements of the culture of the circumpolar zone*. Amer. Anthropol. 31: 579-601. 1929.
- CHILDE, V. GORDON. *Reviews of Paleolit SSSR* (Moskva, 1935), etc. Antiquity 10: 242-245. 1936.
- CLARK, GRAHAME D. *New World origins*. Antiquity 14: 117-137. 1940.
- COLLINS, HENRY B., JR. *Outline of Eskimo prehistory*. Smithsonian Misc. Coll. 100: 533-592. 1940.
- CURTIS, E. S. *The North American Indian* 7-9, 11. 1911-16.
- DENSMORE, FRANCES. *Nootka and Quileute music*. Bur. Amer. Ethnol. Bull. 124. 1939.
- DRIVER, HAROLD. *Wappo ethnography*. Univ. California Publ. Amer. Arch. and Ethnol. 36: 179-220. 1936.
- . *Culture element distributions: VI, Southern Sierra Nevada*. Univ. California Anthropol. Rec. 1: 53-154. 1937.
- . *Culture element distributions: X, Northwest California*. Univ. California Anthropol. Rec. 1: 297-433. 1939.
- DRUCKER, PHILIP. *The Tolowa and their southwest Oregon kin*. Univ. California Publ. Amer. Arch. and Ethnol. 36: 221-300. 1937.
- . *Contributions to Alsea ethnography*. Univ. California Publ. Amer. Arch. and Ethnol. 35: 81-102. 1939.
- DUBOIS, CORA. *Wintu ethnography*. Univ. California Publ. Amer. Arch. and Ethnol. 36: 1-148. 1935.
- EBERT, M. (editor). *Sibirien* 12: 55 ff: *Reallexikon der Vorgeschichte*. 1928.
- EMMONS, GEORGE T. *The Tahltan Indians*. Univ. Pennsylvania Mus. Anthropol. Publ. 4(1). 1911.
- ESSENE, FRANK. *Culture element distributions: Yuki, Lassik, Pomo, Kato—Round Valley*. In press.
- FIELD, HENRY, and PROSTOV, EUGENE. *Archaeology in the Soviet Union*. Amer. Anthropol. 39: 457-490. 1937.
- FINDEISEN, HANS. *Die Fischerei im Leben der "Altsibirischen" Völkerstämme*. Zeitschr. für Ethnol. 60: 1-73. 1929.
- FORDE, C. DARYLL. *Habitat, economy and society*, ed. 2. Chap. 6: 69-95. 1937.
- GIFFORD, E. W. *The coast Yuki*. Anthropos 34: 292-375. 1939.
- and KLIMEK, STANISLAW. *Culture element distributions: II, Yana*. Univ. California Publ. Amer. Arch. and Ethnol. 37: 71-100. 1936.
- and KROEBER, A. L. *Culture element distributions: IV, Pomo*. Univ. California Publ. Amer. Arch. and Ethnol. 37: 117-254. 1937.
- and SCHENCK, W. E. *Archaeology of the Southern San Joaquin Valley, California*. Univ. California Publ. Amer. Arch. and Ethnol. 23: 1-122. 1926.
- GILLIN, JOHN. *A barbed bone projectile point from Utah*. Amer. Antiquity 6: 170-171. 1940.
- GODDARD, PLINY E. *Life and culture of the Hupa*. Univ. California Publ. Amer. Arch. and Ethnol. 1: 1-88. 1903.
- . *Indians of the Northwest coast*. Amer. Mus. Nat. Hist. Handbook Ser. No. 10, ed. 2. 1924.
- GREEY, EDWARD. *The bear worshippers of Yezo and the island of Karafuto (Saghalin)*. Boston, 1884.
- GRUVEL, A. *La pêche dans la préhistoire, dans la antiquité et chez les peuples primitifs*. Paris, 1928.
- GUNTHER, ERNA. *Culture element distributions: Puget Sound*. Unpubl. MS.
- HAEBERLIN, H., and GUNTHER, ERNA. *The Indians of Puget Sound*. Univ. Washington Publ. Anthropol. 4: 1. 1930.
- HEIZER, ROBERT F. *Aconite arrow poison in*

- the Old and New World.* Journ. Washington Acad. Sci. **28**: 358-364. 1938a.
- . *An inquiry into the status of the Santa Barbara spearthrower.* Amer. Antiquity **6**: 137-141. 1938b.
- and FENENGA, FRANKLIN. *Archaeological horizons in central California.* Amer. Anthropol. **41**: 378-399. 1939.
- HITCHCOCK, ROMYN. *The Ainous of Yezo, Japan.* Rep. U. S. Nat. Mus. 1890: 429-502.
- JACOBS, M. *Culture element distributions: Kalapuya.* Unpubl. MS.
- JENKS, A. E. *The problem of the culture from the Arvilla gravel pit.* Amer. Anthropol. **34**: 455-466. 1932.
- JENNESS, DIAMOND. *Prehistoric culture waves from Asia to America.* Journ. Washington Acad. Sci. **30**: 1-15. 1940.
- JOCHELSON, W. *The Koryak.* Mem. Amer. Mus. Nat. Hist. **10** (pt. 2). 1908.
- . *Archaeological investigations in the Aleutian Islands.* Carnegie Inst. Washington Publ. **367**. 1925.
- . *The Yukaghir and Yukaghirized Tungus.* Mem. Amer. Mus. Nat. Hist. **13** (pt. 3). 1926.
- . *History, ethnology and anthropology of the Aleut.* Carnegie Inst. Washington Publ. **432**. 1933.
- KISHINOUE, KAMAKICHI. *Prehistoric fishing in Japan.* Journ. Coll. Agr. Imp. Univ. Tokyo **2**: 327-382, pls. 19-29. 1909.
- KNIFFEN, F. B. *Achomawi geography.* Univ. California Publ. Amer. Arch. and Ethnol. **23**: 297-332. 1928.
- KRAUSE, AUREL. *Die Tlinkit Indianer.* Jena, 1885.
- KROEBER, A. L. *Handbook of the Indians of California.* Bur. Amer. Ethnol. Bull. **78**. 1925.
- . *The Patwin and their neighbors.* Univ. California Publ. Amer. Arch. and Ethnol. **29**: 253-424. 1932.
- DE LAGUNA, FREDERICA. *The archaeology of Cook Inlet, Alaska.* Philadelphia, 1934.
- and BIRKET-SMITH, KAJ. *The Eyak Indians of the Copper River Delta, Alaska.* Copenhagen, 1938.
- LANTIS, MARGARET. *The Alaskan whale cult and its affinities.* Amer. Anthropol. **40**: 438-464. 1938.
- LATTIMORE, OWEN. *The Gold Tribe, "Fish-skin Tatars" of the Sungari.* Mem. Amer. Anthropol. Assoc. **40**. 1933.
- LEWIS, A. B. *Tribes of the Columbia Valley and the coast of Washington.* Mem. Amer. Anthropol. Assoc. **1** (pt. 2). 1906.
- LILLARD, J. B., HEIZER, R. F., and FENENGA, F. *An introduction to the archeology of central California.* Sacramento Junior College Dept. Anthropol. Bull. **2**. 1939.
- MASON, O. T. *Aboriginal American harpoons: A study in ethnic diffusion and invention.* Rep. U. S. Nat. Mus. 1900: 189-305.
- MATHIASSEN, THERKEL. *The question of the origin of Eskimo culture.* Amer. Anthropol. **32**: 591-607. 1930.
- MONTANDON, G. *La civilisation Aïnou et les cultures arctiques.* Paris, 1937.
- MORICE, F. A. G. *The great Déné race.* Anthropos **5**: 132-142. 1910.
- NELSON, E. W. *The Eskimo about Bering Strait.* Ann. Rep. Bur. Amer. Ethnol. **18** (pt. 1). 1897.
- NELSON, N. C. *Notes on the Santa Barbara culture.* Essays in Anthropology presented to A. L. Kroeber: 199-210. 1936.
- NOMLAND, GLADYS A. *Sinkyone notes.* Univ. California Publ. Amer. Arch. and Ethnol. **36**: 149-178. 1935.
- . *Bear River ethnography.* Univ. California Anthropol. Rec. **2**: 91-124. 1938.
- OLSON, RONALD L. *The Quinault Indians.* Univ. Washington Publ. Anthropol. **6**: 1-190. 1936.
- OSGOOD, CORNELIUS. *Contributions to the ethnography of the Kutchin.* Yale Univ. Publ. Anthropol. **14**. 1936.
- . *The ethnography of the Tanaina.* Yale Univ. Publ. Anthropol. **16**. 1937.
- . *Ingalik material culture.* Yale Univ. Publ. Anthropol. **22**. 1940.
- RAINEY, FROELICH. *Archaeological investigations in central Alaska.* Amer. Antiquity **5**: 299-308. 1940.
- . *Mystery people of the Arctic.* Nat. Hist. **48**: 148-154, 170-171. 1941.
- RASMUSSEN, KNUD. *Intellectual culture of the Copper Eskimos.* Rep. 5th Thule Exped. **9**. 1932.
- RAU, CHARLES. *Prehistoric fishing in Europe and America.* Smithsonian Contr. Knowl. **25**. 1885.
- RAY, VERNE F. *The Sanpoil and Nespelem: Salishan peoples of northeastern Washington.* Univ. Washington Publ. Anthropol. **5**. 1932.
- . *Lower Chinook ethnographic notes.* Univ. Washington Publ. Anthropol. **7**: 29-165. 1938.
- . *Culture element distributions: Plateau.* Unpubl. MS.
- SAPIR, EDWARD. *Notes on the Takelma Indians of southwestern Oregon.* Amer. Anthropol. **9**: 251-275. 1907.
- SCHENCK, W. E., and DAWSON, E. J. *Archaeology of the northern San Joaquin Valley.* Univ. California Publ. Amer. Arch. and Ethnol. **25**: 28-413. 1929.
- SMITH, MARIAN W. *The Puyallup-Nisqually.* Columbia Univ. Contr. Anthropol. **32**: 253-268. 1940.
- SPIER, L. *Klamath ethnography.* Univ. California Publ. Amer. Arch. and Ethnol. **30**: 1-338. 1930.

- SPINDEN, H. J. *The Nez Percé*. Mem. Amer. Anthrop. Assoc. 2 (pt. 3). 1908.
- STERN, BERNHARD. *The Lummi Indians of northwest Washington*. Columbia Univ. Contr. Anthrop. 17: 1-127. 1934.
- STEWART, JULIAN H. *Culture element distributions: XIII, Nevada Shoshone*. Univ. California Anthrop. Rec. 4: 2. 1941.
- TEIT, J. A. *The Thompson Indians of British Columbia*. Mem. Amer. Mus. Nat. Hist. 11. 1900.
- . *Notes on the Tahltan Indians of British Columbia*. Boas Anniversary Volume: 337-349. 1906.
- . *The Shuswap*. Mem. Amer. Mus. Nat. Hist. 4. 1909.
- . *The Middle Columbia Salish*. Univ. Washington Publ. Anthrop. 2: 83-128. 1928.
- . *The Salishan tribes of the western plateaus*. Ann. Rep. Bur. Amer. Ethnol. 45: 23-396. 1930.
- TURNER-HIGH, HARRY. *The Flathead Indians of Montana*. Mem. Amer. Anthrop. Assoc. 48. 1937.
- . *Ethnography of the Kutenai*. Mem. Amer. Anthrop. Assoc. 56. 1941.
- ZOLOTOREV, A. *The ancient culture of north Asia*. Amer. Anthrop. 40: 13-23. 1938.

ICHTHYOLOGY.—*The osteology and relationships of the Argentinidae, a family of oceanic fishes.*¹ WILBERT MCLEOD CHAPMAN, U. S. Fish and Wildlife Service. (Communicated by LEONARD P. SCHULTZ.)

The genus *Argentina* was proposed by Linnaeus and was known before him by Gronow and Artdi. The classification of the argentines has ever since been indescribably mixed up with the Salmonidae, Bathylagidae, Retropinnidae, Osmeridae, Microstomidae, etc. All ichthyologists, up to and including Günther (1866), retained these fishes in the family Salmonidae, and this was continued to as recently as 1929 (Kyle and Ehrenbaum, 1929). Gill (1861) recognized Bonaparte's splitting of the Salmoninae and the Argentininae, but he included part of the osmerid fishes in each of the two subfamilies. This he corrected (Gill, 1862) by including all the smelts with *Argentina* in the Argentininae, placing *Microstoma* in a separate family, and introducing a new subfamily in the Salmonidae for *Retropinna*.

Later, Gill (1884) proposed full family status for the group, although he did not give any diagnosis of the family. As late as 1936 (Fowler, 1936), the smelts and argentines were being grouped together in the Argentinidae.

Regan (1914) first showed the differences between, and clearly defined, the Argentinidae and Osmeridae. His classification has been generally accepted, and further anatomical work (Chapman, 1941) has shown it to be well-founded. Regan, however, con-

sidered *Bathylagus* to be an Argentinidae and was followed in this by Norman (1930), Parr (1931), and Beebe (1933), although others, including Barnard (1925), placed *Bathylagus* in the Microstomidae. It has been recently shown (Chapman, 1942) that *Bathylagus* and *Leuroglossus* are only distantly related to *Argentina*, not much more closely related to *Microstoma*, and should be placed in the family Bathylagidae. *Leuroglossus* had been formerly placed in the Argentinidae (Jordan, 1923) and in the Osmeridae (Soldatov and Lindberg, 1930).

As thus restricted, then, the family Argentinidae contains the single genus *Argentina*, of which *Silus* Reinhardt, 1833, *Acantholepis* Kröyer, 1846, and *Glossanodon* Guichenot, 1866, are synonyms. It is the purpose of the present report to describe the osteology of *Argentina* and define the proper position of the Argentinidae in the ichthyological system.

The report is based upon dissections of two specimens of *Argentina sphyraena*, one collected in Christiania Fjord, Norway, by Robert Collett (U.S.N.M. no. 23013), about 192 mm long, and the other taken at Christiania, Norway, by M. G. Hetting (U.S.N.M. no. 17461), about 125 mm long. It is a pleasure to acknowledge the kindness of Dr. Leonard P. Schultz, curator of fishes, U. S. National Museum, in permitting me to work on these specimens.

¹ Received September 26, 1941.

THE CRANIUM

The *ethmoid cartilage* (Figs. 1 and 2) is much less developed than in the typical salmonoid cranium. It extends anteriorly a little beyond the end of the mesethmoid to end on the extended vomer. Between the nasal capsules there is a long narrow foramen in the cartilage. The cartilage which forms the dorsal roof of this foramen is an extension of that which lies under the mesethmoid. The cartilage forming the floor of the foramen ends anteriorly squarely against the ventral ethmoid which indeed appears to be only an ossification of the anterior end of this body of cartilage. In the region of the prefrontals the two bodies of cartilage are united but the presence of the large mesial foramen of the olfactory nerve between the prefrontals restricts their union to a strip of cartilage along the inner edge of each prefrontal. Behind the prefrontals the dorsal cartilage splits and sends a broad, but thin, band of cartilage back to the orbitosphenoid. These two bands of cartilage form the ventral protection of the anterior end of the brain cavity from the orbitosphenoid to the prefrontals. The ventral body of cartilage is broadest and thickest between the prefrontals. A little ahead of these bones it puts out a thickened nubbin of cartilage which aids in the articulation of the palatine arch with the cranium. Directly behind the prefrontal the thickened dorsal surface of this body of cartilage is slightly indented and here are inserted the anterior eye muscles. The cartilage then tapers rapidly to a sharp point directly under the base of the anterior spike of the orbitosphenoid. This point is hidden in a deep cavity in the dorsal surface of the parasphenoid behind the end of the vomer. The thin spatulate end of the parasphenoid does not reach to the ventral ethmoid and, therefore, the vomer for a way lies directly on the ventral cartilage.

The *mesethmoid* (Fig. 1) is a complex element. In dorsal view it appears as a broad nearly flat shield rounded anteriorly and cut off squarely behind, where it extends under the frontals nearly halfway to the prefrontals. If the dorsal portion of the bone is cut transversely ahead of the frontals there is seen to be a thin blade of ossification extending ventrally between two portions of cartilage so that the ap-

pearance of double origin is given the element. There is also a ventral ethmoid ossification. In such fishes as *Thaleichthys*, *Spirinchus* (Chapman, 1941), and the more closely related *Bathylagus* (Chapman, 1942), this bone is completely separated from the mesethmoid by the intervening ethmoid cartilage. But in *Argentina* the mesethmoid and ventral ethmoid are ankylosed around their anterior borders. The posterior ends of the bones are well separated and the ventral ethmoid does not extend as far posteriorly as does the mesethmoid. It does not reach to the parasphenoid. The broad shaft of the vomer covers most of the ventral surface of the bone.

The *frontals* (Figs. 1 and 2) are separate for their entire length, but are divergent only anteriorly where they part to expose the mesethmoid. The interorbital space is depressed to form a broad V-shaped trough. At the upper edges of the trough, near the outer edge of each bone, runs the closed tube of the sensory canal. The tube ends over the prefrontals in a large pore, from whence the sensory canal continues through the nasal. The tube has branches posteriorly, over the sphenotic, and sends one branch to the lateral corner of the frontal, where the sensory canal extends down onto the circumorbital bones. A second branch ends in a pore on the posterior corner of the frontal from whence the sensory canal proceeds postero-mesially across the parietal to meet its opposite over the supraoccipital. Lateral to the tube of the sensory canal the edge of the frontal arches over the socket of the eye, thus protecting the latter dorsally. On its underside the frontal bears a ventrally projecting wing in the posterior ocular region which extends over the dorsal edge of the orbitosphenoid, alisphenoid, and a portion of the anterior face of the sphenotic, which serves to bind the bone more securely to the chondrocranial elements. The frontals cover about half the dorsal surface of the small sphenotics. They also slightly overlie the parietals, but only enough so that the bones are well bound together. Near the midline of the cranium the parietal and frontal do little more than meet. There is no cartilage under the bones at this point. The frontals do not reach to the supraoccipital.

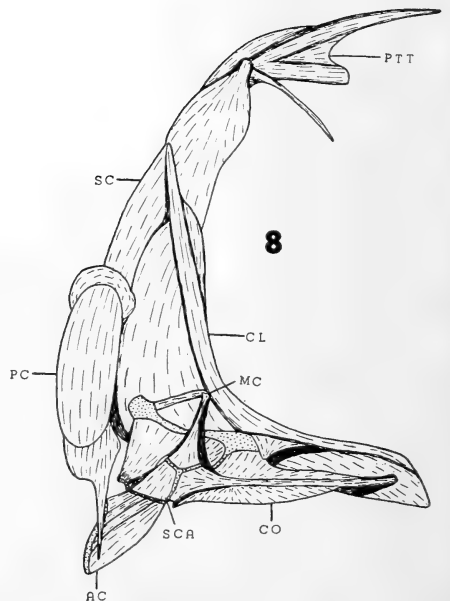
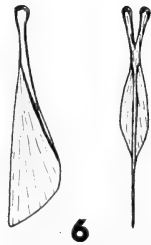
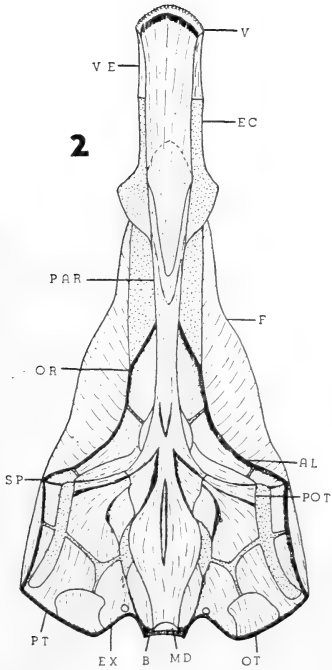
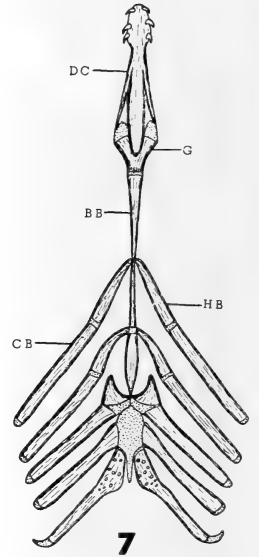
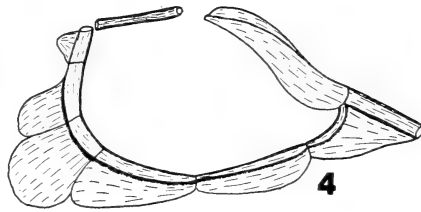
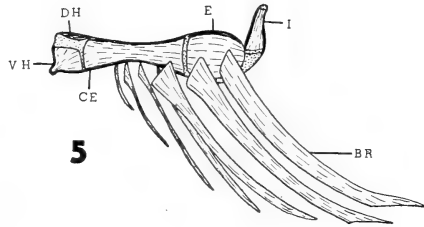
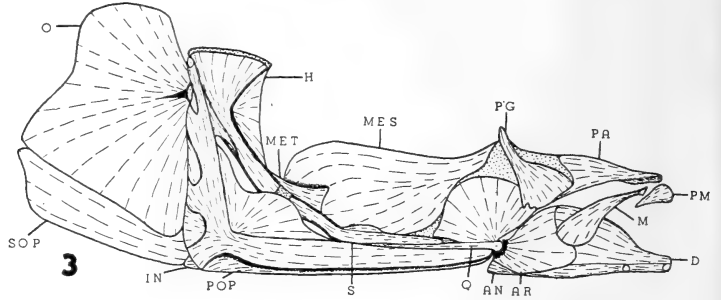
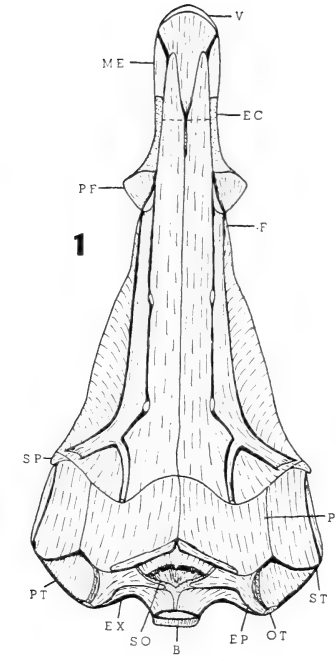

Figs. 1-8.—(See opposite page for explanation.)

The *parietals* (Fig. 1) are thin, broad bones of nearly square shape. The bones meet broadly along the midline where the one on the right overlaps the one on the left very slightly. The parietals cover more than two-thirds of the dorsal surface of the small supraoccipital. Together with the supratemporal, whose edge lies over that of the parietal, the parietal of each side forms a complete osseous roof over the anterior two-thirds of the deep temporal fossa, in which are inserted the anterior trunk muscles, thus forming a deep cavern quite unlike the condition in the salmonoid or other opisthopteroic fishes, and reminiscent of the condition in *Esox*.

Only a small surface of the *supraoccipital* (Fig. 1) is exposed dorsally between and behind the parietals. The bone sends a broad prong anterolaterally along the sturdy cartilage over the anterior semicircular canal. These prongs are covered by the parietals. In contrast to the condition normally found in the salmonids and osmerids, where the dorsal surface is shield-like, nearly circular and extends at least as far as the frontals, the anterior edge of the supraoccipital of *Argentina* is deeply crescentic so that the parietals actually form part of the roof over the brain cavity. The posterior surface of the supraoccipital is at nearly right angles to the dorsal surface. Its broad shield-like area is concave mesially and ends ventrally in a blunt point where it is widely separated from the foramen magnum by the exoccipitals.

Near the dorsal angle of the bone a delicate flange projects posteriorly between the muscles of either side. This is connected with the first interneural by a thin ligament.

The *supratemporal* (Fig. 1) is a thin, but broad, bone which, with the parietal, covers the anterior two-thirds of the temporal fossa. Its entire lateral edge is securely ankylosed to that of the underlying pterotic. Anteriorly the bone overlies the dorsal surface of the sphenotic to such an extent that there is only a narrow slit of the latter exposed between the frontal and supratemporal. Anteromesially the bone rests on the cartilage over the anterior semicircular canal, and here in turn it is covered by the frontal. Along its entire mesial edge the bone overlies, and is securely bound to, the parietal. On the dorsal side of the lateral edge of the bone is the slender tube of the sensory canal, which is not completely closed over dorsally. The sensory canal, after leaving the skull at the end of this bone, extends on to pass through a well-formed tube on the lateral face of the supraclathrum which is indistinguishably fused with that bone.

Each *epiotic* (Fig. 1) presents a small dorsal surface, only a small portion of which is covered by the parietal. The rounded angle of the bone which slopes off posterolaterally encloses the posterior semicircular canal of the inner ear. The tiny dorsal surface not covered by the parietal is flattened and the dorsal fork of the posttemporal is attached there by a broad liga-

ABBREVIATIONS USED ON FIGURES

AC = actinost	E = epihyal	MD = myodome	POT = prootic
AL = alisphenoid	EC = ethmoid cartilage	ME = mesethmoid	PT = pterotic
AN = angular	EP = epiotic	MES = mesopterygoid	PTT = posttemporal
AR = articular	EX = exoccipital	MET = metapterygoid	Q = quadrate
B = basioccipital	F = frontal	O = opercle	S = symplectic
BB = basibranchial	FM = foramen magnum	OR = orbitosphenoid	SC = supraclathrum
BR = branchiostegal ray	G = glossohyal	OT = opisthotic	SCA = scapula
CB = ceratobranchial	H = hyomandibular	P = parietal	SO = supraoccipital
CE = ceratohyal	HB = hypobranchial	PA = palatine	SOP = subopercle
CL = cleithrum	I = interhyal	PAR = parasphenoid	SP = sphenotic
CO = coracoid	IN = interopercle	PC = postcleithrum	ST = supratemporal
D = dentary	M = maxillary	PF = prefrontal	V = vomer
DC = dental cement bone	MC = mesocoracoid	PG = pterygoid	VE = ventral ethmoid
DH = dorsal hypohyal		PM = premaxillary	VH = ventral hypohyal
		POP = preopercle	

Figs. 1-8.—*Argentina sphyraena* Linnaeus: 1, Dorsal view of cranium of small specimen; 2, ventral view of cranium of small specimen; 3, lateral view of suspensorium of large specimen; 4, circumorbital bones of large specimen; 5, lateral view of hyoid apparatus of large specimen; 6, lateral and dorsal views of urohyal of large specimen; 7, dorsal view of ventral bones of the gill arches of large specimen; 8, mesial view of the shoulder girdle of large specimen. (Figs. 1, 2, and 8, $\times 3$; Figs. 3-7, $\times 1\frac{3}{4}$, approximately.)

ment. A strongly ossified strut extends laterally under the posterior edge of the parietal and serves to strengthen that thin bone. The anterolateral face of the bone is shallowly concave to form the mesial wall of the temporal fossa. The posterior face of the bone adjacent to the supraoccipital is heavily ossified. Between this flattened surface and the rounded posterolateral corner of the bone, the lower portion of the bone is deeply concave, continuing the adjacent indentation of the exoccipital. The epiotic touches the supraoccipital dorsally, but ventrally the bones are separated by a narrow band of cartilage. A similar band of cartilage separates the epiotic and the exoccipital. The cartilage between the epiotic and pterotic is broader. The opisthotic touches, but does not overlie the epiotic.

The *opisthotic* (Figs. 1 and 2) is a small, thin bone of irregular shape which curves around the cartilage between the epiotic, exoccipital, and pterotic. It is visible from the dorsal aspect, but has no definite dorsal surface. There is an irregular ventral surface of some size lying over the exoccipital, pterotic and the cartilage between the two and extending more than a third of the way to the junction of these two bones with the prootic.

The dorsal surface of the *pterotic* (Figs. 1 and 2) forms most of the floor of the temporal fossa and is mostly excluded from view by the supratemporal. The bone has no definite posterior or lateral surface. It is only a rounded cover over the horizontal semicircular canal and its junction with the posterior semicircular canal. The ventral surface of the bone is marked by the cartilage-lined socket of articulation of the hyomandibular which extends from near the posterodorsal corner of the skull to the junction of the sphenotic and prootic. About half of the hyomandibular articulation is borne on this bone, the rest being on the cartilage between the sphenotic and prootic and, at its anterior end, on the sphenotic. The pterotic is separated from all other cartilage bones of the cranium by a continuous band of cartilage.

The *sphenotic* (Figs. 1 and 2) is a small, but sturdy, bone with three surfaces. The dorsal surface is nearly covered by the frontal and supratemporal. From the corner of the bone a strongly ossified spur which supports the post-orbital projects downward. The sphenotic is

separated from the pterotic, prootic, and alisphenoid by a continuous, narrow band of cartilage.

The *alisphenoid* (Fig. 2) is a bone of roughly rectangular shape between the orbitosphenoid anteriorly, and the sphenotic and prootic posteriorly. Its dorsal edge is covered by the ventral flange of the frontal. It is separated from the sphenotic by a narrow band of cartilage. The dorsal half of the junction with the prootic is separated by cartilage, but in the lower half the ossifications meet. The anterior ends of the alisphenoids are widely separate.

The *orbitosphenoid* (Fig. 2), which is bilaterally symmetrical, unites the anterior portion of the braincase firmly. On the midline a thin vane of bone projects ventrally. It is extended forward in a fine spike well beyond the main portion of the bone, and a similar, but broader, projection extends posteriorly. From this vane the interorbital septum extends to the parasphenoid. The dorsoposterior corner of the orbitosphenoid is overlapped by the ventral flange of the frontal and thus securely bound to that bone. The entire dorsal edge of the bone abuts on the posterodorsal extension of the ethmoid cartilage. The anteromesial corner is rounded into a cylindrical foramen for the emergence of the large olfactory nerves.

The *prootic* (Fig. 2) is divided into an anterior and lateral face by a sharp ridge that continues the upsweeping line of the parasphenoid wing to the dorsal edge of the prootic at the anterior end of the facet for the hyomandibular. Midway in its length this ridge forms a narrow bridge over the emerging trigeminofacial complex. Two other nerves from this complex emerge in separate foramina on the posterior face of the bone. One extends posteriorly at the dorsal edge of the otolith bulge, the other goes ventrally and emerges on the anterior side of the otolith bulge. On the anterior face of the bone there are also two foramina besides the large opening of the trigeminofacial complex. The dorsalmost one is on the anterior edge of the bone and is not entirely closed, so that it is in fact a deeply rounded notch. The other is more ventral and posterior, directly above the base of the basisphenoid. The two prootics meet ventrally to form the roof of the high, vaulted myodome. The myodome is large anteriorly where its

bottom and sides are formed by the wings of the parasphenoid. It forms a deep channel between the otolith bulges, which is hidden from sight by the flat posterior part of the parasphenoid, and opens posteriorly on the basioccipital under the occipital condyle. The lower portion of the posterior face of the prootic curves outward to form part of the otolith bulges. There is a broad band of cartilage between the prootics and basioccipital, but the bands between them and the other cartilage bones is narrow, although continuous.

The *basisphenoid* is a simple, small rod of bone forking at its dorsal end, sending a short arm to each prootic. It ends ventrally in a small cap of cartilage by which it is attached to the parasphenoid. It serves to separate the posterior eye muscles as they enter the myodome, and to bind the postorbital portion of the cranium more securely to the parasphenoid.

The *basioccipital* (Figs. 1 and 2) forms the entire occipital condyle. Here the bone is constricted and heavily ossified. Anteriorly it broadens out and becomes thinner to form the posterior floor of the otolith bulge. A good deal of its ventral surface is covered by the broad posterior end of the parasphenoid.

The *exoccipital* (Figs. 1 and 2) is the principal bone of the posterior part of the cranium. Prominent on its lateral face is the large foramen of the vagus nerve. Below and ahead of this the bone curves outward to form its share of the otolith bulge. The cartilage at the junction of the exoccipital, pterotic, and prootic is not exposed. The exoccipitals send wings mesially over the posterior surface of the cranium

which are separated at the midline by a narrow band of cartilage. These wings form the upper part of the foramen magnum and exclude the supraoccipital from that opening. Lateral to the foramen magnum each bone is deeply concave. The exoccipital rests on the dorsal part of the occipital condyle, but does not enter into its formation.

The spatulate anterior end of the *parasphenoid* (Fig. 2) terminates on the ethmoid cartilage under the nasal capsule, well short of the ventral ethmoid. Its ventral surface is broadly grooved for the reception of the posterior end of the vomer shaft. Its dorsal surface, in the same region, is more deeply grooved yet to receive the posterior end of the ethmoid cartilage. The interorbital portion of the bone is most narrow, but is well ossified and strong. Ahead of the prootics the bone expands and sends broad but short wings to those bones. Behind these wings the bone again expands slightly over the broad cartilage area between the prootics and the basioccipital. It then tapers to a broad end below the occipital condyle.

The *vomer* (Figs. 1 and 2) is a large, long bone. It is widest anteriorly where its single row of small conical teeth, and the continuing rows on the palatine, form the entire dentition of the upper jaw. The bone is also most heavily ossified at this point. It projects anterior to the mesethmoid and is visible from the dorsal aspect. From here the broad, thin shaft tapers gradually backward over the ventral ethmoid, ethmoid cartilage, and parasphenoid to end on the latter, well behind the prefrontals.

SPECIAL OSSIFICATIONS OF THE SENSORY SYSTEM

The *nasal* is a long, slender, tubular bone extending from the anterior edge of the frontal, and ending well forward on the mesethmoid. It lies over the dorsal side of the nasal capsule but extends well to the posterior and anterior sides of that structure. It is incompletely closed dorsally so as to form a trough rather than a tube, although it is roughly circular in cross section. The dorsal opening is expanded at each end and in the middle, where pores open to the dorsal surface of the skull.

There are nine circumorbital bones in the smaller specimen and eight in the larger (Fig.

4), whose thin, yet broad, areas form a protective shield for the lateral surface of the skull. The long and broad preorbital (No. 1) has the appearance of two elements that are nearly indistinguishably anastomosed. The bone's inner (and dorsal) edge lies along the frontal. The element lies over the eye and extends anteriorly to the nasal capsule. The anterior half of the dorsal edge is bent over laterally to form a half-closed tube for the sensory canal. No. 2 is a thin, flat, circular bone lying between the preorbital and the lachrymal, but not entirely filling the space

between them. This bone is absent in the larger specimen. The broad lachrymal (No. 3) extends forward beyond the end of the frontals where it ends in a sharp point. Its posterior dorsal edge is curved over laterally like that of the preorbital to form a trough for the sensory canal. The rest of the circumorbital bones bear a similar trough along their orbital edges, which in no instance is completely closed over to form a tube. Nos. 5 and 6 overlies each other and are ankylosed securely together but their margins are still distinguishable. No. 7 is rather loosely bound to No. 6 by membranes. No. 8 is

a tiny bone lying at the corner of the sphenotic which is little more than the trough of the sensory canal. No. 9 is larger and more slender. It is only a curved shell around the sensory canal, like the nasal, and has no broad base. There is a considerable space between No. 9 and the preorbital, which is covered above by the lateral extension of the frontal.

The other special ossifications of the sensory system—tubes on the frontals, supratemporals, supracleithra, preopercles, etc.—are described in their proper places.

UPPER JAW

There are but two elements in the upper jaw (Fig. 3): the *premaxillary* and the *maxillary*. Both are slight, slender, and possess slight function. They are toothless, the entire dorsal dentition being borne by the vomer and palatines. The premaxillary is curved around the snout

and attached for its full length to the maxillary. The maxillary is broadened posteriorly where it lies for the most part under the lachrymal. Anteriorly it is slender, but more heavily ossified, and ends in a knob which rests against the cranium.

MANDIBLE

The mandible (Fig. 3) is made up of the *dentary*, *articular*, *angular*, *sesamoid articular*, and *Meckel's cartilage*. The dentary is little larger than the articular. The two bones are overlapped along their junction and firmly ankylosed together. This bond is further strengthened by the heavy Meckel's cartilage, the largest part of which is borne by the articular, but which ends anteriorly in a cavity in the dentary. The lower edge of the dentary is heavy and thickened and, except for the small angular, forms the entire ventral edge of the mandible. The dentary bears no teeth, but the dental surface is sharp and well ossified and could be useful in a shearing action. Along the outer side of the lower edge of the dentary is

the tube of the sensory canal. Posteriorly its ventral edge is not completely closed, but anteriorly it is completely closed and tubular and opens to the surface by pores. The sesamoid articular is slenderly ovoid, with its long axis antero-posteriorly. It is thin and rests on top of the columnar Meckel's cartilage. On it is inserted the adductor mandibularis. The articular end of the articular, with its facet, is thick and bulky. The major part of this formation appears to be an ossification of the posterior end of Meckel's cartilage and, therefore, endosteal in origin. The triangular angular is small, but heavy. Its entire posterior end is the surface of insertion of the ligament from the interopercle.

PALATINE ARCH

The elements of the palatine arch (Fig. 3) which are present are the *palatine*, *pterygoid*, *quadrate*, *mesopterygoid*, and *metapterygoid*. The palatine is long and rather slender, but well ossified. It bears a band of tiny conical teeth on its anterior end. They are about thirty in number and arranged irregularly in three rows. The teeth are similar to those of the

vomer and are continuous with those. This is made possible by the fact that the dentigerous end of the palatine fits closely in a groove between the ventral ethmoid, ethmoid cartilage, and vomer. For this reason it would be easy in undissected specimens to conclude that all the teeth are on the vomer. The dorsal side of the palatine for its entire length is securely

attached to the ethmoid cartilage. At its posterior end the palatine sends a short, superficial splint of bone along the external side of the pterygoid which serves to bind the two bones more tightly together.

The broad, rather thin pterygoid is irregular in shape. Instead of a clean junction with the quadrate, separated by cartilage, the pterygoid extends a short way along the inner side of the quadrate along the entire edge of junction, and there is, furthermore, a small flange which overlaps the quadrate externally, thus locking the bones securely together. There is a thin, superficial, larger ossification extending from the pterygoid dorsally over the cartilage of the region to lie along the anterior side of the prefrontal, making the junction of the palatine arch to the cranium more secure.

Beside the normal quadrant-shaped main body of the quadrate, and the condyle of articulation for the lower jaw, both of which are heavily ossified, the bone is notable for the length and size of the posterior process which is sent back along the anterior arm of the preopercle. This spike is longer than the main body of the bone. From the lateral aspect it

appears razor-thin, but seen dorsally it appears as a broad process tapering to a sharp point under the bend of the symplectic. It lies between the preopercle and the anterior process of the symplectic and binds all these elements together.

The mesopterygoid is much the largest bone in the palatine series. Although broad and long, it is quite thin and pliable. The mesial, or dorsal, end is fairly straight and is bound to the parasphenoid along its entire length. The lower edge is overlain respectively by the metapterygoid, quadrate, pterygoid, palatine, and the cartilage in this region. It forms the roof of the mouth. Although it bears no teeth, there is a rounded patch of heavier ossification in the region of the pterygoid which is perhaps intended for opposition to the large glossohyal teeth below. The bone is shallowly concave on its outer side.

The metapterygoid is a small, thin, triangular bone. The spike-like dorsal end lies against the hyomandibular and the broader ventral end rests on the mesopterygoid. Its strengthening function must be negligible.

HYOID ARCH

The cartilage-capped articular head of the *hyomandibular* (Fig. 3) and the heavily ossified supporting structure form the principal part of the bone. The opercular condyle, which is borne on a short shaft, is likewise heavily ossified. The dorsal angle between it and the articular head of the bone is filled with a wedge of lighter ossification. On the lateral face of the articular head a ridge of bone projects posteriorly and outward. The dorsal part of this ridge slightly overlaps the preopercle and serves to wedge the dorsal end of that bone securely against the opercular condyle. The ventral shaft of the hyomandibular, while not especially broad, or as heavily ossified, as the articular head, is thick and sturdy. A part of its ventral end is covered by the angular flange of the preopercle, and the bones are here again securely bound together by membranes. But between this point and the lateral, more dorsal, ridge of the hyomandibular there is a considerable open space between the two bones. In the anterior angle between the articular head

and the ventral shaft is a broad wing of thinner bone.

The *symplectic* (Fig. 3), as usual, is separated from the hyomandibular by a short column of cartilage. It is a long, slender bone, only half the width of the ventral shaft of the hyomandibular. Its long anterior portion is bound to the posterior process of the quadrate and ends in a pad of cartilage in a little concavity on the posterior side of the main body of the quadrate. There is a slight wing of light bone in the broad dorsal angle of the symplectic.

The *interhyal* (Fig. 5) is small but stout. The broad base is capped with cartilage and attached to the epiphyal. The more pointed dorsal end is likewise capped with cartilage and inserted in a tiny cup on the inner side of the cartilage between the hyomandibular and symplectic.

The *epiphyal*, *ceratohyal*, and two *hypohyals* (Fig. 5) form a long, slender, but heavily ossified, connection between the gill arches and the hyoid arch. The epiphyal is only about one-

third the length of the ceratohyal. Around its lower edge and between the two bones is a narrow band of cartilage. The last two branchiostegals are inserted on the side of this cartilage. The two hypohyals are heavy, small bones, the interior of which remains cartilaginous. The dorsal one is securely bound to the junction of the glossohyal and the first basibranchial. On the ventral one is inserted the short, tough ligament of the urohyal.

There are seven *branchiostegal rays* (Fig. 5), all thin and pliable. The first five are attached to the ceratohyal; the last two to the epihyal. The first is tiny, short, and slender. The second is a little broader, but is much longer. The third

is somewhat broader and a little longer. The remaining four are broad and have the curved shape of the blade of a saber, each with the proximal end shallowly furcate, and the ventral edge of the blade flattened distally.

The *urohyal* (Fig. 6) is a long, thin, pliable bone, the main part of which is in a vertical plane and lies between the sternohyoideus muscles. The anterior end is slender, strongly ossified and nearly circular in cross section. It splits into two slender rods which reach nearly to the two ventral hypohyals to which they are inserted by very short but stout ligaments. The appearance is that the ligaments have been ossified nearly to the hypohyals.

OPERCULAR APPARATUS

All four opercular elements are present (Fig. 3). The *opercle*, *subopercle*, and *interopercle* are very thin and pliable. Only the facet of the opercle and a short supporting ray behind it are more strongly ossified. The opercle is much the largest of the bones. Its lower edge slightly overlaps the entire dorsal edge of the subopercle and the bones here are tightly bound together by connective tissue. There is only a slight crack of open space between the opercle and preopercle, and the lower part of this is filled by the dorsally projecting process of the subopercle. The interopercle is a long bone nearly entirely hidden from lateral view by the

preopercle. It is firmly bound to the subopercle posteriorly, and a short ligament connects it with the angular anteriorly. The *preopercle* is little more than a tube for the sensory canal. The anterior arm is longer than the vertical arm and the two come together at only a little more than a right angle. In the angle is a broad wing of thin bone which overlaps and is bound to the hyomandibular and symplectic. The anterior arm is an open trough. At the angle is a bridge of bone across the trough. The dorsal arm of the bone is made at least semitubular by three other such bridges of thin bone.

GILL ARCHES

The *glossohyal* (Fig. 7) is peculiar because of its dentition and the fact that the dental cement bone is so much larger than the ossification of the glossohyal itself. Only the posterior end of the glossohyal cartilage is ossified where it articulates with the first basibranchial and where the dorsal hypohyals are inserted. The remainder of the glossohyal cartilage extends anteriorly as a long, sturdy rod to the anterior end of the dentigerous surface. The dorsal and lateral surfaces of the cartilage are covered by the thin, dental cement bone. This is purely superficial and can be teased off the cartilage. The two sides do not meet ventrally and the cartilage is there exposed for its full length. This ossification bears nine strong, recurved, conical teeth around its anterior edge, but none

at all on its shank in the smaller specimen. The larger specimen has six teeth, as shown in Fig. 7. The teeth are longer than the bone is wide at this point.

The first *basibranchial* (Fig. 7) is very thin, but deep. It is deeply indented on its posterior edge. Here it sends a slender spur posteriorly to the second basibranchial. This bone sends a similar spur from its dorsal edge to the first basibranchial. In between these two spurs is a rectangular open space of some size. The hypobranchials of the first arch are inserted in this open space above the junction of the ventral spur of the first basibranchial with the second basibranchial. The long, slender second basibranchial becomes broader posteriorly but from lateral view it tapers posteriorly until at

its junction with the third basibranchial it is more nearly circular in cross section. The third basibranchial is short and shaped like an awl, with the point posteriorly. The fourth basibranchial is broad, has a flat dorsal surface, and is entirely cartilaginous. From its posterior end a short nubbin of cartilage projects along the floor of the oesophagus between the fifth ceratobranchials.

There are *hypobranchials* (Fig. 7) on the first three arches. Those of the first are narrow, slender rods of bone hardly half the length of the ceratobranchials. Those of the second arch are similar in shape but considerably shorter. The hypobranchials of the third arch are broad and short. They are inserted by their *distal* ends to the anterior edge of the fourth basibranchial and the ceratobranchial. The proximal end is cartilage-capped and projects ventrally as in the osmerid fishes.

There are five pairs of *ceratobranchials* (Fig. 7). They are long, slender bones which become progressively broader, heavier, and shorter, from those on the first arch to the fifth. Those of the third arch are inserted not only on the hypobranchial but on the fourth basibranchial. Those of the fourth and fifth arches are inserted by broad bases on the fourth basibranchial. The ceratobranchials of the fifth arch have expanded proximal ends and on the base so formed on each is a group of several small, blunt, conical teeth.

Epibranchials are present on the first four arches. Furthermore, on the distal end of the fifth ceratobranchial a short rod of cartilage extends inward that may represent the unossified remnant of a fifth epibranchial. The first epibranchial is similar in size and shape to the ceratobranchial. But near its mesial end a short, slender, cartilage-capped projection meets a similar process from the second suprabranchial. There are similar processes for the same purpose on the second and third epibranchials and on the third and fourth suprabranchials so that the gill arches are securely

bound together dorsally. The epibranchial of the fourth arch is entirely cartilaginous. It is a simple rod projecting dorsally from the ceratobranchial very much like the condition in *Bathylagus* and *Microstoma* where this cartilaginous fourth epibranchial is attached along the posterior edge of the expanded fourth suprabranchial.

The first *suprabranchial* is a slender, simple rod extending upward from the gill arches to the parasphenoid. It is attached proximally to the first epibranchial and second suprabranchial. Both ends are capped with cartilage. The second suprabranchial is flattened with a pointed, cartilage-tipped anterior end, a pointed cartilage-capped process for articulation with the first epibranchial, and a truncated posterior end which is likewise cartilage-capped and joined to the second epibranchial. The third suprabranchial is quite like the second only a little longer and with a broader posterior end to which are attached not only the third epibranchial but the cartilaginous anterior end of the fourth suprabranchial. The cartilage of the anterior end of the bone is not attached to anything. The fourth suprabranchial is greatly expanded dorsally. A well ossified rod extends from the ceratobranchial mesially, in a position normal for the epibranchial. From the anterior end of this a similar heavily ossified rod extends at a posterior angle dorsally and is of the same length as the first rod. It is capped with cartilage at the end. Between these rods of heavier ossification is a wedge of thinner ossification that makes up most of the surface of the bone. On the posterior surface of this high bone is inserted the broad muscle which extends ventrally to the ceratobranchial below.

On the cartilaginous anterior end of the fourth suprabranchial is borne an oblong, superficial dental cement bone which is covered by a group of about twelve short, conical teeth that oppose those on the fifth ceratobranchial below.

PECTORAL GIRDLE

The dorsal fork of the *posttemporal* (Fig. 8) is larger, broader, and stronger than the ventral fork. It lies just under the skin and is attached by ligament to the epiotic. The main body of the bone bears on its outer side a short, well-

ossified tube that carries the lateral line canal, which is open at either end. The ventral fork is slender, nearly circular in cross section and, like the anterior forks of the urohyal, it appears that the ligament has ossified nearly to

the bone of attachment, the opisthotic in this case. It is stiff and stands at nearly right angles to the main body of the bone and the dorsal fork, instead of being in the same plane, as is usual. There is a shallow, broad facet on the inner side of the bone for attachment to the supracleithrum.

The *supracleithrum* (Fig. 8) has a constricted knob at its dorsal end which is attached to the posttemporal. The dorsal third of the bone is thickened by the short tube of the lateral line canal which it bears on its outer surface. The rest of the bone is thin and flat. The bone is slightly concave dorsally to conform to the curvature of the body.

For the most part, the *cleithrum* (Fig. 8) is a thin, flat bone. There is a short dorsal spike from which a ray of heavier ossification extends downward to the insertion of the primary shoulder girdle. Here it is met by a similar strongly ossified ridge from the anterior edge of the ventral arm of the bone. This ridge projects on the inner side of the bone and to this is attached the primary shoulder girdle. A wing of bone projects inward from this ridge to lie over the edge of the coracoid, where there is a slight groove for its reception, and binds the primary shoulder girdle more firmly to the cleithrum.

The primary shoulder girdle (Fig. 8) projects downward at more than a right angle from the cleithrum. The *mesocoracoid*, although slender, and simple, is well ossified and well formed. It ends ventrally in a broadened base on the cartilage between the scapula and coracoid. The edges of those bones are raised to form a simple column for its reception. The bone tapers rapidly to the slender dorsal end where the bone becomes thin and slender and turns posteriorly along the inner surface of the cleithrum to the cartilage over the scapula, thus serving to strengthen the junction between the cleithrum and the primary shoulder girdle.

The *scapula* is large and well ossified. The oval foramen lies nearly in the center of the bone. The lateral edge is straight and attached for its whole length to the cleithrum. The posterior side bears a deeply indented and

heavily ossified facet for the articulation of the first ray of the fin. The entire mesial edge participates in the formation of the raised base for the mesocoracoid. It is separate from the coracoid by a narrow band of cartilage. This band expands anteriorly into a broad, thick triangle, the edge of which joins the cleithrum.

The *coracoid* is normal in shape with a short, blunt, posterior process. The anterior process, which attaches to the anterior end of the cleithrum, is long and slender and leaves a broad interosseous space between the coracoid and cleithrum. The posterior edge is thickened and raised to participate in the mesocoracoid base. There are four proportionately large *actinosts*. The first three are inserted on the scapula; the fourth on the scapula and the adjoining cartilage, but not on the coracoid. There is a continuous band of cartilage around the distal ends of the actinosts, over which the fin rays ride, and each of these bones is also capped with cartilage. The first actinost is nearly as broad as long. The remaining bones are also broad, without the typical hour-glass shape, but they become progressively longer until the fourth is three times the length of the first. It is as long as the scapula.

There are four *postcleithra* on the pectoral girdle of the smaller specimen, here described, but only three on that of the larger specimen, illustrated in Fig. 8. The bones are superficial, covered only by thin skin and are visible externally. All are thin. The uppermost is nearly circular and small. It overlaps, and is there bound to the second and also to the cleithrum and supracleithrum. The second is nearly four times the length, and as broad, as the first. The third is only half the length of the second, and is only a little slenderer. The fourth is as long as the second and third, but is less than half as broad. It is attached ventrally to the posterior process of the coracoid and it appears that the whole series is at least a partial support for the primary shoulder girdle. The fourth postcleithrum lies wholly under the pectoral fin. These bones were apparently overlooked by Kendall and Crawford (1922). Unless stained they could easily escape observation by being torn off with the skin.

AXIAL SKELETON

There are 53 vertebra plus the single upturned caudal element, of which 36 are abdominal and seventeen caudal. There are no ribs on the first two. Their places on the centra are taken by ligaments between the cleithrum and supracleithrum and serve to bind the shoulder girdle to the axial skeleton. The ribs on the next 24 vertebrae are adnate to the centra. On the twenty-seventh centrum are short parapophyses to which the ribs are attached. These parapophyses become progressively longer on the remaining nine abdominal vertebrae, and from then on each pair unite ventrally as the haemal spines of the caudal vertebrae. There are no epipleurals on the first nineteen ribs. The next fifteen ribs bear long, slender epipleurals. On the first six of these the epipleurals seem to be ankylosed to the heads of the ribs. The ribs are, in this place, thick and heavy and perhaps represent the fusion of ribs and parapophyses. On the last nine abdominal vertebrae the epipleurals adhere to the parapophyses at the side of the junction with the rib. On the first eight ribs there are slender tendons of the same size and attached in the same position as the epipleurals. It is believed that they are homologous, and also that the ligament on the first vertebra is likewise homologous, with the epipleurals. No sign of epipleural or tendon is seen on the ribs between the ninth and twentieth vertebrae and it is not believed that they were accidentally removed in dissection.

On the first 27 vertebrae are borne long, slender epineurals, quite similar in shape and

length to the epipleurals. They are attached at the base of the neural spine and seem to be ankylosed thereto.

The neural spines on the abdominal vertebrae are all slender and pliable. The two spines of each vertebra do not become united into a single spine until the twenty-first vertebra, which is the third behind the dorsal fin. The spines beyond this point become progressively heavier and stiffer.

There are eight thin, but broad, interneurals which fill nearly all the space between the neural spines and the top of the body. The first interneural is enormously expanded, and is much broader than any of the remaining ones.

There are 12 pterygiophores for the dorsal fin. The first is inserted between the neural spines of the ninth and tenth vertebrae, well in advance of the first ray of the fin, and the last, which is tiny, lies between the nineteenth and twentieth vertebrae. The second is the longest and largest, although all of the first three pterygiophores are broad and long.

The rays of the anal fin are borne on thirteen slender pterygiophores between the haemal spines of the first eight caudal vertebrae.

The support of the caudal fin is typically homocercal with a single upturned centrum. The neural spines and haemal spines of the next five anterior vertebrae also lend at least some support to the ray of the fin, the neural spine of the penultimate vertebrae being especially shortened and broadened for this purpose.

RELATIONSHIPS

A review of the anatomy of *Argentina* makes understandable the long association that the argentines have had with the salmonoid fishes in ichthyological systematics. The general shape and proportions of the head and body, the disposition of the fins on the body, the presence of an adipose fin, orbitosphenoid, basisphenoid, the broad and deep myodome, which opens posteriorly, the well-formed and functional mesoracoid, the several postcleithra, and the peculiarly inverted third hypobranchials (which are so reminiscent of the osmerid

fishes) are all typical of the salmonoid fishes. But, on the other hand, the argentines in common with the other opisthoproctoid fishes, and in distinction from the salmonoid fishes, have the following characteristics: (1) Dentition is completely lacking on the premaxillaries and maxillaries, and these bones are much reduced in size and function; (2) there is complete lack of supra-maxillaries; (3) the anterior portion of the palatine arch is strongly bound by both cartilage and bony articulation with the ethmoid region of the cranium in the char-

acteristic opisthoproctoid manner; (4) the broad and long mesoptergoid which is obviously destined to aid in the support of the enlarged eye has its ventral edge *under* the cartilage of the palatine arch, not in the same plane with it, and for its entire mesial length it is bound tightly to the parasphenoid; (5) the mesopterygoid and metapterygoid are obviously membrane, not cartilage, bones and the latter is much reduced in size and function; (6) the hyomandibular articulates broadly across the entire lateral edge of the posterior part of the cranium, from the posterior edge of the pterotic to the anterior edge of the sphenotic; (7) the vomer is characteristically broad and thin, has a long posterior shaft (in distinction to the osmerids), and a single row of teeth around the anterior edge which, with the palatine teeth, form the entire dorsal dentition of the mouth; (8) the supraoccipital is broadly shut out from the foramen magnum by the exoccipitals; (9) the fish are exclusively marine and typically bathypelagic with pelagic eggs and larvae (Schmidt, 1918) in abrupt distinction to the normal demersal eggs of salmonoid fishes which are typically buried in, or adhere to, gravel, either near the intertidal area or in fresh water; (10) the cartilage of the cranium, especially of the ethmoid region, is much less developed than in the salmonoids; and last, but by no means least, (11) there is a well-formed and apparently functional spiral valve in the intestine as in the other

opisthoproctoid fishes, quite in distinction to the vestigial remnants of spiral valves encountered in occasional specimens of salmonoid fishes (Kendall and Crawford, 1922).

For these reasons the Argentinidae are to be considered as members of the suborder Opisthoproctoidei of the order Isospondyli, although without question they go a long step toward bridging the gap between those bizarre inhabitants of the ocean depths and normal isospondylous fishes. In a group of fishes the members of which are typically widely different from the other members, the Argentinidae diverge especially far, anatomically speaking. To the rest of the Opisthoproctoidei they stand in much the same relation as the Esocidae do to the other families of haplomid fishes: widely divergent, but descended from a similar stock.

The following synopsis of the Argentinidae will serve to distinguish this family sharply from the other opisthoproctoid fishes (Opisthoproctidae, Macropinnidae, Winteriidae, Xenophthalmichthyidae, Bathylagidae, and Microstomidae). Of these fishes it is most closely related to the Microstomidae.

Synopsis of the family Argentinidae.—Opisthoproctoid fishes with several postcleithra, mesocoracoid, basisphenoid, opisthotics, large air bladder, premaxillaries, laterally directed eyes, and a broad myodome that opens posteriorly.

LITERATURE CITED

- BARNARD, KEPPEL HARCOURT. *A monograph of the marine fishes of South Africa, pt. 1.* Ann. South African Mus. **21**: 1-418, pls. 1-17, figs. 1-18. 1925.
- BEEBE, WILLIAM. *Deep sea fishes of the Bermuda Oceanographic Expedition, No. 3: Argentinidae.* Zoologica **16** (3): 97-147, figs. 26-46. 1933.
- CHAPMAN, WILBERT MCLEOD. *The osteology and relationships of the osmerid fishes.* Journ. Morph. **69** (2): 279-301, 15 figs. 1941.
- . *The osteology and relationships of the bathypelagic fishes of the genus Bathylagus Günther, with a note on the proper systematic position of Leuroglossus stilbicus Gilbert.* Univ. Washington Publ. Biol. 1942. (In press.)
- FOWLER, HENRY WEED. *The marine fishes of West Africa, pt. I.* Bull. Amer. Mus. Nat. Hist. **70** (1): 1-605, figs. 1-275. 1936.
- GILL, THEODORE. *Catalogue of the fishes of the eastern coast of North America, from Greenland to Georgia.* Proc. Acad. Nat. Sci. Philadelphia (ser. 2) **13**: 1-63. 1861.
- . *On the subfamily of Argentininae.* Proc. Acad. Nat. Sci. Philadelphia (ser. 2) **14**: 14-15. 1862.
- . *The ichthyological peculiarities of the Bassalian fauna.* Science **3** (68): 620-622. 1884.
- GUICHENOT, ALPHONSE. *L'Argentine leio-glosse, nouveau genre de Salmonoides.* Ann. Soc. Maine-et-Loire, IX. 1866. (After Jordan, 1919b.)
- GÜNTHER, ALBERT. *Catalogue of the fishes in*

- the British Museum* 6: 1-368. 1866.
- JORDAN, DAVID STARR. *The genera of fishes, pt. II.* Stanford Univ. Publ., Univ. Ser.: 163-284. 1919a.
- . *The genera of fishes, pt. III.* Ibid.: 285-410. 1919b.
- . *A classification of fishes including families and genera as far as known.* Stanford Univ. Publ., Biol. Sci., 3 (2): 79-243. 1923.
- KENDALL, WILLIAM C., and CRAWFORD, DONALD R. *Notice of a spiral valve in the teleostean fish Argentina silus, with a discussion of some skeletal and other characters.* Journ. Washington Acad. Sci. 12: 8-19, figs. 1, 2. 1922.
- KRÖYER, HENRIK NIKOLAJ. *Danmarks Fiske.* 1846. (After Jordan, 1919a.)
- KYLE, H. M., and EHRENBAUM, E. *Teolestei Physostomi, XII, f10-86, in Die Fische der Nord- und Ostsee.* Leipzig, 1929.
- NORMAN, JOHN ROXBOROUGH. *Oceanic fishes and flatfishes collected in 1925-1927. Discovery Rep. 2:* 261-370, pl. 2, figs. 1-47. 1930.
- PARR, ALBERT EIDE. *Deep sea fishes from off the western coast of North and Central America.* Bull. Bingham Oceanogr. Coll. 2 (4): 1-53, figs. 1-18. 1931.
- REGAN, CHARLES TATE. *The Antarctic fishes of the Scottish National Antarctic Expedition.* Trans. Roy. Soc. Edinburgh 49 (2): 229-292, pls. 1-11, figs. 1-16. 1914.
- REINHARDT, JOHANNES. *Bemärkningen Til den Skandinaviske Ichthyologie.* 1833. (After Jordan, 1919a.)
- SCHMIDT, JOHANNES. *Argentinidae, Microstomidae, Opisthoproctidae, Mediterranean Odontostomidae.* Rep. Dän. Oceanogr. Exped. 1908-1910 2 (Biology) (A.5): 1-40, figs. 1-23, 4 charts. 1918.
- SOLDATOV, V. K., and LINDBERG, G. J. *A review of the fishes of the seas of the Far East (Russian text).* Bull. Pacific Sci. Fish. Inst. Vladivostok 5: 1-576, figs. 1-76. 1930.

CHEMISTRY.—A study of ionic adsorption in solutions of silica and alumina.¹

P. G. NUTTING, U. S. Geological Survey.

Some years ago I noted an acid solution of clay that became more acid on the first addition of ammonia. Recently a similar but more pronounced effect was found on adding an alkali to dilute water solutions of pure silica and alumina. This led to finding alkaline solutions that became more alkaline on adding acid. Aside from their purely chemical interest, these findings suggest possible explanations of some puzzling mineral replacements, and the field seemed worth thorough exploration to determine its limits and underlying principles. This task is far from completed but a first summary of results seems in order.

Electrometric titration was the method chiefly used. This gave a series of pH values varying with the amount of reagent added to the solution being studied, which plot in a smooth curve readily repeatable. From among dozens of curves run, I have selected four groups of three concentrations each. These are (1) silica solutions and (2) alumina solutions, each titrated with potassium hydroxide and (3) potassium silicate

and (4) potassium aluminate, each titrated with hydrochloric acid.

Impurities were carefully avoided, but it was later found that they had little effect on the shape of a curve, only displacing it slightly. Filter paper, because of its strong adsorption of cations, was not used. Solutions were made up in fresh pyrex glass. Concentrations were determined in platinum. Carbon dioxide from the air interfered with two concentrations of potassium aluminate as noted below. In a freshly diluted or titrated solution a period of 10 to 40 minutes is required to attain an equilibrium pH reading.

Silica solutions are easily obtained by dissolving pure silica in distilled water—about 5 grams in a 4-liter flask. The pure silica is obtained either from silica gel or from a pure bentonite by digesting in hot strong acid for 24 hours to remove bases followed by thorough washing. In hot water, silica approaches saturation (about 0.4 gram per liter) in about 30 hours. The preparation of pure alumina stock solutions by dissolving in hot water was found not to be feasible. Alumina is soluble to the extent of only

¹ Published by permission of the Director, U. S. Geological Survey. Received October 23, 1941.

TABLE 1.—TITRATION OF THREE SILICA SOLUTIONS WITH POTASSIUM HYDROXIDE

10 ⁻⁵ gram SiO ₂ /cc 1 mg/100 cc		10 ⁻⁴ gram SiO ₂ /cc 10 mg/100 cc		10 ⁻³ gram SiO ₂ /cc 100 mg/100 cc	
cc or mg KOH	pH	cc or mg KOH	pH	cc or mg KOH	pH
0	5.68	0	5.11	0	4.55
0.5	4.73	1	4.45	2.5	4.15
1.0	4.08	2	3.94	5	3.83
1.5	3.95	3	3.68	7.5	3.61
2.0	10.7	4	3.69	10	3.48
—		5	4.14	15	3.51
—		6	6.30	20	4.25
1.91	7.00	6.25	7.00	23.4	7.00 (neutrality)
1.4	3.94	3.4	3.65	12.5	3.44 (minima)

three parts per million, and the residue containing it was found to be always about 30 percent silica. Bredig's method (arc under water) produced too wide a variety of particle sizes. Finally the ammonia precipitate of the chloride was washed down to about 4 percent chloride, then electrolyzed. The potassium silica and aluminate solutions were made up by dissolving weighed amounts of silica and alumina in potassium hydroxide of known concentration. For titration, 100-cc portions were used, obtained by successive dilution of the stock with distilled water whose pH varied little from 6.7. The titrating was by half cc steps from a burette containing 0.1 percent (1 mg

per cc) acid or alkali. The pH of even 10⁻⁹ (one part per billion) silica or alumina solution differs markedly from that of the distilled water with which it is diluted. In Table 1 and Fig. 1 are given results for silica solutions of concentrations 10⁻⁵, 10⁻⁴, and 10⁻³ absolute.

All three solutions became more acid by more than one pH unit on adding the first alkali. At the bottom of Table 1 are given (in pH) the maximum acidity reached, the amount of KOH causing it, and the alkali necessary to neutralize each solution. The stoichiometric ratio is 1.87 grams KOH to combine with each gram of SiO₂ if K₂SiO₃ is formed. That ratio is slightly exceeded in

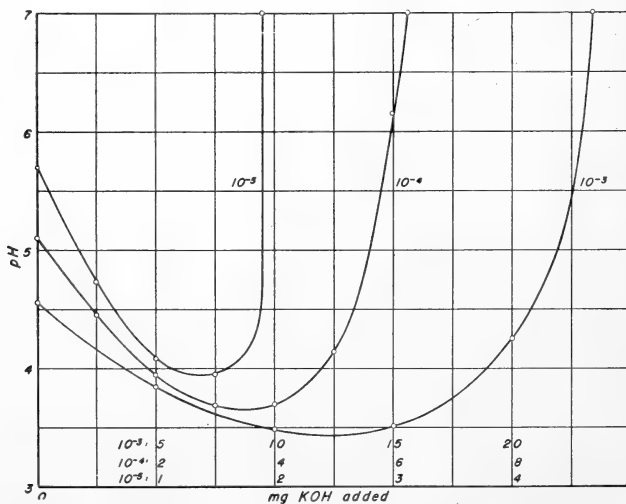

Fig. 1.—Potentiometric titration of 100-cc portions of silica solutions of concentrations 10⁻⁵, 10⁻⁴, and 10⁻³ gram SiO₂ per cc with 0.1 per cent KOH solution. Note three different abscissae scales for the three curves.

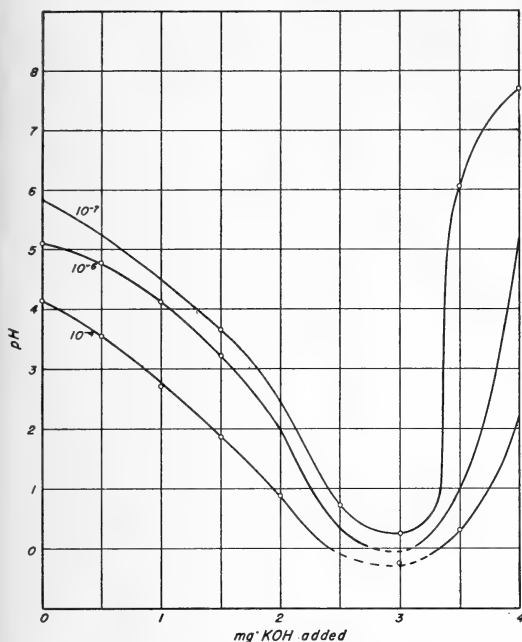

Fig. 2.—Titration of alumina solutions with KOH. Portions of curves below pH = 0 (dashed) are interpolated.

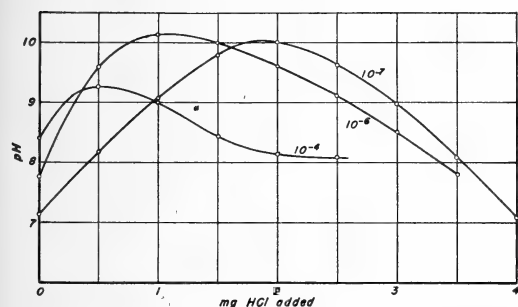

Fig. 3.—Curves showing pH of three dilute solutions of K_2SiO_3 titrated with 0.1 per cent HCl.

TABLE 2.—TITRATION OF ALUMINA SOLUTIONS WITH POTASSIUM HYDROXIDE

cc or mg KOH	10^{-7} 0.01	10^{-6} 0.1	10^{-4} gram/cc 10 mg/100 cc
	pH	pH	pH
0	7.46	5.10	4.15
0.5	5.62	4.75	3.55
1.0	4.51	4.11	2.75
1.5	3.65	3.20	1.86
2.0	2.55	1.95	0.85
2.5	0.72	0.34	(-0.10)
3.0	0.22	(-0.06)	(-0.29)
3.5	6.04	1.00	0.29
4.0	7.68	5.23	2.24

the most dilute solution at pH 7, 0.625 gram KOH per gram SiO_2 being sufficient to neutralize the 10^{-4} solution, and 0.234 the 10^{-3} solution. The more concentrated solu-

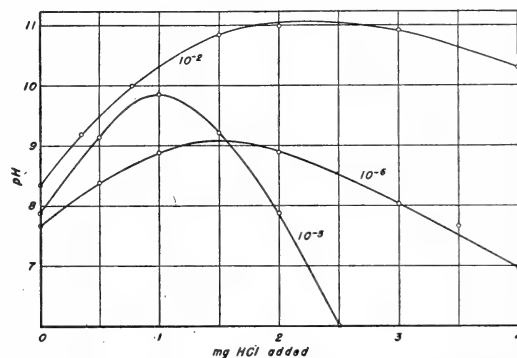

Fig. 4.—Curves showing pH of three dilute solutions of $KAlO_2$ titrated with 0.1 per cent HCl.

tions require proportionately less alkali to neutralize or produce maximum acidity—quite the reverse of alumina solutions. The

TABLE 3.—POTASSIUM SILICATE AND ALUMINATE SOLUTIONS TITRATED WITH HYDROCHLORIC ACID

cc or mg HCl	K_2SiO_3 gram/cc			$KAlO_2$ gram/cc			
	10^{-7}	10^{-6}	10^{-4}	10^{-6}	10^{-5}	10^{-2}	
	pH	pH	pH	pH	pH	pH	
0	7.12	7.75	8.40	7.68	7.86	8.33	
0.5	8.17	9.58	9.25	8.38	9.13	9.50	
1.0	9.08	10.12	8.98	8.87	9.84	10.31	
1.5	9.80	9.98	8.42	9.08	9.20	10.82	
2.0	10.01	9.61	8.12	8.91	7.83	11.04	
2.5	9.61	9.10	8.08	8.51	6.01	11.03	
3.0	8.98	8.48	8.07	8.02	4.18	10.91	
4.0	7.08	—	—	6.95	2.22	10.30	
HCl: K_2SiO_3 at max.	185	11	0.05	HCl: $KAlO_2$ at max.	16	1.0	0.0023

amount of alkali required to produce the minimum pH is roughly proportional to the square root of the concentration.

Typical results of titrating pure alumina solutions with KOH are given in Table 2 and Fig. 2 for solutions 10^{-7} , 10^{-6} and 10^{-4} in absolute concentration.

The first addition of alkali to alumina solutions causes a much larger increase in apparent acidity than in silica solutions. pH minima occur with the same addition of KOH at all three concentrations of alumina. With the 10^{-6} and 10^{-4} solutions these minima are below $\text{pH}=0$. The lowest point reached by the 10^{-4} curve is -0.30 corresponding to an effective hydrogen ion concentration of 2 molar. Such negative (by interpolation) pH values were obtained on a great many titration curves and furnish a clue to the interpretation of the apparently anomalous effects observed.

With alumina solutions, the alkali disposed of bears no relation to the reaction $\text{KOH} + \text{AlOOH}$. At the pH minima, for example, 3 mg KOH is associated with 0.01, 0.1, and 10 mg of Al_2O_3 in the three solutions. Instead of the combining ratio $2\text{KOH}:\text{Al}_2\text{O}_3=1.10$, those ratios are 300, 30, and 0.3. A lowest ratio (0.3) might signify an incomplete reaction but, where a gram of alumina associates with 300 grams of alkali, it can hardly be simple chemical reaction.

Other basic solutions tried with solutions of alumina, silica, and clay include ammonia, alcohol, triethanolamine, sodium hydroxide, and potassium aluminate and fluoride. Many silicates adsorb potassium salts much more powerfully than sodium,

salts, but the pH depressions caused by their hydroxides do not differ markedly. The alkali aluminates produce much the same effects as the hydroxides. The addition of triethanolamine to silica solutions gives a deep pH depression but the curve is irregular perhaps due to its tribasic character. Even alcohol causes a measurable depression.

The reverse effect—an alkaline solution becoming more alkaline on titrating with acid—seemed plausible and was found without difficulty. Dilute solutions of potassium silicate and aluminate, titrated with hydrochloric acid show it well. Three selected curves for each salt are reproduced in Figs. 3 and 4, the numerical data for which are collected in Table 3. As before, 100 cc of solution was titrated with 0.1 percent acid.

The aluminate solutions 10^{-4} and 10^{-3} formed precipitates (by hydrolysis?) on standing. Their residual liquors gave pH curves similar to that for 10^{-6} which is the solubility of the hydroxide. No such effect was apparent in the silicate solutions.

Maximum pH is produced in the silicate solutions by the addition of from 0.5 (in 10^{-4}) to 1.8 mg HCl in the 10^{-7} solution, the more dilute requiring more acid, quite the contrary of any chemical reaction. At the maximum of the 10^{-4} curve the $\text{HCl}:\text{K}_2\text{SiO}_3$ ratio is $0.5:10=0.05$, on the 10^{-6} curve it is $1.1:0.1=11$ while on the 10^{-7} curve it is $1.85:0.01=185$. In the aluminate solutions the disparity is even greater. Evidently both adsorption and hydrolysis play important roles.

DISCUSSION

Only tentative suggestions bearing on the results recorded above appear possible at this time. Although they appear to be caused by selective adsorption, the details are far from clear.

The study of electrolytic conduction 40 years ago showed that each migrating ion carried from 10 to 30 molecules of water with it. The miscellae of silica and alumina sols are notoriously avid adsorbers of ions

and on electro dialysis are dragged through the membranes by both anions and cations. In pure water, with H and OH ions present in equal numbers and strength, the migration of silica or gelatin is impartially toward anode and cathode. The addition of a little KOH or HCl to the sol throws the migration far off balance.

An alkaline precipitate in an acid solution may be readily obtained. To a suspension

of sodium clay (e.g., a swelling bentonite) methyl orange is added, then just sufficient acid to cause precipitation. If carefully done the precipitate will be yellow and the solution red. An acid precipitate in an alkaline solution may be obtained from the same clay by first treating with acid to remove alkali, then neutralizing with alkali. These tests show the powerful selective adsorption of aluminosilicates. Silica gel turns pink when wet with water containing methyl orange, the liquor turning yellow.

The large changes in pH noted in some cases would seem to indicate that heavy concentrations of H (or OH) ions might occur in a thin layer on the glass electrode or at the boundary of the KCl solution. Wiping the glass electrode or rinsing it with distilled water, with or without previous soaking in salt solution, did not affect the pH reading. Replacing the solution being observed with fresh solution was also without effect. A polarization effect is improbable because of the infinitesimal current used for only a small fraction of a second in making a reading and because standing over night did not affect the reading.

Mattson² has recently suggested that soil humus, under certain conditions of oxidation, might be made more acid on the addition of an alkali by permitting the escape of free hydrogen during the oxidation-reduction process. If Mattson's theoretical prediction is realized in actual tests, it may point to an explanation of the simpler and much more general results here reported, but its present application to these results is not apparent.

The wide diversity of cases in which in-

verse pH effects were noted suggested that perhaps many classes of chemical reaction start off with the adsorption of ions and continue so until the adsorption of ions is sufficient to pass the potential hump and complete the reaction. Not denying this possibility, one notes that in some cases reported the reverse effect is at its height with reagent more than a hundred times that called for by the chemical reaction. This would seem to mean an enormous increase in the chemical energy hump with extreme dilution.

The dissociation of water supplies ions of about the same concentration (10^{-7} moles) as that of some of the solutions worked with but it is difficult to see how these ions could be effective in producing an unbalance between anions and cations.

The break-up of long chains of solute into shorter ones and eventually into single molecules would produce an unbalanced demand for OH ions to fill out broken ends leaving excess H ions and acidity. Conversely, the building up of such chains would produce excess OH ions. For a time this explanation seemed acceptable to the writer but it was later found to be inadequate for it would require that a reagent break up (or build up) chains, at a fixed concentration, according to a very definite law. This seems very improbable particularly at the lowest concentrations where the solute probably exists as single molecules.

The ultimate explanation of the observed effects seems likely to be based on selective adsorption; that is, on the formation of ion-rich osmotic atmospheres surrounding micellae and molecules of silica and alumina.

SUMMARY

Experiments are described in which the addition of alkali to acid solutions renders them more acid and in which the addition of acid to alkaline solutions increases their alkalinity.

Curves of electrometric titration of silica and alumina solutions with potassium hydroxide are smooth and show a regular pro-

gression with concentration. The silica curves drop about 1.5 pH units, the alumina curves about 5 units before the final rise to alkalinity. The silica solutions reach maximum acidity on addition of alkali just less than the combining proportion, the alumina solutions on addition of a fixed amount of alkali which, in the most dilute solution, is 300 times the combining proportion.

In titrating solutions of potassium silicate

² MATTSON, SAUTE. *The acid-base condition in vegetation*: Ann. Agr. Coll. Sweden 9: 50. 1941.

and aluminate with hydrochloric acid the pH first rises by from one to three pH units before the final decrease to neutrality. At the maxima of these curves, the ratios of acid to alkali vary enormously with con-

centration and in inverse proportion.

The explanation of the observed anomalous behavior of these titrations is held to lie in a high selective adsorption.

PROCEEDINGS OF THE ACADEMY

373D MEETING OF BOARD OF MANAGERS

The 373d meeting of the Board of Managers was held in the Library of the Cosmos Club on February 6, 1942. President CURTIS called the meeting to order at 8:08 P.M., with 17 persons present, as follows: H. L. CURTIS, F. D. ROSINI, H. S. RAPPLEYE, N. R. SMITH, W. W. DIEHL, R. J. SEEGER, F. H. H. ROBERTS, JR., F. G. BRICKWEDDE, H. B. COLLINS, JR., F. C. KRACEK, J. B. REESIDE, JR., J. E. MCMURTREY, JR., W. A. DAYTON, F. B. SILSBEE, E. W. PRICE, L. W. PARR, and C. L. GARNER.

The minutes of the 372d meeting were read and approved.

President CURTIS announced the following appointments, for 1942 unless otherwise stated:

Executive Committee: J. E. GRAF, L. W. PARR.

Board of Editors of the JOURNAL: R. J. SEEGER, Senior Editor; J. R. SWALLEN, to January, 1945.

Associate Editors of the JOURNAL: W. E. DEMING, representing the Philosophical Society, to January, 1945; C. F. W. MUESEBECK, representing the Entomological Society, to January, 1945.

Committee on Membership: F. C. KRACEK (chairman), F. P. CULLINAN, F. M. DEFANDORF, ALICE C. EVANS, C. L. GAZIN, and J. S. WADE.

Committee on Monographs: ALEXANDER WETMORE and J. H. KEMPTON, to January, 1945.

Committees on Awards for Scientific Achievement: ALEXANDER WETMORE, general chairman.

For the Biological Sciences: ALEXANDER WETMORE (chairman), J. H. KEMPTON, F. H. H. ROBERTS, JR., W. A. DAYTON, C. F. W. MUESBECK, L. W. STEPHENSON and E. W. PRICE.

For the Engineering Sciences: H. N. EATON (chairman), G. W. VINAL, W. D. SUTCLIFFE, W. J. ROONEY, H. C. HAYES, O. E. MEINZER, and C. S. PIGGOT.

For the Physical Sciences: L. V. JUDSON (chairman), A. T. MCPHERSON, K. F. HERZFELD, O. S. ADAMS, F. S. BRACKETT, L. H. ADAMS, and R. C. WELLS.

Committee of Tellers: W. RAMBERG (chairman), L. W. BUTZ, and P. S. ROLLER.

Committee of Auditors: J. W. ROBERTS (chairman), E. W. POSNJAK, and C. H. SWICK.

Committee on Meetings, from June, 1942, to May, 1943: J. H. KEMPTON (chairman), K. S. GIBSON, M. C. MERRILL, ATHERTON SEIDELL, and P. A. SMITH.

The Executive Committee reported that it had instructed the Treasurer to invest the \$4,000 mentioned in the previous report as available for reinvestment in U. S. Savings Bonds of Series G at 2½ per cent interest, instead of in a savings account in a new federally-insured savings and loan association. The Executive Committee also presented the following budget for 1942, which was approved by the Board:

BUDGET

	Allotments	
	1941	1942
Secretary	\$ 450	\$ 450
Treasurer	225	200
Archivist	—	10
Custodian and Subscription Manager of Publications	120	75
Committee on Meetings	350	300
Committee on Membership	10	10

Executive Committee.....		10	10
Board of Editors.....		3,400*	3,100*
Printing, mailing, engraving, reprints.....	3,100		2,800
Editorial assistance.....	240		240
Miscellaneous expenses.....	60		60
Directory.....		350	—
Addendum to the Directory.....		—	60
		<hr/>	<hr/>
Total.....		4,915	4,215

ESTIMATED INCOME FOR 1942

Dues.....	2,575
Subscriptions and sales of the JOURNAL.....	615
Interest and dividends.....	1,049
	<hr/>
Total.....	4,239

* Not including services charged to, and paid for by, authors or their sponsors.

The two nonresident persons whose nominations were presented to the Board on January 9, 1942, were considered individually and duly elected to membership.

The Committee to consider certain questions relating to the Committee on Membership (F. C. KRACEK, chairman) reported some suggestions, which were referred for the making of definite recommendations to a second committee.

The Committee to consider affiliation of the Academy with the American Association for the Advancement of Science (N. R. SMITH, chairman) recommended such affiliation, which was thereby authorized to the Board.

The Secretary reported the following changes in membership: Acceptances, 1; qualified, 2; resignations, 3; retirements, 1. The status of membership as of February 6 was as follows:

	<i>Regular</i>	<i>Retired</i>	<i>Honorary</i>	<i>Patrons</i>	<i>Total</i>
<i>Resident</i>	434	34	3	0	471
<i>Nonresident</i>	127	19	13	2	161
<i>Total</i>	<hr/>	<hr/>	<hr/>	<hr/>	<hr/>
	561	53	16	2	632

The Treasurer, H. S. RAPPLEYE, reported that, in accordance with the instructions of the Executive Committee, he had invested \$4,000 in U. S. Savings Bonds of Series G at 2½ per cent interest.

The Board approved the recommendation of the Custodian and Subscription Manager of Publications, W. W. DIEHL, that 900 copies of the JOURNAL (the same as in 1941) be printed for 1942 and until further notice.

Upon nomination by the Anthropological Society of Washington, F. M. SETZLER was elected a Vice-President of the Academy for 1942 representing that Society.

The Board authorized the President to appoint a Committee to consider the petition for affiliation with the Academy that the Secretary reported received from the District of Columbia Society of Medical Technologists.

The Board instructed the Archivist to deliver to the Board at its next meeting a report on, and the contents of, the sealed package in the Archives relating to the ballots, etc., pertaining to the selection of the original membership of the Academy by the Joint Commission of the Scientific Societies of Washington.

The Board authorized the President to appoint a Committee to consider ways and means of increasing the income of the Academy.

The meeting adjourned at 10:18 P.M.

310TH MEETING OF THE ACADEMY

The 310th meeting of the Academy was held in the Assembly Hall of the Cosmos Club at 8:15 P.M. on February 19, 1942, with President CURTIS presiding.

GEORGE C. VAILLANT, director of the Museum of the University of Pennsylvania, Philadelphia, Pa., delivered an address entitled *The Aztecs of Mexico*, in which it was shown that archeology has a more direct bearing on history in Mexico than in the United States because the Indian population there is almost as important now as in the past. Excavations and docu-

mentary manuscripts were discussed, and the evolution of civilization in Indian Mexico was described.

There were about 90 persons present. The meeting adjourned at 10 P.M. for a social hour.

FREDERICK D. ROSSINI, *Secretary*

Obituary

ERNEST EVERETT JUST died on October 27, 1941. Born August 14, 1883, at Charleston, S. C., he received his early education at Kimball Union Academy in New Hampshire and his A.B. degree at Dartmouth College in 1907. At Dartmouth he specialized in zoology, devoting much of his time to research, and was elected to Phi Beta Kappa. His graduate training was begun at Woods Hole, Mass., under Prof. Frank R. Lillie while he was a member of the faculty of Howard University, and he received his Ph.D. from the University of Chicago in 1916. He was a member of the staff of Howard University from 1907 until his death, being head of the department of zoology from 1912. Most of his summers from 1909 to 1930 were spent at the Maine Biological Laboratory at Woods Hole. During the last 10 or 12 years he conducted his researches in various European laboratories. Just published over

50 papers dealing with fertilization and experimental parthenogenesis in marine eggs, chiefly of annelids and echinoderms. He also published two books, *Basic methods for experiments in eggs of marine animals* and *The biology of the cell surface*. Much of his research was made possible by grants from Julius Rosenwald, the General Education Board, the Carnegie Corporation, and the Rosenwald Foundation with which Howard University cooperated wholeheartedly by extending him numerous prolonged leaves of absence.

He was a member of many societies, among them the American Association for the Advancement of Science, the American Society of Naturalists, the American Society of Zoologists, the Ecological Society of America, and the Société Nationale des Sciences Naturelles et Mathématiques de Cherbourg.

PROGRAMS OF THE ACADEMY AND AFFILIATED SOCIETIES

THE ACADEMY (Cosmos Club Auditorium, 8:15 P.M.):

Thursday, April 16. *Cosmic emotion*. PAUL R. HEYL.

ANTHROPOLOGICAL SOCIETY OF WASHINGTON (U. S. National Museum, 8 P.M.):

Tuesday, April 21. *Archaeological accomplishments during the past decade in the United States*.

FRANK M. SETZLER.

CHEMICAL SOCIETY OF WASHINGTON:

Thursday, April 30. *Precision in the field of biochemistry: The quantitative estimation of important biological substances*. M. X. SULLIVAN. (Georgetown University, 8:15 P.M.)

Thursday, May 14. Section meetings. (University of Maryland, 8:15 P.M.)

MEDICAL SOCIETY OF THE DISTRICT OF COLUMBIA (1718 M Street, NW., 8 P.M.):

Wednesday, April 22 (program by Section on Gastroenterology). *Mechanism and significance of abdominal pain*. HENRY LEROY BOCKUS.

Wednesday, April 29. President's night.

Wednesday, May 6. Annual business meeting.

Wednesday, May 13. Program to be announced.

BOTANICAL SOCIETY OF WASHINGTON (Cosmos Club Auditorium, 8 P.M.):

Tuesday, May 5. *Recent developments in wood pathology*. CARL HARTLEY.
Nutrient study of the cantaloupe. CHARLES H. MAHONEY.

SOCIETY OF AMERICAN BACTERIOLOGISTS, Washington Branch (Georgetown University School of Medicine, 8 P.M.):

Tuesday, April 28. *The bacteriological work of John Tyndall*. MORRIS C. LEIKIND.
Coccidiomycosis. C. W. EMMONS.
Reclamation of used agar. HOWARD I. THALLER.

AMERICAN SOCIETY OF MECHANICAL ENGINEERS, Washington Section (place to be announced, 6:30 P.M.):

Monday, May 18. Annual dinner.

CONTENTS

	Page
ANTHROPOLOGY.—The Ainu double foreshaft toggle harpoon and western North America. GORDON W. HEWES.....	93
ICHTHYOLOGY.—The osteology and relationships of the Argentinidae, a family of oceanic fishes. WILBERT MCLEOD CHAPMAN.....	104
CHEMISTRY.—A study of ionic adsorption in solutions of silica and alumina. P. G. NUTTING.....	117
PROCEEDINGS: THE ACADEMY.....	122
OBITUARY: ERNEST EVERETT JUST.....	124

This Journal is Indexed in the International Index to Periodicals

6.75
D2W23
Vol. 32

MAY 15, 1942

No. 5

JOURNAL OF THE WASHINGTON ACADEMY OF SCIENCES

BOARD OF EDITORS

RAYMOND J. SEEGER
GEORGE WASHINGTON UNIVERSITY

G. ARTHUR COOPER
U. S. NATIONAL MUSEUM

JASON R. SWALLEN
BUREAU OF PLANT INDUSTRY

ASSOCIATE EDITORS

W. EDWARDS DEMING
PHILOSOPHICAL SOCIETY

C. F. W. MUESEBECK
ENTOMOLOGICAL SOCIETY

HARALD A. REHDER
BIOLOGICAL SOCIETY

EDWIN KIRK
GEOLOGICAL SOCIETY

CHARLOTTE ELLIOTT
BOTANICAL SOCIETY

T. DALE STEWART
ANTHROPOLOGICAL SOCIETY

HORACE S. ISBELL
CHEMICAL SOCIETY

PUBLISHED MONTHLY

BY THE

WASHINGTON ACADEMY OF SCIENCES

450 AHNAP ST.

AT MENASHA, WISCONSIN

Entered as second class matter under the Act of August 24, 1912, at Menasha, Wis.

Acceptance for mailing at a special rate of postage provided for in the Act of February 28, 1925.

Authorized January 21, 1933.

Journal of the Washington Academy of Sciences

This JOURNAL, the official organ of the Washington Academy of Sciences, publishes (1) Short original papers, written or communicated by members of the Academy; (2) proceedings and programs of meetings of the Academy and affiliated societies; (3) notes of events connected with the scientific life of Washington. The JOURNAL is issued monthly, on the fifteenth of each month. Volumes correspond to calendar years.

Manuscripts may be sent to any member of the Board of Editors. It is urgently requested that contributors consult the latest numbers of the JOURNAL and conform their manuscripts to the usage found there as regards arrangement of title, subheads, synonymies, footnotes, tables, bibliography, legends for illustrations, and other matter. Manuscripts should be typewritten, double-spaced, on good paper. Footnotes should be numbered serially in pencil and submitted on a separate sheet. The editors do not assume responsibility for the ideas expressed by the author, nor can they undertake to correct other than obvious minor errors.

Illustrations in excess of the equivalent (in cost) of 1½ full-page line drawings are to be paid for by the author.

Proof.—In order to facilitate prompt publication one proof will generally be sent to authors in or near Washington. It is urged that manuscript be submitted in final form; the editors will exercise due care in seeing that copy is followed.

Author's Reprints.—Reprints will be furnished in accordance with the following schedule of prices:

Copies	4 pp.	8 pp.	12 pp.	16 pp.	20 pp.	Covers
50	\$2.00	\$3.25	\$ 5.20	\$ 5.45	\$ 7.25	\$2.00
100	2.50	4.00	6.40	6.75	8.75	2.75
150	3.00	4.75	7.60	8.05	10.25	3.50
200	3.50	5.50	8.80	9.35	11.75	4.25
250	4.00	6.25	10.00	10.65	13.25	5.00

<i>Subscription Rates.</i> —Per volume.....	\$6.00
To members of affiliated societies; per volume.....	2.50
Single numbers.....	.50

Correspondence relating to new subscriptions or to the purchase of back numbers or volumes of the JOURNAL should be addressed to William W. Diehl, Custodian and Subscription Manager of Publications, Bureau of Plant Industry, Washington, D.C.

Remittances should be made payable to "Washington Academy of Sciences" and addressed to 450 Ahnaip Street, Menasha, Wis., or to the Treasurer, H. S. Rappleye, U. S. Coast and Geodetic Survey, Washington, D.C.

Exchanges.—The JOURNAL does not exchange with other publications.

Missing Numbers will be replaced without charge provided that claim is made to the Treasurer within thirty days after date of following issue.

OFFICERS OF THE ACADEMY

President: HARVEY L. CURTIS, National Bureau of Standards.

Secretary: FREDERICK D. ROSSINI, National Bureau of Standards.

Treasurer: HOWARD S. RAPPLEYE, U. S. Coast and Geodetic Survey.

Archivist: NATHAN R. SMITH, Bureau of Plant Industry.

Custodian of Publications: WILLIAM W. DIEHL, Bureau of Plant Industry.

JOURNAL

OF THE

WASHINGTON ACADEMY OF SCIENCES

VOL. 32

MAY 15, 1942

No. 5

GEODESY.—*The distance between two widely separated points on the surface of the earth.*¹ WALTER D. LAMBERT, U. S. Coast and Geodetic Survey.

Suppose two points on the earth to be given by their latitudes and longitudes: What is the length of the line joining the points and what is its direction at these end points? The problem will be discussed and the results stated and illustrated, the proofs being deferred to another occasion.

If we treat the earth as a sphere of given radius, the "line" joining the two points is the arc of a great circle less than 180° , which gives the shortest distance between them, and the problem is one of spherical trigonometry. Two sides and the included angle of a spherical triangle are, in effect, given.

A second approximation to the figure of the earth is a slightly flattened ellipsoid of revolution. It is of interest to inquire what the effect of the flattening is on the length and the direction of the "line" joining the two points. In what follows it will be assumed without much discussion that the line connecting the two points is a geodesic line, or simply a *geodesic*. The geodesic on an ellipsoid of revolution corresponds to an arc of great circle on a sphere or to a straight line in a plane. If we let the flattening of the ellipsoid decrease to zero, a geodesic on the ellipsoid becomes an arc of great circle on the limiting sphere; but, unlike the arc of a great circle, an indefinitely extended geodesic on an ellipsoid does not generally return into itself. Even if we reject those geodesics roughly analogous to arcs of a great circle greater than 2π , we find that there may be more than one geodesic between the same two points. Although the shortest distance is always measured along a geodesic, not every geodesic gives a shortest distance.

¹ Received February 24, 1942.

When two points A and B are inter-visible the lines actually observed by a surveyor are the two plane sections of the surface: (1) by a plane containing the normal at A and the point B ; (2) by a plane containing the normal at B and the point A . These plane sections are in general two distinct curves and a plane section has its characteristic property for only one of its points, the point where the plane contains the normal to the surface; in this it differs from the geodesic on the ellipsoid, from the arc of great circle on the sphere, and from the straight line in the plane. All these have their characteristic properties for all their points, with the possible limitation that the points must not be too far apart. Later an illustration will be given that will show the inapplicability of the idea of a plane section to the present problem.

In deriving the formulas to be given it is necessary to use the parametric, or reduced, latitude of a point on an ellipsoid of revolution, even though the reduced latitude does not appear explicitly in one group of formulas hereinafter given.

Let a and b be the semimajor and semiminor axes of an oblate ellipsoid of revolution. Let f denote flattening, $(a-b)/a$. Let ϕ denote the geographic latitude of a point (inclination of the normal to the surface at the point to the plane of the equator) and β the corresponding reduced or parametric latitude. The relation between ϕ and β is

$$\tan \beta = \frac{b}{a} \tan \phi = (1-f) \tan \phi. \quad (1)$$

Approximately, by neglecting small quantities of the order f^2 , we have in radians

$$\phi - \beta = \frac{1}{2}f \sin 2\phi = \frac{1}{2}f \sin 2\beta.$$

Astronomers sometimes use the geocentric latitude ψ , connected with the geographic latitude ϕ by the relation

$$\tan \psi = \frac{b^2}{a^2} \tan \phi,$$

or approximately in radians

$$\phi - \psi = f \sin 2\phi.$$

If we have tables of $\phi - \psi$, the reduction from geographic to geocentric latitude, we may take half this reduction as the approximate reduction from geographic to parametric latitude.

First assume that the parametric latitudes of the points A and B have been found and are β_1 and β_2 , respectively, and that the difference of longitude is λ ($\lambda < 180^\circ$). On a sphere λ is the angle at the north pole, C , between the two sides of a spherical triangle; the lengths of these sides, AC and BC , are $90^\circ - \beta_1$ and $90^\circ - \beta_2$ (south latitudes are treated as negative). We may solve this triangle by any of various formulas for the side AB opposite C , which call σ , and for the angles at A and B , which we may denote by the same letters A and B , as is usual in trigonometric formulas. These angles give the directions at A and B of the arc AB .

In surveying it is usual to specify direction by azimuth, reckoned from south by way of west around to 360° . If B is west of A and west longitudes are reckoned as positive, it is easy to see by drawing a figure that the azimuths α_1 and α_2 at A and B are connected with the angles A and B of the triangle by the relations

$$\alpha_1 = \text{forward azimuth of } AB \text{ at } A = 180^\circ - A$$

$$\alpha_2 = \text{back azimuth at } B = 180^\circ + B$$

(in direction BA)

The following formulas for the solution of the triangle ACB come from Delambre's (Gauss's) equations for a spherical triangle. The results are expressed directly in terms of the azimuth instead of in terms of the angles of the triangle.

$$\text{Let } \beta = \frac{1}{2}(\beta_2 + \beta_1), \Delta\beta = \frac{1}{2}(\beta_2 - \beta_1)$$

$$\left. \begin{aligned} \sin \frac{1}{2}(\alpha_2 + \alpha_1) \sin \frac{1}{2}\sigma &= -\sin \Delta\beta \cos \frac{1}{2}\lambda \\ \cos \frac{1}{2}(\alpha_2 + \alpha_1) \sin \frac{1}{2}\sigma &= -\cos \beta \sin \frac{1}{2}\lambda \\ \sin \frac{1}{2}(\alpha_2 - \alpha_1) \cos \frac{1}{2}\sigma &= \cos \Delta\beta \cos \frac{1}{2}\lambda \\ \cos \frac{1}{2}(\alpha_2 - \alpha_1) \cos \frac{1}{2}\sigma &= \sin \beta \sin \frac{1}{2}\lambda \end{aligned} \right\} (2)$$

These formulas are proposed rather than other possible ones because: (1) they are nearly self-checking in ways that the experienced computer will readily observe; (2) they are adapted to obtaining the greatest possible accuracy from trigonometric tables to a given number of places; (3) the quantities used are needed later in reducing from the sphere to the ellipsoid.

Though they are nearly self-checking, there is still a possibility that certain errors may escape detection that would be detected by the law of sines, namely,

$$\frac{\sin \lambda}{\sin \sigma} = \frac{\sin \alpha_1}{\cos \beta_2} = -\frac{\sin \alpha_2}{\cos \beta_1}.$$

The azimuths α_1 and α_2 , since they have been obtained from the sphere, need corrections to reduce them to their values on the ellipsoid. If we assume the radius of the sphere to be a , the semimajor axis of the ellipsoid, the distance on the sphere = $AB = s = a\sigma$ (σ in radians) also needs correction to reduce to the distance along a geodesic on the ellipsoid. The required corrections $\delta\alpha_1$, $\delta\alpha_2$, and δs are

$$\delta\alpha_1 = (f \cos^2 \beta_2 \sin \alpha_2 \cos \alpha_2) \frac{\sigma}{\sin \sigma} \quad (3)$$

$$= N\sigma / \sin \sigma$$

$$\delta\alpha_2 = (f \cos^2 \beta_1 \sin \alpha_1 \cos \alpha_1) \frac{\sigma}{\sin \sigma} \quad (4)$$

$$= M\sigma / \sin \sigma$$

where the meanings of M and N are obvious. $\delta\alpha_1$ and $\delta\alpha_2$ will be expressed in the same unit as σ .

$$\delta s = -\frac{1}{2}af(\sigma - \sin \sigma) \frac{\sin^2 \beta \cos^2 \Delta\beta}{\cos^2 \frac{1}{2}\sigma} - \frac{1}{2}af(\sigma + \sin \sigma) \frac{\cos^2 \beta \sin^2 \Delta\beta}{\sin^2 \frac{1}{2}\sigma} \quad (5)$$

In (5) the σ within the parentheses must evidently be expressed in radians. We then have

$$\left. \begin{aligned} \text{Forward azimuth on ellipsoid at } A \\ &= \alpha_1 + \delta\alpha_1 \\ \text{Back azimuth on ellipsoid at } B \\ &= \alpha_2 + \delta\alpha_2 \\ \text{Distance } AB \text{ on ellipsoid along} \\ &\text{geodesic} = a\sigma + \delta s \end{aligned} \right\} \quad (6)$$

where α_1, α_2 and σ come from (2) and $\delta\alpha_1, \delta\alpha_2$ and δs from (3), (4), and (5).

A variant form for δs is

$$\begin{aligned} \delta s = & -\frac{1}{2}af(\sigma - \sin \sigma) \cos^2 \frac{1}{2}\sigma \frac{\sin^2 (\alpha_2 - \alpha_1)}{\sin^2 \lambda} \\ & -\frac{1}{2}af(\sigma + \sin \sigma) \sin^2 \frac{1}{2}\sigma \frac{\sin^2 (\alpha_2 + \alpha_1)}{\sin^2 \lambda} \end{aligned} \quad (7)$$

It is not necessary to compute the parametric latitudes if they are not known or readily available, but the resulting formulas when geographic latitudes are used are slightly more complex.

Compute the spherical triangle given, as before, by the included angle C at the north pole equal to λ , the difference in longitude of A and B , and by the including sides AC and BC , which are now equal to $90^\circ - \phi_1$ and $90^\circ - \phi_2$, where ϕ_1 and ϕ_2 are the geographic latitudes of A and B respectively.

By analogy with (2) we put

$$\left. \begin{aligned} \phi &= \frac{1}{2}(\phi_2 + \phi_1) & \Delta\phi &= \frac{1}{2}(\phi_2 - \phi_1) \\ \sin \frac{1}{2}\sigma \sin \frac{1}{2}(\alpha_2 + \alpha_1) &= -\sin \Delta\phi \cos \frac{1}{2}\lambda \\ \sin \frac{1}{2}\sigma \cos \frac{1}{2}(\alpha_2 + \alpha_1) &= -\cos \phi \sin \frac{1}{2}\lambda \\ \cos \frac{1}{2}\sigma \sin \frac{1}{2}(\alpha_2 - \alpha_1) &= \cos \Delta\phi \cos \frac{1}{2}\lambda \\ \cos \frac{1}{2}\sigma \cos \frac{1}{2}(\alpha_2 - \alpha_1) &= \sin \phi \sin \frac{1}{2}\lambda \end{aligned} \right\} \quad (8)$$

For a check the law of sines is

$$\frac{\sin \lambda}{\sin \sigma} = \frac{\sin \alpha_1}{\cos \phi_2} = -\frac{\sin \alpha_2}{\cos \phi_1}$$

The values of α_1, α_2 and σ are not quite the same as those previously found; the differences are small quantities of the order f .

The corrections to be applied are

$$\begin{aligned} \delta\alpha_1 &= (f \cos^2 \phi_2 \sin \alpha_2 \cos \alpha_2)\sigma / \sin \sigma \\ &+ f \cos^2 \phi_1 \sin \alpha_1 \cos \alpha_1 \end{aligned} \quad (9)$$

$$= N\sigma / \sin \sigma + M$$

$$\begin{aligned} \delta\alpha_2 &= (f \cos^2 \phi_1 \sin \alpha_1 \cos \alpha_1)\sigma / \sin \sigma \\ &+ f \cos^2 \phi_2 \sin \alpha_2 \cos \alpha_2 \end{aligned} \quad (10)$$

$$= M\sigma / \sin \sigma + N.$$

If σ is in radians, formulas (9) and (10) as they stand give $\delta\alpha_1$ and $\delta\alpha_2$ in radians. We have used the same symbol, M , for $f \cos^2 \beta_1 \sin \alpha_1 \cos \alpha_1$ and $f \cos^2 \phi_1 \sin \alpha_1 \cos \alpha_1$ since these two quantities differ from one another by small quantities of the order f^2 , quantities neglected in this discussion. Similarly for N .

For the distance we have now

$$\begin{aligned} \delta s = & \frac{1}{2}af(3 \sin \sigma - \sigma) \frac{\sin^2 \phi \cos^2 \Delta\phi}{\cos^2 \frac{1}{2}\sigma} \\ & -\frac{1}{2}af(3 \sin \sigma + \sigma) \frac{\cos^2 \phi \sin^2 \Delta\phi}{\sin^2 \frac{1}{2}\sigma} \end{aligned} \quad (11)$$

As before, σ within the parentheses is expressed in radians. We then have

$$\left. \begin{aligned} \text{Forward azimuth on ellipsoid at } A \\ &= \alpha_1 + \delta\alpha_1 \\ \text{Back azimuth on ellipsoid at } B \\ &= \alpha_2 + \delta\alpha_2 \\ \text{Distance } AB \text{ on ellipsoid along} \\ &\text{geodesic} = a\sigma + \delta s \end{aligned} \right\} \quad (12)$$

where α_1, α_2 and σ come from (8) and the corrections to them from (9), (10), and (11). The quantities $\alpha_1, \alpha_2, \sigma, \delta\alpha_1, \delta\alpha_2$, and δs differ from the like-named quantities obtained from (2), (3), (4), and (5) by small quantities of the order f^2 , but the combinations $\alpha_1 + \delta\alpha_1, \alpha_2 + \delta\alpha_2$ and $a\sigma + \delta s$ are nearly the same in (6) and (12). See the numerical examples.

Alternative formulas are

$$\begin{aligned} \delta s = & \frac{1}{2}af(3 \sin \sigma - \sigma) \frac{\cos^2 \frac{1}{2}\sigma}{\sin^2 \lambda} \sin^2 (\alpha_2 - \alpha_1) \\ & -\frac{1}{2}af(3 \sin \sigma + \sigma) \frac{\sin^2 \frac{1}{2}\sigma}{\sin^2 \lambda} \sin^2 (\alpha_2 + \alpha_1) \end{aligned} \quad (13)$$

$$\left. \begin{aligned} \frac{1}{2}(\delta\alpha_2 + \delta\alpha_1) &= -\frac{1}{2}f \left(\frac{\sigma}{\sin \sigma} + 1 \right) \\ &\cdot \cos \phi_1 \cos \phi_2 \sin (\alpha_2 + \alpha_1) \\ \frac{1}{2}(\delta\alpha_2 - \delta\alpha_1) &= -\frac{1}{2}f \left(\frac{\sigma}{\sin \sigma} - 1 \right) \\ &\cdot \cos \phi_1 \cos \phi_2 \sin (\alpha_2 - \alpha_1) \end{aligned} \right\} (14)$$

$\delta\alpha_2$ and $\delta\alpha_1$ are obtained from (14) by addition and subtraction.

The formulas for $\delta\alpha_1$ and $\delta\alpha_2$ contain the factor $\sigma/\sin \sigma$. When σ is small this factor is nearly unity and no difficulty arises, but when σ is nearly 180° , that is, when the points A and B are nearly antipodal, $\sigma/\sin \sigma$ is large. A necessary condition that the preceding formulas give at least a first rough approximation to the effect of the flattening on the azimuths is that $\pi - \sigma > f\pi$; or $180^\circ - \sigma > f 180^\circ$, if σ be in sexagesimal measure. For the earth $f 180^\circ$ is about 36 minutes of arc. In practice $180^\circ - \sigma$ should amount to several degrees. The behavior of geodesic lines between two nearly antipodal points is rather curious but the exposition would require considerable space.

Some idea of the possible complications encountered in seeking the line of minimum length between nearly antipodal points may be obtained by considering points on the Equator. Between two points on the Equator not too far apart the Equator itself is obviously a geodesic and a line of minimum length.

But let the two points on the Equator be exactly 180° apart in longitude. The shortest distance between them is along the meridian over the pole. This route takes advantage of the flattening of the earth to decrease the distance traveled. Suppose the difference in longitude to be, not $180^\circ = \pi$ radians, but $\pi(1 - \epsilon)$ radians. It can be shown that for ϵ sufficiently small there is a route between the two points that takes advantage of the flattening by leaving the Equator and going north or south but not all the way to a pole. The azimuth, α , of the geodesic of minimum length and the highest parametric latitude, β_0 , attained by it are given approximately by

$$\sin \alpha = \cos \beta_0 = \epsilon/f,$$

where f is, as usual, the flattening.

Let us take the flattening as $1/300$ in round numbers (the value adopted internationally is $1/297$); we have the following table of approximate values:

TABLE 1.—PROPERTIES OF A MINIMUM GEODESIC BETWEEN TWO POINTS ON EARTH'S EQUATOR
($f = 1/300$ $a\pi = 20,000$ km)

Diff. long. λ	Az. of geodesic α	Max. lat. β_0	Dist. saved $s_E - s_G$
179°24'	90°	0°	0
179 30	123.6	33.6	$\frac{1}{2}af\pi = 0.9$ km
179 36	138.2	48.2	$\frac{1}{2}af\pi = 3.7$
179 42	150.0	60.0	$\frac{1}{2}af\pi = 8.3$
179 48	160.5	70.5	$\frac{1}{2}af\pi = 14.7$
179 54	170.4	80.4	$\frac{1}{2}af\pi = 23.1$
180 00	180	90	$\frac{1}{2}af\pi = 33.3$

s_E is the length along the Equator, s_G the length along the geodesic. There are obviously two symmetrical geodesics, one in each hemisphere. The figures in the table apply to the geodesic in the northern hemisphere. For difference of longitude equal to 180° the meridian and the Equator are both vertical sections; for any pair of points on the equator, the equator itself is the vertical section but does not necessarily give the minimum distance.

No attempt has been made to evaluate the omitted terms in f^2, f^3 , etc. Presumably the coefficients would be extremely complicated. Some idea of the accuracy obtainable with the formulas here given may be obtained from the numerical examples in Table 2.

The table gives: (1) the results, marked a , from formulas (2), (3), (4), (5), and (6), using reduced latitudes; (2) the results, marked b , from formulas (8), (9), (10), (11), and (12), using geographic latitudes; and (3) the results from a more accurate process, marked c , using the necessary number of successive approximations to obtain all the accuracy possible with a seven-place table.

It must be remembered that seven-place tables leave the final figures of the results given decidedly uncertain, so that the discrepancies between results a and b and between either and the accurate result c is

not necessarily much greater than that due to omitted decimals. We may fairly say that for examples I-IV inclusive the theoretical accuracy of the approximate formulas and the numerical accuracy obtainable with six-place tables are about the same.

But in example V, the errors due to omitted terms are much greater. Here the points are within 6° of being antipodal. This 6° is ten times the limit $f\ 180^\circ$ previously given. For points more nearly antipodal than in

Several years before the publication of Andoyer's article the writer of this note had the proofs for formulas equivalent to all those given above but did not publish them.

The process given in this note is only a first approximation and fails for nearly antipodal points. The rigorous solution in any case requires successive approximations and the inclusion of terms of higher order than the first-order terms here considered. The method is explained briefly in Clarke's *Geodesy* (Oxford, 1880), chapter 6, and much more fully with

TABLE 2.—COMPARISON OF THE VARIOUS FORMULAS

Spheroid	I Clarke, 1866	II Bessel	III Bessel	IV Clarke, 1866	V Clarke, 1866
a (km)	6378.206	6377.397			
$1/f$	294.98	299.15			
ϕ^1	+25°00'	+51°12'	+55°45'	+26°29'06''.57:	-55°00'
ϕ_2	+65 00	+51 55	-33 28	+55 00	+65 00
λ	+50 00	+69 03	-108 13	+30°07'38''.94	+174 00
$\alpha_1 + \delta\alpha_1$	135°18'	119°09'	222°07'	150°32'	214°
(a)	25'' .40	18'' .24	38'' .82	53'' .12	34'52'' .49
(b)	26 .39	18 .18	38 .02	53 .37	35 01 .85
(c)	25 .45	18 .20	38 .00	53 .10	35 31 .15
$\alpha_2 + \delta\alpha_2$	296°37'	242°30'	83°23'	310°00'	150°
(a)	45'' .48	57'' .30	50'' .09	00'' .16	20'08'' .53
(b)	46 .49	57 .39	49 .53	00 .21	20 00 .32
(c)	45 .45	57 .32	51 .18	00 .00	19 40 .51
$s + \delta s$ (km)	5675	4602	14110		19344
(a)	.585	.925	.52	3999.997	.27
(b)	.605	.910	.48	4000.011	.29
(c)	.591	.920	.53	4000.000	.22

V the approximation may be expected to be still rougher. The distance in example V by the approximate formulas is fairly accurate; this is to be expected.

BIBLIOGRAPHICAL NOTE

Formula (11), the correction to the distance computed on a sphere with geographic latitudes, has for some years past been given without proof in the *Annuaire du Bureau des Longitudes*. It is presumably due to Henri Andoyer. A proof by him dated 1927 was published posthumously in the *Bulletin géodésique* (No. 34, p. 77, 1932) under the title "Formule donnant la longueur de la géodésique joignant 2 points de l'ellipsoïde donnés par leurs coordonnées géographiques."

abundant numerical illustrations in Helmert's *Die mathematischen und physikalischen Theorien der höheren Geodäsie* 1, chapters 5 and 7 (Leipzig, 1880).

The behavior of a system of geodesics issuing in all directions from a fixed point and extending about halfway around the ellipsoid is treated by Clarke and more fully by Helmert. There is also a posthumous note by Jacobi completed by A. Wangerin in vol. 7 (p. 72) of his Jacobi's *Gesammelte Werke*, entitled "Über die Curve, welche alle von einem Punkte angehenden geodätischen Linien eines Rotationsellipsoid berührt."

A very full treatment of the same general subject was published by E. Fiehot in the *Annales Hydrographiques* (ser. 3) 4: 99, 1921,

under the title "Sur les systèmes géodésiques équilatères à la surface du sphéroïde terrestre." The subject is continued by E. Fichot and P. Gerson in the *Annales* (ser. 3) 5: 1937, under the title: "La zone géodésique antipode."

There is an article by Cayley in the *London, Edinburgh, and Dublin Philosophical Magazine and Journal of Science* 40: 329, 1870, entitled: "On the Geodesic Lines on an Oblate Spheroid," in which the results are expressed in terms of elliptic integrals.

CHEMISTRY.—*The determination of the cystine content of various proteins by different hydrolytic agents, sulphuric, hydrochloric, hydriodic, and a mixture of hydrochloric and formic acids.*¹ W. C. HESS and M. X. SULLIVAN, Georgetown University.

In the analysis of proteins some type of hydrolysis must be employed to separate the complex material into the constituent amino acids. Occasionally, as for example in the estimation of tryptophane, a mild alkaline hydrolysis with $\text{Ba}(\text{OH})_2$ has been found useful, but for most of the amino acids an acid hydrolysis is necessary. For years workers in the protein field have hydrolyzed with 20 per cent HCl or with 6N H_2SO_4 or, occasionally, with stronger H_2SO_4 . Many proteins however, on hydrolysis with these acids form black soluble or insoluble humin. Because of the necessity of decolorizing the black solution and the possible loss of reactive amino acid in the formation of the humin, soluble or insoluble, various investigators have sought to hydrolyze under conditions that avoid humin formation as much as possible.

Sullivan (1) early recommended hydrolyzing with HCl containing TiCl_3 , and Sullivan and Hess (2) found not only that in such an hydrolysis there was an inhibition of humin formation but also that the time required for hydrolysis was greatly lessened. Then Baernstein (3) emphasized the fact that no humin is formed if proteins are hydrolyzed by HI containing H_3PO_2 , and Miller and du Vigneaud (4) reported that a mixture of HCl and HCOOH was superior to HCl for the estimation of cystine in insulin.

¹ Received February 9, 1942.

There appears to be no comprehensive treatment readily available in English. The author hopes to publish one shortly.

For reduced, geocentric, and other kinds of latitude and their relation to geographic latitude see O. S. Adams, *Latitude developments connected with geodesy and cartography*, U. S. Coast and Geodetic Survey Special Publication No. 67.

If the protein is properly hydrolyzed there are several methods of estimating the cystine, and of these the Sullivan method (1) is the most specific and accurate. If the hydrolysis is conducted in a reducing atmosphere as with HI and H_3PO_2 the solution contains not cystine but the reduced form cysteine. In general, sulphuric acid has been found to be a less efficient hydrolytic agent than HCl in that it requires a longer period of heating (5). In work with edestin Kassell and Brand (6), however, report that hydrolysis with H_2SO_4 gives low results for cystine particularly with the Sullivan method, whether the time of hydrolysis is 8 or 15 hours, a finding they attribute to the tendency of the H_2SO_4 to produce substances that interfere with the Sullivan reaction, a situation they find also with HCl if the time of hydrolysis is long. Provided the acids are free from impurities we have never met with such interference. Higher values after precipitation with cuprous chloride, as found by Kassell and Brand, do not necessarily indicate the presence of inhibiting material since cuprous chloride opens a number of cystine complexes that do not react of themselves in the Sullivan reaction (7).

In fact, in work on the determination of cystine in zein we obtained practically the same value whether the hydrolytic agent was H_2SO_4 or HCl, and so were at a loss to account for the findings of Kassell and

Brand with edestin. Accordingly we submitted 10 proteins at our disposal to digestion with H_2SO_4 , HCl, HCl-HCOOH, and HI for periods of time considered optimum for the respective acid and estimated the cystine in the hydrolysates by means of the Sullivan method and the Okuda method.

EXPERIMENTAL

The proteins selected were known to vary from less than 0.5 percent to over 1.25 percent cystine, a range that covers most of the known proteins, exclusive of some albumins and keratins. If any variation from method to method is to be expected it would be more apt to occur in proteins with cystine contents of these orders of magnitude than in the keratins with extremely high cystine values. The edestin, arachin, and casein were carefully isolated and highly purified samples prepared in our laboratory. The proteins from halibut, haddock, salmon, round, and sirloin steaks were samples of those previously described and analyzed by Sullivan and Hess (8). The ox-muscle protein and the shrimp protein were prepared by Dr. D. B. Jones, Bureau of Agricultural Chemistry and Engineering. For the cystine determination a suitable amount of the protein, usually 500 mg, was hydrolyzed with (1) 2.0 cc 6N H_2SO_4 for 12 hours; (2) 2.0 cc 20 percent HCl for 8 hours; (3) 2.0 cc 36 percent HCl and 2.0 cc 95 percent HCOOH for 24 hours; (4) 5.0 cc 57 percent HI containing some H_3PO_2 for 16 hours. The temperature of the bath for all the hydrolyses was 125–130°. With the H_2SO_4 and the HCl digestion there was formed considerable humin, soluble and insoluble. With HCl-HCOOH hydrolysis there was soluble humin but only in some few cases insoluble humin. Hydrolysis with HI led to no humin formation. The HCl-HCOOH hydrolysate was concentrated to a syrup on the water bath and the residue was taken up with 10 cc H_2O . This solution and the hydrolysates from procedures (1) and (2) were decolorized by bringing to a gentle boil with 100 mg acid-washed Carbox E. After filtration the carbon was mixed with 5.0 cc hot N HCl, collected on a filter and washed with water. The respective fil-

trates and washings were brought to pH 3.5 by the addition of 5N NaOH dropwise with stirring, and then diluted to 30 or 25 cc with 0.1 N HCl. The HI hydrolysates were concentrated to a syrup, brought to pH 3.5 and diluted to volume as above.

In the HI hydrolysates only cysteine was present, and the standard for comparison, in the Sullivan method, was a freshly pre-

TABLE 1.—PERCENTAGE CYSTINE CONTENT:
SULLIVAN METHOD

Protein	H_2SO_4	HCl	HCl HCOOH	HI
Halibut	1.04	1.06	1.20	1.15
Haddock	1.19	1.22	1.23	1.28
Salmon	1.13	1.11	1.15	1.23
Sirloin	0.72	0.77	0.78	0.81
Round	0.78	0.82	0.79	0.83
Edestin	1.20	1.23	1.24	1.25
Ox muscle	0.89	0.89	0.94	0.96
Shrimp	0.88	0.90	0.93	0.96
Casein	0.26	0.25	0.28	0.26
Arachin	1.24	1.25	1.26	1.27

pared solution of a highly purified cysteine hydrochloride. It is necessary that the cysteine hydrochloride used as a standard be thoroughly evaluated because cysteine hydrochloride may contain water of crystallization or may be somewhat oxidized. As a

TABLE 2.—PERCENTAGE CYSTINE CONTENT:
OKUDA METHOD

Protein	H_2SO_4	HCl	HCl HCOOH	HI
Halibut	1.12	1.10	1.17	1.22
Haddock	1.23	1.27	1.27	1.28
Salmon	1.19	1.19	1.20	1.27
Sirloin	0.77	0.77	0.79	0.83
Round	0.80	0.87	0.84	0.84
Edestin	1.23	1.27	1.27	1.29
Ox muscle	0.89	0.89	0.94	0.96
Shrimp	0.87	0.95	0.97	0.96
Casein	0.27	0.28	0.30	0.29
Arachin	1.26	1.26	1.29	1.33

consequence, too high results will be found for cysteine in the materials under investigation. The results of the analysis of the 10 proteins by the several hydrolytic methods are given in Tables 1 and 2. All results are corrected for moisture and ash and computed as cystine.

In contradiction to the work of Kassell and Brand, the data given in the tables

show that the cystine values obtained with H_2SO_4 hydrolysis are in agreement with those obtained with HCl hydrolysis (even for edestin) and that there is no evidence of the formation of any material which inhibits the Sullivan method. It may be noted, also, that the Sullivan method and the Okuda method on these hydrolysates give results of the same order of magnitude, and that the results with HCl and with H_2SO_4 are only slightly below those with HCl-HCOOH and with HI. The HI hydrolysates give slightly higher values, a finding that is probably due to the nonformation of humin.

LITERATURE CITED

1. SULLIVAN, M. X. U. S. Publ. Health Rep., Suppl. 78. 1929.
2. SULLIVAN, M. X., and HESS, W. C. Journ. Biol. Chem. **117**: 423. 1937.
3. BAERNSTEIN, H. D. Journ. Biol. Chem. **115**: 25, 33. 1936.
4. MILLER, G. L., and DU VIGNEAUD, V. Journ. Biol. Chem. **118**: 101. 1937.
5. LEVENE, P. A., and BASS, L. W. Journ. Biol. Chem. **74**: 715. 1927.
6. KASELL, B., and BRAND, E. Journ. Biol. Chem. **125**: 435. 1938.
7. HOWARD, H. W., and SULLIVAN, M. X. [Unpublished data.]
8. SULLIVAN, M. X., and HESS, W. C. U. S. Publ. Health Rep., Suppl. 94. 1931.

CHEMISTRY.—*A crystalline sulphur-protein from wheat.*¹ A. K. BALLS, Bureau of Agricultural Chemistry and Engineering.

For the past two years the Enzyme Research Laboratory has been interested as a unit in the investigation of a series of sulphur-containing substances resembling proteins and extracted from wheat flour by gasoline. Practically every member of the laboratory has contributed to the progress of this research. The object of this paper is to present a summary of the findings to date. Later publications will endeavor to present the data in more detail than would be suitable here.

This work started with the observation of Balls and Hale (1) that extraction of unbleached wheat flour by gasoline or ether removed a nitrogen-containing body that gave tests for cysteine when fresh; for cystine after standing in air. Similar observations were made on barley, oats, and corn. After extraction from flour, much of the sulphur-carrying material could be repeatedly precipitated by ethyl acetate and again dissolved in ether or low-boiling petroleum fractions. This "ethyl acetate precipitate" was insoluble in water and contained nitrogen, sulphur, and phosphorus. On dilution of an ether solution with alcoholic HCl, a material was precipitated that was soluble in water but no longer soluble

in fat solvents. This precipitate contained nitrogen and sulphur but no phosphorus. The solvent still held a mixture of lipids containing both nitrogen and phosphorus. This lipid material is now being investigated and will be reported on in due course. The general pattern of the main constituent is that of a phospholipid; it is not, however, lecithin.

A similar precipitate was obtained with acid alcohol from the crude mixture of lipids without prior treatment by ethyl acetate. Both precipitates are evidently mixtures of substances high in nitrogen, but that from the crude material is appreciably higher.

From its content of nitrogen and sulphur and its tendency to dialyze slowly through Cellophane membranes and because solutions thereof did not precipitate with trichloroacetic acid, this material was at first thought to be a peptide of high molecular weight. Later experience has shown it to be a mixture, of which one component is a protein of border line magnitude. This protein was prepared as a crystalline hydrochloride and has been subjected to considerable study. Similar crystals have been prepared in the same way, though in smaller yield, from the "ethyl acetate precipitate," but these have not yet been investigated.

Attempts to recombine the protein and the lipoidal material separated by the acid-

¹ Enzyme Research Laboratory Contribution no. 76. Received February 19, 1942. Part of the work reported on in this paper was done under a grant from the Special Research Funds.

alcohol treatment have been unsuccessful. The existence of compounds of lipid and protein, however, would account for the ready solubility of the protein portion in gasoline, even after partial purification had removed most of the fats, sterols, and other concurrent substances that were in the original extract. It seems reasonable to suppose that a combination existed in the original plant material, and if this is so, the crystalline protein is the first known fragment of a lipoprotein to be obtained in a pure state.

The data of this paper were obtained with crystals made directly from the crude extract, omitting the precipitation by ethyl acetate. The substance was crystallized thrice, with removal of the mother liquor each time. A detailed report of these experiments has been submitted for publication elsewhere by Balls, Hale, and Harris (2).

Freshly milled (unbleached) patent flour was extracted in a large percolator with high-grade petroleum ether. Much of the solvent was next removed from the extract by distillation in vacuum, but enough was allowed to remain so that the extract was still fluid. This extract was then stored at -1.5° for several weeks. The sterols that precipitated during storage were then removed by centrifuging in the cold. The supernatant liquid was diluted with an equal volume of ether and then with 3 volumes of cold 1 N HCl in absolute ethyl alcohol. After standing 1 hour at 0° the precipitate formed by the addition of acid alcohol was separated in a refrigerated centrifuge and repeatedly washed by centrifuging first with absolute alcohol and finally with dry ether. The washing was continued until the solvents dissolved no more material from the precipitate. The residue was then dried in vacuum. About 25 grams of material were obtained from a barrel of flour. This amount of the crude material (which is comparable to that described in our first paper), was dissolved in 100 cc of water, and 300 cc of absolute alcohol was added thereto. A precipitate that formed on addition of the alcohol was centrifuged out, and the supernatant liquid was evaporated

first on a water bath and finally to dryness in vacuum over P_2O_5 . This residue weighed 16.8 grams.

Fifteen grams of the residue were dissolved in 25 cc of water, 225 cc of absolute alcohol then added, and the mixture al-



Fig. 1.—Crystals of peptide, $\times 300$.

lowed to stand for 4 hours at about 5° . A precipitate was formed that appeared under the microscope to consist entirely of crystals (Fig. 1). After removal and drying, these weighed 4.10 grams. Recrystallization was done in the same manner as the step just described. The data of Table 1 show the constancy of composition after recrystallization.

TABLE 1.—CONSTANT COMPOSITION AFTER RECRYSTALLIZATIONS (MATERIAL PRECIPITATED DIRECTLY FROM CRUDE EXTRACT)

Number of crystallizations	N	Cl	S
	Percent	Percent	Percent
One.....	16.20	6.64	4.40
Two.....	17.37	6.57	4.46
Three.....	17.28	—	—
Four.....	17.30	6.56	4.44

The crystals are definitely those of a hydrochloride. An aqueous solution containing 1 mg of substance per cc was at pH 3.9 and contained chlorine precipitable by silver nitrate. The total chlorine found was 0.185 mole per 100 grams, whereas nitrogen present as free amino groups determined by the Van Slyke apparatus was 0.118 mole per 100 grams. The proportion of chlorine to free amino groups is thus very nearly 3:2.

Approximately two-thirds of the molecule of this protein has been identified after the usual acid hydrolysis. Table 2 shows the

TABLE 2.—CONSTITUTION OF THE CRYSTALLIZED SUBSTANCE¹

Constituent	Percent
Chlorine.....	6.57
Sulphur.....	4.42
Nitrogen, total.....	17.35
Nitrogen, free NH ₂ groups....	1.65
Constituent	Proportion of equivalents (tyrosine = 1.00)
Arginine.....	6.9
Cystine.....	3.9
Tyrosine.....	1.0

¹ Of the total nitrogen, 59.6 percent, or nearly two-thirds, is accounted for by arginine, cystine, and tyrosine.

composition as found so far, expressed in equivalents. If the constituent occurring to the least extent (tyrosine) is assumed to be present once in the molecule, a molecular weight of about 6,000 is indicated. The rate of diffusion through a porous membrane from a solution containing 0.5 M NaCl into a solution of the same salt concentration indicated a molecular weight of 10,200, or roughly twice the value calculated from the tryosine content. Both figures must be very approximate, but they are quite in accord with the observed behavior of the substance, which forms only a slight turbidity in warm five-percent aqueous trichloroacetic acid.

The substance thus appears to be on the border line between proteins and high molecular peptides, and on account of the large content of arginine it resembles most the protamines described by Kossel. Since

these similarly basic bodies are usually regarded as the simplest of the proteins, our material is probably better classed as a protein than as a peptide.

The substance is remarkable for its high content of cystine. It was found that 95 percent of the sulphur (so probably all of it) is present as cystine in the crystals, although some existed in an SH form in the original plant material. The new protein is thus capable of oxidation and reduction. Attempts to crystallize the reduced form have failed, apparently because the reduction of all the cystine was not accomplished, and a mixture of reduction products resulted. Nevertheless, the ability of the protein to undergo reduction and oxidation makes it biologically very reactive.

Toxicity to tissues and bacteria.—The work of Stuart and Harris (3) has shown that the crystalline protein, like Dubos's gramicidin (4), is specifically poisonous to certain bacteria. Gram positive bacteria and yeasts were found to be most vulnerable. Ordinary baker's yeast was killed when 5 γ of protein hydrochloride was present per cc of a medium that contained sucrose and the usual nutrient inorganic salts. Growth was prevented by a concentration as low as 1 γ per cc. These investigators advance the opinion that this protein is the yeast-poisonous material long known by brewers to exist in many grains and particularly in wheat.

That toxicity is not confined to microorganisms has been shown by Coulson, Harris, and Axelrod (5). Rabbits were killed in a few minutes by intravenous injections of 1.6 mg per kg, while mice and guinea pigs were killed by intraperitoneal injections of approximately 10 times this dose. Large quantities of the substance, however, could be repeatedly fed by mouth without any noticeable effect, either on the welfare of the animals or on their subsequent susceptibility to injection.

Very small amounts of the protein dissolved in Tyrode's solution produced marked and sustained contraction of the uteri of virgin guinea pigs. The pharmacological picture resembled that produced

by histamine, rather than by proteins, in that repeated doses, after removal of the previously applied solution, caused repeated sets of contractions, thus showing that the tissue was not desensitized by the first application. 50 γ of protein in 50 cc of solution produced contractions similar to those caused by 10 γ of histamine in the same volume.

The effect is not due to histamine or apparently to any small toxic group in the protein structure, for when the protein was subjected to digestion by crude papain and H_2S , the toxicity disappeared. The digestion increased the free amino nitrogen (Van Slyke) in an amount representing the break of only about one-third of the peptide linkages presumed to be present, so that the molecular size of some of the nontoxic end products may still have been considerable. Comparable experiments showed furthermore that this enzyme mixture had no effect on the toxicity of histamine (*i.e.*, did not deaminate or otherwise destroy it).

Effects with certain enzymes.—The oxidative capacity of the new protein in its S-S form is shown by the inhibition of chymopapain, a proteolytic sulphur-containing protein active only in the SH form (6). Buffered mixtures at (pH 4) of crystalline chymopapain and the wheat protein were tested with respect to milk-clotting power, which was found to diminish at a rapid but measurable rate (Fig. 2).

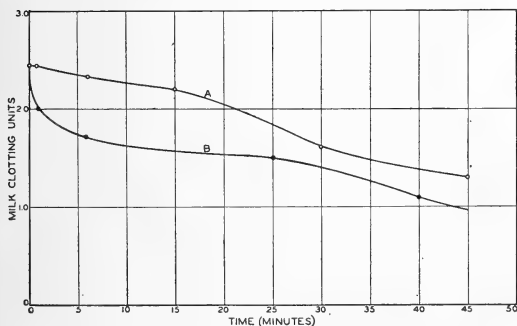

Fig. 2.—Upper curve, rate of inhibition of crystalline chymopapain in a solution of 214 milk-clotting units (active without CN) per cc of 0.1 M ammonium chloride buffer (pH 7.5 ± 0.2), containing 0.3 mg per cc of crystalline flour protein. Lower curve, same but with twice the amount of protein.

Chymopapain is moreover unable to digest the oxidized form of this wheat protein. After saturating the mixture with hydrogen sulphide digestion proceeds rapidly, as with crude papain, until about one-third of the computed number of amino acid linkages have been hydrolyzed. This experiment shows furthermore that while the enzyme is inhibited it is not destroyed and may be reactivated by reduction, thus indicating that the effect of the protein on the enzyme is an oxidation similar to that produced by large amounts of cystine.

Another property of the wheat protein, recently observed by Axelrod and Kies, of the Enzyme Research Laboratory, is its power to inhibit carotene oxidase. This enzyme is a constituent of many legumes and catalyzes the destruction of all carotenoid pigments so far tested. It is thought to accelerate the destruction of carotene and other pigment precursors of vitamin A (as well as of vitamin A itself)² when plant tissues are stored or when dried without prior pasteurization. The enzyme may be readily demonstrated by adding a few drops of a water extract of soybean meal to an acetone solution of carotene that must contain also some unsaturated fat and that has been previously diluted with phosphate buffer (pH 6.4). The color of the carotene rapidly fades, provided only that the water present has not been deprived of its dissolved oxygen. Double bonds in the fatty acid structure participate in the reaction at the end of which the fat shows an increased peroxide number. The enzyme is therefore often referred to as a lipoxidase, whose effect on carotene is an indirect one.

The presence of very small amounts of the protein hydrochloride in a suspension of carotene and fat in buffer was enough to prevent the action of large doses of soybean

² The destruction of carotene by the soybean enzyme was found by Frey, Schultz, and Light (7) to destroy also all appreciable vitamin A activity. Dr. E. M. Nelson, Chief, Vitamin Division, Food and Drug Administration, has also found that destruction of the vitamin A activity results from oxidation of carotene with our enzyme preparation. The Enzyme Laboratory is greatly indebted to Dr. Nelson and Dr. C. D. Tolle for this important information.

extract added subsequently.³ The inhibition, however, requires the presence of an electrolyte, but not necessarily of a buffer. Sodium chloride was sufficient. Other proteins, for example egg white, chymotrypsin, and chymopapain, also inhibit the oxidation. The quantity required of these proteins is much larger, however, so that the effect of the flour protein appears to be outstanding. Furthermore, the inhibition observed with other proteins is independent of the amount of unsaturated fat mixed with the carotene, whereas in the case of the flour protein it is not. Inhibition by the new protein may be overcome by increasing the fat present in the carotene mixture. The quantity of fat needed was found to be roughly proportional to the amount of protein present. The substitution of petroleum oil for the additional fat was without effect, which indicates the inhibition is not altogether a surface matter.

This inhibition, however, is peculiar in that it does not occur if the protein is added first to the soybean extract rather than to the carotene-buffer mixture. The reason for this behavior is unexplained and in all probability will remain so until preparations free from other enzymes are available. There is some evidence that the destruction of the inhibiting power of the flour protein may be due to proteolysis. The soybean extract we have used contained a proteolytic enzyme, and proteinases such as commercial trypsin and crystalline chymotrypsin were found to destroy the inhibitory effect of the flour protein.

In view of these observations, wheat flour itself might be expected to act as an inhibitor, and this was found to be the case, not only with a suspension of flour in water but also with an aqueous extract thereof. Prior digestion of either preparation with

chymotrypsin removed the inhibitory property. This is of interest because soybean meal has been used in bread making for bleaching the yellow color normally imparted to bread by the flour. It has long been known that this bleaching was due to a destruction of carotinoid pigments (chiefly lutein) in the flour. The commercial use was in all probability the first recognition of this oxidizing enzyme.

It is obvious that when soybean meal is added to bread dough, some mechanism destroys the inhibitor originally present in the flour. Since soybean meal and flour are both known to contain proteinases, it may be that the destruction of the yellow color in bread dough is preceded by a proteolysis. It must be remembered that the flour protein, inhibitory to carotene oxidase in the S-S form, is found in flour also in the SH form. In this form it is an activator of any papainlike enzyme present, including the proteinase of wheat.

It is well known that the behavior of carotene oxidase, particularly with respect to the necessity for the presence of unsaturated fats with the carotene, points to the classification of this enzyme as a lipo-oxidase. Moreover, Sumner and Dounce (8) and Sumner and Sumner (9) have shown that soybean meal and oxygen are able to increase markedly the peroxide groups in fat. This was shown experimentally by stirring air into a mixture of fat, soybean meal, and buffer. We have observed here, moreover, that in the presence of the flour protein, peroxide formation in the fat is also diminished. The protein is therefore an inhibitor of the enzymic oxidation of fat.

Because the protein forms a reversible oxidation-reduction system, it was thought that it might also serve as an antioxidant for fats in the absence of an oxidizing enzyme. The previously described "ethyl acetate precipitate," containing this protein and other bodies similar to it in combination with lipids that render the complex soluble in ether and gasoline, is best suited for a test, because the complex is somewhat soluble in fats and oils, whereas the protein portion is not. Dr. M. B. Matlack, of the Enzyme Research Laboratory, has made an

³ A solution of carotene and corn oil was made in acetone containing 10 percent of absolute alcohol. This solution contained 43 γ of carotene and 100 γ of corn oil per cc. One cc of the solution was placed in a dry flask and diluted with 10 cc of water and 0.5 cc of 0.6 M phosphate buffer (pH 6.5). One-tenth cc of an aqueous extract of soybean meal (2.5 g per 100 cc water) usually decolorized half the carotene present in less than one minute. In the presence of 20 γ of the protein hydrochloride, no measurable bleaching was observed in this system during 30 minutes.

investigation of the effect of this material on the speed at which corn oil turns rancid. Judged from the peroxide number of the oil after exposure to light and air for many days, the lipoprotein compound is a good antioxidant. Judged by organoleptic tests, however, the oil was not only not protected but may even have become more susceptible (Fig. 3). The matter is thus not decided. It

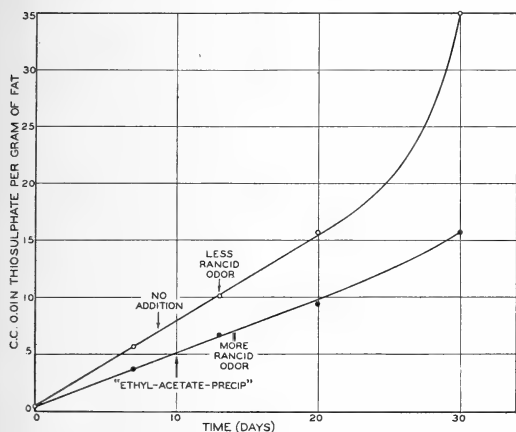

Fig. 3.—Increase in peroxide number of corn oil kept at room temperature (in daylight).

is not improbable that the protein can catalyze the formation of aldehyde and/or ketone bodies at the expense of the fat peroxides, thus causing a low peroxide value but considerable organoleptic rancidity.

Summary.—The composition of a crystalline protein hydrochloride isolated from wheat flour has been partially worked out. There is evidence that this protein is an oxidized fragment of what in the original plant tissue was a cysteine-containing lipoprotein. In the oxidized state, after crystallization, this substance lies on the border line between proteins and similarly constituted bodies of lower molecular weight. It resembles the protamines, being rich in arginine; but unlike the hitherto described protamines, it contains much cystine.

About two-thirds of the molecule (estimated molecular weight, 12,000) has been

identified as consisting of arginine, cystine and tyrosine (in order of frequency).

This protein is particularly toxic to yeasts. It may be the yeast-poisonous substance long known to be present in several grains. It is also toxic when injected into small animals but has no effect by mouth.

The protein is very inhibitory to certain enzymes. Chymopapain is evidently inhibited reversibly by oxidation, presumably at the expense of the cystine in this protein. The protein also protects carotene from oxidation by the carotene oxidase that occurs in many vegetables and seeds.

As a protein, this substance is readily decomposed by certain proteolytic enzymes. Its inhibitory power against the carotene (fat) oxidase disappears on digestion as does its toxicity. The question remains whether the enzymic oxidation of vitamin A and the precursors thereof, inhibited in the plant by substances such as this flour protein, may occur after proteolytic enzymes have destroyed the inhibitor. Because in the plant the protein is in the reduced state, it is a natural activator of the proteinases of the papain type that are almost always present. Should conditions favor proteolysis (and the death of tissue does so), carotene and thus potential vitamin A would be destroyed by a simple oxidative side-reaction.

LITERATURE CITED

1. BALLS, A. K., and HALE, W. S. *Cereal Chem.* **17**: 243-245. 1940.
2. BALLS, A. K.; HALE, W. S.; and HARRIS, T. H. *Cereal Chem.* (In press.)
3. STUART, L. S., and HARRIS, T. H. *Cereal Chem.* (In press.)
4. HOTCHKISS, R. D., and DUBOS, R. J. *Journ. Biol. Chem.* **132**: 279. 1940.
5. COULSON, E. J.; HARRIS, T. H.; and AXELROD, B. *Cereal Chem.* (In press.)
6. JANSEN, E. F., and BALLS, A. K. *Journ. Biol. Chem.* **137**: 459-460. 1941.
7. FREY, C. N.; SCHULTZ, A.; and LIGHT, R. F. *Ind. and Eng. Chem.* **28**: 1254. 1936.
8. SUMNER, J. B., and DOUNCE, A. L. *Enzymologia* **7**: 130-132. 1939.
9. SUMNER, J. B., and SUMNER, R. J. *Journ. Biol. Chem.* **134**: 531-533. 1940.

BOTANY.—*Linanthastrum*, a new West American genus of Polemoniaceae.¹

JOSEPH EWAN, University of Colorado. (Communicated by EDGAR T. WHERRY.)

The perennial montane genus *Linanthastrum* as here established represents a small series of Polemoniaceae of conceivably greater antiquity from the phylogenetic standpoint than the related annual genus *Linanthus*. The present distribution of the genus *Linanthastrum* constitutes what may well be a relict pattern of boreal origin, occupying as it does old mountain masses and tablelands of western North America. This genus is most closely related morphologically to *Linanthus*, but its more northern and montane-to-subalpine distribution suggests a different origin from that genus of more Sonoran tendencies, if one may borrow vegetation-terms from two different schools of ecologists. Furthermore, *Linanthastrum* differs from *Linanthus* in that the calyces are not scarious below the sinuses (cf. Fig. 2)—a character of reliable constancy in the rather natural genus *Linanthus*, when the present perennial

group is removed from it. *Leptodactylon* is its nearest morphological ally on the other side; from this genus *Linanthastrum* differs in having scarcely or not at all pungent, closely opposite, falsely whorled leaves, and very dissimilar calyx. Though *Linanthastrum* occupies about the same geographic region and ecologic niche as *Leptodactylon*, it is not so strongly xerophytic as that genus. A phylogeny of the Polemoniaceae has recently been suggested² in which *Linanthus* is a derivative from *Leptodactylon*, the two genera constituting an evolutionary line distinct from the true *Gilias*, *Langloisia*, *Ipomopsis*, and *Hugelia*. Wherry's phylogeny needs to be modified but slightly to include *Linanthastrum*, in what the author believes to be a natural relationship:

¹ Received October 28, 1941.

² WHERRY, EDGAR T. *A provisional Key to the Polemoniaceae*. *Bartonia* 20: 17. 1940.

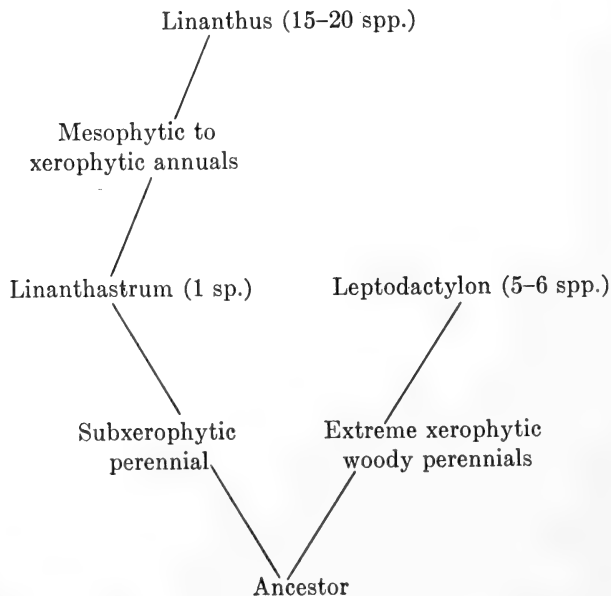

Fig. 1.—A putative phylogeny for three genera of Polemoniaceae: *Leptodactylon*, *Linanthastrum*, and *Linanthus*; in all these the chromosome number $n = 9$.

HISTORICAL NOTE

Thomas Nuttall first recognized the present genus *Linanthastrum* in essentially the sense here defined, naming it *Siphonella*. This was never published by him, but Asa Gray cited the binomial *Siphonella montana* when publishing *Gilia nuttallii* (1870). By his choice of specific name Gray evidently

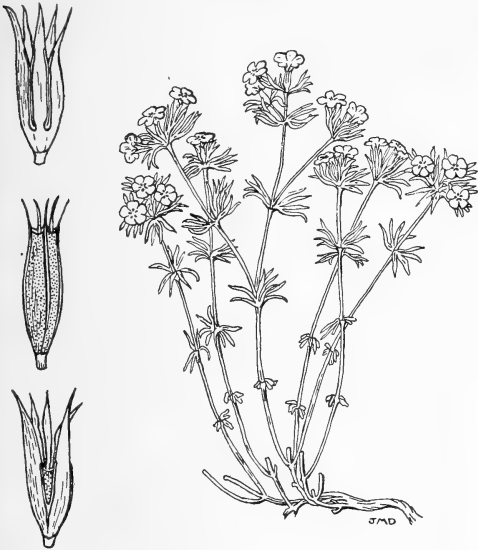

Fig. 2.—*Linanthastrum nuttallii* (Gray) Ewan: Habit sketch from Payson & Armstrong 3458, Wyoming, $\times \frac{1}{2}$. Calyces: Upper, *Linanthastrum nuttallii*; middle, *Leptodactylon pungens* (Torr.) Nutt.; lower, *Linanthus androsaceus* (Benth.) Greene. Intercostal membranes stippled.

wished to record his recognition of Nuttall's part in the characterization of the species. Gray did not designate a type in his original description, for he did not practice the "type basis concept" of the present day. However, Nuttall's contribution toward establishing the concept of *Gilia nuttallii* must be borne in mind when fixing the type of that species. When describing the species Gray placed it in a section *Siphonella*—taking up Nuttall's manuscript generic name—which he considered to be related to the section *Leptodactylon*. (Dalla Torre and Harms (1907) erroneously date the establishment of the section *Siphonella* from the Botany of California (1880) rather than 1870.) Up to 1904, then, our plant was treated as a species of *Gilia*. But in that year Greene's manuscript herbarium name

Linanthus nuttallii was published.³ Milliken did not accept *Leptodactylon* as a genus of the Californian flora, and no comment was made by her as to the anomalous nature of *Linanthus nuttallii* within the genus *Linanthus*. When Rydberg in 1906 resurrected *Leptodactylon* as a genus he included *Gilia nuttallii* therein. (Though proposed by Hooker and Arnott in 1841, Bentham placed *Leptodactylon* in the genus *Gilia* as a section in 1845, and was widely followed.) After Rydberg, *Linanthastrum* was considered a member of the genus *Gilia* by Brand (1907), of *Leptodactylon* by Jepson (1925), and of *Linanthus* by both MacMinn (1939) and Wherry (1940). From this summary of the taxonomic history of *Linanthastrum* it is clear that we are dealing with an anomalous group, fitting poorly into our present alignment of the gilioid genera.

Linanthastrum, genus novum

Siphonella Nutt. ex Gray, Proc. Amer. Acad. 8: 267. 1870, as a synonym.

Herba perennis caulibus e basi lignescente suffrutescens plurimus simpliciusculis erectis subscopariis; foliis 3-7 partitis, laciniis acicularibus non pungentibus brevo-mucronatis integerrimis enervosis; floribus subspeciosis in acillaris superioribus, calycium tubis campanulatis brevibus sinubus inter dentes non scarioso-membranaceis; staminibus sub fauce insertis filamentibus glabris.

Tufted puberulent perennials with rather virgate simple stems, the upper internodes mostly shorter than the leaves; leaves appearing as if whorled, the blades 3-7 parted, the segments linear to acicular, entire, the midnerves obscure. Flowers borne in the upper axils, scarcely exserted from the tufted leaves but somewhat showy. Calyx campanulate, the tube short, not scarious-membranous below the sinuses between the subulate teeth. Corolla-tube funnelliform, pale yellow, the lobes 5, obovate, rounded, cream to white or very pale blue. Stamens inserted just below the throat, the filaments glabrous. Pistil included, nearly equalling the tube. Seeds 2-4 in each locule. Fig. 2.

Type species: *Linanthastrum nuttallii* (Gray) Ewan.

Linanthastrum nuttallii (Gray) comb. nov.

Based on *Gilia Nuttallii* Gray, Proc. Am. Acad. 8: 267. 1870, in turn based on Nuttall coll. from "R[ocky] Mts. Bear R[iver] hills" in

³ MILLIKEN, JESSIE. A review of Californian Polemoniaceae. Univ. Calif. Publ. Bot. 2: 54. 1904.

Acad. Nat. Sci. Philadelphia and in Gray Herbarium a fragment labeled as from "Hb. Ac. Phil." According to the map of Nuttall's travels given by Pennell⁴ the type locality would be in the region of Caribou and Bannock Counties, Idaho. There might be some justification for selecting one of the several collections cited by Gray in the original description as the type, but the present author construes these to be paratypes and has so treated them beyond. Gray's choice of specific name seems to me to denote his intentions clearly.

Paratypes: *Fremont*, without loc.; *Anderson*, from near Carson City, Nev.; *Brewer 2042*, Silver Mountain, Sierra Nevada, Calif. (cf. Jepson, *Madrono* 2: 85. 1933, on this mining town); and *Watson 907*, "E. Humboldt Mts.," Nev., which are the present Ruby Mountains, central Elko County (cf. Linsdale, *Pacific Coast Avifauna* 23: 16. 1936). Gray has noted on sheet of *Brewer 2042*, "Filaments unusually long" and "between *S. montana* and *S. parviflora*." This would indicate that he regarded this collection as somewhat exceptional, as C. A. Weatherly has suggested to the author. However, Wherry (in litt.) considers that these paratypes are "all conspecific, but may represent ecological forms of one another."

Linanthus Nuttallii (Gray) Greene ex Milliken, *Univ. California Publ. Bot.* 2: 54. 1904.

Leptodactylon Nuttallii (Gray) Rydb., *Bull. Torr. Club.* 33: 149. Mar. 1906; practically simultaneously published in *Colorado Agr. Expt. Stat. Bull.*, *Flora of Colorado*, 100: 279. Introduction dated March, 1906, but apparently not issued until later that year.

Gilia Nuttallii var. *montana* (Nutt.) Brand in Engler, *Pflzr.* IV. 250: 125. 1907, based on *Siphonella montana* Nutt. ex Gray. Epithet used by Brand to designate the typical phase of the species.

Gilia Nuttallii var. *parviflora* (Nutt.) Brand, *loc. cit.*, based on *Siphonella parviflora* Nutt. ex Gray, l.c., as synonym, and in turn based on Nuttall coll. from "Bear R. hills" acc. fragments at both Gray Herb. (ex Brit. Mus. Nat. Hist.) and Acad. Nat. Sci. Philadelphia. Wherry (in litt.) states that the differences between this collection and that of *S. montana* are "so slight that it is strange that Nuttall named them differently. His "*Siphonella montana*" has the leaves essentially glabrous, his "*S. parviflora*" has them more or less pilose. I can not see any difference in the size of the flowers which would have suggested the name *parviflora*."

Illustrations: *Watson*, *Botany Fortieth Parallel*, pl. 25, fig. 8, 1871, presumably based on *Watson 907* from Nevada, a paratype, is good. *MacMinn*, *Illus. Man. California Shrubs*, fig. 532, 1939, presumably drawn from either a

Sierran (e.g., Lake Tahoe) or Cascadean specimen, but not indicated.

Rather bushy perennial from a woody branching suffrutescent crown, the stems several, simple, 15–20 cm tall, puberulent, straw-colored; leaf segments 3–7, flat, 1.0–1.5 cm long, strictly linear or actually less than 1 mm broad, glabrous or glabrate, sparingly ciliate, the leaves overlapping due to the relative shortness of the internodes especially in the upper parts (except in plants of southernmost portions of its range), thus forming chara-like tufts near the tips of the stems, those in the lower half soon withering; calyx 8–10 mm long, the tube 2 mm long, the teeth lance-subulate, shortly acute, puberulous; corolla-tube yellow, 8–9 mm long, glabrous within, pubescent with curling hairs without, the lobes 4–5 mm long, white or pale, somewhat chalky, blue; capsule narrowly obovoid, 5 mm long, smooth.

Subalpine meadow borders or less often among rock outcrops and about the margins of scree slopes, always in well-drained, often granitic soils. Washington and northern Idaho south along the Cascades and Sierra Nevada to southern California, the mountains of northern Nevada and Utah, and south along the Rocky Mountains to central Colorado. A taller more slender form differing in greater pubescence occurs in New Mexico, northern Arizona, and (?) in Baja California.

Representative collections (at Univ. Colorado unless indicated): WASHINGTON: Lewis County: Eagle Peak, 5,600 ft., Tatoosh Range, *Ewan 10601*; Goat Mts., *Allen 119* (ANSP)⁵. Kittitas County: Mts. n. Ellensburg (Piper, Fl. Wash. 462). Columbia County: Blue Mts. (Piper, l.c.). IDAHO: Ridge s. Pole Mt., 5,000 ft., *Epling et Kempf s. n.* Valley County: Gold Fork lookout, Sawtooth Mts., 8,000 ft., *J. W. Thompson 13763*. Custer County: Robinson Bar, 25 VI 1931 *Wherry* (Univ. Pa. Herb.). OREGON: Wallowa County: Wallowa Mts., *Ownbey 1843* (Univ. Pa. Herb.). Crook County: *Peck 9637* (ANSP). Harney County: Steins Mt., 8,000–9,000 ft., 1 VII (no year) *Percy Train*. UTAH: Salt Lake County: *Garrett 1559a* (ANSP). CALIFORNIA: Humboldt County: 28 mi. se. Orick, *S. W. Hutchinson 4152*. Modoc County: Little Lily Lake, Pine Creek, Warner Mts., *Wheeler 3789* (ANSP). Mono County: Mammoth Lakes P.O., *Constance 2423* (ANSP); Leevining Canyon, *Benson 3767* (ANSP); Inyo Mts. (Coville, Death Valley Rept. 156). Inyo County: Bishop, 1928, *S. W. Hutchinson s. n.* Wyman Creek, White Mts., *Duran 3048* (Univ. Pa. Herb.). Tulare County: Farewell Gap, *Culbertson 4536* (ANSP); Mt. Whitney (Brand, *op. cit.*). San Bernardino County: Foxeese Creek, *Parish 3686* (ANSP). Riverside County: El Toro, Santa Rosa Mts. (Milli-

⁴ PENNELL, FRANCIS W. *Travels . . . of Thomas Nuttall*. *Bartonia* 18: pl. 3. 1936.

⁵ Abbreviation for Academy of Natural Sciences of Philadelphia.

ken, *op. cit.*). NEVADA: Douglas County: Zephyr Point, 6,300 ft., Lake Tahoe, *Mason 12161*, Elko County: East Humboldt Mts. (i.e., Ruby Mts.), *Watson 907* (ANSP). WYOMING: Lincoln County: Sheep Mt., Snake R. Range, *Payson et Armstrong 3458*. Sublette County: Gros Ventre Mts., *E. B. et L. B. Payson 3028*. COLORADO: ?Lake County: s. slope Fremont Pass, *A. et R. Nelson 145*. Eagle County: w. slope Tennessee Pass, 10,400 ft., *Schmoll 1545*; Oro City, 10,800 ft. (Wheeler Survey Rept. 199). Routt County: Steamboat Sprs., 6,500 ft., VII 1891, *Eastwood*. Jackson County: (formerly part of Larimer County.) Rabbit Ears, *Goodding 1540*. Gunnison County: Ragged Mt., 11,700 ft., (Rydberg, Fl. Colo.). Mineral County: Near Pagosa Peak, San Juan Range (Rydberg, l.c.); 10 mi. e. Wolf Creek Pass on Continental Divide, 12,000 ft., *Penland 1154* (Colo. Coll. Herb.). Custer County: Venable Lake, Sangre de Cristo Mts., *M. Marriage et P. Johnson 14 VII 1932* (Colo. Coll. Herb.). Bent County: Robinson, 4,007 ft. (Rydberg, l.c., presumably pls. carried down on flood waters of Arkansas R.).

Linanthes nuttallii* subsp. *floribundum
(Gray) comb. nov.

Based on *Gilia floribunda* Gray, Proc. Amer. Acad. 8: 267. 1870, in turn based on *Coulter 454* "California, probably on se. borders." Likely from vicinity of Warner Hot Springs, San Diego County, where Thomas Coulter is known to have passed. Paratypes: *E. W. Morse* coll., 1866, from 50 mi. s. San Diego, Baja California and *Coues et Palmer* coll., 1865, from "pine woods of Arizona," according to label from Ft. Whipple, 5 VIII 1865, numbered 98 and annotated "fl. white; throat yellow; scent delicate." (For a descriptive account of *Coues's* visit to Fort Whipple see the *Ibis* (ser. 2) 2: 259-275. 1866.)

Linanthes floribundus Greene ex Milliken, Univ. California Publ. Bot. 2: 55. 1904.

G. Nuttallii var. *parviflora* (Nutt.) Brand subvar. *floribunda* (Gray) Brand in *Ergler Pflzr. IV. 250: 125. 1907.*

G. Nuttallii var. *floribunda* (Gray) Munz, Man. S. California Bot. 399. 1935.

Leptodactylon floribundum (Gray) Tidestrom, Proc. Biol. Soc. Washington, 48: 42. 1935.

Linanthes Nuttallii var. *floribundus* (Gray) McMinn, Illus. Man. Calif. Shrubs 446. 1939.

Illustration: MacMinn, *op. cit.* fig. 533.

Plants of more open habit, the stems slender, generally taller, rather wiry, densely clothed with simple subfiliform or few-lobed leaves; flowers hardly crowded or glomerate, the uppermost distinctly pedicellate, the corollas smaller, 10-15 mm long; seeds usually 4 in each locule (always 2 in each locule in the typical subspecies of *L. nuttallii*, *vide* Gray and Brand).

Dry brushy slopes in clearings of the chaparral. New Mexico south to Chihuahua, Mexico, west to Baja and southern California, but apparently local.

Representative collections (as above, at Univ. Colorado unless otherwise indicated): NEW MEXICO: Lincoln County: Tularosa Creek, White Mts., 18 VIII 1899, *Wootton*. Catron County: 15 mi. s. Luna, 6,700 ft. *C. L. Hitchcock et al. 4482*. ARIZONA: Yavapai County: Fort Whipple. MEXICO: Chihuahua: Pachaco, *Hartmann 682* (ANSP); Baja California: paratype cited above. CALIFORNIA: San Diego County: Warner's Rch., 3,165 ft., VI 1927, *S. W. Hutchinson s. n.*; Descanso, 20 VI 1932, *Epling et al.*; Cold Spring, 21 VI 1932, *Epling et al.* Riverside County: Coyote Canyon, *vide* Milliken, *op. cit.*; Elsinore, *ibid.*; San Jacinto (*ibid.*); Santiago Peak, Santa Ana Mts., *Abrams 1809* (ANSP).

In an occasional individual collection *Linanthes nuttallii floribundum* may appear fully distinct from the typical subspecies, but when a series is studied really satisfactory characters for a key can not be found. Though the two have not been found growing together, the more southern subspecies occupies the more xeric habitats at rather distinctly lower elevations. In the Santa Rosa Mountains of southern California the two subspecies approach each other closely; nevertheless, the two may even there show ecologic preferences. It cannot be finally declared that there are not two species in this genus, as held by Asa Gray, Greene and Milliken. The herbage of the typical subspecies is distinctly hay-scented and the flowers of both it and *L. nuttallii floribundum* are delicately fragrant.

SUMMARY

Linanthes is established as a segregate genus of the giloid complex, most closely related to *Linanthus*, but differing from that rather natural genus in its habit-form, in the calyces not being scarious below the sinuses, in its perennial duration and its more northern, usually upper montane or subalpine, distribution suggestive of a different origin. From *Leptodactylon* it differs in having scarcely or not at all pungent, closely opposite, falsely whorled leaves, as well as in calyx-features. This group of one species with two subspecies is more naturally disposed among the giloid members of the Polemoniaceae when admitted as a small genus of transitional morphology, sharing as it does certain characters of both *Linanthus* and *Leptodactylon*.

BOTANY.—*Marine algae of Hong Kong, II: The genus Catenella.*¹ C. K. TSENG, University of Michigan. (Communicated by H. H. BARTLETT.)

Catenella Grev. (1830) is a genus of small, creeping, dark-purplish algae that form intricate, overlapping patches on mangroves, other marine seed-plants, and muddy rocks in sheltered places, especially the salt marshes between tide marks. It is chiefly tropical and subtropical in distribution, but one of its species occurs also in temperate seas.

Generally, members of this genus have decumbent, creeping, cylindrical or sub-cylindrical, irregularly branched, stoloniferous parts from which issue the more regularly, pinnately or dichotomously to polychotomously branched upper parts, which are, in typical forms, regularly and deeply constricted into subcylindrical to strongly compressed, lomentlike segments. The attachment of the fronds to the substratum is by means of primary, stout, discoid hold-fasts issuing from the stolon and also by secondary haptera, issuing regularly or irregularly from the upper segments. Internally the segments are each composed of a very lacunose medulla of loosely interlacing and anastomosing longitudinal filaments that originate from a central axis and give rise toward the periphery to dichotomously branched, moniliform filaments, which unite firmly to form a compact cortex. Cystocarps are generally solitary and sessile on shortened, terminal segments, each provided with a terminal pore. Spermatangia, consisting of small cell groups immersed in the cortical tissue, are found on swollen segments. Tetrasporangia are oblong, transversely zonately divided, and scattered in the cortex between the moni-

form filaments; they are aggregated in terminal segments.

The type of the genus is *Catenella opuntia* (Good. et Woodw.) Grev., now known as *Catenella repens* (Lightf.) Batt., from Tenby, South Wales, which is now found to be widely distributed in most of the warmer seas. Since the proposal of this genus by Greville in 1830, seven other species have been added. One of these, *C. pinnata* Harv., is now regarded as synonymous with *C. repens*, whereas three others, *C. oligarthra* J. Ag., *C. procera* J. Ag., and *C. major* Sond., are found to belong to other genera and are excluded. There are now four recognized species of *Catenella*: *C. repens*, *C. fusiformis* (J. Ag.) Skottsb., *C. impudica* (Mont.) J. Ag., and *C. nipae* Zanard. To these is to be added another, *C. subumbellata*, described as new in the present paper.

In the past there has been confusion in the naming and separation of these few species. Rather recently, Post (1936) made a revisional study of the genus and cleared up the situation. The nature and relative position of the haptera have been used as the chief distinguishing characteristics; others, such as the differentiation of the long and dwarf shoots, the branching method, and the shape of the segments, have also been used.

Because of their peculiar habitat, different from that of most marine algae, and their relatively small and inconspicuous fronds, members of this genus are not often collected, although they are actually widely distributed in the warmer seas. None has ever been reported from China so far. Quite recently the writer and his collector secured four samples which, when carefully studied and analyzed, are found to represent three species, including one new to science. The following key serves to distinguish them:

- A. Haptera equivalent to entire independent segments, developed at nodes.....
-1. *C. impudica*
- AA. Haptera formed by distal ends of segments.

¹ Received December 31, 1941. The writer planned this series of papers for publication in the Journal of the Hong Kong Fisheries Research Station, and the first number, entitled *Historical survey and list of recorded species*, was issued September, 1940, in Vol. 1, No. 2, pp. 194-210. On account of the fall of Hong Kong the Station and its Journal will now presumably be suspended for an indefinite period, and for the time being the remaining papers of the series are therefore being published wherever circumstances permit.

- B. Frond stout, regularly dichotomously to trichotomously branched, with stout, oblong segments: haptera terminal or seemingly subterminal on segments.....2. *C. nipae*
- BB. Frond slender, irregularly unilaterally, subpinnately or, more generally, subumbellately branched, with linear-elliptical segments; haptera situated in center of verticels.....3. *C. subumbellata*

1. *Catenella impudica* (Mont.) J. Ag.

Figure 1

- Catenella impudica* J. Ag. Sp. Alg. 2 (2): 701. 1852; Möbius, Bearb. Bras. Alg. 335, pl. 10, figs. 16-21. 1889; De-Toni, Syll. Alg. 4: 320. 1897; Post, Notizen 66. 1936.
- Lomentaria impudica* Mont. Pl. Cell. Cent. 197. 1840; Kütz. Sp. Alg. 863. 1849; Kütz. Tab. Phyc. 15: pl. 92, figs. a-c. 1865.

The frond of this species forms a decumbent patch about 1.5 cm high and several centimeters broad. It is distinctly articulate, repeatedly dichotomously or trichotomously branched. The segments are deeply constricted at the nodes, subcylindrical when young but greatly compressed when older, and elliptical

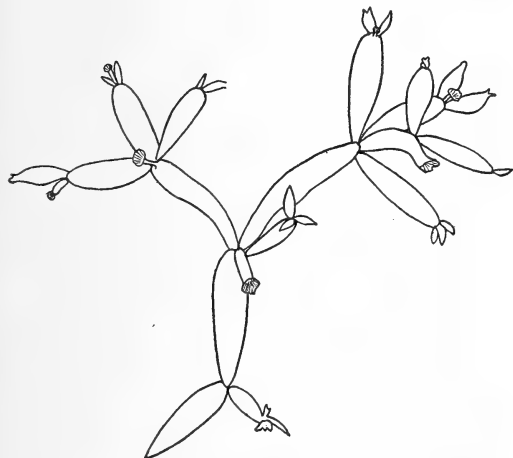

Fig. 1.—Habit sketch of *Catenella impudica* (Mont.) J. Ag. About $\times 4$.

or oblanceolate, rarely oblong, in shape. Mature segments are as much as 1.5 mm broad and are generally three to four times as long. The haptera represent entire independent segments, which remain linear-subcylindrical in shape and become definite in growth as the apices are transformed into adhesive, broad discs. They always occur at the deeply constricted nodes, generally between two other

segments of the same order (cf. Fig. 1). The materials collected are all sterile.

HABITAT: Forming decumbent patches on trunks of mangroves in sheltered salt marshes, in the littoral region, Aberdeen, Hong Kong Island, in July 1941 (*Taam A151*).

DISTRIBUTION: Sinnamary, French Guiana, northern South America (type locality), and nearby regions; the West Indies, Brazil, Africa, India, and the Malay Archipelago.

Catenella impudica can be easily recognized by its regularly, repeatedly, predominantly trichotomous branching, its deeply constricted, elliptical or oblanceolate segments, and its haptera representing entire, independent segments issuing at the constricted nodes.

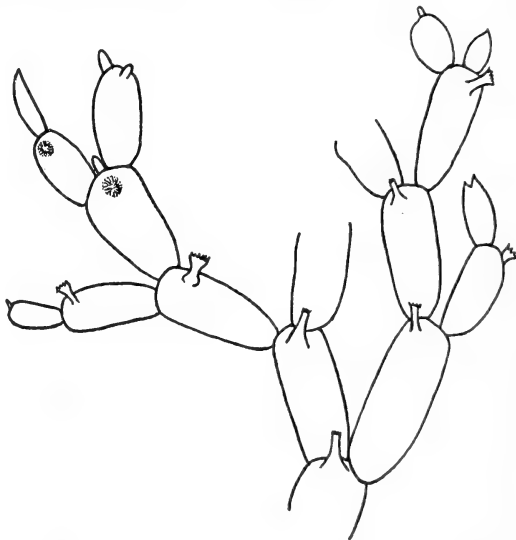

Fig. 2.—Habit sketch of *Catenella nipae* Zanard. About $\times 5.4$.

2. *Catenella nipae* Zanard.

Figure 2

- Catenella Nipae* Zanard. Phyc. Ind. Pub. 143. 1872; De-Toni, Syll. Alg. 4: 321. 1897; Post, Notizen 68. 1936; Boergesen, *Cat. Nip.* Burma 266. 1938.
- Catenella Opuntia* Harv. Phyc. Austr. 5: pl. 296. 1863 [non *C. Opuntia* Good. & Woodw.] Grev.].
- Catenella Opuntia* var. *elatior* J. Ag. Sp. Alg. 3 (1): 588. 1876.

Plants of *C. nipae* are larger and stouter than those of the other known species of *Catenella*. The frond is creeping below and subflabellately caespitose, about 3 cm high. It is distinctly, deeply constricted and regularly, repeatedly

dichotomously to trichotomously branched. The segments are strongly compressed, elliptically oblong, sometimes obovate, reaching a breadth of 2 mm and about two to three

regular, predominantly dichotomous branching, its large, stout, oblong, deeply constricted segments, and its terminal or seemingly subterminal haptera developed from all the segments.

3: *Catenella subumbellata* sp. nov.

Figures 3-5

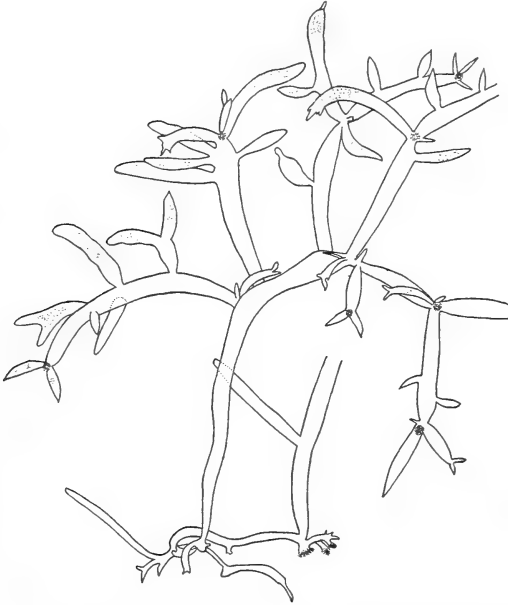

Fig. 3.—Habit sketch of *Catenella subumbellata* Tseng, sp. nov. About $\times 3.4$.

times as long. The haptera are developed from the terminal ends of all the segments, which thus become limited. However, the subterminal growth of these segments usually continues to some extent after the formation of the haptera, which then become pushed to a lateral position, thus appearing subterminally situated (cf. Fig. 2). The branches of the next order originate close behind the haptera, which are actually the distal ends of the segments of the preceding order. These haptera always bend down ventrally, thus attaching the frond to the substratum. The few specimens collected are all sterile.

HABITAT: Forming decumbent patches on muddy rocks in sheltered salt marsh, in the littoral region, Shatin, Kowloon, in May 1940 (Tseng 2788).

DISTRIBUTION: Sarawak, Borneo (type locality); widely distributed in the area from Aru Islands, New Guinea and East Australia in the South Pacific, westward to Calcutta, India.

The present species is easily recognized by its

Frons fusco-purpurea, surculis procumbentibus reptans, pulvinato-caespitosa, plerumque inferne unilateraliter vel subpinnata, superne subumbellatim ramosa; ramis ramisque lineari-filiformibus, solum ad basin constrictis; fulcris flagelliformibus ad mediam partem subumbellarum formantibus, apud terminem arborum praecedentium; tetrasporangiis ad apices solum articularum aggregatis, inter fila moniliformia corticis positiss, transverse divisiss. Cystocarpia et spermatangia ignota.

Specimen typicum, *Tseng 2840* (in Herb. C. K. Tseng), ad rupes argillosas littoreas, in aqua tranquilla prope Taipo, Kowloon, 19 VI, 1940.

The new species has a dark purple frond, creeping with a slender, linear, procumbent, stolonlike part from which issue downward well-developed, primary, discoid holdfasts, attaching firmly to the substratum. The upper part is rather profusely branched, the branching usually subpinnate or rarely unilateral near the base and predominately repeatedly subumbellate upward (cf. Figs. 3 and 4). The segments are subcylindrical to slightly compressed, linear to elliptical in shape, reaching a breadth of 1 mm but generally much slenderer, usually only 500–800 μ broad and generally three to six times as long, although in the lower subpinnately branched portions the segments may be more than ten times longer than broad. The terminal segments taper upward to a fine point, sometimes even aculeate. Constrictions as a rule are found only at the bases of the branches; in other words, there is usually only one segment to a branch.

Virtually all the segments are definite in growth and always terminate in the formation of a hapteron, soon after the formation of which two to four, sometimes more, new segment-initials are differentiated somewhere below, but always very close to it (cf. Fig. 4). At first this newly formed attachment organ occupies the central part, surrounded by the much younger

new segments, thus forming a more or less cymose "umbel." In the early stage of the development the hapteron, with its stalk now cut off from the mother segments, is still the most conspicuous in the pseudoumbel. Soon, however, because of its much slower growth, it becomes more and more obscured by the fast-growing young segments surrounding it (cf.

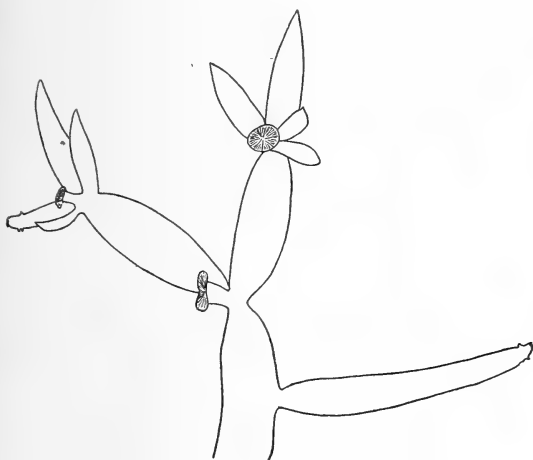

Fig. 4.—Upper portion of *Catenella subumbellata* Tseng, sp. nov., showing young and mature haptera. About $\times 8$.

Fig. 4). It also begins to bend more strongly toward the ventral side while the surrounding segments grow upward. When mature this hapteron, originally the apex of the preceding segment, becomes a comparatively obscure and insignificant discoid structure generally deflected ventrally, in the middle of the pseudoumbel, the segments of which have now branched repeatedly in a similar way, always with a similar attachment organ forming the center of each "umbel."

Internally, the structure of *C. subumbellata* is typical of members of this genus, that is, having a very lacunose medulla with interlacing, longitudinal filaments and a compact cortex of dichotomous, moniliform filaments. Specimens collected are all tetrasporic. Tetrasporangia are aggregated in the terminal segments. They are oblong and transversely, zonately divided, about $45\text{--}55\mu$ broad and $60\text{--}70\mu$ long, found between the moniliform filaments of the cortex (cf. Fig. 5).

HABITAT: Forming procumbent patches on

muddy rocks in sheltered salt marsh in the littoral regions, Kowloon: Shatin, in May 1940 (Tseng 2787), and near the market, Taipo, in June 1940 (Tseng 2840, TYPE).

The present new species is most closely related to *C. nipae* in the similarity of hapteron formation. In both cases the haptera are the distal ends of the segments, not the whole segment as in the case of *C. impudica*. It is, however, distinctly different from *C. nipae* in the much slenderer, less stout, longer and linear-elliptical segments, in the predominantly subumbellate branching, sometimes subpinnate or unilateral near the base, and in the strictly terminal position of the haptera, which form the umbos of the pseudoumbels. In the umbellate branching it also resembles *C. impudica*, which differs, however, in having the independent segment type of hapteron; the latter is also much more robust and has more swollen and deeply constricted segments. The present species also reminds one somewhat of *C. repens* (*C. opuntia*). The latter, however, has a much

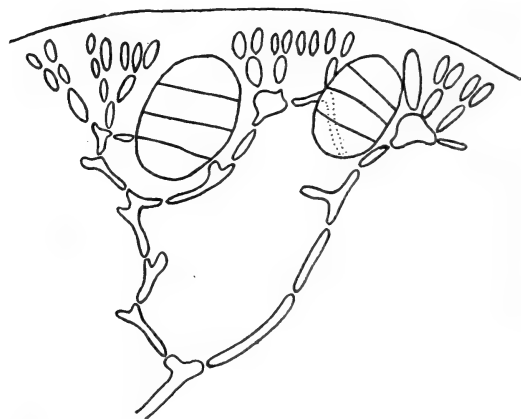

Fig. 5.—Transverse section of a segment of *Catenella subumbellata* Tseng, sp. nov., showing structure of frond and tetrasporangia. About $\times 247$.

more robust thallus, with strongly and regularly constricted branches, with much more compressed and laterally swollen segments, and with irregularly placed haptera, belonging to the emergent type and representing outgrowths rather than modified branches as in the cases of *C. nipae*, *C. impudica*, and the present species.

SUMMARY

From a single region three species of *Catenella* are found, including one new species, which are all recorded here for the first time from Hong Kong as well as from China as a whole. They are *C. impudica* (Mont.) J. Ag., *C. nipae* Zanard., and *C. subumbellata* Tseng, sp. nov., all fully described herein. They all represent plants of the salt-marsh flora of the Hong Kong region, the first one growing on trunks of mangroves and the last two on muddy rocks, all found in the littoral region and in very sheltered places.

The writer wishes to express his thanks to Prof. William Randolph Taylor, of the University of Michigan, for his advice during this study.

LITERATURE CITED

- AGARDH, J. G. *Species genera et ordines algarum* 2 (2): 337-720. 1852; 3: i-vii, 1-724. Lund, 1876.
- BOERGESEN, F. *Catenella nipae used as food in Burma*. Journ. Bot. 76 (909): 265-271. 1938.
- DE-TONI, J. B. *Sylloge algarum omnium hucusque cognitarum (Sylloge Floridearum)* 4 (1): xx+lxii+388 pp. Patavii, 1897.
- GREVILLE, R. K. *Algae Britannicae, or Descriptions of the marine and other inarticulated plants of the British Islands, belonging to the order Algae; with plates illustrative of the genera, lxxxviii+218 pp.* Edinburgh, 1830.
- HARVEY, W. H. *Phycologia Australica; or, A history of Australian seaweeds, etc.* 5: x pp. +pls. 241-300 (with descriptions) +lxxiii pp. London, 1863.
- KÜTZING, F. T. *Species algarum*, vi+922 pp. Leipzig, 1849.
- . *Tabulae phycologicae* 15: 36 pp., 100 pls. Leipzig, 1865.
- MÖBIUS, M. *Bearbeitung der von H. Schenck in Brasilien gesammelten Algen*. Hedwigia 28 (5): 309-347, pls. 11, 12. 1889.
- MONTANGE, C. *Seconde centurie de plantes cellulaires exotiques nouvelles. Décades I et II*. Ann. Sci. Nat. Sér. 2, Bot., 13: 193-207. 1840.
- POST, E. *Systematische und pflanzengeographische Notizen zur Bostrychia-Caloglossa-Assoziation*. Rev. Alg. 9: 1-84. 1936.
- ZANARDINI, J. *Phycearum indicarum pugillus*. Mem. Ist. Veneto 17: 129-170, pls. 1-12. 1872.

BOTANY.—*New Asteraceae from northern Mexico collected by C. H. Muller.*¹
S. F. BLAKE, Bureau of Plant Industry.

This paper contains descriptions of six apparently new species and one variety of Asteraceae collected by Dr. C. H. Muller in 1939 in the Mexican states of Coahuila and Nuevo Leon on his expedition for the Division of Plant Exploration and Introduction, Bureau of Plant Industry, U. S. Department of Agriculture. The only species here described of any particular phyto-geographic significance is *Brickellia urolepis*. This is strikingly similar to *Brickellia hastata* Benth. of southern Baja California, and no very closely related species is known from the intervening region.

With the exception of the *Brickellia*, which was collected in Coahuila, all these plants come from the Sierra de la Cebolla, a part of the Sierra Madre about 50 miles south of Monterrey in Nuevo Leon. Dr. Muller informs me that a considerable

number of new species in other groups were collected in the same range, which reaches an altitude of at least 2,900 m (9,500 feet) and is perhaps fourth in height among the mountains of Nuevo Leon. The name Sierra de la Cebolla does not occur on the officially published topographic map of Mexico ("Carta de la República Mexicana à la 100,000a"), but it is the range passing southwest of La Trinidad shown on sheet 11-III-(F) [published in 1904], and its location is approximately longitude 100°15' W., latitude 25° N.

***Brickellia urolepis* Blake, sp. nov.**

Herba perennis infra inflorescentiam saepius simplex 6-11 dm alta, caulibus minute crispopuberulis foliosis; folia infimis exceptis alterna tenuiter petiolata linearia v. linear-lanceolata acuminata basi late hastata et saepe leviter cordata supra glabrescentia subtus crispopuberula vel hispidula et dense glanduloso-

¹ Received March 3, 1942.

adpersa; capitula mediocria 23–26-flora ca. 12 mm alta ca. 7–18 per caulem prope apicem caulis in ramis axillaribus 2–4-cephalis divergentibus 4–7 cm longis paucibracteatis v. subnudis paniculata, pedicellis tenuissimis crispopuberulis non glandulosis saepius 8–15 mm longis; involucri campanulati valde gradati 6–7-seriati appressi 10–12 mm alti phyllaria extima anguste subulata attenuata ca. 2 mm longa 0.5 mm lata puberula subherbacea ca. 1-costata apice interdum laxa, sequentia ovata 1–1.3 mm lata viridescens v. purpurascens albide 4–6-costata obtusa deinde abrupte subcirrhate herbaceo-appendiculata (appendice 0.5–0.8 mm longa) breviter ciliata prope apicem sparse puberula et sessili-glandulosa, sequentia lineari-oblonga obtusa v. acutiuscula brevi-ciliata ceterum glabra, intima linearia obtusa v. acuta laxe brevi-ciliata margine scariosa; achenia submatura 10-costata dense erecto-hispidula 4 mm longa; pappi albi 6 mm longi setae ca. 28 hispidulae.

Stems solitary or few, slender, from a short thick rhizome, the slender elongate roots sometimes tuberous-thickened at apex; lowest leaves (so far as seen) hastate-ovate, obtuse, ca. 5.5 cm long, 2–2.5 cm wide above the lobes; leaves thin, 3- or 5-plinerved, entire-margined (except for the basal pair of lobes), above green, minutely crisp-puberulous, glabrescent, beneath slightly paler green, the blade (middle leaves) 4.5–10.5 cm long, 2.3–6.5 cm wide at base (including the lobes), 7–10 mm wide above the lobes, the very slender petiole 7–20 mm long; heads at first nodding; disk (moistened) 12 mm high, 8 mm thick; involucre about equaling the corollas; corollas ochroleucous, subcylindric, 6.4 mm long, glabrous except for the apically sessile-glandular, semicircular, obtuse, apiculate teeth; undivided part of style 2.3 mm long, at base turbinate-thickened and densely tomentose, the branches linear-clavellate, 4.7 mm long.

MEXICO: Common in moist oak-maple woods, Cañon del Pajarito, Sierra de la Madera, Municipio de Cuatro Ciénegas, Coahuila, 6 Sept., 1939, *C. H. Muller* 3185 (type no. 145130, Nat. Arb. Herb.).

The only close ally of this species is the geographically remote *Brickellia hastata* Benth., of southern Baja California (Magdalena Bay and Santa Margarita Island). That is a

shrubby plant; the leaves are mostly opposite, and well-developed ones bear 1 or 2 or sometimes several broad blunt teeth or short lobes above the basal pair; the 12–17-flowered heads are crowded at apex of stem and branches into close cymose panicles; and the conspicuous cirrhate phyllary tip of *B. urolepis* is absent or barely indicated.

Grindelia obovatifolia Blake, sp. nov.

Herba perennis erecta 3–5 dm alta; caules 1–2 simplices ubique villosi non glandulosi foliosi 1–2-capitati; folia basalia ovalia v. elliptica obtusa crenato-serrata utrinque villosa, lamina 4–5 cm longa 2–2.7 cm lata, petiolo vix marginato laminam subaequante saepe prope apicem lobos parvos foliaceos 1–2-jugos gerente; folia caulina 14–17, inferiora et media obovata obtusa sessilia amplectentia crenato-serrata dentibus obtusis supra ubique sed non dense hirsutula subtus in costa laxe villosa in superficie sparsius hirsutula et substipitato-glandulosa 3.5–6 cm longa 1.5–2.8 cm lata, superiora sensim minora oblonga v. elliptico-oblongo acutiuscula sessilia amplectentia; pedunculus 2–4 cm longus nudus; capitula (sicco) 2.8–4.2 cm lata non foliaceobracteata; involucri 7–9.5 mm alti gradati ca. 5–6-seriati parum resinosi phyllaria exteriora et media lanceolata v. extima subulata glabra (extimis dorso paullum villosulis exceptis) 0.8–1.5 mm lata, appendice herbacea anguste triangulari v. lanceolato-subulata 1.5–2.5 mm longa plana acuta patente non revoluta quam basi chartacea brevior donata, intima lineari-oblonga breviter acuminata non patentia non herbaceo-appendiculata; radii ca. 17–20, lamina 13–14 mm longa 4 mm lata; achenia submatura oblongo-obovata 3–3.5 mm longa apice truncato-rotundata edentata non rugosa; pappi aristae ut videtur 2–3 caducae subcapillares laevissimae subrectae 4.2–4.7 mm longae quam corolla paullo breviores.

Rhizome up to 10 cm long, 5 mm thick; basal leaves subcordate to acute at base, slightly stipitate-glandular beneath; stem leaves mostly somewhat longer than the internodes, thin-chartaceous, not resinous, closely crenate-serrate throughout, the teeth usually bearing a thick apical gland; disk depressed-hemispherical, 7–10 mm high, 1.3–1.7 cm thick (as pressed); rays golden-yellow, linear-elliptic,

2-3-denticulate; disk flowers numerous, their corollas golden-yellow, glabrous, 5-5.6 mm long (tube 2.2-2.5 mm, teeth 1 mm); style appendages triangular-ovate, acute, slightly shorter than the stigmatic lines.

MEXICO: Abundant throughout pine-oak and oak-Douglas fir forest, Transition Zone, east slope of Sierra de la Cebolla, Municipio de Montemorelos, Nuevo Leon, 21 Aug., 1939, *C. H. Muller* 2932 (type no. 145127, Nat. Arb. Herb.).

This plant is distinctive in appearance because of its decidedly obovate stem leaves. It is probably nearest *Grindelia robinsonii* Steyermark, of San Luis Potosi, a smaller plant with much shorter rays, smaller achenes, fewer stem leaves (only the lowest of which are obovate) and shorter and broader, mostly erect phyllary tips.

***Erigeron basilobatus* Blake, sp. nov.**

Perennis rhizomatosus simplex 3.5-5 dm altus; caulis 1(-2)-capitatus patenti-vel reflexo-pilosus supra longe nudus; folia basalia subrosulata majuscula ovata obtusa grosse crenata vel sinuata basi abrupte in petiolum subaequalem anguste marginatum contracta saepe basi pinnatifida lobis 1-2-jugis oblongis obtusis 8-10 mm longis, utrinque non dense pilosa pilis patentibus basi plusminusve incrassatis, lamina 4-10.5 cm longa 2.8-4.5 cm lata; folia caulina 4-6, inferiora saepius oblonga v. ovata obtusa sessilia amplectentia grosse pauciserrata, superiora sensim minora oblonga integra, suprema multo minora lanceolata v. subulata bracteiformia; pedunculus nudus 6-19 cm longus; capitulum majusculum 3.5-4 cm latum; involucri 6-8 mm alti ca. 3-seriati paulum gradati phyllaria appressa lineari-lanceolata longe acuminata parce patenti-pilosa, interiora ca. 3-vittata anguste scarioso-marginata; radii numerosi albi ca. 3-seriati 12 mm longi 1.2 mm lati; achenia hirsutula 2-nervia; pappus simplex persistens.

Rhizomes creeping, slender, 8 cm long and more, bearing 1-3 terminal flowering stems or sometimes a sterile rosette; stem naked in its upper half or third, rarely bearing a single erect 1-headed branch from below the middle, the hairs in its lower part spreading or reflexed, many-celled, white, about 1 mm long, those in its upper part reflexed; petioles of basal leaves

3.5-5.5 cm long; crenations or lobes of the leaves blunt, callous-apiculate like the apex of leaf; lower stem leaves 5.5-8.5 cm long, 1.5-2.5 cm wide, the upper 2-4.5 cm long, 0.8-1.8 cm wide; disk (as pressed) 1.3-1.5 cm wide, about 8 mm high; rays numerous (100 or more), sparsely puberulous at apex of tube, about 14 mm long (tube 2 mm, lamina linear, 12 mm long, 1.2 mm wide, 2-3-denticulate, 3-4-nerved); disk flowers very numerous, their corollas yellow, glabrous except for the sparsely puberulous and apically slightly crested teeth, 4 mm long (tube 1.2 mm, throat 2.2 mm, teeth 0.6 mm long); disk achenes (immature) oblong, compressed, 2-nerved, 1 mm long, sparsely hirsutulous, their pappus simple, of about 28-30 slender subequal hispidulous bristles 2.5-3 mm long; ray achenes and pappus similar; style branches with very short deltoid obtusish hispidulous appendages.

MEXICO: Common in pine-oak forest, east slope of Sierra de la Cebolla, Municipio de Montemorelos, Nuevo Leon, 21 Aug., 1939, *C. H. Muller* 2934 (type no. 145128, Nat. Arb. Herb.).

A comparatively coarse plant, rather distinctive in appearance because of the large, usually basally pinnatifid basal leaves and greatly reduced, mostly clasping and entire stem leaves.

***Erigeron metrius* Blake, sp. nov.**

Perennis saepius pauciramosus ascendens v. decumbens 3-6 dm altus ubique dense canescenti-vel cinereo-pilosus foliosus; folia internodiis subaequalia sessilia integra inferiora anguste obovata obtusiuscula 2-2.5 cm longa 4-7 mm lata superiora anguste elliptica v. lineari-oblonga sensim minora; capitula in apicibus caulis et ramorum solitaria longe pedunculata 2-2.3 cm lata; involucri ca. 3-seriati paulum gradati 5 mm alti phyllaria lineari-lanceolata acuminata dense pilosa; radii numerosi albi roseo-tincti ca. 7 mm longi; achenia 2-nervia hirsutula; pappus e corona brevi lacerato-ciliata et aristis ca. 10 fragilibus sistens.

Stem 1-2 mm thick at base, usually with few ascending branches, sometimes simple and 1-headed, densely pilose with slenderly conical-based few-celled white hairs 1-2 mm long, the hairs varying from wide-spreading on lower

part of stem to subappressed on the peduncles; internodes mostly 5–15 mm long; leaves alternate, densely pilose on both sides with spreading or subascending hairs with small tuberculate bases, the lower obtuse to acutish, weakly 3-nerved, the upper 1–1.5 cm long, 1.5–3 mm wide; peduncles 6–14 cm long, canescent-pilose with erectish or subappressed hairs; rays 100 or more, 3-seriate, white, rosy on the back, sparsely pubescent on tube, 8 mm long (tube 1.5 mm, lamina linear, 2–3-denticulate, 4-nerved, 6.5 mm long, 0.8–1 mm wide); disk corollas very numerous, yellow, sparsely puberulous toward base of tube, hispidulous-crested on teeth, 2.7 mm long (tube 0.7 mm, throat 1.5 mm, teeth 0.5 mm long); disk achenes (very immature) oblong, erect-hirsutulous, 2-nerved, their pappus of a lacerate-ciliate basally connate crown of squamellae about 0.4 mm long and about 10–13 fragile hispidulous bristles 2.5 mm long, the whole in a single series; ray achenes and pappus similar; appendages of the style branches (disk flowers) so short as to make the tips appear subtruncate; anther tips narrowly triangular.

MEXICO: Scattered in chaparral, upper west slope of Sierra de la Cebolla, above 2750 m altitude, Municipio de Rayones, Nuevo Leon, 21 Aug., 1939, *C. H. Muller* 2914 (type no. 145126, Nat. Arb. Herb.).

A member of the group of *Erigeron* centering about the imperfectly known *Erigeron pubescens* H.B.K., but apparently distinct from any described species.

***Sabazia mullerae* Blake, sp. nov.**

Perennis gracilis decumbens nodis infimis radicanibus 2.5–3 dm longa; caulis simplex v. breviter ramosus subsparse pilosus, pilis inferioribus patentibus superioribus erectis v. subappressis; folia (inferioribus delapsis exclusis) ca. 4–6-juga lanceolato-ovata acuta basi cuneata v. rotundato-cuneata pauciserrata brevissime petiolata subsparse pilosa; pedunculi solitarii terminales 1-capitati 9–16.5 cm longi; capitulum 1.5–1.8 cm latum; involucri 5–6 mm alti 3-seriati gradati phyllaria ovata acutiuscula v. obtusa basi albida subchartacea supra membranaceo-herbacea ciliata ceterum glabra 3–5-vittata; radii 10–13 albi dorso roseo-tincti alte 3-dentati; achenia radii glabra epapposa, disci hispidula pappifera, pappo

sub-3-seriato gradato ca. 25-aristato persistente.

Stem about 1 mm thick, usually with few short erectish branches below, pubescent with mostly spreading hairs below, erect- or subappressed-pilose above; leaves opposite; internodes 1.8–4 cm long, mostly surpassing the leaves; petioles narrowly margined, 1–2 mm long; blades 1.8–2.8 cm long, 7–12 mm wide, rather sparsely pilose on both sides with more or less ascending subtuberculate-based white hairs, few-serrate (teeth 2–3 pairs, remote, callous-tipped, 0.5–1 mm high), triplinerved; peduncles rather sparsely pilose with erectish hairs; phyllaries 1.5 (outer) to 2.5 mm wide, the outer rather stiffly white-ciliate, the inner more loosely pilose-ciliate with many-celled purplish-based hairs, on back glabrous or the outer with a few hairs along the midrib; ray flowers fertile, the corolla densely pilose on tube, 8–9 mm long (tube 2 mm, limb cuneate-oblong, 7–8-nerved, 6–7 mm long, about 3.5 mm wide, the teeth ovate, obtuse, 1.5–2 mm long); disk flowers numerous, their corollas yellow, densely pilose on tube, hirsutulous outside and papillose within on teeth, 3.4 mm long (tube 1.2 mm, throat 1.6 mm, teeth 0.6 mm long); outer pales lance-ovate, usually abruptly contracted near middle and there often with a shoulder or short tooth on one or both sides, submembranous, 4–5 mm long, about 1.5 mm wide, 3–4-vittate, obscurely ciliate, the inner narrowly lanceolate, 3.5 mm long, 0.5 mm wide, entire; ray achenes obcompressed, obovoid, glabrous, epappose, 2 mm long; disk achenes (not quite mature) obovoid, plumpish, erect-hirsutulous, 2.2 mm long, their pappus of about 25 graduated sub-3-seriate linear-lanceolate hispidulous-ciliate awns, the outer about 1.5 mm, the inner 2.8 mm long.

MEXICO: Sparse in open chaparral, upper west slope of Sierra de la Cebolla, above 2750 m altitude, Municipio de Rayones, Nuevo Leon, 21 Aug., 1939, *C. H. Muller* 2902 (type no. 145123, Nat. Arb. Herb.).

This species, the northernmost true member of the genus, is nearest *Sabazia triangularis* var. *papposa* Blake, of Chiriqui, Panama, and *S. pinetorum* var. *dispar* Blake, of Guatemala, and is very similar to both of these in habit. In the former the pappus of the disk achenes consists of 5–6 obtuse squamellae 0.8 mm long.

In the latter the stem is ascending- or sub-appressed-pubescent, the upper leaves are decidedly narrower than the lower, and the pappus is definitely double, the outer series consisting of 10 acuminate or obtusish linear awns 1.2–1.7 mm long, the inner of 10 subaristate lanceolate awns 2.5 mm long. *Sabazia anomala* Greenm. and *S. leiachenia* Blake, the only other pappiferous species of the genus, are erect or erectish annuals with a pappus of 10 equal 1-seriate blunt squamellae.

The species is named for Mrs. Katherine Muller, who accompanied her husband on the expedition and assisted in the field work.

***Tagetes mulleri* Blake, sp. nov.**

Perennis simplex v. erecte ramosa ca. 7 dm alta foliosa ubique glaberrima, venis paginae superioris foliorum et dentibus involucri minute puberulis exceptis; folia majuscula pinatisecta, segmentis majoribus 3–4-jugis cum terminali lanceolato-ellipticis v. lanceolatis acuminatis crebre et acutissime serratis disperse punctatis lateralibus 2.5–4.5 cm longis 8–17 mm latis, jugis 2 infimis multo minoribus laceratis additis, rachi angustissime marginata; capitula apice caulis terna et in apice rami solitaria majuscula ca. 4 cm lata, pedunculis sparse bracteatis 5.5–8.5 cm longis; involucri campanulati 11 mm alti ca. 8-dentati, dentibus deltoideis acutiusculis apice 1-glandulosis et dense sordide puberulis, tubo lineis duplicibus glandularum praedito; radii 8 magni flavi ca. 2 cm longi; corollae disci nigro-virides; achenia supra sparse hispidula 7 mm longa; pappi aristae 4–6 lineari-lanceolatae acuminatae 4–5.5 mm longae cum squamellis 5–7 similibus multo brevioribus alternantes, omnes liberae.

Stem solitary from a slender running rhizome or this sometimes apparently deeper and vertical, 2–4 mm thick below, subterete, multistriate, somewhat angled above, pithy, simple below the inflorescence or with few erect branches; leaves opposite; internodes mostly 3–6 cm long, much shorter than the leaves; leaves including petiole 8–12 cm long, 4–9 cm wide, the proper petiole (below the lowest pair of leaflets) only 3–5 mm long, the 2 lower pairs of leaflets deeply lacinate, 4–9 mm long, the segments cirrhus-tipped, the principal leaflets 3–4 pairs, sharply and closely serrate with mostly simple triangular 1-glandular cuspidate

teeth 1.5–2 mm long, acute at base, rather sparsely punctate with small round glands, above dark green, minutely and sparsely hispidulous along the veins, beneath lighter brighter green, glabrous, the terminal leaflet up to 5.5 cm long, 1.8 cm wide; peduncles slender, striate, not distinctly thickened below the head; each phyllary bearing a terminal linear-oblong gland and (on the tube) 2 rows of 4–5 glands each, the upper roundish, the lower oblong-linear, the teeth densely sordid-puberulous toward apex; rays "deep yellow," 2.5 cm long, glabrous (tube 5 mm, lamina obovate-oblong, 3-denticulate, 8–10-nerved, 2 cm long, 7 mm wide); disk corollas blackish-green, obscurely puberulous at base of throat, 7.5 mm long (tube 3 mm, throat slender, 2 mm, teeth oblong, acute, 2.5 mm long); achenes of ray and disk similar, linear, slightly hispidulous above on the angles, 6.5–7 mm long; pappus essentially similar in ray and disk, of 4–6 narrowly linear-lanceolate, acuminate, hispidulous-ciliolate awns (3) 4–5.5 mm long, and about 5–7 acuminate or sometimes obtuse and lacerate-tipped, narrowly linear to linear-lanceolate squamellae 1–2.5 mm long, all free; style branches with deltoid, hispidulous, abruptly and slenderly cuspidate-tipped appendages.

MEXICO: Very abundant on moist slopes, in pine forest, trail from La Trinidad up the Sierra de la Cebolla, Municipio de Montemorelos, Nuevo Leon, 20 Aug., 1939, *C. H. Muller* 2869 (type no. 145122, Nat. Arb. Herb.).

Allied to *Tagetes lemmoni* Gray and *T. palmieri* Gray but with relatively broader leaflets, distinctive pappus, and many minor differential characters.

***Psacalium peltatum* var. *adenophorum*
Blake, var. nov.**

Inflorescentia dense glanduloso-puberula pilis aliis brevibus pluriloculatis aliis longioribus crasse conicis vel basi inflatis, omnibus apice glanduliferis; involucrum similiter sed minus dense glandulosum.

MEXICO: Common in chaparral on both sides of the mountain, upper west slope of Sierra de la Cebolla, above 2750 m altitude, Municipio de Rayones, Nuevo Leon, 21 Aug. 1939, *C. H. Muller* 2911 (type no. 145124–5, Nat. Arb. Herb.).

In typical *Psacalium peltatum* (H. B. K.) Cass., as represented in the U. S. National Herbarium by Pringle 3340 and C. & E. Seler 1259 from the vicinity of Patzcuaro, Michoacan, the type locality, the inflorescence and involucre are densely villous with many-celled, loosely spreading, eglandular white hairs. In Pringle 9871, from Cuernavaca, Morelos, which Rydberg² has referred to *P. peltatum*, the inflorescence is pilosulous or villosulous with shorter hairs containing much purplish color-

² Bull. Torrey Bot. Club 51: 373. 1924.

ing matter but without evident terminal glands. In the very closely allied and probably not specifically distinct *P. argutum* Rydb., from Durango and San Luis Potosi, the pubescence is much as in Pringle 9871, but perhaps shorter and stiffer. Although the difference in pubescence between var. *adenophorum* and typical *P. peltatum* would ordinarily indicate specific distinctness in this group, it is apparently not reinforced by any other distinctive characters, and the form collected by Dr. Muller seems, on the whole, best regarded as of only varietal rank.

ZOOLOGY.—Are "frontoparietal" bones in frogs actually frontals?¹ THEODORE H. EATON, JR., Cornell University. (Communicated by C. LEWIS GAZIN.)

Recently the writer (1939) showed that in *Rana clamitans*, *Hyla regilla*, *Bufo californicus*, and *Scaphiopus hammondi* the so-called "frontoparietal" bones each develop from a single center of ossification instead of from two, as stated by W. K. Parker (1871) for *Rana temporaria*. Parker's opinion, which has been repeated by many writers, was that the anterior center represented the frontal, the posterior the parietal; hence the compound name for the adult bones. He also (1876) speaks of the "frontoparietals" as being "double bones" in *Bufo vulgaris*.

Since 1939 I have found that in *Pseudis paradoxa* (Figs. 1-4), *Rana esculenta* (Figs. 5-7), *R. temporaria* (Parker's species; Fig. 8), and *Dendrobates auratus* (Fig. 9) these bones develop from single centers, just as in the four types described previously. Cleared larvae of *Rana catesbeiana* and two late larvae of *R. aurora draytonii* that I examined also agree with these.

The apparent reason for Parker's statements and figures is this: Under a dissecting microscope the wet, illuminated surface of each "frontoparietal" at an early stage reflects an anterior and a posterior ring of light where it bulges over the forebrain and midbrain, respectively. These rings correspond with the edges of Parker's "frontals" and "parietals," but they indicate only convexities, not separation. Sometimes

there are circles of melanophores (Fig. 8), giving the same illusion.

The fact that no exception is found among these several genera, and even in Parker's species, to the rule of development from single sliverlike centers of ossification suggests that this method may be universal in Salientia and that no evidence exists to warrant the term "frontoparietal."

Another statement by Parker (1877) is the following, called to my attention by Prof. E. L. Rice, of Ohio Wesleyan University: "In the small frog, *Pseudis paradoxa* . . . the parieto-frontals arise as one bone on either side, and are subsequently segmented into parietal and frontal." The series I examined, however, verifies only the first half of this sentence. There was no trace of subsequent segmentation (Figs. 1-4).

In *Pipa parva* the right and left "frontoparietals" fuse in the median line, making a single broad plate over the brain, even in larvae in which the legs are not yet well developed (for example, head-body length 15 mm, tail 25, foreleg 3, hindleg 9). In my series, unfortunately, no younger stages were available.

The general scheme of development of these bones in Salientia, then, is as follows: They first appear, one on each side, above the lateral wall of the cranium, fitting the depression between cerebral hemispheres and optic lobes; this is in half-grown or slightly older larvae. Extending forward and

¹ Received November 29, 1941.

back they reach the ethmoid cartilage and synotic tectum, partly overlapping each. This stage, in which they are slender, widely separated strips of bone, is passed

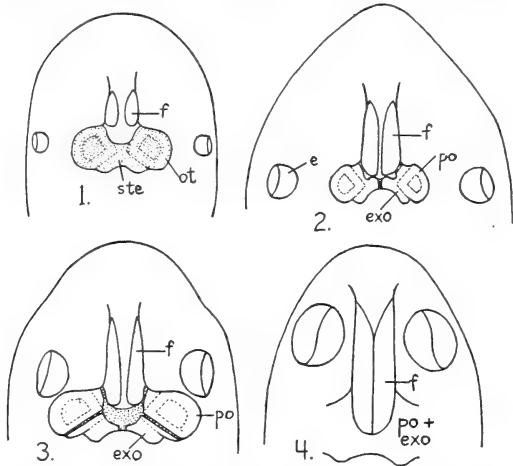

Figs. 1-4.—*Pseudis paradoxa*: 1, Larva (148 mm, head-body 54 mm, hindlegs minute), dorsal view of cranium, stippled parts cartilage; 2, neotenic larva (188 mm, head-body 64 mm, legs large); 3, transforming (140 mm, head-body 44 mm, hindlegs large, one foreleg out); 4, adult head-body 53 mm).

in the late larvae of most species, but in *Hyla* and *Pseudacris* it is retained in the adult. With most genera, as *Rana*, *Bufo*, *Pseudis*, *Dendrobates*, and *Scaphiopus*, the "frontoparietals" spread to meet in the

median line at or before transformation, but a permanent suture remains. Only in *Pipa*, of the types I have seen, does this suture disappear.

The next question concerns the homology of these bones. As the Salientia are in all probability derived from early labyrinthodonts, we may to advantage compare the frog skull with that of the Carboniferous *Paleogyrinus decorus* (Fig. 10). The Salientia lack most of the dermal roofing bones, those that are stippled in the figure. This loss affects two regions, the orbital and temporal, and may be correlated with (a) shortening of snout with relative enlargement of eyes, and (b) dorsomedial spread of the area of origin of the temporal muscles, which in a labyrinthodont filled a narrow space beneath the roofing bones, lateral to the wall of the cranium. In the posterior part of the skull a frog retains no dermal bones except the quadratojugal and squamosal, both of which lie entirely lateral to the jaw muscle origin on the prootic. Postorbital, postfrontal, intertemporal, supratemporal, tabular, and dermosupraoccipital are missing. Since these extend around three sides of the parietals in *Paleogyrinus*, it is highly probable that the latter also atrophied in response to the same influence, leaving the frontals to extend somewhat posteriorly as

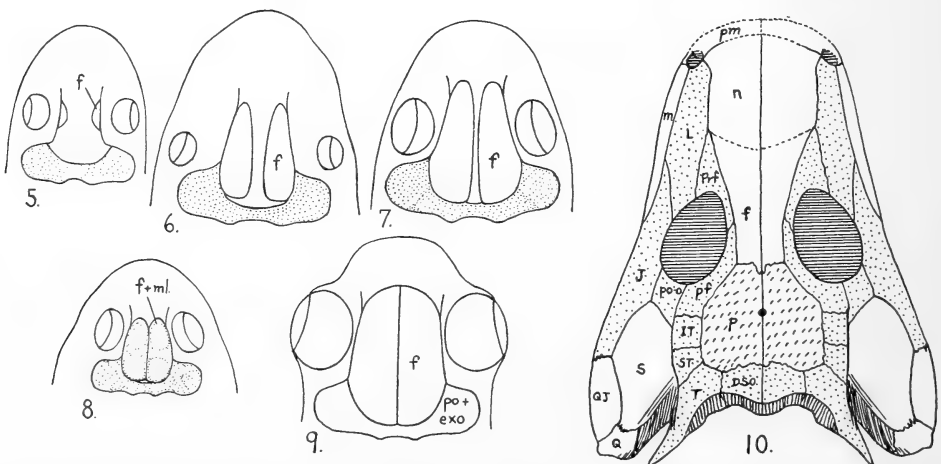

Figs. 1-7.—*Rana esculenta*: 5, Larva (32 mm, head-body 16 mm, short legs); 6, larva (63 mm, head-body 25 mm, short legs); 7, transforming (21 mm, head-body 15 mm, four legs, tail stump.)
 Fig. 8.—*Rana temporaria*: Late larva (57 mm, head-body 22 mm, hindlegs 21 mm).
 Fig. 9.—*Dendrobates auratus*: Late metamorphosis (head-body 14 mm).
 Fig. 10.—*Paleogyrinus decorus* (adapted from Watson, 1926, fig. 13):
 Stippled bones are those absent in frog skull.

the snout shortened and eyes enlarged. For these reasons, in the absence of any developmental evidence in modern frogs, it appears likely that the "frontoparietals" are frontals only.

For the use of specimens in this study I wish to thank Dr. Arthur Loveridge, Museum of Comparative Zoology (*Pseudis paradoxa*, *Rana temporaria*, and *R. esculenta*); Dr. C. M. Bogert, American Museum of Natural History (*Pseudis paradoxa*); Mr. Edgardo Mondolfi, Caracas, Venezuela, and Dr. Doris M. Cochran, U. S. National Museum (*Pipa parva*).

LITERATURE CITED

- EATON, T. H., JR. *Development of the frontoparietal bones in frogs*. Copeia 1939 (2): 95-97, 1 fig. 1939.
- PARKER, W. K. *On the structure and development of the skull of the common frog (Rana temporaria L.)*. Phil. Trans. Roy. Soc. London, 161: 137-211, 8 pls. 1871.
- . *On the structure and development of the skull in the Batrachia; Part II*. Ibid. 166: 601-670, 9 pls. 1876.

- and BETTANY, G. *The morphology of the skull*. London, 1877.
- WATSON, D. M. S. *The evolution and origin of the Amphibia*. Phil. Trans. Roy. Soc. London (ser B) 214: 189-257. 1926.

ABBREVIATIONS FOR FIGURES

- dso = dermosupraoccipital
 e = eye
 exo = exoccipital
 f = frontal
 f+ml = frontal with rings of melanophores
 it = intertemporal
 j = jugal
 l = lacrimal
 m = maxillary
 n = nasal
 ot = otic capsule
 p = parietal
 pf = postfrontal
 pm = premaxillary
 po = prootic
 poo = postorbital
 prf = prefrontal
 q = quadrate
 qj = quadratojugal
 s = squamosal
 st = supratemporal
 ste = synotic tectum
 t = tabular

ICHTHYOLOGY.—*Notes on some fishes from the Gulf of California, with the description of a new genus and species of blennioid fish.*¹ LEONARD P. SCHULTZ, U. S. National Museum.

Among some fishes sent to the United States National Museum from the Gulf of California, a blennioid fish was found to be undescribed and other species are worthy of report. The author wishes to thank E. F. Ricketts for sending these specimens in for study.

Hypsoblenniops, new genus

After studying the fishes related to *Hypsoblennius* and Herre's description of his *Spinoblennius* (Herre, Field Mus. Nat. Hist. Publ. Zool. 18 (12): 435. 1935, type *S. spiniger*; Herre, *ibid.* 21: 399, fig. 39. 1936), along with a paratype of *S. spiniger* kindly sent from the Field Museum to the United States National Museum, I have considered it best to propose a new genus for this little blenny from the Gulf of California.

¹ Published with the permission of the Secretary of the Smithsonian Institution. Received December 26, 1941.

Genotype: *Hypsoblenniops rickettsi*, new species.

Named *Hypsoblenniops* in reference to its relationship with *Hypsoblennius*.

This new genus is close to *Hypsoblennius* Gill and *Spinoblennius* Herre but differs from the former in having the preopercle armed with three strong spines, one at the lower angle and a smaller one above and another below that spine, and from the latter in having three slender, pointed preopercular spines instead of a single flat one at the lower angle.

A simple tentacle about $\frac{1}{3}$ to $\frac{1}{2}$ diameter of eye occurs on its upper margin. All cirri are said to be lacking in *Spinoblennius spiniger* Herre, but an examination of one of his paratypes shows a small, simple ocular tentacle, its length about $\frac{2}{3}$ the pupil. The anterior nostril near front of eye is tubular, with a very small cirrus on its dorsal margin in the new species but rudimentary in *Spinoblennius*, though said in the original description to be lacking.

The lateral line is incomplete, of about 9 to 11 pores, ending over a verticle through the anus; the gill membranes are attached as far up as the lower edge of the base of the pectoral fin; teeth more or less rigid, set on jaw bones and not on the fleshy lips; no canine tooth at corner of mouth; about 16 teeth in each jaw.

***Hypsoblenniops rickettsi*, new species**

Fig. 1

Holotype.—A specimen (U.S.N.M. no. 119731) 19.8 mm in standard length was taken by E. F. Ricketts in Concepcion Bay, Mexico, the night of March 28, 1940, by a light while at anchorage, along with eight paratypes bearing same data, U.S.N.M. no. 119732. In addition, one paratype was taken in San Carlos

snout to origin of anal 52.0, 46.6, 49.2; length of longest ray of caudal fin 24.2, 21.8, 24.0; longest ray of pectoral 27.8, 25.2, 29.0; longest pelvic ray 20.2, 21.3, 20.7; longest dorsal spine (third) 11.1,—, 12.0; longest soft ray of anal 8.6,—,9.3.

The following counts were made respectively: Dorsal rays XII, 16; XII, 16; XII, 16; XII, 16; XII, 16; XII, 16; XII, 16; anal rays ii, 18; ii, 18; ii, 19; ii, 18; ii, 17; ii, 18; ii, 19; pectoral rays 12–12; 12–12; 12–12; 12–12; 12–12; pelvics usually I, 2, occasionally I, 3; pores in lateral line 9;—; 10; 9; 11; branchiostegals 5.

The lower rays of the pectoral fin are a little exerted and enlarged; the large eye is mostly in the anterior half of the head; the maxillary extends to below the front of the pupil; the

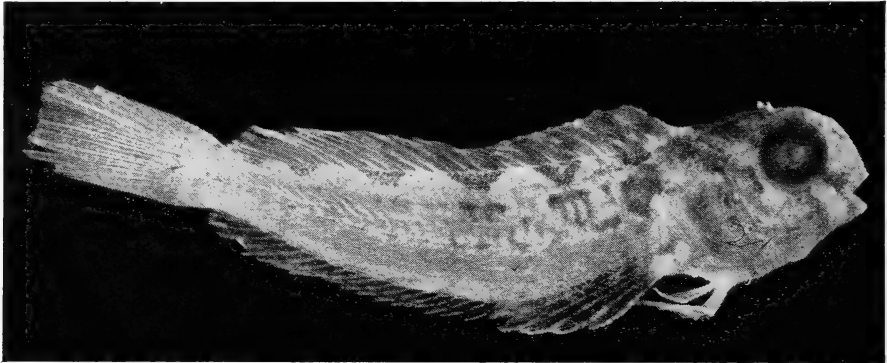

Fig. 1.—*Hypsoblenniops rickettsi*, new species. Photograph of holotype, U.S.N.M. no. 119731. The preopercular spines have been outlined on the photograph to bring out their shape.

Bay, Mexico, at night by use of a light, April 4, 1940, by E. F. Ricketts, U.S.N.M. no. 119733.

Description.—Based on holotype and 9 paratypes. The counts and measurements are given first for the holotype and then for certain of the paratypes, respectively. The standard lengths are 19.8; 20.2; and 18.3 mm. Total lengths 24.5, 23.1, and 22.1 mm. All the following measurements are expressed in hundredths of the standard length: Length of head 31.3, 28.7, 30.6; length of snout 8.6, 7.4, 8.7; diameter of eye 10.1, 9.9, 12.0; postorbital length of head 14.1, 14.9, 15.3; width of interorbital space 7.1, 7.4, 8.2; length from front of premaxillary to rear edge of maxillary 9.1, 9.4, 9.8; greatest depth (at rear of head) 20.2, 21.3, 23.0; least depth of body 7.1, 7.9, 8.7; distance from tip of snout to origin of dorsal fin 27.3, 26.7, 27.5;

head is blunt forward, with a rounded profile, and the mouth not quite so far forward as region in front of eyes; the body is compressed; top of head flat, with some more or less hardened skin in region of occiput.

The color pattern in alcohol of *Hypsoblennius rickettsi* consists of six bars or dorsal saddles, all situated under the dorsal fin and extending down to midsides, on some specimens ending there as an inverted v-shaped mark or in others the \wedge -shaped marks extend to the anal fin in an irregular manner; these dorsal saddles divide into a U-shaped mark on the dorsal fin to form 12 bars on it; the lower six rays of the pectoral fin are blackish, the upper rays hyaline; at the base of each anal ray is a black pigment spot; the under side of the head is crossed with three dark bars, the first from below front of

eye through corner of mouth meeting its fellow on chin, although front of chin is pale; the second bar from below eye meets its fellow on under side of head; the third, less distinct than the others, ends at base of branchiostegals; tip of snout with two narrow dark color bars separated by a pale space, rear of head pigmented; base of rays of caudal fin pigmented, forming a dark wavy line.

In color pattern this new species resembles *Spinoblennius spiniger* Herre. *S. spiniger* has XII, 11 dorsal and II, 15 or 16 anal rays in contrast to XII, 16 and II, 17 to 19 in *Hypsoblennius rickettsi*.

Named *rickettsi* in honor of E. F. Ricketts, of the Pacific Biological Laboratory, who was responsible for the collection of the specimens.

Genus **Chaenopsis** Gill

Chaenopsis Gill, Ann. Lyc. Nat. Hist. New York 8: 141, pl. 3, fig. 3. 1863 (type, *C. ocellatus* Poey).

Lucioblennius Gilbert, Proc. U. S. Nat. Mus. 13: 103. 1890 (type, *L. alepidotus* Gilbert).

After having examined the types of the species referred to the genera *Chaenopsis* and *Lucioblennius*, as well as other specimens in the United States National Museum, I am convinced that only a single species should be recognized in the American waters of the Pacific Ocean and only one in the American waters of the Atlantic Ocean. The types of *Lucioblennius alepidotus* and *L. lucius* are small specimens in poor condition and difficult to study. With the aid of a binocular microscope it is thought that

the fin rays have been counted correctly, and my counts differ considerably from those in current descriptions. Data are given in the accompanying table.

The number of spines in the dorsal fin appears to be from XVIII to XX in both species, although it is difficult to determine the first soft ray. There are 13 rays in the pectoral fins and 12 or 13 rakers on the lower part of the first gill arch. Sometimes a few rudiments occur between the main rakers, these not included in the above counts. Probably the vomer always has a few very weak teeth. This character is more strongly developed in the Atlantic specimens than in the Pacific ones.

Chaenopsis alepidotus (Gilbert)

Lucioblennius alepidotus Gilbert, Proc. U. S. Nat. Mus. 13: 103. 1890.

Lucioblennius lucius Osburn and Nichols, Bull. Amer. Mus. Nat. Hist. 25: 179, fig. 15. 1916.

The following specimens in the U. S. National Museum have been examined:

U.S.N.M. no. 44373 (co-type of *L. alepidotus*), lat. 25°02'30" N., long. 110°43'30" W., March 17, 1889, *Albatross*.

U.S.N.M. no. 48264 (co-type of *L. alepidotus*), lat. 25°02'45" N., long. 110°43'30" W., March 17, 1889, *Albatross*.

U.S.N.M. no. 87550² (type of *L. lucius*), San Josef Island, 1911, *Albatross*.

U.S.N.M. no. 56396, Santa Catalina Island, Miss Frances Lauderback.

U.S.N.M. no. 102159, San Gabriel Bay, Espiritu,

² Catalogued in American Museum by error as no. 5207.

TABLE 1.—DORSAL AND ANAL FIN RAY COUNTS MADE ON THE TWO SPECIES OF CHAENOPSIS

Specimen	Standard length (in mm.)	Dorsal rays					Anal rays			
		52	53	54	55	56	36	37	38	39
<i>C. ocellatus</i> :										
U.S.N.M. no. 8007.....	110.5	—	1	—	—	—	—	1	—	—
U.S.N.M. no. 116807.....	46-88	1	3	2	—	—	2	2	2	—
Total.....		1	4	2	—	—	2	3	2	—
<i>C. alepidotus</i> :										
U.S.N.M. no. 44373.....	34.0	—	—	1	—	—	1	—	—	—
U.S.N.M. no. 48264.....	33.5	—	1	—	—	—	—	1	—	—
U.S.N.M. no. 87550.....	36.7	—	1	—	—	—	1	—	—	—
U.S.N.M. no. 56396.....	153.0	—	—	—	—	1	—	—	—	1
U.S.N.M. no. 101948.....	39.5	1	—	—	—	—	—	—	1	—
U.S.N.M. no. 102159.....	45.4	—	1	—	—	—	—	1	—	—
U.S.N.M.....	120.0	—	—	—	1	—	—	1	—	—
Total.....		1	3	1	1	1	2	3	1	1

Santo Island, 1 to 4 fathoms, February 22, 1936, Hancock Expedition.
 U.S.N.M. no. 101948, Playa Blanco, Costa Rica, February 8, 1935, W. L. Schmitt, U.S.N.M. no. 119721, Concepcion Bay, March 29, 1940, E. F. Ricketts, Pacific Biological Laboratory.

Jordan and Starks (Proc. U. S. Nat. Mus. 32: 74-76, fig. 7. 1907) give an excellent figure of this species. There are a few tiny teeth at the head of the vomer that show up in clay impressions not visible otherwise.

Chaenopsis ocellatus Poey

Chaenopsis ocellatus Poey, in Gill, Ann. Lyc. Nat. Hist. New York 8: 143. 1863.

The following specimens are in the U. S. National Museum and have been examined:

U.S.N.M. no. 8007 (type of *C. ocellatus*), Cuba, Prof. F. Poey.

U.S.N.M. no. 116807, Tortugas, Fla., W. H. Longley.

Longley and Hildebrand (Papers Tortugas Lab. Carnegie Inst. Washington 34: 275-276. 1941) give an excellent color description of this species.

DESCRIPTION OF THE ADULT OF PORICHTHYS ANALIS Hubbs and Schultz

The original description of *Porichthys analis* Hubbs and Schultz (Proc. U. S. Nat. Mus. 86: 485. 1939) was based on two small specimens 95.5 and 80 mm in standard length, the only known examples of this toadfish then known. It now gives me pleasure to describe an adult of this species, 255 mm in standard length and 280 mm from tip of snout to tip of tail.

The following measurements are expressed in hundredths of the standard length: Greatest

depth 17.5; distance from tip of snout to origin of soft dorsal 35.5; and to origin of spinous dorsal 27.9; from tip of chin to anus 39.4; length of head 28.1; interorbital width 11.8; length of orbit 3.3; length of upper jaw 15.8; length of snout 7.6; distance from tip of lower jaw to tip of V of branchiostegal row of photophores 8.3; least distance between the nearly parallel ventral rows of photophores 3.9; distance from anus to anterior extension of ventral row of photophores 16.3; height of pectoral arch of pleural row of photophores 5.5; length of this arch 9.4.

Teeth on premaxillaries, vomer and dentary hooked backward, those on palatines mostly in a single row hooked inward; dorsal and anal fins free from the caudal; pectoral fin pointed medially; peritoneum black; lateral line organs essentially as described for the young of this species.

The color in alcohol is dark above, paler below with a tinge of brown, with 7 or 8 dorso-lateral dark bars that are obscured forward more or less by the uniform dark color of the upper parts of the body, but more evident posteriorly; the dorsal fin has 7 obliquely directed darkish bars, but these are separated from those on the body at the base of the fin by the obliquely directed pale areas, except the first one at the origin of the soft dorsal fin; base of caudal fin blackish, then across the middle of this fin is a wide pale band; the distal half of the caudal fin is blackish; pelvics and pectorals dusky; basal half of anal fin pale, the distal margin with a wide blackish band; area under pectoral fin base (axil) pale; upper part of lower lip dark with white band below that extends to behind maxillary and joins a more extensive pale area.



CONTENTS

	Page
GEODESY.—The distance between two widely separated points on the surface of the earth. WALTER D. LAMBERT	125
CHEMISTRY.—The determination of the cystine content of various proteins by different hydrolytic agents, sulphuric, hydrochloric, hydriodic, and a mixture of hydrochloric and formic acids. W. C. HESS and M. X. SULLIVAN	130
CHEMISTRY.—A crystalline sulphur-protein from wheat. A. K. BALLS	132
BOTANY.— <i>Linanthesastrum</i> , a new West American genus of Polemoniaceae. JOSEPH EWAN	138
BOTANY.—Marine algae of Hong Kong, II: The genus <i>Catenella</i> . C. K. TSENG	142
BOTANY.—New Asteraceae from northern Mexico collected by C. H. Muller. S. F. BLAKE	146
ZOOLOGY.—Are "frontoparietal" bones in frogs actually frontals? THEODORE H. EATON, Jr.	151
ICHTHYOLOGY.—Notes on some fishes from the Gulf of California, with the description of a new genus and species of blennioid fish. LEONARD P. SCHULTZ	153

6
D 2 11 2
VOL. 32

JUNE 15, 1942 No. 6

JOURNAL
OF THE
WASHINGTON ACADEMY
OF SCIENCES

BOARD OF EDITORS

RAYMOND J. SEEGER
GEORGE WASHINGTON UNIVERSITY

G. ARTHUR COOPER
U. S. NATIONAL MUSEUM

JASON R. SWALLEN
BUREAU OF PLANT INDUSTRY

ASSOCIATE EDITORS

W. EDWARDS DEMING
PHILOSOPHICAL SOCIETY

C. F. W. MUESEBECK
ENTOMOLOGICAL SOCIETY

HARALD A. REHDER
BIOLOGICAL SOCIETY

EDWIN KIRK
GEOLOGICAL SOCIETY

CHARLOTTE ELLIOTT
BOTANICAL SOCIETY

T. DALE STEWART
ANTHROPOLOGICAL SOCIETY

HORACE S. ISBELL
CHEMICAL SOCIETY

PUBLISHED MONTHLY

BY THE

WASHINGTON ACADEMY OF SCIENCES

450 ANNAIP St.

AT MENASHA, WISCONSIN

Entered as second class matter under the Act of August 24, 1912, at Menasha, Wis.
Acceptance for mailing at a special rate of postage provided for in the Act of February 28, 1925.
Authorized January 21, 1933.

Journal of the Washington Academy of Sciences

This JOURNAL, the official organ of the Washington Academy of Sciences, publishes (1) Short original papers, written or communicated by members of the Academy; (2) proceedings and programs of meetings of the Academy and affiliated societies; (3) notes of events connected with the scientific life of Washington. The JOURNAL is issued monthly, on the fifteenth of each month. Volumes correspond to calendar years.

Manuscripts may be sent to any member of the Board of Editors. It is urgently requested that contributors consult the latest numbers of the JOURNAL and conform their manuscripts to the usage found there as regards arrangement of title, subheads, synonymies, footnotes, tables, bibliography, legends for illustrations, and other matter. Manuscripts should be typewritten, double-spaced, on good paper. Footnotes should be numbered serially in pencil and submitted on a separate sheet. The editors do not assume responsibility for the ideas expressed by the author, nor can they undertake to correct other than obvious minor errors.

Illustrations in excess of the equivalent (in cost) of 1½ full-page line drawings are to be paid for by the author.

Proof.—In order to facilitate prompt publication one proof will generally be sent to authors in or near Washington. It is urged that manuscript be submitted in final form; the editors will exercise due care in seeing that copy is followed.

Author's Reprints.—Reprints will be furnished in accordance with the following schedule of prices:

Copies	4 pp.	8 pp.	12 pp.	16 pp.	20 pp.	Covers
50	\$2.00	\$3.25	\$ 5.20	\$ 5.45	\$ 7.25	\$2.00
100	2.50	4.00	6.40	6.75	8.75	2.75
150	3.00	4.75	7.60	8.05	10.25	3.50
200	3.50	5.50	8.80	9.35	11.75	4.25
250	4.00	6.25	10.00	10.65	13.25	5.00

<i>Subscription Rates.</i> —Per volume.....	\$6.00
To members of affiliated societies; per volume.....	2.50
Single numbers.....	.50

Correspondence relating to new subscriptions or to the purchase of back numbers or volumes of the JOURNAL should be addressed to William W. Diehl, Custodian and Subscription Manager of Publications, Bureau of Plant Industry, Washington, D.C.

Remittances should be made payable to "Washington Academy of Sciences" and addressed to 450 Ahnaip Street, Menasha, Wis., or to the Treasurer, H. S. Rappleye, U. S. Coast and Geodetic Survey, Washington, D.C.

Exchanges.—The JOURNAL does not exchange with other publications.

Missing Numbers will be replaced without charge provided that claim is made to the Treasurer within thirty days after date of following issue.

OFFICERS OF THE ACADEMY

President: HARVEY L. CURTIS, National Bureau of Standards.

Secretary: FREDERICK D. ROSSINI, National Bureau of Standards.

Treasurer: HOWARD S. RAPPLEYE, U. S. Coast and Geodetic Survey.

Archivist: NATHAN R. SMITH, Bureau of Plant Industry.

Custodian of Publications: WILLIAM W. DIEHL, Bureau of Plant Industry.

JOURNAL

OF THE

WASHINGTON ACADEMY OF SCIENCES

VOL. 32

JUNE 15, 1942

No. 6

BOTANY.—*New grasses from Venezuela.*¹ ZORAIDA LUCES, Servicio Botanico, Ministerio de Agricultura y Cría, Caracas, Venezuela. (Communicated by AGNES CHASE.)

In the course of a year's study, on behalf of the Ministry of Agriculture of Venezuela, in the grass division of the United States National Herbarium, under the supervision of Mrs. Agnes Chase, several undescribed species were found in the collection of Venezuelan grasses, which it was my official mission to study. The main results of my labor are condensed in a memoir on the *Genera of grasses of Venezuela*, which it is hoped will be published in the near future. Meanwhile, the new species are presented herewith. In addition there are a new genus and six new species of bamboos, which Dr. F. A. McClure kindly undertook to describe. This is the place to express to Mrs. Chase my profound gratitude for her constant help and teaching during my stay in Washington, and my sincere thanks to Dr. F. A. McClure, our foremost specialist on bamboos, and to all the friends who have aided me in my work. Following are the descriptions of the new species:

Helleria Fourn. Mex. Pl. 2: 128. 1886

A single species, *Helleria livida* (H.B.K.) Fourn., based on *Bromus lividus* H.B.K., is included. This species was placed in *Festuca* by Willdenow (Spreng. Syst. Veg. 1: 353. 1825). The genus differs from *Festuca* chiefly in the large loose spikelets with flexuous rachilla, the florets spreading at maturity, the lemmas and paleas thin-membranaceous, the lemma at maturity expanded from just above the base, the palea loose, narrow, acuminate; caryopsis oblong-lanceolate, concavo-convex in cross section, with a minute embryo. Densely caespitose grasses of high paramos of Mexico and the Andes of Venezuela.

¹ Received February 24, 1942.

Helleria fragilis Luces, sp. nov.

Fig. 1

Perennis, dense caespitosa; culmi 30–35 cm alti, compressiusculi; vaginae glabrae; ligula

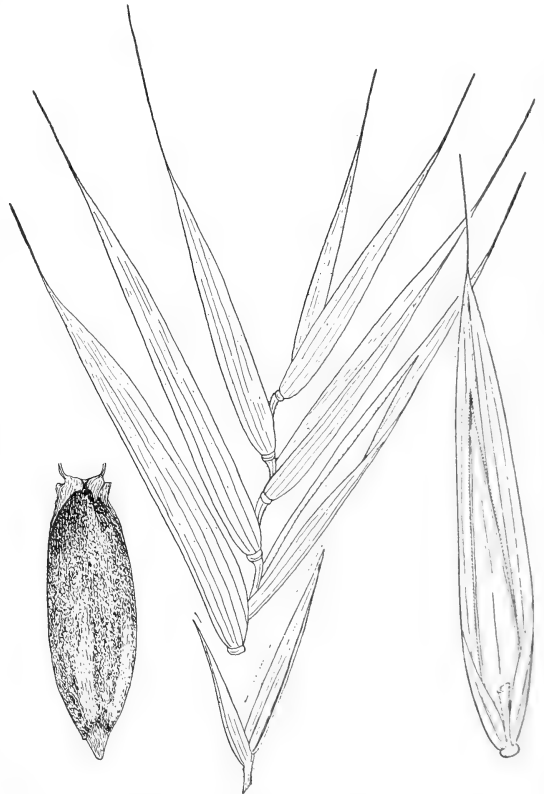

Fig. 1.—*Helleria fragilis*, spikelet and floret, $\times 2\frac{1}{2}$; caryopsis, $\times 10$. (Type.)

firma, acuminata, scaberrima; laminae firmae, 5–11 cm longae, involuto-setaceae, scaberrimae; panicula simplex, 7–10 cm longa, 2–4 cm lata, axi pedicellis que rigidis scabris; spiculae geminae, 3–4 cm longae, 5–7 florum, pedicello altero 5 mm, altero 8–15 mm longo; rachilla

flexuosa, fragilissima, flosculis patentibus; glumae acuminatae, tenuiter membranaceae, prima 7–10 mm, secunda 11–15 mm longa; lemma planum, ecarinatum, 2.2–3 cm longum, 5-nervi, lanceolato-acuminatum, in aristam 5–7 mm longam attenuatum; palea subhyalina, longe acuminata quam lemma multo brevior et angustior; caryopsis oblongo-lanceolata, circa 3.5 mm longa, concavo-convexa.

Plant perennial, in dense tussocks; culms 30 to 35 cm tall, very slender, stiff, scabrous to glabrous, subcompressed, branching at the lower nodes, the nodes glabrous; sheaths longer than the internodes, glabrous; ligule membranaceous, acute, 3 to 5 mm long; blades 5 to 11 cm long, firm, involute, setaceous, acuminate, very scabrous; panicle simple, narrow, 7 to 9 cm long, 2 to 4 cm wide, the axis and pedicels stiff, angled, scabrous; spikelets in groups of 2, one pedicel 5 mm long or less, the other 8 to 15 mm, erect, the spikelets 3 to 4 cm long, with 5 to 7 florets and a rudiment; rachilla minutely scabrous, zigzag, very fragile, the florets spreading; glumes acuminate, thin-membranaceous, scabrous, the first 7 to 10 mm long, the second 11 to 15 mm long, broader than the first; lemma flat from just above the base, without a keel, 2.2 to 3 cm long, thin-membranaceous, minutely scabrous, 5-nerved, lanceolate-acuminate, tapering into an awn about 5 to 7 mm long; palea thin, minutely scabrous, 2-keeled, long-acuminate, about 2/3 as long as the body of the lemma and much narrower; caryopsis oblong-lanceolate, about 3.5 mm long, concavo-convex, the embryo minute.

This species is related to *Helleria livida* (H.B.K.) Fourn., but in that species the panicles are compound, the axis and pedicels capillary, flexuous, very scabrous, the spikelets in groups of three, smaller, with the glumes as long as the florets.

The type is in the Herbario Nacional de Venezuela, Ministerio de Agricultura y Cría, a duplicate type in the U. S. National Herbarium, collected in Páramo de Tucani, Sierra Nevada de Mérida, altitude 4,500 m, State of Mérida, Venezuela, December 17, 1910, by Dr. A. Jahn, no. 62. Another collection was made on rocky ridges, higher paramos, near El Gavilan, 4,200 m, State of Mérida, Venezuela, January 25, 1929, by H. Pittier, no. 13276.

***Eragrostis plurinodis* Swallen, sp. nov.**

Fig. 2

Perennis dense caespitosa; culmi 35–55 cm longi, graciles, ramosi, erecti vel patentés, plurinodes, internodiis inferioribus elongatis; vaginae internodiis breviores, glabrae, in ore pilosae; laminae 3–10 cm longae, 1–2 mm latae, glabrae, firmae, adscendentes, planae vel involutae; paniculae 3–6 cm longae, ramis brevibus appressis 1–3 spiculatis; spiculae 7–13 mm longae, 1.5–2 mm latae, 10–20-florae, pallidae vel purpurascens; lemmata 2–2.1 mm longa, abrupte acuta vel subacuminata, nervis prominentibus; paleae lemmatibus paulo breviores, carinis minute ciliatis.



Fig. 2.—*Eragrostis plurinodis*, panicle, $\times 1$; floret, $\times 5$. (Type.)

Densely tufted perennial; culms 35–55 cm long, slender, branching or proliferous at the lower and middle nodes or with a few short flowering branches from the upper nodes, erect or apparently finally spreading and appearing like stolons, the lower internodes usually elongate, the upper ones much shorter; sheaths shorter than the internodes, glabrous or with a small tuft of hairs at the mouth; blades 3–10 cm long, 1–2 mm wide, glabrous, fine-pointed, firm, stiffly ascending, flat, or drying involute especially toward the tip; panicles 3–6 cm long, the short branches appressed, bearing 1–3 short-pedicel spikelets; spikelets 7–13 mm long, 1.5–2 mm wide, 10–20-flowered, pale but tinged with purple; lemmas 2–2.1 mm long, rather abruptly acute or subacuminate, the nerves prominent, minutely scabrous on the

keel; palea a little shorter than the lemma, minutely ciliate on the keels.

The type is in the Herbario Nacional de Venezuela, Ministerio de Agricultura y Cría, collected in fields around Cunaviche, State of Apure, Venezuela, February 13, 1941, by C. E. Chardon, no. 249.

This species is related to *E. acuminata* Doell and *E. rufescens* Schult. but differs from the former in being perennial and from the latter in having slender, several-noded, stolonlike culms.

***Luziola pittieri* Luces, sp. nov.**

Fig. 3

Perennis, debilis; culmi caespitiosi, graciles, foliis laxis; vaginae compressae, subcarinatae, scabrae; ligula subhyalina acuminata, 10–13 mm longa; laminae planae, lineares, acuminatae, 10–35 cm longae, 2–6 mm latae; paniculae masculae femineaeque similes, pyramidales, laxae, patentes, circa 6–8 cm longae, raro usque ad 14 cm longae, axi ramisque scabris; spiculae longe pedicellatae, pallidae, masculae circa 4 mm longae, lemmate paleaque subhyalinis, lemmate 7–9-nervio, palea 9–11-nervia; spiculae femineae circa 1.5 mm longae, palea lemmateque valde 9–11-nerviis; caryopsis globosa, 1.4–1.5 mm longa, pallida, striata.

Plant perennial, weak, 30–50 cm tall, branching at the straight or somewhat geniculate base, from soft slender rhizomes; culms very slender, caespitose, the nodes glabrous; foliage lax, the sheaths strongly compressed, subcarinate, glabrous, membranaceous, with transverse distant veins visible on the inner face, the margins more delicate; ligule subhyaline, long-acuminate, 10–13 mm long; blades flat, scabrous on both surfaces and on the margins, linear, acuminate, 10 to 35 cm long, 2 to 6 mm wide; inflorescence of unisexual panicles, the staminate and pistillate similar, but the pistillate often on shorter culms, pyramidal, lax, open, usually not more than 8 cm long, rarely as much as 14 cm long, the axis and branches scabrous; spikelets long-pedicellate, pale, the staminate spikelets about 4 mm long, lemma and palea obtuse, subhyaline, the nerves inconspicuous, the lemma 7–9-nerved, the palea 9–11-nerved; pistillate spikelets about 1.5 mm long, lemma and palea equal, not completely covering the caryopsis, with 9–11 conspicuous minutely scabrous nerves; caryopsis

globose, 1.4–1.5 mm long, pale, striate.

The type is in the Herbario Nacional de Venezuela, Ministerio de Agricultura y Cría, duplicate type in U. S. National Herbarium, collected near Dos Caminos, Guárico, Venezuela, by H. Pittier, no. 12530, September 12, 1927. Known only from State of Guárico,

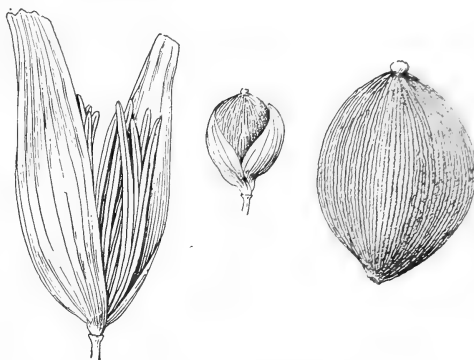

Fig. 3.—*Luziola pittieri*, staminate and pistillate spikelets, $\times 10$; caryopsis, $\times 20$. (Type.)

Venezuela. A second collection is from Lagoon of Mesa de El Sombrero, Guárico, in muddy places. September 10, 1917, H. Pittier, no. 12475.

This species is related to *Luziola peruviana* Gmel. and to *L. gracillima* Prod. From the first it differs in the larger staminate panicle and smaller staminate spikelets, in the smaller pistillate spikelets, the lemma and palea not exceeding the caryopsis, and in the strongly striate fruit. From *L. gracillima* it differs in the laxer blades, smaller staminate spikelets and in the larger pale pistillate spikelets, the blades of *L. gracillima* being erect and relatively stiff, the staminate spikelets 7 mm long and the pistillate spikelets dark purple and 1 mm long.

***Digitaria atra* Luces, sp. nov.**

Fig. 4

Perennis; culmi caespitiosi, gracillimi, erecti, 30–38 cm alti, nodis 2 vel 3; vaginae quam internodia breviores, striatae, papilloso-villosae; ligula membranacea, 1–1.5 mm longa; laminae marginibus involutis, flexuosae, acuminatae, 6–25 cm longae, utrinque papilloso-villosae; racemi solitarii (rarius geminati), 6–7 cm longi, rachi 3-angulata, 0.5 mm lata; pedicelli pilosuli; spiculae ellipticae, acuminatae, circa 2.5 mm longae, glumis nullis; lemma sterile palli-

dum, acutum, 3-nerviium, pubescens, pilis capitellatis; fructus atra-brunnescens, minutissime papillosus, marginibus pallidis, subhyalinis.

Plant perennial, caespitose, 30 to 38 cm tall; culms very slender, somewhat flat, erect, stiff, with 2 or 3 nodes, from copiously pilose to almost glabrous near the base; sheaths much shorter than the internodes, striate, minutely papillose and with long silky hairs; ligule obtuse, membranaceous, 1 to 1.5 mm long; blades



Fig. 4.—*Digitaria atra*, two views of spikelet, and fruit, $\times 10$. (Type.)

flexuous, striate, acuminate, 6 to 25 cm long, 2 to 3 mm wide, papillose-villous on both surfaces, the hairs longer and denser toward the base, the margins involute; racemes solitary (rarely paired), 6 to 7 cm long, the rachis 3-angled, 0.5 mm wide, slightly winged; pedicels loosely pilose; spikelets elliptic, acuminate, about 2.5 mm long, both glumes wanting; sterile lemma pale, acute, 3-nerved, slightly shorter than the fruit, covered with whitish capitellate hairs; fruit blackish brown, the lemma minutely papillose-roughened, with narrow pale subhyaline margins, the base at the back with a minute stripe of pale capitellate hairs on either side, sometimes with but one stripe.

The type is in the Herbario Nacional de Venezuela, Ministerio de Agricultura y Cría, collected by A. S. Müller in Tabay, State of Mérida, Venezuela. Only known from the type collection.

This is the only American species of *Digitaria* in which the second glume is wholly suppressed. In *D. gracillima* (Scribn.) Fernald the second glume is one-fourth to two-thirds as long as the dark brown fruit, but in that the 2 to 5 long slender racemes are distant on an elongate axis. The African group allied to *D. uniglumis* (Rich.) Stapf, with blackish fruit and suppressed or reduced second glume, has panicles of several to very numerous racemes on an elon-

gate axis, and the pedicels bear stiff hairs as long as the spikelets.

***Digitaria fragilis* (Steud.) Luces, comb. nov.**

Paspalum fragile Steud. Syn. Pl. Glum. 1: 17. 1854. The type specimen, collected in Cumaná, Venezuela, by Funck & Schlim, no. 724, the name in Steudel's script, is in the Paris Herbarium.

Digitaria rhachitricha Henr. Blumea 1: 95. 1934. Based on *Funck & Schlim* 724, but the locality given as Colombia. It seems probable that some specimens of this collection were distributed with the name written on a Colombia label, but that the plants really came from Cumaná. The specimen of this number in the Boissier Herbarium in Geneva is labeled "Venezuela, Cumaná."

***Mesosetum chaseae* Luces, sp. nov.**

Fig. 5

Perenne, caespitosum, valde stoloniferum, stolonibus foliosis, 70–100 cm longis; culmi floriferi erecti, 60–65 cm alti; vaginae glabrae, marginibus ciliatis; ligula minuta, fimbriato-ciliata; laminae firmae, planae vel subinvolutae, 3–13 cm longae, 3–7 mm latae, acuminatae, marginibus cartilagineis, papilloso-hispidis; racemus 5.4–7.5 cm longus, 4–5 mm latus, rachi 1 mm lata, anguste alata, marginibus scabris; spiculae imbricatae, lateraliter compressae, pallidae, 5 mm longae; glumae aequales, circa 4.5 mm longae, gluma prima 3-nervia, nervo centrali scabro, supra medium carinato subalato, apice mucronato; gluma secunda naviculata, 5–7-nervia; lemma flosculae masculae naviculatum, 5 mm longum, quam glumae latius et longius, 5-nerviium; palea 4 mm longa; fructus circa 4.5 mm longus, elliptico-lanceolatus, acuminatus, lemmate subcompresso apice subcarinato, carina minute hirsuta.

Plant perennial, caespitose, with strong leafy stolons, 70 to 100 cm long, branching at the nodes, the nodes pubescent, the internodes subcompressed, glabrous, purplish; flowering culms simple or sparingly branching, erect, 60 to 65 cm tall; leaves about 9, rather crowded on the lower half of the culm, the sheaths shorter than the internodes, glabrous, the margins ciliate, the hairs longer toward the summit, the collar with a ring of erect hairs or glabrescent; ligule minute, fimbriate-ciliate; blades firm,



Fig. 5.—*Mesosetum chaseae*, flowering plant, stolon, and reverse view of raceme, $\times \frac{1}{2}$; spikelet, $\times 10$ (duplicate type); mature fruit, $\times 10$. (Chase 12550.)

flat to subinvolute, 3 to 13 cm long, 3 to 7 mm wide, tapering from the base to an acuminate apex, papillose-hispid on the upper surface at least toward the base, the nerves prominent on the lower surface, the margins cartilaginous, papillose-hispid; raceme 5.4 to 7.5 cm long, 4 to 5 mm wide, the rachis 1 mm wide, narrowly winged, the margins scabrous; spikelets imbricate, laterally compressed, pale, 5 mm long, very minutely scaberulous; glumes equal, about 4.5 mm long, the first 3-nerved, the midnerve scabrous, keeled above the middle, and narrowly winged, extending into a mucro between the lobes of the 2-lobed apex, the lateral nerves approaching the midnerve toward the summit; second glume naviculate, 5- to 7-nerved, with obliquely transverse nerves visible on the inner face; lemma of the staminate floret naviculate, 5 mm long, exceeding the glumes and much wider, 5-nerved, the nerves stronger and darker toward the apex, with obliquely transverse veins visible on the inner face toward the summit, its palea 4 mm long, the margins inflexed, hyaline; fruit about 4.5 mm long, elliptic-lanceolate, acuminate, the lemma subcompressed and slightly keeled toward the apex, the keel with short stiff hairs, the palea enclosed by the margins of the lemma.

Type is in the Herbario Nacional de Venezuela, Ministerio de Agricultura y Cría, a duplicate type in the U. S. National Herbarium; collected in vicinity of Santomé, State of Anzoátegui, Venezuela, August to November 1940, by A. G. Sandoval. Other collections from the same locality are "sandy soil above morichale along Rio Guara Guara, vicinity of Santomé, March 25, 1940," Chase 12550 (very overmature); and Sandoval, July 1940.

In the U. S. National Herbarium is a fragmentary specimen of this species from Rupunni Savanna, British Guiana, collected by Melville.

This species does not fall into any of the groups proposed by Swallen in his revision of the genus *Mesosetum* (Brittonia 2: 363-392. 1937).

Paspalum indutum Luces, sp. nov.

Fig. 6

Perenne, subrobustum, basi hirsutissimum; culmi erecti, 100-115 cm alti, nodis longe villosis; vaginae subcompressae, collo velutissimae, infimae appresso-villosissimae, supremae

basi pilosae, marginibus glabris vel pilosissimis; ligula 0.5-1.5 mm longa; laminae planae, 4.5-42 cm longae, 3-11 mm latae, acuminatae, dense velutissimae, basi longe villosissimae, nervo medio valido; panicula tota subviscida, 17-21 cm longa, racemis 25-32, axi scabro, sparse piloso, basi et axillis longe villosis; spiculae geminae, ellipticae, 2-2.5 mm longae, 1 mm latae; gluma secunda et lemma sterile glanduloso-pubescentia fructum occultantia, gluma 5-nervia; lemmate 3-nervio; fructus ellipticus, pallidus.



Fig. 6.—*Paspalum indutum*, two views of spikelet, and fruit, $\times 10$. (Type.)

Plant perennial, rather robust, with very strong and hairy base; culms erect, thick toward the base, rather slender toward the summit, compressed or subcompressed, 1-1.15 m tall, sparsely pilose or glabrescent, the nodes with long very silky hairs; sheaths subcompressed toward the summit, mostly shorter than the internodes, closely enveloping the culms, the lowest copiously appressed-villose, the upper pilose at the very base, very minutely papillose, glabrous to very pilose especially along the margins, a dense band of grayish silky hairs on the collar; ligule membranaceous, 0.5-1.5 mm long; blades flat, linear, 4.5-42 cm long, 3-11 mm wide, acuminate, densely appressed grayish velvety, with a tuft of silky hairs about 7 mm long at the back of the ligule, the midnerve strong, the margins often fluted, the lower narrowed toward the base, the upper rounded at base; panicle long-exserted, 17-21 cm long, of 25-32 racemes, the whole panicle somewhat viscid, the common axis scabrous, sparsely pilose, with a tuft of silky hairs at the very base and in the axils; rachis very slender, scabrous, sparsely pilose; spikelets in pairs on slender pedicels, elliptic, 2-2.5 mm long, 1 mm wide; second glume and sterile lemma equal, covering the fruit, the glume 5-nerved, the lemma 3-nerved, both glandular-pubescent, the lemma less densely so; fruit elliptic, pale.

The type is in Herbario Nacional de Venezuela, Ministerio de Agricultura y Cría, a fragment of it in the U. S. National Herbarium, collected in Pozo Hondo, near Egido, 960 m altitude, State of Mérida, Venezuela, April 1940, by R. Sargent, no. 37.

Related to *Paspalum coryphaeum* Trin., differing in the less robust culms, the narrower, velvety blades, and smaller and viscid panicles.

***Paspalum nudatum* Luces, sp. nov.**

Fig. 7

Perenne, verisimiliter subaquaticum, caespitosum; culmi gracillimi, erecti, 30–44 cm alti; vaginae internodiis longiores, compressae, carinatae; ligula hyalina, 5–6 mm longa, acuminata; laminae erectae, involutae, glabrae, minutissime papillosoe; racemi bini, conjugati, ascendentes, graciles, 3–5.5 cm longi; spiculae solitariae, pallidae, elliptico-obovatae, 1.5 mm longae, 1 mm latae, glumis nullis, lemmate sterili glabro minutissime papilloso, 5-nervio; fructus pallidus, elliptico-obovatus, papillosus.



Fig. 7.—*Paspalum nudatum*, two views of spikelet, and fruit, $\times 10$. (Type.)

Plant perennial, apparently subaquatic, caespitose; culms 30 to 44 cm tall, very slender, erect, stiff, subcompressed, with 1 or 2 nodes, glabrous; sheaths much longer than the internodes, strongly compressed, carinate, loose, the nodes visible, strongly striate, glabrous; ligule hyaline, 5 to 6 mm long, acuminate; blades firm, erect, glabrous, obscurely minutely papillose, closely involute, 0.8 mm wide as folded, narrower than the top of the sheath, with rather stiff hairs at base, back of the ligule; racemes 2, conjugate, narrowly ascending, very slender, 3 to 5.5 cm long; margins of the rachis and pedicels minutely scabrous; spikelets solitary, pale, elliptic-obovate, 1.5 mm long, 1 mm wide; both glumes wanting, the sterile lemma glabrous, very minutely papillose, 5-nerved, as long as the fruit but narrower; fruit pale, elliptic-obovate, strongly papillose.

The type is in the Herbario Nacional de

Venezuela, Ministerio de Agricultura y Cría, duplicate type in the U. S. National Herbarium, collected in Tinaquillo, altitude 422 m, State of Cojedes, Venezuela, August 8, 1940, by Carlos Chardon. Only known from the type collection.

This species resembles *Paspalum pictum* Ekman, but that has sheaths much less compressed, the racemes 1 to 4, not conjugate, the spikelets paired, more crowded, smaller, obovate-pyriform, the second glume present and the fruit less papillose.

***Panicum mirandum* Luces, sp. nov.**

Fig. 8

Perenne, basi decumbens, nodis infra radicans; culmi ascendentes, 90–100 cm alti, papilloso-hirsuti ramosi, ramis divaricatis, nodis pubescentibus; vaginae papilloso-pilosae; ligula minuta; laminae planae, lanceolatae, acuminatae, 6–15 cm longae, 7–16 mm latae; paniculae 12–14 cm longae lataeque, axi ramisque gracilibus, flexuosis; spiculae plerumque geminae, interdum solitariae, raro ternatae, 2 mm longae, ellipticae, glabrae, glumis et lemmate sterili 7–9-nerviis, gluma prima quam spicula brevior; gluma secunda et lemmate sterili fructum occultantibus; fructus ellipticus, brunneus, laevis, 1.5 mm longus, 1 mm latus, apiculatus.



Fig. 8.—*Panicum mirandum*, paired spikelets, and fruit, $\times 10$. (Type.)

Plant perennial, decumbent at base and producing stilt roots at the nodes; culms ascending, 90 to 100 cm tall, terete, producing divaricate branches, the internodes papillose to papillose-hirsute, the nodes densely pubescent; sheaths striate, shorter than the internodes on the main culm, longer on the branches, papillose-pilose, especially toward the summit and on the margins, densely pubescent at the junction with the blades; ligule membranaceous, less than 0.5 mm long; blades flat, somewhat firm, lanceolate, acuminate, usually asymmetric at the narrowed base, 6 to 15 cm long, 7 to 16 mm

wide, glabrous or sparsely hirsute on the upper surface, especially toward the base, faintly appressed-pubescent on the under surface, the margins scabrous and minutely fluted; panicles 12 to 14 cm long, as wide or somewhat wider, the axis and branches very slender, flexuous, pilose in the axils; spikelets usually in pairs, both sessile or nearly so at the ends of the delicate ultimate branchlets, some spikelets solitary, rarely in threes, equal, 2 mm long, elliptic, glabrous, minutely scabrous toward the summit, the nerves prominent, 7 to 9 in both glumes and sterile lemma; first glumes of both spikelets slightly shorter than the spikelets, sometimes in one of the spikelets less than half or minute; second glume and sterile lemma equal, covering the fruit; sterile palea small and delicate; fruit elliptic, dark-brown, smooth and shining, 1.5 mm long, 1 mm wide, apiculate.

The type is in the U. S. National Herbarium, no. 602176, and a fragment of it in the Herbario Nacional de Venezuela, Ministerio de Agricultura y Cría, collected in Guinand Estate (Cárdenas) Siquire Valley; altitude 500 to 1,000 m, State of Miranda, Venezuela, March 19-24, 1913, by H. Pittier, no. 6483. Only known from the type collection.

This species is not closely related to any other *Panicum*; it appears to be in the group with *P. ovuliferum* Trin. and *P. pantrichum* Hack. but differs from both in many characters and strikingly in the dark brown fruit.

***Panicum orinocanum* Luces, sp. nov.**

Fig. 9

Perenne, caespitosum; culmi simplices, erecti, 30-40 cm longi, gracillimi, basi nodosi; vaginae striatae, glabrae, internodiis breviores; ligula 0.3 mm longa; laminae firmae, 2-10.5 cm longae, 1-2 mm latae, acuminatae, planae vel involutae, glabrae; panicula patens, 3-5 cm longa lataque, axi ramisque capillaribus, flexuosis; spiculae longe pedicellatae, ellipticae, 1.5-2 mm longae, nervis prominentibus; gluma prima quam dimidio spicula brevior, 3-nervia; gluma secunda et lemma sterile 6-7 nervia, firmula; fructus ellipticus, subacuminatus, circa 1.5 mm longus, 0.7 mm latus, lemmate obscure pubescenti.

Plant perennial, caespitose, the culms knotted at base, 30 to 40 cm tall, simple, very slender, erect, stiff, glabrous, the nodes usually

dark, sometimes pale; sheaths striate, glabrous, shorter than the internodes; ligule membranaceous, 0.3 mm long, with a dense ring of hairs, about 1 mm. long, back of it; blades firm, linear, acuminate, flat or involute, glabrous on both surfaces, 2 to 10.5 cm long, 1 to 2 mm wide, the lower sometimes shorter; panicle open, 3 to 5 cm long and about as wide, the axis



Fig. 9.—*Panicum orinocanum*, spikelet and two views of fruit, $\times 10$. (Type.)

and branches capillary, flexuous, glabrous; spikelets long-pedicelled, elliptic, glabrous or minutely scaberulous, sometimes with few obscure hairs at the base, 1.5 to 2 mm long, the nerves prominent; first glume 3-nerved, half as long as the spikelet or slightly shorter, second glume and sterile lemma 6- to 7-nerved, rather firm, the first slightly shorter than the second, the sterile lemma usually with a staminate flower, the sterile palea shorter than the lemma, membranaceous; fruit pale, elliptic, subacuminate, about 1.5 mm long, 0.7 mm wide, the lemma sparsely and obscurely pubescent with delicate white hairs.

The type is in the Herbario Nacional de Venezuela, Ministerio de Agricultura y Cría; a duplicate type in U. S. National Herbarium; collected in Alto Orinoco, in savannas of the Río Cataniapo, Puerto Ayacucho, altitude 88 m, Venezuela; May 23, 1940, by Ll. Williams, no. 13090.

COLOMBIA: In thin pockets of soil in cavities of ferruginous sandstone, about 60 km southeast of Orocué, altitude about 150 m, Comisaría El Vichada, April 20, 1939, Oscar Haught, no. 2775.

This species is related to *Panicum micranthum* H.B.K., but that is freely branching from a delicate base, has broader pilose blades, smaller spikelets, and glabrous fruits.

***Panicum cervicatum* Chase, sp. nov.**

Fig. 10

Perenne, olivaceum; culmi simplices subrobusti, rigidi, erecti vel ascendentes, 80-135 cm

alti; vaginae glabrae vel hispidae; ligula ciliata, 1–2 mm longa; laminae erectae vel ascendentes, durae, plerumque planae, 20–35 cm longae, 10–18 mm latae, acuminatae, glabrae, scaberrulae, vel hispidae; panícula erecta, 30–50 cm longa, ramis rigidis patentibus, pedicellis rigi-

hispid to nearly glabrous; sheaths glabrous to strongly hispid, the lower overlapping, the others shorter than the internodes, sometimes retrorse-hispid at the summit; ligule a ring of stiff hairs 1 to 2 mm long; blades erect or ascending, stiff, flat or the margins involute in



Fig. 10.—*Panicum cervicatum*, portion of panicle, $\times 1$; spikelet, two views of rachilla segment, and fruit, $\times 10$. (Type.)

dis, spiculis oblique positis; spiculae 6.5–8.5 mm longae 3–3.5 mm latae, turgidae, glabrae, basi constrictae; rachillae segmentum supremum (infra lemma fertile) subcarnosum, processum cartilagineum, crassiusculum, glabrum, ad basin (juxta supraque lemma sterile) gerentum; glumae et lemma sterile 9–11 nervia, acuminatae; gluma prima ovata, 3.5–4 mm longa; gluma secunda et lemma sterile hiantes, purpurascens, fructum superantes; fructus 4–4.5 mm longus, 2.2–2.4 mm latus, ellipticus, laevis.

Plants perennial, olivaceous, in clumps of few to several simple subrobust culms 80 to 135 cm tall, stiffly ascending to spreading, glabrous to roughened or hispid below the nodes and below the panicle; nodes appressed

drying, 20 to 35 cm long, 10 to 18 mm wide, long-acuminate, glabrous or scaberrulous to appressed-hispid on both surfaces, the firm scabrous margins hispid-ciliate, but the hairs readily breaking off; panicle erect, 30 to 50 cm long, open and nearly as wide at maturity, the stiff axis, branches, and branchlets striate, scabrous, stiffly flexuous toward the ends, the spikelets set obliquely on stiff pedicels toward the ends of the branchlets; spikelets 6.5 to 8.5 mm long, 3 to 3.5 mm wide, turgid, but constricted at base, glabrous, the glumes and sterile lemma firm, widely gaping at maturity, strongly 9- to 11-nerved, strongly pointed, blotched with dark purple, the first glume broadly ovate, about half as long as the sterile lemma, the second glume slightly longer than the sterile

lemma, both exceeding the fruit, the sterile lemma enclosing a well-developed palea; rachilla segments 0.7 to 1.2 mm long, thick, that between the sterile and fertile florets somewhat fleshy with an expanded summit and a thick cartilaginous process at the back; fruit 4 to 4.5 mm long, 2.2 to 2.4 mm wide, elliptic, smooth and shining, with a prominent scar at base.

Type in the U. S. National Herbarium, no. 1500814, collected in sandy clay cerrado aberto (campo with low scattered trees), 300–325 m altitude, Tres Lagoas, Matto Grosso, Brazil, February 4, 1930, by Agnes Chase, no. 10737.

The peculiar upper rachilla segment with the cartilaginous flaplike process is unlike anything in *Panicum* known to the writer. Before maturity this rachilla segment disarticulates at the base, remaining attached to the fruit (the flap sometimes remaining with the sterile lemma) but at maturity the rachilla segment usually breaks at the summit remaining with the sterile lemma. The specific name refers to the stiff-necked posture of the spikelets.

This species somewhat resembles *Panicum olyroides* H.B.K., to which Doell referred two

early collections from Minas Geraes, *Regnell* III 1369, Caldas (examined in Brussels), and *Warming*, Lagoa Santa, in 1864 (examined in Paris). It differs from *P. olyroides* in the less diffuse panicle and in the spikelets constricted at base with relatively long rachilla segments, and in the glabrous fruit, the fruit of *P. olyroides* having a tuft of thick hairs on the margins of the lemma at base.

Sandy or sandy-clay savannas, campos, and open cerrados, southern Venezuela and Brazil.

VENEZUELA: Amazonas, Isla de El Raton, *Williams* 13221.

BRAZIL: Maranhão: Barra do Corda to Gra-jahú, *Swallen* 3648. Minas Geraes: Serra do Cipó, *Chase* 9138. Pratinha, *Dorsett & Popenoe* 189b; Uberlandia, *Chase* 11167. Goyaz: Annapolis, *Chase* 11519; Viannapolis, *Chase* 11281; Rio Verde, *Chase* 11713; between Jataty and Rio Araguaya, *Chase* 11736. Matto Grosso: Near Rio Araguaya, *Chase* 11863; Tres Lagoas, *Chase* 10737; northwest of São Lourenço, *Chase* 11959; Sources du Paraguay, *Weddell* 3081. São Paulo: Casa Branca, *Chase* 10591.

BOTANY.—*New bamboos from Venezuela and Colombia.*¹ F. A. McCLURE,²
U. S. National Herbarium. (Communicated by AGNES CHASE.)

A study of the bamboos of Venezuela was undertaken at the request of Miss Zoraida Luces, Servicio Botanico, Ministerio de Agricultura y Cría, Venezuela, in connection with the preparation of her memoir on the *Genera of grasses of Venezuela*, which she carried out in the grass division of the U. S. National Herbarium. By way of facilitating the completion of this part of the project and familiarizing herself with the special technique, Miss Luces prepared dissections of the spikelets of all the critical species of bamboos. Mrs. Agnes Chase inked my pencil drawings, thus greatly hastening the consummation of the work.

Seven species (six from Venezuela, one from Colombia) are here described, in four genera, one of which is new to science. One transfer is made. A complete enumeration of the Venezuelan bamboos represented in the collections of the Herbario Nacional de Venezuela and the U. S. National Herbarium will be published later.

***Arthrostylidium ampliflorum* sp. nov.**

Fig. 1

Species flosculis amplissimis insignis.

Rami (floriferi tantum ex culmo disjuncti adsunt) usque ad 48 cm longi, tenues, omnino glabri, ima basi tantum divisi, internodiis basalibus aliquot brevissimis exceptis elongatis, infra nodos primo glaucis, nodis ad cicatricem collario glauco cinctis, supra cicatricem saepe valde et gibbose inflatis et secundum summam supercillii circumsecus anguste sulcatis, vaginae inferiores deciduae glabrae leviter farinosae. *Foliorum vaginae* angustae arctae omnino glabrae, nervis parum elevatis striatae, apice vel truncatae vel concavae; *auriculae* haud vel parum evolutae, glabrae; *setae orales* utrinque

0–1–2, 1–2 cm longae, graciles, glabrae; *ligula* subnulla; *petiolus* 1–2 mm longus, supra hispidulus, subtus glaber; *foliorum laminae* usque ad 128 mm longae et usque ad 13 mm latae, anguste lanceolatae, attenuate acuminatae, basi cuneato-rotundatae, textura tenues, supra glabrae subtus obscure scabrae, altero margine antrorse spinulosae altero subglabrae, costa invalida, nervis secundariis utrinque 4–5 vix quam tertiariis validioribus, venulis transversis supra haud visibilibus subtus interdum raris ac prope nullis aegre distinguendis, obliquis, sese remotis. *Inflorescentiae* ex apice ramorum foliiferorum egredientes, subspicatae, usque ad 10 cm longae, pleraeque 7–9-spiculatae. *Pedunculus* in foliorum vaginis ex toto celatus. *Rhachis* usque ad 5.5 cm longa, tenuis, glabra, semel ramosa, ramis (*pedicellis*) vix 1 mm longis, adpressis, glabris, solitariis, 1-spiculatis. *Spiculae* amplae, valde compressae, 4–6-florae, laxiusculae. *Flosculae* perfectae, infima interdum et suprema semper paullo tabescente. *Glumae* 2 vel 3, sibi approximatae, apice acuminatae, in aristam longam attenuatae, subglabrae vel plus minusve valde hispidulae, inaequales I: angustissima, 1-nervi, 5–7 mm longa, arista 2.5–3.5 mm longa non exclusa, II: 5–7-nervi, 10–11 mm longa, arista 2.5–4 mm longa non exclusa, III (forsan potius lemma sterilem dicenda): 9–11 nervi, usque ad 18 mm longa, arista 3–6 mm longa non exclusa. *Lemma* lanceolatum, apice acuminatum in aristam scabram attenuatum, usque ad 28 mm longum, arista usque ad 9 mm longa non exclusa, 13–15-nerve, extus subtiliter scabrum vel granulosum, nervo mediano deorsum scabro sursum hispidulo prominuloque. *Palea* usque ad 19 mm longa, lemma (dempto aristo) aequans vel brevior vel paullo exserta, apice obtusa, bicarinata, quum carinis ciliatis sursum in apiculas breves penicillatas excurrentibus bicornata, extra carinas utrinque 3-nervis hispidulaeque, inter carinas 2–4 nervis, antrorse hispida. *Rhachillae segmenta* gracilia, compressa claviformia, apice subito inflata (post abscissionem flosculae apice late poculiformia), omnino glabra, infimis 1–2 mm longis haud disarticulantibus, ceteris 5–7 mm longis, infra lemmata fertilia disarticulanti-

¹ Contribution from the Botanical Survey, Lingnan University, in continuation of bamboo research facilitated by occasional grants-in-aid from the National Research Council, the Rockefeller Foundation, and the China Foundation. Received February 24, 1942.

² Professor and curator of economic botany, Lingnan University, Canton, China, on leave in the United States.

bus. *Lodiculae* 2 (an typice?) interdum 1-0, subaequales, 4-5 mm longae, vel lanceolatae vel suboblanceolatae, obtusae, subopacae, 3-5-nerves, utrinque glabrae vel extus subtilissime

via, tenuia, glabra (an semper?). *Fructus* maturus non ad huc inventus.

Type in U. S. National Herbarium, no. 1126694, ex Herb. Nat. Hist. Mus. Vienna, col-

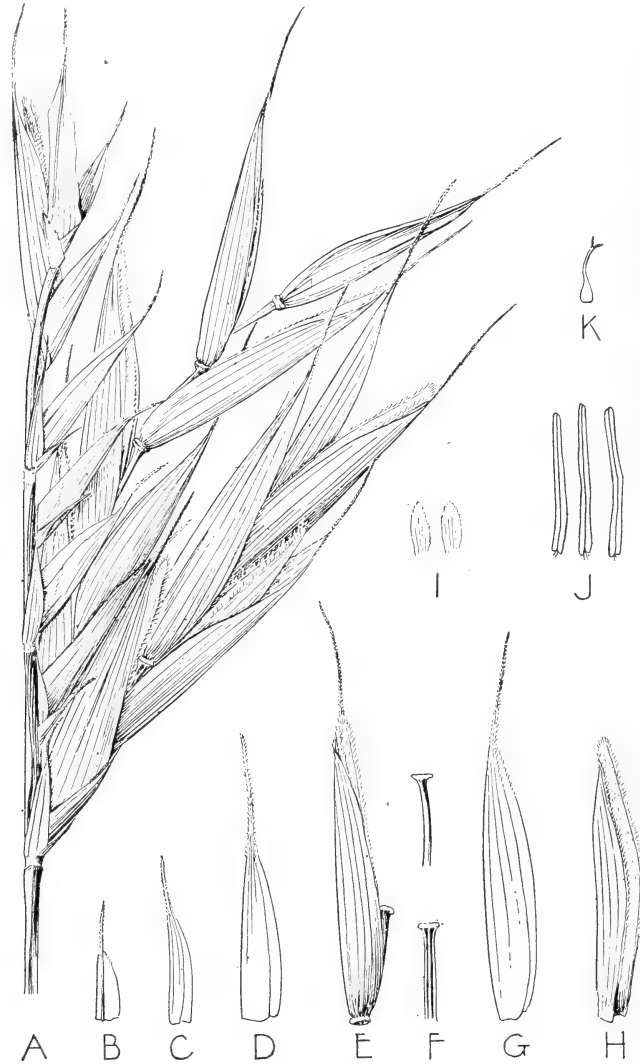

Fig. 1.—*Arthrostylidium ampliflorum*: A, Apical portion of an inflorescence; B, glume I (abaxial aspect); C, glume II; D, glume III (or sterile lemma); E, floret; F, lateral aspect (above) and outer aspect of rhachilla segment; G, lemma; H, palea; I, lodicules; J, stamen complement; K, pistil. All $\times 2$. (Type.)

adpresse puberulae, margine subglabrae vel prope apicem obscure ciliolatae. *Antherae* usque ad 10 mm longae, sublineares, sursum paullo attenuatae, apice obtusae. *Ovarium* glabrum, angustum, sursum in stylum longum tenuem glabrum attenuatum. *Stigmata* 2, bre-

lected by H. Karsten s.n., Venezuela, without other data. U. S. National Herbarium no. 1298695, ex Herb. Hort. Petrop., a single flowering branch, evidently represents the same collection.

This species is clearly distinguished from all

others of the genus known to me by its very large florets. Another striking feature is the conspicuous junction of the rhachilla segments with the florets. Viewed as a distinct unit, this

Arthrostylidium geminatum sp. nov.

Fig. 2

Species distinctissima sine affinitate arcta quam ad speciem mihi cognitam.

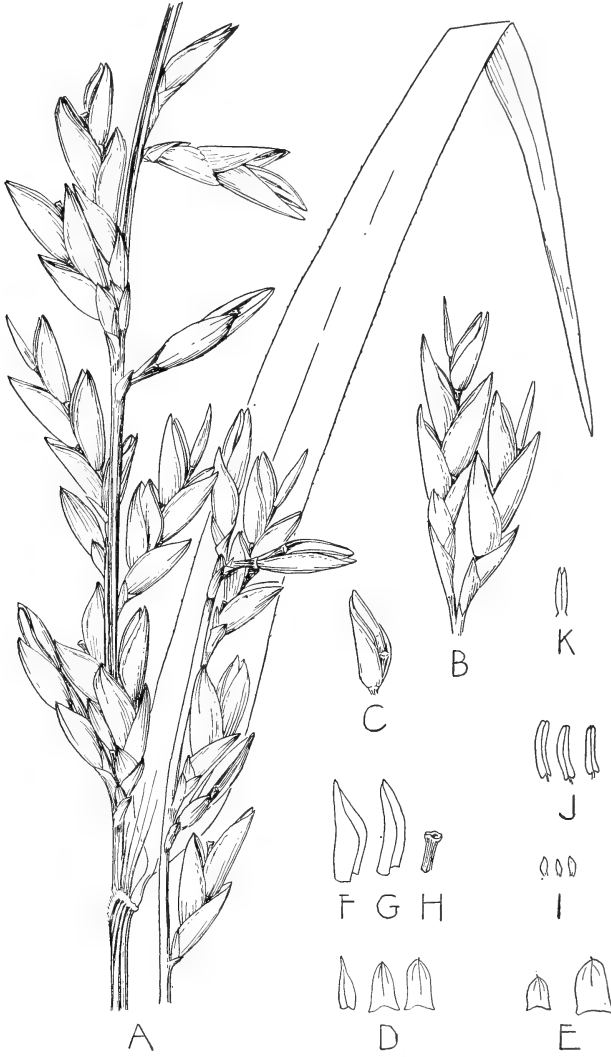

Fig. 2.—*Arthrostylidium geminatum*: A, Inflorescence; B, typical pair of spikelets; C, floret from middle of spikelet; D, typical set of 3 glumes; E, typical set of 2 glumes; F, lemma; G, palea; H, rhachilla segment; I, lodicules; J, stamens; K, pistil (stigmas lacking). All $\times 2$. (Type.)

region may be described as oblatly inflated. After the floret falls, the abruptly spreading summit of the rhachilla segment is like a shallow bowl.

Culmi altitudinis ignoratae usque ad 2.5 cm crassi; *internodia* fistulosa, inania, leviter elevato-striata, omnino glabra, teretia, supra sedem ramorum haud sulcata; *nodi* supra ci-

catricem vix inflati, ad cicatricem fibrillis vaginarum dissolutarum fimbriati. *Culmorum vaginae* (desideratae) evidenter haud deciduae sed in situ dissolventes. *Rami* (floriferi tantum adsunt) numerosissimi, subverticillati, omnes tenuissimi, 8-40 cm longi, ima basi tantum divisi, omnino glabri, levi, nitidi, plerique simul folias simul inflorescentias gerentes, nodis infimis tantum gemmiferis, saepe gibbose inflatis geniculatisque, vaginis glabris persistentibus fotis. *Foliorum vaginae* tenues, glabrae, sursum tenuiter elevato-nervosae, basi leves, pleraeque altero margine ciliatae altero glabrae; *auriculae* haud vel vix evolutae; *setae orales* paucae vel plurae vel nullae, 2-3 mm longae, rigidae, confertae, parallelae, glabrae, graciles, basi vix inflatae; *ligula* subnulla; *petiolus* 2-3 mm longus, fuscus, gracilis, utrinsecus glaber; *foliorum laminae* textura tenues, usque ad 9 cm longae et usque ad 9 mm latae, lineari-lanceolatae, apice attenuate acuminatae, basi cuneato-rotundatae, utrinsecus glabrae vel subglabrae, marginibus antrorse spinulosae, mox vel tarde deciduae, nervis secundariis quam tertiariis utrinque vix validioribus, venulis transversis haud visibilibus. *Inflorescentiae* ex apice ramorum foliiferorum singulatim egredientes, subpaniculatae. *Pedunculus* tenuis, enodosus, basi in foliorum vagina suprema velatus, sursum usque ad 3 cm exsertus, glaber. *Rhachis* usque ad 10.5 cm longa, gracilis, rigidiuscula, glabra, supra sedem ramulorum applanata vel sulcata, ramis glabris, adpressis, usque ad 2.5 mm longis, solitariis vel rarius approximatis, vulgo 2- (raro 3-) spiculatis, spicula suprema tantum in quoque ramulo brevipedicellata, lateralibus sessilibus vel subsessilibus. *Spiculae* in quoque inflorescentia usque 18 circa, usque ad 15 mm longae, compressae, pauciflorae, laxiusculae. *Glumae* 2-3, sibi approximatae, extus glabrae, intus apicem versus setis albis antrorse strigosae, I: 1.5-4 mm longa, oblonga vel subtriangula, apice obtusa et apiculata vel longe acuminata, dorso 1-3 nervi vel 1-carinata, II: 2.5-4 mm longa, ovata vel oblonga, apice obtusa, apiculata, dorso 3-nervi, III (forsan potius lemma sterilem dicenda): 3-4 mm longa, oblonga, apice obtusa apiculata, dorso 3-nervi, lemmatibus fertilibus simili sed multo brevioribus. *Flosculae* vulgo 5-6 quarum infima saepe suprema semper tabescente. *Lemma* fertile medianum usque ad 7 mm longum, superioribus inferiori-

busque vulgo paullo brevioribus, omnibus apice subacutis vel subito acuminatis, extus omnino glabris, intus apicem versus saepissime setis albis antrorse strigosis, nervis extus obscuris intus prominentibus circa 5. *Palea* lemma aequans vel brevior, raro paullo exserta, apice obtusa vel subacuta, interdum subtiliter comosa, dorso inter et secus carinas antrorse scabra, alioquin omnino glabra, nervis extus obscuris. *Rhachillae segmenta* infra tantum lemmata fertilia disarticulantia, infimis 1-2 mm longis, superioribus gradatim longioribus usque ad 3 mm longis, omnia secus latus proximum valde applanata, apicem versus abrupte infundibuliformia, apice subtilissime ciliolata alioquin glabra. *Lodiculae* 3 (eisdem in typo in mala conditione) parvae, circa 1 mm longae, crassiusculae, opacae, utrinsecus glabrae, margine (?). *Antherae* pleraeque in typo descitae reliquis usque ad 3.5 mm longis, linearibus, apice obtusis. *Ovarium* angustum, glabrum. *Styli* 2, glabri, fere ad basin distincti. *Stigmata* (desiderata). *Fructus* maturus non ad huc inventus.

Type in Herbario Nacional de Venezuela, Ministerio de Agricultura y Cría, Alfredo Jahn no. "125?" (no. 11, teste Zoraida Luces), collected Oct. 20, 1910, at Páramo de La Cristalina, on the border of the State of Trujillo, Venezuela; duplicate in the U. S. National Herbarium, no. 602204 (Jahn no. 11).

Arthrostylidium purpuratum sp. nov.

Fig. 3

Species arcte affinis *Arundinariae aristulatae* Doell, sed praecipue characteribus sequentibus differt: foliorum lamina supra glabris subtus omnino pilosis; pedicellis multo brevioribus; flosculis fuscis, lemmatibus paleisque intus purpura aciter tinctis extus haud viride punctatis; spiculis flosculisque multo longioribus; lemmatibus dorso valde scabris, marginibus ad apicem longe ciliatis; rhachillae segmentis fere duplo longioribus.

Rami (3 floriferi tantum inter se disjuncti, partem infimam carentes, in specimine adsunt) usque et ultra 68 cm longi, gracillimi, debiles, sublignosi, nisi forsan ima basi indivisi, omnino glabri, substriate maculati, nodis plus minusve inflatis. *Foliorum vaginae* arctae, angustae, omnino glabrae, elevato-nervosae, striate maculatae; *auriculae* raro subnullae, vulgo valide

evolutae, oblongae vel subfalcatae, crassae, plus minusve excurrentes inflataeque, tuberosae, pleraeque glabrae vel interdum sparse hispidae; *setae orales* raro perpaucae, vulgo nu-

serta, dorso hispidula, apice recta, margine denticulata ciliataque; *petiolus* 1-2 mm longus, fusce purpuratus, supra antrorse scaber, subtus glaber; *foliorum laminae* usque ad 10.5 cm lon-



Fig. 3.—*Arthrostylidium purpuratum*: A, Apical portion of inflorescence; B, glume I (abaxial aspect); C, glume II, with acuminate apex; C', glume II, with two keels and bifurcate apex, as found where it is addorsed to the main rhachis; D, floret; E, rhachilla segment, lateral (left) and inner aspects; F, lemma; G, palea; H, lodicule complement; I, two stamens from floret in lower part of spikelet; I', stamen from floret in upper part of spikelet; J, pistil; K, apex of leaf sheath showing typical well-developed auricle and oral setae, petiole, and base of leaf blade. All $\times 2$ except A, which is $\times 1\frac{1}{2}$. (Type.)

merosae, tenues, glabrae vel basi scabriusculae, subpurpuratae, usque ad 10 mm longae, valde flexuosae, vel ex marginibus vel undique ex auriculis egredientes; *ligula* brevissima vix ex-

gae et usque ad 12 mm latae, lanceolatae, acuminatae, basi anguste rotundatae, supra glabrae, subtus omnino pilis antrorsis pallidis dense vestitae, marginibus cartilagineae.

altero margine valide altero debiliter spinulosae, nervo medio valido, secundariis utrinque 4-5 e tertiariis vix distinctis, venulis transversis utrinque haud visibilibus. *Inflorescentiae* ex apice ramorum foliiferorum singulatim egredientes, paniculatae. *Pedunculus* usque ad 15 cm exsertus (parte infima usque ad 6.5 cm longa in foliae vagina fota), tenuis, subherbaceus, fistulosus, glaber, tenuiter elevato-nervosus. *Rhachis* usque ad 10 cm longa, tenuis, plus minusve angulata, glabra vel secus angulas vel scabra vel hispidula, simul iterumve divisa, ramis paucis, tenuissimis, vel adpressis vel patulis vel etiam retrorsis, quum pulvinis valide evolutis. *Pedicelli* gracillimi, vel scabri vel hispidi, lateralibus brevibus, 2-3 mm longis hispidis vel pilosis, terminalibus usque ad 12 mm longis, scabris vel hispidis. *Spiculae* angustae, gracillimae, laxiusculae, compressiusculae, subrectae. *Glumae* 2, sibi approximatae, inaequales, apicem versus secus nervum medium antorse scabrae, nervo medio in aristam scabram producto, I: circa 5 mm longa arista 1-2 mm longa non exclusa, anguste lanceolata, apice attenuate acuminata, subhyalina, decolorata vel viridiuscula, 1-3 nervi, II: usque ad 9 mm longa arista 1-2 mm longa non exclusa, oblongo-lanceolata, dorso apiceque variabile, nunc 3-nervi quum apice integro acuminata, nunc dorso bicarinata quum apice inaequaliter bifurcata, altera carina (nervo principali) in aristulam scabram producta, altera ad latus exteriorem obtuse alata, textura membranacea, deorsum purpura tincta sursum viridiuscula, extus glabra vel prope apicem hispidula, marginibus ad apicem ciliata. *Flosculae* subfusiformes vix compressae, usque ad 6 bene evolutae, adde huc unam terminalem tabescentem, omnes purpura fusca tinctae. *Lemma* lanceolatum, apice acuminatum, in aristam longam attenuatum, marginibus prope apicem longe ciliatum, plerumque 7-nerve, usque 17 mm rarius 18 mm longum arista 7 mm longa non exclusa, inferioribus superioribusque brevioribus. *Palea* 9-10 mm longa, fere numquam exserta, angusta, apice acuta vel subacuta, bicarinata, secus carinas anguste cartilagineas ciliata, inter carinas prope apicem hispida, alioquin extus fere omnino subtiliter scabra. *Rhachillae segmenta* infra tantum lemmata fertilia disarticulantia, gracillima, subclaviformia, secus latus proximum applanata, sulcata gla-

braque, secus latus distantem convexa et supra medium fusca granulosaque, infra medium straminea leviter nitidaque, apice interdum subtilissime ciliolata, I: circa 4 mm longo, superioribus gradatim longioribus usque ad 7 mm longis. *Lodiculae* 3, hyalinae vel subopacae, interdum purpura leviter tinctae, intus glabrae extus hispidulae, marginibus ciliolatae, anterioribus 2 usque ad 1.5 mm longis, deorsum angustatis, sursum oblique ovatis, apice obtusis, posteriore usque ad 2 mm longa, lanceolata, apice attenuate acuminata. *Stamina* 2 (an typice?), *antheris* usque ad 7 mm longis, linearibus, apice obtusis emarginatisque, in statu siccato fusco-brunneis. *Ovarium* glabrum, angustum, postice sulculo leviter notatum, apice in stylum gracillimum glabrum attenuatum. *Stigmata* 2, adpresse pilosa vel subplumosa. *Fructus* maturus non ad huc inventus.

Type in Herbario Nacional de Venezuela, Ministerio de Agricultura y Cría, Ll. Williams no. 10905, collected in 1938 at the summit of El Alvila, Federal District, Venezuela. There are two sheets under this number. The second sheet bearing a ramiferous node of a sterile culm, apparently not conspecific, was excluded from the type and given the number *Williams* 10905-A to distinguish it. Principal among the peculiarities of this specimen that led to its exclusion are: the more highly lignified, firmer texture of the wood, the almost complete lack of auricles and oral setae on the leaf sheaths, the very different shape of the leaf blades and, perhaps most important, the very different character and distribution of the pubescence of the leaf blades.

The specific epithet alludes to the dark purple color of the lemmas and paleas, which is particularly intense on the inner surface.

***Arthrostylidium venezuelae* (Steud.)
comb. nov.**

Chusquea Venezuelae Steud. Syn. Pl. Glum. 1: 337. 1854; Munro, Trans. Linn. Soc. 26: 55. 1868.

Although he had not seen the plant, Munro suspected, on account of the sessile spikelets, that it belonged in *Arthrostylidium*. This suspicion has been confirmed by a study of authentic material of the species. The type, J. Linden no. 494 (Voy. Funck et Schlim), cited by Steudel as Funck et Schlim no. 494, collected

at alt. 5000 ft. at Galipan, Caracas, Federal District, Venezuela, "1846, fl. en Avril," was seen by Dr. A. S. Hitchcock in the Boissier Herbarium at Geneva. I have studied several fragmentary specimens from the type collection at the U. S. National Herbarium, and the following specimens from Venezuela in the Herbario Nacional de Venezuela and U. S. National Herbarium:

ARAGUA: Rancho Grande (Parque Nacional), *Pittier* 13983.

WITHOUT PRECISE LOCALITY: *Voronoff* [*Woronow*] 454.

*Elytrostachys*³ gen. nov.

Genus faciebus aliis *Nasto* Juss. aliis *Perrierbambui* A. Camus arcte affine. Tamen, genus nostrum a *Perrierbambu* (genere in Hannonis⁴ Insula indigeno) characteribus saltem sequentibus distinguendum est: planta caespitosa; rhizoma stricte determinatum; rhachin fotentibus bracteis laminiferis setas orales insignas gerentibus; spiculae sesquiflorae; palea dorso invaginata ita intus fistulifera, in fistulam rhachillae segmentum gracillimum cum floscula inchoativa praefixa celans. Genus *Elytrostachys* a *Nasto* (genere in Insula Bourbonia et Hannonis Insula indigeno) characteribus sequentibus abit: inflorescentia brevissima quasi spicata, sine pedunculo distincto, paucispiculata, a latere indeterminata, rhachi principali brevissimi, bracteis amplis plerisque laminiferis gemmiparis, setas orales insignes gerentibus obtecta, rhacheos ramulis unisquibusque prophyllum ima basi gerentibus; spiculae pauciflorae (in speciebus notis sesquifloris); lemmata sterilia nulla; stigmata typice 2. Denique, ut aliquis opinabatur, genus nostrum, saltem inflorescentiarum habitu superficiali (videlicet: inflorescentiae ex apice ramorum egredientes, compressae, quasi spicatae, bracteis laminiferis tectae) remote simile *Phyllostachy* Sieb. & Zucc. videtur. Tamen, rhizomate determinato tantum, culmi internodiis teretibus, ramis plurimis verticillatis, staminibus 6, stigmatibus 2, palea intus fistulosa, etc., quamobrem *Elytrostachys* a *Phyllostachy* remote distat.

³ ἔλυτρον, covering, alluding to the elytra-like bracts that cover the main rhachis and conceal the real structure of the inflorescence from the casual observer, + σπᾶχυς, a spike, alluding to the spikelike aspect of the inflorescence.

⁴ "Hannibal's Island, i.e. Madagascar.

Characteres generis: *Planta* caespitosa, caespitibus discretis. *Rhizoma* determinatum. *Culmi internodia* fistulosa, inania, teretia, supra sedem ramorum vix vel leviter et breviter tantum sulcata. *Culmi vaginae* (demptis eis plantarum juvenissimarum) desideratae. *Rami* plurimi, vel subverticillati vel verticillati, tenues. *Foliorum laminae* marginibus subtiliter serrato-scabrae, maturitate quidem venulas transversas manifestas carentes. *Inflorescentiae* ex apice ramorum foliferorum singulatim egredientes, sine pedunculo distincto, breves, compressae, quasi spicatae, vel racemose vel paniculatim ramosae, a latere indeterminatae, axibus subsidiariis brevibus unisquibusque ima basi prophylo fotis, plerisque sursum bracteis gemmiparis tectis itaque *pseudospiculas*⁵ componentibus; rhachin principalem foventibus bracteis laminiferis setas orales insignes gerentibus. *Spiculae* pauciflorae (in speciebus notis sesquiflorae), lemmata steriles carentes. *Glu-mae* typice 2, sibi approximatae. *Rhachillae segmentum* infra tantum lemma fertile articulans claviforme, haud applanatum, vel breve vel plus minusve elongatum. *Palea* dorso invaginata ita intus fistulifera, intra fistulam rhachillae segmentum gracillimum cum floscula inchoativa praefixa celans. *Lodiculae* typice 3. *Stamina* typice 6. *Fructus* ignoratus.

Typus: *Elytrostachys typica*.

The specimens that served as the basis of the description of the type species of the genus *Elytrostachys* had been labeled by someone "*Phyllostachys aurea* Riviere?". This misidentification apparently led to the supposition that both this and the Colombian species were introduced, since no species of *Phyllostachys* has been found to be native in South America. Aside from the rather deceptive appearance of the peculiar, spikelike inflorescences that are borne singly at the tips of leafy branches and are clothed with laminiferous bracts, the plant has nothing in common with *Phyllostachys* except the very general characters that bind all the bamboos together. The most obvious affinities of the genus *Elytrostachys* are with *Nastus* Juss. and *Perrierbambus* A. Camus. With *Nastus*, *Elytrostachys* has in common the verticillate branching habit of the culm, the

⁵ For definition and explanation of term pseudospikelet see McClure, this JOURNAL 24: 541-548. 1934.

lack of conspicuous transverse veinlets in the leaf blades, and the general plan of the spikelets, including the terminal, rudimentary floret. The type species of *Nastus*, however, differs from that of *Elytrostachys* in the following fundamental respects: Inflorescences borne on more elongate, specialized, ebracteate peduncles, larger and more effusely branched but laterally determinate (i.e., without tardily developing buds) and lacking throughout prophylls, gemmiparous bracts and undeveloped buds; spikelets very uniform in size, each with several sterile lemmas, the palea shallowly sulcate at the back, not fistulose, and 3 styles. *Elytrostachys* has in common with *Perrierbambus*, so far as their type species are concerned, the following characters: the verticillate branching habit of the culm, the lack of transverse veinlets in the leaf blades, the general orientation and structure of the inflorescence, and the following features of the spikelet: two glumes, one fertile lemma, no sterile lemmas, three lodicules, six stamens with free, filiform filaments. *Perrierbambus*, however, besides having a very different appearance in the fragments seen, differs, as described by Mlle. Camus, in the following respects: rhizomes traccant (indeterminate?), the culms distant from each other, giving the plant a dumetose habit; the spikelets 1-flowered, the palea not keeled nor dorsally invaginate, and without any vestige of a rhachilla segment or rudimentary terminal floret at its back. While the two lines are apparently rather closely allied, their fundamental difference in the rhizome habit, on the vegetative side, and in the structure of the spikelet and the palea of the fertile floret, on the reproductive side, have led me, in the light of the significance of these characters in other genera, to expect that other supporting differences will be found when more ample material becomes available.

It is a noteworthy fact, though not one to be given undue weight in deciding their taxonomic disposition, that *Nastus* and *Perrierbambus* are both Old World genera. *Perrierbambus* is known only from Madagascar, and *Nastus* from the Isle of Bourbon and Madagascar. All South American species hitherto attached to *Nastus* have proved, insofar as they have been studied critically, to belong to other New World genera.

Elytrostachys typica sp. nov.

Fig. 4

Planta conferte caespitosa; *rhizoma* determinatum (teste Pittier per colloquia). *Culmi* 6–10 m alti, basi usque ad 4 cm crassi (teste Pittier), *internodiis* (ramifero sectio mediano tantum culmi adest) teretibus, infra nodos paullo sericeis, alioquin glabris vel glabrescentibus, intus fistulosis, inanibus, *nodis* vix inflatis. *Culmorum vaginae* (desideratae). *Rami* (floriferi tantum adsunt) 5–33 cm longi, tenues, crassitudine subaequales, ima basi tantum divisi, omnino glabri, *nodis* vix inflatis, eorum mediis haud gemmiferis, *vaginas* persistentes gerentibus. *Foliorum vaginae* arctae, cylindratae, glabrae, apice tantum elevato-nervosae alioquin immerse nervosae; *auriculae* parvae, glabrae, interdum subnullae; *setae orales* paucae, usque ad 15 mm longae, rigidulae, erectae (haud radiatae), dempta basi bulbosa gracillimae, antrorse scabrae; *ligula* subnulla; *petiolus* gracilis, 1.5–2 mm longus, subtus glaber, supra secus medium hispidulus; *foliorum laminae* usque ad 83 mm longae et usque ad paene 10 mm latae, lanceolatae vel oblongo-lanceolatae, apice attenuate acuminatae basi rotundatae, supra prope margines plus minusve scabrae alioquin utrinsecus glabrae, nervis secundariis utrinque 3–4, e tertiariis sursum aegre distinguendis. *Inflorescentia* circa 30 cm longa; *rhachis* principalis glabris, internodiis claviformibus, infimo usque ad 8 mm longo superioribus gradatim multo brevioribus; *bractea gemmiparae* (rhacheos principalis) vulgo 3, rarius 4, subspatuliformes, laxae, usque ad 15 mm longae, subelevate nervosae, glabrae, suprema interdum excepta foliiferae; *auriculae* minutae, glabrae; *setae orales* paucae, usque ad 25 mm longae, graciles, pleraeque radiatae, dempta basi bulbosa glabra gracillimae scabrae; *ligula* subnulla; *laminae* petiolatae, et alioquin ut in foliorum laminis (vide supra); *bractea suprema* (rhacheos principalis) interdum a ceteris differens: oblonga, auriculas et setas orales carens, apice integra vel laminellam decoloratam angustissime linearem sessilem persistentem gerens, lamellam tamen interdum funditus carens; *pseudospiculae* (axes subsidiarii, omnes in typo juveniles) superiores maximae; *prophylla* carinis late alata, margine alae subtiliter ciliolata alioquin utrinque glabra;



Fig. 4.—*Elytrostachys typica*: A, Inflorescence at tip of leafy branch (note tip of rhachilla segment at base of exerted floret); B, laminiferous bract (or sheath) from the base of the inflorescence (the blade has fallen); C, very young pseudospikelet from the axil of bract at left (note prophyll at its base); D, aphyllous, long-tipped bract, the uppermost on the main rachis; E, immature pseudospikelet from the axil of bract at left (note prophyll at its base); F, glume I; G, glume II; H, rhachilla segment which terminated the main rachis and bore a fertile floret; I, lemma; J, palea; K, palea in longitudinal section, showing rudimentary rhachilla segment and floret, which lie in the fistula or dorsal fold; L, a lodicule from the anterior pair: adaxial (left) and abaxial aspects; M, anther; N, pistil; O, diagram showing the parts of a typical inflorescence: Beginning at the base, we find the following appendages at the successive levels: A prophyll, with a vegetative bud in its axil; two bracts, each with a vegetative bud in its axil; three empty bracts; three laminiferous bracts (or sheaths) each with a reproductive bud (young pseudospikelet, its prophyll shown separately) in its axil; aphyllous, long-tipped bract, with a reproductive bud (young pseudospikelet; its prophyll shown separately) in its axil; first glume; second glume; lemma, in longitudinal section; palea, in longitudinal section, showing, within the fistula or dorsal fold, the slender rhachilla segment bearing a rudimentary floret (the reproductive organs of the fertile floret omitted); P, diagram showing the appendages of a typical lateral axis or pseudospikelet, as compared with those of the main axis of the inflorescence. The appendages are (beginning at the base): A prophyll; gemmiparous bract with a pseudospikelet in its axil; first glume; second glume; a perfect floret (the slender rhachilla segment bearing a rudimentary floret shown removed from the dorsal fold of the palea); the reproductive organs of the fertile floret omitted. All, except O and P, $\times 2$. (Type.)

bractea gemmiparae (axium subsidiorum) vulgo 1, raro nullae, glumis similes sed multo breviores. *Spiculae* sesquiflorae subfusiformes vix compressae. *Glumae* 2, laxae, glabrae, papyraceae, nervosae, apice acutae vel obtusae, I: usque ad 11 mm longa, anguste triangula, II: usque ad 15 mm longa, quam I fere duplo ampliore, naviculiforme. *Rhachillae segmentum* flosculam fertilem gerens glabrum, in axi principali plerumque brevissimum, rarissime usque ad 6 mm longum, in axibus subsidiariis vulgo usque ad 6.5 mm longum. *Floscula* fertilis decidua, subfusiformis, modice inflata, vix compressa. *Lemma* usque ad 22 vel 23 mm longum lanceolatum, apice attenuate acuminatum, extus glabrum, nervis plus minusve manifeste nervosissimum, intus et nervis et venulis oblique transversis prominentibus notatum. *Palea* lemma aequans vel brevior vel rarius longior, angustior, ventricosula, apice subobtusata, extus glabra, nervosa, intus venulas transversas carens. *Lodiculae* 3, typice subhyalinae trinervesque, intus glabrae, extus puberulae, margine subtiliter ciliatae, anterioribus 2 maioribus usque ad 4 mm longis, basi angustatis, sursum gibbose ovatis, posteriore lanceolata angustioreque, omnibus pervariabilis, interdum deformibus crassis et opacis, saepe minutis. *Stamina* vulgo 6, raro 5 (1-2 interdum plus minusve tabescentibus), usque ad 15 mm longa, angusta, supra in apicem obtusam paullo attenuata. *Ovarium* glabrum fusiforme, apice attenuatum. *Stigmata* 2, sibi approximata, erecta, rigidula, scabra vel tomentosa (an typice?). *Fructus* non ad huc inventus.

Type in Herbario Nacional de Venezuela, Ministerio de Agricultura y Cría, Pittier no. 9226, collected February 21, 1921, at alt. 600 m, in the edge of a monsoon forest near El Limon, Valle Puerto La Cruz, Federal District, Venezuela. Duplicate in U. S. National Herbarium, no. 1067333.

***Elytrostachys clavigera* sp. nov.**

Figs. 5, 6

Species e generis typo differt praecipue foliorum laminis supra, basin versus, scabris; inflorescentiarum bracteis laminiferis ultra $\frac{1}{2}$ longioribus latioribusque et pro parte saltem sericeo-pubescentibus; glumis circa $\frac{1}{4}$ longioribus; rhachillae segmenta flosculam fertilem

gerente vulgo circa duplo longiore et per medium saltem pubescente; flosculis perfectis vulgo $\frac{1}{3}$ brevioribus.

Culmi altitudinis ignoratae usque ad vel ultra 4 cm diametro, *internodiis* in medio culmi usque ad vel ultra 37 cm longis, setis aciculiformibus adpressis plus minusve dense obsitis, fistulosis, inanibus, teretibus, ligno circa 2 mm crasso, *nodis* vix inflatis, ad cicatricem prominulam collario angusto cinctis. *Culmorum vaginae* (desideratae). *Rami* (fliferi tantum adsunt) usque ad 20 cm longi, tenues, crassitudine subaequales, ima basi tantum divisi, omnino glabri, nodis vix inflatis, eorundem mediis haud gemmiferis, omnibus vaginas persistentes gerentibus. *Foliorum vaginae* arctae, cylindratae, glabrae vel fere glabrae, omnino immerse nervosae vel apice tantum elevato-nervosae; *auriculae* parvae, glabrae, interdum subnullae; *setae orales* paucae, usque ad 12 mm longae, dempta basi bulbosa glabra graciles scabraeque, rigidulae, erectae vel patentes; *ligula* subnulla; *petiolus* gracilis, circa 1 mm longus, aut utrinque vel glaber vel hispidulus aut superficiei altera utra hispidulus; *foliorum laminae* pleraeque descitae, reliquis usque ad 75 mm longis et usque ad 11 mm latis, lanceolatis, apice attenuate acuminatis, basi rotundatis, infra glabris, supra praecipue basin versus antrorse scabris, marginibus subtiliter serrato-scabrae, nervis secundariis utrinque 3-4, sursum a tertiariis aegre distinguendis. *Inflorescentia* usque ad 50 mm longa; *rhachis* principalis deorsum saltem pubescens, internodiis claviformibus, infimo usque ad 9 mm longo, superioribus gradatim multo brevioribus, supremo vix 1 mm longo; *bractea gemmiparae* (rhacheos principalis) vulgo 3-4, alveoliformes, laxae, subpapyraceae, fragiles, facile fissiles, usque ad 22 mm longae, pleraeque immerse nervosae, pro parte saltem subsericeo-pubescentes, suprema interdum excepta omnes foliiferae; *auriculae* modice evolutae, angustissimae, glabrae, fragilissimae prius dissolventes quam eas foliarum vaginarum; *setae orales* plures, usque ad 18 mm longae, pleraeque radiatae, graciles, rigidulae, dempta basi bulbosa scabrae; *ligula* subnulla; *laminae* petiolatae, alioquin ut in foliorum laminis (vide supra); *bractea suprema* (rhacheos principalis) interdum a ceteris differens: oblonga, auriculas et setas orales carens, apice

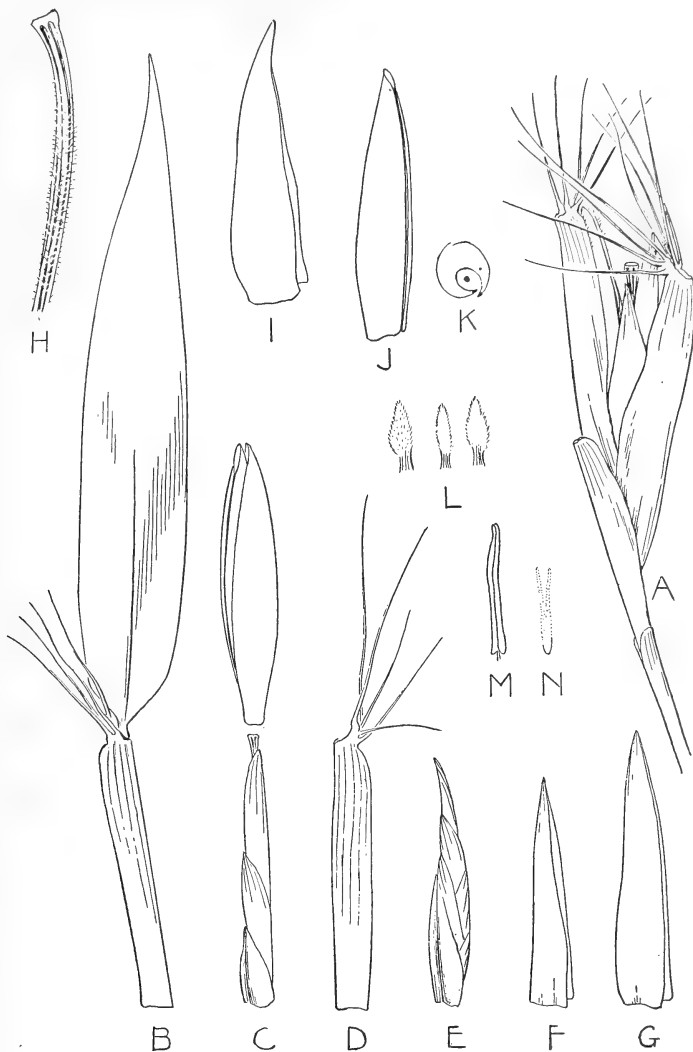

Fig. 5.—*Elytrostachys clavigera*: A, Inflorescence (the bracts have lost their blades, note apex of empty rhachilla segment at center); B, laminiferous bract (or sheath) from base of inflorescence; C, pseudospikelet (with disarticulated floret) from axil of bract at left (note prophyll at base); D, bract (or sheath) from which the blade has fallen; E, immature pseudospikelet from axil of bract at left (note prophyll at base); F, glume I; G, glume II; H, rhachilla segment, which bore a fertile floret (at tip of main rhachis); I, lemma; J, palea (note dark line marking course of fistula or dorsal fold, which often widens to an elongate, narrowly funnel shaped mouth at the apex); K, diagrammatic cross section of the palea (the dot indicates the rudimentary rhachilla and floret which lie in the dorsal fold); L, lodicules (left and right are abaxial and adaxial aspects, respectively, of one of the anterior pair, center is adaxial aspect of the posterior one); M, anther; N, pistil. All $\times 2$. (Type.)

integra vel laminellam decoloratam angustissimam linearem sessilem persistentem gerens, laminellam tamen interdum funditum carens; *pseudospiculae* (rhacheos rami) compositae, bis terve divisae; *prophylla* carinis late alata, alis margine subtiliter ciliolatis, alioquin utrinque

glabra; *bractee gemmiparae* (axium subsidi-
orum) vulgo 1, rarius 2-0, glumis similes sed
multo breviores, suprema rarissime inani
(gemmae carente). *Spiculae* sesquiflorae sub-
fusiformes, vix compressae. *Glumae* 2, laxae,
papyraceae, pallidae, nervosae, lanceolatae,

apice acutae vel obtusae, vulgo (infima in rhachi principali excepta) glabrae vel fere glabrae, I: usque ad 14 mm longa, II: usque ad 18 mm longa. *Rhachillae segmentum* flosculam fertilelem gerens claviforme, valde striatum, plus minusve curvatum, per medium pilosum, in axi principali usque ad 17 mm longum,

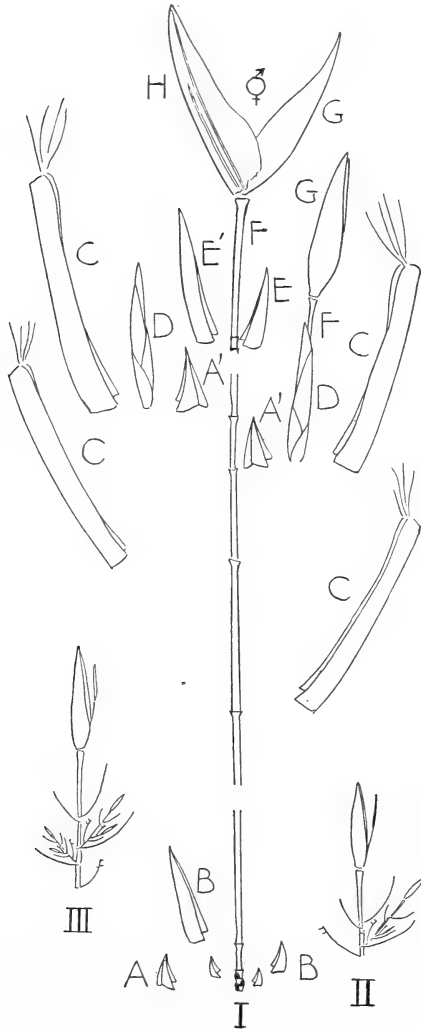

Fig. 6.—*Elytrostachys clavigera*: I, Diagram showing the parts of a typical inflorescence: A, A', Prophylls; B, aphyllous bracts (the lower two have vegetative buds in their axils); C, laminiferous bracts, the blades omitted; D, pseudospikelets with prophylls removed; E, E', glumes I and II; F, rhachilla segments supporting fertile florets; G, fertile florets; H, palea of fertile floret and, in its fistula, a rudimentary rhachilla segment and floret. II and III, Diagrams of secondary rhachises (pseudospikelets) shown at D above. (Type.)

ceteris brevioribus gracilioribusque. *Floscula fertillis* decidua, fusiformis, modice inflata, vix vel paullo compressa. *Lemma* usque ad 17 mm longum, naviculiforme, ventricosulum, extus fere glabrum sed subtiliter granulolum, omnino plus minusve manifeste nervosum, intus et nervis et venulis oblique transversis prominentibus notatum. *Palea* lemma aequans vel paullo longior, ventricosula, sparse nervosa, glabra, subtiliter granulosa, apice subobtusa. *Lodiculae* typice 3, intus glabrae extus puberulae, margine subtiliter ciliolatae, anterioribus 2 maioribus, usque ad 4 mm longis, basi angustatis, supra gibbose ovatis, posteriore angustiore brevioraque, lanceolata, omnibus pervariabilis, vel hyalinis vel opacis, interdum deformibus. *Stamina* 6, usque ad 8 mm longa, apice obtusa (pleraque in specimine descita). *Ovarium* angustum, subfusiforme, sursum hispidulum. *Stigmata* 2, sibi approximata, erecta, rigidula, hispidula. *Fructus* non ad huc inventus.

Type in U. S. National Herbarium (4 sheets) 1062456–1062459, H. M. Curran no. 123, collected "April-May, 1916, growing wild in inaccessible mountain region, alt. 150–600 m, along the Norosi-Tiquisio trail, Lands of Loba, Dept. of Bolivar, Colombia. *Cariso de Castilla*. Introduced (?)."

The following flowering specimens from Costa Rica belong here: *Tonduz* 3627 (U. S. Nat. Herb. nos. 825695 and 1111016) and *Tonduz* 9498 (U. S. Nat. Herb. nos. 825696 and 1021541).

This species was misunderstood, by the collector, as belonging to the genus *Phyllostachys*, which accounts for the queried word "introduced" in the field notes attached to the type. It is clearly and closely related to the type of *Elytrostachys* but is easily distinguishable, as far as the available material is concerned, by the following characters: leaf blades scabrous on the upper surface, especially toward the base; laminiferous bracts of the inflorescence a half larger and at least in part pubescent; glumes one-fourth longer; rhachilla segments bearing fertile florets commonly twice as long and pubescent, at least in the middle portion; perfect florets commonly one-third shorter; ovary hispidulous in the upper part.

The specific epithet alludes to the elongate rhachilla segments which support the fertile florets. These remain as a cluster of club-

shaped branches, exerted beyond the glumes, and constitute a characteristic feature of the subsidiary axes in old inflorescences from which the fugacious mature florets have fallen away.

The following description of seedling plants included in the type collection, but not used as a basis of the formal description of the species may be helpful in field identifications (the plants are about 25 cm tall and of unknown age, perhaps about a year old): *Plant* caespitose. *Rhizome* strictly determinate. *Culms* (the primary one evidently withering soon after the secondary ones are established) erect or suberect, the internodes terete, entirely glabrous and purple-punctate to densely tomentose throughout, fistulose, the wood thin. *Culm sheaths* apparently persistent, or at least somewhat so, shorter than the internodes, elevate-nervose, glabrous and purple-punctate to densely tomentose throughout, subtruncate at the summit; *auricles* minute, very variable, sometimes almost entirely undeveloped, more rarely strongly developed, falcate, glabrous; *oral setae* several, commonly up to 10 mm, rarely 20 mm, long, slender, stiff, somewhat spreading, obscurely and sparsely scabrous; *ligule* very short, not exerted; *blades* green, fugacious, lanceolate, like the leaf blades but sessile or subsessile, smaller, and more obtuse at the apex and subtruncate at the base. *Branches* (not yet developed). *Leaf sheaths* elevate-nervose, densely covered between the veins with very minute points, otherwise glabrous throughout but sometimes hirsute near the margins or more or less densely hispid throughout; *auricles* very variable, sometimes almost entirely undeveloped, rarely strongly developed, falcate, glabrous; *oral setae* several, often wine-colored, 10–20 mm long, slender, stiff, erect or somewhat spreading, obscurely and sparsely scabrous; *ligule* very short, not exerted; *petiole* very short, pale, glabrous or hispidulous on both surfaces, the margins somewhat ciliolate; *leaf blades* up to 126 mm or more in length and up to 24 mm in width, oblong-lanceolate, acuminate at the apex, rounded at the base, the upper surface, principally near the base, densely scabrous or hispidulous, the lower glabrous throughout or with a few short hairs near the base, the margins minutely serrate-scabrous, the secondary nerves 3–4 on each side of the midrib,

clearly distinct from the tertiary ones, transverse veinlets usually not at all evident but sometimes seen on the upper surface of very young leaves as very distant and oblique.

Chusquea hispida sp. nov.

Fig. 7

Species in forma vaginarum culmi arcte similis *Chusqueae tuberosae* Swallen sed, quoad specimina quae ad manum sunt, in characteribus sequentibus differt: culmi vaginis textura tenuioribus, conferte et pulchre elevato-nervosis, cum setis patulis aciculiformibus basi bulbosis obsitis; culmorum internodiis infra nodos tantum hirsutis alioquin glabris; foliorum laminis tenuioribus; alioquin omnibus partibus textura plus herbaceis.

Culmi subscandentes (teste Pittier) longitudinalis ignotae usque (statu siccato) ad 7.5 mm diametro; *internodia* teretia vel cylindrata, supra sedem ramorum haud applanata nec sulcata, sublignosa, solida vel subsolida, intus textura submedullosa, extus infra nodos cum setis aciculiformibus basi bulbosis hirsuta alioquin glabra nitidaque; *nodi* ad cicatricem prominulam cum collario tenui hispido cincti, supra cicatricem modice inflati. *Culmorum vaginae* plus minusve persistentes, arcte amplexantes, basi in zonam angustam fuscam hispidam tenuatae, supra basin omnino farinosae conferte et pulchre elevato-nervosae, cum setis patulis aciculiformibus basi bulbosis obsitae, apice extus in laminam sensim inentes, intus *ligula* tenui 1 mm alta subacute arcuata margine subtiliter ciliata notatae, *auriculas* et *setas orales* carentes; *lamina* amplissima, patula, vaginae propriae subaequilongae, apice in apicula subito acuminata, basi cordata utrinque excurrentes, textura omnino tenella, extus ad medium basis interdum sparse pilosa alioquin utrinsecus glabra, marginibus subtilissime spinulosa, utrinque elevato-nervosa, venulis transversis obliquis sese remotulis praecipue extus manifestis notata. *Rami* primarii interdum solitarii sed typice ad quemque nodum culmi in ordinibus duobus dispositi, I (inferiores): numerosi, prompte evoluti, graciles, crassitudine subaequales, usque ad 24 cm longi, vulgo ima basi tantum divisi, II (superior): unus tantum, tarde evolutus, longus, robustus, ad quemque nodum verticillum

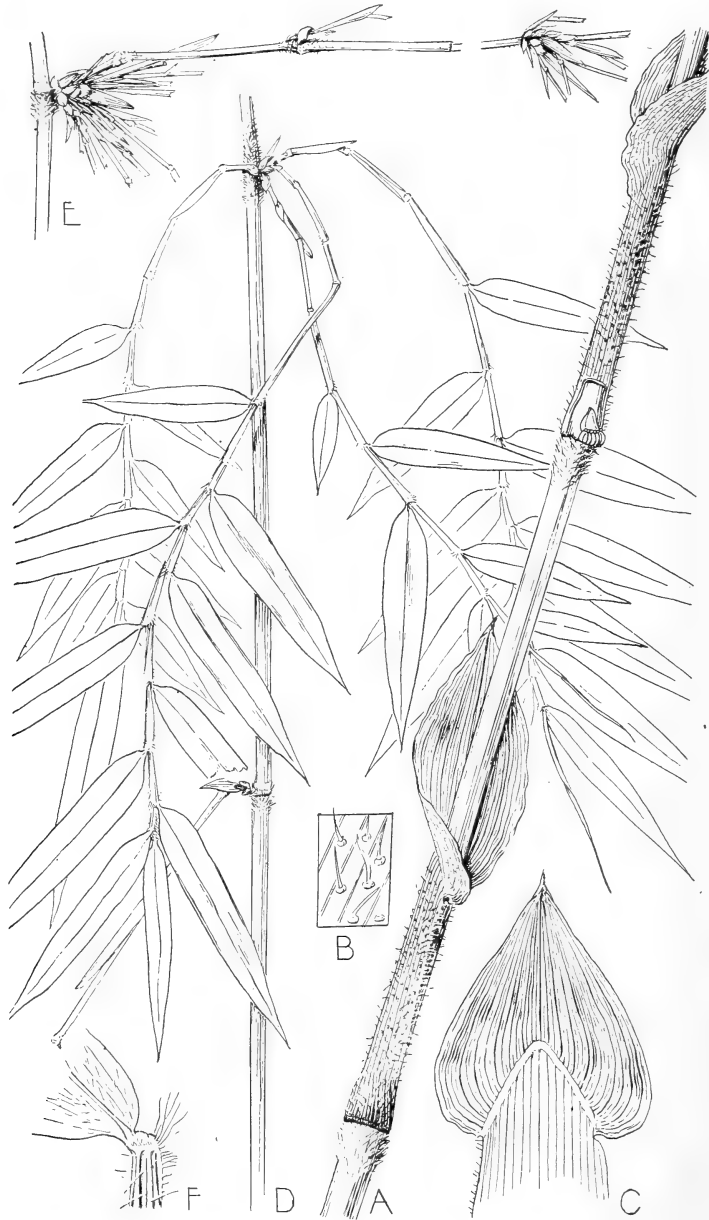

Fig. 7.—*Chusquea hispida*: A, Portion of young culm, showing two culm sheaths, the base of the upper sheath removed to show a cluster of very young, subequal branches (below) and an unopened bud (compare later stage at E); B, enlargement of a portion of the surface of the culm sheath proper; C, adaxial aspect of upper portion of culm sheath and blade, showing the ligule; D, portion of culm, showing lowest branching nodes; E, portion of culm, showing a typical branching node from the midst of the series (compare the early stage shown at the upper node in A); F, enlargement of the meeting place of the leaf sheath and blade. All $\times \frac{1}{2}$ except B and F. (Type.)

ramulorum gerens, ramis ramulisque omnibus nodis plus minusve inflatis hirsutisque, internodiis scabris, cum vaginis plus minusve persistentibus elevato-nervosis inter nervos granulosis hispidisque obtectis. *Foliorum vaginae* in quoque ramo usque ad 13, insigniter carinatae, valde elevato-nervosae, inter nervos subtiliter granulosae, vulgo praecipue apicem versus dorso pilosae et marginibus longe ciliatae, margine poculi (petioli cicatrice) prominentis longe ciliatae; *ligula* subnulla; *auriculae* nullae; *setae orales* plures, confertae, usque ad 1.5 mm longae; tenuissimae, pallidae, glabrae, flexuosae; *petiolus* brevissimus subnullus; *foliorum laminae* usque ad 11 cm longae et usque ad 18 mm latae, oblongo- vel ovato-lanceolatae, acuminatae, basi cuneato-rotundatae, textura tenues, marginibus subtiliter spinulosae et vulgo revolutae, subtus prope basin et interdum secus costam pilosae, supra secus costam et secus alterem marginem scabrae alioquin vel glabrae vel subtilissime asperae, nervis secundariis utrinque 2-3, sese remotis, tenuis sed subtus distinctissimis, venulis transversis debilibus et sese remotis, in laminis juvenilibus interdum manifestis, alioquin aegre vel haud discernendis. *Inflorescentiae* (desideratae).

Type in the Herbario Nacional de Venezuela, Ministerio de Agricultura y Cría, H. Pittier no. 7159, collected May 13, 1917, at alt. above 1,400 m, in upper Catuche wood, near Caracas, Federal District, Venezuela; "half-climbing, forming extensive thickets (*carri-zales*) characteristic." Duplicate type in U. S. National Herbarium, no. 987284.

Neurolepis pittieri sp. nov.

Fig. 8

Species habitu et coloratione inflorescentiae arcte affinis *N. nobili* (Munro) Pilger. Tamen, posterior species differt planta fere omnibus partibus ampliore, panicularum axi ramisque inter tantum supercilios prominentes pubescentibus, spiculis $\frac{1}{3}$ - $\frac{1}{2}$ brevioribus sed proportionem latioribus, glumis hirsutiuseculis distincte carinatis apiculatisque, lemmatibus subtiliter pubescentibus.

Planta monocarpica, caespitosa, caespitibus discretis (teste Pittier per colloquia). *Culmi* 5.5-6 m alti, erecti vel suberecti, simplices vel basin versus divisi, sublignosi; *internodia* per-

brevia, infra nodos interdum setis pallidis brevibus adpressis leviter vestita alioquin glabra, cum vaginis imbricatis persistentibus foliorum omnino velata (culmorum vaginis distinctis in type saltem speciei nullis). *Foliorum vaginae* compressae, crasse carinatae, praecipue deorsum elevato-nervosae, basin versus puberulae alioquin glabrae nitidaeque, apice post et ultra ligulam productae in processibus duobus, eisdem usque ad 6.3 cm longis, planis, tenuis, anguste subtriangulis, sursum ad apicem obtusam attenuatis, textura medullosis, in statu siccato fragilissimis, utrinque dense et subadpresso hirsutis, facie adaxiale ad hoc, praecipue basin versus, setis vel fibrillis crassis adpressis compressis ciliatis obsitis, marginibus interioribus glabris exterioribus sursum glabris deorsum setis crassis conferte ciliatis et sensim in auriculis inentibus; *auriculae* oblique egredientes, usque ad 2 cm longae et 2-3 mm latae, crassae, inflatae, adpressae haud excurrentes, basi glabrae, apice cum setis crassis 2-5 mm longis conferte vestitae; *ligula* ad medium circa 7 mm longa, apice subtiliter convexa vel subrecta, margine dense ciliolata; *petiolus* haud articulatus, deorsum in vaginam et sursum in laminam sensim inens, glaber, crassus, rigidus, profunde sulcatus; *foliorum laminae* usque ad 215 cm longae, attenuatae, et usque ad 17 cm latae, lanceolatae, apice longe acuminatae, basi longe angustequae attenuatae fere ad basin petioli decurrentes, supra secus marginem alterem scabrae alioquin utrinsecus glabrae, marginibus cartilagineis antrorse spinulosae, nervis secundariis utrinque usque ad 16 vel 17, tertiariis in quoque commissura 6-8, venulis transversis sese remotis, supra aegre vel haud discernendis, subtus fere omnino plus minusve clare visibilibus. *Inflorescentia* ex apice culmi singulatim egrediens, paniculata, erecta, subherbacea, omnino rigida, ramosissima; *pedunculus* fistulosus, inanis, usque ad 2 m longus, longe exsertus, internodiis longissimis prope tantum nodos haud inflatos hispidulis, alioquin glabris; *rhachis* usque ad 174 cm longa, fistulosa, inanis, crasse elevato-striata, supra sedem ramorum valde sulcata, omnino puberula, praecipue versus nodos hirsuta, paniculae axibus alioquin omnino dense hispidis; *rami* primarii plerique solitarii, adpressi vel plus minusve patuli, longitudine pervariabiles, usque ad 24.5 cm longi, crassi, elevato-striati, ramis secunda-

riis gracilis, adpressis vel patulis, interdum basi pulvinatis, ramulis ultimis (*pedicellis*) 1-2 mm longis, tenuissimis. *Spiculae* usque ad 5-5.5 mm longae, numerosissimae, confertissimae, primo ovato-fusifformes, demum plus minusve

redactis. *Lemmata sterilia* subaequales circa 3 mm longa, ovata vel oblongo-ovata, apice rotundato apiculata, omnino nitida, glabra vel infima subtilissime hispidula, ut in lemmatibus fertilibus colorata, 1-carinata, nervis alioquin

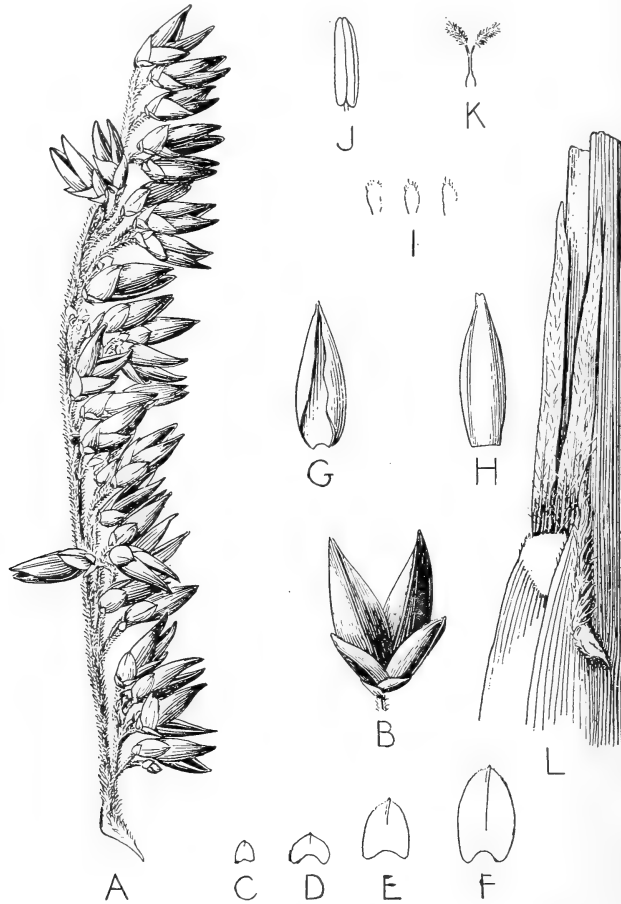

Fig. 8.—*Neurolepis pittieri*: A, Branch of the inflorescence; B, spikelet; C, glume I; D, glume II; E, sterile lemma I; F, sterile lemma II; G, fertile lemma; H, palea; I, lodicule complement; J, stamen; K, pistil; L, apex of leaf sheath, showing the unarticulated petiole and the peculiar processes extending behind and beyond the ligule. All $\times 4$ except A, which is $\times 2$, and L, which is $\times 1$. (Type.)

compressae laxaeque. *Glumae* 2, sibi approximatae, decoloratae, intus strigosae extus glabrae, dorso interdum leviter tantum carinatae, I: circa 0.75 mm longa, ovata vel subtriangula, apice obtusa vel hebet acuta, II: circa 1 mm longa, cordiforme, apice late obtuso interdum apiculata. *Floscula* suprema tantum perfecta, maturitate hians, infimis 2 ad lemmata sterilia

obscurissimis. *Lemma fertile* 4.5-5 mm longum, ovato-lanceolatum, apice in apiculam teretem subito acuminatum, extus omnino glabrum, leve, nitidum, intus deorsum viridis tinctum, sursum purpura dense et aciter maculatum, ventricosum, dorso haud carinatum, nervis paucis, extus obscurissimis, intus prominulis purpuratisque. *Palea* lemmati similiuscula sed

bulgo paullo brevior apice obtuse vel emarginata, dorso haud carinata sed nervis duobus sese remotis immersis aegre discernendis notata. *Rhachillae segmenta* fere obsoleta, haud vel supra tantum glutam superiorem disarticulantia. *Lodiculae* 3, subaequales, circa 0.75 mm longae, subhyalinae, apice vulgo purpura tinctae, margine ciliolatae, anterioribus duobus gibbose ovato-lanceolatis, posteriore anguste lanceolata. *Antherae* 3, usque ad 3 mm longae, apice obtusae emarginataeque. *Ovarium* minutum fusiforme glabrum. *Styli* 2, sibi approximati, circa 0.5 mm longi, glabri. *Stigmata* 2, plumosa. *Fructus* maturus non ad huc inventus.

Type (4 sheets) in the Herbario Nacional de Venezuela, Ministerio de Agricultura y Crfa, Pittier no. 10067, collected January 2, 1922, in meadows and forest at alt. 1,700–2,000 m, between Colonia Tovar and El Lagunazo, State of Aragua, Venezuela. Duplicate in U. S. National Herbarium, nos. 1064685–1064687.

The following specimens in the Herbario Nacional de Venezuela also apparently belong here: *Tomayo* 1613, collected February 25, 1941, at alt. 1,550 m, enroute Maracay-Choroni, State of Aragua, Venezuela, under the native names *Cogollo* and *Cogollo de montana*, with the field note "yerba sublenosa. En selvas nubladas." The collector says that, according to the village people, the leaves are used to make hats. This sterile specimen shows the peculiar buds at the base of the culm, which are not shown in the type. *Allart* 368, collected in December, 1924, at alt. 1,800–2,000 m in Colonia Tovar, State of Aragua, Venezuela (dupl. in U. S. Nat. Herb. no. 1230261), is apparently a depauperate state of the species, as there is no perceptible difference in the spikelets. *Allart's* specimens differ from the type, however, in much smaller stature (68 cm); in the denser arrangement and greater length of the pubescence of the inflorescence axes; and in the lack of petiolate leaf blades, the sheaths clothing the culms bearing only sessile blades of greatly reduced size. It is possible, therefore, that this plant may be found, when more fully known, to merit a separate taxonomic status.

Although apparently quite distinct from all the known species of the genus, *Neurolepis pittieri* bears a broad similarity to *N. nobilis*

(Munro) Pilger, especially in the general appearance of the inflorescence and the coloration of the spikelets. The latter species differs, however, judging by duplicates from Purdie's collection on which Munro based his description (Trans. Linn. Soc. 26: 72. 1868) in the following respects: the plant much larger in stature and in nearly all parts, notably the inflorescences and leaf blades; the axis and branches of the inflorescence pubescent only on the prominent ridges; spikelets much shorter (one-half to two-thirds as long) and proportionately broader; glumes distinctly keeled and apiculate and somewhat hirsute; and lemmas obscurely pubescent.

Dr. Pittier reports that the leaf blades are used by the natives to make hats and to thatch houses, and that the plant dies upon flowering. According to Dr. Pittier, the Spanish name *Cogollo* signifies "clumps," in allusion to the caespitose habit of the plant.

The opportunity recently afforded for the study of representatives of *Neurolepis* (syn.: *Platonia* Kunth, *Planotia* Munro), in comparison with various bamboo genera, has inclined me to the belief that its true taxonomic position is somewhere among the other grass genera rather than with the bamboos. I shall not presume to speculate upon the proper taxonomic disposition of the genus. It seems appropriate, however, to point out here the following characters that I believe to be sufficient to exclude *Neurolepis* from consideration as a "true bamboo": Inflorescence axes coarse, subherbaceous; leaf petioles very thick, deeply sulcate, not at all articulated, the blades persistent; culms subligneous or subherbaceous, unbranched except at the base; culm sheaths usually not differentiated from the leaf sheaths.

The only obvious affinity of *Neurolepis* with any of the generally accepted bamboo genera is toward *Chusquea*, through the very close similarity of the fundamental structure of the spikelets, which led Nees (Linnaea 9: 486. 1834) to place it as a subgenus (*Platonia* Kunth) under *Chusquea*, and Munro to include it in his Monograph. But here the resemblance ends and, as Ruprecht pointed out more than a hundred years ago (Act. Acad. Caes. Petrop. ser. VI. Sci. Nat. 3: 120. 1840), ". . . *Platonia* [*Neurolepis*] vero natura sua valde a *Chusquea* distat."

BOTANY.—*New tropical American Acanthaceae*.¹ E. C. LEONARD, U. S. National Museum. (Communicated by WILLIAM R. MAXON.)

A critical study of material assembled under the genus *Blechum* in the U. S. National Herbarium and the herbaria of the Missouri Botanical Garden, the New York Botanical Garden, and Field Museum of Natural History has disclosed four new species, which are described herewith. One of these belongs to *Blechum*; the others, though bearing a superficial resemblance to *Blechum*, pertain to three genera that are not very closely related to it.

In the present paper a new form of *Blechum brownei* is described, also, and *B. pedunculatum* is transferred to *Stenandrium*.

Blechum killipii Leonard, sp. nov.

Herba, caulibus simplicibus vel ramosis, erectis vel adscendentibus, bifariam hirtellis, pilis retrorsis, infra glabratis; folia petiolata, laminis oblongis vel oblongo-lanceolatis, acuminatis, in petiolum decurrentibus, undulatis vel leviter crenatis, supra sparse hirsutis, pilis albis, costa et venis subtus pubescentibus, pilis minutis curvatis; spicae terminales; bractea dense imbricatae, ovatae, obtusae vel subacutae, pilosae et ciliatae; bracteolae oblanceolatae, acutae, dense pilosae et ciliatae; calycis segmenta linearia, infra pilosa, ciliata; corolla alba vel lilacina, pubescens; capsulae minute pubescentes, pilis retrorsis; semina brunnea.

Erect or ascending, suffrutescent herbs up to 40 cm high; stems simple or branched, hirtellous, the tips densely so, the hairs lower down arranged in 2 rows, the basal portions sometimes glabrate; petioles up to 1.5 cm long or occasionally as much as 2.5 cm, hirtellous; leaf blades oblong-lanceolate, mostly up to 6 cm long and 2.5 cm wide (occasionally larger), acuminate and often slightly curved toward the blunt tip, narrowed at base and decurrent on the petiole, undulate to shallowly crenate, the costa and veins minutely pubescent (the hairs curved), otherwise glabrous, or the upper surface beset with scattered stiff white hairs about 1 mm long; spikes terminal, up to 4 cm long and about 2 cm in diameter, the rachis

densely hirtellous, the bracts closely imbricate, ovate, up to 12 mm long and 10 mm wide (the lowermost often larger and leaf-like), obtuse to acutish, more or less pilose and ciliate with white straight hairs up to 1.5 mm long, the veins sometimes pubescent with small curved hairs; bractlets oblanceolate, about 10 mm long and 3 mm wide, acute, densely pilose and ciliate with straight white hairs up to 3 mm long; calyx segments linear, pilose and ciliate (basal portions glabrous), the posterior segment 4.5 mm long and barely 0.5 mm wide, the others about 5 mm long and 0.75 mm wide; corolla white or tinged with lavender, finely pubescent, about 1.5 cm long, 5 mm in diameter at throat, the limb about 12 mm broad, the segments obovate, about 5 mm in diameter, shallowly emarginate; capsule 7.5 mm long, 5 mm broad, pubescent, the hairs minute, those of the tip spreading, the others retrorse; seeds flat, brown, about 2 mm in diameter.

Type in the U. S. National Herbarium, no. 1045999, collected on rocks of stream bed in dense forest, Seamens Valley, Portland, Jamaica, altitude 150 to 250 m, February 14, 1920, by William R. Maxon and Ellsworth P. Killip (no. 82).

The following additional specimens, all from Jamaica, have been examined: Woodlands on eastern slopes of John Crow Mountains, *Britton* 4132; Seamens Valley, Portland, *Maxon & Killip* 61a; foothills of John Crow Mountains, *Maxon & Killip* 223; Stony Valley River gully, *Orcutt* 5893; Vinegar Hill, *Perkins* 1245; Spring Bank, 2¼ miles west of Port Antonio, *Wight* 91.

Intermediate between *Blechum brownei* Juss. and *B. blechoides* (Sw.) Hitchc. From the latter it differs in its much smaller corollas (white or lilac, instead of violet), and its densely pilose and ciliate bracts. It is more closely related to *B. brownei*, but in that species the corollas are somewhat smaller and more slender, and are usually purple or pinkish, and the hairs on the bracts and bractlets are much shorter and less numerous.

Blechum brownei Juss. forma *puberulum*
Leonard, f. nov.

A forma *typica* bracteis *puberulis* recedit.

¹ Received March 14, 1942.

Type in the U. S. National Herbarium, no. 1451437, collected on dry roadbed along bank of Jean Rabel River, vicinity of Jean Rabel, Haiti, January 30, 1929, by E. C. Leonard and G. M. Leonard (no. 12696).

This appears to be more widely distributed than the typical form of the species, its range extending from eastern and southern Mexico throughout Central America, the West Indies, and northern South America; it occurs also in Guam, Formosa, and the Philippine and Caroline Islands. The typical form apparently is limited to Florida, Oaxaca, Veracruz, the Yucatan Peninsula, British Honduras, Honduras, Costa Rica, several of the West Indian Islands, and the Guianas. Occasional intermediate specimens with slightly downy bracts are to be found in regions where both grow together. From data given on the labels, there is no indication that the puberulent form results as an environmental response. It is as likely to occur in moist situations as in dry arid places.

***Herpetacanthus panamensis* Leonard, sp. nov.**

Herba, caulibus simplicibus vel parce ramosis, adscendentibus, bifariam pubescentibus, pilis retrorsis, infra glabratis; folia pauca, breviter petiolata, laminis ellipticis, apice acutis vel subobtusis, basi angustatis in petiolum decurrentibus, integris vel undulatis, glabris, cystoligeris, costa et venis subtus pubescentibus, pilis minutis curvatis; spicae plures, terminales et subterminales; bracteae laxe imbricatae, ovatae vel ellipticae, acutae, subglabrae, ciliatae; bracteolae oblongae, acuminatae, glabrae, ciliatae; calyx subinaequalis, segmentis glabris, ciliatis; corolla pilosula; capsulae glabrae.

Herbaceous; stems ascending, up to 20 cm high, simple or sparingly branched, pubescent in 2 lines, the hairs minute, jointed, retrorsely curved, or the lower portion of the stem glabrate; leaves few, usually about 4, the blades elliptic, up to 10 cm long and 4 cm wide, acute or obtusish at apex (the tip blunt), narrowed at base and decurrent on the short petiole (2 to 5 mm), entire or undulate, glabrous except for the petiole, costa and veins beneath, these pubescent with minute curved hairs; cystoliths prominent on the upper surface; spikes several, up to 4 cm long, 1 to 1.5 cm in diameter, forming a terminal panicle, the rachis sparingly

pubescent, with minute curved hairs; bracts rather loosely imbricate, ovate to elliptic, up to 12 mm long and 7 mm wide, acutish, thin, glabrous or subglabrous, sparingly ciliate, the hairs about 0.5 mm long; bractlets oblong, 7 mm long, 0.25 to 1.5 mm wide, acuminate, glabrous, ciliate; calyx about 6 mm long, slightly asymmetric, the segments subulate, 4 to 5 mm long, the larger ones about 0.5 mm wide, the others slightly narrower, all tipped by 1 or 2 white hairs up to 0.5 mm long, ciliate with minute gland-tipped hairs, otherwise glabrous; corolla 8 mm long, the lips about 5 mm long, pilosulous, the upper one ovate, acuminate, minutely bidentate, the lower one 3-lobed, the lobes rounded, about 3 mm long, the tube white-pilose within; stamens typical of the genus; capsules glabrous, pointed at apex, 9 mm long, 3 mm broad, the solid stipitate base 4 mm long; mature seed not seen; retinacula rounded at apex.

Type in the U. S. National Herbarium, no. 1405734, collected in deep shade in the Changuinola Valley, Panama, March 14, 1924, by V. C. Dunlap (no. 554); isotype in herbarium of Field Museum of Natural History, no. 708196. Standley's no. 40851, collected in wet forest of Barro Colorado Island, Canal Zone, November 1925, is also this species.

Herpetacanthus, belonging to the subtribe Isoglossinae, is one of several genera having a 2-lipped corolla and four stamens. Among these it is readily recognized by the peculiar character of the stamens, the posterior pair being 2-celled (with one of the cells distinctly superposed), the anterior pair 1-celled. Eight species have previously been known, all from Brazil. *H. panamensis* is probably nearest *H. schulzii* but can be separated readily by its shorter spikes (much shorter than the subtending leaves) and by its glabrous capsules. The color of the corolla can not be ascertained from the herbarium material but may be assumed to be white, as is usual in the genus.

***Justicia herpetacanthoides* Leonard, sp. nov.**

Suffrutex, caulibus erectis vel adscendentibus, bifariam pilosis; folia breviter petiolata, laminis ovatis, apice rotundatis, vel obtusis vel emarginatis, basi angustatis, integris, pilosis; spicae multae, terminales et subterminales; bracteae imbricatae, ovatae, obtusae vel

subacutae, hirsutae, ciliatae; bracteolae oblanceolatae; calycis segmenta lanceolata, ciliata; corolla alba, pubescens; capsulae retrorse puberulae; semina fusca.

Suffrutescent herb up to 30 cm high or more; stems branched, erect or ascending, pilose in 2 lines, the hairs spreading or slightly retrorse; petioles up to 1 cm long, pilose; leaf blades ovate, up to 4 cm long and 2.5 cm wide, rounded, obtuse or emarginate at apex, narrowed at base, rather firm, entire, pilose, the hairs diminishing in size and number toward tip of blade; spikes up to 4 cm long and 1.5 cm in diameter, numerous, terminal and subterminal, forming a panicle, the rachis hirtellous, the bracts ovate, up to 8 mm long and 6 mm wide, obtuse to acutish, rounded at base to a short flat petiole, hirsute, ciliate, the marginal hairs about 0.75 mm long; bractlets oblanceolate, up to 6 mm long and 2.5 mm wide, otherwise similar to bracts; calyx segments lanceolate, 3.5 mm long, about 1 mm wide, ciliate, faintly 3-nerved; corolla 8 mm long, white, pubescent, the lower anther cells strongly calcarate; capsule 5 mm long, 2 mm broad, puberulent, the hairs spreading at tip, retrorse toward base; seeds dark brown, acutish, slightly more than 1 mm broad and long.

Type in the U. S. National Herbarium, no. 1493986, collected along a rocky trail at Chichen Itza, Yucatan, June 23, 1932, by W. C. Steere (no. 1510).

Related to *Justicia lundellii* Leonard but easily distinguishable by its larger and more numerous spikes and its larger, ovate bracts and corollas. Moreover, it seems not to blacken in drying, as does *J. lundellii*.

***Beloperone blechioides* Leonard, sp. nov.**

Suffrutex, caulibus pubescentibus, pilis albis curvatis retrorsis, infra glabratis; folia petiolata, laminis lanceolato-ovatis, acutis, subapiculatis, basi angustatis, in petiolum decurrentibus, sparse pubescentibus et ciliatis; spicae terminales vel subterminales; bracteae ovatae, obtusae vel subacutae, dense imbricatae, pilosae, dense ciliatae; bracteolae oblongo-lanceolatae; calycis segmenta lanceolata, trinervia, tenuia, ciliata; corolla alba, pauce purpureo-maculata; capsulae retrorse hirtellae.

A suffrutescent herb up to 40 cm high or more; stems shallowly grooved, pubescent with white retrorsely curved hairs about 0.75 mm long, these arranged more or less in 2 rows, the lower portions of the stem sometimes glabrate; petioles up to 2 cm long, the pubescence a mixture of pointed, spreading, variously curved hairs and shorter glandular ones ending in flat expanded tips; leaf blades lance-ovate, up to 9.5 cm long and 4.5 cm wide, acute at apex (the tip blunt and subapiculate), acute or obtuse at base and decurrent on the petiole, dull green, undulate, sparingly pubescent and ciliate, the hairs 0.5 to 0.75 mm long, on the lower surface confined chiefly to costa and nerves; cystoliths conspicuous under lens; spikes terminal and subterminal, about 2 cm long and 2 cm in diameter, each subtended by a pair of small leaves (up to 3 cm long and 1.5 cm wide), the rachis and peduncle pilose; bracts closely imbricate, quadrifarious, ovate, obtuse to acutish, thin, dull green, pilose, densely ciliate, the hairs white, about 1 mm long; bractlets oblong-lanceolate, about 8 mm long and 2.5 mm wide, otherwise similar to bracts; calyx deeply 5-lobed, the segments lanceolate, about 5 mm long and 1.5 mm wide near base, thin, green, 3-nerved, ciliate; corolla about 2 cm long, white, spotted with purple around the throat and lips, pubescent, the lobes about 5 mm long, ciliate; capsule 11 mm long and 4 mm broad, hirtellous, the hairs spreading at the tip, those of the lower portion retrorse; mature seed not seen.

Type in the herbarium of Field Museum of Natural History, no. 1035787, collected on moist shady slopes of a barranca near a stream on Montaña Nonojá, 3 to 5 miles east of Camotán, Department of Chiquimula, Guatemala, altitude 600 to 1800 m, November 11, 1939, by Julian A. Steyermark (no. 31740).

Except for its corollas, typical in every respect of *Beloperone*, this species could be mistaken for *Blechum*. The nature of growth and the exact height of the plant can not be ascertained from the present material, which consists of a single branch about 40 cm long. Nor is the exact length of the mature corolla known, the description being drawn from an immature flower extracted from one of the spikes.

Stenandrium pedunculatum (Donn. Sm.)

Leonard, comb. nov.

Blechnum pedunculatum Donn. Sm. Bot. Gaz. 49: 457. 1910.

The present species, founded on specimens collected near Gualan, Guatemala, by Charles C. Deam (no. 6277), is very closely allied to *S. mandioccanum* Nees, of southern South America. The two have much the same appearance, except that *S. pedunculatum* is usually larger with stronger suffrutescent stems. The seeds of both species are covered with peculiar

retrorely barbed hairs, these shorter in *S. mandioccanum* than in *S. pedunculatum*. Distinguishing characters, however, are found in the capsules and in the pubescence of the branchlets. In *S. pedunculatum* the capsules are entirely glabrous and the pubescence of the branchlets is composed of rather straight, whitish, spreading hairs. In *S. mandioccanum* the capsules are pubescent, though sparingly so, with minute mostly retrorse hairs, and the stems are densely pubescent with small, brown, curved hairs or are even subtomentose.

ZOOLOGY.—*New species of urocoptid land mollusks from Mexico.*¹ PAUL BARTSCH, U. S. National Museum.

The United States National Museum has recently received a collection of Mexican land shells from Miss Marie E. Bourgeois, of Mexico, D.F., among which are two new species of the family Urocoptidae. A third species, which was collected by J. Mathewson in 1898 and which has come to the National Museum through the Shimek collection, also proves to be a remarkable new member of the family. The three are here described and figured.

Coelostemma bourgeoisana, n. sp.

Fig. 1

Shell small, white, early whorls slightly horn colored, cylindrical-conic, with the summit tapering rather acutely toward the apex. The nucleus consists of about 2 well-rounded turns, which are microscopically granulose. The post-nuclear whorls are slightly rounded and marked by retractively slanting axial ribs, which are slightly variable in strength and spacing. Suture moderately constricted. Base well rounded, narrowly, openly umbilicated, and marked by the continuation of the axial ribs. The last whorl is solute for about one-tenth of a turn. The aperture is irregularly triangular; peristome reflected and somewhat thickened. The columella is rather large, equal to about one-fourth of the width of a whorl. It is heavier in the early whorls and becomes materially re-

duced in the last and is marked by numerous very slender, almost hairlike, granulose axial riblets.

The 30 specimens before me were collected by Miss Marie E. Bourgeois on a hillside under limestone rocks at Ixtapan de la Sal, State of Mexico, in May 1939.

The type, U.S.N.M. no. 536039, has 15.3 whorls and measures: Height, 15.4 mm; greatest width of spire, 5.0 mm. Paratypes: U.S.N.M. no. 536040.

The exceedingly fine, hairlike, granulose axial riblets of the columella will distinguish this from the other members of the group.

Haplocion mariae, n. sp.

Fig. 2

Shell small, pupoid, horn colored, covered with a curious film, almost suggesting a more or less dehiscent periostracum, tapering gently toward the apex. The nucleus consists of about 1.5 rounded, microscopically granulose turns. The early succeeding whorls are well rounded; the later ones are a little less so. They are crossed by strong, decidedly retractively curved axial ribs, which are about half as wide as the spaces that separate them. Suture strongly constricted. Periphery well-rounded. Base short, narrowly perforate; the last whorl solute for about one-tenth of a turn. Aperture irregularly triangular; peristome expanded and reflected. The columella is rather slender and apparently solid in the penultimate turn and on the three or four preceding it where it is also somewhat twisted. In the whorls posterior

¹ Published by permission of the Secretary of the Smithsonian Institution. Received March 2, 1942.

to this, the axis becomes broader, hollow, and straight.

Sixty specimens of this species are before me collected by Miss Marie E. Bourgeois on a hillside under limestone rocks at Ixtapan de la Sal, State of Mexico, in May 1939.

The type, U.S.N.M. no. 536037, has 12.6 whorls and measures: Height, 11.3 mm.; greatest width of spire, 3.4 mm. Paratypes: U.S.N.M. no. 536038.

The peculiar axis of this species differentiates it from any of the other *Haplocion*s known to me.

rounded on the median cylindrical portion of the shell. They are crossed by retractively curved, irregular lines of growth, which on the last whorl attain the strength of axial riblets. These are about half as wide as the spaces that separate them. On the last fifth of a turn these riblets become quite irregular and much more closely approximated. The last whorl is solute for about one-tenth of a turn. Base well rounded, with an umbilical pit or a slight perforation. Aperture irregularly triangular; peristome slightly expanded and reflected. The columella is hollow and very broad, widest on the poste-



Figs. 1-3.—New urocoptid mollusks from Mexico: 1, *Coelostemma bourgeoisana*, $\times 4$; 2, *Haplocion mariae*, $\times 4$; *H. mathewsoni*, $\times 2$.

Haplocion mathewsoni, n. sp.

Fig. 3

Shell of pupoid shape, tapering abruptly toward the summit, with the median part cylindrical and slightly contracted basally. The shell is bicolor; that is, the posterior half of the whorls is brown, while the anterior is flesh colored. The nucleus consists of about 2 whorls, which are microscopically granulose. The succeeding turns are moderately rounded on the posterior part of the sloping top, almost flattened on the anterior portion and slightly

terior portion and decidedly narrowed on the last turn. It is smooth and marked only by slightly retractively slanting lines of growth.

The type, U.S.N.M. no. 536036, has 17.3 whorls and measures: Height, 28.0 mm; greatest width of spire, 8.8 mm.

There were 10 specimens in the lot collected by J. Mathewson in 1898 in the State of Mexico. The 9 paratypes bear the U.S.N.M. no. 510074. They came to the United States National Museum through the Shimek collection.

This is the largest species of *Haplocion* known to me.



CONTENTS

	Page
BOTANY.—New grasses from Venezuela. ZORAIDA LUCES.....	157
BOTANY.—New bamboos from Venezuela and Colombia. F. A. Mc- CLURE.....	167
BOTANY.—New tropical American Acanthaceae. E. C. LEONARD....	184
ZOOLOGY.—New species of urocoptid land mollusks from Mexico. PAUL BARTSCH.....	187

The Journal is Indexed in the International Index to Periodicals

6.75
D2 W...

VOL. 32

JULY 15, 1942

No. 7

JOURNAL

OF THE

WASHINGTON ACADEMY OF SCIENCES



BOARD OF EDITORS

RAYMOND J. SEEGER
GEORGE WASHINGTON UNIVERSITY

G. ARTHUR COOPER
U. S. NATIONAL MUSEUM

JASON R. SWALLEN
BUREAU OF PLANT INDUSTRY

ASSOCIATE EDITORS

W. EDWARDS DEMING
PHILOSOPHICAL SOCIETY

C. F. W. MUESEBECK
ENTOMOLOGICAL SOCIETY

HARALD A. REHDER
BIOLOGICAL SOCIETY

EDWIN KIRK
GEOLOGICAL SOCIETY

CHARLOTTE ELLIOTT
BOTANICAL SOCIETY

T. DALE STEWART
ANTHROPOLOGICAL SOCIETY

HORACE S. ISBELL
CHEMICAL SOCIETY

PUBLISHED MONTHLY

BY THE

WASHINGTON ACADEMY OF SCIENCES

450 ANNA ST.

AT MENASHA, WISCONSIN

Entered as second class matter under the Act of August 24, 1912, at Menasha, Wis.

Acceptance for mailing at a special rate of postage provided for in the Act of February 28, 1925

Authorized January 21, 1933.

Journal of the Washington Academy of Sciences

This JOURNAL, the official organ of the Washington Academy of Sciences, publishes (1) Short original papers, written or communicated by members of the Academy; (2) proceedings and programs of meetings of the Academy and affiliated societies; (3) notes of events connected with the scientific life of Washington. The JOURNAL is issued monthly, on the fifteenth of each month. Volumes correspond to calendar years.

Manuscripts may be sent to any member of the Board of Editors. It is urgently requested that contributors consult the latest numbers of the JOURNAL and conform their manuscripts to the usage found there as regards arrangement of title, subheads, synonymies, footnotes, tables, bibliography, legends for illustrations, and other matter. Manuscripts should be typewritten, double-spaced, on good paper. Footnotes should be numbered serially in pencil and submitted on a separate sheet. The editors do not assume responsibility for the ideas expressed by the author, nor can they undertake to correct other than obvious minor errors.

Illustrations in excess of the equivalent (in cost) of 1½ full-page line drawings are to be paid for by the author.

Proof.—In order to facilitate prompt publication one proof will generally be sent to authors in or near Washington. It is urged that manuscript be submitted in final form; the editors will exercise due care in seeing that copy is followed.

Author's Reprints.—Reprints will be furnished in accordance with the following schedule of prices:

Copies	4 pp.	8 pp.	12 pp.	16 pp.	20 pp.	Covers
50	\$2.00	\$3.25	\$ 5.20	\$ 5.45	\$ 7.25	\$2.00
100	2.50	4.00	6.40	6.75	8.75	2.75
150	3.00	4.75	7.60	8.05	10.25	3.50
200	3.50	5.50	8.80	9.35	11.75	4.25
250	4.00	6.25	10.00	10.65	13.25	5.00

<i>Subscription Rates.</i> —Per volume.....	\$6.00
To members of affiliated societies; per volume.....	2.50
Single numbers.....	.50

Correspondence relating to new subscriptions or to the purchase of back numbers or volumes of the JOURNAL should be addressed to William W. Diehl, Custodian and Subscription Manager of Publications, Bureau of Plant Industry, Washington, D.C.

Remittances should be made payable to "Washington Academy of Sciences" and addressed to 450 Ahnaip Street, Menasha, Wis., or to the Treasurer, H. S. Rappleye, U. S. Coast and Geodetic Survey, Washington, D.C.

Exchanges.—The JOURNAL does not exchange with other publications.

Missing Numbers will be replaced without charge provided that claim is made to the Treasurer within thirty days after date of following issue.

OFFICERS OF THE ACADEMY

President: HARVEY L. CURTIS, National Bureau of Standards.

Secretary: FREDERICK D. ROSSINI, National Bureau of Standards.

Treasurer: HOWARD S. RAPPLEYE, U. S. Coast and Geodetic Survey.

Archivist: NATHAN R. SMITH, Bureau of Plant Industry.

Custodian of Publications: WILLIAM W. DIEHL, Bureau of Plant Industry.

JOURNAL

OF THE

WASHINGTON ACADEMY OF SCIENCES

VOL. 32

JULY 15, 1942

No. 7

ASTRONOMY.—*Great astronomical treatises of the past.*¹ EDGAR W. WOOLARD
Washington. (Communicated by RAYMOND J. SEEGER.)

INTRODUCTION

Through the ages, the torch of learning has been handed on largely by means of tangible records and documents—in ancient times by inscriptions and written manuscripts, in more recent times by printed books. In the development of the sciences this transmission of knowledge from generation to generation and from one civilization to another is as vital a factor as the observation and the creative thought by which knowledge is first brought into existence, because without the benefit of accumulated information, experience, and thought from the past, no natural science could be brought to a highly advanced state.

The progressive evolution of astronomy from its emergence in remote antiquity to its present highly developed form, as recorded in the extant writings from successive periods during the past 3,000 years or more, is one of its principal sources of general interest; a knowledge of modern astronomy is immeasurably enriched, and its fascination and romance are greatly enhanced, by a familiarity with the circumstances of its beginnings and early development, the methods by which astronomical observations and calculations have been made and results established throughout past times, and the succession of concepts to which the steady accumulation of observed facts gave rise, until finally the subject attained its present form. This historical development is also of direct technical interest; a familiarity with the provenience and evolution of astronomical ideas and practices—their adumbration, filiation, and de-

velopment—and with the reasoning by which principles and theories have been successively formulated through the centuries is of inestimable didactic value in contributing to a clear and appreciative comprehension and a convincing understanding of the now established concepts, accepted technical practices, and prevailing theories to which the course of thought during the past has progressively led. Many astronomical ideas and procedures, although they have evolved from origins in simple concepts naturally suggested by observation and have developed by a succession of steps each natural in itself, are in their present form so remote from their beginnings that they may seem far from natural; the categorical presentation of modern refined concepts and established results in systematic logical form, with the description of the elaborate instrumental equipment, complex observational procedures, and intricate mathematical calculations on which they now are based, is greatly illuminated by an indication of the path actually followed historically in the progressive construction of this system with the former methods and means available at successive times during its development. Historical knowledge and perspective *with critical insight* will also prevent the attitude of scepticism sometimes engendered by the revisions of thought continually involved in the progress of the sciences; it will lead to a more adequate realization of the intrinsic merit of the ancient learning, and to a recognition of the importance of this learning both as a basic element in our own knowledge and as an indispensable foundation for the derivation

¹ Received February 6, 1942.

of many modern results; and it will materially aid toward the desirable end of integrating scientific knowledge with the rest of human culture.

The historian himself, in the difficult task of constructing as complete and accurate an account as possible of the development of astronomy, must critically study *all* the surviving earlier astronomical records and documents—the sole original source of information—from every land. In all times (including the present), however, among the total multitude of existing books there have always been a limited few that stand out from others in their field and with the passage of time survive as monuments, either marking a particularly fundamental advance through the accounts of important original investigations they contain or else being of permanent value as outstanding presentations of the state of knowledge of their subject at the time; and the greater among these writings are worthy of being treasured and read by all students and lovers of astronomy as well as by historians. These great scientific works are as precious a heritage as other imperishable literature from the past; they offer the reader rich rewards in pleasure and satisfaction and are a valuable auxiliary to the general histories of astronomy. No more effective or inspiring method is available for extending the usual textbook information about the outstanding developments and advances during the past than to study the actual original writings wherein those who were the principal contributors give their own expositions of their work and describe the procedures by which they arrived at their results; no textbook account of any of these works can take the place of an actual examination of the original.

The purpose of the present paper is to indicate the more noteworthy writings that have been of the greatest significance in either determining or recording the historical evolution of astronomy, from ancient to modern times; and in the case of each, to discuss briefly its part in the development of astronomical thought, and to provide bibliographical references to printed editions now available to the general reader.

Astronomy may be broadly divided into (1) spherical and practical astronomy—the observation, exact description, and systematic discussion of the apparent positions and motions of the heavenly bodies on the celestial sphere; (2) theoretical astronomy—the construction of systematic theories of the actual arrangement and real motions of the celestial bodies in space that will account for the observed phenomena and from which these phenomena may be predicted by mathematical calculation; and (3) descriptive astronomy and astrophysics—the observation and physical interpretation of the characteristic features and intrinsic natures of the individual celestial bodies. During the pretelescopic period, from antiquity to the early seventeenth century, astronomy was practically confined to the first and second of these subdivisions, i.e., to what may be called “fundamental astronomy”; moreover, this part of astronomy, though now overshadowed by astrophysics (the rise of which began shortly after the middle of the nineteenth century), forms the essential foundation and framework of the entire science. In this paper we therefore confine ourselves to fundamental astronomy, and shall limit the discussion to the period closing with Laplace (d. 1827) and Bessel (d. 1846).

For readers whose interest is primarily in astronomy itself, rather than in history as such, the principal criterion for appraising the relative importance of early writings will be their comparative significance in having influenced the developments of thought that actually led to the eventual establishment of our own learning. Contrary to the impression likely to be conveyed by some modern writers, the astronomical ideas that now prevail in our civilization are not simply the chronologically latest of a discontinuous succession of mutually independent systems of thought, each a complete revolution over its predecessors, and all (with the exception of the most recent!) of little merit. Instead, fundamental astronomy as it now exists is the outcome of an essentially unbroken development extending from remote antiquity to modern times, throughout which the ac-

cumulated learning from the past conserved and transmitted down the centuries by successive civilizations, was explicitly the basis for progressive extensions and attendant successive *revisions in particulars* that gradually led to the now established system. Modern astronomy has developed out of the ancient learning; and in it old and new ideas are combined in a design woven in many lands through many ages. A study of the more important original writings from successive periods will lead to a realization of this essential *continuity of the development*, and to an appreciation of the enduring importance of the earlier learning for the later achievements. Necessarily, to have been of significance in this development, knowledge that originated at any particular time and

place must, through some channel, have become synthesized with the astronomical thought of the civilizations by way of which our own civilization has received its culture; from the scientific astronomical point of view, any knowledge that developed in isolation from the particular stream of thought through which learning historically became established in our own civilization is of only limited interest, although it may be of the utmost significance and importance from other points of view.

Hence a generalized sketch of the historical development of astronomy within a framework of social and political history is an essential background for a discussion of the astronomical writings of the past and their significance.²

DEVELOPMENT OF ASTRONOMY IN RELATION TO POLITICAL HISTORY

Modern science is essentially a development of Western learning, but it has been founded upon the heritage from the ancient Orient, where the earliest civilizations appeared. Of the three principal cultural groups in the world, broadly speaking—the Chinese, the Hindu, and our own—all three are of Eastern origin; but the first two remained exclusively Eastern, while the third has developed from a blend of Eastern and Western elements. Civilization and culture in Europe, during both ancient and medieval times, originated by diffusion westward from the nearer Orient, by way of the Mediterranean regions.

The historic period—i.e., the era of contemporary written records of the history and culture of mankind—first opens about 3100 B.C. in Egypt along the Nile River, and somewhat earlier in Sumer along the lower Tigris and Euphrates; but archeological explorations have shown that in these regions and also in some other parts of the great crescent-shaped area that stretches northward along the eastern shore of the Mediterranean and eastward and southward down the Tigris and Euphrates to the Persian Gulf, as well as in parts of Asia Minor, the development of civilization had been in progress over a period which in some localities probably extends back to 4500 B.C. or

earlier. Through trade and commerce, migration and colonization, warfare and conquest, the ancient peoples of western Asia and the eastern Mediterranean regions were in continual contact with one another; and, under cultural influences from Egypt and Sumer, Oriental civilization steadily spread and developed among the other early nations that became established in western Asia,³ while one great empire after another rose to political supremacy over the region.

² In preparing the following historical section, the author has relied principally upon: J. H. BREASTED, *The conquest of civilization*, new ed. (New York), 1938. J. H. BREASTED, *Ancient times*, 2d ed. (Boston), 1935. Cf. V. G. CHILDE, *The Orient and Europe*, Rept. Brit. Assoc. Adv. Sci. for 1938, pp. 181–196; and E. A. SPEISER, *Ancient Mesopotamia and the beginnings of science*, Univ. Pennsylvania Bicentennial Conference: Studies in the History of Science, pp. 1–11 (Philadelphia), 1941.

³ Particularly the Phoenicians along the Mediterranean coast in north Syria and the Canaanites in Palestine, among both of whom a flourishing civilization had developed by the twentieth century B.C.; the Hittites in Anatolia (Asia Minor), from remote times until the great empire they built up in Asia Minor, Syria, and eastward beyond the Euphrates, finally collapsed under barbarian invasions about 1200 B.C.; and, in somewhat later times, the Syrians (Arameans) who had developed a flourishing civilization (especially at Damascus) by 1200 B.C., and the Hebrews, who began to displace the Canaanites after 1400 B.C. and developed a notable culture in Judea after the ninth or eighth century B.C.

Sumer had come under the control of Akkad, just to the north, by the twenty-sixth century B.C., when Sargon built up a powerful nation in western Asia that extended from Elam at the head of the Persian Gulf, far up the Tigris and Euphrates to the west and north, penetrating to the Mediterranean and probably into eastern Asia Minor; after about 2300 B.C., the whole lower Tigris-Euphrates region (Plain of Shinar) was a unified nation under both Sumer and Akkad with a great civilization centered at the city of Ur, but it declined after 2200 B.C. before the attacks of invaders, Sumer and Ur falling to the Elamites. Later, however, Amorites from Syria, invading Akkad, seized the town of Babylon, and before 1900 B.C., under Hammurabi, had become supreme over the entire region of Sumer and Akkad, which henceforth was known as Babylonia. This early Babylonian civilization had been completely destroyed by about 1750 B.C. through a plundering invasion by Hittites, and subsequent permanent occupation by Kassites from the east; and cultural progress ceased. Still farther north along the Tigris, however, was a civilization drawn largely from Sumeria that had for many centuries been developing at Assur. About 1300 B.C. Assur commenced to extend her power, first over the Tigris-Euphrates region and then over other areas, until finally, by the capture of Damascus in 732 B.C. and the conquest of Egypt in 674 B.C.,⁴ the Assyrian Empire had come to include the whole of western Asia and the Nile Valley. Under the Assyrians the ancient learning was revived; the time of Assurbanipal (d. 626 B.C.) was the golden age of Assyrian art and learning in which astronomy held an important place, though it was in part only a reflection of more ancient Assyrian and Babylonian culture.

⁴ Egypt, except for a brief period of domination by the Hyksos from Syria in the seventeenth century B.C., had until this time been independent, and in fact during the sixteenth and fifteenth centuries B.C. had extended her own power until the eastern shore of the Mediterranean and some of the territory over to the northern Euphrates had been brought under her rule; after 1400 B.C., however, under invasions (especially by the Hittites) and revolts, the Egyptian Empire in Asia began to decline and finally collapsed about 1150 B.C.

Meanwhile, the desert tribes of the Chaldeans had been establishing themselves at the head of the Persian Gulf and gradually mastering Babylonia, while the Medes were advancing from the northeastern mountains; under their combined assault, Nineveh was destroyed in 612 B.C., and the Assyrian Empire fell. The Medes established a strong Iranian kingdom in the mountains east of the Tigris, extending from the Persian Gulf to the Black Sea, while the Chaldeans ruled the whole of the Tigris and Euphrates Valleys and the eastern Mediterranean shores, with their capital at Babylon, reviving the early Babylonian civilization, which had perished centuries before, and attaining a much higher level (particularly in astronomy); but 60 years after the fall of Nineveh the Iranian tribes known as the Persians, who had long been settled in the mountains of Elam at the head of the Persian Gulf, conquered the Medes, brought the Chaldean Empire to an end by the capture of Babylon in 538 B.C., and by 525 B.C. had extended the Persian Empire over Egypt, western Asia and Asia Minor, and eastward almost to India. Iranian culture and learning, dawning about the sixth century B.C. at the time of Zoroaster, advanced to high levels under the influence of the conquered civilizations; much of the most important Chaldean astronomical work was done under Persian rule.

Persia was the last of the great Oriental powers of antiquity; political and cultural supremacy were now to pass temporarily to the West, where another civilization had already begun to arise.

As early as 2000 B.C., under Egyptian and Hittite influence, a high level of civilization had become established on the island of Crete and was beginning to spread to the adjacent coast of the Aegean Peninsula to the northwest, where an especially notable development took place at Mycenae after 1600; but a succession of barbarian invasions of the Aegean region by tribes from the north, migrating southward west of the Black Sea, which began before 2000 B.C., had almost destroyed this early Aegean civilization by 1200 B.C. or before, and led to many migrations and disturbances through-

out the eastern Mediterranean regions. Between 1300 and 1000 B.C., these invading tribes—the ancestors of the later Greeks—became established throughout the Aegean region, including the coast of Asia Minor, commingling to some extent with the earlier Aegean peoples; and among them, from the surviving remnants of the Cretan civilization and under continued Oriental influences, civilization and culture began slowly to develop. After the sixth century B.C., Greek civilization and learning made remarkable progress, and during the next few centuries the Greeks achieved the highest civilization and greatest culture ever attained in the ancient world.

Greece did not come under Assyrian or Persian rule, although Greek colonies in Asia Minor were at times conquered; but in the fourth century B.C. the Macedonians, north of the Greek Peninsula, began a series of conquests that by 338 B.C. had made them masters of all Greece, by 333 had overthrown the Persian Empire, and by 323 had built up the vast empire of Alexander the Great, which included Greece, Egypt, Asia Minor, and western Asia over into India. The Macedonian rulers had been strongly influenced by the Greek culture; the conquests of Alexander carried Greek civilization throughout the ancient world and into the very heart of Asia, and at the same time materially enlarged Greek learning. After Alexander's death his empire became divided under different Macedonian leaders: The kingdom of the Ptolemies was established in Egypt; the Seleucids ruled over western Asia, but the Seleucid Empire soon began to disintegrate—in particular, Bactria (adjacent to India) became independent in 250 B.C.; and Parthia (north of Persia) not only became a separate country in 249 B.C., ruled by the Arsacid dynasty, but during the second century B.C. built up an empire of its own that included Babylonia. From the many centers of influence founded by the Macedonians, the Greek culture continued during the next three centuries to spread and become widely established, particularly in Egypt, western Asia, and India. Alexandria, founded in 332 B.C., became the leading intellectual center

of the world. At the same time, the Babylonians continued their own developments, especially in astronomy, through the Seleucid and Arsacid periods, and contributed materially to Greek learning.

Meanwhile, the vast power of Rome had been slowly rising in the West: The western Mediterranean lands had long remained in a state of barbarism, little influenced by the Oriental civilizations. It was in Italy and Sicily that the West first began to be influenced by the eastern Mediterranean culture, largely through westward migrations (especially of the Etruscans) beginning in the twelfth century B.C. and through contact with Greek and Phoenician colonies founded in that region while Rome was still a rude barbarian settlement. The Latin (Italic) tribes then occupying central Italy, after having been subject to the Etruscans from the eighth century B.C. until about 500 B.C., had become securely established under the leadership of Rome by about 400 B.C.; and the city of Rome then began to expand her power. By 275 B.C. Rome controlled Italy north of the Po; she then began the development of an empire that successively took in all of Italy, the Phoenician colony of Carthage on the African coast, Macedonia, the eastern empires that had been formed from Alexander's empire, Greece, Egypt, and eventually the still barbaric peoples of western Europe, reaching its greatest extent about 100 A.D. The Romans themselves added little to Greek learning; but as Roman civilization developed during the growth of the empire, it continually became more and more influenced by the Greeks (though its foundation was Etruscan), establishing the Greek culture and language still more firmly throughout the civilized world.

Barbarian invasions, which began about the third century A.D., combined with internal strife and decline, and the rise of a New Persia in the Tigris-Euphrates region (under the Sassanians), led to a division of the Roman Empire in the fourth century into Eastern and Western Empires, and finally to its collapse and breakup. In the West, the ancient world came to a final end in 476 A.D., the Western Roman Empire

having been completely replaced by barbarian kingdoms; the ancient civilization and learning almost disappeared in the West, and the Dark Ages settled over Europe. In the East, classical learning steadily declined; and a rapid rise of the Moslem Arabs in the early seventh century destroyed the remaining Eastern Roman Empire (Byzantine Empire) except for a small fragment in Asia Minor and the Balkan peninsula ruled by the successors of the Roman Emperors at Constantinople, where the ancient civilization survived until the Turkish conquest in 1453.

By 750 A.D. the Moslem Empire included Arabia, western Asia (over to India), Egypt and northern Africa, and Spain; the capital was at Baghdad. After the middle of the eighth century the Moslems actively cultivated the ancient learning that came into their possession: First, from their contacts with the peoples of the Tigris-Euphrates region and, after the conquest of Persia, with the scholars of India, they obtained Babylonian and Hindu knowledge and also the Greek learning that had been transmitted to those regions; later, they came into contact with the original Greek writings. The culture of Islam—a fusion of Arabic with Persian and Greco-Persian elements—soon became supreme throughout the learned world, and Arabic the principal literary language. The Moslem supremacy in Asia declined after the tenth century, but continued in Spain (among the Moors) until the capture of Cordova and Seville by the Spaniards in the thirteenth century, and survived still longer in Egypt. The rise of Mongol power in Asia during the thirteenth century, with the capture of Baghdad in 1258, destroyed the Eastern Caliphate. Under the Mongols, Persia became for a time a leading center of learning, but during the fifteenth century intellectual progress came to an end in the East.

Meanwhile, the cultivation of classical learning, gathered from Persia, Mesopotamia, Syria, Egypt, and the Byzantine Empire, and concentrated with knowledge from India, by Moslem scholars of many different nationalities, had carried the legacy of the ancients westward along both

the northern and southern shores of the Mediterranean as far as Spain and Morocco. During the eleventh century, the Arabic learning had commenced to spread slowly from Spain into other parts of western Europe, but this diffusion did not reach significant proportions until about the thirteenth century. Finally, during the fifteenth and sixteenth centuries, the Renaissance in western Europe opened the modern era, first in Italy and then successively in other countries.

During the course of the long succession of historical events sketched above, the cultivation of astronomy among the nations that were involved resulted in the eventual establishment of astronomical learning in its present form in our own civilization.⁵

The astronomical knowledge that developed among the ancient Oriental nations of the pre-Hellenic period as a result of centuries of continued astronomical observation—principally in Egypt and Babylonia, where the cloudless skies and clear atmosphere were especially favorable for the observation of celestial phenomena—constituted the beginning from which modern astronomy has evolved. Historical records from ancient Egypt give evidence of astronomical observation extending back into the early third millennium, although no actual records of systematic observations from any period are known, nor are any specific Egyptian observations used in extant writings from later times. From Babylonia, written records of observations of the planet Venus made nearly 4,000 years ago are still extant; but not until after the eighth century B.C. did the Babylonian astronomical observations become sufficiently systematic and precise to lead to a very exact knowledge of celestial phenomena. The earliest observations were necessarily simple, and more or less rough: All ancient peoples grouped the brighter

⁵ The development of astronomy is included in the general summaries of scientific and cultural progress among different nations given in the various introductory sections and chapters of GEORGE SARTON, *Introduction to the history of science*, Carnegie Inst. Washington Publ. No. 376; volumes 1 (1927) and 2 (1931) cover the period from antiquity through the thirteenth century.

stars into constellations; introduced the zodiac in one form or another, as a means of following the apparent motions of the sun, the moon, and the five planets visible to the unaided eye; and based calendars, and methods of measuring time, on celestial phenomena. Particular attention was always given to eclipses, heliacal risings and settings of the planets and bright stars, conjunctions, and other similar occurrences. From centuries of observation, the characteristics of the apparent motions of the sun, moon, and planets among the fixed stars became accurately enough known, especially in Babylonia, for empirical methods of predicting celestial phenomena to be constructed. In general, astronomy was cultivated largely for religious and astrological purposes.

Babylonian astronomy was gradually developed during the 3,000 years or more preceding the Christian Era, by the various peoples who occupied the Tigris-Euphrates region from Sumerian to Roman times. It remained primitive until during the late Assyrian period, when a continuous series of carefully recorded systematic astronomical observations began with the reign of Nabonassar in 747 B.C. and extended over several centuries. From the long records of observations, the later Babylonians obtained an accurate knowledge of the periods and principal inequalities of the apparent motions of the celestial bodies, and constructed elaborate methods for mathematically representing these motions and calculating remarkably exact ephemerides of the positions and principal phenomena of the sun, moon, and planets, including the prediction of eclipses. Babylonian astronomy reached its most advanced stage during the third and second centuries B.C. at the period when Greek astronomy was rapidly developing; and the Greeks, especially Hipparchus, used many of the Babylonian results.

Egyptian astronomy never approached the level attained by Assyro-Babylonian learning, nor apparently was it ever greatly influenced by the Greek and Babylonian knowledge, and it can not compare in importance with the Babylonian as a founda-

tion for Greek astronomy. The later Egyptians developed methods for roughly calculating the apparent motions of the moon and the planets, but they never advanced beyond simple approximate procedures in which no account was taken of the details of the inequalities.

The Chaldean astronomy was the earliest scientific system of astronomical knowledge; but apparently it was entirely empirical, and dominated by religious and astrological motives. There is no certain evidence that either the Egyptians or the Babylonians constructed any explanatory theories, other than primitive mythological cosmologies, to account for the phenomena they observed or for the empirical rules they developed. Upon the basis of the accumulated Oriental knowledge, however, particularly that of the Chaldeans, the ancient Greeks initiated the development of astronomy as a logical science, by introducing natural physical law and abstract rational thought in place of mythology and mysticism, formulating general principles in place of particular statements, and constructing systematic physical and mathematical theories of the arrangement and motions of the heavenly bodies in space for the explanation and calculation of celestial phenomena in place of a collection of empirical rules. Ancient astronomical science was essentially and almost wholly a creation by the Greeks; but the Orient provided the initial stimulus to the constructive intellectual genius of the Greeks, and supplied an indispensable foundation of observational data and empirical results from 30 centuries of activity. It was among the Ionians, in closest contact with the Orient, that Greek philosophy and science first began to develop.

The astronomical and mathematical knowledge of their Oriental predecessors and contemporaries began to be introduced among the Greeks about the seventh century B.C., and Greek philosophy appeared in the sixth century with Thales and the Pythagoreans, although scientific astronomy as distinguished from philosophical speculation did not begin until the early fourth century B.C. While Hellenic culture was being disseminated and established

throughout the civilized world by the conquests of Alexander and the expansion of the Roman Empire, the Greeks actively continued the development of astronomy, making particularly extensive use of the Babylonian results.

The great Greek astronomers Hipparchus (second century B.C.) and Ptolemy (second century A.D.) developed astronomy to the most advanced stage that was attained in ancient times; and for more than 1,000 years after the fall of the ancient civilization, no essentially new development or important further progress was effected in astronomy as left by the Greeks. Learning practically disappeared in the West, although a limited knowledge of Greek astronomy (obtained from old Roman writings) existed in some of the monasteries, especially after the eighth or ninth century; but at the declining Alexandrian school and among the nations of the East, Greek astronomy continued to be cultivated to a limited extent: Syriac versions of the Greek writings had been preserved among the Nestorian Christians, followers of the Syrian monk Nestorius who was exiled from Constantinople in the early fifth century, and whose missionaries founded religious institutions in many parts of western Asia; Greek astronomy had been carried to Persia by refugees from the Academy at Athens, closed by Justinian in 529; and in the pagan Harranian settlements the classical tradition still survived. Through these channels of diffusion, Greek learning was first transmitted to Baghdad after the rise of the Moslem Empire. Moslem astronomy, after the first impulse from India, was based wholly on the Greek writings—principally those of Ptolemy; and as transmitted by the Arabs to western Europe after the opening of the revival of learning, astronomy was substantially the same as when left by Ptolemy. The Arabs were accurate observers and skillful calculators; they contributed many new observations, tables, and treatises; and some of the Hindu and Arabic ideas which became integrated with the Greek knowledge, particularly in mathematics, were of great importance; but the improvements effected by the Moslems in

astronomical science were only in details. Astronomy as slowly revived in Europe—first through Latin, Hebrew, and Spanish versions of Arabic astronomical and mathematical writings translated during the twelfth and thirteenth centuries, and later through the study of original Greek writings—was therefore essentially the ancient Greek astronomy as developed by Ptolemy (although the earlier and much less advanced ideas of Aristotle were also accepted to some extent); and modern astronomy emerged in western Europe directly through a progressive modification of the Ptolemaic astronomy. The impress of the Greeks and the Arabs is still apparent in the terminology of astronomy and uranography; and even traces of ancient Babylonian influence remain.

As the ancient astronomy gradually became known in Europe, the first active efforts to continue its development, and to remove the imperfections that became apparent, began during the fifteenth century—particularly in Germany, through the work of Peurbach (1423–1461) and Regiomontanus (1436–1476); but no important advances were made until, during the sixteenth and seventeenth centuries, Copernicus and Kepler transformed the Ptolemaic astronomy into a form which prepared the way for Newton and his successors.

The writings now surviving, which provide the original record of these ages of development, become fewer and more fragmentary the farther back in history we penetrate; the details of the earliest developments and mutual exchanges of ideas among different peoples are obscured by the mists of remote antiquity and cannot now be traced with certainty, while the beginnings are completely lost in the darkness of prehistoric times. The more conspicuous of the celestial phenomena that are immediately apparent to direct observation were undoubtedly among the first natural occurrences to be consciously noticed by primitive man; and even in prehistoric times the inhabitants of many different lands were led by one motive or another to begin astronomical observations and records. To early peoples, the starry heavens were an

intimate part of daily life and thought; celestial phenomena were the guide for numerous practical activities, and the basis of many popular customs. The cultivation of astronomy was not confined to the nearer Orient, where the particular development that has led to the learning of our own civilization had its beginning; and the relations between the nearer Orient and the ancient civilizations in India and eastern Asia, where the other principal cultural developments originated,⁶ are imperfectly known, but apparently the development of ideas in western Asia and the Mediterranean region was not significantly influenced by the eastern Asiatic peoples. Astronomy was cultivated in China and India, beginning in very remote times—possibly extending back to the third millennium B.C. in China, and probably into the second millennium or farther in India—but in both regions it remained rather primitive until comparatively late times, and mostly independent of developments to the westward. Chinese culture may have been somewhat influenced in very remote times by Babylonia and possibly by ancient India, and it is certain that a trade connection existed between Sumeria and an early civilization in the Indus Valley that extended back to 2500 B.C. or earlier; but only very little is known either of the earliest part of the historic period in China (which does not open until about the fourteenth century B.C.) or of the period in India before 1500 B.C. Later, through contacts during the time of the Persian Empire and after the conquests of Alexander, learning was introduced into India from the westward; and in time some of the Hindu knowl-

edge permeated to China, especially after the first century A.D. The earliest historic contact of China with the West was in the second century B.C., when the silk route to the Roman Orient was established; but at least a few ideas seem to have filtered through from Chaldea, Greece and possibly Persia as early as the fourth century B.C., and perhaps from India in the eighth century B.C. After the fourth century A.D., the development of Chinese astronomy was dominated by influences from the nations to the westward.

The earliest coherent Chinese astronomical writings now extant date from shortly before the Christian Era; the ancient astronomy recorded in them undoubtedly dates back in large part to at least 400 B.C., and includes some material that is several centuries older still. With some further development, this ancient system continued to prevail in China until the adoption of Western astronomy from the Jesuits in the late seventeenth century.⁷ The Chinese astronomers directed their efforts almost wholly to the mere observation of celestial phenomena and the regulation of the calendar, and to the cultivation of astrology; during the thirteenth century, the influence of the Moslem Persians and Arabs penetrated to China, and observatories (superior to any in Europe at that time) were established (e.g., at Peking) where observations with the ancient instruments were made for several centuries, but Chinese astronomical knowledge remained comparatively primitive, and astronomical science was never developed to an important extent. In India, however, a scientific Hindu astronomy had developed by the fifth or sixth century A.D., although some uncertainty exists as to the extent to which it developed independently of Greek influence; but progress ceased after the twelfth century, and a belated attempt (at Jaipur and elsewhere in north India) to revive activity in the early eighteenth century did not accomplish anything of importance.

The Hindus exerted an indirect influence

⁶ The theme of the present discussion does not require any consideration of the astronomical knowledge which developed among the Maya, Aztec, and Inca civilizations, or among the different aboriginal and primitive peoples of various parts of the world. The astronomical ideas of some of these races are briefly described by E. ZINNER, *Geschichte der Sternkunde* (Berlin), 1931. For a summary of Mayan astronomy, see also: J. E. TEEPLE, *Maya astronomy*, Carnegie Inst. Washington Publ. 403, pp. 29–115, 1930; cf. MAUD W. MAKEMSON, *The Maya calendar*, Pop. Astron. 50: 6–15, 1942. Some writers have advanced the speculation that the Chinese and the Mayan systems of astronomy had a common origin (see, e.g., Journ. Roy. Astron. Soc. Canada 33: 1–4, 1939).

⁷ See HERBERT CHATLEY, *Ancient Chinese astronomy*, Occas. Notes Roy. Astron. Soc. No. 5, pp. 65–74, June 1939.

on western astronomy by being the first nation to communicate astronomical knowledge to the Arabs and by contributing several important mathematical ideas; the principal Hindu astronomical writings are therefore of some interest for the present discussion. Of more direct interest are the principal Arabic treatises, particularly those which were most influential in the transmission of the ancient astronomy to the West during the Revival of Learning. The

writings of greatest general interest, however, are: The outstanding Hellenic treatises that record the most important creative achievements of the Greeks; the Egyptian and more particularly the Babylonian records that served as the original foundation for the Greek developments; and the contributions from western Europe that transformed the ancient astronomy into modern form.⁸

THE CONTEMPORARY WRITINGS

No general treatise on astronomy is known from either Egypt or Babylonia. The astronomical knowledge of the ancient Egyptians must be inferred from the surviving inscriptions and pictorial representations of the heavens found on monuments and in the temples and tombs, from a few fragmentary manuscripts, and from the existing references (often untrustworthy) to Egyptian astronomy in Greek writings. Our knowledge of Assyro-Babylonian and Chaldean astronomy is derived principally from cuneiform clay tablets found in large numbers in the ruins of the temples and palaces, particularly in the great library where works of past ages were systematically assembled by the Assyrian king Assurbanipal at Nineveh in the seventh century B.C. The cuneiform astronomical tablets date from about 2000 B.C. to the beginning of the Christian Era, and are inscribed with records of observations, astrological omens, data on the rising, setting, and other phenomena of stars and constellations and calculated ephemerides of the moon and planets.

Many of the more important Babylonian astronomical tablets are reproduced in cuneiform and phonetic transcriptions, accompanied by German translations and explanatory discussions, in F. X. KUGLER, *Sternkunde und Sterndienst in Babel* (2 vols. and 3 supplements, Aschendorffsche Verlagsbuchhandlung, Münster in Westfalen, 1907-1935; the third supplement was prepared by J. Schaumberger, after Kugler's death in 1929); and an examination of representative examples of these original texts

is the best way of obtaining a satisfactory idea of Babylonian astronomy.⁹ The Babylonian ephemerides were based on empirical rules deduced from long observation of celestial phenomena; auxiliary tables and occasional precepts for computing the ap-

⁸ An essential factor in the progress of astronomy was the development of appropriate mathematical methods for the treatment of celestial phenomena. Effective mathematical aids adapted to this purpose (other than ordinary numerical calculation) were not available until the Greeks formulated spherical geometry and the elements of trigonometry; the early development of these subjects was to a large extent directly in connection with astronomy. The Greeks were the first to construct an abstract logical system of mathematical knowledge, especially geometry; but, as in the case of astronomy, the development which led to the great mathematical achievements of the Greeks originated under Oriental influence. The Egyptians and especially the Babylonians made remarkable progress in elementary mathematics—principally in the solution of arithmetical problems, the formulation of rules for finding areas and volumes of geometric figures, and the solution of algebraic equations—but accomplished little in the way of general theorems or logical proofs. For a general account of Egyptian and Babylonian mathematics as recorded in extant papyrus manuscripts and cuneiform tablets, see O. NEUGEBAUER, *Vorlesungen ueber Geschichte der antiken mathematischen Wissenschaften*, Bd. I: *Vorgriechische Mathematik* (Berlin), 1934; and on Greek mathematics, Sir THOMAS L. HEATH, *Manual of Greek mathematics* (Oxford), 1931.

⁹ For general accounts of Babylonian astronomy, see: J. K. FOTHERINGHAM, *The indebtedness of Greek to Chaldean astronomy*, *Observatory* 51: 301-315, 1928 (rep. in *Quellen und Studien Gesch. Math. Astr. u. Phys.* B2: 28-41, 1932); A. T. OLMSTEAD, *Babylonian astronomy*, *Amer. Journ. Semitic Lang. and Lit.* 55: 113-129, 1938; ZINNER, *Geschichte der Sternkunde*, pp. 33-69. On Babylonian influences in early Greek astronomy, cf. O. NEUGEBAUER, *On some astronomical papyri and related problems of ancient geography*, *Trans. Amer. Phil. Soc.* 32: 251-263, 1942.

parent lunar and planetary motions are included among the cuneiform tablets, but in the absence of expository texts the methods of computation must usually be inferred from an analysis of the entries themselves. These ephemerides are characterized by being constructed with the aid of arithmetic progressions. The Babylonians were the first to represent the irregular motion of a celestial body as the mathematical resultant of a set of simple artificial components; the particular resolution of the actual motion into components that could be represented and compounded by arithmetic progressions was determined by the mathematical methods then available.

There is no treatise in which all the principal Egyptian records are reproduced and critically discussed, although a large number of examples of the inscriptions and pictorial diagrams are scattered through various publications. Typical examples of the Egyptian portrayal of the sky are reproduced in the Bulletin of the Metropolitan Museum of Art (New York), Feb. 1928 (Sect. II), and vol. 18, pp. 283-286, 1923; and in *Isis* 14: 301-325, 1930, and 17: 262-263, 1925. Examples of calendrical star tables are given in *Osiris* I: 500-509, 1936, and *Isis* 17: 6-24, 1932. The noted Denderah planisphere has been reproduced in many books and articles (recently in *The Sky*, Dec. 1940). A facsimile and translation of a demotic papyrus showing a calculation of the dates of new moon will be found in *Quellen und Studien Gesch. Math. Astron. u. Phys.* B4: 383-406, 1938; and the extant tables of planetary positions (probably constructed from combined observations and calculations) have been edited and discussed by O. NEUGEBAUER, *Egyptian planetary texts*, Trans. Amer. Phil. Soc. 32: 209-250, 1942. These lunar and planetary texts are from Roman times, but the methods seem to date from at least the first period of the Hellenistic age.¹⁰

¹⁰ On Egyptian astronomy, see: ZINNER, *Geschichte der Sternkunde*, pp. 1-32; HERBERT CHATLEY, *Egyptian astronomy*. Journ. Egyptian Archaeol. 26: 120-126, 1941; and O. NEUGEBAUER, *Nature* (London) 143: 115, 1939. The book by E. M. ANTONIADI, *L'astronomie égyptienne* (Paris, 1934) is too uncritical to be a source of reliable

The way in which Egyptian and Babylonian astronomical and mathematical knowledge was transmitted to Greece is incompletely known; many of the earlier Greek writings are lost, and hence the development of ideas cannot be completely traced, either among the early Greeks themselves or from the Greeks to their sources.¹¹ It is known, however, that many Greek scholars traveled extensively in foreign countries, especially Egypt; and that collections of Babylonian astronomical observations were sent to Greece after the capture of Babylon by Alexander (331 B.C.).

In the abundance of Greek writings that survive comparatively little has been preserved in original form. In general, the extant manuscripts are transcriptions made long after the works were originally written, and they require critical collation and editing by competent scholars before trustworthy versions of the ancient writings can be obtained. Some of the Greek writings have been found only in medieval Arabic translations. Arabic manuscripts—comprising many translations as well as original Moslem writings—survive in large numbers, especially in the Spanish archives, although many of them have not been carefully examined. In fact, museums and libraries contain a large quantity of source material for the history of learning among the ancient nations which has not yet been critically studied, while additional material is constantly being discovered through continued explorations in the Orient; and as these documents come to be studied, further vistas into the past may be opened up, although our historical knowledge must always remain more or less incomplete.

Many medieval Latin manuscripts—both translations of Arabic and Greek writings, and original Latin compositions—are in existence. With the invention of printing

information and does not take account of recent important discoveries, but the extensive collection of citations from Greek and Roman writers that it includes is of interest; Antoniadi greatly exaggerates the achievements of the Egyptians and the extent to which the Greeks were indebted to them.

¹¹ On early Greek astronomy (to about 250 B.C.), see Sir THOMAS HEATH, *Aristarchus of Samos* (Oxford), 1913.

about 1450, astronomical works, both ancient and contemporary, were printed in great numbers; the ancient works were issued in the original tongues and in Latin translations. These early editions, as well as the original editions of many later writings, are of course now rare; but most of the more important astronomical writings of past times (including those of the Hindus) are now available in comparatively recent editions, usually in both the original language and a translation into a modern language, although many have not been translated into English. A few are available only in old scarce editions; and some still do not exist in a modern language.

In reviewing the writings that have been most influential in the development of astronomical thought—either because they constitute especially significant advances in the evolution of ideas that have directly led to our own learning, or because they were widely accepted as standard sources of information—we shall list the most easily obtainable good editions of each, including in general both the original text and a translation into a modern language.¹²

From among all astronomical writings,

¹² The original text is, of course, necessary for critical study and is desirable even for the general reader. An ability, if not actually to read a work independently in the original language, at least to follow the original intelligently with the aid of a translation adds immeasurably to the pleasure and satisfaction of the reader and greatly enhances his appreciation of the content; it is principally for the *expression of thought* contained in the ancient writings that they are now read, not primarily for factual information, and much of the character of the original is inevitably lost in even the best of translations by competent scholars, to say nothing of inferior translations. A sufficient reading knowledge of Greek and Latin for the purposes of the general reader of astronomical and mathematical writings does not offer any insurmountable obstacle to the earnest student. Arabic presents more difficulties, while the Egyptian (hieroglyphic, hieratic, and demotic) and cuneiform must usually be left to specialists, but a knowledge of the fundamental principles of these languages is an aid to the appreciative and effective use of the edited texts and translations prepared by Oriental scholars. On the Egyptian language, see O. NEUGEBAUER, *Vorgriechische Mathematik*, pp. 72-78; and ADOLF ERMAN, *Die Hieroglyphen* (Sammlung Götschen. Nr. 608), 2te auf. (Berlin), 1923. On the cuneiform writing, see NEUGEBAUER, *ibid.* pp. 49-67; and BRUNO MEISSNER, *Die Keilschrift* (Samml. Gösch. 708), 2te auf. (Berlin), 1922.

there is little difficulty in selecting three outstanding treatises which rank foremost in fundamental importance for the historical evolution of modern astronomy, and which may be recommended to the general reader for first attention. The first of these works is the *Syntaxis mathematica* of PTOLEMY, usually referred to as the *Almagest*; written in the second century A.D., it remained for 1,400 years the almost universally accepted standard authority, and upon it were based practically all other important astronomical writings during this period. The *Almagest* occupies a position in astronomy corresponding to that of Euclid's *Elements* in geometry. Ptolemy collects and systematizes the astronomical knowledge that had been developed by his predecessors, and amplifies and extends it by his own contributions; his treatise forms a comprehensive account of the final stage to which astronomy was developed in ancient times. The second of the three treatises is the *Astronomia nova* of KEPLER, 1609, which constitutes the first fundamental advance in astronomical ideas that was accomplished after Ptolemy; it records the results obtained from Kepler's study of Tycho Brahe's observations, including the first two laws of planetary motion. The third is the *Philosophiæ naturalis principia mathematica* of NEWTON, 1687, which completed the foundation of astronomy; it gives the physical interpretation of Kepler's empirically derived kinematical laws, and provides all the theoretical principles necessary for the exact mathematical calculation of celestial phenomena. The entire development represented by these three treatises was completely effected without the aid of the telescope.

There are also a number of other writings which, for one reason or another, are of sufficient historical importance or especial interest to claim particular attention in the present discussion, some of which—e.g., the *De revolutionibus orbium coelestium* of COPERNICUS—will immediately occur to the reader; but from the viewpoint of their significance for the logical development of the fundamental principles of astronomy, the above three works overshadow all others.

The most authoritative version of the Greek text of the *Almagest* is the edition by HEIBERG: *Claudii Ptolemaei opera quae exstant omnia Volumen I, Syntaxis Mathematica*, editit J. L. Heiberg (in 2 vols., 1154 pp. $6\frac{1}{2} \times 4\frac{1}{2}$ in.), Leipzig (Teubner), 1898–1903. A German translation from Heiberg's text is available: KARL MANITIUS, *Des Ptolemäus Handbuch der Astronomie*, 2 vols., Leipzig (Teubner), 1912–1913. The Greek text accompanied by a French translation was published by the Abbé HALMA, 1813–1816; the original is now rare, but a photographic reprint has recently been issued: *Composition mathématique de Claude Ptolémée*, par M. Halma, réimpression facsimilé, 2 vols., Paris (Hermann), 1927. Halma's text, however, can not be regarded as definitive, and his translation is somewhat deficient in places. No English translation of the *Almagest* has been published.¹³

The 13 books of the *Almagest* contain an account of spherical astronomy, including the necessary principles of trigonometry, a discussion of precession, and a star catalogue; theories and tables of the motions of the sun, the moon, and the five planets, based on the hypothesis of eccentrics and epicycles; the theory of solar and lunar eclipses; and a determination of the sizes and distances of the sun and the moon. Except for constructing the theories of the planets and discovering the lunar inequality now called the evection, Ptolemy probably derived the contents of the *Almagest* almost entirely from Hipparchus (though adding many extensions and improvements), and many of the results depend upon principles that had been established very early in the development of scientific Greek astronomy. This development had

¹³ For other astronomical writings of Ptolemy, see Vol. 2 of the above edition of the *Opera Omnia: Opera astronomica minora*, ed. J. L. Heiberg, Leipzig (Teubner), 1907. For a German translation of the treatise in which Ptolemy explains the principles of the stereographic projection, see *Isis* 9: 255–278, 1927. Ptolemy is also noted for his treatise on geography, which is second in importance only to the *Almagest*, and which influenced geography as long and as profoundly as the *Almagest* influenced astronomy; on the important manuscripts and editions of the geographical treatise, see *Isis* 20: 267–274, 1933; 22: 533–539, 1935; and 30: 328, 1939.

begun in the fourth century B.C.; the work of Eudoxus of Cnidos (408–355) constituted the transition from the early speculative period to the period of scientific investigation. Eudoxus wrote a systematic description of the recognized constellations and the phenomena of the heavens, developed the elementary principles of the geometry of the celestial sphere and through his hypothesis of homocentric spheres made the earliest known attempt to account quantitatively for the observed irregular motions of the sun, moon, and planets among the stars by means of a true physical theory; his astronomical writings, none of which have survived, were partly the basis of many of the later treatises and further developments through which astronomy gradually reached the stage represented by the *Almagest*.

The fundamental hypotheses of the *Almagest*, as stated by Ptolemy, are

... that the firmament is spherical and moves as a sphere; and that the earth also is sensibly spherical in form, considered as a whole, while in position it lies at the middle of the universe as though it were the center, being in magnitude and distance relatively only a point with respect to the sphere of the fixed stars, and undergoing no change of place through motion.

These principles had long been a generally accepted part of Greek thought; they began to emerge during the sixth and fifth centuries B.C. among some of the Greek speculative philosophers of that period, and to replace the older fanciful cosmologies of the mythological period, although in general the astronomical ideas of the early philosophers were exceedingly primitive and differed greatly from one another.¹⁴ The concept of the heavens as a complete revolving sphere, or series of concentric spheres, entirely surrounding the earth, was a part of several of the early philosophical systems; that the earth was located at the center in free space, without support, was held by Anaximander (ca. 611–547) and Parmenides

¹⁴ The details of the astronomical ideas held by the different Greek philosophers prior to the time of Eudoxus will be found in HEATH, *Aristarchus of Samos*, pp. 1–189; and J. L. E. DREYER, *History of the planetary systems*, pp. 6–86 (Cambridge Press), 1906. Both of these books are now rare.

(early fifth century) among others; while the spherical form of the earth was taught by the Pythagoreans in the late sixth century B.C. (although it is uncertain whether Pythagoras himself adhered to this view) and by Parmenides (who recognized that the temperature zones of the earth arise from its sphericity). In many cases, these ideas appear to have been mere a priori opinions without much foundation; but empirical data and rational arguments in support of them were in time forthcoming as Greek knowledge continued to develop. The sphericity of the earth came to be generally accepted during the early fourth century B.C.; several estimates of its size were made, though on what basis is unknown. The first known actual measurement of the dimensions of the earth was by Eratosthenes (275–194); in Ptolemy's treatise on geography a later measurement by Posidonius (ca. 135–50) is adopted. In general, on the basis of the evidence then available, the earth was regarded as stationary at the center of the universe; but the Greeks explicitly recognized that conceivably the earth could be in motion and the observed motions of the heavenly bodies only apparent, and this hypothesis was definitely adopted by some; Philolaus (fifth century B.C.), e.g., maintained that the earth, in common with the sun and other heavenly bodies, revolves around a "central fire"; Heraclides of Pontus (fourth century B.C.) taught the axial rotation of the earth (and incidentally a motion of Mercury and Venus around the sun); and Aristarchus of Samos (fl. ca. 280 B.C.) advocated both a rotation of the earth and an orbital revolution around the sun. The basis for these ideas is uncertain, and they appear to have met with little acceptance in ancient times.

Spherical astronomy in the form found in the *Almagest* was the result of a development that had begun with Eudoxus or possibly even earlier. The oldest Greek mathematical writings now extant, however, are two small treatises by Autolycus of Pitane (fl. ca. 310 B.C.), one on the formal geometry of the rotating celestial sphere (though the celestial sphere is not mentioned by name) and the other on the diurnal and heliacal

risings and settings and daily and annual periods of visibility of the fixed stars and zodiacal signs; both apparently were derived largely from a still earlier work on Spherics probably written by Eudoxus. The Greeks used the term "Spherics" for abstract spherical geometry developed specifically in a form for application in astronomy but without explicit reference to the celestial sphere; while the description of the actual aspects of the heavens was called "Phenomena." For the Greek text (79 pp., $6\frac{1}{2} \times 4\frac{1}{2}$ in.) of the treatises by Autolycus, with a Latin translation, see F. HULTSCH: *Autolyki de sphaera quae movetur, de orbitibus et occasibus*, Leipzig (Teubner), 1885; these treatises are also available in a German translation: *Autolykos, Rotierende Kugel und Aufgang und Untergang der Gestirne*, übersetzt von ARTHUR CZWALINA, Leipzig (Akademische Verlagsgesellschaft), 1931. The writings of Autolycus were one of the sources used by his younger contemporary, the geometer Euclid (323–285? B.C.), in preparing a treatise on *Phenomena*, of which the Greek text (56 pp., $6\frac{1}{2} \times 4\frac{1}{2}$ in.) with a Latin translation, edited by H. MENGE, is included in *Euclidis opera omnia* ediderunt J. L. Heiberg et H. Menge, vol. VIII, Leipzig (Teubner), 1916; this treatise is devoted principally to the geometrical theory of the phenomena of the diurnal motion. These early works do not contain any trigonometry or any consideration of spherical triangles as such; the principal special circles of the celestial sphere are recognized—horizon, equator, tropics, ecliptic and its obliquity, etc.—but no reference is made to any system of coordinates. The systematic use of formal geometric coordinate systems, particularly ecliptic coordinates, on the celestial sphere, and the development and application of adequate observational procedures and mathematical aids, were apparently largely owing to Hipparchus, second century B.C.; only unimportant fragments of his writings now remain, but the *Almagest* provides an extended account of his accomplishments and results. Hipparchus effected many improvements in the instrumental equipment then in use, probably devising several of the

instruments himself; he began the development of trigonometry,¹⁵ without which many necessary astronomical calculations were difficult or impossible except as aided by the use of a celestial globe or armillary sphere; and he systematically observed the celestial bodies, discovering the precession of the equinoxes (which apparently was never recognized by the Babylonians, though different authorities are not in agreement on this point), and constructing a catalogue of several hundred stars. Among the Greeks, observation, though not lacking, was always overshadowed by theoretical investigation; according to Ptolemy, practically no records of observations of the fixed stars existed prior to Hipparchus, except a few by Aristyllus and Timocharis in the early third century B.C. The star catalogue in the *Almagest*, extending the one compiled by Hipparchus, is the earliest existing record of the aspect of the fixed stars; and it is a primary source of the classic 48 constellations which, with the 40 others added in later times, still appear on modern charts of the heavens with the romantic legends of Greek and Roman mythology woven about them, although even in ancient Greek times the historical origin of most of these asterisms was already

¹⁵ The earliest trigonometrical treatise now extant is a work on Spherics written by Menelaus of Alexandria about 100 A.D.; the Greek original is lost, but Arabic and other translations survive. This work is a treatise on spherical trigonometry disengaged from stereometry and astronomy. See MAX KRAUSE, *Die Sphärik von Menelaos aus Alexandrien*. Abh. Ges. Wiss. Göttingen, Phil.-Hist. Kl., Dritte Folge, Nr. 17, Berlin (Weidmann), 1936, which includes the Arabic text and a German translation; and A. A. BJÖRNBO, *Studien ueber Menelaos' Sphärik*. Abh. Ges. math. Wiss. 14: 1-154, Leipzig (Teubner), 1902. Evidence exists that the development of trigonometry by Hipparchus, Menelaus, and Ptolemy was a natural continuation of Babylonian ideas; this development was continued by the Moslems, who incorporated some ideas from the Hindus. Trigonometry, insofar as it consists of the geometrical properties of plane and spherical triangles and methods for their numerical solution, was brought to essentially its present form by Regiomontanus (Johann Müller) and Peurbach in the sixteenth century. The Greeks inscribed angles in circles, and accomplished their calculations by means of the chords subtending central angles; the chord was replaced by the sine, and the other trigonometric functions added, in later times.

obscured by the mists of antiquity.¹⁶ A critical edition of this star catalogue was issued by C. H. F. PETERS and E. B. KNOBEL, *Ptolemy's catalogue of stars* (Carnegie Inst. Washington Publ. No. 86), Washington, 1915. Ptolemy also gives a careful description of the course of the Milky Way among the constellations.

The Ptolemaic theory of the solar system was the culmination of a progressive development extending back to the period in the sixth century B.C. when the concept of rotating crystalline spheres, naturally suggested by the apparent celestial motions, was introduced by the early Greek philosophers. On the basis of this general concept, Eudoxus constructed the first geometric theory that attempted to represent quantitatively the details of the observed apparent motions of the sun, moon, planets and fixed stars; by means of a system of 27 revolving spheres with mutually inclined axes, he accounted for the diurnal motions, and for the paths and principal variations in speed of the sun, moon, and planets among the fixed stars. Shortly afterward Callippus modified this system by adding seven more spheres to improve the agreement of the theory with observation. Probably these spheres were generally regarded, not as material bodies, but only as abstract geometrical constructions for computing the motions; but Aristotle (384-322 B.C.), who further developed the theory¹⁷ by add-

¹⁶ The stars were grouped into constellations in very remote times among all peoples. Possibly the Greeks derived their constellations, at least in part, from the earlier ones of the Egyptians and Babylonians, of which our knowledge is incomplete and often uncertain. The oldest systematic description of the Greek constellations that has come down to us was written about 270 B.C. by the poet Aratus; it is based on an earlier treatise by Eudoxus. The Greek text (732 lines) and an English translation of the *Phaenomena* of Aratus, edited by G. R. MAIR, are included in the same volume of the Loeb Classical Library that contains the writings of Callimachus and Lycophron (London, Heinemann, 1921; now handled by the Harvard University Press); the excellent English translation published by Robert Brown, Jr., in 1885, is now difficult to obtain, but is reprinted in an astrological volume by A. E. PARTRIDGE, *The story of the heavens*, Seattle (Simplex Publishing Co.), 1936.

¹⁷ See GIOVANNI SCHIAPARELLI (1835-1910), *Le sfere omocentriche di Eudosso, di Callippo e di Aristotele*, Scritti sulla Storia della astronomia

ing 22 more spheres to the system, explicitly considered them to be physical realities. As a theory of the physical constitution of the universe, the Aristotelian spheres continued to be rather widely accepted, not only in Greek and Roman times, but also during the Middle Ages¹⁸; in mathematical astronomy, however, they were gradually superseded by systems of moving excentric circles and epicycles. The theory of homocentric spheres could not satisfactorily account for some phenomena—in particular, as the Greeks recognized at an early period, the occurrence of annular eclipses and the great variations in brightness of the planets imply considerable variations in the distances of the moon and the planets from the earth. The conception of excentric and epicyclic motions in space—which is essentially only a modification of the concept of homocentric spheres—was applied by Apollonius of Perga (third century B.C.) to explain the apparent motions, though

probably the idea had originated still earlier; and it was systematically employed by Hipparchus and Ptolemy, who regarded it, however, not as a physical reality, but only as a basis on which the motions of the sun, moon and planets could be represented and calculated by means of an abstract geometrical system. Ptolemy adopted Hipparchus's theories of the sun and the moon, extending the latter by including evection; and constructed corresponding theories and tables of the planets, for which the necessary observations had not been available to Hipparchus.

Ptolemy's theory of eclipses is taken substantially from Hipparchus, with some improvements. Naturally, at that time only vague and conflicting ideas prevailed in general as to the physical nature of the celestial bodies; but the correct explanations of the moon's light, the phases of the moon, and lunar and solar eclipses had been given by several philosophers of the sixth and fifth centuries, and were an accepted part of Greek elementary astronomy at the time of Aristotle (although apparently this knowledge was not widespread among the people, who looked upon eclipses with superstitious terror). From the theory constructed by Hipparchus, the time of a lunar eclipse could be predicted to within an hour or two, and that of a solar eclipse with somewhat less accuracy, but the magnitudes could be only roughly calculated.

As Ptolemy explicitly states, no way of determining the distances of the planets from the earth was available in ancient times. That the celestial bodies are not all at the same distance had long been evident from such phenomena as occultations and eclipses; and various orders of distance had been adopted by different writers on the basis of the indirect evidence then available. The traditional order adopted by Ptolemy—Moon, Mercury, Venus, Sun, Mars, Jupiter, Saturn—had been generally accepted since the second century B.C., and was based principally on the criterion of relative rapidity of apparent motions; the planets confined to limited elongations were separated from the others by the sun. The earliest ideas of the magnitudes of the distances

antica (3 vols. Bologna, Zanichelli, 1925–1927): vol. 2, pp. 1–112 (first published in 1877). Cf. DREYER, *History of the planetary systems*, pp. 87–122; and HEATH, *Aristarchus of Samos*, pp. 190–224.

¹⁸ Aristotle's extension of the theory of homocentric spheres was his principal contribution to the development of astronomy. His astronomical writings as a whole are of secondary importance and interest; he collected and systematized the best knowledge of his time, as he did in other subjects, but the Greek astronomy of that period was still in an undeveloped state and unfortunately was crystallized in this form in Aristotle's writings, to be persistently invoked during later centuries in support of doctrines that could no longer reasonably be considered tenable. Aristotle was primarily a speculative philosopher, and his voluminous writings include many obscurities and unfounded ideas, although they also contain evidence of independent and careful observation. The astronomical material (largely of a metaphysical character) is found principally in the second book of *De caelo*; but shooting stars, comets and the Milky Way are discussed in *Meteorologica* (Bk. I), and the system of planetary spheres (though not fully treated in any of Aristotle's own extant writings) is briefly described in *Metaphysica* (Bk. XI, ch. 8). Translations of all these treatises have appeared in *The works of Aristotle translated into English* published at Oxford (Clarendon Press); the Greek text of *De caelo* with an English translation by W. K. C. GUTHRIE, has been published in the Loeb Classical Library (Harvard Univ. Press, 1939); the passages from *Metaphysica* are quoted in HEATH, *Aristarchus of Samos*, pp. 194, 212, 217, and the other astronomical writings of Aristotle are discussed in chap. xvii.

were mere speculations or arbitrary surmises; the first known actual measurement was by Aristarchus, who determined the relative distances of the sun and the moon (and hence the relative diameters too) by observing the angular distance of the moon from the sun at the time of the quarter phase. Aristarchus also determined the relative diameters of the sun and the earth by a method based on the measurement of the angular breadth of the earth's shadow through observations of lunar eclipses. The Greek text (30 pp., 6×9 inches) of Aristarchus's treatise "On the Sizes and Distances of the Sun and the Moon," with an English translation, is included in Sir THOMAS HEATH, *Aristarchus of Samos*, Oxford (Clarendon Press), 1913, a book unfortunately already rare. The eclipse method was further developed and applied by Hipparchus to determine the sizes and distances of the sun and the moon in terms of the earth's radius. These methods are perfectly sound; but the values obtained for the size and distance of the sun were greatly in error because of the difficulty of accurately measuring the necessary quantities, especially with the rough instruments then available, and their uncertainty seems to have been realized by Hipparchus. Ptolemy adopted the eclipse method to get the distance of the sun in terms of that of the moon; but he determined the distance of the moon by a parallax method. The values adopted in the *Almagest* for the size and distance of the moon are fairly accurate; but the value of 1210 radii of the earth for the distance of the sun was highly erroneous although it was not substantially improved until the solar parallax was determined by Richer and Cassini from observations of Mars in 1671-73.

After the appearance of the *Almagest*, many of the earlier writings continued to be extensively used in preparation for the study of Ptolemy's advanced and difficult treatise; several of them, in fact, were systematically gathered together into a collection that became known as the "Little Astronomy," in contradistinction to Ptolemy's great treatise to which they formed an introduction. This collection comprised:

the works on Spherics by Autolycus and Euclid, already discussed; a later treatise on Spherics by Theodosius, who probably flourished about the beginning of the first century B.C., but whose works are largely compilations that have their source in Eudoxus or other early writers antedating Autolycus and Euclid; two other works by Theodosius—"On Habitations," relating to the aspects of the right, parallel, and oblique spheres, and "On Days and Nights," devoted principally to the variations of the lengths of day and night and the location of the sunrise and sunset points in relation to the position of the sun in the ecliptic; Euclid's "Optics"—a treatment of elementary perspective; Aristarchus's treatise on the sizes and distances of the sun and the moon; Hypsicles's "On Ascensions" (early second century B.C.)—a rudimentary set of six theorems on the times of rising of the zodiacal signs, and the oldest Greek work wherein the (ecliptic) circle is divided into 360 parts; and Meneleus's "Spherics."¹⁹

Moreover, there were in ancient times several elementary general textbooks of considerable interest: Preceding the *Almagest* was the introductory treatise "Elements of Astronomy" commonly attributed to Geminus (fl. ca. 70 B.C.), although it may not be genuine. It is largely a compilation

¹⁹ A critical edition of the works of Theodosius was recently issued by Heiberg and Fecht: J. L. HEIBERG, *Theodosius Tripolites sphaerica*, Abh. Ges. Wiss. Göttingen, Phil.-Hist. Kl., Neue Folge, 19, Nr. 3; RUDOLF FECHT, *Theodosii de habitationibus liber: De diebus et noctibus libri duo*, ibid., Nr. 4, Berlin (Weidmann), 1927. This edition gives the Greek text (148 pp. 6½×10 inches) and a Latin translation; a German translation of the Spherics by CZWALINA, *Theodosios von Tripolis Sphaerik*, is included in the same volume with the translation of Autolycus, previously cited; and a French translation has been published by PAUL VER EECKE, *Les sphériques de Théodose de Tripoli*, Bruges (Desclée de Brouwer), 1927, the introduction to which contains a list of the theorems from the other two treatises. Euclid's work on Optics (in vol. 7 of *Euclidis opera omnia*) has been translated into French by PAUL VER EECKE, *Euclide, l'optique et la catoptrique*, Paris et Bruges (Desclée de Brouwer), 1938. On Hypsicles, see K. MANIUS, *Des Hypsikles Schrift Anaphoricos nach Ueberlieferung und Inhalt kritisch dargestellt*. (Dresden) 1888; cf. V. DE FALCO, *Beiträge zur kritischen Textgestaltung des Autolykos und des Hypsikles*, Quellen u. Stud. Ges. Math. Astr. u. Phys. B1: 278-300, 1930.

of common knowledge from the time just before Hipparchus, and shows an influence of the Stoic philosopher Posidonius; it includes a valuable treatment of the calendar, calendrical cycles and the exeligmos, and considers rather fully the zodiac, the constellations, the circles on the celestial sphere, the apparent motions of the celestial bodies, eclipses, the climatic zones of the earth, and other topics, but contains very little about the planetary theories. The Greek text (116 pp., $6\frac{3}{4} \times 4\frac{1}{2}$ in.) with a German translation was edited by CAROLUS MANITIUS: *Gemini elementa astronomiae*, Leipzig (Teubner), 1898. Cleomedes (probably first century B.C.) also wrote a summary of Stoic astronomy, based chiefly on Posidonius, which is of particular interest for the details it contains of the measurements of the earth by Eratosthenes and Posidonius, and the recognition of some of the effects of astronomical refraction. The Greek text (114 pp., $6\frac{1}{2} \times 4\frac{1}{2}$ in.) with a Latin translation was issued by H. ZIEGLER: *Cleomedis de motu circulari corporum caelestium libri duo*, Leipzig (Teubner), 1891; and a German translation was made by ARTHUR CZWALINA: *Kleomedes Die Kreisbewegung der Gestirne*, Leipzig (Akademische Verlagsgesellschaft), 1927. A treatise "On the Mathematical Knowledge Needed to Read Plato," by Theon of Smyrna (second century A.D., nearly a contemporary of Ptolemy), includes a book on astronomy that forms a valuable supplement to the *Almagest*; it is largely a compilation from Adrastus and Dercyllides of knowledge at the time of Hipparchus. The Greek text (165 pp., $6 \times 9\frac{1}{2}$ in.) with a French translation was edited by J. DUPUIS: *Théon de Smyrne, philosophe platonicien, exposition des connaissances mathématiques utiles pour la lecture de Platon*, Paris (Hachette), 1892. A later textbook, introductory to the astronomy of Hipparchus and Ptolemy, particularly the theories of the sun, moon, and planets, was written by Proclus (410-485 A.D.); the Greek text (119 pp., $6\frac{1}{2} \times 4\frac{1}{2}$ in.) with a German translation was published by CAROLUS MANITIUS: *Procli Diadochi hypotyposis astronomicarum positionum*, Leipzig (Teubner), 1909.

The *Almagest*, like many ancient writings, was the subject of later commentaries, which often are especially valuable for the historical details, and the extracts from earlier writings now lost, which they contain but which are usually very tedious reading. Among the writings of Pappus of Alexandria (probably end of third century A.D.) is a commentary on the *Almagest*, of which only Books V and VI are known to have survived; Theon of Alexandria (late fourth century A.D.), the father of Hypatia, wrote another commentary, which incorporates much of the one by Pappus. An edition of the Greek text of these two commentaries (with valuable notes) is being issued by the Abbé ROME, *Commentaires de Pappus et de Théon d'Alexandrie sur l'Almageste*: Tome I, *Pappus d'Alexandrie, commentaire sur les livres 5 et 6 de l'Almageste*, Rome (Biblioteca Apostolica Vaticana), 1931; Tome II, *Théon d'Alexandrie, commentaire sur les livres 1 et 2 de l'Almageste*, Vatican City (Bibl. Apost. Vat.), 1936. The introductions to these volumes include an explanation (in French) of the tables in the *Almagest*. Of commentaries on other writings, the one by Simplicius (sixth century A.D.) on Aristotle is especially valuable to the historian; it has been edited by J. L. HEIBERG: *In Aristotelis de caelo commentaria* (Berlin, 1894).²⁰

The few Roman astronomical writings contain nothing original and are of little scientific importance. Pliny's famous "Na-

²⁰ In chronological order, the authors of the extant Greek writings of which editions have been cited in the foregoing discussion are:

B. C.	A. D.
384-322 Aristotle	ca. 100 Menelaus
Fl.ca.310 Autolycus	2nd cent. Ptolemy
323-285? Euclid	2nd cent. Theon of Smyrna
Fl.ca.280 Aristarchus	Late 3rd cent.? Pappus
Fl.ca.275 Aratus	Late 4th cent. Theon of Alexandria
2nd cent. Hypsicles	410-485 Proclus
Ca. 100? Theodosius	6th cent. Simplicius
1st cent.? Cleomedes	
Fl.ca.70 Geminus	

Brief extracts (in English) from some of these and a number of other Greek writers are given by HEATH, *Greek astronomy*, New York (Dutton), 1932. See also the delightful little volume by D'ARCY W. THOMPSON, *Science and the classics* (Oxford Univ. Press), 1940.

tural History" contains an interesting section (Bk. II) devoted to astronomy (available in the Loeb Classical Library), and several other compilers and commentators wrote on the subject.

The respects in which the Ptolemaic astronomy is now known to be defective have been much overemphasized in modern textbooks and popular writings, to the neglect of its intrinsic merit and its great importance as a foundation for the later development of modern astronomy. Greek astronomy, especially from the time of Hipparchus on, was for the most part developed according to sound scientific principles, by means of mathematical reasoning based on observational data that extended over many centuries. A high degree of success was achieved in the progressive formulation of theories by which celestial phenomena could be represented and calculated as accurately as they were then known from observation. For this purpose, the adoption of the geocentric hypothesis rather than the heliocentric is logically of secondary importance; and the system of excentrics and epicycles as a formal mathematical method is in principle above criticism. Besides, the planetary theory is not the whole of even the ancient astronomy; and a number of passages in the *Almagest* may easily be recognized as occurring in practically unchanged form as an integral part of modern treatises, while many other sections have merely now been superseded by material entirely equivalent but in a more refined or expeditious form. Of the physical arguments in the *Almagest*, few can justly be characterized as absurd. Ptolemy insisted on the physical reality of the fixity of the earth at the center of the universe, but only after express recognition and consideration of the evidence then available for other possibilities; some of the arguments by which he supported his hypothesis are scientifically unsound, but the others, though now recognized to be untenable, were entirely reasonable in the state of physics and mechanics at that time. There is ample evidence that the Greek scientific astronomers, unlike the early speculative

philosophers, regarded their systems of spheres and epicycles, however, as nothing more than abstract geometrical constructions for conveniently representing and calculating celestial motions. The *Almagest* is an enduring monument to the genius of the ancient astronomers; and moreover it was through the explicit further development and revision of ancient astronomy in the form left by Ptolemy—not through its replacement by independent developments—that modern astronomy was constructed.

A change from the geocentric basis to the heliocentric is easily made without otherwise essentially altering the Ptolemaic system, and was the first of the successive modifications through which the Ptolemaic theory was transformed into the modern structure. This simple change of reference basis was made by Copernicus (1473–1543), and is the only important respect in which the Copernican system differs from the Ptolemaic; the traditional system of excentrics and epicycles is retained practically unchanged except for the simplification resulting from the reduction in the number of circles needed, 34 being used altogether, while the mathematical demonstrations and calculations in the *Almagest* are not fundamentally affected. The significance of the Copernican theory is as a transition between ancient and modern astronomy; as a contribution to the planetary theory, it was neither an original concept nor an important advance; and even the practical gain for computation was not great, either in convenience or in improved accuracy of the representation of phenomena. The celebrated treatise by Copernicus is expressly only a formal revision or reconstruction of the *Almagest*, in which Ptolemy is followed in the main with great fidelity and no basic new empirical considerations are introduced. An exceptional understanding of Ptolemy's principles and methods enabled Copernicus to adapt them to the heliocentric hypothesis, and to initiate the fundamental criticism and reconstruction of astronomy for which a need had long been apparent.²¹ The *Almagest* had first

²¹ See A. ARMITAGE, *Copernicus*, London (Allen

become generally known in the West through a Latin translation completed in 1175 by Gerard of Cremona from an Arabic version. The Moslem astronomers had already perceived that the tables based on Ptolemy's theories were frequently at variance with observations; and some of the later Moslems had attempted to return to Aristotle's system of material spheres or to introduce various makeshifts. During the general revival of learning, the diverse and conflicting hypotheses encountered in the different Greek writings and the rise of the authority of Aristotle (whose astronomical writings were first introduced in the West at the end of the twelfth century), together with the disagreements among the different tables that had been constructed and the failure of any of them to represent celestial phenomena accurately, led to many further attempts to improve on Ptolemy or to substitute other theories, although many of the fanciful ideas which were advocated could not seriously profess to account for the details of the celestial motions. These attempts persisted into the sixteenth century; Fracaster, for example, in 1538 used an Aristotelian system of 79 revolving crystalline spheres. In general, however, Aristotle did not gain the supremacy in astronomy, especially among the learned, that he attained in many other fields of thought from the thirteenth century until the Renaissance; nor was any appreciable success achieved in attempting to improve on the Ptolemaic system. Astronomy at the time of Copernicus was essentially still where Ptolemy had left it.

A facsimile reprint of the original Latin edition of Copernicus's treatise has been issued: *Nicolai Copernici Torinensis de revolutionibus orbium coelestium libri VI, 1543*, Paris (Hermann), 1927. The best text, however, is that of the third edition (Amsterdam, 1617; reprinted in 1640). A new Latin edition, printed from the original manuscript, was issued at Thorn in 1873 on the occasion of the 400th anniversary of the birth of Copernicus. Other than a rare

Latin-Polish edition (Warsaw, 1854), the only complete translation into a modern language is a German version by C. L. MENZZER: *Nicolaus Copernicus aus Thorn ueber die Kreisbewegungen der Weltkörper*, Thorn 1879 (rep. Leipzig, Akad. Verlagsges. 1939); but the first 11 chapters of Book I may be obtained in a French translation accompanied by the Latin text: A. KOYRÉ, *Nicolas Copernic, des révolutions des orbés célestes*, Paris (Alcan) 1934 (this edition contains a number of misprints and some errors of translation). The general reader may be more interested in the much briefer and simpler *Commentariolus*, which (together with the *Letter against Werner* and the *Narratio Prima* of Rheticus) is translated into English, with many helpful notes, in EDWARD ROSEN, *Three Copernican treatises*, New York (Columbia Univ. Press), 1939.

The diffusion and general acceptance of the Copernican hypothesis were very gradual. For a long time, the Copernican and the Ptolemaic systems were both in use as formal means for the calculation of ephemerides; the tables based on the Copernican theory were widely used for this purpose even when the theory itself was but little accepted. Copernicus definitely insisted on the physical truth of his hypotheses of the revolution and the rotation of the earth, and sought to establish them exclusively on the basis of astronomical data, but his arguments were not logically conclusive. The conflicts and inconsistencies that had existed for ages between efforts to determine the physical structure of the planetary system and attempts to construct tables that would represent observations, and the failure of mathematical astronomy to exert much influence on prevailing philosophical and theological views, continued throughout the Middle Ages, especially during the periods when the hostility and intolerance of the Church made it unsafe in many places to declare adherence to the new doctrines; and of course at all times in history many backward ideas prevailed among people at large. The telescopic discoveries by Galileo (1564-1642), especially his detection of the satellites of Jupiter and

and Unwin), 1938; and GRANT MCCOLLEY, *The eighth sphere of Copernicus*, Popular Astronomy 50: 133-137, 1942.

the phases of Venus, provided the first new evidence in support of the Copernican doctrine, and helped to establish the heliocentric theory through their immediate popular appeal; but Galileo did not take any direct part in the development of the planetary theory, nor were his arguments in favor of the Copernican ideas logically effective. During more than 200 years after the death of Copernicus, both the Ptolemaic and the Copernican systems continued to be taught in many places.

Meanwhile, in the sixteenth century the obvious need for additional and more accurate observations on which to base the development of improved theories and tables led to widespread activity in observational astronomy, carried on by means of the ancient instruments. The first improvements of consequence that had been effected in methods and instruments of observation since the time of Hipparchus and Ptolemy were accomplished by Tycho Brahe (1546–1601), who was the earliest observer to estimate and allow for instrumental errors and the effects of refraction, and to realize the importance of *continuous* records of the positions and motions of all the celestial bodies. He attained a much greater degree of accuracy in his observations than had ever before been achieved; he redetermined all important astronomical constants except the solar parallax, and constructed the last important star catalogue of the pretelescopic era.²² Tycho's magnificent series of observations of the

²² A definitive edition of Tycho's complete works (in Latin), including his letters and the records of his observations, has been edited by J. L. E. DREYER, *Tychonis Brahe Dani opera omnia*, 15 vols., Hauniae (Libraria Gyldendaliana), 1913–1929. The contents of the principal writings are described in some detail in the biography by DREYER, *Tycho Brahe*, Edinburgh (Black), 1890. Tycho's contributions to theoretical astronomy were comparatively unimportant, but for historical completeness his planetary system (*Opera* 4: 155–170) should be mentioned. Of especial interest to the general reader are the descriptions of Tycho's instruments and methods of observation in the *Astronomiae instauratae mechanica* (*Opera* 5: 1–162), and the nature of the observations that he took (which fill T. X–XIII of the *Opera*). On the improvements that he introduced into trigonometrical calculation, see DREYER, *Observatory* 39: 127–131, 1916.

sun, moon and planets, when compared with the contemporary tables and ephemerides, demonstrated the insufficiency of all existing theories; and from a detailed analysis of these observations, especially those of the planet Mars, Kepler (1571–1630), in a prolonged systematic search for an hypothesis that would satisfy them, finally derived, by successive trial of one hypothesis after another, both geocentric and heliocentric, his three laws of planetary motion, modifying the Copernican excentrics to ellipses and formulating the laws governing the motions of the planets in these ellipses. The first two laws were explicitly established for Mars from the observations, but their validity for the other planets and for the moon was mostly assumed; the third law was demonstrated for the planets and for Jupiter's satellites.

Kepler's complete writings (mostly in Latin) fill eight large volumes²³; but the greater part is a curious mixture of science, pseudoscience and mysticism, including astrology. From the viewpoint of scientific astronomy, there is comparatively little of value except in the *Astronomia nova seu physica coelestis tradita commentariis de motibus stellae Martis* and the *Epitome astronomiae Copernicanae*. In his first published work, the *Prodromus dissertationum cosmographicarum continens mysterium cosmographicum* (1596), Kepler compares the Ptolemaic and Copernican systems, stressing the greater simplicity of the latter; and constructs his fanciful planetary system based on the five regular solids.²⁴ Later, he derived his first two laws of planetary motion in the *Astronomia nova* (1609), which also contains a qualitative foreshadowing of the law of gravitation; for a German version of this great treatise, see *Johannes Kepler Neue Astronomie uebersetzt und*

²³ *Joannis Kepleri astronomi opera omnia* edidit Ch. Frisch, 8 vols., Frankfurt (Heyder & Zimmer), 1858–1871. A new edition of the original text of Kepler's works is now in course of publication: *Johannes Kepler Gesammelte Werke*, hrsg. von Walther von Dyck† und Max Caspar, Munich (Beck), 1937–.

²⁴ This work has been translated into German by MAX CASPAR, *Johannes Kepler Mysterium Cosmographicum—Das Weltgeheimnis*, Augsburg (Filsler), 1923.

eingeleitet von Max Caspar, München-Berlin (Oldenbourg) 1929. The third law appears in the *Harmonices Mundi* (1619), which has also been translated by CASPAR: *Johannes Kepler Weltharmonik*, München-Berlin (Oldenbourg) 1939. The *Epitome astronomiae Copernicanae*, 1618 (*Opera*, VI) is of particular interest as an attractive general summary of contemporary ideas and for the information it contains on the historical development of astronomical terminology.

The *Tabulae Rudolphinae* prepared by Kepler for the calculation of ephemerides appeared in 1627, superseding the *Tabulae Prutenicae* (1551), which had been constructed by Reinhold on the basis of the Copernican theory but which had effected little improvement over the medieval tables based on the Ptolemaic astronomy.

Very few of Kepler's contemporaries fully comprehended and appreciated his work; and the general acceptance of his results, even among the adherents of the Copernican doctrine, was very slow, especially on the Continent. Meanwhile, many fruitless philosophical speculations were proposed such as the vortex theory of Descartes.

Kepler's Laws are simply empirical statements describing the way in which the planets move, inferred directly from observations. These laws do not explain the planetary motions, but they suggest that an influence of some kind is exerted on the planets by the sun; this fact was realized by Kepler, and the same idea had also occurred to many others who had speculated on the cause of planetary motions—even the inverse square law, among others, had been suggested—but these ideas remained barren of results until the profound investigations by Sir Isaac Newton (1642–1727). The limited knowledge of mechanics which existed during ancient and medieval times related principally to statics; only confused and largely erroneous ideas prevailed as to the motions of bodies. The explicit formulation of the correct general physical laws to which motions of material bodies conform was begun by Galileo and completed by Newton; since the celestial bodies do

not move in the straight lines which, according to the Laws of Motion, are characteristic of motions undisturbed by the action of external forces, it was natural to infer that the moon and the planets are acted upon by forces of attraction. It had, of course, long been realized that the earth exerts an attraction on all bodies at its surface; and the laws of the motion of bodies falling under the action of this attraction had been investigated by Galileo. Newton demonstrated (1) that the force which holds the moon in its orbit around the earth is identical with the force which causes bodies near the surface of the earth to fall; and (2) that the law to which this force conforms is of the inverse square type. On this basis, Newton formulated the hypothesis of universal gravitation, and systematically applied it to explain the celestial motions; in particular, he showed that all three of Kepler's Laws may be deduced from this principle alone, and he accounted for many of the irregularities in the motion of the moon that had been known from observation since ancient times.

The original Latin editions of Newton's monumental treatise are, of course, now all rare. The first edition appeared in 1687, the third in 1726: SIR ISAAC NEWTON, *Philosophiae naturalis principia mathematica*, Editio tertia, London, 1726. The third edition was reprinted in 1871: *Sir Isaac Newton's Principia reprinted for Sir William Thomson and Hugh Blackburn*, Glasgow, 1871. A fine English translation (from the third edition) is now easily accessible: FLORIAN CAJORI, *Sir Isaac Newton's Mathematical principles of natural philosophy and his system of the world* (Motte's translations revised), Berkeley (University of California Press), 1934. The first two Books of the *Principia* are devoted to the motions of bodies in general, while in the third Book these general results are applied to the phenomena of the solar system: the *System of the world* is a nonmathematical summary of the material in the third Book of the *Principia*. Newton probably obtained many of his results with the aid of the Infinitesimal Calculus which he had devised, but in the *Principia* the work is recast into the

customary geometric form of the time.²⁵

The *Principia* is the culmination of the long development, beginning in remote antiquity, through which the fundamental ideas and principles of modern astronomy gradually were progressively evolved and established. In this development, each successive outstanding advance was based directly and explicitly on the accumulated learning from the past. The great Babylonian astronomers Naburianos and Cidenas relied on the preceding centuries of observations; Hipparchus based his work on the Babylonian data and results, and on the ideas of his Greek predecessors; Ptolemy extended and completed the work of Hipparchus; fourteen centuries later Kepler, on the basis of Tycho Brahe's observations and with the aid of mathematical theorems developed 18 centuries previously by the Greek geometer Apollonius, completed the revision of the Ptolemaic astronomy that had been begun by Copernicus, and laid the foundation on which the Newtonian system has been erected. The Babylonians had analyzed the observed apparent planetary motions empirically, in terms of numerical progressions; the Greeks represented these motions by means of geometric theories in which the complex apparent movements were resolved into combinations of component uniform circular motions in space—first by the Eudoxian device of homocentric spheres, later by systems of excentrics and epicycles. The Greek geometrical procedures are entirely comparable to modern analytical methods—the terms of the infinite trigonometric series now used in formal calculations are the algebraic counterparts of the ancient geometric epicycles and deferents—but the Greek system was not adapted to the extension necessary to take into account all the irregularities subsequently revealed as observations accumulated. In the evolution of ideas, from the *empirical rules* for the apparent motions on the sky derived by the Babylonians, through the successive

formal *geometric theories* of the motions in space constructed by the Greeks and, centuries later, by Copernicus, to the *kine-matical laws* of Kepler and the *physical theory* of Newton, each stage is explicitly founded on a revision of previous systems, largely conserving the learning of the past but incorporating further developments of ideas that often had begun to emerge long before. A familiarity with the theories of Hipparchus and Ptolemy, especially with the terminology of the Ptolemaic theory, is essential to a proper understanding of the work of Copernicus and Kepler and to a full comprehension of the evolutionary development and the basis of modern astronomy. In the writings of each outstanding contributor, we find frequent explicit references and acknowledgements to his great predecessors, connecting modern astronomy directly with its beginnings in the past by a continuous chain of thought extending back nearly 30 centuries to the ancient Babylonian and Egyptian observers.

During the long stationary period following Ptolemy, the Moslem astronomers, in addition to translating the Greek works, wrote numerous original treatises and compiled many new tables; and the more outstanding of these writings, though containing no fundamental advances, are of great interest and importance as having been standard and widely used works among the Moslems and as being the medium through which western Europe first became acquainted with the ancient astronomy.

The initial source of Arabic knowledge was principally the Hindu learning, which had its origin in extreme antiquity. In remote times the inhabitants of ancient India, profoundly impressed by the beauty of the heavens, cultivated astronomy as a sacred duty. The beginnings of Indian astronomy—in the form of a rudimentary and often inaccurate acquaintance with the simplest aspects of celestial phenomena, a rough calendar, and a crude cosmology—are found in the Vedas, and in the Brāhmaṇas and Jyōtiṣas annexed to the Vedas; the earliest known formal astronomical treatise is the Vedāṅga Jyōtiṣa, probably

²⁵ A useful analysis of Newton's investigations and results is given by W. W. ROUSE BALL, *An essay on Newton's "Principia."* London (Macmillan), 1893; now rare.

dating from about 1400 B.C. and devoted mostly to a calendar for use in the regulation of religious ceremonies. The successive Vedic, and post-Vedic or Jaina, writings reflect a gradually increasing knowledge of the principal fixed stars and asterisms, the planets, the phenomena of the diurnal motion, and the apparent motions of the sun, moon, and planets through the zodiac; and improved calendars and systems of chronology were devised; but until a century or more after the opening of the Christian Era, Hindu astronomy remained very primitive and rudimentary, and not until about the fifth century A.D. did the scientific period in its development begin. It was brought to its most highly developed form during the interval from 500 A.D. to 1150 A.D.

Most of the Hindu astronomical writings prior to 500 A.D. have perished and are known only through fragments or through references and citations in other works. Many of the extant writings, in the form in which they now survive, have resulted from successive revisions and interpolations of older works, of unknown date and authorship, over a long period of time. It is uncertain how much of the content of the original older compositions is retained in the recensions now known; and the extent to which the progressive later developments were independent of influence from other nations, especially Greece, is somewhat controversial. A native Hindu astronomy unquestionably existed in remote antiquity and remained an important element in the learning of later times; but astronomical knowledge is known also to have been transmitted to India from other regions at several different periods during ancient times. There is archeological evidence that in the remote past, perhaps the early third millennium B.C., the earliest Indian civilization was influenced by Babylonia. Possibly contacts with China existed. In the time of Darius the Great, about 500 B.C., the valley of the Indus was a Persian satrapy; Alexander's invasion of India in 327 B.C., and the rise of the Greek kingdom of Bactria, established long enduring contacts with the Hellenic world. Probably,

however, it must always remain more or less uncertain to what extent the origin and development of scientific astronomy in India were influenced by such Babylonian and Greek learning as may have been introduced. Some Greek knowledge was eventually incorporated into Hindu astronomy—Greek methods and Greek technical terms may readily be recognized in many of the Hindu writings; but apparently the Greek astronomy was transmitted in very imperfect and incomplete form. Often the Greek and the Hindu methods and numerical constants are quite different, but in many cases numerical values identical with Greek or Babylonian values are used. There can be no doubt that considerable original work was done in India, notwithstanding what may have been borrowed bodily or suggested by Greek and Greco-Babylonian ideas; but it is difficult to determine the extent to which Hindu astronomy in its final form represents a natural development of native elements and the extent to which it represents an assimilation and development of foreign ideas.

The earliest Hindu astronomical writings of a scientific character were the so-called Siddhāntas. A considerable number were originally composed sometime before 500 A.D., but the now surviving texts of the ones that have been preserved are later versions. The most important were the Brahma Siddhānta and the Sūrya Siddhānta. The content of some appears to have been drawn from a foreign source—the lost Romaka Siddhānta, as the name suggests, must have been an adaptation from some Greek or Roman work, and is known to have adopted for the length of the year the exact value used by Hipparchus and Ptolemy, while the Paulīśa Siddhānta may have been of Babylonian origin. In the Siddhāntas, the early mythological cosmologies are replaced by a spherical earth, unsupported and stationary in space.

The earliest extant text from the scientific period is the Āryabhaṭīya by Āryabhaṭa, who was born in 476 A.D. and with whom the most important period of Hindu astronomy begins. His treatise, composed in 499, is the oldest extant Hindu astronomical

text bearing the name of an individual author. An English translation with notes has been published by W. E. CLARK: *The Āryabhaṭīya of Āryabhaṭa*, University of Chicago Press, 1930; and another English translation, by PRABODH CHANDRA SENGUPTA, appeared in *Journal of the Department of Letters (Calcutta University)*, vol. 16, 1927. The Āryabhaṭīya is a brief descriptive summary of the most distinctive principles of the author's own system of astronomy, not a detailed working manual of then existing astronomical knowledge in general, and it contains many imperfections; it is the earliest known Hindu text to include a section dealing specifically with mathematics. Āryabhaṭa based his treatise on the main principles of the older Siddhāntas, but systematized and further developed the subject; apparently he was largely the founder of scientific Hindu astronomy—his writings exerted great influence for many centuries, and were the basis for many subsequent developments by later Indian astronomers. He explained the planetary motions by means of a system of epicycles; whether the idea was original with him or borrowed from the Greeks is uncertain, but the Hindu system of epicycles differs in several important ways from the Greek theory. Āryabhaṭa also introduced into India the theory of the diurnal rotation of the earth, but this idea was rejected by other Hindu astronomers.

Āryabhaṭa was followed during succeeding centuries by several outstanding writers: Varāhamihira, early sixth century, was mainly a compiler; his *Pañcasiddhāntikā*, a summary of five of the older Siddhāntas, formed an exposition of all the more important astronomical doctrines current in his time. In the seventh century, Brahmagupta, one of the greatest of the Hindu scientists (although a severe critic of Āryabhaṭa), wrote two treatises which for many centuries were among the most widely used astronomical works in India; the earlier was the *Brāhma Sphuṭa Siddhānta*, a revised version of the old *Brahma Siddhānta* with some original developments by Brahmagupta incorporated, and the later was the *Khaṇḍakhādya*. An Eng-

lish translation of this second work, with notes and a series of appendices which provide a summary of Hindu astronomical ideas, has recently been issued by P. C. SENGUPTA: *The Khaṇḍakhādya, an astronomical treatise of Brahmagupta*, University of Calcutta, 1934. The most celebrated of the Hindu astronomers was Bhāskara or Bhāskarācārya, born in 1114; his greatest work, the *Siddhānta S'iromaṇi*, on mathematics and astronomy, was written about 1150, and like many of the other Hindu writings is based largely on late versions of the *Sūrya Siddhānta*.

The *Sūrya Siddhānta* is the foremost work among the astronomical writings of ancient India; it is a complete treatise on Hindu astronomy, and in somewhat modernized form it has remained a standard work in widespread use in India along with Brahmagupta's writings. The compilers of the *Sūrya Siddhānta* are unknown—it claims to have been revealed directly by the Sun about 2,165,000 years ago. The version now extant probably had taken form about 1100 A.D., and is a composite work founded on an original 800 or 900 years older. The monumental English translation and commentary by Burgess is a model of scholarly research, and indispensable in any study of Hindu astronomy; originally published in 1860 in the *Journal of the American Oriental Society*, it has recently been made again available: EBENEZER BURGESS, *Translation of the Sūrya-Siddhānta, a text-book of Hindu astronomy*, reprinted from the edition of 1860, edited by P. Gangooly, with an introduction by P. C. Sengupta; University of Calcutta, 1935. This version embodies considerable material drawn from Āryabhaṭa and Brahmagupta. A fantastic theory of the physical cause of planetary motions is included, and many of the methods give only approximate results, but on the whole the *Sūrya Siddhānta* is a sound and fairly accurate system of astronomical knowledge.

The Hindu works are written in Sanskrit verse, which is exceedingly difficult to translate and often is difficult to interpret after it has been translated; the style is so concise and elliptical that a copious com-

mentary, exceeding the original text in length, is usually required to make the text intelligible. For the most part the Hindu writings are simply collections of factual assertions and rules for solving problems, rather than formal expositions. The specific editions listed in the foregoing discussion have been confined to ones issued very recently; many of the other writings mentioned are also available in less easily obtainable publications, but those cited include the works of greatest general interest and are representative of Hindu astronomy. Much the same topics are covered in all the different treatises—rules for finding the mean and the true places of the planets with the aid of epicycles or eccentrics; solutions of a wide variety of problems in spherical and practical astronomy, including the use of the gnomon and the armillary sphere; methods for calculating conjunctions and other aspects of the planets, lunar and solar eclipses, the position of the moon's cusps, and heliacal risings and settings of stars and planets; the calendar, and systems of chronology; and descriptions of the constellations, particularly the zodiac.²⁶

It was from the works of Brahmagupta that the Arabs first obtained a knowledge of astronomy: At the court of al-Mansur, in the eighth century, the Arabian scholars met the Hindu scientist Kankah, who acquainted them with Brahmagupta's treatises. Many of the Hindu writings were translated into Arabic. After the initial impulse, however, Moslem astronomy was based wholly on the ancient Greek writings—almost exclusively on Ptolemy; a knowledge of the Greek learning was first communicated to the Moslems at the court of Baghdad by Nestorian Christians from Khusistan at the head of the Persian Gulf.

Among the great profusion of Arabic writings on astronomy, the treatise by al-Farghānī or Alfraganus, composed in the ninth century, was later one of the most influential in western Europe. The Arabic text

(109 pp., 6×8 inches) with a Latin translation was edited by J. GOLIUS: *Alfraganus, Elementa astronomica*, Amsterdam, 1669 (no later edition has been published). This treatise, based on Ptolemy, is an account of astronomy as known to the Moslems in the ninth century; it was translated into Latin in the twelfth century, and widely read in Europe until the time of Regiomontanus. The most outstanding of the Arabic treatises, however, was written by al-Battānī or Albategnius (ca. 857–929), one of the greatest of the Moslem astronomers. The Arabic text, with a Latin translation and extensive notes including a glossary of Arabic astronomical terms, has been edited by C. A. NALLINO: *Al-Battānī sive Albatēni opus astronomicum*, Pubblicazioni del Reale Osservatorio di Brera in Milano, No. XL, 3 vols., 1899–1907. This treatise, likewise based on the *Almagest* but with improved tables and constants, was also extremely influential in western Europe until the time of the Renaissance.

The Moslems were ardent observers, and are particularly noted for their activity in the construction of instruments and the compilation of tables. The Arabic instruments and methods of observation and calculation were described by Aboul-Hassan Ali de Maroc, whose treatise has been translated into French: *Traité des instruments astronomiques des Arabes composé au trizième siècle par Aboul Hhassan Ali, de Maroc*; traduit par J.-J. Sédillot et publié par L. Am. Sédillot, 2 vols., Paris, 1834–1835; and *Supplément*, 1844. Among the masterpieces of Moslem observational astronomy is the systematic description of the constellations by Al-Sufi (903–986); a French translation, with parts of the Arabic text, was published by H. C. F. C. SCHJELLERUP: *Description des étoiles fixes composée au milieu du dixième siècle de notre ère par l'astronome Persan Abd-al-Rahman al-Sūfi*: St.-Pétersbourg (l'Académie Impériale des Sciences) 1874. Cf. *Metrop. Mus. Studies* (New York), vol. 4 (pt. 2): 179–197, March, 1933. Of the Moslem astronomical tables, the more important were: the Hakemite Tables, compiled in Egypt by Ibn Jūnis (d. 1009), perhaps the greatest of the Mos-

²⁶ See the introductions and other explanatory material in the editions of the Hindu writings to which reference has been made. Cf. SUKUMAR RANJAN DAS, *Scope and development of Indian astronomy*, *Osiris* II: 197–219, 1936.

lem astronomers; the Toledan Tables, which superseded the Hakemite Tables in the twelfth century; and the famous Alfonsine Tables, probably completed about 1272 under the patronage of King Alfonso X. The Alfonsine Tables, which remained the best available for 300 years, and the *Libros del Saber*, an encyclopedic compilation (in Spanish) of astronomical knowledge from Arabic writings (published at Madrid, 1863-1867, in 5 large folio volumes, by Don Manuel Rico y Sinobas) circulated widely through Europe and were of great importance in the revival of astronomy in the West.²⁷

The Arabic writings in Latin translations were the principal source of information in western Europe until studies of original Greek manuscripts commenced to spread during the Renaissance; but original works began to be composed early in the Revival of Learning. The numerous astronomical books issued during medieval and early modern times are described in treatises on the history of astronomy; for the most part, they represent no significant advances, and are of importance chiefly to the historian. The principal elementary textbook of astronomy throughout medieval times was the *Tractatus de sphaera* or *Sphaera mundi* written about 1233 by SACROBOSCO, also known as John of Halifax or Holywood. It remained very popular for more than 400 years—it was one of the first astronomical books to be printed, and editions in great

number continued to be issued until the middle of the seventeenth century; it is a rather crude little treatise, apparently derived from Alfraganus and Albategnius, on the rudiments of Ptolemaic astronomy, and is devoted principally to spherical astronomy; the contents are reviewed in some detail by WALTER B. VEAZIE, *Chaucer's textbook of astronomy: Johannes de Sacrobosco*, Univ. of Colorado Studies, Ser. B. 1: 169-182, 1940. During the transition period of the fifteenth to the seventeenth centuries, the textbooks which at first appeared were only summaries of Ptolemaic astronomy,²⁸ but during the latter part of the period an increasing number either included an account of both the Ptolemaic and Copernican hypotheses or else were explicitly based on the Copernican theory. Of especial interest to the general reader is the important exposition of contemporary astronomical knowledge from the Copernican point of view by KEPLER, *Epitome astronomiae Copernicanae* (1618), which has already been mentioned.²⁹

²⁸ PEURBACH'S *Theoricae novae planetarum*, 1472, was especially noted, and editions continued to be issued for a hundred years. A rare work of this period, which, because of its unique character, deserves mention, is PETER APIAN, *Astronomicum Caesareum*, Ingolstadt, 1540, of which only 35 copies are known now to be in existence; it is described by S. A. IONIDES, *Osiris* I: 356-389, 1936 (cf. *Publ. Astron. Soc. Pacific* 46: 325-338, 1934). The unique interest of the book lies in the numerous charts and combinations of rotatable paper dials it contains for graphically calculating celestial phenomena and solving astronomical problems; it is based on the Ptolemaic theory, and gives remarkably accurate results. The book also discusses Apian's noted discovery that the tails of comets always point away from the sun; and it contains the earliest printed planisphere (first published separately in 1536, and reproduced in facsimile in 1927 by L. Rosenthal's Antiquariat, Munich).

²⁹ Also of great interest is the earliest star atlas (though star maps and constellation figures had appeared in several earlier printed works): JOHANN BAYER, *Uranometria* (1603), with its 51 beautiful copper engravings of the constellations as drawn by Albrecht Dürer, in which the stars were for the first time distinguished by Greek letters. The next notable work of this kind, the great star atlas by FLAMSTEED, *Atlas coelestis*, was published at London in the eighteenth century, and a French edition with much smaller plates, edited by FORTIN, was issued at Paris. An important and worth-while element of the romantic charm of the night sky has been lost with the disappearance of the classic constellation figures from modern charts of the heavens.

²⁷ See J. H. REYNOLDS, *The Hakemite Tables of Ebn Jounis*, *Nature* (London), 128: 913-914, 1931; ERNST ZINNER, *Die Tafeln von Toledo (Tabulae Toletanae)*, *Osiris* I: 747-774, 1936; J. L. E. DREYER, *The original form of the Alfonsine Tables*, *Mon. Not. Roy. Astr. Soc.* 80: 243-262, 1920. After the decline of Moslem learning in Asia, astronomy was later temporarily revived in the East by Persian and Tartar astronomers under the Mongols. A great observatory was founded at Marāgha in northwest Persia, where extensive observations were made with magnificent instruments; and another important scientific center developed at Khānbalīq. The last of the Oriental astronomers was Ulugh Begh (d. 1449), who worked at an observatory built at Samarkand in 1420; the tables which he compiled included the first star catalogue constructed from original observations since the time of Hipparchus and Ptolemy. See E. B. KNOBEL, *Ulugh Beg's catalogue of stars*, Carnegie Inst. Washington Publ. No. 250 (Washington), 1917.

During the course of the eighteenth century, textbooks and popular treatises came to be generally based on Newtonian principles, and the traditional content amplified by descriptive material obtained from telescopic observation; the first treatise based on gravitational principles was DAVID GREGORY, *Astronomiae physicae et geometricae elementa*, Oxford, 1702. Among the most widely used books, representative of the generally accepted astronomical thought of this period, were the numerous editions (during the 18th and early 19th centuries) of JAMES FERGUSON, *Astronomy explained upon Sir Isaac Newton's principles*, and the popular work by LALANDE, *Abrégé d'astronomie* (Paris, 1775).

With the establishment and general acceptance of the Newtonian system, the principal problem of astronomy became to deduce, from the Laws of Motion and the Law of Gravitation, the motions of the bodies in the solar system, and to account, on the basis of the Newtonian theory, for all the details of the observed apparent motions. As the precision of astronomical observations increased, many details of the celestial motions were revealed that had not appeared in Tycho Brahe's observations; and it is a remarkable fact that the Law of Gravitation both explains Kepler's Laws and at the same time immediately shows that these laws can be only first approximations, and had Tycho's observations been either a little less exact or a little more accurate Kepler could hardly have deduced his laws from them.

The development of Celestial Mechanics was initiated by the brilliant work of Clairaut, D'Alembert, Euler (whose *Theoria motuum planetarum et cometarum*, 1744, is the earliest analytical solution of the Problem of Two Bodies), and Lagrange. The first to undertake the systematic construction of complete gravitational theories for the motions of all the principal bodies of the solar system was LAPLACE (1749-1827), whose results are contained in his *Traité de mécanique céleste*. Laplace developed the equations to only a comparatively low order

of approximation, but they demonstrated the agreement of the celestial motions with Newton's Law to at least the degree of accuracy that had then been attained in observational astronomy. The observations accumulated by Tycho Brahe, their coordination by Kepler into his empirical laws, the formulation of the hypothesis of universal gravitation by Newton, and the subsequent verification of this hypothesis through the comparison of the theoretical motions with observations form a classic example of Scientific Method.

Meanwhile, Bradley's discoveries of aberration (1728) and nutation (published 1748) had supplied in principle the necessary basis for attaining in practice the increased accuracy that became potentially possible with the continued refinement of instrumental equipment; and following Laplace, a need for further development of the theories of the celestial motions was soon provided by the introduction of a higher order of precision into the astronomy of position under the leadership of Bessel (1784-1846). With the work of Laplace and Bessel, which opened the prolific development of gravitational astronomy and positional astronomy during the nineteenth century, we may appropriately conclude the present survey. The latter part of the nineteenth century closes a very definite period in the development of astronomical science: The great era of Fundamental Astronomy, extending back to ancient Egypt and Babylonia, was over; and the rise of sidereal astronomy (initiated by Sir William Herschel in the latter eighteenth century) and astrophysics had begun.³⁰ We are now in the midst of the new period, in which astrophysics and studies of the sidereal and extragalactic systems are the fields of predominating interest and activity.

³⁰ Classical astronomy, as known in the nineteenth century, is well represented by Sir JOHN HERSCHEL, *Outlines of astronomy* (10th ed., 1869); SIMON NEWCOMB, *Popular astronomy* (5th ed., 1884); and C. A. YOUNG, *General astronomy* (rev. ed. 1904), all of which are still worthy of study. See also AGNES M. CLERKE, *Popular history of astronomy during the nineteenth century*, 4th ed., London (Black), 1902.

PALEONTOLOGY.—*Fossil Mammalia from the Almy formation in western Wyoming.*¹ C. LEWIS GAZIN, U. S. National Museum.

In the course of investigations for the U. S. Geological Survey in western Wyoming in 1936, J. B. Reeside, Jr., B. N. Moore, and W. W. Rubey discovered several localities for fossil vertebrate remains in beds regarded as the Almy formation. These exposures were of the deeper red beds stratigraphically below the Knight, and at certain places, as observed by Rubey, unconformably below this formation as it is exposed in the vicinity of the Green River in the southwestern part of Sublette County. Unfortunately all the materials were too fragmentary for certain identification, but in 1939 Rubey, with the assistance of John Rogers, succeeded in finding a lower jaw of a species of the primate *Plesiadapis* in Almy beds exposed along La Barge Creek, about 7 miles due west of the town of La Barge in Lincoln County. The writer visited several of these localities during the summer of 1941, and with the assistance of G. F. Sternberg and Franklin Pearce he was successful in securing additional material from the La Barge Creek locality and determinable remains, including a *Coryphodon* skull and a lower jaw of *Eohippus*, from exposures at a stratigraphically higher level about 9 miles north of the La Barge Creek occurrence.

The La Barge Creek locality, sections 1 and 12, T. 26 N., R. 114 W., has produced the following forms:

Plesiadapis rubeyi, n. sp.

Plesiadapis, cf. *cookei* Jepsen

Creodont, gen. and sp. undet.

Phenacodus almiensis, n. sp.

Ectocion sp.

The very incomplete fauna here listed suggests the Clark Fork stage, or uppermost Paleocene, indicated primarily by the *Plesiadapis* material, together with the presence and suggested predominance of *Phenacodus*. The beds at this locality are a reddish, pebbly clay, partly conglomeratic. They were mapped by A. R. Schultz² as the

northward equivalent of the Almy formation and are so regarded by Rubey, who interprets this site as being several hundred feet stratigraphically below the top of the formation.

The more northerly locality mentioned above, in the upper part of one of the branches of Dry Piney Creek, sections 23 and 24, T. 28 N., R. 114 W., has yielded but two forms, and these have been tentatively identified as *Coryphodon radians* and *Eohippus index*. The beds here were mapped by Schultz as a part of the Knight formation; Rubey, however, considers the exposures as being of the uppermost part of the Almy and possibly including the limy layers regarded as representing the Fowkes formation. In any case the beds at this point seem definitely of lower Eocene age, or Wasatchian. The two forms encountered appear most closely related to corresponding types described by Cope from the vicinity of Evanston, Wyo., presumably out of the Knight. It should be further mentioned that a few miles north of La Barge and a short distance to the east of the Dry Piney Creek locality well developed, variegated exposures of Knight have produced a Lost Cabin fauna.³

There follows a systematic description of the materials discovered well down in the Almy as exposed along La Barge Creek and regarded as Clarkforkian or uppermost Paleocene:

***Plesiadapis rubeyi*, n. sp.**

Fig. 1

Type.—Portion of right ramus of mandible with P₃-M₂, M₁ incomplete, U. S. N. M. no. 16696.

Horizon and locality.—Almy formation, NE $\frac{1}{4}$ SW $\frac{1}{4}$ sec. 1, T. 26 N., R. 114 W., about 7 miles west of La Barge, Lincoln County, Wyo.

Specific characters.—A little larger than *P. gidleyi*. Lower cheek teeth long and relatively narrower than in *P. gidleyi*, particularly P₃ and

¹ Published by permission of the Secretary, Smithsonian Institution. Received March 26, 1942.

² SCHULTZ, A. R., U. S. Geol. Surv. Bull. 543, pl. 1. 1914.

³ BONILLAS, YGNACIO, Journ. Mamm. 17: 139-142. 1936.

to a less extent P_4 . Cusps of teeth more inflated and basins a little less broadly excavated. Anteroexternal cingulum about base of protoconid weaker on M_2 . Paraconid and metaconid on M_2 of about equal height and slightly closer together than in *P. gidleyi*.

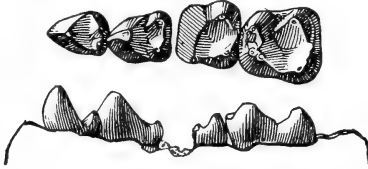

Fig. 1.—*Plesiadapis rubeyi*, n. sp. Right lower dentition, P_3 to M_2 inclusive, type specimen, U. S. N. M. no. 16696, lingual and occlusal views. $\times 3$. Almy Paleocene, Wyoming. Drawing by Sydney Prentice.

Description.—*Plesiadapis rubeyi*, as indicated by the lower jaw portion, is a little larger than the Tiffany *P. gidleyi*, or than *P. dubius* of the Clark Fork. The Almy form differs from these two species principally in the actually and relatively greater anteroposterior length of the lower cheek teeth. These comparisons are facilitated by the statistics given by Simpson⁴ for *P. gidleyi*. The deviation of the measurements of *P. rubeyi* from the mean of *P. gidleyi* divided by the standard deviation of *P. gidleyi* varies from +4.5 to +5.5 for the lengths of the teeth, but with no significant figures pertaining to the widths. The relation of length to width of teeth appears comparable to that in the Silver Coulee *P. fodinatus*, and the proportions of M_2 given by Jepsen⁵ are very close to those in *P. rubeyi*; however, M_1 in the Almy form is strikingly smaller. No measurements were given for the premolars of *P. fodinatus*. *P. anceps* from the Scarritt Quarry⁶ in the Crazy Mountain field is comparable in size with *P. rubeyi* but exhibits much shorter and simpler premolars and M_2 is relatively wider.

In P_4 of *P. rubeyi* the acute posterointernal ridge extending down the protoconid is somewhat deflected at a point about halfway down its length, suggesting an incipient metaconid. A very slight increase in the development of the anterior keel on P_4 immediately above the

entoconid of P_3 might suggest a paraconid. The heel of P_4 is distinctly basined and exhibits two cusps, the hypoconid and entoconid. These cusps are also distinguished on P_3 but not so widely spaced.

TABLE 1.—MEASUREMENTS (IN MILLIMETERS) OF LOWER TEETH, NO. 16696, OF *Plesiadapis rubeyi*

Measurement	P_3	P_4	M_1	M_2
Anteroposterior diameter.....	2.8	2.9	3.0*	3.7
Transverse diameter...	1.9	2.2	2.7*	3.2

* Estimated.

The length of the preserved dentition, P_3 - M_2 inclusive, is 12 mm.

Plesiadapis, cf. *cookei* Jepsen

A large form of *Plesiadapis* is represented in the collection from the La Barge Creek locality (SW $\frac{1}{4}$ NE $\frac{1}{4}$ sec. 12, T. 26 N., R. 114 W.) by the greater portion of a left mandibular ramus, U. S. N. M. no. 16698. The specimen includes P_3 , most of P_4 , M_2 complete, and a small portion of M_3 . The teeth appear to be a little larger than in the type from the Clark Fork, as indicated by Jepsen's⁷ measurements, and are relatively elongate, particularly the premolars. The difference in the latter respect from the type of *P. cookei* is probably less significant than this character was found to be in comparisons of *P. rubeyi* with related species.

P_3 and P_4 both exhibit a bilobed talonid, although this portion of P_4 is incomplete. The rugosity of the enamel on the anterolingual portion of P_4 gives rise to a suggestion of a paraconid, not developed to this extent, however, on P_3 . Neither of these teeth shows any evidence of a metaconid.

In M_2 the metaconid, very close to the paraconid, is posterolingual to this cusp and joined by a ridge to the protoconid. The external cingulum on this tooth is not well developed and is in evidence only from the anterolateral portion of the hypoconid to an anterior position on the protoconid. The enamel on this tooth is somewhat rugose, most noticeably about the hypoconid and on the posterior wall of the trigonid.

⁴ SIMPSON, G. G., Amer. Mus. Nov. 817: 3-7. 1935.

⁵ JEPSEN, G. L., Proc. Amer. Philos. Soc. 69: 515-517. 1930.

⁶ SIMPSON, G. G., Amer. Mus. Nov. 873: 19-20. 1936.

⁷ JEPSEN, G. L., *ibid.*, pp. 525-528. 1930.

TABLE 2.—MEASUREMENTS (IN MILLIMETERS) OF LOWER TEETH, NO. 16698, OF PLESIADAPIS, CF. COOKEI

Measurement	P ₃	P ₄	M ₁	M ₂	M ₃
Anteroposterior diameter	5.2	5.3	5.4*	6.4	10.*
Transverse diameter	3.7	5.5	...

* Estimated.

Creodont, gen. and sp. undet.

A portion of an upper cheek tooth, U. S. N. M. no. 16699, including the protocone or deutocone but externally incomplete, is regarded as representing a form of creodont. A portion of one of the external cusps is preserved, presum-



Fig. 2.—*Phenacodus almiensis*, n. sp. Left upper dentition, P³ to M³ inclusive (M³ drawn reversed from right side), type specimen, U. S. N. M. no. 16691, occlusal view. ×2. Almy Paleocene, Wyoming.

ably the metacone, in which case the tooth resembles the posterior and lingual portions of M¹ in a species of *Didymictis*. The protocone and cusp presumed to be the metacone are of about equal height, although the protocone appears much more robust, and the outer angle of the tooth is evenly rounded, not projecting.

Phenacodus almiensis, n. sp.

Fig. 2

Type.—Partial skeleton, including palatal portion of skull with canines and cheek teeth, P³ to M³, cervical vertebrae, and incomplete limb and foot bones, U. S. N. M. no. 16691.

Horizon and locality.—Almy formation, SW¹/₄ NE¹/₄ sec. 12, T. 26 N., R. 114 W., about 7 miles west of La Barge, Lincoln County, Wyo.

Specific characters.—Size small with cusps of teeth relatively acute, somewhat crescentic, and uninflated. Anteroexternal and posteroexternal angles of upper teeth moderately acute. Parastyle well developed on P³ to M³. Slight tetartocone and protoconule on P³; prominent on P⁴ with the addition of a weak, posteriorly placed metaconule. Hypocone well developed and lingual in position on all upper molars.

Metaconule in line between metacone and hypocone. Mesostyle, metacone, and metaconule distinct on M³.

Description.—*Phenacodus almiensis* is represented by a left maxillary portion, U. S. N. M. no. 16992, including P⁴ to M², and two isolated upper teeth, in addition to the more extensive material comprising the type. The form appears to be appreciably smaller than any of the variants included in the *Phenacodus primaevus* group.⁸ It is distinctly smaller also than the Tiffany *P. grangeri*⁹ but a little larger than the Gray Bull forms, *P. copei* and *P. brachypternus*. Comparisons with the Tiffany *P. matthewi* and *P. gidleyi*⁹ are not satisfactory, inasmuch as these are known only from lower teeth, and

none was found of *P. almiensis*; however, the difference in size indicated by these lower teeth is significant.

In comparison with material of the *Phenacodus primaevus* group, *P. almiensis* is seen to have much less inflated cusps, and these tend to be more crescentic in appearance, and the outer angles of the upper teeth are more acute. Also, the parastyles are better developed, and P⁴ exhibits a weak metaconule. In these respects *P. almiensis* strongly resembles *Ectocion* but differs from members of that genus in important structural characters. That is, the metaconule of the upper molars is not forward in position but in line with the metacone and hypocone; also, the third upper molar is not triangular and has a rather well developed hypocone. The mesostyle, metacone, and metaconule of M³ are less developed than in *Ectocion* but are more distinct than in *Phenacodus*. The

⁸ See MATTHEW, W. D., and WALTER GRANGER, Bull. Amer. Mus. Nat. Hist. 34: 332-348. 1915. See also SIMPSON, G. G., Amer. Mus. Nov. 954: 17-19. 1937.

⁹ SIMPSON, G. G., Amer. Mus. Nov. 817: 22-25. 1935.

hypocone in all the molars appears relatively heavy and more lingual in position than in *Ectocion*.

TABLE 3.—MEASUREMENTS (IN MILLIMETERS) OF UPPER TEETH, NO. 16691, OF *PHENACODUS ALMIENSIS*

Measurements	C	P ³	P ⁴	M ¹	M ²	M ³
Anteroposterior diameter	5.8	8.2	8.5	9.0	9.2	7.8
Transverse diameter	4.0	7.3	8.5	10.0	11.0	10.6

The length of the preserved portion of the dentition, P³ to M³, is 42.5 mm. The length of the upper molars series, M¹ to M³, inclusive, is 25.5 mm.

Ectocion sp.

A fragment of a left mandibular ramus exhibiting P₄ and the anterior part of the trigonid of M₁, U. S. N. M. no. 16695, is believed to represent a species of the condylarth *Ectocion*. The complete tooth appears to be about the size of P₄ in *E. ralstonensis*¹⁰ from the Clark

Fork beds. The cusps are relatively high and acute, and the pattern appears more crescentic in comparison with the inflated bunodont type of tooth seen in *Phenacodus*, although the entoconid is lacking as in that genus. However, *Ectocion ralstonensis* is described as having a relatively weak entoconid in comparison with the typical Gray Bull forms. A very slight cuspule is seen near the base of the protoconid posteriorly, as suggested in illustrations of P₄ belonging to the type of *E. ralstonensis*, not placed so high as observed in *Phenacodus* material. The hypoconid is more externally placed and both trigonid and talonid portions of the tooth have a much better developed crescentic pattern than in *Eohippus*. The enamel of the premolar is weakly rugose and there is a slight cingulum about the external wall.

The possibility of this specimen belonging to the form herein described as *Phenacodus almiensis* is not entirely eliminated, but the tooth is distinctly too small to occlude properly with the upper dentition of *P. almiensis*.

¹⁰ See MATTHEW, W. D., and WALTER GRANGER, *ibid.*, p. 353. 1915.

Obituary

THOMAS HERBERT NORTON, distinguished author, diplomat, and research chemist, died on December 2, 1941, after a short illness.

Dr. Norton was born June 30, 1851, at Rushford, N. Y. He was graduated from Hamilton College in 1873 as valedictorian. In 1883, after many colorful experiences abroad, which were vividly described by Charles E. Monroe in the "News Edition" of the American Chemical Society for August 10, 1935, he became professor of chemistry at the University of Cincinnati. In 1900, he was appointed American consul at Harput, Turkey; in 1905 he was transferred to Smyrna, and in 1906 he went to Chemnitz, Germany. Beginning in 1911, Dr. Norton made a survey of the chemical industries of foreign countries for the Department of Commerce. When he returned to the United States he was chosen for the preparation of a

report on the supply of dyestuffs for American industries. The report that he prepared revealed that foreign firms not only manufactured the chief part of the dyestuffs used in the United States, but that they employed various means to prevent the entrance of American rivals into the field of competition. Dr. Norton took a most active part in securing legislation to alleviate these unsatisfactory conditions and to foster the American chemical industry.

Dr. Norton's outstanding ability and wide interest brought him many honors and responsibilities. He received honorary degrees from Hamilton College and from the University of Heidelberg; in 1937 he received the Lavoisier Medal. Among the many scientific organizations to which he belonged was the Washington Academy of Sciences.—H.S.I.

CONTENTS

	Page
ASTRONOMY.—Great astronomical treatises of the past. EDGAR W. WOOLARD.....	189
PALEONTOLOGY.—Fossil Mammalia from the Almy formation in western Wyoming. C. LEWIS GAZIN.....	217
OBITUARY: THOMAS HERBERT NORTON.....	220

The Journal is Indexed in the International Index to Periodicals

6.75
D2-1123

Vol. 32

AUGUST 15, 1942 No. 8

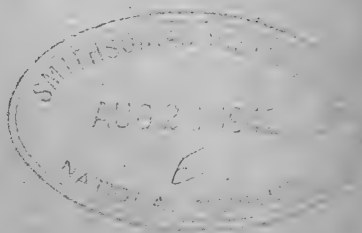

JOURNAL

OF THE

WASHINGTON ACADEMY OF SCIENCES

BOARD OF EDITORS

RAYMOND J. SEEGER
GEORGE WASHINGTON UNIVERSITY

G. ARTHUR COOPER
U. S. NATIONAL MUSEUM

JASON R. SWALLEN
BUREAU OF PLANT INDUSTRY

ASSOCIATE EDITORS

W. EDWARDS DEMING
PHILOSOPHICAL SOCIETY

C. F. W. MUESEBECK
ENTOMOLOGICAL SOCIETY

HARALD A. REHDER
BIOLOGICAL SOCIETY

EDWIN KIRK
GEOLOGICAL SOCIETY

CHARLOTTE ELLIOTT
BOTANICAL SOCIETY

T. DALE STEWART
ANTHROPOLOGICAL SOCIETY

HORACE S. ISBELL
CHEMICAL SOCIETY

PUBLISHED MONTHLY

BY THE

WASHINGTON ACADEMY OF SCIENCES
450 ARNAIP ST.
AT MENASHA, WISCONSIN

Entered as second class matter under the Act of August 24, 1912, at Menasha, Wis.
Acceptance for mailing at a special rate of postage provided for in the Act of February 23, 1925
Authorized January 21, 1933.

Journal of the Washington Academy of Sciences

This JOURNAL, the official organ of the Washington Academy of Sciences, publishes (1) Short original papers, written or communicated by members of the Academy; (2) proceedings and programs of meetings of the Academy and affiliated societies; (3) notes of events connected with the scientific life of Washington. The JOURNAL is issued monthly, on the fifteenth of each month. Volumes correspond to calendar years.

Manuscripts may be sent to any member of the Board of Editors. It is urgently requested that contributors consult the latest numbers of the JOURNAL and conform their manuscripts to the usage found there as regards arrangement of title, subheads, synonymies, footnotes, tables, bibliography, legends for illustrations, and other matter. Manuscripts should be typewritten, double-spaced, on good paper. Footnotes should be numbered serially in pencil and submitted on a separate sheet. The editors do not assume responsibility for the ideas expressed by the author, nor can they undertake to correct other than obvious minor errors.

Illustrations in excess of the equivalent (in cost) of 1½ full-page line drawings are to be paid for by the author.

Proof.—In order to facilitate prompt publication one proof will generally be sent to authors in or near Washington. It is urged that manuscript be submitted in final form; the editors will exercise due care in seeing that copy is followed.

Author's Reprints.—Reprints will be furnished in accordance with the following schedule of prices:

Copies	4 pp.	8 pp.	12 pp.	16 pp.	20 pp.	Covers
50	\$2.00	\$3.25	\$ 5.20	\$ 5.45	\$ 7.25	\$2.00
100	2.50	4.00	6.40	6.75	8.75	2.75
150	3.00	4.75	7.60	8.05	10.25	3.50
200	3.50	5.50	8.80	9.35	11.75	4.25
250	4.00	6.25	10.00	10.65	13.25	5.00

Subscription Rates.—Per volume.....\$6.00
 To members of affiliated societies; per volume..... 2.50
 Single numbers..... .50

Correspondence relating to new subscriptions or to the purchase of back numbers or volumes of the JOURNAL should be addressed to William W. Diehl, Custodian and Subscription Manager of Publications, Bureau of Plant Industry, Washington, D.C.

Remittances should be made payable to "Washington Academy of Sciences" and addressed to 450 Ahnaip Street, Menasha, Wis., or to the Treasurer, H. S. Rappleye, U. S. Coast and Geodetic Survey, Washington, D.C.

Exchanges.—The JOURNAL does not exchange with other publications.

Missing Numbers will be replaced without charge provided that claim is made to the Treasurer within thirty days after date of following issue.

OFFICERS OF THE ACADEMY

President: HARVEY L. CURTIS, National Bureau of Standards.
Secretary: FREDERICK D. ROSSINI, National Bureau of Standards.
Treasurer: HOWARD S. RAPPLEYE, U. S. Coast and Geodetic Survey.
Archivist: NATHAN R. SMITH, Bureau of Plant Industry.
Custodian of Publications: WILLIAM W. DIEHL, Bureau of Plant Industry.

JOURNAL

OF THE

WASHINGTON ACADEMY OF SCIENCES

VOL. 32

AUGUST 15, 1942

No. 8

*Cosmic emotion.*¹ PAUL R. HEYL, National Bureau of Standards.

Every one of us is born into a wonderland—the universe in which we live and move and have our being, and which, from the dawn of human thinking, has exerted a profound fascination upon the mind.

Man's reaction to the riddle of the universe is an interesting study, leading to a conclusion perhaps rather unexpected—that in this respect modern man differs less from his primitive forbears than might be supposed. An analysis of the cosmic emotion evidenced in the earliest human records reveals six principal elements in its composition, five of which are to be found in modern man, all qualitatively unaltered, though in some cases much intensified. The sixth element, though strong in earlier times, has now almost faded away, but its place has been taken by a seventh element of distinctly modern origin.

First and foremost among these permanent elements we may place wonder and its invariable concomitant, curiosity. The presence of these elements in very young children testifies to their ancient racial character. It is recorded that the physicist Clerk Maxwell, in his early years, was continually asking his elders, "What is the go of that?" Every parent can match this from his own experience, and primitive man doubtless asked many such questions with no one to answer them. But curiosity, like hunger, becomes stronger the longer it remains unsatisfied, and lacking an answer it will manufacture one for itself.

The records of the past are full of such guesses at the causes of natural phenomena, mostly anthropomorphic in character. The

stormy waves of the sea were caused by the wrathful strokes of Neptune's trident; the attraction of the magnet for iron was due to an indwelling spirit, and the thunderbolts of Jove still live in poetic parlance. Gradually, however, man learned that there was one source from which he could obtain an answer to his questions—Nature herself. It has been well said that an experiment is a question put to Nature, and it is interesting to reflect that the experimental method and the growth of modern science have their origin in the urge of these two primitive instincts—wonder and curiosity.

Primitive though they may be, these elements are still with us. Time has but strengthened and ripened them and widened their field of application. It is no longer necessary that an occurrence be rare or spectacular to excite our wonder. We have learned that the simplest and most commonplace natural phenomenon, even the falling of an apple from a tree, is, when we stop to think about it, as Newton did, wonderful past all speaking. Nor is this recognition of the wonder of the commonplace confined to scientific men.

Seventy years ago, some of William Kingdon Clifford's most successful popular addresses on science were given before audiences of London working men. It is true that Clifford was the greatest master of lucid exposition in our language, but some of the credit must be given to the receptive audiences. It is unthinkable that even a Clifford could interest, say, a primitive group of Australian black-fellows in such subjects without the liberal use of experiments according to the classical definition—involving a bright light or a loud noise.

Several years ago I was asked to given an

¹ Address presented to the Washington Academy of Sciences on March 19, 1942. Received March 19, 1942.

address before the scientific staff of the General Electric Research Laboratory at Schenectady, and also to make a popular broadcast from their radio station. As a subject for the address to the staff I suggested: "Old and New Ideas about Gravitation," and for the radio broadcast: "Practical Suggestions for Improving the Acoustics of Buildings." I was advised by the management of the radio station to use the same subject for the broadcast that I had chosen for the staff meeting, as their experience told them that it would excite the greater popular interest.

The third element in man's cosmic emotion is reverential awe. This also dates back to remote antiquity, as is evidenced by the world-wide prevalence of sun worship. With the passing centuries this element has lost none of its strength. It has been a favorite theme of the poets, ancient and modern. The words of the Psalmist are familiar to us all:

The heavens declare the glory of God; and the firmament sheweth his handywork.
Day unto day uttereth speech, and night unto night sheweth knowledge.

Three thousand years later Tennyson expresses the same feeling:

Flower in the crannied wall,
I pluck you out of the crannies,
I hold you here, root and all, in my hand,
Little flower—but *if* I could understand
What you are, root and all, and all in all,
I should know what God and man is.

Closely connected with this element of reverential awe and, in fact, a corollary to it, is man's feeling of his own insignificance as compared with the physical universe. David gives expression to this also:

When I consider thy heavens, the work of thy fingers,
The moon and the stars, which thou hast ordained;
What is man that thou art mindful of him?

With the growth of our knowledge of the universe this feeling of our own physical insignificance has been greatly intensified. It is perhaps not generally realized how small the ancients believed the universe to be. The Greeks placed the abode of the gods no farther away than the summit of Mount

Olympus. Omar Khayyam complains of his cramped quarters:

And that inverted Bowl they call the Sky,
Whereunder crawling coop'd we live and die

A legend of the days of Mohammed tells how the Prophet made a round trip to heaven and back in one night, mounted on a miraculous steed, to confer with Allah about the number of prayers to be required of the faithful. Even allowing for the element of the miraculous, such a legend could hardly have taken root and flourished in the environment of our modern ideas of the size of the universe. Contrast the ancient concept of the universe with that of the present day, and we can begin to appreciate how much this feeling of physical insignificance has been intensified.

But no matter how insignificant an individual may feel, there is a certain measure of compensation in feeling one's self to be a member of a large group, and the larger the better. For this reason speculation as to the possibility of intelligent life elsewhere in the universe has been particularly attractive to our earthbound race.

A generation ago there was much discussion of the question of possible inhabitants of the planet Mars. Little is now heard of this in scientific circles. Cosmically speaking, life as we know it is a delicate hothouse plant, capable of existing only within rather narrow limits of temperature and composition of atmosphere, and every increase in our knowledge of these conditions as they prevail on Mars has made the existence of intelligent life on that planet more and more improbable. The same applies to all the other planets of our solar system; they are either too hot or too cold, or their atmospheres lack sufficient oxygen and water.

But are not the stars of heaven suns like our own, and among these millions of suns and their attendant planets is it not reasonable to suppose that there may be a few thousand bodies as well fitted as our earth to sustain human life?

For this question astronomy has rather a staggering answer. It is true that these stars are suns, but it does not necessarily follow that they all have planetary systems. In

fact, it is now regarded as quite possible that but very few of them are so favored. Jeans goes so far as to call our system a freak system, and to suggest that there may be but one other like it.

There is today no perfectly satisfactory and generally accepted theory of the origin of our solar system. That the planets once formed part of the sun is beyond doubt, but how they came to be detached from it is still uncertain. Laplace's nebular hypothesis, after a reign of more than a century, had to be abandoned, as it was found that it failed to satisfy an important condition of celestial mechanics. Several other hypotheses have been proposed, none of which is completely satisfactory, but all of which agree in ascribing the origin of the solar system to a close approach or a grazing collision between our sun and another star. And so widely scattered are the stars of heaven that such an encounter could not be expected to occur oftener than once in ten million million years. Our little colony of life may be only an ant hill in a vast desert, and man's feeling of physical insignificance is intensified by a sense of cosmic loneliness.

These four elements—wonder, curiosity, reverential awe, and physical insignificance, have been features of man's cosmic emotion since earliest times, and bid fair to remain so as long as our race shall last. Such changes as time has wrought in them have been quantitative, in most cases an increase in intensity. To these four is to be added a fifth, which, though prominent in bygone years, has now almost faded away—superstitious fear.

During the Middle Ages it was the universal custom in Europe to ring the church bells on the approach of a thunder storm with the idea of frightening away the Prince of the Power of the Air and his attendant demons. Bells are still to be seen in old churches bearing inscriptions such as: "I break the lightning," or "I put demons to flight." In earlier days this fear often prompted human sacrifice in times of famine or pestilence, to appease the supposed anger of the gods. In some places, on the principle that prevention is better than cure, a human victim was sacrificed annu-

ally in the spring of the year in order to ensure fertility of the fields during the coming season. In our time this element of superstitious fear has all but disappeared, but its place has been taken by another element, qualitatively new and of distinctly modern origin.

The supposed agency of demons and spirits in natural phenomena has, with the modern development of the sciences, been replaced by physical causation and laws of Nature. These laws are now so well understood that we can, for instance, predict with reasonable accuracy a clear or rainy morrow, and with perfect accuracy an eclipse of the sun. Passing from the macrocosm to the microcosm, we have learned the cause of many diseases and the cure for some of them. We prefer lightning rods to church bells and antitoxins to incantations. Though much of Nature is still beyond our prediction or control, it is no mean attainment to have achieved a sufficient intellectual mastery of our environment to begin to understand it. And as we pass the Cosmos in review before the mind and reflect that of all Nature man alone has achieved this mastery, there wells up within us a sense of intellectual superiority that goes far toward alleviating our feeling of physical insignificance. Man may be but the merest speck in the universe, yet in his intelligent comprehension of it is he not but little lower than the angels?

In the year 1875 the physicist Maxwell gave this growing feeling of intellectual superiority a powerful stimulus.

The more we have learned of the laws of Nature the more profound is the respect which they have inspired. Like the laws of the Medes and Persians, they alter not. We may defy them, but no one is sufficiently influential to escape the consequences of his defiance. Such progress as we have made in the control and utilization of natural forces has been attained by making allies of some of them, and cunningly pitting one force against another, as, for instance, the air resistance to a parachute against the force of gravity on the aviator. Imagine then the effect produced in the scientific world when Maxwell pointed out that it lies within the

power of intelligence to reverse the action of one of Nature's fundamental laws, known as the second law of thermodynamics.

According to this law heat, like water, when left to itself, naturally runs downhill. If we put a cold spoon in a cup of hot tea the spoon becomes warmer and the liquid cooler. This transfer of heat from the higher level of temperature to the lower will continue until both spoon and liquid reach a common level of temperature. It would be against all experience to expect the spoon to become colder and the tea hotter.

It is true that water can be raised from a lower to a higher level, but only by expending work upon it, as, for instance, by lifting it in a bucket or by working a pump handle. And it is possible to make heat run uphill from a cool body to one that is warmer, but, as with water, only at the price of expenditure of work. But Maxwell showed that it is theoretically possible for intelligence to bring this about without expending any work. The practical difficulty is that we lack for the present a vision keen enough and a touch delicate enough to see and handle the single molecules of which all bodies are composed.

Of the three states of matter, solid, liquid, and gaseous, the structure of a gas is the simplest, and it was upon this that Maxwell based his demonstration. Imagine a swarm of bees flying about in a closed box, colliding with each other occasionally, and rebounding from the walls of the box. Suppose also that some of the bees are flying rapidly and some slowly, while the majority are flying at intermediate speeds, and you will have a good idea of the structure of a gas. The molecules of which a gas is composed are, of course, very small, far too small to be seen with a microscope, but their number is so great and their velocities are so high (of the order of a mile a second) that the pressure produced by the joint impact of millions of these molecules upon the walls of the containing vessel is by no means inconsiderable. This it is, in fact, which sometimes bursts a steam boiler.

When we say that a gas or a vapor is "hot" it is our way of expressing the physical fact that its molecules have a higher

velocity than those of a cooler gas. The molecules of the hot steam inside the boiler are moving much more rapidly than those of the air outside, and the pressure on the boiler plates from within is greater than the counter pressure from without. The wall of the boiler is supposed to be strong enough to take care of this difference of pressure, but if the water is kept boiling vigorously the number of steam molecules continually increases until their joint impact is so great that the boiler plates give way.

Returning to Maxwell's argument, imagine a gas contained in a vessel divided into two parts by a partition, and suppose the gas on each side of the partition is at the same temperature, that is, the molecules on each side have the same average velocity. Suppose that there is a tiny door in the partition, in charge of a little intelligent being who can see the molecules and distinguish between the rapidly moving and the slow ones. When this being sees a rapid molecule in the right-hand compartment headed for the door it is his duty to open the door and let the molecule pass into the left compartment, but he is to keep the door closed against slow molecules on the right. Conversely, he is to allow only the slow molecules to pass from the left to the right. By this sorting process the average velocity of the molecules on the right will continually decrease, while that of those on the left will increase. The effect of this will be that the temperature of the gas on the left will rise while that on the right will fall, and heat will run uphill.

This argument of Maxwell's is something more than an interesting fairy tale. It teaches us that when, from our experience, we have formulated what we call a law of Nature we are not to regard this as the last word on the subject; that Nature's way of working when left to herself may be radically altered when intelligence takes the reins. Nor is the necessary degree of intelligence to be regarded as an unattainable ideal. Much progress has been made in this direction since Maxwell's day, and more will be made in the future. While we are not yet able to see molecules we can do many things with them without seeing

them. We can, for instance, count the number of molecules in a cubic foot of a gas with at least as great accuracy as we can count the population of New York City.

There is much justification for the feeling of intellectual superiority with which man surveys his environment. The intensity which this feeling may attain is well illustrated by an old story.

It is said that at one time an astronomer discovered a new star, which he found by his measurements to be approaching the earth with a high velocity. He calculated that it would strike the earth in a few months. He did not announce his discovery, fearing to witness the orgy of lawlessness and despair which might follow such an announcement, but night after night he studied this approaching doom, fascinated by it. One night he spoke out and addressed the star as follows:

"I know that you will soon destroy me and everything living, but I can calculate the day—nay, even the hour—when this will happen, while you are but a blind brute thing, and I would not change places with you!"

There is one more element in our cosmic emotion which we shall consider. Man finds himself in a wonderland which excites curiosity and inspires awe. He feels his own physical insignificance and the transitory nature of his stay, and yet he is not content to be a mere "super" in the cosmic drama, but feels qualified for a speaking part. He wants to be remembered, he feels an urge to leave his mark on the universe, at least on such portion of it as is within his reach.

We can trace this element far back into antiquity. This it was which built the pyramids, and which prompted the proud boast of the Roman emperor who said: "I found Rome of brick and left it of marble." In modern times this element has suffered a qualitative change, and assumed a form less materialistic and more altruistic, but the primitive urge is still there. When the founder of the Smithsonian Institution made his will in which his estate was left to the United States of America "for the increase and diffusion of knowledge among

men," his solicitor expressed surprise at this unusual bequest. Smithson replied: "My name will be remembered among men when the Percys and Northumberlands are forgotten."

But after all, such monuments, physical or intellectual, can affect only a tiny fraction of the universe—our earth and its inhabitants. In ancient times, when the earth was regarded as the most important part of the visible universe, one might reasonably feel that in beautifying a city or in bettering human society he had done something of cosmic importance, but with our broader outlook the case is different. Not that this detracts in the slightest from the laudable character of such efforts, but considering our cosmic insignificance all such efforts must be recognized to be of but local and temporary importance.

But there are times when all of us find it a relief to think qualitatively rather than quantitatively. Archimedes, that pioneer mechanical engineer, is reputed to have said "Give me a place where I may stand, and I will move the earth." The modern engineer does not even ask for a place to stand, for he knows that by merely shooting a bullet in an easterly direction he can (to a microscopic extent) play the part of Joshua and lengthen the day. Moreover, he knows that (still qualitatively speaking) he can perform actions whose results reach far beyond terrestrial limits. When he strikes a match to light his cigarette as he walks down the street, he knows that he has started light waves, some of which will travel outward and onward in space, perhaps forever.

With increasing knowledge of the universe our eyes have been opened, and we see that our actions may sometimes have a small measure of cosmic scope. It is inevitable that this should lead to speculation as to the possibility of broadening and increasing our cosmic reach. But here we leave the realm of fact and enter that of fancy. It is an attractive realm, as we all know, and by your leave I will tell you another story.

As I journeyed through the world I came to the shore of an ocean reaching far as the eye could see. The water of this ocean was

colorless and transparent and was ceaselessly in motion; even in parts where there were no breakers the water was continually moving in currents. And as I walked along the shore I noticed that there was no living thing in the water, not even a blade of sea-grass; nor did any living thing appear on the beach as far as I could see inland. Thus I wandered ever along the shore of the ocean, watching for some living thing, but finding none.

At length, after many miles of traveling, I came to a place where the sea ran inland, forming a little pool wherein the ceaseless currents played. By the side of this pool there lay an old man, gazing intently into the beautiful clear sea water, and my heart was glad at the sight of a living thing.

"Tell me, father," said I, "what is the name of this ocean? And what curse is laid upon it that there is no living thing in its waters?"

The old man looked at me for some moments without speaking. Then he said, apparently ignoring my first question:

"There are living things in it, but they are few."

"I have traveled many days," said I, "but I have seen none."

"When I was your age, my son," said the old man, "I traveled many months before I found them, and I have lain here watching them ever since."

I looked in the pool, and I saw amid the ceaseless water currents a swarm of living things, hollow, clear-walled creatures, some like single bubbles, some like a heap of bubbles fused together; and the sea water within them was colored a beautiful rich tint, which was new to me. I saw that in those creatures which were composed of many bubbles the color was deep, while in the simpler ones the color was paler, and in the single bubbles I could detect no color at all. I watched the creatures swimming about and pulsating rhythmically, and I said to the old man:

"They are beautiful! And are these the only living creatures in the ocean?"

He shook his head. "I do not know. The ocean is so vast—there may be others—but I have found none."

I looked again in the pool, and I saw that some of the creatures lay still, and their color was paler than that of their fellows of like degree of complexity. The old man said: "They are sleeping." And I saw one creature which, from its complexity, should have had the deepest color of all, but it lay motionless and colorless; and the old man said: "It is dead."

I asked the old man: "What gives to the water within the living creatures its color? Do they secrete coloring matter?"

He answered: "I thought so when I began to study them, but it is not so. Do you see the hairs that line their internal cavities?"

I looked, and I saw that the creatures had little hairs within, and that these hairs were constantly moving, beating and churning up the sea water within. The old man said: "When the sea water is beaten thus it suffers a subtle change and becomes colored."

And I said: "Why then is not the whole ocean colored, since it is ceaselessly beating upon its shore?"

The old man said: "I do not understand it; but it seems that it becomes colored only when it is stirred up by living creatures."

As I silently mused over this my ear caught the sound of a faint chirping. The old man said: "It is made by the creatures in the pool. The more complex ones are able to utter sounds, and the highest of all are even able to communicate with each other by this means."

"They talk!" said I. "Then they must think!"

"Ay, that they do," said the old man, "and strange and sad are some of their thoughts; for in the years that I have studied them I have come to understand a little of their language. For instance, this beautiful color is to them the very essence of the pleasure of their lives. The deeper colored pity the paler, and pity most of all those single bubbles which appear devoid of color."

"Are they really colorless?" said I, "Or is their color only so pale as to be imperceptible?"

The old man bade me look again into the pool.

"Do you see," said he, "how the most complex and active creatures, having many hairs moving, are the deepest in color, and how those with fewer hairs to churn the water are paler? Are the single bubbles totally devoid of hairs?"

"No," said I, "they have a few, and these move slowly."

"What think you then? Are these devoid of color, or is it simply a question of degree?"

I felt that my question was answered.

"Ay," continued the old man, "it is a question of degree; for once or twice in the years that I have watched them I have seen single bubbles, under stress of great excitement, churn the water within them so vigorously with their few hairs that it assumed a pale tint."

Then I said, remembering how I had seen the sleeping ones and the dead one: "The depth of color in any creature seems to be proportional to its bodily activity; and, among different creatures, to their complexity."

"Right," said the old man, "and this fact has been recognized by the most complex creatures themselves."

I said: "When the creatures sleep or die, and their color fades, what becomes of it? Is the change produced by beating the sea water so unstable that when the beating ceases the water reverts to its colorless condition?"

The old man looked grave. "So I thought at first, and many a sad hour have I passed thinking of the labor spent in producing this beautiful color, so unstable that it was doomed to perish with the ceasing of the labor that produced it. But," and here his face brightened, and he spoke with assurance, "it is not so. This change once produced is permanent; it can never be undone."

"But what then becomes of the color?"

He pointed to the pool, and I looked in. One of the most deeply colored creatures was just falling asleep. Slowly and still more slowly moved the hairs within it, and its color gradually faded. I watched closely, but I could not see where the color went. Then there came an instant when the

ceaseless wash of the currents slackened, and in that instant I saw the water about the creature tinged with the beautiful color. I looked up at the old man.

"Ay," said he, "the color is permanent; but the colored water continually diffuses through the creature's body, waking or sleeping, and is dispersed and diluted in the vast ocean. When they sleep their motion is so far reduced that diffusion renders them pale; and when they die they become absolutely colorless. But the color does not die, the beautiful color—no, it cannot!"

"And do they know this?" said I, pointing to the pool. His face again became grave.

"I find that there is a great difference of opinion among the most complex of them. They all realize that it is this color that makes their lives worth living, and they recognize that its intensity is proportional to their bodily activity. They have an instinctive feeling that the color is permanent, but they are sorely puzzled to account for its fading during sleep and its disappearance at death; so that some say that this instinctive feeling of the permanence of the color is a delusion; that the color is really a most unstable thing, and that colored sea water can exist only within a living organism. This conclusion they sorrowfully accept and make the best of it. Others there are who refuse to accept it, and who cling to their instinct." And the old man sighed as he looked at the restless wash of the water in the pool. Presently he said:

"How long will it take, think you, until the whole ocean becomes of this beautiful color?"

I said, "If there be other creatures elsewhere, and many colonies of them—"

"Nay," said he, "I know not if there be such—I hope—but how long?"

I looked long and silently in the pool. Then I said:

"I see some creatures that are very pale; and they are not asleep, for they are moving about."

The old man's brow grew dark. "These are lazy ones," said he. "They have allowed themselves to become discouraged, and say: 'Why should we labor and beat our hairs to produce a color which must perish

with us?" These are they that retard by just so much the coloring of the ocean."

"Nay, father," said I, "be not angry with them. It is but natural. Remember that they do not know."

"True," said he, and his face grew kind and pitiful, "they do not know."

Said I: "Suppose some great falling rock should crush these creatures out of existence?"

"But the color!" said the old man, "the color cannot be crushed out of existence! And the ocean is so vast—there may be other colonies elsewhere; and even if there be none now, they may in time arise as this colony has done, I know not how. The ocean will be colored!"

I was silent a long time. Then I happened to think of my first question, which still remained unanswered.

"Tell me, father," said I, "what is the name of this ocean?"

"I have never heard but one name for it," said he, "and that is the name given it by these creatures themselves. 'Tis a strange name; there is no exact equivalent for it in our language. The nearest is Energy-of-the-Universe."

"And what do they call this beautiful color?"

"They are not agreed upon a single name. Some call it Consciousness, and some call it Soul."

PALEONTOLOGY.—*New genera of North American brachiopods.*¹ G. ARTHUR COOPER, U. S. National Museum.

In preparing the brachiopod chapter for the forthcoming "Index to North American Fossils," the writer encountered a number of nomenclatorial problems which are here adjusted. It also became evident that a number of new generic names should be proposed for groups of species not yet adequately designated. The generic diagnoses are given herewith without illustration, but most of these genera will be well figured in the forthcoming book. Besides the adjustment of certain homonyms and corrections of printer's errors, reasons for revival of erroneously suppressed names are given. Inasmuch as the "Index" will be in constant use by students the suggested changes should make for clearer understanding and stability in brachiopod nomenclature.

ADJUSTMENT OF HOMONYMS

Callipleura n. name, to replace *Cyclorhina* Hall and Clarke (1894, p. 146); not Peters, 1871, mammal. Genotype: *Rhynchospira nobilis* Hall, 1860.

Plectospira n. name, to replace *Ptychospira* Hall and Clarke (1894, p. 112); not Slavik, 1869, gastropod. Genotype: *Terebratula ferita* von Buch, 1834.

¹ Published by permission of the Secretary of the Smithsonian Institution. Received Apr. 21, 1942.

Pustulina n. name, to replace *Vitulina* Hall (1860, p. 72); not Swainson, 1840, gastropod. Genotype: *Vitulina pustulosa* Hall, 1860.

Trigonirhynchia n. name, to replace *Uncinulina* Bayle (1878, pl. 13, figs. 13-16); not Terquem, 1862, echinoderm. Genotype: *Uncinulina fallaciosa* Bayle, 1878.

Barroisella campbelli n. name, to replace *Lingula subspatulata* Meek and Worthen, 1868 (p. 437, pl. 13, fig. 1), the designated type of *Barroisella*, not *Lingula subspatulata* Hall and Meek, 1854-56.

ADJUSTMENT OF SYNONYMY

Dictyonina n. name, to replace *Iphidella* Walcott, 1912, not Walcott, 1905 (equals *Paterina*). In 1872 Billings proposed the genus *Iphidea* with *I. bella* Billings as genotype. The following year Meek proposed the genus *Micromitra* with *Iphidea* (??) *sculptilis* Meek as genotype. This name was not proposed as a substitute for *Iphidea* as suggested by Schuchert and Levene (1929, p. 69, 84) but as a separate genus. Such substitution did take place in 1905 by Walcott (p. 304), who distinctly states that *Iphidella* is proposed to replace *Iphidea* of Billings (not Bayly). From the list of species placed under *Iphidella* by Walcott it is clear that he had a very broad conception of the

genus. In 1912 Walcott (p. 359) redefined the genus and selected another type species, *Trematis pannulus* White, a procedure contrary to the rules of nomenclature. The type of *Iphidella* is the type of *Iphidea*, i.e., *Iphidea bella* Billings. The genotype of *Iphidea* was placed by Walcott in the genus *Paterina*, which was proposed by Beecher in 1891 with *Obolus labradoricus* as genotype, a species that Billings (p. 478) had already assigned to *Iphidea*. It is therefore apparent that *Iphidea* and *Paterina* are generically identical. Inasmuch as *Iphidea* was stillborn, the name *Paterina* must now be used for these shells. *Iphidella* thus becomes a synonym of *Paterina*, leaving Walcott's *Iphidella* without a name, for which *Dictyonina* is proposed.

REVIVED NAMES

Craniops Hall (1859, p. 84) revived and substituted for *Pholidops*. The name *Craniops* appeared first in a list under a heading "Changed Names, Remarks, etc." and was used for the species *Orbicula* (?) *squamiformis* Hall. Its next use was in the advance copies of the *Paleontology of New York* 4. 1867, but did not appear in the final copy. In 1860 (p. 92) Hall published the name *Pholidops* as a new genus and cited *Orbicula* ? *squamiformis* as the first species, and this was later fixed as type by S. A. Miller, 1889. Inasmuch as *Craniops* and *Pholidops* are exact and objective synonyms, the former name has priority over the latter. The use of *Craniops* in a list with a described species was a valid proposal of a name at that time.

Stenocisma revived and substituted for *Camerophoria*. The conditions under which this name was proposed and the subsequent history are discussed fully by Dall (1877, p. 65) and need not be repeated here. Conrad clearly designated *Terebratula schlotheimi* von Buch as type of his genus and this designation must stand.

Orthambonites revived and used for certain brachiopods hitherto referred to *Orthis*. *Orthambonites* Pander, 1830, type *O. transversa* Pander, is to be used for costate Orthidae having both valves convex. The genus generally has been regarded as a

synonym of *Orthis*, but the latter was restricted to species of the type of *O. callactis* with concave dorsal valve. The writer therefore revives the name *Orthambonites* for the biconvex species common in the Lower and Middle Ordovician of this country and Europe.

Resserella replaces *Dalmanella* as restricted by Schuchert and Cooper. The status of *Dalmanella* was thrown into confusion when Schuchert and Cooper (1932, p. 126) erroneously stated the type species to be *Orthis testudinaria* Hall and Clarke, not Dalman, equals *O. rogata* Sardeson. According to the rules of nomenclature the type should be regarded as the species named by Hall and Clarke, i.e., *O. testudinaria* Dalman. As thus restricted a single species (*Dalmanella edgewoodensis* Savage) in this country conforms strictly to the type. This leaves many species hitherto referred to *Dalmanella* without a generic name. Öpik (1933) claims these species to be referable to *Onniella* Bancroft, but according to the writer's view most of them are not congeneric with *Onniella*, which is restricted, as at present known, to a few Richmond species. The Black River and Trenton *Dalmanellas* actually are conspecific with *Resserella*. Restriction of *Dalmanella* to species of the type of *D. testudinaria* makes Bancroft's genus *Wattsella* a synonym of *Dalmanella* s.s.

Torynifer recognized. This name was proposed by Hall and Clarke (1894, pl. 84) for a fragment of a dorsal valve which exhibits a peculiar concave hinge-plate and which they felt was so unusual that it must be named despite its fragmentary condition. In the National Museum the writer discovered specimens almost identical with Hall and Clarke's fragment, which come from Pierce Springs, Larue County, Ky. These prove *Torynifer* to be the dorsal valve of "*Reticularia*" *pseudolineata* (Hall). *T. criticus* is thus a synonym of "*R.*" *pseudolineata*, and the generic name may be applied to the American Mississippian "*Reticularias*." *Torynifer* possesses a deeply concave undivided hinge-plate attached to a long median septum, a feature unlike that of the British type of *Reticularia*, according

to diagrams of the genotype published by George (1932). In these no septum is indicated and the hinge-plate is divided like that of the martinias. *Torynifer* also possesses a flat deltidial plate in the ventral valve which is not indicated in the British *Reticularia*. The writer therefore proposes to use the name *Torynifer* for the American Mississippian species of *Reticularia*.

CORRECTIONS

Septothyris Cooper and Williams, 1935.—Although this genus is monotypical, a printer's error prevented an unambiguous designation of the type. The type designation does not appear under the heading "Genotype," which is in its correct place but is incorrectly offset as an incomplete center heading "*Septothyris* Cooper and Williams, n. sp." The fact that the incomplete center heading is the actual designation inadvertently offset and minus the specific name should be obvious. The type of *Septothyris* is *S. septata* Cooper and Williams.

Trematorthis Ulrich and Cooper 1938.—In Ulrich and Cooper's "Ozarkian and Canadian Brachiopoda" the heading "*Trematorthis* Ulrich and Cooper, nov." appears. This is a lapsus for *Trematorthis*, which is correctly spelled in all other parts of the text. Page proof in the writer's possession bears the correct heading *Trematorthis*.

NEW GENERA AND SPECIES

Longispina Cooper, n. gen.

Small, quadrate in outline; hinge forming widest part; concavo-convex; costate; ventral posterior margin provided with a few long spines extending outward nearly parallel to the hinge.

Ventral interior with strong teeth; delthyrium open; dental plates absent; muscular field large and with flabellate diductor impressions. Dorsal interior with elongate, compressed and bilobed cardinal process. Brachial processes obsolete, median ridge low. Pseudopunctate.

Genotype: *Chonetes emmetensis* A. Winchell, Rep. Lower Peninsula Michigan, 1866, p. 92. Winchell's types redescribed and figured by Ehlers and Kline, Contr.

Mus. Paleont. Univ. Michigan 4 (10): 156, 1934. Reference specimens U.S.N.M. nos. 108206a-d.

Differs from *Plioconetes* Paeckelmann in great length of spines, absence of brachiophores, and presence of a median ridge. Species assigned here are: *Chonetes mucronatus* (Conrad), *C. robustus* Raymond, and *C. vicinus* (Castelnaud).

Institella Cooper, n. gen.

Subrectangular in outline with hinge equal to about greatest shell width. Ventral valve with convex umbo, but anterior to the umbo appears a deep, narrow-sulcus that extends anterodorsally as a long sharp tongue. Flanks bounding sulcus convex with steep slopes to lateral margin. Dorsal valve with sulcate umbo, but anterior to umbo a narrow carinate fold occurs that rises anterodorsally to meet the ventral tongue. Lateral margins of ventral valve with a frill extending ventrally and outward. Dorsal valve with corresponding ventrally and outwardly directed frill. Ventral valve with short interarea and small delthyrium under the low beak.

Ventral interior with large flabellate diductors occupying deep cavities on each side of the median ridge formed on the inside by the sulcus. Adductors small, elongate, crenulate and located anterior to delthyrium on the median ridge.

Dorsal valve with thin median septum occupying internal groove produced by exterior fold. Adductor field small, located just anterior to cardinal process. Brachial impressions as in *Dictyoclostus* but small. Cardinal process erect bilobed.

Ventral valve with prominent spines along posterior margin and cardinal extremity where largest ones are located. Dorsal valve without spines. Surface costellate and reticulate.

Genotype: *Productus leonardensis* R. E. King, Univ. Texas Bull. 3042: 70, pl. 14, figs. 4-9. 1930. Reference specimens U.S.N.M. nos. 108549a-f.

Differs from *Dictyoclostus*, which it resembles externally, by the extravagant lateral flanges, the deep sulcus, carinate dorsal fold, and cardinal area of ventral valve.

Costellirostra Cooper, n. gen.

Subtriangular in outline, dorsal valve deeper than the ventral one, ventral beak with minute foramen just posterior to apex. Uniplicate; ventral valve with long anterior tongue. Valves multicostellate, impunctate.

Ventral interior with short concave deltidial plates; teeth stout, supported by callosus. Muscular field elongate oval with large diductor impressions. Adductors nearly central, attached to small platform. Dorsal interior with long thick cardinal process; myophore having two long outer prongs and two shorter inner ones. Crura short and stout, extending anteroventrally from base of shaft. Median ridge long and thick.

Genotype: *Atrypa peculiaris* Conrad, 5th Ann. Rep. Geol. Surv. New York, 1841, p. 56. Reference specimens U.S.N.M. nos. 95547a, 108209a-c.

Differs from *Eatonia* by its multicostellate ornamentation, more flabellate ventral muscular area and more extravagantly developed cardinal process. Other species are *E. singularis* (Vanuxem) and *E. tennesseensis* Dunbar.

Paurorhyncha Cooper, n. gen.

Large, subtriangular, with unequally deep valves, the ventral one slightly convex but the dorsal one very deep; uniplicate; multicostellate.

Ventral interior with much reduced dental plates and small teeth. Muscular area small, elongate-oval. Foramen minute, beak closely pressed onto dorsal umbo. Deltidial plates vestigial. Dorsal interior with long median septum supporting a small V-shaped chamber to which the divided hinge-plate is attached. Socket plates elevated, crural bases concave, often swollen.

Genotype: *Rhynchonella endlichi* Meek, Bull. U. S. Geol. Surv. Terr. (ser. 2) 1: 46. 1875. Syntype U.S.N.M. no. 7798a; dorsal interior U.S.N.M. no. 108213.

Differs from *Leiorhynchus* in the presence of a deep V-shaped chamber. From *Plethorhyncha* it differs in the slighter development of the dorsal median septum, smaller ventral muscular field and mode of thickening of hinge-plate.

Sedenticellula Cooper, n. gen.

Small, rhynchonelloid, with ventral sulcus and dorsal fold. Surface multicostate with costate increasing in number by intercallation. Ventral interior with sessile spondylium; dorsal interior with long median septum, and small cruralium divided by a median septum.

Genotype: *Camarophoria hamburgensis* Weller, Bull. Geol. Soc. Amer. 21: 500. 1910.

Distinguished from *Camarophoria* by its leiorhynchoid exterior and sessile spondylium.

Brevispirifer Cooper, n. gen.

Medium sized, generally longer than wide, with hinge equal to or slightly wider than midwidth. Valves costate, lamellose; fold and sulcus noncostate.

Ventral interior with strong, short, flaring dental plates. Muscular area oval. Dorsal socket-plates confined to sides of valve and attached to floor by short supporting plates. Cardinal process absent.

Genotype: *Spirifer gregaria* Clapp, in Hall, 10th Rep. New York State Cab. Nat. Hist., 1857, p. 127. Reference specimens U.S.N.M. nos. 108216a-c.

This genus suggests *Mucrospirifer* but is longer than wide and possesses supporting plates in the dorsal valve. Besides the type, *S. lucasi* Stauffer and *S. davisii* Nettelroth are assigned here.

Fimbrispirifer Cooper, n. gen.

Wider than long with narrowly rounded sides; valves multicostate with fold and sulcus costate. Entire surface marked by concentric lamellae, each bearing a single row of small spines. Ventral interior with strong dental plates. Dorsal interior with shallow narrow socket-plates that converge toward the center and join a callosity under the beak. Median ridge low.

Genotype: *Spirifer venustus* Hall, 10th Rep. New York State Cab. Nat. Hist., 1857, p. 133. Reference specimens U.S.N.M. nos. 39489a, 108217a.

Suggests the completely costate *Costispirifer* but differs in presence of concentric lamellae and spines and inside the dorsal

valve in the presence of short supporting plates. *Paraspirifer* possesses similar spiniferous lamellae but the fold and sulcus are noncostate. *S. divaricatus* Hall and *S. grieri* Hall belong here.

Costispirifer Cooper, n. gen.

Large, spiriferoid in outline and profile; multicostae with costate fold and sulcus. Costae flat and marked by fine radial costellae. Ventral teeth small, dental plates short and thick. Delthyrium covered by a short convex pseudodeltidium. Dorsal valve with stout, shallow socket plates restricted to the side of the valve and supported by callus only.

Genotype: *Spirifer arenosus planicostatus* F. M. Swartz = *Costispirifer planicostatus* (Swartz), U. S. Geol. Surv. Prof. Paper 158-C: 56. 1929. Reference specimens U.S.N.M. nos. 97942a-c, 97943a, b.

Differs from *Fimbrispirifer* by its broad flat costae, covered by radial costellae and absence of any plates supporting the socket plates. *Spirifer arenosus* (Conrad) and *S. unicus* Hall are also placed here.

Dimegelasma Cooper, n. gen.

Large, spiriferoid in outline and profile with smooth fold and sulcus; flanks costate. Shell substance coarsely endopunctate. Ventral interior with long, strong dental plates. Delthyrium partially covered by a flat delthyrial plate. Muscular field long and oval. Dorsal valve with crural bases attached to sides of valve and united medially to a short low septum.

Genotype: *Spirifer neglectus* Hall, Geol. Surv. Iowa 1 (pt. 2): 643, pl. 20, fig. 5. 1858. Reference specimens U.S.N.M. nos. 49163a, b; 108218.

Differs from the Permian genus *Spiriferella* with which it has been confused by its endopunctate shell, elongate dental plates, and flat delthyrium. The Russian *Spiriferella* is impunctate, the dental plates are short, and the pseudodeltidium is convex.

Spondylospira Cooper, n. gen.

Shell cyrtinoid in outline with costellate fold and sulcus. Ventral valve hemipyramidal, delthyrium open; surface of inter-

area deeply striated at right angles to the hinge, the ridges between the striae representing growth tracks of teeth on the hinge margin. Interior of ventral valve with dental plates and median septum grown together to form a cyrtinoid spondylium, in which the median septum extends posterodorsally into the chamber formed by the spondylium. Dorsal interior with short and low median ridge, small crural bases. Descending lamellae of spire supported by a calcareous net. Shell substance punctate, exterior granulose.

Genotype: *Spondylospira reesidei* Cooper, n. sp.

Resembles *Cyrtina* in outline and profile but differs in having a costate fold and sulcus, dentate cardinal edge, no deltidial plate, and the descending lamellae of the spire supported by a calcareous net. Besides the genotype, *Spiriferina alia* Hall and Whitfield and *Cyrtina lewesensis* Lees are placed here.

Spondylospira reesidei Cooper, n. sp.

Small, cyrtinoid in outline and profile; wider than long. Ventral valve hemipyramidal, beak often twisted. Costae bifurcating anteriorly. Sulcus shallow, occupied by a costa that bifurcates near the front margin. Fold low, formed by a single costa on the umbo. This costa bifurcates about 2½ mm anterior to the beak. The two costae thus produced then bifurcate near the middle of the valve to produce four costae, which extend to the margin. Flanks marked by six to nine costae.

Ventral interior with high median septum, and shallow spondylium. Dorsal interior having united jugum and descending branches of spire united to floor of valve by a calcareous net.

Holotype: U.S.N.M. no. 10346a. Paratypes: U.S.N.M. nos. 103468b-g.

Triassic (Seven Devils formation), east side of Mission Creek, 1½ miles above Mission, 4½ miles above Jaques, about sec. 15, T. 36 N., R. 3 W., Nez Perce County, Idaho.

Spondylospira reesidei differs from *S. alia* by its smaller size and stronger costae; it differs from *S. lewesensis* in having fewer costae in the fold and sulcus and more on the flanks.

Cryptothyrella Cooper, n. gen.

Large, elongate, lenticular in lateral profile, elliptical to subcircular in cross section. Anterior commissure rectimarginate to uniplicate. Beak strongly incurved; foramen minute, apical. Dorsal beak fitting into a concave plate under ventral beak. Surface smooth, shell substance impunctate.

Ventral interior with long divergent dental lamellae on each side of the elongate triangular muscle field. Dorsal interior with long median septum supporting divided hingeplate. Brachidium with compressed spiral cones and inverted Y-shaped jugum, the tail of the Y directed posteroventrally.

Genotype: *Whitfieldella quadrangularis* Foerste, Kentucky Geol. Surv. Bull. 7: 327, pl. 1, figs. 4a-c. 1906. Syntypes U.S.N.M. no. 84891.

Differs from *Whitfieldella* by the minute foramen, large triangular muscular field, and the elongate form of the valves.

Plectoconcha Cooper, n. gen.

Terebratuloid, generally rotund and longer than wide; uniplicate with superimposed alternate multiplication. Foramen large, permesothyrid, labiate. Deltidial plates not exposed.

Ventral interior with large strong teeth not supported by dental plates. Pedicle collar strong. Cardinalia with strong, inner socket plate and deep sockets. Crural bases thin short, crural process attached at end of hinge-plate. Loop short and wide, descending lamellae short and flaring laterally; transverse ribbon slightly arched.

Genotype: *Rhynchonella aequiplicata* Gabb, Geol. Surv. California, Pal., 1: 35, pl. 6, fig. 37. 1864.

Externally resembles the Permian *Hemiptychina* but differs in not possessing dorsal septal plates and in the shorter, wider loop.

Oleneothyris Cooper, n. gen.

Large, sulcate, with smooth exterior. Beak erect, foramen large, mesothyrid, marginate to labiate. Deltidial plates concealed in adults.

Ventral hinge teeth supported by callus only; ventral muscular area pyriform in

outline, situated anterior to the teeth. Cardinalia with strong, high inner socket ridges corrugated on the surface facing the socket; exterior hinge-plates short, moderately concave and united with a short crural base extending posteriorly nearly to the cardinal process. Crural processes moderately long, bluntly pointed; descending lamellae short and stout, produced anteriorly into moderately long processes. Transverse band directed slightly posteriorly and strongly ventrally to form an inverted V. Cardinal process large. Dorsal adductor scars located near the middle of the valve and lying anterior of a low and wide median ridge, pyriform in outline and fairly large.

Genotype: *Terebratula harlani* Morton, Amer. Journ. Sci. 18: 250, pl. 3, fig. 16. 1829. Reference specimens U.S.N.M. nos. 559395-559397.

Differs from *Terebratula* s.s. in having a greater development of inner socket ridges, broader crural bases, stouter crural processes, and the transverse band of loop in form of an inverted V.

Choristothyris Cooper, n. gen.

Shell thick, small, subcircular in outline with a narrow, slightly curved hinge. Anterior commissure sulcate, surface multicostate to plicate. Beak suberect to erect; foramen large, submesothyrid; deltidial plates small, disjunct.

Ventral interior with large teeth having deep fossettes in callus supporting them. Muscular area large and flabellate, divided by a low but stout median ridge. Cardinalia strong with inner socket ridges strong and high, bounding deep and wide sockets. Hinge-plates small, concave. Crural bases short and stout; loop terebratelliform with long slender crural processes. Cardinal process ponderous. Adductor impressions on each side of a high, thin median septum reaching to the center of the valve.

Genotype: *Terebratula plicata* Say, Amer. Journ. Sci. 2: 43. 1820. Reference specimens U.S.N.M. nos. 2395, 103556.

Differs from *Terebratella* in its angularly costate exterior and cardinalia. The hinge-plate of *Terebratella* is deeply concave and united with the median septum, and its cardinal process is a small callosity at the

beak. The cardinal process of *Choristothyris* has a strong shaft with trilobed myophore occupying the space between the crural bases.

***Atrypella shrocki* Cooper, n. sp.**

Shell of about average size for the genus, slightly longer than wide; lateral margins rounded, anterior margin truncated. Greatest width at about the middle. Dorsal valve the deeper, and with gentle convexity in lateral profile but strongly convex in anterior profile. Ventral valve with strongly incurved beak; gently swollen in the umbonal and medial regions but depressed in the anterior third to form a shallow sulcus; ventral tongue short, bent almost at right angles to the lateral commissure and with narrowly rounded extremity. Dorsal valve with short narrowly rounded fold in the anterior third somewhat tumid in the median region and with steep slopes to the lateral margins. Surface smooth. Measurements of holotype: Length, 18 mm; width, 16.7 mm; thickness, 11.6 mm.

Holotype: U.S.N.M. no. 108210a. Paratype: U.S.N.M. no. 108210b.

Horizon and locality: Silurian (Huntington limestone), SE $\frac{1}{4}$ SW $\frac{1}{4}$ sec. 29, T. 27 N., R. 1 E., 3 miles east-northeast of the bridge over the Wabash River at Georgetown, Indiana. Named after Dr. R. R. Shrock, who discovered the species.

Suggests the common *Atrypa phoca* Salter of the Arctic but differs in having a more elongate outline, deeper sulcus, narrower and more elevated fold, and less convex dorsal valve.

***Trigonirhynchia sulcata* Cooper, n. sp.**

Uncinulus stricklandi (auct. not Sowerby)
Bassler, U. S. Nat. Mus. Bull. 92: 1312.
1915.

Large, subtriangular, slightly wider than long with greatest width in anterior third. Lateral margins curving gently to the narrowly rounded anterolateral extremities. Anterior margin straight. Surface marked by 20-26 costae, 6-9 on the fold, 7-9 on the flanks.

Ventral valve shallow, gently and evenly convex in lateral profile. Sulcus broad and

shallow, originating in posterior third; tongue long, anteriorly rounded and bent at right angles to the valve surface. Flanks narrowly convex. Beak small, pressed onto the dorsal umbo.

Dorsal valve the deeper, posterior half most convex in lateral profile, anterior half nearly flat. Fold low, defined in the front half, flanks gently convex and very steep-sided.

The holotype has a length of 30 mm, width of 32 mm, thickness 23.7 mm, and width of fold of 19.5 mm.

Holotype: U.S.N.M. no. 108553.

Horizon and locality: Waldron shale, Waldron, Indiana.

This species has been generally identified with *Uncinulus stricklandi* (Sowerby) of the British Silurian but differs in its wider and shallower sulcus and narrower, less strongly defined fold.

LITERATURE CITED

- BAYLE. *Explication carte géologique France*, Atlas. 1878.
- BILLINGS, E. *On some fossils from the Primordial rocks of Newfoundland*, Canadian Nat. Geol., n. ser., 6 (4). 1872.
- COOPER, G. A., and J. S. WILLIAMS. *Tully formation of New York*. Bull. Geol. Soc. Amer. 46. 1935.
- DALL, W. H. *Index to the names which have been applied to the subdivisions of the class Brachiopoda*. U. S. Geol. Surv. Bull. 8. 1877.
- GEORGE, T. N. *The British Carboniferous reticulate Spiriferidae*. Quart. Journ. Geol. Soc. 88. 1832.
- HALL, J. *Catalogue of the species of fossils described in Volumes I, II, and III to the Palaeontology of New York*. 12th Ann. Rep. New York State Cab. Nat. Hist. 1859.
- . *Contributions to paleontology*. 13th Rep. New York State Cab. Nat. Hist. 1860.
- and J. M. CLARKE. *Introduction to the study of the genera of the Palaeozoic Brachiopoda*. Paleont. New York 8 (2). 1894.
- MEEK, F. B. *Paleontological report. Descriptions of new species of fossils*. 6th Ann. Rept. U. S. Geol. Surv. Terr. 1873.
- and A. H. WORTHEN. *Geology and paleontology*. Geol. Surv. Illinois 3. 1868.
- ÖPIK, A. *Über einige Dalmanellacea aus Estland*. Acta et Comment. Univ. Tartuensis (Dorpatensis), A25. 1933.
- PANDER, C. H. *Beiträge zur Geognosie des russischen Reiches*. 1830.

SCHUCHERT, C., and G. A. COOPER. *Brachiopod genera of the suborders Orthoidea and Pentamerioidea*. Mem. Peabody Mus. Nat. Hist. 4 (1). 1932.

SCHUCHERT, C., and C. M. LEVENE. *Brachiopoda*. Fossilium Catalogus. 1929.

ULRICH, E. O., and G. A. COOPER. *Ozarkian*

and *Canadian Brachiopoda*. Geol. Soc. Amer. Special Papers 13. 1938.

WALCOTT, C. D. *Cambrian Brachiopoda with descriptions of new genera and species*. Proc. U. S. Nat. Mus. 28. 1905.

———. *Cambrian Brachiopoda*. Mon. U. S. Geol. Surv. 51. 1912.

GEOLOGY — *Atlantic coastal "terraces."*¹ RICHARD FOSTER FLINT, Yale University. (Communicated by G. ARTHUR COOPER.)

The problem of the Pleistocene² "terraces" along the Atlantic coast of the United States from New Jersey to Florida breaks down into three subsidiary questions: (1) How much of the Coastal Plain was covered by the sea at any time during the Pleistocene? (2) What definite strandlines are present? (3) What is the cause of the striking difference in Pleistocene deposits and topography between the regions north and south of the James River? On all three questions confusion of marine features with fluvial features must be avoided. Each of these questions will be considered briefly:

Area covered by the sea.—Three lines of evidence help to fix the area covered by the sea at one time or another: *sediments, fossils, and topography.*

SEDIMENTS appear to be better size-sorted in the marine littoral zone than under most stream conditions, and they commonly contain less ferruginous and kaolinitic material than do stream deposits. Types of stratification may be much the same in both marine and fluvial deposits, but cut-and-fill bedding is certainly fluvial and not marine. Judged on these characters, the sediments below an altitude of about 100 feet in southern Virginia and below 160 feet in Georgia appear to be mainly marine, whereas nowhere north of the James River do sediments that are thought to be marine occur higher than 50 feet.

Between the James River and Florida the average grain size of the Pleistocene sediments is finer than the surface exposures indicate, for borings and rare deep

cuts exhibit a change downward from the common surface sand and silt to stratified silt and clay. The coarse surface sediments may represent offlapping deposits laid down in the littoral zone.

FOSSILS: No Pleistocene marine fossils had been reported from the Atlantic Coastal Plain from altitudes higher than 28 feet until Hyyppä found a marine diatom flora in a deposit, apparently Pleistocene, sampled by Stephen Taber near McBeth, S. C., with a surface altitude of about 70 feet.³ Surface samples are commonly barren, but the finer subsurface sediments in the region south of the James River offer a promising field for diatom studies as borings and other excavations open them up.

TOPOGRAPHY: The evidence afforded by topography is good. Cooke, Monroe, and others have described bars and swales in various districts between the James River and Florida. The bars are numerous and massive and include hooked spits. They occur as high as 100 feet altitude in southern Virginia, 180 feet in Georgia, and 240 feet in north-central Florida. In general, they become more numerous and more massive from the James River southward. None has been reported from the region north of the James at altitudes greater than 50 feet.

These bars are marine features without doubt, but they do not fix the sea levels of the times when they were built, because the tops of bars that are being fashioned by the sea at present occur through a wide range of vertical positions extending well above and well below the surface of the sea itself.

Definite strandlines.—Ordinarily it is easier to determine that the sea has stood

¹ Received May 25, 1942.

² For the purposes of this paper, the Pleistocene is considered to represent the time from the Pliocene to the present.

³ Flint, R. F., *Pleistocene features of the Atlantic Coastal Plain*. Amer. Journ. Sci. 238: 780. 1940.

over a broad territory than to fix the positions at which its shore stood during appreciable pauses. The best evidence—perhaps the only satisfactory evidence—of the latter consists of wave-cut cliffs or scarps facing the sea. In identifying such features in the weak materials of the Coastal Plain we must set aside all river-facing scarps as being possibly stream-cut, and we can not make use of the numerous bars because their tops may have stood above or below sea level.

Fortunately there are two definite wave-cut scarps, recognized in Virginia by Wentworth and elsewhere by Cooke: the Surry scarp and the Suffolk scarp. The Surry scarp is 15 to 35 feet high and has a slope of 1° to $2\frac{1}{2}^{\circ}$. It separates a dissected surface to landward, from a less dissected and much more gently sloping surface to seaward. It occurs discontinuously from the James River to the Savannah River, a distance of 375 miles, and throughout this distance its toe stands at an altitude of 90 to 100 feet. The Suffolk scarp has a maximum height of 60 feet and a maximum slope of 5° . Its discontinuous length is greater than that of the Surry scarp, because it continues south into Florida. Its toe stands at 20 to 30 feet. This scarp is believed to be younger than the Surry scarp because it is fresher and is not blanketed by later sediments.

The discontinuities in both scarps are due in part to lateral subaerial erosion but chiefly to lack of original development, (a) back of bars, and (b) near the mouths of large rivers. It seems likely that these rivers built sediments into the sea faster than the waves could remove them, and that thus significant cliffing by the waves was prevented.

The sea must have stood, at least briefly, at many levels other than those recorded by the Surry and Suffolk scarps, and perhaps clear evidence of other shorelines will be discovered, though apparently it has not yet been established. The burden of proof that other shorelines are present must rest with those who postulate such features.

Striking differences between the regions south and north of the James River.—From the James River south to Florida there is

satisfactory evidence from sediments, fossils, and topography of Pleistocene marine encroachment reaching 100 feet near the James and reaching higher altitudes farther south, and, in addition, topographic evidence of two long stillstands of the sea. On the other hand, from the James River north through New Jersey, undoubted marine deposits are present up to an altitude of only 30 feet. The tops of bars stand somewhat higher, but generally at higher altitudes we find stream sediments, and, along the rivers, stream-cut terraces. It appears likely that while the Surry scarp was being cut in the region south of the James River, the Potomac, Susquehanna, and Delaware River systems were building alluvium into the sea farther north. At that time the shoreline probably lay east of the present Chesapeake Bay and Delaware Bay shoreline. It seems likely that later, as emergence and perhaps upwarping occurred, this alluvium was dissected and reworked by these same rivers, and that the alluvium, largely reworked, is represented today by the Beacon Hill, Bridgeton, and Pensauken sediments in New Jersey and the Sunderland, Wicomico, and Talbot sediments in Maryland and Delaware. The Suffolk scarp appears to postdate these events and is probably the correlative of the Cape May sediments and shore features in New Jersey.

The features described here are marine plains, marine bars, inconspicuous scarps, and fluvial plains. As none of them is properly a terrace, this term is misleading. To be sure, the area lying between the toe of the Surry scarp and the toe of the Suffolk scarp has a terrace-like form, but its width is so great compared with its height that this form becomes conspicuous only when represented by a profile with the vertical dimension exaggerated. For this reason it seems best either to inclose the word *terrace*, as applied to these features, in quotation marks, to show that although frequently used it is not appropriate, or to avoid using it altogether.

An independent problem concerns the dates of origin of the Suffolk and Surry scarps. As these features are warped little if at all, probably they record fluctuations

of sea level rather than crustal movements. As they lie higher than present sea level, probably they date from interglacial rather than glacial times. According to current estimates, if all existing glaciers were to melt, the sea would rise to somewhere near the level of the Surry scarp. Perhaps, therefore, this scarp records a complete deglaciation. Judged on this basis, the Suffolk scarp would record a much less complete deglaciation. There is evidence, as shown by Mansfield and Cooke, that between Surry time and Suffolk time there was an interval when the sea level was lower than at present, perhaps indicating a glacial age. The broad wave-cut bench⁴ that surrounds the island of Bermuda with a maximum present depth of 65 to 75 feet below sea level may perhaps be a record of this same post-Suffolk interval of lower sea level.

⁴ Sayles, R. W., *Bermuda during the Ice Age*. Proc. Amer. Acad. Arts and Sci. 66: 447. 1931.

It is certain that the sea has not stood higher than the altitude of the toe of the Suffolk scarp at any post-Suffolk time. Hence it may be inferred that the Suffolk scarp represents the latest interglacial time of any consequence—possibly the Peorian interglacial sub-age. In this case the Surry scarp might be tentatively considered to represent the Sangamon interglacial age. No direct evidence bearing on this dating, however, is known to the writer.

MacClintock⁵ suggests that the Cape May formation in New Jersey, which the writer considers to be the correlative of the Suffolk scarp, is of Sangamon date. If this dating were correct, the Surry scarp would have to be referred to an earlier interglacial age, probably the Yarmouth. But until additional facts become available, this matter remains in the realm of speculation.

⁵ MacClintock, P., *Marine topography of the Cape May formation*. Bull. Geol. Soc. Amer. 51: 2002. 1940.

BOTANY.—*Hugelia Bentham preoccupied*.¹ LOUIS CUTTER WHEELER, University of Pennsylvania. (Communicated by EDGAR T. WHERRY.)

The polemoniaceous genus *Hugelia* Bentham in Edwards's Botanical Register 19 (n. s., vol. 6): t. 1622. 1833, is recognized by some authors, e.g., Jepson, Man. Fl. Pl. Calif., 792–793. 1925?, though others, e.g., Munz, Man. So. Calif. Bot., 393, 401–402. 1935, Craig, Bull. Torr. Bot. Club 61: 385–396, 411–428. 1934, and Macbride, Contr. Gray Herb. n. s. 49: 51–58. 1917, consider it as only a subdivision of the genus *Gilia* Ruiz & Pavon. Brand in Engler, Pflanzenreich IV. 250: 164–168. 1907, placed it under *Navarretia* as a subgenus. There seems to be no published consideration of the effect of Article 61 of the International Rules of Botanical Nomenclature, ed. 3, 1935, on the use of *Hugelia* Bentham as a genus. The provisions of Article 61 are: "A name of a taxonomic group is illegitimate and must be rejected if it is a *later homonym*, that is if it duplicates a name previously and validly published for a group of the same rank based on a different type. Even if the earlier homonym is

illegitimate, or is generally treated as a synonym on taxonomic grounds, the later homonym must be rejected."

In publishing *Hugelia*, Bentham made the following explanation in a footnote: "In honour of Baron Charles de Hügel of Vienna. *Hugelia* of Reichenbach is *Didiscus D. C.*"

It has been difficult to trace the preoccupying *Hugelia*. Various references are given in indices and nomenclators. Much weary delving has unearthed a work in which the genus was defined, after a fashion. The genus commemorated the same man as did Bentham's, merely differing in spelling by an umlaut over the "u"; therefore *Hügelia* is a mere orthographic variant of *Hugelia*, the names are homonymous under the terms of Art. 61, Note, and the later of the two must be rejected.

The bibliographical data are: *Hügelia* H. G. L. Reichenbach, Iconographia Botanica Exotica sive Hortus Botanicus Imagines Planatarum, t. 201, p. 2. 1828–1830. The genus is defined in observations

¹ Received June 6, 1942.

at the top of page 2 of the text for plate 201 by telling how it differed from *Trachymene* Rudge. Included was only *Hügelia coerulea*, based on *Trachymene coerulea* Graham, Edinb. New Philos. Journ. 5: 380. 1828 (July–Sept. number). It is quite possible that *Hügelia* Reichenbach was published earlier elsewhere. On page 1 of the text for plate 201 Reichenbach cites: "201. *Hugelia coerulea* Rchb. Conspect. regni veget. n. 3760. C. et Mittheil. a. d. Geb. d. Flora, n. 13. p. 50." The first half of this reference is readily interpreted; but in the well-known Conspectus, 144. 1828, the genus is undescribed, and a footnote refers to "*Hugelia cyanea* Jc. exot. 201. planta ex elegantissima." The second part of Reichenbach's reference proved difficult to elucidate, and the publication involved has not been located. The reference was finally explained upon consulting the Allgemeines Bücher Lexikon by Wilhelm Heinsius, Achter Band, Erste Abtheilung, von Otto August Schulz. 1836. On page 3 the entire reference is given as follows: "Abend-Zeitung. Mit ein. Wegweiser im Gebiete d. Kunste u. Wissenschaften. Hrsg. v. C. S. Th. Winkler (Th. Hell.) Nebst. e. artist. Notizenblatte v. C. A. Böttiger. 12–18. Jahrg. 1828–34. kl. Fol. Dresden, Arnold. "12. Jahrg. m. d. Beibl.: Einheimisches. 13. J. m. d. Beibl.: Mittheil. a. d. Gebiete d. Flora u. Pomona, red. v. H. G. L. Reichenbach."

It appears that vol. 13 of what seems to have been a botanical and horticultural supplement to the evening paper of Dresden probably was published in 1829 if volumes 12–18 appeared 1828–34. (The common impression that publication of names of plants in newspapers is ineffective seems to be without support in the International Rules of Botanical Nomenclature.) If this newspaper supplement were really published in 1829, the *Iconographia Exot. Bot.* t. 201 was probably not published earlier than that year. It is going to require considerable bibliographical delving to establish the exact date of publication of the several parts of the *Iconographia*. However, for purposes of the present paper, it is only necessary to show that *Hügelia*

Reichenbach was published prior to *Hugelia* Bentham (1833). Two copies of the *Iconographia* with Centuria III (of which only 50 plates were published) have been examined. The first, kindly lent by the Arnold Arboretum, has all three centuries bound together. The fascicle covers are missing and there is no title page for Cent. III. The title page of the entire work gives the dates as 1827–1830. The second, examined in the library of the Academy of Natural Sciences of Philadelphia, has the three centuries bound separately, each with its own title page, and even the original fascicle covers are preserved. However, this copy seems to be a German edition, for there is a brief German text in front of the Latin text for Cent. III and the synonymy, at least, for the Latin text, is abbreviated. The date of publication on the title page of Cent. III is given as 1827–1830. The fascicle cover of Cent. III bears no date. (Pritzel, *Thes. Lit. Bot.* ed. 2 does not mention a German edition.) In absence of proof to the contrary, the date given in a work must be accepted (Rules, Art. 45). Furthermore, there is contemporary evidence that plate 201 appeared prior to 1833, since Otto August Schulz in Wilhelm Heinsius, *Allgemeines Bücher Lexikon*, Achter Band, Zweite Abtheilung (covering books published 1828–1834) p. 147. 1838, stated, concerning the *Iconographia*, that Centuria III, Fascicles 1–5, were published in Leipzig in 1828–1830.

Having thus established that *Hugelia* Bentham is preoccupied, the next consideration is the propriety of conserving this genus. The case is not impressive as the genus is small, comprising, according to Craig, a recent monographer, only 8 species; is of no consequence horticulturally; and is often considered a mere subdivision of *Gilia*. Moreover, the preoccupying genus may have priority over *Didiscus* DC., in which event the name *Hugelia* were properly reserved for that umbelliferous genus.

Being deemed unworthy of conservation, the next question is, what is the valid name for *Hugelia* Bentham? According to Brand, *Welwitschia* Reichenbach, *Handbuch*, 194. 1837, was the next generic name published

for the group, but this is a *nomen rejiciendum* in favor of the famous gymnospermous *Welwitschia* Hooker f., Gard. Chron. 1862: 71. 1862. According to both Macbride and Craig, the next generic name is *Eriastrum* Wooton & Standley, Contr. U. S. Nat. Herb. 16: 160. 1913, which was substituted for *Hugel* Bentham 1833 on the ground that De Candolle had used *Hugel* in 1830. The fact that in DC. Prod. 4: 72. 1830, *Hugel* Reichenbach was cited in synonymy does not affect the validity of Wooton & Standley's generic name.

This study was undertaken at the instance of Prof. Edgar T. Wherry, who in connection with review of the Polemoniaceae of certain western states desired to use names for taxonomic groups in accordance with current rules of nomenclature.

Conclusion: *Hugel* Bentham, 1833 (Polemoniaceae), is preoccupied by *Hügel* Reichenbach, 1828-1830 (Umbelliferae). The proper name for the polemoniaceous genus, provided it be deemed worthy of generic rank, is *Eriastrum* Wooton & Standley, 1913.

ENTOMOLOGY.—*The genus Ferdinandea Rondani*.¹ FRANK M. HULL, University of Mississippi. (Communicated by ALAN STONE.)

The genus *Ferdinandea* comprises a small group of closely related species of flies of the subfamily Cheilosinae from the Holarctic region and as far south as Sumatra. None are known from South America, the Ethiopian region, or Australia. There are 14 described species, including those of this study. Eight dipterists have described the known species, and the European species have been frequently redescribed.

In this genus the opacity of the abdomen varies; almost all species, with the exception of *montana*, n. sp., are partly or wholly metallic; the hyalinity of the wing varies from unspotted in *isabella*, described in this paper, to characteristic tiny clouds upon the cross veins or larger subtriangular clouds, as in three species. These flies are well equipped with long bristles upon the thorax but vary in the number of scutellars, prescutellars, and especially notopleurals, as pointed out by Shannon. There is a certain amount of variation in the large thoracic bristles, and sometimes the number on the two respective sides of the same individual differs. In some individuals one member of a pair of bristles may be quite weak. Other characters concern the color of the antennae and arista, the color of the legs, and the diffuse and obscure spot sometimes found upon the face. There is a series of two to seven tiny microbristles found upon the radial sector of the wing.

The following key is based upon my study of nine species and upon the descriptions and figures of the others:

KEY TO THE DESCRIBED SPECIES OF *FERDINANDEA*

1. Segments of abdomen entirely bright brassy colored, without any trace of darker posterior borders. Thorax with four notopleural bristles on each side, in groups of two; rarely with fewer. 2
 Abdomen usually metallic, always with darker posterior borders (not necessarily opaque) upon some of segments; two or three notopleural bristles present, very rarely if ever with four. 4
2. Wing with cross veins definitely clouded, occasionally faint. 3
 Wing without trace of clouds anywhere; only stigmal base brownish and wing uniformly pale yellowish brown. Four notopleural bristles, four scutellars, and four prescutellars; radial sector with two microbristles (*India*). *isabella*, n.sp.
3. Four notopleural bristles; an obscure facial vitta present, which is sometimes only a spot upon tubercle; femur wholly yellowish or its basal half brown; four pairs of scutellars, one weak pair of prescutellars, five or six microbristles (western United States). *croesus* O. S.
 Two or three notopleurals, or irregular upon the two sides; femur wholly pale yellow; face yellow, tubercle faintly brown, cheek spot barely indicated; scutellum with five pairs of bristles (*Arizona*). *croesus* var. *midas*, n.var.
4. Abdomen yellowish brown, nonmetallic; at least second and third segments with black, wedgelike spots; cross veins of wing without brown clouds; antennae wholly black. Thorax with three pairs of

¹ Received January 1942.

- notopleurals, five scutellars, and one pair of prescutellars; seven microbristles present (India).....*montana*, n.sp.
 Abdomen partly or largely metallic, with dark posterior borders; wing almost always clouded, at least upon cross veins. 5
5. Wing with a brownish cloud or a triangle lying on and below stigma.....6
 - Wing with only cross veins clouded.....8
 6. Three pairs of notopleural bristles; arista reddish basally, darker apically; postmargins of second and third abdominal segments black; petiole beyond first posterior cell shorter than discal cross vein. Face yellow, pollinose, and pilose except upon brown tubercle; femora brown, yellowish apically, anterior tibia brownish (Oregon, New Mexico).....*aeneicolor* Shannon
 - Not such flies.....7
 7. A strong brown cloud below stigma of wing; antenna reddish, arista brown; scutellum brownish red, black pilose, with five pairs of scutellars and four prescutellars (Malaya).....*maculipennis* Curran
 - A weak brown cloud beneath stigma; third antennal joint brownish black; scutellum waxy yellow (Sumatra).....*sumatranus* de Meij.
 8. Abdomen short and broad, highly shining purplish bronze, hind border of segments 2 and 3 shining blackish; spots on cross veins of wings faint or absent (Formosa).....*formosanus* Shiraki
 - Abdomen relatively slender, the cross bands subopaque or at least dull; cross vein wing spots usually conspicuous...9
 9. At least base of arista pale in color, often thickened and microscopically pubescent.....10
 - Arista wholly blackish or brownish black, rather slender.....13
 10. Pile of front and vertex chiefly black; mesonotum with some black pile; dull abdominal bands premarginal, posterior margins brassy (Europe, from Sweden to Spain and Italy)....*ruficornis* Rondani
 - Pile of front and mesonotum pale yellow, at most light brown. Two pairs of notopleural bristles.....11
 11. Three pairs of black scutellar bristles, a single pair of weak prescutellars, and five microbristles on wing (Virginia, New Jersey, Pennsylvania, New York).....*buccata* Loew
 - Four or five pairs of scutellar bristles; face with a brownish-black V in middle; vertical stripes of pubescence rather wide.. 12
 12. Legs yellow; cross veins strongly clouded, seven microbristles on wing; arista black tipped, longer than antenna. Four and sometimes five scutellars and four weak prescutellars (New Jersey, Ohio, Penn-

- sylvania, Massachusetts, New Hampshire, Connecticut, Mississippi).....*dives* O. S.
- Hind legs with femur brownish black on its basal half, cross veins weakly clouded; arista wholly pale, thick basally, as long as antenna; four scutellars, four very weak prescutellars, and five or six microbristles (New York, New Hampshire, Massachusetts).....*nigripes* O. S.
13. Face with a blackish middle stripe or at least a dark central spot; thorax with four gray vittae (southern Europe).....*aurea* Rondani
 - Face wholly reddish yellow; if brown upon the tubercle there are only two gray stripes on thorax.....14
 14. Vertex entirely black; thorax greenish black with four gray vittae; four notopleurals, five pairs of scutellars, four strong prescutellars, six microbristles present; frontal and mesonotal pile black (Japan, Europe from Sweden and Finland to Italy).....*cuprea* Scop.
 - Vertex yellow; thorax purplish black with two gray stripes (Bulgaria, Hungary).....*sziladyi* Drensky

Ferdinandea croesus Osten Sacken var. **midas**, n. var.

An individual from southern Arizona shows several differences from northwestern specimens of *croesus* O. S. in my collection. In this fly there are only two notopleurals on one side and three upon the other. The scutellum has five pairs of bristles, and there are only four in northwestern specimens. The femur is wholly pale yellow. The face is yellow, with the tubercle showing faintly brown; the cheek spot is barely indicated.

Type: One male, southern Arizona; author's collection.

Ferdinandea montana, n. sp.

Male: Length 12 mm; wing 11 mm. *Head*: Eyes quite pilose, the vertex gray-pollinose with long, gray bristly hairs. Occiput gray-pollinose with pale silvery pile, rather short above, longer below. Front densely silvery-gray pollinose, a bare black lunule above the antennae on each side. Face wholly pale yellowish pubescent or pollinose, continuing upon the cheeks; everywhere pale yellow in ground color except for the median brown stripe and tubercle and the slender brown band dividing the face from the cheeks. Pile of cheeks and upper sides of face pale, shining yellow, upon the front

black. Antenna dark blackish brown, the third joint rather large, slightly subquadrate, the arista long and black. *Thorax*: Dully shining grayish black with four stripes of light greenish-gray pollen; the middle pair broad, running to the base of the scutellum and in some lights divided into an inner and outer pair, the inner pair narrower and present only on the anterior half of the thorax. Humeri light brownish yellow, yellow-pollinose; humerus and pleuron and a narrow band along the anterior margin of the mesonotum, again upon the postcallus, the ventral margin and lateral corners of the scutellum all yellow-pilose. Pile of dorsum chiefly long, slender, black, and erect, with some shorter, golden pile. There are three extremely long black bristles on the sides before the suture, four on the sides of the thorax behind the suture and anterior to the posterior calli; a single bristle diagonally in front of the posterior calli, a pair of bristles in front of the scutellum, three bristles upon each posterior callus and five pairs upon the scutellum. Scutellum large, pale yellow, subtranslucent, black bristly pilose. *Abdomen*: Grayish yellow, subtranslucent on the first segment and middle and base of second segment, elsewhere on the abdomen clear, light brownish yellow, with a median blackish vitta on each of the second, third, and fourth segments that does not reach the posterior margin. Pile of abdomen chiefly light golden-yellow, long and bushy on the sides of the segments, rather flat and appressed along the posterior margins of second, third, and fourth segments and somewhat less appressed in the middle of these segments. *Legs*: Almost wholly pale yellow, the base of both the middle and anterior femur, dorsally and anteriorly, narrowly brown in color. Posterior femur rather slender. There are a few blackish bristles but not spines upon the apical fourth of the outer, lateroventral portion of the femur. There is a pair of bristles near the middle on the lateral surface of both hind and midtibiae. *Wings*: Pale brown, stigmal cell brownish yellow, a series of seven tiny bristles on the basal part of the second and third longitudinal vein.

Holotype: One male, Kashmir, Gulmarg, 8,500 feet, summer, 1913. Lt. Col. F. W. Thomson, 1914-12; three paratypes, females, same data. Type in the British Museum; paratypes in author's collection.

Ferdinanda isabella, n. sp.

Female: Length 11 mm; wing 10 mm. *Head*: Vertex and occiput yellowish-brown pollinose. Front shining black, with more or less gray pollen, narrowly brown along the margin in front of the antennae. The whole face and cheeks are light, clear yellow, slightly more brownish red about the tubercle and the posterior part of the cheeks. Face broadly covered with pale yellowish pubescence. Antenna large, light brownish red, the third joint darker above, about as long as wide and broadly rounded; the arista blackish. Eyes moderately pilose. *Thorax*: Shining brassy-black, with four stripes of grayish pollen. Pleuron blackish, dusted with grayish pollen and with brassy pile. Humeri light yellow, yellowish pollinose and pilose. There is long yellow pile continued narrowly along the edge of the thorax, along the calli and the basal corners and ventral margin of the scutellum. Pile of thorax chiefly fine, bristly, and black, with some pale pile intermixed. Scutellum large, clear, translucent yellow, short, black, bristly pilose; three long black bristles on the upper part of the mesopleuron, two others between the mesopleuron and the suture, a pair just behind each humerus, two on the sides of the thorax just above the wing, three on each postcallus, one in front of each postcallus, four in front of the scutellum, and four pairs on the scutellum. *Abdomen*: Broadly oval, wider than the thorax, wholly brilliant, shining golden-brown, covered everywhere with golden pile, somewhat appressed and conspicuous along the posterior margins of the segments. *Legs*: Pale yellow. The anterior and middle femur are each narrowly brownish near the base. The hind femur is quite slender, blackish, bristly pilose on the lateral and dorsal surfaces; its apical third is without spines. The basal and dorsal third of hind tibia and its apex are black bristly pilose. *Wing*: Pale brown, stigmal cell brownish yellow, the area about the stigma a little thickened and brownish. Base of second and third longitudinal vein with two slender delicate black bristles.

Holotype: One female. Kashmir, Gulmarg, 8,500 feet, summer 1913, Lt. Col. F. W. Thomson, 1914-182. Type in the British Museum.

ZOOLOGY.—*Earthworms of the Northeastern United States: A key, with distribution records.*¹ THEODORE H. EATON, Jr., Cornell University. (Communicated by G. ARTHUR COOPER.)

In the States east of the Mississippi River and north of Virginia about 17 species of native earthworms are found, with about 13 more believed to have been introduced from Europe. They belong to four families; the great majority, including all the introduced species, are Lumbricidae. Information about these earthworms is too scattered to be of much help to a general biologist, agronomist, or forester who wishes to identify the species he finds or uses in the laboratory. Most of the papers on earthworms are taxonomic and concerned with a small area or with a limited group. It seemed, therefore, that a key based so far as possible on external features, and accompanied by descriptive and distributional notes, might be useful.

Distribution records already published are cited by State or country, followed by an abbreviation in parentheses of the author's name and the year of publication, given in full in the bibliography. Names thus abbreviated are the following: Gates (G), Heimburger (H), Olson (O), Smith (S).

Distribution records given as new are based upon specimens that I have collected or have seen in collections, and for the determination of which I therefore am responsible. The sources of these are likewise abbreviated in parentheses. (E) refers to my own collection; (AM) the collection of the American Museum of Natural History, specimens being lent through the kindness of Dr. W. G. Van Name, associate curator of invertebrates; (FC) the collection made by Dr. C. E. Johnson, of the New York State College of Forestry, Syracuse, courtesy of Professors Ralph T. King and W. A. Dence; (NM) the United States National Museum collection, courtesy of Dr. Waldo L. Schmitt; (NY) the New York State Museum collection, Albany, kindness of Dayton Stoner, State zoologist. To the institutions and persons named I am much indebted for the opportunity to study these specimens.

¹ Received April 7, 1942.

INTRODUCED VERSUS NATIVE EARTHWORMS

It is the opinion of the specialists on earthworms (e.g., Michaelsen, 1903; Smith, 1928; Gates, 1929; Stephenson, 1930) that while an individual worm can not travel far by its own activity, nevertheless some species are carried very frequently for long distances by human agency, as among the roots of plants shipped for horticultural purposes, and thus are introduced into foreign countries. In Santiago, Chile, for instance, Michaelsen found thousands of worms of familiar European species to one native Chilean, but when he collected in the interior, in small towns less subject to European contacts, he found many Chilean species as well. Likewise in western Australia European species of Lumbricidae are practically the only earthworms found near towns. In India, Ceylon, New Zealand, South Africa, and elsewhere in European settlements, the same is true. Apparently the introduction of these adaptable and hardy kinds may cause the decline or disappearance of local species.

In the United States, species that are well known in Europe have appeared at widely separated points, such as San Francisco, New York, and Illinois, and at least in a few cases (Smith, 1928) they are known to have spread since their first discovery, increased in numbers, and to a large extent replaced American species. The predominant family in Europe and North America is Lumbricidae, which accordingly is suited to climatic changes. One abundant species, *Allolobophora caliginosa*, survives equally well winter temperatures of 40°–50° below zero in northern New York, and summer heat of 120° in the shade in the Punjab Province of India. In Europe and North America the chance of being transported by land or by sea is relatively great because of the amount of trade and travel. It would be surprising, therefore, if Lumbricidae were not introduced into new habitats much

more frequently than some of the tropical families of earthworms.

American species have appeared in Europe at least twice: *Sparganophilus eiseni* in the banks of the Thames; *Eisenia carolinensis* at Hamburg.

It must be left to later studies to determine what effect introduced earthworms have upon soil and soil productivity. That they are introduced and do live successfully where Europeans settle has not been questioned seriously.

FEATURES OF EARTHWORMS

Fig. 1 shows the more obvious external characters of a sexually mature *Lumbricus terrestris*. A good hand lens, or better still a low-power dissecting microscope, is necessary to see many of these. Earthworms are hermaphroditic, but fertilization of the eggs

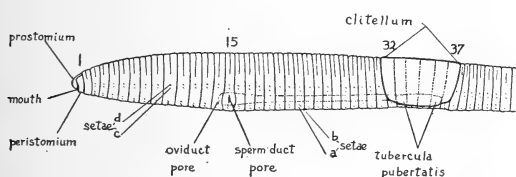

FIG. 1.—External characters of sexually mature earthworm (*Lumbricus terrestris*).

is accomplished by an exchange of sperm between one individual and another; afterward each of the pair releases its own eggs into a small capsule, which is secreted by its girdle or clitellum and slips off over the forward end. Most of the characters used in identifying species appear only in mature worms. Therefore it is necessary to collect individuals that have a clitellum, although immature ones from the same location can often be identified by their general resemblance to the mature.

CHARACTERS INDEPENDENT OF SEXUAL MATURITY

Condition of the prostomium.—This is the first apparent segment of the body. It is not counted as a segment because it lies above and in front of the mouth and does not contain the usual segmental organs. On the upper (dorsal) surface the prostomium

may send a tongue backward on the surface of the first true segment (peristomium). If this tongue goes all the way to the following groove, completely dividing the top of the peristomium, then the worm is practically certain to be a species of *Lumbricus*. If the peristomium is not completely divided on top, it belongs to another genus.

Arrangement of setae.—The minute bristles or setae of an earthworm number eight to the segment in the kinds found in the Northeastern States, although some southern and tropical worms have a great many more. These eight are usually in four pairs, as shown in the figure, but in some species the pairing is so distant that they are described as separate, or widely paired. The four setae on each side occupy about the same positions in successive segments and therefore form four rows running lengthwise. These rows, beginning with the most ventral, are called *a*, *b*, *c*, and *d*.

Color.—Most earthworms are pale pinkish, with little pigment or none. Others are dark reddish brown or purplish (*Lumbricus*, *Sparganophilus*). In these pigmented kinds the color is heaviest at the forward end and on the upper side. Often a dark line runs along the dorsal side. This is in part the dorsal blood vessel, which lies above the digestive canal, close to the body wall. Worms sometimes show iridescence, or physical color (bluish or purple) independent of pigment. A conspicuously green worm is *Allolobophora chlorotica*.

CHARACTERS DEPENDENT ON SEXUAL MATURITY

Clitellum.—In a zone covering several segments the cuticle becomes raised and smooth, so that intersegmental furrows wholly or partly disappear. The number of segments covered may be determined by looking on the ventral surface, which as a rule is not affected, or the tips of the setae may be visible through the swollen girdle. It is almost always necessary to determine, by counting, which segments bear the clitellum. Some species are extremely constant in this feature (*Octolasion lacteum*), others vary as much as three or four segments one way or the other, so that addi-

tional characters are required. In the key the location of the clitellum is given by the numbers of the first and last segments it covers; e.g., 25, 26–29, 30 means that it begins on 25 or 26 and goes to 29 or 30.

Tubercula pubertatis.—On each side of the clitellum near its lower edge may appear a series of two or three small swellings on successive or alternate segments, or a ridge reaching three or four or five segments. Their location is within the limits of the clitellum, but they are sometimes absent. If on alternate segments the numbers are separated by colons; e.g., 31:33:35; if in a ridge or on adjoining segments, a dash is used; e.g., 28–30.

Openings of sperm ducts.—In the majority of North American earthworms the sperm ducts open low on each side of segment 15, thus in front of the clitellum, but there are several exceptions to this. Also species sometimes differ in the presence or absence of a swelling or papilla at the opening of the duct.

Openings of oviducts.—As a rule these are very small pores, one on each side of segment 14, lower than the sperm duct opening. They are less frequently used in classification.

Spermathecae (or seminal receptacles) are internal pouches which receive the sperm from another individual. Their pores open on the upper part of each side in the grooves between certain segments, which are designated as grooves 8/9, 9/10, etc., meaning those between 8 and 9, between 9 and 10, and so on.

Sperm sacs (or seminal vesicles) are the internal pouches which hold the sperm produced by the same individual, prior to its discharge. They can only be seen by dissection. When present they are usually in some or all of segments 9–12.

USE OF THE KEY

In using the following key to identify an unfamiliar species, one should read first the statement marked *A*, and decide whether it fits the worm; if not, go to *AA*. If this then agrees, make a similar choice between *B* and *BB*, then *C* and *CC*, and so on, until the name of the species is reached. In a few cases there are three alternatives presented, as in the genus *Allolobophora*: *I*, *II*, and *III*. In such a case one is to be chosen.

In "running down" a worm that turns out to be *Lumbricus terrestris*, for example, we would meet the following characters:

- AA. Not threadlike; segments less than 250.
- BB. Clitellum begins behind 15; sperm duct pores in front of clitellum.
- CC. Prostomium completely divides peristomium . . .
- DD. Clitellum begins behind 28; sperm duct pores with distinct papillae.
- E. Clitellum 32–37; tub. pub. 33–36 . . .

One does not, therefore, go through the whole key, but simply picks out the appropriate choices. If a contradiction should come up, so that the specimen at some point in the key does not fit either of the choices given, then one of the following must be the case:

1. It is a species not hitherto known from this region.
2. It is an abnormal variation, such as may spoil a key character perhaps once in a hundred times.
3. A mistake has been made at a previous point in the key.
4. The key is at fault, which is entirely possible.

For localities outside the Northeastern States this key will not be satisfactory because other species may be found. Characters given in the key should not be taken as adequate for genera or families.

KEY TO EARTHWORMS OF NORTHEASTERN STATES, WITH DISTRIBUTION RECORDS

- A. Threadlike; segments 400–500; length 12–21 cm. Setae in 2 ventral and 2 dorsal rows (each side), the dorsal sometimes absent. Clitellum ring-shaped.
Haplotaxis emissarius (Forbes, 1890). HAPLOTAXIDAE
 Fairmont, Ind., Havana, Ill., Hampton, Va. (NM); Ohio (O, '28). These slender worms, pale red and iridescent when alive, are aquatic, living in underground water, marshes, and wells. Native.
- AA. Not threadlike; segments less than 250.
- B. Clitellum begins at or in front of segment 15. Sperm duct pores behind clitellum.
- C. Clitellum on 13–18; setae widely paired.*Diplocardia* Garman, 1888. MEGASCOLECIDAE

- d. Clitellum a complete girdle. Length 5-10 cm. *D. singularis* (Ude, 1893)
 Indiana (H, '15); Illinois (S, '28); Ohio (O, '28). This species is reported from stream banks and under logs; scattered, but locally common. Native.
- DD. Clitellum not a complete girdle.
- E. Sperm duct pores on 19.
 - F. Spermathecal pores in grooves 6/7-8/9. Last hearts in 12. Length 20-30 cm. *D. communis* Garman, 1888
 Illinois (S, '28); southwestern Ohio (O, '28). *Diplocardia communis* is described as common in upland soil about Urbana, Ill., but less numerous since the introduction of the European *Lumbricus terrestris* about 1896. Native.
 - FF. Spermathecal pores in grooves 7/8, 8/9. Last hearts in 13. Length 20-25 cm. *D. riparia* Smith, 1895
 Indiana (H, '15); Illinois (S, '28); central Ohio (O, '28). This worm is reported in wooded pastures, rich bottomland, along streams or beside ponds. Native.
 - EE. Sperm duct pores on 20; length 7-15 cm. *D. verrucosa* Ude, 1895
 Illinois (S, '28); Nebraska (G, '29). Native.
- cc. Clitellum on 15-25; setae closely paired; sperm duct pores on 19.
 *Sparganophilus eiseni* (Smith, 1895). GLOSSOSCOLECIDAE
 Indiana (H, '15); Illinois (S, '28); Ohio (O, '28); New York (O, '40); Massachusetts, Florida, Michigan, Wisconsin, Louisiana, Mexico, Guatemala (G, '35). New records: Squaw Bay, Lake Erie (NM); Ashokan, New York (AM); north shore Oneida Lake, New York, marshy stream edge (FC); West branch Fish Creek, below Kasoag Lake, Oswego County, New York, under stone at edge of water (FC); edge of Susquehanna River, 4 miles southwest of Owego, New York, in wet mud (E). Ithaca, New York, wet mud (E). This is a slender species, 15-20 cm long, with 165-220 segments, pink with a bluish or purplish sheen when alive. It lives in very wet mud, beside or in streams or lakes. There is a record of its occurrence in the Thames River, England, probably by introduction from the United States. Native.
- BB. Clitellum begins behind 15; sperm duct pores in front of clitellum. LUMBRICIDAE
- c. Prostomium does not completely divide peristomium.
- D. Clitellum begins in front of 30.
 - E. Clitellum does not reach as far back as 28. *Eiseniella tetraedra* (Savigny, 1826)
 Massachusetts, Pennsylvania, Ohio, Indiana, Illinois, Michigan, Colorado, California, Washington (G, '35); New York (O, '40). New records: Cascadilla gorge, Ithaca, New York (13, 15. E); banks of Susquehanna River below Owego, New York (13, 15. E); highly organic mud beside pond, Waverley, New York (13. E); edge of creek, McLean bogs, Tompkins County, New York (13. FC); Cedarvale, New York, under stones, edge of creek (15. FC); Pratts Falls, Onondaga County, New York, along creek (11, 13. FC); Cascades near Collingwood, Onondaga County, New York (11. FC); Bronx County, New York City (11, 13. AM); Edgewater, New Jersey (13. AM); Meech's Island, Shelburne, Vermont, in lake, under stones (NY); Rock Creek Park, Washington, District of Columbia, near creek, in wet mud (13. E). European. The numbers in parentheses refer to the segment bearing the sperm duct pores in various specimens. This is a variable feature in *Eiseniella tetraedra*; several "varieties" have been named according to this and the position of the clitellum, which likewise varies:
 Clit: 22 or 23-26 or 27 Spd. pores 13. *typica*
 Clit: 23 or 24-27, 28, 29 Spd. pores 15. *hercynia*
 Clit: 20 or 21-24 or 25 Spd. pores 11. *hammoniensis*
 Clit: 20 or 21-24 or 25 Spd. pores 13. *neapolitana*
 Clit: 20 or 21-24 or 25 Spd. pores 15. *minni*

Since two or more of these varieties often occur together in one locality, they are probably not subspecies but standardized individual variations, like the black and cinnamon bears. Probably the difference is due to assortment of genetic allelomorphs. The species is small, usually 3-6 cm, and the posterior part has a four-cornered rather than cylindrical form in most specimens. It has a wide range in the Old World. The preferred habitat is wet or polluted banks of streams and ponds.
- EE. Clitellum reaches at least as far back as 28.
 - F. Spermathecal pores dorsal to seta line *d*. *Eisenia* Malm, 1877
 - g. Setae widely paired, ab:bc:cd = 5:9:5. *E. veneta hortensis* Michaelsen, 1890
 Europe, Africa, South America, San Francisco, California (S, '17), Cleveland, Ohio (G, '42). A stream-bank species, Illinois (S, '28). European. The clitellum is on 26, 27-32, 33; tubercula pubertatis 30-31; spermathecal pores in grooves 9/10, 10/11; segments 80-120; length 4-10 cm.
 - GG. Setae closely paired.
 - H. Spermathecal pores in furrows 8/9, 9/10, 10/11; clitellum 24-30.
 *E. lönnbergi* (Michaelsen, 1894)

Georgia, North Carolina, Virginia, Maryland, Massachusetts (G, '35); Connecticut (G, '42). Native. The record from Massachusetts refers to a white pine-hemlock-hardwood forest.

HH. Spermathecal pores in furrows 9/10, 10/11.

- i. Each segment ringed with a brown line; clitellum 24, 25, 26-32; tub. pub. 28-30, 31. *E. foetida* (Savigny, 1826)

Europe; introduced into the United States where it is common and widespread. New records: Compost heaps, Onondaga Hill, New York (FC); Syracuse, New York (FC); Brooklyn, New York, under humus and rotten vegetables (AM); in rubbish heap and humus, Bergen Beach, New York (AM); Edgewater, New Jersey (AM); Ashokan, New York (AM); Kenwood, New York, under log in earth (NY); Howes Cave, New York (NY); pasture, streambank, Ithaca, New York (E). The published records of habitats include manure heaps, sewer outlets, polluted stream-banks, decaying straw, dead logs, and similar places where moisture and organic content are both high. The length is 6-13 cm, and the banded appearance is the most obvious character of this worm.

II. Segments not ringed with brown.

- J. Tub. pub. 29-31; clitellum 24, 25, 26-31, 32, 33. . . *E. rosea* (Savigny, 1826)

Europe, Maine, New York, Georgia, Indiana, Illinois, Louisiana, Arizona, California (S, '17); Ohio (O, '28). European. New records: Pratts Falls, Onondaga County, New York, under stones by creek (FC); Syracuse, New York, in "heap of clay," on sidewalks, and in alfalfa field (FC). The length is 3-8 cm, the color pale pinkish. A general characteristic of preserved specimens is that the clitellum is swollen to about twice the diameter of the adjacent parts of the body.

- JJ. Tub. pub. 27-29; clitellum 24-31. *E. carolinensis* Michaelsen, 1903

This species was described from a specimen introduced with plants into Hamburg from Fayetteville, North Carolina (S, '17), a second example of transfer from America to Europe. Length 3.5 cm.

FF. Spermathecal pores, if present, in or ventral to seta line *d*.

- g. More than 2 pairs of sperm sacs; spermathecae present.

- h. Setae closely paired; sperm sacs in 9-12. *Allolobophora* Eisen, 1874

- i. Tub. pub. 31:33 or 31-33; clitellum 24, 25, 26, 27, 28-32, 33, 34, 35. *A. caliginosa* (Savigny, 1826)

Europe; the most abundant, widespread, and ecologically adaptable species in the United States. New records: (New York) Along brook in pasture below Cascades, south of Collingwood, Onondaga County (FC); alfalfa lot, Syracuse (FC); Paek Forest, Warrensburg (FC); Whetstone Gulf, stream side (FC); Jamesville, Onondaga County (FC); Junius Ponds area, Ontario County (FC); Ithaca: Fall and Cascadilla gorges, lawns, McGowan woodlot (E); dry ditch beside field, and bank of Susquehanna River, below Owego (E); Rose, Wayne County, in coarse mull and in woody peat (virgin and cultivated) (E); Potter, Yates County, in woody peat (E); Palmyra, Wayne County, in coarse mull under hardwood forest (E); McLean, Tompkins County, in fine mull in forest (E); Newcomb, Essex County, in grassy fields (E); New York City (AM). (Pennsylvania) Polluted stream bank, Sayre (E). (New Jersey) Alpine, Palisades near Edgewater, Edgewater (AM). This species shows a variability similar to that of *Eiseniella tetraedra*, in that two "varieties" have been named. But the distinction here concerns the tubercula pubertatis: in var. *typica* they are separate swellings on 31:33; in var. *trapezoides* they form ridges extending from 31-33. In many specimens it is difficult to decide which condition is present, and the two forms very generally occur together. In New York State *trapezoides* seems to be slightly more frequent. In Ohio (O, '28) and Illinois (S, '28) it is described as much more abundant than *typica*. The clitellum also varies in position, being most frequently about 27-34. Again I do not believe that these differences have subspecific value, since neither in Europe nor in America are they geographically significant, but suggest rather that one or more pairs of genetic allelomorphs may be responsible, the proportions varying among different populations of the species. The use of trinomials would then be misleading. This worm is pale pinkish; length 6-17 cm.

- II. Tub. pub. 32-34; clitellum 27, 28-35. *A. longa* Ude, 1885

Europe, Maine, Grand Manan, Toronto, Indiana (S, '17); Connecticut (G, '42). New records: Region of New York City (AM); Brooklyn, New York, under stones, humus, rotten vegetables (AM); pasture near McLean bogs, Tompkins County, New York (E). In size and general appearance this species is much like *A. caliginosa*. Only determination of the segments bearing the tubercula pubertatis will separate them externally.

- III. Tub. pub. 31:33:35; clitellum 29-37; color greenish when alive or freshly preserved. *A. chlorotica* (Savigny, 1826)

Europe, Greenland, Vancouver, Mexico, Guatemala, North Carolina, District of Columbia, Indiana, Colorado, California (S, '17); Ohio (O, '28); Illinois, stream banks (S, '28). New records: (New York) Syracuse (FC); Ithaca, Cascadilla gorge (E); bank of Susquehanna River below Owego, in mud and in dead wood (E); greenhouse, New York City (AM); Rensselaer (NY). (Pennsylvania) Polluted creek bank, Sayre (E). (Maryland) Bethesda (NM). This worm prefers wet and usually highly organic or polluted soil. Fresh specimens in formalin are grass-green, with a contrasting pink clitellum, which is as near as any earthworm comes to beauty. The length is 5-7 cm.
- HH. Setae separate or widely paired; sperm sacs in 9, 11, 12.

 - *Dendrobaena* Eisen, 1874

I. Clitellum 25, 26-31, 32; tub. pub. 28-30. *D. subrubicunda* (Eisen, 1874)

Europe, Newfoundland, Niagara, Illinois, Colorado, California (S, '17); Indiana (H, '15); Ohio (O, '28); Massachusetts (G, '35). New records: Ashokan, New York (AM); Alpine, New Jersey (AM). This species is described as common in a polluted stream-bank in Illinois (S, '28). Length, 4-7.5 cm.
 - II. Clitellum 27, 28, 29-33, 34; tub. pub. 31-33. *D. octaedra* (Savigny, 1826)

Europe, northern Asia, Iceland, Greenland, Newfoundland, Mexico, Colorado (S, '17); Illinois (S, '28). New record: Lake Placid, New York (FC). Length, 2.5-4 cm.
- GG. Two pairs of sperm sacs, in 11, 12. Spermathecae absent (or imperfectly developed in *B. tenuis*). *Bimastos* Moore, 1893
- H. Setae closely paired.

 - I. Clitellum covers less than 10 segments.

 - J. Clitellum begins on or in front of 23.

 - K. Clitellum on 23-28. *B. palustris* Moore, 1895

Pennsylvania, New Jersey, North Carolina (G, '29). Native. This species is found in wet soil beside ponds or streams. There is a prominent swelling enclosing a cavity at the opening of each sperm duct. Tubercula pubertatis are lacking. Length, to 7.5 cm.
 - KK. Clitellum 20, 22-29, 30; *ab* greater than *cd*. *B. gieseleri* (Ude, 1895)

Georgia, Florida, Ohio, Illinois, Kansas, Texas (G, '29); Indiana (O, '28). Native. Specimens from Florida and Georgia have clitellum 20-30, and are called var. *typica*. Some from Florida and those from the other States named have it located on 22-29, 30: var. *hempeli* Smith, 1915. The habitat is rotten wood, decaying logs, and leaf accumulations. Length, 5-8 cm.
 - KKK. Clitellum 22-29; *ab = cd*. *B. tumidus* Eisen, 1874a

Mount Lebanon, New York. Native. The only record since Eisen (1874a) is a report by Olson (1940) of specimens found "near Oneida Lake."
 - JJ. Clitellum begins on or behind 24.

 - K. Clitellum 24-30; tub. pub. (indistinct) 25, 26-29, 30.

. *B. parvus* (Eisen, 1874a)

New York, Michigan, Kansas, California, Louisiana, Mexico, Guatemala, also China, Japan, Africa (S, '17); Ohio (O, '28); Massachusetts (G, '35). New record: Ashokan, New York (AM), not Pratts Falls (O, '40). Native. Length, 2.5-4 cm.
 - KK. Clitellum 24, 25-31; tub. pub. (indistinct) 24, 25-30.

. *B. beddardi* (Michaelson, 1894)

Michigan, Illinois, Montana, Florida, California, Washington, Hawaii (S, '17); Ohio, near end of Lake Erie (O, '28). Native. This is found in "wet situations and in decaying logs, stumps, or moss" (S, '17).
 - KKK. Clitellum 25-32 (slightly on 33). *B. heimbürgeri* (Smith, 1928)

This species is described from a specimen found in a stream bank below White Heath, Illinois. The tubercula pubertatis are apparently absent, there is very little pigmentation, and the length of the specimen is 7.7 cm. Smith notes a close resemblance to *B. palustris*.

II. Clitellum covers 10 or 11 segments.

J. Clitellum 23-32 or 24-33. *B. longicinctus* (Smith and Gittins, 1915)

Urbana, Illinois (S, '17); southeastern Ohio (O, '28). Smith describes this worm as common in lawns and woods, while Olson reports it from a wet, wooded ravine, under leaves. Length, 6-9 cm. No tubercula pubertatis. Native.

JJ. Clitellum 27-37. *B. zeteki* (Smith and Gittins, 1915)

Illinois, Indiana, Michigan (S, '17); Susquehanna River, New York (G, '29); southwestern Ohio (O, '28). Native. This species occurs in soil under logs or decaying leaves, and in dead logs under the bark. Length, 10-14 cm.

HH. Setae widely paired. *B. tenuis* (Eisen, 1874a)

Europe, Asia, Alaska, Bering Island, Canada, Vancouver Island, Mexico, South America, Maine, New York, Ohio, Illinois, Indiana, Michigan, Colorado, California, Washington (S, '17); Massachusetts (G, '35); Connecticut (G, '42). It is difficult to judge from these records whether this species was originally North American, European, or circumpolar. The first specimens were those described by Eisen from New York State. Smith (1917) considers the European *B. constrictus* (Rosa, 1884) to be the same species. These worms favor rotting logs, decaying leaves, hay, or manure piles.

DD. Clitellum on 30-35; setae widely paired. *Octolasion lacteum* (Örley, 1881)

Europe, Mexico, Colorado, California, Indiana, Illinois, Ohio (S, '17); Connecticut (G, '42). New records: (New York) Ithaca: Fall Creek and Cascadilla gorges (E); McLean bogs, Tompkins County, in fine black mull and in pasture (E, FC); Ringwood preserve, Freeville, Tompkins County, in leaf mat (E); Arnot Forest, Van Etten, stream side (E); Potter, Yates County; in woody peat (E); south side of Susquehanna River, below Owego, in wet decaying wood (E); Ashokan (AM); Bergen Beach (AM); Syracuse (FC); White Lake, Onondaga County (FC); Pratts Falls, Onondaga County, along creek (FC); under stones along creek, Cedarvale (FC); Cascades, Butternut Creek, Onondaga County, along brook in open pasture (FC); South Pond area, North Constantia, Oswego County (FC); Salmon River, in woods south of Parish, Oswego County. (FC). As these records show, *O. lacteum* favors, but is not limited to, moist and highly organic soil. Smith (1928) describes it as an upland and streambank species in Illinois. The length is highly variable, 5-16 cm, but the position of the clitellum combined with wide separation of the seta rows makes this species easy to recognize.

CC. Prostomium completely divides peristomium by means of an extension backward on the dorsal side, to the second furrow. *Lumbricus* Linnaeus, 1758

D. Clitellum begins on or in front of 28; sperm duct pores without distinct papillae.

E. Clitellum on 26, 27-32; color red. *L. rubellus* Hoffmeister, 1843

Europe, Siberia, Newfoundland, Washington, Oregon, California, Michigan (S, '17); Ohio, near Toledo (O, '28); Massachusetts (G, '35). New records: Ithaca, New York, Fall Creek gorge (E); banks of Susquehanna River, between Owego and Waverley, New York, in mud and dead wood (E); McLean bogs, Tompkins County, New York, in wet mull and in muck (E); Rose, Wayne County, New York, in woody peat, in forest (E); polluted creek bank, Sayre, Pennsylvania (E); Rock Creek Park, Washington, District of Columbia, beside stream (E). This worm seems to require a great deal of moisture and organic matter. It and the other three species of *Lumbricus* listed here are European. Length, 7-15 cm.

EE. Clitellum on 28-33; dark red. *L. castaneus* (Savigny, 1826)

Europe, Canada, New York (S, '17); Massachusetts (G, '35); Syracuse, New York (FC). A smaller species. Length, 6-10 cm.

DD. Clitellum begins behind 28; sperm duct pores with distinct papillae.

E. Clitellum 32-37; tub. pub. 33-36. *L. terrestris* Linnaeus, 1758

Europe, Mexico, Newfoundland, Maine, Massachusetts, New York, Connecticut, Maryland, District of Columbia, Ohio, Michigan, Illinois, Minnesota, Colorado, California (S, '17). Smith (1928) says that in Illinois this familiar species has become abundant after being first reported about 1896 and has tended to replace the native American *Diplocardia communis*. In Ohio Olson (1928) says it has become widely distributed "in the last ten years." It is present abundantly in New York State, from numerous localities, but not the Adirondack Forest so far as known. The habitats include coarse mull soil in forests or fields, mud beside streams, lawns, woody peat, and the inside of a rotten log. Length, 10-30 cm.; color, reddish brown, especially forward.

EE. Clitellum 34-39; tub. pub. 35-38. *L. festivus* (Savigny, 1826)

This is a European species reported from Canada (S, '17), but not yet from the United States.

REFERENCES

- EISEN, G. *Om Skandnaviens Lumbricider*. Öfv. Vet. Akad. Förh. **30**: 43-56. 1874.
- . *Bidrag till Kännedom om New Englands och Canadas Lumbricider*. Öfv. Vet. Akad. Förh. **31**: 41-49. 1874a.
- FORBES, S. A. *On an American earthworm of the family Phreoryctidae*. Bull. Illinois State Lab. Nat. Hist. **3**: 107-116. 1890.
- GARMAN, H. *On the anatomy and histology of a new earthworm (Diplocardia communis gen. et sp. nov.)*. Bull. Illinois State Lab. Nat. Hist. **3**: 47. 1888.
- GATES, G. E. *The earthworm fauna of the United States*. Science **70**(1811): 266-267. 1929.
- . *The earthworms of New England*. Proc. New England Zool. Club **15**: 41-44. 1935.
- . *Check list and bibliography of North American earthworms*. Amer. Midl. Nat. **27**(1): 86-108. 1942.
- HEIMBURGER, H. V. *Notes on Indiana earthworms*. Proc. Indiana Acad. Sci. **1914**: 281-285. 1915.
- HOFFMEISTER, W. *Beitrag zur Kenntnis deutscher Landanneliden*. Arch. Naturg. **9**: 183-198. 1843.
- LINNAEUS, CAROLUS. *Systema naturae*, ed. 10. 1758.
- MALM, A. W. Öfv. Hortik. Förh. Göteborg **1**: 45. 1877.
- MICHAELSEN, W. *Oligochaeten des naturhistorischen Museums in Hamburg*. Mitt. Mus. Hamburg **7**. 1890.
- . *Die Regenwurm-Fauna von Florida und Georgia*. Zool. Jahrb., Abt. Syst. **8**: 177-194. 1894.
- . *Die Lumbriciden-Fauna Nordamerikas*. Abh. nat. Ver. Hamburg **16**: 1-22. 1900.
- . *Die geographische Verbreitung der Oligochaeten*, 186 pp. Berlin. 1903.
- MOORÉ, H. F. *Preliminary account of a new genus of Oligochaeta*. Zool. Anz. **16**: 333-334. 1893.
- . *On the structure of Bimastos palustris, a new oligochaete*. Journ. Morph. **10**: 473-496. 1895.
- OLSON, H. W. *The earthworms of Ohio*. Ohio Biol. Surv. Bull. **17**: 46-90. 1928.
- . *Earthworms of New York State*. Amer. Mus. Nov., No. **1090**: 1-9. 1940.
- ÖRLEY, L. *A Magyarországi Oligochaeták Faunája. I. Terricolae*. Math. Term. Közlem. Magyar Akad. **16**: 563-611. 1881.
- . *A palearktibus övben élő terrikoláknak revisiója és elterjedése*. Ertek. term. Kör. Magyar Akad. **15**: 1-34. 1885.
- ROSA, D. *Revisione dei Lumbricidi*. Mem. Accad. Sci. Torino (2) **43**: 397-476. 1893.
- SAVIGNY, J. C. *Analyse d'un mémoire sur les lombrics par Cuvier*. Mem. Acad. Sci. Inst. France **5**: 176-184. 1826.
- SMITH, FRANK. *Notes on species of North American Oligochaeta*. Bull. Illinois State Lab. Nat. Hist. **4**: 285-297. 1895.
- . *Two new varieties of earthworms, with a key to described species in Illinois*. Bull. Illinois Lab. Nat. Hist. **10**: 551-559. 1915.
- . *North American earthworms of the family Lumbricidae in the collections of the U. S. National Museum*. Proc. U. S. Nat. Mus. **52**: 157-182. 1917.
- . *An account of changes in the earthworm fauna of Illinois, and a description of one new species*. Bull. Div. Nat. Hist. Surv. Illinois **17**(10): 347-362. 1928.
- and E. M. GITTINS. *Two new species of Lumbricidae from Illinois*. Bull. Illinois State Lab. Nat. Hist. **10**: 545-550. 1915.
- STEPHENSON, J. *The Oligochaeta*. Oxford. 1930.
- UDE, H. *Über die Rückenporen der terricolen Oligochaeten, nebst Beiträgen zur Histologie des Liebesschlauches und zur Systematik der Lumbriciden*. Zeitschr. wiss. Zool. **43**: 87-143. 1885.
- . *Beiträge zur Kenntnis ausländischer Regenwürmer*. Zeitschr. wiss. Zool. **57**: 57-75. 1893.
- . *Beiträge zur Kenntnis der Enchytraeiden und Lumbriciden*. Zeitschr. wiss. Zool. **61**: 111-141. 1895.

ZOOLOGY.—*Some echinoderms from northwestern Greenland.*¹ AUSTIN H. CLARK, U. S. National Museum, and GORDON J. LOCKLEY, British Museum (Natural History).

In July and early August, 1940, Capt. Robert A. Bartlett and his associates carried out extensive dredging operations in the waters off northwestern Greenland in depths of 12 to 110 fathoms. The echinoderms brought back numbered 282 specimens representing 13 species. Although generally speaking the fauna of the shallow waters of the west Greenland seas, especially the southern portion, is well known as a result of the work of various Danish investigators and expeditions, there are still many details to be filled in and consequently all records are of value. In the present collection the most interesting specimen is the single example of *Leptasterias polaris* form *subacervata* Fisher, which, though properly referable to that form, shows a rather close approach to the form *acervata* of the region of Bering Strait. The junior author left Washington before the completion of this paper. All the identifications were rechecked by the senior author, who is therefore to be held responsible for any errors that may be found.

LOCALITIES

The localities at which echinoderms were collected were the following (unless otherwise indicated the dredging was done by Captain Robert A. Bartlett):

III.—West Turnavik, Labrador (lat. 55° 15' N., long. 59° 20' W.); Sam Bartlett, July 6. XV and XVI.—Melville Bay, near Thom Island; 15–80 fathoms; bottom with much kelp; Sam Bartlett and Albert Barnes, July 19. XXIV, XXV, and XXVI.—Between the north shore of Parker Snow Bay and Conical Rock; 25–45 fathoms; mostly pebbles and shells; July 22. XXX, XXXI, XXXIV, XXXVII, and XXXVIII.—About 1 mile northwest (true) of Conical Rock; 25–60 fathoms; July 22. XL, XLII, XLIII.—West side of Wolstenholme Island; about 12 fathoms; July 23. XLIV.—Off

Wolstenholme Island; 13–17 fathoms; July 23. LI, LII, LV, LVII, and LIX.—Off north shore of Wolstenholme Island; 13–25 fathoms; July 23. LXXII.—Near the south end of Humboldt Glacier; 110 fathoms; D. C. Nutt, August 3.

LIST OF SPECIES

ASTEROIDEA: *Crossaster papposus* var. *squamatus* (Döderlein), XXXI (5, all with ten rays). *Stephanasterias albula* (Stimpson), XVI (6; one is almost perfectly regular with six rays 13 mm long; one has three rays 20 mm long and two buds; the others have six rays of various lengths). XXV (1, with three equal rays 10 mm long and two minute and inconspicuous buds). XXX (2). XXXI (7, of which one regenerating individual has seven rays, the others six; in some of these the skeleton is unusually slender with the interstices large, giving the animals a superficial resemblance to *Leptasterias groenlandica*). LXIII (1). LXII (5). LIX (4). Other than the exceptions mentioned, all have six rays. *Leptasterias polaris* var. *subacervata* Fisher, LII (1; R = 60 mm. In this individual the characters are much more strongly marked than in one at hand from Disco, which does not differ very noticeably from *L. p. polaris*. Both agree in having the groups of enlarged spines confined to the midradial line of the rays, and about six in number. In the specimen from Disco [R = 75 mm] the groups of enlarged spines consist of usually 7–9 spines in a circle surrounding a somewhat larger central one; but the peripheral spines are very little, if any, larger than those of the general abactinal surface. The groups of spines rise only very slightly above the general surface, and from above are noticeable only because they form usually regular rosettes in an otherwise uniformly scattered spiny armature. In the specimen from locality LII the groups of spines rise abruptly and for some distance above the abactinal surface so that they are very conspicuous in lateral view. There are 3–7 smaller spines surrounding a larger central

¹ Published by permission of the Secretary of the Smithsonian Institution and the Keeper of Zoology, British Museum. Received April 28, 1942.

one, but the lateral spines are considerably larger than those scattered over the abactinal surface so that the rosettes are very conspicuous from above. Except for the restriction of the groups of enlarged spines to the midradial line of the rays, this specimen resembles others from Bering Sea [*acervata*] more than it does any we have hitherto seen from Greenland). *Leptasterias groenlandica* (Steenstrup), XVI (1). XXXI (1). XLIII (2). LI (1). LVII (2). LIX (3; in one R=20 mm).

OPHIUROIDEA: *Ophiacantha bidentata* (Retzius), XXV (1). XXXI (2). XLIV (2). *Ophiopholis aculeata* (Linné), III (38). XVI (3). XXV (11). XLIII (2). LII (2). *Ophiura sarsi* Lütken, XVI (4). XXV (13). XLIII (1). *Ophiura robusta* (Ayres), III (6). XVI (1). XXV (14). XXX (1). XXXI (21). XXXVII (1). XXXVIII (1). XLIII (10). *Ophiosten sericeum* (Forbes), III (6). XVI (2). XXX (5). XXXVIII (5). XLIII (1, with the disk rounded-pentagonal, 13 mm in diameter). *Ophiopleura borealis* Danielssen and Koren, LXXII (1, large, with the disk 36 mm in diameter).

ECHINOIDEA: *Strongylocentrotus droebachiensis* (O. F. Müller), XV (12; up to 55 mm in diameter; olive brown to olive green; spinulation variable, from short, dense, and fairly uniform to unequal, with the primaries long, up to 16 mm, and the secondaries short and slender). XXIV (5; up to 45 mm in diameter; test purplish black, spines bright yellow-green, or test pale dull purplish, spines dull olive green; primary spines long, up to 17 mm, secondaries slender, short, and sparse; with or without giant pedicellariae). XXXIV (9; up to 30 mm in diameter; yellow brown; primaries

rather long, secondaries short and slender). XL (6; up to 43 mm in diameter; olive brown to olive green; spinulation variable, from dense and fairly uniform to sparse and unequal with long primaries and short and slender secondaries). LV (3; up to 54 mm in diameter; orange brown; spinulation diverse; numerous giant pedicellariae).

CRINOIDEA: *Heliometra glacialis* (Leach), XXV (arm fragment). XXVI (1). XL (1). LIII (5). LIV (5).

HOLOTHUROIDEA: *Cucumaria frondosa* var. *japonica* Semper, XL (4; these specimens, the largest of which is 85 mm long, contracted, have in the body wall very numerous spicules that agree perfectly with those figured by Mortensen from a specimen taken not far away; following Mortensen, we assign all the specimens from this area to this form). LI (8).

REFERENCES

- CLARK, AUSTIN H. *Echinoderms collected by Capt. Robert A. Bartlett in the seas about Baffin Land and Greenland*. Journ. Washington Acad. Sci. **26**(7): 294-296, figs. 1-4. July 15, 1936.
- . *Echinoderms from Greenland collected by Capt. Robert A. Bartlett*. Proc. U. S. Nat. Mus. **89**: 425-433, pls. 58, 59. Feb. 27, 1941.
- HEDING, S. G. *The Scoresby Sound Committee's 2nd East Greenland Expedition in 1932 to King Christian IX's Land*. Echinoderms. Meddel. om Grønland **104**(13): 1-68, pls. 1, 2. Feb. 25, 1935.
- . *6 og 7 Thule Expedition til Sydøstgrønland 1931-33*. Echinoderms. Meddel. om Grønland **108**(1): 1-34, figs. 1-6, Nov. 20, 1936.
- MORTENSEN, TH. *The Godthaab Expedition 1928*. Echinoderms. Meddel. om Grønland **79**(2): 1-62, pl. 1. 1932 (with bibliography).

PROCEEDINGS OF THE ACADEMY AND AFFILIATED SOCIETIES

CHEMICAL SOCIETY

539TH MEETING

The 539th meeting (58th annual meeting) was held in the auditorium of the Cosmos Club on Thursday, January 8, 1942, at 8:15 P.M. President BEKKEDAHL presided. The annual reports of officers for 1941 were read and approved. The Society was addressed by the retir-

ing-president, Dr. H. L. HALLER, on the subject *The search for new insecticides*.

540TH MEETING

The 540th meeting was held in the auditorium of the Cosmos Club on Thursday, February 12, 1942, at 8:15 P.M. President BEKKEDAHL presided. It was announced that Prof. M. X. SULLIVAN, of Georgetown Univer-

sity, was to be awarded the Hillebrand Prize of 1941 for his studies in the biochemistry of sulphur with special reference to the quantitative estimation of biologically important compounds. Dr. WOJCIECH SWIETOSLAWSKI, of the Mellon Institute of Industrial Research, addressed the Society on the subject *Precritical, critical, and postcritical phenomena*.

541ST MEETING

The 541st meeting and annual dinner was held in the auditorium of the Cosmos Club on Thursday, March 12, 1942, at 6:30 P.M. President BEKKEDAHL gave an account of the rules of award of the Hillebrand Prize. Dr. H. L. HALLER spoke on the history and scientific attainments of Dr. M. X. SULLIVAN, of Georgetown University, the recipient of the award for 1941, who was then presented with the Award, by President BEKKEDAHL. Dr. SULLIVAN responded with an entertaining speech of acceptance. The Society was then addressed by Dr. VINCENT DU VIGNEAUD of the Cornell University Medical School, on the subject *The conversion of methionine to cystine in the animal body*.

542D MEETING

The 542d meeting was held in the auditorium of the Cosmos Club on Thursday, April 9, 1942, at 8:15 P.M. President BEKKEDAHL presided. The society was addressed by Dr. DUNCAN A. MACINNES, of the Rockefeller Institute for Medical Research, on the subject *Electrophoretic study of proteins*.

543D MEETING

The 543d meeting was held in the White-Gravenor Building of Georgetown University on Thursday, April 30, 1942, at 8:15 P.M. President BEKKEDAHL presided. The Society was addressed by Prof. M. X. SULLIVAN, of Georgetown University, on the subject *Precision in the field of biochemistry; the quantitative estimation of important biochemical substances*.

544TH MEETING

The 544th meeting was held in the Arts and Science Building of the University of Maryland, College Park, Md., on Thursday, May 14, 1942. The meeting was preceded by a dinner in the university dining hall at 6:30 P.M. A general

meeting was called to order at 8:20 P.M. by President BEKKEDAHL. The assembly was then directed to the rooms where the following divisional meetings were held.

Biochemistry, Dean Burk, Presiding

The effect of a choline-deficient diet on the production of liver tumors by p-dimethylaminoazobenzene (butter yellow): HELEN M. DYER (The George Washington University School of Medicine).

The application of the polarograph in biological chemistry: RICHARD J. WINZLER (National Cancer Institute).

Enzymic hydrolysis of purothionin: W. S. HALE, T. H. HARRIS, and B. A. AXELROD (Bureau of Agricultural Chemistry and Engineering).

Organic Chemistry, Nathan L. Drake, Presiding

The dienyne double addition reaction for the synthesis of alicyclic compounds: LEWIS W. BUTZ (Bureau of Animal Industry).

The preparation and properties of some functional derivatives of carcinogenic hydrocarbons: HUGH J. CREECH (University of Maryland).

The isolation, chemical composition, and properties of an allergenic carbohydrate-free protein from cottonseed: JOSEPH R. SPIES (U. S. Department of Agriculture).

Physical Chemistry, M. M. Haring, Presiding

Dipole moments of some organic compounds: W. J. SVIRBELY and JOHN LANDER (University of Maryland).

Color of polymethine dyes: A. L. SKLAR (Catholic University of America).

Catalyzed hydrolysis of amide and peptide bonds in proteins: JACINTO STEINHARDT (Research Laboratory of the Textile Foundation at the National Bureau of Standards).

Inorganic and Analytical Chemistry, W. L. Hill, Presiding

Complex ions of cupric nitrite in aqueous solution: A. I. KOSSIAKOFF and D. V. SICKMAN (Catholic University of America).

Determination of beryllium in biological materials: E. D. PALMES and L. T. FAIRHALL (National Institute of Health).

Distribution of copper and zinc in soils: R. S. HOLMES (Bureau of Plant Industry).



CONTENTS

	Page
COSMIC EMOTION. PAUL R. HEYL.....	221
PALEONTOLOGY.—New genera of North American brachiopods. G. ARTHUR COOPER.....	228
GEOLOGY.—Atlantic coastal "terraces." RICHARD FOSTER FLINT...	235
BOTANY.— <i>Hugelia</i> Bentham preoccupied. LOUIS CUTTER WHEELER	237
ENTOMOLOGY.—The genus <i>Ferdinanda</i> Rondani. FRANK M. HULL.	239
ZOOLOGY.—Earthworms of the Northeastern United States: A key, with distribution records. THEODORE H. EATON, JR.....	242
ZOOLOGY.—Some echinoderms from northwestern Greenland. AUSTIN H. CLARK and GORDON J. LOCKLEY.....	250
PROCEEDINGS: CHEMICAL SOCIETY.....	251

The Journal is Indexed in the International Index to Periodicals

506.73

.J2 W23

VOL. 32

SEPTEMBER 15, 1942

No. 9

JOURNAL

OF THE

WASHINGTON ACADEMY OF SCIENCES

BOARD OF EDITORS

RAYMOND J. SEEGER
GEORGE WASHINGTON UNIVERSITY

G. ARTHUR COOPER
U. S. NATIONAL MUSEUM

JASON R. SWALLEN
BUREAU OF PLANT INDUSTRY

ASSOCIATE EDITORS

W. EDWARDS DEMING
PHILOSOPHICAL SOCIETY

C. F. W. MUESEBECK
ENTOMOLOGICAL SOCIETY

HARALD A. REHDER
BIOLOGICAL SOCIETY

EDWIN KIRK
GEOLOGICAL SOCIETY

CHARLOTTE ELLIOTT
BOTANICAL SOCIETY

T. DALE STEWART
ANTHROPOLOGICAL SOCIETY

HORACE S. ISBELL
CHEMICAL SOCIETY

PUBLISHED MONTHLY

BY THE

WASHINGTON ACADEMY OF SCIENCES

450 AHNAP St.

AT MENASHA, WISCONSIN

Entered as second class matter under the Act of August 24, 1912, at Menasha, Wis.
 Acceptance for mailing at a special rate of postage provided for in the Act of February 28, 1925.
 Authorized January 21, 1933.

Journal of the Washington Academy of Sciences

This JOURNAL, the official organ of the Washington Academy of Sciences, publishes (1) Short original papers, written or communicated by members of the Academy; (2) proceedings and programs of meetings of the Academy and affiliated societies; (3) notes of events connected with the scientific life of Washington. The JOURNAL is issued monthly, on the fifteenth of each month. Volumes correspond to calendar years.

Manuscripts may be sent to any member of the Board of Editors. It is urgently requested that contributors consult the latest numbers of the JOURNAL and conform their manuscripts to the usage found there as regards arrangement of title, subheads, synonymies, footnotes, tables, bibliography, legends for illustrations, and other matter. Manuscripts should be typewritten, double-spaced, on good paper. Footnotes should be numbered serially in pencil and submitted on a separate sheet. The editors do not assume responsibility for the ideas expressed by the author, nor can they undertake to correct other than obvious minor errors.

Illustrations in excess of the equivalent (in cost) of 1½ full-page line drawings are to be paid for by the author.

Proof.—In order to facilitate prompt publication one proof will generally be sent to authors in or near Washington. It is urged that manuscript be submitted in final form; the editors will exercise due care in seeing that copy is followed.

Author's Reprints.—Reprints will be furnished in accordance with the following schedule of prices:

Copies	4 pp.	8 pp.	12 pp.	16 pp.	20 pp.	Covers
50	\$2.00	\$3.25	\$ 5.20	\$ 5.45	\$ 7.25	\$2.00
100	2.50	4.00	6.40	6.75	8.75	2.75
150	3.00	4.75	7.60	8.05	10.25	3.50
200	3.50	5.50	8.80	9.35	11.75	4.25
250	4.00	6.25	10.00	10.65	13.25	5.00

<i>Subscription Rates</i> .—Per volume.....	\$6.00
To members of affiliated societies; per volume.....	2.50
Single numbers.....	.50

Correspondence relating to new subscriptions or to the purchase of back numbers or volumes of the JOURNAL should be addressed to William W. Diehl, Custodian and Subscription Manager of Publications, Bureau of Plant Industry, Washington, D.C.

Remittances should be made payable to "Washington Academy of Sciences" and addressed to 450 Ahnaip Street, Menasha, Wis., or to the Treasurer, H. S. Rappleye, U. S. Coast and Geodetic Survey, Washington, D.C.

Exchanges.—The JOURNAL does not exchange with other publications.

Missing Numbers will be replaced without charge provided that claim is made to the Treasurer within thirty days after date of following issue.

OFFICERS OF THE ACADEMY

President: HARVEY L. CURTIS, National Bureau of Standards.
Secretary: FREDERICK D. ROSSINI, National Bureau of Standards.
Treasurer: HOWARD S. RAPPLEYE, U. S. Coast and Geodetic Survey.
Archivist: NATHAN R. SMITH, Bureau of Plant Industry.
Custodian of Publications: WILLIAM W. DIEHL, Bureau of Plant Industry.

JOURNAL OF THE WASHINGTON ACADEMY OF SCIENCES

VOL. 32

SEPTEMBER 15, 1942

No. 9

ANTHROPOLOGY.—*Archeological accomplishments during the past decade in the United States.*¹ FRANK M. SETZLER, U. S. National Museum.

During the past 12 years archeological exploration in the United States has been accelerated to such a degree that many felt the profession scarcely prepared to profit by all the advantages placed at its disposal. Never before, and perhaps never again, will so many archeological sites be excavated simultaneously within the continental United States. The archeologists who participated can congratulate themselves in having accomplished so much under such unusual stimulation.

Prior to 1930 average field expeditions consisted for the most part of 10–15 laborers and assistants, working continuously from 3 to 4 months, with an average cost of about \$2,500. From 1935 to 1940 exploration personnel increased to an average of 150 men and functioned from 36 to 48 months continuously. Well-staffed laboratories were established in the field. The material culture obtained was cleaned, prepared, classified, restored, and processed from day to day. The technique in some instances was streamlined to such an extent that almost from the time the first shovel was pushed into a site archeological specimens and data began to roll out in published form. An archeologist could no longer ponder or gloat over the results of a back-breaking day of digging. He had to serve as engineer and personnel manager handling large crews of men; as an efficiency expert, and above all, a skilled public accountant, timekeeper, and high class execu-

tive. At night reports of the day's work were written. Everything as far as possible had to be standardized. Above all, many thousands of men and women were given legitimate employment. Total man-hours on large-scale projects reached astronomical proportions. The final results may never be entirely comprehended; mistakes were made, but the contributions to American archeology have been enormous. One can safely assume that if a goal had been set in 1930 under the prevailing conditions of the time, for archeological explorations within the subsequent 50 years, this goal has already been reached and in some areas surpassed during the past 6 or 7 years.

Many factors have played an important part in bringing about the results during the past decade. One of the most important was the Federal financing of archeological projects to provide legitimate employment for thousands of laborers in the field and laboratories. Prior to 1930 Federal assistance to States was limited to a "Fund for Cooperative Ethnological and Archeological Investigations," supervised by the Bureau of American Ethnology under the Smithsonian Institution, to which competent scientific organizations with limited funds could apply.

Early in 1933 various States obtained funds from the Federal Government, through the Emergency Relief Administration, to assist in giving employment to their needy. Under such a grant the town of Marksville, La., provided me with a number of laborers for the excavation and restoration of the Marksville site. Because I was unaccustomed to providing gainful

¹ Address of the retiring president of the Anthropological Society of Washington, delivered at the 707th meeting of the Society, April 21, 1942. Published by permission of the Secretary of the Smithsonian Institution. Received April 23, 1942.

employment to more than 10 men working on a mound, it required considerable experimentation and readjustment to keep a crew of over 100 men busy and yet provide careful supervision while excavations progressed on three mounds, a village site, and a man-made earth embankment partially encircling the site. This experience, however, proved valuable when in December 1933 the Civil Works Administration was established in Washington. Its primary purpose was to reduce unemployment. Previous experience at Marksville had convinced the Smithsonian officials that under proper supervision and with a sufficient number of trained men, worth-while scientific results on a large scale could be obtained. Within a few weeks 11 archeological projects employing about 1,500 persons were organized. The sites selected were limited by climatic and economic factors. Seven projects were established in Florida, and one each in Georgia, North Carolina, Tennessee, and California. The selection took into consideration a long range program of archeological research, especially in areas where it would not interfere with existing programs of state or other outside organizations. Those who played an active part in this emergency may recall the many headaches and uncertainties resulting from the experiment. Nevertheless it proved that under competent and trained supervisors, scientific archeological explorations could serve as a legitimate channel for relief employment. The publications resulting from these relief explorations, which lasted from about the middle of December 1933 to April 1934, indicate that scientific standards were maintained. Many of the unforeseen difficulties which resulted from this rapidly organized program were later corrected.

About the same period a new type of emergency presented itself along the Tennessee River and its tributaries, namely, the eventual flooding of vast areas as a result of the construction of several Tennessee Valley Authority dams. Realizing that numerous archeological sites were located in the areas to be flooded, and that the impounded waters would either destroy or

prevent any excavation of these sites, the board of directors of the T.V.A. appointed Maj. W. S. Webb to supervise the necessary surveys and excavations in southern Tennessee and northern Alabama. Here again the required labor was furnished by C.W.A., F.E.R.A., and W.P.A. relief agencies.

In some respects the success achieved by the archeological projects under the direction of the Smithsonian Institution caused numerous archeologists to apply for similar projects within their States. Because of the limited archeological staff in the Smithsonian Institution it was impossible actively to direct the many projects submitted to the new organization, known as the Works Progress Administration. The Smithsonian Institution was requested, however, to assist the Federal W.P.A. office in an advisory capacity in determining the qualifications of the men assigned by the state to direct the archeological programs outlined in the various applications. Within the following year one-half of the States in the Union made application for archeological projects. As time went on these programs became better organized until in July 1938 only state-wide projects under direction of the most competent organization, museum, or university within the State were considered eligible. From then on the responsibility of a program of excavation, laboratory analysis, and the writing and publishing of the final report rested entirely in the hands of the state archeologist and the sponsoring agency.

Quarterly progress reports resulted from all these projects and these reports were recently deposited in the National Museum.² These are now indexed and a brief summary made of the work reported. In many cases the sponsoring agency has published a detailed report of excavations and summarized the results obtained; in other

² The following restrictions have been placed on the use of these quarterly reports: "Although these reports are available to qualified and interested persons, care must be taken that no publication should result from the use of these materials except (A) after the scientific sponsor has been notified and has granted permission; (B) after the scientific sponsor is unable to publish a detailed report; (C) after the scientific sponsor has published a full account of the results obtained."

cases the final reports are awaiting publication. Several progress reports have been published from time to time.

At the end of this fiscal year, June 30, 1942, almost all archeological exploration sponsored by the Works Progress administration and those assisted by C.C.C. allotments will terminate. Some of the laboratories processing archeological specimens may continue to operate on a reduced staff basis until all specimens have been analyzed. It is, therefore, within the period covered by this paper that the origin and completion of one of the most far-flung archeological enterprises ever undertaken by a single nation were accomplished.

To compare the results dollar for dollar would be impossible. The money allotted by the Government was matched by the sponsor in varying degrees ranging from 5 per cent to as high as 50 per cent of the total spent, but the main purpose was to provide legitimate employment to the thousands of relief workers. In most cases over 85 per cent of the total allotments were used for wages or salaries, because the overhead expenses of archeological supplies, such as shovels, trowels, and laboratory material cost relatively little. Since the results obtained were entirely scientific and educational, no overproduction resulted. The most immediate danger, if these projects were to have continued for another 10 years, would have been exhausting all archeological sites. After such large-scale operations, working under the pressure of time, it may be fortunate that this phase of field work will now be terminated. After the results have been digested and summary reports published, it will give the archeologist an opportunity to survey critically the new contributions that have been made and plan future research work, even with a reduced crew, toward the solution of certain important problems on the basis of the many new theories resulting from the work of the past ten years. Then, too, if our techniques, laboratory analyses, and classifications are to change and improve as much again within the next 10 years, many of the more important sites should be preserved in order to check theories, stratification, and conclusions.

It is of interest to review some of the contributions of the past 12 years. In my opinion the most important archeological contributions that have been made during this period are:

1. The general acceptance that man lived in North America contemporaneously with now extinct animals, such as *Bison taylori*, *Camelops*, mammoth, etc.; even though no exact dates can be determined, we are confident that these associations occurred some time between 10 and 20 thousand years ago.

2. Outlining the more important cultural manifestations in the Mississippi River Valley, especially in the Southeast.

3. Recognition of new archeological manifestations in the southern portions of New Mexico and Arizona.

4. The application of archeological techniques to the restoration and reconstruction of several early European settlements, such as Jamestown, Williamsburg, St. Augustine, and Plymouth.

These contributions should in no way detract from essential detailed studies that were made in other parts of the country. The four cited above, after all, form primarily a framework in which details will have to be grouped before the entire picture can be assembled and a masterpiece produced, provided, of course, that the artist or artists can be found to bring together all the elements required for such a painting. Explorations in other portions of the country have obtained important results and have contributed much to the details of previously outlined cultural patterns.

So far as Early Man in America is concerned, the relief agencies have played only a minor part. Most of the work during the past 10 years, which was concentrated on the excavation of Folsom or Yuma sites, was financed by more or less privately endowed institutions. The Lindenmeier site in Colorado, the Sandia Cave and Clovis-Portales sites in New Mexico, Gypsum Cave in Nevada, Signal Butte in western Nebraska, sites in north-central Texas, the Cochise complex in southern Arizona and New Mexico, sites in California and Oregon, and others in Utah and Minnesota have all contributed evidence toward the Paleo-

Indian problem in North America. The published accounts dealing with this subject have accumulated very rapidly during the past 12 years. In one of the recent summaries covering this field 112 publications were cited, all of which were printed since 1930.

As a result of these intensive studies one can now conclude from the archeological evidence that an essentially modern type of American Indian³ migrated from Asia into North America about 15,000 years ago. The diagnostic features of his material culture as well as their association with certain extinct animals is well known. Aside from the importance of definitely establishing the antiquity of man in this hemisphere, these investigations have attracted the interest of geologists and paleontologists in that short but constantly expanding geological period, the Pleistocene, during which man became an integral part of the American fauna. Geologists as well as archeologists have developed a spirit of cooperation in these studies that never existed prior to 1930.

The second and, from my own point of view, the most important area in which archeological work has made the most rapid strides during the past 12 years is in the Southeast, especially in eastern Texas, Oklahoma, Louisiana, Alabama, Georgia, Florida, Tennessee, Kentucky, and Arkansas. Over 60 per cent (more than 1.5 million dollars a year) of the total allotments for W.P.A. archeological projects was assigned here. In other words, the amount of archeological explorations in this section of the Southeast is due almost entirely to the Federal allotments granted, through such agencies as C.W.A., F.E.R.A., W.P.A., and C.C.C., which provided the labor for extensive excavations.

Except for the archeological program of the Bureau of American Ethnology in Florida and the earlier surveys by C. B. Moore, no extensive explorations had been carried on in the Southeast before 1933. In the winter of 1933-34 the Smithsonian

Institution sponsored 10 C.W.A. excavations in the Southeast. These experiments, together with those inaugurated by the T.V.A., led the way to subsequent large-scale programs in the various States. Some of the C.W.A. work in Florida was continued. In Georgia the city of Macon sponsored the large archeological program at Ocmulgee, which later became a National Historical Monument, and excavations were continued under the National Park Service; additional projects were completed on St. Simons Island near Brunswick; Irene Mound near Savannah; sites near Columbus; and a State survey. In northern Alabama work was concentrated in the Tennessee River Valley. All are familiar with the T.V.A. reports published in the Bureau of American Ethnology bulletins. The work in Mississippi was limited primarily to the Natchez Trace Survey. In Louisiana several projects concentrated on the Marks-ville and Tchefunete problems.

As indicated before, the limited number of excavations in the Southeast prior to 1930 gave only a jumbled picture of certain exceptional sites which had produced unusual specimens. Nothing more than a guess gave any indication of the relative chronology. Many felt that the prehistoric ancestors of the Muskogean, Natchez, Tunica, and other ethnological groups lived in the Southeast about the beginning of the Christian Era. Archeologists had a hunch that they were considerably influenced by some mysterious groups farther south in Mexico. Recent archeological excavations brought about a lengthening and foreshortening of the chronology in the Southeast. By this I mean that the finding of Folsom projectile points indicates that early man hunted over parts of the country. Even though no concentrated accumulation of such artifacts has been discovered in association with the extinct faunal complex farther west, a sufficient number of these diagnostic projectiles has been sent to the National Museum, as well as a large number discovered in our archeological collections from the Southeast, to indicate that Folsom man roamed the rivers and valleys for his sustenance. From such evidence it is certainly justifiable

³ No human skeletal material has yet been found in direct association with the well-established archeological and paleontological strata.

to extend man's existence in the Southeast back at least to 10,000 years before the Christian Era. On the other hand, the chronology of the more sedentary groups, those lineal ancestors of the historically known Indian tribes, unquestionably has not only been condensed, but the cultural stratification much more sharply defined. Without repeating the various and innumerable foci thus far established, one can safely assume in a very general way that the archeological complexes appearing in the Southeast after the beginning of the Christian Era can be divided into three main divisions: early, middle, and historic.

By "early" is meant the widespread pre-agricultural complex characteristically associated with shell heaps. Throughout the Southeast these deposits are found along the coasts and along the banks of the larger inland rivers. The complex is characterized by mortars and pestles, tubular pipes, a large variety of shell beads and pendants, bone awls and tubes, and stemmed projectile points. The lower strata give no evidence of pottery, which would indicate preagriculture. This suggests a simple sedentary existence depending on hunting, fishing, and root- and berry-gathering. The most important sites containing this complex are Stallings Island in Georgia, Tchefuncte in Louisiana, Pickwick Basin in Alabama, and Indian Knoll in Kentucky. Pottery does occur in the later phases in all of these sites and consists uniformly of a crude fiber-tempered variety, probably the earliest type in the Southeast. There are minor variations from site to site, such as disc beads plastered on bone tubes with asphalt, from Indian Knoll in Kentucky; and different decorative treatments on the pottery. Nevertheless, not only are there sufficient differences between the various sites to show an adjustment to the local environment, but a general uniformity exists between the archeological complexes in the Southeast and the objects from similar sites in New England and the Pacific coast. This indicates a probable hemispheric similarity of a widespread cultural level.

So far as chronology of these people is concerned it can be safely assumed that

they represent the first pottery-using people in the Southeast. As to whether they represent descendants from the much earlier Folsom hunters we have no evidence. My guess is that these semi-sedentary people represent a much more recent Asiatic migration of modern American Indians inhabiting the coasts and river valleys some time after A.D. 500. From this period up to A.D. 1800 archeologists in the Southeast have developed a most convincing series of cultural manifestations. These evolve from this early period through the various stages which led to the variety of historical Indian cultures found in the Southeast at the time of European discovery. Numerous outside influences account for these varieties. The introduction of maize, allowing more leisure and a more or less guaranteed staple food economy, permitted the development of complex political and religious organizations as well as the byproducts of large ceremonial centers, such as Ocmulgee, Etowah, Kolemokee, Moundville, Troyville, and Spiro. Large tribal migrations took place into the area as well as out of the Southeast. Even though some slight influence is obvious from farther south in Mexico, the only real proof of these contacts rests in artistic similarities, and these occur almost at the close of the protohistoric period, probably within the sixteenth or seventeenth century.

Cultural similarities have also been established between certain manifestations in the Ohio Valley and some of the Upper Mississippi Valley cultures. Numerous publications have described in detail the results from these W.P.A. archeological explorations; more will follow. One can safely assume, I think, that the broad outlines of the prehistoric cultures in the Southeast have been more or less established as to their relative chronology and cultural relations. Many more problems remain, especially the historical antecedence; in other words, the strict application of the historical method to Southeastern prehistory.

These accomplishments, when considered from the point of view of what was known prior to 1930, speak for themselves. Credit, it seems to me, must go first to the men re-

sponsible for outlining and directing the programs of research. Nevertheless they would still be working on their plans if the Federal and State relief agencies had not supplied the labor and material. Neither could have accomplished the results without the other. The same is true of the projects elsewhere.

The third most important archeological contribution during the past decade resulted from concentrated excavations in southwestern New Mexico and southern and northern Arizona. From scattered excavations in southern Arizona prior to 1930 a concerted effort has been made, both by well-organized programs and continuous excavations, to obtain data necessary to solve the problems of prehistory in this section of the Southwest as had been done in northern New Mexico and northeastern Arizona. The results of these investigations, entered into by various privately endowed organizations, have been published and provide a resume of the important cultural manifestations. These results together with the highly developed dendrochronology make it possible to observe cultural movements and variations, and enable the specialist to establish specific dates for the sites.

As a result of these concentrated programs the occurrence of two basic cultures in the Southwest can be postulated: The Anasazi and Hohokam. The ramifications of the Anasazi through the various Basketmaker and Pueblo stages is well known. The men working in the southern Arizona field propose that the earliest and most widespread complex, known as the Cochise, consisted of a simple hunting complex, the remains of which are found with certain extinct fauna which they have dated around 8000 B.C. From this hunting and gathering complex developed a more sedentary group out of which, about the beginning of the Christian era, two variations developed, the Mogollon and the Hohokam.

These people lived in large communities and made fine undecorated pottery and artistically carved stone objects—all in all a rather closely knit, well-developed, sedentary culture. During this same period the

people known as the Basketmakers lived in caves and shelters in northern New Mexico, wove beautiful sandals, and made artistically decorated coiled baskets. These two centers of cultural influence continued to expand; then contact and an interchange of ideas took place between the north and south. About A.D. 1000 the Hohokam reached the peak of its cultural influence, and the now well-established Pueblo cultures in the north began to expand to the south. About A.D. 1200 this northern Pueblo culture began a definite southward movement, forcing its influence through the Salado group upon the Hohokam and began the latter's eventual decline. The Pueblos, owing to catastrophic droughts were forced out of the San Juan drainage, and owing to somewhat similar ecological factors spread southward. The droughts also caused a decrease in their area of domination and resulted in several regional and somewhat culturally separable groups. About A.D. 1600 the picture is well known from historical accounts, with the Hopi in Arizona, the Zuñi in New Mexico, the Pima along the Gila and Salt Rivers, while the Papago were spreading farther south.

Definite cultural influences, coming from centers farther south in Mexico, have been found in these southern Arizona sites; while pottery and other culture material from the Great Plains area has been found among the Pueblo cultures in northern New Mexico. These represent only the highlights from an area which in 1930 was considered drained so far as new archeological manifestations were concerned.

The fourth outstanding accomplishment is the application of modern archeological techniques to recovering, verifying, and supplementing historical accounts of early European settlements in the United States. This approach differs only in point of time and cultures involved. Ever since the archeologist emphasized the historical approach instead of trying to accumulate quantities of beautiful pottery or arrowheads and pipes, he became a collaborator with the student of history and the ethnographer. Since 1930 this technique has proved its value in supplementing and verifying the

limited written accounts dealing with some of the first European settlements in America.

The best-known example and one of longest duration is the work at Jamestown Island, Va. Similar approaches were made at St. Augustine, Fla., and quite recently in and around Plymouth, Mass. At Jamestown historical and archeological research are working together to unravel the story of the years between 1607 and 1699, at which time Jamestown was the outstanding community in the colony of Virginia. The historical records of this first century of English colonization of America are meagre. The settlers were naturally too busy trying to keep body and soul together to do much recording for the edification of their descendants. Many of the records that were made have been destroyed or lost. Moreover, even as today, people seldom preserved records of their houses, furniture, dishes, and the like. Many of these, especially the nonperishable type, such as rum bottles, spoons, buckles, seals, and china, are being recovered through controlled archeological excavations. On the other hand, the existing documents, such as maps, deeds, and court records, assist in determining facts that no amount of excavation could produce. The important contribution is that both disciplines, history and archeology, are working together toward the solution of specific problems. This type of collaboration at the most recent end of our time scale is just as important as collaboration between the Pleistocene geologist or paleontologist and the archeologist at the extreme opposite end of our human history scale. This combination of efforts or techniques appears to me to cover the

whole field of anthropology; functional or applied anthropology bridges a similar gap between ethnology and sociology. Similar examples could be cited for geography, economics, psychology, biology. The new science seems to be "growing up" and expanding in every direction.

Getting back to archeology, I feel confident that historical-archeology⁴ will continue to play an important part in the restoration of sites historically associated with our own European cultures and from the point of view of popular interest will play a very prominent part in supplementing the cultural background of our own ancestors.

Many other contributions have been made in those sections of the country which have not been stressed. There is the taxonomic classification, the reanalysis of earlier archeological excavations, the archeological survey of Kansas, explorations in Maine, New York and Pennsylvania, the work at the Kincaid site in southern Illinois, and the excavation of the Angel Mound group in southwestern Indiana. To these may be added dendrochronology in the Mississippi Valley from which some definite dates have been determined.

One is always limited in preparing a summary of this kind. I have endeavored to select those phases of the work that in the light of present conditions have contributed most to our knowledge of prehistoric man in the United States. At the same time I have tried to point out the unusual social conditions that made possible the large-scale archeological operations.

⁴ A poor name. Perhaps Colonial-archeology would be a better term, although such a collaboration of two disciplines would not necessarily be limited to the Colonial period.

BOTANY.—*Two new dwarf species of Rubus from western China and Tibet and their Asiatic relatives.*¹ EGBERT H. WALKER, U. S. National Herbarium.

Several species of dwarf *Rubus* occur in the area from western North America, through Kamchatka, the Far East, Japan, China, and Tibet, the exact relationships of which are uncertain. To these the writer is now adding the two new species described in this review. Both belong in the subgenus *Cylactis* Focke, according to the recent characterization of the group by L. H. Bailey.² He places in this group the western North American species *R. lasiococcus* A. Gray and the eastern Asiatic and western North American species *R. pedatus* J. E. Smith, and, if he were not confining his studies to the North American species, would probably include also the Asiatic species *R. fockeanus* S. Kurz, *R. rubrisetulosus* Cardot, and possibly *R. potentilloides* W. E. Evans. Focke has placed most of these species in the subgenus *Dalibarda*,³ based on *Dalibarda repens* L., 1753 (*Rubus dalibarda* L., 1764), which Bailey maintains as a separate genus.⁴ To the writer, however, the segregation of this as a separate genus seems un-

tenable, because it is distinct only in respect to its cleistogamous flowers, a character that seems to be no greater a criterion for generic segregation than is the character of dioecious flowers used to set aside the subgenus *Chamaemorus* within the genus *Rubus*. *Dalibarda* as a genus or subgenus has been variously treated, and the species assigned to it have been equally variable in the extensive literature on the genus.

This assemblage of Asiatic species, which may thus be provisionally considered in the subgenus *Cylactis*, may be distinguished by the following key:

- a¹. Leaves mostly 5-foliolate.
 b¹. Carpels about 5; leaflets toothed, not deeply lobed.
 c¹. Peduncles more than 1 cm long; sepals oblong-ovate, acute to obtuse.
 1. *R. pedatus*
 c². Peduncles 1 cm long; sepals ovate, long acuminate to caudate. . . . 3. *R. yui*
 b². Carpels about 20; leaflets deeply lobed [ex char.] 5. *R. potentilloides*
 a². Leaves mostly 3-foliolate.
 b¹. Leaves serrate or doubly serrate, more than 1 cm wide; sepals lanceolate and setulose or ovate and not setulose; stipules entire or 1- to 5-toothed.
 c¹. Stipules entire or 1-toothed.
 d¹. Sepals ovate; leaves coarsely and doubly serrate; carpels 12 to 20 2. *R. fockeanus*
 d². Sepals lanceolate or oblong lanceolate; leaves rather finely and simply serrate; carpels about 6.
 3. *R. yui*
 c². Stipules 3- to 5-toothed or incised 4. *R. rubrisetulosus*
 b². Leaflets deeply lobed or incised, less than 1 cm wide; sepals broadly ovate, not setulose; stipules entire.
 c¹. Carpels 24; petals entire or sinuate [ex char.] 5. *R. potentilloides*
 c². Carpels about 3; petals lobed or coarsely toothed. . . . 6. *R. clivicola*
 1. ***Rubus pedatus*** J. E. Smith, Pl. Icon. Ined. 3. pl. 63. 1791; W. O. Focke, Sp. Rub. 16. 1910 (Bibl. Bot. 17²); L. H. Bailey, Gentes Herb. 5: 40. 1941.

Based on a collection by A. Menzies from western North America. The type has not been examined.

Distribution: From northern California, Idaho, and Montana to Alaska and Japan.

¹ Published by permission of the Secretary of the Smithsonian Institution. Received June 12, 1942.

² Gentes Herb. 5: 21. 1941: "Plant unarmed, with wiry thinly woody or almost herbaceous stems often prostrate or running, with no clear distinction of primocanes and floricanes . . . ; leaves lobed or ternate; stipules broad, attached on axis but sometimes also adnate at base to petiole; flowers solitary or very few." On p. 24 it is described thus: "Plants low, often repent, unarmed or bearing a few weak bristles, without definite primocane and floricanes succession, stems more or less herbaceous to thin and somewhat ligneous; leaves various; flowers hermaphrodite but sometimes functionally asexual, borne few to several on a branched or forked leafy weak stem; fruit blackberry-like. Mostly high northern."

³ Focke, in Species Ruborum, p. 13. 1910, describes *Dalibarda* as follows: "Calyx fere rotatus, cupula brevis plana; stamina in anthesi divaricata; carpella pauca (saepissime 5) vel complura (ad 20), discreta, matura aut sicca, aut succosa.—Herbae perennes, reptantes, humiles (calyce *R. Fockeani* excepto) inermes, non setoso-glandulosae; stipulae liberae, persistentes, in plurimis speciebus latae. Species paucae, inter se parum affinis, sed omnes humiles, herbaceae, reptantes, inermes."

⁴ In Gentes Herb. 5: 21. 1941, he excludes *Dalibarda* from *Rubus* "because of its few pistils not placed on a developed torus and its cleistogamous flowers." Elsewhere he has referred to the dry, non-fleshy fruits.

Asiatic specimens examined: JAPAN: *Tsunezo Takemoto* 1195 (A)⁵; *Kakuo Uno* 16938 (A), 17304 (A); *E. H. Wilson* in 1914 (without number) (A).

2. *Rubus fockeanus* S. Kurz, Journ. Asiat. Soc. Bengal 44²: 206. 1875; Hook. f. Fl. Brit. Ind. 2: 334. 1878; W. D. Focke, Sp. Rub. 16. 1910.

Based on collections, probably by J. D. Hooker and C. B. Clarke, "in pascuis alpinis, Sikkim-Himalaya, e.g., in jugis Singalelah, 12-14000 ped. s. m." (See the original description and Hooker's Flora of British India.)

Synonym: *R. loropetalus* Franch. Pl. Delav. 203. 1889. Based on Delavay 2837, from Yunnan. A photograph in the Arnold Arboretum of the type in the Paris herbarium has been examined. For note on this reduction see comments with Cardot's description of *R. rubrireticulosus*, and Focke in Notes Bot. Gard. Edinburgh 5: 71. 1911.

Distribution: Hupeh, China, to Sikkim, India.

Chinese specimens examined: YUNNAN: *Delavay* 2837 (photo and fragment) (A), Apr. 6, 1889 (W), July 9, 1889 (G, W), 1889 (W); *Forrest* 5679 (W); *Handel-Mazzetti* 3281 (W); *Rock* 4738 (W); *C. W. Wang* 68494 (A); *T. T. Yü* 15984 (A, W). SZECHWAN: *Handel-Mazzetti* 7225 (A); *E. H. Wilson* 1002 (A). HUPEH: *A. Henry* 6839 (G, W).

3. *Rubus yui* Walker, sp. nov.

Humilis inermis, caulibus reptantibus suffruticosis, junioribus pubescentibus pilis albis subappressis et pilis erectis glandulosis; stipulae liberae ovatae acutae vel obtusae; folia 3-5-foliolata, orbiculata, 3-5 cm diametro, petiolata (1-5 cm), molliter pubescentia et glanduloso-pubescentia praecipue in nervis, foliis late ovatis vel orbicularibus obtusis duplo-serratis; ramuli floriferi circa 10 cm longi, uniflori; calyx circa 8 mm longus, intus valde pubescens extra ad basin glanduloso-pilosus, lobis late ovatis longe acuminatis vel caudatis; stamina complura biseriata in margine tori lati inserta; carpella circa 6; fructus globosus, circa 1 cm diametro, ut videtur succulentus.

A low repent, radican, suffrutescens, un-

armed plant with indumentum of soft white, subappressed hairs and much longer erect glandular hairs on younger stems, petioles, leaves (sparingly), and calyx; creeping stems rather slender, branching, brownish, the 1-flowered erect branches about 10 cm long; stipules free from the petiole, ovate, acute, to obtuse, asymmetric, pubescent, 5 to 10 mm long, appearing scalelike on creeping parts; leaves with petioles 1 to 5 cm long, 3- to 5-foliolate, orbicular, 3 to 5 cm broad, the leaflets shortly petioluled, 1.5 to 3 cm long, broadly ovate to orbicular, rounded at apex, cuneate to truncate at base, sometimes slightly lobed, coarsely and more or less doubly serrate, sparingly soft pubescent and glandular on both surfaces but especially on the veins; flowers white, terminal, solitary, usually subtended by a leaf, apparently nodding, nearly 2 cm in diameter, the peduncle scarcely 1 cm long; calyx deeply 5-lobed, the lobes broadly ovate and long acuminate or caudate (1.5 to 3 mm), 8 mm long, soft pubescent especially within, glandular-hairy at base; petals probably 5, elliptic ovate, obtuse, entire, 10 to 12 mm long, glabrous, veined; stamens numerous, biseriata, unequal in length, on margin of a wide torus-cup, about half the length of the calyx lobes, the anthers small, orbicular, the filaments rather broad; carpels about 6, the style 1.5 mm long, the ovary 1 mm long, glabrous; fruit globose, about 1 mm in diameter, crimson, apparently somewhat fleshy.

Type in the herbarium of the Arnold Arboretum collected by T. T. Yü, no. 19840, at Lung-tahmuru in the upper Kiukiang Valley, Yunnan, in an *Abies* forest at 3,800 meters altitude. August 9, 1938; reported to be common. Additional specimens examined, also at the Arnold Arboretum, are *T. T. Yü* 19303, collected at Newahlung, Salwin-Kiukiang Divide, Yunnan, under a rhododendron-bamboo thicket at 3,500 meters altitude, July 11, 1938, also common; *C. W. Wang* 65818 (in fruit) collected at "Gue-sai-gue, Tsa-wa-rung," Sikang, on the border of a woods, at 3,200 meters altitude, August, 1935.

This species seems most nearly related to *R. fockeanus* S. Kurz but differs in its ovate rather than lanceolate or oblong-lanceolate sepals and petals, fewer carpels, more coarsely and doubly

⁵ The locations of the specimens examined are: A, Arnold Arboretum; G, Gray Herbarium; W, U. S. National Herbarium.

serrate leaves and often five leaflets. It also resembles *R. pedatus* J. E. Smith but differs in its coarser stems, larger flowers, broadly ovate, long acuminate or caudate sepals, and shorter pedicels. From *R. rubrisetulosus* Cardot it differs in its entire stipules and broader, less setulose sepals.

4. *Rubus rubrisetulosum* Cardot, Not. Syst. (Lecomte) 3: 289. 1917.

Based on a collection by A. David in 1870 in the Paris herbarium (?) from "province de Moupine,"⁶ Szechwan.

Distribution: Tibet, Yunnan, and Szechwan.

Specimens examined: YUNNAN: *Handel-Mazzetti* 8887 (A); *T. T. Yü* 68044 (A), 68204 (A), 68204A (A).

5. *Rubus potentilloides* W. E. Evans, Notes Bot. Gard. Edinburgh 12: 179. 1912.

Based on Ward 1777 (type), 3166, 1132, all from Upper Burma. No specimens have been seen.

6. *Rubus clivicola*⁷ Walker, sp. nov.

Humilis inermis, caulibus reptantibus suffruticosis, junioribus pubescentibus; stipulae liberae, ovatae vel suborbiculatae, integrae; folia trifoliolata orbicularia, 0.8–1.5 cm diametro, petiolata (circa 8 mm longa), subtus moliter pubescentia et parce glanduloso-pubescentia, foliolis valde 3-lobatis, lobis alte fissis, apice rotundatis, acutis vel obtusis; ramuli floriferi breves, uniflori; calyx circa 7 mm longus, externe pubescens, lobis late ovatis longe caudatis; petala lobata vel grosse dentata; stamina circa 30, uniseriata inaequalia; carpella circa 3; fructus ignotus.

A low, repent, radican, suffrutescent, unarmed plant with indumentum of soft white hairs on younger stems, petioles, leaves (especially on veins of lower surface), and calyx lobes and scattered shorter brown glandular hairs especially on the leaves; creeping stems slender, wiry, dark reddish brown, the flowering branches scarcely 2 cm long, 1-flowered; stipules free from the petiole, scarious, ovate to suborbicular, entire, more or less ciliate,

⁶ For explanation of the misuse of this name by David, see notes by W. P. Fang in Contr. Biol. Lab. Sci. Soc. China Bot. Ser. 12: 4. 1939.

⁷ This name, meaning an inhabitant of the slopes, is selected because most of the specimens examined were collected on scree or other rocky slopes.

often occurring on the creeping stems as scales; leaves with pubescent petiole about 8 mm long, trifoliolate, orbicular, 0.8 to 1.5 cm broad, the leaflets petioluled (the central one longest), deeply 3-lobed (each lobe deeply divided), obtuse at base, the lobes rounded and acute to obtuse at apex, the veins rather prominent beneath (but less so than in *R. fockeanus*); flowers terminal, white, about 1 cm broad, the peduncle about 1 cm long; calyx deeply 5- (sometimes 4-) lobed, the lobes broadly ovate, caudate (1 mm), 5 to 6 mm long, softly pubescent especially on the margin; petals 5 (sometimes 4), ovate, lobed or coarsely toothed, about 7 mm long, glabrous; stamens about 30, uniseriate, of several lengths, the anthers small, ovate, the filaments broad; carpels about 3, about 2.5 mm long, the ovary 0.75 mm long, glabrous, the style rather slender, 1.5 mm long, the stigma abrupt; fruit unknown.

Type in the United States National Herbarium, no. 1512903, collected by J. F. Rock, no. 23317, on a mossy scree at 4,200 meters altitude in mountains of Tjonatong, Upper Salween River, Tsarong Province, southern Tibet, June-July, 1932, on the expedition of the University of California Botanical Garden to southwestern China. Additional specimens examined, all from Yunnan and all in the herbarium of the Arnold Arboretum, are: *Handel-Mazzetti* 9197⁸ from near the Yunnan-Tibet-Burma border between the Salween and the Irrawadi Rivers, "in pluvisilvis mixtis temperatis vallis Tjiontson-lumba infra Tschamutong," at 3,050 meters altitude, July 2, 1916; *T. T. Yü* 19277 from Newahlung on the Salwin-Kiukiang Divide, common on a rocky surface under a shady forest at 2,800 to 3,000 meters altitude; *T. T. Yü* 22082 from Swang-Chiang on the Salwin-Kiukiang Divide, common on a rocky mountain slope at 2,800 meters altitude.

In its deeply divided leaves this species seems to resemble *R. potentilloides* W. E. Evans, but it differs from the original description in its distinctly lobed or coarsely toothed petals, far fewer carpels (3 rather than 24), and uniseriate (rather than biseriata) stamens.

⁸ This number and no. 8339 are cited in *Handel-Mazzetti, Symbolae Sinicae*, as *R. potentilloides* W. E. Evans, but they do not conform with the original description of that species in respect to the number of carpels, number of stamen series, and petal-lobing.

ZOOLOGY.—*Porifera from Greenland and Baffinland collected by Capt. Robert A. Bartlett.*¹ M. W. DE LAUBENFELS, Pasadena Junior College. (Communicated by WALDO L. SCHMITT.)

The collections of Arctic sponges on which this report is based were dredged by Capt. R. A. Bartlett in August 1927, July 1931, August and September 1933, and July 1940. Twenty-one species are represented. Nine species and one genus are new.

CLASS DEMOSPONGIAE

Haliclona permollis (Bowerbank)

This species was described as *Isodictya permollis* by Bowerbank (1866, p. 278). It is one of the few sponges with a wide distribution taken by Captain Bartlett; it is cosmopolitan and abundant.

The specimen in the present collection is a mass a little over 1 cc in size. The spicules and their arrangement are typical. In other respects the smallness of the specimen precludes satisfactory comparison. It was dredged in Fox Basin, lat. 66° 43' N., long. 80° 07' W., at a depth of 32–37 fathoms, August 12, 1927.

Isodictya histodermella, n. sp. Fig. 1 A

The holotype (U.S.N.M. no. 22688) was dredged July 22, 1940, at a depth of 60 fathoms, Parker Snow Bay, NW. (true) of Conical Rock. A second specimen was dredged August 12, 1927, in Fox Basin, lat. 66° 43' N., long. 80° 07' W. This is a fragment of finger-sized projection similar to those on the larger specimen.

The holotype is a palmate-shaped mass with several projections the size and shape of fingers. The whole is 15 cm high and between 1 and 2 cm thick. The consistency is spongy, and the color the usual pale drab of sponges that have been preserved for some months. The surface is nearly smooth, microscopically slightly hispid, with no detachable or special ectosome present. The oscules are 2 to 3 mm in diameter, mostly scattered, occurring chiefly along the narrower edges of the digitate projections. The endosome is somewhat cavernous, the interior being much more "open-work" than the outer portion, so that the sponge may almost be described as "hollow." The megascleres are oxeas approximately 14 by 270 μ . The microscleres are palmate isochelas 30 to 40 μ long.

¹ Received May 25, 1942.

The specific name is given in recognition of the structural resemblance of this sponge to specimens of the genus *Histodermella*, which is remarkable for having just such an open-work but not quite hollow interior. In other respects the resemblance ceases. The spiculation in particular is very different. No other species of *Isodictya* is especially close to the one under discussion; it may, however, be compared with the genotype, *Isodictya palmata*, originally described as *Spongia palmata* by Lamarck (1814, p. 452). Superficially the genotype looks like *Isodictya histodermella*, but its interior is far less cavernous. The microscleres of *I. palmata* (Fig. 1, B) are rather peculiar in shape, whereas those of the species here described are typical isochelas.

Orina consimilis (Lundbeck)

This species was described from the Arctic, as *Gelliodes consimilis* by Lundbeck (1902, p. 77). A very similar species is the sponge described as *Gellius arcoferus* by Vosmaer (1885, p. 29). The latter is also Arctic, as are many other species and specimens of the genus *Orina*.

The specimen in the present collection, taken August 31, 1927, at the southeast corner of Fox Basin, lat. 66° 46' N., long. 79° 15' W., is remarkable for having toxas of two thicknesses. The larger are about 5 by 100 μ , the smaller only 2 by 100 μ . For this reason one might be tempted to describe it as a new species, but the other characters are typical.

Iophon piceus (Vosmaer)

This species was described as *Aleblion piceum* by Vosmaer (1882, p. 42), from the Arctic. It is here proposed that the following species be dropped in synonymy to *piceus*: *Remiera dubia* Hansen (1885, p. 5), from the Arctic, and *Iophon frigidus* Lundbeck (1905, p. 183), from Greenland. Neither *piceus* nor *dubia* is adequately known, but from what information is available they seem to be conspecific with the well-described *frigidus* and the specimens under discussion. The latter have megascleres and anisochelas only about 70 per cent as large as those of Lundbeck's Greenland species, and have bipocilli far more abundant. These differ-

ences, however, do not warrant setting up a new species for Bartlett's material, which consisted of two Fox Basin specimens, one from lat. 66° 43' N., long. 80° 07' W., August 12, 1927, from a depth of 32–36 fathoms; the other without detailed locality data, taken August 26, 1927, from 25–31 fathoms.

Myxilla incrustans (Johnston)

This species was described as *Halichondria incrustans* by Johnston (1842, p. 122). It is abundant in the north Atlantic and Arctic regions. Captain Bartlett dredged this sponge at 32–37 fathoms in Fox Basin, lat. 66° 43' N., long. 80° 07' W., August 12, 1927, and at a depth of 32–37 fathoms on August 13, 1927.

Myxilla acribria, n. sp. Fig. 1 C

The holotype (U.S.N.M. no. 22689) was dredged in Fox Basin in 1933; detailed locality data are lacking. It is an amorphous mass 1 by 1.5 by 2 cm in size. The consistency is spongy and the color dull brown. The surface is finely hispid and lipostomous. The structure consists of plumose ascending columns, with the same sort of spicules echinating and coring the tracts.

The principal megascleres are commonplace smooth styles 12 by 465 μ . There are some special dermal tyloles with microspined heads; total size about 9 by 375 μ . The microscleres are anchorate isochelas as typical of this genus, but are a little larger than common, often up to 90 μ in length.

The genus *Myxilla* is represented by many Arctic species, some of which are common. The present specimen is as different from these other Arctic *Myxillas* as could well be and still be left in the genus. On the other hand, it is almost identical with one of the few species of this genus from the southern hemisphere. Ridley and Dendy (1886, p. 472) in their "Preliminary Report on the Monaxonida collected by H.M.S. *Challenger*," described *Myxilla cribrigera* from Chile. The specimen collected by Captain Bartlett in Greenland bears an amazing resemblance to *M. cribrigera* in all characters except the important one which Ridley and Dendy selected as a basis for their specific name. Their specimen had well-defined pores arranged in special inhalant areas. The Greenland specimen conspicuously lacks this cribrate structure, which together with the vast geo-

graphical separation, seems to warrant naming it *acribria*, rather than identifying it as *cribrigera*.

Mycale vosmaeri (Levinsen)

This species was described from the Arctic by Levinsen (1886, p. 20) as *Esperella vosmaeri*. Brøndsted (1914, p. 489) maintained that it was conspecific with *Mycale lingua* (described as *Hymeniacion lingua* by Bowerbank, 1858, p. 305), and his opinion has been generally followed in this regard. This assumes that *M. lingua* is a highly variable species and that *vosmaeri* falls within the range of variation. I disagree, and propose that *vosmaeri* be reinstated as a valid species.

Captain Bartlett dredged this *Mycale* three times: Fox Basin, August 13, 1927, in 34–37 fathoms, and August 26, 1927, in 25–31 fathoms; and Parker Snow Bay, NW. Greenland, July 22, 1940, in 25–45 fathoms.

Levinsen's species was supposed to differ from Bowerbank's by lacking the smaller type of anisochelas and by having much smaller sigmas. In some specimens of *lingua* the smaller anisochelas do not seem to be of a conspicuously smaller range, but in all Captain Bartlett's specimens, as in Levinsen's, there seems to be no smaller type of anisochela at all. In all Captain Bartlett's specimens the sigmas are even smaller (10 to 12 μ) than in Levinsen's (20 μ); in typical *lingua* they are 27 to 32 μ . These sigmas in *vosmaeri* are more strongly contorted than in typical *lingua*. In typical *lingua* the megascleres are smooth substrongyles 750 to 850 μ long, but in Levinsen's specimen they are 650 μ long, and in those collected by Captain Bartlett they range from 600 to 680 μ .

Echinoclathria schmitti, n. sp.

The holotype (U.S.N.M. no. 22690) was dredged in Fox Basin, at a depth of 34–37 fathoms, lat. 66° 46' N., long. 79° 15' W., August 13, 1927. It is a lamella or fragment of a vase; the piece of the wall is 7 mm thick and 5 cm high. Foreign objects, since removed, have left two cavities 7 mm in diameter, clear through the wall. The consistency is spongy and the color light brown. The surface is even, punctiform, with pores 50 μ in diameter, 125 μ apart (center to center). The numerous oscules are a trifle under 1 mm in diameter, about 4 mm apart. There is no ectosomal specialization. The

endosome consists of specular tracts about 100 μ in diameter, in a confused specular matrix. The latter could be interpreted as representing specular connections between the tracts, or loosely echinating spicules on them.

The only spicules are styles; many are about 4 by 200 μ , and many others 12 by 220 μ . One might regard these as two distinct types, but there are fairly numerous intermediate-sized spicules.

The only other species of *Echinoclathria* that is very close to this one is the genotype *E. tenuis* Carter (1885, p. 355), from south Australia. The two are very close indeed. There are two reasons for establishing a new species for the Arctic sponge. One is the vast distance between Greenland and Australia, which is certainly inadequate by itself alone but is significant in connection with other differences. The other and more critical difference is that in *tenuis* the interstitial spicules are tylostyles quite unlike those in *schmitti*. Brøndsted (1933, p. 14) described two sponges from Greenland that are practically certainly conspecific with *schmitti*. He very dubiously identified them with *Phakellia beringensis* Hentschel (1929, p. 975). This species is named for Dr. Waldo L. Schmitt, of the United States National Museum.

Halichondria fibrosa (Fristedt)

This species was described as *Amorphina fibrosa* by Fristedt (1887, p. 426), from the Arctic.

Captain Bartlett dredged this species on September 5, 1933, between the Island of Ooglit and the Eskimo village of Pingitkalik, northeast of Melville Peninsula, Fox Basin, near the entrance to the Fury and Hecla Straits. Earlier, on August 26, 1927, he dredged a sponge from Fox Basin, in 25–31 fathoms, that is probably conspecific. It is similar in spiculation and structure but is different in external shape. One side is astonishingly smooth and imperforate, as if it had been closely affixed to some smooth flat substratum. The other side is extremely cavernous, as though it had been loaded with foreign objects since removed.

Cioxeamastia, n. gen.

This genus is erected for the following species (*C. polycalypta*) as genotype. It is of the family Halichondriidae, with spiculation and most other characters quite typical, but differs

in possessing conspicuous closed fistules closely resembling those that characterize the genus *Polymastia* of the family Suberitidae. The genus *Ciocalypta* of the Halichondriidae also has fistules, but these are coarser than those of *Cioxeamastia*. The spiculation of *Ciocalypta* is not typical of its family.

Cioxeamastia polycalypta, n. sp.

The holotype (U.S.M.N. no. 22691) was dredged in Fox Basin at a depth of 34–37 fathoms, August 13, 1927. It is subspherical, 3 cm in diameter, with about 50 closed fistules of the *Polymastia* type, each 1 by 3 mm in transverse section and 4 mm high. The consistency is spongy and the color pale dull yellow. The surface is smooth and lipostomous. The ectosome is not detachable or conspicuously different from the rather dense endosome; in this regard it is not typical of the Halichondriidae. The spicules, as in *Halichondria*, consist of oxeas of great variation in size and in more or less confusion; most of them range in size from 4 by 200 to 12 by 700 μ .

Hymeniacion heliophila (Parker)

This species was described as *Stylotella heliophila* by Parker (1910, p. 766) in his famous discussion of the development of the nervous system. His species is a typical *Hymeniacion* and is extremely close to *H. carnuncula*, the common European *Hymeniacion*. The two may be synonymous. The Greenland specimen is definitely more like the American-Atlantic species (*heliophila*) than the European-Atlantic ones.

Captain Bartlett took this sponge while otter-trawling off Wolstenholm Island, northwest Greenland, in 13–25 fathoms, on July 23, 1940.

Polymastia bartletti, n. sp.

The holotype (U.S.N.M. no. 22692) was dredged in Fox Basin, lat. 67° 45' N., long. 79° 09' W., at 38 fathoms on August 24, 1927. It is subspherical, about 6 cm in diameter, and somewhat flattened on top and bottom. The consistency is firm but elastic, and the color a very pale yellow. The surface is very smooth except that there are about a dozen large conules or fistules about 6 mm high and 6 mm diameter at the base, together with several dozen smaller conules about 1.5 mm high and

2 mm diameter. No oscules are evident. The ectosome is a dense cortex 1.5 to 2 mm thick. The endosome is "crumb-of-bread" and more of the ochre-yellow than is the (paler) cortex.

The ectosomal spicules are tylostyles 6 by 350 to 6 by 400 μ , erect, with points toward the exterior. The endosomal spicules are tylostyles 9 by 540 to 12 by 600 μ ; the larger each is, the less pronouncedly tylole it is. Most of these are arranged in rough tracts about 130 μ in diameter. Between these, there are many spicules strewn in confusion, some of which are as small as 4 by 200 μ .

But for the cone-shaped fistules this would be a typical *Suberites*. One would suggest comparison with *Suberites insignis* Carter (1886, p. 118), from south of Australia, which is described as resembling a nudibranch, but unfortunately not figured. The present species differs from most of the representatives of the genus *Polymastia* in that the latter have much longer fistules. There are, however, two already described with very low fistules, as follows: *Polymastia laganoides* Lambe (1894, p. 129) from Bering Sea (Arctic), which has three sizes of spicules and is probably most closely related to *P. bartletti*; and *Polymastia megasclera* Burton (1934, p. 567), from Australia, which has extremely large spicules.

This species is named in honor of Capt. Robert A. Bartlett.

Tentorium semisuberites (Schmidt)

This species was described as *Thecophora semisuberites* by Schmidt (1870, p. 50) from Greenland. Lambe (1896, p. 198) recorded it from northeastern Canada. The specimen collected by Captain Bartlett is astonishingly like Schmidt's original, even to having just four symmetrically placed oscular chimneys on the dome-shaped upper surface. It was dredged at 20-30 fathoms on September 3, 1933, at the entrance to Fury and Hecla Straits.

CLASS HYALOSPONGIAE

Trichasterina sagittaria Topsent

This species was described by Topsent (1913, p. 9) from the Arctic. The specimen collected by Captain Bartlett was dredged at a depth of 110 fathoms on July 29, 1931, off East Greenland, lat. 74° 21' N., long. 16° 30' W.

Acanthascus nealus, n. sp. Fig. 1 E

The holotype (U.S.N.M. no. 22693) was dredged at 120 fathoms depth on July 30, 1931, off East Greenland, lat. 74° 04' N., long. 17° 58' W. It is a cone-shaped vase and shows no certain indication of having been erect. It is 10 cm long and 10 cm diameter, with walls about 1 cm thick. The consistency is fragile and the color dirty drab. The walls are pierced by canals of three sizes; the largest are 3 mm in diameter, the medium ones nearly 1 mm in diameter, and the abundant smaller ones are microscopic. The surface is nearly smooth, not at all hispid.

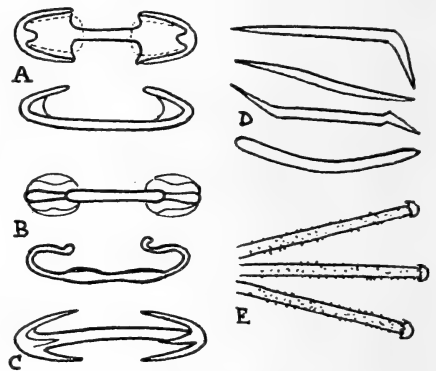

Fig. 1.—A, Microscles of *Isodictya histodermella*, n. sp., $\times 750$; B, microscles of *Isodictya palmata*, from Bowerbank, "Monograph of the British Spongiadae," 1866, plate 52, $\times 750$; C, microscles of *Myxilla acribria*, n. sp., $\times 250$; D, microscles of *Leucettusa usa*, n. sp., $\times 205$; E, microscles of *Acanthascus nealus*, n. sp., ends of the discoasters, $\times 500$.

Another specimen was dredged the same day at the same place. There are a number of fragments each about the size of the palm of the hand. It would appear that if fitted together correctly they would form a cone-shaped vase 15 cm long and 11 cm in diameter at the open end. This vase, however, to judge from its attachments to rocks, was decidedly not upright, but lay on its side as it grew. The pointed end clearly shows that it was not attached. The walls vary from 5 cm thick at the open end of the cone to 15 mm thick as the closed (pointed) end of the cone is approached.

The bulk of the spiculation consists of diactines up to 65 μ in diameter and 20 mm long. These make a felted mass. Their ends often are strongly lute and microspined. The dermal and

so-called gastral spicules are regular hexactines, each ray about 10 by 200 μ and entirely microspined; a few are pentacts and stauracts. They are somewhat smaller in the smaller of the two specimens. The microscleres consist of abundant commonplace oxyhexasters 125 μ in diameter, and discohexasters of the same diameter. The latter were not found in the second (larger) specimen but may have been really present, or possibly washed out as the specimen was in a damaged condition. They are not typical for this genus.

In spite of minor differences these two specimens may be confidently regarded as conspecific. The evidence that they grew naturally on one side is not regarded as peculiar; many other *Hyalospongia* may have grown similarly, but once detached from the bottom by a dredge they cease to give evidence thereof. It is suggested that such tilted positions are associated with a bottom current regularly in one direction rather than currents coming at one time or another from different directions. There are now six species of this genus.

Three are decidedly hispid:

A. cactus Schulze (1886, p. 48), the genotype, from Japan, has dermal and gastral pentacts where most of the others have hexacts. The shape is cylindrical.

A. platei Schulze (1899, p. 45), from California, is like the above but with dermal and gastral hexacts.

A. grossularia Schulze (1886, p. 48), from the Antarctic, is similar to both the above but has two sorts of discohexasters instead of one.

Three are smooth, not hispid:

A. pachyderma Okada (1932, p. 94), from Japan, is similar to *platei* except for being smooth surfaced, thick-walled, and oval.

A. alani Ijima (1898, p. 55), from Japan, is like the above except that it has two sorts of discohexasters instead of one.

A. nealus (new species) from Greenland is similar to *pachyderma* except that it is thin-walled and conical.

Class CALCISPONGIAE

Leuconia ananas (Montagu)

This species was described by Montagu (1812, p. 97) as *Spongia ananas*. It is fairly common in the Arctic and about the Scandinavian coasts.

Captain Bartlett dredged two specimens of this sponge on August 4, 1927, in 25 fathoms, 4 miles east of Cape Dorchester, and one other specimen in Fox Basin, August 26, 1927, at 25-31 fathoms. All three specimens are more distinctly pedicillate than usual for this species.

Sycandra hebe, n. sp.

The holotype (U.S.N.M. no. 22694) was dredged on August 12, 1927, at a depth of 32-37 fathoms, in Fox Basin, lat. 66° 43' N., long. 80° 07' W. It is a cylinder 11 mm high. The lower half is nearly solid and only 1 mm in diameter. The consistency is as fragile as in most Calcispongiae, and the color is the usual white. The surface is fairly smooth. The terminal cloaca is less than 1 mm in diameter. The walls are about 170 μ thick, containing often only a single layer of flagellate chambers about 80 μ in diameter, 160 μ long.

The bulk of the spiculation consists of regular triaxons with rays 5 by 50 to 8 by 120 μ . There are diactines with one ray only about 20 μ long, at 120° to the other, which is nearly 300 μ long; their diameter is 15 μ . These occur felted in the wall, often protrude into the cloaca, and sometimes protrude slightly at the surface at an acute angle (nearly tangent) to it.

Associated with the protrusion of these diacts into the cloaca are protoplasmic auxiliaries so that there are cloacal trabeculae. These have hitherto been associated with the solitary species of *Sycandra*, its genotype; this was originally described by Schmidt (1870, p. 74), as *Ute utriculus*, and is recorded from Greenland and the North Atlantic. Many other sponges were temporarily supposed to be in the genus *Sycandra*, chiefly by Haeckel, but have been removed to the correct genera, chiefly by Dendy and Row.

One must keep in mind the possibility that the present specimen may be a juvenile *Sycandra utriculus*, but data to that effect are wanting as yet. The specimen collected by Captain Bartlett lacks the gastral tetraxons of *utriculus*, and has diactines much smaller than those (12 by 1500 μ) of *utriculus*.

Scypha lingua (Haeckel)

This species was described as *Sycortis lingua* by Haeckel (1872, p. 278) from Newfoundland. The sponge described by Haeckel (1872, p. 353)

as *Sycandra arctica* var. *polaris*, which was elevated to specific rank by Dendy and Row (1913, p. 747) is synonymous with *Scypha lingua*. Captain Bartlett dredged this species from a depth of 25–31 fathoms in Fox Basin, August 26, 1927.

It is notable that another member of the genus *Scypha* has been recorded from western Greenland; this was described as *Sycon karajakense* by Breitfuss (1898, p. 207) but differs strikingly from *lingua* in having small strongyles on the distal tufts where *lingua* has long oxeas.

Sycetta sagitta, n. sp.

The holotype (U.S.N.M. no. 22695) was collected at the west end of White Island, Frozen Strait, Fox Channel, August 10, 1933. It is ovoid, subcylindrical, of typical sycon-type architecture. It is 18 mm high and 4.5 mm in diameter where it is thickest. The consistency is softly fragile and the color is a pale yellow. The surface is nearly smooth, devoid of terminal tufts for the flagellate chambers. The terminal oscule is barely 300μ in diameter, and the cloaca scarcely wider. The flagellate chambers are about 120μ in diameter and 450μ long.

The principal spicules are pronouncedly sagittal triactines, some actually T-shaped. The shorter (paired) rays are about 4 by 100μ and the basal (unpaired) rays about 5 by 300μ . The gastral spicules are sagittal as usual, with the apical ray (projecting into the cloaca) somewhat bent. By very careful search two gastral tetractines (or quadriradiates) were found and one freakish pentactine. This is clearly very close to *Sycetta sagittifera* Haeckel (1872, p. 240), from Ceylon, but there are several definite differences between the two species. The Ceylon species has flagellate chambers less packed together, and as a result looks lumpy from the surface, while *sagitta* is smooth. Haeckel records no tetractines at all. Some of his spicules have rays 6 by 800μ , whereas none of those in the Greenland specimen are nearly that large. As these two closely related species become better known, more differences between them may perhaps be discovered.

Leucettusa usa, n. sp. Fig. 1 D

The holotype (U.S.N.M. no. 22696) was collected in Fox Basin, at a depth of 25–31 fathoms, on August 26, 1927; two others were taken in the same haul, and a fourth was collected August 13, 1927, at 34–37 fathoms in Fox

Basin, lat. $66^{\circ} 46' N.$, long. $79^{\circ} 15' W.$ This last is the largest of the four.

The shape is very irregularly subcylindrical, in one case wider than high. The sizes are 20 to 34 mm high, 10 to 22 mm wide. The consistency is quite spongy for a Calcsponge, and the color is white. The surface is smooth, with very small pores. The apical oscule is from 2 to 7 mm in diameter, varying directly with the diameter of the sponge, independent of the height. The ectosome has more spicule content, and less protoplasm; the endosome has less spicule content and more protoplasm.

The principal spicules are very large tetractines with angles and actines approximately equal but with one pair of opposite actines often somewhat crooked. The rays are often about 85 by $1,100\mu$.

There is a dermal layer of smaller radiates, rays about 30 by 450μ . Some of these are triactines, tangentially placed. Others are tetractines with three rays tangent and one ray hypodermal.

There are vast numbers of very distinctive microscleres. These are sometimes oxeas, but more often bent, even sharply bent. They may have two or more angular bends in their length. Some are strongylote. The size is usually about 3 by 100μ , but with some little variation.

This species is strongly corticate like the type of the genus *Leucettusa*, which was described as *Leucetta corticata* Haeckel (1872, p. 129) from the West Indies; in fact, except for spiculation this species and the one here described are practically identical and very different from all other members of the genus. Yet *corticata* has few (if any) proper tetractines and none of the peculiar microscleres. On the other hand, *Leucettusa dictyogaster* Row and Hozawa (1931, p. 751), from West Australia, has spicules nearly exactly like those of *usa*, although its microscleres are twice as thick as those in the Greenland sponge. Furthermore, the Australian species is scarcely corticate at all, and has a very peculiar habitus of anastomosing tubes.

Leucosolenia macleayi (Lendenfeld)

This species was described as *Ascetta macleayi* by Lendenfeld (1885, p. 1086) from Australia, but it was soon found to be abundant and cosmopolitan. Captain Bartlett's specimen came from 20–30 fathoms near the entrance to Fury and Hecla Straits on September 3, 1933.

LITERATURE CITED

- BOWERBANK, J. S. *A monograph of the British Spongiadae* 2: 1-388. Ray Society, London, 1866.
- BREITFUSS, L. L. *Catalog der Calcareae der zoologischen Sammlung des königlichen Museums für Naturkunde zu Berlin*. Arch. Naturg. 63: 205-226. 1898.
- BRØNSTED, H. V. *Conspectus faunae Groenlandicae. Porifera*. Medd. om Grønland 23(2): 457-544. 1914.
- . *The Godthaab Expedition 1928: Porifera*. Medd. om Grønland 79(5): 1-25. 1933.
- BURTON, M. *Sponges*. Great Barrier Reef Exped. Sci. Repts. 4(14): 513-614. 1934.
- CARTER, H. J. *Descriptions of sponges from the neighborhood of Port Phillip Heads, South Australia, continued*. Ann. Mag. Nat. Hist. (ser. 5) 17: 40-53, 112-127, 431-441, 502-516. 1886.
- DENDY, A., and R. W. H. ROW. *The classification and phylogeny of the calcareous sponges; with a reference list of all the described species, systematically arranged*. Proc. Zool. Soc. London, 1913: 704-813.
- FRISTEDT, K. *Sponges from the Atlantic and Arctic Oceans and the Bering Sea*. Vega-Expeditionens Vetensk. Iakttagelser (Nordenskiöld) 4: 401-471. 1887.
- HAECKEL, E. *Die Kalkschwämme: eine Monographie* . . . 2: 1-418. Berlin, 1872.
- HANSEN, G. A. *Spongiadae*. The Norwegian North-Atlantic Expedition 1876-78, 13: 1-25. Christiania, 1885.
- HENTSCHEL, E. *Die Kiesel- und Hornschwämme des nördlichen Eismeers*. Fauna Arctica 5: 859-1042. 1929.
- IJIMA, I. *The genera and species of Rossellidae. Preliminary notice*. Annot. Zool. Japon. 2: 41-55. 1898.
- JOHNSTON, G. *A history of British sponges and Lithophytes*: xii+264 pp. Edinburgh, London, Dublin, 1842.
- LAMARCK, J. B. P. A. deM. *Sur polypiers empâtes*. Ann. du Muséum 20: 370-386, 432-458. 1813.
- LAMBE, L. *Sponges from the western coast of North America*. Proc. and Trans. Roy. Soc. Canada 12(4): 113-138. 1894 [1895].
- LENDENFELD, R. VON. *A monograph of the Australian sponges. Part III*. Proc. Linn. Soc. New South Wales 9: 1083-1150. 1885.
- LEVINSEN, G. M. R. *Kara-Havets Svampe (Porifera)*. Dijnpha-Togtets zool. bot. Udbytte: 341-372. 1886.
- LUNDBECK, W. *Porifera. Part I: Homorhaphidae and Heterorrhaphidae*. Danish Ingolf-Expedition 6: 1-108. 1902.
- . *Porifera. Part II: Desmacidonidae (pars)*. Danish Ingolf-Expedition 6: 1-219. 1905.
- MONTAGU, G. *An essay on sponges, with descriptions of all the species that have been discovered on the coast of Great Britain*. Mem. Werner. Soc. 2: 67-122. 1818.
- OKADA, Y. *Report on the hexactinellid sponges collected by the United States Fisheries steamer Albatross in the Northwestern Pacific during the summer of 1906*. Proc. U. S. Nat. Mus. 81 (2935): 1-118. 1932.
- PARKER, G. H. *The reactions of sponges with a consideration of the origin of the nervous system*. Journ. Exp. Zool. 8: 765-805. 1910.
- RIDLEY, S. O., and A. DENDY. *Preliminary report on the Monaxonida collected by H.M.S. Challenger. Parts I and II*. Ann. Mag. Nat. Hist. (ser. 5) 18: 325-351, 470-493. 1886.
- ROW, R. W. H., and S. HOZAWA. *Report on the Calcareae obtained by the Hamburg South-west Australian Expedition of 1905*. Sci. Rep. Tohoku Imp. Univ. (ser. 4: Biol.) 6(4): 727-809. 1931.
- SCHMIDT, O. *Grundzüge einer Spongien-Fauna des atlantischen Gebietes*: iv+88 pp. Leipzig, 1870.
- SCHULZE, F. E. *Ueber den Bau und das System der Hexactinelliden*. Abh. Akad. Wiss. Berlin, 1886: 1-97.
- . *Amerikanische Hexactinelliden nach dem Materiale der Albatross-Expedition bearbeitet*: 126 pp. Jena, 1899.
- TOPSENT, E. *Spongiaires provenant des campagnes scientifiques de la Princesse Alice dans les mers du Nord (1898-1899, 1906-1907)*. Résult. Camp. Sci. Monaco 45: 1-67. 1913.
- VOSMAER, G. C. J. *Report on the sponges dredged up in the Arctic Sea by the Willem Barents in the years 1878 and 1879*. Nederl. Arch. Zool. Suppl. 1: 1-58. 1882.
- . *The sponges of the Willem Barents Expedition from 1880 and 1881*. Bijdr. Dierk. 12: 1-47. 1885.

ZOOLOGY.—*Sinocybe*, a new genus of *colobognath* millipeds from China.¹ H. F. LOOMIS, Bureau of Plant Industry.

The milliped order Colobognatha is considered more primitive than any of the other orders of Chilognatha, as its mouthparts are of simplified form, adapted to sucking, instead of being developed into the more complicated mechanisms required for chewing foods. Parallel, but not necessarily simultaneous, evolution of structures is indicated by the fact that in this order legs 9 and 10 of the males have been modified for sexual purposes, whereas in other orders having these structures, termed "gonopods," at the anterior end of the body, legs 8 and 9 are modified. The gonopods of Colobognatha have not been changed to the extent found in the other orders, where the variations of structure offer many of the best taxonomic characters. There are other structural features in this order also which give evidence of closer association with prehistoric forms.

Geographic distribution of the order is another measure of its antiquity, for, while the members are found in all of the continents and many adjacent islands, relatively few genera and species are involved and, because of this and their diversity, these are looked upon as somewhat disconnected remnants of a much more populous fauna in past eras.

At the present time the Central American tropics and Malaysia vie for the lead in number of known species, although the United States is not far behind and has a diversity of forms surpassing all other countries.

One of the most typical of the Central American families of millipeds, although a small one, is the Platydesmidae of the present order. As the name implies, its species are very broad, with great development of the lateral carinae, and the legs are separated by broad sterna. This family is not known in the United States but is replaced by the Andrognathidae, containing some species resembling the platydesmids, in development of carinae, while others do not, being more slender, although to both forms

narrow sterna are common. The superficial resemblance of the broad forms of these two families, which have quite similar gonopods, has caused many diplopodists to recognize only a single family. There are no more fundamental differences, however, between related families than the narrow sterna of the Andrognathidae, supporting a fungiform process separating the legs, and the very wide, simple sterna of the Platydesmidae lacking any counterpart of that process.

The Malayan genus *Pseudodesmus*, long referred to the latter family, has very narrow sterna, but whether a fungiform process is present is not known, although the narrow sterna alone are sufficient grounds for removing the genus from the Platydesmidae and locating it near or in the Andrognathidae, the latter course being followed here.

The discovery, 23 years ago, of a new generic member of the Andrognathidae in the Lu Mountains, Kiangsi Province, China, provides a connecting link, both geographically and structurally, between *Pseudodesmus* and the North American *Brachycybe*. The new genus is represented by two specimens, a male and nearly mature female, collected by O. F. Cook and the writer near Kuling, not far from the site where many specimens of an extremely bizarre milliped, later made the type of a new and archaic family of the order Merocheta,² were found. The presence of *Sinocybe*, as the new genus is to be named, lends further support to the view that the Lu Mountains contain a residual but superficially known milliped fauna of great age.

***Sinocybe*, new genus**

Type: *Sinocybe cooki*, new species, from central China.

Diagnosis.—*Sinocybe* occupies a place almost intermediately between the North American *Brachycybe* and the Malayan *Pseudodesmus*. As compared to *Pseudodesmus* the body is smaller;

² COOK, O. F., and H. F. LOOMIS. A new family of spined millipeds from central China. Journ. Washington Acad. Sci. 14 (5): 103-108. 1924.

¹ Received April 22, 1942.

relatively broader; less convex; with fewer segments; surface less strikingly sculptured, although having two transverse series of tubercles instead of one; the preanal scale is in a special excision of the last segment, rather than excluded from it as shown in Pocock's illustration of *Pseudodesmus verrucosus*.³ *Sinocybe* differs from *Brachycybe* in being much more convex; dorsal sculpture more strongly developed, especially on the anterior segments; head much flatter and thinner and with a raised margining rim on each side above the antenna; first segment strongly deflexed, thick, without expanded and projecting carinae and only slightly wider than the head.

Description.—Body close-jointed, the size and shape almost the same as the Californian *Brachycybe rosea* Murray, but the dorsal arch much higher (Fig. 1, B), with the head and anterior segments sloping or deflexed (Fig. 1, A), while in *Brachycybe* the anterior segments are horizontal.

Head turned underneath the first segment so that the vertex does not project beyond the first segment when viewed from above (Fig. 1, C), subcordate in outline when viewed from in front; in profile very thinly lenticular; raised marginal rim present above each antenna, surface pubescent along the posterior margin, elsewhere glabrous and very minutely punctate; antennae rising from the sides of the head, rather robust and compact, none of the joints notably elongate or crassate; gnathochilarium as in *Brachycybe*.

First segment facing forward, vertical to the body; rather small and thick as in *Pseudodesmus* and like it in being without produced carinae or expanded margins; surface finely and densely pubescent, with several large, elongate tubercles, but without a series of smaller tubercles as on the other segments.

Following anterior segments with lateral carinae produced forward as in *Brachycybe*, but with the posterior margin overlapped by the carinae of the next segment (Fig. 1, C); in *Pseudodesmus* the carinae are more strongly produced forward, the outer limits narrowed, subacute, whereas in *Sinocybe* they are broadly rounded, subtruncate; second segment with carinae much thicker than any others, the dorsum

strongly arched and the transverse crest beset with tubercles in a single series; segments 3 and 4 with the crest reduced but bearing a single series of tubercles; subsequent segments with two rows of tubercles, dorsum with a strongly impressed median sulcus and a less definite transverse depression between the rows of tubercles; surface above and below pubescent; lateral carinae projecting outward as in *Brachycybe*, the pore in the margin, near the posterior corner (Fig. 1, D).

Posterior segments of the same general pattern as in *Brachycybe*; the penultimate segment with the two rows of tubercles scarcely reduced in size.

Last segment not tuberculate above; pubescent on the sides only; apical margin with six small teeth; ventral margin deeply excised and completely enclosing the moderately sized and nearly semicircular preanal scale on the sides and in front (Fig. 1, E); a shallower, less apparent excision is present in *Brachycybe* but in *Pseudodesmus*, as shown in Pocock's illustration (*loc. cit.*), the scale does not indent the margin of the last segment in the least.

Legs scarcely attaining the sides of the body; coxae narrowly separated; each sternum with a small anterior median lobe projecting slightly forward between the coxae of the preceding legs; each coxa with an inflated sack arising from an apical perforation.

Gonopods rather small and compact, resembling partially atrophied legs, as in *Brachycybe*.

Sinocybe cooki, new species

A mature male and a nearly mature female collected at Kuling, Kiangsi Province, China, October 17, 1919, by O. F. Cook and H. F. Loomis. Male type in the U. S. National Museum; female paratype in Museum of Comparative Zoology, Cambridge, Mass.

Description.—Body of the type 18 mm long and 3 mm wide, composed of 55 segments; similar in outline to *Brachycybe rosea* Murray but body arch much higher.

Head bent obliquely under body; cordate in front view, thinly lenticular in profile; surface finely pubescent along posterior margin, elsewhere glabrous, shining and very minutely punctate; margins of head, above antenna sockets, with a fine raised rim reaching half way to the middle of the posterior margin; antennae

³ Ann. Mag. Nat. Hist. (ser. 5) 20: pl. 14, fig. 3. 1887.

at sides of head; moderately robust; joints 1, 3, 4, and 5 subequal, about as broad as long, slightly exceeded by joints 2 and 6, the latter somewhat broader than the other joints.

First segment almost vertical, at a right angle to the long axis of the body; size small, scarcely wider than the head; thick and without expanded or projecting margins; median surface strongly impressed longitudinally, the surface on either side of the middle with three large, crest-like tubercles; one near the front corner directed obliquely backward and outward; an-

brous above but not below; last few segments with dorsum much less pubescent between the large submedian tubercles than elsewhere.

Second segment with forwardly produced lateral carinae much thicker than the other carinae; dorsum strongly arched, transversely elevated into a broad, indefinite ridgelike prominence or crest bearing a series of 10 to 12 rounded tubercles of which the inner one on each side is the largest; next two segments crossed by decreasingly elevated tuberculate crests; segments thereafter with two series of

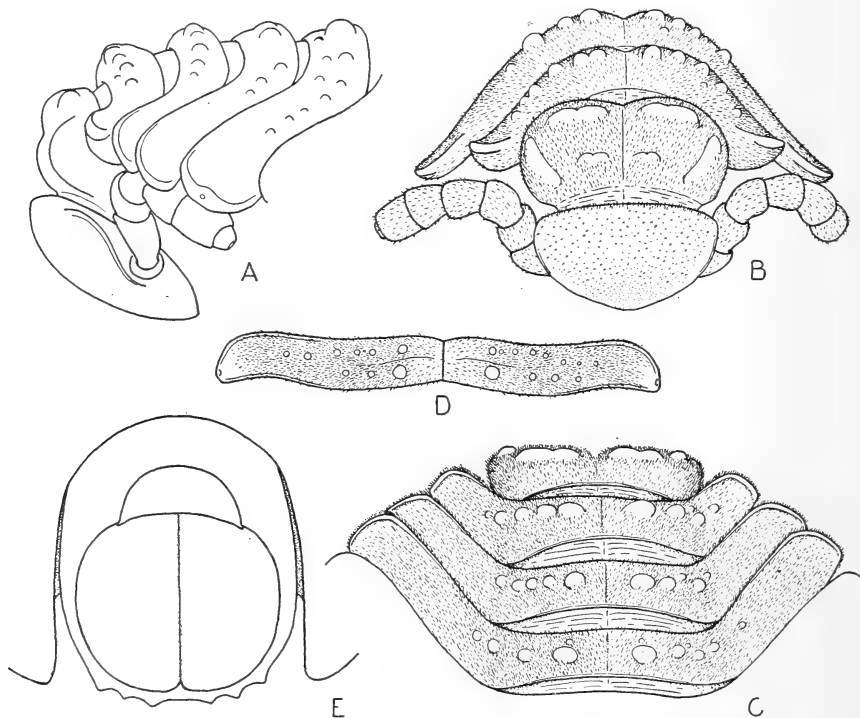

Fig. 1.—*Sinocybe cooki*, new species: A, Head and first five segments, lateral view; B, head and first three segments, anterior view; C, anterior end of body showing first four segments, dorsal view; D, segment from middle of body, dorsal view; E, last segment, anal valves and preanal scale, ventral view.

other of equal size close to the posterior margin and paralleling it; the third tubercle less than half as large as the others, transverse, slightly in front of the middle of the segment and rather close to the median impression; surface of segment with dense, subappressed pubescence but the tubercles smooth and shining; other segments with pubescence similarly disposed except that a small area near the pore is glabrous, and on the posterior segments the pubescence recedes from the lateral carinae and the last half dozen carinae are almost completely gla-

tubercles separated by a depression extending half way to the lateral margin; anterior series of tubercles extending farther laterad and containing 12 to 18 tubercles decreasing in size from the large median pair; posterior series with 6 to 8 tubercles, the median pair of both series largest; on the anterior segments the inner pair of tubercles rather close together but wide apart on the posterior segments; lateral carinae declined from the dorsum with the outer portion becoming almost horizontal; outer margin short, the anterior corner broadly

rounded, the posterior corner slightly produced caudad; pore opening outward from the margin near the posterior corner; carinae of the anterior segments overlapped behind by the carinae of the next segment; margins of the outer half of the carinae raised above the inner surface but gradually lowered after the first few segments.

Penultimate segment with lateral carinae produced straight back, widely separated; the inner margins parallel, smooth; the outer margins, and those of several preceding segments, finely serrate.

Last segment longer than broad, the dorsum longer than on any other segment; surface smooth and glabrous except on the sides which are slightly pubescent; apex broadly rounded and with six small, subapical, marginal teeth or tubercles; ventral margin with a deep, semicir-

cular excision which completely surrounds the preanal scale on the sides and in front.

Preanal scale almost a semicircle, crescentic, the posterior margin lightly emarginate, continuing the line of the margin of the last segment around the anal valves.

Valves strongly inflated, together almost hemispherical, the margins meeting in a groove.

Legs close together, the narrow sterna with anterior lobes projecting up and forward between the coxae of the preceding legs; coxae each with an inflated sack projecting from an apical perforation; tip of legs just attaining the sides of the body.

Gonopods closely resembling those of *Brachycybe*, being short, rather stout, curved forward and inward, and with easily distinguished leg-like joints.

PROCEEDINGS OF THE ACADEMY AND AFFILIATED SOCIETIES

THE ACADEMY

374TH MEETING OF THE BOARD OF MANAGERS

The 374th meeting of the Board of Managers was held in the library of the Cosmos Club on March 16, 1942. President CURTIS called the meeting to order at 8:01 P.M., with 23 persons present, as follows: H. L. CURTIS, F. D. ROSINI, H. S. RAPPLEYE, N. R. SMITH, R. J. SEEGER, F. H. H. ROBERTS, JR., F. G. BRICKWEDDE, H. B. COLLINS, JR., F. C. KRACEK, W. G. BROMBACHER, F. M. SETZLER, H. L. HALLER, A. H. CLARK, A. WETMORE, J. E. McMURTREY, JR., W. A. DAYTON, F. B. SILSBEE, E. W. PRICE, L. W. PARR, H. G. DORSEY, H. STABLER, and, by invitation, G. A. COOPER and J. R. SWALLEN.

The minutes of the 373d meeting were read and approved. President CURTIS announced the following appointments:

Committee to consider certain questions relating to the membership: H. B. COLLINS, JR. (chairman), and E. W. PRICE.

Committee to consider the petition for affiliation of the District of Columbia Society of Medical Technologists: L. W. PARR (chairman), F. H. H. ROBERTS, JR., and A. H. CLARK.

Committee to consider ways and means of increasing the income of the Academy: W. A. DAYTON (chairman), H. S. RAPPLEYE, and F. B. SILSBEE.

For the Committee on Membership, Chairman KRACEK presented nominations for 6 persons (4 resident and 2 nonresident).

Three persons, one each from Canada, Mexico, and Argentina, were considered in-

dividually and duly elected to honorary membership.

For the Committee to consider certain questions relating to membership, Chairman COLLINS presented a report recommending (a) that three members of the Committee on Membership be reappointed each year in order to increase the degree of continuity in that Committee, (b) that more honorary members from South America be considered, and (c) that the number of honorary members be limited by the present Board to 25. The Board approved these recommendations.

For the Committee to consider the petition for affiliation of the District of Columbia Society of Medical Technologists, Chairman PARR presented a report recommending that this petition be declined. The Board approved this recommendation.

For the Committee to consider ways and means of increasing the income of the Academy, Chairman DAYTON presented a report recommending (a) that the number of active resident members be increased from 450 to 600, (b) that the membership of the Academy be canvassed regarding the matter of increasing dues from \$5 to \$6 annually, (c) that a Committee be appointed to obtain patrons for the Academy, and (d) that the JOURNAL of the Academy consider the placing therein of appropriate paid advertising. The Committee also reported that 33 State Academies of Science affiliated with the American Association for the Advancement of Science were being circularized with an appropriate questionnaire. The Board acted separately on each of the foregoing recommendations, as follows: (a) It was decided

to submit to the membership for their approval a proposed amendment to the bylaws increasing the permissible number of resident members from 450 to 500; (b) it was decided not to consider increasing the membership dues; (c) the President was authorized to appoint a Committee on patrons for the Academy; (d) the question of obtaining income by selling advertising space in the JOURNAL was referred to the Board of Editors. The Committee was thanked for the work accomplished.

The Secretary reported the following data relating to the membership: Acceptances, 2; qualified, 1; retirements, 1; status of membership as of March 16, 1942:

	Regular	Retired	Honorary	Patrons	Total
Resident	433	36	3	0	472
Nonresident	129	19	13	2	163
Total	562	55	16	2	635

The Secretary reported as follows on the "List of Officers for 1942 of the Washington Academy of Sciences and its Twenty Affiliated Societies": 1500 copies of a 4-page booklet, without cover, under the foregoing title, were published under date of February 9, 1942, with mailing actually being made on February 21, 1942. The cost was as follows: Editorial services, \$10; printing, \$20.20; total, \$30.20. Since a total of \$60 was allotted for the job, a balance of \$29.80 remains in the treasury.

Archivist SMITH reported that he had opened the sealed package relating to the selection of the original membership of the Academy by the Joint Commission of the Scientific Societies of Washington and found nothing in it of particular interest. Only one ballot carried any notation beyond that of the marks for balloting.

On recommendation of the Board of Editors, it was moved and carried that (a) the operational increase of 6 per cent proposed by the George Banta Publishing Co. as a surcharge effective with the issue of April 15, 1942, be approved; (b) the practice of giving free to authors 50 reprints without covers be discontinued after the March 15, 1942, issue; (c) the Executive Committee be authorized to reconsider, in consultation with the Board of Editors of the JOURNAL, the 1942 budget allotment for the JOURNAL.

Following a statement by the Secretary that the bylaws were in need of revision on several noncontroversial points, it was moved and carried that the President appoint a Committee to consider proposed amendments to the bylaws.

Following some considerable discussion, it was moved and carried that the President appoint a Committee to consider ways and means of decreasing the operating expenses of the Academy without decreasing the services performed.

311TH MEETING OF THE ACADEMY

The 311th meeting of the Academy was held in the assembly hall of the Cosmos Club at 8:15 P.M. on March 19, 1942, with President CURTIS presiding.

The meeting was devoted to the presentation by the Academy of its Awards for Scientific Achievement for 1941, as follows:

For the Biological Sciences, to G. ARTHUR COOPER, U. S. National Museum, in recognition of his distinguished service in the field of invertebrate paleontology, notably for the discovery of anatomical structures hitherto unknown.

For the Engineering Sciences, to THEODORE R. GILLILAND, National Bureau of Standards, in recognition of his distinguished service in originating automatic ionosphere recordings for continuously variable radio frequencies.

For the Physical Sciences, to STERLING B. HENDRICKS, U. S. Bureau of Plant Industry, in recognition of his distinguished service in determining the constitution of micaceous and other complex minerals.

The recipients were introduced by ALEXANDER WETMORE, HERBERT GROVE DORSEY, and FRANCIS O. RICE, respectively, and gave brief addresses concerning the work for which they were given the awards.

There were about 70 persons present. A social hour followed the meeting.

312TH MEETING OF THE ACADEMY

The 312th meeting of the Academy was held in the assembly hall of the Cosmos Club at 8:15 P.M. on April 16, 1942, with President CURTIS presiding.

PAUL R. HEYL, chief of the section on sound at the National Bureau of Standards, delivered an address entitled *Cosmic emotion*, published in the August, 1942, issue of this JOURNAL.

There were about 110 persons present. A social hour followed the meeting.

375TH MEETING OF THE BOARD OF MANAGERS

The 375th meeting of the Board of Managers was held in the library of the Cosmos Club on May 18, 1942. President CURTIS called the meeting to order at 8:01 P.M., with 18 persons present, as follows: H. L. CURTIS, F. D. ROSSINI, N. R. SMITH, W. W. DIEHL, R. J. SEEGER, J. E. GRAF, F. H. H. ROBERTS, JR., H. B. COLLINS, JR., F. C. KRACEK, W. G. BROMBACHER, F. M. SETZLER, J. B. REESIDE, JR., F. B. SILSBEE, E. W. PRICE, C. L. GARNER, and, by invitation, G. A. COOPER, J. R. SWALLEN and C. E. CHAMBLISS.

The minutes of the 374th meeting were read and approved. President CURTIS announced the following appointments:

Committee on patrons for the Academy: C. E. CHAMBLISS (chairman) H. C. FULLER, C. L. GARNER, and J. W. MCBURNEY.

Committee to consider proposed amendments to the bylaws: F. B. SILSBEE (chairman), N. R. SMITH, and F. D. ROSSINI.

Committee to consider ways and means of decreasing the operating expenses of the Academy: F. G. BRICKWEDDE (chairman), E. W. PRICE, and H. STABLER.

For the Executive Committee, President CURTIS reported that this Committee had held a meeting just preceding the meeting of the Board, had received written and oral reports from the Board of Editors regarding the needs of the JOURNAL for more funds in order to publish as much or slightly more material in 1942 than in 1941, had received through the Secretary an oral report from the Treasurer that the Academy would probably just balance its budget for 1942 with the present allotments, and had unanimously agreed to recommend to the Board that no change be made in the allotment to the JOURNAL for 1942. The Committee felt that any funds available for the JOURNAL should be conserved for the next year, when its needs for assistance would certainly be greater.

For the Committee on Meetings, Chairman GARNER presented a summary report on the activities and budget of his Committee for the past 12 months. He reported that the Academy had held 7 meetings from October, 1941, through April, 1942, at an average cost of \$40.56 per meeting. This was slightly less than normal because, for the October, 1941, meeting, half of the expenses were paid by the Washington Society of Engineers. Under the present plans, each meeting of the Academy normally costs about \$45, which includes, on the average, \$20 for the rental of the assembly hall, \$9 for the lantern operator, \$3 for dinners for the Speakers, and \$13 for the buffet luncheon. It was recommended that consideration be given to obtaining as many out-of-town speakers as possible. Of the \$300 allotted to the Committee on Meetings for 1942, \$194.13 has been expended, leaving \$105.87 for the three meetings from October through December. The apparent excess of the pro-rata amount for the first four meetings of 1942 arose from the fact that commitments for the first three meetings were made on the basis of the 1941 budget before the allotment for 1942 was announced.

It was moved and carried that Chairman GARNER and his Committee be commended for their good work.

For the Committee on Membership, Chairman KRACEK presented nominations for 17 persons (13 resident and 4 nonresident).

Six persons (4 resident and 2 nonresident), whose nominations had been presented on March 16, were considered individually and duly elected to membership.

For the Committee to consider proposed amendments to the bylaws, Chairman SILSBEE presented a report recommending five amendments, as follows:

(a) In Article I, Section 2, second sentence, after the word "retired" insert: "from the active practice of their profession."

(b) In Article I, Section 2, paragraph 1, add the sentence: "Persons who have been dropped from membership for nonpayment of dues may be reinstated upon approval of the Board of Managers and upon payment of back dues for two years, together with the dues for the year of reinstatement."

(c) In Article III, Section 5, delete the sentence "Associate Editors shall be appointed by the President for a term of three years." (This sentence properly belongs in the Standing Rules of the Board.)

(d) In Article IV, Section 1, third sentence, delete the first "and," and after "publications" insert "and Committee of Tellers." In Article VI, Section 1, change the last paragraph to read: "The Committee of Tellers shall canvass the votes and report the results at the annual meeting of the Academy." (This change would permit the Committee of Tellers to read their own report at the annual meeting, instead of transmitting it to the Secretary.)

(e) In Article VI, Section 1, fourth paragraph, last sentence, change "second Tuesday" to "first Thursday." (This change would give the Committee of Tellers always two weeks in which to count the ballots. Under the existing rule, the time may be as short as one day.)

The Board voted to submit these proposed amendments, with the word "gainful" in place of "active" in part (a), to the membership for approval.

The Secretary reported the following data relating to the membership: Acceptances, 2; qualified, 1; deaths, 3; retirements, 1; resignations, 3; status of membership as of May 18, 1942:

	<i>Regular</i>	<i>Retired</i>	<i>Honorary</i>	<i>Patrons</i>	<i>Total</i>
<i>Resident</i>	432	35	3	0	470
<i>Nonresident</i>	130	18	15	2	165
	—	—	—	—	—
<i>Total</i>	562	53	18	2	635

Archivist SMITH reported the addition to the Archives of an important document, entitled "Royal Society (of London), Charter-Book Signatures, 1660-1912."

On recommendation of the Board of Editors, the Board approved the following regulation relating to illustrations in the JOURNAL, as of May 15: "Illustrations in excess of the equivalent (in cost) of one page and a half of line drawings shall be paid for by the author."

The Secretary read a letter received from the office of the American Association for the Advancement of Science informing the Academy of its election as an affiliated member of the A.A.A.S. on the same basis as affiliated State academies of science. Each affiliated Academy may appoint one representative on the Council of the A.A.A.S., and two honorary junior

members, one boy and one girl, to the Association. The Association provides a research grant to each Affiliated Academy in the amount, each year, of 50 cents for each member of the Academy who is also a member of the A.A.A.S.

The Secretary read a letter from WALDO L. SCHMITT, resident member of the Academy, recommending that the Academy carry on a drive for increased subscriptions to the JOURNAL in Central and South America by extending one year's free subscription to a number of selected institutions and by widely distributing copies of the contents of the JOURNAL in those countries.

The letter was referred to the Custodian and Subscription Manager of Publications for appropriate reply.

Adjournment was made at 10:04 P.M.

376TH MEETING OF THE BOARD OF MANAGERS

The 376th meeting of the Board of Managers was held in the library of the Cosmos Club on June 8, 1942. President CURTIS called the meeting to order at 8:02 P.M., with 13 persons present, as follows: H. L. CURTIS, F. D. ROSINI, N. R. SMITH, R. J. SEEGER, F. H. H. ROBERTS, JR., H. B. COLLINS, JR., F. C. KRACEK, A. H. CLARK, W. A. DAYTON, L. W. PARR, and, by invitation, G. A. COOPER, J. R. SWALLEN, and J. H. KEMPTON.

The minutes of the 375th meeting were read and approved.

President CURTIS announced the following appointment: A. H. CLARK to be the Academy's representative for 1942 on the Council of the American Association for the Advancement of Science.

For the Committee on Meetings, Chairman KEMPTON reported that STUART MUDD, of the University of Pennsylvania, would address the October meeting of the Academy on the subject *Bacteria and the electron microscope*. He also reported that there appeared to be insufficient funds remaining to carry the normal program of meetings for October, November, and December.

Fifteen persons (13 resident and 2 nonresident), whose nominations were presented on May 18, 1942, were considered individually and duly elected to membership.

For the Committee to consider ways and means of increasing the income of the Academy, Chairman DAYTON presented a report giving in detail the results of the questionnaire sent out to each of 33 State Academies of Science affiliated with the American Association for the Advancement of Science, from whom replies were received from all but two. Chairman DAYTON was complimented on the excellent work of his Committee and was instructed to prepare a summary of his report for distribution to the members of the Board of Managers through the office of the Secretary.

The Secretary presented the following data relating to membership: Acceptances, 4; deaths, 1.

Adjournment was made at 9:24 P.M.

NEW MEMBERS

The following persons were recently elected members of the Academy:

Resident

TAISIA MAXIMOVNA STADNICHENKO, associate geologist, U. S. Geological Survey, in recognition of her microscopic and microthermal studies of coal.

LEO OTIS COLBERT, director of the U. S. Coast and Geodetic Survey, Rear Admiral, in recognition of his leadership in the advancement of the science and art of cartography.

FLOYD SHELTON DAFT, senior biochemist, National Institute of Health, in recognition of his work in biochemistry, particularly his researches with vitamins of the B complex.

HENRY MILES O'BRYAN, associate professor of physics, Georgetown University, in recognition of his contributions to physics, particularly his researches on the solid state.

MERRITT NICHOL POPE, agronomist, U. S. Bureau of Plant Industry, in recognition of his studies on the physiology, morphology, and genetics of barley.

MARY ELIZABETH REID, cytologist, National Institute of Health, in recognition of her contributions in the field of nutrition in relation to growth and development.

STEPHEN BRUNAUER, associate chemist, U. S. Bureau of Plant Industry, in recognition of his researches in the surface layers of adsorbed gases on catalytic and other materials, which have made clear the atomic and molecular characters of various gases when adsorbed on various materials and which have thrown light on the reasons for the catalytic action of promoters in catalysis.

MARY EUGENIE MAVER, senior biochemist, National Cancer Institute, in recognition of her outstanding research on the isolation and purification of physiologically active proteins, such as diphtheria toxins and the proteinase of cellular tissues.

EVELYN BUTLER TILDEN, bacteriologist, National Institute of Health, in recognition of her studies on Protozoa, Oroya fever, trachoma and spirochetal diseases, and the preparation of new and rare sugars by bacterial oxidation, and of a new type of amylase.

CHARLES EDWARD WHITE, professor of inorganic chemistry, University of Maryland, in recognition of his work on fluorescence, particularly as a means of quantitative inorganic microanalysis.

WILLIAM DONALD URRY, physical chemist, Geophysical Laboratory, Carnegie Institution of Washington, in recognition of his work on

natural radioactivity, particularly as applied to problems in geophysics.

LEE MILO HUTCHINS, head of the division of forest pathology, U. S. Bureau of Plant Industry, in recognition of his work on virus diseases of tree fruits, particularly the technique of studying virus diseases of woody plants.

RALPH WILLARD IMLAY, geologist, U. S. Geological Survey, in recognition of his work on the Mesozoic geology of Mexico and the Gulf region of the United States.

KARL HILDING-BEIL, hydraulic engineer, National Bureau of Standards, in recognition of his investigations in connection with aircraft instruments, corrosion and physical properties of copper, and hydraulics.

GEORGE GORHAM DEBORD, bacteriologist, District of Columbia Health Department, in recognition of his work in food and medical bacteriology.

JOSEPH JOHN FAHEY, geochemist, U. S. Geological Survey, in recognition of his meritorious work in geochemistry and mineralogy.

ERNEST FRANKLIN FLOCK, senior physicist, National Bureau of Standards, in recognition of his meritorious work in the field of calorimetry and for revealing studies of combustion processes.

GLENN ARTHUR GREATHOUSE, physiologist, U. S. Bureau of Plant Industry, in recognition of his work on the chemistry of disease resistance in plants.

FOREST KLAIRE HARRIS, associate physicist, National Bureau of Standards, in recognition of his work in the field of precise electrical measurements.

GARGIS HOVENNES KEULEGAN, physicist, National Bureau of Standards, in recognition of his mathematical and experimental investigations in the fields of elasticity and hydrodynamics.

ROBERT M. SALTER, chief, U. S. Bureau of Plant Industry, in recognition of his work in soil fertility, especially fertilizer application and the influence of soil reaction on efficiency of soil and fertilizer phosphorus.

Nonresident

DOW V. BAXTER, associate professor of silvics and forest pathology, School of Forestry, University of Michigan, in recognition of his contributions to forest pathology, particularly his researches on the genus *Poria*.

VILHJALMUR STEFANSSON, explorer, in recognition of his outstanding contributions to our knowledge of the history, geography, and ethnology of the Arctic.

ROBERT RAYNOLDS McMATH, director of the McMath-Hurlburt Observatory, University of Michigan, Pontiac, Mich., in recognition of his contributions to the science of astronomy in general and to our knowledge of solar prominences in particular.

CHESTER STOCK, professor of paleontology, California Institute of Technology, Pasadena, Calif., research associate of the Carnegie Institution of Washington, and curator of paleontology, Los Angeles Museum, Los Angeles, Calif., in recognition of his contributions to vertebrate paleontology, particularly the Tertiary and Pleistocene vertebrates of Western United States.

WILLIAM HAY TALIAFERRO, dean of the division of biological sciences and professor and head of the department of bacteriology and parasitology, University of Chicago, Chicago, Ill., in recognition of his distinguished leadership in the field of parasitology, with particular reference to the cytology, physiology, and immunology of the parasitic Protozoa and to notions regarding the cellular basis of immunology in general.

Honorary

ALFONSO CASO, director of the National Institute of Anthropology and History, Department of Public Education, Mexico, in recognition of his contributions to archeology, particularly his excavations at Monte Alban and his direction of the anthropological work of the Government of Mexico.

DIAMOND JENNESS, chief of the division of anthropology, National Museum of Canada, Ottawa, Canada, in recognition of his contributions to the ethnology, archeology, and anthropology of the Canadian aborigines, both Eskimo and Indian.

ALFREDO SORDELLI, director of the Institute of Bacteriology, Buenos Aires, Argentina, in recognition of his work in research on anaerobic antitoxins and their standardization.

GEOLOGICAL SOCIETY

590TH MEETING

The 590th meeting of the Society was held at the Cosmos Club, January 8, 1941, President J. B. REESIDE, JR., presiding.

Program—H. D. MISER: *The Devonian system in Arkansas and Oklahoma*. An unusual variety of flint of Devonian age known as novaculite, much of which in appearance resembles white marble, is widespread in the Ouachita Mountains of Arkansas and Oklahoma. This rock was used by the early American Indians for making stone implements, and their many long-abandoned quarries, some of which are on Indian Mountain near the Hot Springs National Park, may still be visited. By modern man the novaculite is used for making oilstones, which are marketed in the United States and other countries.

Petrified logs of trees that lived 300,000,000 years ago in the Devonian period are found in the Woodford chert in the Arbuckle Mountains of Oklahoma. One of the tree trunks, which is the largest known petrified log of so great an age, has been transported to the campus of the East Central Oklahoma State Teachers College at Ada, Okla., where it has been erected by John Fitts as a monument to the memory of the late David White, one of the world's distinguished geologists.

Commercial petroleum has been produced from porous limestone of Devonian age in the greater Seminole and other fields in central Oklahoma for almost 20 years. This limestone is commonly referred to as the Hunton. Oil is also obtained in many areas in Oklahoma from the Misener sand, apparently a dune sand of Devonian or Mississippian age.

R. C. WELLS: *The relative abundance of nickel in the earth's crust.* Figures for the percentage of nickel in different classes of rocks were given showing that nickel is found mainly in magnesian rocks, especially in nickeliferous olivine, in pyroxenite, in peridotite, and in dunite. Based on the proportions of ocean and different kinds of rocks in the 10-mile crust the average nickel content was estimated to be 0.016 percent, a slightly lower figure than most previous estimates.

T. L. KESLER: *Genetic history of the pegmatites and associated rocks of the Carolina tin belt.* A belt of the Piedmont province in southern North Carolina, extending 24.5 miles from Lincolnton southwestward to Grover, contains hundreds of pegmatite bodies characterized by the presence of cassiterite and spodumene. The pegmatite bodies are enclosed in muscovite schists and hornblende-biotite gneisses which, in the vicinity of the town of Kings Mountain, lie conformably between a very large and irregular granitic body to the west and interbedded crystalline limestone, quartzite, and muscovite schist to the east. The hornblende-biotite gneisses are strongly metamorphosed limestone; incompletely altered limestone shows the development of minerals characteristic of the hornblendic rocks. Triassic diabase dikes cut rocks of all other types.

Regional folding, which preceded or accompanied the metamorphism of the sedimentary rocks, set up strains that were compensated by

recurrent flexing and jointing which provided channels for the introduction of successive waves of aqueous solutions that deposited the pegmatite minerals. In general, these minerals were deposited in prominent joints where the rocks are uniformly competent over broad areas, and parallel to strike and dip where competent and incompetent rocks are interbedded. The solutions also permeated considerable muscovite schist adjacent to the channels, and the schist was partly replaced by pegmatite minerals, particularly quartz, albite, and microcline. The greisen of the tin belt, which commonly contains cassiterite, is muscovite schist partly replaced by quartz, with residual muscovite coarsened by recrystallization.

The pegmatite bodies contain at least 25 hypogene minerals, 5 derived from the wall rocks, and 7 or more formed by weathering. Some of the hypogene minerals are rare, and many cannot be reliably placed in the sequence of deposition. Paragenetic relations are based largely on successive fracturing and consequent veining of earlier by later minerals. Deposition of the commoner types occurred in the following stages, beginning with the earliest: (1) tourmaline, beryl, and apatite; (2) cassiterite and columbite-tantalite; (3) quartz (greisen formed); (4) spodumene; (5) microcline; (6) medium-grained albite (minor alteration of spodumene and microcline to muscovite); (7) fine-grained albite and quartz (abundant, accompanied by minor quantities of sulphides and apatite).

591ST MEETING

The 591st meeting of the Society was held at the Cosmos Club, January 22, 1941, President J. B. REESIDE, JR., presiding.

Informal communications.—W. P. WOODRING reported the occurrence of marine Lower Miocene fossils in Cajon Pass, Calif., and discussed their paleogeographic significance.

Program.—J. BRIDGE: *Correlation of early Paleozoic sections in Texas.*

H. C. SPICER: *Resistivity studies in the potash area of New Mexico.* The results of some electrical resistivity studies were described that were made over the potash deposits near Carlsbad, N. M. The Gish-Rooney apparatus was used in the investigation and its application is briefly described. Geological features pertain-

ing to the area are briefly given. From the interpretations of the apparent resistivity curves, structural contours were determined on the tops of the Rustler and Salado formations, cross sections showing the depths to the formations were made, and the probable eastern boundary of salt water was located. An explanation is offered on the formation of the greatly depressed area found in the salt and in the Rustler formation near the western edge of the area studied. Some of the apparent resistivity curves are shown in conjunction with the logs of nearby drill holes.

G. W. STOSE: *Structural interpretation of the Death Valley region by Levi Noble*. Later pre-Cambrian, Cambrian, and Tertiary rocks have been thrust northwestward over earlier pre-Cambrian metamorphic rocks. The fault plane is called the Amargosa thrust. The thrust plate is broken into innumerable blocks and slices which form a complex mosaic and is named the Amargosa chaos. The chaos is divided into the Virgin Spring, Calico, and Jubilee phases, each characterized by certain kinds of rocks. Unconformably upon the overthrust chaos was deposited the Funeral formation, composed of fanglomerate and basaltic lava of late Pliocene age. These younger rocks are deformed by folds and normal faults, which also folded the Amargosa thrust into several plunging anticlines of northwest trend. The earlier pre-Cambrian rocks below the thrust are exposed by erosion on the crests of these anticlines. The folds in the late Pliocene fanglomerate and basalt are so recent that they are reflected in the present topography. Death Valley is primarily a syncline in the Funeral fanglomerate, modified by faulting.

592D MEETING

The 592d meeting of the Society was held at the Cosmos Club, February 12, 1941, President J. B. REESIDE, JR., presiding.

Informal communications.—F. L. HESS: *A silicified coral from Florida*.

Program.—F. G. CALKINS: *Curves for determining plagioclases*. Curves for determining the composition of plagioclases by the methods that have been found most useful are combined in a single convenient chart.

D. E. WHITE: *Antimony deposits of the Yellow Pine District, Idaho*.

R. W. CHAPMAN: *The Laurel "pseudomigmatite" and its significance in petrogenesis*. The Laurel pseudomigmatite lies in the vicinity of Laurel, Md., about 17 miles southwest of Baltimore. A cover of Cretaceous gravels obscures its areal extent, but it is at least 48 square miles. On the north the pseudomigmatite is bounded by Guilford granite and Wissahickon schist, on the northeast by gabbro, on the east by Cretaceous gravels, on the south by schist and gneiss, and on the west by the Wissahickon formation.

The pseudomigmatite is gray, medium to fine grained, and faintly foliated. Chief minerals are quartz, oligoclase, biotite, and muscovite. Remnants of Wissahickon schist and quartzite are common in it.

Although the pseudomigmatite looks like a true migmatite, it is believed to have originated by the granulation, flowage, and recrystallization of the Wissahickon formation under conditions of stress, high temperature, and abundant water. This is suggested by: (1) the close mineralogical and chemical similarity of the two rocks, (2) the granulated and recrystallized texture, (3) the abundance of Wissahickon schist and quartzite remnants which do not show granulation or recrystallization, and (4) the complete gradation from pseudomigmatite into Wissahickon schist across contacts.

The Laurel pseudomigmatite has most of the features of a plutonic igneous rock, but it does not show intrusive contacts. It is thought, however, that if conditions of metamorphism had been more intense it might have developed even these. This suggests that some rock bodies, which have all the characteristic features of true igneous rocks, may have actually originated by the recrystallization of older formations.

593D MEETING

The 593d meeting of the Society was held at the Cosmos Club, February 26, 1941, President J. B. REESIDE, JR., presiding.

Informal communications.—M. I. GOLDMAN discussed the presentation of scientific papers and urged that members of the Society refrain from reading prepared manuscripts; he then read extracts from recent numbers of *Science* on this subject.

Program.—M. M. KNECHTEL: *Influence of topography on continental glaciation in north-*

central Montana. Glacial striae on shonkinite exposures at Snake Butte, a prominent intrusive in the plains south of Harlem, Mont., trend southeastward. A train of shonkinite boulders, many of them enormous and some of them striated, extends southeastward 50 miles from Snake Butte across the plains of the Fort Belknap Indian Reservation. The ice of the Keewatin glacier is believed to have piled high against the north side of the Bearpaw Mountains, developing a southeastward gradient of its surface down the pre-glacial Missouri River valley, now occupied by Milk River. Thinning of the ice in this down-gradient direction offers an explanation for the southeastward movement of the Snake Butte boulders, as the rock debris in the mobile basal part of the ice sheet would presumably be transported in the directions of diminishing pressure toward the thinner marginal parts of the glacier.

Interrelations are suggested between southeastward-trending glacial, topographic, and bedrock features in the Fort Belknap Indian Reservation, where *roches moutonnées* and glacial rock basins are tentatively identified. The speaker adopts Calhoun's explanation of drainage changes brought about by the glacier in the vicinity of the Bearpaw and Little Rocky Mountains.

C. P. ROSS and R. G. YATES: *Coso quicksilver district, Inyo County, Calif.* The hot springs in the Coso Range in the southwestern corner of Inyo County, Calif., have been known and utilized for their supposed medicinal value since about 1875. About 1929 the presence of cinnabar in some of the hot spring sinter deposits was recognized, but development and production so far have been small. At least two of the deposits are of interest as possible sources of large amounts of quicksilver under emergency conditions.

The Coso Range contains Jurassic (?) granitic rocks, in part covered by Pleistocene (?) rhyolitic and basaltic lava and pyroclastics. Faults furnished passageways for the lava and later for the hot spring water. Early in the hot-spring activity large quantities of opaline sinter were deposited from large volumes of alkaline solution. Later alkaline solutions of somewhat different composition left cinnabar in openings widely but irregularly distributed throughout the sinter. At present relatively small amounts of acid water and steam rise through the sinter.

D. G. THOMPSON: *Fluctuations of water levels in wells caused by distant earthquakes.*

594TH MEETING

The 594th meeting of the Society was held at the Cosmos Club, March 12, 1941, President J. B. REESIDE, JR., presiding.

Informal communications.—J. BRIDGE: *Dreikanter from Cambrian formations of the United States.*

Program.—W. E. RICHMOND: *Application of X-ray methods to mineral analysis.* X-ray diffraction powder photographs of analysed chromites from various localities give the unit cell-edge lengths. These cell-edge lengths increase with the chromium content for a given percentage of Fe_2O_3 . These lengths plotted against chromium content give a uniform straight-line curve.

W. S. BURBANK: *Spiral fracturing from volcanic centers.*

E. CLOOS: *Deformation of oolites in relation to cleavage.*

595TH MEETING

The 595th meeting of the Society was held at the Cosmos Club, March 26, 1941, President J. B. REESIDE, JR., presiding.

Informal communications.—A. C. SPENCER spoke in commendation of the paper by E. CLOOS presented at the last meeting and referred to it as an epochal advance in studies of rock deformation. He described folded veinlets and ladder veins which also may be used to measure deformation.

M. I. GOLDMAN discussed the origin of stylolites and pointed out that true stylolitic structures may in places signify a thinning of beds amounting to more than 20 per cent.

Program.—D. J. CEDERSTROM: *Progressive down-dip changes in composition in artesian waters from the Cretaceous rocks of Virginia.* Near the Fall Zone ground waters in the Cretaceous strata are soft, low in dissolved mineral content, and contain moderate amounts of carbon dioxide. Down the dip to the east the waters become hard, owing to solution of calcium carbonate. The free carbon dioxide in the waters in the Fall Zone enables the waters to take a maximum of 250 parts per million of bicarbonate (as calcium bicarbonate) into solution. About 20 to 30 miles east of the Fall

Zone the waters become soft as a result of base exchange. Eocene glauconite sand and clayey sediments in the Potomac section probably act as exchangers.

The difference between a maximum of 250 parts per million of bicarbonate due to the solvent action of free carbon dioxide on limy material and a maximum of 800 parts of bicarbonate found in some waters far down the dip has not been accounted for. Small amounts of free carbon dioxide in these waters appear to indicate that carbon dioxide is being liberated by some Coastal Plain sediments. There is considerable doubt that methane is capable of reducing sulphates, as suggested by Renick. Carbon dioxide and methane might be liberated and hydrogen sulphide produced by the reduction of sulphates through the agency of organic matter in the sediments. The entire problem, however, must be regarded as unsolved.

Waters containing more than a few parts per million of chloride are found only in eastern Nansemond County and Norfolk County. The brackishness of these waters is believed to be due to lack of flushing out of marine waters with which the sediments were once saturated.

Waters containing 1 to 6 parts per million of fluoride occur within the soft water zone. The origin of the fluoride is unknown but it is believed to be derived in large part from some normal constituent of the Potomac group.

P. S. SMITH: *Recent hydrographic surveys along the Atlantic Coast.*

R. F. FLINT: *Atlantic coastal terraces.* (Published in this JOURNAL 32 (8): 235-327. 1942.)

596TH MEETING

The 596th meeting of the Society was held at the Cosmos Club, April 9, 1941, President J. B. REESIDE, JR., presiding.

Informal communications.—W. B. LANG discussed the occurrence of langbeinite in this country and its production as a commercial source of potash.

M. W. ELLIS described a method of making casts and molds of fossils with a rubberlike substance soluble in ammoniacal water solution.

Program.—C. B. READ: *Sequence and relationships of late Paleozoic floras in the southwestern United States.*

W. P. WOODRING: *Ancient soil and ancient dune sand in the Santa Maria district, California.* Remnants of siliceous hardpan are widespread in the Santa Maria district. Though hardpan may have formed at different times, at least much of it antedates development of the present topographic surface and is considered part of an ancient soil of post-Pleistocene age, younger than terrace deposits assigned to the late Pleistocene. The hardpan is troublesome in geologic mapping. In extensive areas where bedrock consists of sand and gravel it is the hardest and most completely exposed material. Its attitude may bear any relation to the attitude of bedrock strata.

Dune sand, now fixed by vegetation, is thought to be younger than the ancient hardpan. On the south side of the Santa Maria Valley this inactive ancient dune sand extends from the coast to localities 20 miles inland, whereas modern dune sand is limited to a narrow coastal strip. The ancient dune sand is inferred to indicate a climatic change, either stronger winds or greater aridity than at present, more probably greater aridity.

E. P. HENDERSON: *A large weathered meteorite from the Coastal Plain of Georgia.* (Published in extended form in Proc. U. S. Nat. Mus. 92: 141-150, 2 pls. 1942.)

597TH MEETING

The 597th meeting of the Society was held at the Cosmos Club, April 23, 1941, President J. B. REESIDE, JR., presiding.

Informal communications.—D. G. THOMPSON: *Sand coated with humous material from borders of depressions in Carolina Bay country.*

Program.—G. A. COOPER: *Facies relations of the Hamilton group along the Catskill front.*

F. C. KRACEK: *The ternary system gold-silver telluride.*

A. M. MORGAN: *The role of solution in the development of the Pecos River basin, N. Mex.*

598TH MEETING

The 598th meeting of the Society was held at the Cosmos Club, November 12, 1941, President J. B. REESIDE, JR., presiding.

Informal communications.—RALPH CANNON discussed systematic variation in fluorescence of members of scheelite-powellite series. Ranges from blue through white to yellow occur in powellite.

Program.—E. T. MCKNIGHT: *Zoning of ore deposits in the Tri-State district.* Examples of small scale zoning in peripheral parts of the Oklahoma-Kansas field were described and illustrated. The core of each zoned area is massive gray spar dolomite formed by replacement of the limestone; it commonly contains, near its center, introduced (cave filling) Cherokee shale and a high percentage of chert relative to the dolomite. Pink spar dolomite is a vug phase nearly coextensive with the gray spar but subordinate in total mass. Surrounding the dolomite is the sphalerite zone which tends to ring the gray spar core in a closed irregular but commonly oblong circuit. Some of the highest grade ore is found where the dolomite and sphalerite overlap on the inner edge of the sphalerite zone. Chalcopyrite and enargite are confined almost entirely to this area of overlap, though they may extend back a short distance in the dolomite. The galena zone overlaps the sphalerite zone but tends to lie just outside of it. Still farther out comes the barren "boulder ground" zone characterized by coarse marcasite and abundant calcite in loose bouldery chert that is residual from more or less complete removal by solution of the original limestone. Beyond this comes the unaltered limestone. Jasperoid replaces the limestone in all the outer zones up to the unaltered limestone but does not encroach very far on the dolomite core except on the inner side of the sphalerite zone where the gray spar dolomite is partly replaced. Removal of the ore along the combined sphalerite and galena zones leaves an asymmetric stope, characterized on the inner wall by massive gray spar with subordinate pink spar vugs that may contain some calcite, on the outer wall by open bouldery ground with jasperoid and abundant calcite. The zoned areas are commonly only a few hundred feet across. Numerous examples, more nearly circular in ground plan, are indicated in the Joplin area by the descriptions of Smith and Siebenhal.

D. GALLAGHER: *Granitization in Central Africa.*

MAX DEMOREST: *Types of ice flow within glaciers.* Four "types of ice flow" that form a gradational series are recognized. Each type is characteristic of distinct glacial conditions of surface configuration and underlying topography. The types are called: (1) extrusion flow,

(2) obstructed extrusion flow, (3) obstructed gravity flow, and (4) gravity flow.

The first two types occur only where the surface of a glacier is of gentle slope and where the glacier's floor is either nearly horizontal or sloping upward in downstream direction (ice sheets, piedmont glaciers, névé fields, and some valley glaciers). The stresses responsible for flow are differential pressures resulting from the slope of the upper surface. For that reason the two types are grouped together as "pressure-controlled" types. In extrusion flow the differential pressures cause the more plastic basal ice of a glacier to be extruded from beneath the less plastic overlying ice. Where the flow is obstructed, whether by a topographic barrier or in the forward thinning end of a glacier, the movement is forward and surfaceward. The extruded ice overrides the obstruction.

Gravity flow can occur only where the glacier's floor has an appreciable slope. It is, therefore, called "drainage-controlled." The surface of the glacier is either parallel to the floor or slopes less steeply. Under such circumstances a glacier may be likened to a tilted pack of cards, in which each card (of infinitesimal thickness) slides differentially over the next below it. These differential movements increase with depth, yet the uppermost layer moves fastest as it is carried by the sum of all underlying movements. The stresses responsible for such movements are shear components of gravitative force. Where gravity flow is obstructed, there is, as with obstructed extrusion flow, a forward and surfaceward movement. If the surface slope is gentle, such movement will have an upward component, but if the surface slope is steep, the lines of movement will also slope downstreamward. Where the surface slope of a glacier is reduced downstreamward, a transition from obstructed gravity flow to obstructed extrusion flow occurs.

599TH MEETING

The 599th meeting of the Society was held at the Cosmos Club, November 26, 1941, President J. B. REESIDE, JR., presiding.

Program.—P. W. GUILD: *Chromite deposits of the Kenai Peninsula, Alaska.*

CHESTER STOCK: *Cretaceous reptiles from the Moreno formation, California.*

M. D. FOSTER: *Chemical composition of salty*

ground waters along the Atlantic and Gulf Coasts. Salty waters encountered in water-bearing sands along the Atlantic and Gulf coasts do not appear to be simple mixtures of ground-water with more or less sea water. When the salty waters are compared with theoretical mixtures of fresh ground waters and sea water—the ground waters being from comparable depths in the same formations and the amount of sea water being that indicated by the chloride contents of the salty waters—the natural salty waters are found to be characteristically lower in calcium, magnesium, and sulphate and higher in sodium content, suggesting that the waters have undergone base-exchange and reduction of sulphate.

The indicated replacement of magnesium and calcium in the salty waters by sodium from base-exchange minerals in the sands suggests that these base-exchange minerals are not in equilibrium with present day sea water or with salty waters formed by its admixture with fresh ground waters in which sodium bicarbonate is the predominant constituent. These relations further suggest that the water-bearing sands have at some time been flushed of salt water, at least to a point farther down the dip than at present by water having a lower Ca/Na and Mg/Na ratio and that the salt water now contaminating the fresh waters is a new advance inland of sea water and not connate waters.

The low sulphate content of the salty waters is attributed to reduction of sulphate, but whether the causative agent of the reduction was living organisms or inanimate organic matter or whether reduction took place at the time the sediments were deposited or subsequently cannot be proved definitely at the present time. The parent salt waters of these salty waters may have been connate waters in which sulphate had been reduced—as reduction is known to take place in environmental conditions like those under which some of the

sediments in the Coastal Plain were laid down. In the flushing implied by the low calcium and magnesium content of the waters the connate waters may have been forced seaward but may not have been completely flushed from the beds and subsequent lowering of the fresh water head relative to the head of sea water may have permitted the connate water to move farther inland.

The fact that unselected salty waters from widely different sources, both geographically and geologically, in the Atlantic and Gulf Coastal Plain have apparently undergone similar alterations in mineral composition would seem to indicate that the conditions responsible for these alterations are rather general throughout the area.

600TH MEETING

The 600th meeting of the Society was held at the Cosmos Club, December 10, 1941, President J. B. REESIDE, JR., presiding.

Program.—Presidential Address: *Upper Cretaceous sediments of the Western Interior.*

49TH ANNUAL MEETING

The 49th Annual Meeting was held immediately following the 600th regular meeting. The reports of the secretaries, treasurer, and auditing committee were read and approved. Officers for the year 1942 were then elected, as follows:

President: C. S. ROSS.

Vice-Presidents: L. W. CURRIER, H. INSLEY.

Treasurer: K. J. MURATA.

Secretary: J. J. FAHEY.

Council: R. C. CADY, R. P. FISCHER, PHILIP S. GUILD, H. S. LADD, C. F. PARK, JR.

The Society nominated J. B. REESIDE, JR., to be a Vice-President of the Washington Academy of Sciences for the year 1942.

Obituaries

WALTER FORD REYNOLDS, principal mathematician and chief of the section of triangulation, Division of Geodesy, U. S. Coast and Geodetic Survey, Washington, D. C., died in his native city of Baltimore on Friday, May 1, 1942, after an illness of several months.

Born on May 25, 1880, the son of Robert

Fuller and Catherine (Myers) Reynolds, his school career carried him through the grammar and high schools of Baltimore, and through Johns Hopkins University (A.B., 1902) where he remained for several years engaged in graduate work in mathematics and physics. Upon the completion of his studies, he served as an

instructor in mathematics in Baltimore City College (1905-6) and as a computer in the U. S. Naval Observatory (1907).

Entering the Coast and Geodetic Survey in 1907 as a computer, Mr. Reynolds devoted his talents to the study of geodetic surveys, particularly to the mathematical analysis and adjustment of triangulation and to the solution of intricate problems in geodetic surveying.

During the latter part of the first World War Mr. Reynolds served as acting chief of the Division of Geodesy, and from 1917 to 1924 was chief computer of that division. Since 1924, as chief of the section of triangulation, he gave his entire time to directing the work of a staff of mathematicians in the computation and adjustment of the national triangulation survey of the country. He also directed the computation of similar work executed in Alaska, Puerto Rico, and the Hawaiian Islands.

Mr. Reynolds was the author of a number of reports and technical manuals. The reports included survey results in a number of States: Alabama, Mississippi, Maine, Missouri, and Minnesota, and in Alaska. There were also two manuals of considerable importance: *Relation between plane rectangular coordinates and geographic positions* (1921) and *Manual of triangulation computation and adjustment* (1927). These have become standards with engineers engaged on surveying operations, and are used in some technical schools.

He held membership in the Mathematical Association of America, Philosophical Society of Washington, Washington Academy of Sciences, American Geophysical Union, National Geographic Society, American Congress on Surveying and Mapping, and Pi Gamma Mu.

On June 26, 1907, Mr. Reynolds was married to Ada C. Williams, who with three children, Catherine A. Mummert, Robert W. and Walter F. Jr., survives him.—CLEMENT L. GARNER.

EDWARD CENTER GROESBECK, a member of the Washington Academy of Sciences since 1932, died on May 9, 1942, in his sixty-first year. He was born at Albany, N. Y., on October 15, 1881, and since the early age of 3 years he was totally deaf. With the help of a devoted teacher, however, he perfected his speaking ability and also learned the art of lip reading, in which he acquired great skill in later life. His early education was essentially that of a normal

boy, and in 1904 he was graduated from Williams College with the degree of B.A., and two years later from Massachusetts Institute of Technology with the degree of S.B. All this was accomplished by his own endeavors without the aid of special tutors. The honorary degree, A.M., was conferred by Williams College in 1909.

After graduation Mr. Groesbeck served for 3 years as research assistant to Prof. Henry Marion Howe, Columbia University, an association that was a deciding factor in his choice of a life career. After a year in the laboratory of the Taylor Wharton Steel Co., High Bridge, N. J., he was associated with the Pittsfield branch of the General Electric Co. (1910-15). Later (1915-18) he renewed his association with Professor Howe as research assistant, and in this capacity he was stationed at the National Bureau of Standards during the first World War where he was engaged on problems relating to ordnance steels. After the termination of this work in 1918, he was retained on the metallurgical staff of the Bureau, where he was progressively advanced up to the rank of metallurgist and served for 20 years until retirement for physical disability in 1938.

He made valuable contributions to knowledge in the field of microscopy of metals. In this work recompense for his handicap was attained in the ability to concentrate, which he developed to an extraordinary degree. This was also a decided advantage to him in the work of reviewing and evaluating data in the technical literature as a basis for a number of Bureau of Standards information circulars on metals and alloys which he compiled. It was in research on corrosion, however, in which he excelled and in which field he made numerous notable contributions. He was a member of the American Institute of Mining and Metallurgical Engineers, the American Society for Testing Materials, and the American Society for Metals.

In 1926, he married Miss Lee Robinson of Washington, D. C., who died in 1930. Pleasant, genial, always cheerful, with a keen interest in all the commonplace incidents of daily life, and possessed of a keen sense of humor, Mr. Groesbeck, was a favorite with his fellow workers. He asked only to be accepted on an equal footing with them without any special privileges because of his handicap.—HENRY S. RAWDON.

PROGRAMS OF THE ACADEMY AND AFFILIATED SOCIETIES

PHILOSOPHICAL SOCIETY OF WASHINGTON (Cosmos Club Auditorium, 8:15 P.M.):

Saturday, October 10. *Theoretical aspects of electrical breakdown in solids.* R. J. SEEGER.

CHEMICAL SOCIETY OF WASHINGTON (The George Washington University, 8:15 P.M.):

Thursday, October 8. Divisional meetings on biochemistry, inorganic and analytical chemistry, organic chemistry, and physical chemistry.

ENTOMOLOGICAL SOCIETY OF WASHINGTON (U. S. National Museum, 8 P.M.):

Thursday, October 1. Motion picture: *Grasshopper control in the Argentine.* CARL J. DRAKE.

MEDICAL SOCIETY OF THE DISTRICT OF COLUMBIA (Mayflower Hotel):

Tuesday, Wednesday, and Thursday, September 29, 30, and October 1. 14th Annual Scientific Assembly of the Medical Society of the District of Columbia.

BOTANICAL SOCIETY OF WASHINGTON (Cosmos Club Auditorium, 8 P.M.):

Tuesday, October 6. Symposium: *Determining the deterioration of cellulose caused by microorganisms and ultraviolet radiation, and its relation to plant fiber and fabric uses in the present emergency* (illustrated), led by H. D. BARKER.

AMERICAN SOCIETY OF CIVIL ENGINEERS, District of Columbia Section (U. S. Chamber of Commerce Auditorium, 8:15 P.M.):

Tuesday, September 22. Lecture, motion picture, demonstration: *Synthetic rubber.*

CONTENTS

	Page
ANTHROPOLOGY.—Archeological accomplishments during the past decade in the United States. FRANK M. SETZLER.....	253
BOTANY.—Two new dwarf species of <i>Rubus</i> from western China and Tibet and their Asiatic relatives. EGBERT H. WALKER.....	260
ZOOLOGY.—Porifera from Greenland and Baffinland collected by Capt. Robert A. Bartlett. M. W. DE LAUBENFELS.....	263
ZOOLOGY.— <i>Sinocybe</i> , a new genus of colobognath millipeds from China. H. F. LOOMIS.....	270
PROCEEDINGS: THE ACADEMY.....	273
PROCEEDINGS: GEOLOGICAL SOCIETY.....	277
OBITUARIES: WALTER FORD REYNOLDS, EDWARD CENTER GROESBECK	283

The Journal is Indexed in the International Index to Periodicals

S-1676
D-1000
VOL. 32

OCTOBER 15, 1942

No. 10

JOURNAL

OF THE

WASHINGTON ACADEMY OF SCIENCES

BOARD OF EDITORS

RAYMOND J. SEEGER
GEORGE WASHINGTON UNIVERSITY

G. ARTHUR COOPER
U. S. NATIONAL MUSEUM

JASON R. SWALLEN
BUREAU OF PLANT INDUSTRY

ASSOCIATE EDITORS

W. EDWARDS DEMING
PHILOSOPHICAL SOCIETY

C. F. W. MUESEBECK
ENTOMOLOGICAL SOCIETY

HARALD A. REHDER
BIOLOGICAL SOCIETY

EDWIN KIRK
GEOLOGICAL SOCIETY

CHARLOTTE ELLIOTT
BOTANICAL SOCIETY

T. DALE STEWART
ANTHROPOLOGICAL SOCIETY

HORACE S. ISBELL
CHEMICAL SOCIETY

PUBLISHED MONTHLY

BY THE

WASHINGTON ACADEMY OF SCIENCES
450 AHNALP ST.
AT MENASHA, WISCONSIN

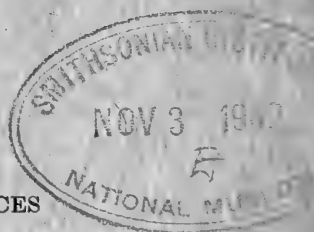

Entered as second class matter under the Act of August 24, 1912, at Menasha, Wis.
Acceptance for mailing at a special rate of postage provided for in the Act of February 28, 1925
Authorized January 21, 1933.

Journal of the Washington Academy of Sciences

This JOURNAL, the official organ of the Washington Academy of Sciences, publishes (1) Short original papers, written or communicated by members of the Academy; (2) proceedings and programs of meetings of the Academy and affiliated societies; (3) notes of events connected with the scientific life of Washington. The JOURNAL is issued monthly, on the fifteenth of each month. Volumes correspond to calendar years.

Manuscripts may be sent to any member of the Board of Editors. It is urgently requested that contributors consult the latest numbers of the JOURNAL and conform their manuscripts to the usage found there as regards arrangement of title, subheads, synonymies, footnotes, tables, bibliography, legends for illustrations, and other matter. Manuscripts should be typewritten, double-spaced, on good paper. Footnotes should be numbered serially in pencil and submitted on a separate sheet. The editors do not assume responsibility for the ideas expressed by the author, nor can they undertake to correct other than obvious minor errors.

Illustrations in excess of the equivalent (in cost) of 1½ full-page line drawings are to be paid for by the author.

Proof.—In order to facilitate prompt publication one proof will generally be sent to authors in or near Washington. It is urged that manuscript be submitted in final form; the editors will exercise due care in seeing that copy is followed.

Author's Reprints.—Reprints will be furnished in accordance with the following schedule of prices:

Copies	4 pp.	8 pp.	12 pp.	16 pp.	20 pp.	Covers
50	\$2.00	\$3.25	\$ 5.20	\$ 5.45	\$ 7.25	\$2.00
100	2.50	4.00	6.40	6.75	8.75	2.75
150	3.00	4.75	7.60	8.05	10.25	3.50
200	3.50	5.50	8.80	9.35	11.75	4.25
250	4.00	6.25	10.00	10.65	13.25	5.00

<i>Subscription Rates.</i> —Per volume.....	\$6.00
To members of affiliated societies; per volume.....	2.50
Single numbers.....	.50

Correspondence relating to new subscriptions or to the purchase of back numbers or volumes of the JOURNAL should be addressed to William W. Diehl, Custodian and Subscription Manager of Publications, Bureau of Plant Industry, Washington, D.C.

Remittances should be made payable to "Washington Academy of Sciences" and addressed to 450 Ahnaip Street, Menasha, Wis., or to the Treasurer, H. S. Rappleye, U. S. Coast and Geodetic Survey, Washington, D.C.

Exchanges.—The JOURNAL does not exchange with other publications.

Missing Numbers will be replaced without charge provided that claim is made to the Treasurer within thirty days after date of following issue.

OFFICERS OF THE ACADEMY

President: HARVEY L. CURTIS, National Bureau of Standards.

Secretary: FREDERICK D. ROSSINI, National Bureau of Standards.

Treasurer: HOWARD S. RAPPLEYE, U. S. Coast and Geodetic Survey.

Archivist: NATHAN R. SMITH, Bureau of Plant Industry.

Custodian of Publications: WILLIAM W. DIEHL, Bureau of Plant Industry.

JOURNAL

OF THE

WASHINGTON ACADEMY OF SCIENCES

VOL. 32

OCTOBER 15, 1942

No. 10

CHEMISTRY.—*The behavior of cystine dimethylester dihydrochloride and of cysteine monomethylester monohydrochloride in the Sullivan reaction for cysteine and cystine.* M. X. SULLIVAN, W. C. HESS, and H. W. HOWARD,¹ Georgetown University.

In a study of the defence mechanism of the animal body attention was given years ago to the sulphur system as exemplified by cystine and cysteine. For these compounds there was devised a test of remarkable specificity, directly for cysteine and indirectly for cystine, that is, after a preliminary reduction or cleavage of the disulphide bonds (1, 2, 3, 4). The procedure in testing for cystine is as follows: To 5.0 cc of solution containing 0.5 to 1.0 mg cystine and 0.1N with respect to hydrochloric acid add (A) 2.0 cc of 5 percent aqueous sodium cyanide, mix and wait 10 minutes, add (B) 1 cc of 0.5 percent aqueous 1,2-naphthoquinone-4-sodium sulphonate, mix by shaking for 10 seconds; add (C) 5.0 cc of 10 percent sodium sulphite in 0.5N sodium hydroxide, mix and let stand 30 minutes; add (D) 2.0 cc of 5N sodium hydroxide, mix and add (E) 1.0 cc of 2.0 percent sodium hyposulphite ($\text{Na}_2\text{S}_2\text{O}_4$) in 0.5N sodium hydroxide. The result is a vivid red-colored solution. In testing for cysteine, the cyanide added in step (A) is 1.0 cc of 1.0 percent sodium cyanide in 0.8N sodium hydroxide and the naphthoquinone is added immediately after mixing. The rest of the procedure is as for cystine. With hydrolysates containing material buffering against alkali the addition of the 5N sodium hydroxide before the hyposulphite is necessary, but in other cases it may be omitted.

In as much as a positive Sullivan reaction requires the cysteine structure and that the

¹ The data in this paper were taken, in part, from the dissertation presented by H. W. Howard in partial fulfillment of the requirements for the degree of Doctor of Philosophy, Georgetown University. Received June 24, 1942.

SH, NH_2 , and COOH groups be free, it is of interest to compare the behavior of cystine dimethylester and cysteine monomethylester with the behavior of cystine and cysteine respectively. Measurements with these substances under a variety of conditions are described in the present paper.

Brand, Harris, and Biloon (6) from preliminary observations suggested that in the Sullivan reaction for cystine the methylester hydrochloride may develop more color than that produced by the equivalent amount of cystine.

Over a period of years we have found that cystine dimethylester dihydrochloride will give approximately 20 percent more color than cystine when the experiment is conducted on freshly prepared solutions in 0.1N hydrochloric acid using 2.0 cc of 5 percent aqueous sodium cyanide to open the disulphide bond and omitting the addition of the 5N sodium hydroxide. Similar results were obtained when the solution of the ester was kept at 5°C. over night. However, when the ester hydrochloride is allowed to stand at 25–30°C. in 0.1N hydrochloric acid for 4 hours or more it gives practically the same value as an equivalent amount of cystine, whereas, if the solvent is water there is little difference between freshly prepared solutions and those kept at room temperature over night. These points are illustrated by the data in Table 1.

When the agent employed to open the disulphide bond is 5 percent sodium cyanide dissolved in normal sodium hydroxide as used in our more recent work (5) the ester hydrochloride gives the same color value as

an equivalent amount of cystine whether the ester is dissolved in 0.1N hydrochloric acid or in water and whether the solutions are freshly prepared or old, because the ester is saponified by the alkaline solution.

Fischer and Suzuki (7) early reported that the ester hydrochloride is rapidly saponified by alkali. They also observed a slight change of rotation when the ester hydrochloride was allowed to stand in aqueous solution. Abderhalden and Wybert (8), however, found no change in the optical rotation of the ethylester hydrochloride on standing 2 hours in water. As far as we have ascertained no one has hitherto tested the stability of the cystine dimethylester dihydrochloride in 0.1N hydrochloric acid. As shown in Table 1 this ester is saponified by 0.1N hydrochloric acid at room temperature in the course of 22 hours but in water it is not saponified appreciably during the same period.

TABLE 1.—THE PERCENTAGE COLORIGENIC VALUE OF CYSTINE DIMETHYLESTER DIHYDROCHLORIDE COMPARED WITH CYSTINE TAKEN AS 100 AT VARIOUS ACIDITIES

Age of Solution	Solvent			
	0.1N HCl	0.05N HCl	0.025N HCl	Dis-tilled water
Freshly made.....	119	124	124	121
2 hours standing at room temperature.....	111	118	119	121
4 hours standing at room temperature.....	108	114	118	120
22 hours standing at room temperature.....	104	111	114	118
22 hours at 5°C.....	121			

Since no reference to cysteine monomethylester hydrochloride could be found this compound was made from cysteine hydrochloride for comparison with cysteine.

One gram of cysteine hydrochloride was dissolved in 25 cc of anhydrous methyl alcohol and dry gaseous hydrogen chloride was passed into the solution for one hour with warming to 45°C. for the first 10 minutes. The solution was then poured into 500 cc of anhydrous ethyl ether, and the mixture was allowed to stand in the icebox for 48 hours. The cysteine methylester hydrochloride separated out in good yield as prisms. Since the ester was very hygroscopic it was warmed in a Schmiedeberg apparatus with methyl alcohol as the boil-

ing liquid and was then transferred to a vacuum desiccator over sulphuric acid.

In a capillary tube the ester hydrochloride melted between 137 and 138.5°C. but softened at lower temperatures (110–130°C.). It is soluble in methyl alcohol and in water, slightly soluble in absolute ethyl alcohol and in acetic anhydride, insoluble in ethyl ether, petroleum ether, benzene, or acetone. Like cysteine it gave a red color with sodium nitroprusside and ammonia and a blue color with dilute ferric chloride. On analysis it gave the theoretical value for sulphur and nitrogen and 102 percent of the theoretical value for chlorine.

In the Okuda (9) method for cysteine, equivalent amounts of the cysteine monomethylester hydrochloride and cysteine hydrochloride gave the same titre, 0.95 cc of M/600 potassium iodate for 1.0 mg of cysteine. The Okuda method depends on the reactive (SH) so it does not indicate whether the methyl group had been split off at the acidity of the reaction, 2.0 percent hydrochloric acid. It may be said, however, that the ester dissolved in 2.0 percent hydrochloric acid saponifies very rapidly. After reduction with zinc and hydrochloric acid for 30 minutes at room temperature the titre of the ester was the same as before reduction and therefore no disulphide form was present.

The Sullivan method for cysteine, as early recommended (2), calls for the addition of 2.0 cc of 1.0 percent solution of sodium cyanide in 0.8N sodium hydroxide as an antioxidant and accelerator of the reaction. Using this alkaline cyanide the freshly prepared ester gave 102–105 percent as much color as an equivalent amount of cysteine because the alkalinity was sufficiently high to saponify the ester readily. In fact under these conditions the color generated was practically the same as that given by cysteine whether the test was made shortly after solution in 0.1N hydrochloric acid or after standing 22 hours.

On the other hand, when 2.0 cc of 5 percent aqueous sodium cyanide was used, as in the cystine test, the cysteine methylester hydrochloride in 0.1N hydrochloric acid gave 125 percent as much color as cysteine

treated in like manner. Again, with 2.0 cc of 1.0 percent aqueous sodium cyanide a freshly prepared solution of cysteine methyl-ester hydrochloride in 0.1N hydrochloric acid gave 125-129 percent as much color as cysteine similarly treated. When the solution was kept at 5°C. for 22 hours, however, the color decreased to 118 percent, while kept at 25-30°C. it decreased to 115 percent. With the ester dissolved in water the colorimetric value compared with cysteine was 127 percent when tested immediately, and 125 percent when tested after 22 hours standing at room temperature.

SUMMARY

From the data it can be concluded that (1) both cystine dimethylester dihydrochloride and cysteine monomethylester monohydrochloride are saponified rapidly by cyanide dissolved in alkali to yield cystine and cysteine respectively; (2) the cystine dimethylester dihydrochloride is saponified by standing in 0.1N hydrochloric acid for 22 hours at room temperature, whereas, the monomethylester of cysteine is not appreciably saponified under similar circumstances; (3) the cystine dimethylester dihydrochloride is not saponified appreciably by 0.1N hydrochloric acid at 5°C. in the course of 22 hours; (4) in solutions of low acidity the cystine dimethylester dihydrochloride at room temperature is saponified much more slowly than in 0.1N hydrochloric acid; (5) both

esters are relatively stable in aqueous solutions; (6) both the cystine dimethylester dihydrochloride and the cysteine monomethylester hydrochloride have a higher colorigenic value than cystine and cysteine respectively in the Sullivan reaction, when aqueous sodium cyanide is employed to cleave the disulphide or to act as an adjuvant in the cysteine reaction; (7) cystine dimethylester dihydrochloride gives practically the same value as cystine if sodium cyanide dissolved in normal sodium hydroxide is employed to cleave the disulphide; (8) cysteine monomethylester hydrochloride treated with 1.0 percent sodium cyanide in 0.8N sodium hydroxide gives the same value as cysteine; (9) the preparation and properties of cysteine monomethylester hydrochloride are described.

LITERATURE CITED

- (1) SULLIVAN, M. X. U. S. Public Health Rep., **41**: 1030. 1926.
- (2) ———. U. S. Public Health Rep., **44**: 1421. 1929.
- (3) ———. U. S. Public Health Rep., Suppl. 78. 1929.
- (4) ——— and HESS, W. C. U. S. Public Health Rep., **44**: 1599. 1929.
- (5) ———. Journ. Biol. Chem., **116**: 221. 1936.
- (6) BRAND, E.; HARRIS, M. M.; and BILOON, S. Journ. Biol. Chem., **86**: 315. 1930.
- (7) FISCHER, E., and SUZUKI, U. Zeitschr. physiol. Chem., **45**: 221. 1905.
- (8) ABDERHALDEN, E., and WYBERT, E. Ber., **49**: 2449, 2472. 1916.
- (9) OKUDA, Y. Journ. Biochem. Japan, **5**: 217. 1925.

PALEOBOTANY.—*A Miocene grapevine from the valley of Virgin Creek in northwestern Nevada.*¹ ROLAND W. BROWN, U. S. Geological Survey.

Leaves called *Vitiphyllum crassifolium* Fontaine and *Cissites parvifolius* (Fontaine) Berry and supposed to belong to species of the grape family (Vitaceae) have been described from the Lower Cretaceous formations of the Atlantic coastal region of Maryland and Virginia. If these leaves be regarded as correctly identified they place members of this family among the first dicotyledons to appear in the fossil plant

¹ Published by permission of the Director, U. S. Geological Survey. Received July 7, 1942.

records of the United States. Other specimens called *Ampelopsis*, *Cissus*, *Cissites*, and *Vitis* have been reported from the Upper Cretaceous and Paleocene of the Western Interior. Unmistakable seeds and leaves of grapes have been found from the Eocene onward both in America and Europe. Until now, however, no fossil wood of the Vitaceae has appeared in the United States, although three species have been described from Europe: *Vitoxylon coheni* Schuster (1911) from the Paleocene south-

east of Rügen, Prussia; *Vitoxylon ampelopsoides* Schönfeld (1930) from the Miocene of southwestern Germany; and ?*Vitis* sp. Kräusel (1920) from the Miocene of Opeln, Silesia.

The specimen described in this paper was donated to the National Museum in April, 1942, by Mark M. Foster, of Denio, Oreg. It came from a point about 300 feet within the main drift of the Rainbow Ridge Opal Mine located on Virgin Creek, a tributary of Thousand Creek in Humboldt County, Nev., and roughly 28 miles, as the crow flies, southwest of Denio. Photographs and a description of this locality were published by H. C. Dake (1933) and C. A. Reeds (1927), and the geology and paleontology of the region were described by J. C. Merriam (1907, 1910, 1911). According to Merriam the opal-bearing strata occur in the middle zone of a 3-parted sequence he called the Virgin Valley beds. These beds approximate 1,500 feet in thickness and have a low synclinal structure. They rest upon "Canon Rhyolite" below and terminate beneath a capping of "Mesa Basalt" above. The lower zone of the Virgin Valley beds comprises white to varicolored volcanic ash and tuff. The middle zone contains brown to gray clay and ash, diatomaceous beds, and thin-bedded carbonaceous shales with numerous lignitic layers. The upper and largest zone, chiefly of white, buff, and cream-colored ash and tuff, and some diatomaceous beds, rests, perhaps unconformably, upon the middle series.

In 1907 (p. 381) Merriam reported mammal remains as being common in parts of the lower and upper zones, and that only a few fragments of bones were found in the middle series. In 1910 (p. 30) and 1911 (p. 204), however, without a specific reference by way of retraction of his previous statement, he said that no mammal remains had been found in characteristic beds of the lower zone and only imperfect fragments in the upper zone, but that the principal fossil horizons fall within a stratigraphic interval of only a few hundred feet near the middle of the section. Dake, on the other hand, in 1933 (p. 17), presumably after visiting the area and recognizing Merriam's divisions,

said that "the upper beds are soft in texture, of a light color, and carry an abundance of mammalian fossil remains." As the writer has not visited the region, he can offer no enlightenment on these contradictory statements. Both Merriam and Dake, nevertheless, are in agreement that the middle zone contains the precious opal, some fragmentary fossil leaves, and considerable fossil wood. On the basis of the mammalian remains vertebrate paleozoologists now assign the Virgin Valley beds to the upper half of the Miocene. The fauna appears to be older than that in the Mascall formation of Oregon and younger than that in the "Sheep Creek beds" of western Nebraska and eastern Wyoming (Stirton, 1939, p. 628).

VITACEAE.

Vitoxylon opalinum Brown, n. sp.

Figs. 1-3

The specimen is light-colored, 7 cm long and 1.3 cm in diameter. The surface of the woody cylinder, where it is not covered by thin lamellae of bark, is somewhat striated and furrowed longitudinally. At nodes 4.5 cm apart and separated by almost a half-turn around the stem emerge two sturdy tendrils or what perhaps may have been the basal portions of the peduncles of fruit clusters. These encircle the stem in a counterclockwise direction. No leaf scars remain at the points opposite the emergence of the tendrils.

The transverse section of the woody cylinder is shown in Fig. 3, magnified 14 times. The entire section is now elliptical because of distortion by pressure before fossilization, as shown by the oblong and irregular outlines of the pith and vessels in the left half of the figure. Normally, these should be approximately circular in cross-section. The pith and vessels are either replaced or filled by dark opal, but the remaining structures are of gray and somewhat softer opallike material that does not take as high a polish and reveals no cellular details. Rays are numerous and relatively narrow. Doubtless some of this narrowness is illusory and not exactly representative of the original width before the wood was distorted and opalized. Examined with a hand lens in just exactly the right light these rays appear much wider than the photograph indicates. In general, only one

radial row of vessels lies between adjacent rays. The vessels are arranged in 10 rings, suggesting an approximate age of 10 years for this portion of the vine. Because of the extensive opaliza-

tion and obliteration of the finer cellular structures it was deemed futile to cut radial and tangential sections.

The bark, structure of the woody cylinder,

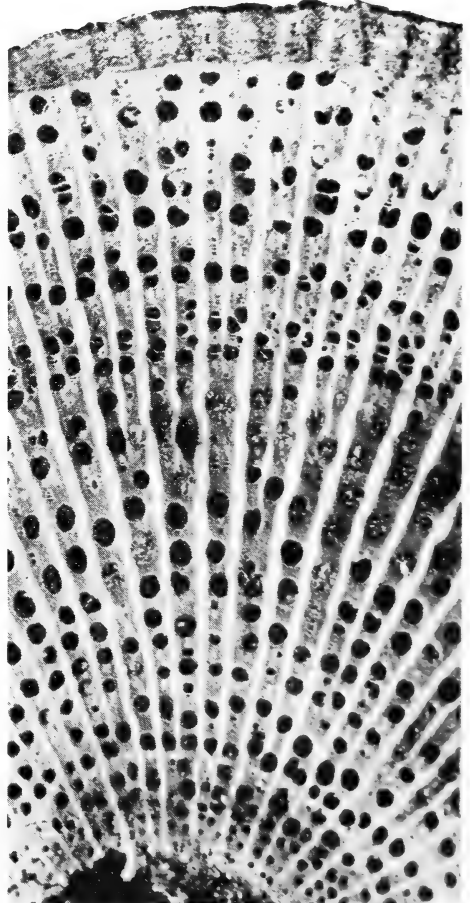
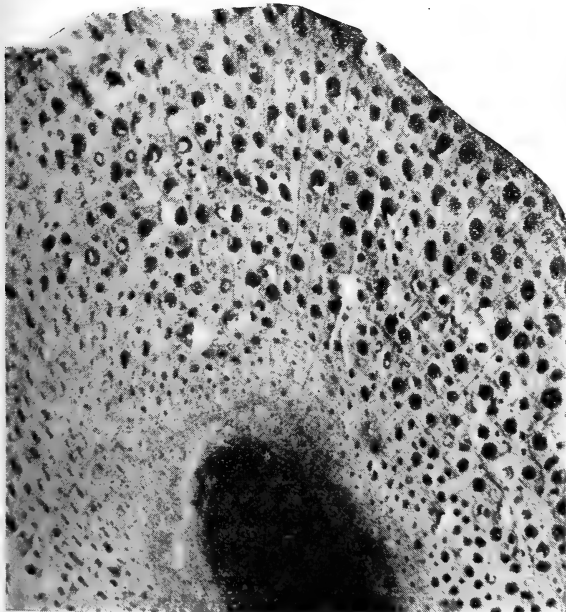
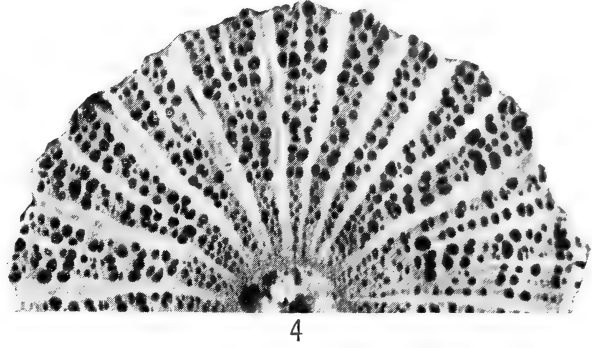

Figs. 1-3.—*Vitoxylon opalinum* Brown, n. sp.: 1, 2, Two views of the specimen to show emergence of the tendrils, natural size; 3, transverse section, $\times 14$. Fig. 4.—Transverse section of *Parthenocissus quinquefolia*, $\times 14$. Fig. 5.—Transverse section of *Vitis labrusca*, $\times 14$.

and especially the tendrils characterize this specimen as a portion of a grapevine (*Vitis*). Inasmuch as comparable woody material from all the 60 living species of *Vitis* was not readily available, it is at present impossible to indicate the relationship of the fossil within the genus. Its narrow rays, however, suggest that it is not closely related to the fox grape (*V. labrusca*) of the Eastern United States. A section of the latter (Fig. 5) displays much broader rays and somewhat larger vessels. The native species of *Vitis* now living closest to the fossil locality are *V. arizonica*, which inhabits stream banks from western Texas to southeastern California, and *V. californica*, which grows in the western Sierra Nevada foothills, the Great Valley, and the Coast Ranges of California. Comparison of the fossil with these species has, however, not satisfied the writer that close relationship exists.

A transverse section (Fig. 4) of the Virginia-creeper (*Parthenocissus quinquefolia*), introduced for comparison, displays fewer and broader rays than species of *Vitis* and multiple instead of single rows of vessels between adjacent rays. In these respects the fossil is clearly aligned with *Vitis* rather than with *Parthenocissus*. Sections of *Ampelopsis* resemble those of *Parthenocissus* in having multiple rows of vessels between broad rays.

The species of *Vitis* are distributed in the Northern Hemisphere but are most abundant in temperate regions. The related genus *Ampelopsis* comprises 20 species in temperate North America and Asia. *Cissus*, with about 200 species, is found chiefly in tropical and subtropical regions, and *Parthenocissus*, with 10 species, inhabits temperate North America and Asia.

Vitoxylon opalinum is clearly different from the three described European fossil species. Schönfeld's *V. ampelopsoides*, as the specific name implies, is apparently allied to *Ampelopsis*. As for the other two, *V. coheni* and ?*Vitis* sp., Schönfeld expresses some doubt as to whether they are correctly identified as Vitaceae.

The writer has not seen any of the fossil leaves said to have been found in the middle zone of the Virgin Valley beds, but they were reported by Merriam to be rushes, willows, and fragments of other species. Such wood as has not been completely replaced by opal and now

included in the Virgin Valley opal collection in the National Museum is coniferous and belongs to the division normally without resin ducts. One specimen appears to be a species of *Sequoia*, but, as no thin sections of these woods have yet been cut, definite generic identifications can not be given. The presence of a grape in the flora suggests a somewhat moister climate than obtains in the region today, which is semiarid and practically treeless, the dominant woody vegetation being sagebrush with a few scattered junipers. Grapes are generally stream-side plants usually in association with a fair mixture of trees and shrubs over which they climb. No wild grapes now live in Humboldt County, Nev. The carbonaceous shales and thin lignitic layers in the middle zone, together with the large amount of included fossil wood, also corroborate the probability of a moister climate at the time those sediments were deposited. The evidence from the fossil mammals accords with this hypothesis in that, although a few species seem to indicate an environment of open plains, some were clearly adapted to a region with wooded areas.

A species of grape is represented by leaves called *Vitis washingtonensis* (Knowlton) Brown in the middle Miocene Latah formation at Grand Coulee, Wash. A seed, called *Vitis bonseri* Berry, also from that locality, may be the same species. Associated with these grapes is a large number of other species—an assemblage indicating climatic conditions approaching those prevailing in the southeastern United States today. It may be postulated that if and when the associates of *Vitoxylon opalinum* from the Virgin Valley beds become known they will be found to be related to or perhaps identical with species from the Latah formation and of the fossil flora from Coal Valley, Nevada, now being studied by Axelrod (1940a, p. 163; 1940b, p. 480). These floras reflect the moister Miocene climate of the northern part of the Great Basin before the advent of more arid conditions in the Pliocene.

The writer is grateful to Dr. J. B. Reeside, Jr., of the Geological Survey, for supplying the specimen of *Parthenocissus quinquefolia*; to E. P. Henderson, of the U. S. National Museum, for petrographic examination of the fossil; and to N. W. Shupe, of the Geological Survey, for the excellent photographs.

LITERATURE CITED

- AXELROD, D. I. *The Pliocene Esmeralda flora of west-central Nevada*. Journ. Washington Acad. Sci. **30**: 163-174. 1940a.
- . *Late Tertiary floras of the Great Basin and border areas*. Bull. Torrey Bot. Club **67**: 477-487. 1940b.
- DAKE, H. C. *Opals in Virgin Valley, Nevada*. Rocks and Minerals **8**(1): 16-18. 1933.
- The reader interested in precious opal will find this issue of *Rocks and Minerals* particularly helpful, as it is a special number devoted to opal and includes a complete bibliography of the subject to that date.
- KRÄUSEL, RICHARD. *Nachträge zur Tertiärflora Schlesiens 2. Braunkohlenhölzer*. Jahrb. preuss. geol. Landesanst. f. 1918 **39**(1): 459, pl. 34, fig. 5; pl. 38, figs. 8-9, text figs. 10-11. 1920.
- MERRIAM, J. C. *The occurrence of middle Tertiary mammal-bearing beds in northwestern Nevada*. Science, n. ser., **26**: 380-382. 1907.
- . *Tertiary mammal beds of Virgin Valley and Thousand Creek, in northwestern Nevada. Part 1. Geologic history*. Bull. Univ. California Dept. Geol. **6**: 21-53. 1910; *Part 2. Vertebrate faunas*. *ibid.*: 199-304. 1911.
- REEDS, C. A. *Desert landscapes of northwestern Nevada*. Nat. Hist. **27**: 448-461. 1927.
- SCHÖNFELD, ERICH. *Über zwei neue Laubhölzer aus dem Miozän*. Senckenbergiana **12**: 111-126, figs. 1-18. 1930.
- SCHUSTER, JULIUS. *Paleozäne Rebe von der Greifswalder Oie*. Ber. deutsch. Bot. Ges. (Berlin) **29**: 540-544, pl. 21. 1911.
- STIRTON, R. A. *The Nevada Miocene and Pliocene mammalian faunas as faunal units*. Proc. 6th Pacific Sci. Congr.: 627-640. 1939.

BOTANY.—*On new algae of the genus Codium from the South China Sea*.¹ C. K. TSENG and WM. J. GILBERT, Department of Botany, University of Michigan. (Communicated by H. H. BARTLETT.)

When the senior author reported *Codium elongatum* C. Ag. from Hainan, China (Tseng, 1936, p. 170), he was not entirely without doubt. The plant so reported is similar to *Codium cylindricum* Holm. in general appearance, but the utricles are too small. It is similar to *Codium elongatum* in its utricles but differs in the divaricate branching and the short segments between the forkings. Since the materials available were sterile, he had to be content to place them with the widely distributed, rather variable *C. elongatum* of warmer waters.

Recently, the junior author was studying collections of *Codium* from the Philippines and was puzzled with a few specimens found to be very similar to the Hainan plants, which had been provisionally identified as *C. elongatum*. After the dried specimens from the two regions had been boiled to restore their natural conditions as nearly as possible, they were found to be similar

¹ Papers from the Department of Botany of the University of Michigan, no. 785. Received Feb. 27, 1942. This article was submitted to the Philippine Journal of Science for publication. Its receipt was acknowledged by the editor in June 1941. To date, however, the authors have not received any proof. The article has quite certainly not been published yet in Manila and, under the present circumstances, is most unlikely to be.

in the size and form of the utricles. In some of the specimens, however, the utricles adhered to one another so closely that it was difficult to separate them. Others behaved like ordinary *Codia* with easily separable utricles. The coherent utricles of the one kind proved to be provided with conical, spinelike outgrowths, which were absent in the other. This and other differences convinced the authors that two species were involved, both still undescribed. Both are reported from Hainan Island, China, and the Philippines, in the northwestern and eastern parts of the South China Sea.

1. *Codium bartlettii* Tseng & Gilbert, sp. nov.

Figs. 1, 2a

Frons viridiuscula, unilateraliter subdichotoma, divaricata, ca. 17 cm alta; segmentis subcylindricis vel complanatis, cuneate dilatatis, ca. 1 cm latis, interdum hinc illinc inter se per tenacula adhaerentibus; filamentis medullae 30-60 μ diam.; utriculis 100-360 μ (generaliter 130-280 μ) crassis, 600-1,100 μ (generaliter 700-900 μ) longis, subcylindricis vel clavatis, raro obovoideis, apice truncatis (Fig. 2a). membrana apicali paulum stratosata, ca. 5-10 μ crassa; parietali tenuiore, 2-3 μ crassa; pilis numerosis sub apicem utriculorum circulatim posit.

plerumque ca. 22–26 μ latis, interdum solum 15 μ , basi subconstrictis, plerumque ex vestigiis cicatriciformibus vel elevatis deciduis; gametangiis subfusiformibus, ca. 75–90 μ latis, 270–320 μ longis, supra mediam utriculorum, singulis vel binis, interdum utriculos excedentibus.

Specimen typicum: *H. H. Bartlett 13954*, ex loco dicto "Puerto Galera Bay," Mindoro, Insulis Philippinis, 12–17 Mai. 1935, in Herb. Univ. Michiganensi, ex profunditate ca. 12 ped. Specimina alia ex "Batangas Channel," Puerto Galera, Mindoro (*Bartlett 14015*) et Yuling-Kang, Hainan, Sina, Apr. 1934 (*Tseng 853*).

As in most of the branched *Codia*, the frond of *Codium bartlettii* appears to be many times subdichotomously branched. The forking, however, is unequal in that one side usually appears to be continuous with the axis below it and that the branches on the other side are less developed. These features result in mature fronds of characteristically unilateral appearance (cf. Fig. 1). The branching is divaricate, with very broad and roundish angles. As a rule, the lower the dichotomy, the more divaricate the branching. This species has the further peculiarity that segments of the same frond sometimes adhere to one another by means of tenacula of rhizoidal fibers (cf. Fig. 1). Knoblike protrusions are found on some segments. These, when examined microscopically, are also composed of rhizoidal filaments, and it appears that they are immature tenacula. Another characteristic is that the thallus of the new species is complanate, which is especially clear in the infra-axillary dilations. The young segments, however, are generally subcylindrical. The segments between the forkings are cuneate and short, generally 1–2 cm long; sometimes the segments are dilated at both ends and narrowed at the middle, thus assuming a dumb-bell shape. The dilated part of the segments reaches a width of one centimeter. The frond gradually tapers upward and seems to be much elongated, since the type specimen, which represents only the upper portion of a plant, measures 17 cm.

Tseng 853 from Hainan is one of the two specimens formerly reported by the senior author (*Tseng*, 1936, p. 170) as "*Codium elongatum*." This specimen is young and sterile and does not show adherence of segments by rhizoidal fibers. There are, however, several knob-

like protrusions, evidently immature tenacula, here and there on the segments. Similar knob-like protrusions are also found in the type specimen. The important characteristics of the Hainan plant agree so well with the Philippine specimens that the authors do not feel any hesitation in referring it to the same species.

Codium bartlettii is a member of the section *Elongata* De-Toni, probably nearest to *C. elongatum*, which is presumed to be widely distributed in warmer and tropical seas. The latter plant (*C. Agardh*, 1822, p. 454; *Setchell*, 1933, p. 188, pl. 26, fig. 2; pl. 29, fig. 3) resembles the present species in the infra-axillary dilations of the thallus, the cuneate segments, and the size and form of the utricles. The unilateral and broadly divaricate branching, the much shorter segments, and the much smaller gametangia, however, differentiate it clearly from *C. elongatum*. The next species that should be compared with the present one is *C. cylindricum* (*Holmes*, 1895, p. 250, pl. 7, figs. 1a, b; also cf. *Okamura*, 1915, p. 177, pl. 141), which is found abundantly on the coast of Kwantung and Fukien Provinces, China, in the northern part of the South China Sea. In its general aspect *C. cylindricum* is similar, especially certain forms with strong infra-axillary dilations and divaricate branching. It has, however, much longer segments between the forkings, does not have the characteristic unilateral branching even in mature specimens several meters long, has much larger and longer utricles (as much as 900 μ in diameter and 2 mm long), which are plainly visible to the naked eye and have differently shaped, somewhat broader gametangia. Also resembling the new species in the divaricate branching and the shape and size of the utricles is *C. divaricatum* *Holmes* (1895, p. 250, pl. 7, figs. 2a, b; also cf. *Okamura*, 1915, p. 155, pl. 136), reported from Japan and North China. That species, however, is a much larger, darker colored, and very tough plant, with much longer segments between the forkings, which has mature utricles with rounded, convex apices, very much thickened (up to 60 μ) clearly stratified apical membranes, and somewhat differently situated and larger gametangia (180 μ in diameter and 450 μ long).

The only species reported to have unilateral branching is *C. unilaterialis* *Setchell & Gardner* (1924, p. 710, pl. 15, figs. 30, 31; pl. 36) from

the Gulf of California. That species, however, is cylindrical, with much narrower segments, and has very narrow angles of branching and much broader gametangia. Another species of the same alliance is *C. cuneatum* Setchell & Gardner (1924, p. 708, pl. 16, figs. 34, 35; pl. 34) also from the Gulf of California, which has short cuneate segments, flattened thallus, utricles of similar shape and size, and subfusiform gametangia. It has, however, an entirely different type of branching, being regularly dichotomous-flabellate, with much narrower angles of forking, much broader,



Fig. 1.—*Codium bartlettii* Tseng & Gilbert, sp. nov.: Habit sketch of a part of the type, showing especially the intersegmental cohesion by tenaculae and the unilateral branching, $\times 0.4$.

cuneate segments, and broader and shorter gametangia.

From all the more or less closely related species, the new one differs additionally in the peculiar ability of the segments to fuse with one another by means of tenacula of delicate rhizoidal fibers growing out from the thallus. This is apparently a result of growth stimulated by the contact of the segments. The phenomenon is not at all common among members of the section *Elongata* De-Toni, being reported, so far, in only two other species. These are *C. intricatum* Okamura (1915, p. 74, pl. 120, figs. 9–13) and *C. coarctatum* Okamura (1915, p. 141, pl. 134, figs. 4–12), both originally described from Japan and the first one later found in the Loochoo Islands and Hainan. The senior author has seen hundreds of living specimens of *C. cylindricum*, *C. divaricatum*, and others of similar habit with segments frequently overlapping one another but has never found similar cases of anastomosis by tenacula.

It seems, therefore, to be peculiar to certain species, notably members of the *repens* group of the section *Tomentosa* De-Toni. *C. bartlettii*, although resembling *C. intricatum* and *C. coarctatum* in the possession of intersegmental tenacula, differs definitely from both species in many respects. These latter are small, low-creeping plants with irregular branching, which, although also divaricate, has much narrower angles of forking and is never unilateral. In *C. intricatum* the segments between the forkings are not so distinctly flattened and cuneate, and the gametangia are generally ovate rather than elongate-subfusiform as in *C. bartlettii*. *C. coarctatum* has a strongly flattened thallus, which is, however, dorsiventral, with much narrower utricles ($50\text{--}60\mu$).

2. *Codium papillatum* Tseng & Gilbert, sp. nov.

Figs. 2, b–d, 3

Frons viridis, subdichotoma, saepe irregularis, ut videtur unilateralis vel alternatim ramosa, si furcata, ramis alterutris inaequalibus, divaricata, ca. 8 cm alta, parte basali discoidea ad substratum affixa (cf. Fig. 3); segmentis junioribus subcylindricis, vetustioribus complanatis, segmentis inferioribus inter bifurcationes sursum dilatatis, brevioribus quam latioribus (ca. 7 mm latis, plerumque 2–5 mm longis); infimis stipitifformibus parvissimis, sequentibus usque ad frondis mediam gradatim grandioribus, superioribus aliquantulum parvioribus; apicalibus elongatis, flagelliformibus sursum plus minusve tumidis; filamentis medullariis $30\text{--}60\mu$ diametentibus; utriculis papillatis, $100\text{--}300\mu$ (generaliter $140\text{--}240\mu$) latis, $600\text{--}900\mu$ (generaliter $650\text{--}850\mu$) longis, subcylindricis vel obovoideis, apice truncatis vel subtruncatis, membrana parietali tenui, $2\text{--}3\mu$ crassa, apicali leviter foveolata, ca. $10\text{--}20\mu$ crassa (cf. Fig. 2, d); papillis solidis late conicis, $10\text{--}16\mu$ latis, $8\text{--}10\mu$ altis, apice obtusis vel acutiusculis (cf. Fig. 2, b, c); pilis numerosis sub apicem utriculorum cyclice positissis, ca. $25\text{--}30\mu$ crassis, basi saepe constrictis, caducis, delapsu cicatrices rotundas vel semilunares vel elevatas formantibus; gametangii ellipsoideis vel ovoideis, plerumque ca. $70\text{--}90\mu$ latis, $200\text{--}270\mu$ longis, saepissime singulis, interdum binis, raro trinis supra mediam utriculorum positissis.

Specimen typicum: *H. H. Bartlett 13786*, ex "Puerto Galera Bay," Puerto Galera, Mindoro.

Insulis Philippinis, 12-17 Mai, 1935, in Herb. Univ. Michiganensi. Specimina alia ex Cavite, Cavite Prov., Luzon, Insulis Philippinis, Jul. 1935 (*Bartlett 14595a*).

Only a few specimens are available. The materials are fortunately in good fruiting condition, and can be well compared with other related species. Two specimens in the type collections and also *Bartlett 14595a*, are larger than the actual type specimen, being about 8

cm high and 7 mm broad in the dilated parts of the segments. In general appearance and internal characteristics, however, they agree well with the type.

The present plant was first thought to be only a small form of the previous species, namely, *Codium bartlettii*. Further studies revealed the important characteristic presence of the papilliform outgrowths of the utricles. So far as the information of the authors goes,

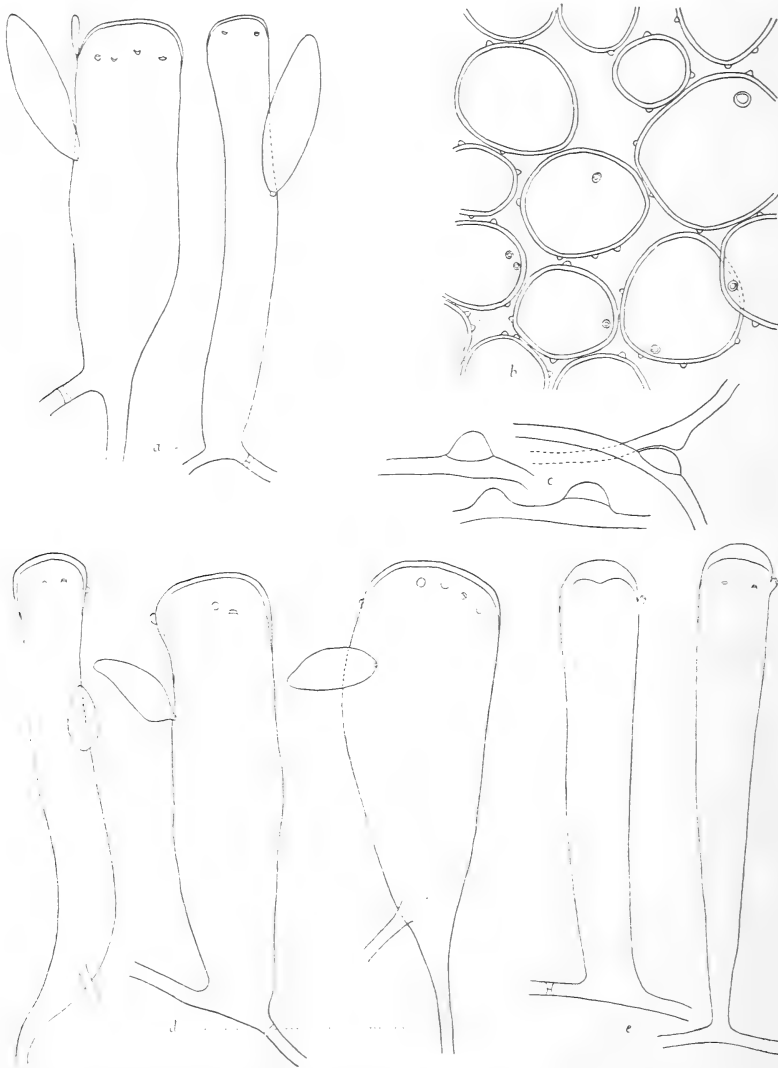

Fig. 2.—(a) *Codium bartlettii* Tseng & Gilbert, sp. nov.: Two utricles showing a hair, several hair-scars, and two gametangia. $\times 80$. (b-d) *Codium papillatum* Tseng & Gilbert, sp. nov.: b, Vertical view of some utricles with the conical papillae, $\times 64$; c, some utricular papillae, $\times 358$; d, three utricles showing some papillae and hair-scars, and three gametangia, $\times 64$. (e) *Codium papillatum*, var. *hainanense* Tseng, var. nov. Two utricles showing hair-scars and the thickened apical membranes, $\times 64$.

such utricular papillae have never been reported before. As mentioned above, the plant is extraordinary in that the utricles adhere to each other quite firmly and are separated with difficulty. If an attempt is made to separate them, the upper portion of the utricles generally breaks away from the lower. When thus broken, mounted and examined microscopically, a vertical view of the utricles, rather than a lateral view, was obtained, giving the clearest view of the papillae (cf. Fig. 2b). These are merely outgrowths from the cell wall of the utricles and have no connection with the cytoplasm whatsoever (cf. Fig. 2c). They are found mostly somewhere below the apices of the

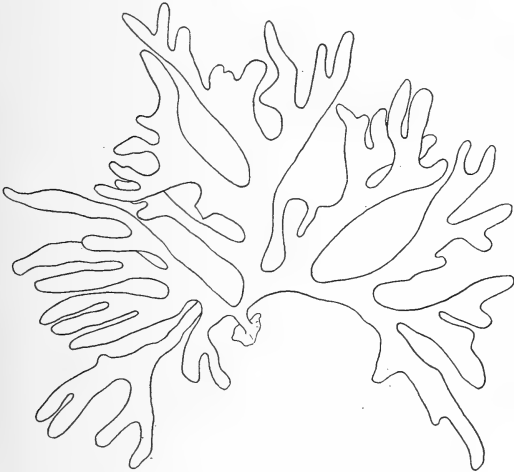

Fig. 3.—*Codium papillatum* Tseng & Gilbert, sp. nov.: Habit sketch of the type, showing the branching, $\times 0.7$.

utricles, sometimes at the tips, and occasionally very low down on the side walls of the utricles.

The present species is a member of the section *Elongata* De-Toni, probably nearest to *C. bartlettii* described above, which it resembles in the divaricate branching, the somewhat cuneate, short, flattened segments between the forkings, and the size and shape of the utricles. The absence of tenacula, the smaller size of the frond and segments, the much thicker, sometimes foveolate apical ends of the utricles, and the different shape of the much shorter gametangia, besides the presence of the characteristic papillae on the utricles, separate it easily from the first described new species. From the widely distributed *C. elongatum* it differs in the divaricate branching with short segments be-

tween the forkings, the foveolate, thickened apical membrane of the utricles, the utricular papillae, and the smaller, somewhat differently shaped gametangia. The divaricate branching and the thickened apices of the utricles remind one of *C. divaricatum* of Japan and North China. That species, however, is a much larger and tougher plant which has the segments between the forkings several times as long, the apical membranes of the utricles three to four times as thick, and the gametangia much larger and differently shaped.

2a. *Codium papillatum* Tseng & Gilbert, var. *hainanense* Tseng, var. nov.

Fig. 2e

Frons subdichotoma, divaricata, ca. 10 cm alta, segmentis junioribus subcylindricis, segmentis vetustioribus complanatis, infra axillas cuneate dilatatis, ca. 1 cm latis; utriculis papillatis, 150–300 μ latis, 650–950 μ longis, subcylindricis vel obovoideis, apice truncatis vel subtruncatis, membrana apicali leviter foveolata, ca. 15–30 μ crassa; pilis numerosis sub apicem utriculorum positis, ca. 25–30 μ latis. Gametangia ignota.

Specimen typicum: *Tseng 771*, ex Tsinglan-Kang, Wenchang, Hainan, Sina, 7 Apr. 1934, in Herb. C. K. Tseng.

Var. *hainanense* is a much larger and more robust plant than the nomenclatorial typical form of the species with respect to the height of the frond, the breadth of the segments, and, to a lesser extent, the size of the utricles. The apical membrane of the utricles is much thicker and more clearly stratified and foveolate. The papillae, however, are not so abundant, and the coherence of the utricles not so firm as in the typical form. The specimen *Tseng 771*, upon which the new variety is based, was reported under "*Codium elongatum*" (pro parte) by the senior author (Tseng, 1936, p. 170). Although the material available is sterile, the plant agrees well with the species to which it is referred in the important characteristics, e.g., the behavior of the utricles, the utricular papillae, the apical thickening of the sometimes foveolate apical membrane of the utricles, the form and size of the utricles, and the divaricate branching of the frond. Differing, however, from the typical form in the few points already mentioned, it is described as a new variety.

LITERATURE CITED

- AGARDH, C. A. *Species algarum rite cognitae cum synonymis, differentiis specificis et descriptionibus succinctis* 1 (pt. 2): 169-531. 1822. Lund.
- HOLMES, E. M. *New marine algae from Japan*. Journ. Linn. Soc. Bot. 31: 248-260, pl. 7-12. 1895.
- OKAMURA, K. *Icones of Japanese algae* 3: 8+218 pp., pls. 101-150. 1915. Tokyo.
- SETCHELL, W. A. *Some early algal confusions. II*. Univ. California Publ. Bot. 17(9): 187-254, pls. 26-45. 1933.
- SETCHELL, W. A., and GARDNER, N. L. *New marine algae from the Gulf of California*. Proc. California Acad. Sci. 12(29): 695-949, pls. 12-88, map. 1924.
- TSENG, C. K. *Studies on the marine Chlorophyceae from Hainan*. Amoy Marine Biol. Bull. 1(5): 129-200, map. 1936.

BOTANY.—*An undescribed Atropellis on cankered Pinus virginiana*.¹ M. L. LOHMAN, EDITH K. CASH, and ROSS W. DAVIDSON, Bureau of Plant Industry. (Communicated by JOHN A. STEVENSON.)

Two species of *Atropellis* have been reported (3) as occurring in association with cankers of scrub pine, *Pinus virginiana* Mill., in the Allegheny and Appalachian forest areas. The commoner of the two, *Atropellis tingens* Lohm. & Cash, is known to occur on various species of pines, native and exotic, in natural stands or plantings from New England to Florida, Ohio, and Arkansas. The other, *A. piniphila* (Weir) Lohm. & Cash, a species typically of the Rocky Mountain area and presumably very infrequent in the Southeastern States, is recorded but once for this host and once for loblolly pine, *P. taeda* L. The cankers due to these two fungi on various hosts are discussed briefly by Boyce (1). That due to *A. tingens* is described more fully by Diller (2).

It is in association with a similar canker that there has been found on scrub pine in Virginia and North Carolina a third and undescribed species of the genus, peculiarly interesting because of its rather atypical ascospores and the fact that it colors the test solution (5 per cent KOH) chocolate-brown rather than the greenish blue or bluish brown characteristic of the other species of *Atropellis* occurring on pines (2, 3). While no inoculations have been made, it is reasonable to assume that the fungus is pathogenic in view of its constant association with cankers and discolored wood as in

the case of the previously mentioned species.

What appears to be the earliest record is a specimen collected by R. W. Davidson, in Shenandoah County, Va., May, 1933. In June and July, 1933, five specimens were received among samples of diseased pines from the George Washington National Forest, New Kent and Spotsylvania Counties, Va., and Alamance County, N. C., all collected by J. D. Diller. The fungus later was noted in the field by Lohman and Diller in Buncombe, McDowell, Davie, and Forsyth Counties, N. C., at various times from the following September to June, 1934.

When the early collections of the fungus were received, it was believed to be a saprophyte of secondary importance, following mechanical or insect injury and also following cankering due to *Atropellis tingens*. In 1940, however, in the study of specimens currently collected by Diller in Goochland County, Va., the fungus was obtained in culture from ascospores and the general similarity in cultural characteristics between it and *A. pinicola* Zell. & Goodd. and *A. tingens* was demonstrated. Except for the lack of production of the *Atropellis* conidial (? spermatial) stage, which, however, likewise is lacking in all of the specimens among collections received to date, the general characteristics of the fungus are in agreement with those previously reported for ascospore cultures of *A. arizonica* Lohm. & Cash and for a number of cultures of *A. tingens* isolated from the colored infected wood of various species of pines (3).

Cultures were made from the discolored wood and from ascospores that had been

¹ The work of the present account, in part, and that incorporated in a previous account on *Atropellis* (3), in connection with which the studies herein reported were initiated, are credited to the Civilian Conservation Corps and to the Division of Forest Pathology and the Division of Mycology and Disease Survey in cooperation. Received July 6, 1942.

induced to shoot out onto the surface of corn meal agar in petri dishes. The cultures from these two sources were similar in rate of growth and general appearance. Both gave a brown reaction ("old gold" to "Hessian brown")² when particles of 3-month-old mycelium were placed in dilute KOH solution. On malt agar medium the mycelial mats were erumpent, black and uneven, of slow growth and with scattered or marginal areas of fine, gray tomentum. (Cf. 3, fig. 1, A, B.)

Most of the ascospores developed one or two septa on germination (Fig. 1, D). The germ tubes, both lateral and terminal, de-

veloped about 2 mm in diameter, and fusoid, more or less subsigmoid spores; with *A. piniphila* in the blackish-brown exciple and size of ascospores; and is more like *A. tingens* with respect to ascus measurements. On the other hand, in comparison with these four species it is distinct in the somewhat lighter colored hymenium, as seen in expanded ascocarps, the sharply pointed to apiculate ascospores, and in the apparent lack of a similar conidial stage; also, in the brownish epithecium which, relative to its development, is largely responsible for the resultant rich brown color given by the KOH test. Of these features, the characteristic shape of

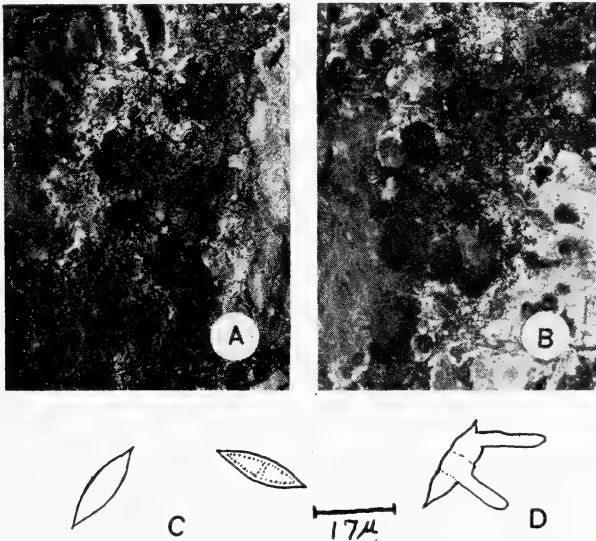

Fig. 1.—*Atropellis apiculata* on *Pinus virginiana*: A, closed, B, partly opened apothecia, $\times 10$; C, ascospores outlined with the aid of the camera lucida; D, germinating ascospore.

veloped and grew slowly when the test plates were held in the refrigerator at a temperature of about 11°C. No conidia were found in cultures grown for three months, in which respect they differ from comparable cultures of *Atropellis tingens*.

This fungus agrees with the four canker-forming species previously described (3), namely, *Atropellis arizonica*, *A. pinicola*, *A. piniphila*, and *A. tingens*, with respect to all features of generic importance. It is in particularly close agreement with *A. arizonica* in having relatively small apothecia,

the ascospore is utilized in naming this species.

Atropellis apiculata, sp. nov.

Fig. 1, A-D

Apotheciis ex cortice erumpentibus, sessilibus vel substipitatibus, plus minusve aggregatis, coriaceis, atro-fuscis, 1.5–2 mm diam., subglobosis dein expansis, patelliformibus dein exaridis hysteriformibus, aliis triangulis atque irregulariter compressis; margine undulato, laciniato, incurvato; hymenio pruinoso, cinnamomeo vel atro-fuseo; ascis cylindricoclavatis, apice obtusis, 8-sporicis, 80–110 μ longis, 10–12 μ latis; ascosporis hyalinis, fu-

² Quoted color terms are from Ridgway (4).

soideis, subsigmoideis, apiculatis, 1-2-septatis, 20-24 μ longis, 4.8-6.5 μ latis, apicibus (2-3 μ longis) inclusis; paraphysibus filamentosis, septatis, ramosis, apice brunneolis, conglutinatis; hypothecio pallide brunneo; strato interiore subhyalino; cortice crasso, atro, exterius rugoso; statu conidico in natura et culturis indeprehenso.

Hab. in cortice ramorum vivorum *Pini virginianae*.

Apothecia emerging from the bark over cankered areas, scattered or in more or less dense groups, coriaceous, sessile or substipitate, subglobose, then expanded and patellate, 1.5-2 mm in diameter, with lacerate, undulate margin, inrolled on drying, then hysteriform, triangular, or irregularly compressed, furfuraeous, dark brownish ("blackish brown" to "fuscous-black"); hymenium pruinose, light to dark brown or nearly black ("dark vinaceous-drab" to "raisin black" and sometimes lighter, "pinkish buff" or "cinnamon-rufous"); asci cylindric-clavate, gradually attenuated toward the base, broadly rounded to slightly flattened at the apex, 8-spored, 80-110 \times 10-12 μ ; spores hyaline, fusoid to subsigmoid with sharply pointed or apiculate ends, biseriata above, irregularly uniseriate below, continuous with granular contents, at last 1-septate or more rarely 2-septate, unstricted, 20-24 \times 4.8-6.5 μ , including the apiculae, 2-3 μ in length; paraphyses filamentous, septate, branched, slightly swollen at the apex, becoming granular incrustated and forming a brownish epithecium which in age breaks into islands or tufts that tend to break away; hypothecium of pale brown, fine, densely interwoven hyphae;

medullary layer 100-150 μ thick, subhyaline, appearing loose in hyphal structure; cortex about 50 μ thick at the margin and 200 μ at the base, of compacted, black, thick-walled, closely septate hyphae which on the surface build hyphal clumps that give the exciple a furfuraeous appearance.

On cankered twigs and small branches and on main stems of seedlings of *Pinus virginiana* Mill. in Virginia and North Carolina, probably widespread but infrequent.

Specimens examined.—VIRGINIA: Shenandoah County, May 25, 1933, R. W. Davidson (F. P. 66206); Goochland County, June 23, 1933, J. D. Diller 75 (F. P. 66204) and July 25, 1940, J. D. D. 1002 (F. P. 94036); New Kent County, June 20, 1933, J. D. D. 29-A (F. P. 66208) and July 25, 1940, J. D. D. 1003 (F. P. 94034); Spotsylvania County, June 23, 1933, J. D. D. 71 (F. P. 66207) and July 25, 1940, J. D. D. 1001 (F. P. 94035, *type*); George Washington National Forest, July, 1933, J. D. D. 213-A (F. P. 66209). NORTH CAROLINA: Alamance County, June 28, 1933, J. D. D. 123 (F. P. 66205).

LITERATURE CITED

- (1) BOYCE, J. S. *Forest pathology*, 600 pp., illus. New York, 1938.
- (2) DILLER, J. D. *A canker of eastern pines associated with Atropellis tingens*. Journ. Forestry (in press).
- (3) LOHMAN, M. L., and EDITH K. CASH. *Atropellis species from pine cankers in the United States*. Journ. Washington Acad. Sci. 30: 255-262, illus. 1940.
- (4) RIDGWAY, R. *Color standards and color nomenclature*, 43 pp., illus. Washington, 1912.

ENTOMOLOGY.—*New species of Anastrepha and notes on others (Diptera, Tephritidae)*.¹ ALAN STONE, Bureau of Entomology and Plant Quarantine.

As was expected when work was terminated on the writer's revision (7)² of the genus *Anastrepha*, several new species have since come to light. The present paper is designed to describe these new species and to publish additional information of interest concerning others. Some of this material is from the continued active collecting of

James Zetek, while the species from Venezuela and British Guiana were submitted by Pablo Anduze and J. N. Knull, respectively.

There has been some confusion concerning the correct family name for the fruit flies commonly known as Trypetidae. The essential facts that led to the adoption in this paper of the little-used name Tephritidae are as follows: Until very recently the writer was not aware that the name Trypetidae was not the first name used for the

¹ Received June 20, 1942.

² Numbers in parentheses refer to literature cited at the end of the paper.

family, so that when *Trypeta* Meigen fell as a synonym of *Euribia* Meigen [see Stone (6, p. 410)] it seemed necessary to change to the name Euribiidae. It now appears that the name Trypetidae was not used until 1862 by Loew (2, p. 49), whereas Newman in 1834 (5, p. 396) introduced the name Tephrites as a "Natural Order" under the Stirps Muscina, and based on the genus *Tephritis*. In 1835 Macquart (3, p. 447) used the name Tephritidae as the name of a "sous-tribu," and other workers such as Bigot, Walker, Frey, and Hendel have used it since then. Since it is desirable, if not mandatory, to follow priority in family names, and since the well-established name of Trypetidae must be dropped if we consider a synonym not available as the basis of a valid family name, it appears advisable to accept the family name Tephritidae. The only other possibility would be the name Trupaneidae, arrived at either by basing the family name on the name of the oldest included genus or by sinking *Tephritis* as a subgenus of *Trupanea*. The former procedure, mentioned (by citation of the name Trypaneinae), but not accepted, by Hendel in 1910 (1, p. 311), would not be sanctioned by the International Commission of Zoological Nomenclature in this case (opinion 133), whereas the latter, although suggested by Malloch in 1931 (4, p. 276), is not sound from a taxonomic standpoint.

***Anastrepha gigantea*, n. sp.**

Figs. 4, 8

Very large, yellow-orange. Clypeal ridge strongly protuberant, with no median depression. Mesonotum 5.0 mm long, orange, with humerus, lateral stripe from transverse suture to scutellum, very slender median stripe fading out posteriorly, and scutellum paler; pleura mostly pale yellowish; metanotum entirely yellow orange. Macrochaetae black; pile yellow orange. No sternopleural bristle. Wing 13.5 mm long, the band along costa yellow orange, the other bands brownish; costal and S-bands joined from anterior margin of wing to cell R_1 , the hyaline band only very faintly indicated in cells R_1 and R_{2+3} ; V-band complete and broadly joined to S-band anteriorly; vein R_{2+3} slightly undulant; vein M_{1+2} curved forward to

meet apex of S-band. *Female terminalia*: Ovipositor sheath 9.4 mm long, tapering from base to short distance beyond spiracles and then nearly parallel-sided to apex; spiracles about 1.8 mm from base. Rasper of rather large hooks in several rows. Ovipositor about 9.0 mm long, with a slight lateral swelling beyond end of oviduct but no distinct serrations.

Type material.—Holotype, female (U.S.N.M. no. 56317).

Type locality.—El Cermeño, Panamá.

The single specimen was trapped by James Zetek, February 6, 1940. This, the largest known *Anastrepha*, will fit into neither half of the first couplet of the writer's key to species. Among the species with a swollen clypeal ridge it is nearest to *benjamini* Lima, but it is quite distinct in wing pattern and terminalia.

***Anastrepha doryphoros*, n. sp.**

Figs. 7, 14

Large, yellow-orange. Mesonotum 3.7 mm long, yellow orange, with narrow median stripe slightly widened posteriorly, border of transverse suture, sublateral stripe from transverse suture to scutellum, and scutellum yellowish white; pleura mostly pale yellowish; metanotum entirely yellow orange. Macrochaetae black; pile orange-brown. Sternopleural bristle very fine. Wing 10.0 mm long, the pattern yellow-orange on basal-anterior portion, brownish on apical-posterior portion; most of wing colored, but costal cell, a spot at apex of vein R_1 extending into cell R_{2+3} , a spot near base of cell R_{4+5} , most of cell 2nd M_2 , cell M_1 , anal lobe, and a poorly defined band across cell Cu_1 hyaline or subhyaline. *Female terminalia*: Ovipositor sheath 9.0 mm long, tapering to slender apical half, the spiracles 1.65 mm from base. Rasper 1.07 mm long, the hooks rather small, gradually decreasing in size basally; tip 0.32 mm long, with abrupt constrictions just distad of end of oviduct, a slight flaring to base of serrate portion, and then tapering to apex, the serrations indistinct, occupying less than half of tip.

Type material.—Holotype, female (U.S.N.M. no. 56318).

Type locality.—El Cermeño, Panamá.

The single specimen was trapped by James Zetek, December 5, 1939.

This species goes to couplet 19 in the writer's

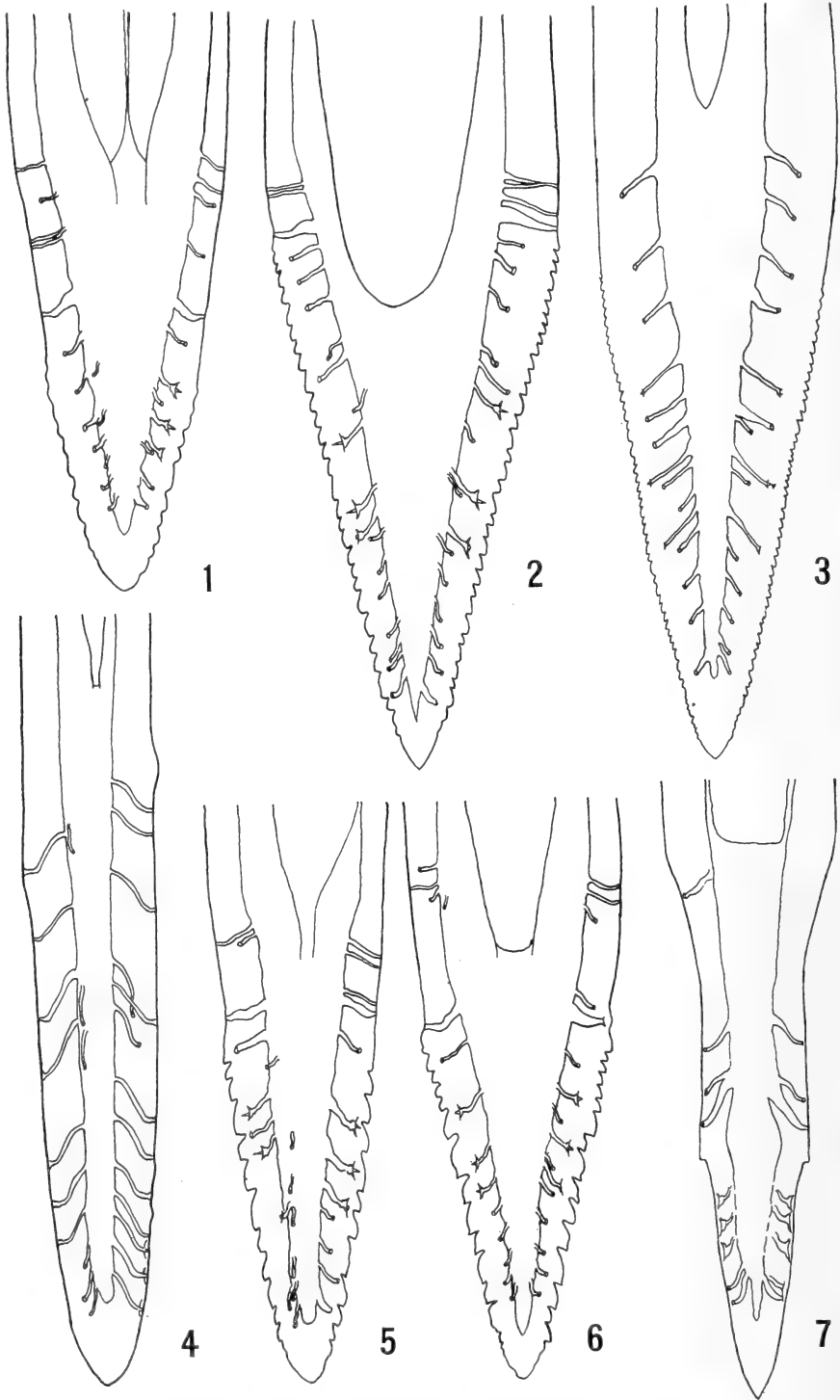

Figs. 1-7.—Ovipositor tips of new species of *Anastrepha*: 1, *teli*; 2, *anduzei*; 3, *dryas*; 4, *gigantea*; 5, *parishi*; 6, *guianae*; 7, *doryphoros*.

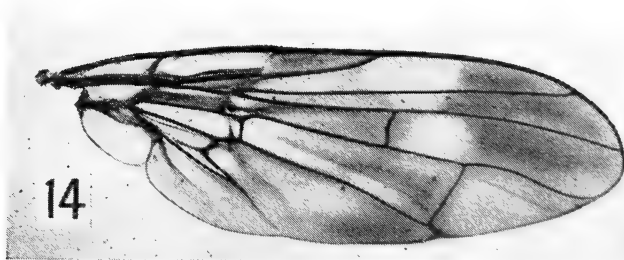
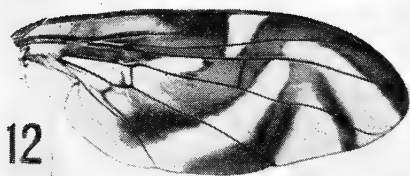
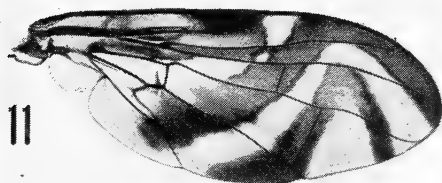
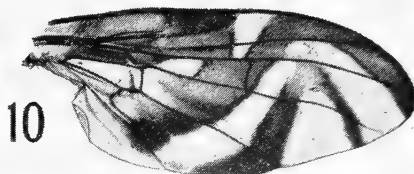
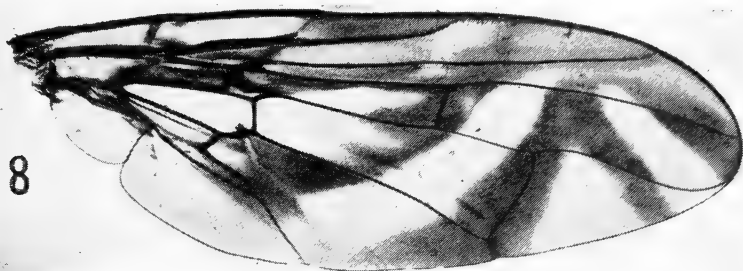

Figs. 8-14.—Wings of new species of *Anastrepha*: 8, *gigantea*; 9, *parishi*; 10, *teli*; 11, *dryas*; 12, *anduzei*; 13, *guianae*; 14, *doryphoros*.

key, but can be carried no further because of the atypical wing pattern with no distinct S-band. The relationship of this species is not at all clear. The rather elongate rasper somewhat resembles that in *balloui* Stone, but the wing pattern and ovipositor tip are unlike those of any other species known to the writer.

Anastrepha anduzei, n. sp.

Figs. 2, 12

Medium sized, yellow-brown; mesonotum 2.5–3.6 mm long, yellow brown, with humerus, median stripe expanding posteriorly, sublateral stripe from transverse suture to scutellum, and scutellum yellowish white; pleura above, including all of metapleuron, yellowish white; metanotum entirely yellow-orange. Macrochaetae black, pile pale, yellow-brown. No sternopleural bristle, or a very weak one. Wing 6.5–8.5 long, the bands yellow-brown; costal and S-bands rather broadly connected along vein R_{4+5} , V-band complete, usually narrowly joined to S-band anteriorly. *Female terminalia*: Ovipositor sheath 2.5–2.7 mm long, rather stout, tapering apically, the spiracles about 0.5 mm from base. Rasper of medium-sized, rather compressed hooks in four or five rows. Ovipositor 2.2–2.4 mm long, rather stout, the base distinctly widened, the tip finely serrate from acute apex to a point basad of end of oviduct; width at base of serrate portion more than half distance from apex of ovipositor to end of oviduct. *Male terminalia*: Tergal ratio about 1.0; clasper about 0.34 mm long, stout basally, flattened apically, tapering to an acute apex; teeth at or near middle; a distinct postero-lateral swelling at level of teeth.

Type material.—Holotype, female (U.S.N.M. no. 56319); paratypes, 90 females, 77 males U. S. National Museum and Museo Nacional de Ciencias, Caracas, Venezuela).

Type locality.—San Estaban, Carabobo, Venezuela.

Distribution.—State of Carabobo, Venezuela.

The holotype and 13 paratypes were collected at San Estaban, November 22 to 30, 1939, and the remaining paratypes at San Estaban from December 1, 1939, to January 7, 1940, and at Puerto Caballo, on January 13, 1940, by Pablo Anduze, for whom the species is named.

In the writer's key this species would run to *lutzi* Costa Lima in couplet 71, but it differs

from *lutzi* in having the costal and S-bands of wing much more broadly connected, in having distinct pale stripes on mesonotum, and in having sides of ovipositor tip less angulate.

Anastrepha parishi, n. sp.

Figs. 5, 9

Medium sized, yellow-orange. Mesonotum 3.25 mm long, yellow-orange, with an indistinct median stripe widening posteriorly, humerus, lateral stripe from transverse suture to scutellum, and scutellum paler; pleura yellow-brown, brighter yellow just below notopleuron; metanotum entirely yellow-orange. Macrochaetae orange brown; pile pale yellowish. No sternopleural bristle. Wing 7.5 mm long, the bands yellow brown; costal and S-bands connected at vein R_{4+5} ; V-band joined to S-band anteriorly; vein M_{1+2} nearly reaching apex of S-band. *Female terminalia*: Ovipositor sheath 2.7 mm long, the spiracles about 0.95 mm from base. Rasper of moderate sized hooks in a compact mass of 7 or 8 rows. Ovipositor 2.5 mm long, rather slender, the base slightly widened, the tip 0.26 mm long, tapering, with about 10 rather flat teeth on each side.

Type material.—Holotype, female (U.S.N.M. no. 56320).

Type locality.—Bartica, British Guiana.

The single specimen was collected by H. S. Parish, August 20, 1901. I take great pleasure in naming the species in honor of its collector.

This species would run to *irretita* Stone in couplet 84 of the writer's key, but differs in having the serrations of the ovipositor tip beginning nearer the apex of the oviduct, and in having the V-band of the wing joined to the S-band anteriorly.

Anastrepha teli, n. sp.

Figs. 1, 10

Medium sized, yellow-orange. Mesonotum 3.0–3.5 mm long, yellow-orange, with narrow median stripe widening posteriorly to include the acrostichal bristles, humerus, and lateral stripe from transverse suture to scutellum yellowish white; usually an indistinct dark spot on scuto-scutellar suture; pleura pale yellowish; metanotum entirely yellow orange. Macrochaetae nearly black; pile brownish, paler on median stripe. Sternopleural bristle very weak or absent. Wing 7–8 mm long, the bands orange

to brown; costal and **S**-bands connected on vein R_{4+5} ; **V**-band complete, separated from **S**-band. *Female terminalia*: Ovipositor sheath 2.68–3.0 mm long, the spiracles about 1.0 mm from base. Rasper of moderate sized hooks in about 6 rows. Ovipositor 2.4–2.6 mm long, rather stout, the tip 0.22–0.28 mm long, tapering to a rather blunt apex, with about 10 inconspicuous rounded serrations on scarcely more than apical half.

Type material.—Holotype, female, paratypes, 3 females (U.S.N.M. no. 56321).

Type locality.—El Cermeño, Panamá.

Distribution.—Panamá.

The holotype was trapped at the type locality October 17, 1939, by James Zetek. Two topotypes were trapped December 12, 1939, and February 6, 1940. The third paratype was trapped at La Campana, Panamá, December 14, 1938.

This species runs to *irretita* Stone, in couplet 84 of the writer's key, but the ovipositor tip is not angulate at the base of the serrate portion and the serrations are shallower. It differs from *parishi* in having the serrations begin considerably farther from the apex of the oviduct, and in having the **V**-band of the wing separated from the **S**-band.

Anastrepha guianae, n. sp.

Figs. 6, 13

Medium sized, yellow-brown. Mesonotum 3.36 mm long, yellow-brown, with humerus, median stripe widening posteriorly to include the acrostichal bristles, lateral stripe from transverse suture to scutellum, and scutellum paler yellow; pleura mostly pale yellowish; metanotum narrowly darkened laterally. Macrochaetae rather dark orange-brown; pile pale yellow. Sternopleural bristle rather strong, yellow brown. Wing 7.5 mm long, the bands yellow brown; costal and **S**-bands rather broadly connected at vein R_{4+5} ; **V**-band complete, very narrowly joined to **S**-band anteriorly. *Female terminalia*: Ovipositor sheath 2.18 mm long, rather stout, about 0.88 mm from base. Rasper of rather stout hooks in a triangular patch of about 5 rows. Ovipositor 2.01 mm long, slightly widened at base, the tip 0.25 mm long, tapering from base of serrate portion to rather acute apex, with about 16 serrations on each side.

Type material.—Holotype, female (U.S.N.M. no. 56322).

Type locality.—Bartica, British Guiana.

The single specimen was collected by H. S. Parish, August 26, 1901.

This species would run to couplet 86, but it differs from *zuelaniae* Stone in having no constriction between the end of the oviduct and the beginning of the serrations, and in having the **V**-band of the wing narrowly joined to the **S**-band; it differs from *turpiniae* Stone in having the serrations of the ovipositor tip more extensive, the nonserrate portion of the tip less tapering, and the **V**-band of the wing narrowly joined to the **S**-band.

Anastrepha dryas, n. sp.

Figs. 3, 11

Medium sized. Mesonotum 3.0 mm long, orange-brown, with humerus, a median stripe expanding abruptly posteriorly to reach the dorsocentral bristles, a lateral stripe from just in front of transverse suture to scutellum, and scutellum pale yellow; pleura mostly pale yellow; metanotum entirely yellow-orange. Macrochaetae brownish black; pile yellowish brown. Sterno-pleural bristle very weak. Wing 7.5 mm long, the bands orange yellow and brown; costal and **S**-bands narrowly connected at vein R_{4+5} and hyaline triangle beyond stigma constricted or closed at vein R_{2+3} ; **V**-band rather broad anteriorly, entirely separated from **S**-band; vein R_{2+3} slightly undulant at level of hyaline triangle. *Female terminalia*: Ovipositor sheath 3.86 mm long, tapering to apical third and then nearly parallel sided, the spiracles 1.1 mm from base. Rasper of many long, curved hooks in about 11 rows. Ovipositor 3.53 mm long, the extreme base slightly widened, the apical portion slightly widened to level of serrations; ovipositor tip about 0.4 mm long, the many minute serrations starting at basal fifth and the serrate portion tapering to an acute point.

Type material.—Holotype, female (U.S.N.M. no. 56323).

Type locality.—San Esteban, Carabobo, Venezuela.

The single specimen was collected by Pablo Anduze between December 1 and 6, 1939.

This species will run to *duckei* Costa Lima in couplet 90, but differs from *duckei* in being a

smaller species, with many more teeth in the rasper, and with a stouter ovipositor tip, not at all constricted basad of the serrate portion. The species is also close to *dissimilis* Stone, the terminalia being very similar, but the median portion of the S-band is considerably narrower in *dissimilis*, so that the costal and S-bands are widely separated.

NEW RECORDS FOR ANASTREPHA SPECIES

Distribution

As a result of the study of additional material including the new species described in this paper, the following new records of distribution have been discovered:

ARGENTINA (10)³:

Anastrepha dissimilis Stone. Two females and two males reared at Corrientes, May 9, 1941, from *Passiflora*, by H. L. Parker.

BRITISH GUIANA (11):

Anastrepha fraterculus (Wied.); *A. guianae*, n. sp.; *A. parishii*, n. sp.; *A. serpentina* (Wied.).

PANAMÁ (59):

Anastrepha doryphoros, n. sp.; *A. gigantea*, n. sp.; *A. perdita* Stone, a female, trapped at El Cermeño, January 27, 1942, by James Zetek; *A. subramosa* Stone (inadvertently omitted from list in writer's revision); *A. teli*, n. sp.

UNITED STATES (16); TEXAS (11):

Anastrepha lathana Stone, Webb County, Tex., December 4, 1940, G. H. Shiner.

VENEZUELA (15)

Anastrepha anduzei, n. sp.; *A. cordata* Aldrich; *A. dryas*, n. sp.; *A. grandis* (Macquart); *A. manihoti* Costa Lima.

Food Plants

Additional reared material, from various sources, has resulted in the following new³ data on food plants:

³ Numbers in parentheses here after each country indicate the total number of species now known.

Achras sapota L. (Sapotaceae). Experimental food plant of *Anastrepha flavipennis* Greene by James Zetek.

Eugenia coloradoensis Standley (Myrtaceae). *Anastrepha fraterculus* (Wied.) on Barro Colorado Island, reared by James Zetek.

Eugenia variabilis Baillon (Myrtaceae). According to Max Kisliuk, the guarobeiera, listed in the writer's paper as host of *bahiensis* and *bondari*, is this species.

Labatia standleyana (Pittier) (Sapotaceae). The first recorded natural food plant for *Anastrepha flavipennis* Greene, reared by James Zetek from El Cermeño, Panamá, June 17, 1941. *A. serpentina* (Wied.) was reared from this host at the same time.

Lucuma obovata HBK. (Sapotaceae). Dr. J. E. Wille, chief of the Peruvian Entomological Service, has informed the writer that this is the preferred host of *Anastrepha serpentina* (Wied.) in Peru, the infestation sometimes being very heavy.

Mangifera indica L. (Anacardiaceae). Experimental food plant of *Anastrepha flavipennis* Greene by James Zetek.

Passiflora sp. (Passifloraceae). *A. dissimilis* Stone reared at Corrientes, Argentina, by H. L. Parker.

LITERATURE CITED

- (1) HENDEL, FRIEDRICH. *Über die Nomenclatur der Acalyptratengattungen nach Th. Beckers Katalog der paläarktischen Dipteren*, Bd. 4. Wien Ent. Zeit. 29: 307-313. 1910.
- (2) LOEW, HERMANN. *Monographs of the Diptera of North America. Part 1*. Smithsonian Misc. Coll. 6(1). 1862.
- (3) MACQUART [PIERRE JUSTIN MARIE]. *Histoire naturelle des insectes. Diptères*. Tome 2. 1835.
- (4) MALLOCH, J. R. *Acalyptrata (Helomyzidae, Trypetidae, Sciomyzidae, Sapromyzidae, etc.) Diptera of Patagonia and South Chile*, pt. 6, fasc. 4. British Museum.
- (5) NEWMAN, EDWARD. *Attempted division of British insects into natural orders*. Entomologist 2: 379-431. 1834.
- (6) STONE, ALAN. *The generic names of Meigen 1800 and their proper application (Diptera)*. Ann. Ent. Soc. Amer. 34: 404-418. 1941.
- (7) ———. *The fruitflies of the genus Anastrepha*. U. S. Dept. Agr. Misc. Publ. 439. 1942.

BACTERIOLOGY.—*Incidence of leptospirosis among dogs in Honolulu as determined by serological agglutination tests.*¹ JOSEPH E. ALICATA and VIRGINIA BREAKS, Honolulu, T. H.

Recent reports of the widespread occurrence of leptospirosis among dogs in the continental United States have caused considerable veterinary and public-health interest in this disease. Geographically, the cases reported involve 14 states: Alabama, California, Connecticut, Georgia, Louisiana, Massachusetts, Maryland, Michigan, New Jersey, New York, Ohio, Pennsylvania, Virginia, and Wisconsin. Cases have been reported also from the District of Columbia and Puerto Rico (1). Serological studies have shown 34.0 percent canine infection in some sections of California (4), 11.8 percent in New York (4), and 38.1 percent in Pennsylvania (5). These and other reports have led to the conclusion that probably 25 to 50 percent of the dogs in the United States are temporary or permanent carriers of the causative organisms *Leptospira canicola* and *L. icterohemorrhagiae* (2).

The present paper, reporting on positive leptospiral sero-reactions, presents additional information regarding the geographical distribution and incidence of canine leptospirosis. The presence of this disease in dogs became suspected following recognition of local human and murine leptospirosis in 1937 (3), and from communications received from local veterinarians regarding the existence of undiagnosed cases of acute jaundice. The first findings of *Leptospira* agglutinins in the sera of local dogs were made in 1940 on the sera of 7 out of 11 dogs submitted for examination by Dr. L. C. Moss, veterinarian, to Dr. K. F. Meyer, Hooper Foundation, San Francisco, Calif.

¹ Study conducted from special funds appropriated by the Public Health Committee of the Chamber of Commerce of Honolulu and through the facilities of the University of Hawaii. The writers wish to express their appreciation to Dr. K. F. Meyer and Mrs. B. Stewart-Anderson of the Hooper Foundation, University of California, for helpful suggestions in the course of this study and for submitting our original strains of *Leptospira* cultures; also to thank Dr. L. C. Moss for making possible the obtaining of the sera used in this survey. Received April 9, 1942.

Methods.—Sera were collected from 23 dogs (nos. 1–23) submitted to a veterinary hospital for various causes and 77 (nos. 24–100) obtained at random from a local dog pound. In each case the blood was withdrawn from the femoral vein. Only one test was conducted on each animal. The microscopic agglutination test, using fresh formalin-killed antigens, was used. The porcelain-plate method as described by Meyer, Stewart-Anderson, and Eddie (4) was adopted. Each of the sera was tested for agglutinins against the canicola strain, *L. canicola*, and the classical strain, *L. icterohemorrhagiae*. A series of dilutions of serum was made with Verwoort-Schüffner buffer solution. The final dilutions in the plates ranged from 1:10 to 1:30,000. The clumps of agglutinated organisms were ascertained by the use of a darkfield. Since agglutination in low dilutions is considered doubtful, only serum positive in a dilution of 1:100, or greater, is regarded in this study as significant.

Results and interpretation of the serological agglutination tests.—As shown in Table 1 and summarized in Table 2, of the 100 dogs examined 20 gave stronger sero-agglutination reactions to *L. icterohemorrhagiae* than to *L. canicola*, as follows: 1 in 1:100, 15 in 1:300, 2 in 1:1000, 1 in 1:10,000, and 1 in 1:30,000. In addition, 19 sera reacted more strongly to *L. canicola*, as follows: 1 in 1:100, 7 in 1:300, 5 in 1:1,000, 1 in 1:10,000, and 5 in 1:30,000. Those cases in which the titer was between 1:100 to 1:1000 and the animals appeared normal were considered as possible latent infections; those that showed illness, as in nos. 1, 2, 9, 13, and 21, might have represented an early stage of the disease and not sufficient time had elapsed for agglutinins to develop in larger amounts. The 8 cases reported (nos. 17, 3, 27, 12, 35, 62, 78, and 88) in which the agglutination titer was between 1:10,000 and 1:30,000 are regarded as active clinical cases. Of these, the 2 dogs (nos. 17 and 3)

reacting positive to the classical strain showed jaundice whereas the other 6 dogs reacting positive to the canicola strain were anicteric and showed, in most cases, general malaise, muscular tremor, and dehydration.

Through the use of culture methods (Verwoort's medium), leptospirae were isolated from the kidneys of two dogs suspected of having died of canicola fever. One of these dogs, just before death, showed a sero-agglutination titer of 1:300,000 for *L. canicola* and 1:30,000 for *L. icterohemorrhagiae*. The other dog, just before death, showed a sero-agglutination titer of 1:10,000 for *L. canicola* and 1:1,000 for *L. icterohemorrhagiae*.

Discussion.—The results of this study indicate that 39 percent of the dogs examined had or were passing through a case of leptospirosis. Of these, about one-half showed infection with the classical strain and the other half with the canicola strain. These findings differ from reports of surveys conducted in the continental United States where the canicola strain has usually been found most common. In San Francisco, of 59 dogs examined 3 reacted to the classical strain and 33 to the canicola strain (4); in New York, of 111 dogs examined 3 reacted to the classical strain and 10 to the canine strain (4); in Pennsylvania, of 105 dogs examined canicola strain was found to be three times as frequent as the classical strain (5). On the other hand, Meyer and coworkers (4) found 10 out of 12 dog sera from Detroit, Mich., positive for the classical strain; the dogs, in this case, were reported to be in some way connected with cases of human Weil's disease.

The epizootiological relationships of canine and murine leptospirosis has not been definitely established. In San Francisco, Meyer and coworkers (4) found a low incidence of infection with *L. icterohemorrhagiae* among dogs in spite of the fact that 35 percent of the rats in the same locality were found to carry this organism. Of a series of 500 rats trapped at random in Honolulu, silver-stained sections of kidneys of these animals revealed only 13 or 2.6 percent infection with leptospirae. All these positive rats

were trapped in localities near fresh-water streams. Kidney emulsion of these rats produced clinical leptospirosis with jaundice when inoculated into young mice and guinea pigs. These findings point out a low relationship between the incidence of murine and canine leptospirosis. Infection of dogs with the classical strain appears therefore to be brought about by intercanine association in the same way that the canicola infection takes place among dogs. The canicola strain as far as is known is not found in rats.

Summary.—Microscopic agglutination tests, using fresh formalin-killed *Leptospira canicola* and *L. icterohemorrhagiae* as antigens, have been conducted on the sera of 100 dogs from Honolulu. Of these, 20 percent of the sera gave stronger agglutination reactions to *L. icterohemorrhagiae* than to *L. canicola* and 19 percent reacted more strongly to *L. canicola*.

Leptospirae were recovered from two dogs suspected of having died of canicola fever.

Out of 500 rats examined in Honolulu, 2.6 percent were found to harbor leptospirae. This low incidence points out little epizootiological relationship between murine and canine infections. The disease in dogs with the classical strain of *Leptospira* is believed to be brought about through intercanine associations as in the case of the canicola strain.

LITERATURE CITED

1. ANONYMOUS. *Geographical distribution of leptospirosis in the U. S.* North Amer. Vet. 22(12): 720. 1941.
2. ANONYMOUS. *Leptospirosis on the increase.* North Amer. Vet. 22(11): 662. 1941.
3. ALICATA, J. E. *A study of trichinosis and infectious jaundice in the Hawaiian Islands.* Trans. 47th Ann. Meet. Hawaii Terr. Med. Assoc., pp. 95-101. 1937.
4. MEYER, K. F., STEWART-ANDERSON, B., and EDDIE, B. *Canine leptospirosis in the United States.* Journ. Amer. Vet. Med. Assoc. 95 (753): 710-729. 1939.
5. RAVEN, C., and BARNES, K. *Incidence of canine leptospirosis as determined by agglutination-lysis tests of sera from dogs in Pennsylvania.* Journ. Bact. 40(2): 329. 1940.

TABLE 1.—POSITIVE LEPTOSPIRA AGGLUTINATION REACTIONS NOTED IN THE SERA OF 39 OUT OF 100 DOGS EXAMINED; FORMALINIZED CULTURES OF *L. ICTEROHEMORRHAGIAE* AND *L. CANICOLA* USED

Dog No.	Titer of sero-reaction: First line for <i>L. icterohemorrhagiae</i> ; second line for <i>L. canicola</i>								Clinical observations
	1:10	1:30	1:100	1:300	1:1,000	1:3,000	1:10,000	1:30,000	
42	+++ +++	++ +	++ 0	0 0	0 0	0 0	0 0	0 0	Normal
1	++ 0	++ 0	++ 0	+ 0	0 0	0 0	0 0	0 0	Icteric
2	+++ 0	+++ 0	+++ 0	++ 0	0 0	0 0	0 0	0 0	General malaise
9	+++ +++	+++ +	++ 0	+ 0	0 0	0 0	0 0	0 0	Bloody urine
10	++ 0	++ 0	++ 0	+ 0	0 0	0 0	0 0	0 0	Dermatitis
13	+++ +++	+++ ++	++ +	+ 0	0 0	0 0	0 0	0 0	Coughing, subnormal temperature
19	++++ +	+++ +	++ 0	+ 0	0 0	0 0	0 0	0 0	Normal
51	+++ ++	+++ ++	++ +	+ 0	0 0	0 0	0 0	0 0	Normal
53	+++ +	+++ 0	++ 0	+ 0	0 0	0 0	0 0	0 0	Normal
59	+++ ++	+++ ++	++ +	+ 0	0 0	0 0	0 0	0 0	Normal
60	+++ +++	+++ ++	++ +	+ 0	0 0	0 0	0 0	0 0	Normal
61	+++ +++	+++ ++	++ +	+ 0	0 0	0 0	0 0	0 0	Normal
69	+++ ++	+++ ++	+ +	+ +	0 0	0 0	0 0	0 0	Normal
74	++++ +++	+++ ++	+++ +	++ +	0 0	0 0	0 0	0 0	Normal
84	++++ ++	+++ ++	++ +	+ 0	0 0	0 0	0 0	0 0	Normal
95	+++ ++	+++ +	++ 0	+ 0	0 0	0 0	0 0	0 0	Normal
68	++++ ++	+++ ++	++ +	+ +	+ 0	0 0	0 0	0 0	Normal
80	++++ ++	+++ ++	+++ +	++ 0	+ 0	0 0	0 0	0 0	Normal
17	++++ +++	++++ ++	+++ ++	+++ ++	++ +	+ +	+ 0	0 0	Icteric; vomiting
3	++++ ++++	++++ ++++	++++ ++++	++++ ++++	+++ ++	+++ 0	+++ 0	++ 0	Icteric
64	++ +++	+ +++	0 +	0 0	0 0	0 0	0 0	0 0	Normal
16	+++ +++	++ +++	+ ++	0 +	0 0	0 0	0 0	0 0	Stomatitis

TABLE 1—Continued

Dog No.	Titer of sero-reaction: First line for <i>L. icterohemorrhagiae</i> ; second line for <i>L. canicola</i>								Clinical observations
	1:10	1:30	1:100	1:300	1:1,000	1:3,000	1:10,000	1:30,000	
18	++ ++	+ ++	0 ++	0 +	0 0	0 0	0 0	0 0	Normal
29	++ +++	++ ++	+ ++	0 +	0 0	0 0	0 0	0 0	Normal
55	++++ ++++	+++ ++++	++ +++	0 +	0 0	0 0	0 0	0 0	Normal
67	++ +++	+ +++	+ ++	0 +	0 0	0 0	0 0	0 0	Normal
83	+++ +++	++ +++	+ ++	0 +	0 0	0 0	0 0	0 0	Normal
93	++ ++++	+ +++	+ ++	0 +	0 0	0 0	0 0	0 0	Normal
21	++ +++	+ +++	+ ++	+ ++	0 +	0 0	0 0	0 0	Vomiting
37	+++ +++	++ +++	+ ++	0 ++	0 +	0 0	0 0	0 0	Normal
43	+++ ++++	++ +++	++ ++	+ ++	0 +	0 0	0 0	0 0	Normal
46	+ +++	+ +++	0 ++	0 ++	0 +	0 0	0 0	0 0	Normal
57	++++ ++++	+++ +++	++ +++	+ +	+ +	0 +	0 0	0 0	Normal
27	++ ++++	++ ++++	+ +++	+ +++	0 ++	0 +	0 +	0 0	Malaise; dehydration; muscular tremor
12	++++ ++++	++++ ++++	++++ ++++	+++ ++++	+++ ++++	+ ++++	0 +++	0 +	Vomiting; dehydration
35	++ ++++	+ ++++	0 ++++	0 ++++	0 +++	0 +++	0 +++	0 ++	Malaise; dehydration
62	++++ ++++	++++ ++++	++++ ++++	++++ ++++	+++ ++++	+++ ++++	+++ ++++	++ +++	Dehydration; muscular tremor
78	++++ ++++	++++ ++++	+++ ++++	+++ ++++	+ +++	0 ++	0 ++	0 +	Malaise; dehydration
88	++++ ++++	++++ ++++	+++ ++++	+++ ++++	++ ++++	++ ++++	++ ++++	+ ++	Malaise; muscular tremor

TABLE 2.—SUMMARY OF THE AGGLUTINATION TITER OF THE 39 POSITIVE DOG SERA

Number reacting more strongly to:	Titer						Total
	1:100	1:300	1:1,000	1:3,000	1:10,000	1:30,000	
<i>L. icterohemorrhagiae</i>	1	15	2	0	1	1	20
<i>L. canicola</i>	1	7	5	0	1	5	19

ZOOLOGY.—*Stereobalanus canadensis* (Spengel), a little-known enteropneustan from the coast of Maine.¹ EDWARD G. REINHARD, Catholic University of America and University of Maine Marine Laboratory.

A considerable number of specimens of an enteropneustan, hitherto known only from four fragments dredged off Cape Breton, Nova Scotia, were collected by the author on the coast of Maine during the summers of 1940 and 1941. William C. McIntosh, who collected the type material, sent it to Spengel in 1878 for study. The latter described the animal (1893) under the name *Balanoglossus canadensis* and subsequently (1901) created a new genus, *Stereobalanus*, to receive it. Although Spengel's description is extremely detailed and authoritative, it is necessarily lacking in some particulars since the material was poorly preserved and did not comprise a complete specimen. These deficiencies, coupled with the fact that the appearance of the animal when alive was entirely unknown also introduced unavoidable errors into the description. Spengel himself, commenting on the poor quality of the specimens, remarks: "Dies ist um so mehr zu bedauern, als *Balanoglossus canadensis* durch eine ganze Reihe interessanter Eigentümlichkeiten ausgezeichnet ist. Eine abermalige Untersuchung dieser Art unter Benutzung reicherer und besser erhaltenen Materials ist daher sehr wünschenswerth."

Stereobalanus was first encountered by the author on July 31, 1940, while on a dredging trip in Frenchmans Bay with a party of students and staff members of the University of Maine Marine Laboratory. The collecting ground has been revisited on two occasions since, and no dredge haul has failed to yield some specimens of this species. The hauls were made at a depth of 40–50 feet about half a mile southeast of Crabtree Light at the mouth of Sullivans River. The bottom at this station is a soft, fine mud. Together with *Stereobalanus canadensis*, the dredge usually contained such mud-dwellers as the hydroid *Corymorpha pendula*, the polychaete *Nephtys caeca*, or the starfish *Ctenodiscus crispatus*.

It is very difficult to collect this animal in perfect condition with the apparatus

used, a 3-foot scallop drag. A box dredge or some other type of equipment might give better results. *Stereobalanus* is extremely soft-bodied and fragile. The specimens were mostly entangled in the meshes of the net bag and almost invariably mutilated. Although more than 40 were obtained, only 4 were entire. I was fortunate in being able to enlist the aid of my friend Dorothy Olsen Johnston, collaborating artist of the American Museum of Natural History, who at once made color sketches of the living animal. For her work, reproduced in Fig. 1, I am deeply grateful.

Size.—Total length up to 50 mm. Since Maine is probably the southern limit of the species, it is likely that Nova Scotia specimens may be larger.

Color.—The color is a pale lemon-yellow except for the liver region, which is brown.

Proboscis.—The proboscis of the largest specimen, measured alive, showed a length of 11 mm and a width of 6 mm. Well-fixed mature specimens had proboscides averaging 6–7 mm in length and about 5 mm in width at the base. The dimensions given by Spengel for the proboscis (5 mm long and 7 mm wide) and his illustration (pl. 17, fig. 1) are obviously based on strongly contracted specimens. In life, the proboscis is nearly twice as long as it is broad, and even in properly fixed animals it retains a length greater than the width.

As in other Enteropneusta, the proboscis is joined to the anterior surface of the collar by means of a short, thin, tapering neck. Spengel's statement that the neck is absent in *Stereobalanus* is clearly erroneous and again attributable to the highly contracted nature of the material at his disposal.

Collar.—The collar is approximately as wide as the base of the proboscis and has a length of 2–3 mm. It is very short in comparison to the collar-length of most other Enteropneusta. The presence of two circular furrows gives the collar a triannulate appearance. Spengel was unable to discover collar-pores in this species, but they are

¹ Received June 9, 1942.

clearly evident if the collar is severed from the trunk and the posterior collar surface examined. The pores lie directly dorsal to the pharynx, one on each side of the midline.

Skeleton of proboscis and collar.—This is sufficiently well illustrated in Fig. 2 to require no additional comment. The drawing was made from a whole mount of a small specimen and checked against maceration-preparations of larger specimens.

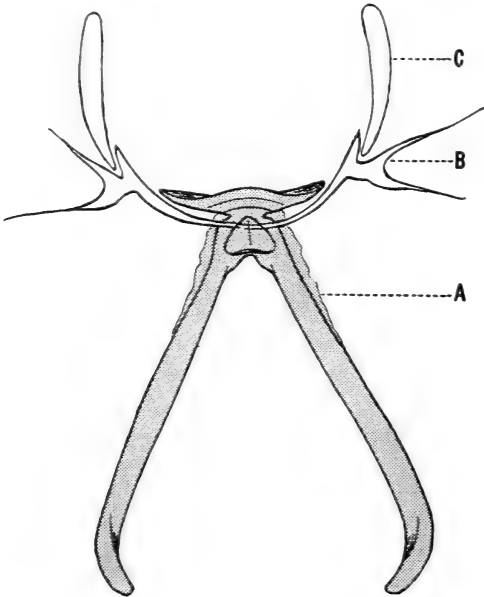

Fig. 2.—The proboscis skeleton of *Stereobalanus canadensis*, ventral aspect, with associated structures: A, proboscis skeleton; B, chondroid tissue; C, marginal lamellae.

Trunk.—The trunk measures up to 36 mm in length and is nearly uniform in diameter except in the caudal region where it becomes somewhat less thick. Its general width equals or slightly exceeds that of the proboscis and collar. It bears a distinct dorsal and ventral longitudinal ridge, and its surface, except for these ridges, is conspicuously ruffled.

In the branchiogenital region, which is immediately posterior to the collar, *Stereobalanus* exhibits several unusual features. Instead of possessing a series of gill pores, as does the familiar *Dolichoglossus*, there is a single, deep, slitlike pore on each side, dorsolateral in position. Its presence gives

rise to a smaller dorsal and larger ventral genital wing in which the gonads are located. The gills are visible externally, particularly if the genital wings are spread apart slightly.

The number of gills varies with the size of the individual. Young specimens have 12 or 13 pairs of gills, while average mature individuals have about 36 pairs. The gill skeleton consists of 3-pronged forks. The arch that joins the three prongs of a fork

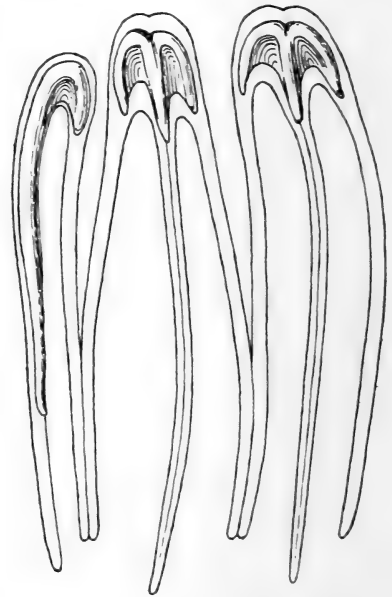

Fig. 3.—The first three forks of the gill skeleton of a mature *Stereobalanus canadensis* showing chitinous thickenings as seen from inner side.

together is feeble in young specimens and in the posterior gills of older animals. Elsewhere it is greatly thickened with a massive cap of chitin. Spengel's "Rücken massig verdickt." is therefore true only of the older gill skeletons.

Following the branchiogenital region, a portion of the trunk entirely devoid of gills or gonads intervenes before the liver region is reached. This transitional portion, which is somewhat longer than the branchiogenital region itself, was somehow missed by Spengel, who reported the liver region as following directly upon the gill region. Van der Horst (1927-39), on the basis of comparative studies on other Enteropneusta,

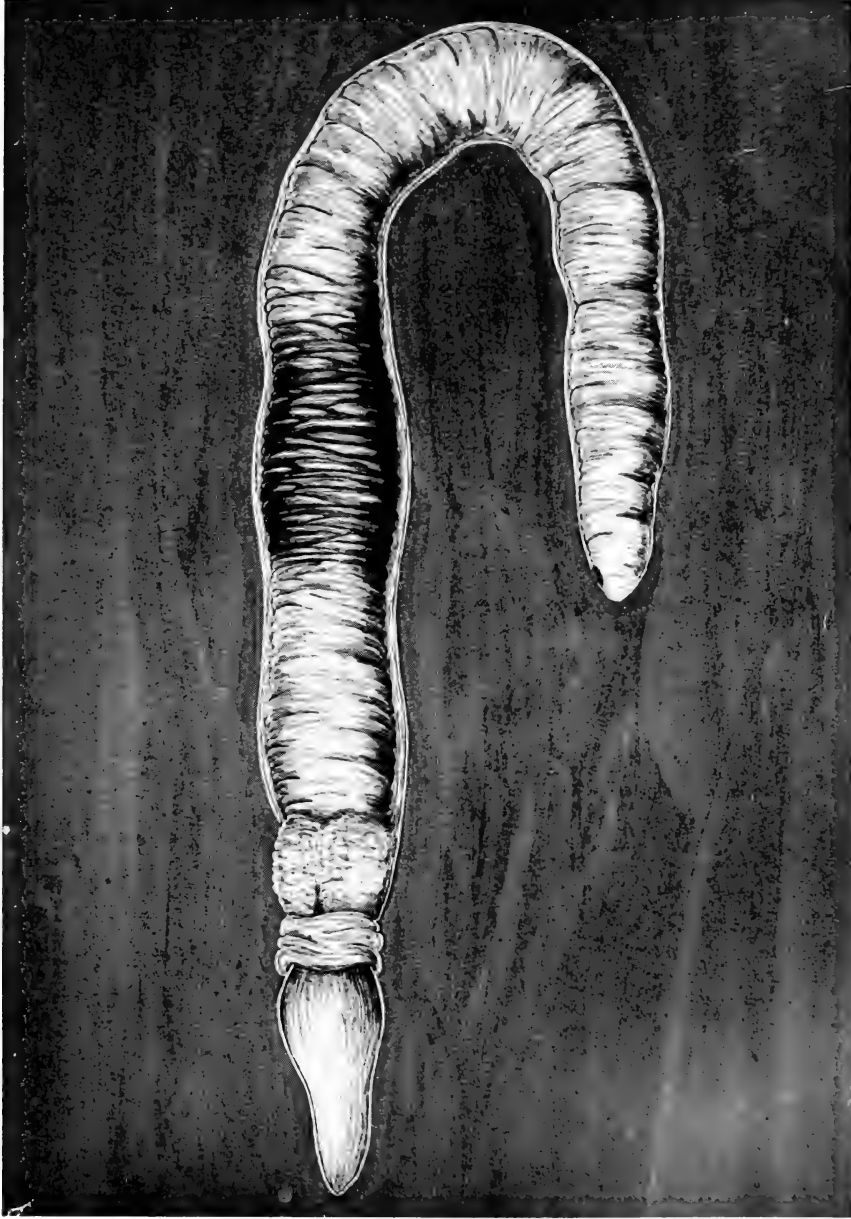

Fig. 1. *Stereobalanus canadensis* (Spengel). Four times natural size. From a color sketch of the living animal by Dorothy Olsen Johnston.



challenged this point in Spengel's description of *Stereobalanus canadensis*. Reexamination of this species therefore fully confirms Van der Horst's suspicion (*l.c.*, p. 240).

The hepatic region, distinctly set apart by its dark color in life, occupies about one-fifth of the trunk length, but its anterior and posterior limits are not sharply defined. The skin in this region is thrown into transverse rugae which appear to be finer and more pronounced than those present elsewhere on the trunk.

The posthepatic region possesses no special external features. In some specimens the anus is terminal, in others it appears to be ventral and subterminal.

General remarks.—This species is the only known representative of the genus *Stereobalanus*. It is hoped that rediscovery of this animal in a locality where further

specimens are easily obtainable will stimulate research into the internal anatomy and histology of a species that manifests morphological peculiarities of great interest, among them being a proboscis sense organ unique among Enteropneusta. The specimens obtained in Maine, after anesthetization, were fixed in Kleinenberg's solution and stored in alcohol. They have been deposited in the U. S. National Museum.

REFERENCES

- SPENDEL, J. W. *Die Enteropneusten des Golfes von Neapel*. Fauna und Flora des Golfes von Neapel, monogr. 18. 1893.
 ———. *Die Benennung der Enteropneustengattungen*. Zool. Jahrb., Abt. Syst., 15: 209–218. 1901.
 VAN DER HORST, C. J. *Hemichordata*, in Bronn's "Klassen und Ordnungen des Tier-Reichs," 4(4): Buch 2, t. 2, lfg. 1–6. 1927–39.

PROCEEDINGS OF THE ACADEMY AND AFFILIATED SOCIETIES

PHILOSOPHICAL SOCIETY

1187TH MEETING

The 1187th meeting was held in the Cosmos Club auditorium, Saturday, October 11, 1941, President McCOMB presiding. The program consisted of a series of papers on the National Geographic Society—National Bureau of Standards Eclipse Expedition of 1940.

IRVINE, C. GARDNER (National Bureau of Standards): *The design and construction of eclipse apparatus*.

PAUL A. McNALLY, S. J. (Georgetown University): *Contact times of the 1940 eclipse, determined from photographs of the partial phases*.

E. O. HULBURT (Naval Research Laboratory): *Sky brightness at Patos, Brazil, during twilight and during the total solar eclipse of 1940*.

C. C. KIESS (National Bureau of Standards), by invitation¹: *The 1940 flash spectrum*.

T. R. GILLILAND (National Bureau of Standards), by invitation: *Radio observations of the ionosphere at the 1940 eclipse in Brazil*.

R. H. STEWART (National Geographic Society), by invitation: *The story of the expedition in colored motion pictures*.

The National Geographic Society—National

¹ The words "by invitation" signify that the author was not a member of the Society.

Bureau of Standards Eclipse Expedition of 1940 was stationed at Patos, in the state of Paraiba de Norte of Brazil, this location being north and west of Recife. The eclipse was on October 1. The program of scientific work planned for this expedition was so varied in nature that results of considerable scientific importance were obtained although a thin veil of clouds partially obscured the eclipse during the period of totality. Mr. Irvine C. Gardner, the leader of the expedition, described the new corona cameras, polarigraphs, and spectrographs which were specially designed and constructed for use at this expedition.

1188TH MEETING

The 1188th was a joint meeting with the Washington Academy of Sciences on October 16, 1941. Commdr. FRANCIS W. REICHELDERFER, Chief of the Weather Bureau, delivered an address entitled *Some famous weather maps*.

1189TH MEETING

The 1189th meeting was held in the Cosmos Club auditorium, Saturday, October 25, 1941, President McCOMB presiding. An invited paper on *X-ray spectroscopic studies of multiple ionization* was presented with illustrations by Mr. L. G. PARRATT, of Cornell University. The paper

was discussed by Messrs. F. L. MOHLER and A. BLAKE.

1190TH MEETING

The 1190th meeting was held in the Cosmos Club auditorium, Saturday, November 8, 1941, President McCOMB presiding. An invited paper on *The modern nautical chart—a scientific achievement* was presented with illustrations by Mr. AARON L. SHALOWITZ, of the Coast and Geodetic Survey. Ptolemy, the Portolanos, and Mercator were the three great early influences on contemporary chart making. The beginning of the modern nautical chart dates back to less than 150 years ago when systematic surveying was instituted by the various maritime nations. In this country the Coast and Geodetic Survey published its first chart of New York Harbor in 1845, and marked a definite departure from the uncoordinated and highly generalized surveys of Colonial days. Progressive development in methods of surveying, particularly in the application of sound to the determination of depth and distance, has steadily pushed forward the frontiers of accurate hydrographic surveys and has given the nautical chart a leadership in precision seldom attempted in other branches of map construction. In the most recent type of chart greater emphasis is laid on depth contours in order to bring into prominence the many submarine features that are useful to the modern navigator equipped with an echo-sounding device.

An invited paper on *Reproduction of charts and maps* was presented with illustrations by Mr. DUDLEY P. BARNETTE, of the Coast and Geodetic Survey.

Reproduction of charts and maps for issue to the public is accomplished by several methods. For quick reproduction or for temporary use, photostats, ozalid prints, blueprints, or bromide enlargements may be used.

For quantity production, photoengraving (line-cuts), wax engraving, or photolithography are the methods to be used. Photoengraving and wax engraving offer little opportunity for corrections or changes to the printing plate, but in the more widely used method of photolithography the metal printing plate may be easily corrected or changed. Photolithography and offset printing are now synonymous, since the older method of photolithography from

stone printing plates is rapidly disappearing. In photolithography, color work, either simple, such as solid color areas, or complicated, such as patterns, stipples, rulings or screens, can be readily accomplished.

Photolithography requires the skill of many artisans to accomplish the final product. Represented in this list are artists, draftsmen, copper-plate engravers, photographers, type compositors, transferers, process plate makers, and pressmen, each rendering a separate contribution to the whole.

In lithography such methods as deep etch, dry-lithography, and Van Dyke are used under circumstances fitting to the subject and quantity of production.

Many time-saving methods are used in connection with the reproduction of charts such as mechanically engraving lettering, soundings (figures), and symbols in copper plate engraving or engraving on stained glass negatives, and the use of mechanically made shading mediums to emphasize particular features.

1191ST MEETING

The 1191st meeting was held in the Cosmos Club auditorium, Saturday, November 22, 1941, President McCOMB presiding. An invited paper on *Microphotography* was presented with illustrations by Mr. VERNON D. TATE, of the National Archives. It was discussed by Dr. BROMBACHER.

A microphotograph is a reduced-size photographic facsimile of a textual original that is too small to be read by the unaided eye. In recent years, microphotography has become a medium of immense significance in the collection, preservation, use and dissemination of documentary materials of all types. The technique is employed in archives, libraries, museums, and other scholarly institutions, in business and industry, by societies and committees, individuals, and the Federal Government. Although popularly considered new, microphotography can be traced back almost a hundred years. Equipment is available for small, medium-sized, and large-scale undertakings. The product, by act of Congress, must be judicially noticed. Microphotography is regarded by those who have interested themselves in its application to documentation as the most significant technological achievement since the invention of printing.

A paper on *Quartz resonators* was presented with illustrations by Mr. FRANCIS E. FOX, of the Catholic University of America. It was discussed by Mr. A. BLAKE.

Quartz plates have become very widely used for frequency stabilization of oscillators, in "single frequency" and other electrical filters, and as sources of high frequency sound. There has been a large amount of investigation concerning the resonant and oscillating frequencies of such quartz plates, and the problem of determining the resonant frequencies of such a slab is far from simple for such a complex structure as that of quartz.

For special configurations (long thin rods, thin circular plates, wave surface plates, etc.) approximations may be obtained that yield several discrete sets of frequencies, and the interaction of these frequency sets produces "combination frequency sets." The vibration of specimens may be investigated optically by using the specimen as one arm of an interferometer; by an analysis of the electrical resonance curves, and so on. In one specimen, an x-cut quartz plate $2.50 \times 2.50 \times 0.11$ cm, over 200 distinct resonant frequencies were observed in the frequency range from 2,436 kc to 2,552 kc.

1192D MEETING

The 1192d meeting was held in the Cosmos Club auditorium, Saturday, December 6, 1941, President McCOMB presiding. Mr. GIBSON read the report of the treasurer, Mr. DEMING, the latter being delayed by storms, which held up air service from Providence, where he had been lecturing. The treasurer's report stated that the income from dues and investments was \$1,308.81, that the expenditures were \$1,280.55, leaving a surplus of \$28.26. The average expenditure per member was \$4.09. During the year a \$2,000 Cosmos Club bond was called, and the \$2,000 is held in a trust account, which was discussed by Messrs. M. D. HERSEY, W. G. BROMBACHER, F. G. BRICKWEDDE, H. H. HOWE, and W. J. HUMPHREYS. The report of the auditing committee, H. S. RAPPLEYE, L. V. JUDSON, and G. R. WAIT, was presented by the chairman, Mr. RAPPLEYE. The report of the auditing committee was accepted as read, and the report of the treasurer was accepted.

The joint report of the secretaries was pre-

sent by the corresponding secretary, Mr. STIMSON. It showed an active membership of 315 as of December 1, 1941. The following persons were elected to membership during the fiscal year: CARL A. BECK, L. T. BOURLAND, F. W. BROWN, 3d, PATRICK J. DONOVAN, W. J. ECKERT, ALEXANDER ELLETT, GAETANO FERLAZZO, FRANCIS D. FOX, HERBERT FRIEDMAN, KARL GERHARD, ROBERT WINSLOW GORDON, ARMIN W. HELZ, JOHN M. IDE, WM. G. MADOW, MRS. MARCELLA L. PHILLIPS, MORRIS RELSON, GEORGE D. ROCK, WM. H. SANDERS, HAROLD L. SAXTON, PAUL LAURENS SMITH, RICHARD TOUSEY, HORACE M. TRENT, CLEMENT WINSTON, WM. E. WOOD.

The report of the committee on elections, F. WENNER, H. D. HARRADON, and MICHAEL GOLDBERG, was presented by the chairman, Mr. WENNER. He announced that all the elected officers received a majority of the votes with respect to each of the remaining candidates for the same office. Messrs. H. H. HOWE, H. L. CURTIS, A. G. McNISH, and F. WENNER discussed the precedent that the actual count of the votes should not be announced. The report was accepted and the president declared the following to be duly elected:

President: W. G. BROMBACHER.
 Vice Presidents: R. J. SEEGER, H. F. STIMSON.
 Corresponding Secretary: W. EDWARDS Deming.
 Treasurer: WALTER RAMBERG.
 Members-at-large of the General Committee: G. GAMOW, C. L. GARNER.

The president opened the meeting for discussion of Society policies and recommendations to the General Committee. Mr. SEEGER as an editor of the JOURNAL of the Washington Academy of Sciences commended Mr. L. V. JUDSON for his efficient work as associate editor for the Philosophical Society. The publications of the Society and of the JOURNAL were also discussed by Messrs. M. D. HERSEY, L. B. TUCKERMAN, and W. J. HUMPHREYS.

The acting secretary, Mr. STIMSON, read a rough draft of the minutes, and these were approved as read.

A paper on *Great geomagnetic storms of the present sun-spot cycle* was presented with illustrations by Mr. A. G. McNISH of the Department of Terrestrial Magnetism. It was

discussed by Messrs. H. L. CURTIS, P. A. SMITH, F. WENNER, and N. H. HECK.

The President announced the program for the next meeting. He then asked Past Presidents, R. E. GIBSON and F. G. BRICKWEDDE, to escort the newly elected President, Mr. BROMBACHER, to the chair. After a few remarks Mr. BROMBACHER adjourned the meeting for the social hour.

1193D MEETING

The 1193d meeting was held in the Cosmos Club auditorium, Saturday, December 20, 1941, President BROMBACHER presiding. An invited paper on *Archery paradise, paradox, and paralysis* was presented with slides and motion pictures by Mr. C. N. HICKMAN, of the Bell Telephone Laboratories. It was discussed by Messrs. OLMSTEAD, PAWLING, DEMING, BRIGGS, GAMOW, P. A. SMITH, L. B. TUCKERMAN, and F. B. SILSBEE.

Up until about 12 years ago, the velocity of an arrow had never been measured except by the use of a stop watch. During the past 10 years the study of the internal ballistics of the bow and arrow has furnished a paradise for a number of physicists. For at least two centuries archers have tried to explain the paradox of how an arrow gets around the bow to hit the mark that it is pointed at. Moving pictures, taken at the rate of 4,000 frames a second, show how the arrow gets around the bow. Over 50 percent of the archers, sooner or later, are stricken with what is often called paralysis or freezing. This interesting but annoying affliction was discussed.

The President announced the appointments to the Committee on Membership for the current year: WILLIAM A. WILDHACK (National Bureau of Standards), chairman, ALBERT K. LUDY (Coast and Geodetic Survey), and HOWARD S. ROBERTS (Geophysical Laboratory).

1194TH MEETING

The 1194th meeting was held at the Cosmos Club auditorium, Saturday, January 17, 1942, President BROMBACHER presiding. The program consisted of an address by the retiring president, Mr. McCOMB, on the subject *Geophysical measurements in the laboratory and in the field*. This address appeared in this JOURNAL 32: 65-79 1942.

1195TH MEETING

The 1195th meeting was held in the Cosmos Club auditorium, Saturday, January 31, 1942, President BROMBACHER presiding. A paper on *The ABC's of physical measurements* was presented with illustrations and demonstrations by Mr. FRANK WENNER, of the National Bureau of Standards. It was discussed by Messrs. BLAKE and CRITTENDEN. The formulation of a more or less complete system of physical quantities, dimensions, standards, units, and quantitative expressions involves an analysis of the results obtained in a variety of physical measurements. All such systems, whether considered to be merely systems of units or systems of measurements, must of necessity be based on some philosophical point of view. While any one of several philosophical points of view may be used, the major features of that used in discussing the ABC's of physical measurements are these:

1. Words such as length, time, area, volume, velocity, resistance, field strength, induction, etc., serve to suggest mental concepts of quantities which are of different physical natures. No one of these physical natures is definable in terms of the others.

2. The proportionality factor that appears in the relation between the result obtained when a quantity is measured by the use of a standard of a like quantity, and the result obtained when the quantity is measured by the use of a standard of an unlike quantity, is a physical quantity. For example, a current may be measured by the use of a standard of current. It may also be measured by the use of a standard of electromotive force. The first gives

$$I = A \text{ units of current}$$

and the second gives

$$I = BC \text{ units of electromotive force}$$

where I represents the current, A and C numbers, and B the proportionality factor. Measurements similar to these constitute the experimental basis of one of the group of relations which taken collectively is known as Ohm's law. Here B represents the conductance or reciprocal of the resistance. In many analogous cases the proportionality factor always has the same magnitude. In these cases it is considered to be a constant of nature, but

nevertheless it is a physical quantity, not merely a number.

The paper was illustrated by lantern slides and by the making of a number of measurements. Measurements of the earth's magnetic field and of the earth's magnetic induction served to show that these quantities are of different physical natures, and that therefore the proportionality factor, namely, the permeability, is a physical quantity, not merely a number. These conclusions are of course based on the particular philosophical point of view used.

An invited paper on *The biological action of high energy radiation* was presented with slides and moving pictures by Mr. PAUL S. HENSHAW, of the National Cancer Institute. It was discussed by Messrs. BOWERS, WHITE, HUMPHREYS, ROLLER, and MOHLER.

Radiation such as X-rays or gamma rays of radium may, on the one hand, act on cells in such manner as to cause cancer, and on the other hand, in such manner as to cure it. Some insight into this seemingly paradoxical action was furnished by describing how radiation acts on certain simpler forms and by considering three basic types of radio-biologic action. In the killing of yeast cells, the breaking of chromosomes and the production of mutations, may vary directly with exposure to radiation. Where the effect is all-or-none, the change appears to be due to some kind of single event occurring in the cells. Second, in cases where the effect (such as multipolar cell division) is all-or-none but not manifest until a certain accumulation of dosage has taken place, the effect is due to the combined action of a series of events. Third, in cases where the effect is not all-or-none but manifested by degree (such as delay in cell division), the effect is likewise due to the combined action of a series of events, but in this case each event contributes to the amount of effect. These constitute the three basic types of radiobiologic action visualized at this time.

Whereas multipolar cell division, such as that caused by X-rays, usually leads to cell death, it may in some instances give rise to a cellular modification that permits malignant behavior. This furnished at least a plausible explanation of how radiation may, by the same mechanism of action, cause cell death in one instance and malignant growth in another.

The president announced that Mr. JOYCE had resigned as chairman of the Communications Committee because of duties requiring frequent absence from the city, and that Mr. JOHN BEEK, JR., had been elected to fill his place for the remainder of the term of office.

1196TH MEETING

The 1196th meeting was held in the Cosmos Club auditorium, Saturday, February 14, 1942, President BROMBACHER presiding. An invited paper on *The molecular basis for the mechanical properties of acetate rayon* was presented with illustrations by Mr. ARNOLD M. SOOKNE, of the Textile Foundation. It was discussed by Messrs. O'BRYAN, HARRIS, P. A. SMITH, ROLLER, and STIMSON.

The mechanical properties of films and filaments of cellulosic materials are known to be affected by the chain-lengths of the molecules that they are composed of, but the exact nature of the relationship is still unclear. As part of a general program of study of the physical properties of textile fibers, an investigation of the effect of chain-length on the mechanical properties of cellulose acetate is in progress by research associates of the Textile Foundation at the National Bureau of Standards.

The separation of cellulose acetate into fractions of widely different chain-lengths by fractional precipitation, and some of the mechanical properties of these fractions were described. The results of creep measurements made on films prepared from the fractions were analyzed in terms of the stretching of simple mechanical models composed of elastic elements (springs) and viscous elements (dashpots).

Some of the commercial implications of fundamental studies of fiber structure were discussed, with particular reference to the production from abundant materials of fibers having the desirable properties of those natural fibers of which there is a national shortage.

The president invited the members to present more informal communications.

1197TH MEETING

The 1197th meeting was held in the Cosmos Club auditorium, Saturday, February 28, 1942, President BROMBACHER presiding. An invited paper on *The electron microscope as a tool for the study of inorganic materials* was presented

with moving pictures and lantern slides by Mr. HERBERT INSLEY, of the National Bureau of Standards. It was discussed by Messrs. RAMBERG, H. L. CURTIS, SILSBEE, HUMPHREYS, DORSEY, P. A. SMITH, BROMBACHER, SAYLOR, BRUNAUER, BEEK, and MCBURNEY.

The electron microscope is useful for the study of inorganic materials occurring in very finely divided condition because of its high magnification, high resolving power, and great depth of focus. These characteristics are compared with those of the light microscope and some limitations of the electron microscope are pointed out. The operation of the microscope and preparation of object material are described with the aid of motion pictures.

In the study of clay minerals, the electron microscope has shown that (1) kaolinite and halloysite, which are very similar in X-ray structure patterns, occur in grains having dissimilar shapes, (2) clays that have similar colloidal properties may have very different particle shapes, (3) clays with somewhat different chemical compositions are similar in particle shape and size and may belong to the same isomorphous series.

1198TH MEETING

The 1198th meeting was held in the Cosmos Club auditorium, Saturday, March 14, 1942, President BROMBACHER presiding. A paper on *A new determination of the constant of gravitation* was presented with illustrations by Mr. Paul R. Heyl, of the National Bureau of Standards. It was discussed by Messrs. MASON, P. A. SMITH, WHITE, STIMSON, H. L. CURTIS, CRITTENDEN, and L. B. TUCKERMAN.

A new determination of the constant of gravitation has been made, using the torsion balance. The plan of work was the same as that published in the Bureau of Standards Journal of Research in December, 1930. A number of suggested improvements in the apparatus were considered, some of which were tried and two of which were adopted. Photographic recording of the time of swing was used in place of visual observation and a change was made in the position of the large attracting masses which greatly simplified the length measurements. Two different tungsten filaments were used, one hard drawn and one specially annealed and kept straight during the drawing and subsequent handling. The final result

obtained was $6.673 \pm 0.003 \times 10^{-8} \text{ cm}^3 \text{ g}^{-1} \text{ sec}^{-2}$.

Compared with the 1930 result of $6.670 \pm 0.005 \times 10^{-8}$, it will be seen that the increase in precision is hardly appreciable. It may therefore be concluded that the limiting point of diminishing returns has been reached with this form of apparatus, and that future work on this constant must make use of a radically different method.

An informal communication on the trend of published values of the velocity of light with time was presented by Mr. H. L. CURTIS, of the National Bureau of Standards.

1199TH MEETING

The 1199th meeting was held in the Cosmos Club auditorium, Saturday, March 28, 1942, President BROMBACHER presiding. A paper on *The adsorption of gases and vapors on solids* was presented with illustrations by Mr. STEPHEN BRUNAUER, of the Bureau of Plant Industry. It was discussed by Messrs. HERZFELD, MOHLER, TUCKERMAN, HUMPHREYS, GOLDBERG, and DEMING.

Under the term "adsorption" chemists usually include two distinct phenomena: Van der Waals adsorption, a process resembling condensation; and chemical adsorption, a process similar to chemical reactions. Although there are some points of similarity, the two processes are different and require entirely different theoretical approach for their explanation. The classical treatment of Langmuir was meant to apply to both processes, and indeed there are a few isolated cases of adsorption where the theory does apply. The majority of experimental data, however, do not obey the Langmuir equation. The reason for this is different in the two adsorption processes.

One of the fundamental assumptions in Langmuir's theory is that adsorption is unimolecular. This assumption is not obeyed in Van der Waals adsorption, because this type of adsorption is usually multimolecular. In the literature of Van der Waals adsorption one finds five different isotherm types, only one of which obeys the Langmuir equation. In the last few years an equation has been developed by the author and coworkers for the Van der Waals adsorption of gases to include all five isotherms. The equation enables one to evaluate the surface areas and the average pore diameters of the adsorbents, as well as the heats

of adsorption; and the values obtained from the theory agree very well with the experimental results. The theory also predicts correctly the temperature dependence of adsorption. (The collaborators in this work were E. TELLER, P. H. EMMETT, W. EDWARDS DEMING, and LOLA S. DEMING).

Langmuir's other assumption is that the heat of adsorption is constant over the surface. This is obeyed only roughly in Van der Waals adsorption, but very seldom in chemisorption. Recently a theory of chemisorption was developed by the author and collaborators on the assumption that the heat of adsorption varies over the surface, and that the variation is proportional to the fraction of the surface covered by adsorbed gas. Equations were developed also for the rates of adsorption and desorption. The new equations fit very well the curves obtained 10 years ago for the rates of adsorption of nitrogen on iron catalysts. In the second place, they enable one to calculate the adsorption isotherm from the rates of adsorption, and excellent agreement was obtained between theory and experiment. Finally, from the same rate equation one can calculate the kinetic expression for the decomposition of ammonia over iron catalysts, and again excellent agreement was found with experiment. (The collaborators in this work were Miss K. S. LOVE and R. G. KEENAN.)

1200TH MEETING

The 1200th meeting was held in the Cosmos Club auditorium, Saturday, April 11, 1942, President BROMBACHER presiding. A paper on *Calibration of mercurial and aneroid barometers* was presented with illustrations and exhibits by Mr. D. P. JOHNSON, of the National Bureau of Standards. It was discussed by Messrs. H. L. CURTIS, McCOMB, L. B. TUCKERMAN, PAWLING, P. A. SMITH, MEARS, STIMSON, and B. G. JONES.

Five years ago an accuracy of 0.1 mm of mercury was regarded as entirely adequate for the calibration of any portable aneroid or mercurial barometer. The recent development of aneroid instruments capable of measuring pressure changes equivalent to a three inch head of air has made necessary a corresponding improvement of the standards. At the same time, by using a sensitive aneroid to keep track of small pressure changes, it is possible to

eliminate the uncertainty which results when readings of a number of instruments cannot be exactly simultaneous.

A normal barometer has been built which consists essentially of a U-tube of 20-mm bore, with one arm evacuated, a pair of telescopes for sighting on the mercury surface, and a scale. The uncertainty due to the capillary depression of the mercury meniscus in a U-tube of this size is about 0.01 mm of mercury and sets this limit to the accuracy attainable with the instrument. The system was therefore designed for ease and speed of reading, consistent with a sensitivity of 0.01 mm of mercury. A scale in the eyepiece of the telescope is seen superposed on the metal scale, forming a vernier which can be easily read to 0.01 mm. With proper illumination it is possible to set on the mercury surface more closely than the scale can be read. Corrections are applied for all factors which can be evaluated, including temperature, gravity, head of air between the standard and instruments tested, capillarity, and residual pressure in the evacuated arm. The room temperature is held constant for several hours before reading. With this instrument, pressure measurements can be made one minute apart, with an over-all accuracy believed to be better than 0.03 mm of mercury.

The president announced the program for a joint meeting with the Washington Academy of Sciences.

1201ST MEETING

The 1201st was a joint meeting with the Washington Academy of Sciences on April 16, 1942. Mr. Paul R. Heyl, of the National Bureau of Standards, delivered an address entitled *Cosmic emotion*, published in the August 1942 issue of this JOURNAL.

1202D MEETING

The 1202d meeting was held in the Cosmos Club auditorium, Saturday, April 25, 1942, President BROMBACHER presiding. An invited paper on *Diet in experimental cancer* was presented with illustrations by Mr. DEAN BURK, of the National Cancer Institute. It was discussed by Messrs. PAWLING, HUMPHREYS, P. A. SMITH, and H. L. CURTIS.

Studies of the past few years make it certain that various types of cancers may be influenced by dietary composition. As a general rule, even

if not invariably, the growth of tumors is affected by dietary factors in much the same manner as is the growth of the host animals. In particular, tumor growth can often be prevented if constituents essential for body growth are largely omitted from the diet. Studies on the influence of diet on the formation of liver cancers induced by the feeding of butter yellow (*p*-dimethylaminoazobenzene) to rats have been very illuminating in showing that a large array of factors may be involved. Some factors, such as riboflavin and protein (casein, egg albumen) are anti-carcinogenic and tend to protect against cancer formation. Other factors, such as biotin and inositol, have been found to be procarcinogenic, tending to promote tumor formation. Still other materials, including cystine, choline, and crude vitamin concentrates, are amphicarcinogenic, that is, they may act anticarcinogenically under one set of dietary circumstances, and procarcinogenically under a different set of conditions. Evidently both vitaminic and avitaminic factors are involved in the controlling dietary balance, and the interpretation of the data may also be made in terms of sulfur, nitrogen, and methyl groups concerned. Very little work has been directed yet toward distinguishing between dietary effects upon initiation as contrasted to growth and development of tumors, and most of the work has dealt with animal tumors, induced or spontaneous, primary or secondary. Application to human cancer of information obtained with animal tumors is largely a problem for the future but certain aspects are definitely under attack at present.

The president announced that the Joseph Henry Lecture would be presented in the fall.

1203D MEETING

The 1203d meeting was held in the Cosmos Club auditorium, Saturday, May 9, 1942, President BROMBACHER presiding. An invited paper on *The absorption spectra of some organic dyes* was presented with illustrations by Mr.

A. L. SKLAR, of the Catholic University of America. It was discussed by Messrs. FOURT, DURAND, and BROMBACHER.

The assignment of the light absorption associated with the color of organic molecules to a non-Rydberg electronic transition involving the unsaturation electrons was discussed from chemical and physical viewpoints. Evidence was summarized for the view that the 2,500 Å band of benzene is associated with transition between the two molecular energy states which may be considered as arising from a resonance splitting of the two Kekule structures. The same idea was carried over to the polymethine dyes, in which the two most stable resonance structures (I_a and I_b) are the analogues of the Kekule structures.

The only differences in the two cases are first, that the two structures, I_a and I_b , do not interact directly, but only through a series of "intermediate" structures of higher energy in which the positive charge is on one of the carbon atoms of the chain; and, second, that the two structures, I_a and I_b , may, in unsymmetrical dyes ($R_1 \neq R_2$), have slightly different energies. This view was then used to explain the following observations¹: the increase of peak wavelength with chain length n ; the existence of a "deviation" to shorter wavelengths in unsymmetrical dyes when compared to symmetrical dyes; the increase of the "deviation" with n ; the apparent existence of a convergence limit; the Brooker sensitivity rule, and the Schwartzback rule.

The president announced the election of the new Committee on Communications as follows: Messrs. K. F. HERZFELD (chairman), LAWRENCE WOOD, and PETER COLE. He announced that this would be the last meeting of the season.

FRED L. MOHLER, *Recording Secretary*.

¹ L. G. S. BROOKER and coworkers. *Journ. Amer. Chem. Soc.* **62**: 1116; **63**: 3129, 3203, 3214; **64**: 199.

Obituaries

CLINTON HART MERRIAM, who was an active spirit in the organization of the Washington Academy of Sciences when it was being founded toward the close of the last century, died quietly on March 19, 1942, after several

years of failing health, at Berkeley, Calif., in his 87th year. On account of his life of high achievement along zoological and anthropological lines, not only has the Academy but all students interested in these and kin-

dred subjects lost a leader who set a pace well worthy to follow.

Dr. Merriam was born in New York City on December 5, 1855, son of Clinton L. Merriam and Caroline Hart Merriam. His interest in natural history began early in life, and it broadened in scope and matured in character as time went on. In 1872, and in his 17th year, he became naturalist of the Hayden Survey, which made explorations of the Yellowstone area. In 1874 he entered Sheffield Scientific School of Yale, and completed the course in 1877. While there he wrote his *Review of the Birds of Connecticut*, a very creditable piece of work.

He graduated from the College of Physicians and Surgeons, of New York, in the Class of 1879. On March 7, 1878, he assisted in founding the Linnaean Society of New York, and was elected its first president. During the years 1879 to 1885 Dr. Merriam built up a good medical practice at his home in Lewis County, N. Y.

During the spring of 1883, as surgeon of the sealing vessel *Proteus*, he visited the ice fields off the coast of Labrador and Greenland, to make a study of the hooded seals. He brought back valuable records and many specimens. In the autumn of the same year he joined with 22 others in founding the American Ornithologists' Union and was elected secretary, and during 1900-1902 he was its president. In 1885 he became chief of the Division of Ornithology, United States Department of Agriculture, which was the forerunner of the Biological Survey and, at present, the Fish and Wildlife Service. During the 25 years Dr. Merriam was chief, he planned and carried out a number of field expeditions to obtain data on life zones, distribution of animal and plant life, laws of temperature control, and geographic distribution of life. Among these may be mentioned the Biological Survey of San Francisco Mountain and Desert of the Little Colorado River, Arizona; Biological Reconnaissance of Idaho; Death Valley Expedition; and Biological Survey of Mount Shasta, California.

While Merriam was on the Death Valley Expedition in 1891 President Harrison appointed him a member of the U. S. Bering Sea Commission, to study fur-seal conditions on the Pribilof Islands.

The vast number of mammals collected by members of the Biological Survey enabled him to describe many new species, of which 651 type specimens are in the National Museum collections. He also monographed the pocket gophers, shrews, weasels, and the grizzly and big brown bears.

Dr. Merriam had considerable to do in planning the personnel and route of the Harriman Alaska Expedition, with Dr. Lewis R. Morris, physician of Mr. Harriman, and member of the Boone and Crockett Club. On the return of the expedition he devoted much time to editing its publications. In consideration for his untiring services, Mrs. E. H. Harriman established a special trust fund to enable him to carry on research work, which after retiring from the Biological Survey in 1910 he devoted largely to the linguistic studies of California Indians. During the years 1917 to 1925 Dr. Merriam was chairman of the United States Geographic Board.

Among the scientific societies and clubs in which he held membership the following may be mentioned: American Ornithologists' Union, Linnaean Society of New York, National Academy of Sciences, Washington Academy of Sciences, Boone and Crockett Club, Cosmos Club, American Society of Naturalists, Biological Society of Washington, American Philosophical Society, American Society of Mammalogists, Anthropological Society of Washington, and Zoological Society of London. In a number of these he was among the founders, and of a majority of them he was president at one time or another.

As author or editor he always endeavored to obtain exact facts, so that his 500 or more publications went through the most careful scrutiny before they were ready for publication. He helped many with editorial suggestions, and there are some reports that never would have seen the light of day had he not given much time to editing and revamping crudely prepared notes or manuscripts. Merriam was a man of many friends and admirers, and through his publications and advocacy he helped scores of ornithologists and mammalogists with their problems.

In science, as in other lines, there are contemporary waves where groups of individuals interested in similar problems associate together for a better understanding and ad-

vancement of their vocation or hobby. In the case of Dr. Merriam, he was one of the last to join his zoological contemporaries who passed beyond before him. The group of naturalists to which Dr. Merriam belonged was indeed a distinguished one, but none made a greater contribution than he to the natural history of America, and none will be remembered with more affection.—A. K. FISHER.

ANDREW STEWART, born in Washington, D. C., on September 3, 1867, died on June 28, 1942, in his home at 1442 Clifton Street, Washington, D. C., after an illness of a year. Through his departure science lost a devotee; the Nation lost a citizen of intense loyalty; several cultural and patriotic organizations lost a leader and historian; and a household that typifies the finest of American home life lost a loving husband and father.

The Stewart family descended from Scotch and English lines that have been traced to the Royal House of England. In America they have long been prominent in the affairs of southwestern Pennsylvania and the Nation's Capital. Stewart's grandfather, the Honorable Andrew Stewart, for whom he was named, served Pennsylvania as a member of Congress for 18 years and gained the nickname of "Tariff Andy" through his continuous and successful advocacy of the protective tariff. He was also one of the initiators of the Chesapeake and Ohio Canal. David Shriver Stewart, father of the subject of this obituary, served in Washington as the chief of a division of the Patent Office.

The culture, sincerity, and patriotism derived from a background of ancestors who had served with distinction in the Revolution, the War of 1812, and the Civil War were reflected in Stewart's character. He graduated from Central High School where, because of high scholastic standing and proficiency in military drill, he was made first commanding officer of the cadets, holding the rank of major. After graduation he studied chemistry in Germany, and in 1895 he received the degree of doctor of philosophy, cum laude superato, at the University of Leipzig.

In 1895 Dr. Stewart returned to the United States and served for a short time in the "poison squad" of the Bureau of Chemistry, De-

partment of Agriculture, under the late Dr. Harvey W. Wiley. Next, he conducted research on chemical synthesis for Sharp & Dohme. From 1897 to 1900, he and the late Dr. George W. Johnston established and conducted a chemical analytical laboratory, which was a pioneering project in that field in Washington. He lectured on this subject at the National Veterinary College and the Medical Schools of the George Washington and Georgetown Universities, and was associate editor of the *National Medical Review*. In 1902, he entered the Dendro-Chemical Laboratory of the Bureau of Chemistry, Department of Agriculture, and from 1903 to 1905 was in charge of that laboratory.

After a period spent largely in writing and the management of family estates, Dr. Stewart entered the Bureau of Mines in 1918, serving in the Division of Mineral Technology, which then conducted the Bureau's work on helium. As a result, he played a prominent part in pioneering work that led to important developments in later years. In 1925, when a Helium Division was organized in the bureau to handle the development and operation of helium plants to supply the Army and Navy, Dr. Stewart was made assistant to the chief of the division, and served in that capacity until he retired in 1933. He was a member and secretary of the Interdepartmental Patents Board.

Among his many publications was one entitled *About Helium*, which was written to present information to the layman concerning the history, properties, production, and uses of helium. This pamphlet is one of the most widely read of the Bureau of Mines' publications.

Dr. Stewart was a prominent member of the Sons of the American Revolution and the Society of Colonial Wars. From 1934 to 1938, he was vice-president general of the General Society of the War of 1812, and served the District society at various times as president, first vice president, registrar, and historian. In Masonic circles, he was past master of Harmony Lodge No. 17, a 32d degree Mason, and a member of the Shrine. He was a member of the Washington Academy of Sciences, the American Chemical Society, the American Association for the Advancement of Science, and the Cosmos Club.—R. A. CATTELL.

PROGRAMS OF THE ACADEMY AND AFFILIATED SOCIETIES

PHILOSOPHICAL SOCIETY OF WASHINGTON (Cosmos Club Auditorium, 8:15 p.m.):

Saturday, October 24. *Latent image in photographic plates.* ALBERT MAY.

MEDICAL SOCIETY OF THE DISTRICT OF COLUMBIA (1718 M Street, NW., 8 p.m.):

Wednesday, October 21. Panel discussion on *Civilian hospitals and hospitalization during wartime.*

Wednesday, October 28. Panel discussion on *Undulant fever (Brucellosis).*

BOTANICAL SOCIETY OF WASHINGTON (Cosmos Club Auditorium, 8 p.m.):

Tuesday, November 3. *Present status of the production of natural rubber.* T. D. MALLERY.
Chromosome number and hybridization in gladiolus. RONALD BAMFORD.

CONTENTS

	Page
CHEMISTRY.—The behavior of cystine dimethylester dihydrochloride and of cysteine monomethylester monohydrochloride in the Sullivan reaction for cysteine and cystine. M. X. SULLIVAN, W. C. HESS, and H. W. HOWARD.....	285
PALEOBOTANY.—A Miocene grapevine from the valley of Virgin Creek in northwestern Nevada. ROLAND W. BROWN.....	287
BOTANY.—On new algae of the genus <i>Codium</i> from the South China Sea. C. K. TSENG and WM. J. GILBERT.....	291
BOTANY.—An undescribed <i>Atropellis</i> on cankered <i>Pinus virginiana</i> . M. L. LOHMAN, EDITH K. CASH, and ROSS W. DAVIDSON.....	296
ENTOMOLOGY.—New species of <i>Anastrepha</i> and notes on others (Diptera, Tephritidae). ALAN STONE.....	298
BACTERIOLOGY.—Incidence of leptospirosis among dogs in Honolulu as determined by serological agglutination tests. JOSEPH E. ALICATA and VIRGINIA BREAKS.....	305
ZOOLOGY.— <i>Stereobalanus canadensis</i> (Spengel), a little-known enteropneustan from the coast of Maine. EDWARD G. REINHARD....	309
PROCEEDINGS: PHILOSOPHICAL SOCIETY.....	311
OBITUARIES: CLINTON HART MERRIAM, ANDREW STEWART.....	318

The Journal is Indexed in the International Index to Periodicals

500.73
D2W23

Vol. 32

NOVEMBER 15, 1942

No. 11

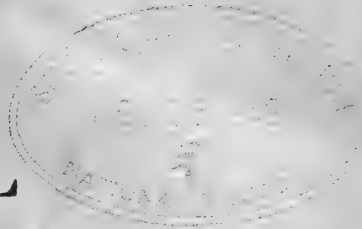

JOURNAL

OF THE

WASHINGTON ACADEMY OF SCIENCES

BOARD OF EDITORS

RAYMOND J. SEEGER
GEORGE WASHINGTON UNIVERSITY

G. ARTHUR COOPER
U. S. NATIONAL MUSEUM

JASON R. SWALLEN
BUREAU OF PLANT INDUSTRY

ASSOCIATE EDITORS

W. EDWARDS DEMING
PHILOSOPHICAL SOCIETY

C. F. W. MUESEBECK
ENTOMOLOGICAL SOCIETY

HARALD A. REHDER
BIOLOGICAL SOCIETY

EDWIN KIRK
GEOLOGICAL SOCIETY

CHARLOTTE ELLIOTT
BOTANICAL SOCIETY

T. DALE STEWART
ANTHROPOLOGICAL SOCIETY

HORACE S. ISBELL
CHEMICAL SOCIETY

PUBLISHED MONTHLY

BY THE

WASHINGTON ACADEMY OF SCIENCES

450 ANNAIR St.

AT MENASHA, WISCONSIN

Entered as second class matter under the Act of August 24, 1912, at Menasha, Wis.
Acceptance for mailing at a special rate of postage provided for in the Act of February 28, 1925.
Authorized January 21, 1933.

Journal of the Washington Academy of Sciences

This JOURNAL, the official organ of the Washington Academy of Sciences, publishes: (1) Short original papers, written or communicated by members of the Academy; (2) proceedings and programs of meetings of the Academy and affiliated societies; (3) notes of events connected with the scientific life of Washington. The JOURNAL is issued monthly, on the fifteenth of each month. Volumes correspond to calendar years.

Manuscripts may be sent to any member of the Board of Editors. It is urgently requested that contributors consult the latest numbers of the JOURNAL and conform their manuscripts to the usage found there as regards arrangement of title, subheads, synonymies, footnotes, tables, bibliography, legends for illustrations, and other matter. Manuscripts should be typewritten, double-spaced, on good paper. Footnotes should be numbered serially in pencil and submitted on a separate sheet. The editors do not assume responsibility for the ideas expressed by the author, nor can they undertake to correct other than obvious minor errors.

Illustrations in excess of the equivalent (in cost) of one full-page line drawing are to be paid for by the author.

Proof.—In order to facilitate prompt publication one proof will generally be sent to authors in or near Washington. It is urged that manuscript be submitted in final form; the editors will exercise due care in seeing that copy is followed.

Unusual cost of foreign, mathematical, and tabular material, as well as alterations made in the proof by the author, may be charged to the author.

Author's Reprints.—Reprints will be furnished in accordance with the following schedule of prices (approximate):

Copies	4 pp.	8 pp.	12 pp.	16 pp.	20 pp.	Covers
50	\$2.00	\$3.25	\$ 5.20	\$ 5.45	\$ 7.25	\$2.00
100	2.50	4.00	6.40	6.75	8.75	2.75
150	3.00	4.75	7.60	8.05	10.25	3.50
200	3.50	5.50	8.80	9.35	11.75	4.25
250	4.00	6.25	10.00	10.65	13.25	5.00

Subscription Rates.—Per volume.....\$6.00
 To members of affiliated societies; per volume..... 2.50
 Single numbers..... .50

Correspondence relating to new subscriptions or to the purchase of back numbers or volumes of the JOURNAL should be addressed to William W. Diehl, Custodian and Subscription Manager of Publications, Bureau of Plant Industry, Washington, D.C.

Remittances should be made payable to "Washington Academy of Sciences" and addressed to 450 Ahnaip Street, Menasha, Wis., or to the Treasurer, H. S. Rappleye, U. S. Coast and Geodetic Survey, Washington, D.C.

Exchanges.—The JOURNAL does not exchange with other publications.

Missing Numbers will be replaced without charge provided that claim is made to the Treasurer within thirty days after date of following issue.

OFFICERS OF THE ACADEMY

President: HARVEY L. CURTIS, National Bureau of Standards.
Secretary: FREDERICK D. ROSSINI, National Bureau of Standards.
Treasurer: HOWARD S. RAPPLEYE, U. S. Coast and Geodetic Survey.
Archivist: NATHAN R. SMITH, Bureau of Plant Industry.
Custodian of Publications: WILLIAM W. DIEHL, Bureau of Plant Industry.

JOURNAL

OF THE

WASHINGTON ACADEMY OF SCIENCES

VOL. 32

NOVEMBER 15, 1942

No. 11

CHEMISTRY.—*The third dissociation constant of phosphoric acid and its variation with salt content.*¹ ROGER C. WELLS.

In studying the origin of phosphate deposits W. W. Rubey, of the Geological Survey, found rather incomplete and conflicting information in the literature concerning the third dissociation constant of phosphoric acid, especially its variation with ionic strength. Such measurements as had been made covered chiefly very dilute solutions; some included the ionic strength of blood, but none that of sea water. At Mr. Rubey's request the writer has attempted to extend information on this subject, with the ultimate object of throwing light on the conditions under which phosphate deposits are supposed to be formed in nature.

The principal result of the investigation is that the concept of ionic strength is unnecessary and inapplicable. The constant appears to have values of a different order in salt solutions and in sea water from those obtaining when only phosphate buffers are present.

The constant desired was not the thermodynamic or activity constant but one generally termed the apparent dissociation constant, which has been found more useful for at least a first approach. The thermodynamic constant is based on the following equilibrium:



in which the quantities in brackets represent the activities of the ions indicated. The first difficulty encountered is to determine these activities. As this has not yet been done for all conditions it is general practice to derive and use certain "apparent con-

stants," which are suitable for practical work up to a certain point, and that practice is followed here. In this paper, then, $[\text{PO}_4^{---}]$ and $[\text{HPO}_4^{--}]$ are replaced by $[\text{PO}_4''']$ and $[\text{HPO}_4'']$ meaning simply the stoichiometrical concentrations of those radicals, or, for example, such salts as trisodium phosphate and disodium phosphate, respectively. $[\text{H}^+]$ is retained with the usual significance of an ionic concentration; it was determined by hydrogen electrode measurements.

The apparent constant, K_3' , although thus defined somewhat arbitrarily, shows a surprising constancy for widely different values of the concentration of the ions involved.

For ordinary practical purposes equation (1) shows that at any given pH the ratio $[\text{PO}_4''']/[\text{HPO}_4'']$ must have a fixed value, or vice versa. Examined more minutely, however, the constant is found to vary slightly with temperature, with the concentration of the phosphate buffer salts and more particularly with the presence of other salts, such as sodium chloride or sea salts.

The constant is best determined by measuring $[\text{H}^+]$ in mixtures of, say, disodium phosphate and trisodium phosphate. These salts are of course not wholly ionized in moderate concentrations but they appear to be ionized to nearly the same extent, so that little is lost by using

$$\frac{[\text{PO}_4''']}{[\text{HPO}_4'']} \quad \text{for} \quad \frac{[\text{PO}_4^{---}]}{[\text{HPO}_4^{--}]}$$

Equilibrium (1) has little application to acid solutions because K_3 is very small and even a moderate quantity of hydrogen ions

¹ Published by permission of the Director, Geological Survey. Received July 15, 1942.

would convert practically all of the PO_4''' into HPO_4'' (or even into $\text{H}_2\text{PO}_4'$). It is only in alkaline solutions in which $[\text{H}^+]$ becomes small that $[\text{PO}_4''']$ becomes relatively large. Even for the alkalinity considered in this paper there must be a slight hydrolysis of the trisodium phosphate:



This hydrolysis, the extent of which can be calculated from the pH, obviously results in a slight decrease in the Na_3PO_4 taken and an equal increase in the Na_2HPO_4 taken. This correction may be made a small one by using suitable proportions of the two phosphates.

As the solutions involved are sometimes made by neutralizing phosphoric acid with sodium hydroxide it is convenient to designate in some way the extent of the neutralization. This may be indicated by the letter R , ranging from 0 to 3. Thus 1 indicates that the neutralization has gone from 0 to 1, that is, from H_3PO_4 to NaH_2PO_4 ; 2 indicates Na_2HPO_4 ; and 3 indicates Na_3PO_4 . Mixtures are intermediate. This number R has no reference to the total sodium in the solution but only to the amount of the hydrogen in the different phosphate combinations, H_3PO_4 , $\text{H}_2\text{PO}_4'$, HPO_4'' , and PO_4''' . Thus, in sea water $[\text{Na}^+]$ is high but R would be about 2, indicating HPO_4'' as the principal phosphate ion. For most of the mixtures used in the present study R was 2.5. M_P is the total phosphate molality, so that for $R=2.50$ very nearly half of M_P is present as $\text{H}_2\text{PO}_4'$ and half as PO_4''' . This paper is largely a study of the pH of mixtures containing one mol of disodium phosphate to one mol of trisodium phosphate, with or without additional sodium chloride. M_{Cl} is the molality of chloride, generally NaCl , and M_S the total molality of sea salts. For average sea water with $\text{Cl}=1.900$ per cent and density 1.027 $M_S=0.514$.

The ionic strength, μ , is calculated as indicated by Lewis and Randall.²

PREVIOUS WORK

Nearly all previous work deals with rela-

² LEWIS, G. N., and RANDALL, MERLE. *Thermodynamics*, p. 373, 1923.

tions in solutions containing only phosphate buffers. For some reason many results have been plotted against the ionic strength, but as the concept of ionic strength has been found of little use in the present investigation figures for it have been omitted in reviewing the previous work unless the authors used it exclusively.

Abbott and Bray³ found 7.8×10^{-13} for K_3 at $0.05 M_P$ and 18°C ., based on hydrolysis and conductivity measurements with ammonium salts. Making allowances for ionization they derived a figure of 3.6×10^{-13} for K_3 or 12.44 for $\text{p}K_3$ ($= -\log K_3$) but both values of K_3 are smaller than those calculated later from pH measurements by others using sodium salts.

From measurements by Salm⁴ at 19°C ., $M_P=0.1$, and correcting for hydrolysis, one obtains the following results for K_3' and $\text{p}K_3'$.

R	$[\text{PO}_4''']$	$[\text{HPO}_4'']$
2.03	0.00293	0.097
2.14	0.0135	0.086
$[\text{H}^+]$	K_3'	$\text{p}K_3'$
9.8×10^{-11}	3.0×10^{-12}	11.52
1.3×10^{-11}	2.0×10^{-12}	11.47

Similar measurements by Ringer⁵ were made at 18°C . from which I calculate $M_P=0.0292$ and the following values of $\text{p}K_3'$.

R	$[\text{PO}_4''']$	$[\text{HPO}_4'']$	pH	$\text{p}K_3$
2.191	0.0048	0.024	10.97	11.66
2.66	0.0154	0.0136	11.77	11.72

Prideaux⁶ gives data leading to the following figures ($M_P=0.1$, $t=16^\circ \text{C}$.):

R	$[\text{PO}_4''']$	$[\text{HPO}_4'']$	pH	$\text{p}K_3$
2.05	0.0049	0.0950	10.23	11.52
2.10	0.0098	0.0902	10.60	11.57
2.16	0.0157	0.0843	10.70	11.43
2.19	0.0185	0.0815	10.89	11.54
2.22	0.0215	0.0785	10.92	11.48
2.50	0.0480	0.0520	11.54	11.57

E. Blanc⁷ finds $\text{p}K_3'=11.64$ at 25°C . for $M_P=0.004$.

³ ABBOTT, G. A., and BRAY, W. C. *Journ. Amer. Chem. Soc.* **31**: 760. 1909.

⁴ SALM, E. *Zeitschr. physikal. Chem.* **57**: 471. 1906.

⁵ RINGER, W. E. *Chemisch Weekblad* **6**: 446. 1909.

⁶ PRIDEAUX, E. B. R. *Journ. Chem. Soc.* **99** (1): 1224. 1911.

⁷ BLANC, E. *Journ. Chim. Phys.* **18**: 28. 1920.

From Sørensen's measurements on Na_2HPO_4 Prideaux and Ward⁸ calculate $\text{pK}_3' = 11.59$, based on $\frac{1}{18}$ M solutions.

Michaelis and Mizutani⁹ find that $\text{pK}_3' = 11.53$ at 14°C . for $M_P = 0.02$ and that 60 per cent of alcohol raises this to 12.58, an effect which is in the opposite direction to that of sodium chloride studied in this paper.

Britton¹⁰ finds $\text{pK}_3' = 11.57$ at 20°C . as an average over a range of R from 2.06 to 2.65 and M_P about 0.01, but without correction from the hydrolysis of PO_4''' .

Sendroy and Hastings¹¹ made a few determinations of pK_3' at 38°C . in solutions containing NaCl . Their figures decrease rapidly with increasing ionic strength, but they do not go above an ionic strength of 0.20.

Kugelmass¹² found 11.99 and 11.83 for pK_3' at 20°C . and 38°C . respectively for M_P ranging from 0.003 to 0.025. Little or no variation with the molality is indicated over the small range covered.

Bjerrum and Unmack¹³ made measurements of potentials with very dilute sodium-phosphate solutions. Some of their results calculated as above give the following figures:

0°C .	R	$[\text{PO}_4''']$ (Corrected)
18	2.333	0.01270
18	2.500	0.01710
18	2.333	0.00285
25	2.333	0.01220
25	2.500	0.01650
25	2.333	0.00250
37	2.333	0.01110
37	2.500	0.01530
37	2.333	0.00230

$[\text{HPO}_4'']$ (Corrected)	pH	pK_3'
0.03020	11.39	11.77
0.02290	11.64	11.77
0.01002	11.37	11.92
0.03070	11.28	11.68
0.02350	11.50	11.66
0.01030	11.20	11.82
0.03180	11.07	11.52
0.02470	11.28	11.48
0.01050	10.92	11.59

Average pK_3' at 18°C . and $M_P = 0.042$	11.77
Average pK_3' at 25°C . and $M_P = 0.042$	11.67
Average pK_3' at 37°C . and $M_P = 0.042$	11.50

⁸ PRIDEAUX, E. B. R., and WARD, A. T. Journ. Chem. Soc. 125 (1): 423. 1924.

From the above results pK_3' appears to decrease with rising temperature at a given molality. The figures for lower molalities are apparently less reliable than the others. There is generally a decrease in pK_3' with increasing molality at each temperature.

Hahn and Klockmann¹⁴ reach a figure of 11.89 for pK_3' in very concentrated solutions by means of a titration method.

Considering all the above measurements one may conclude that pK_3' decreases slightly with rising temperature and also with increasing molality. An average of five of the best results just referred to gives $\text{pK}_3' = 11.66$ at 20°C . and $M_P = 0.04$, whereas the writer finds 11.60.

METHODS

$[\text{H}^+]$ was determined by a hydrogen electrode combined with a tenth-normal calomel electrode. Liquid potentials were eliminated by making fresh connections with saturated potassium chloride before each measurement. A sodium-hydroxide solution was made by diluting a nearly saturated solution, as described by Sørensen, and protected from the carbon dioxide of the air. Mallinckrodt's $\text{Na}_2\text{HPO}_4 \cdot 12\text{H}_2\text{O}$ and H_3PO_4 were used. Some $\text{Na}_2\text{HPO}_4 \cdot 12\text{H}_2\text{O}$ was also recrystallized for this study by F. S. Grimaldi and used as the source of phosphate in most of the measurements. It was brought to the mixture $R = 2.50$ by adding sodium hydroxide. Dilutions were made with boiled freshly distilled water.

Definite mixtures were prepared, pH determined and $[\text{H}^+]$ calculated. From K_w $[\text{OH}^-]$ was calculated and taken as equal to the $[\text{NaOH}]$ and $[\text{Na}_2\text{HPO}_4]$ formed by equation (2), from which the final $[\text{HPO}_4'']$ and $[\text{PO}_4''']$ were calculated. Values of K_w used were read from a curve passing through the following points:

⁹ MICHAELIS, L., and MIZUTANI, M. Zeitschr. physikal. Chem. 116: 135. 1925.

¹⁰ BRITTON, H. T. S. Journ. Chem. Soc. 1927: 614.

¹¹ SENDROY, J., JR., and HASTINGS, A. B. Journ. Biol. Chem. 71: 783. 1927.

¹² KUGELMASS, I. N. Biochem. Journ. 23: 587. 1929.

¹³ BJERRUM, N., and UNMACK, AUGUSTA. Danske Viden. Selskab., Math. fys. Med. 9: 1. 1929.

¹⁴ HAHN, F. L., and KLOCKMANN, R. Zeitschr. physikal. Chem. 151: 80. 1930.

0° C.	0.11×10^{-14}
5	0.28×10^{-14}
10	0.28×10^{-14}
15	0.47×10^{-14}
20	0.72×10^{-14}
25	1.11×10^{-14}
30	1.70×10^{-14}
35	2.25×10^{-14}
40	2.80×10^{-14}

The variation of K_w with ionic strength was neglected, and only mixtures requiring a small correction for hydrolysis were considered, as dilute solutions and those involving a large correction for hydrolysis led to unreliable results. Moreover the variation of K_w with ionic strength is not known for higher ranges of the ionic strength.

RESULTS

The effect of temperature on the pH of phosphate mixtures is so small that it is difficult to detect with indicators. A "universal" indicator appeared to suggest a decrease in pH with rise of temperature, alizarin changed in the opposite direction, and malachite green faded out.

When determined by E.M.F. measurements the results for pH, with R between 2 and 3, showed a slight decrease with rise of temperature, in agreement with Bjerrum and Unmack. As K_w increases considerably with rising temperature the calculated values of K_3' in some instances decreased with rising temperature but in the great majority of instances K_3' increased with rising temperature. Facilities were not available to make measurements over a wide range of temperature. Based on results at 25° C. and 30° C. pH appeared to decrease about 0.02 unit per degree rise of temperature, agreeing fairly well with Bjerrum and Unmack, who found a decrease of 0.019 unit per degree. The calculations given in Table 5 for temperatures below 20° C. and above 30° C. are based on extrapolations on the latter basis.

The first series of measurements of pH and pK_3' , shown in Table 1, was made with only the phosphate buffers, Na_3PO_4 and Na_2HPO_4 , present. The combined molality of the two phosphate radicals is expressed as M_P .

The results presented in Table 1 show only a slight increase in pH with decreasing

molality of the buffer mixtures, for all of which $R=2.50$. The change is approximately linear with $\sqrt{M_P}$, and may be represented by equation (3) at 27° C. The corresponding relation for pK_3' is given by equation (4).

$$\text{Buffer only. } pH = 11.43 - 0.26\sqrt{M_P} \quad (3)$$

$$\text{Buffer only. } pK_3' = 11.57 - 0.50\sqrt{M_P} \quad (4)$$

Similar equations hold for μ in place of M_P except that 0.26 and 0.50 become 0.13 and 0.25, respectively.

TABLE 1.—MEASUREMENTS OF pH AND pK_3' IN PHOSPHATE SOLUTIONS AT 27°, $R=2.50$

M_P	$\sqrt{M_P}$	pH	$K_3' \times 10^{12}$	pK_3'
0.3014	0.550	11.28	5.21	11.28
0.2410	0.491	11.34	4.37	11.36
0.1929	0.440	11.29	4.86	11.31
0.1544	0.393	11.30	4.69	11.33
0.1205	0.347	11.32	4.36	11.36
0.0964	0.310	11.38	3.65	11.44
0.0771	0.278	11.37	3.63	11.44
0.0617	0.248	11.34	3.79	11.42
0.0493	0.222	11.39	3.14	11.50

If similar relations obtained when the ionic strength included sodium chloride the problem would be simple. Actually, the addition of sodium chloride introduces a shift of considerably greater magnitude, so that the results can no longer be represented simply as a function of the combined ionic strength, but they are rather some function of the ratio of foreign salt to the buffer phosphate salts. The use of the function ionic strength is, of course, not necessary in considering merely the effect of dilution on a single mixture of salts in a fixed proportion. A series of measurements is shown in Table 2 in which a buffered mixture containing

TABLE 2.—MEASUREMENTS OF pH AND pK_3' IN SOLUTIONS CONTAINING 3 MOLS OF PHOSPHATE TO 1 MOL OF SODIUM CHLORIDE 27° C., $R=2.50$

M_P	pH	$K_3' \times 10^{12}$	pK_3'
0.1205	11.00	9.54	11.02
0.0964	11.05	8.41	11.08
0.0771	11.07	7.82	11.11
0.0617	11.13	6.61	11.18
0.0494	11.16	5.92	11.23
0.0395	11.18	5.38	11.27
0.0316	11.17	5.25	11.28

some sodium chloride was diluted over a considerable range.

Although the results for pH and pK_3' in Table 2 are linear with respect to $\sqrt{M_P}$ they are all considerably lower than corresponding results in Table 1 and they do not extrapolate to the same figure for $\sqrt{M_P}=0$. On the other hand, if P and NaCl are varied independently irregular results are obtained. Furthermore, the lowering effect of NaCl can not be expressed as any simple function of the combined ionic strength.

As the outcome of numerous trials the following equations (5) and (6) for pH and pK_3' respectively were found to take account of various mixtures of buffer ($R=2.50$) and NaCl at 27° C. fairly well. Their application is shown in Table 3.

In salt solutions.

$$\text{pH} = 11.43 - 0.26\sqrt{M_P} - 0.98\sqrt[3]{M_{\text{NaCl}}} \quad (5)$$

In salt solutions.

$$pK_3' = 11.57 - 0.50\sqrt{M_P} - 0.98\sqrt[3]{M_{\text{NaCl}}} \quad (6)$$

Inasmuch as the ionic strength does not apply in general it is impossible to give an equation based on ionic strength without considering the nature of the salts.

In sea water pH is controlled largely by carbonates, R for the phosphates in sea water is much below 2.50, and the question arose whether equation (6) would be applicable. Some experiments with artificial sea water showed that the effect of sea salts is very similar to that of sodium chloride and that M_S can be used for M_{NaCl} in equations (5) and (6).

When sea salts are added to the phosphate buffers a precipitate of calcium phosphate is thrown down. A solution, however, was made up containing all the principal constituents of sea water except calcium and magnesium but with 0.054 mol of potassium chloride per liter and 0.010 mol per liter of the phosphate buffers substituted for the calcium and magnesium salts and sodium bicarbonate. The composition of representative sea water and that of the imitation sea water are shown in Table 4.

TABLE 4.—NORMAL SEA WATER AND IMITATION SEA WATER. MOLS PER LITER

Constituent	Normal	Imitation
NaCl.....	0.412	0.412
MgCl ₂	0.052	None
Na ₂ SO ₄	0.028	0.028
CaCl ₂	0.010	None
KCl.....	0.009	0.063
NaHCO ₃	0.002	None
KBr.....	0.001	0.001
Phosphate.....	—	0.010
Total.....	0.514	0.514

The results for pH and pK_3' obtained with the imitation sea water are included in Table 3, next to the last row. They show that equations (5) and (6) are applicable if M_S is used in place of M_{NaCl} where S is the total molality of the sea salts. The last row gives results when this sea water was diluted one half; although they are not so good they are of the right order and confirm the applicability of equations (5) and (6).

In any equation for pK_3' for sea water M_P is really negligible, so that, as a result

TABLE 3.—EFFECT OF NaCl AND SEA SALTS ON pH AND pK_3' OF PHOSPHATE SOLUTIONS. 27° C., $R=2.50$

M_P	M_{NaCl}	$\sqrt{M_P}$	$\sqrt[3]{M_{\text{NaCl}}}$	pH observed	pH calc. by (5)	pK_3' observed	pK_3' calc. by (6)
0.0100	0.0100	0.100	0.215	11.13	11.19	11.46	11.31
0.0100	0.1000	0.100	0.464	11.00	10.95	11.23	11.07
0.0100	0.5333	0.100	0.811	10.57	10.61	10.66	10.73
0.0100	1.0000	0.100	1.000	10.38	10.42	10.45	10.54
0.0150	0.8000	0.122	0.929	10.57	10.49	10.51	10.60
0.0316	0.0105	0.178	0.219	11.17	11.17	11.28	11.28
0.0493	None	0.222	—	11.39	11.37	11.50	11.46
0.0100	0.513 ^a	0.100	0.800 ^a	10.64	10.62 ^a	10.74	10.74 ^a
0.0050	0.256 ^a	0.071	0.634 ^a	10.59	10.79 ^a	10.77	10.91 ^a

^a Using M_S (molality of sea salts) instead of M_{NaCl} .

of the above experiments and calculations, we may write the following tentative equation for sea water at 27° C.:

$$pK_3' = 11.57 - 0.98\sqrt[3]{M_S} \quad (7)$$

Although equations (5), (6), and (7) are empirical, they seem to be a great improvement over extrapolations of equations that have been suggested previously. In studying the second dissociation constant of phosphoric acid J. W. H. Lugg¹⁵ gives an equation of the following form to represent the relations when the ionic strength is contributed almost entirely by a foreign salt like sodium chloride:

$$pK' = pK - \frac{1.5}{1+n} \quad (8)$$

in which n ranges from 0.60 for NaCl to 1.65 for the buffers alone. Such an equation may be applicable to the third dissociation constant in the presence of any given single salt, but it is not known whether it could be applied to mixtures like sea water.

Table 5 presents rounded values of pK_3' calculated for the conditions stated. Other values may be computed by equations (4), (6), or (7), taking account of variation with temperature, or interpolated from those given in the table. M_X represents M_P when only buffers are present and either M_{NaCl} or M_S when sodium chloride or sea salts are in considerable excess.

The variation of pK_3' with the molality of the phosphate and sodium chloride, respectively, at 27° C. is shown in Fig. 1. The

¹⁵ Trans. Faraday Soc. 27: 297. 1931.

lower curve refers to the buffer mixtures, the upper to a large excess of sodium chloride or sea water. The lines are based on results calculated from the equations; the experimental results suggest a very slight curvature instead of straight lines.

The interest and assistance of W. W. Rubey, P. G. Nutting, F. S. Grimaldi, K. J. Murata, and H. C. Spicer in the preparation of this paper are gratefully acknowledged. Mr. Rubey especially contributed many helpful suggestions and verified the calculations.

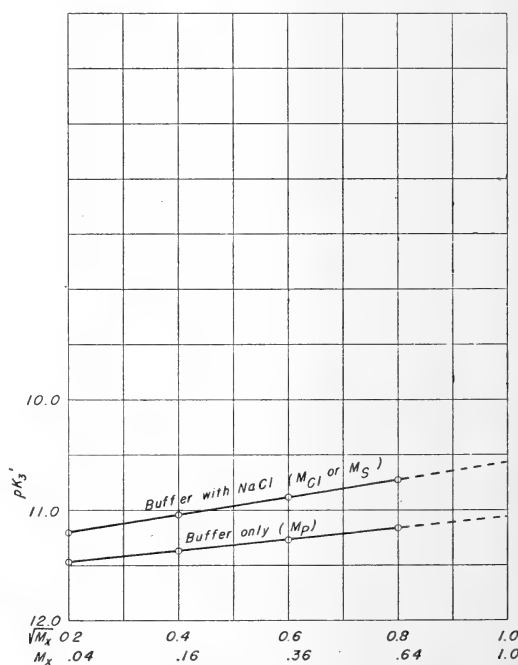

Fig. 1.—Variation of pK_3' with molality at 27° C. Lower curve, buffer mixture; upper curve, a large excess of NaCl or sea water.

TABLE 5.—VALUES OF pK_3' AT CERTAIN TEMPERATURES AND MOLALITIES (M)

	$M_X =$	0.04	0.16	0.36	0.64
		<i>Temp.</i>			
In presence of only buffer of strength indicated	0° C.	11.98	11.88	11.78	11.68
	10°	11.79	11.69	11.59	11.49
	20°	11.60	11.50	11.40	11.30
	30°	11.41	11.31	11.21	11.11
	40°	11.22	11.12	11.02	10.92
In presence of a large excess of NaCl or sea salts of strength indicated	0°	11.74	11.55	11.39	11.24
	10°	11.55	11.36	11.20	11.05
	20°	11.36	11.17	11.01	10.86
	30°	11.17	10.98	10.82	10.67
	40°	10.98	10.79	10.63	10.48

CRYSTALLOGRAPHY.—*Morphologie de l'idocrase.*¹ Abbé J.-ARTHUR TREMBLAY, Université Laval, Québec (Canada). (Communicated by G. TUNELL.)

SOMMAIRE

Étude détaillée de l'importance relative des formes cristallines de l'idocrase, $\text{Ca}_{10}\text{Mg}_2\text{Al}_4\text{Si}_9\text{O}_{34}(\text{OH})_4$. Le groupe spatial s'en déduit par la méthode morphologique de Donnay (1939). On trouve $C4/acn$, avec le rapport d'axes habituel $c:a=0.5372$. En tournant le cristal de 45° , le rapport d'axes devient $c:a=0.7597$, et le groupe s'écrit $P4/nnc$. Le groupe spatial trouvé au moyen des rayons X (*Strukturbericht*, 2: 127, 1937) est bien $P4/nnc$.

L'ordre observé d'importance relative des formes est comparé à l'ordre théorique, dans le cas de la loi de Bravais classique, qui donnait l'aspect I^{***} , et dans le cas de la loi généralisée (Donnay et Harker, 1937), qui conduit au groupe $P4/nnc$. L'accord est meilleur dans ce dernier cas, quoique certaines anomalies persistent.

INTRODUCTION

L'analyse morphologique des espèces cristallines par la méthode Donnay (1939) conduit au groupe spatial, sans nécessiter l'emploi des rayons X. L'importance relative des formes extérieures reflète la symétrie interne, c'est-à-dire celle de la disposition des atomes à l'intérieur de la maille. Tel est le point de départ de cette méthode, d'après laquelle sept minéraux, jusqu'à présent, ont été étudiés de façon détaillée. Donnay a publié des travaux sur cinq d'entre eux: l'apophyllite, tétragonale (1937); le rutile et le zircon, tétragonaux (1938a); la danburite, orthorhombique (1940b); la microlite, isométrique (1941). Les deux autres, la columbite et la stéphanite, orthorhombiques, ont été traités par un de ses élèves, E. D. Taylor (1940a et b). Le groupe spatial trouvé est, dans chaque cas, celui qu'ont donné les rayons X, sauf pour la columbite, où le développement de la zone des faces ($0kl$) s'avère incompatible avec les résultats radiologiques.

On trouvera dans ce travail l'application de la méthode au cas de l'idocrase (ou

vésvuvienne). Plusieurs formules ont été proposées pour ce minéral. *Strukturbericht* (2: 127, 1937) donne celle de C. Gottfried, $\text{Ca}_{10}\text{Mg}_2\text{Al}_4\text{Si}_9\text{O}_{34}(\text{OH})_4$.

L'idocrase cristallise dans le système tétragonal. Elle présente le plus souvent un facies prismatique allongé, avec tantôt le prisme $m\{110\}$ dominant, tantôt le prisme $a\{010\}$. Elle montre assez fréquemment un facies pyramidal et très rarement le facies tabulaire basal (Fig. 1.)

DONNEES D'OBSERVATION

L'*Atlas der Krystallformen* de Goldschmidt (1918) reproduit 249 cristaux d'idocrase. De ces figures, sept sont illisibles et quinze autres représentent des cristaux de localité inconnue. Négligent ces 22 figures, il en reste 227 dont l'étude statistique montrera la fréquence et le développement des formes représentées. Sur ces figures apparaissent 47 formes, que je désignerai par les lettres conventionnelles de Goldschmidt. L'orientation habituelle ($c:a=0.5372$) sera provisoirement utilisée. On ne tiendra aucun compte du clivage pour décider de l'importance des formes (Donnay, 1938a). L'importance d'une forme relève en tout premier lieu de sa fréquence; la grandeur des faces n'intervient que pour départager des formes d'à peu près même fréquence.

L'étude statistique est menée comme suit.

(1) On examine d'abord toutes les figures d'une même localité. Pour chacune de ces figures, on fait le relevé des formes par ordre de grandeur décroissante (voir tableau 1, pour le cas des cristaux de Pfitsch).

TABLEAU 1.—PFITSCH (TYROL)

N° de la fig.	Observateur	Classement des formes
133	Zepharovich	$p a \vartheta m c f (i s) t$
134	Zepharovich	$a m p f \vartheta i s c t$
135	Zepharovich	$p a m \vartheta c f o h (i d) (s b) t r u$
136	Zepharovich	$p \vartheta c m i b t s d u$
137	Zepharovich	$m p c i s o u$
156	Groth	$a m f p c s \vartheta i d b o t u c$

¹ Received May 15, 1942.

On en tire la *fréquence* de chaque forme pour la localité considérée, c'est-à-dire le nombre de fois que la forme a été représentée. On calcule ensuite le *rang moyen* de chaque forme de la façon suivante (voir tableau 2, pour le cas des cristaux du Vésuve): en face de chaque forme, désignée par la lettre de Goldschmidt et les indices de Miller, on indique combien de fois elle occupe le 1^{er} rang, le 2^e rang, . . . etc. Dans l'exemple du Vésuve, la forme *a* {010}, sur 35 cristaux figurés, vient 16 fois au 1^{er} rang, 9 fois au 2^e, 6 fois au 3^e, 4 fois au 4^e; son rang moyen est $(16 \times 1 + 9 \times 2 + 6 \times 3 + 4 \times 4) / 35 = 1.9$. Le rang moyen donne donc une mesure approximative de la grandeur, laquelle est d'autant plus considérable que le rang moyen est plus petit. Le résultat est une liste de formes classées par ordre d'importance pour la localité étudiée (les formes d'importance à peu près égale sont réunies entre parenthèses).

Trois tableaux sont donnés à titre d'exemples: Vésuve, facies prismatique avec *a* dominant (tableau 2); Piémont, facies prismatique avec *m* dominant (tableau 3); Pfitsch (Tyrol), facies pyramidal avec *p* dominant (tableau 4).

(2) On examine ensuite les différents classements obtenus pour les diverses localités (tableau 5). On en tire la *fréquence absolue* ou fréquence de localité, c'est-à-dire le nombre de localités où la forme est représentée. On calcule ensuite son *rang moyen de localité* (comme ci-dessus pour le rang moyen de figure). On arrive ainsi (tableau 6) à dresser la liste finale² des formes par

² Pour obtenir le rang moyen de localité, on peut accorder plus de poids aux localités qui sont représentées par un nombre plus grand de figures. Le résultat est alors le suivant: $m \ a \ (c \ p) \ s \ f \ t \ o \ i \ \vartheta \ h \ b \ z \ u \ x \ d \ r \ v \ \gamma \ \omega \ \eta \ n \ (\alpha \ \pi) \ \nu \ \beta \ \xi \ (\psi \ \Delta) \ e \ l \ \delta \ \sigma \ q \ y \ \varphi \ F \ Y_2 \ L_1 \ L_2 \ Y_3 \ (\epsilon \ r_1) \ ? \ N \ \mu \ \lambda$. On voit que cette liste ne diffère guère de celle du tableau 6, surtout en ce qui concerne les formes les plus importantes.

TABLEAU 2.—VÉSUYE (FACIES PRISMATIQUE, *a* DOMINANT)

Nombre de cristaux figurés: 35

Nombre total de formes figurées: 30

Nombre de formes par cristal: minimum, 4; maximum, 18.

Lettre	Formes Indices	Fré- quence	Nombre de figures où la forme occupe le rang suivant:																Rang moyen	
			1 ^{er}	2 ^e	3 ^e	4 ^e	5 ^e	6 ^e	7 ^e	8 ^e	9 ^e	10 ^e	11 ^e	12 ^e	13 ^e	14 ^e	15 ^e	16 ^e		17 ^e
<i>a</i>	010	35	16	9	6	4	1.9
<i>m</i>	110	35	13	10	6	3	1	2	2.3
<i>p</i>	111	35	3	10	14	5	2	..	1	2.9
<i>c</i>	001	35	5	5	5	12	6	1	1	3.4
<i>f</i>	120	27	9	8	5	2	1	..	1	1	4.6
<i>o</i>	011	25	1	2	4	6	4	6	1	1	6.8
<i>i</i>	132	20	..	1	2	3	2	1	2	2	3	2	1	1	8.7
<i>s</i>	131	16	2	2	2	5	1	3	..	1	7.9
<i>\vartheta</i>	113	15	1	4	3	2	1	2	1	1	7.9
<i>t</i>	331	11	2	2	3	..	3	1	7.3
<i>h</i>	130	9	2	4	1	..	1	1	5.9
<i>z</i>	121	8	1	1	1	2	3	8.6
<i>b</i>	221	4	1	1	1	1	7.7
<i>d</i>	241	4	1	..	1	2	8.0
<i>y</i>	141	4	2	..	1	..	1	10.5
<i>v</i>	151	4	1	1	1	1	10.5
ξ	032	3	2	1	9.3
<i>r</i>	112	3	1	2	9.6
<i>u</i>	021	3	1	1	1	9.6
<i>l</i>	243	2	1	..	1	1	7.0
π	031	2	1	1	8.5
ω	377	6.0
<i>g</i>	5.20.2	7.0
ν	012	11.0
F	7.13.1	12.0
<i>x</i>	133	12.0
Y_2	481	13.0
L_1	8.10.15	14.0
L_2	571	15.0
Y_3	5.19.2	16.0

Classement définitif: *a m p c f o i (s \vartheta) (t h) z b d (y v) \xi 'r u) l \pi \omega g \nu F x Y_2 L_1 L_2 Y_3*.

ordre d'importance décroissante, pour l'es-pèce.

PROJECTION GNOMONIQUE

On adopte l'ordre d'importance décroissante des formes trouvé au tableau 6, savoir:

<i>m</i>	<i>a</i>	(<i>c p</i>)	<i>s</i>	<i>f</i>	(<i>t o</i>)	<i>i</i>	<i>ð</i>		
110	010	001	111	131	120	331	011	132	113
<i>h</i>	<i>u</i>	(<i>z b</i>)	<i>d</i>	<i>r</i>	<i>x</i>	<i>v</i>	γ	η	
130	021	121	221	241	112	133	151	118	114
α	<i>n</i>	π	ν	ω	<i>l</i>	Δ	ψ	<i>e</i>	
1.1.20	122	031	012	377	243	454	470	351	
($\sigma \delta$)	β	ξ	(ϵ	<i>q</i>	λ)	r_1	μ		
135	117	1.1.10	032	116	383	445	461	885	
<i>y</i>	φ	?N	<i>g</i>	F	Y_2	L_1	L_2		
141	350	441	5.20.2	7.13.1	481	8.10.5	571		
Y_3									
5.19.2									

Outre ces 47 formes, relevées sur les dessins de l'Atlas de Goldschmidt, il en existe beaucoup d'autres qui, bien qu'ayant été observées, n'ont jamais été figurées.

L'ordre de ces formes est mis en évidence sur la projection (Fig. 2): les pôles gnomoniques sont marqués par des cercles dont le rayon décroît avec l'importance de la

forme correspondante. La symétrie tétra-gonale holoèdre permet d'utiliser seulement la moitié d'un octant, l'octant avant-droit-supérieur, où tous les indices sont positifs. La projection gnomonique est ici un carré coupé par une diagonale. C'est la partie située au-dessus de la diagonale qui est employée dans l'étude des zones et dans la recherche du groupe spatial. Comme le groupe trouvé imposera un changement d'orientation, la partie de la projection située au-dessous de la diagonale montre la projection gnomonique du cristal dans la nouvelle orientation. Pour cela, on n'a qu'à tourner la feuille de 45°, dans le sens contraire à celui de la marche des aiguilles d'une montre. L'étude comparative des deux orientations met en évidence la différence de grandeur des deux mailles, les changements d'indices des faces et la variation du type des zones.

DETERMINATION DU MODE DU RESEAU ET DE LA FACE UNITAIRE

On détermine le mode du réseau en se basant sur l'étude des zones dont les faces ne sont perpendiculaires à aucun plan de symétrie. Dans la zone des faces (*hkh*) on

TABLEAU 3.—ALPE MUSSA, PIÉMONT (FACIES PRISMATIQUE, *m* DOMINANT)

Nombre de cristaux figurés: 36
 Nombre total de formes figurées: 20
 Nombre de formes par cristal: minimum, 2; maximum, 11

Lettre	Formes Indices	Fré- quence	Nombre de figures où la forme occupe le rang suivant											Rang moyen	
			1er	2e	3e	4e	5e	6e	7e	8e	9e	10e	11e		12e
<i>m</i>	110	36	30	3	3	1.3
<i>a</i>	010	34	5	20	8	1	2.2
<i>c</i>	001	32	..	8	9	5	5	2	3	3.8
<i>p</i>	111	32	..	1	9	13	4	3	2	4.2
<i>s</i>	131	29	..	1	2	5	8	3	5	3	2	5.6
<i>t</i>	331	22	..	1	..	2	2	9	4	3	1	6.0
<i>o</i>	011	16	4	6	3	..	2	1	5.6
<i>i</i>	132	15	1	..	2	5	4	3	6.3
<i>f</i>	120	10	1	1	2	4	2	3.5
<i>ð</i>	113	9	3	..	4	1	1	..	8.7
<i>b</i>	221	3	1	1	..	1	7.3
<i>q</i>	383	2	2	8.0
γ	118	2	1	..	1	9.0
β	1.1.10	2	1	..	1	9.0
<i>z</i>	121	2	1	1	..	9.5
ψ	470	1	2.0
φ	350	1	2.0
α	1.1.20	1	9.0
δ	117	1	10.0
σ	135	1	11.0

Classement définitif: *m a (c p) s t o i f ð b q (\gamma \beta) z (\psi \varphi) \alpha \delta \sigma*.

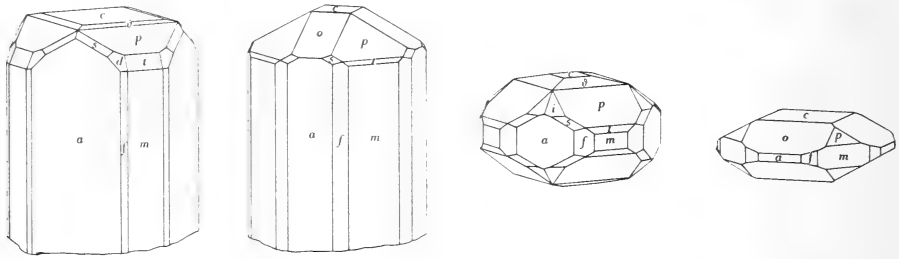

Fig. 1.—Différents facies de l'idocrase: prismatique allongé avec *a* (Vésuve) ou *m* (Piémont) dominant, pyramidal trapu (Tyrol) et tabulaire épais (Laurel, Argenteuil, Québec).

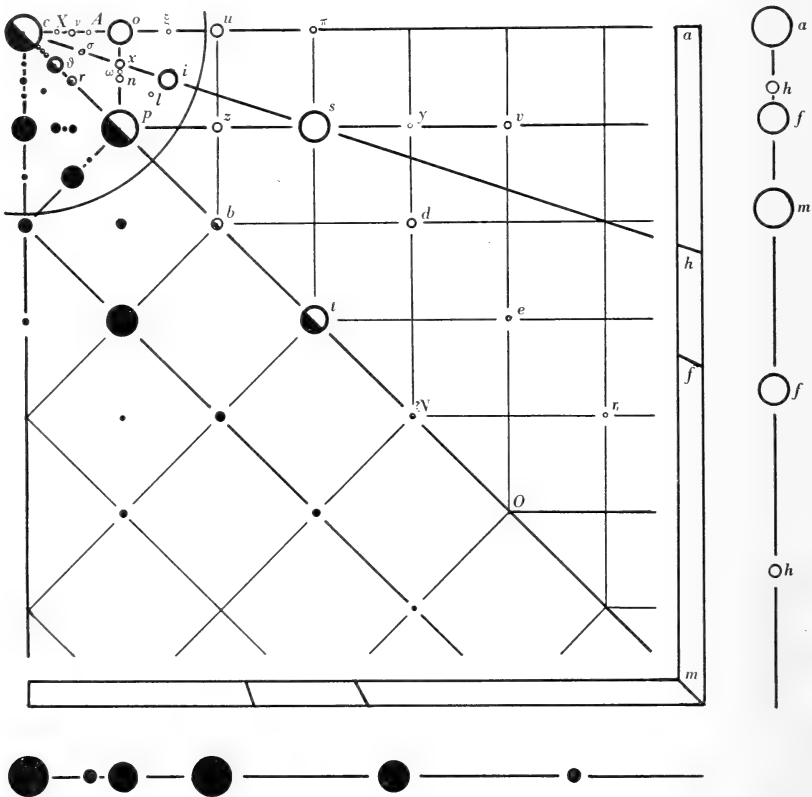

Fig. 2.—Projection gnomonique de l'idocrase (octant avant-droit-supérieur). Au-dessus de la diagonale, orientation *C*; en-dessous, orientation *P*.

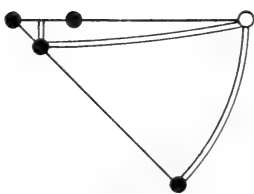

Fig. 3.—Aspect *C****

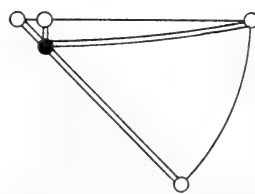

Fig. 4.—Aspect *C4/acn*

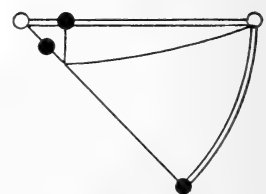

Fig. 5.—Aspect *P4/nnc*

TABLEAU 4.—PFITSCH (TYROL) (FACIES PYRAMIDAL)

Nombre de cristaux figurés: 6 Nombre total de formes figurées: 16
 Nombre de formes par cristal: minimum, 7; maximum, 15

Lettre	Formes Indices	Fréquence	Nombre de figures où la forme occupe le rang suivant:													Rang moyen	
			1 ^{er}	2 ^e	3 ^e	4 ^e	5 ^e	6 ^e	7 ^e	8 ^e	9 ^e	10 ^e	11 ^e	12 ^e	13 ^e		14 ^e
<i>p</i>	111	6	3	1	1	1	2.0
<i>m</i>	110	6	1	2	1	2	2.6
<i>c</i>	001	6	2	..	3	1	4.8
<i>i</i>	132	6	1	..	2	1	1	1	6.6
<i>θ</i>	113	5	..	1	1	1	1	..	1	4.2
<i>a</i>	010	4	2	2	1.5
<i>s</i>	131	5	1	..	2	1	1	7.6
<i>t</i>	331	5	1	..	2	1	1	9.0
<i>f</i>	120	4	1	1	..	2	4.8
<i>o</i>	011	3	1	1	1	7.6
<i>b</i>	221	3	1	1	1	9.0
<i>d</i>	241	3	3	9.0
<i>u</i>	021	3	1	1	..	1	12.6
<i>μ</i>	885	1	7.0
<i>x</i>	133	1	..	14.0
<i>e</i>	351	1	..	14.0

Classement définitif: *p m c (i θ a) s (t f) o b d u μ (x e)*.

TABLEAU 5.—CLASSEMENT DES FORMES DANS LES DIVERSES LOCALITÉS (47 FORMES—227 FIGURES—37 LOCALITÉS)

Localité	Classement des formes	A	B	C	D
1. Alpe Mussa (Piémont).....	<i>m a (c p) s t o i f θ b g (γ β) z (ψ φ) α δ σ</i>	36	20	2	11
2. Vésuve.....	<i>a m p c f o i (s θ) (t h) z b d (y v) ξ (r u) l π ω q v F x Y₂ L₁ L₁ Y₃</i> ...	35	30	4	18
3. Wilui (Sibérie).....	<i>(m p) c a o t i s f u θ b x</i>	17	11	4	8
4. Monte Somma (Vésuve).....	<i>m a c p f o s r i b θ u h v π η (v t) ? N θ α d (z ξ β ω η)</i>	14	27	4	17
5. Zermatt (Suisse).....	<i>m a c (s p) θ (i t) o w f e b x e n</i>	13	16	4	14
6. Piémont.....	<i>m a (c p) s o f t i θ h</i>	11	11	3	9
7. Val de Susa (Italie).....	<i>a (c m) p s t x f i z (d Δ)</i>	11	12	5	9
8. Aberdeenshire (Ecosse).....	<i>m p c a f t s r h o η u r i γ i z x</i>	10	17	5	10
9. Autres localités (Norvège).....	<i>a m (o c) h θ p f i s u v (η φ) γ</i>	8	15	3	11
10. Oural.....	<i>a m p (s t c) i n z o r</i>	7	11	5	10
11. Pfitsch (Tyrol).....	<i>p m c (i θ a) s (t f) o b d u μ (x e)</i>	6	16	7	15
12. Eker (Norvège).....	<i>m c (f a) p θ i h v r t γ</i>	6	13	6	11
13. Tennberget (Dalarne).....	<i>m c a p o t s f u h d i</i>	5	12	5	12
14. Monzoni (Val de Fassa) (Tyrol).....	<i>(a m) p c t o b (f s)</i>	4	9	6	7
15. Aarvold (Norvège).....	<i>p c m (f o a) t s</i>	4	8	1	7
16. Monti Albani (Italie).....	<i>(a m p) c t o f s h θ v z u d i</i>	4	5	5	15
17. Nelle-Galles du Sud.....	<i>m a p s t (c o i)</i>	3	8	5	8
18. Ala (Piémont).....	<i>a m c t s p h z o f b i θ</i>	3	13	3	8
19. Cziklova (Hongrie).....	<i>p m a o c</i>	3	5	3	4
20. Combe Robert, Avigliana (Piémont).....	<i>m a c p s t i o z</i>	2	9	8	9
21. Frugard (Suède).....	<i>a c m</i>	2	3	3	3
22. Finlande.....	<i>c m a f h</i>	2	5	4	5
23. Nombreuses localités.....	<i>m (p a) h o s θ r</i>	2	8	4	8
24. Egg (Norvège).....	<i>(m a) c p (f i) α</i>	2	7	5	6
25. Pyrénées.....	<i>a m p c o f s</i>	2	7	3	7
26. Friedeberg (Silésie).....	<i>m (c a) p s (h o) θ d i u</i>	2	12	4	11
27. Predazzo (Tyrol).....	<i>m (a p) f o c s i t (θ z) λ b σ δ</i>	2	15	10	13
28. Vallée de Saas (Valais).....	<i>m a s t</i>	2	4	4	4
29. Gross-Venediger (Tyrol).....	<i>m p a f (θ t) c s u i</i>	1	10		
30. Sandford, Me (U.S.A.).....	<i>m a c f h i p u s d t π</i>	1	12		
31. Pajsberg (Suède).....	<i>a m p f c o s t</i>	1	8		
32. Kiura (Prov. Bungo).....	<i>m a f p c l θ o i</i>	1	9		
33. Cintra (Portugal).....	<i>(m a) (f p) c i s</i>	1	7		
34. Manneetsock (Groenland).....	<i>c a m f p t</i>	1	6		
35. Gweedore in Donegal (Irlande).....	<i>m c (a f) o</i>	1	5		
36. Amity (Orange City).....	<i>m p</i>	1	2		
37. Raon l'Etape (Vosges).....	<i>m a c t p</i>	1	5		

A: nombre de cristaux figurés pour la localité considérée.
 B: nombre de formes figurées pour la localité considérée.

C: nombre minimum de formes figurées sur un cristal.
 D: nombre maximum de formes figurées sur un cristal.

observe (tableau 8): $p s z v y \Delta q$. Le *segment arithmétique*³ donne s à la distance 3, z à $4/2$, v à 5, y à $8/2$ (*op* étant pris pour unité). A cause de la symétrie tétragonale holoèdre, cette zone est la même que celle des (hkk), qui contient les faces du *segment harmonique*³: $x n \omega$. La face x est à la distance $1/3$, n à $2/4$, et ω à $3/7$. On a évidemment affaire à une zone double avec dominante unitaire simple p . Cette zone ne suffit pas, à elle seule, pour déterminer la mode du réseau. Elle élimine le mode primitif (P) et le mode à maille centrée (I), montrant qu'on est dans l'autre orientation. Reste à voir si le réseau est à base centrée (C) ou à faces centrées (F).

Les renseignements nécessaires seront fournis par l'étude d'une autre zone, dont le type sera différent dans les deux modes. L'équation de la zone $c i s$ est $k = 3h$. Toutes les faces de cette zone satisfont donc au

³ La terminologie employée ici est celle de la règle harmonique-arithmétique, due à Peacock (1936).

critère $C = (h+k)$ pair, et la zone doit être du type simple, avec (131) dominante, dans le cas d'un réseau C . Par contre, dans le cas d'un réseau F , la zone deviendrait double, avec la même dominante. Or, la zone $c i s$ comprend les faces $s i x \sigma$, qui sont respectivement aux distances 1, $1/2$, $1/3$, $1/5$ (tableau 7). C'est donc une zone simple, et le réseau est C . On relève une anomalie dans le manque de face à la distance $1/4$, mais σ (à la distance $1/5$) n'est signalée que deux fois dans les figures de l'Atlas. Les trois autres faces, beaucoup plus importantes, ne laissent aucun doute sur le type, simple, de cette zone (i est nettement plus importante que x). Puisque la dominante s doit s'écrire (131), on en déduit que p est bien la face unitaire (111).

DETERMINATION DU GROUPE SPATIAL

Les zones dont les faces sont perpendiculaires à un plan de symétrie, miroir ou plan avec glissement, serviront à déterminer le groupe spatial. Ce sont les zones des faces

TABEAU 6.—CLASSEMENT DÉFINITIF DES FORMES

Formes			Nombre de localités où la forme occupe le rang suivant:																												Rang moyen			
Lettre	Indices	Fréquence absolue	1 ^{er}	2 ^e	3 ^e	4 ^e	5 ^e	6 ^e	7 ^e	8 ^e	9 ^e	10 ^e	11 ^e	12 ^e	13 ^e	14 ^e	15 ^e	16 ^e	17 ^e	18 ^e	19 ^e	20 ^e	21 ^e	22 ^e	23 ^e	24 ^e	25 ^e	26 ^e	27 ^e	28 ^e		29 ^e	30 ^e	
			<i>m</i>	110	37	24	10	3
<i>a</i>	010	36	13	13	6	4	2.0	
<i>c</i>	001	34	2	7	12	6	4	2	1	3.4	
<i>p</i>	111	33	5	5	9	8	3	1	2	3.3	
<i>s</i>	131	28	1	3	6	2	8	6	1	1	6.4	
<i>f</i>	120	27	4	7	4	1	2	4	3	1	1	5.9	
<i>t</i>	331	26	4	5	7	2	3	1	1	1	1	1	6.9	
<i>o</i>	011	25	1	2	6	8	1	2	2	3	6.4	
<i>i</i>	132	23	1	1	3	5	3	5	2	..	2	1	8.3	
<i>ø</i>	113	16	1	1	2	3	2	..	4	2	..	1	8.3	
<i>h</i>	130	13	1	3	1	1	..	3	2	1	..	1	7.9	
<i>u</i>	021	11	1	2	1	1	3	2	1	11.5	
<i>z</i>	121	10	1	2	2	..	2	1	1	1	12.4	
<i>b</i>	221	9	1	..	1	3	1	3	11.2	
<i>d</i>	241	8	1	1	2	1	..	2	1	13.0	
<i>r</i>	112	6	3	2	1	10.6	
<i>x</i>	133	6	1	1	1	1	1	1	1	1	15.3	
<i>v</i>	151	5	1	1	1	1	1	13.2

Classement définitif: $m a (c p) s f (t o) i ø h u (z b) d r x v$.
 A ces formes, il faut ajouter les suivantes, dont la fréquence absolue est inférieure à 5 et pour lesquelles la notion de rang moyen perd toute signification:

γ	η	α	n	π	ν	ω	l	Δ	ψ	e	(σ)	δ	β	ξ
118	114	1.1.20	122	031	012	377	243	454	470	351	135	117	1.1.10	032
(ϵ)	g	λ	r_1	μ	y	φ	?N	ρ	F	Y_2	L_1	L_2	Y_3	
116	383	445	461	885	141	350	441	5.20.2	7.13.1	481	8.10.5	571	5.19.2	

Les formes entre parenthèses sont de même importance.

($hk0$), ($0kl$) et (hhl). La zone des faces ($0kl$) est la même que celle des faces ($h0l$), à cause de la symétrie tétragonale holoèdre.

(1) La zone mf des faces ($hk0$) contient cinq faces qui ont été figurées: $m f h \psi \varphi$ (tableau 7). Le segment harmonique, avec ces faces aux distances respectives 1, $1/2$, $1/3$, $3/5$, $4/7$, indique une zone simple. Il a toutefois une anomalie dans le manque de faces aux distances $2/3$ et $1/4$, anomalie sans grand intérêt vu la rareté des faces ψ et φ . L'importance relative des formes m , f et h est très bien marquée.

(2) La zone des faces ($0kl$) comprend, en

ordre d'importance décroissante: $o u \pi \nu \xi$, plus deux faces connues, mais rares: A et X (tableau 7). Le segment arithmétique donne les faces o (011), u (021), π (031), ξ (032) respectivement aux distances 1, 2, 3, $3/2$. Sur le segment harmonique, on trouve ν (012) à la distance $1/2$, X (013) à $1/3$ et A (023) à $2/3$. C'est là une zone simple parfaite, avec dominante unitaire o (011).

(3) Dans la zone des (hhl), on a les faces suivantes: $p t \vartheta b r \gamma \eta \alpha \delta \beta \epsilon \lambda \mu ?N$ (tableau 8). Sur le segment arithmétique, on a, toujours en ordre d'importance décroissante, des faces aux distances suivantes ($c p$

TABLEAU 7.—DÉVELOPPEMENT DES ZONES SIMPLES

Distance au pôle				Zone des faces $0kl$				Zone des faces $hk0$				Zone des faces $h.3h.l$			
I	II	III	IV	I	II	III	IV	I	II	III	IV	I	II	III	IV
1/5												σ 135			
1/4												(134)			
1/3				X026				h 260				x 133			
1/2				ν 024				f 240				i 132			
		3/5	4/7								ψ 8.14.0				
	2/3				A046				(460)	ϕ 6.10.0					
1	3/2			o 022				m 220				s 131			
2				u 042	ξ 064										
3				π 062											

REMARQUE.—Les formes non observées ont leur symbole entre parenthèses.

TABLEAU 8.—DÉVELOPPEMENT DES ZONES DOUBLES

Distance au pôle			Zone des faces hhl			Zone des faces hkh ou hkk		
I	II	III	I	II	III	I	II	III
1/9			χ 119					
	2/16			γ 2.2.16				
1/7			δ 117					
	2/12			ϵ 2.2.12				
1/5			ζ 115					
	2/8			η 228				
1/3			θ 113			x 133		
	2/4	3/7		r 224			n 244	ω 377
		3/5			κ 335			(355)
1	4/2		p 111	b 442		p 111		
		7/3					z 242	
3		11/3	t 331			s 131		
	8/2			$?N$ 882			y 282	
5	12/2		O551			v 151		
7						w 171	Z.12.2	

REMARQUES.—Les formes non observées ont leur symbole entre parenthèses. Les faces O(551), ζ (115), χ (119) sont données comme rares dans l'Atlas; de même que les faces Z(2.12.2) et v (171).

étant pris pour unité): p à 1, t à 3, b à $4/2$, O à 5, ? N à $8/2$. Sur le segment harmonique, l'ordre est le suivant: ϑ à $1/3$, r à $2/4$; les autres faces sont trop rares pour mériter d'être prises en considération. On voit clairement l'existence d'une zone double avec dominante unitaire simple p (111).

Les tableaux 7 et 8 ont été dressés sur le modèle des tableaux que Donnay (1938b) a employés pour illustrer le développement théorique des zones.

Dans un réseau à base centrée C , sans plans de symétrie avec glissement (Fig. 3), la zone des faces ($hk0$) serait du type double; elle devient simple par l'effet d'un plan avec glissement a , perpendiculaire à l'axe d'ordre 4. Dans le cas du réseau C , la zone des faces ($0kl$) serait simple avec dominante déplacée (021); la dominante, éloignée de (011) par le mode C du réseau, y est ramenée par un plan avec glissement c . Enfin, en position diagonale, la zone des faces (hhl) serait simple dans le cas du seul réseau C ; c'est un plan avec glissement n qui la transforme en zone double. On a donc pour groupe spatial $C4/acn$, avec le rapport d'axes $c:a=0.5372$ (Fig. 4).

D'après les conventions modernes, il convient d'orienter le cristal de façon à le rapporter à la maille la plus petite possible. Dans le cas présent, la maille (à base centrée) est une maille double; il suffit de tourner le cristal de 45° autour de l'axe vertical pour le rapporter à la maille simple. Dans cette nouvelle orientation (Fig. 5), le réseau est primitif et le groupe spatial se note $P4/nnc$. Le rapport d'axes devient $c:a=0.7597$.

Ces résultats sont d'accord avec ceux que fournissent les rayons X (*Strukturbericht*).

AVERTISSEMENT

Jusqu'ici, j'ai employé les lettres de Goldschmidt pour désigner les formes dans l'orientation C (base centrée). Dans le reste du travail, ces lettres désigneront les mêmes formes dans la nouvelle orientation, P . La matrice de transformation est la suivante: $C \rightarrow P = \frac{1}{2} \frac{1}{2} 0 / \frac{1}{2} \frac{1}{2} 0 / 001$. Les nouveaux indices (HKL) figurent à côté des anciens dans le tableau 9.

TABLEAU 9.—TRANSFORMATION D'INDICES

Indices premiers entre eux			Indices multiples	
C (hkl)	P (HKL)	Lettre	C (hkl)	P (HKL)
110	010	m	220	020
010	110	a	020	110
001	001	c	002	002
111	011	p	111	011
131	121	s	131	121
120	130	f	240	130
331	031	t	331	031
011	112	o	022	112
132	122	i	132	122
113	013	ϑ	113	013
130	120	h	260	240
021	111	u	042	222
221	021	b	442	042
121	132	z	242	132
241	131	d	241	131
112	012	r	224	024
133	123	x	133	123
151	231	v	151	231
118	018	γ	2.2.16	0.2.16
114	014	η	228	028
1.1.20	0.1.20	α	2.2.40	0.2.40
122	134	n	244	134
031	332	π	062	332
012	114	v	024	114
377	257	ω	377	257
243	133	l	243	133
454	198	Δ	8.10.8	198
470	3.11.0	ψ	8.14.0	3.11.0
351	141	e	351	141
135	125	σ	135	125
117	017	δ	117	017
1.1.10	0.1.10	β	2.2.20	0.2.20
032	334	ξ	064	334
116	016	ϵ	2.2.12	0.2.12
383	5.11.6	q	6.16.6	5.11.6
445	045	λ	8.8.10	0.8.10
461	151	r_1	461	151
885	085	μ	16.16.10	0.16.10
141	352	y	282	352
350	140	φ	6.10.0	280
441	041	? N	882	082
5.20.2	15.25.4	g	10.40.4	15.25.4
7.13.1	3.10.1	F	7.13.1	3.10.1
481	261	Y_2	481	261
8.10.5	195	L_1	8.10.5	195
571	161	L_2	571	161
5.19.2	7.12.2	Y_3	5.19.2	7.12.2

TOTAL INDICIEL

Meen (1939) a observé, provenant de la région du Grand Lac des Esclaves, des cristaux ayant jusqu'à un pouce de long, de couleur brun-chocolat légèrement verdâtre et de facies prismatique trapu; chaque spécimen montrant la base bien développée aux deux extrémités. Il signale que C. Gottfried (1930) a déterminé une maille à base centrée. Il montre que le réseau P apporte une simplification notable des in-

dices. Pour 12 formes, le *total indiciel* (Ungemach, 1935) est 50 dans l'orientation *C* et 38 dans l'orientation *P*. Pour les 48 formes figurées de l'espèce, je trouve les totaux indiciels suivants:

(1) avec les indices de Miller premiers entre eux,

dans l'orientation *C*:536,
dans l'orientation *P*:408;

(2) avec les indices multiples, satisfaisant aux critères du groupe spatial,

dans l'orientation *C*:609,
dans l'orientation *P*:507.

PREDICTION DES DIMENSIONS ABSOLUES
DE LA MAILLE

La formule de l'idocrase est encore imprécise. *Strukturbericht* (2: 127. 1937) donne comme formule idéale: $Ca_{10}Mg_2Al_4Si_9O_{34}(OH)_4$. La formule trouvée par Meen est en accord avec celle de Machatschki: $X_{38}Y_{26}Z_{36}(O, OH, F)_{152}$ $X = Ca(Na, K, Mn)$; $Y = Al, Fe''', Fe''$, Mg, Ti, Zn, Mn ; $Z = Si$.

Avec la formule proposée par *Strukturbericht*, on trouve que *Z*, le nombre de molécules contenues dans la maille est au minimum de 2, en ce sens que la symétrie du groupe spatial peut être satisfaite si $Z=2$.

Si $Z=2$, on obtient pour le volume de la maille *P*:

$V_0 = 1380.07 \text{ \AA}^3$, et prenant comme densité moyenne 3.4, on a

$a_0 = 12.20 \text{ \AA}$ et $c_0 = 9.27 \text{ \AA}$.

Si $Z=4$, les résultats sont: $V_0 = 2760.14 \text{ \AA}^3$,
 $a_0 = 15.37 \text{ \AA}$ et $c_0 = 11.68 \text{ \AA}$.

Les rayons *X* donnent:

$a_0 = 15.63 \text{ \AA}$ et $c_0 = 11.83 \text{ \AA}$,

avec rapport d'axes $c_0:a_0=0.757$.

Dans un cas, tel que celui de l'idocrase, où la formule chimique est très compliquée, on ne peut espérer prédire avec certitude les dimensions absolues de la maille.

LOI DE BRAVAIS CLASSIQUE

La loi de Bravais classique donne l'ordre d'importance des formes en partant du réseau, tandis que la loi généralisée con-

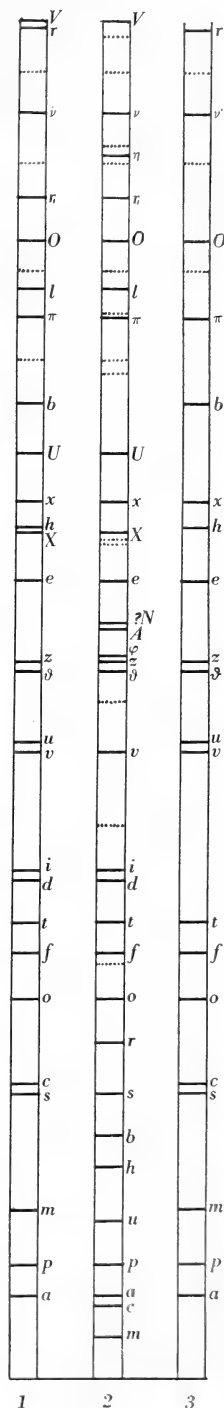

Fig. 6.—Listes théoriques d'importance décroissante des formes: (1) Groupe $P4/nnc$ (loi général-Isée); (2) Réseau *P*; (3) Réseau *I* (loi de Bravais classique). Lire de bas en haut.

duit à cet ordre en partant du groupe spatial. La Fig. 6 a été construite à l'aide d'un abaque, analogue à celui de Mallard (1879, 1: p. 314), préparé par M. le Professeur Donnay. $P4/nnc$ est le groupe trouvé par la loi généralisée; P et I sont les deux modes possible du réseau. Si l'on ne connaissait que la loi de Bravais classique, l'ordre observé d'importance relative des formes imposerait le réseau I .

Sur la Fig. 6, on lira de bas en haut; le nombre qui suivra la forme est le numéro d'ordre observé tiré du tableau 6. Les 18 premières formes de la liste théorique sont, dans le cas du réseau P : $m(1)$, $c(3)$, $a(2)$, $p(3)$, $u(12)$, $h(11)$, $b(13)$, $s(5)$, $r(16)$, $o(7)$, (221) (non observée), $f(6)$, $t(7)$, $d(15)$, $i(9)$, (230) (non observée), $v(18)$, (032) (non observée), tandis que, dans le cas du réseau I , elles deviennent: $a(2)$, $p(3)$, $m(1)$, $s(5)$, $c(3)$, $o(7)$, $f(6)$, $t(7)$, $v(18)$, $u(12)$, $\vartheta(10)$, $z(13)$, $e(29)$, $h(11)$, $x(17)$, $b(13)$, $\pi(23)$, (150) (non observée).

On voit que les 8 premières formes de la liste I , ont un numéro d'ordre observé plus petit que 10; que les 5^e, 6^e, 7^e formes de P ont les numéros 12, 11, 13 et que le n° 5 viendrait après. En effet, la fréquence absolue de $s(5)$ (tableau 6) est 28, tandis que les fréquences de u , h , b sont respectivement 11, 13, 9. La forme s est donc beaucoup plus importante que u , h , b . Ceci est déjà un argument en faveur du réseau I .

Dans les formes subséquentes, le réseau P présente une anomalie en ce que la forme (221) qui arrive 11^e dans l'ordre théorique, n'a jamais été observée. Or, dans la liste I , cette forme, qui doit obéir au critère d'extinction I (somme paire), se trouve rejetée en dehors du tableau, car en devenant (442) elle voit son importance diminuer de beaucoup.

Dans la liste P , les 3 premières formes non observées sont les 11^e, 16^e et 18^e de l'ordre théorique, tandis que dans la liste I ce sont les 18^e, 20^e et 22^e. L'absence de

ces formes dans I ne constitue qu'une légère anomalie, puisque leur rang les classe parmi les formes rares. Dans P , au contraire, les trois premières formes non observées viennent avant des formes importantes.

Ces observations montrent que la loi de Bravais classique⁴ ferait conclure à un réseau I .

RESEAU SIMULE

La loi généralisée a conduit au groupe $P4/nnc$ et la loi de Bravais classique au réseau I . Or le groupe $P4/nnc$ et le réseau I ont les mêmes extinctions sauf pour les faces (hkl). Le groupe $P4/nnc$ n'impose à celles-ci aucune restriction, tandis que le réseau I exige que la somme des indices soit paire.

On a donc ici un très beau cas de *réseau simulé*. Ce cas est encore plus typique que celui de l'apophyllite (Donnay, 1937) dont le groupe spatial est $P4/mnc$ et qui simule aussi le réseau I .

Le groupe $P4/mnc$ n'impose aucune condition aux faces (hkl) et ($hk0$).

La figure 6 montre que les deux formes (hkl) les plus communes sont $d(131)$ et $i(122)$. Le critère I (somme paire) diminue de beaucoup l'importance de ces formes et les rejette en dehors du tableau, tandis que dans le cas du groupe $P4/nnc$ elles sont bien à leur place quant à l'importance observée. De plus d et i sont plus importantes que v , première forme (hkl) qui apparaisse dans l'ordre théorique du réseau I . L'étude statistique, en effet, a montré que d et i précèdent v en ordre d'importance.

Dans les résultats précédents, l'ordre relatif des formes dans chaque zone était bien marqué et a conduit sans difficulté au groupe spatial $P4/nnc$. Cependant l'ordre relatif de toutes les formes entre elles, présente plusieurs anomalies qui ont été indiquées.

L'accord entre l'importance théorique

⁴ Mallard (1879, 1, p. 315) utilise l'orientation P et il a le bon rapport d'axes $c:a=0.760$. L'ordre qu'il a observé est le suivant:

Lévy	h^1	p	m	a^1	b^1	$a^{1/3}$	$b^{1/3}$	b^1	$b^{1/2}$	h^3	h^2	$b^{1/2}$
Miller	010	001	110	011	112	031	122	120	130	111		
Gdt.	m	c	a	p	o	t	i	h	f	u		

Cet ordre diffère un peu de celui du tableau 6, dans lequel a précède c et f vient avant o . Le peu de formes observées ne justifie pas la conclusion de Mallard, qui a cru pouvoir en déduire un réseau P . Le réseau I s'accorderait d'ailleurs mieux que le réseau P avec ces données incomplètes.

des formes et leur importance observée est nonobstant meilleur aux termes de la loi généralisée qu'à ceux de la loi classique.

INDICES MOYENS

La loi des indices moyens (Friedel, 1908), basée sur l'influence de la densité réticulaire, permet de prédire le rapport d'axes à partir des indices des formes connues.

Cette loi tire sa justification de la loi de Bravais. Friedel (1908) en appliquant cette loi à une grande quantité de minéraux a montré que les résultats ne sont d'ailleurs qu'approximatifs.

D'après la loi des indices moyens, on devrait avoir, dans le cas d'une espèce cristalline tétragonale,

$$c:a = 2\Sigma l : \Sigma(h+k),$$

avec une approximation d'autant meilleure que le nombre de formes connues est plus grand.

Dans le cas de l'idocrase, j'ai tenu compte des 47 formes figurées dans l'*Atlas*, ainsi que des 46 autres formes observées.

Dans la première orientation, on trouve: (1) avec les indices de Miller premiers entre eux (réseau *P*), $c:a = 0.759$; (2) avec les indices multiples exprimant la loi de Bravais généralisée (groupe *P4/nnc*), $c:a = 0.764$. Dans la même orientation, les indices multiples exprimant la loi de Bravais classique (réseau *I*) conduisent au rapport $c:a = 0.712$. Le rapport calculé est 0.7597.

Dans la deuxième orientation, on trouve: (1) avec les indices premier entre eux (réseau *C*), $c:a = 0.585$; (2) avec les indices multiples exprimant la loi généralisée (groupe *C 4/acn*), $c:a = 0.596$. Les indices multiples exprimant la loi de Bravais classique donnent, dans cette orientation (réseau *F*), $c:a = 0.544$. Le rapport calculé est 0.5372.

Tous ces résultats confirment la validité de la loi des indices moyens dans le cas de l'idocrase. On ne peut cependant en tirer aucune conclusion quant à la possibilité de généraliser cette loi en tenant compte de la symétrie du groupe spatial et en utilisant les indices multiples appropriés.

REMERCIEMENTS

Je remercie Monsieur le Professeur

J. D. H. Donnay pour les directives qu'il m'a données au cours de la préparation de ce travail et pour le soin qu'il a mis à revoir mon manuscrit. Je dois à l'obligeance de Monsieur le Professeur C. Faessler les cristaux à facies tabulaire de Laurel.

REFERENCES

- DONNAY, J. D. H. *Morphologie de l'apophyllite*. Bull. Acad. Roy. Belgique (Cl. des Sc.) (5) **23**: 749-761. 1937.
- . *Crystal morphology of zircon and rutile*. Mém. Soc. Russe de Minér. (2) **67**: 31-46 (en anglais), 47-62 (en russe). 1938a.
- . *Le développement des zones cristallines*. Ann. Soc. Géol. Belgique **61**: B-260-287. 1938b.
- . *Crystal space-groups determined without x-rays* (abstract). Amer. Min. **24**: 184. 1939.
- . *Analyse morphologique de la danburite*. Trans. Soc. Roy. Canada (3), Section IV, **34**: 33-43. 1940.
- . *Morphologie cristalline de la micro-lite*. Mém. Soc. Roy. Canada (3), Section IV, **35**: 51-56. 1941.
- DONNAY, J. D. H., et HARKER, DAVID. *Généralisation de la loi de Bravais*. Compt. Rend. **204**: 274-276. 1937a.
- . *A new law of crystal morphology extending the Law of Bravais*. Amer. Min. **22**: 446-467. 1937b.
- . *Nouvelles tables d'extinctions pour les 230 groupes de recouvrements cristallo-graphiques*. Nat. Can. **67**: 33-69. 1940.
- FRIEDEL, G. *Observations sur les caractéristiques moyennes des espèces cristallines*. Bull. Soc. Franç. Min. **31**: 5-40. 1908.
- GOLDSCHMIDT, VICTOR. *Atlas der Krystallformen 4*: Heidelberg. 1918.
- GOTTFRIED, C. *Die Mineralien der Adamellogruppe*. Chemie der Erde **5**: 106-112. 1930.
- MALLARD, E. *Traité de cristallographie*, 1: Paris. 1879.
- MEEN, V. B. *Vesuvianite from Great Slave Lake region, Canada*. Univ. Toronto Studies, Geol. Ser., **42**: Contrib. Can. Min., 69-74. 1939.
- PEACOCK, M. A. *On normal triclinic face-symbols and the harmonic-arithmetic rule*. Amer. Min. **22**: 210. 1936.
- TAYLOR, E. D. *The morphology of columbite crystals*. Amer. Min. **25**: 123-138. 1940a.
- . *Stephanite morphology*. Amer. Min. **25**: 327-337. 1940b.
- UNGEMACH, H. *Sur certains minéraux sulfatés du Chili*. Bull. Soc. Franç. Minér. **58**: 97-221. 1935.

BIOPHYSICS.—*Effect of nutrient cultures on the reaction of maize seedlings to light.*¹ J. H. KEMPTON, Bureau of Plant Industry.

Following the demonstration that cultures of nutrient salts increased the size of maize seedlings grown in the dark,² it became of interest to determine how the cultures affected the reaction of plants to brief periods of illumination. The present paper reports on a single experiment testing this point.

The nutrient culture used was that given by Eaton³ at double his concentration and modified by increasing KH_2PO_4 by a factor of 10. The control culture was grown with distilled water.

The plantings were made in coarse, crushed quartz in 40 tin ointment cans covered with tin-sealed tubes. Each can, containing 600 grams of oven-dried quartz moistened with 120 cc of solution or distilled water, was planted with 20 seeds of Funk Yellow Dent. Seed weights were recorded for each lot of 20 seeds.

The cans were kept in a dark room where the air temperature ranged from 85° to 86° F. Four days after planting, one-half the cans from each culture were chosen at random and arranged in a circle at such a distance from a 1,000-watt Mazda lamp as to give each can 100 foot-candles illumination. A strong blast of air was blown just under the lamp at about 3 feet above the plants to prevent, so far as possible, a rise in air temperature. The plants were exposed to this illumination for 1 hour, after which they were again enclosed in tin tubes and left in the dark. During the light exposure the air temperature rose 2° F. Twenty-four hours later the experiment was terminated and the seedlings were measured. Lengths were recorded separately for mesocotyls and coleoptiles. No leaves had appeared at this date—five days after planting. These parts, together with the roots and seed residues, were washed free of the coarse quartz and oven dried at 100° C. The several seedling parts were weighed as products of single cans—not as individual plants.

The measures expressed as means of individuals are given in Table 1 and the analyses of variance are shown in Table 2.

The reaction to light was actually and relatively much greater in the plants grown in the salt solution than in those grown in distilled water. This is shown by the length and weight of mesocotyl, as well as in weight of tops (Figs. 1 and 2A; 2B). The roots were not appreciably affected by the culture or by the light exposure given the tops (Fig.

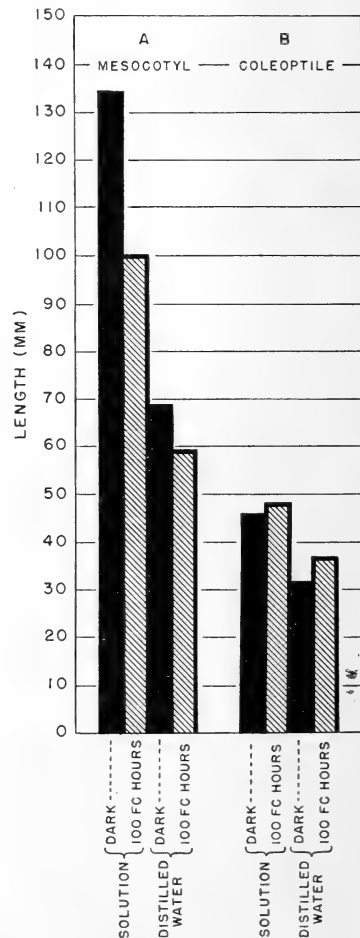

Fig. 1.—Mean length (mm) of mesocotyl (A) and coleoptile (B) of maize seedlings grown in distilled water and in nutrient solution. Solid bars represent seedlings always in the dark, hatched bars seedlings subjected to 100 foot-candle-hours of Mazda light four days after planting.

¹ Received July 31, 1942.

² KEMPTON, in press. Journ. Agr. Res.

³ Journ. Agr. Res. 53: 433-444. September 1936.

2C). The result confirms previous experiments as to the lack of response of roots to culture solutions.² The exposure to 100 foot-candle-hours of Mazda increased the length of the coleoptile by a significant amount in the distilled water culture but only slightly in solution (Fig. 1B).

In conformity with the increase in seedling weight, the seed residue shows less material remaining in the seeds planted in the salt solution than in those in distilled water (Fig. 3A). There was little difference between the four treatments in the total amount of dry matter recovered and in the dry matter lost (Figs. 3B and 4B).

The quantity of recovered dry matter

translocated is much greater in the seedlings grown in the salt solution than in those grown in distilled water. No such conclusion can be reached with respect to light, as the experiment was not capable of establishing differences in weight of less than 7 per cent. In the plants growing in the salt solutions, 0.06 per cent less dry matter was translocated in the seedlings exposed to 100 foot-candle-hour Mazda and in distilled water the light exposure apparently resulted in a 4 per cent increase in dry matter translocated.

The analyses of variance show that the exposure to 100 foot-candle-hours Mazda illumination affects the weight of the meso-

TABLE 1.—MEASUREMENTS EXPRESSED AS MEANS OF SINGLE SEEDS AND SEEDLING PARTS WHEN GROWN IN THE INDICATED CULTURES IN TOTAL DARKNESS AND IN THE LIGHT SHOWN

Seed or seedling part	Nutrient solution		Distilled water		Standard error of difference
	Dark	100 FC hours Mazda	Dark	100 FC hours Mazda	
<i>Length (mm)</i>					
Mesocotyl.....	134.85	100.32	68.80	59.71	3.22
Coleoptile.....	46.26	48.30	31.67	36.37	1.51
<i>Weight (g)</i>					
Mesocotyl.....	.02509	.02047	.01618	.01494	.00075
Tops.....	.02112	.02503	.01073	.01289	.00077
Roots.....	.02397	.02464	.02235	.02348	.00077
Seed residue.....	.1859	.1867	.2073	.1950	.0056
Total dry matter recovered.....	.2561	.2568	.2566	.2463	.0048
Recovered dry matter translocated.....	.07018	.07014	.04926	.05131	.00179
Seed planted.....	.3145	.3159	.3190	.3102	.0056
Lost dry matter.....	.0584	.0591	.0624	.0639	.0015
Per meter of mesocotyl length....	.1861	.2047	.2361	.2505	.0128

TABLE 2.—ANALYSES OF VARIANCE BASED ON MEANS OF 20 SEEDLING GROUPS FOR THE SEED AND SEEDLING PARTS SHOWN

Source of variation	Degrees of freedom	Mean squares										
		Length		Weight								
		Mesocotyl	Coleoptile	Mesocotyl	Tops ¹	Roots	Seed residue	Recovered dry matter	Recovered dry matter translocated	Seed planted	Lost dry matter	Per meter of mesocotyl
Total.....	39	940.75	58.94	.0000180	.000040	.000004	.000179	.000119	.000116	.000184	.000024	.0015415
Culture.....	1	28,444.09†	1,757.48†	.0005220†	.001270†	.000020*	.002285†	.000145	.003950†	.000010	.000079	.0229173†
Light.....	1	4,758.07†	113.44†	.0000860†	.000090†	.000008	.000374	.000229	.000010	.000162	.000005	.0027117
Interaction.....	1	1,619.23†	17.74	.0000280†	.000010	.000001	.000158	.000111	.000011	.000280	.000038	.0000451
Error.....	36	51.88	11.39	.0000028	.000003	.000003	.000158	.000115	.000016	.000187	.000022	.0009568

¹ Includes coleoptile, leaves, and stem.

* P < .05.

† P < .01.

cotyl and the tops but not the total amount of dry matter translocated. This is illustrated in Fig. 2A and B and Fig. 4A. Evidently even this brief period of low illumination increases the dry matter in the coleoptile and leaves and reduces it in the mesocotyl by approximately an equal amount. The light, therefore, did not increase the speed with which dry matter was moved from the seed but determined its destination by initiating the development of leaves. In a sense, the speed with which

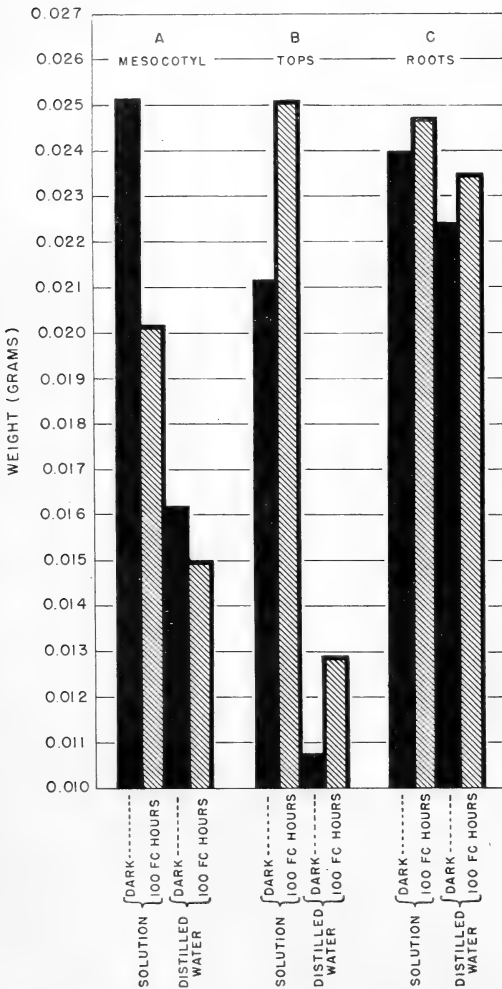

Fig. 2.—Mean weight (g) of mesocotyl (A), tops (B), and roots (C) of maize seedlings grown in distilled water and in nutrient solution. Solid bars represent seedlings always in the dark, hatched bars seedlings subjected to 100 foot-candle-hours of Mazda light four days after planting.

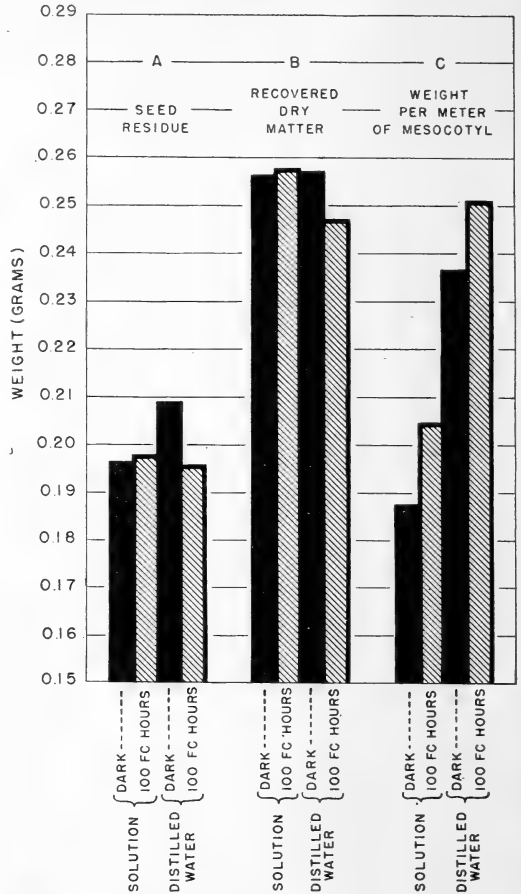

Fig. 3.—Mean weight (g) of seed residue (A), total dry matter recovered (B), and weight per meter of mesocotyl length (C) of maize seedlings grown in the distilled water and in nutrient solution. Solid bars represent seedlings always in the dark, hatched bars seedlings subjected to 100 foot-candle-hours of Mazda light four days after planting.

the solutes travelled up the axis was increased by illumination, since more dry matter was moved into the leaves, but this was accomplished chiefly by stopping the elongation of the mesocotyl, thus reducing the distance from the seed to the leaves. Further, the checking of elongation of the mesocotyl resulted in this organ being heavier per unit length in the lighted series of both cultures, though not significantly so.

Neither the culture nor the illumination affected the quantity of dry matter lost, although the unrecovered dry matter almost equaled the amount translocated.

There is a certain and here unknown loss of weight from diffusion of soluble material into the culture solution and Fig. 4B shows, as would be expected, this factor to be slightly greater in distilled water than in the salt solution. Three other factors contributing to loss of dry matter are in the order of their importance, micro-organisms, oxidation and loss of energy in converting the stored dry matter into soluble forms and finally losses in handling the seedlings. In this experiment this last source of loss must have been inconsequential because the small size of the seedlings made their complete recovery more certain.

The solution used in this experiment is more conducive to leaf development than to mesocotyl elongation, but it exerted a pronounced effect on the sensitivity of the mesocotyl to light. The elongation of the mesocotyl presumably is controlled by growth substances released from the coleoptile, which are inactivated by light. It follows, therefore, that the resistance of these substances to light must be altered by the salts in the solution or else their formation must be reduced. The latter assumption can hardly be urged in view of the very evident stimulation of elongation by the salts in the solution.

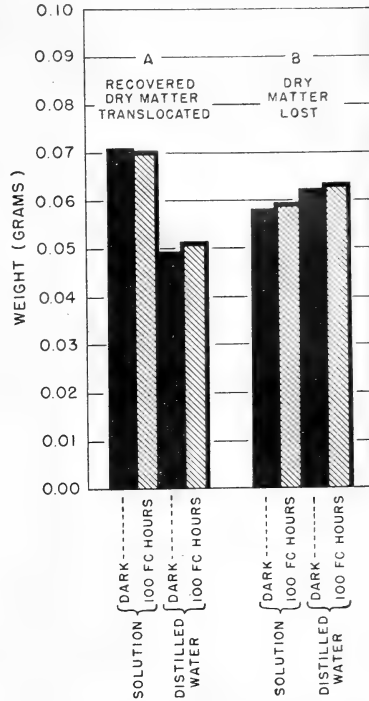

Fig. 4.—Mean weight (g) of the recovered dry matter that had been translocated from the seed to the seedling (A) and dry matter lost (B) of maize seedlings grown in distilled water and in nutrient solution. Solid bars represent seedlings always in the dark, hatched bars seedlings subjected to 100 foot-candle-hours of Mazda light four days after planting.

BOTANY.—*Three new species of Acanthaceae from Mexico.*¹ By E. C. LEONARD, U. S. National Museum. (Communicated by WILLIAM R. MAXON.)

A study of Mexican Acanthaceae in the U. S. National Herbarium and the Dudley Herbarium of Stanford University, in connection with preparing a treatment of the family as it occurs in the Sonoran Desert region, has revealed three new species. These are described herewith. One is from Baja California, another from Veracruz, and the third from the west-central portion of the republic.

***Bucragenia ruellioides* Leonard, sp. nov.**

Herba, caulibus pubescentibus; petioli alati; lamina foliorum oblonga vel late elliptica,

breve acuminata vel acuta, basi angustata, parce puberula; flores solitarii vel fasciculati, bracteis foliaceis suffulti; bractee floriferae lineari-lanceolatae, pubescentes, ciliatae; bracteolae subulatae, puberulae; calyx puberulus, segmentis subulatis, ciliatis; corolla minuta, subregularis, lobis ovatis; stamina inclusa; capsulae glabrae; semina muricata.

Herb; stem simple or probably branched, 40 cm high or more, the pubescence a mixture of minute curved hairs and larger spreading ones up to 1 mm long; petioles up to 3 cm long, winged; leaf blades oblong to broadly elliptic, up to 12 cm long and 5 cm wide, short-acuminate to acute (the tip usually blunt), narrowed at base, the blade gradually long-decurrent, thin, rather veiny, inconspicuously and spar-

¹ Published by permission of the Secretary of the Smithsonian Institution. Received July 16, 1942.

ingly puberulous, beset with a few additional scattered white hairs about 0.5 mm long; cystoliths prevalent on the upper surface but inconspicuous and delicate; flowers 1 to several, sessile or nearly so, borne in the axils of leaflike bracts, these usually 1 to 2 cm long and 0.5 to 1 cm wide, the lowermost bracted clusters subtended by the leaves; bracts subtending the individual flowers linear-lanceolate, 6 to 9 mm long, 1.5 mm wide, sparingly pubescent, ciliate, the costa prominent; bractlets subulate, ciliate, puberulous; calyx 4 mm long, puberulous, deeply parted, the segments subulate, ciliate; corolla tubular, barely 3 mm long, the lobes ovate, about 0.5 mm long and broad, obtuse, the posterior ones sparingly bearded; stamens included, 1 mm long, the staminodes about half as long as the filaments of the fertile stamens; capsules 10 to 12 mm long (the solid basal portion about 5 mm long), glabrous, 2 to 4-seeded; seeds about 2 mm in diameter, brown, muricate.

Type in the Dudley Herbarium of Stanford University, no. 184953, collected at Zacuapan, Veracruz, Mexico, in shady locality, October, 1929, by C. A. Purpus (no. 14083).

This species is well marked and easily distinguished from other members of the genus by its leafy inflorescence. Because of its minute and inconspicuous bracted flower-clusters and a certain resemblance in the leaves, it is possible to mistake it for cleistogamous plants of *Ruellia strepens* L.

Justicia wigginsii Leonard, sp. nov.

Frutex, caulibus pluribus, striatis, albo-puberulis, infra glabratis, griseis; petioli breves; lamina foliorum ovata, obovata, vel lanceolata, apice rotundata vel acuta, basi angustata, minute puberula; spicae secundae, laxae, glanduloso-puberulae; bracteae subcucullatae; bracteolae lanceolatae; calycis segmenta puberula, glanduloso-ciliolata, posticum minutum setaceum, altera lineari-lanceolata; corolla rubra, labio superiore erecto, apice bilobo, inferiore trilobo, patulo, lobis oblongis, rotundatis; stamina exserta; capsulae parce glanduloso-puberulae; semina valde tuberculata et minute papillosa.

Shrubs; branches numerous, striate, closely white-puberulous, the older portions glabrate, gray; petioles slender, up to 5 mm long; leaf blades ovate, obovate, or lanceolate, up to 2

cm long and 1 cm wide, rounded to acute at apex, narrowed at base, inconspicuously puberulous; flowers borne in loose secund spikes, these puberulous, with glandular and eglandular hairs intermixed; bracts in threes, glandular-ciliate, the middle one 2.5 mm long, subcucullate, the lateral ones lanceolate, 3 mm long, about 0.75 mm wide near base; calyx deeply 5-parted, the posterior segment subulate, about 3 mm long, the others linear-lanceolate, about 6 mm long and 1.5 mm wide, rather firm, indistinctly striate-veined, puberulous and glandular-ciliate; corolla up to 3 cm long, red, finely but sparingly pubescent, the tube about 1 cm long, somewhat saccate, the upper lip straight, erect, 2-lobed at apex, the lower lip somewhat spreading, 3-lobed, the lobes oblong, about 7 mm long, rounded at apex, the middle lobe about 4 mm wide at base, the lateral ones about 2 mm wide; stamens about as long as the upper lip, the anther cells unequal, one 2 mm long, the other 2.5 mm long, the lobes spreading at base; capsules 11 mm long, sparingly glandular-puberulous; seeds flattened, 2.5 mm broad, strongly tuberculate, minutely papillose.

Type in the Dudley Herbarium of Stanford University, no. 263987, collected in a rocky wash 27.7 miles south of Pozo Alemán, Baja California, March 4, 1935, by Ira L. Wiggins (no. 7874). A specimen collected by Brandegee from cliffs at Comondu, Baja California, March 21, 1889, without number, is also this species.

Justicia wigginsii is a peculiar plant having the inflorescence of *J. hians* Brandeg. and the corolla of *J. mexicana* Rose, but differing from both in its irregular calyx.

Jacobinia roseana Leonard, sp. nov.

Frutex, caulibus subteretibus, glabris, gracilibus; petioli breves; lamina foliorum ovato-lanceolata vel ovata, acuminata, basi angustata in petiolum decurrens, supra glabra, subtus in axillis venarum parce barbata; flores plures, conferti, axillares; bracteae lineares, hirtellae, plus minusve ciliatae; bracteolae subulatae, minute hirtellae; calyx puberulus, segmentis lanceolatis, acuminatis; corolla rubra labio superiore apice minute bilobo, inferiore trilobo, lobis oblongis, rotundatis; stamina exserta; capsulae glabrae; semina rubra vel fusca, tuberculata.

Shrub up to 1 meter high or more; stems slender, subterete, glabrous or sparingly and minutely pubescent near the nodes; leaf blades ovate-lanceolate to ovate, up to 7 cm long and 3.5 cm wide, acuminate (the tip blunt), narrowed at base and decurrent (petiole up to 1 cm long), entire, glabrous above, beneath sparingly barbate in axils of veins; flowers borne in axillary and terminal clusters, often crowded and numerous; bracts linear, about 1 cm long and 1 mm wide, minutely and sparingly hirtellous, ciliolate, often beset with long scattered marginal hairs up to 1 mm long; bractlets subulate, about 5 mm long, minutely hirtellous; calyx 4-5 mm long, the segments puberulous, lanceolate, 3.5 mm long, 1.5 mm wide, acuminate; corolla scarlet, puberulous without, 2.5 cm long, the tube 5 mm in diameter at mouth, the lips subequal, about 13 mm long, the posterior one minutely 2-lobed at apex, the anterior one 3-cleft nearly to middle, the lobes oblong, rounded; stamens about equaling the upper lip, the anthers 2.5 mm long, the cells parallel, unequally attached to the connective;

capsule 1 cm long and 5 mm in diameter, narrowed to a solid stipitate base 5 mm long, glabrous, 4-seeded; seeds reddish brown, slightly flattened, about 2.5 mm broad, tuberculate.

Type in the U. S. National Herbarium, No. 208675, collected at Manzanillo, Colima, Mexico, December 1 to 31, 1890, by Edward Palmer (no. 946). Besides a specimen from the same locality (*Ferris* 6034), the following additional material has been examined:

MICHOACÁN: Coacomán, *Hinton* 12620, 15845, 16104.

MORELOS: Xochitepec, *Lyonnet* 1173, 1515, 2652.

MEXICO: Temascaltepec, *Hinton* 5190.

The present species is closely allied to *J. mexicana* but differs in its narrow bracts and bractlets, these definitely exceeding the calyx. On the basis of *Palmer* 946 it was described by Dr. J. N. Rose² long ago, but no species name was given it by him. The more ample recent material above cited agrees closely.

² *Contr. U. S. Nat. Herb.* 1: 349. 1895.

BOTANY.—*Two zoophagous species of Acrostalagmus with multicellular Desmidiopsis-like chlamydo spores.*¹ CHARLES DRECHSLER, Bureau of Plant Industry.

Considered collectively, the fungi that under terrestrial conditions attack actively motile eelworms after the usual manner of parasites, by invading them with germ tubes from affixed or ingested conidia, show more than an ordinary degree of morphological distinctiveness. The zoopagaceous form I described earlier (2) as *Euryancale sacciospora* bears curiously appendaged conidia on lateral branches of bizarre outward shape. In the helicoid modification of their distal portions, as also in the close septation of these portions, and in the production on them, mostly laterally, of plural sessile conidia, the conidiophores of my *Meristacrum asterospermum* (3) embody features thoroughly alien to the more familiar insectivorous members of the Entomophthoraceae. The somewhat similar conidiophores of the hyphomycetous parasite I named *Meria coniospora* (4), which in their transverse septation and in their production of

conidia on slender sterigmata arising singly from the delimited segments show curious analogy with promycelia of the rusts as well as with the basidia of *Auricularia*, appear to have no parallel among the Mucedinaceae except in *Meria Laricis* Vuillemin [= *Hartigella Laricis* (Hartig) Lindau], a fungus whose sporulation was held very unusual both by Vuillemin (8) and by Lindau (5). *Harposporium anguillulae* Lohde (6) as set forth by Zopf (9) offers marked individuality in its globose conidiiferous branches and curious sickle-shaped conidia. Globose conidiiferous branches and conidia of peculiar design likewise give distinctive character to the three congeneric parasites which I presented as new species under the binomials *H. helicoides*, *H. oxycoracum*, and *H. diceraeum* (4).

On the other hand no exceptional distinctiveness attaches to the four nematode-destroying parasites I described as *Acrostalagmus bactrosporus*, *A. obovatus*,

¹ Received August 8, 1942.

Cephalosporium balanoides, and *Spicaria coccospora* (4). With respect to the morphology of their conidial apparatus these species show close correspondence with the rather numerous group of entomogenous fungi that in large part have been subsumed under the same genera; the correspondence, indeed, appearing rather clearly presumptive of an intimate taxonomic relationship. Further evidence in favor of such a relationship is supplied by two similar hyphomycetous parasites that have come under my observation, one attacking eelworms, the other attacking rotifers.

The former parasite made its appearance in a maizemeal-agar plate culture that after being occupied by a species of *Pythium* had been further planted with a few pinches of leaf mold gathered in Arlington, Va., on January 7, 1941. A species of *Bunonema* introduced with the forest refuse, and like other representatives of the genus feeding only on the surface of agar plates, had multiplied steadily during the first four weeks to attain a population of approximately 2000 individuals. Scattered specimens were then observed succumbing to fungus infection. Additional animals were found dead on successive days, until by the end of another week all active individuals of the species were exterminated.

Owing to optical difficulties it was not possible to observe the entrance of the fungus into the animal host, or to follow the progress of mycelial invasion. After an infected eelworm had died, however, and been largely expropriated of its globulose degenerating contents, the fully developed assimilative mycelium became plainly visible. In many instances, a single filament, rather closely septate and bearing some few lateral branches, extended the entire length of the animal's body (Fig. 1, A, B), while in other instances two main filaments could be recognized (Fig. 1, C). From this decidedly meager mycelium two or three branches were soon pushed through the host integument to develop externally as colorless fertile hyphae (Fig. 1, A, a; B, a, b). The fertile hyphae that came to project into the air by virtue of an erect or ascend-

ing posture, as also the aerial terminations of similar hyphae procumbent in their proximal portions, often bore two, three, or four flask-shaped conidiiferous branches in verticillate arrangement at the distal end of one or more of their constituent segments (Fig. 1, A, b; C, a; D; E; F). Somewhat less often conidiiferous branches were borne singly on aerial portions of fertile hyphae (Fig. 1, C, a; D), while in procumbent portions they almost invariably arose singly and erect to present more nearly the appearance of autonomous conidiophores (Fig. 1, G). Regardless of posture and position, each flask-shaped branch produced at its tip usually from 5 to 15 small, hyaline, irregularly angular conidia (Fig. 1, H), which remained attached in a cohering cluster.

In addition to the conidial apparatus just described the fungus was occasionally found producing knots of yellowish-brown thick-walled cells within the agar culture medium underlying the body of a parasitized nematode. Some of these knots, or chlamydo-spores, if such they may be called, consisted of only three or four enlarged globose cells, which from their linear arrangement obviously represented distal segments of rather short hyphae that after emerging from the animal's body had directed their growth downward into the subjacent culture medium (Fig. 1, C, b). In the larger specimens three or four cells were likewise often present in a single row, but here they merely formed a stalk on which was borne distally an expanded part composed of 10 to 15 cells in sarciniform arrangement—the whole structure usually having a flattened clavate shape (Fig. 1, B, e). The colored cells of the chlamydo-spores, unlike the colorless cells of the fertile hyphae, contained numerous small globules of apparently somewhat oily character.

Development of submerged multicellular resting bodies supplementary to the production of hyaline aerial conidia on flask-shaped terminal or lateral branches has not been seen in any material of *Acrostalagmus bactrosporus*, *A. obovatus*, *Cephalosporium balanoides*, or *Spicaria coccospora*. Among the other hyphomycetes that I have observed attacking nematodes after the

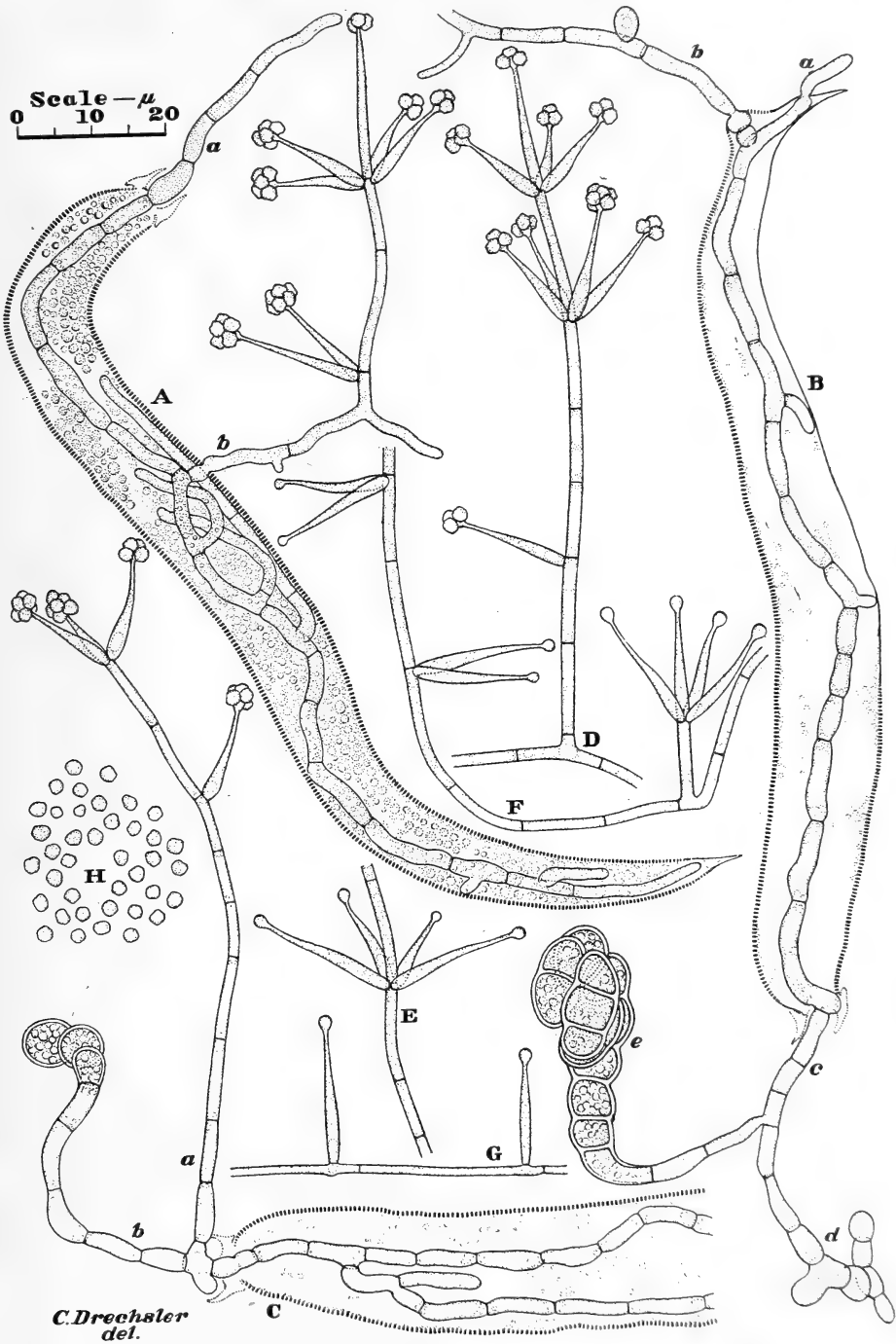

Fig. 1.—*Acrostalagmus goniodes*, drawn to a uniform magnification with the aid of a camera lucida; $\times 1,000$ throughout. A, Specimen of *Bunonema* sp. killed by the parasite; from the assimilative mycelium two branches, a and b, have been put forth externally; b has given rise to an erect conidiophore. B, Specimen of *Bunonema* sp. killed by fungus and almost depleted of its contents; the assimilative mycelium has put forth three external hyphae, a, b, c; the hypha c has given rise to an abortive chlamydospore, d, and to a well developed chlamydospore, e. C, Anterior portion of parasitized *Bunonema* host; from the assimilative mycelium an erect conidiophore, a, has grown out, together with a submerged branch, b, on which a small chlamydospore has been formed. D, An erect conidiophore. E, F, Portions of ascending conidiophores. G, Prostrate hypha bearing two erect conidiiferous branches. H, Conidia, showing variations in size and shape.

usual manner of parasites only *Harposporium anguillulae* has been found producing resting bodies to supplement its hyaline conidia, the resting bodies in this species being formed, however, within the animal host through modification mostly of intercalary cells in the assimilative mycelium. Apart from the development of chlamydospores by the *Bunonema* parasite, production of submerged multicellular resting bodies was noted in a culture prepared early in December, 1932, for the purpose of obtaining chytridiaceous fungi destructive to root-rotting species of *Pythium*. The culture in question was started by planting *P. ultimum* Trow on maize-meal-agar in a Petri dish. Several days later it was further planted by adding a small quantity of potting soil from a greenhouse in Washington, D. C., and, moreover, was flooded with about 1 cc of sterile water. A small species of rotifer, evidently introduced with the soil, soon began to multiply in the thin layer of free water. At first its population increased without hindrance, but after some weeks had elapsed periodic examinations never failed to show many specimens newly killed by a parasitic fungus. The same fungus later came to light as a parasite of small rotifers in a maize-meal-agar plate culture that had been planted with a decaying watercress (*Rorippa nasturtium* Rusby) leaf taken from a commercial watercress bed near Woodstock, Va., on May 13, 1938.

Individual rotifers killed by the fungus were usually found each with its head and tail strongly retracted; its rounded body, often less than 75μ in diameter, then showing little of the shape distinctive of living specimens (Fig. 2, A). The fleshy interior was permeated with a hyaline branching mycelium, composed of hyphae which at intervals were constricted in a manner somewhat suggestive of the haustorial filaments ascribed by Couch (1) to various species of *Septobasidium*, including, for example, his *S. purpureum*. The upper surface of the dead animal was usually overgrown abundantly with erect or ascending hyaline conidiophores whose axial filaments bore flask-shaped conidiiferous branches, mostly in whorls of three, immediately be-

low the several septa dividing them transversely (Fig. 2, A, a, b, c). The oblong colorless conidia (Fig. 2, B) formed at the tip of each flask-shaped branch, as well as at the tip of the tapering cell terminating each axial filament, remained attached in a cohering cluster. On the under side of the dead animal the assimilative mycelium would put forth into the agar substratum short filaments (Fig. 2, A, d) that sometimes concluded their development by giving rise terminally to a yellowish, thick-walled, globose structure either continuous (Fig. 2, A, e) or uniseptate (Fig. 2, A, f). Usually, however, the short filaments produced a much more distinctive structure consisting of 8 to 15 thick-walled, yellowish or brownish cells, filled with globuliferous contents and arranged, for the most part, in a single layer (Fig. 2, A, g-n). When viewed flatwise these structures in some instances presented a rather smoothly circular or smoothly elliptical peripheral outline, while in other instances the marginal outline was characteristically lobate.

Despite their more pronounced differentiation it is believed that the submerged multicellular bodies produced abundantly by the rotifer parasite are truly homologous with the submerged multicellular chlamydospores of the *Bunonema* parasite. A convincing homology is likewise evident with respect to the more commonplace aerial conidial apparatus whereby the two fungi are readily recognized as species of *Acrostalagmus* presumably related closely to the congeneric nematode-destroying forms, *A. bactrosporus* and *A. obovatus*, even though in the latter forms no accessory type of reproduction has been observed. An association of two types of asexual reproduction corresponding at least approximately to those here concerned was made known more than half a century ago by Thaxter (7) in the original descriptive account of his *Desmidiospora myrmecophila*, a remarkable fungus he found growing out of a large ant on the under side of a rotting log in Connecticut. The hyaline septate mycelium of this entomogenous form was set forth as giving rise at the apex of subulate basally inflated basidia to hyaline subfusiform microconidia

12 μ long and 2 to 2.5 μ wide. Since the branches that Thaxter designated as basidia in accordance with an older usage are clearly equivalent to the phialides of more recent authors, the conidia produced on them offer obvious homology with the aerial conidia of both the *Bunonema* parasite and the rotifer parasite. Aside from the hyaline microconidia, Thaxter attributed to *D. myrmecophila* the production of curious macroconidia—terminal, flat, short-stalked, multicellular, thick-walled, reddish-brown or fawn-colored bodies, dichotomously lobed several times in succession, 12 to 14 μ thick, and measuring 68 μ (maximum 90 μ) presumably along the median axis and 80 μ (maximum 100 μ) in the greater dimension transverse to this axis. From Thaxter's description and illustration it is evident that these macroconidia strikingly resemble the resting spores of the rotifer parasite in many respects, as, for example, in their terminal origin on rather short hyphal branches, in their brown coloration, in their unusual dimensional proportions, and in the flat, mostly uniplanar arrangement of their numerous thick-walled component cells. Differences of detail are, to be sure, present in the much greater size and much more pronounced lobation of the macroconidia ascribed to *D. myrmecophila*.

In considering the essential nature of the multicellular resting spores produced by the rotifer parasite it seems significant that although the animal host of this fungus has nearly always been found succumbing on the surface of agar plate cultures, the spores in question were always formed under the surface of the agar medium, while the associated reproductive apparatus referable to *Acrostalagmus* was always extended into the air. In view of these circumstances the multicellular spores must be regarded as having developed in submerged positions from normal preference rather than from constraint. Despite their distinctive morphology they would appear, therefore, to represent chlamydo-spores rather than conidia, and may appropriately be reckoned in the same category with the similarly yellowish or brownish, thick-walled, globuliferous chlamydo-spores of *Harposporium anguillu-*

lae and *Arthrobotrys oligospora* Fres. If analogy is not misleading, the remarkable macroconidia of *Desmidiospora myrmecophila* may likewise be more nearly equivalent to chlamydo-spores than to true conidia. Since much porous absorbent material is often found on the under side of rotting logs, a habitat like that of Thaxter's fungus might during dry periods permit aerial conidia to be formed in positions where during wet spells opportunity is afforded for the production of submerged reproductive bodies.

It is not evident at present that in the group of zoophagous fungi here concerned the production of chlamydo-spores, even of very distinctive chlamydo-spores, can be interpreted as an indication of taxonomic separateness. Accordingly the *Bunonema* parasite and the rotifer parasite are described as new members of the genus *Acrostalagmus*.

Acrostalagmus goniodes,² sp. nov.

Mycelium nutritum hyalinum, parve ramosum, septatum, intra vermiculos nematoideos viventes evolutum, ex hyphis filiformibus 1.5-3 μ crassis constans. Hyphae fertiles extra animal emortuum evolutae, incoloratae, repentes vel ascendentes vel erectae, axe simplicibus vel parvulum ramosae, vulgo 50-500 μ longae, 1.2-2.5 μ crassae, in cellulis 7-18 μ longis consistentes, quarum quaedam 1-4 ramulos conidiferos (phialas) ferunt; ramulis conidiferis saepe 2-4 verticellatis, lageniformibus, 10-20 μ longis, basi 1.2-2.3 μ crassis, quoque sursum in sterigma .5 μ crassum abeunte et ex apice ejusdem 5-15 conidia deinceps gerente; conidiis cohaerentibus, hyalinis, rotunde polygoniis, plerumque 1.3-2.1 μ diam. Chlamydo-spores in materia subjacenti oriundae, ex hyphis immersis leniter latescentes, flavidae vel fulvae, parte posteriore sarciniiformes, omnino 12-30 μ longae, 6-15 μ latae, 3-18 cellulis constantes.

Vermiculos nematoideos speciei *Bunonematis enecans* habitat in humo silvestri in Arlington, Virginia.

Assimilative mycelium hyaline, somewhat branched, septate, growing within living

² γωνιῶδης, angular, having reference to the shape of the conidia.

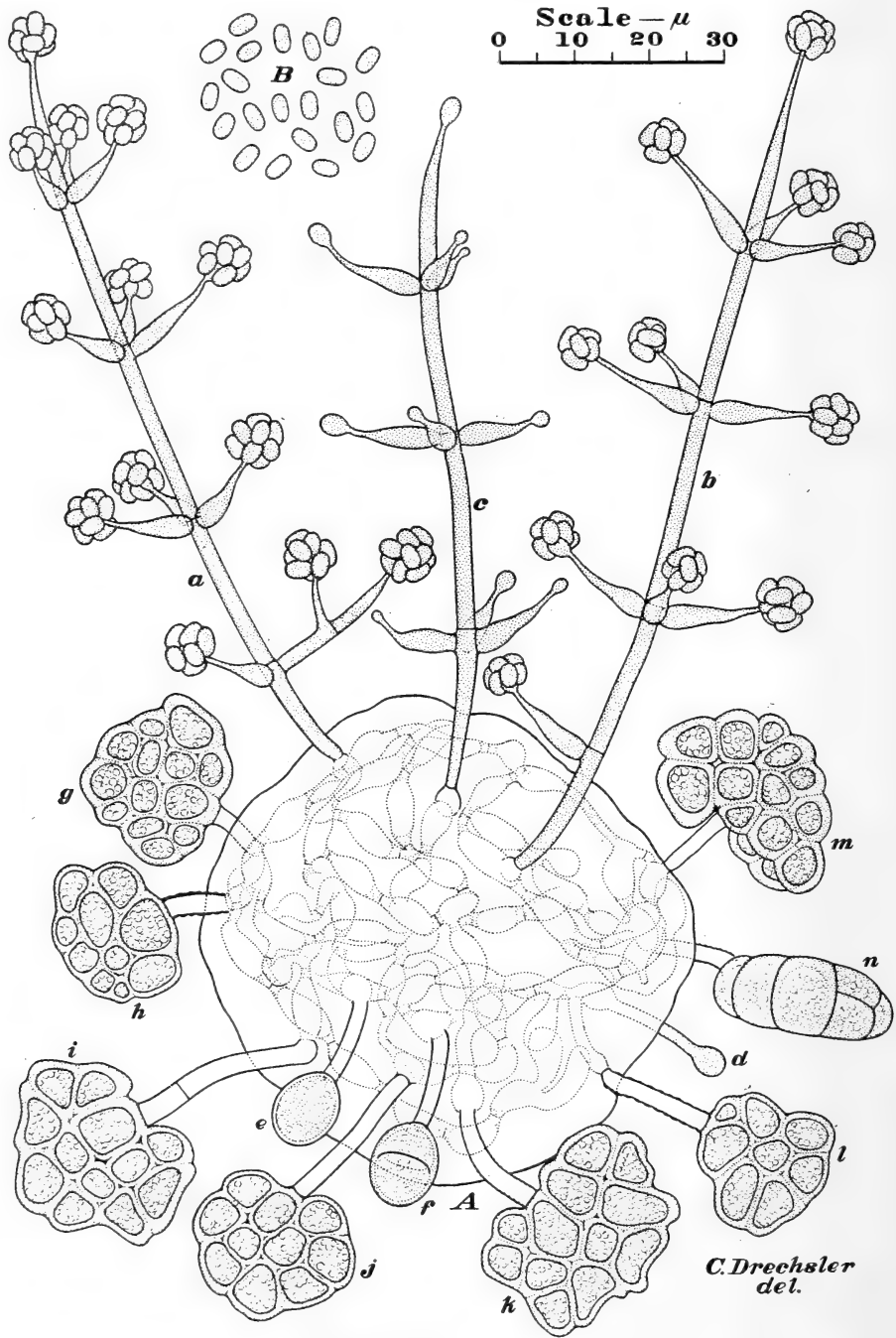

Fig. 2.—*Acrostalagmus tagenophorus*, drawn to a uniform magnification with the aid of a camera lucida; $\times 1,000$ throughout. A, Specimen of rotifer killed by the fungus. Three conidiophores, a, b, c, have been extended into the air; a and b are shown with conidial clusters attached, whereas c is shown in denuded condition. Into the underlying material have been extended eleven outgrowths, namely: a young hypha, d; two hyphae bearing poorly developed chlamydospores, e, f; eight hyphae bearing well developed chlamydospores, g–n, of which seven, g–m, are shown flatwise, whereas one, n, is shown edgewise. B, Conidia, showing variations in size and shape.

nematodes, and consisting of filamentous hyphae 1.5 to 3μ wide. Conidiophorous hyphae formed outside of the dead animal host, creeping or ascending or erect, colorless, their axial filaments simple or sparingly ramified, commonly 50 to 500μ long, 1.2 to 2.5μ wide, and consisting of segments 7 to 18μ long, of which some bear 1 to 4 conidiiferous branches (phialides); conidiiferous branches often arranged verticellately, flask-shaped, 10 to 20μ long, 1.2 to 2.3μ wide at the base, each tapering distally into a sterigma $.5\mu$ wide whereon 5 to 15 conidia are formed one after another to cohere in a head; conidia colorless, rounded polyhedral, mostly 1.3 to 2.1μ in diameter. Chlamydo-spores formed in the material underlying animal host, each borne terminally on a submerged hypha, its stalk-like proximal part widening gradually into the sarciniform distal part, yellowish or yellowish brown, altogether usually 12 to 30μ long, 6 to 15μ wide, and composed of 3 to 18 thick-walled cells.

Destroying nematodes belonging to a species of *Bunonema* it occurs in leaf mold in Arlington, Va.

Acrostalagmus tagenophorus,³ sp. nov.

Mycelium nutritum hyalinum, ramosum, septatum, intra viventia animalcula rotifera evolutum; hyphis hic illic constrictis, 1– 4μ crassis. Hyphae fertiles extra animal emortuum evolutae, erectae vel ascendentes, incoloratae, axe simplices vel parce ramosae, vulgo 50– 250μ longae, magnam partem 1.8– 2.5μ crassae, in cellulis plerumque 15– 30μ longis constantes quae vulgo 3 (rarius 1 vel 2) ramulos conidiferos (phialas) verticellatos sursum ferunt; ramulis conidiferis lageniformibus, plerumque 10– 15μ longis, basi 2.5– 3.5μ crassis, sursum in sterigma $.5\mu$ crassum abeuntibus, 5–15 conidia deinceps gerentibus; conidiis hyalinis, ellipsoideis vel rotunde oblongis, plerumque 3.5– 4μ longis, 2– 2.5μ crassis. Chlamydo-spores in materia ambiendi vel subjacenti immersae, ex hyphis fumadis 5– 25μ longis 2– 3μ crassis ortae, terminales, fulvae vel olivaceae, applanatae, subdisciformes vel margine aliquid lobosae, vulgo ex 8–15 cellulis constantes, plerumque medio 15– 20μ longae, 18– 30μ latae, 8– 10μ crassae.

Animalia rotifera necans habitat in humo

³ τάρηνον, pan for frying, having reference to the shape and attachment of the chlamydo-spores; and φορέω, to bear.

pingui in Washington, D. C., et in foliis *Rorippae nasturtii* putrescentibus prope Woodstock, Va.

Vegetative mycelium colorless, branched, septate, developing within living rotifers, consisting of hyphae 1 to 4μ wide, which here and there are rather markedly constricted. Conidiophores rising erect or ascending from the dead animal host, colorless, their axial filaments simple or sparingly branched, commonly 50 to 250μ long, mostly 1.8 to 2.5μ wide, composed of segments usually 15 to 30μ long which at the distal end commonly bear 3 (less often 1 or 2) conidiiferous branches (phialides) in verticellate arrangement; conidiiferous branches flask-shaped, mostly 10 to 15μ long, 2.5 to 3.5μ wide at the base, terminating in a sterigma $.5\mu$ wide, on which 5 to 15 conidia are formed one after another to collect in a cohering head; conidia colorless, prolate ellipsoidal or rounded oblong, mostly 3.5 to 4μ long and 2 to 2.5μ wide. Chlamydo-spores formed terminally on smoky hyphae often 5 to 25μ long and 2 to 3μ wide, in positions under the surface of the material surrounding or underlying the dead animal host, flat disc-shaped or often with somewhat lobate margin, commonly consisting of 8 to 15 thick-walled cells, along the median axis measuring 15 to 20μ , in the greater dimension transverse to this axis measuring 18 to 30μ , in thickness measuring 8 to 10μ .

Destroying rotifers in rich soil in Washington, D. C., and in decaying leaves of *Rorippa nasturtium* near Woodstock, Va.

LITERATURE CITED

1. COUCH, J. N. *The genus Septobasidium*: 480 pp. Chapel Hill, N. C. 1938.
2. DRECHSLER, C. *Five new zoopagaceae destructive to rhizopods and nematodes*. *Mycologia* **31**: 388–415. 1939.
3. ———. *Three fungi destructive to free-living terricolous nematodes*. *Journ. Washington Acad. Sci.* **30**: 240–254. 1940.
4. ———. *Some hyphomycetes parasitic on free-living terricolous nematodes*. *Phytopathology* **31**: 773–802. 1941.
5. LINDAU, G. *Die Pilze Deutschlands. Oesterreichs und der Schweiz. VIII. Abteilung: Fungi imperfecti: Hyphomycetes (erste Hälfte)*. In Rabenhorst, L., *Kryptogamen-Flora*, ed. 2, Bd. 1, Abt. **8**: 852 pp. Leipzig, 1904–1907.
6. LOHDE, G. *Ueber einige neue parasitische Pilze*. *Tagebl. Versamml. deut. Naturf. Aertze* **47**: 203–206. 1874.

7. THAXTER, R. *On certain new or peculiar North American Hyphomycetes. II. Helicocephalum, Gonatorrhodiella, Desmidiospora nov. genera and Everhartia lignatilis n. sp.* Bot. Gaz. 16: 201-205. pl. 19. 1891.
8. VUILLEMIN, P. *Les Hypostomacees nouvelle famille de champignons parasites.* Bull. Soc. Sci. Nancy (2) 14: 15-67. 1896.
9. ZOPF, W. *Die Pilze.* In Schenk, A., *Handbuch der Botanik* 4: 271-781. Breslau. 1890.

ZOOLOGY.—*Some new land shells from Costa Rica and Panama.*¹ HAROLD A. REHDER, U. S. National Museum.

The United States National Museum has received from time to time interesting collections of mollusks from Prof. Manuel Valerio, of San José, Costa Rica. Among these sendings several new species of land shells have turned up, which are herewith described. Similarly, the Museum has received a small but valuable collection of land shells from the Province of Chiriquí, Republic of Panama, from Mrs. Robert Adams Terry, among which are two forms that are diagnosed in this paper.

Helicina terryae, n. sp.

Figure 16

Shell small, subglobose, conic, thin but solid. Spire flesh colored, last whorl pale yellow; sculpture when fresh of irregular, oblique, and subspiral grooves on a surface smooth except for obscure growth wrinkles. When worn the shell appears to be sculptured with fine, crowded, wavy riblets or wrinkles, which in fresh shells of this and other species are seen to be part of the shell structure, visible through the periostracal layer. Whorls $4\frac{3}{4}$, only very slightly convex, suture finely impressed. Aperture oblique, broadly semicircular. Lip thickened, strongly reflexed, broadest in the peripheral region. Columella area thickened, finely granulose, the granulation extending more obscurely over the thin callus. No tooth at the base of the columella.

The type, U.S.N.M. no. 539026, measures: Height, 8.2 mm; diameter, 9.8 mm, and was collected in Chiriquí Province, Republic of Panama.

This little shell is named for the discoverer, Mrs. Robert Adams Terry. It resembles *H. tenuis* but is slightly more depressed and broader, with a broader aperture. The color is also quite distinctive.

¹ Published by permission of the Secretary of the Smithsonian Institution. Received July 31, 1942.

Succinea haustrellum, n. sp.

Figure 19

Shell broadly ovate, thin, pale straw yellow in color. Whorls 3, weakly convex, last one very large; suture impressed; sculpture consisting of axial growth wrinkles. Aperture ovate, patulous, columella forms a straight line with the parietal wall.

The type, U.S.N.M. no. 536013, was collected at Pedernal, Guanacaste Province, Costa Rica, at an altitude of 200 meters. It measures: Height, 13.1 mm; breadth, 8 mm.

A smaller paratype, U.S.N.M. no. 536014, is present, as well as two specimens, U.S.N.M. no. 536012, from San José, Costa Rica.

This species differs from the other Central American Succineas in having a shorter spire and larger aperture. The type has the edge of the outer lip somewhat broken.

Spiraxis (Rectaxis) paulisculpta, n. sp.

Figure 18

Shell small, cylindrical-turrite, glassy white to pale corneous, translucent, smooth, except for obscure irregular growth wrinkles. Whorls 8+, weakly convex, with a moderately deep, slightly overriding suture. Nuclear whorls not clearly demarcated from postnuclear whorls. First $2\frac{1}{2}$ nuclear whorls smooth, remaining whorls very gradually widening, sculptured with irregular growth wrinkles. Aperture ovate-lanceolate. Outer lip thin, simple, slightly arcuate, almost vertical; columella straight, slightly oblique.

The type, U.S.N.M. no. 536016, measures: Height, 4 mm; diameter, 1.2 mm, and was collected at Santa María, San José Province, Costa Rica, at an altitude of 1,550 meters. U.S.N.M. no. 536017 contains 10 specimens from the same locality.

This species differs from all the mainland species of *Spiraxis* that I have noted by the weak development of sculpture on the whorls.

Streptostyla (Streptostyla) valerioi, n. sp.

Figure 17

Shell cylindric-ovate, golden-yellow when fresh, smooth except for very fine irregular

growth wrinkles. Nuclear whorls 2½, rounded, separated by a very fine impressed suture. Postnuclear whorls 4, very slightly convex with an irregular, threadlike subsutural white

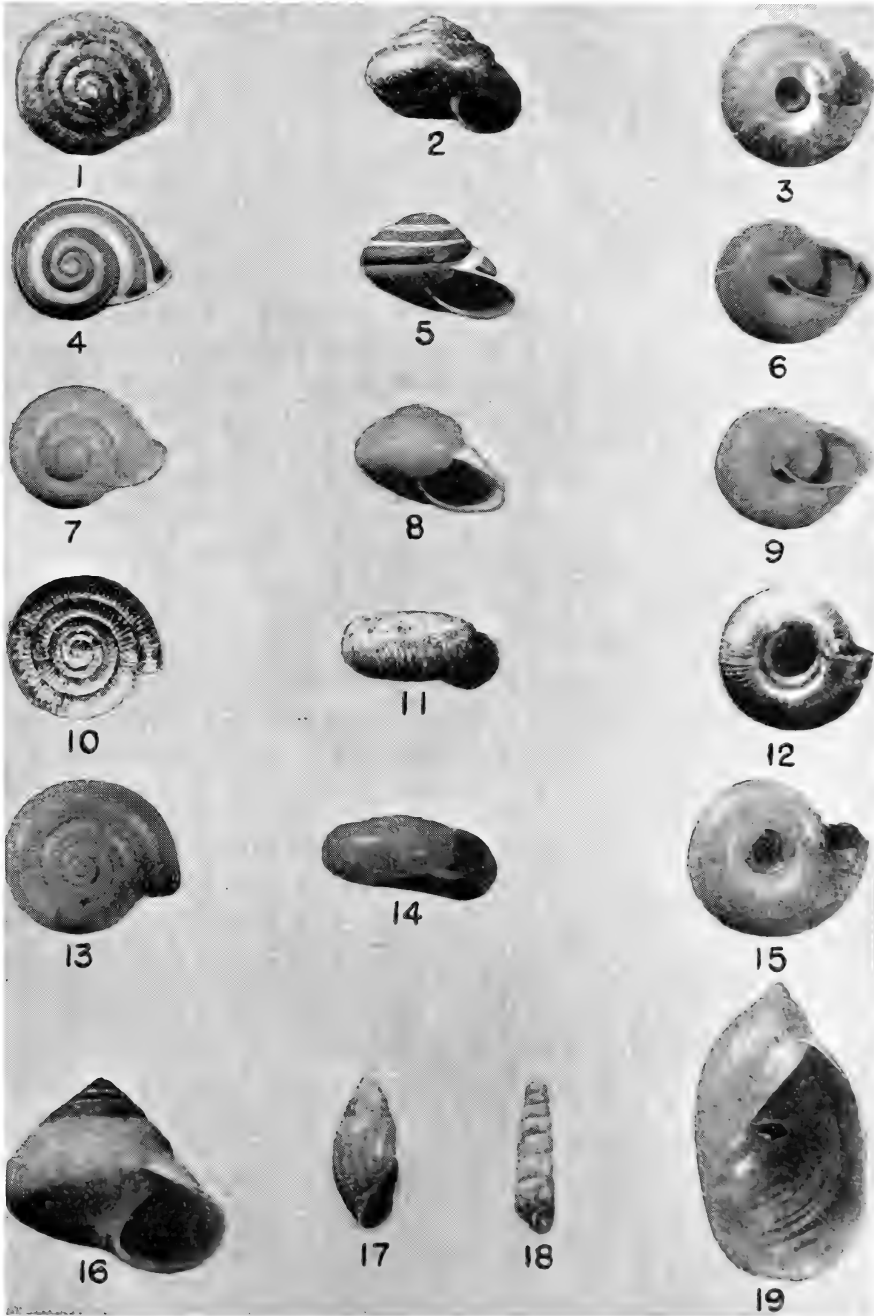

Figs. 1-19.—Land mollusks from Costa Rica and Panama. 1-3, *Thysanophora costaricensis*, n. sp.; 4-6, *Leptarionta venusta venusta* Gude; 7-9, *Leptarionta venusta albata*, n. subsp.; 10-12, *Rotadiscus pilsbryi*, n. sp.; 13-15, *Systrophia (Systrophella) costaricana*, n. sp.; 16, *Helicina terryae*, n. sp.; 17, *Streptostyla (Streptostyla) valerioi*, n. sp.; 18, *Spiraxis (Rectaxis) paulisculpta*, n. sp.; 19, *Succinea haustrellum*, n. sp.

band; last whorl subcylindric; suture rather irregular, very shallow. Aperture lanceolate, slightly less than half the length of the whole shell; outer lip arched forward in the middle. Columella strongly turrite.

The type, U.S.N.M. no. 536020, measures: Height, 20.2 mm; diameter, 9.1 mm; length of aperture, 10.5 mm, and comes from Cervantes, Cartago Province, Costa Rica, 1,480 meters.

U.S.N.M. no. 536021 contains a paratype from the same locality. Professor Valerio also sent two specimens from Tablazo, San José Province, Costa Rica (U.S.N.M. no. 536022), collected at 1,800 meters, and two specimens from La Verbena, San José Province, Costa Rica (U.S.N.M. no. 536024), collected at 1,000 meters. A specimen collected by Dr. W. M. Mann at Navarro, Cartago Province, Costa Rica (no. 365678) appears to belong here also.

S. valerioi differs from other *Streptostylas* of Panama and Costa Rica in its cylindrical shape and short aperture.

***Rotadiscus pilsbryi*, n. sp.**

Figures 10-12

Shell very small, discoid, horn colored, rather closely coiled, with flattened spire. The nucleus, of $1\frac{3}{4}$ whorls, is smooth, glassy, while the remaining 3 whorls are sculptured with more or less equidistant axial ribs which have finer axial threads between them. Suture rather deep. Umbilicus rather broad, measuring about one-third of the diameter of the shell. Aperture crescentic; peristome simple, thin.

The type, U.S.N.M. no. 536018, measures: Height, 1 mm; greater diameter, 2.1 mm, and comes from Santa María, San José Province, Costa Rica, at an altitude of 1,550 meters.

U.S.N.M. no. 536019 contains four specimens from the same place.

From *Rotadiscus hermanni* Pfeiffer, Veracruz, Mexico, this species differs in being slightly larger and in having coarser sculpture, riblets being larger and more distantly spaced.

***Thysanophora costaricensis*, n. sp.**

Figures 1-3

Shell of medium size for the genus, moderately depressed, horn colored. Whorls $4\frac{3}{4}$, convex, somewhat flattened below the deeply impressed suture, last whorl descending slightly. Nuclear whorls $1\frac{3}{4}$, of which the first $\frac{3}{4}$ whorl is smooth, the next whorl marked by evenly separated, retractive riblets. Postnuclear whorls marked by rather coarse, retractive, cuticular

riblets crossing the strong axial growth wrinkles. These retractive riblets are irregular and often interrupted, with comparatively wide interspaces. The umbilicus is deep and moderately large, contained about 4 times in the diameter of the shell; the walls of the umbilicus are sculptured with granules axially arranged along the growth lines. Aperture almost circular; lip simple, thin.

The type, U.S.N.M. no. 536009, measures: Height, 3.0 mm; diameter, 4.1 mm, and was collected at La Caja, near San José, San José Province, Costa Rica, at 1,000 meters.

Six specimens from the same locality are contained in U.S.N.M. no. 536010 and several specimens were collected at San José, Costa Rica, U.S.N.M. no. 536011.

This species resembles in shape *T. balboa* Pilsbry from Panama, which, however, is larger and has finer retractive riblets.

***Systrophia (Systrophiella) costaricana*, n. sp.**

Figures 13-15

Shell small, subdiscoid, spire slightly elevated, periphery rounded, thin, pale straw-yellow. Nuclear whorls almost 2, convex, smooth; postnuclear whorls $2\frac{3}{4}$, convex, smooth except for growth wrinkles; suture moderately deep. Umbilicus moderately narrow, measures less than one-third of the diameter of the shell. Aperture broadly lunate; peristome thin, simple.

The type, U.S.N.M. no. 536023, measures: Height, 3.7 mm; greater diameter, 7.7 mm, and was collected at Coto on the Golfo Dulce, Puntarenas Province, Costa Rica, at an altitude of 20 meters.

This species is geographically close to *S. (S.) zeteki* Pilsbry, from Panama, but is smaller, comparatively higher, with a more elevated spire and a smaller umbilicus. It likewise lacks the spiral striae of that species.

***Leptarionta venusta albata*, n. subsp.**

Figures 7-9

Like the typical form but completely white, except for a small chestnut area around the umbilical region; apex slightly greenish yellow.

The type, U.S.N.M. no. 536030, measures: Height, 14.2 mm, diameter, 20.4 mm, and was collected by Mrs. Terry in Chiriquí Province, Panama. Two other specimens from the same source are under U.S.N.M. no. 536031.

A specimen with the typical coloration, also collected by Mrs. Terry in Chiriquí, is depicted in Figs. 4-6.

PROGRAMS OF THE ACADEMY AND AFFILIATED SOCIETIES¹

THE ACADEMY (Cosmos Club Auditorium, 8:15 P.M.):

Thursday, November 19. *Color blindness and its relation to the detection of camouflage.* DEANE B. JUDD.

PHILOSOPHICAL SOCIETY OF WASHINGTON (Cosmos Club Auditorium, 8:15 P.M.):

Saturday, November 21. *Nuclear moments.* D. R. INGLIS.

Saturday, December 5. Annual meeting. *Stellar explosions.* GEORGE GAMOW.

ANTHROPOLOGICAL SOCIETY OF WASHINGTON (U. S. National Museum, 8 P.M.):

Tuesday, November 17. *Anthropology and the Alaska-Canada Highway.* FROELICH G. RAINEY.

Tuesday, December 22. To be announced.

CHEMICAL SOCIETY OF WASHINGTON (Cosmos Club Auditorium, 8:15 P.M.):

Thursday, November 12. *The specific action of proteolytic enzymes: Current problems and recent advances.* MAX BERGMANN.

Thursday, December 10. *Substitute fuels in a world at war.* GUSTAV EGLOFF.

ENTOMOLOGICAL SOCIETY OF WASHINGTON (U. S. National Museum, Room 43, 8 P.M.):

First Thursday of each month.

NATIONAL GEOGRAPHIC SOCIETY (Constitution Hall, 8:15 P.M.)²:

Friday, November 20. *Aleutians.* BEN EAST.

Friday, November 27. *Navy.* Capt. LELAND P. LOVETTE.

Friday, December 4. *U. S. A.* FRANCIS R. LINE.

Friday, December 11. *England.* HARVEY KLEMMER.

Friday, December 18. *Ski Troops-Parachute Troops.* MAJ. ALBERT JACKMAN and MAJ. JOHN TAPPIN.

BOTANICAL SOCIETY OF WASHINGTON (Cosmos Club Auditorium, 8 P.M.):

Tuesday, December 1. Two papers on *Effects of light and temperature on the vitamin C content of plants.* CHARLOTTE ELLIOTT, MARY E. REID.

HELMINTHOLOGICAL SOCIETY OF WASHINGTON:

Wednesday, November 18, 5 P.M., at Zoological Division, Beltsville Research Center, Beltsville, Md.

Wednesday, December 9, 8 P.M., in Room 43, U. S. National Museum.

SOCIETY OF AMERICAN BACTERIOLOGISTS, Washington Branch (George Washington University School of Medicine, 1335 H Street, NW., 8 P.M.):

Tuesday, November 24. *Summary of recent work in control of triple typhoid vaccine.* Maj. GEORGE F. LUIPPOLD.

Mechanism of bacterial species adaptation to high temperatures. R. R. SPENCER.

The differentiation of human and chicken strains of Escherichia coli. J. M. LEISE.

Development of sulfonamide resistance (fastness) in Staphylococcus aureus correlated with greatly increased synthesis of p-aminobenzoic acid by the organisms. LT. MAURICE LANDY, LT. COL. NEWTON W. LARKUM, ELIZABETH J. OSWALD, and FRANK STREIGHTOFF.

AMERICAN SOCIETY OF ELECTRICAL ENGINEERS (Department of Commerce Auditorium, 8 P.M.):

Wednesday, December 9. Joint meeting with American Society of Civil Engineers, American Society of Mechanical Engineers, and National Society of Professional Engineers. *Conservation of material in the war effort.* Brig. Gen. W. H. HARRISON.

¹ Notices to be published in this space must reach G. A. Cooper, U. S. National Museum, not later than the 29th of the month preceding that of publication.

² Lectures open only to members of the National Geographic Society who have subscribed to season tickets.

CONTENTS

	Page
CHEMISTRY.—The third dissociation constant of phosphoric acid and its variation with salt content. ROGER C. WELLS.....	321
CRYSTALLOGRAPHY.—Morphologie de l'idocrase. Abbé J.-ARTHUR TREMBLAY.....	327
BIOPHYSICS.—Effect of nutrient cultures on the reaction of maize seedlings to light. J. H. KEMPTON.....	338
BOTANY.—Three new species of Acanthaceae from Mexico. E. C. LEONARD.....	341
BOTANY.—Two zoophagous species of <i>Acrostalagmus</i> with multicellular <i>Desmidiospora</i> -like chlamydo spores. CHARLES DRECHSLER.....	343
ZOOLOGY.—Some new land shells from Costa Rica and Panama. HARALD A. REHDER.....	350

This Journal is Indexed in the International Index to Periodicals

506.78
I = W = 3
VOL. 32

DECEMBER 15, 1942

No. 12

JOURNAL OF THE WASHINGTON ACADEMY OF SCIENCES

BOARD OF EDITORS

RAYMOND J. SEEGER
GEORGE WASHINGTON UNIVERSITY

G. ARTHUR COOPER
U. S. NATIONAL MUSEUM

JASON R. SWALLEN
BUREAU OF PLANT INDUSTRY

ASSOCIATE EDITORS

W. EDWARDS DEMING
PHILOSOPHICAL SOCIETY

C. F. W. MUESEBECK
ENTOMOLOGICAL SOCIETY

HARALD A. REHDER
BIOLOGICAL SOCIETY

EDWIN KIRK
GEOLOGICAL SOCIETY

CHARLOTTE ELLIOTT
BOTANICAL SOCIETY

T. DALE STEWART
ANTHROPOLOGICAL SOCIETY

HORACE S. ISBELL
CHEMICAL SOCIETY

PUBLISHED MONTHLY

BY THE

WASHINGTON ACADEMY OF SCIENCES

450 AHNAP ST.

AT MENASHA, WISCONSIN

Entered as second class matter under the Act of August 24, 1912, at Menasha, Wis.

Acceptance for mailing at a special rate of postage provided for in the Act of February 28, 1925.

Authorized January 21, 1933.

Journal of the Washington Academy of Sciences

This JOURNAL, the official organ of the Washington Academy of Sciences, publishes: (1) Short original papers, written or communicated by members of the Academy; (2) proceedings and programs of meetings of the Academy and affiliated societies; (3) notes of events connected with the scientific life of Washington. The JOURNAL is issued monthly, on the fifteenth of each month. Volumes correspond to calendar years.

Manuscripts may be sent to any member of the Board of Editors. It is urgently requested that contributors consult the latest numbers of the JOURNAL and conform their manuscripts to the usage found there as regards arrangement of title, subheads, synonymies, footnotes, tables, bibliography, legends for illustrations, and other matter. Manuscripts should be typewritten, double-spaced, on good paper. Footnotes should be numbered serially in pencil and submitted on a separate sheet. The editors do not assume responsibility for the ideas expressed by the author, nor can they undertake to correct other than obvious minor errors.

Illustrations in excess of the equivalent (in cost) of one full-page line drawing are to be paid for by the author.

Proof.—In order to facilitate prompt publication one proof will generally be sent to authors in or near Washington. It is urged that manuscript be submitted in final form; the editors will exercise due care in seeing that copy is followed.

Unusual cost of foreign, mathematical, and tabular material, as well as alterations made in the proof by the author, may be charged to the author.

Author's Reprints.—Reprints will be furnished in accordance with the following schedule of prices (approximate):

Copies	4 pp.	8 pp.	12 pp.	16 pp.	20 pp.	Covers
50	\$2.00	\$3.25	\$ 5.20	\$ 5.45	\$ 7.25	\$2.00
100	2.50	4.00	6.40	6.75	8.75	2.75
150	3.00	4.75	7.60	8.05	10.25	3.50
200	3.50	5.50	8.80	9.35	11.75	4.25
250	4.00	6.25	10.00	10.65	13.25	5.00

Subscription Rates.—Per volume.....\$6.00
 To members of affiliated societies; per volume..... 2.50
 Single numbers..... .50

Correspondence relating to new subscriptions or to the purchase of back numbers or volumes of the JOURNAL should be addressed to William W. Diehl, Custodian and Subscription Manager of Publications, Bureau of Plant Industry, Washington, D.C.

Remittances should be made payable to "Washington Academy of Sciences" and addressed to 450 Ahnaip Street, Menasha, Wis., or to the Treasurer, H. S. Rappleye, U. S. Coast and Geodetic Survey, Washington, D.C.

Exchanges.—The JOURNAL does not exchange with other publications.

Missing Numbers will be replaced without charge provided that claim is made to the Treasurer within thirty days after date of following issue.

OFFICERS OF THE ACADEMY

- President:* HARVEY L. CURTIS, National Bureau of Standards.
Secretary: FREDERICK D. ROSSINI, National Bureau of Standards.
Treasurer: HOWARD S. RAPPLEYE, U. S. Coast and Geodetic Survey.
Archivist: NATHAN R. SMITH, Bureau of Plant Industry.
Custodian of Publications: WILLIAM W. DIEHL, Bureau of Plant Industry.

JOURNAL

OF THE

WASHINGTON ACADEMY OF SCIENCES

VOL. 32

DECEMBER 15, 1942

No. 12

ASTROPHYSICS.—*Concerning the origin of chemical elements.*¹ G. GAMOW,
The George Washington University.

It is well known that the chemical analysis of the universe indicates a striking uniformity in the distribution of various chemical elements. In fact, we know that the meteorites, which most probably represent the fragments of some old broken-up planet, possess nearly the same proportions of various elements as the samples of terrestrial material, and that the spectral analysis of our sun and other stars leads again to a very similar chemical constitution.² It may be added that the recent investigations of interstellar absorptions indicate that approximately the same chemical constitution should be also ascribed to the extremely rarified gaseous material filling up the interstellar space.

Considering the known abundances of various elements from the point of view of possible nuclear transmutations, we should ask ourselves first of all whether these abundances are due to some nuclear processes taking place *at present* in various parts of the universe, or whether the abundance-curve should be considered as a "frozen-distribution" corresponding to some unusual conditions that existed in the *early creative stage* of the universe? The recent study of the problem of stellar energy

sources shows quite definitely that *some features* of the abundance-curve are of more or less contemporary origin and can be understood on the basis of thermonuclear reactions taking place in the hot interior of stars. Thus, for example, we know that light elements lithium, beryllium, and boron are subject to rather rapid destructive reactions in the presence of hydrogen at the temperatures ranging from 5 to 15 million degrees. These thermonuclear reactions proceed according to the equations:

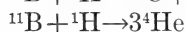
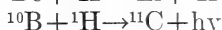
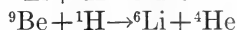
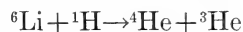

and result in the complete destruction of the elements in question and the formation of the large amounts of thermonuclearly inert helium. It was suggested by Gamow and Teller³ that these particular reactions represent the main source of energy in the early stages of stellar evolution (in the so-called red-giant-stars), and that entering the main sequence the star must have these three elements completely destroyed in its interior regions. Although in the outer layers of the star the temperature is not high enough to induce such reactions, a certain amount of these elements must have been removed by diffusion from the stellar atmospheres, a fact that explains the anomalous drop in the corresponding region of the abundance-curve. In the next, main-sequence stage of stellar evolution the tem-

¹ Received October 26, 1942.

² The only large discrepancy between the chemical constitution of stellar and of terrestrial material consists in comparatively large abundance of hydrogen and helium in stars (35 per cent H and at least a few percent of He) as compared with the earth (0.001 percent of H, and 0.000,000,000,1 percent of He). There is, however, no doubt that this large discrepancy in abundances is of purely secondary character and is entirely due to the fact that H and He, being the light gases, had much better chance to escape from the terrestrial atmosphere into the surrounding empty space.

³ G. GAMOW and E. TELLER. Phys. Rev. 55: 791. 1939.

perature in the interior rises up to 20 million degrees, inducing thermonuclear reactions of the next two elements, carbon and nitrogen, which, according to Bethe,⁴ undergo the following transformations:

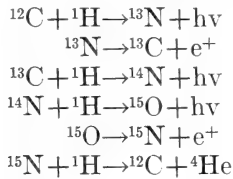

We see from these formulae that carbon and nitrogen are not being completely destroyed by the reaction, but are constantly regenerated, thus serving only as some kind of catalysis for the transmutation of hydrogen into helium. The above reactions, however, serve to establish a definite balance between the relative abundances of ^{12}C — ^{13}C and ^{14}N — ^{15}N isotopes. For the temperature and pressure existing in stellar interiors, the equilibrium-proportions of these isotopes have been calculated by Bethe to be 70:1 and 500:1, which is in fair agreement with the observed abundances.

In spite of these successes in understanding the features of the abundance-curve for lightest elements, however, the situation becomes much more difficult in the case of heavier elements. In fact, there seems to be no doubt that the much higher temperatures, needed for the transmutation of heavier elements, are not to be found in stellar interiors or, for that matter, in any other part of the present state of the universe.⁵ Thus the only possible way to understand the origin of heavy, and particularly of radioactive elements lies in the assumption that in some previous stage of the development of our universe, physical conditions have been in general entirely different from what they are now, and that the temperature and density of matter then were, as a rule, much higher. Such a hypothesis finds strong support in the theory of ex-

panding universe, according to which the matter, which is at present distributed rather rarely through space, expanded from the original state of very high density and temperature. It is particularly interesting that, according to the measured rate of present expansion, these extraordinary physical conditions in space must have been existing only about 2 or 3 billion years ago, a period of time comparable with the life-period of the long-living radioactive elements (thorium and uranium), which are still in existence.

Considering the present abundance of elements as the result of these long-past conditions, one can follow two different points of view: (1) That the abundance-curve corresponds to a thermodynamic equilibrium state at some very high density and temperature, which existed during a certain early expansion-stage of the universe; and (2) that relative abundances of various elements are due to a non-equilibrium breaking-up process of the original bulk of nuclear matter caused by a rapid expansion in the early evolutionary stages.

A detailed study of the first possibility was carried out recently by Chandrasekhar and Henrich,⁶ who calculated the equilibrium-numbers of various nuclei corresponding to conditions of extremely high densities and temperatures. In these calculations, which extended over the first 20 elements of the periodic system, the authors took into account the exact values of the mass-defects of the nuclei in question with the interesting result that the theoretical abundance-curve repeats rather exactly all local irregularities of the empirical curve. It must be noticed, however, that this particular result does not necessarily speak in favor of the thermodynamic-equilibrium hypothesis, since also in the case of a rapid breaking-up process more stable nuclei should have been produced in larger quantities than the less stable ones.

In respect to the general behavior of the abundance-curve, the results are considerably less satisfactory, which is owing exclusively to a very peculiar behavior of the

⁴ H. BETHE. *Phys. Rev.* 55: 434. 1939.

⁵ An attempt to understand the building-up (Aufbau) process of heavy elements at the comparatively low temperatures existing in stars was made by Weizsäcker (*Phys. Zeitschr.* 39: 633. 1938), but it turned out to be completely unsuccessful and has been entirely abandoned.

⁶ S. CHANDRASEKHAR and L. R. HENRICH. *Astr. Journ.* 9: 288. 1942.

empirical curve. In fact, the general habitus of this curve can be characterized as a *rapid exponential decrease up to the middle of the periodic system, and an approximate constancy in the second half of it.* (See figure.)

This character of the exponential curve excludes any possibility of understanding the abundance of all elements as the result of some kind of equilibrium, since in choosing the temperature and density so as to fit the decreasing half of the curve (Chandrasekhar and Henrich assume $\rho = 10^7 \text{ gm/cm}^3$ and $\tau = 8.10^9 \text{ }^\circ\text{C}$), one should necessarily expect the continuation of such decrease also for the group of heavier elements. There also seems to be no physical possibility of

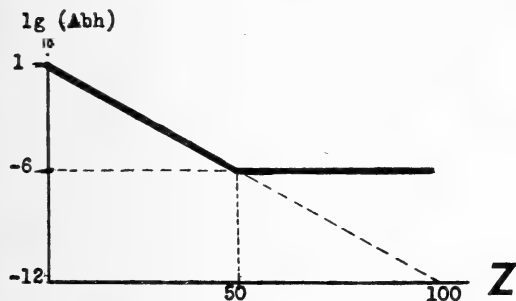

explaining the peculiarity of the empirical curve by any kind of "freezing up" of heavier elements while the lighter ones are still being transformed. In fact, any such transformation should be necessarily connected with the emission of a large number of high-energy neutrons, which are bound to affect the relative number of heavier elements, and to cause the later part of the curve to drop down.

We can try now to investigate the second possibility, and to see which kind of distribution could be obtained from the hypothesis of a rapid breaking up of the original superdense nuclear matter. We must remember that, according to our present knowledge of nuclear fission-processes, all nuclei that are heavier than uranium would be immediately broken into

two or more approximately equal parts (slight deviation from equality of fission-fragments being due to the irregular character of the mass-defect curve). If we assume for a moment that each unstable superheavy nucleus breaks up in only two approximately equal parts, the statistical result of such a breaking up process, will evidently correspond to *an equal abundance of all elements belonging to the second half of the periodic system, and to a complete absence of all lighter elements.*

This gloomy picture may be improved, however, if we remember that: (1) Even in ordinary uranium-fission a number of free neutrons are being emitted in each breaking-up process, and this number most probably increases in the case of the more violent fission of superheavy nuclei. Neutrons produced this way will turn spontaneously into protons, and will contribute to a larger abundance of hydrogen. (2) Although (in the known fission-processes of radioactive elements), the nucleus always breaks in only two fragments, *we may expect that for the heavier nuclei the probability of triple and higher order splitting is considerably larger.* Such multiple splitting of nuclei several times heavier than uranium will not much affect the equipartition in the second half of the periodic system, but will, on the other hand, produce a large number of lighter nuclei.

It seems, therefore, on the basis of the foregoing remarks, that this possibility is not entirely excluded, that the main features of the abundance curve may be explained as the result of a complicated fission-process. In order to answer this question in a more definite way it will be necessary to study the stability of superheavy nuclei with respect to multiple-fission and to investigate the statistical distribution of the fission-fragments in a successive breaking down process. The work in this direction is now in progress, and its results (if any) will be published later.

PHYSICS.—*Physical explanation and the domain of physical experience.*¹ R. B. LINDSAY, Brown University. (Communicated by R. J. Seeger.)

The prevalent interest of philosophers in physics and of physicists in philosophy is a sign of healthy progress in science, though some hard-boiled experimental physicists have expressed the opinion that much of it is merely an excuse for talking, which ends only in futility. However this may be, and however true it may be that philosophers have asked and will probably continue to ask many questions that physicists can not answer, it is also a fact that their observations, even when irritating, serve a useful purpose if they foster a more careful examination of what physicists mean by what they say. Consider, for example, the statement that physics is a "vicious abstraction."² This ought to be sufficient to start a train of thought or at any rate to throw a new light on the old question: What is physics? We may take it for granted that the author of the statement is not attributing vice to physicists but is using the term "vicious" in its purely technical sense of faulty or incorrect. The statement implies, therefore, that physicists are guilty not only of abstraction but abstraction of an essentially bad kind.

It is perfectly clear to all physicists who have taken the trouble to think about the foundations of their science that physics deals with an abstraction from the totality of experience. Reading of the article just mentioned suggests that the inherent viciousness lies in the fact that physicists are willing to work with only that kind of experience which they can control with some precision in the laboratory. This they proceed to isolate from all "foreign" influences and then to describe in terms of a language that is also specifically invented for this purpose and is quite different from that of everyday speech. If they achieve a measure of success in this description, it is only, to accept the view of the philosopher critic, because they have deliberately decided to forego any relation of the abstracted experience to the rest of experience.

It is probably unnecessary to analyze these strictures in detail. Most physicists will be likely to see in them only the distaste of a philosopher for anything less than the whole universe as a realm of discourse and the well-defined fear that if any part of experience is left out of consideration, the description of the rest is bound to be inadequate. We may frankly admit that this situation has not seriously disturbed physicists in the past, but it serves once more to focus attention on the fundamental problem of what physicists really do.

The activity of the physicist naturally divides itself into two parts: (1) the acquisition of experience and (2) the description of experience. Both processes involve abstraction. In the first the physicist examines the world of experience and picks out those elements that possess interest and offer possibility of coherent description, i.e., involve consistent routines. In no sense does he pretend to explain all the mysteries of nature: he is very "choosy" in his selection of material. This often irritates the philosopher and to some extent even the ordinary citizen, who is usually subject to the delusion that physicists understand everything that goes on in nature and is often sadly disillusioned when he asks a physicist about some problem only to be told that physics has not found it profitable to consider this particular group of sense impressions. Every now and then someone gets highly excited over the inability of physicists to give a clear-cut answer to a question like this: Does hot water freeze faster than cold water? There is no need to multiply examples. We are here neglecting the fact that even if the physicist attempts an explanation of the phenomenon in question his language is commonly unintelligible to the layman. We are concerned rather with the physicist's selection of data. It therefore seems worth while to make a few observations on the element of abstraction in a physicist's choice of the experience he wishes to describe. Its importance for the problem of physical explanation is obvious,

¹ Received September 30, 1942.

² FRIES, H. S., *Philosophy of Science*, July 1939.

since explanation inevitably depends on the character of the experience to be described. This at once suggests the question: Would not an enlargement of the domain of physical experience lead to a valuable expansion of the concepts useful for physical description? It is an alluring field for speculation. There is general recognition of the fact that it has proved extremely difficult—some would say impossible—to describe in logically consistent fashion the phenomena we call atomic in terms of the concepts developed for the description of classical macroscopic phenomena. These concepts were, of course, constructed from the experience they attempt to organize and subsume. It has frequently been pointed out that it is at best rather unreasonable to expect them to prove convenient for the description of new experience, without modification and amplification. At any rate, the fact remains that in the attempt to salvage the older concepts for use in describing newer phenomena physicists have been forced to strange devices, such as replacing Hamiltonian functions (which have a precise meaning in the theory of classical mechanics) by differential operators which have no physical meaning at all in classical mechanics. Much of the modern debate on the methodology of physics centers around the question whether this is the most effective method of stimulating physical research and of producing the type of physical theory best suited to the organization of physical knowledge, what we may call in short the best kind of physical explanation. At the present time the question is being settled on a pragmatic basis: even if the elements of the modern theory are bizarre, they are justified by the experimental confirmation of the predictions resulting from them. Logically no more can be demanded. Actually it may be doubted whether even theoretical physicists are entirely satisfied with the situation. Certainly many teachers of physics are puzzled and bewildered.

To one who insists that for the successful development of physics we must not be content to invent new concepts solely from our imagination without regard to experience but should attempt to enlarge the actual

domain of that experience, the reply may be made that this is just what is really happening all the time with the advancement of modern research. In nuclear physics, for example, an almost inexhaustible mine of new experience is being opened up. Will this not supply us with new concepts? It is true that the language of physics is being enriched by many new names and that we hear much of deuterons, neutrons, neutrinos, anti-neutrinos, and mesotrons, but it is significant that these are still names of particles, i.e., elements characteristic of classical physics based on the macroscopic phenomena of motion. Physicists are still calling on the experience of classical physics to furnish the conceptual background of the new experience of recent physical discovery. We have grown so accustomed to the traditional analysis of physical experience that it is difficult to think of a departure from it or even a generalization of it. It is conceivable, however, that a useful broadening of the realm of physical data would result from closer association between physicists and psychologists in the study of the sensations. After all, these furnish ultimately all our physical experience. It would pay to investigate them rather more carefully than has been the habit of physicists in the past. Consider here the valuable work on audition started years ago by Helmholtz and continued more recently by Harvey Fletcher and his colleagues at the Bell Telephone Laboratories; also the more recent work of Wever and Bray at Princeton and Stevens and Davis at Harvard. Intensive study of all the sense perceptions can hardly fail to suggest new ways of constructing physical concepts. One of the best auguries for the success of this cooperation of the physical and biological sciences is the increasing use of physical laboratory apparatus by psychologists and biologists. The progress of science may well be accelerated in this way even faster than by intense preoccupation with very highly specialized fields like cosmic rays or nuclear physics, simply because that out of it there may come a new attitude toward the data of physics.

We have all at some time or other been struck by the essential arbitrariness or con-

ventionality of the methods of physical measurement. Thus in the construction of most scales the spaces between the marks are chosen equal. It seems a very natural thing to do, and yet how arbitrary it really is! In thermometry, for example, it amounts to a definition of temperature as a *linear* function of the length of a bar of metal or of a thread of mercury or of the pressure of a gas, etc. The procedure passes the pragmatic test in most cases, though there are certain instances where it leads to queer results; thus in acoustics the scale of absolute acoustic intensity fails entirely to agree with the scale of observed loudness, the relation being more like a logarithmic one. It is customary to treat the absolute scale as the fundamental one and to attribute the lack of agreement to the peculiar physiological behavior of the ear. When we consider that the physical theory of sound was originally based on auditory sensations, this appears as a somewhat curious circumstance. It is left to the reader as a suggestion of: (1) the possibility of supplementing the conventional realm of physical data by a modification of measuring scales, and (2) the possibility that the suggestions of how this may be usefully accomplished may come from cooperative study in the borderline field of physics and psychology through a more searching study of sense-perceptions.

The utility of these considerations for theoretical physics may be noted in the increasing interest in the part that the *observer* plays in physical theories. Classical theory treats the data of physics as independent of the observer and considers him a creature whose mistakes in making measurements can be largely ironed out by the expedient of many repetitions of the same measurement and the liberal use of an arbitrary theory of errors. The observer plays no rôle in classical physical theory except to invent the theory. Quantum mechanics and relativity have brought him back very decidedly into the picture. It would seem only reasonable to pay more attention to his actual raw experience. As an interesting commentary on the present situation a physicist who has had a great deal to do with re-emphasizing the importance of the

observer in physical theories, Niels Bohr, has been led to the enunciation of a principle of limitation of human experience in the form of the so-called complementarity concept. Bohr apparently feels that physicists will forever be forced to think in terms of our intuitive notions of space and time. This implies his conviction that all physical experience will be forced into these conventional categories. This limitation would seem to be unwarranted conservatism; certainly it involves a lack of optimism with regard to the evolution of the human organism. It would be remarkable if our descendants a thousand years from now were to consider experience wholly from the standpoint of our present knowledge and methods of gaining it. It is hard to believe that the so-called primitive intuitions of space and time on which all our physical experimentation is based have reached their final form. The human mind has proved itself again and again very adaptable in adopting new points of view. Thus there was a time when the axioms and postulates of Euclidean geometry were considered to be *a priori* synthetic judgments imposed by necessity on the mind, so that without them no logical use of the space concept in science was possible. This attitude was shown to be illusory by the development of non-Euclidean geometry. The point may be made that this is of theoretical interest only and can have no influence on physical measurements. This not only begs the question at issue but is at variance with any reasonable interpretation of the history of physics, where it has been demonstrated many times that new methods of experimentation have developed from purely theoretical suggestions. There appears to be no fundamental limitation to this process except through the adoption of a point of view which must be characterized as frankly metaphysical.

What has just been said about space concepts may equally well apply to time. The theory of relativity has showed the theoretical advantage of depriving the concept of time of any preferred status and of putting it on the same logical basis as space. The objection may be made that this will have

little effect on the way in which time enters into our actual measurements. This view is of questionable merit, for the so-called primitive notion of time may ultimately undergo considerable modification by the adoption of a new attitude toward its use in physics. In physical equations, time is only a convenient parameter for the comparison of physical systems. Thus, instead of comparing two systems directly with each other and setting up a one-to-one correspondence between them, we prefer to introduce a third system called a clock and compare each system separately with this. It is a convenient though arbitrary procedure. Possibly some day we shall recognize its arbitrariness more vividly and decide to do without it. In the meantime the public or social conception of time with which the conventional procedure is linked may and probably will undergo considerable change with the rapid increase in the speed of communication. Few will argue that the widespread use of radio is not going to alter the primitive conception of time among millions of listeners. The ultimate effect of this on the interpretation of physical data may be very great. The science of mechanics, which now considers that it has solved every problem of motion when it has expressed the coordinates of every system in terms of

the arbitrary time parameter, would become a quite different discipline in which the setting up of direct relations among the coordinates of different systems would take the center of the stage.

To sum up, the nature of physical explanation will undergo considerable modification in the not very distant future, not merely through changes in the language used to describe physical experience, but also through an extension of the realm of this experience itself. At the same time, no matter how enlarged this realm may become, physics will continue to remain a "vicious abstraction" to the philosopher critics, since there is no likelihood that physicists will ever include *all* experience in their data. The age-old problem of the most suitable character of physical concepts, i.e., whether they should most appropriately be linked as closely as possible to actual experience or whether they should be constructed by the free use of the imagination independently of their relation to experience, will never be solved because it is a question of taste. Nevertheless, with the broadening of the data new concepts will evolve and the nature of the abstraction which is physics will always be in continual flux like everything else pertaining to man.

ENTOMOLOGY.—*New Australian Tingitidae (Hemiptera)*.¹ CARL J. DRAKE
Iowa State College, Ames, Iowa.

This paper contains the descriptions of three new genera, 11 new species, and one new variety of Tingitidae from Australia. The types of the new species are in my collection.

Ulonemia concava, n. sp.

Moderately large, elongate, brown, the paranota lighter in color. Head with the three front spines short, brown, tuberclelike, the hind pair short, blunt, testaceous, appressed. Rostral channel narrow, open behind, the rostrum barely reaching to middle coxae, the laminae whitish testaceous. Antennae moderately long, moderately stout; segment I a little stouter and less than twice as long as II; III long, two and one-half times as long as IV, the latter slightly

thickened. Eyes moderately large, black. Legs moderately long, brown.

Pronotum moderately convex, pitted, tricarinate, the carinae distinct, not areolated, the lateral divaricating anteriorly; calli distinct, smooth; collar raised, areolated, not produced in front, the median portion slightly raised; paranota narrow, slightly reflexed, biseriate in front, very narrow, carinalike and nonreticulated behind. Elytra distinctly constricted behind the middle; costal area narrow, uniseriate, the areolae smaller at constriction; subcostal area biseriate; discoidal area bounded by sharply elevated nervures, narrowed at base and apex, widest near middle, there six areolae deep, the outer margin nearly straight.

Length, 3.45 mm; width, 0.95 mm.

¹ Received July 29, 1942.

Holotype (male) and paratype, Cedar Creek, Queensland. The paranota and constricted elytra separate it from its congeners.

Ulonemia leai, n. sp.

Moderately long, moderately broad, brown. Head brown, with five rather short, porrect, brown spines. Antennae brown, rather long, slender; segment I stouter, much stouter and twice as long as II; III nearly three times as long as IV, the latter mostly black-fuscous, moderately thickened. Rostrum extending slightly beyond mesosternum; laminae testaceous, slightly concave within on mesosternum.

Pronotum convex above, pitted, sharply tricarinate; lateral carinae distinctly divaricating anteriorly, indistinctly areolate; hood moderately large, strongly flattened above, not produced in front, very narrow and non-reticulated at humeral angles. Elytra broadest slightly beyond middle; costal area rather narrow, uniseriate; subcostal area broader, biseriate; discoidal area sharply set off by raised nervure, narrowed at base and apex, widest at middle, there seven or eight areolae deep, the outer boundary slightly sinuate; sutural area slightly more widely reticulated posteriorly. Wings longer than abdomen, smoky in color.

Length, 3.20 mm; width, 1.10 mm.

Type (female), Corns District, collected by A. M. Lea (Hacker collection). This species is broader than *U. concava* and has a distinctly dorsally flattened hood. The character of the hood will also separate it from other members of the genus.

Ulonemia decoris, n. sp.

Very similar to *U. concava* in color and form, but with the hood larger and depressed above and much broader paranota. Paranota rather broad, strongly reflexed, nearly uniform in width and not narrowed at humeri, bi-triseriate. Hood moderately large, not projecting in front, strongly depressed. Rostrum reaching meso-metasternal suture. Pronotum, elytra, and color very similar to *concava*, including constricted costal area. Antennae moderately long, brown; segment I stouter and a little longer than II; III three times as long as IV. Spines on head short, blunt, brown. Wings longer than abdomen, brownish.

Length, 3.40 mm; width, 1.00 mm.

Type (male) and allotype (female), Mount Glorious, Queensland. Paratype, 1 specimen taken with type; 6 specimens, Maleny, Queensland, January 10, 1925; Cornbiey, South Australia, N. B. Tindale.

Malandiola semota, n. sp.

Moderately large, cinereotestaceous, with brownish areas. Head convex above, brown, the front and hind pairs of spines represented by small, testaceous tubercles, the median wanting. Eyes moderately large, black, transverse. Antenniferous tubercles thick, short, testaceous. Antennae brownish, indistinctly pilose; segment I short, slightly stouter than II; III moderately long, nearly four times as long as IV, the latter short, thickened apically, mostly dark fuscous. Rostral channel deep, narrow, open behind, the rostrum extending between middle legs.

Pronotum moderately convex, pitted, tricarinate; median carina distinct, slightly elevated on triangular process; lateral carinae distinct on triangular process, becoming obsolete on disk, wanting in front; paranota very narrow, completely reflexed, carinalike at humeral angles. Collar, areolated, similar in form to *similis* Hacker, the median portion also extending triangularly posteriorly. Elytra without costal area, subcostal area triseriate; discoidal area large, widest at middle, the outer margin sinuate.

Length, 3.10 mm; width, 1.10 mm.

Type (male) and allotype (female), Murray Bridge, South Australia, H. Hacker. Paratype, 14 specimens, taken with type; 12 specimens, Williamstown and Point Lincoln, South Australia, H. Hacker; 1 specimen, Kiata, Victoria, October 1929, F. E. Wilson. This species is distinctly larger than *M. similis* Hacker and the lateral carinae are distinctly defined behind. In *similis* the lateral carinae are more or less obsolete, and the male is usually much smaller than the female. *Simplex* Horvath is a shorter species, with shorter head and collar, and the pronotum is unicarinate.

Codotingis, n. gen.

Head short, with five spines. Eyes large. Rostral channel open behind, the rostrum long. Bucculae closed in front. Orifice present. Antennae slender, with segment I and II short; III longest, slenderest; IV fusiform, moderately

long. Pronotum convex, pitted, tricarinate, moderately narrowed anteriorly; hood scarcely projecting in front, inflated, united beneath with median carina and extending posteriorly nearly to disk; paranota narrow, almost completely reflexed, reticulated. Elytra divided into the usual areas, the discoidal area large, extending beyond the middle of elytra. Wings present.

Type of genus, *Codotingis recurva*, n. sp. This genus belongs to the subfamily Tingitinae. It may be separated from *Leptopypha* Stal, *Melandiola* Horvath, and other allied genera by the hood.

Codotingis recurva, n. sp.

Small, reddish brown, the hood and elytra lighter in color. Head reddish brown, the median spine short, tuberclelike, the front and hind pairs slender, testaceous, appressed; eyes large, reddish. Antennae moderately long, slender, yellowish brown, the apical segment black; segment I short, stouter and less than twice as long as II; III slender, testaceous, three times as long as IV. Rostrum long, extending almost to end of sulcus, the sulcus gradually widening posteriorly.

Pronotum distinctly tricarinate, the lateral carinae long, thin, divaricating a little anteriorly; median carina slightly higher than lateral; hood small, inflated, projecting posteriorly, the crest located behind; paranota very narrow, uniseriate, totally reflexed except opposite calli, there nearly vertical. Elytra broadest opposite apex of triangular process, somewhat narrowed apically, completely overlapping and jointly rounded behind when at rest; costal area narrow, recurved, the outer margin not touching subcostal area; subcostal area wider, biseriate; discoidal area widest beyond middle, there seven areolae deep, the outer margin faintly raised and strongly bowed; sutural areas more widely reticulated.

Length, 2.65 mm; width, 1.20 mm.

Type (female), Nanango District, Queensland, November 1927, taken by H. Hacker.

Callithrinco serratus Horvath

Two specimens, male and female, National Park, Queensland, May, 1934, F. A. Perkins. The male is distinctly narrower than the female. The antennae are moderately long, slender, brown, the apical half of terminal seg-

ment black, thicker and hairy; segment I short, stouter and twice the length of II; III very slender, straight, three times as long as IV. The rostral channel is deep, narrow, entirely open behind, the sides foliaceous and areolate; rostrum very long, not quite reaching the end of the sulcus. The bucculae are broad, areolate, and closed in front.

Callithrinco signatus, n. sp.

Color, shape, and general appearance very similar to *C. serratus* Horvath, but separated from it by the triseriate costal area, median carina less foliaceous on disk, and the paranota much less turned up and less elevated within. Rostrum long, extending to end of sulcus. Antennae brown, the distal half of last segment black; segment III very slender, three times as long as IV. Head with five stout, moderately long spines. Pronotum moderately convex, truncate in front, the erect protuberance at base of collar smaller than in *serratus* and the setose hairs on paranota fewer and shorter; median carina sharply arched but not strongly foliaceous on disk, moderately elevated apically. Nervure separating subcostal and discoidal areas sinuate, the erect, setose hairs mostly wanting or greatly reduced. Costal area irregularly bi-triseriate, the outer margin spined as in *serratus*. Other characters very similar to *serratus*.

Length, 2.95 mm; width, 1.25 mm.

Type (male) and allotype (female), Mount Glorious, Queensland, September 26, 1928, H. Hacker.

Inonemia, n. gen.

Head not strongly produced in front, with two hind spines; clypeus prominent, ridge-like; eyes moderately large. Antenniferous tubercles short, stout; antennae moderately long, rather slender; segment I short, a little stouter and longer than II; III longest, straight; IV moderately long, scarcely thicker than III. Bucculae very broad, reticulated, closed in front. Rostrum extending to mesosternum; rostral channel rather broad, the laminae rather low, meeting behind. Legs short, the femora short. Orifice indistinct. Pronotum moderately convex, pitted, tricarinate, the lateral carinae long, strongly divaricating anteriorly; calli present; collar raised, reticulated; hood absent, paranota expanded and reticu-

lated in front, wanting on posterial half. Elytra considerably wider than pronotum, divided into usual areas, the outer margin of costal area strongly, arcuately rounded at the base; wings present.

Type of genus, *Inonemia mussiva*, n. sp. Allied to genera *Neotingis* Drake and *Acysta* Champion but easily distinguishable by its semilacy appearance, distinctly divaricating lateral carinae, short femora and paranota. The head is also a little longer and broader; the pronotum, paranota, and elytra are very similar in texture and appearance.

***Inonemia mussiva*, n. sp.**

Cinereotestaceous, with indistinct brownish areas. Head reddish brown; eyes reddish black; hind pair spines short, testaceous, appressed, not reaching middle of eyes. Antennae indistinctly pilose, testaceous, the tip of terminal segment black; segment II about twice as long as IV. Rostrum and laminae dark fuscous. Legs short, beset with short setae, testaceous, the femora short, rather stout, reddish brown.

Pronotum coarsely pitted, truncate in front, a little darker in color than elytra; calli impressed, dark brown; carinae distinct, not foliaceous; paranota short, projecting laterally, biseriate, not extending posteriorly beyond calli; hind triangular process large, more coarsely pitted. Elytra broad at base, about the width of costal area, wider than pronotum, widest near the basal third, thence narrowed posteriorly; costal area rather broad, mostly biseriate, the areolae not very large and nearly rounded; subcostal area long, rather narrow, triseriate in widest part; discoidal area large, extending considerably beyond middle, widest near middle, there six or seven areolae deep, the areolae small and rounded; sutural area large, areolae becoming a little larger distally.

Length, 2.30 mm; width, 1.10 mm.

Type (male) and allotype (female), Roma, Queensland, November 30, 1930, L. Franzen.

***Inonemia mussiva brevis*, n. var.**

Very similar to *I. mussiva* n. sp. but with much shorter antennae, the entire antennae being shorter than the third antennal segment of *mussiva*. Antennae short, testaceous, the apical third or fourth black; segment I short, scarcely longer or thicker than II; III twice as long as IV. Other characters similar to *mussiva*.

Type (female), Roma, Queensland, November 30, 1930, collected by L. Franzen.

***Engynoma*, n. gen.**

Head short, convex above, with five slender spines. Eyes moderately large, transverse. Bucculae broad, areolated, closed in front. Rostral channel rather deep, moderately wide, open behind, the laminae foliaceous. Antennae rather slender, moderately long; segments I and II short, moderately thickened; III long, slender; IV fusiform, moderately long. Pronotum convex above, moderately narrowed anteriorly, tricarinate; all carinae long; hood absent; collar distinct, areolated, with two erect spines. Calli present; paranota narrow, linear, reflexed, areolated, with or without spines on margins; hind process long, triangular. Elytra longer than the abdomen, jointly overlapping behind when at rest, with the usual areas sharply defined. Legs moderately long, slender.

Type of genus, *Engynoma* (*Perissonemia*) *tasmaniae* Drake and Poor. *Tingis spinicollis* Horvath, *T. angulata* Hacker, and *T. insularis* Hacker also belong to this new genus. In these four species and the two new forms described below, there is an erect, slender, moderately long, sharp spine on each side of the median line (near the middle) of the collar. In *spini-*
collis, *angulata*, and *insularis*, the lateral margins of the paranota are also armed. In *immaculata* n. sp., *deaba* n. sp., and *tasmaniae* (Drake and Poor), the paranota are unarmed. The six known species are all rather similar in appearance and from the Australian region.

***Engynoma immaculata*, n. sp.**

Elongate, narrow, testaceous; legs and antennae brownish, the tarsi and terminal segment of antennae black. Head pale brown, with five long, slender, testaceous spines. Rostrum brown, extending almost to middle of mesosternum, the laminae pale testaceous, not meeting behind.

Pronotum moderately convex, finely pitted, carinae distinctly more foliaceous than in *tasmaniae*, uniseriate, the areolae broader; paranota also distinctly broader, uniseriate, strongly reflexed, uniseriate behind, biseriate in front, the outer row of areolae large, broader than long, rectangular; collar rather long, finely areolated, the two spines erect, slender, rather

long. Elytra elongate, slightly constricted beyond the middle, the margins subparallel; costal area slightly reflexed, rather narrow, mostly biseriata, the inner row of areolae very small and sometimes disappearing at the constriction; subcostal area a little broader, triseriate; boundaries separating subcostal, discoidal and sutural areas distinctly raised, finely areolated. Legs slender, pale brown, the tarsi black.

Length, 3.00 mm; width, 0.80 mm.

Holotype (male), Cedar Creek, Queensland, January 25, 1931, H. Hacker. This species is more elongate and has more foliaceous carinae and paranota than *tasmaniae*. It is not easily confused with other members of the genus.

***Engynoma deaba*, n. sp.**

Moderately large, cinereotestaceous, with a few small, black-fuscous markings. Head dark brown, shiny, with five testaceous spines, the median porrect. Rostral channel narrow, deep, the laminae testaceous, foliaceous, not meeting behind; rostrum dark brown, reaching between middle legs. Antennae testaceous, indistinctly pilose; segment I short, slightly longer and stouter than II; III about two and one-half times as long as IV, the latter fusiform and mostly black. Eyes rather large, black. Legs testaceous, the tips of tibiae and tarsi dark fuscous.

Pronotum moderately convex, pitted, tricarinate; carinae foliaceous, each uniseriate; the areolae moderately large, the lateral pair slightly diverging anteriorly, slightly concave within on disk; collar distinct, areolated, the two spines erect; paranota rather narrow, moderately reflexed, slightly wider opposite calli, uniseriate; triangular process with a transverse, black-fuscous band near the middle extending across costal and subcostal areas; boundaries separating subcostal, discoidal and sutural areas moderately elevated, finely areolated; costal area uniseriate, the areolae moderately large; subcostal area triseriate, the areolae small.

Length, 3.20 mm; width, 1.10 mm.

Holotype (female) and paratype, National Park, Queensland, December, 1933, H. Hacker. This insect is a little larger than *angulata* (Hacker), *insularis* (Hacker) and *spinicollis* (Horvath) and the lateral margins of the paranota and elytra are without spines.

***Furcilliger comptus*, n. sp.**

Moderately large, obovate, brownish to yellowish brown, sometimes with a few small fuscous spots, armed with numerous slender spines, and rather densely clothed with fine, decumbent hairs. Head brownish, with five long, slender nearly erect, brown spines; eyes rather small, dark. Rostrum long, brownish, black at apex, extending almost to end of sulcus; laminae thick, high, finely hairy, not widely separated, entirely open behind. Bucculae broad, V-like excavated in front, meeting at the base, produced downward at each end in front so as to form a small tooth. Legs moderately long, pale brown, beset with numerous, short, bristly hairs. Antennae moderately long, brownish; segments I and II thick, beset with bristly hairs, the latter shorter and obconical; III long, slender; IV absent.

Pronotum rather strongly convex, clothed with numerous short hairs, tricarinate; lateral carinae strongly converging behind disk and then slightly converging anteriorly until they become contiguous with the sides of the median carina, terminating in front at base of hood, each finely areolated; median carina distinctly more elevated on disc, there arched; all carinae beset with slender spines; hood small, scarcely produced in front, highest near center, there with a forked spine. Paranota almost completely reflexed, beset with numerous sharp spines, the outer margin turned up so as to appear almost like lateral carinae. Triangular process rather large, hairy, areolate. Elytra clothed with fine hairs, with lateral margins and nervures separating areas beset with slender spines; costal area rather broad, with three, moderately large, confused rows of areolae, the areolae hyaline; subcostal area narrower, biseriata; discoidal area large, widest a little behind middle, the outer margin sinuate. Sides of thorax beset with fine bristly hairs. Venter brownish, with shorter bristly hairs. Wings smoky, nearly as long as elytra, the latter a little longer than abdomen.

Length, 3.90 mm; width, 1.80-2.00 mm.

Type (male), allotype (female), and 2 paratypes, Imbil, Queensland, January, 1936, collected by A. R. B. Combs, on *Gmelina leichhardtii* (family Verbenaceae). This species has differently formed paranota, carinae, and wider costal area than *T. asperulus* Horvath. It is

also clothed with hairs and armed with many more spines. There may be some question regarding the generic position of *comptus* n. sp., but it seems advisable to place it in *Furcilliger* Horvath until the limits of the genus are more clearly defined.

***Leptopharsa enodata*, n. sp.**

Head brown, convex above, with five moderately long spines, the three frontal spines testaceous and erect, the hind pair brownish and appressed. Bucculae broad, reticulated, contiguous at the base in front, the margins in front above the base angulately excavated so as to form a V-opening. Rostral channel wide, wider and concave within on mesosternum, the laminae rather low, testaceous, reticulated; rostrum extending to middle of mesosternum. Antennae very long, slender, testaceous, the apical segment mostly black; segment I very long, nearly four times as long as II, the latter short; III very long, slenderest, four times as long as IV; IV long, slightly thickened, about equal in length to I and II taken together. Body beneath black. Legs testaceous, slender, the tarsi black. Eyes transverse, moderately large, black.

Pronotum brown, rather strongly convex, pitted, reticulated behind, tricarinate; median

carina mostly uniseriate, arched on disk, there bi- or triseriate; lateral carinae uniseriate, strongly constricted behind disk; hood rather small, inflated, scarcely produced forward, the crest about the center; paranota rather narrow, mostly biseriate; the outer margin broadly rounded. Elytra widest in front of middle, somewhat narrowed apically, slightly constricted behind middle, the outer margin finely serrate; costal area rather broad, irregularly triseriate; subcostal area more closely reticulated, quadriseriate; discoidal area narrowed at base and apex, extending beyond middle of elytra, widest beyond middle, there six areolae deep, the outer boundary sinuate. General color of reticulation brownish, somewhat variegated with dark brown or fuscous areas. Areolae largely hyaline.

Length, 3.20 mm; width, 1.30 mm.

Type (male), allotype (female), and 1 paratype, North Pine River, Queensland, September 15, 1920, H. Hacker; 1 paratype, Conodale, Queensland, January 7, 1930, H. Hacker. This species is much slenderer than *gracilis* (Hacker) and has much narrower paranota, narrower costal area, and less foliaceous median carina. The reticulations are also a little thicker.

ICHTHYOLOGY.—Seven new American fishes.¹ ISAAC GINSBURG, Fish and Wildlife Service. (Communicated by ELMER HIGGINS.)

This paper originated in and is part of the result of a study of material received from two sources: (1) Some species collected by the research vessel *Atlantis* in 1937 and kindly submitted to me for study by Dr. Albert E. Parr when he was director of the Bingham Oceanographic Foundation; (2) a part of the collection of fishes obtained by the research boat *Pelican* in connection with the shrimp investigation of the Fish and Wildlife Service, which came into my hands through the courtesy of my colleagues in the service, Milton J. Lindner and William W. Anderson. Three undescribed species from the northern part of the Gulf of Mexico were found in those two collections. In attempting to distinguish properly *Emblemaria piratula* and deter-

mine its affinities, I discovered three undescribed species of that genus in the National Museum, and mixed in with the *Emblemarias* one new goby. All these species are described herein. Two of the species are described from specimens obtained by the well-known Wilkes Expedition more than a hundred years ago. All the holotypes are in the U. S. National Museum. Paratypes of two species are deposited in the Bingham Collection.

***Bollmannia communis*, n. sp. (Gobiidae)**

Soft dorsal and anal predominantly with 14 rays, sometimes 13 or 15. (Out of 78 specimens in which the rays were counted in both fins, 64 have the predominant counts; 2 have 13 rays in both fins; the other 12 variants have only either fin with 13 or 15 rays while the other has 14.) Pectoral rays 21-23, the tip of

¹ Received July 18, 1942.

the fin reaching a vertical variably placed between the bases of the first to third dorsal ray. Approximately upper third of opercle almost entirely covered with two large scales. Cheek well scaled from about middle of eye backward, except a rather broad naked strip along its lower margin. Fourth or fifth spine the longest, tip of longest spine usually reaching, when stretched along the back, to base of fourth ray of second dorsal in large male, varying from base of third to seventh; to base of first or second ray in female. Posterior dorsal and anal rays of male reaching more or less beyond end of hypural, those of female about reaching there or slightly short. Tip of ventral fin about reaching anus, often slightly past anus in male or slightly short in female. As compared with all 11 species of *Bollmannia* now authentically known, the caudal is rather long, longer or as long as in most of them, but averaging shorter than in *longipinnis*; the head averages moderately long and the eye is medium to rather large. First dorsal with a posterior black spot; male with a broad, black or dusky band on the distal margin of the same fin; other fins shaded more or less with dusky or blackish; head and body usually without definite marking, body sometimes with a median row of five faint smudges.

This species is described from 81 specimens, 45–108 mm, obtained in the northern part of the Gulf of Mexico; 37 specimens obtained by the *Atlantis* in 1937 at 5 stations; 44 specimens obtained by the *Pelican* during 1938–39 at 16 stations. The extremes of the geographic range of the samples studied are from off Padre Island, Tex., to off the Mississippi Delta; between latitudes 26° 34' and 29° 29' and longitudes 88° 46' and 96° 53' 30". The extremes of the vertical range are 3.5 to 45 fathoms. This is evidently a common species in that region, and it is remarkable that it has remained undiscovered up till now. It is not that it has been masquerading under an alias. As far as I know, no specimens have ever been recorded under any name. It probably has a circumscribed geographic or vertical distribution.

Holotype, U.S.N.M. no. 119873: *Pelican* station 77-1; 28° 59' N., 89° 29' W.; 10 fathoms; male, total length 83 mm, standard length 52.5 mm; caudal 59, ventral 30.5, pectoral 26.5 depth 25, peduncle 12.5, head 29, postorbital,

13.5, head depth 20.5, head width 17, maxillary 13.5, snout 9, eye 8.5, antedorsal 34.

This species is structurally nearest to *Bollmannia* (sic) *litura* Ginsburg (Smithsonian Misc. Coll. 91 (20). 1935), from the coast of Haiti. It has the eye not so large as in *litura* (which has a very large eye, larger than in any known species of its genus); there are no intergrades in this measurement among specimens of the two species so far measured. The second dorsal and anal counts are distinctly higher in *communis*, although there is some slight degree of intergradation. The head and postorbital average less in *communis*; but there is considerable intergradation in those measurements.

Another congener that occupies adjacent waters, *B. boqueronensis* Evermann and Marsh, differs from *communis* in having a lengthwise row of scales along the lower margin of the cheek; a shorter head, there being no intergrades in the specimens measured; and fewer dorsal and anal rays but with a slight degree of intergradation.

Recently Fowler described what he took to be a new species, *Bollmannia jeannae* (Proc. Acad. Nat. Sci. Philadelphia 93: 95, figs. 7–9. 1941) from off Key West. I have not examined Fowler's specimens, but judged by his description and figure it is evident that they do not belong to the same species as *communis*. *B. jeannae* is probably based on specimens of *Bollmannia boqueronensis*; anyway his description and figure do not prove that they differ from it. Fowler does compare his *jeannae* with *boqueronensis* and points out certain differences, but they do not hold. The same differences are apparent also when authentic specimens of *boqueronensis* are compared with the figure published by Evermann and Marsh. This is because that figure is not altogether accurate. But the supposed differences are seen to be nonexistent when correctly identified specimens of *boqueronensis* are studied.

Garmannia mediocricula, n. sp. (Gobiidae)

Garmannia hemigymina Fowler (not Eigenmann and Eigenmann), Proc. Amer. Philos. Soc. 82: 791. 1940 (Rio de Janeiro).

D. VII: 12–13. A. 10. P. 20–21.

Anterior scales, from near base of pectoral to under space between the two dorsals, in a

very narrow band of one row and a second incomplete row; thence scaled area broadening out in wedge-shaped manner to ends of vertical fins; caudal peduncle completely scaled. About 34 scales in a complete longitudinal row. (Most scales in caudal row missing; but judged by traces of their impressions there were probably 4.) First spine in male shorter than second. Head subterete. Maxillary in male ending approximately under posterior margin of pupil. (The two specimens are now uniformly dark; possibly any color pattern originally present has faded by now.)

Ventral 24.5, pectoral 24–24.5, depth 20.5, peduncle 14.5, head 30.5–31, postorbital 18.5–19, head depth 16–17, head width 17, maxillary 13.5, snout 7.5–8.5, eye 8.5–9.5, antedorsal 38.

This species is described from two specimens, 28–29 mm as now measured, the caudals frayed at the end, 23–23.8 in standard length; obtained by the Wilkes Expedition at Rio de Janeiro. The smaller specimen is designated the holotype, U.S.N.M. no. 119876.

The extent of squamation of this species is rather intermediate between *G. hildebrandi* and *G. paradoxa*, from the Atlantic and Pacific coasts of Panama, respectively; but as shown by the lateral line organs *mediocricula* is nearer structurally to the Pacific *paradoxa*. Besides some differences in the details of the lateral line organs, *mediocricula* differs from *paradoxa* in having a subterete, instead of depressed, head, more pectoral rays and a more extensive squamation. Of its Atlantic coast congeners, *mediocricula* is probably nearest to *G. spes*; but no specimen of *spes* of adequate size is available for comparison. It differs widely from *spes* in the number of pectoral rays.

While I have so far not examined the type of *Gobius hemigymnus* Eigenmann and Eigenmann, their description differs so widely and in so many important particulars from the two specimens here described that they cannot belong to that species as they were identified by Fowler. "*Gobius*" *hemigymnus* is probably a species of *Risor*.

***Lonchopisthus lindneri*, n. sp.**
(Opisthognathidae)

D. X–XI 18. A. III 16–17. P. 18–19. Caudal with 16 segmented rays.

Gill rakers 18–22 on upper limb of first gill

arch, 33–36 on lower limb; total number of gill rakers on first arch 51–55 (range of both sides of the three specimens studied). Scales in 59–60 oblique rows below lateral line and 25 rows behind lateral line, to base of caudal; 37–39 scales in lateral line, ending under base of sixth soft ray. Scales present on antedorsal area to a vertical at a little distance behind posterior margin of eye; present also on throat in front of ventral base, and on pectoral base; cheek nearly all scaled behind a vertical through posterior margin of eye; a patch of scales on upper anterior part of the opercle in three or four lengthwise rows and extending over about anterior half of opercle; the narrow space between lateral line and base of dorsal with a lengthwise row of embedded, sometimes partly with nonimbricate scales, the row sometimes partly interrupted. Maxillary ending on a vertical behind eye, at a distance a little less than diameter of pupil, its posterior edge well emarginate, with a large supplemental bone. Second soft ventral ray, from its outer margin, notably prolonged, reaching past origin of anal. Posterior edge of pectoral on a vertical approximately through base of tenth dorsal spine. Soft rays of dorsal and anal unbranched, except last three or four branched, the last one divided to its base. Teeth in a single row in each jaw, of moderate size, none notably enlarged; no teeth on vomer.

Head and body uniformly colored in one specimen, anterior part of body with a few very faint, light, narrow, diffuse cross bands against a darker background in two; vertical fins dusky, caudal darkest becoming black posteriorly; outer surface of lower lip with a black area at angle of mouth, wedge-shaped, tapering anteriorly towards upper margin of lip, extending about midway between angle of mouth and symphysis of jaw, sharply marked in two specimens, rather faint in one.

Measurements of two specimens 96–105 mm, 60.1–61.7 mm in standard length. Caudal 59–70.5, pectoral 23–24, depth 26.5–29, peduncle 9–9.5, total length of head 30.5–32.5, length of head to tip of opercular spine 27.5–30, total length of postorbital 16–18.5, head depth 23–23.5, head width 14–15.5, maxillary 17.5–18.5, snout 5–6, eye 10–11, antedorsal 31.5–32.5.

This species is described from three specimens: *Pelican* station 112-4; off Padre Island, Tex.; 27° 13' N., 96° 47' W.; 33 fathoms; 64

mm in standard length with a teratological jaw on one side and generally in poor condition. *Atlantis* station 2840; off Isle Derniere, La.; 28° 19' N., 90° 59' W.; 31 fathoms; 61.7 mm in standard length. *Pelican* station 112-3; off Padre Island; 27° 13.5' N., 96° 40' W.; 42 fathoms; 60.1 mm in standard length. The species thus inhabits the same region, at the same depth, as *Bollmannia communis*. The latter two specimens were taken together with that species. The last specimen is designated as the holotype, U.S.N.M. no. 119874. The specimen obtained by the *Atlantis* is deposited in the Bingham Collection.

This species is nearest to *L. micrognathus*, a short account of which is given below for the purpose of comparison. It differs chiefly in having fewer gill rakers on the first gill arch. The cross-banded color pattern, judged by current descriptions of *micrognathus*, is apparently less distinct in *lindneri*. Judged by the specimens examined, it appears that *lindneri* may differ in the frequency distributions of some characters, namely, in averaging a lower scale count, a higher soft dorsal and pectoral count, a longer head, maxillary and antedorsal distance, and a larger eye, possibly also a longer caudal; but these can be determined only from much larger samples than those available. It may be of some significance that one of the three specimens of *lindneri* has 10 dorsal spines, whereas *micrognathus* appears to have constantly 11. This species is named for Milton J. Lindner, of the Fish and Wildlife Service.

***Lonchopisthus micrognathus* (Poey)**

D. XI 17-18. A. III 16-17. P. 18.

The above counts are based on three specimens from Cuba which I had for comparison with the preceding species: Poey's two types (U.S.N.M. no. 4785), 59-76 mm in standard length, now in bad condition; a small specimen 24 mm in standard length (no. 82510). Gill rakers in the two larger specimens 22-24 on upper limb of first gill arch, 39-40 on lower limb, total count 62-63 (range of one side of each). Oblique rows of scales below lateral line about 62-74. Caudal broken in the larger specimen, probably entire or nearly so in the two smaller, 44.5-50.5. In the two larger specimens: head to tip of opercular spine 26-27.5, maxillary 16-17, eye 9-9.5, antedorsal

28.5-29.5. Longley (Carnegie Inst. Washington Publ. 535: 244, 1941) states that all his Tortugas specimens of this species had 11 dorsal spines, the same count as determined by me.

***Emblemaria signifer*, n. sp. (Blenniidae)**

Emblemaria atlantica Fowler (not Jordan and Evermann), Proc. Amer. Philos. Soc. 82: 796. 1940 (Rio de Janeiro).

D. XX 12. A. II 20-21. P. 13.

First dorsal spine notably longer than following spines, in form of long filament, its tip reaching, when stretched along back, to base of tenth dorsal spine; second spine less than half length of the first; third spine subequal to second; fourth appreciably longer than preceding two; gradually increasing in length from fourth to eighth; eighth to eleventh subequal; thence gradually decreasing; last spine notably short, about half of first segmented ray; distal edge of dorsal thus with two well marked depressions, one behind first spine, the other between the two parts of the fin. Orbital cirrus very short, less than diameter of pupil, rather broad, unbranched, without fimbriae; narial cirrus slender and slightly longer. Maxillary reaching a vertical behind eye at a distance slightly over half its diameter in the larger specimen, not quite as far in smaller. Ventral apparently falling considerably short of anus (broken near its end). A few dark spots near base of dorsal distantly placed from one another, not alined in a regular row; anterior part of dorsal black basally, with a whitish margin; color evidently faded now and no other marks discernible.

Measurements of holotype, U.S.N.M. no. 119877, Rio de Janeiro, Wilkes Expedition: Total length 33 mm, standard length 27.8 mm, caudal 19.5, depth 18.5, peduncle 9, head 25.5, postorbital 15.5, maxillary 14.5, snout 7, eye 7, antedorsal 19.5. This account is drawn from the holotype and one paratype, 27 mm (U.S.N.M. no. 83144), the two specimens originally in the same lot.

The specimens here described do not belong to *E. atlantica* as they were identified by Fowler, but to a hitherto undescribed species. In fact, *signifer* is one of the more strongly marked species of its genus. The soft dorsal count is lower than in any species of *Emblemaria* so far discovered; the spinous dorsal and

anal counts are lower than in most of them; the outline of the dorsal, especially the filamentous and very long first spine as compared with the following spines is different than in any of them. (The dorsal outline of *guttata*, the next species described, comes nearest to that of *signifer*, but the difference is still considerable.) The latter character may possibly differ with age and sex. That remains to be determined. But it is very unlikely that such sex or age differences, if any, will be sufficiently pronounced to mask species differences. The combination of the above characters, together with the very short orbital cirrus, should make the identification of specimens of *signifer* an easy matter.

Emblemaria guttata, n. sp.

D. XXII 14. A. II 23. P. 14.

First dorsal spine moderately longer than second, its tip reaching base of ninth dorsal spine; the spines gradually increasing in length from second to fourth, thence decreasing; last spine considerably shorter than first segmented ray; the distal dorsal edge thus with two moderate emarginations, one behind first spine and one between the two parts of the fin. Orbital cirrus slender, medium, somewhat less than eye diameter, branched at base; narial cirrus still shorter, likewise branched. Maxillary reaching a vertical past eye at a distance about equaling half its diameter. Ventral ending at a considerable distance before anus.

An area on upper half of fish, under anterior part of dorsal, comprising posterior part of head and anterior part of body, irregularly beset with small dark spots; a median row of somewhat larger spots on body from base of pectoral backward, well marked on anterior part of body, faint or hardly perceptible on posterior part; anterior part of dorsal, between third and seventh spines and centered along middle of fin, with a large very dark brown spot, elongate-elliptical with its long axis in a lengthwise direction, rather well marked off from surrounding pigment; basal area of fin below spot very light, distal area and that behind spot dark, but appreciably lighter than spot.

Holotype, U.S.N.M. no. 101999; Secas Isle, Panama; 12 fathoms; W. L. Schmitt; February 5, 1935. Its measurements are as follows: Total length 36 mm, standard length 30.7 mm;

caudal 18, peduncle 9, head 29.5, postorbital 16.5, maxillary 16.5, snout 6.5, eye 9, ante-dorsal 20.

This species about agrees with *E. nivipes* Jordan and Gilbert, another species from Panama, in the number of dorsal and anal rays and in having a rather small, ramose orbital cirrus; it differs in the outline of the dorsal and in color. The dorsal outline of *guttata* resembles that of *signifer* described above from the Atlantic, but the two depressions in the fin are rather shallow, not so pronounced as in the latter. The rather profuse and fine spotting on part of the head and body is unlike the species of *Emblemaria* so far discovered, most of which have a diffuse and rather faint cross-banded color pattern.

Emblemaria piratula Ginsburg and Reid, n. sp.²

Suborbital very rough and bony at the surface, irregularly rugose and pitted, its distal margin somewhat roughly and irregularly crenate; anterior upper quadrant of orbital rim likewise bony and irregularly, rather rudimentarily tuberculate, but without definite, well-marked tubercles; two parallel ridges on upper aspect of snout presenting somewhat same appearance as orbital rim. Dorsal modally with 19 spines (in 9 specimens), sometimes with 18 (in 1) or 20 (in 2); segmented rays usually 14 (in 6) or 15 (in 5), sometimes 13 (in 1); total dorsal count 33 (in 7) or 34 (in 5). Anal with 2 flexible spines, modally with 21 segmented rays (in 8), often with 20 (in 4). Pectoral rays typically 13 (in 9), sometimes 12 (in 1). Anterior part of dorsal high, the spines increasing in length from first to fourth or fifth; tip of fourth spine about reaching base of twelfth to fifteenth; fourth to sixth spines highest, subequal; thence decrease gradually in length; last spine subequal to first segmented ray, the two parts of the fin nearly altogether and smoothly continuous. Orbital cirrus well developed, rather stout, long, nearly reaching to dorsal origin or a little short (broken off in most specimens); simple narial cirrus less than eye

² After I had drawn up a preliminary account of this species based on the *Pelican* specimen, I went to compare it with material of its genus in the National Museum and found that Earl D. Reid had independently come to the conclusion that the *Albatross* specimens represented an undescribed species. We therefore agreed to publish this species jointly.—I. G.

diameter. Maxillary reaching a vertical past eye at a distance about equalling diameter of pupil or not quite that far. Tip of ventral reaching anus or falling moderately short. Posterior margin of pectoral approximately on a vertical through anal origin.

Color of comparatively recently preserved specimen: Anterior part of dorsal black with a subtriangular whitish area near base, the black color gradually fading out posteriorly; head and body dusky, nearly uniformly sprinkled with minute, nearly microscopic, dark dots, except light, pigmentless areas on upper posterior part of head, upper, anterior part of body, and along dorsal base; no other distinctive markings. The specimens collected in 1885 have the color of the dorsal as described above, except that in some of them the black pigment is absent near the base of the fin; the head and body have now faded.

Measurements of one paratype: Total length 25 mm, standard length 21.4 mm; caudal 18, depth 17.5, peduncle 8.5, head 28, maxillary 14, snout 6.5, eye 6.5.

Holotype: U.S.N.M. no. 119875; *Pelican* Station 142-6; off St. Andrews Bay, Fla.; 29° 56' N., 86° 7.5' W.; 18 fathoms; 22 mm. In addition, the National Museum has 11 specimens, 22-27 mm, obtained by the *Albatross* in 1885 at three stations off the west coast of Florida, in 24-26 fathoms, as follows: Station 2406, 28° 46' N., 84° 49' W., 26 fathoms (U.S.N.M. no. 101091); station 2407, 28° 47' 30'' N., 84° 37' W., 24 fathoms (no. 101090); station 2374, 29° 11' 30'' N., 85° 29' W., 26 fathoms (no. 101089). The above account of the species is drawn from these 11 paratypes and the holotype. One specimen, 20 mm, in no. 101091 is in bad condition, and its identification not altogether certain.

This is a well-marked species. The black anterior dorsal with its well-marked white spot at the base is very distinctive and imaginatively suggests the pirate's flag. The spinous dorsal and the anal counts average lower than in all species of *Emblemaria*, except *signifer*. The rough, bony suborbital gives it a distinctive appearance. In other species of *Emblemaria* the suborbital is also rough after the skin is removed; but in *piratula* it is so at the surface, and more decidedly so. This as well as the strong ridges on the snout apparently represent the initial stages in the development of the

head armature as seen in the related genus *Acanthemblemaria*.

Emblemaria piratica, n. sp.

D. XXI-13. A. II 24. P. 13.

Upper aspect of snout with two lengthwise parallel rows of bony tubercles, one on each side of and near to midline, four tubercles in a row, one similar tubercle on midline between the two rows, near their posterior end; upper anterior quadrant of orbital rim roughly tuberculate, but not with the rather clear-cut tubercles of snout; one tubercle slightly behind and below nostril; suborbital not bony nor rough at surface. First three spines very high, subequal, tip of third reaching to base of sixteenth dorsal spine; fourth to sixth spines considerably shorter than first three, and moderately shorter than following spines, the margin of the dorsal therefore forming a moderate depression behind anterior three spines; the spines from seventh backward gradually decreasing in length; the last spine but little shorter than first segmented ray, the two parts of the fin thus nearly continuous, forming one fin with but a slight depression between them. Orbital cirrus about half diameter of eye, very slender, not branched; narial cirrus similar, somewhat shorter. Maxillary reaching a vertical past eye, at a distance a little less than diameter of pupil. Tip of ventral falling only a little short of anus.

Head and body a nearly uniform reddish brown; body with rather faint spots in a median row, the anterior ones very faint, the posterior ones somewhat better marked. The anterior and highest part of dorsal black; the more posterior part of spinous dorsal, from fifth spine backward, traversed by broad, oblique bands, running obliquely downward and backward, alternating black or dusky and light yellowish pigmentless; the soft dorsal dusky basally and distally, light and pigmentless along its middle part, lengthwise; anal with a broad blackish marginal area, more intensely pigmented anteriorly than posteriorly, the basal part of fin dusky; ventral dark, nearly black; pectoral and caudal light.

Holotype and only specimen studied: U.S. N.M. no. 101944; Secas Isle, Panama, 12 fathoms; W. L. Schmitt; February 5, 1935. Total length 28 mm, standard length 23.8 mm; caudal 18.5, depth 18.5, peduncle 7.5, head 28.

postorbital 16.5, maxillary 12.5, snout 6.5, eye 8.5, antedorsal 19.

The presence of distinct rather well developed bony tubercles on the upper aspect of the snout sets off *piratica* from all its congeners now known. The other species of *Emblemaria* have bony ridges in the same location. In

piratica these ridges have developed distinct tubercles. As noted under *piratula*, here also this character evidently represents one of the first stages in the development of the armature of the head, which reaches a high degree in *Acanthemblemaria*.

ZOOLOGY.—*Further remarks on some Mexican Urosaurus.*¹ M. B. MITTLEMAN.
(Communicated by HERBERT FRIEDMANN.)

A short time ago I had occasion to discuss *Uta nelsoni* Schmidt in a review of the Mexican so-called *Uta ornata* complex. I indicated at the time (This JOURNAL 31: 72-73. 1941) that on the basis of the type alone this nominal form seemed distinct enough from *bicarinata* and *anonymorpha* but was probably best disposed of as a subspecies of *bicarinata*. More recently (Bull. Mus. Comp. Zool. 91: 168. 1942), because no additional material had come to hand, I reiterated my former statement but included *nelsoni* as well as *bicarinatus* and *anonymorphus* in the redefined genus *Urosaurus*. As matters stood, *U. b. bicarinatus* was thought to range not farther east than Acapulco, Guerrero; *U. b. anonymorphus* was known to occur from Tierra Colorada, Guerrero to Tonolá, Chiapas; the unique type of *U. b. nelsoni* was known from Cuicatlán, Oaxaca.

Through the kindness of Dr. Edward H. Taylor I have had opportunity to examine, and report herewith, four *Urosaurus* from the type locality of *nelsoni* (EHT-HMS nos. 14054-57); in addition, Dr. Taylor has kindly lent me three *Urosaurus* from Totolapan, Oaxaca, which is about midway between Cuicatlán and the previously known range of *anonymorphus*. The seven specimens are exceedingly interesting, clarifying as they do the status of *nelsoni* and offering further information on the relationships and distribution of *bicarinatus* and *anonymorphus*. The apparent differences, which I previously reported as existing between *nelsoni* and the more southerly races *bicarinatus* and *anonymorphus*, now appear

to rest solely on the basis of individual variation in the type specimen of *nelsoni* (U.S.N.M. no. 46836). With good series of *anonymorphus* and *bicarinatus* before me, as well as Dr. Taylor's topotypes of *nelsoni*, I fail to note anything of a distinctive nature in the *nelsoni* that would serve to separate them from *bicarinatus*. The characters I heretofore considered diagnostic of *nelsoni*, as the immucronate ventrals, poor development of dorsolateral and lateral tubercles, smaller enlarged dorsals, and different proportions of the head, lack confirmation in these newly available individuals. In all the characters named, as well as others, I can not distinguish between *nelsoni* and *bicarinatus*. The Cuicatlán material (*nelsoni*) is fully as tuberculate, ventrals as mucronate, enlarged dorsals as big, and the head proportions are entirely within the range of variation exhibited by a good series of specimens from Cuernavaca, Morelos (*bicarinatus*). I must therefore regard *nelsoni* as a synonym of *bicarinatus*. The illusory distinction of the type specimen reflects a common type of individual or local variation seen in all *Urosauri*, especially in remote or end populations.

The specimens from Totolapan, Oaxaca (EHT-HMS nos. 14051-53), are interesting variants of the *anonymorphus* type; superficially they are somewhat like intergrades between this latter race and *bicarinatus*, although immediately recognizable as being much closer to *anonymorphus*. I think that here we are dealing with another case of the recrudescence of parental characters, in relatively remote populations of a derivative form, which occurs elsewhere in the *Urosauri* (cf. *U. clarionensis* and *U.*

¹ Received October 10, 1942.

auriculatus). Actual intergradation between *bicarinatus* and *anonymorphus* takes place, so far as known, only in eastern Guerrero, in the vicinity of Acapulco. The race *bicarinatus* largely follows the Río Balsas drainage in both the Upper and Lower Balsan biotic provinces (see Smith, Field Mus. Nat. Hist. Zool. Ser. 26: 15 *et seq.* 1939), while *anonymorphus* is largely restricted to the Tehuantepecan province, but extends westward to eastern Guerrero (Lower Balsan) and eastward to Chiapas (Tapachulan province). Thus, as now known, *bicarinatus* extends northward from Guerrero to Puebla, thence southeastward through northern Oaxaca to Cuicatlán. *U. b. anonymorphus* ranges from Tierra Colorada, Guerrero, to Tonolá, Chiapas; the most northerly record for the race is from Totolapan, Oaxaca. In Oaxaca, the ranges of *bicarinatus* and *anonymorphus* do not

meet, for the Río Balsas basin in the north and the Tehuantepec drainage of the south are separated by two great barriers: the high plains surrounding Oaxaca City and the range of mountains north of this city. The subspecies *anonymorphus* is now known from the following Oaxaca localities: Tehuantepec (type locality); Tuchitan; San Geronimo Ixtepec; Tres Cruces; Mount Guengola; Portillo los Nanches; San Bartolo; El Limón; Cajon de Piedra; Cerro Arenal; Mixtequilla; Salina Cruz; Huamehula; Totolapan. It is known also from Tierra Colorada, Guerrero, and Tonolá, Chiapas.

I am grateful to Dr. Edward H. Taylor for the opportunity to examine and publish information on lizards in his collection. Dr. Hobart M. Smith has kindly offered additional information on the Mexican biotic provinces involved.

PROCEEDINGS OF THE ACADEMY

NEW MEMBERS

The following persons were recently elected nonresident members of the Academy:

BROTHER LEON (JOSEPH SYLVESTRE SAUGET Y BARBIER), professor of botany, Colegio de la Salle, Vedado, Havana, Cuba, in recognition of his contributions to botany, particularly his researches on the palms of Cuba.

JOSÉ ANTONIO BERNABÉ NOLLA, director of Insular Government Agricultural Experiment Station, Rio Piedras, Puerto Rico, in recognition of his outstanding work in agricultural science, especially in plant physiology with tobacco and in plant nutrition from the standpoint of Liebig's law of the minimum.

313TH MEETING OF THE ACADEMY

The 313th meeting of the Academy was held jointly with the Washington Branch of the Society of American Bacteriologists, in the assembly hall of the Cosmos Club at 8:15 P.M. on October 15, 1942, with President CURTIS presiding. A. B. CRAWFORD introduced the speaker.

STUART MUDD, professor of bacteriology in the School of Medicine at the University of Pennsylvania, Philadelphia, Pa., delivered an address entitled *Structural differentiation within bacterial cell as shown by the electron microscope*. Professor MUDD discussed the differentiation of bacterial capsule, protoplasmic membrane, and nuclear material, and pointed out certain implications regarding the rationale of the uses of

vaccines and serums. The lecture was illustrated with many electron micrographs.

There were about 175 persons present. A social hour followed the meeting.

377TH MEETING OF THE BOARD OF MANAGERS

The 377th meeting of the Board of Managers was held in the library of the Cosmos Club on October 19, 1942. The meeting was called to order at 8:00 P.M. by President CURTIS, with 21 persons present, as follows: H. L. CURTIS, F. D. ROSSINI, N. R. SMITH, W. W. DIEHL, J. E. GRAF, F. G. BRICKWEDDE, H. B. COLLINS, JR., W. G. BROMBACHER, E. P. WALKER, A. H. CLARK, ALEXANDER WETMORE, J. B. REESIDE, JR., J. E. McMURTREY, JR., W. A. DAYTON, F. B. SILSBEE, E. W. PRICE, L. W. PARR, C. L. GARNER, H. G. DORSEY, HERMAN STABLER, and, by invitation, J. R. SWALLEN.

The minutes of the 376th meeting were read and approved.

President announced the following appointments: A. J. LOTKA, to be the Academy's delegate at the inauguration on September 30, 1942, of Henry Noble Wright as president of the City College of the College of the City of New York; ATHERTON SEIDELL, to be chairman of the Committee on Meetings, in place of J. H. KEMPTON, who resigned because of his appointment to an assignment in South America.

The Board authorized an additional allotment of \$15 for the Committee on Meetings for

1942, with instructions to omit refreshments from the programs of the meetings for November, December, and January.

The Board instructed the President to appoint a Committee to consider recommendations regarding ways of increasing the income of the Academy.

The Secretary reported the following information regarding the membership: Acceptances to membership, 14; qualifications for membership, 18; deaths, 4; retirements, 4; resignations, 2; status of membership as of October 17, 1942:

	<i>Regular</i>	<i>Retired</i>	<i>Honorary</i>	<i>Patrons</i>	<i>Total</i>
<i>Resident</i>	437	33	3	0	473
<i>Nonresident</i>	137	19	16	2	174
<i>Total</i>	574	52	19	2	647

On recommendation of the Editors, the Board authorized the Editors to comply with the War Production Board's Order No. 977 regarding the turning in of all obsolete cuts for scrap metal (obsolete cuts being defined as all those for which request by the authors has not been made within 30 days after publication), and to charge authors for illustrations in excess of the equivalent in cost of one full-page line cut and for all unusual costs relating to foreign, mathematical, and tabular matter.

The Secretary read to the Board some proposed changes in the Standing Rules, and was instructed to distribute copies of the proposed changes to the members of the Board for action at the next meeting.

The meeting adjourned at 9:31 P.M.

FREDERICK D. ROSSINI, *Secretary*.

Obituary

WILLIAM EDWARD PARKER, Captain (Retired), United States Coast and Geodetic Survey, died on September 30, 1942, at his home in Fort Lauderdale, Fla., following a long illness. He was born at Newton, Mass. on March 21, 1876, son of William C. Parker and Emily A. (Goodwin) Parker. After graduation from the Newton High School, he entered Massachusetts Institute of Technology from which he graduated in 1899 with the degree of B.S. in Civil Engineering. He entered the field corps of the Coast and Geodetic Survey on February 18, 1901.

His first assignment in this Service was on the old *Hydrographer* in 1901 on the Atlantic coast. From 1902 to 1905 he had served on the ships *Patterson*, *Gedney*, and *Bache* on assignments in Alaska, Puerto Rico, Panama, Florida, and off the New England coast. In 1906 he went to the Philippine Islands where he served on the ship *Fathomer* for two years. After his tour of duty in the Philippines he again was assigned to duty in Alaska from 1909 to 1910 on the ship *Patterson*. From 1911 to 1914 he was engaged on coast pilot work and during the latter part of this period prepared plans for the construction of the ship *Surveyor*. He was assigned to Washington headquarters as chief of the Section of Vessels and Equipment from 1915 to 1918. In the World War he was transferred by executive order to the Navy, and from 1918 to 1919 served in the Compass Division of the Naval Observatory.

After his return to the Coast and Geodetic Survey in 1919 after the war, Captain Parker performed his most outstanding work as chief of the Division of Hydrography and Topography (now Coastal Surveys), a major division of the Service. This division has direct charge of the ships of the Service and of all coastal surveys for chart construction. He served as chief

for 12 years, 1919 to 1931. It was during this period that marked improvements and developments were made in the technique and methods of hydrographic surveying. Captain Parker recognized the possibilities of echo sounding, which was developed about this time, in hydrographic surveying, and cooperated to the fullest extent with manufacturers of echo-sounding equipment. He arranged for the installation of one of the early fathometers on a Coast and Geodetic Survey ship on the Atlantic coast and encouraged the development and improvements in echo-sounding apparatus until finally the entire fleet of survey ships was fully equipped.

Following this outstanding contribution to surveying, Captain Parker next became interested in a method for locating a surveying ship when out of sight of land, now known as radio acoustic ranging. By this method the ship is located by determining the elapsed time of transmission through the water to distant hydrophones of the sound from the explosion of a depth bomb at the ship. Using this method, he planned the survey of the entire area of George's Bank in 1930 and carried this survey to a successful conclusion in 1931. While these methods naturally have now been improved and large areas surveyed since these early developments, they were the foundation of the present surveying technique of the Coast and Geodetic Survey, and have contributed in large part to the outstanding position of this Service among surveying organizations of the world.

From April 1931 to the time of retirement from active service October 31, 1934, Captain Parker was in command of the ship *Hydrographer* (new), engaged on offshore surveys in the Gulf of Mexico.

G. T. RUDE.

INDEX TO VOLUME 32

An asterisk (*) denotes the abstract of a paper presented before the Academy or an affiliated society.

PROCEEDINGS OF THE ACADEMY AND AFFILIATED SOCIETIES

Anthropological Society of Washington. 91.
 Chemical Society of Washington. 92, 151.
 Geological Society of Washington. 277.
 Philosophical Society of Washington. 311.
 Washington Academy of Sciences. 62, 84, 122, 273, 370.

AUTHOR INDEX

- ALICATA, JOSEPH E. Experimental transmission of endemic typhus fever by the sticktight flea, *Echidnophaga gallinacea*. 57.
 ——— and BREAKS, VIRGINIA. Incidence of leptospirosis among dogs in Honolulu as determined by serological agglutination tests. 305.
- BALLS, A. K. A crystalline sulphur-protein from wheat. 132.
- BARNETTE, DUDLEY P. *Reproduction of charts and maps. 312.
- BARTSCH, PAUL. New species of urocoptid land mollusks from Mexico. 187.
- BLAKE, S. F. New Asteraceae from northern Mexico collected by C. H. Muller. 146.
- BREAKS, VIRGINIA. See JOSEPH E. ALICATA. 305.
- BROWN, ROLAND W. A Miocene grapevine from the valley of Virgin Creek in northwestern Nevada. 287.
- BRUNAUER, STEPHEN. *The adsorption of gases and vapors on solids. 316.
- BURK, DEAN. *Diet in experimental cancer. 317.
- CASH, EDITH K. See M. L. LOHMAN. 296.
- CATTELL, R. A. Andrew Stewart (obituary). 320.
- CEDERSTROM, D. J. *Progressive down-dip changes in composition in artesian waters from the Cretaceous rocks of Virginia. 280.
- CLARK, AUSTIN H. Science and war. 33.
 ——— and LOCKLEY, GORDON J. Some echinoderms from northwestern Greenland. 250.
- CHAPMAN, R. W. *The Laurel "pseudomigmatite" and its significance in petrogenesis. 279.
- CHAPMAN, WILBERT McLEOD. The osteology and relationships of the Argentinidae, a family of oceanic fishes. 104.
- COOK, O. F. A scientific approach to African colonization. 1.
- COOPER, G. ARTHUR. New genera of North American brachiopods. 228.
- CURTIS, HARVEY L. A review of the methods for the absolute determination of the ohm. 40.
- DAVIDSON, ROSS W. See M. L. LOHMAN. 296.
- DE LAUBENFELS, M. W. Porifera from Greenland and Baffinland collected by Capt. Robert A. Bartlett. 263.
- DEMOREST, MAX. *Types of ice flow within glaciers. 282.
- DRAKE, CARL J. New Australian Tingitidae (Hemiptera). 359.
- DRECHSLER, CHARLES. Two zoophagous species of *Acrostalagmus* with multicellular *Desmidiopsis*-like chlamydospores. 343.
- EATON, THEODORE H., JR. Are "frontoparietal" bones in frogs actually frontals? 151.
 ——— Earthworms of the Northeastern United States: A key, with distribution records. 242.
- EWAN, JOSEPH. *Linanthastrum*, a new West American genus of Polemoniaceae. 138.
- FISHER, A. K. Clinton Hart Merriam (obituary). 318.
- FLINT, RICHARD FOSTER. Atlantic coastal "terraces." 235.
- FOSTER, M. D. *Chemical composition of salty ground waters along the Atlantic and Gulf coasts. 282.
- FOX, FRANCIS E. *Quartz resonators. 313.
- GAMOW, G. Concerning the origin of chemical elements. 353.
- GARNER, CLEMENT L. Walter Ford Reynolds (obituary). 283.
- GAZIN, C. LEWIS. Fossil Mammalia from the Almy formation in western Wyoming. 217.
- GILBERT, WM. J. See C. K. TSENG. 291.
- GINSBURG, ISAAC. Seven new American fishes. 364.
- HARRIS, H. M. Notes on *Harmostes*, with descriptions of some new species (Hemiptera: Corizidae). 27.
- HENSHAW, PAUL S. *The biological action of high energy radiation. 315.
- HESS, W. C. See M. X. SULLIVAN. 285.
 ——— and SULLIVAN, M. X. The determination of the cystine content of various proteins by different hydrolytic agents, sulphuric, hydrochloric, hydriodic, and a mixture of hydrochloric and formic acids. 130.
- HEWES, GORDON W. The Ainu double foreshaft toggle harpoon and western North America. 93.
- HEYL, PAUL R. *A new determination of the constant of gravitation. 316.
 ——— Cosmic emotion. 221.
- HICKMAN, C. N. *Archery paradise, paradox, and paralysis. 314.

- HOWARD, H. W. See M. X. SULLIVAN. 285.
- HULL, FRANK M. The genus *Ferdinandea* Rondani. 239.
- INSLEY, HERBERT. The electron microscope as a tool for the study of inorganic materials. 315.
- ISELL, HORACE S. Thomas Herbert Norton (obituary). 220.
- JOHNSON, D. P. *Calibration of mercurial and aneroid barometers. 317.
- KEMPTON, J. H. Effect of nutrient cultures on the reaction of maize seedlings to light. 328.
— See also LOUIS R. MAXWELL. 35.
- KESLER, T. L. *Genetic history of the pegmatites and associated rocks of the Carolina tin belt. 278.
- KNECHTEL, M. M. *Influence of topography on continental glaciation in north-central Montana. 279.
- LAMBERT, WALTER D. The distance between two widely separated points on the surface of the earth. 125.
- LEONARD, E. C. New tropical American Acanthaceae. 184.
— Three new species of Acanthaceae from Mexico. 341.
- LINDSAY, R. B. Physical explanation and the domain of physical experience. 356.
- LOCKLEY, GORDON J. See AUSTIN H. CLARK.
- LOHMAN, M. L.; CASH, EDITH K.; and DAVIDSON, ROSS W. An undescribed *Atropellis* on cankered *Pinus virginiana*. 296.
- LOOMIS, H. F. *Sinocybe*, a new genus of colobognath millipeds from China. 270.
- LUCES, ZORAIDA. New grasses from Venezuela. 157.
- MAXWELL, LOUIS R.; KEMPTON, J. H.; and MOSLEY, VERNON. Effect of temperature and time on the X-ray sensitivity of maize seeds. 18.
- MCCLURE, F. A. New bamboos from Venezuela and Colombia. 167.
- MCCOMB, H. E. Geophysical measurements in the laboratory and in the field. 65.
- McKNIGHT, E. T. *Zoning of ore deposits in the Tri-State district. 282.
- MISER, H. D. *The Devonian system in Arkansas and Oklahoma. 277.
- MITTELMAN, M. B. Further remarks on some Mexican *Urosaurus*. 370.
- MOSLEY, VERNON. See LOUIS R. MAXWELL. 18.
- NUTTING, P. G. A study of ionic adsorption in solutions of silica and alumina. 117.
- RAWDON, HENRY S. Edward Center Groesbeck (obituary). 284.
- REHDER, HARALD A. Some new land shells from Costa Rica and Panama. 350.
- REINHARD, EDWARD G. *Stereobalanus canadensis* (Spengel), a little-known enteropneustan from the coast of Maine. 309.
- RICHMOND, W. E. *Application of X-ray methods to mineral analysis. 280.
- ROSS, C. P., and YATES, R. G. *Coso quicksilver district, Inyo County Calif. 280.
- RUDE, G. T. William Edward Parker (obituary), 372.
- SCHULTZ, LEONARD P. Notes on some fishes from the Gulf of California, with the description of a new genus and species of blennioid fish. 153.
— The first record of the ophichthyid eel *Scytalichthys miurus* (Jordan and Gilbert) from the Galapagos Islands, with notes on *Mystriophis interinctus* (Richardson). 83.
- SETZLER, FRANK M. Archeological accomplishments during the past decade in the United States. 253.
- SHALOWITZ, AARON L. *The modern nautical chart—a scientific achievement. 312.
- SHOEMAKER, CLARENCE R. A new species of Amphipoda from Uruguay and Brazil. 80.
- SKLAR, A. L. *The absorption spectra of some organic dyes. 318.
- SOOKNE, A. M. *The molecular basis for the mechanical properties of acetate rayon. 315.
- SPICER, H. C. *Resistivity studies in the potash area of New Mexico. 278.
- STONE, ALAN. New species of *Anastrepha* and notes on others (Diptera, Tephritidae). 298.
- STOSE, G. W. *Structural interpretation of the Death Valley region by Levi Noble. 279.
- SULLIVAN, M. X. See W. C. HESS. 130.
- SULLIVAN, M. X.; HESS, W. C.; and HOWARD, H. W. The behavior of cystine dimethylester dihydrochloride and of cysteine monomethylester monohydrochloride in the Sullivan reaction for cysteine and cystine. 285.
- SWINGLE, WALTER T. Three new varieties and two new combinations in *Citrus* and related genera of the orange subfamily. 24.
- TATE, VERNON D. *Microphotography. 312.
- TREMBLAY, J.-ARTHUR. Morphologie de l'idocrase. 327.
- TSENG, C. K. Marine algae of Hong Kong, II: The genus *Catenella*. 142.
— and GILBERT, WM. J. On new algae of the genus *Codium* from the South China Sea. 291.
- WALKER, EGBERT H. Two new dwarf species of *Rubus* from western China and Tibet and their Asiatic relatives. 260.
- WELLS, R. C. *The relative abundance of nickel in the earth's crust. 278.
— The third dissociation constant of phosphoric acid and its variation with salt content. 321.
- WENNER, FRANK. *The ABC's of physical measurements. 314.
- WHEELER, LOUIS CUTTER. *Hugelia* Bentham preoccupied. 237.
- WILSON, CHARLES BRANCH. Description of a new genus and species of copepod parasitic in a shipworm. 60.
- WOODRING, W. P. *Ancient soil and ancient dune sand in the Santa Maria district, California. 281.
- WOOLARD, EDGAR W. Great astronomical treatises of the past. 189.
- YATES, R. G. See C. P. ROSS. 280.

SUBJECT INDEX

- Anthropology.* Archeological accomplishments during the past decade in the United States. FRANK M. SETZLER. 253.
The Ainu double foreshaft toggle harpoon and western North America. GORDON W. HEWES. 93.
- Astronomy.* Great astronomical treatises of the past. EDGAR W. WOOLARD. 189.
- Astrophysics.* Concerning the origin of chemical elements. G. GAMOW. 353.
- Bacteriology.* Incidence of leptospirosis among dogs in Honolulu as determined by serological agglutination tests. JOSEPH E. ALICATA and VIRGINIA BREAKS. 305.
- Ballistics.* *Archery paradise, paradox, and paralysis. C. N. HICKMAN. 314.
- Biophysics.* Effect of nutrient cultures on the reaction of maize seedlings to light. J. H. KEMPTON. 338.
Effect of temperature and time on the X-ray sensitivity of maize seeds. LOUIS R. MAXWELL, J. H. KEMPTON, and VERNON M. MOSLEY. 18.
*The biological action of high energy radiation. PAUL S. HENSHAW. 315.
- Botany.* An undescribed *Atropellis* on cankered *Pinus virginiana*. M. L. LOHMAN, EDITH K. CASH, and ROSS W. DAVIDSON. 296.
Hugelia Bentham preoccupied. LOUIS CUTTER WHEELER. 237.
Linanthastrum, a new West American genus of Polemoniaceae. JOSEPH EWAN. 138.
Marine algae of Hong Kong, II: The genus *Catenella*. C. K. TSENG. 142.
New Asteraceae from northern Mexico collected by C. H. Muller. S. F. BLAKE. 146.
New bamboos from Venezuela and Colombia. F. A. McCLURE. 167.
New grasses from Venezuela. ZORAIDA LUCES. 157.
New tropical American Acanthaceae. E. C. LEONARD. 184.
On new algae of the genus *Codium* from the South China Sea. C. K. TSENG and WM. J. GILBERT. 291.
Three new species of Acanthaceae from Mexico. E. C. LEONARD. 341.
Three new varieties and two new combinations in *Citrus* and related genera of the orange subfamily. WALTER T. SWINGLE. 24.
Two new dwarf species of *Rubus* from western China and Tibet and their Asiatic relatives. EGBERT H. WALKER. 260.
Two zoophagous species of *Acrostalagmus* with multicellular *Desmidiospora*-like chlamydo-spores. CHARLES DRECHSLER. 343.
- Cartography.* *Reproduction of charts and maps. DUDLEY P. BARNETTE. 312.
*The modern nautical chart—a scientific achievement. AARON L. SHALOWITZ. 312.
- Chemistry.* A crystalline sulphur-protein from wheat. A. K. BALLS. 132.
A study of ionic adsorption in solutions of silica and alumina. P. G. NUTTING. 117.
The behavior of cystine dimethylester dihydrochloride and of cysteine monomethylester monohydrochloride in the Sullivan reaction for cysteine and cystine. M. X. SULLIVAN, W. C. HESS, and H. W. HOWARD. 285.
The determination of the cystine content of various proteins by different hydrolytic agents, sulphuric, hydrochloric, hydriotic, and a mixture of hydrochloric and formic acids. W. C. HESS and M. X. SULLIVAN. 130.
The third dissociation constant of phosphoric acid and its variation with salt content. ROGER C. WELLS. 321.
- Crystallography.* Morphologie de l'idocrase. J.-ARTHUR TREMBLAY. 327.
- Entomology.* New Australian Tingitidae (Hemiptera). CARL J. DRAKE. 359.
New species of *Anastrepha* and notes on others (Diptera, Tephritidae). ALAN STONE. 298.
Notes on *Harmostes*, with descriptions of some new species (Hemiptera: Corizidae). H. M. HARRIS. 27.
The genus *Ferdinandea* Rondani. FRANK M. HULL. 239.
- Ethnology.* A scientific approach to African colonization. O. F. COOK. 1.
- General science.* Cosmic emotion. PAUL R. HEYL. 221.
Science and war. AUSTIN H. CLARK. 33.
- Geochemistry.* *Application of X-ray methods to mineral analysis. W. E. RICHMOND. 280.
*Chemical composition of salty ground waters along the Atlantic and Gulf coasts. M. D. FOSTER. 282.
*Progressive down-dip changes in composition in artesian waters from the Cretaceous rocks of Virginia. D. J. CEDERSTROM. 280.
- Geodesy.* The distance between two widely separated points on the surface of the earth. WALTER D. LAMBERT. 125.
- Geology.* *Ancient soil and ancient dune sand in the Santa Maria district, California. W. P. WOODRING. 281.
Atlantic coastal "terraces." RICHARD FOSTER FLINT. 235.
*Coso quicksilver district, Inyo County, Calif. C. P. ROSS and R. G. YATES. 280.
*Genetic history of the pegmatites and associated rocks of the Carolina tin belt. T. L. KESLER. 278.
*Influence of topography on continental glaciation in north-central Montana. M. M. KNECHTEL. 279.

- *Resistivity studies in the potash area of New Mexico. H. C. SPICER. 278.
- *Structural interpretation of the Death Valley region by Levi Noble. G. W. STOSE. 279.
- *The Devonian system in Arkansas and Oklahoma. H. D. MISER. 277.
- *The Laurel "pseudomigmatite" and its significance in petrogenesis. R. W. CHAPMAN. 279.
- *The relative abundance of nickel in the earth's crust. R. C. WELLS. 278.
- *Types of ice flow within glaciers. MAX DEMOREST. 282.
- *Zoning of ore deposits in the Tri-State district. E. T. McKNIGHT. 282.
- Geophysics.* Geophysical measurements in the laboratory and in the field. H. E. MCCOMB. 65.
- Ichthyology.* Notes on some fishes from the Gulf of California, with the description of a new genus and species of blennioid fish. LEONARD P. SCHULTZ. 153.
- Seven new American fishes. ISAAC GINSBURG. 364.
- The osteology and relationships of the Argentinidae, a family of oceanic fishes. WILBERT McLEOD CHAPMAN. 104.
- The first record of the ophichthyid eel *Scytalichthys miurus* (Jordan and Gilbert) from the Galapagos Islands, with notes on *Mystriophis inertinctus* (Richardson). LEONARD P. SCHULTZ. 83.
- Medical entomology.* Experimental transmission of endemic typhus fever by the sticktight flea, *Echidnophaga gallinacea*. JOSEPH E. ALICATA. 57.
- Medicine.* *Diet in experimental cancer. DEAN BURK. 317.
- New members of the Academy.* 63, 276, 370.
- Obituaries.* GROESBECK, EDWARD CENTER. 284. JUST, ERNEST EVERETT. 124. MERRIAM, CLINTON HART. 318. NORTON, THOMAS HERBERT. 220. PARKER, WILLIAM EDWARD. 372. REYNOLDS, WALTER FORD. 283. STEWART, ANDREW. 320.
- Paleobotany.* A Miocene grapevine from the valley of Virgin Creek in northwestern Nevada. ROLAND W. BROWN. 287.
- Paleontology.* Fossil Mammalia from the Almy formation in western Wyoming. C. LEWIS GAZIN. 217.
- New genera of North American brachiopods. G. ARTHUR COOPER. 228.
- Photography.* *Microphotography. VERNON D. TATE. 312.
- Physics.* *A new determination of the constant of gravitation. PAUL R. HEYL. 316.
- A review of the methods for the absolute determination of the ohm. HARVEY L. CURTIS. 40.
- *Calibration of mercurial and aneroid barometers. D. P. JOHNSON. 317.
- Physical explanation and the domain of physical experience. R. B. LINDSAY. 356.
- *Quartz resonators. FRANCIS E. FOX. 313.
- *The ABC's of physical measurements. FRANK WENNER. 314.
- *The absorption spectra of some organic dyes. A. L. SKLAR. 318.
- *The adsorption of gases and vapors on solids. STEPHEN BRUNAUER. 316.
- *The electron microscope as a tool for the study of inorganic materials. HERBERT INSLEY. 315.
- *The molecular basis for the mechanical properties of acetate rayon. ARNOLD M. SOOKNE. 315.
- Zoology.* A new species of Amphipoda from Uruguay and Brazil. CLARENCE R. SHOEMAKER. 80.
- Are "frontoparietal" bones in frogs actually frontals? THEODORE H. EATON, JR. 151.
- Description of a new genus and species of copepod parasitic in a shipworm. CHARLES BRANCH WILSON. 60.
- Earthworms of the Northeastern United States: A key, with distribution records. THEODORE H. EATON, JR. 242.
- Further remarks on some Mexican *Urosaurus*. M. B. MITTELMAN. 370.
- New species of urocoptid land mollusks from Mexico. PAUL BARTSCH. 187.
- Porifera from Greenland and Baffinland collected by Capt. Robert A. Bartlett M. W. DE LAUBENFELS. 263.
- Sinocybe*, a new genus of colobognath millipeds from China. H. F. LOOMIS. 270.
- Some echinoderms from northwestern Greenland. AUSTIN H. CLARK and GORDON J. LOCKLEY. 250.
- Some new land shells from Costa Rica and Panama. HARALD A. REHDER. 350.
- Stereobalanus canadensis* (Spengel), a little-known enteropneustan from the coast of Maine. EDWARD G. REINHARD. 309.



CONTENTS

	Page
ASTROPHYSICS.—Concerning the origin of chemical elements. G. GAMOW.	353
PHYSICS.—Physical explanation and the domain of physical experience. R. B. LINDSAY.	356
ENTOMOLOGY.—New Australian Tingitidae (Hemiptera). CARL J. DRAKE.	359
ICHTHYOLOGY.—Seven new American fishes. ISAAC GINSBURG.	364
ZOOLOGY.—Further remarks on some Mexican <i>Urosaurus</i> . M. B. MITTLEMAN. (Communicated by HERBERT FRIEDMAN.)	370
PROCEEDINGS: THE ACADEMY.	371
OBITUARY: WILLIAM EDWARD PARKER.	372
INDEX TO VOLUME 32.	373

This Journal is Indexed in the International Index to Periodicals



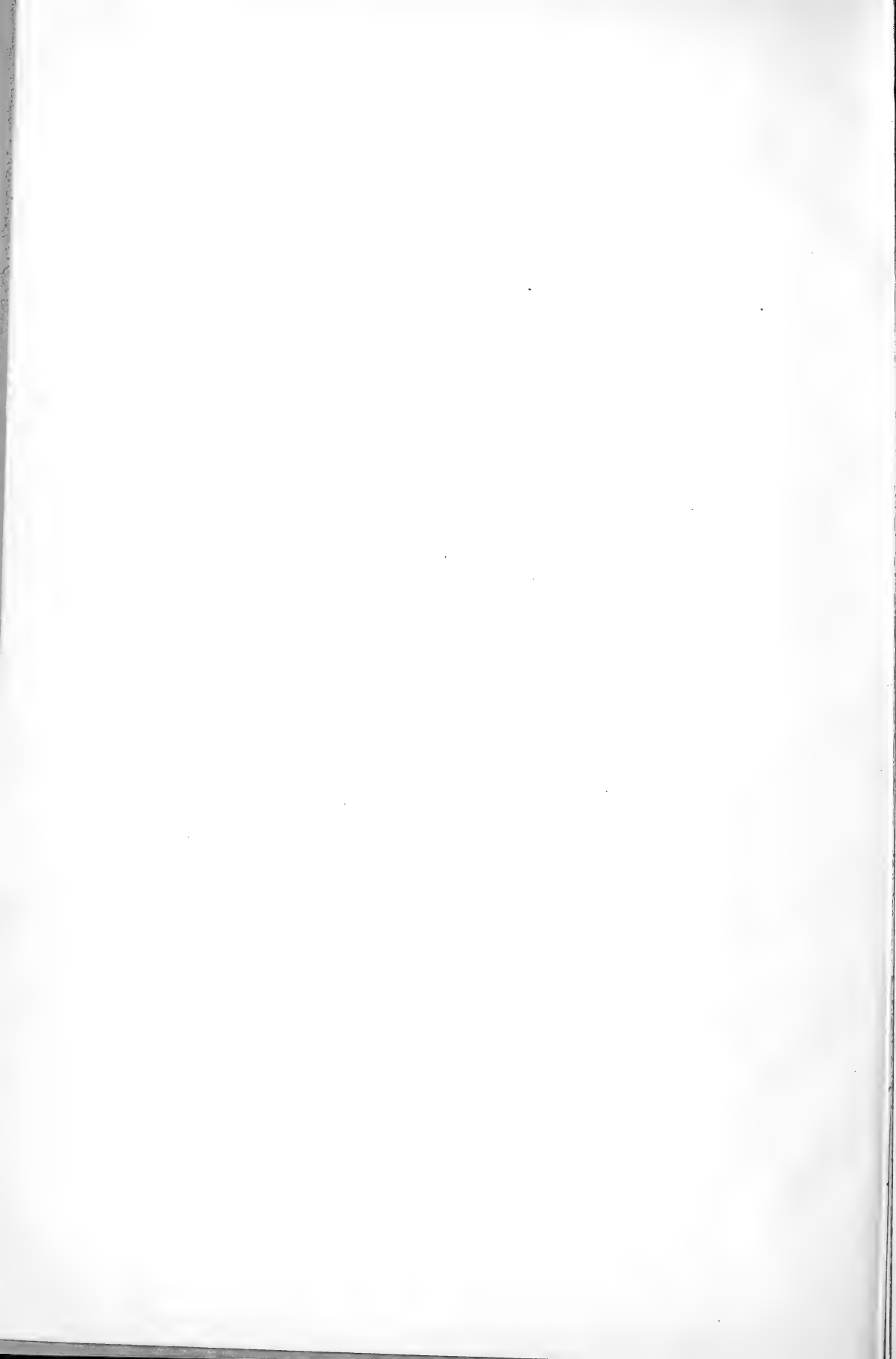



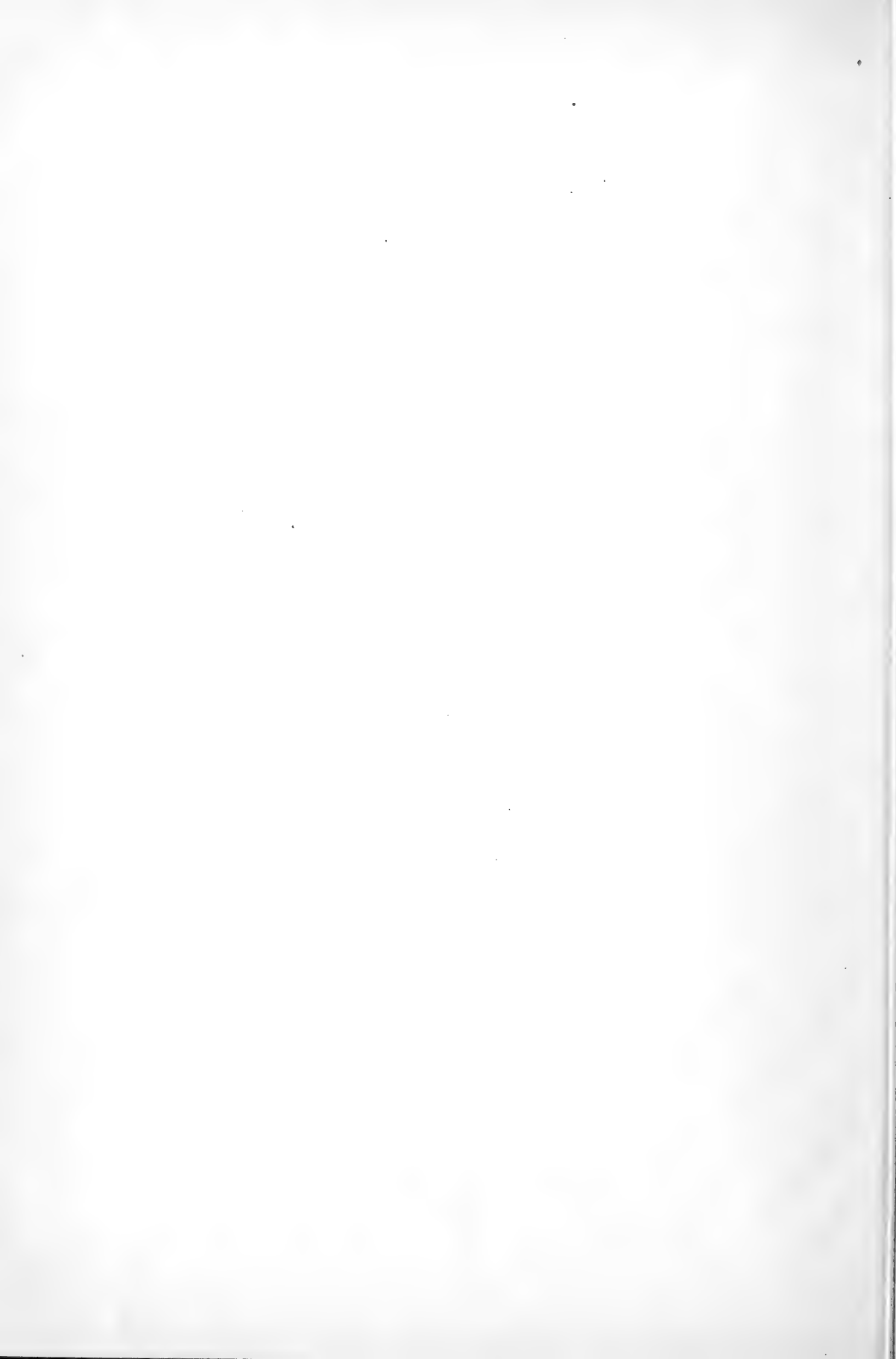



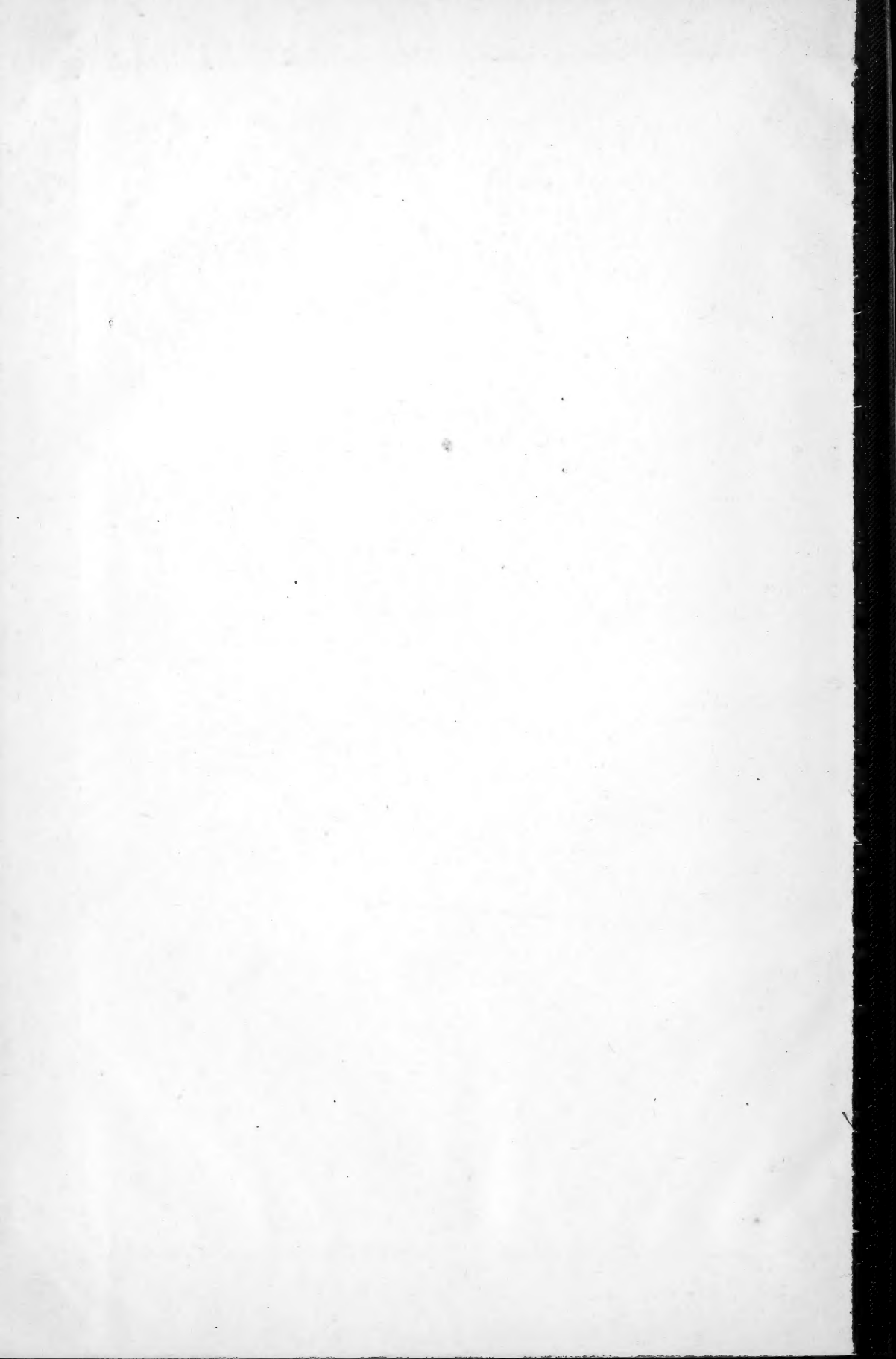



SMITHSONIAN INSTITUTION LIBRARIES



3 9088 01303 1869