

LABORATORY GUIDE  
*of*  
INDUSTRIAL CHEMISTRY

---

ALLEN ROGERS

UC-NRLF



8 32 327

D. VAN NOSTRAND COMPANY  
NEW YORK

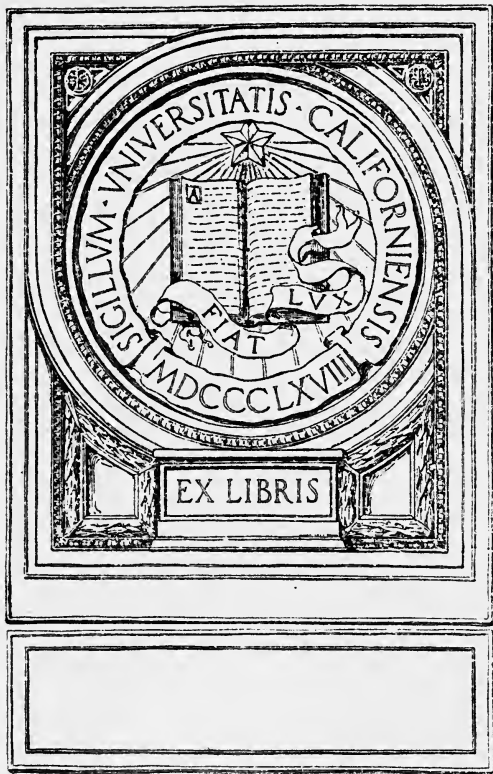

EX LIBRIS

187.6-1938

**The D. Van Nostrand Company**

intend this book to be sold to the  
Public at the advertised price, and  
supply it to the Trade on terms which  
will not allow of reduction.



LABORATORY GUIDE  
OF  
INDUSTRIAL CHEMISTRY



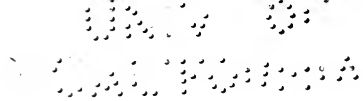

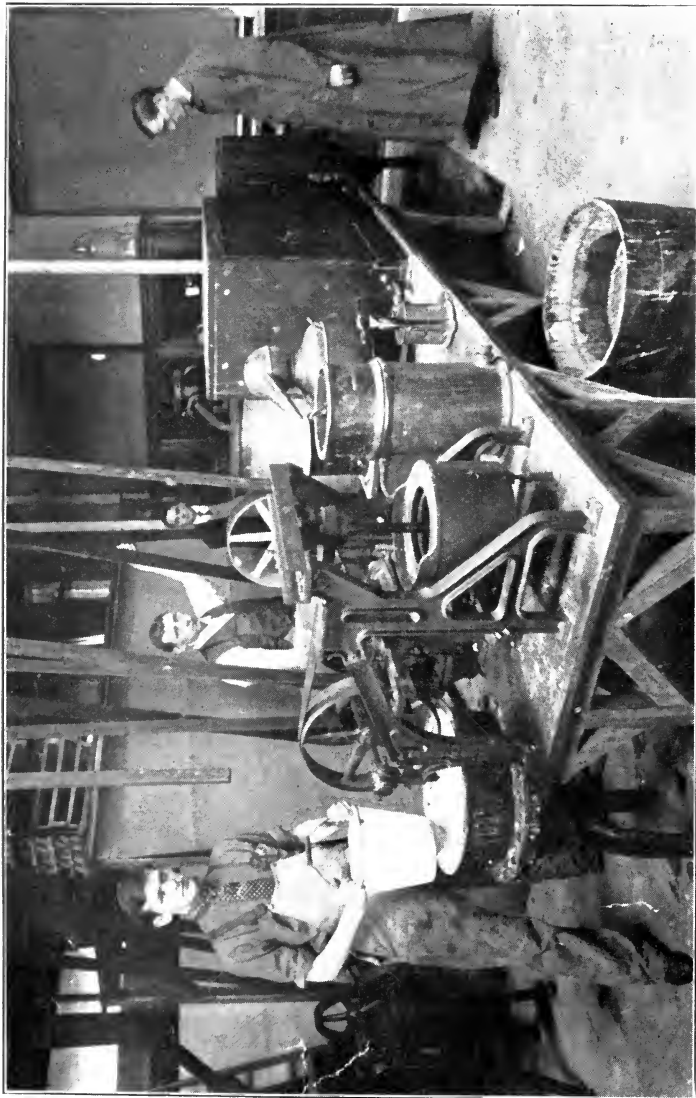

Rogers' Industrial Chemistry.

CHEMICAL WORKS.

Frontispiece.



LABORATORY GUIDE  
OF  
INDUSTRIAL CHEMISTRY

BY  
ALLEN ROGERS, PH.D.

INSTRUCTOR IN INDUSTRIAL CHEMISTRY, PRATT INSTITUTE, BROOKLYN; MEMBER  
AMERICAN CHEMICAL SOCIETY; SOCIETY OF CHEMICAL INDUSTRY;  
AMERICAN LEATHER CHEMISTS ASSOCIATION

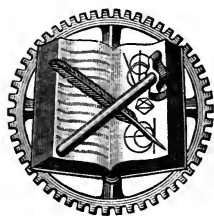

NEW YORK

D. VAN NOSTRAND COMPANY

23 MURRAY AND

1908

27 WARREN STS.

Copyright, 1908  
By D. VAN NOSTRAND COMPANY

TO VAN  
NOSTRAND

*The Plimpton Press Norwood Mass. U.S.A.*

78

## FACTS WHICH SHOULD BE REMEMBERED

Do right and you will be successful.

Do the task which is set before you, and do it with a smile.

Do not be a time server.

Do not use your neighbor's standard solution for accurate determinations.

Do not borrow apparatus.

Keep your desk and apparatus clean, if you hope to obtain satisfactory results.

Always have a towel and sponge in your desk, and use them when you leave for the day.

Glass-ware will break if dropped to the floor.

Never touch a machine until you are told how to use it.

Never run a machine without oil.

Leave your machine or kettle in better condition than you found it.



## PREFACE

IN the average course of chemistry as taught in our technical schools there is little or no attempt made to bring the student in close touch with manufacturing conditions. This state of affairs is exceedingly difficult to understand, when we consider the large amount of time devoted to practical work in some of our engineering courses.

The factory is surely no less fertile a department of this industrial era than the railroad or the foundry. For in the manufacturing plant there is more need of techno-practical (if such a term may be used) trained men than in any other branch of industry. Unquestionably it is necessary to have organization for the manipulation of power, machinery, and labor, so as to obtain the maximum of production with the minimum of expenditure or depreciation of plant. But in addition, it is highly essential that we understand the chemical principles upon which these industries are based.

The object of this book, therefore, is to acquaint the student of chemistry with a few commercial processes, by introducing practical methods of handling materials on a large scale; the care and use of machinery; the cost of raw material; transportation; wage system; the handling of men and shop discipline.

The subject-matter of this book presupposes a certain knowledge of chemistry; and purposely leaves many of the minor details to be worked out by the student. Great leeway is also given to the instructor in order that he may exer-

cise his own originality. A few suggestions, however, may not be out of place, and may serve as a guide to those engaged in this important branch of teaching.

The first chapter has been introduced in order to insure that the student understands the use and value of the various methods employed for taking the density of liquids, and the tests given should be conducted by each individual.

The work in the second chapter, dealing with inorganic preparations is best conducted on the foremanship system which is carried out at Pratt Institute as follows: One man is assigned as foreman of the chemical works and has as his assistants three or more of his classmates. The work which he is given may be the manufacture of barium chlorid for example. He first has his men make an analysis of witherite to determine the percentage content of barium and also test the strength of the hydrochloric acid. In order that the work may be more commercial he is told to estimate the cost of producing 15,000 lbs., it being understood that all weighings are made in grams. The necessary quantity of mineral is then weighed, crushed and treated with the diluted acid in the kettle as described under that preparation.

During such a preparation as the one cited it will be necessary to remove impurities, this being regulated by analytical tests.

Chapter three is devoted to the dyeing of textile fibers. Here it will be advantageous to have all tests mounted with names of color, method employed, and any other data written under each skein.

In the fourth chapter the preparations given have been selected with the view of manufacturing commercial products rather than following the usual custom of making organic substances to illustrate typical organic groups. Here

it has been found advisable to have the student save a 4-dram sample of each compound, which he seals and mounts on cardboard. In the case of the coal-tar colors, the student should make dye-tests with the same, mounting the skeins and color on the same card. In order, also, to illustrate the use of his colors in the manufacture of lakes he should prepare dry and pulp colors, mounting them on cardboard together with rub-outs in glue and Japan.

In the chapters devoted to soap, paint, leather and paper the work outlined comes again under the head of foremanship method and should be conducted along the same line as for inorganic chemicals. The foreman should be held responsible for the quality as well as quantity of the output from his plant; he should see that all machinery is left in perfect condition, and that his factory is clean.

The advantages gained by this foremanship system are self-evident, giving the student more confidence in his own ability than by any other possible means.

As we are only beginning to see the first faint light of dawn in this all-important branch of education, the author will be gratified, indeed, if this book proves to be of any service to those who are attempting to solve the great problem of Industrial Education, and especially the teaching of Industrial Chemistry.

In conclusion, the author desires to express his appreciation of the kindness and courtesy shown to him by his many friends for the many valuable suggestions which have been so helpful to him in the preparation of this volume.

ALLEN ROGERS.

PRATT INSTITUTE.

Brooklyn, September, 1908.





## TABLE OF CONTENTS

	PAGE
PREFACE . . . . .	vii
I GENERAL PROCESSES . . . . .	1
II INORGANIC PREPARATIONS . . . . .	15
III DYEING OF TEXTILE FIBERS . . . . .	23
IV COMMERCIAL ORGANIC COMPOUNDS, COAL-TAR COLORS AND SYNTHETIC OILS . . . . .	52
V PIGMENTS AND LAKES . . . . .	81
VI DRIERS, VARNISHES, PAINTS AND STAINS . . . . .	90
VII SOAP AND ALLIED PRODUCTS . . . . .	108
VIII LEATHER MANUFACTURE . . . . .	121
IX WOOD FIBER, PULP AND PAPER . . . . .	136
X USEFUL DATA . . . . .	142



## CHAPTER I

### GENERAL PROCESSES

1. **Lixiviation.** — Weigh out roughly 5000 grams of crude salt, which has been ground to a fairly fine powder in the mill. Agitate with 30 liters of water in a kettle or receptacle provided with an arbor. When all soluble matter has dissolved, run into kettle or tanks and allow to stand until clear. Next draw off the supernatant solution, wash the residue several times with fresh water, or until a test portion shows only minute traces of chlorides in solution. This process demonstrates the method employed in extracting soluble substances from products containing varying amounts of soluble and insoluble matter.

2. **Spontaneous Evaporation.** — In the warmer climates advantage is taken of the sun's heat to produce evaporation. This may also be accomplished in cooler localities, only less rapidly, by the sun and wind. To demonstrate this process the solution obtained above is placed in shallow pans exposed to the sun and wind in the open air, the rate of evaporation being noted from day to day. To obtain the best results, the pans should be large, the depth of the liquid not over two inches, and should be arranged in such a manner as to be easily covered in case of rain.

3. **Evaporation by Direct Application of Heat.** — This method is not used very extensively, but where it is employed there are two general methods in use, *i.e.* (a) By bringing the flame in contact with the bottom of the pan; (b) By pass-

ing the heated gases or flame over the top of the liquid to be evaporated. The first may be easily illustrated in the laboratory by placing a copper or iron kettle directly over the charcoal fire or gas flame. This will shortly bring the liquid to a quiet boil, which may then be regulated to suit the required condition. The second form can only be reproduced on a fairly large scale, so that it is not advisable to try to introduce such a process into laboratory work.

**4. Evaporation by Indirect Application of Heat.** — This

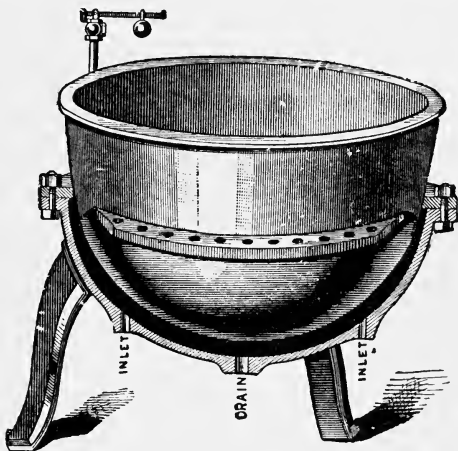

FIG. 1. — Steam Jacket Kettle. The Stuart & Peterson Co., Burlington, N. J.

means of evaporation may be carried out by various methods. The one which is most widely employed is by means of steam, in which case a steam-jacketed kettle, or tank with steam-coils is used, but usually the former. In conducting an evaporation by this means place your solution in the kettle, and open the drip to the outer jacket. The object of this is to drain the kettle, allow the first condensation to escape and to prevent bumping. The exhaust-valve is opened, the inlet

valve given a half turn, and then slowly opened until a good supply of dry steam issues from the drip. The drip is then closed and the inlet of steam regulated to secure the proper heat for evaporation. This should not be too strong as it will cause the solution to boil over the sides, and not too weak as this would consume an excessive amount of time. The best condition is a quiet boil, which as the concentra-

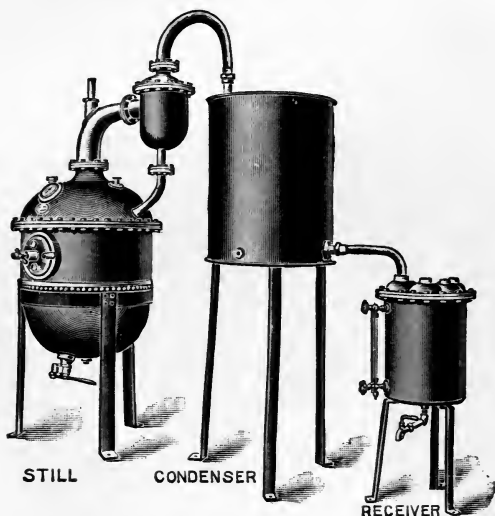

FIG. 2. — Vacuum Pan. Thomas Burkhard,  
Brooklyn, N. Y.

tion continues may be regulated by slowly cutting down the steam. This is necessary to prevent the formation of a hard cake which would be produced if the heat were continued the same, or increased during the operation.

**5. Evaporation in Vacuo.** — The different forms of apparatus used for vacuum evaporation vary much in their construction but all depend nevertheless on reduced pressure. The necessary equipment for a plant to demonstrate this

process consists of a vacuum-pump (dry system), a pan, condenser and receiver. The pump may be of any form although one taking up a small space and power driven is preferable. The pan consists of a globular copper or iron vessel with steam-jacket, water-gage, manhole, minometer, thermometer, peep glasses, and discharging valve. A "catch-all" is introduced between the pan and condenser to hold back any liquid carried over mechanically by the steam. The condenser is a tin lined copper coil and is surrounded by running water. The receiver should be connected with the bottom of the condenser and also provided with water-gage.

In conducting the process the liquid should be introduced until the pan is about half full. The manhole is then covered, and the pump started. The steam should be slowly introduced into the jacket and so regulated that a quiet boil is obtained. This can be seen through the peep-holes. When the operation is complete, the pressure is slowly reduced by means of an exhaust-valve, and the contents removed through the discharge.

**6. Crystallization.** — The process of crystallization may be demonstrated in connection with evaporation. Thus if a solution is evaporated until small crystals begin to appear on the surface and is then run into tanks and allowed to cool it will be noticed that well-defined crystals shortly begin to collect on the bottom and sides of the vat; the size of which will depend upon the nature of the substance and also upon the rate of evaporation. Thus if evaporation takes place rapidly small crystals are produced, while the slower the evaporation the larger the crystals.

One of the best salts to use for illustrating this process is sodium sulphate, which on slow evaporation yields a large crop of well-defined crystals.

Very good crystallizing vats may be made by having an oak barrel cut in the middle, or small wash-tubs may be used for the purpose. Tanks of porcelain, stoneware, glass or enamel may also be obtained.

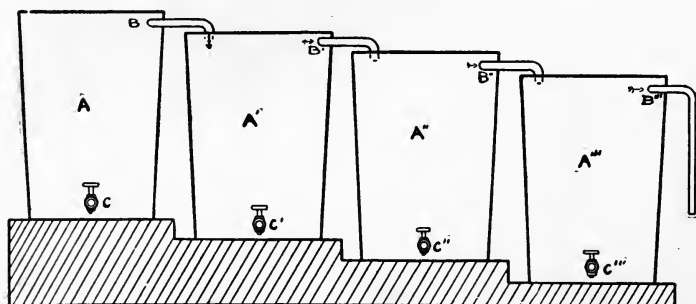

FIG. 3. — Settling Tanks.

**7. Levigation.** — To illustrate this process, the substance is mixed with water and ground in the wet condition. From the mill it passes into a series of settling tanks arranged in battery. The heaviest material is deposited in A and thus becomes finer as it reaches the last tank. Such a plant can be readily obtained by securing several ice-cream packers and arranging them so that A is about two inches higher than A'' and so on down the line having an overflow from tank to tank. The coarse particles are then returned to the mill and the process continued until all of the substance is in a very fine state of division.

**8. Filtration.** — One of the simplest forms of filters consists of a wooden frame of four flat sticks over which is hung either cotton or woolen cloth in such a manner as to form a bag. The filtrate may be turbid at first but soon becomes clear when the first portion may be returned to the filter.

**9. Pressure Filtration.** — A convenient and rapid form of

filtration is by means of pressure. This may be applied by either of two methods.

The first method is one in which a vacuum is employed, the air being thus exhausted from the receiver. This may be demonstrated in the laboratory by means of the laboratory

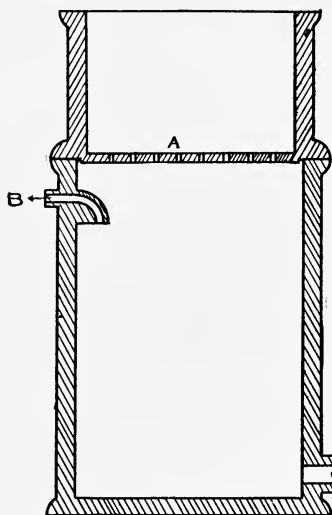

FIG. 4. — Vacuum Filter. A, Filter Bed; B, Exhaust; C, Outlet.

size of suction filter which is made of stoneware and can be obtained from any dealer in chemical apparatus. The most satisfactory filter is made by spreading a piece of cotton over the perforated plate, pouring over this about one-half inch of asbestos fiber, and then another piece of cloth. Such a filter will retain the finest of precipitates.

A second form of pressure filtration is carried out by means of the filter press which is largely used in the industries, especially where

the insoluble portion is the essential product. These presses vary much in construction although all are based upon the same principle. A small press can be secured which will answer for purpose of instruction. The press consists of a strong iron frame in which a number of filter cells are supported. Each cell is made up of two flat metal plates, separated by a hollow distance frame. The liquid holding the insoluble matter in suspension enters the frame through openings in the side. The solid matter is retained in the filter cloth while the pressure forces the liquid through



the cloth, where it follows the grooves, and finally escapes through the necessary openings at the lower side of the plate. The sediment retained by the cloth collects in the cells and forms a solid cake, which finally completely fills each cell. The press is then opened, cleaned and is ready to again be put into operation.

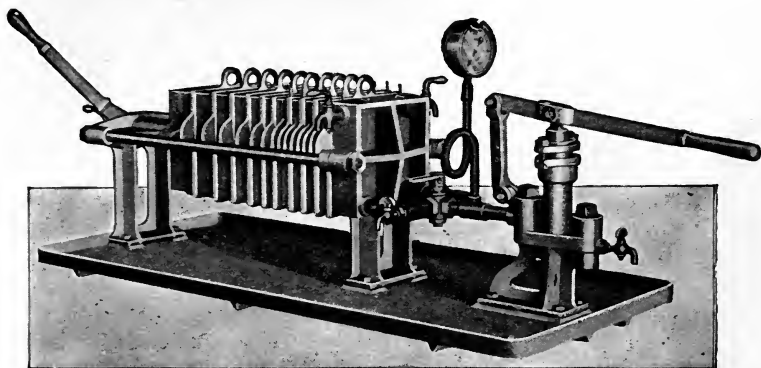

FIG. 5. — Filter Press. T. Shriver & Co., Harrison, N. J.

**10. The Centrifugal Machine.** — The centrifugal machine is used more for drying than as a means of filtration, and consists of a cylindrical basket of perforated sheet metal fixed on a vertical shaft, which rotates at a very high speed. The contents of the baskets are driven to the outer wall by the centrifugal force allowing the liquid to be thrown off while the solid is retained by the screen. In working with such a machine much care is necessary to avoid an uneven load, so that it is well in some instances, especially with chemical salts, to pour in the salt after the machine is in motion.

**11. Calcination.** — This process may be represented by means of a small reverberatory furnace or, if this is not available, the ordinary muffle furnace may be employed.

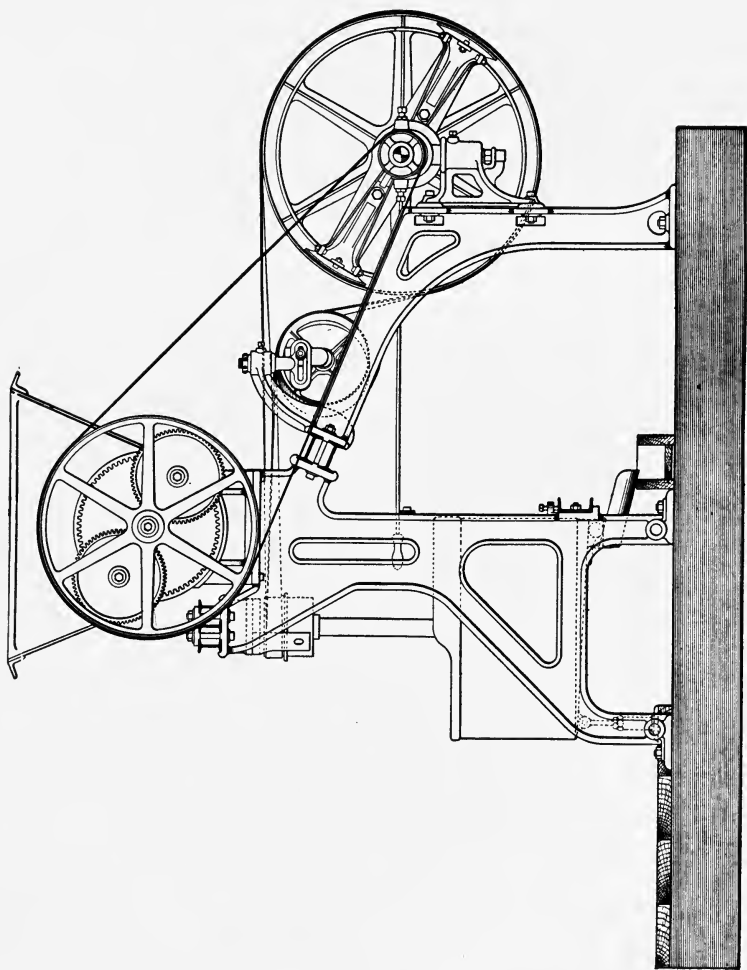

FIG. 6. — Centrifugal Machine. The American Tool and Machine Co., Boston, Mass.

By constructing a bridge of fire-clay at the front of the muffle the charge may be introduced and worked as desired. One of the simplest examples of calcination is the preparation of red oxid, which is given under the head of pigments.

**12. Sublimation.** — In this process the substance passes from a solid to a vapor and then to a solid without passing through the intermediate liquid stage, and may be most readily represented by heating crude naphthalene in an iron kettle over a low flame or, better, on asbestos. The naphthalene vaporizes and may be condensed by placing a cone over the top of the kettle leaving a very small opening in the top for escaping gases. The cone may be made of sheet iron or even of heavy cardboard. A piece of muslin or filter paper may also be stretched over the kettle which serves as a filter and retains any liquid which might be given off.

**13. Distillation.** — There are many forms of apparatus employed for fractional distillation, but the one which is most available is the French column still; which can be obtained from any copper maker. These stills may be heated by steam-coils, steam-jacket or by open fire according to the nature of the product being distilled.

**14. Density.** — By density or specific gravity of a liquid is meant its relative weight as compared to the weight of an equal volume of water at a definite temperature. The determination of specific gravity is one of the most frequent operations in chemical work. For all practical purposes the test may be made with the hydrometer, but for very exact results the pyknometer or specific gravity bottle is employed.

Three systems of hydrometer scales are in common use, besides a great many special ones intended for obtaining a particular substance in a liquid; the principle, however, is

the same in each. These instruments are usually of glass, having a bulb weighted at the lower end, and drawn out at the upper end to a long slender tube carrying a scale. The graduations on the scale being at the top and read downward, the largest number being at the bottom, except in one instance—that of Baumé's scale for liquids lighter than water, where it is the reverse.

When the hydrometer is placed in a liquid it sinks sufficiently to displace a volume equal in weight to the weight of the instrument and floats in an upright position.

**15. The Direct Specific Gravity Hydrometer.**—This instrument is so constructed that the reading of the scale shows the density of a liquid as compared with water at 15° C. The point to which it sinks in pure water is marked 1.000.

These hydrometers as usually employed are in a set of four. The first spindle is graduated from .700 to 1.000 and is for liquids lighter than water, the 1.000 being at the bottom; while the remainder of the set are for liquids heavier than water, with the smaller number at the top starting with 1.000.

Practical use is made of the density of solutions for determining the weight of a given volume.

Measure 1000 c.c. of water and take its specific gravity.

Multiply the specific gravity by 1000.

Now pour the water into a weighted flask and after a second weighing, record the weight of the water. Conclusion?

Measure 1000 c.c. of a salt solution (10 per cent) and take its specific gravity, multiply the specific gravity by 1000, weigh the salt solution. How does it correspond with the theory? Conclusion?

Repeat the experiment with caustic soda solution, sul-

furic acid, hydrochloric acid, nitric acid, ammonia, alcohol and benzine or naphtha.

**16. Twaddell's Hydrometer.** — This is also a direct reading instrument. The set consists of a series of spindles (usually six) having graduations from  $0^{\circ}$  to  $174^{\circ}$ . The reading for water at  $15.5^{\circ}$  is taken as  $0^{\circ}$  and each rise 0.005 sp. gr. is recorded on the scale as one additional division. Thus  $10^{\circ}$  Twaddell becomes 1.050 sp. gr. The density by this means is recorded as  $10^{\circ}$  Tw. for instances.

Twaddell readings are readily converted into specific gravity in the following manner:

Multiply the reading by .005 and add 1.000 to the product. Thus,  $15^{\circ}$  Tw. = 1.075 sp. gr.

$$(1.000 + (15 \times .005) = 1.075)$$

In the reverse order specific gravity may be converted into Twaddell. Thus, 1.150 sp. gr. becomes  $30^{\circ}$  Tw.

$$((1.150 - 1.000) \div .005 = 30)$$

That is, from the specific gravity subtract 1.000 and divide by .005.

This is the most convenient hydrometer for factory or laboratory use. It is, however, not adapted to liquids lighter than water.

Take the density of water with the Twaddell hydrometer.

Take the density of the salt solution used in the former experiment.

Calculate its specific gravity.

How does this agree with the former readings?

**17. Baumé's Hydrometer.** — This is a very unscientific instrument, but is largely used in technical work. Its readings have no very direct relation to specific gravity. Baumé dissolved 15 parts of pure salt in 85 parts of pure water at

12.5° C. The point to which his instrument sank was marked 15; the point to which it sank in pure water was marked 0. The distance between these points was divided into fifteen equal parts. This produced an instrument for liquids heavier than water.

For liquids lighter than water, the point to which the instrument sank in a 10 per cent solution of salt was marked 0, and that to which it sank in water was marked 10, the distance between these points was divided into ten equal parts, and this graduation continued the entire length of the spindle. The 0° thus being at the bottom of the stem, the lighter the gravity of the liquid tested, the greater numerically is the reading of the scale. For instance, a liquid reading 70 Bé is of less density than one at 50 Bé, which in turn is lighter than water at 10 Bé.

To further complicate matters, the instrument makers appear to have become confused and produced instruments with erroneous scales. A test made several years ago disclosed thirty-four different scales, none of which were correct.

The conversion of American Standard Baumé readings to specific gravity is usually accomplished by reference to tables, but may be worked out as follows:

$$\text{Sp. gr.} = \frac{144.3}{144.3 - \text{Bé}} \quad (\text{for liquids heavier than water at } 15^{\circ} \text{ C.})$$

$$\text{Sp. gr.} = \frac{140}{130 + \text{Bé}} \quad (\text{for liquids lighter than water at } 17.5^{\circ} \text{ C.})$$

There is still another form of Baumé which is in quite common use, the so-called rational scale Baumé instrument (Kolb's) which indicates zero in pure water at 15° C. and 66 in sulfuric acid of sp. gr. 1.842 at 15° C.

Take the density of water, salt solution, caustic soda solu-

tion, sulfuric acid, hydrochloric acid, nitric acid, ammonia, alcohol, naphtha.

By conversion determine their specific gravity. How does this agree with the first set of experiments in density?

**18. The Pyknometer.** — This consists of a small bottle, having ground into its neck a capillary tube enlarged at its upper end to form a reservoir which is closed by a stopper. The bottle is filled with the liquid to be tested, and the stopper loosely inserted. When the bottle and contents have reached the normal temperature the excess of liquids in the reservoir is removed by means of filter paper until the level of the liquid reaches the mark thereon. The stopper is tightly inserted, and after cleaning and drying is then weighed.

The density of the liquid is ascertained by the following:

$$\text{Sp. gr.} = \frac{\text{Weight of bottle and liquid} - \text{weight of bottle}}{\text{Weight of bottle and water} - \text{weight of bottle}}$$

Or,

$$\text{Sp. gr.} = \frac{\text{Weight of liquid}}{\text{Weight of equal volume of water}}$$

Determine the specific gravity of salt solution, caustic soda, sulfuric acid, hydrochloric acid, and alcohol.

**19. Westphal Balance.** — This is a special form of balance for determining the density of liquids. A glass plummet of known weight and volume is suspended from the beam by a fine platinum wire, and is submerged in the liquid to be tested. The weight which the plummet loses is the weight of the liquid displaced. By using a set of riders this loss can be determined, and when recorded gives the specific gravity of the liquid.

Determine the specific gravity of a salt solution, caustic soda solution, sulfuric acid, hydrochloric acid, and alcohol.

In all determination of density the question of tempera-

ture is an important factor, and all corrections should be made accordingly. When using the Twaddell hydrometer for commercial purposes, however, the addition of  $1^{\circ}$  Tw. for each  $20^{\circ}$  F. above  $60^{\circ}$  will suffice.

## REFERENCES

Outlines of Industrial Chemistry. Frank Hall Thorp. New York, 1907.

Wagner's Chemical Technology. Sir William Crooks and Ferdinand Fisher. New York, 1904.

Hand Book of Industrial Organic Chemistry. S. P. Sadtler. Philadelphia, 1906.

*Books on Technical and Analytical Chemistry*

Animal Fats and Oils. 6 vols. L. E. Andes. London, 1897-1903.

Oil Analysis. A. H. Gill. Philadelphia, 1903.

Chemical Technology and Analysis of Oils, Fats and Waxes. 2 vols. J. Lewkowitsch. London, 1904.

Commercial Organic Analysis. A. H. Allen. 6 vols. Philadelphia, 1896-1907.

Chemical Analysis of Iron. A. A. Blair. Philadelphia, 1906.

Organic Analysis. A. B. Prescott. New York, 1901.

Engineering Chemistry. Thos. B. Stillman. Easton, Pa., 1905.

Quantitative Chemical Analysis. Frank Clowes and J. B. Coleman. London, 1906.

Quantitative Chemical Analysis. C. R. Fresenius. New York, 1903.

Text-book of Quantitative Analysis. J. C. Olsen. New York, 1908.

Volumetric Analysis. Francis Sutton. Philadelphia, 1904.



## CHAPTER II

### INORGANIC PREPARATIONS

**20. Aluminium Sulfate.** —  $(\text{Al}_2(\text{SO}_4)_3 \cdot 18\text{H}_2\text{O})$ . Intimately mix 1000 grams of bauxite with 3000 grams of soda ash, and introduce this mixture in small portions into an iron crucible which is sufficiently heated to cause a fusion of the mass. When the evolution of gas ceases add fresh portions, and so on until all has been introduced, and a quiet fusion results. The temperature is brought to a bright red heat and continued so for about two hours. The whole is then poured while still molten, into a shallow iron pan to cool. The ground mass is then lixiviated, and the dark colored solution boiled with the addition of sodium carbonate to precipitate the iron. After filtering off the iron, the solution is again boiled with sodium bicarbonate or carbon dioxide introduced, to precipitate the aluminium hydroxid. Wash the precipitate with hot water, dissolve in the necessary amount of diluted sulfuric acid, evaporate to a density of  $40^\circ$  Tw. and allowed to crystallize. Evaporating the mother liquor for a further yield.

The filtrate from the aluminium hydroxid precipitate is also evaporated to recover the sodium carbonate.

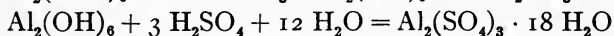
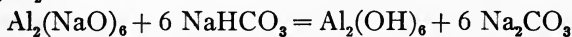
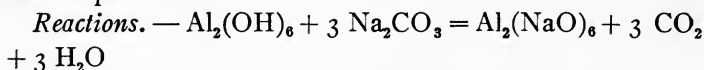

In preparing the above salt an analysis should be made to determine the per cent of  $\text{Al}_2\text{O}_3$  in bauxite in order to esti-

mate the necessary quantity of sodium carbonate, sodium bicarbonate and sulfuric acid. The student should also be required to estimate the theoretical yield, and cost per pound of his finished product, taking into account the question of freight, labor, interest on investment, wear and tear of machinery, and containers, besides that of his raw materials.

*Example:*

1000 lbs. of Bauxite at $\frac{1}{2}$ c. per lb . . . . .	\$5.00
3000 lbs. of Soda-ash at $1\frac{1}{4}$ c. . . . .	37.50
3230 lbs. of Sodium bicarbonate at 2 c. . . . .	64.60
1884 lbs. of Sulfuric acid at 2 c. . . . .	37.68
9114 lbs. of Incoming freight at 6 c. per 100 lbs. f. o. b., N. Y. . . . .	5.46
4269 lbs. of Outgoing freight at 6 c. per 100 f. o. b., N. Y. . . . .	2.53
Containers at 15 c. per 100 lbs. . . . .	6.30
	<hr/>
	\$159.07
Addition of 20 per cent for labor, interest, wear and tear, etc. . . . .	31.80
Total cost. . . . .	<hr/>
	\$190.88

$$\frac{190.88}{4269} = 4.47 \text{ cents per lb.}$$

**21. Antimony-Potassium Tartrate.** —  $\text{KSbO}(\text{C}_4\text{H}_4\text{O}_6) \frac{1}{2} \text{H}_2\text{O}$ .

Dissolve 1000 grams of cream of tartar in 15 liters of boiling water and slowly add 800 grams antimony oxid. When all has dissolved filter the hot solution and evaporate to point of crystallization. Allow to cool, separate the crystals and again evaporate the mother liquor for further yield.

This salt is known commercially as Tartar Emetic.

Estimate cost per pound.

**22. Ammonium Sulfate.** —  $(\text{NH}_4)_2\text{SO}_4$ .

Determine the amount of ammonium hydroxid and sulfuric acid necessary to produce 2000 grams of  $(\text{NH}_4)_2\text{SO}_4$  as follows:

$$(1) (\text{NH}_4)_2\text{SO}_4 : 2 \text{NH}_3 :: 2000 : x$$

$$x = \text{amt. of NH}_3$$

Take the specific gravity of your ammonia and refer to the table to find the per cent of  $\text{NH}_3$

$$\frac{x}{\text{per cent}} = \text{amt. of ammonium hydroxid to use.}$$

$$(2) (\text{NH}_4)_2\text{SO}_4 : \text{H}_2\text{SO}_4 :: 2000 : y$$

$$y = \text{amt. of H}_2\text{SO}_4.$$

Take specific gravity and refer to table as for ammonia. Now mix the sulfuric acid with about ten times its volume of water and slowly add the ammonia. Evaporate to obtain crystals.

Estimate cost per pound.

**23. Barium Chlorid.** —  $(\text{BaCl}_2, 2 \text{H}_2\text{O})$ .

To estimate the necessary quantity of material for the production of 5000 grams of barium chlorid the following method should be employed.

$$\text{Calculation.} \text{ — } \text{BaCl}_2, 2 \text{H}_2\text{O} : \text{Ba} :: 5000 : x$$

$$x = \text{amt. of Ba necessary.}$$

As the barium is derived from the mineral witherite the percentage content should be determined by analysis and from this the quantity of mineral determined thus:

$$\frac{x}{\text{per cent of Ba}} = \text{amt. of witherite.}$$

$$\text{BaCl}_2, 2 \text{H}_2\text{O} : 2 \text{HCl} :: 5000 : y$$

$$y = \text{amt. HCl}$$

By taking the specific gravity of the acid and referring to table the percentage strength is obtained when

$$\frac{y}{\text{per cent of HCl}} = \text{amt of acid required.}$$

The mineral is ground, placed in a suitable vessel, and 10 liters of water added. The hydrochloric acid is then slowly introduced, and the solution brought to boiling; about 200 grams of powdered witherite is added to precipitate the iron and aluminium, and the solution evaporated to 55° Tw. filtered, and allowed to crystallize. The mother liquor being concentrated for a further yield.

Estimate cost per pound.

**24. Ferrous Ammonium Sulfate.** —  $(\text{FeSO}_4(\text{NH}_4)_2\text{SO}_4 \cdot 6 \text{H}_2\text{O})$ .

Dissolve 1400 grams of ferrous sulfate and 664 grams of ammonium sulfate in 2000 c.c. of water separately, heating to 60° C. Filter if necessary and mix the two solutions, concentrate, add 36 grams of sulfuric acid and allow to crystallize. Remove the crystals from the mother liquor, dry in the centrifugal machine, and evaporate the mother liquor for more crystals.

Test for purity and estimate the cost per pound.

**25. Lead Acetate.** —  $(\text{Pb}(\text{C}_2\text{H}_3\text{O}_2)_2 \cdot 3 \text{H}_2\text{O})$ .

In order to manufacture 2000 grams of lead acetate it will first be necessary to make an analysis of the litharge and acetic acid and from the percentage composition determine the quantity of each to be employed.



**26. Lead Nitrate.** —  $\text{Pb}(\text{NO}_3)_2$ .

This compound may be prepared in the same manner as recommended for the acetate.

**27. Magnesium Chlorid.** — ( $\text{MgCl}_2 \cdot 6 \text{H}_2\text{O}$ ).

Having determined the per cent of magnesium in magnesite, and the strength of hydrochloric acid, estimate the quantity of each necessary to produce 4000 grams of the salt.

Mix the magnesite with an equal quantity, by weight, of water, slowly add the acid and heat on the steam bath until the action ceases. If acid in reaction make neutral with magnesite. Digest for an hour and filter while still hot. Evaporate the filtrate on the steam bath to a density of  $60^\circ \text{Tw.}$  and allow to cool. The crystals are removed and separated from the mother liquor in the centrifugal machine. The liquor being evaporated for further yield.

Estimate the cost per pound.

Magnesium chlorid is very deliquescent, and should be placed in a bottle as soon as removed from the centrifugal machine.

**28. Potassium Dichromate.** — ( $\text{K}_2\text{Cr}_2\text{O}_7$ ).

Dissolve 1350 grams of potassium carbonate in 1500 c.c. of water. Add this solution slowly to 4200 grams of lime, and let stand until all of the lime is slaked. Stir well, evaporate to dryness, and heat to  $150^\circ \text{C.}$  until thoroughly powdered. Mix with 2700 grams of powdered chromite and heat in a reverberatory furnace with oxidizing flame at a bright red heat for 3 to 4 hours; cool the mass, pulverize, and extract with 9000 c.c. of water. Concentrate until crystals begin to form and then add a hot concentrated solution of potassium sulfate, to precipitate the calcium from the calcium chromate. To the yellow filtrate of potassium chromate, add sulfuric acid, diluted with twice its volume of water, until strongly acid, and let the liquid cool. Filter off the crystalline precipitate, redissolve the mass in hot water, and recrystallize. Evaporate the mother liquor for further yield,

which, however, may be contaminated with potassium sulfate.

**29. Potassium Chromate.** — ( $K_2CrO_4$ ).

This salt is prepared from potassium dichromate and potassium carbonate according to the following reaction:

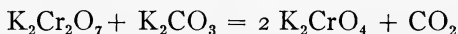

Therefore estimate the quantity of each necessary to produce 2000 grams.

**30. Potassium Permanganate.** — ( $KMnO_4$ ).

Ignite a quantity of powdered pyrolusite at a red heat on an iron plate to burn out any carbonaceous matter it may contain. Dissolve 840 grams of caustic potash in 1200 c.c. of water, stir in 420 grams of potassium chlorate and heat until dissolved. Then mix in 720 grams of the ignited pyrolusite, evaporate to a smooth, thick paste, and heat to redness in an iron crucible, adding small portions at a time. When thoroughly hard let the crucible cool and break out the mass with a chisel. Then boil with a large excess of water, passing a stream of carbon dioxide into the boiling solution to convert any hydroxide into carbonate. The green liquid passes over into a violet solution of potassium permanganate, and a dense brown precipitate forms. Filter through asbestos or glass wool and evaporate the filtrate until needle-like crystals appear on the surface. Allow to cool. Separate the crystals and evaporate the mother liquor for further yield.

**31. Potassium Sodium Tartrate.** — ( $KNaC_4H_4O_6 \cdot 4 H_2O$ ).

The preparation of this compound is based upon the reaction:

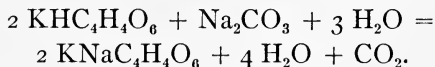

Therefore estimate the quantity of cream of tartar and soda

ash necessary to produce 3000 grams and work out a method of preparation.

**32. Soda Ash.** —  $\text{Na}_2\text{CO}_3$ .

Prepare a saturated brine solution by dissolving 880 grams of salt in 3000 c.c. of water at  $15^\circ$  C. To this brine add 1000 c.c. of ammonia (Sp. gr. .910) and pass in carbon dioxide so long as the gas is absorbed and a precipitate is formed. Care should be taken to keep the vessel cool and to use a large delivery tube in order to prevent clogging.

The precipitate produced is sodium bicarbonate and should be filtered by suction and washed with a little cold water to remove adhering salt. It is then dried and heated strongly (do not fuse) to convert the bicarbonate to the carbonate.

The liquor may be heated with milk of lime to recover the ammonia.

**33. Disodium Hydrogen Phosphate.** —  $(\text{Na}_2\text{HPO}_4 \cdot 12 \text{H}_2\text{O})$ .

Into a lead-lined tank or porcelain dish introduce 5000 grams of bone-ash and mix with it 3880 grams of sulfuric acid (Sp. gr. 1.80). The mixing is conducted in the open air or hood. Stir well and allow to stand over night. Lixivate the mass with twice its volume of water and boil by blowing in steam. Filter off the soluble portion and wash the residue several times with fresh water. Evaporate the filtrate and washing to a convenient bulk, and neutralize the boiling solution with a concentrated solution of 2750 grams of soda-ash. Filter off the precipitate of calcium carbonate and evaporate the filtrate until the solution has a density of  $25^\circ$  T. at  $60^\circ$  F. The crystals which separate on cooling should be dried in the centrifugal and bottled as soon as possible. *Reaction ?*

**34. Sodium Bisulfite.** —  $(\text{NaHSO}_3)$ .

This compound is usually placed on the market as a liquid containing 33.3 per cent of the salt. It is prepared by passing sulfur dioxide into a solution of sodium carbonate until completely saturated. The  $\text{SO}_2$  may be easily obtained by burning sulfur in a small furnace, made by boring a hole in an ordinary muffle, and drawing the gas by suction through the soda solution, which may be placed in flasks or small casks.

Therefore have the student estimate the quantity of soda-ash, water, and sulfur to produce 10,000 grams of the product, also estimate cost per pound and write reactions.

### 35. Zinc Sulfate. — $(\text{ZnSO}_4 \cdot 7 \text{H}_2\text{O})$ .

Having determined the strength of the sulfuric acid and zinc oxide, estimate the quantity necessary to produce 5000 grams of zinc sulfate and work out the method of procedure.

The foregoing salts represent a few typical preparations, and it is left to the instructor to make the list as complete as he sees fit.

### REFERENCES

- Sulfuric acid and Alkali. Geo. Lunge. London, 1906.
- Richter's Inorganic Chemistry. Edgar F. Smith. Philadelphia, 1906.
- Principles of Inorganic Chemistry. Harry C. Jones, 1906.
- The Principles of Inorganic Chemistry. Wilhelm Ostwald and Alexander Findley. London, 1904.
- Treatise on Chemistry. I. I. D. Heinde. New York, 1907.
- Outlines of Inorganic Chemistry. F. A. Gouch and J. A. Walker. New York, 1905.





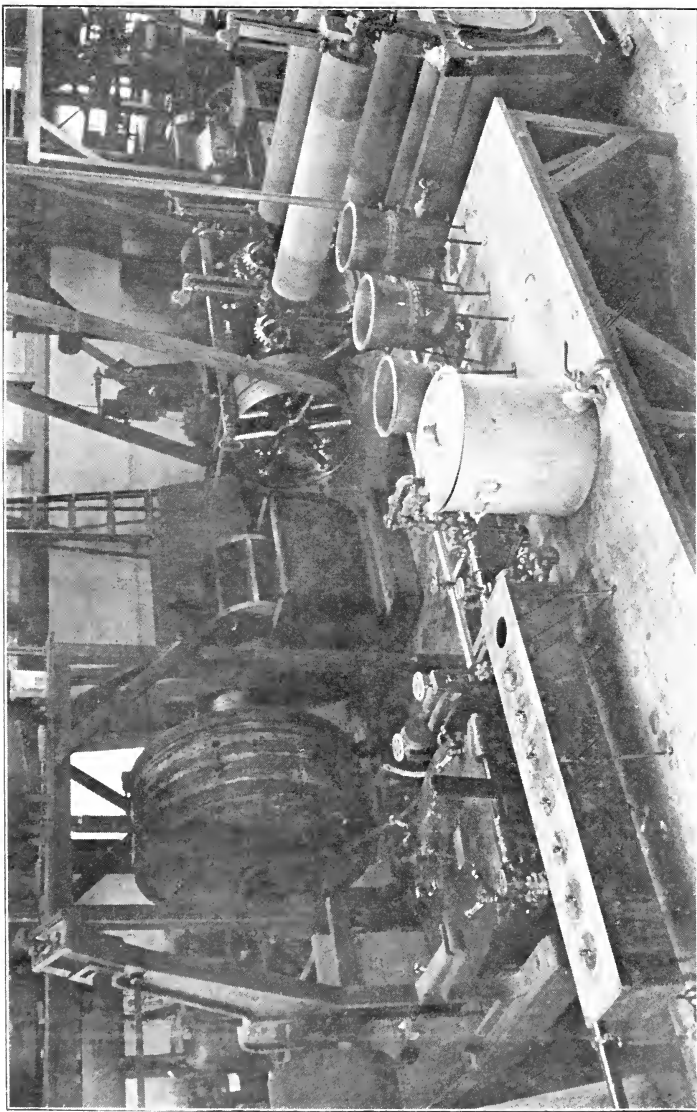

Rogers' Industrial Chemistry.

BLEACHING, DYEING, AND PRINT WORKS.

## CHAPTER III

### DYEING OF TEXTILE FIBERS

36. Dyeing is the process of precipitating coloring-matter upon or within the substance of a body by chemical action. The solution may be neutral, acid, or alkaline according to the nature of the material, and of the dyestuff employed.

37. There are two general classes of dyestuffs, namely natural and artificial. Owing to the large number of coal-tar colors on the market, however, and the ease with which they are applied, the natural colors have been steadily replaced until to-day logwood is practically the only one which is of any importance in the trade.

38. For practical reasons the coal-tar colors are divided generally into the following groups: —

1. Acid dyes.
2. Basic dyes.
3. Dyes of the eosin group.
4. Substantive dyes.
5. Mordant dyes.
6. Developed dyes.
7. Spirit colors.

39. **Acid Dyes.** — These colors are chiefly used for wool dyeing, but they are also applied to silk, and with few exceptions the dyeing takes place in an acid bath. They are only of little interest for cotton, but, on the other hand, they are of great importance for jute. The commercial dyestuffs consist of the alkali or lime salts of the color acid. Thus, in the

case of wool dyeing, the wool acts as a base, combining with the color acid to form an insoluble compound.

**40. Basic Dyes.** — These colors are chiefly used for mordanted cotton. Large quantities are also consumed in silk dyeing, and a considerable amount of a few brands is used for wool. They are also extensively used for jute dyeing. Basic dyes are the salts of colorless bases, that is, the color does not appear until the salt is formed. The commercial dyestuffs are usually salts of acetic, oxalic, nitric, sulfuric, or hydrochloric acid, and most of them are soluble in water. In the process of dyeing these compounds decompose, setting free the acid, while the base combines with the acid constituent of the animal fiber, or with the acid mordant in the case of vegetable fiber, thus producing the color on the fabric.

**41. Dyes of the Eosin Group.** — In the textile industry these colors are used for wool and silk, also to a small extent on cotton. They are derived from fluorescein by the action of halogens. To this group belong eosin, erythrosin, phloxin, rose bengal, and uranin. All of these dye-stuffs possess a yellowish-green fluorescence.

**42. Substantive Dyes.** — These are very largely consumed for dyeing cotton and unions; they are also used for wool and silk. They are sometimes called "direct dyes" owing to the fact that they dye cotton direct without mordanting. To this group belong the benzidine dyes, primulin, congo, diamin, benzo and immedial colors.

**43. Mordant Dyes.** — They comprise a great variety of coloring-matters, both natural and artificial, which are dyed on all fibers by the aid of metallic mordants. Many of these dyes are polygenetic, and they possess the property of forming insoluble color lakes with metallic oxids. The usual method employed is to mordant the goods before passing into the dye-bath, which usually contains nothing but the

color. In a few cases the mordant and color are introduced into the same bath. While in the process known as "stuffing" the goods are first run in the color and subsequently in the mordant.

**44. Developed Dyes.** — Under this heading are included two different methods of developing, viz: —

(a) The production of dyestuffs from substances which possess no dyeing quality themselves, but which can be changed into dyestuffs by a chemical reaction taking place on the fiber.

(b) The production of new products by further developing dyestuffs so as to change their shade and properties.

The first of these processes is represented by the production of anilin black. The second by the process of diazotizing, both of which will be taken up later on.

**45. Spirit Colors.** — These dyes are insoluble in water, but soluble in alcohol. They are sometimes used for dyeing silk, and when dissolved in acetone for printing silk and cotton, also for making colored varnish.

**46. General Instructions for Dyeing.** — In conducting dye-tests it will prove advantageous to make up the solutions as follows:

Natural dyestuffs and tannins . . .	10 per cent solution
Coal-tar colors . . . . .	1 per cent solution
Acids . . . . .	10 per cent solution
Salts . . . . .	10 per cent solution
Soap . . . . .	1 per cent solution

Provide yourself with a reel, a convenient form of which is represented in the illustration. As all tests are conducted on the weight of the material, it is necessary to determine the number of yards required to give a skein of definite weight. The following list, however, may prove useful:

German knitting worsted . . . 20 yds. weigh 5 grams  
 Cotton yarn, 22-ply . . . . . 200 yds. weigh 10 grams  
 Spun silk, single thread . . . 260 yds. weigh 5 grams

By noting the example given below a clear idea may be gained as to the use of the solutions mentioned and the reason for having the skeins of definite weight.

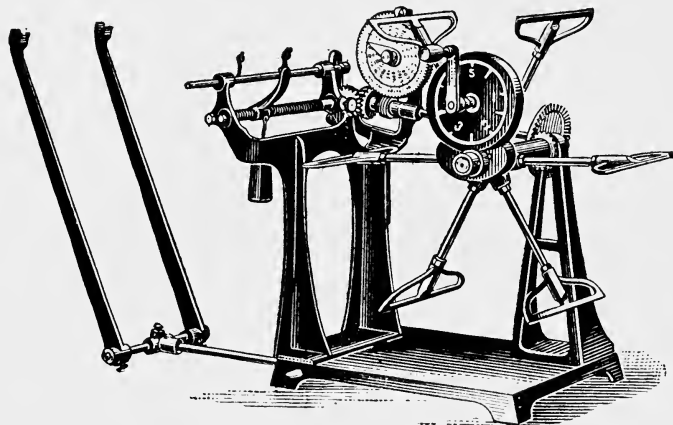

FIG. 7. — Testing Reel. Charles H. Knapp, Paterson, N. J.

**47. Example.** — Prepare a dye-bath with 2 per cent of congo red, 2 per cent of sodium carbonate, and 20 per cent of Glauber's salt, using six 10-gram skeins of cotton yarn, boil for half an hour. Remove, rinse and dry.

Thus:  $6 \times 10 = 60$  grams.

2 per cent of 60 grams is 1.2 grams.

20 per cent of 60 grams is 12 grams.

As the congo red is a one per cent solution, it will require 120 c.c.

As the sodium carbonate is a ten per cent solution it will require 12 c.c.

And as the Glauber's salt is a ten per cent solution it will require 120 c.c.

48. The dye-tests are best made in porcelain beakers, placed in brine to secure a uniform temperature. The skein is suspended on a glass rod, and the position changed at least once in five minutes during the time of dyeing.

On completing the tests the skeins are hung up to dry, twisted, and mounted as follows:

49. Place each end of the skein over the two middle fingers, twist until tight, then bring the right-hand loop under the wrist and up through the loop in the left. Now holding the two loops stretch the skeins out straight, and allow to curl together. In this manner a very tight and even skein is the result. These skeins should then be mounted on cardboard by sewing through from the back, catching down the threads on the under side in such a way that it does not show from the front.

50. **Wool.** — In the study of dyes and dyeing we will first take up the natural mordant colors, which may be used for wool.

One of the oldest and most important dyes for wool is logwood or campeachy wood, which is the wood of a larch tree growing abundantly in the West Indies, Mexico, and parts of Central America. It is imported in logs weighing about 400 lbs. The fresh wood is colorless, or nearly so, and contains a glucoside, composed of hematoxylin and sugar. It is cut into chips or rasped. These chips are then digested with hot water when the solution on evaporation gives the logwood extract of the market.

Formerly for wool dyeing the chips were allowed to oxidize before extraction, but now this is accomplished in the solution and the product is known as hematein, which comes on the market either as paste or powder.

Logwood is a mordant color, by which we mean that the color is only produced by bringing it in contact with some metal. In this way a combination takes place with the formation of an insoluble lake.

51. In the first bath we will boil two skeins of wool with 10 per cent logwood extract (on the weight of the fiber) for one half hour.

The slight brownish color produced on the wool is of no value as it is not fast to washing, and consequently would be removed. It has, however, enough affinity for the coloring principle of logwood to absorb sufficient of it to produce a good color when afterwards mordanted.

52. To show that the logwood has been absorbed by the wool we will boil one of these skeins in a solution of 5 per cent of ferrous sulfate and 1 per cent of copper sulfate for half an hour. In this case copper hematite and ferrous hematite are formed, the latter being probably oxidized to ferric hematite by the air.

This experiment simply shows the power of wool to absorb colors, but does not represent the actual process employed in dyeing.

To dye wool with logwood or other mordant color, it is first mordanted and afterwards introduced into the dye-bath. To mordant wool with metallic mordants it is boiled with solution of alum, or potassium dichromate with addition of acids, whose function will be discussed later. The wool acts chemically upon the salts, decomposing them, and fixing the aluminum or chromium so that it cannot be washed out, being in such a form that it combines readily with the logwood and similar colors to form the desired lakes.

53. To demonstrate the process of mordanting we will boil three 5-gram skeins of wool for half an hour in a solution



of 5 per cent of alum and 3 per cent of oxalic acid in 300 c.c. of water.

54. One of the skeins we will dye by boiling half an hour with 5 per cent hematein powder in 200 c.c. of water. The skein is removed and washed, and a second skein introduced into the same bath to see if it is exhausted, or the amount of color left.

55. The third skein is dyed with 6 per cent of fustic extract being boiled for half an hour.

56. The usual mordant for logwood on wool is chromium. The wool is boiled in a solution of potassium or sodium dichromate, together with some acid or acid salt as sulfuric acid, oxalic acid, tartaric acid, or potassium bitartrate.

The color produced by logwood depends upon the mordant used, and is an example of a class of dyestuffs known as polygenetic colors. While monogenic colors are those which only one color or shade of that color is produced, no matter what mordant may be used.

The various acids act as assistants to the mordant, giving different results for the following reasons:

(1) Sulfuric acid liberates chromic acid from the potassium dichromate which is taken up by the fiber:



(2) Oxalic acid slowly produces chromium hydroxid which is taken up by the fiber:



In the first case the chromic acid is partly reduced by the wool fiber; the unreduced chromic acid oxidizes the coloring matter of logwood and then combines with it to form a black lake. In the second case chromium hydroxid combines

directly with the logwood without oxidation. Cream of tartar, tartaric, and lactic acid have the same effect as oxalic acid.

Besides influencing the composition of the body absorbed by the wool, assistants are used with metallic mordants for the following purposes:

(1) To prevent superficial and uneven mordanting. For example, wool decomposes alum so rapidly that in mordanting in large quantities, where portions of the material are more exposed for a time to the action of the mordanting liquid than other portions, some parts of the wool will take up the aluminium more rapidly than others and stripes or spots will appear when dyeing. Further the mordant is liable to be superficially attached to the wool, and the color lake subsequently formed will rub off. The addition of sulfuric acid, oxalic acid, of potassium bitartrate to the mordant bath prevents the alum from decomposing so rapidly and aids to produce even the fast colors.

(2) To cause more of a mordant to be taken up. Sulfuric acid added to potassium dichromate by liberating chromic acid, causes the wool to combine with a larger portion of the mordant. Wool takes up chromic acid from potassium dichromate to a certain extent:



57. To demonstrate the above methods of dyeing we will mordant two skeins of worsted with 3 per cent potassium dichromate and 2 per cent oxalic acid in 200 c.c. of water, boiling half an hour.

We will then boil one of the skeins with 8 per cent of hematein paste for half an hour. Following with the second skein as an exhaust test. That is to see how much color remains in the bath.

58. We will then mordant two more skeins as above with 3 per cent of dichromate of potassium and  $1\frac{1}{4}$  per cent of sulfuric acid, boiling  $1\frac{1}{2}$  hours, and dye with 8 per cent of hematein paste for one hour, running the second skein as an exhaust test.

59. Mordant two 5-gram skeins with 3 per cent of  $K_2Cr_2O_7$ , and  $2\frac{1}{2}$  per cent cream of tartar, boiling  $1\frac{1}{2}$  hours and dye with 8 per cent of hematein paste for an hour.

60. Besides the methods given above there is another process known as the single bath method, in which the dye and mordant are applied in the same bath. The color lake is formed and slowly absorbed by the wool after the manner of a direct dye. The method has two disadvantages: first, part of the color lake is liable to be fixed only superficially on the fiber, second part of the dye is precipitated in the bath and lost. It is, however, largely used both for cotton and wool, especially in the case of cheap dyes like logwood, in which the cost of the dye is not great compared with the time and cost of labor in dyeing.

61. To illustrate this method we will dye a skein of woolen yarn with 10 per cent logwood, 3 per cent ferrous sulfate, 1 per cent oxalic acid in 200 c.c. of water for one and one-half hours.

The methods described for logwood apply to other mordant colors, or that is dyestuffs which are invariably fixed upon the fiber in the form of metallic lakes, with a color which may be different from that of the coloring principle. They are very important dyes, being characterized by great fastness to washing, light and other agencies.

62. Of the coal-tar colors the acid dyes are used to a great extent on wool, both on account of their cheapness and for the reason that they are easily applied.

The process of dyeing on animal fibers is to be regarded as

a salt or lake formation, in which the wool or silk acts the part of the base, while the color acid plays the part of the acid. With the exception of picric acid, the acid colors are sold as salts, mostly alkali salts, but a few in the form of lime salts.

63. The general method of procedure is to prepare a bath of 10 per cent of Glauber's salt (sodium sulfate) and 4 per cent of sulfuric acid with the necessary amount of dyestuff. After the material is entered the temperature is raised to boiling and the dyeing finished by boiling three-fourths of an hour.

64. For purposes of demonstration we will dye a 5-gram skein of wool with several of the following colors, using 1 per cent of dyestuff:

- |                           |                               |
|---------------------------|-------------------------------|
| (a) Fast red              | (f) Acid magenta (all brands) |
| (b) Patent blue           | (g) Acid violet (all brands)  |
| (c) Scarlet 6 R. crystals | (h) Orange (all brands)       |
| (d) Naphthol yellow S.    | (i) Naphthol brown O.         |
| (e) Scarlet 2 R.          | (j) Naphthol black D.         |

All other acid colors.

65. **Silk.** — This is the fibrous substance which the silk-worm spins to form its cocoon. Silk resembles wool in many respects. The numerous kinds of silk may be divided into two classes — artificially reared and wild silk. The principle species of silk-worms feed on the leaves of the white mulberry, and is reared in China, Japan, India, Italy, the south of France, Greece, and to a slight extent in the United States. In Asia the worms are reared in the open air, but in Europe this is done in sheds. The eggs are placed on shelves, and the temperature of the room raised from 18° C to 25° C in 12 days, when the eggs hatch, the caterpillars are removed to another room, and feed on the leaves of the

white mulberry. They grow rapidly, changing their skin every 4 to 6 days. At the end of 30 to 33 days the mature worms creep into birch twigs or bundles of broom or heather, where they spin themselves into cocoons. The spinning lasts 3 days, generally, but in order to be more sure that all of the worms have ceased spinning, 5 days are allowed to elapse before the cocoons are collected. Some of the finest having been selected for breeding the rest are killed, either by exposing them in stoves to a temperature of 60–75° C for 3 hours, or by steaming them for 10 minutes.

Before the silk is spun it is found in the worm as two liquids, one a clear, colorless liquid, the other colorless or yellow, which are both secreted from two glands, one on each side of the head, communicating with a capillary orifice in the head. The silk liquid solidifies on coming in contact with the air, forming a uniform double fiber, which in some places may be seen separated into 2 filaments.

The cocoons having been sorted, the silk is reeled off. After removing the outer portion of the cocoon, which consists of a loose tangle of threads, a number of cocoons are placed in warm water to soften the gum, and the ends of the fibers from 4 to 18 cocoons are collected and reeled off as one thread. The length of the fiber in a single cocoon varies from 1000 to 4000 yards.

**66. Organzine** or warp silk is composed of the reeled off fibers of a number of cocoons. Tram or weft silk contains a smaller number of fibers. The outer portions of the cocoons are used in the manufacture of silk. Cocoons pierced, or otherwise defective and the innermost layers of the cocoon are used for spun silk. These are fermented with water, boiled with soda, washed, dried, combed, carded, and spun.

**67.** The count of spun silk is the number of hanks of 840 yards to the pound. The size of raw silk is measured by

the weight of 1000 yards in drams avoirdupois. A pound of 1 dram silk contains 250,000 yards.

**68.** Silk is hygroscopic, and absorbs moisture from the air. It can be made to absorb up to 30 per cent of water without feeling damp. The legal quantity of water in silk is 10 per cent and it is sold on that basis, the moisture in each purchase being determined by conditioning. Silk is very strong; it is elastic and can be stretched one-seventh of its length without breaking.

**69.** Silk behaves like wool toward metallic salts used for mordants. It decomposes the salts even in cold solution. It likewise acts in a similar manner toward coloring matters in general, but has less affinity for acid colors, and a greater affinity for basic colors.

**70.** The luster of silk is increased after dyeing by treatment with acids; by this means it acquires a peculiar feel, and emits a peculiar crackling sound when compressed. The scroup feel, as it is called, is frequently desired. Tartaric acid gives the best results.

**71.** The absorptive power of silk is taken advantage of in the weighing of the fiber, which is accomplished by means of tannic acid, iron and other salts.

The dyeing of silk is usually accomplished with mordant colors, but for demonstration we will dye a few samples in an acid bath, and some in a neutral bath.

**72.** For the acid bath make a solution of sulfuric acid 10 grams in 200 c.c. of water. To this add 1 per cent of dye, enter the silk at 86°-104°, and raise to 203° F. Continue dyeing until the bath is nearly exhausted.

The dyestuff for this bath may be

(a) Scarlet 6 R cryst

(c) Brilliant orange O.G.R.

(b) Naphthol yellow S.

(d) Acid magenta 4 B.

73. In place of sulfuric acid employ acetic acid, using:

- (a) Methyl violet (all brands)      (c) Janus yellow G. R.  
(b) Safranin (all brands)          (d) Dianil orange G. pat.

74. Prepare the bath with 10 per cent olive oil soap, broken with 2 per cent of acetic acid, add 1 per cent of color, enter a skein lukewarm and slowly raise to 180 F., rinse well and scroup with  $\frac{1}{2}$  per cent solution of tartaric acid.

- (a) Safranin F. F. extra.          (c) Methylene blue B. B.  
(b) Phosphin N.                      (d) Methyl violet 1 B.-7 B.

75. **Vegetable Fibers.** — The bases of all vegetable fibers is to be found in cellulose, a compound belonging to a class of naturally occurring substances known as carbohydrates. These fibers may be divided into two classes. (1) Seed hairs; that is fibers attached to the seed of plants — as the common thistle, dandelion, and cotton. Cotton is the only fiber of this kind of commercial importance. Each fiber is composed of a single cell. They vary from one-fourth to two inches in length. (2) Bast fibers: fibers from the stem or leaves of plants — as jute, flax, etc. The fibers may be quite long, in some cases upward to 6 feet. They are compound fibers being composed of bundles of cells cemented together. The cells or ultimate fibers are quite short.

About 30 kinds of vegetable fibers are used in the United States, not all of them, however, as textile fibers. The most important are cotton, flax (linen), hemp, jute, and china grass.

76. **Cotton.** — Cotton is enclosed in a 3 to 5-valved capsule or boll, which bursts when ripe. It is picked by hand and ginned to remove seeds and coarse impurities like leaves, from the seed hairs or lint. The cotton is packed in bales weighing from 300 to 500 pounds.

77. Cotton is graded chiefly by its length of fiber, though its freedom from dust, color, leaves, seeds, and seed particles are also considered. The longer fibers are smaller in diameter, are silkier, and can be spun into finer threads than the coarser.

78. Our cotton is of two types. Sea Island cotton has the longest and finest staple, and commands the highest price of any commercial cotton. It is grown only on the islands and along the coast of South Carolina and Florida, and to a limited extent along the Gulf of Mexico. It is less than one per cent of our crop.

The remaining ninety-nine per cent, known as the American Upland, has a larger staple and is of a better quality than the East Indian and other growths, except the Egyptian, which comes between American Upland and Sea Island in quality and price.

79. **Properties of Cotton.** — Dilute mineral acids, as sulfuric, or hydrochloric, have little action on cellulose, unless allowed to dry upon it; as the fiber dries and the acid becomes more concentrated, the cellulose is affected. Fibers composed of cellulose like cotton or linen, become weaker or packed to a powder under such conditions. The degree to which this change occurs depends on the temperature at which the drying takes place, and upon the strength of the acid.

The destruction of vegetable fibers by the action of mineral acid at an elevated temperature is called carbonization, for the reason that the powder hydro-cellulose is usually black, or nearly so, and it was thought to be carbon. Wool is not destroyed by carbonization.

Cellulose has weak acid and basic properties, and will absorb acids or alkalis from very dilute solutions. Beyond this, dilute solutions of caustic alkalis have no action on



cotton, whether hot or cold, and the same may be said of sodium or potassium carbonate, soap, borax, and phosphate of soda. On the other hand when cotton is treated with strong solutions of caustic soda and washed, it undergoes a peculiar change. It contracts 20 to 25 per cent in length, and becomes heavier, denser, and stronger. This change was first observed in 1850 by John Mercer, an English cotton printer, from whence it has the name mercerization. The action of the caustic soda is to combine with the cellulose forming the compound,  $C_{12}H_{20}O_{10} \cdot 2NaOH$ .

This washed with water, decomposes with the production of cellulose hydrate,  $C_{12}H_{20}O_{10}H_2O$ , which is the formula of mercerized cotton; the gain in weight of the cotton is 4.5 to 5.5 per cent.

80. Mercerized cotton differs from ordinary cotton in several respects. It has a much greater affinity for dyes, especially for direct cotton colors like congo red, taking up more from solution, and leaving less in the dye-bath. It also has a greater affinity for mordants than ordinary cotton.

81. When a fiber is weakened by anything which may come in contact with it during manufacture, as in bleaching, dyeing, etc., it is said to be tendered. The tendering may take place only to a slight extent, or it may result in an actual destruction of the fiber. Tendered goods are found to be rotten, after a short time.

The following agencies may tender cotton: Mildew, frost, crystals of salts, acids, salts, as aluminum chlorid, ferric chlorid, and magnesium chlorid, and oxidation. While cotton is completely dissolved by concentrated solution of zinc chlorid, ammoniacal copper hydroxid and converted into nitro-cellulose by nitric acid.

82. Cotton yarn should always be "boiled off" or "wetted out" before dyeing. This is done by boiling with water

in which is about 1 gram of sodium carbonate to 500 c.c. When thoroughly wet they are placed in clean water until needed.

Prepare a dye-bath with 2 per cent of color (direct dye), 2 per cent of sodium carbonate, and 20 per cent of Glauber's salt (sodium sulfate), using six 10-gram skeins, boil for half an hour. Remove, rinse and dry.

List of a few direct dyestuffs for tests on cotton.

Congo red 4 R.	Benzo purperin
Primulin	Dianil red
Benzo orange R.	Dianil brown
Benzo green B. B.	Oxy diamin brown 3 G. N.
Diamin black R. O.	Oxy diamin black J. W. F.
Diazo brown G. R.	

**83.** Dye six 5-gram skeins of wool in the same way, without the sodium carbonate.

If we examine the two solutions after dyeing cotton and wool with a direct color, we find:

1. The wool has exhausted the dye-bath; that is, it has withdrawn almost all dyestuff from solution.

2. The cotton has not exhausted the bath, but has left a considerable portion of the dye unabsorbed.

The experiment illustrates the characteristic difference between animal and vegetable fibers in their behavior toward direct dyes.

The object in adding salt to the dye-bath is to cause a decrease in the solubility of the dye, and thereby cause more of it to go on to the fiber.

Hard water should not be used for dyeing as it caused a precipitate of the dye as magnesium and calcium salts with a consequent loss.

When cotton yarn dyed with a direct color is boiled in

water, part of the color will be removed or stripped from the fiber.

84. Plait a skein of the dyed cotton with undyed cotton and boil it for 15 minutes.

85. Do the same with wool, using the undyed woolen yarn.

These tests show that cotton is more easily stripped than wool. It also shows in the case of cotton, that the undyed cotton takes the color away from the other and eventually they would become of the same color.

86. If we subject the dyed yarn to the action of warm water and soap — that is, imitate the action of washing — the solution becomes colored. If white material is present it also becomes colored, *i.e.*, the color is said to blend.

Plait a skein of the dyed cotton with undyed cotton, make a solution of 2 grams of soap in 200 c.c. of water, heat to 60° C. Introduce the plaited skein and work for 10 minutes. It is then rinsed in cold water, wrung out and dried.

87. Test the dyeing of wool in the same way and note results in each case.

88. If a skein is placed in direct sunlight for several days the color will fade. All dyes are effected by light, but vary in their resistance toward it.

Dyes are also treated for fastness to acid. This test represents their resistance to acids in the air and perspiration.

89. Introduce a skein of dyed yarn into a 25 per cent solution of acetic acid and work for 5 minutes. Wring out, wash and dry. Note any change in color.

Another test is for fastness to alkalis.

90. Introduce a skein of yarn into a 1 per cent solution of sodium carbonate and work for 5 minutes. Note any change.

The above lists are members of a class of dyes, known as direct cotton colors, or substantive cotton colors, which will

dye cotton, wool, or any other fiber without the aid of other substances.

**91. Mercerization.** — Dissolve 80 grams of caustic soda in 400 c.c. of water and allow the solution to cool.

Cut a piece of unbleached cotton cloth about 6 inches long and 2 inches wide. Measure it carefully, wet, squeeze, and then immerse it for 5 minutes in the above solution, remove, wash and dry. Remeasure. How much has it shrunk? What per cent?

**92.** Immerse 4 boiled-off skeins of cotton yarn in the above solution, work carefully for 5 minutes, remove, wash with water, then with water containing a little acetic acid, and dry. Are they in any way different from ordinary cotton?

**93.** Dye a skein of your mercerized cotton with  $\frac{1}{2}$  per cent *Oxamine blue* and 10 per cent sodium sulfate in 200 c.c. of water, boiling 15 minutes. Is the bath exhausted? This dye is a direct cotton color.

**94.** Dye an unmercerized skein in the same way. Which skein takes up the more dye? Which is darker?

**95.** Work two skeins of mercerized cotton 30 minutes in 2 per cent tannic acid in 200 c.c. cold water.

**96.** Mordant two unmercerized skeins in the same way.

**97.** Dye one of each, mercerized and unmercerized, in a separate bath of  $\frac{1}{2}$  per cent methyl violet in 200 c.c. of water at 50° C., working 20 minutes. Is the bath exhausted? Which skein takes up the more dye? The depth of color depends upon the amount of tannic acid taken up. Which takes up the more tannic acid?

**98.** Dye a skein of mercerized cotton with 1 per cent of *methylene blue* in 200 c.c. water at 50° C. working 15 minutes.

**99.** Dye an unmercerized skein in the same way. What difference do you see?

Both of these dyes are basic colors. That is, they are salts of color bases, direct dyes for wool, but not for cotton, and are dyed on cotton with tannic acid mordant, or mordants of acid nature.

100. Mordant five 10-gram skeins of cotton yarn with 5 per cent of sumach in 400 c.c. of water, boiling for 15 minutes, or until "wetted out," and allowed to stand one hour.

101. Dye one skein, which has been mordanted as above (100), with each of the following, using 2 per cent of the dyestuff, temperature 120-140° F.

- |                       |                                  |
|-----------------------|----------------------------------|
| (a) Auramin           | (c) Malachite green (all brands) |
| (b) Safranin T extra. | (d) Methyl violet R.             |

102. Mordant five 10-gram skeins of cotton yarn with 5 per cent of cutch in 400 c.c. of water in the same manner as above.

103. Dye one skein which has been mordanted as above (102), with each of the following, using 1 per cent of the dyestuff.

- |                       |                                  |
|-----------------------|----------------------------------|
| (a) Auramin.          | (c) Malachite green (all brands) |
| (b) Safranin T extra. | (d) Methyl violet R.             |

These tests illustrate some of the numerous sources of tannic acid as applied in dyeing and printing.

The examples given under tannic acid mordants serve to illustrate a large class of basic colors which are applied to cotton, and as they all act in practically the same manner it will not be necessary to give more along this line, except to include a list for those desiring to make a more exhaustive study of the subject.

A few other basic colors:

- |                           |                         |
|---------------------------|-------------------------|
| (a) Rhodamin (all brands) | (f) Magenta             |
| (b) Brilliant green cryst | (g) Janus red B.        |
| (c) Cotton green          | (h) Janus yellow        |
| (d) New fast blue         | (i) Naphthol blue R. T. |
| (e) Phosphin              | (j) Bismarck brown      |

**104. Diazotizing and Developing.** — When goods dyed with primulin, and many other direct colors, are treated with a solution of nitrous acid, and then with a developer, new dyes are produced with new properties. They are insoluble in water, and valuable on account of being fast to washing. The process is called diazotizing and developing.

Direct cotton colors and bodies which can be diazotized and developed contain the group  $\text{NH}_2$ . They are related to ammonia in which one atom of hydrogen has been replaced by a complex group of atoms as  $\text{C}_6\text{H}_5\text{NH}_2$  anilin. When these substances are treated with nitrous acid, the two combine to form a diazonium salt:

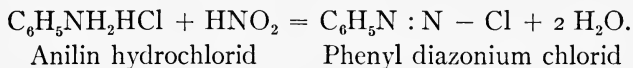

or for any of these compounds:



Diazonium compounds are, for the most part, very unstable, and even explosive in the solid state.

When a diazonium salt is treated with phenol, or an aromatic amine under proper conditions, the two combine directly and a stable compound is formed. For example,

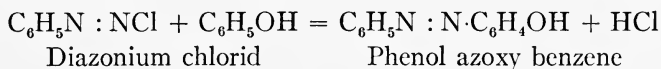

This is the kind of action which takes place when a diazotized fabric is treated with a developer. The developer

combines with the diazonium compound to form a more stable body, which is a new dye.

Some diazo colors:

- |                        |                                  |
|------------------------|----------------------------------|
| (a) Sulphin            | (e) Dianil black                 |
| (b) Oxamine violet     | (f) Dianil ogene sky blue N.     |
| (c) Oxamine blue B. G. | (g) Oxy. diamin ogene O. T. pat. |
| (d) Dianil brown       | (h) Primulin                     |

**105.** Dye five 10-gram skeins of boiled off cotton yarn with 4 per cent primulin, 30 per cent of salt and 5 per cent of sodium carbonate in 400 c.c. of water; heat, enter the yarn and boil 30 minutes. Work from time to time. Is the bath exhausted?

**106.** Diazotize four of the dyed skeins in a bath of 3 per cent of sodium nitrite, and 200 per cent dilute hydrochloric acid in 400 c.c. of water. Free nitrous acid is liberated according to the reaction:

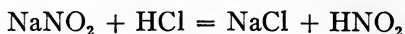

Enter the yarn and work ten minutes. The diazotized primulin is very unstable, and must be developed as soon as possible.

**107.** Hang one skein of the yarn, after diazotizing and before developing in the sunshine for 10 minutes, and then develop as in (a) below.

**108. Developing.** — Have ready the following baths, enter one skein in each, work cold 10 minutes, wash and dry.

(a) 1 per cent beta-naphthol and 1 per cent sodium hydroxid in 200 c.c. water.

(b) 1 per cent of resorcin and 2 per cent sodium hydroxid in 200 c.c. of water.

(c) 2 per cent alpha naphthol and 4 per cent sodium carbonate in 200 c.c. water.

The preceding experiment shows that different developers, acting upon diazotized primulin produce different dyes of different colors. It also shows that light decomposes diazotized primulin, and prevents it from uniting with the developer.

**109. Mordants of Metallic Tannates.** — Insoluble metallic tannates possess an attraction for basic colors, equal to if not greater than tannic acid. The presence of the metal aids in the decomposition by reason of a portion neutralizing the liberated acid of the coloring-matter, and it is probable that a very insoluble tannate of the metal and the color base is produced. The process of converting tannic acid into insoluble metallic salts is termed fixing, and is usually carried out after mordanting with tannic acid. Salts of antimony, iron and sometimes tin are used as fixing agents.

Antimony tannate is colorless and gives the brightest and fastest colors. For this purpose tartar emetic is usually employed,  $\text{KSbO} (\text{C}_4 \text{H}_4\text{O}_6) \frac{1}{2} \text{H}_2\text{O}$ .

**110.** Boil three 10-gram skeins of cotton yarn with 5 per cent of tannic acid dissolved in 500 c.c. of water, until the cotton is thoroughly wetted out. At least 15 minutes. Allow the solution to cool an hour, working the yarn from time to time. Tannic acid is absorbed more readily by cotton from a cold solution. Squeeze well and proceed as below.

Skein No. 1. Dye as directed below. (111.)

Skein No. 2. Fix with antimony, by working 10 minutes in a bath of 2 per cent tartar emetic in 400 c.c. water.

Skein No. 3. Fix with iron by working 10 minutes in a bath of 5 per cent copperas and 3 per cent calcium carbonate in 400 c.c. water.

**111.** Prepare three dye-baths with 1 per cent malachite green in 200 c.c. of water. Enter a skein in each bath, raise the temperature to  $65^\circ \text{C}$ ., and keep at this temperature for



20 minutes. The yarn should be worked carefully. Squeeze and dry without washing.

**112. Removal of Stains.** — Fruit or vegetable stains may be removed usually by washing with dilute oxalic acid or vinegar. Dilute hydrochloric acid will also give the same result.

Most coal-tar colors may be removed by bleaching powder and an acid. The best method is to dip the goods into the solution or emulsion of the chlorid of lime and after working for 2 or 3 minutes ring out, then dip in a 3 per cent solution of oxalic acid and wash thoroughly. Hydrochloric or sulfuric acid or even vinegar may be used. This is of course for white goods which have been stained with coal-tar colors or inks. Stains may be moved from the hands in the same manner.

An easy method of removing stains from the hands is to wash in a 1 per cent solution of potassium permanganate, then in a 2 per cent solution of oxalic acid and rinse thoroughly.

Stains caused by tannic acid and iron inks can usually be moved with oxalic acid or potassium acid-oxalate.

Iron rust can be removed in the same manner. Many vegetable stains may be removed by simply soaking in tepid water.

Mordant colors as a rule are more difficult to discharge from the hands or fabrics, but can be removed by the following treatment.

Place in the hand about two teaspoonfuls of chlorid of lime and cover with about twice as much sodium carbonate. Just moisten (do not wet) with water and work into a paste. When the paste becomes warm rub over the hands or fabric like soap. Work until nearly dry, and then rinse. Follow this treatment with a strong solution of sodium bisulfite

and without rinsing by a strong solution of oxalic acid. Wash well, and dry.

Grease spots, oils, paints, varnishes, and tar may be removed by washing or rubbing with a cloth saturated with either naphtha, benzene, ether, chloroform, carbon disulfid, carbon tetrachlorid, turpentine, or common kerosene.

Those who desire to make a more exhaustive study of this subject should refer to the literature published by the various coal-tar color companies. A brief outline, however, will be given here in case such literature is not available.

**113. The Sulfur Dyestuffs on Cotton.** — The colors belonging to this group are absorbed by cotton in a bath containing sodium sulfid.

The bath is prepared by boiling a solution containing from 2 to 10 per cent of dyestuff, 2 to 3 per cent of sodium carbonate, 5 to 10 per cent of sodium sulfid, and 10 to 20 per cent of sodium chlorid, or Glauber's salt. The fiber is entered into the boiling bath and worked until finished, about one and one-fourth hours.

It is very essential that, after dyeing, the cotton should be thoroughly washed before drying.

**Examples.** — *Immedial black* 15 per cent, sodium sulfid 10 per cent, soda-ash 5 per cent, Glauber's salt 20 per cent. *Immedial yellow* 5 per cent, sodium sulfid 5 per cent, soda-ash 5 per cent, Glauber's salt 5 per cent. *Immedial Dark blue* 20 per cent, sodium sulfid 20 per cent, soda-ash 10 per cent, Glauber's salt 20 per cent. *Katigen Indigo 2 R.* L. extra 10 per cent, sodium sulfid 20 per cent, soda-ash 6 per cent, Glauber's salt 50 per cent. *Katigen black T.* extra 7.5 per cent, sodium sulfid 15 per cent, soda-ash 8 per cent, Glauber's salt 60 per cent.

**114. Vat Colors on Cotton and Wool.** — The most important dyestuff of this class is Indigo, which is produced

upon the fiber by first treating with an alkalin solution of Indigo white, which, on oxidation in the air, is reconverted into the blue. The term "vat" applies to the vessel employed for dissolving the Indigo and also to the solution itself, which may be prepared by the aid of various reducing agents.

**115. The Zinc Lime Vat:**

10 grams of Indigo M.L.G. powder or 25 gr. paste  
10 grams of zinc dust  
30 grams of quick lime.

Mix the zinc dust with 150 c.c. of water at 50° C; add the Indigo and then the lime with constant stirring. The whole is left to stand for 6 hours, but is stirred from time to time. The reduction is complete when a drop of the solution placed on a sheet of glass runs off as a yellow liquid which oxidizes in the air in the course of forty-five to fifty seconds.

The reduced solution is then diluted with 500 c.c. of water, and the cotton fiber dyed in it by thoroughly soaking. It is then wrung out, and dried in the air; the process being repeated until the requisite shade is obtained.

**116. The Sulfate of Iron Vat.** — By following the same direction as above this bath may be prepared by using

10 grams Indigo M.L.B. powder.  
50 grams ferrous sulfate.  
60 grams lime.

**117. The Hydrosulfite Vat** (for cotton). — This vat is based on the property of hydrosulfurous acid  $\text{H}_2\text{S}_2\text{O}_4$  of forming with Indigo a colorless double compound which is soluble in alkalies, and is decomposed by the weakest oxidation; Indigo blue being thereby liberated.

For practical use the sodium salt of hydrosulfurous acid  $\text{Na}_2\text{S}_2\text{O}_4$  is prepared by allowing zinc dust to act on sodium

bisulfite in a tightly closed vessel, the mixture being kept stirred and cooled. The reaction is usually complete within 4 or 5 hours. The hydrosulfite solution is rendered slightly alkaline with milk of lime in order to diminish its instability, and is then ready for use. The procedure is as follows:

100 parts of sodium bisulfite solution  $71.4^{\circ}$  Tw.  
 225 parts of cold water, and in the course of half an hour  
 $3\frac{3}{4}$  parts of zinc dust stirred into this solution.

The whole, which is stirred from time to time, is left to stand for 4 or 5 hours, and then mixed with

11 $\frac{1}{2}$  parts of lime slaked in  
 30 parts of water.

After allowing the sediment to settle, the clear solution is decanted, and 7 parts caustic soda solution  $36^{\circ}$  Tw. added.

The hydrosulfite solution is now ready for use. Should stand at  $19-20^{\circ}$  Tw., and kept in a tight bottle in a dark room.

#### 118. Preparation of Dye Vat:

10 grams of Indigo are mixed with  
 30 grams of hot water; to this mixture  
 85 grams caustic soda  $76^{\circ}$  Tw. are added, and the whole well stirred; after heating to  $50^{\circ}$  C.  
 250 grams of hydrosulfite solution  $20^{\circ}$  Tw. are added and the temperature kept at  $50^{\circ}$  C.

In the course of the reduction which takes place, and which is tested in the usual way with a sheet of glass, more hydrosulfite solution is added in several portions. The reduced Indigo ought to run off the sheet of glass as a yellow liquid, which oxidized in twenty to thirty seconds.

The cotton fiber is then dyed in the same manner as indicated in the case of the zinc vat.

**119. The Hydrosulfite Vat** (for wool). — The process is essentially the same, only the use of caustic soda must be replaced by milk of lime in sufficient amount to produce an alkaline reaction.

**120. Turkey-red upon Cotton.**—The name turkey-red is applied to the color produced upon cotton by the aid of alizarin, alumina, lime, and fatty acid compounds. This fatty acid compound known as Turkey-red oil is prepared by treating olive oil or castor oil with concentrated sulfuric acid, usually 3 parts of acid being added to 10 parts of oil. (See 313.)

The acid is slowly poured into the oil with constant stirring, and the whole then let to stand until a sample of the product is found to dissolve completely in water, whereupon it is poured into water and washed with a solution of sodium chlorid until free from sulfuric acid.

During the process of mixing the temperature should not be allowed to rise above 40° C. Sometimes the last trace of acid is neutralized with ammonia.

The production of a good Turkey-red upon cotton can only be attained by practise; the directions given should, however, yield fairly good results if carefully followed.

**121. Clearing.** — Free the cotton fiber (10-gram skeins) from grease, etc., by boiling in a weak solution of sodium carbonate; wring out thoroughly.

**122. Oiling.** — Without drying, enter into a bath containing:

10 grams Turkey-red oil  
90 grams water

and work until thoroughly soaked. Wring out and dry in hot-air cupboard at 40-50° C.

Repeat this operation twice, drying between each immersion.

**123. Alumina Mordant.** — Work the fiber through a bath of aluminium acetate 9° Tw.; wring out and dry at 40-50° C.

Repeat this treatment.

**124. Chalking.** — Enter the cotton into a bath containing  
6 grams of chalk and  
1 liter of water

at 30–40° C. Stir well for about half an hour, and then wash thoroughly in clean water. It is unnecessary to dry the cotton before dyeing.

**125. Dyeing.** — Stir the dyestuff (15 per cent alizarin paste) into the water and enter the skein at 20–25° C. Work the skeins at this temperature for about 20 minutes, and then heat up so that in about half an hour the temperature rises to 60° C. Keep at this point for about an hour, then wring well and dry.

**126. Steaming.** — Steam the dried cotton for one hour at a pressure of 15 pounds or for 2 hours without pressure; then wash well.

**127. Brightening.** — Brighten the dyed material in a closed apparatus at a pressure of 5 pounds. Work in a solution of 4.5 grams of soap in 1 liter of water; leave the cotton in it for 10 minutes and wash well.

**128. Colors Produced Directly upon the Fiber by Oxidation.** — Anilin black, the typical member of this group, is produced directly on the cotton fiber by the oxidation of anilin, and the two following methods will suffice to indicate the manner in which dyestuffs of this kind are formed:

I. One bath black —

The bath should contain

5 per cent anilin

12 per cent hydrochloric acid

6 per cent dichromate of soda

5 per cent copper sulfate.

The cotton should be entered into the bath and worked

for one hour; then the bath should be raised to boiling during another hour, and the fiber worked at this temperature for another half hour; wash and dry.

## II. Oxidation, black —

126 grams anilin hydrochlorid are dissolved in  
300 c.c. of water, and mixed with  
40 grams chlorate of soda  
150 grams acetate of alumina 21.6° Tw.  
5.7 grams ammonium chlorid  
3 grams copper sulfate

and the whole made up to one liter.

The fiber is thoroughly impregnated in this solution, wrung out and dried.

It is then worked for half an hour at 60° C. in a bath containing

2.5 per cent bichromate of soda  
.5 per cent anilin hydrochlorid  
.2 per cent sulfuric acid 161.8 Tw.

and then washed and dried.

## REFERENCES

- The Literature published by Meister Lucius and Bruning.  
Farben Fabriken vorm, Frederick Bayer & Co.  
Badische Anilin and Soda Fabriken.  
Cassella Color Company.  
Kalle and Company.  
Berlin Anilin Works.  
Heller and Merz.  
Dyeing and Calico Printing. A. Sansone. London, 1897.  
The Printing of Textile Fabrics. C. F. S. Rothwell. London, 1897.  
Color in Woven Design. Roberts Beaumont. London, 1902.  
Principles of Dyeing. G. S. Fraps. New York, 1903.  
Textile Fibers. J. Merritt Mathews. New York, 1904.

## CHAPTER IV

### COMMERCIAL ORGANIC COMPOUNDS, COAL-TAR COLORS, AND SYNTHETIC OILS

#### 129. Iodoform. — (CHI<sub>3</sub>).

25 grams potassium iodid  
5 grams acetone.

Dissolve 25 grams of potassium iodid in 500 c.c. of water and add 5 grams of acetone. To this mixture add, through a drop funnel with constant shaking, a dilute solution of sodium hypochlorite as long as a precipitate forms. Allow the precipitate to settle. Decant off the liquid, wash with water two or three times, filter, drain thoroughly, dry on filter paper, and recrystallize from alcohol.

The solution of sodium hypochlorite used in this experiment, may be made by precipitating all the calcium in a solution of bleaching powder by a solution of sodium carbonate. A slight excess of sodium carbonate will not interfere with the reaction.

#### *Reaction:*

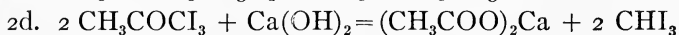
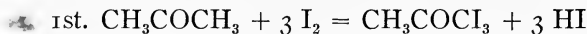

#### 130. Acetyl Chlorid. — (CH<sub>3</sub>COCl).

100 grams glacial acetic acid  
80 grams phosphorus trichlorid.

To 100 grams of glacial acetic acid contained in a 250 c.c.



distilling flask, add by means of a dropping funnel 80 grams of phosphorus trichlorid. The distilling flask must be connected with a return condenser and be immersed in ice water. While the phosphorus trichlorid is being added the flask must be constantly shaken. After 10 minutes the ice water may be replaced with warm water and heated until almost all the hydrochloric acid gas has been evolved. The condenser may be then turned down and the acetyl chlorid rapidly distilled off. The acetyl chlorid is very easily decomposed by moisture so the receiver must be protected by a calcium chlorid tube. The acetyl chlorid may be purified by redistillation, using a thermometer.

*Reaction:*

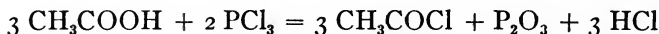

**131. Ether.** —  $((\text{C}_2\text{H}_5)_2\text{O})$ .

Ether is extremely volatile and inflammable. Take care that no flame is brought near it.

150 grams (80 c.c.) conc. sulfuric acid

85 grams (110 c.c.) absolute alcohol.

A distilling flask ( $\frac{1}{2}$  liter) is fitted with a thermometer with bulb below liquid (Fig. 8), and is separatory funnel. The side tube of the distilling flask is fixed by a cork into the upper end of a long condenser. An adapter is fitted to the lower end and passes through the neck of a flask, which is surrounded by ice. The sulfuric acid and alcohol are cautiously mixed together in the distilling flask which is then placed upon a sand bath and attached to the condenser. The mixture is heated at  $140^\circ \text{C}$ . and alcohol is run in from the funnel at the same speed as the liquid distils (about three drops a second). The temperature must be kept constant at  $140\text{--}145^\circ \text{C}$ . When about 150 c.c. of alcohol has been added and converted into

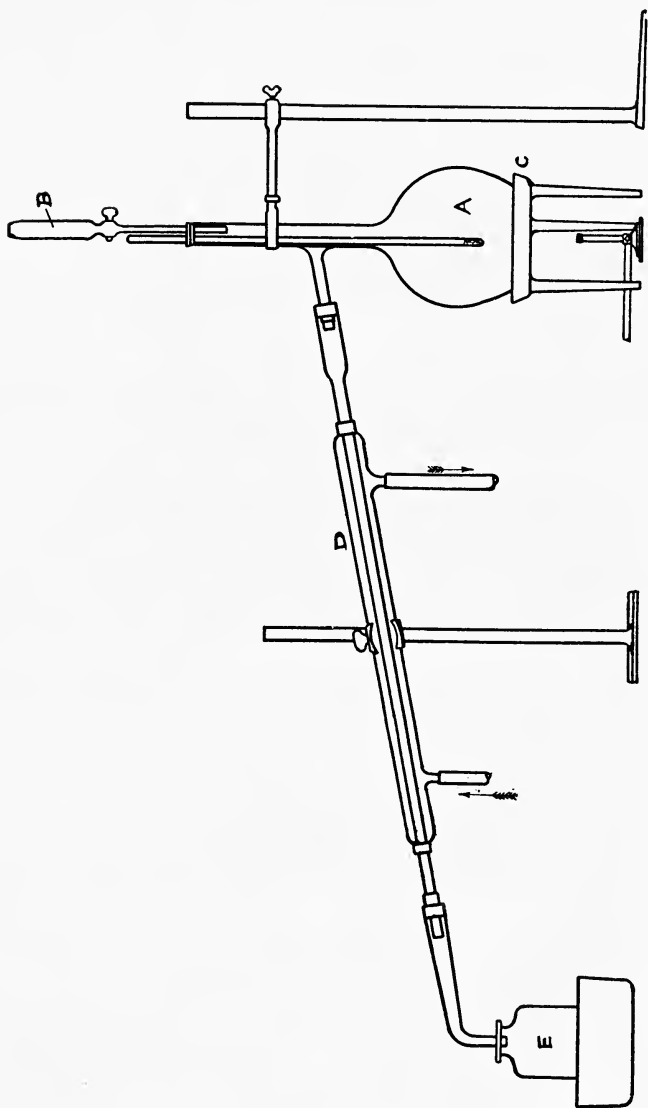
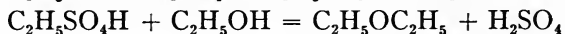

FIG. 8. — A, Distilling flask; B, Separating funnel; C, Sand bath; D, Condenser; E, Receiver.

ether, the distillation is stopped. The receiver now contains in addition to ether, alcohol, water and sulfurous acid. The liquid is poured into a large separating funnel and a small quantity (30-40 c.c.) of dilute caustic soda added and well shaken. After settling, the caustic soda solution is drawn off below, and about the same quantity of a strong solution of common salt added, and the process of shaking and drawing off repeated. The ether, which is now free from sulfurous acid and from most of the alcohol, still contains water. It is therefore poured into a large dry distilling flask and some pieces of solid calcium chlorid added. It is allowed to stand loosely corked over night. The distilling flask is now attached to a long condenser and heated on the water bath. The ether, which distils, can be freed from traces of alcohol and water by metallic sodium. A few very thin slices of sodium are dropped into the receiver and the vessel closed with a cork, through which an open calcium chlorid tube is inserted.

When the action ceases the ether is decanted and distilled on the water bath at a constant temperature of 35° C.

*Reactions:*



*Properties.* — Colorless, mobile liquid; b. p. 35°; Sp. gr. .720° at 15°; burns with a luminous flame; not miscible with water; 9 parts of water dissolve 1 part of ether, and 35 parts of ether dissolve 1 part of water at the ordinary temperature.

**132. Chloroform.** — (Trichloromethane) ( $\text{CHCl}_3$ )

200 grams bleaching powder (fresh)

800 c.c. water

40 grams (50 c.c.) acetone.

A large round flask (four liters) is fitted with a cork, through which a bent tube passes, connecting the flask with a long condenser and receiver. The flask is placed upon a large sand bath. Grind the bleaching powder into a paste with 400 c.c. of water and rinse it into the flask with the remaining 400 c.c. Add the acetone and attach the flask to the condenser. Heat cautiously until a reaction sets in, which is indicated by the frothing of the liquid. Remove the flame for a time, until the reaction has moderated; finally boil the contents until no more chloroform distils. This is easily determined by collecting the distillate in a test-tube and observing if any drops of heavy liquid are present. The distillate is shaken with dilute caustic soda solution in a separating funnel and the lower layer of chloroform run into a distilling flask. A few pieces of solid calcium chlorid are added and left until the liquid is clear, when it is distilled from the water bath with the thermometer inserted into the neck of the flask. Yield about 40 grams.

The bleaching powder acts as though it consisted of a compound of calcium hydroxid and chlorin, and the process probably occurs in two stages.

*Reactions:*

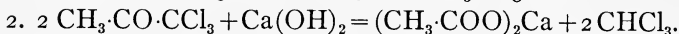

*Properties.* — Colorless liquid possessing a sweet smell, b. p. 61–62°; Sp. gr. 1.525 at 0°; very slightly soluble in water; non-inflammable.

*Reaction.* — 1. Heat a few drops with double its volume of methyl alcoholic potash. On the addition of water a clear solution is obtained. Potassium formate and chlorid being formed.



2. Bring into a test-tube two drops of chloroform, one drop of anilin and 1 c.c. of alcoholic potash and warm in the fume cupboard. Note the intolerable smell of phenyl carbamin (carbamin reaction),

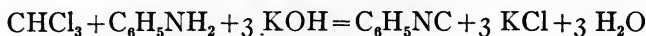

**133. Amyl Acetate.** — ( $\text{CH}_3\text{COOC}_5\text{H}_{11}$ ).

A distilling flask is attached to a condenser and receiver. The flask is provided with separatory funnel as in the preparation of ether. A mixture of equal parts of amyl alcohol and sulfuric acid (100 c.c. of each) is poured into the flask which is then heated in the oil-bath to  $140^\circ \text{C}$ ., and kept at this temperature. A mixture of equal volume of glacial acetic acid and amyl alcohol (200 c.c. of each) is now added, drop by drop, from the tap funnel at the speed at which the liquid distils. When all the mixture has been added, the distillate is shaken with a solution of sodium carbonate in a separatory funnel, until the upper layer of amyl acetate no longer reddens blue litmus paper. It is again shaken with a concentrated solution of calcium chlorid (100 grams in 100 c.c. water); after removing the solution of calcium chlorid the amyl acetate is allowed to stand over fused calcium chlorid for 12 hours and then distilled. The portion passing over between  $140\text{--}155^\circ \text{C}$ . being very pure amyl acetate.

*Reaction:*

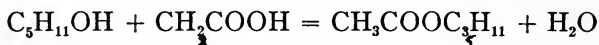

This compound is used very extensively as a solvent for gun-cotton and in the manufacture of varnish.

**134. Nitrobenzol.** — ( $\text{C}_6\text{H}_5\text{NO}_2$ )

200 grams of benzol

240 grams of nitric acid, Sp. gr. 1.4

360 grams of sulfuric acid, Sp. gr. 1.82.

The nitric acid is added in small portions at a time to the sulfuric acid contained in a 1000 c.c. flask. During this operation the flask is well cooled under the tap. The mixture is transferred to a tap funnel and added slowly to the benzol contained in a two liter flask. The flask is well shaken after each addition and the temperature not allowed to rise above 25° C. until nearly all of the acid has been added. A wide glass tube is now attached by a cork to the flask forming an air condenser, and the mixture heated on the water-bath for an hour at 60° C. being frequently shaken. The contents of the flask are poured into about two liters of water when the nitrobenzol settles to the bottom, which can be removed by means of a separatory funnel. It is then washed several times with water. The nitrobenzol is next run into a distilling flask fitted with a thermometer and connected with a long glass tube about 8–10 mm. in diameter, forming an air condenser. The oil is distilled over a free flame.

At first water and benzol pass over, then the temperature rises rapidly to over 200° C. when the receiver is changed and the nitrobenzol collected at 204–207° C.

*Properties.* — Light-yellow liquid, with a smell of bitter almonds; b. p. 206–207°, m. p. 3°, Sp. gr. at 15° 1.208. Nitrobenzol comes on the market as (1) light or pure nitrobenzol, b. p. 205–210°, Sp. gr. 1.2; and (2) heavy nitrobenzol (containing nitrotoluoles), b. p. 210–220°, Sp. gr. 1.18. The terms “light” and “heavy” apply to the boiling point only, not to the specific gravities.

*Use.* — Pure nitrobenzol is used for the manufacture of anilin, benzidin, and in perfumery. Heavy nitrobenzol is used in the manufacture of magenta.

*Reaction:*

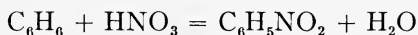

135. Anilin. —  $C_6H_5NH_2$ 

200 grams of nitrobenzol  
240 grams of iron powder  
20 grams of hydrochloric acid.

The iron, together with 320 c.c. of water is placed in a large flask of 2–3 liters capacity and well shaken. The flask is warmed slightly and a few drops of nitrobenzol added. Then the acid is poured into the flask and the remainder of

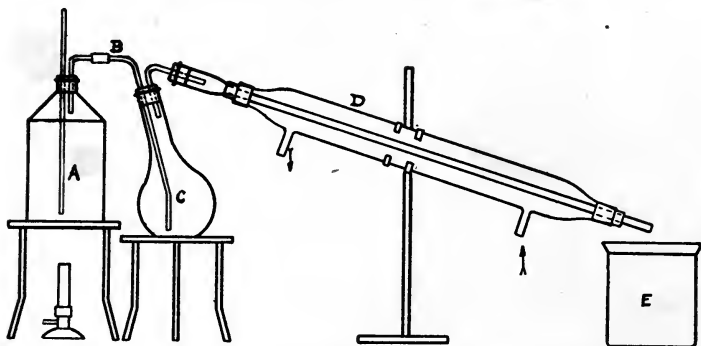

FIG. 9. — A, Can for generating steam; B, Tube passing below surface of liquid; C, Flask; D, Condenser; E, Receiver.

the nitrobenzol is introduced in small portions at a time. After each addition the flask is thoroughly shaken and cooled under the tap. The addition of nitrobenzol is so regulated as to keep the temperature about 80–90°. When the reaction is finished (shown by no further rise in temperature on shaking) the contents of the flask are distilled with steam (Fig. 9) till the distillate is no longer milky. The distillate is transferred to a separatory funnel and the anilin drawn off. The water is now saturated with salt and the oil which rises to the top is added to the first portion and the whole distilled.

A little water passes over at first and is separately collected; then anilin passes over at 182°.

*Properties.* — Colorless oil with a peculiar smell; b. p. 182°, Sp. gr. 1.026.

Commercial “pure anilin” is tested by distillation. At least 90 per cent by volume should distil at 180°. It should give a clear solution with hydrochloric acid; a yellow color indicates the presence of nitrobenzol.

“Anilin for Red” (*i.e.*, for the manufacture of magenta) is a mixture of anilin (32–42 per cent), ortho-toluidin (35–50 per cent), and para-toluidin (14–24 per cent). It results from the reduction of “heavy nitrobenzol.” It should boil between 190° and 200°, and have a specific gravity of 1.007 to 1.009 at 15° C.

*Use.* — Anilin is used for making a large number of its substitution products as well as for quinolin, indulin, magenta, anilin blue, diazo-benzene salts (for azo dyes), and anilin black.

*Reaction:*

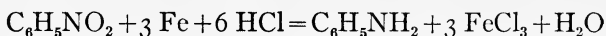

**136. Picric Acid.** —  $(\text{C}_6\text{H}_2(\text{NO}_2)_3\text{OH})$

20 grams phenol

20 grams sulfuric acid (conc.)

100 grams nitric acid.

Heat together on a water-bath to about 100° C. a mixture of 20 grams phenol and 20 grams conc. sulfuric acid until complete solution takes place. Dilute with twice the volume of water and transfer to a separatory funnel. Now add this mixture *gradually, carefully*, and with *constant shaking*, to 100 grams of conc. nitric acid. Warm the mixture on a water-bath until the red color changes to yellow, then pour into a liter of water, filter off the crystals, drain thoroughly, wash with



water, and recrystallize from hot water containing 10 per cent sulfuric acid.

Dye a skein of worsted and silk in a solution of the acid as given in dye-test Nos. 63 and 73. Be careful of the salts of this acid as they explode when heated or struck.

1.  $C_6H_5OH + H_2SO_4 = C_6H_4(OH)SO_3H + H_2O$ .
2.  $C_6H_5(OH)SO_3H + 3 HNO_3 = C_6H_2(OH)(NO_2)_3 + 3 H_2O + H_2SO_4$ .

**137. Cinnamic Acid.** —  $(C_6H_5CH-CHCOOH)$

20 grams benzaldehyde

30 grams acetic anhydrid

10 grams sodium acetate (anhydrous).

A mixture of 20 grams benzaldehyde, 30 grams acetic anhydrid, and 10 grams anhydrous pulverized sodium acetate is heated in a flask provided with a wide vertical air condenser, for 8 hours, in an oil-bath at  $180^\circ C$ . If the experiment cannot be made at one time, a calcium chlorid tube may be placed over the end of the condenser. After the reaction is complete, the hot reaction product is poured into a large flask; add water and distil with steam (see Fig. 9) until no more benzaldehyde passes over.

The quantity of water used here is large enough so that all cinnamic acid except a small oily impurity goes into solution. The solution is then boiled a short time with some animal charcoal and filtered. On cooling the cinnamic acid separates out in lustrous leaves. Drain and dry. Determine melting point.

*Reactions:*

1.  $C_6H_5COH + CH_3COONa = C_6H_5CH : CHCOONa + H_2O$ .
2.  $C_6H_5CH : CHCOONa + H_2O + (CH_3CO)_2O = C_6H_5CH : CHCOOH + CH_3COONa + CH_3COOH$ .

**138. Benzoyl Chlorid.** — (C<sub>6</sub>H<sub>5</sub>COCl)

50 grams benzoic acid  
90 grams phosphorous pentachlorid.

Treat 50 grams benzoic acid in a dry 500 c.c. flask with 90 grams of finely pulverized phosphorous pentachlorid under the hood. The two are shaken well together, upon which an energetic action takes place with the evolution of hydrochloric acid; in order to prevent the cracking of the flask, place it on a wooden block and not on any stone or porcelain.

After standing for a time, it is twice fractionated, using a long wide air condenser. Determine the boiling point.

*Reaction:*

**139. Fluorescein.** — C<sub>20</sub>H<sub>12</sub>O<sub>15</sub>H<sub>2</sub>O

30 grams phthalic anhydrid  
44 grams resorcinol  
14 grams zinc chlorid.

The materials are ground together in a mortar and heated in an oil-bath to 180° C. For this purpose a nickel crucible may be used. As soon as the temperature has reached 180° C., 14 grams of zinc chlorid are added gradually during 10 minutes, the melt being stirred with a glass rod. After the zinc chlorid has been added the temperature is raised to 210° C., and kept at this temperature until the mass becomes solid (one to two hours). The cold melt is broken out of the crucible with a chisel or knife, powdered, and dissolved in dilute caustic soda. After filtering, hydrochloric acid is added, which precipitates the fluorescein; this is filtered, washed and dried. The crude substances are treated with alcohol (boiling), and the residue after filtering is dried.

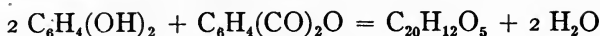
*Reaction:*

One-third of the solution obtained by treatment with caustic soda is evaporated to dryness, and a dye-test made with it on wool and silk as given under tests Nos. 63 and 73.

**140. Eosin.** —  $(\text{C}_{20}\text{H}_6\text{Br}_4\text{O}_5\text{Na}_2)$ 

15 grams fluorescein

33 grams bromin

60 grams alcohol.

The fluorescein is placed in a flask, 60 grams of alcohol added, and the bromin dropped in slowly from a small separatory funnel. When half the bromin has been added, the dibromid which is formed is in solution; but on further addition of bromin the tetrabromid separates out. After standing for two hours the precipitate is filtered, washed first with alcohol, then with water, and converted into the sodium salt by mixing it with a little hot water, carefully neutralizing with caustic soda (avoiding an excess of this reagent) and evaporating to dryness on the water-bath.

*Properties.* — Eosin forms bluish-red crystals or a brownish-red powder, dissolving in water with a bluish-red color.

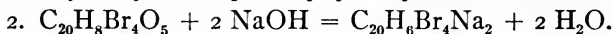
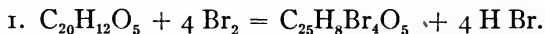
*Reaction:*

Dye a skein of worsted and silk as under tests Nos. 63 and 73.

**141. Dimethyl Anilin.** —  $(\text{C}_6\text{H}_5\text{N}(\text{CH}_3)_2)$ 

150 grams anilin

50 grams anilin hydrochlorid

150 grams methyl alcohol.

The mixture is heated in a closed iron retort for 7 to 8

hours to  $230^{\circ}$ – $240^{\circ}$ , the product then made alkaline with NaOH, distilled with steam, and the oil separated. It is dried over solid caustic potash and the fraction boiling at  $190^{\circ}$ – $200^{\circ}$  is collected.

*Properties.* — Mobile liquid; b. p.  $192^{\circ}$  C.

*Reaction:*



Anilin hydrochlorid is made by dissolving the anilin in hydrochloric acid and evaporating to the point of crystallization. Trade name, anilin salt.

#### 145. Methyl Violet. T. B.

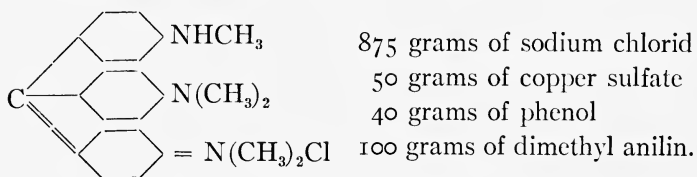

The salt and copper sulfate (finely powdered) are well mixed together in a mortar, and a solution of 40 grams of phenol in 10 c.c. of water added, and the whole stirred well. The dimethyl anilin is now added and the mixture transferred to a round flask and heated on the water-bath for 8 hours, at  $55^{\circ}$ . The product is poured out into a porcelain basin and allowed to cool. In order to free it from phenol and salt, it is broken up and added gradually to three liters of water (boiling) to which has been added milk of lime, prepared from 40 grams of CaO and 200 c.c. of water. After heating until no more lumps are present, the mixture is allowed to settle, and the clear solution of salt and calcium phenate decanted.

The residue of copper oxid, methyl violet and calcium sulfate is washed again by decantation, and finally filtered.

In order to get rid of the copper oxid the precipitate is boiled with dilute sulfuric acid, and sodium sulfate (free from chlorid) added to precipitate the dye, which is filtered and washed. The precipitated violet is subsequently dissolved in water and reprecipitated with salt.

*Properties.* — Methyl violet is a glistening greenish powder, dissolving in water with a violet color.

Dyes silk and wool violet; cotton, after mordanting with tannin and tartar emetic. Tests Nos. 63-73 and 110.

*Reactions:*

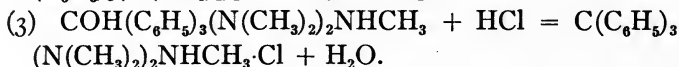
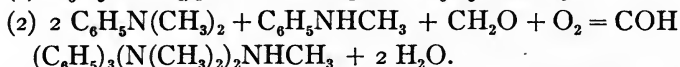
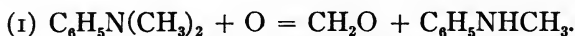

#### 146. Fast Green O (dinitrosoresorcin).

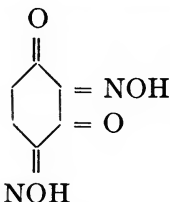

40 grams of resorcinol  
90 grams of conc. hydrochloric acid  
51 grams of sodium nitrite.

The resorcinol is dissolved in 1600 c.c. of water and the hydrochloric acid added, together with 200 grams of common salt. Ice is added till the temperature is  $0^\circ \text{C}$ ., and into this solution, which is stirred mechanically, the sodium nitrite dissolved in 200 c.c. of water is allowed to flow very slowly, the temperature not being allowed to rise above  $8^\circ$ . This takes about half an hour. When all of the nitrite has been added, the liquid should show a faint acid reaction. After standing for one hour, the brownish-yellow precipitate is

filtered, washed with ice cold water, and the paste dried on a porous plate.

*Reaction:*

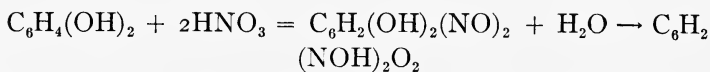

*Properties.* — Grayish-brown powder, soluble in hot water. Dyes iron mordanted cotton or wool green. Dye a skein of cotton and worsted. Test 110 for cotton.

**147. Naphthol Yellow S.** —  $(\text{C}_{10}\text{H}_4(\text{NO}_2)_2\text{SO}_4\text{K}_2)$

100 grams a-naphthol  
400 grams conc. sulfuric acid  
200 grams conc. nitric acid.

The sulfuric acid is warmed in a round bottom flask to  $100^\circ\text{C}$ . and the finely powdered a-naphthol added gradually. The temperature is now raised to  $120^\circ\text{C}$ . and kept at this point for 3 or 4 hours. The sulfonation mixture is then poured into 600 c.c. of water and stirred mechanically. As soon as the temperature is about  $30^\circ$  the nitric acid is added very slowly drop by drop through a tap-funnel, the temperature not being allowed to rise over  $45^\circ$ . The dinitronaphthol sulfonic acid, which separates out after standing, is filtered at the pump, washed with saturated salt solution till free from acid, and mixed with boiling water. Potassium carbonate is now added till an alkaline reaction is obtained, and, after cooling the precipitated potassium salt, filtered and dried on a porous plate.

*Properties.* — Orange-yellow powder. Dyes wool and silk yellow from an acid-bath. Dye a skein of worsted and silk as under tests No. 63 and 73.

*Reaction:*



**148. P-sulfanilic Acid.** —  $(C_6H_4NH_2HSO_3)$ 

200 grams anilin

220 grams conc. sulfuric acid.

The anilin is stirred into the acid contained in a shallow porcelain dish, and the acid sulfate thus obtained ( $C_6H_5NH_2H_2SO_4$ ) is heated in an oven till the temperature reaches  $205^\circ C$ . This must take four hours. The oven is kept at this temperature for six hours more. The product is broken up and dissolved in hot water with the addition of 80 grams of caustic soda (alkalin reaction must be obtained). The solution of sodium sulfanilate is boiled for a few minutes with a little animal charcoal and filtered hot. On acidifying with hydrochloric acid (congo paper must be turned blue), the sulfanilic acid crystallizes out; after standing over night it is filtered at the pump and dried at  $100^\circ$ .

*Properties.* — Sulfanilic acid crystallizes from water in large colorless plates containing one molecule of water of crystallization, which, however, is easily driven off. Sulfanilic acid is used largely in the preparation of azo-dyes.

*Reaction:*

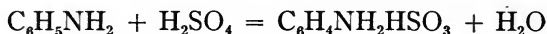
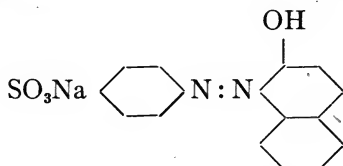
**149. Orange II.** —

34.6 grams of P-sulfanilic acid

14.4 grams of sodium nitrite

28.8 grams of  $\beta$ -naphthol.

The sulfanilic acid is dissolved in water by careful addi-





flask of one liter capacity, fitted with an air condenser, and boiled on a sand-bath for ten or twelve hours.

The hot liquid is poured into hot water containing 30 grams of hydrochloric acid, and the whole well stirred. After cooling, the acetanilid is filtered at the pump, washed with cold water, and dried in the centrifugal.

*Properties.* — Acetanilid is difficultly soluble in cold water but easily soluble in hot water, from which it separates on cooling in white leafy crystals; m. p., 115°; b. p., 295°. By boiling with concentrated hydrochloric acid, it is hydrolyzed to anilin and acetic acid.

*Use.* — Acetanilid is used largely for the preparation of p-nitranilin.

*Reaction:*

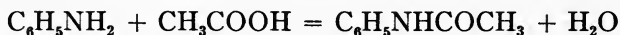

**151. P-nitracetanilid.** —  $\text{C}_6\text{H}_4\text{NH}(\text{CH}_3\text{CO})\text{NO}_2$

200 grams of acetanilid

600 grams of conc. sulfuric acid

125 grams of conc. nitric acid

100 grams of conc. sulfuric acid.

The acetanilid is dissolved in 600 grams of sulfuric acid in a round bottom flask, the temperature not being allowed to rise above 40°. The solution is cooled to 5°–10° by immersion in ice-water, and the cool mixture of 125 grams nitric acid and 100 grams of sulfuric acid added very slowly. After each addition the flask is well shaken and cooled in the ice-water, the temperature being kept below 15°. After standing a short time, the nitration mixture is poured into about 20 liters of water containing several pieces of ice, when the p-nitracetanilid separates out, and is filtered, washed free from acid, and dried on a porous plate.

*Use.* — P-nitracetanilid is used for the preparation of p-nitranilin and p-amidoacetanilid.

*Reaction:*

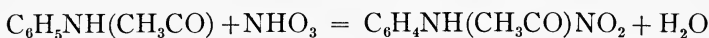

**152. P-nitranilin.** — ( $\text{C}_6\text{H}_4\text{NH}_2\text{NO}_2$ )

200 grams of p-nitracetanilid.

The acetyl compound is boiled with 500 c.c. of dilute sulfuric acid (25 per cent) in a round bottom flask connected with a reflux condenser until the whole dissolves. The clear solution is poured into a beaker, and the free base precipitated by adding dilute caustic soda solution till alkaline. After cooling, the p-nitranilin is filtered, recrystallized from hot water, and dried on a porous plate.

*Properties.* — Yellow needles or prisms; m. p., 147°; dissolves in 1250 parts of water at 18°; not volatil with steam.

*Use.* — P-nitranilin is used in the production of azo-dyes, and also for the preparation of its diazo-compound, which, by combination with  $\beta$ -naphthol on the fiber, yields paranitranilin red. Dye a skein of cotton as given under tests Nos. 105, 106 and 108.

*Reactions:*

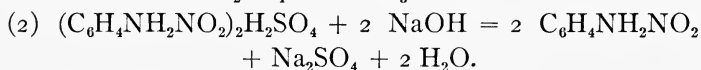
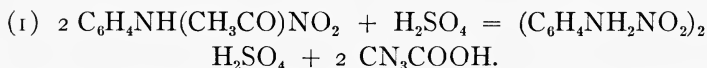

**153. Anthraquinone.** — ( $\text{C}_6\text{H}_4(\text{CO})_2\text{C}_6\text{H}_4$ )

20 grams anthracene

240 grams glacial acetic acid

40 grams chromium trioxid dissolved in 30 c.c. of water,  
then 150 c.c. glacial acetic acid added.

The anthracene is dissolved in the acetic acid by boiling them together in a round bottom flask (one liter) with upright condenser over wire gauze. The solution of chromium trioxid is then dropped in from a tap-funnel, pushed into the top end of the condenser, while the liquid is kept cooling. The operation should last about one hour. The solution becomes a deep green. It is allowed to cool, and is poured into water (one liter) which precipitates the anthraquinone in the form of a brown powder. After standing for one hour it is filtered through a large folded filter, washed with a little hot water, then with warm dilute caustic soda, and again with water. It may be purified by sublimation.

*Properties.* — Yellow needles: m. p., 277°; sublimes at 250°; b. p. 382°; insoluble in water, soluble in acetic acid, less soluble in benzin.

*Reaction:*  $C_6H_4(CH)_2C_6H_4 \rightarrow C_6H_4(CO)_2C_6H_4$

**154. Anthraquinone Sulfonic Acid.** —  $(C_6H_4(CO)_2C_6H_3 \cdot SO_3H)$   
 100 grams anthraquinone  
 100 grams fuming sulfuric acid.

The finely powdered anthraquinone is added to the sulfuric acid and the mixture heated gradually on the oil-bath till a temperature of 160° is obtained. The mixture is slowly and carefully poured into hot water (2 liters), the solution boiled for some time, and the unchanged anthraquinone filtered off at the pump. The filtrate is neutralized with caustic soda and allowed to cool, when the greater part of the sodium anthraquinone sulfonate crystallizes out. (This is the so-called "silver salt.") A second crop of crystals may be obtained by further concentration of the filtrate, but is apt to be contaminated with sodium sulfate.

*Properties.* — The sodium salt crystallizes from water

with one molecule of water of crystallization, having the formula  $C_{14}H_7SO_3NaO_2H_2O$ . On melting with caustic soda it is converted into alizarin.

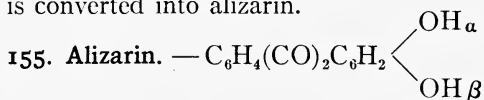

100 grams sodium anthraquinone sulfonate

300 grams caustic soda

18 grams potassium chlorate.

The caustic soda is dissolved in 300 c.c. of water in an autoclave and the sodium anthraquinone sulfonate stirred in. The potassium chlorate is dissolved in 100 c.c. of water (hot) and thoroughly mixed with the mass.

The lid of the autoclave is then fixed on and the whole heated for 20 hours to  $170^\circ$ . After cooling the melt is extracted with boiling water several times, and the solution acidified with hydrochloric acid.

The alizarin which separates out is filtered at the pump, washed with water, pressed on a porous plate and dried at  $120^\circ$ .

*Properties.* — Yellow powder, slightly soluble in boiling water, can be sublimed to long red needles. Dyes cotton, mordanted with alumina, scarlet red; with tin, bluish-red; with iron, violet; with chromium, brown.

*Reaction:*

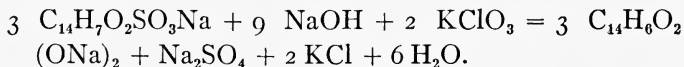

160. **Methylene Blue.** —

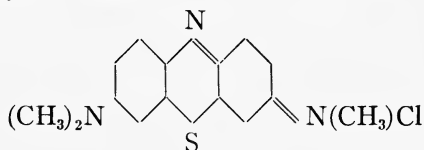

- 48 grams dimethyl anilin
- 130 grams conc. hydrochloric acid
- 14.2 grams sodium nitrite
- 40 grams zinc dust
- 100 grams sodium thiosulfate
- 50 grams potassium dichromate
- 106 grams sulfuric acid
- 16 grams neutral sodium chromate.

Twenty-four grams of dimethyl anilin are dissolved in a mixture of 80 c.c. of water and 130 grams of concentrated hydrochloric acid, and the solution cooled with ice to 12–15°. This is stirred mechanically, and a solution of 14.2 grams of sodium nitrite run in slowly (delivery tube underneath the surface of the liquid), taking care that the temperature does not rise above 15°. The nitroso compound is reduced by adding about 40 grams of zinc dust carefully, and the reduction is complete when the solution is of a clear red color. The amount of zinc added must be sufficient to neutralize the hydrochloric acid, so that congo paper is no longer turned blue. The solution is now diluted with water to 1000 c.c. and a solution of 24 grams of dimethyl anilin in the exact quantity of hydrochloric acid necessary to form the hydrochlorid (about 20 c.c.) added, and then a solution of 100 grams of sodium thiosulfate in a little water.

The mixture is oxidized by adding a concentrated solution of 50 grams of potassium dichromate and boiling for two hours; 106 grams of sulfuric acid diluted with 200 c.c. of water are now added, and the solution boiled to expel  $\text{SO}_2$ .

The leuco-methylene blue is oxidized by adding 16 grams of neutral sodium chromate dissolved in a little water, and the resulting dye is precipitated by adding salt. The base is filtered, dissolved in a little boiling water to which a little

hydrochloric acid has been added, and the hydrochlorid precipitated by common salt, filtered and dried on a porous plate.

*Properties.* — Dark green or red-brown bronzy powder, easily soluble in water, forming a blue solution. Dyes tannin mordanted cotton blue. Dye a skein of cotton as under test No. 110.

*Reaction:*

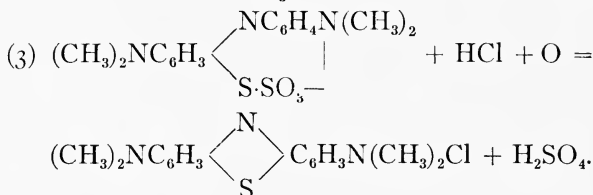
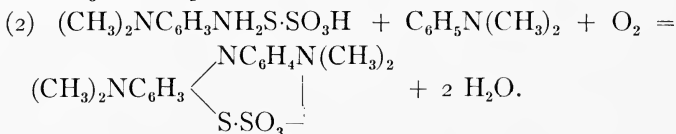
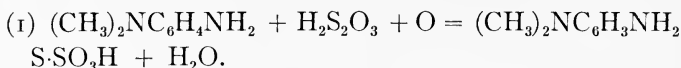

**161. Indulin.** — (Spirit soluble)

250 grams of anilin

60 grams of anilin hydrochlorid.

The anilin is mixed with 24 grams of conc. hydrochloric acid in a round bottom flask, and a solution of 14.4 grams of sodium nitrite in a little water added. The mixture is allowed to stand over night, and is then warmed to 40–50° in order to complete the conversion of the diazoamido-benzol into amido-azobenzol.

Sixty grams of anilin hydrochlorid are now added, and the mixture heated in an oil-bath, the temperature being gradually raised to 175–180°, and kept at this point for four

hours. The melt is poured into water and acidified with hydrochloric acid. The indulin is filtered from the solution of anilin hydrochlorid, dried at  $70^{\circ}$  and ground.

*Properties.* — Bluish-black powder, insoluble in water, soluble in alcohol with blue-violet color. Dyes blue when dissolved in acetone (prepared from acetic acid and glycerin), etc., and printed on cotton.

This indulin is a mixture of the following bases:

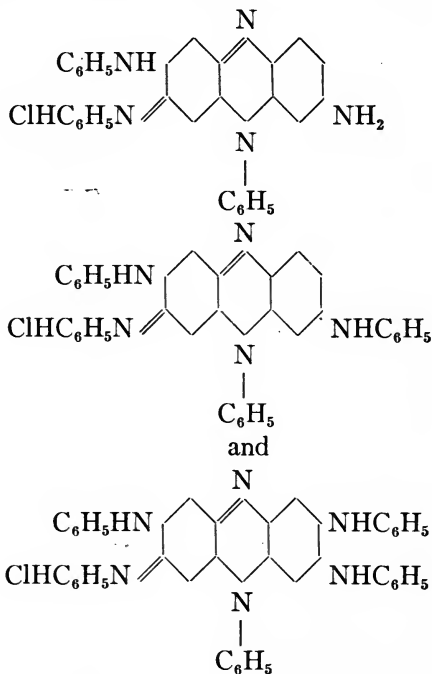

**162. Indulin.** — (Water soluble)

50 grams indulin (spirit soluble)

300 grams conc. sulfuric acid.

Fifty grams of indulin are dissolved in 300 grams of sul-

furic acid and the mixture heated on the water-bath till a sample is soluble in dilute alkali.

The mixture is poured into water, the sulfonated dye filtered, washed, transferred to a porcelain evaporating dish and neutralized with caustic soda solution. The solution of the sodium salt is now evaporated to dryness and powdered.

*Properties.* — Bronzy or blue-black powder, soluble in water with bluish-violet color. Dyes wool and silk blue from an acid-bath.

This substance is a mixture of the sodium salts of the various spirit-soluble indulins. Dye a skein of worsted and silk as in test No. 63-73.

**163. Primulin.** — Chief constituent:

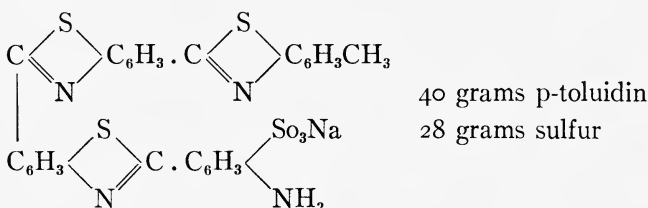

The substances are well mixed together and heated in a casserole in an oil-bath. The temperature is slowly raised to 250°, sulfureted hydrogen is evolved, and the mass becomes yellow. The reaction is finished when no more gas is given off.

The cold mass is powdered finely, added to four times its weight of fuming sulfuric acid (30 per cent SO<sub>3</sub>) and warmed to 70-80° for a few minutes, till a sample dissolves in dilute alkali.

The sulfonation mixture is then poured into ten times its volume of ice-water, and the sulfonic acid of the primulin base which is precipitated is filtered and washed till free



from acid. The paste is stirred up with dilute ammonia until alkaline, filtered at the pump, and washed twice with cold water. The residue is the ammonia salt of dehydrothio-p-toluidin sulfonic acid, which is always present, and the filtrate contains the primulin. This is saturated with salt, when the primulin separates out, is filtered and dried.

*Properties.* — Yellow powder, easily soluble in water. Dyes unmordanted cotton primrose-yellow from an alkaline or neutral bath; this is usually diazotized on the fiber and developed with  $\beta$ -naphthol, when a fast red is obtained. Dye a skein of cotton as in test No. 82.

**164. Artificial Neroli.** — ( $C_{10}H_7OCH_3$ )

50 grams  $\beta$ -naphthol  
50 grams methyl alcohol  
20 grams sulfuric acid.

The sulfuric acid is slowly added to the methyl alcohol, the mixture cooled under the tap, and the  $\beta$ -naphthol introduced. The whole is then heated in a sand with a temperature of  $125^\circ C$ . in a flask provided with a reflex condenser, and connected for reduced pressure.

After heating for six hours the product is thrown into hot water where the nerolin separates out on cooling.

*Properties.* — White crystalline compound melting at  $70^\circ C$ . and boiling at  $294^\circ C$ .

**165. Artificial Lilac.** — ( $C_{10}H_{17}OH$ )

80 grams oil of turpentine  
20 grams ethyl alcohol  
20 grams nitric acid (Sp. gr. 1.25).

The oil of turpentine, alcohol and nitric acid are mixed together and allowed to stand in a cool place for several days. During this time crystals separate. The mother liquor is poured off neutralized with an alkali, after which another

crop of crystals separate. The preparation only succeeds in cool weather, as in summer a resinous mass is usually obtained. The crystalline body which separates is known as terpinol and has a melting point at  $35^{\circ}\text{C}$ . The body thus obtained is terpin hydrate which by boiling with dilute hydrochloric acid gives a colorless oil known as terpinol, having an odor resembling hyacinths.

**166. Niobe Oil.** —  $(\text{C}_6\text{H}_5\text{COOCH}_3)$

50 grams of benzoic acid.

The benzoic acid is dissolved in an excess of methyl alcohol and saturated with dry hydrochloric acid gas. After saturation the solution is heated for about four hours in a water-bath, and then poured into an equal volume of water. The oil which separates is purified by rectification.

*Properties.* — This oil which in methyl benzoate has a specific gravity of 1.103 and b. p.  $195^{\circ}$ . Synthetic oil of birch.

**167. Benzaldehyde.** —  $(\text{C}_6\text{H}_5\text{COH})$

50 grams of benzyl chlorid

40 grams of copper nitrate

500 grams of water.

The mixture of benzyl chlorid, copper nitrate and water are heated to boiling in a round bottom flask with upright condenser on the sand bath for a day (8–9 hours). A slow current of carbon dioxid is at the same time passed through the liquid to prevent oxidation of the benzaldehyde by absorption of oxygen from the air. During the process nitrous fumes are slowly evolved. When the reaction is complete, the contents of the flask are extracted with ether, and the yellow oil remaining, after distilling off the ether, is well shaken with a saturated solution of sodium bisulfite and allowed to stand for some time. The colorless crystal-

line mass which separates out is filtered, washed with a little alcohol and ether, and then drained in a porcelain filter. The aldehyde is regained by adding dilute sulfuric acid in excess and distilling with steam. The distillate is extracted with ether, dehydrated over calcium chlorid, decanted and the ether distilled off.

*Properties.* — Colorless liquid, known as artificial oil of almond; b. p.  $179^{\circ}$  C.; Sp. gr. 1.0504 at  $15^{\circ}$ .

*Reaction:*

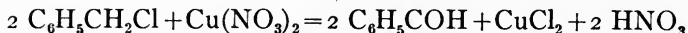

**168. Cinnamic Aldehyde.** — ( $\text{C}_6\text{H}_5(\text{CH} : \text{CHCOH})$ ).

This compound is the chief ingredient of oil of cassia and cinnamon. It is prepared artificially in large quantities by the action of caustic soda on a mixture of benzaldehyde and acetaldehyde, according to the equation.

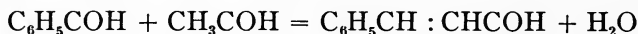

*Properties.* — Colorless oil boiling at  $247^{\circ}$  C.

**169. Anisol.** — ( $\text{C}_6\text{H}_5\text{OCH}_3$ )

5 grams sodium  
100 grams methyl alcohol  
20 grams phenol  
40 grams methyl iodid.

The methyl alcohol is poured into a round bottom flask connected with an upright condenser. The sodium cut into small pieces is then added. When the sodium has dissolved, the phenol and methyl iodid are added. The mixture is heated on the water-bath until the solution has no longer an alkaline reaction (2–4 hours). As much as possible of the methyl alcohol is distilled off on the water-bath and water added to the amber-colored residue. A colorless oil separates

out, which is extracted with ether. The ethereal solution is dehydrated over calcium chlorid and distilled, first on the water-bath, until the ether has been driven off, and then over the flame. Almost the whole of the residue distils at 150–155°.

*Reaction:*

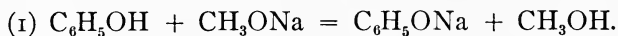

*Properties.* — Colorless liquid possessing an agreeable odor resembling of anise.

#### REFERENCES

- Richter's Organic Chemistry. Edgar F. Smith. Philadelphia, 1905.  
 Organic Chemistry. A. Bernthsen. London, 1906.  
 Organic Chemistry. J. B. Cohen. New York, 1907.  
 Practical Organic Chemistry. J. B. Cohen. New York, 1907.  
 Synthetic Dyestuffs and their Intermediate products. J. C. Cain and J. T. Thorpe. London, 1905.  
 The Chemistry of Essential Oils. Ernest J. Perry. London, 1899.  
 Organic Coloring-Matter. G. Shultz and P. Julius. London, 1904.  
 Practical Methods of Organic Chemistry. Ludwig Gattermann. London, 1906.

## CHAPTER V

### PIGMENTS AND LAKES

**170. Pigments.** — Pigments are mineral or organic bodies, usually insoluble in water, oils, or other neutral solvents, and are used to impart color to a base, by admixture with its substance.

The color of a pigment depends upon the amount and kind of light which it reflects. It is necessary that the pigment be opaque in order to give good "covering power," that is, it should entirely conceal the surface to which it is applied.

The chief pigments are given in the following table:

<i>Whites</i>	<i>Blues</i>	<i>Greens</i>
White Lead	Ultramarine	Ultramarine
Lead Sulfate	Prussian Blue	Brunswick Green
Lead Oxychlorid	Smalt	Chrome Green
White Zinc	Cobalt Blue	Guignet's Green
Zinc Sulfid	Copper Blue	Copper Greens
Barytes	Indigo	Arsenic Green
Gypsum	Chinese Blue	
Whiting-		
Lithophone	Violet	
	Ultramarine	
<i>Yellows</i>	<i>Reds</i>	<i>Blacks</i>
Chrome Yellow	Red Lead-	Lamp Black
Yellow Ochre	Chrome Red	Ivory-Black
Cadmium Yellow	Red Ochre-	Bone-Black

<i>Yellows</i>	<i>Reds</i>	<i>Blacks</i>
Orpiment	Venetian Red	Graphite
Litharge	Vermilion	
Gamboge	Realger	
Indian Yellow	Antimony Red	
	Carmine	

<i>Orange</i>	<i>Browns</i>
Orange Mineral	Umbers
Chrome Orange	Vandyke Brown
Antimony Orange	Sepia

Many other pigments, both natural and artificial are in use, but as they do not have a distinctive color, are not included in the above classification. For detail description of these pigments the student is referred to some of the books given in the list of references.

The preparation of some typical pigments will be taken up in order to give the method employed in handling artificial colors.

**171. Prussian Blue.** — Dissolve 1000 grams of sulfate of iron (*ferrous*) in 15 liters of water and add 50 grams of hydrochloric acid. To this solution add a solution of 1000 grams of ferrocyanid of potassium and 50 grams of hydrochloric acid in 30 liters of water. Now slowly add to the mixture 400 grams of bleaching powder, when the white precipitate will be changed to a blue one. To hasten the oxidation, it is well to boil with open steam for a short time. This pigment being finally divided is slow to settle at first, so should be allowed to stand for several days. When the prussian blue has settled somewhat the top liquid is syphoned off, and the tank again filled with water. This process of washing is continued until the test of the wash water shows

only slight traces of sulfates. The pigment is next passed into the filter press, washed again, removed, dried, and ground to a fine powder in the ball mill.

**172. Red Oxid.** — Place about 1000 grams of ferrous sulfate in an iron crucible and heat until nearly all of the fumes of sulfuric anhydrid are given off. Then add 100 grams of slaked lime and heat until uniform color is obtained.

**173. Vermilion.** — Put 300 grams of mercury and 114 grams of sulfur into a mortar and triturate until the ingredients are thoroughly incorporated. Dissolve 76 grams caustic potash in a 14-inch vaporating dish, using 600 c.c. of water, and add the contents of the mortar. Heat to 45° C., and keep at this temperature for several hours stirring very thoroughly at frequent intervals, and keeping the volume of water constant for the first two hours. The temperature must be regulated not to exceed 45° C. nor less than 40° C.

In the course of 2 or 3 hours the mass becomes brown and then gradually turns a bright red. When the desired vermilion color is acquired, which is usually after 6 or 8 hours, wash by decanting until free from alkali. Filter by means of the press, dry on grass plates at not over 45°.

**174. Antimony Vermilion.** — 140 grams of sodium thio-sulfate are dissolved in 250 c.c. of water, making a solution of 40° Tw. Mix 100 c.c. of antimony chlorid with 40 c.c. of water. Place the thiosulfate in a casserole and add the antimony solution. Heat slowly, and when the red color is developed, filter.

**175. Scheele Green.** — Dissolve 150 grams of arsenious oxid in 1000 c.c. of water containing 200 grams of sodium carbonate. Next dissolve 150 grams of copper sulfate in 2000 c.c. of water. When both solutions are ready, mix together, allow to settle, wash and filter.

**176. Chrome Yellow.** — Dissolve 2000 grams of lead acetate in 8 liters of water and filter if necessary. Then dissolve 1550 grams of sodium dichromate in 8 liters of water and mix the two solutions. Wash by decantation, filter and dry. If all of the color is not precipitated add a little more lead acetate.

**177. Chrome Red.** — Weigh out 500 grams of lead acetate and 175 grams of sodium dichromate; dissolve each separately in 10 liters of water, then mix the two solutions. Allow the precipitate of chrome yellow to settle out, pour off the supernatant liquor, add a solution of 75 grams of caustic soda in 500 c.c. of water, and boil for about half an hour, or until the yellow has assumed a red color, then filter, wash and dry.

**178. Chrome Orange.** — Dissolve 500 grams of lead acetate in 10 liters of water, next weigh out 125 grams of sodium dichromate and 125 grams of sulfate of soda and dissolve in 10 liters of water. Mix the two solutions together, allow the precipitate to settle. Pour off the clear liquor, then add a solution of 50 grams of caustic soda in 1000 c.c. of water, boil the mixture for about 20 minutes, filter, wash and dry.

**179. Satin White.** — Weigh out 800 grams of lime and after mixing with water make into a thin cream with more water. Weigh out 1700 grams of aluminium sulfate and dissolve in 5 liters of water. Mix the two and heat to a boil, then allow to settle. Decant the clear liquor, wash, and allow to settle. Filter and dry.

**180. Chrome Green.** — Formed by heating chromium hydroxid.

**181. Brunswick Green.** — Four shades of Brunswick Green may be made by using the proportions given under the following separate heads. In each case, however, the sulfate of iron and lead are dissolved in separate vessels and added to the suspended barytes, while the yellow prussiate



of potash and dichromate of soda may be dissolved together and added to the above mixture.

**182. Pale Green Brunswick Green.** — 1000 grams of barytes, 130 grams of acetate of lead, 10 grams sulfate of iron, 40 grams sulfate of iron, 10 grams potassium ferrocyanid, and 40 grams dichromate of soda.

**183. Middle Brunswick Green.** — 100 grams barytes, 135 grams acetate of lead, 15 grams of sulfate of iron, 15 grams potassium ferrocyanid, 45 grams dichromate of soda.

**184. Deep Brunswick Green.** — 1000 grams of barytes, 140 grams acetate of lead, 20 grams ferrous sulfate, 20 grams of potassium ferrocyanid, 45 grams of dichromate of soda.

**185. Extra Deep Brunswick Green.** — 1000 grams of barytes, 100 grams acetate of lead, 40 grams of ferrous sulfate, 40 grams potassium ferrocyanid, and 50 grams dichromate of soda.

**186. Lakes.** — Color lakes are insoluble compounds of dyestuffs with suitable precipitant on an insoluble base. This base is similar in action to the fibers in ordinary dyeing. According to the nature it may assist in the preparation of the dyestuffs or may act merely as a carrier for the colors. The physical condition of this base is also important, as it effects the covering power, cheapness, and character of the pigments produced. The precipitants used are such chemicals as will render the dyestuffs insoluble. Those ordinarily employed are barium chlorid, calcium chlorid, lead acetate or nitrate, zinc sulfate, tannic acid, etc.

The lakes are precipitated according to the particular directions, washed, filtered, and either dried or used in pulp form. These lakes are used for various purposes, and the characteristics must be suitably varied. They are usually classified according to their method of practical application.

The general classes are as follows:

Colors for the manufacture of lithographic inks, paint colors, colors for kalsomine or wall finishes, colors for wall paper and coated paper surfaces.

**187. Lithographic and Printing Inks.** — The lakes for these are ground in varnish. They must be fast to water and for high grade inks must possess covering power, fastness to light and varnishing. In some cases these inks are required to be transparent.

**188. Paint Colors.** — In the manufacture of paints the pigments are ground with oil or varnish. For this purpose the lakes must be insoluble in the medium, especially for use in sign and ornamental painting, as solubility in oil will cause the colors to run into each other.

**189. Kalsomine or Wall Finishes.** — For this purpose the colors must be in powder form. They are mixed with water and then with milk of lime or other suitable material. On this account, colors must resist the action of lime and should mix easily with water.

**190. Wall Paper and Coated Surface Paper Colors.** — These lakes are usually in pulp form, but the dry powder may be used if very finely ground. The colors are ordinarily applied by the use of a sizing material, such as glue, casein, etc. For this purpose the lakes must be absolutely insoluble in water.

**191. Crimson Lake.** — This is one of the most important lakes and its preparation takes place in three stages: first the preparation of the cochineal liquor; second, the preparation of hydroxid of aluminium; and third, the combination of these two.

Weigh out 200 grams of cochineal and mix with 2000 c.c. of water, and boil for five minutes; add 30 grams of cream of tartar and boil again; then add 4 grams of alum, boil, strain, and add to the decoction 50 grams more of cream

of tartar. The cochineal liquor is ready. To prepare the alumina, weight out 420 grams of alum (or its equivalent of sulfate of aluminium), dissolve in 3000 c.c. of hot water, also 140 grams of ammonium carbonate in 2000 c.c. of hot water. Add the alum solution to the carbonate solution, stirring well, then wash well with hot water. This alumina precipitate is next mixed with cochineal liquor and the whole boiled together; when the crimson lake is formed it is filtered off, washed and dried.

**192. Some Basic Colors used for Lakes.** — The use of basic colors in producing lakes depend upon their affinity for acid radicles, and is best illustrated by example.

**193. Violet Lake.** — Weigh out 100 grams barytes and mix with 500 c.c. of boiling water; add to this mixture 2 grams of methyl violet and stir well. When the dye has dissolved, add 2 grams of tartar emetic, then a solution of 3 grams of tannic acid in 100 c.c. of hot water. On allowing to settle if the top liquor is highly colored it is an indication that sufficient tannic acid has not been added. If necessary, add more tannic acid, wash, filter, and dry.

The following lakes may be made in a similar manner, using the method given above.

**194. Blue Lake.** — 100 grams barytes, 3 grams tartar emetic, 3 grams methylene blue, 6 grams tannic acid.

**195. Crimson Lake, R.** — 100 grams barytes, 3 grams tartar emetic, 3 grams safranin, 6 grams tannic acid.

**196. Brown Lake.** — 100 grams of barytes, 3 grams tartar emetic, 3 grams Bismarck brown, and  $4\frac{1}{2}$  grams of tannic acid.

**197. Scarlet Lake.** — 100 grams barytes, 3 grams of tartar emetic, 1 gram of safranin, 2 grams auramin, and  $4\frac{1}{2}$  grams tannic acid.

**198. Some Acid Colors used for Lakes.** — The following

is a list of acid colors adapted for the manufacture of lakes which are precipitated with barium chlorid. The example given will serve for the entire list.

Mix 15 parts of sulfate of aluminium in 150 parts of water, with a solution of 10 parts of acid green L. in 100 parts of water. Then precipitate with 32 parts of barium chlorid in 640 parts of water. On adding  $6\frac{1}{2}$  parts of soda-ash in 65 parts of water, the alumina is precipitated in the lake, thus producing a complete separation.

**199. Reds.** — Acid magenta; Azo cochineal; Azo crimson S.; Azo esoin; Azo pheloxin 2 G.; Bordeaux extra; Brilliant crocein 3 B.; Fast red A., B. T.; Ponceau 2 R.L. 5 R.L.

**200. Orange.** — Orange II. B. G.L.; Mandarin G.

**201. Yellow.** — Fast yellow extra; Fast light yellow; Naphthol yellow S.

**202. Greens.** — Acid green L.; Brilliant acid green 6 B.; New acid green 3 B. X., G X.

**203. Blues.** — Alizarin blue S A P. S H E.; Cotton blue; Fast blue greenish; Gallocyanin; Indulin B.

**204. Violets.** — Acid violet 4 B, extra, 1 R. ext. 8 B.; Alkali violet; fast acid violet.

**205. Brown.** — Fast brown.

**206. Grays.** — Acid black 8 B.

**207. The Alizarin Colors** are very fast to light and water, and are extensively employed in paints as well as lithographic inks, etc. An example will serve for the class:

## I

Mix 243 c.c. of a 10 per cent solution of aluminium sulfate

125 c.c. of a 10 per cent solution of soda-ash.

Wash out three times. To this add

30 c.c. of a 10 per cent solution of calcium chlorid

70 c.c. of a 10 per cent solution of sodium phosphate.

Wash twice and add,

3 c.c. of a 10 per cent acetic acid solution.

## II

Dissolve or stir up

30 parts (grams) Alizarin red

5 parts Turkey red oil

5 parts 10 per cent calcium chlorid

2000 parts water.

Add I to II, and allow to remain for some time, afterwards bring to a boil, boil for several hours or until the red is completely developed. Wash and filter.

**208. Colors which are Precipitated with Lead Salts.** — Use 30 parts of aluminium hydroxid, 20 parts of barytes,  $1\frac{1}{2}$  parts of color, 1 part of lead nitrate.

All acid colors given above; also: Uranin, O.N.; Eosin, all brands; Erythrosin, all brands; Phloxin, all brands; Rose bengal, G.B.

**209. Crimson Red.** — Dissolve 200 grams of logwood extract in 2000 c.c. of hot water, and add a solution of 150 grams of sulfate of aluminium in 2000 c.c. of water. Mix well and introduce 65 grams of soda-ash dissolved in 1000 c.c. of water. Boil for 10 or 15 minutes, wash and filter.

Ferric chlorid gives a bluish black precipitate under the same conditions. Copper sulfate a violet black; antimony chlorid a violet; chromic acid or bichromate gives a bronze-black precipitate.

By mixing various amounts of fustic or Persian berry the shade may be modified.

## CHAPTER VI

### DRIERS, VARNISHES, PAINTS AND STAINS

**210. Driers.** — When some substances, such as acetate of lead, acetate of manganese, red lead, manganese borate, etc., are added to paints and varnishes, these become dry or hard much quicker than otherwise. Linseed oil mixed or heated with such bodies dries much quicker. From this fact has arisen the plan of adding, in the manufacture of paints and varnishes, “driers,” as they are called, for the purpose of facilitating the drying or hardening.

A very small quantity of “drier” will cause the drying of a large quantity of oil; from 0.5 to 1 per cent of the weight of the oil is usually sufficient.

Manganese compounds are more energetic drying agents than lead compounds. Driers which dissolve easily in the oil, such as linoleates and resinates, are more active than those which, like red lead or manganese, do not dissolve in the oil.

When raw linseed oil is mixed with lead oxid or manganese borate very little of these is taken up, and the rapidity of drying is not much increased. But if the oil be heated with them they are more freely dissolved and the treated oil dries much more rapidly.

Some of the substances which are used for driers, are, acetate of lead, red lead, orange lead, white lead, chrome yellow, litharge, manganese dioxid, manganese sulfate, manganese acetate, ferrous sulfate and ferric oxid.

Of late years, however, the linoleates, resinates and



Rogers' Industrial Chemistry.

DRY COLOR AND PAINT FACTORY.

THE UNIVERSITY OF CHICAGO  
LIBRARY



borates of lead and manganese have come into common use on account of the fact that they dissolve completely in oil, so that no "foots" are produced; and being soluble, no long heating of the oil is needed, so that paler oils can be produced.

Some of these driers are prepared in the following manner:

**211. Lead Borate.** — Dissolve 100 grams of acetate of lead in 1000 c.c. of water and add to it a solution of 65 grams of borax in 1000 c.c. of water; wash, filter, and dry.

**212. Manganese Borate.** — Dissolve 100 grams of manganese sulfate in 1000 c.c. of water and add to it a solution of 80 grams of borax in 1000 c.c. of water; wash, filter, and dry.

**213. Lead Linoleate.** — Is made by preparing a neutral soda soap from linseed oil and caustic soda, and pouring this into a solution of lead acetate.

**214. Manganese Linoleate.** — Is made in a manner similar to the lead compound.

**215. Lead Resinate.** — This substance is prepared by making a rosin soap and adding it to a solution of lead acetate.

**216. Manganese Resinate.** — Is made in a similar manner, using  $\text{MnSO}_4$ .

**217.** Linseed oil that has been strongly boiled with a large proportion of drier and then mixed with turpentine forms a liquid drier which mixes freely with paint, and hence is very serviceable for the use of painters.

**218. Heavy Drier, No. 1.** — Introduce 1000 grams of raw linseed oil into a copper kettle and heat under the hood slowly adding 100 grams of borate of lead. Boil until clear and when cooled sufficiently add 1000 grams of turpentine and stir well.

**219. Japan Drier.** —

175 grams of raw linseed oil  
 75 grams of flake litharge  
 35 grams of kauri gum  
 20 grams of granulated manganese  
 1000 grams of turpentine.

Cook the oil, litharge, gum, and manganese together until a drop when cold is brittle. Then after cooling the mass to between 250 and 300° F., add the turpentine slowly.

**220. Drier, No. 11.** — Dissolve as much lead resinate in turpentine as possible and use only in the cold. Of this drier 5 per cent of the amount of oil which is contained in the paint, is used.

**221. Paint and Varnish Remover, No. I.**

Mix 200 c.c. of anilin with  
 200 c.c. of benzol  
 10 c.c. of nitro-benzol.

**222. Paint and Varnish Remover, No. II.**

100 c.c. of amyl acetate  
 100 c.c. of anilin  
 200 c.c. of benzol.

**223. Paint and Varnish Remover, No. III.**

100 c.c. of wood alcohol  
 100 c.c. of benzol.

**224. Rust Remover.** — Powdered emery and paraffin oil.

**225. Protective Varnish for Iron.** — Dissolve 100 grams of paraffin wax in 1 liter of benzin.

**226. French Polish.** — This polish is prepared by dissolving:

24 grams of gum copal  
 16 grams of gum arabic  
 45 grams of gum shellac in  
 1 liter of alcohol,

**227. Spirit Varnishes.** — These varnishes are made in the cold and are useful when a quick drying varnish is desired.

**228. Shellac Varnish.** — Dissolve 400 grams of shellac in 1 liter of alcohol.

**229. French Varnish.** —

500 grams of white shellac dissolved in  
1000 c.c. of alcohol and to this when filtered add  
150 grams Venice turpentine.

**230. Brown Hard Spirit Varnish.** — Dissolve 100 grams of sandarac, 200 grams of orange shellac, 25 grams gum elemi, and 50 grams of Venice turpentine in 1 liter of alcohol.

**231. Mastic Varnish.** — Dissolve 500 grams of gum mastic in 1 liter of turpentine.

**232. Dammar Varnish.** — Dissolve 400 grams gum dammar in 1 liter of warm turpentine.

**233. Collodion Varnish.** — Dissolve 25 grams of gum-cotton in a mixture of 720 grams of amyl alcohol and 360 grams of amyl acetate.

**234. Oil Varnishes.** — Oil varnishes are divided commercially into two groups — coach varnishes and cabinet varnishes. Although there is very little difference between them, either in the method of making or in the materials used.

The process in outline consists of the following stages: 1st. melting (or "running," as it is known in the trade), the resin or "gum"; 2d. boiling the oil; 3d. mixing the melted gum and boiling oil; 4th. boiling the varnish; 5th. thinning the boiled product; 6th. clearing.

I. *Running.* — The running of the gum is carried out in copper kettles heated by direct flame. This part of the process must have the utmost care as over-heating will give a poor grade of varnish and under-heating will not

give a uniform product. To make a good varnish it requires experience to know just when to stop heating.

II. *Oil Boiling.* — While the gum is being “run,” the oil to be used is boiled. This is done in the boiling pot. The oil is heated to about 500° F., for 1 to 2 hours, when it is ready for mixing with the gum.

III. *Mixing.* — When the gum has been properly melted the necessary quantity of boiling oil is poured into the melted gum, which is stirred energetically all the time.

IV. When the gum and oil are first mixed a rather cloudy mass is produced and in order to make this transparent, and to make the varnish string, it is necessary to boil again. The point at which to stop boiling depends upon the varnish; but as a rule when a drop taken between the thumb and finger forms strings, when the fingers are separated, is an indication of the end point.

V. *Thinning.* — After the boiling operation described above is completed, the pot and its contents are removed from the fire and placed at some distance from any flame. Here it is mixed with turpentine to a working consistency. Although it is necessary to mix the turpentine with the varnish mass at as high a temperature as possible, yet it is advisable to allow the hot varnish mass to cool down somewhat before adding the turps (350° F); this should also be added in small quantities at a time, this means the mixing will be properly done without too great a loss of turps.

VI. *Clearing and Aging.* — Freshly made varnish is most unsatisfactory to use, and all the best qualities are subjected to an aging and clearing process before they are sent out. Thus in standing, the more insoluble particles separate out and the top layer becomes clear.

The following list will serve to demonstrate the manufacture of oil varnishes in general:

**235. Finishing Body Varnish for Coaches.** — Melt or run 80 grams of best African animi, pour in 160 grams of boiling linseed oil and boil slowly for 4 to 5 hours or until it strings well. Allow to cool (350° F.) and add 280 grams of turpentine.

**236. Elastic Carriage Varnish.** — Run 80 grams of gum copal, mix 200 grams of oil, add 2½ grams of dried copperas and 2½ grams of litharge, boil until it strings, cool and thin with 440 grams turps.

The preparation of materials and compounding of varnish therefrom cannot be set forth actually so as to produce practical results at all times owing to the variation in the raw materials. With a little experience, however, the few formulas given below will be found to give very satisfactory results.

**237. Fine Light Coach Oil.** — Place in the varnish kettle

4000 grams of raw linseed oil  
 10 grams of borate of manganese  
 and 30 grams of litharge.

Heat to 375° to 450° F. for several hours, or until a sample placed on glass becomes solid within a few minutes.

**238. Medium Coach Oil.** — Following the above direction use

4000 grams raw linseed oil  
 10 grams borate of manganese  
 20 grams of red lead  
 30 grams litharge.

**239. Strong Coach Oil.** —

4000 grams raw linseed oil  
 10 grams borate of manganese  
 50 grams red lead  
 50 grams litharge  
 50 grams black oxid of manganese.

By following the general directions given under the head of oil varnish, the student may be able to produce some very good results with the subsequent list of formulas:

**240. Extra Fine Copal Varnish.**

150 grams of African copal  
 300 grams of fine light coach oil (hot)  
 thin with 480 grams of turpentine.

**241. Elastic Varnish.**

50 grams African copal  
 50 grams animi gum  
 300 grams medium coach oil (hot)  
 thin with 480 grams turpentine.

**242. Tool Varnish.**

150 grams gum kauri  
 150 grams rosin W. G.  
 120 grams strong coach oil (hot)  
 thin with 288 grams turpentine  
 240 grams benzin.

**243. Ready Mixed Paint.** — There is hardly an industry which has made more rapid progress in the past fifteen years than the manufacture of “ready to use” paints. Nearly every user of paint goes through the stage of desiring to become his own paint manufacturer, and there are, even at present, many who fondly imagine that they can prepare mixed paints by means of a wooden paddle and a wash-tub, capable of ranking as protective and decorative agents with the material compounded by the aid of powerful and special machinery.

There has been much dissatisfaction in regard to ready mixed paints, and justly as numerous brands have been placed upon the market, which were not much better than

chalk and water. Conscientious manufacturers, however, have done much to bring these frauds to light, and we may look to a time in the not far distant future, when all brands of paint will be properly labeled, and the public educated to the requirement of a ready to use paint.



FIG. 10. — Mixing Machine. Chas. Ross & Son Co., Brooklyn, N. Y.

**244. Mixing.** — In the manufacture of ready mixed paint the necessary amount of raw linseed oil is placed in the mixing machine. The body containing coloring matter is introduced in small portion at a time, new lots being added only as the paste becomes limp.

The mixture is then run through the mill until perfectly

smooth when rubbed out on glass. It is then thinned as desired.

The method of procedure varies to quite an extent in different plants although all are based on the same general principle.

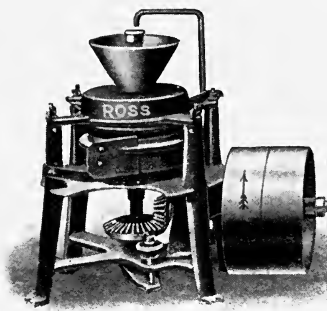

FIG. 11. — Stone Grinding Mill. Chas Ross & Son Co., Brooklyn, N. Y.

From the following formulas the general method may be obtained, and various shades produced.

**245. White.** — Pour into the can of the mixer 1160 grams of raw linseed oil and start the machine in motion.

Now add slowly a mixture of

2500 grams of dry white lead  
2500 grams of zinc oxid.

Mix thoroughly, or until a smooth paste is obtained which will run easily from the can. This paste is passed through the mill, the stones being adjusted so as to obtain a product free from lumps when rubbed out on glass. After passing through the mill it is then brought into the mixer again, and thinned by adding,

1500 grams of raw linseed oil  
1000 grams of boiled linseed oil  
350 grams of Japan drier  
150 grams of turpentine.

When thoroughly mixed it is run into cans and is ready for use.

A quantity of the above thinning mixture should be made



up. Kept in stock and labeled Standard Oil and will be subsequently referred to as such.

The following formulas should be worked in the same manner as just given for white, taking the precaution to have the mill thoroughly cleaned from one color before introduc-

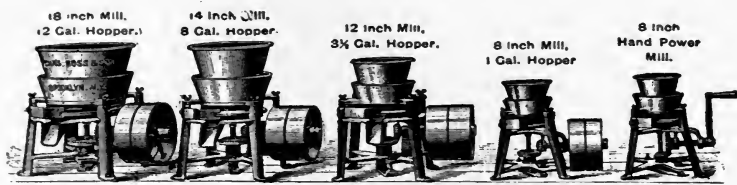

FIG. 12. — Iron Mills for Paint Grinding, which are cheaper than Stone Mills, and much easier to clean. They are, however, not so durable, or do not grind as fine as Stone Mills. Chas. Ross & Son Co., Brooklyn, N. Y.

ing another. A good plan also is to run from light to darker shades thus obviating the necessity of so much cleaning of the mill and mixer. Where facilities will permit, it is advisable to use one mixer and mill for each color manufactured.

#### 246. Light Colonial.

2500 grams dry white lead  
 2500 grams zinc oxid  
 100 grams lemon chrome yellow  
 1200 grams raw linseed oil  
 thin with 2700 grams standard oil.

#### 247. Cream.

2500 grams white lead  
 2500 grams zinc oxid  
 60 grams lemon chrome yellow  
 30 grams medium chrome yellow  
 1160 grams raw linseed oil  
 thin with 2650 grams standard oil.

- 248. Yellow.** 2000 grams white lead  
 2000 grams zinc oxid  
 100 grams chrome yellow  
 1160 grams raw linseed oil  
 thin with 2600 grams standard oil.
- 249. Straw.** 2000 grams white lead  
 2000 grams zinc oxid  
 1800 grams golden ochre  
 100 grams orange yellow  
 1400 grams raw linseed oil  
 thin with 2850 grams standard oil.
- 250. Flesh.** 2000 grams white lead  
 2000 grams zinc oxid  
 500 grams golden ochre  
 290 grams French ochre  
 30 grams princess metallic  
 10 grams lamp-black  
 1160 grams raw linseed oil  
 thin with 2580 grams standard oil.
- 251. Apple Green.**  
 2250 grams white lead  
 2250 grams zinc oxid  
 540 grams lemon chrome yellow  
 2400 grams chrome green  
 1350 grams raw linseed oil  
 thin with 2250 grams standard oil.
- 252. Light Blue.**  
 2250 grams white lead  
 2250 grams zinc oxid  
 500 grams Chinese blue  
 1160 grams raw linseed oil  
 thin with 3000 grams standard oil.

**253. Dark Blue.**

2000 grams white lead  
2000 grams zinc oxid  
1000 grams Prussian blue  
1160 grams raw linseed oil  
thin with 3000 grams standard oil.

**254. Drab.**

2450 grams white lead  
2450 grams zinc oxid  
25 grams lamp black  
1160 grams raw linseed oil  
thin with 3000 grams standard oil.

**255. Azure Blue.**

2500 grams white lead  
2500 grams zinc oxid  
10 grams Chinese blue  
30 grams lemon chrome yellow  
thin with 2600 standard oil.

**256. Slate.**

2250 grams white lead  
2250 grams zinc oxid  
200 grams lamp-black  
1160 grams raw linseed oil  
thin with 3000 grams standard oil.

**257. Dark Lead.**

2120 grams white lead  
2120 grams zinc oxid  
650 grams golden ochre  
10 grams Chinese blue  
120 grams graphite  
1100 grams raw linseed oil  
thin with 2400 grams standard oil.

**258. Sage Green.**

	2000 grams white lead
	2000 grams zinc oxid
	1300 grams French ochre
	580 grams chrome green
	180 grams lamp-black
	30 grams Venetian red
	1200 grams raw linseed oil
thin with	2800 grams standard oil.

**259. Dark Olive Green.**

	3500 grams golden ochre
	600 grams French ochre
	980 grams drop black
	120 grams chrome green
	20 grams lemon chrome yellow
	1350 grams raw linseed oil
thin with	3450 grams standard oil.

**260. Brunswick Green.**

	4000 grams extra deep Brunswick green
	160 grams lemon chrome yellow
	1160 grams linseed oil
thin with	2850 grams standard oil.

**261. Indian Red.**

	6620 grams Venetian red
	1230 grams princess metallic
	2400 grams raw linseed oil
thin with	5430 grams standard oil.

By changing the proportion of pigment any range of shade and tint may be obtained. The above are merely given, therefore, to illustrate the methods of procedure.

262. Putty. — This substance is very important, being used in setting glass, filling nail holes, etc. It is made on a commercial scale by mixing the constituents together under a heavy stone roller running in a steel foundation. The process of manufacture may, however, be demonstrated in the laboratory by means of a kneading machine and is carried out as follows:

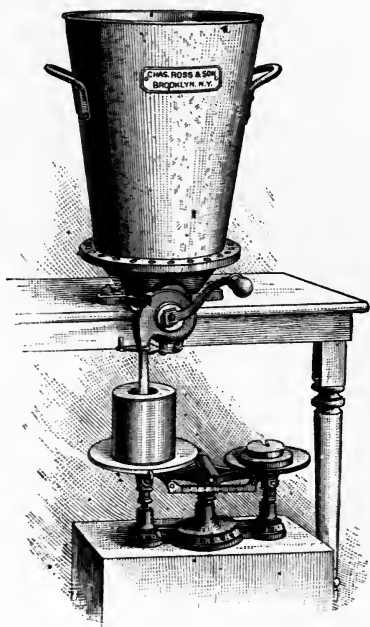

FIG. 13.—Can Filling Machine. Chas. Ross & Son Co., Brooklyn, N. Y.

Three hundred grams of raw linseed oil is placed in the machine. A mixture of 1100 grams of whiting and 500 grams of lead carbonate is slowly added to the oil, the arms being kept in constant motion. Care must be taken to have the oil and mixture smooth before introducing new

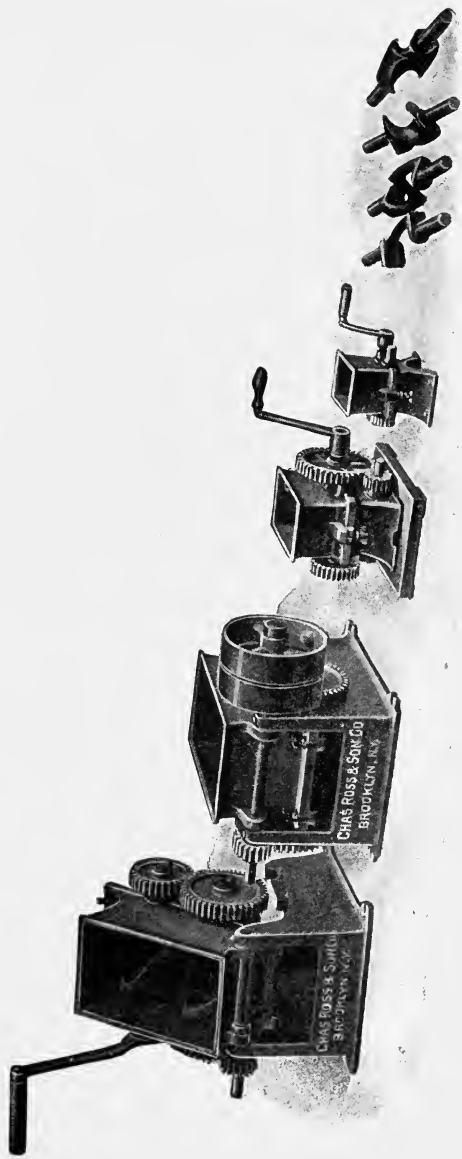

FIG. 14. — Kneading Machines. Chas. Ross & Son Co., Brooklyn, N. Y.

portions. The finished product should not stick to the hands, but if such is the case a small amount of the mixture in excess of the above may be added. The putty is then allowed to stand several days to sweat when it is again kneaded with the addition of a small amount of whiting if necessary.

**263. Oil Stains and Wood Fillers.** — The following list of formulas will serve to illustrate the large class of substances put on the market as wood fillers and oil stains. They consist of a base to which various pigments may be added to produce the desired effect. The mixing and grinding is conducted as given under ready mixed paint.

**264. Stain and Filler Base.** — 1200 grams of starch is placed in the mixer and worked into a thin paste with 810 grams of water. When thoroughly triturated 2700 grams boiled linseed oil, 1350 grams turpentine and 3860 grams of Japan added, the whole being run until perfectly smooth. This should be made in large amounts, ready for use, and labeled, Stain Base, which is then used as a body for the various stains.

**265. Light Oak or Ash Stain.** — Place in the mixing machine 720 grams of boiled oil; 360 grams turpentine. To this slowly add a mixture of 240 grams raw sienna, 80 grams burnt umber, and 400 grams silica. When thoroughly incorporated transfer to mill, grinding until perfectly smooth when rubbed out on glass. Return to mixer and thin with 7200 grams of stain base.

Work well and can while still in suspension.

The following list of oil stains may be prepared by following the general direction given for light oak or ash:

**266. Dark Oak Stain.**

320 grams silica  
 320 grams burnt Italian sienna  
 160 grams burnt umber

720 grams boiled linseed oil  
360 grams turpentine  
7200 grams stain base.

**267. Chestnut Stain.**

640 grams silica  
160 grams burnt Italian sienna  
80 grams boiled Turkey umber  
720 grams boiled linseed oil  
360 grams turpentine  
7200 grams stain base.

**268. Yellow Pine or Maple Stain.**

160 grams raw Italian sienna  
120 grams chrome yellow  
580 grams silica  
720 grams boiled linseed oil  
360 grams turpentine  
7200 grams stain base.

**269. Walnut Stain.**

920 grams burnt Turkey umber  
120 grams burnt Italian sienna  
720 grams boiled linseed oil  
360 grams turpentine  
9000 grams stain base.

**270. Mahogany Stain.**

1000 grams burnt Italian sienna  
160 grams burnt Turkey umber  
720 grams boiled linseed oil  
360 grams turpentine  
9000 grams stain base.

Oil stains are often made from coal-tar colors soluble in oil.



Water stains are prepared by dissolving various coal-tar colors in water.

Spirit soluble stains are made by dissolving the color base in alcohol or a good spirit varnish.

Oil varnish stain may be made by substituting a good grade of oil varnish for the linseed oil in the above formula, or they may be made by dissolving oil soluble coal-tar colors in varnish.

#### REFERENCES

The Chemistry of Paints. Maxmilian Toch. New York, 1907.  
Technology of Paint and Varnish. Alvah Horton Sabin. New York, 1905.

Modern Pigments and their Vehicles. Frederick Maire. New York, 1908.

Mixed Paint, Color Pigments and Varnishes. Clifford D. Holley and E. F. Ladd. New York, 1908.

The Chemistry of Paint and Painting. A. H. Church. London, 1901.

The Chemistry of Paint and Paint Vehicles. Clare H. Hall. New York, 1906.

Paint and Varnish Facts and Formulæ. J. H. Hoff. New York, 1905.

Painter's Colors, Oils and Varnishes. G. H. Hurst. London, 1901.

The Manufacture of Lake and Mineral Pigments. Josef Bersch. Translated by A. C. Wright. London, 1901.

## CHAPTER VII

### SOAP AND ALLIED PRODUCTS

**271. Soap.** — In the manufacture of soap there are three general processes employed, viz.: boiled soaps, half-boiled soaps, and cold made soaps; but owing to the method employed they will be taken in the reverse order.

In the installation for a miniature soap works it is necessary to provide a lye tank, kettle, crutcher, frames, slabber,

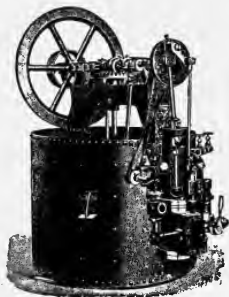

FIG. 15. — Crutcher.  
Houchin Aiken Co.,  
Brooklyn, N. Y.

cutting machine, chipper, mill, plodder press and dies, all of which may be secured from manufacturers of soap machinery. Some of the following formulas can also be worked out on a small scale by using a good sized iron kettle, a small garden rake with a wooden box to serve as a frame, and the cake cut by means of a piece of piano wire or thin knife.

The proportions given hereafter are for a crutcher having a capacity of one hundred pounds, but may be

varied to suit the requirements.

**272. Cold made Soap.** — The term cold made soap is applied to those soaps in which the fat and oil are only heated sufficiently to melt them, say, not over 120° F. and the cold lye then introduced. This process gives a hard soap but is quite apt to contain either unsaponified fats or free alkali.

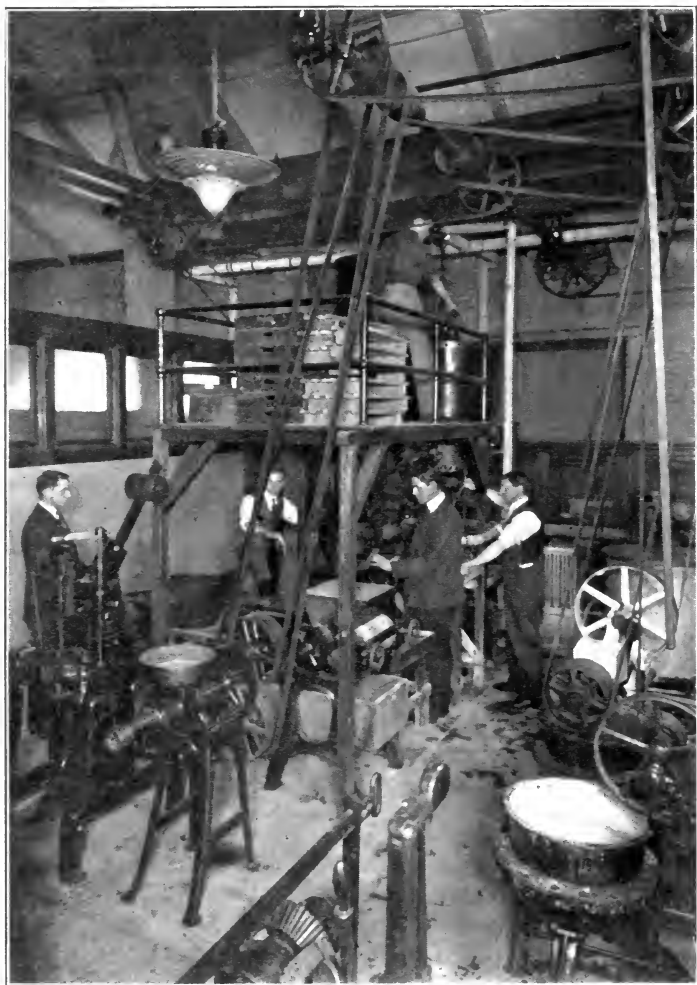

Rogers' Industrial Chemistry.

MINIATURE SOAP WORKS.



In making soap by the cold process, care must be taken to have all materials perfectly fresh and clean. The lyes should never be used the same day they are made. Use the lye cold.

**273. Process.** — Weigh out 34 lbs. of tallow and place in crutcher, then turn on the dry stream and heat until melted. When all of the tallow is in a liquid state, introduce 17 lbs. of cocoanut oil, 17 lbs. of cotton-seed oil and agitate. When a temperature of between  $115^{\circ}$ – $120^{\circ}$  F. is secured 35 lbs. of  $36^{\circ}$  Bé lye is added. The mass is then crutched (stirred) until the soap begins to form, which is indicated by the formation of flakes when a sample is taken upon the paddle. It is next run into a frame and allowed to stand for 24 hours to complete saponification and harden. The sides and ends of the frame are then removed, the cake passed through the slabber and cutting machine. The bars of soap thus formed are placed on racks in the drying room, and

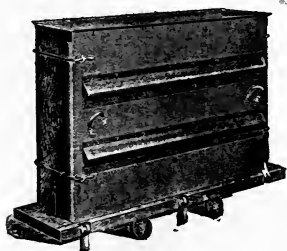

FIG. 16.—Soap Frame.  
Houchin Aiken Co., Brooklyn, N. Y.

allowed to stand for several days until thoroughly dry. The bars are now run through the clipper where it is cut into flakes about one sixteenth of an inch thick. These chips are spread on wire racks and returned to the drying room.

When the chips are brittle and snap they are ready for the milling process which is conducted as follows:

**274. Milling.** — The chips are run through the granite roller mill and collected in a box sufficiently large to hold the entire batch. Eight ounces of a good soap perfume (say, oil of Rose Geranium) is then sprinkled over the chips which are shaken up uniformly; distribute the oil and then run again

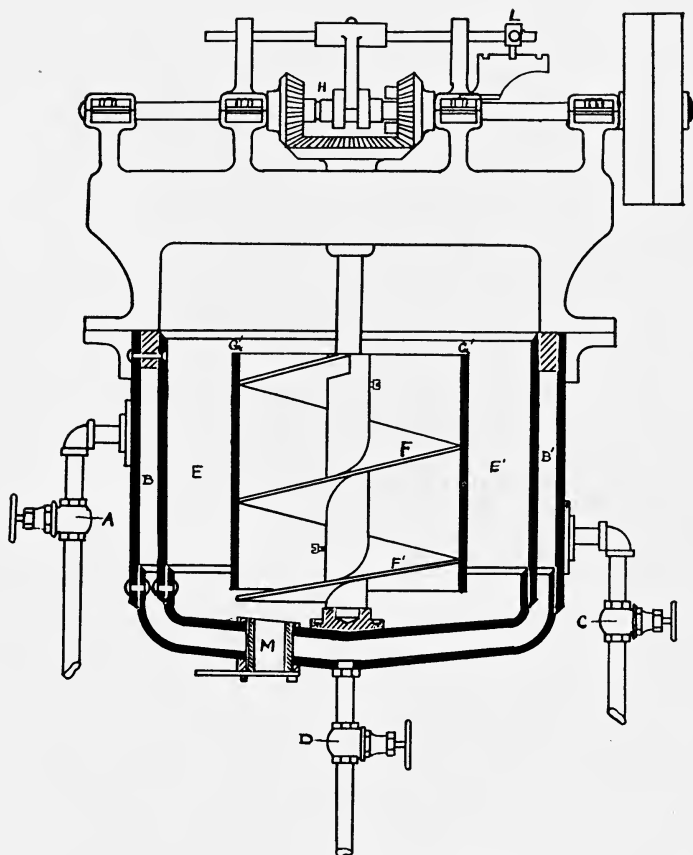

FIG. 17. — Detail of Crutcher. A, Inlet for steam; B, Steam jacket surrounding kettle; C, Outlet for escaping steam and condensation; D, Slip to jacket; E, Space for contents; F, Worm for agitation; G, Case for worm; H, Friction clutch; M, Gate for dumping charge.

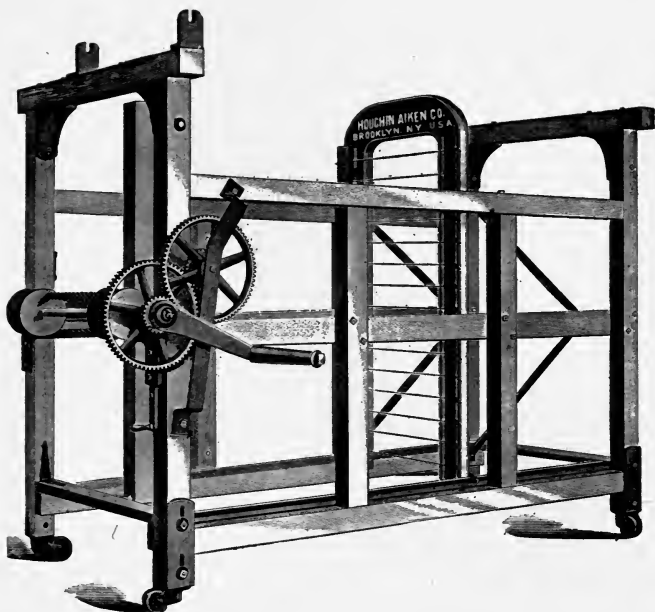

FIG. 18. — Slabbing Machine. Houchin Aiken Co., Brooklyn, N. Y.

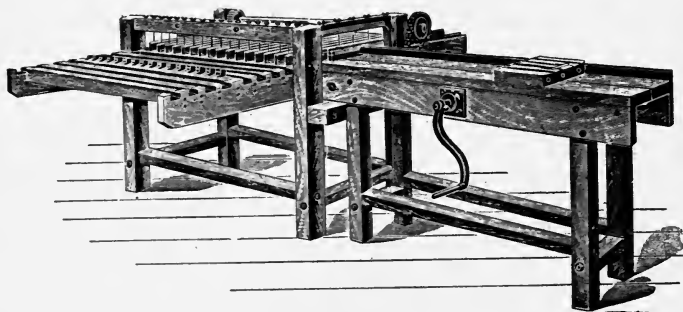

FIG. 19. — Cutting Machine. Houchin Aiken Co., Brooklyn, N. Y.

through the mill, setting the granite rollers a little closer and finally setting the roller tight. Repeat the milling several times or until a uniform ribbon comes from the knife of about the thickness of paper.

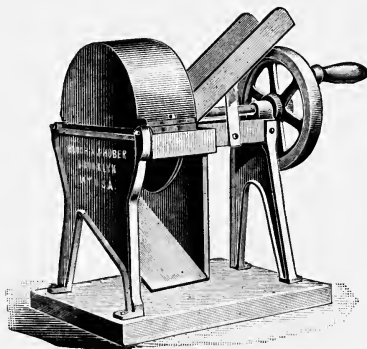

FIG. 20.—Chipping Machine. Houchin Aiken Co., Brooklyn, N. Y.

milled soap introduced. As soon as the soap begins to discharge put on the forming plate desired for use. Keep the hopper of the plodder filled, as this will in a measure keep out air bubbles and prevent the soap from being streaked.

The first 15 or 20 feet should be returned to the plodder, as the bars have not received the full pressure. As soon as the soap runs smooth and free from streaks it may be cut into any convenient length and pressed.

**276. Pressing.** — The dies being adjusted, and the press well oiled, the faces are then moistened with a strong salt

**275. Plodding.** — From the mill the soap is passed to the plodder which is a machine provided with a screw compressor. The nose of the plodder is slightly warmed and the

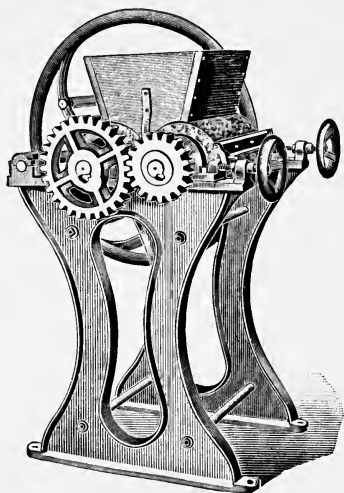

FIG. 21.—Two-roller Soap Mill. Houchin Aiken Co., Brooklyn, N. Y.



solution, and the cake placed in position. A heavy blow is then delivered with the foot followed by a second short blow

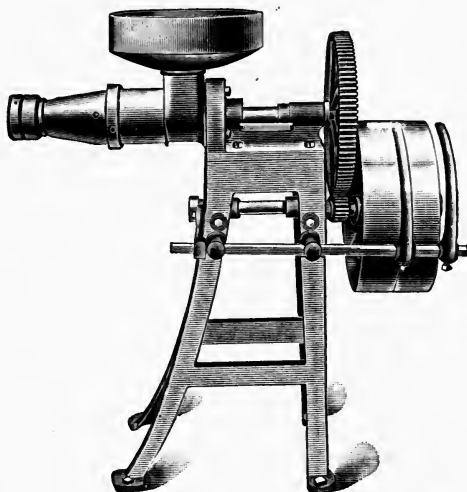

FIG. 22. — Plodding Machine. Houchin Aiken Co., Brooklyn, N. Y.

as the original stroke rebounds. After the first ten or dozen cakes are pressed it will not be necessary to moisten the die so frequently.

**277. Green Castile Soap.**

- 25 lbs. of tallow
- 12 lbs. of coconut oil
- 25 lbs. of olive oil foots (green)
- 9 lbs. of cotton-seed oil
- 36 lbs. of soda-lye at 35° Bé.

Warm the fats and oils to 110° F., crutch in the lye and when the soap has formed run into frames, allow to harden, then follow general direction.

**278. Laundry Soap.**

- 30 lbs. of tallow
- 30 lbs. of cocoanut oil
- 30 lbs. of caustic soda-lye 36° Bé
- 8 lbs. of sodium carbonate solution 35° Bé
- 8 ounces of oil of mirbane.

This soap is cut into cakes and dried and is not milled as in the case of toilet soaps.

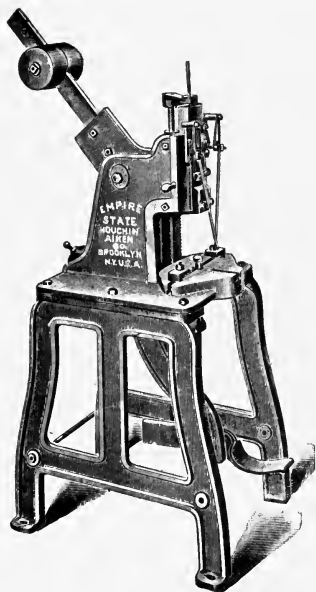

FIG. 23. — Soap Press. Houchin Aiken Co., Brooklyn, N. Y.

**279. Half Boiled Soaps.** —

By this process very fine soap can be made, almost equal to the best boiled soaps. But with them, the same as with cold process, great care must be taken to have perfectly pure stock.

**280. Palm Oil Soap.** — Place in the crutcher

- 18 lbs. of palm oil
- 36 lbs. of cocoanut oil
- 9 lbs. of tallow

and heat to a temperature of 160° F.

Add 36 lbs. of 35° Bé soda-lye and crutch slowly for about 3 minutes; now cover up to keep warm, and allow to stand for one hour and three-quarters. At the end of this time the charge will have warmed up to 170–180° F. The crutcher is then started very slowly. At first the soap will be thick and hard to crutch but will soon thin down and become hotter. If after crutch-

ing for 10 minutes the soap for some reason does not thin down and get hot, throw on a little steam, being careful not to raise the temperature over 180° F. After the soap has been well crutched and is free from lumps, it should be tested by rubbing some in the palm of the hand; if saponificating is complete it will form flakes, while if insufficient alkali is present it will remain like a fat. Also test for strength on the tip of the tongue. The soap should have a very little sharp taste; if too mild add a small amount of lye until it can just be tasted, but if at first it burns the tongue add a little more cocoanut oil.

After the addition of alkali or fat, crutch well and when it begins to thicken (which is shown by the soap dropping free from the paddle in flakes) run into the frame immediately and allow to cool.

For laundry soap the perfume is crutched in just before framing, while for toilet soap it is only added when milled.

Eight ounces of citronella oil or other essential oil will perfume 100 lbs. of soap.

#### 281. Green Castile Soap.

28 lbs. of tallow  
28 lbs. of olive oil foots (green)  
14 lbs. of cocoanut oil.

Mix the above and warm to 150° F., then add a mixture of

36 lbs. of caustic soda lye 33° Bé  
4 lbs. of caustic potash lye 35° Bé.

#### 282. Tar Soap.

25 lbs. of cocoanut oil  
25 lbs. of olive oil foots  
30 lbs. of caustic soda lye at 33° Bé  
5 lbs. of pine tar  
5 lbs. of glycerin.

Warm the oils, tar and glycerin together. When at 140° F. crutch in the lye and continue crutching until all are well combined; cover up and allow to stand one and one-half to two hours. Then follow general directions.

### 283. Laundry Soap.

- 31 lbs. of tallow
- 6 lbs. of cocoanut oil
- 19 lbs. of rosin W. G.
- 32 lbs. of caustic soda-lye at 33° Bé.

Melt the tallow and cocoanut oil, then introduce 19 lbs. of rosin; when melted well together, allow to cool down to 130° F., then add the lye, letting the soap stand for one and a half to two hours. When the soap is finished and just before framing add 8 lbs. of sodium carbonate solution 35° Bé and 8 ounces of citronella. Crutch well and frame. When the soap has set sufficiently long to properly harden it is cut into cakes and is ready for use, as soon as dry.

### 284. Dog Soap.

- 50 lbs. of tallow
- 5 lbs. of cocoanut oil
- 27½ lbs. caustic soda-lye at 36° Bé
- 5 lbs. of strong tobacco solution
- 5 lbs. of powdered sulfur
- 5 ounces carbolic acid.

The tobacco solution is made by boiling tobacco stems in water; mix the sulfur and tobacco solution together. When the soap is well formed crutch in the warm sulfur and tobacco; then add the carbolic acid and frame.

**285. Boiled Soaps.** — Owing to the recovery of glycerin this process is employed very largely and in fact the bulk of soap is manufactured in this manner. In order to illustrate this process we will take as an example the manufacture of

**286. Palm Oil Soap.**

100 lbs. of tallow  
100 lbs. of rosin  
10 lbs. of palm oil.

Put the tallow into the kettle and begin boiling with open steam, adding caustic soda-lye at  $10^{\circ}$  Bé (about 90 lbs.); continue boiling until the alkali strength is all absorbed; now add stronger lye at  $15^{\circ}$  Bé, boiling constantly (about 100 lbs.) until the strength is all absorbed; continue the boiling, but now add stronger lye at about  $20^{\circ}$  Bé until the soap is strong and ready to grain.

Boil well, adding enough dry salt to cause the lye to separate and run free from the soap; close off the steam and allow the lye to settle.

**287. Rosining.** — Run off the spent lye and add about 160 lbs. of lye at  $15^{\circ}$  Bé, boiling well with the open steam until the soap becomes firm and of good grain. While the soap is boiling well, spread the broken rosin over the surface, and as the alkali strength is absorbed add lye at  $15^{\circ}$  Bé. When nearly all of the rosin has been added, add salt to keep the soap open and float the rosin on salt instead of the alkali strength; when all the rosin has been added, boil well with closed steam for 3 or 4 hours, until the curd is round and dry; allow the soap to settle over night.

**288. Strengthening.** — Run away the spent lye. Begin boiling with the open steam, running in about 80 lbs. of lye at  $10^{\circ}$  Bé; boil well until the soap becomes thin. Then while boiling well, add lye at  $20^{\circ}$  Bé until the soap opens and is sharp with alkali.

Continue the boiling about 5 hours with the close steam only, when the soap should have a hard, strong grain, and be rough on the surface; shut off the steam and allow to settle over night.

**289. Finishing.** — Run off and save the lye that has settled out, as it contains alkali strength which can be used. Turn on the open steam and add the 10 lbs. of palm oil, running in a little water to thin the soap. If the soap is weak add lye at 5° Bé.

When the soap is finished it should be smooth and shining, boiling with a rolling motion, and a sample taken on the trowel should slide off in flakes.

**290. Framing.** — Allow the soap to settle a few days until it has cooled to about 145° F. Run sufficient for one frame into the crutcher, and add 6 to 8 per cent of soda-ash solution at 36° Bé. Crutch well for 2 minutes, add the perfume and crutch until smooth. Dump into frame and allow to stand several days to harden. On setting it is then slabbed and cut but not milled as in the case of toilet soap.

**291. Rosin Soap.** — Owing to the fact that plain tallow soap does not lather, it is always necessary to add something to produce this effect, consequently rosin is used in laundry soap for this purpose. While for the purpose of cheapening and making a harder product silicate of soda is sometimes employed. The following formula therefore will serve to illustrate a soap of this character.

150 lbs. of tallow  
75 lbs. of rosin  
15 lbs. of sodium silicate.

The method of manufacture is the same in this case as for the previous example. After finishing, however, the silicate of soda is added as follows:

Put the silicate of soda into a small kettle and add water, boiling until it registers 5° Bé (hot); then add soda-ash until it registers 7° Bé, then salt until it makes 8° Bé while boiling hot.

Now run about 70 lbs. of the soap into the crutcher and add 30 lbs. of the hot silicate of soda solution. Crutch well; add the perfume and continue crutching until the soap starts to form. Dump into the frame and treat as directed above.

**292. Soap Powder.** — There are many kinds of soap powders on the market. They are all, however, prepared from soap and soda-ash, sometimes borax is also used. The following will serve as an illustration:

Eight pounds of tallow and 8 lbs. of cocoanut oil placed in the crutcher and heated to 150° to 160° F.; 8 lbs. of caustic lye 33° Bé is now crutched in and the soap allowed to stand for 2 hours. At the end of this time crutch until thin and add hot water until quite thin. Crutch in one-half pound of sulfate of soda which has been dissolved in hot water and then add 25 lbs. of soda-ash, keeping the soap thin by the addition of hot water. When thoroughly mixed run into frames and let stand over night; then cut into bars and open pile to dry. When thoroughly dry chip and grind, when it is ready for use.

**293. Soft Soap.** — “Transparent” soft soap is in good demand under the name of “glycerin soft soap,” “crown soap” etc. Its chief constituent is linseed oil and the lye most suitable is that from caustic potash. The lye is prepared several days before using in order that it may become clear. A very good soap may be made by melting 4 lbs. of rosin in a crutcher or iron kettle and adding 21 lbs. of linseed oil, and 21 lbs. of cotton-seed oil. The temperature is then raised to 160° F. and a mixture of 42 lbs. of caustic potash-lye 22° Bé and 12 lbs. of caustic soda-lye 25° Bé introduced.

The mass is then crutched for 5 minutes, allowed to stand for 2 hours and crutched again until the soap is smooth. It is finally run into the container, and when cool is ready for use.

REFERENCES

Modern Soaps, Candles and Glycerine. L. L. Lamborn. New York, 1906.

American Soaps. Henry Gathman. New York, 1904.

The Art of Soap Making. Alexander Watt. London, 1901.

A Collection of Formulæ. A. W. Honchin. Goldsboro, Md., 1904.





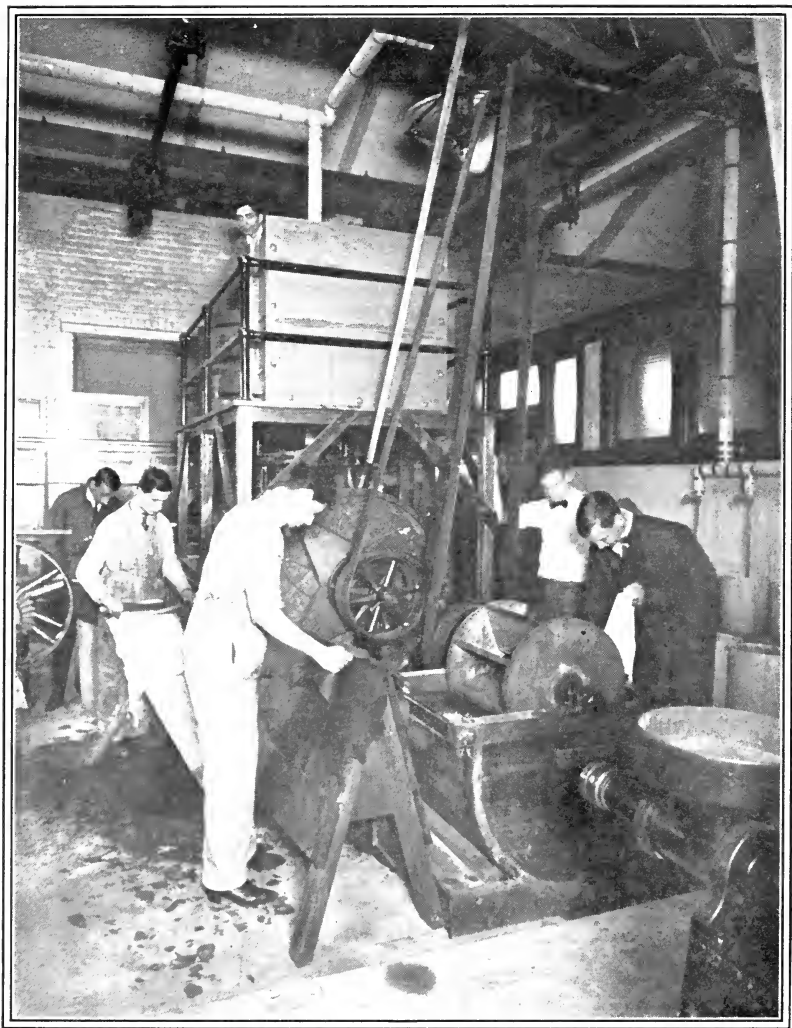

Rogers' Industrial Chemistry.

MINIATURE TANNERY.

## CHAPTER VIII

### LEATHER MANUFACTURE

The object of tanning is to render the skins of animals imputrescible and pliable. As only a small amount of leather is required with the hair on, preliminary treatments are necessary to remove it before entering into the actual tanning process.

In conducting the work along this line it will be found best to follow the outline as given below:

**294. Soaking.** — As the skins or hides come to the tanner they are usually in the dry salted or pickled condition, and contain besides the salt a large amount of blood and dirt. The first step therefore is to place them in a pit containing water, where they are allowed to remain until soft. They are then rinsed off in fresh water to remove as much of the dirt and blood as possible. When washing is complete the skins are placed over a round inclined table called a "beam." Here the excess of flesh, ear-laps and tail are trimmed off by means of a sharp knife called a "flesher." Machines are also used to accomplish this result.

**295. Depilating.** — The next step in the process consists in removing the hair and epidermis and is usually accomplished by means of milk of lime, although other substances are sometimes employed. The most common method in use is to prepare sufficient milk of lime to cover the skins, to which has been added .5 per cent of sodium sulfid on the weight of the lime. The skins, after being introduced into this mixture, are turned twice each day in such a manner as to bring the ones on

the top into the bottom of the pit. This treatment requires from 4 to 8 days depending on the nature of the skin; the proper time being indicated by the ease with which the hair and epidermis are removed when rubbed over with the finger.

The chemical action which takes place in this treatment is due to the combination of the calcium hydroxid with the fat surrounding the hair pellicle and that between the fiber thus forming a lime soap, which loosens the hair and epidermis, swells up and separates the fiber bundles. The hair itself is only very slightly altered. Old limes will unhair much more readily than new ones, which is often advantageous for dressing goods; although for sole-leathers and others requiring firmness, new limes are preferred.

When properly limed the skins are removed from the pit and allowed to drain. They are again placed over the beam where their plump condition makes it easy to remove the remaining flesh with the fleshing knife, and also to scrape off the loosened hair by means of a blunt knife. In case of hides (heavy leather) much of the lime is also worked out by this means. After unhairing and fleshing the skins or hides are placed in a pin-mill where they are washed with running water for half an hour or until the fine hair, etc., have been removed. The stock is then in the proper condition for the subsequent treatments.

**296. Puering or Bating.** — This procedure is carried out in order to free the skin from lime, to produce a soft, flacid, open condition and to smooth down the grain. There are numerous methods in vogue, most of which depend upon fermentation for their beneficial action. Some of the substances in use are hen, pigeon and dog manure; sour milk in the form of dermi-former; fermenting bran; puerine; and many others. Many non-fermenting baits are also on the market, the most common of which is lactic acid.

The fermenting process has the advantage over the non-fermenting in that the skins become open in the former and thus allows of a more uniform combination of the hide substance with the tanning material.

**297.** A process which gives very excellent results and which may be carried out with perfect safety is covered with letters patent by Frances J. Oaker, of New York City, and is as follows: Into a paddle-box introduce sufficient water for easy working of the skins. Add 5 per cent of syrup glucose and one-half per cent of flowers of sulfur computed on the weight of the skins. Raise the temperature of the bath to 105° F., and add 1 lb. of yeast for each 1000 lbs. of skin treated (or in small lots one yeast cake for 2 small skins) and allow to stand for 24 hours. The bath at this time has started active fermentation, when the skins are introduced together with an addition of one-half the original amount of glucose and sulfur. The skins are now run for about 5 minutes and allowed to stand for 1 hour; then run again for 5 minutes and the treatment continued until the test with phenol phthalein on a piece of the skin cut for the heaviest part shows that all of the lime has been neutralized. When this point is reached the fibers will be found to be well open and the skin in a soft and pliable condition with a smooth and silky grain. The time required for this operation should be from 6 to 8 hours in the case of heavy skins, with a correspondingly shorter period for lighter ones.

**298. One Bath Chrome Tannage.** — The skins after coming from the puer are washed thoroughly in running water and are ready for the actual tanning process. As one bath chrome liquors are the simplest to handle, we will first take up this method. First, however, it will be necessary to prepare the liquor, which may be accomplished as follows:

Dissolve 1000 grams of sodium dichromate in 1400 c.c. of

water and add to this 1000 grams of conc. sulfuric acid; now heat if necessary, and slowly add 600 grams of syrup glucose, waiting until the action subsides after each addition before adding the next portion.

When all of the glucose has been added, the liquid will assume a green color, and, when cool, is ready for use.

The skins after being washed from the puer are slated, that is, they are stretched by rubbing the flesh side with a stone slicker which besides stretching the skin frees it from excess of water. The skins are next placed in the mill, the door adjusted, and the mill revolved. Ten per cent of the above liquor computed on the weight of the skins is now weighed out and diluted with three times its volume of water, and this solution introduced through the trunnion of the mill. The skins are then drummed one and a half hours (sheep and calfskin), at the end of which time, 1 per cent of sodium bicarbonate dissolved in a small amount of water is added, and drummed for one-half hour longer. They are then removed from the drum, placed on the horse over night in order to drain and hydrate. On removing from the drum samples are taken from the thickest part of several skins and placed in boiling water. If they remain flat it proves that the tanning is complete. Should they curl up, however, it indicates undertanning. The skin should then be returned to the mill and worked in a second liquor of one-half the strength of the original. After standing over night they are then washed for one-half hour in running water, taken from the drum, put out in order to remove excess of water, to smooth out and stretch them.

**299. Dyeing.** — The plugs are put in place again. The skins now returned to the drum, worked for one-half hour with a solution of 3 per cent hematin paste and  $\frac{1}{4}$  per cent of soda-ash in a small amount of water at 140° F. When the

dyeing is finished several plugs are removed while the mill is in motion in order to draw off the excess of liquor. The plugs are then replaced. A solution containing 1 per cent of ferrous sulfate and  $\frac{1}{4}$  per cent of copper sulfate is introduced through the trunnion, and revolved for 15 minutes longer.

**300. Fat Liquoring.** — The plugs are again drawn and the skins washed in running water for 15 minutes. The fat liquor is next added, which consists of an emulsion of  $1\frac{1}{2}$  per cent of chip soap in as little water as possible and 1 per cent of neatsfoot oil at  $140^{\circ}$  F., working one-half hour. After draining, the skins are put out, and a coat of equal parts of glycerin and water applied to the grain. They are again allowed to drain for about 2 hours, put out, and finally tacked out on boards to dry. When thoroughly dry they are removed from the boards, placed in damp sawdust until soft, and may then be ironed or glazed as desired.

**301. Ironing.** — If a dull finish is desired, the skins are given a light coat of setine No. 1 (Vacuum Oil Company), ironed with a hot flat-iron and are then ready for the market.

**302. Glazing.** — For producing a glaze on leather a solution is made as follows:

100 parts of hematin paste  
500 parts of water  
25 parts ammonia  
10 parts ferrous sulfate  
100 parts blood or egg albumen  
200 parts water  
10 parts glycerin.

Before glazing the grain is cleared with very dilute acetic, lactic, or formic acid. The size is then well rubbed in, dried, and glazed under a glass roller. Nigrosene sizes are also much used.

**303. Colored Chrome.** — The chromed skins after standing for 24 hours are thoroughly washed, put out and then worked in a solution of gambia, sumac, or fustic, standing about 2° T., which has been rendered acid with a very small amount of sulfuric acid (1 oz. to 300 lbs. of solution). The temperature should be about 110° F., and the skins should be run 1 to 2 hours. This operation should be conducted in a paddle-box. They are next put out to remove excess of liquor and fixed with  $\frac{1}{2}$  per cent of tartar emetic by running for 15 minutes in the drum. A solution of basic color is now run in through the trunion (2 to  $\frac{1}{2}$  per cent at 140° F.) and worked for 20 minutes. The plugs are then removed to free the skins from excess of solution and finally fat liquored with a solution of  $1\frac{1}{2}$  per cent of soap and 1 per cent of neatsfoot oil at 140° F. for one-half hour. On removing from the drum the skins are thrown over the horse to drain and are finally tacked out, and the following solution applied to the grain:

150 parts of acetic acid  
 4 parts sodium dichromate  
 1500 parts water.

When dry they are removed from the boards, placed in damp sawdust to soften, and a finishing size prepared as follows:

56 parts of egg or blood albumen  
 1 part of sodium dichromate  
 7 parts of acetic acid  
 300 parts of water

is well mixed and thoroughly rubbed into the grain; allowed to dry, and then glazed. It is sometimes necessary to apply several coats before the desired finish is secured.

**304. Two Bath Chrome Tannage.** — The first really important advance in chrome tanning was made by Augustus



Schultz in 1884. The process he adopted was probably suggested by a method of mordanting wool by chromium oxid and depended on the power of the pelt to absorb free chromic acid (as it does all other free acids), and the subsequent reduction of the latter on the fiber to a basic chromic salt, which produces the tannage. The method employed is as follows:

A bath is prepared consisting of 5 per cent of sodium or potassium dichromate, and  $2\frac{1}{2}$  per cent of concentrated hydrochloric acid, regulated on the weight of the wet prepared pelts, and dissolved in sufficient water for convenient use in the paddler or drum. The skins are worked in this bath until they take on a uniform yellow color throughout. They are now freed from superfluous chrome liquor by draining or "putting out," which may be done by hand on the slating table, or by the machine. The skins, on coming from the chroming bath, may be allowed to lie for some time without serious injury, but should be protected from action of light, which reduces the chrome at the expense of the skin, and renders the subsequent tannage irregular. The best results are obtained by allowing the skin to lie for 24 hours. A somewhat strong "hypo" bath is prepared as a preliminary "dip," the skins being simply drawn through it to fix the chrome on the surface and piled on the horse.

The reducing bath is next prepared by dissolving 10 per cent of sodium thio-sulfate and 5 per cent of hydrochloric acid in sufficient water. The skins are then worked in the bath until a duck-egg green is produced uniformly throughout the skin. They are then removed from the drum or paddle, allowed to stand 24 hours, are then washed and finished as given under the one-bath process.

The reactions which takes place are represented by the following equation:

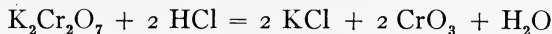

In the "dip" some chromium dioxid is produced

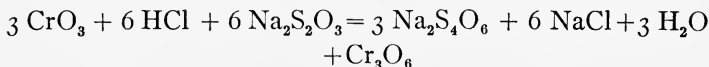

In the reducing bath we have two stages in the reaction.

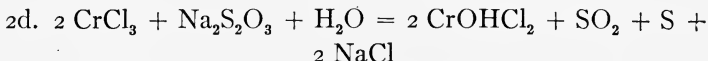
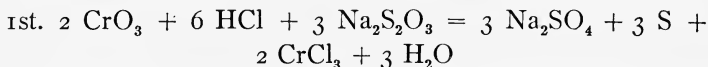

The  $\text{CrOHCl}_2$  is held by the fiber and is probably finally converted to  $\text{Cr}(\text{OH})_3$  by the action of the bicarbonate used for washing.

It will be seen that the two bath method varies from the one bath in the fact that more or less of the precipitated sulfur is taken up by the fiber. In fact, a test to tell whether a chrome tanned skin is one bath or two bath may be made by wrapping a silver coin in the leather, placing in the hot-water oven for half an hour and noting, that if turned black the leather was made by a two-bath process.

**305. Vegetable Tannage.** — The process employed in the production of leather with the vegetable tanning materials vary extremely according to the class of leather which is being produced, both in the materials selected and the time required. In sole-leather tanning, when thick hides are used, many months are frequently needed; while with thin skin, and with the aid of mechanical motion which circulates the liquor, the process is often complete within a few hours.

The simplest method of tannage is the old form used for sole-leather manufacture, but owing to the time required it cannot be readily conducted as a laboratory process. A brief outline of the process, however, may not be out of place.

The hides as they come from the liming process are de-haired and washed and then entered into a weakly acid bath which usually consists of old, nearly exhausted tan liquors. As these old liquors may not always be sufficiently acid, a small amount of some acid, such as lactic acid, is introduced.

After the hides have remained from 8 to 10 days in the "suspenders" they are usually laid in pits called "handlers" which are worked in series of 6, 8, or 10 pits, containing the same number of hides. The weakest liquor from the youngest pit is run to the suspender daily, a new and stronger liquor is run to the pit holding the oldest and most tanned pack; as this pack is removed the next in age takes its place while the youngest pack enters the pit containing the weakest liquor, and so on down the series. In this way each pack receives a change of liquor of regular graduated strength; passing from perhaps a Sp. gr. of 1.002 (20° Bkr.) to one of about a Sp. gr. 1.050 (40° Bkr.). As the hides come from the handlers they are completely or nearly colored through and then pass to the "layers."

In the layers the hides are dusted with ground bark and remain undisturbed for several weeks, or until the leather has attained all of the weight and solidity of which it is capable. It is then washed in clear liquor, and scoured with stone and brush till the bloom is removed. A light coat of oil is applied on the grain, partly dried and "struck out" either on the table or machine and colored as desired.

306. The finer grades of leather, such as goat, sheep and seal for bookbinding, pocket-books, and the like, are usually tanned with sumac, although other tanning extracts are often employed. For this method of tanning, the skins are more thoroughly puered than for sole-leather; while paddles and drums are largely used to hasten the absorption of the tanning material.

The general method of procedure is given under the head of vegetable tan.

**307. Vegetable Tan.** — In this process the skins are first prepared as under chrome tannage, namely, they are soaked to remove blood and dirt, then introduced into milk of lime with  $\frac{1}{2}$  per cent of sodium sulfid on the amount of lime used. The liming should be continued for 6 to 8 days, or until the hair and epidermis are well loosened. They are then de-haired, fleshed, and are ready for the puering process, which is conducted in the same manner as for chrome tannage; the process being continued until the grain is smooth, the fibers well separated, and a test with phenol phthalein, to a cut portion, shows no evidence of lime. The skins are now thoroughly washed, and are ready for the actual tanning process.

**308. Querbracho Extract.** — Querbracho is put on the market as a heavy paste and is shipped in barrels weighing about 600 lbs. It is produced in various places, one of the principal manufacturers, however, being the Stamford Manufacturing Company, Stamford, Conn. Sufficient extract is dissolved in water at  $70^{\circ}$  F. to produce a solution standing at 4 Bé. The skins are now fastened on sticks by means of hooks and allowed to hang in the tan liquor in such a manner that they may be lifted several times each day in order to agitate the liquor. At the end of 3 days a quantity of extract equivalent to the weight of the skin is added to the tan liquor and the process continued until completely struck through. The time required is usually about 6 days for calfskin, although this may vary to some extent.

**309. Retanning.** — When properly tanned the skins are put out and shaved. They are then retanned in sumac, using about 2 per cent on the weight of the skin and  $\frac{1}{10}$  per cent of sulfuric acid in a paddle and run for about 2 hours.

**310. Preparatory Treatment.** — An important factor in the preparing of leather is to free it from all substances still adhering to it from the tanning process; this is generally done by allowing the skins to remain for some time in running water, whereby all impurities are washed off.

After this treatment, run in the drum for half an hour with running water, finally introducing warm water for 10 minutes.

It is necessary that the leather is freed in this manner from all superfluous tannin, as other wise when dyeing, especially with basic colors, spots are liable to form.

In working sheepskins it is also necessary to remove the grease, which may be accomplished by the following method:

Scour in the drum with a weak solution of soda (about  $\frac{1}{2}$  per cent on the weight of the water), then rinse in lukewarm running water for 20–30 minutes, afterwards run for 5 minutes through a bath containing 1 part of sulfuric acid to 60 parts of water at 60° F. Rinse in cold, clear running water for 15 minutes to remove the sulfuric acid.

**311. Dyeing.** — Work the well-cleaned skins in a solution of 2 parts of acetic acid to 800 parts of water. The skins are then removed from the drum and the solution of the color applied with a brush, or the skin may be dipped in the color solution.

The former, however, gives more satisfactory results for those not skilled in manufacturing.

The color solution is prepared by dissolving the dyestuffs in water at 130° F., and will vary according to the depth of color desired, ranging from  $\frac{1}{2}$  to 10 per cent solution.

The skins are spread on the table and the warm color solution brushed on evenly. After the color has set they are washed in lukewarm water, allowed to drain, finally struck out, tacked out, and are given a coat to soluble leather oil.

When the skins are dry they are removed from the boards,

softened with the moon knife, and filled with flaxseed and milk. This mixture is prepared by boiling 1 lb. of flaxseed in a bucket of water until a good extract is obtained. For use, take a portion of this extract and add to it an equal volume of milk, heat to 120° F., and apply several coats. If it is desired to produce a grain, the leather is boarded, which consists in rolling under a board having a cork bottom. If smooth dull finish it is allowed to dry and softened by means of staking.

If glazed it is coated with egg or blood albumen and worked on the glazing machine.

**312. Fat Liquors for Chrome Leather.** — Dissolve 200 grams of chip soap in 600 grams hot water. When cool, add 70 grams of neatsfoot oil, and stir in one direction.

For use take 6 per cent of this emulsion on the weight of the skins.

The following fat liquors may also be found useful:

- |     |                         |
|-----|-------------------------|
| (1) | 500 grams soft soap     |
|     | 300 grams water         |
|     | 150 grams neatsfoot oil |
| (2) | 500 grams soft soap     |
|     | 300 grams water         |
|     | 130 grams castor oil    |
|     | 20 grams linseed oil.   |

The preparation of chip soap and soft soap will be found in the chapter on soap making.

**313. Turkey Red Oil.** — This compound known also as soluble oil is largely employed in the tanning industry and may be prepared as follows:

Provide a suitable vessel, place in it 160 grams of castor oil of good quality. Run in slowly, taking about an hour

over the operation, and stirring well all the time, 24 grams of strong sulfuric acid. Allow the mixture to stand 24 hours. At the end of this time stir in 170 c.c. of water until the whole mass has a uniform creamy appearance; next allow to stand for 24 hours, when it will be found to have settled out into two layers, one of oil at the top, the other of acid water below. Run this off through a tap funnel; next dissolve 20 grams of common salt in 170 c.c. of water and add this to the oil, shaking well as before; again allow to stand for 24 hours. Then run off the bottom aqueous layer. Now add concentrated ammonia slowly with constant stirring into the oil until a clear, transparent liquid is obtained. Finally add sufficient water to make 350 grams, when Turkey Red Oil of 50 per cent strength will have been made.

**314. Carriers Stuffing Grease.** — In working heavy leather it is customary to fill the hides with grease which helps to give it a body and renders it more pliable. A good stuffing grease may be made as follows:

100 grams of town tallow  
50 grams moellen degreas  
50 grams petroleum jelly

are melted together. When melted the mixture is allowed to cool somewhat and 100 grams of cod oil stirred in before it sets.

**315. Combination Tannage.** — Once a leather is thoroughly tanned with a vegetable material it is little affected by alum or chrome, while on the other hand alum or chromed tan leather is still capable of absorbing a large amount of vegetable tanning material.

A mineral tannage gives a soft flat leather; while vegetable tannage gives a full plump leather which can only be made soft by stuffing with a large amount of grease. Consequently

advantage is taken of the ability of chrome tanned leather to absorb tannic acid, thus producing a full leather, which retains the softness characteristic of mineral tannage. To carry out the process the skins after being washed from excess of chrome liquor are run in a weak solution of gambia for several hours, and may then be finished in the same manner as given for chrome tanning. Combination tannages also have the advantage over straight chrome in that they may be colored with basic colors in the same manner as given under vegetable tannage.

**316.** Some vegetable tanning materials and the contents of tannic acid:

Hemlock	8-10 per cent Tannin
Larch	9-10 per cent Tannin
Saw Palmetto	5-13 per cent Tannin
Sweet Fern	4- 6 per cent Tannin
Alder	16-20 per cent Tannin
Common Birch	2- 5 per cent Tannin
Chestnut Bark	17 per cent Tannin
Chestnut Wood	3- 6 per cent Tannin
Oak Bark	12-14 per cent Tannin
Galls	50-60 per cent Tannin
Canaigre	25-30 per cent Tannin
Sumac	18-25 per cent Tannin
Querbracho	20 per cent Tannin
Gambeer	35-65 per cent Tannin
Divi-Divi	40-45 per cent Tannin
Mimosæ	12-20 per cent Tannin
Valonia	40 per cent Tannin
Myrobalans	28-35 per cent Tannin



## REFERENCES

- The Principles of Leather Manufacture. H. R. Procter. New York, 1903.
- Practical Tanning. Louis A. Flemming. Philadelphia, 1903.
- Modern American Tanning. Jacobsen Publishing Company. Chicago, 1902.
- Leather Dressing. M. C. Lamb. London, 1907.

## CHAPTER IX

### WOOD FIBER, PULP AND PAPER

**317.** In a laboratory manner it is impossible to go very extensively into the manufacture of paper, without entailing a great expense. A few simple tests may be performed, however, which will enable the student to more fully appreciate some of the operations introduced in this very important industry.

Paper consists of cellulose fibers matted or felted in a sheet. The raw materials employed are wood pulp, cotton or linen rags, esparto, straw, hemp, flax, jute, etc.

**318. Wood Pulp.** — As the bulk of paper on the market is made entirely or in part from wood fibers, this raw material will be the only one considered in this chapter. For a more detailed account of the processes involved the student is referred to the books of references given at the end of the chapter. Wood pulp is of two kinds, mechanical and chemical.

**319. Mechanical Pulp.** — Mechanical pulp may be made in the laboratory by forcing a stick of poplar, hemlock, spruce, pine or bass wood against a revolving emery-wheel, over which a small stream of water plays continuously. The resulting pulp is passed through several screens to remove insufficiently disintegrated particles. The finely divided pulp is then brought into a settling tank when it is washed, bleached, filled and colored as subsequently described under the treatment of chemical pulp.

**320. Chemical Pulp.** — Chemical pulp is prepared by the

soda process, the sulfite process, or by the sulfate process. The soda process is largely used for soft woods. The bark is removed by shaving. The wood is then chipped in a machine, or by hand by cutting across the grain. To separate the knots, the chips are thrown into water where the heavy parts go to the bottom, thus leaving the clear wood on top. The digester is nearly filled with chips, which are then covered with a caustic liquor of about 10° Bé. The cover of the digester is safely screwed in place, and the charge heated until a pressure of 90 lbs. is obtained; which pressure is held from 8 to 10 hours. The effect of this "cooking" is to reduce the wood to a soft mass of grayish-brown color; while the liquor becomes dark brown and has increased somewhat in density. Now open the valve of the digester very slowly in order to release the pressure. *Much care must be taken here to avoid any possibility of an explosion.* If the process has been conducted properly, the stock will all crumble to a pulp which together with the "black liquor" is transferred to a suitable apparatus when it is systematically washed, and the wash waters saved until their density falls below 8° Bé.

This liquor may be evaporated to a density of 38° Bé, when it may be burned. The "black ash" thus obtained may be recausticized with milk of lime and from 80 to 90 per cent of the original soda recovered. The pulp obtained above is thoroughly washed. It is then passed through a screen to remove the larger particles.

**321. Bleaching.** — The washed pulp is next placed in a vessel provided with some form of agitator where it is mixed with a weak solution of calcium hypochlorite. Only a clear solution of bleaching powder should be used, so that no dirt will be introduced into the insoluble residue, as it will cause spots in the paper. If the liquid is heated to 90° or 100° F.,

or a little acid added, the process is hastened. Alum forms aluminium hypochlorites with bleaching powder solutions, which is very effective; a slightly acid alum or "bleaching" alum is commonly employed. From 18 to 25 parts of bleaching powder is used for each 100 parts of pulp. As soon as bleached, the process is stopped; otherwise the fiber is liable to be chlorinated, and color again taken up. The excess of hypochlorite in the pulp is washed out with water, or is destroyed by adding an antichlor, such as sodium thio-sulfate. The action of the antichlor is as follows:

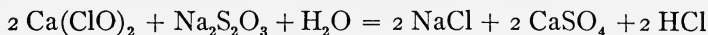

The pulp must be thoroughly washed after bleaching, even when antichlors are used, since injurious substances may be left in the pulp.

Other materials than bleaching powder, such as ozone, hydrogen peroxid, sulfurous acid, liquid chlorin, or sodium peroxid have been suggested for bleaching, but as yet the hypochlorites are the most employed.

**322. The Paper Making Process.** — The first operation "furnishing" or charging the stack; the kinds and quantity of material employed depend on the quality of the paper to be produced. In order to give the paper body, weight, and greater smoothness, mineral filler on "loading" material is employed. This must be exceedingly fine, and not have too high a specific gravity or soluble in water. It must be free from dirt, grit, and mica. The loading is done after the fiber has been well beaten with water. The filler is thoroughly mixed with pulp, and then the sizing material added, and the whole beaten until a perfect mixture of all the materials are obtained. Some of the fillers which are employed in paper making are clay, chalk, and calcium sulfate, while a good size may be prepared from rosin with a concentrated

solution of soda-ash. The proportion of filler and size vary within quite a wide range; good results, however, may be secured by using 5 per cent of filler and 3 per cent of size on the weight of the moist pulp. After the pulp, filler, and size are well beaten, a solution of aluminium sulfate is added in sufficient quantity to neutralize the soda of the rosin soap. The result of this treatment is to form free rosin, and some aluminium hydroxid which becomes entangled in the openings between the fibers. Paper is usually colored by adding pigments or dyes to the pulp. For white paper, the slight yellow tinge of bleached fiber is neutralized with a trace of blue or pink, ultramarine or cool-tar dyes being used. Some pigments are precipitated in the fiber by adding solutions in the hollander.

The sheet is formed in three different ways: by the hand frame, by the cylinder machine, and by the Fourdrinier machine.

**323. The Hand Frame.** — For laboratory work this method may be employed. It is simply a rectangular frame covered with wire gauze and having a slight removable ledge around the sides. The frame is submerged in the pulp, mixed to a thin cream with water; when raised, the ledge retains some of the pulp on the gauze, while the water drains through; at the same time the frame is slightly shaken from side to side, causing the fibers to "felt," thus forming a mat of pulp on the gauze. The frame is then inverted over a woolen felt blanket on which the sheet of pulp drops. A number of these pieces of felt, each carrying a sheet of pulp, are piled one above the other, and heavily pressed until the water is expelled. The sheets are then dipped in a fairly strong solution of glue or gelatin and allowed to dry slowly.

The dried sheet is then run between a hot roller to produce a final finish. A common photographic burnisher will

answer the purpose very well, it only being necessary to have two polished rolls in place of the usual machine having only one polished roll.

**324. Rosin Size.** — Into an iron kettle place 700 c.c. of water and dissolve in this 20 grams of soda-ash. Bring to a boil and slowly add 150 grams of powdered rosin. A large amount of carbon dioxid is generated, consequently the kettle should be of sufficient capacity to prevent the liquid from passing over the side. In order to avoid too great a loss by evaporation, water is added from time to time, the level being regulated by means of a stick having a notch cut at the original height of the liquid. When all of the rosin has dissolved, the mixture is allowed to cool, and is practically a 25-per cent solution of rosin soap. A stronger size may be made by using less water.

*Casein Size.* — This size is prepared by dissolving casein in cold soda-ash (5 to 1) or borax solution. It is applied in the same manner as that given for rosin size.

**325. Colored Paper.** — The pulp colors described in Chapter VI may be added to the pulp in the beater in any amount desired to produce the required shade. Very often, however, the color is produced by direct application of coal-tar dyes, the general method of procedure being as follows:

The pulp and filler are introduced into the pulping machine and well worked. The requisite amount of color, previously dissolved in water, is now added, well worked in, and then followed by the rosin size and alum. The well-beaten mass is then worked into sheets and treated as given above.

To produce light shades  $\frac{1}{2}$  per cent of color on the weight of the dry pulp is used. For medium shades 1 per cent is employed. For heavy shades as much as 3 per cent may be necessary.

The dyestuffs used for coloring pulp may be any acid color

or direct cotton color. Other colors will require fixing agents.

The following list of colors may be found of service.

Uranin O soluble	Dianil red
Eosin, all brands	Dianil scarlet
Erythrosin, all brands	Dianil blue
Acid violet, all brands	Dianil brown
Naphthol yellow, all brands	Dianil black
Orange, all brands	Direct black

#### REFERENCES

- Practical Paper making. G. Clapperton. London, 1907.  
Chapters on Paper Making. C. Beadle. London, 1904.  
The Paper Chemist. Stevens. London, 1908.  
A Text Book of Paper Making. C. F. Cross and E. J. Bevan.  
London, 1900-1906.  
Dyeing of Paper Pulp. Julius Erfurt. London, 1901.

## CHAPTER X

### USEFUL DATA

**326. Thermometer Conversions.** — In order to convert Centigrade (Celsius) into Fahrenheit (above freezing-point) multiply by 9, divide the product by 5, and add 32 to the quotient.

To convert Fahrenheit above freezing-point into Centigrade, subtract 32, multiply the remainder by 5, and divide the product by 9.

To convert Reaumur into Fahrenheit, multiply by 9, divide by 4, and add 32 to the quotient.

To convert Fahrenheit into Reaumur, subtract 32, multiply the remainder by 4, and divide the product by 9.

**327. Mensuration of Volume.** — The standard gallon measures 231 cu. in. and weighs 8.338 lbs.

One cubic foot contains 7.4805 gallons and weighs 998.8 ounces or 62.425 lbs.

For facility of computation, the weight of a cubic foot of water is usually taken as 1000 ounces or 62.5 lbs.

Water expands from 40° to 202° to the amount of .0467 .002715 for each degree giving an increase of 1 cubic foot in 21.41 cubic feet.

**328. To Compute Volume of a Cube.** — Multiply a side of a cube by itself and that product again by a side.

**329. To Compute Volume of a Parallelopipedon.** — Multiply length by breadth and that product again by depth.

**330. To Compute Volume of a Cylinder.** — Multiply area of base by height.



### 331. HYDROMETER SCALE SHOWING THE RELATIONS OF SPECIFIC GRAVITY, BEAUMÉ AND TWADDELL.

Specific Gravity	Degrees Beaumé	Degrees Twaddell	Specific Gravity	Degrees Beaumé	Degrees Twaddell	Specific Gravity	Degrees Beaumé	Degrees Twaddell
1.000	0	.0	1.185	22	36.0	1.440	44	88.0
1.007	1	1.4	1.195	23	38.0	1.454	45	90.8
1.014	2	2.8	1.199	24	39.0	1.470	46	94.0
1.022	3	4.4	1.210	25	42.0	1.485	47	97.0
1.029	4	5.8	1.221	26	44.2	1.501	48	100.2
1.036	5	7.2	1.231	27	46.2	1.576	49	103.2
1.044	6	8.8	1.242	28	48.4	1.532	50	106.4
1.052	7	10.4	1.252	29	50.4	1.545	51	109.2
1.060	8	12.0	1.261	30	52.2	1.560	52	112.6
1.067	9	13.4	1.275	31	55.0	1.580	53	116.0
1.075	10	15.0	1.286	32	57.2	1.595	54	119.4
1.083	11	16.6	1.298	33	59.6	1.615	55	123.0
1.091	12	18.2	1.309	34	61.8	1.635	56	127.0
1.100	13	20.0	1.321	35	64.2	1.650	57	130.4
1.108	14	21.6	1.334	36	66.8	1.670	58	134.4
1.116	15	23.2	1.346	37	69.2	1.690	59	138.2
1.125	16	25.0	1.359	38	71.8	1.710	60	142.0
1.134	17	26.8	1.372	39	74.4	1.730	61	146.4
1.143	18	28.6	1.384	40	76.8	1.750	62	150.6
1.152	19	30.4	1.398	41	79.6	1.775	63	155.0
1.161	20	32.2	1.412	42	82.4	1.795	64	159.0
1.171	21	34.2	1.426	43	85.2	1.820	65	164.0

*Example.* — Diameter of a cylinder is 3 feet and its height is 7 feet; what is the volume?

First to get area of base multiply the square of the diameter by .7854 then this product by the height: —

$$3 \times 3 \times .7854 = 7.068$$

$$7.068 \times 7 = 49.476 \text{ cubic feet}$$

If it is desired to know the contents in gallons then

$$49.476 \times 7.4805 = 370.1 \text{ gallons.}$$

**332. To Compute Volume of a Cone.** — Multiply the area of the base by perpendicular height, and take one-third of product.

**333. To Compute Volume of a Frustum of a Cone.** — Add together square of the diameters of greater and lesser sides and product of the two diameters; multiply the sum by .7854 and this product by height; then divide the last product by 3.

*Example.* — What is the volume of frustum of a cone diameter of greater and lesser ends being 5 and 3 feet, and height 9 feet.

$$\begin{aligned} 5^2 + 3^2 + (5 \times 3) &= 49 \\ 49 \times .7854 &= 38.4846 \\ \frac{38.4846 \times 9}{3} &= 115.4538 \text{ cubic feet.} \end{aligned}$$

**334. To Compute Volume of Sphere.** — Multiply the cubic of the diameter by .5236.

*Example.* — What is the volume of a sphere the diameter being 10 inches.

$$10^3 = 1000 \text{ and } 1000 \times .5236 = 523.6 \text{ cubic inches.}$$

This rule will apply to the measurement of kettles which as a rule are one-half a sphere.

If the kettle is a combination of a sphere and cylinder the measurement of each may be made and the contents thus determined. In all of the above measurements it is a simple matter to ascertain the number of pounds by multiplying the number of cubic feet by 62.425 and then by the specific gravity of the substance in question.

**335.** The weight per pound of a few common substances may be found useful as indicated in the following table:

SOLIDS

Substance	Weight per Cu. Ft.	Substance	Weight per Cu. Ft.	Substance	Weight per. Cu. Ft.
Charcoal . . . . .	27.5	Cannel . . . . .	82.3	Magnesia . . . . .	150.
Alum . . . . .	107.	Coke . . . . .	62.5	Magnetic ore . . . . .	317.6
Asbestos . . . . .	192.	Concrete . . . . .	137.5	Marble . . . . .	165.
Asphalt . . . . .	140.6	Earth, soil . . . . .	76.	Mud . . . . .	101.
Borax . . . . .	107.	dry . . . . .		Quartz . . . . .	166.25
Brick . . . . .	150.	“ loose . . . . .	93.7	Red lead . . . . .	558.7
Cement,		“ moist sand . . . . .	120.	Ro stone . . . . .	123.8
Portland . . . . .	81.25	Granite . . . . .	165.	Salt . . . . .	133.
Clay . . . . .	120.6	Gravel . . . . .	137.5	Sand . . . . .	112.
Coal . . . . .		Gypsum . . . . .	135.5	Sulfur . . . . .	127.
Anthracite . . . . .	84 to 102.5	Lime . . . . .	50.25	Pumice-stone . . . . .	57.
Caking . . . . .	79.8	Lime stone . . . . .	197.25		

LIQUIDS AND SEMI SOLIDS

Substance	Weight in lbs. per Cu. Ft.	Substance	Weight in lbs. per. Cu. Ft.	Substance	Weight in lbs. per. Cu. Ft.
Acid, acetic . . . . .	66.3	Butter . . . . .	58.8	Milk . . . . .	64.5
“ Sulfuric . . . . .	115.5	Cotton . . . . .	59.3	Oil, linseed . . . . .	58.7
“ Hydrochloric . . . . .	75.	Glycerin . . . . .		Petroleum . . . . .	55.
“ Nitric . . . . .	70.	60° . . . . .	78.7	Resin . . . . .	68.
Alcohol 95% . . . . .	51.	Ice . . . . .	57.5	Starch . . . . .	59.
Ammonia . . . . .		Lard . . . . .	59.	Sugar . . . . .	100.3
27.9% . . . . .	55.6	Leather . . . . .	60.	Tallow . . . . .	58.8

To compute the weight of a body in pounds per cubic foot, divide the specific gravity by 16.

**336. To Compute Pressure of a Fluid upon Bottom of its Containing Vessel.** — Multiply area of base by height of fluid in feet, and product by weight of a cubic foot of fluid.

**337. To Compute Pressure of a Fluid upon a Vertical, Inclined, or any Surface.** — Multiply area of surface by height of center of gravity of fluid in feet, and product by weight of cubic foot of fluid.

*Example.* — What is pressure upon a sloping side of a pond of fresh water 10 feet square and 8 feet in depth.

Center of gravity  $8 \div 2 = 4$  feet from surface.

Then  $10^2 \times 4 \times 62.5 = 25,000$  lbs.

### 338. Equivalents of Metric Weights and Measures

1 pound = 453.59 grams

1 oz. avoirdupois = 28.349 grams

1 U. S. gallon = 3.785 liters

1 U. S. liquid oz. = 29.574 cc.

$\frac{\text{grains per imperial gallon}}{0.7} = \text{parts per } 100,000.$

Parts per 100,000  $\times 0.7 =$  grains per imperial gallon.

$\frac{\text{Grains per U. S. gallon}}{0.583} = \text{parts per } 100,000.$

Parts per 100,000  $\times .583 =$  grains per U. S. gallon.

### 339. Table of Multiples.

Centimeters  $\times 0.3937 =$  inches.

Centimeters  $\times 0.0328 =$  feet.

Centimeters cubic  $\times 0.0338 =$  apothecaries' fluid ounces.

Diameter of a circle  $\times 3.1416 =$  circumference.

U. S. Gallons  $\times 3.785 =$  liters.

U. S. Gallons  $\times 0.833565 =$  imperial gallons.

Gallons, imperial  $\times 1.199666 =$  U. S. gallons.

U. S. Gallons  $\times 8.33505 =$  pounds of water.

Gallons, imperial  $\times 10 =$  pounds of water.

Gallons, imperial  $\times 4.54102 =$  liters.

Grains  $\times 0.0648 =$  grams.

Inches  $\times 0.0254 =$  meters.

Inches  $\times 25.4 =$  millimeters.

Miles  $\times 1.609 =$  kilometers.

Ounces, troy  $\times 1.097 =$  ounces of avoirdupois.

Ounces avoirdupois  $\times 0.9115 =$  ounces troy.

Pounds, avoirdupois  $\times 0.4536 =$  kilograms.

Pounds avoirdupois  $\times 0.8228572 =$  pounds troy.

Pounds, troy  $\times 0.37286 =$  kilograms.

Pounds, troy  $\times 1.21527 =$  pounds avoirdupois.

The square of the circumference of a circle  $\times 0.07958 =$  area.

**340. Board and Timber Measure.** — In board measure all boards are assumed to be 1 inch in thickness.

**341. To Compute Measure of Surface.** — When all dimensions are in feet, multiply length by breadth and product will give surface in square feet.

When either of dimensions are in inches divide the product by 12.

*Example.* — What are numbers of square feet in a board 15 feet long by 16 inches wide.

$$15 \times 16 = 240 \text{ and } 240 \div 12 = 20 \text{ sq. ft.}$$

**342. To Compute Volume of Round Timber.** — When all dimensions are in feet, add together squares of diameters of greater and lesser sides and product of the two diameters; multiply sum by .7854 and product by one-third of length.

When the length is in feet and diameter in inches, proceed as above, and divide by 144.

If surface or board measure is desired multiply volume by 12.

**343. Units for Computing Safe Strain that may be borne by New Ropes, Hausers and Cables.**

Description	Circumference Ins.	ROPES				HAUSERS		CABLES	
		White		Tarred		White	Tarred	White	Tarred
		3 Strands Lbs.	4 Strands Lbs.	3 Strands Lbs.	4 Strands Lbs.	3 Strands Lbs.	3 Strands Lbs.	3 Strands Lbs.	3 Strands Lbs.
White	2.5 to 6	1140	1330	—	—	600	—	—	—
“	6 to 8	1090	1260	—	—	570	—	510	—
“	8 to 12	1045	880	—	—	550	—	530	—
“	12 to 18	—	—	—	—	550	—	550	—
“	18 to 26	—	—	—	—	—	—	560	—
Tarred	2.5 to 5	—	—	855	1005	—	460	—	—
“	5 to 8	—	—	825	940	—	480	—	—
“	8 to 12	—	—	780	820	—	505	—	—
“	12 to 18	—	—	—	—	—	—	—	505
“	18 to 26	—	—	—	—	—	—	—	525
Manila	2.5 to 6	810	950	—	—	440	—	—	550
“	6 to 12	760	835	—	—	465	—	510	—
“	12 to 18	—	—	—	—	—	—	535	—
“	18 to 26	—	—	—	—	—	—	560	—

*Illustration.* — What weight can be borne with safety by a manila rope of 3 strands having a circumference of 6 inches?

$$6^2 \times 760 = 27,360 \text{ lbs.}$$

**344. Weights. Evaporative Power per Weight and Bulk of different Fuels.**

Fuel, Bituminous	Weight per Cu. Ft. Lbs.	Steam from Water at 212° by 1 lb. Fuel Lbs.	Cu. Ft. in a Ton No.	Fuel, Anthracite	Weight per Cu. Ft. Lbs.	Steam from Water at 212° by 1 lb. Fuel Lbs.	Cu. Ft. in a Ton No.
Cumberland, max..	52.92	10.7	42.3	Peach Mountain...	52.79	10.11	41.6
“ min..	54.29	9.44	41.2	Forest Improve....	53.66	10.06	41.7
Duffryn.....	53.22	10.14	42.09	Beaver Meadow...	56.19	9.88	39.8
Cannel, Wigan....	48.3	7.7	46.37	Lackawanna .....	48.89	9.79	45.8
Blossburgh .....	53.05	9.72	42.2	Lehigh .....	65.32	8.93	40.5
Newcastle .....	50.82	8.76	44	COKE			
Pittsburg.....	46.81	8.2	47.8	Natural Virginia...	46.64	8.47	48.3
Sydney .....	47.44	7.99	47.2	Cumberland .....	31.6	8.99	70.9
Clover Hill, Va....	45.49	7.67	49.2	MISCELLANEOUS			
Cannelton, Ind....	47.65	7.34	47	Charcoal Oak.....	24.	5.5	104
Scotch.....	51.09	7.08	43.8	Peat .....	30.	5	75
				Pine Wood .....	21.	4.7	106.6

## 345. Pressure and Temperature of Saturated Steam

Pressure per Sq. In. Lbs.	Temperature °	Pressure per Sq. In. Lbs.	Temperature °
1	102.1	37	262.6
2	126.3	38	264.2
3	141.6	39	268.8
4	153.1	40	267.3
5	162.3	41	268.7
6	170.2	42	270.2
7	176.9	43	271.6
8	182.9	44	273
9	188.3	45	274.4
10	193.3	46	275.8
11	197.8	47	277.1
12	202	48	278.4
13	205.9	49	279.7
14	209.6	50	281
15	213.1	51	282.3
16	216.3	52	283.5
17	219.6	53	284.7
18	222.4	54	285.9
19	225.3	55	287.1
20	228	56	288.2
21	230.6	57	289.3
22	233.1	58	290.4
23	235.5	59	291.6
24	237.8	60	292.7
25	240.1	61	293.8
26	242.3	62	294.8
27	244.4	63	295.9
28	246.4	64	296.9
29	248.4	65	298
30	250.4	66	299
31	252.2	67	300
32	254.1	68	300.9
33	255.9	69	301.9
34	257.6	70	302.9
35	259.3	71	303.9
36	260.9	72	304.8



Pressure and Temperature of Saturated Steam, *continued*

Pressure per Sq. In. Lbs.	Temperature	Pressure per Sq. In. Lbs.	Temperature
73	305.7	109	334
74	306.6	110	334.6
75	307.5	111	335.3
76	308.4	112	336
77	309.3	113	336.7
78	310.2	114	337.4
79	311.1	115	338
80	312	116	338.6
81	312.8	117	339.3
82	313.6	118	339.9
83	314.5	119	340.5
84	315.3	120	341.1
85	316.1	121	341.8
86	317.8	122	342.4
87	318.6	123	343
88	319.4	124	343.6
89	320.2	125	344.2
90	321	126	344.8
91	321	127	345.4
92	321.7	128	346
93	322.5	129	346.6
94	323.3	130	347.2
95	324.1	131	347.8
96	324.8	132	348.3
97	325.6	133	348.9
98	326.3	134	349.9
99	327.1	135	350.1
100	327.9	136	350.6
101	328.5	137	351.2
102	329.1	138	351.8
103	329.9	139	352.4
104	330.6	140	352.9
105	331.3	141	353.5
106	331.9	142	354
107	332.6	143	354.5
108	333.3	144	355

**Pressure and Temperature of Saturated Steam, *continued***

Pressure per Sq. In. Lbs.	Temperature	Pressure per Sq. In. Lbs.	Temperature
145	355.6	240	397.5
146	356.1	250	401.1
147	356.7	260	404.5
148	357.2	270	407.9
149	357.8	280	411.2
150	358.3	290	414.4
155	361	300	417.5
160	363.4	350	430.1
165	366	400	444.9
170	368.2	450	456.7
175	370.8	500	467.5
180	372.9	550	477.5
185	375.3	600	487
190	377.5	650	495.6
195	379.7	700	504.1
200	381.7	800	519.5
210	386	900	533.6
220	389.9	1000	546.5
230	393.8		

**346. Frigorific Mixtures.**

Mixtures	Parts	Fall of Temperature	Mixture	Parts	Fall of Temperature
Sea salt . . . . .	5	- 15° to - 25°	Snow . . . . .	1	- 40° to - 73°
Ammonium nitrate . . . . .	5		Calcium chlorid . . . . .	3	
Snow or powdered ice . . . . .	12		Snow . . . . .	8	
Ammonium chlorid. . . . .	5	- 5° to - 18°	Dilute sul- furic acid . . . . .	10	- 68° to - 91°
Snow or powdered ice . . . . .	0				

**347. Speed of Pulleys.**

$V$  and  $v$  speed of driving and driven pulleys.

$D$  and  $d$  diameter of driving and driven pulleys.

$R$  and  $r$  number of revolutions.

$$D = \frac{dr}{R}; \quad \frac{d-DR}{r}; \quad \frac{R-dr}{D}; \quad r = \frac{Dr}{d}$$

In a train of pulleys the final velocity

$$V = VD, D,, D,,, \text{ etc } \div d, d,, d,,,$$

**348. Unit of Electrical Resistance.** — The *ohm* represented by the resistance offered at  $0^{\circ}$  C. to an unvarying electric current by a column of mercury 14.4521 grams in mass, of a constant cross-sectional area, and of a length of 106.3 centimeters.

**349. Unit of Current.** — The *ampere*, which is an unvarying current passed through a solution of silver nitrate in water and deposits silver at the rate of .001118 grams per second.

**350. Unit of Electro-Motive Force.** — The *volt* is the pressure which if steadily applied to a conductor whose resistance is one Ohm will produce a current of one ampere.

**351. Unit of Quantity.** — The *coulomb*, which is the quantity of electricity transferred by a current of one ampere in one second.

**352. Unit of Capacity.** — The *farad*, which is the capacity of a condenser charged to a potential of 1 volt by 1 coulomb of electricity.

**353. Unit of Work.** — The *joule*, which is equal to  $10^7$  units of work in the C. G. S. system and which is practically equivalent to the energy expended in one second by an ampere in an ohm.

**354. Unit of Power.** — The *watt*, which is equivalent to the work done by one joule per second.

REFERENCES

Van Nostrand's Chemical Annual. John C. Olsen. New York, 1907.

Mechanics' and Engineers' Pocket Book. Charles H. Haswell. New York, 1906.

A Pocket Book for Chemists. Thomas Bayley. London, 1902.

# INDEX

A	PAGE	C	PAGE
Acid Colors for Lakes .....	87	Calcination .....	7
Acid Dyes .....	23	Centrifugal Machine .....	7
Acid Dyes for Wool .....	31	Chemical Pulp .....	136
Acetanilid .....	68	Chloroform .....	55
Acetyl Chlorid .....	52	Chrome Green .....	84
Alizarin .....	72	Chrome Orange .....	84
Alizarin Lake .....	88	Chrome Red .....	84
Aluminium Sulfate .....	15	Chrome Tannage .....	123, 126
Ammonium Sulfate .....	17	Chrome Yellow .....	84
Amyl, Acetate .....	57	Cinnamic Acid .....	61
Anilin .....	59	Cinnamic Aldehyde .....	79
Anilin Black .....	50	Cold Made Soap .....	108
Anisol .....	79	Collodion Varnish .....	93
Anthraquinone .....	70	Colored Chrome .....	126
Anthraquinone Sulfonic Acid ..	71	Combination Tannage .....	133
Antimony-potassium Tartrate ..	16	Cotton .....	35
Antimony Vermilion .....	83	Cotton, Properties of .....	36
		Cotton, Mercerized .....	37
		Crimson Lake .....	86
		Curriers' Stuffing Grease .....	133
		D	
		Dammar Varnish .....	93
		Density .....	9
		Depilating .....	121
		Developed Dyes .....	25
		Developing .....	43
		Diazotizing .....	42
		Dimethyl Anilin .....	63
		Direct Dyes for Cotton .....	38
		Distillation .....	9
		Disodium Hydrogen Phosphate ..	21
B			
Barium Chlorid .....	17		
Basic Dyes .....	24		
Basic Dyes on Cotton .....	41		
Basic Dyes for Lakes .....	87		
Bating .....	122		
Baumé's Hydrometer .....	11		
Benzaldehyde .....	78		
Benzoyl Chlorid .....	62		
Bleaching Pulp .....	137		
Boiled Soap .....	116		
Brown Hard Spirit Varnish ..	93		
Brunswick Green .....	84		

	PAGE		PAGE
Dog Soap .....	116	Indulin (S. S.) .....	74
Driers .....	90	Indulin (W. S.) .....	75
Dyeing .....	25	Iodoform .....	52
Dyeing Leather .....	124, 131	Ironing .....	125
Dye Tests on Cotton .....	39	Iron Sulfate Vat .....	47
<b>E</b>		<b>L</b>	
Electrical Units .....	153	Lakes .....	85
Eosin .....	63	Laundry Soaps .....	114, 116
Eosin Group .....	24	Lead Acetate .....	18
Equivalents of Metric System ..	146	Lead Nitrate .....	18
Ether .....	53	Leather Manufacture .....	121
Evaporation .....	1	Levigation .....	5
Evaporative Power of Fuels ...	149	Lilac .....	77
<b>F</b>		Lixiviation .....	1
Fast Green O .....	65	Logwood Lakes .....	89
Fat Liquoring .....	125	Logwood on Wool .....	27
Fat Liquors for Chrome Leather ..	132	<b>M</b>	
Ferrous Ammonium Sulfate ..	18	Magnesium Chlorid .....	19
Filter Press .....	7	Mastic Varnish .....	93
Filter, Vacuum .....	6	Mechanical Pulp .....	136
Filtration .....	5	Mensuration of Volume .....	142
French Polish .....	92	Mercerized Cotton .....	40
French Varnish .....	93	Metallic Mordants .....	27
Frigorific Mixtures .....	152	Methyl Violet .....	64
<b>G</b>		Methylene Blue .....	72
Glazing .....	125	Metric Equivalents .....	146
Green Castile Soap .....	113, 115	Mordant Dyes .....	24
<b>H</b>		Mordants of Metallic Tannates ..	44
Half Boiled Soap .....	114	<b>N</b>	
Hand Frame .....	139	Naphthol Yellow S. ....	66
Hydrosulfite Vat .....	47, 49	Neroli Oil .....	77
<b>I</b>		Niobe Oil .....	78
Indigo .....	46	Nitrobenzol .....	57
		P-nitracetanilid .....	69
		P-nitranilin .....	70



	PAGE		PAGE
Vat Colors .....	46	Wool.....	27
Vegetable Fibers .....	35	Wood Fillers .....	105
Vegetable Tannage .....	128	Wood Pulp .....	136
Vermilion.....	83		
		<b>Z</b>	
<b>W</b>		Zinc Sulfate.....	22
Water Stains .....	107	Zinc Vat .....	47
Westphal Balance .....	13		



**MEMORANDA**

# MEMORANDA

# MEMORANDA

# MEMORANDA

# MEMORANDA

# MEMORANDA

# MEMORANDA

# MEMORANDA



**MEMORANDA**

# MEMORANDA

# CHEMICAL BOOKS

*Published by the*

**D. VAN NOSTRAND COMPANY**

---

**American Institute of Chemical Engineers.** Transactions.

Volume I., 1908. 5 folding plates. 41 illustrations.  
8vo. cloth. 212 pp. net, \$6.00

Vol. II., 1909. fold. plate. 50 illus. 312 pp. net, \$6.00

Vol. III., 1910. 2 fold. plates. Illus. 414 pp. net, \$6.00

**Annual Reports on the Progress of Chemistry.** Issued annually by the Chemical Society. 8vo. cloth. Vol. I., 1904, to Vol. VII., 1910, now ready. each, net, \$2.00

**BAILEY, R. O.** *The Brewer's Analyst.* Illustrated. 8vo. cloth. 423 pp. net, \$5.00

**BEEKMAN, J. M.** *Principles of Chemical Calculations.*  
In Press.

**BENNETT, HUGH G.** *The Manufacture of Leather.*  
110 illustrations. 8vo. cloth. 438 pp. net, \$4.50

**BERNTHSEN, A.** *A Text-book of Organic Chemistry.*  
English translation. Edited and revised by J. J. Sudborough. Illus. 12mo. cloth. 690 pp. net, \$2.50

**BIRCHMORE, W. H.** *The Interpretation of Gas Analyses.*  
Illustrated. 12mo. cloth. 75 pp. net, \$1.25

- BLÜCHER, H.** **Modern Industrial Chemistry.** Translated by J. P. Millington. Illus. 8vo. cloth. 795 pp. net, \$7.50
- BLYTH, A. W.** **Foods: Their Composition and Analysis.** A manual for the use of analytical chemists, with an introductory essay on the History of Adulterations. *Sixth Edition, thoroughly revised, enlarged and rewritten.* Illustrated. 8vo. cloth. 634 pp. \$7.50
- **Poisons: Their Effects and Detection.** A manual for the use of analytical chemists and experts, with an introductory essay on the Growth of Modern Toxicology. *Fourth Edition, revised, enlarged and rewritten.* Illustrated. 8vo. cloth. 772 pp. \$7.50
- BÖCKMANN, F.** **Celluloid; Its Raw Material, Manufacture, Properties and Uses.** 49 illustrations. 12mo. cloth. 120 pp. net, \$2.50
- BOOTH, WILLIAM H.** **Water Softening and Treatment.** 91 illustrations. 8vo. cloth. 310 pp. net, \$2.50
- BOURGOUGNON, A.** **Physical Problems and Their Solution.** 16mo. boards. Illustrated. (Van Nostrand's Science Series No. 113.) \$0.50
- BRUCE, EDWIN M.** **Detection of the Common Food Adulterants.** Illus. 12mo. cloth. 90 pp. net, \$1.25
- BUSKETT, E. W.** **Fire Assaying.** A practical treatise on the fire assaying of gold, silver and lead, including descriptions of the appliances used. Illustrated. 12mo. cloth. 112 pp. net, \$1.25
- CAVEN, R. M., and LANDER, G. D.** **Systematic Inorganic Chemistry from the Standpoint of the Periodic Law.** A text-book for advanced students. Illustrated. 12mo. cloth. 390 pp. net, \$2.00

- CHURCH'S Laboratory Guide.** A manual of practical chemistry for colleges and schools, specially arranged for agricultural students. *Eighth Edition, revised and partly rewritten* by Edward Kinch. Illustrated. 8vo. cloth, 365 pp. net, \$2.50
- CHRISTIE, W. W.** Boiler-waters, Scale, Corrosion, Foaming. 77 illustrations. 8vo. cloth. 242 pp. net, \$3.00
- CORNWALL, H. B.** Manual of Blow-pipe Analysis. Qualitative and quantitative. With a complete system of determinative mineralogy. *Sixth Edition, revised.* 70 illustrations. 8vo. cloth. 310 pp. net, \$2.50
- d'ALBE, E. E. F.** Contemporary Chemistry. A survey of the present state, methods, and tendencies of chemical science. 12mo. cloth. 172 pp.
- ECCLES, R. G.** Food Preservatives; Their Advantages and Proper Use. The practical versus the theoretical side of the pure food problem. 8vo. paper. 220 pp. \$0.50
- ELIOT, C. W., and STORER, F. H.** A Compendious Manual of Qualitative Chemical Analysis. Revised with the co-operation of the authors, by William R. Nichols. *Twenty-second Edition, newly revised* by W. B. Lindsay. Ill. 12mo. cloth. 205 pp. net, \$1.25
- ENNIS, WILLIAM D.** Linseed Oil and Other Seed Oils. An industrial manual. 88 illustrations. 8vo. cloth. 336 pp. net, \$4.00
- FAY, IRVING W.** The Chemistry of the Coal-tar Dyes. 8vo. cloth. 473 pp. net, \$4.00

- FISCHER, E.** Introduction to the Preparation of Organic Compounds. Translated from the new (eighth) German edition by R. V. Stanford. Illustrated. 12mo. cloth. 194 pp. **\$1.25**
- FOYE, J. C.** Chemical Problems. *Fourth Edition, revised and enlarged.* 16mo. cloth. 145 pp. (Van Nostrand Science Series, No. 69.) **\$0.50**
- GIBBS, W. E.** Text-book of Physics. Part I. Solids and Fluids. (Carnegie Technical Schools Text-books.) Illustrated. 8vo. boards. 278 pp. **net, \$1.50**
- GROSSMANN, J.** Ammonia and Its Compounds. Illustrated. 12mo. cloth. 151 pp. **net, \$1.25**
- HALE, WILLIAM J.** Calculations in General Chemistry. With definitions, explanations and problems. *Second Edition, revised.* 12mo. cloth. 185 pp. **net, \$1.00**
- HALL, CLARE H.** Chemistry of Paints and Paint Vehicles. 8vo. cloth. 141 pp. **net, \$2.00**
- HILDITCH, T. P.** A Concise History of Chemistry. 16 diagrams. 12mo. cloth. 273 pp. **net, \$1.25**
- HOPKINS, N. M.** Experimental Electrochemistry: Theoretically and Practically Treated. 132 illustrations. 8vo. cloth. 298 pp. **net, \$3.00**
- HULLEVIGUE, L.** The Evolution of the Sciences. 8vo. cloth. 377 pp. **net, \$2.00**
- HURST, H. E., and LATTEY, R. T.** Text-book of Physics. Illustrated. 8vo. cloth. 648 pp. **net, \$3.00**
- INGLE, HERBERT.** Manual of Agricultural Chemistry. Illustrated. 8vo. cloth. 388 pp. **net, \$3.00**

- JOHNSTON, J. F. W.** **Elements of Agricultural Chemistry.** Revised and rewritten by Charles A. Cameron and C. M. Aikman. *Nineteenth Edition.* Illustrated. 12mo. cloth. 502 pp. **\$2.60**
- KEMBLE, W. F., and UNDERHILL, C. R.** **The Periodic Law and the Hydrogen Spectrum.** Illustrated. 8vo. paper. 16 pp. **net, \$0.50**
- KEMP, J. F.** **A Handbook of Rocks.** For use without the microscope. *Fourth Edition revised.* Illustrated. 8vo. cloth. 250 pp. **net, \$1.50**
- KERSHAW, J. B. C.** **Fuel, Water, and Gas Analysis, for Steam Users.** 50 ill. 8vo. cloth. 178 pp. **net, \$2.50**
- KOLLER, T.** **Cosmetics.** A handbook of the manufacture, employment and testing of all cosmetic materials and cosmetic specialties. Translated from the German by Charles Salter. 8vo. cloth. 262 pp. **net, \$2.50**
- KRAUCH, C.** **Testing of Chemical Reagents for Purity.** Authorized translation of the *Third Edition*, by J. A. Williamson and L. W. Dupré. With author's additions and emendations. 8vo. cloth. 350 pp. **net, \$3.00**
- LASSAR-COHN.** **Introduction to Modern Scientific Chemistry.** In the form of popular lectures suited for University Extension students and general readers. Translated from the *Second German Edition* by M. M. Pattison Muir. Illus. 12mo. cloth. 356 pp. **\$2.00**
- LUNGE, GEORGE.** **Technical Methods of Chemical Analysis.** Translated from the *Second German Edition* by Charles A. Keane, with the collaboration of eminent experts. To be complete in three volumes. Vol. I. (in two parts). 201 ill. 8vo. cloth. 1024 pp. **net, \$15.00**  
Volumes II. and III. in active preparation.

**LUNGE, GEORGE.**—*Continued.*

— **Technical Chemists' Handbook.** Tables and methods of analysis for manufacturers of inorganic chemical products. Illus. 12mo. leather. 276 pp. **net, \$3.50**

— **Coal, Tar and Ammonia.** *Fourth and Enlarged Edition.* In two volumes, not sold separately. 305 illustrations. 8vo. cloth. 1210 pp. **net, \$15.00**

— **The Manufacture of Sulphuric Acid and Alkali.**  
A theoretical and practical treatise.

Vol. I. Sulphuric Acid. *Third Edition, enlarged.* In two parts, not sold separately. 500 illustrations. 8vo. cloth. 1225 pp. **net, \$15.00**

Vol. II. Sulphate of Soda, Hydrochloric Acid, Leblanc Soda. *Third Edition, much enlarged.* In two parts, not sold separately. 335 illustrations. 8vo. cloth. 1044 pp. **net, \$15.00**

Vol. III. Ammonia Soda. Various Processes of Alkali-making, and the Chlorine Industry. 181 illustrations. 8vo. cloth. 784 pp. **net, \$10.00**

Vol. IV. Electrolytical Methods. In Press.

**LUQUEUR, L. M. Minerals in Rock Sections.** The practical methods of identifying them with the microscope. *Third Edition.* 86 illustrations. 8vo. cloth. 150 pp. **net, \$1.50**

**MARTIN, G. Triumphs and Wonders of Modern Chemistry.** A popular treatise on modern chemistry and its marvels written in non-technical language. 76 illustrations. 12mo. cloth. 358 pp. **net, \$2.00**

**MELICK, CHARLES W. Dairy Laboratory Guide.** 52 illustrations. 12mo. cloth. 135 pp. **net, \$1.25**



- MERCK, E.** **Chemical Reagents: Their Purity and Tests.**  
8vo. cloth. 250 pp. net, \$1.50
- MILLER, E. H.** **Quantitative Analysis for Mining Engineers.** *Second Ed.* 8vo. cloth. 158 pp. net, \$1.50
- MOSES, A. J., and PARSONS, C. L.** **Elements of Mineralogy, Crystallography, and Blowpipe Analysis from a Practical Standpoint.** *Fourth Edition.* 583 illustrations. 8vo. cloth. 448 pp. net, \$2.50
- MUNBY, A. E.** **Introduction to the Chemistry and Physics of Building Materials.** Illus. 8vo. cloth. 365 pp. (Van Nostrand's Westminster Series.) net, \$2.00
- MURRAY, J. A.** **Soils and Manures.** 33 illustrations. 8vo. cloth. 367 pp. (Van Nostrand's Westminster Series.) net, \$2.00
- NAQUET, A.** **Legal Chemistry.** A guide to the detection of poisons as applied to chemical jurisprudence. Translated, with additions, from the French, by J. P. Battershall. *Second Edition, revised with additions.* 12mo. cloth. 190 pp. \$2.00
- OLSEN, J. C.** **A Textbook of Quantitative Chemical Analysis by Gravimetric and Gasometric Methods.** Including 74 laboratory exercises giving the analysis of pure salts, alloys, minerals and technical products. *Fourth Edition, revised and enlarged.* 74 illustrations. 8vo. cloth., 576 pp. net, \$4.00
- PARRY, ERNEST J.** **The Chemistry of Essential Oils and Artificial Perfumes.** *Second Edition, thoroughly revised and greatly enlarged.* Illustrated. 8vo. cloth. 554 pp. net, \$5.00

- PERKIN, F. M.** **Practical Methods of Inorganic Chemistry.** Illustrated. 12mo. cloth. 152 pp. net, \$1.00
- PHILLIPS, J.** **Engineering Chemistry.** A practical treatise. Comprising methods of analysis and valuation of the principal materials used in engineering works. *Third Edition, revised and enlarged.* Illustrated. 12mo. cloth. 422 pp. net, \$4.50
- PLATTNER'S Manual of Qualitative and Quantitative Analysis with the Blowpipe.** *Eighth Edition, revised.* Translated by Henry B. Cornwall, assisted by John H. Caswell, from the *Sixth German Edition*, by Friedrich Kolbeck. 87 ill. 8vo. cloth. 463 pp. net, \$4.00
- PRESCOTT, A. B.** **Organic Analysis.** A manual of the descriptive and analytical chemistry of certain carbon compounds in common use. *Sixth Edition.* Illustrated. 8vo. cloth. 533 pp. \$5.00
- PRESCOTT, A. B., and JOHNSON, O. C.** **Qualitative Chemical Analysis.** *Sixth Edition, revised and enlarged.* 8vo. cloth. 439 pp. net, \$3.50
- PRESCOTT, A. B., and SULLIVAN, E. C.** **First Book in Qualitative Chemistry.** For studies of water solution and mass action. *Eleventh Edition, entirely rewritten.* 12mo. cloth. 150 pp. net, \$1.50
- PROST, E.** **Manual of Chemical Analysis.** As applied to the assay of fuels, ores, metals, alloys, salts, and other mineral products. Translated from the original by J. C. Smith. Illus. 8vo. cloth. 300 pp. net, \$4.50
- PYNCHON, T. R.** **Introduction to Chemical Physics.** *Third Edition, revised and enlarged.* 269 illustrations. 8vo. cloth. 575 pp. \$3.00

- ROGERS, ALLEN.** *A Laboratory Guide of Industrial Chemistry.* Illustrated. 8vo. cloth. 170 pp. net, \$1.50
- ROGERS, ALLEN, and AUBERT, ALFRED B.** *Industrial Chemistry.* Written by a staff of eminent specialists. 8vo. cloth. Illustrated. In Press.
- ROTH, W. A.** *Exercises in Physical Chemistry.* Authorized translation by A. T. Cameron. 49 illustrations. 8vo. cloth. 208 pp. net, \$2.00
- SCHERER, R.** *Casein: Its Preparation and Technical Utilization.* Translated from the German by Charles Salter. *Second Edition, revised and enlarged.* Illustrated. 8vo. cloth. 196 pp. net, \$3.00
- SCHWEIZER, V.** *Distillation of Resins, Resinate Lakes and Pigments.* Illustrated. 8vo. cloth. 183 pp. net, \$3.50
- SCOTT, W. W.** *Qualitative Chemical Analysis.* A laboratory manual. Illus. 8vo. cloth. 176 pp. net, \$1.50
- SEIDELL, A.** *Solubilities of Inorganic and Organic Substances.* A handbook of the most reliable quantitative solubility determinations. *Second Printing, corrected.* 8vo. cloth. 367 pp. net, \$3.00
- SENER, G.** *Outlines of Physical Chemistry.* *Second Edition, revised.* Illus. 12mo. cloth. 401 pp. \$1.75
- SEXTON, A. H.** *Fuel and Refractory Materials.* *Second Ed., revised.* 104 illus. 12mo. cloth. 374 pp. net, \$2.00
- SMITH, W.** *The Chemistry of Hat Manufacturing.* Revised and edited by Albert Shonk. Illustrated. 12mo. cloth. 132 pp. net, \$3.00
- SPEYERS, C. L.** *Text-book of Physical Chemistry.* 20 illustrations. 8vo. cloth. 230 pp. net, \$2.25

- STEVENS, H. P.** *Paper Mill Chemist.* 67 illustrations.  
82 tables. 16mo. cloth. 280 pp. net, \$2.50
- SUDBOROUGH, J. J., and JAMES, J. C.** *Practical Organic Chemistry.* 92 illustrations. 12mo. cloth.  
394 pp. net, \$2.00
- TITHERLEY, A. W.** *Laboratory Course of Organic Chemistry, Including Qualitative Organic Analysis.*  
Illustrated. 8vo. cloth. 235 pp. net, \$2.00
- TOCH, M.** *Chemistry and Technology of Mixed Paints.*  
62 photo-micrographs and engravings. 8vo. cloth.  
166 pp. net, \$3.00
- **Materials for Permanent Painting.** A manual for  
manufacturers, art dealers, artists, and collectors.  
With full-page plates. Illustrated. 12mo. cloth.  
208 pp. net, \$2.00
- TUCKER, J. H.** *A Manual of Sugar Analysis. Sixth Edition.* 43 illustrations. 8vo. cloth. 353 pp. \$3.50
- VAN NOSTRAND'S Chemical Annual,** Based on Biedermann's "Chemiker Kalender." Edited by J. C. Olsen,  
with the co-operation of eminent chemists. *Second Issue,* 1909. 12mo. cloth. net, \$2.50
- VINCENT, C.** *Ammonia and Its Compounds.* Their  
manufacture and uses. Translated from the French  
by M. J. Salter. 32 ill. 8vo. cloth. 113 pp. net, \$2.00
- VON GEORGIEVICS, G.** *Chemical Technology of Textile Fibres.* Translated from the German by Charles  
Salter. 47 illustrations. 8vo. cloth. 320 pp. net, \$4.50
- **Chemistry of Dyestuffs.** Translated from the *Second German Edition* by Charles Salter. 8vo. cloth.  
412 pp. net, \$4.50

- 
- WANKLYN, J. A. Milk Analysis.** A practical treatise on the examination of milk and its derivatives, cream, butter and cheese. Illus. 12mo. cloth. 73 pp. \$1.00
- **Water Analysis.** A practical treatise on the examination of potable water. *Eleventh Edition, revised*, by W. J. Cooper. Illus. 12mo. cloth. 213 pp. \$2.00
- WINCHELL, N. H. and A. N. Elements of Optical Mineralogy.** An introduction to microscopic petrography. 350 ill. 4 plates. 8vo. cloth. 510 pp. \$3.50
- WINKLER, C., and LUNGE, G. Handbook of Technical Gas Analysis.** *Second English Edition.* Illustrated. 8vo. cloth. 190 pp. \$4.00
- WORDEN, C. E. The Nitrocellulose Industry.** A compendium of the history, chemistry, manufacture, commercial application, and analysis of nitrates, acetates, and xanthates of cellulose as applied to the peaceful arts. With a chapter on gun cotton, smokeless powder and explosive cellulose nitrates. Illustrated. 8vo. cloth. Two volumes. 1239 pp. net, \$10.00
- 

**D. VAN NOSTRAND COMPANY**  
**Publishers and Booksellers**

23 MURRAY AND 27 WARREN STREETS, NEW YORK.

SECOND ISSUE, 1909

12mo. cloth 575 Pages Net, \$2.50

---

---

VAN NOSTRAND'S  
**Chemical Annual**

A HANDBOOK OF USEFUL DATA

for analytical, manufacturing and investigating chemists and chemical students.

BASED ON BIEDERMANN'S "CHEMIKER KALENDER"

EDITED BY

**Prof. J. C. OLSEN, A.M., Ph.D.**

*Polytechnic Institute of Brooklyn; formerly Fellow Johns Hopkins University; author of "Quantitative Chemical Analysis"*

WITH THE CO-OPERATION OF EMINENT CHEMISTS

---

**CONTENTS**

New Tables—Physical and Chemical Constant of the Essential Oils and Alkaloids.

Melting Points and Composition of the Fusible Alloys.

Density of Carbon Dioxide Polenske Values of Oils, etc.

Tables for the Calculation of Gravimetric, Volumetric, and Gas Analyses.

Tables of the Solubility, Boiling and Freezing Points, Specific Gravity, and Molecular Weight of the commonly used Inorganic and Organic Compounds.

Specific Gravity Tables of Inorganic and Organic Compounds.

Other Physical and Chemical Constants of Chemical and Technical Products.

Conversion Tables of Weights and Measures.

New Books and Current Literature of the Year.

---

ALL TABLES WILL BE REVISED ANNUALLY TO GIVE THE MOST RECENT AND ACCURATE DATA

---

---

**D. Van Nostrand Company**  
**23 Murray and 27 Warren Sts., New York**



**THIS BOOK IS DUE ON THE LAST DATE  
STAMPED BELOW**

**AN INITIAL FINE OF 25 CENTS  
WILL BE ASSESSED FOR FAILURE TO RETURN  
THIS BOOK ON THE DATE DUE. THE PENALTY  
WILL INCREASE TO 50 CENTS ON THE FOURTH  
DAY AND TO \$1.00 ON THE SEVENTH DAY  
OVERDUE.**

JAN 11 1937

JUL 27 1939

OCT 2 1945



261220  
P145  
R8  
Rogers

